

HOME WORKSHOP EXPLOSIVES

BY:
UNCLE
FESTER

ART © JEFF GRATHER 1989



“Covers the manufacture of nitroglycerin (which the author claims to have dropped in the snow while drunk out of his mind), nitroglycol, nitromannitol, PETN and cyclonite. Those with a special fondness for their fingers may hesitate before following these relatively easy-to-follow recipes.”

– *Hustler*

“Explosives covered include... The kind of stuff that, frankly, it may be easier to make yourself, because it’s such a nuisance to buy.”

– David Hinckley, *New York Daily News*

“Others, more dangerous ones, are humble men leading humble lives. Men like Uncle Fester... This book is Da Bomb!”

–Rich Butts, *San Fran X-Press*

The initial publication of this book was delayed for several months due to the messy and incompetent help of my Third World friends Mad Abe, Evil Joe, and Rick the Jap. Thanks guys! I couldn’t have done it without you!

HOME WORKSHOP EXPLOSIVES

by
Uncle Fester

**Festering Publications
Green Bay, Wisconsin**

DISCLAIMER

This book in no way condones illegal activity! It is your responsibility to determine the legality of your actions. Further, because we have no control over the workmanship, materials, tools, methods, or testing procedures employed, we hereby disclaim any responsibility for consequences resulting from the fabrication or compounding of any item described in this book. We cannot and will not accept any responsibility for this information and its subsequent use. This book is sold for informational purposes only!

HOME WORKSHOP EXPLOSIVES © 2002 By Steve
Preisler

All Rights Reserved Printed in USA

Published by: Festering Publications 826 S. Baird
Green Bay, WI 54301

ISBN 0-9701485-4-2 Library of Congress Catalog Card
Number 89-092677

TABLE OF CONTENTS

Preface.....	3
Things That Go Boom In The Night	6
The Nitric Esters	11
Nitric And Sulfuric Acids	30
Nitroglycerin	41
Nitroglycol	62
Nitromannitol	74
PETN	91
RDX	105
Ammonium Nitrate Mixtures	117
Fuel Air Explosives	139
Detonation Systems	146
Fun With Explosives	156
Appendix I: Safety	
Appendix II: Aspirators And Water Bed Pumps	
Appendix III: Of Interest To All	

PREFACE

Not too long ago in this country, explosive materials were widely accepted as just another tool. As such, they were easily available to people with only a minimum of paperwork and perfunctory oversight. Oh, how times have changed!

Like a bad movie which we have seen too many times, a very familiar story played before our eyes. A very small number of people misused their free access to explosive substances. In response, those in positions of power declared a war upon that inanimate object, the explosive. Since it is next to impossible to wage a war against an inanimate object, the real underlying agenda showed through.

Those who seek out positions of political power generally do so because they like to control other people. The war on explosives presented an opportunity to expand the power of central authority at the expense of the rest of us. The rest of us took a beating, like we usually do.

Just like the inmates of a giant insane asylum, we have been locked inside and all the pointed objects taken away, lest we hurt ourselves. In most places, even obtaining a large firecracker such as an M-80 requires resort to the underground market. Little attention has been paid to the real underlying issues, such as why we are all being locked up inside the asylum rather than singling out miscreants and locking them up instead. One could also ask why is it that people would want to blow things up, when

previously the idea hadn't come to them. Such questions are inconvenient when the agenda is based upon gaining power and control.

The war on explosives hasn't worked out quite the way it was advertised. People intending to commit mayhem switched to pipes stuffed full of reloading powder when nice commercial dynamites became difficult to buy. The only real effect was to limit the freedom and the ability to do work with explosives of the people who don't deserve to be locked up inside this insane asylum. That's how it always works when war is declared upon an inanimate object. The ordinary people take it on the chin, while those intending to do evil are uneffected.

Now in the year 2002, we are in the midst of a "war on terror". Once again we have war against the inanimate. To the extent that we are at war, it is against Moslem guerrillas, and the states which support them. Such a clear presentation, however, will not do. It would raise too many uncomfortable questions. Questions like who let the borders get so out of control that we are now infiltrated with groups of suicide kamakazees? Another question which will not be raised is why I should be giving up my liberties, when we are under attack by foreign enemies?

When the enemy is "terror", it justifies making everybody the suspect, and that's just the way they like it.

Welcome to the new America. A happy place where waiting in line for inspection is the new national pastime. A schizoid place where "terror alerts" are issued, along with instructions to just

carry on life as usual. A wacky place where officials tell us that the terrorists are here to try to kill us because they so hate our freedom.

I hope that the preceding discussion didn't upset you too much. If it did, the rest of this book might be too much for you to bear. That's because this book is all about one of those inanimate enemies, the explosive. In this book, I will detail to the best of my ability, and in the clearest language I can use, just how high strength explosives are made and used. Throughout this book, I will strive to make the detail of the presentation the focal point, rather than reciting a litany of explosive mixture compositions.

In this way, I hope that you can come to know that inanimate enemy, and maybe recognize him for what he is. He is a tool with many useful purposes. He can do great amounts of work, and he can provide great amounts of entertainment when used recreationally. The purposes to which this tool is put is a function of the individual, not the substance.

Read on, and enjoy!

Uncle Fester

6 HOME WORKSHOP EXPLOSIVES

THINGS THAT GO BOOM IN THE NIGHT

The first step towards gaining an understanding of explosives is to understand how they work. From this piece of knowledge, an appreciation for many of the finer points of explosive technology will naturally flow.

An explosive is a substance or a mixture (usually a solid or a jelly in form) that is unstable. This unstable substance undergoes a very rapid chemical reaction after being set off in the proper manner. The result is that the originally rather small amount of explosive is almost instantly converted into a very large amount of hot gases. These hot gases are at first trapped into the amount of space that the explosive charge originally occupied, but they expand very rapidly and violently. The result is the familiar sight of an explosive fireball and its accompanying shock wave.

As we all know, not all explosives are created equal. Some explode so fiercely that they destroy everything within range, while others are useful for fireworks, but not much more. Why the wide variance in power? The answer to that lies in the three main factors contributing to an explosives performance.

The first and generally the most important factor in determining the performance of an explosive is its detonation rate. To understand what is meant by the term detonation rate, see the drawing below.

The drawing shows a charge of explosive in which a blasting cap has just gone off, triggering a detonation. Pay close attention to the detonation wave spreading outward in all directions from its source at the blasting cap. On the outward side of this front, the explosive is unchanged, but on the inward side, it has been detonated and converted to hot gases. The rate that this detonation wave travels through the explosive is called the detonation rate. This number is usually expressed in the form of meters travelled per second (m/s). It is not hard to imagine why a more powerful explosive will have the higher detonation rate. The more instantly

THINGS THAT GO BOOM IN' NIGHT 7

the mass of explosive is converted into hot gases, the less chance these gases will have to fritter away without doing any damage. Typical detonation rates range from over 8000 m/s for cyclonite (RDX) down to a couple thousand for black powder..

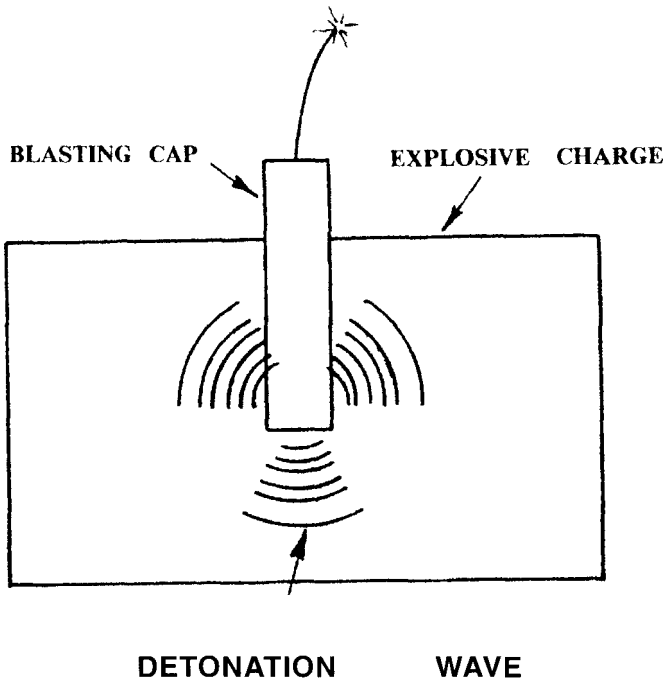

Just as different explosives have different detonation rates, the same explosive under varying conditions will have a range of detonation rates. For a solid explosive such as RDX or PETN, this rate depends largely upon how dense the mass of explosive is. For example, if the charge consists of finely crystalline material, its detonation rate will be quite a bit less than if it has been melted together into one solid rock. This is because the finely powdered material is less dense than the rock form. Those

8 HOME WORKSHOP EXPLOSIVES

readers who have ever compared the volume of a pound of snow versus a pound of ice will quickly grasp this. Ice and snow are both made of frozen water, but the fine crystalline snow takes up much more space.

There are exceptions to this general rule. For example gunpowders deflagrate much faster when they are ground finely. Similarly, explosive mixtures containing ammonium nitrate detonate much faster, and are thereby more powerful when the ammonium nitrate component of the mixture is ground quite finely.

A liquid explosive like nitro is always going to have the same density, so it does not exhibit this effect. This, however, does not mean that the liquid explosive will always have the same detonation rate. When the pure liquid explosive is mixed with binders to make a safer explosive, its detonation rate goes down quite a bit. In the case of nitro, when it is mixed with binders to make dynamite, its detonation rate can be cut in half. The solid explosives like PETN or RDX also show this effect when they are mixed with binders to make plastique. The general rule is that the pure substance will be a good deal more powerful (although less safe and convenient to handle) than the resulting plastique or dynamite. The second factor determining the performance of an explosive is how much hot gas a given amount of explosive will be converted to when it detonates. This factor is just as important as the detonation rate in determining how violent the resulting explosion will be. Unlike the detonation rate, this factor is not influenced by the density of the explosive or what binders it may be mixed with. One gram of black powder will only produce 270 c.c. of gas (volume of gas adjusted back to room temperature and normal pressure by use of the ideal gas law) while the same amount of RDX will make over 1000 c.c. of gas. Since it is this conversion of the explosive to gases that makes the blast, the extreme importance of this factor is easy to understand.

The final main factor determining how powerful an explosive is, is how much heat is produced in the blast (i.e., how hot the resulting gases are). This is because gases expand when they are heated, so the same amount of gas when reduced to standard pressure and room temperature can be a good deal greater when hot. Black powder produces about 700 calories of heat per gram, while nitro and PETN make in the neighborhood of 1500 calories per gram.

If one takes these three factors together, you can get a good measure of the relative power of the explosives. A convenient way to do this is just to multiply the three factors together to get a number with which to compare the various explosives. A list of explosives compiled in this manner according to power would have RDX, PETN, nitro and a few of its close cousins crowded at the top, and then a middle group of which TNT is a typical example, and then a lower group including black powder and mercury fulminate.

Most members of this lower group do not detonate like the high explosives do. They explode in a different manner called deflagration. Deflagration can be most closely compared to a rapid burning. The outer surfaces of the individual particles catch fire and burn their way into the centers of the particles. With these explosives, maximum power is obtained by very finely granulating the material. This is in contrast to the high explosives where the greatest power is obtained when the pure material, if it is a solid, is in the form of a large solid rock. These lower explosives find most of their use in blasting caps to provide the initial shock that sets off the high explosive, and as propellants or primers for bullets.

As you probably already know, most of the high explosives require a fairly violent blow to set them off. Exceptions to this rule include spoiled explosives which have been ruined by bad storage, and materials such as azides which are OK for primers but not a main charge. We'll ignore the latter materials

10 *HOME WORKSHOP EXPLOSIVES*

in this book.

The forcefulness of the shock needed to cause detonation varies from explosive to explosive. TNT is very hard to set off, while on the other extreme, nitro and PETN are pretty easy to bring to detonation. To meet these varying needs, a range of blasting caps with increasing power, labelled numbers 1 through 8 are available. With almost all the explosives detailed in this book, I will note which number blasting cap is required to set it off. A larger blasting cap than needed to set the material off is generally not recommended, but may sometimes be advantageous by causing a condition called “overdriving” in which a more powerful blast is obtained.

Some of the high explosives covered in this book can also be set off by exposure to heat or grinding friction. Where this is applicable, it will be noted, along with suggestions for taking advantage of this property. The danger from grinding friction should always be kept in mind while making, storing, and using explosives. One’s purpose is more likely to be served when the detonator sets off the explosive rather than some residue caught in threads somewhere.

Finally, I must warn the reader that only the most powerful of explosives are covered in this book. A small amount of them could easily make the careless experimenter a memory. These materials become most dangerous when the handler ceases to be afraid of them! For this reason they are not recommended as an adjunct to drunken revelry or other tomfoolery. Be warned!

THE NITRIC ESTERS

Since all of the compounds dealt with in this book, with the exception of RDX (cyclonite) belong to a class of chemicals called nitric esters, this discussion will begin by explaining exactly what are nitric esters, how they are made, what precautions can be followed by the home experimenter to get maximum yields of product, and some of the pitfalls likely to ensnare the unwary experimenter during the stages of production, purification and use of this most powerful class of explosives.

The layman who goes to the library and brings home an armful of good explosive books is sure to see the term "nitric ester" used repeatedly, with the predictable response of "Huh?" being the result. Since this class of explosives is so important, and forms the heart of *Home Workshop Explosives*, this term must be explained. An ester is a member of a family of related chemicals, all of whom can be made by reacting together an alcohol and an acid (or its derivatives, for those organic chemistry purists out there). The acid and the alcohol link together by splitting off a water molecule, and form the new compound, an ester. A nitric ester is an ester formed when the acid is nitric acid. A very large variety of nitric esters can be made from nitric acid, just by using a variety of alcohols. It is likely that all of them are explosive. The simplest nitric ester, methyl nitrate, is made by reacting together methyl alcohol (wood alcohol easily found at the local hardware store) and nitric acid. The following shows how these two react together to form an ester. All nitric esters in this book are formed by the same mechanism:

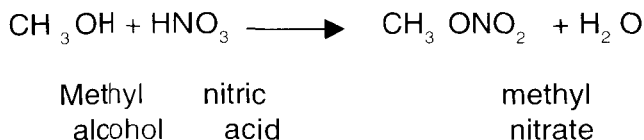

12 HOME WORKSHOP EXPLOSIVES

At the end of this chapter, the details of how to prepare methyl nitrate will be covered to illustrate the points made in this chapter.

Similarly, ethyl nitrate is made from ethyl alcohol (grain alcohol, the drinking variety) and nitric acid. The infamous nitroglycerin is the product of nitric acid and glycerin (glycerol). This same analogy can be carried throughout the entire class of chemicals called the nitric esters.

For the person interested in producing these chemicals, a main area of concern is naturally going to be how to get the maximum yield product from each batch. For the industrial-scale manufacturer, the emphasis may shift to how to get the cheapest product in the least amount of time. To answer these questions, the process of forming the nitric esters must be looked at more closely.

The process of forming a nitric ester belongs to a class of reactions called equilibrium reactions. What is meant by this is that all of the starting materials do not automatically and rapidly get converted into products. A good percentage of the starting materials (in the case of nitro, glycerin and nitric acid) are likely to just lay around in the mixture and refuse to react together.

This frustrating course of events can be avoided for the most part by a knowledge of what's going on, and using strategy to shape events to our liking.

Just how much of the starting materials are going to be turned into products can be figured out using a little algebra and what is called the equilibrium equation. Let's take the case of nitro production since nitro is such an effective explosive, and making it is required for the creation of gelatin dynamite. This is the reaction that forms nitro:



Here we see that one molecule of glycerin and three molecules of nitric acid are required to make one molecule of nitroglycerin and three molecules of water. The equilibrium formula for this reaction looks like this:

$$\text{Constant} = \frac{(\text{nitro}) (\text{water})^3}{(\text{glycerin}) (\text{nitric acid})^3}$$

Here the constant is in the neighborhood of 50, but depends upon the temperature that the reaction is being done at. What this equation means is that the reaction goes forward making nitro until the concentration of nitro in the mixture times the concentration of water to the third power, divided by the concentration of nitric acid times the concentration of glycerin to the third power reaches the value of the constant.

Now for the point of all this. In order for good yields of product to be obtained, it is crucial that there be as little water as possible in the mixture, and that the concentration of nitric acid be as high as possible. With a little bit of high school level algebra, you can easily prove to yourself that a little bit of water in the mix, since its concentration is raised to the third power, will wreak havoc on the amount of nitro allowed to be produced before the constant number is reached.

There are several methods for keeping the amount of water in the mix to a minimum. First of all, glycerin used in the reaction should not have any water in it. This can present a problem because the best source of glycerin is the local pharmacy, and the bottle it comes in is not likely to say how much water it contains. I have found a wide variety of quality in, drug store glycerin. Some, like the Gull Pharmacy brand which was my favorite, was virtually pure glycerin with no

14 HOME WORKSHOP EXPLOSIVES

added water. Other rubbish brands which will not be named here had unacceptably high amounts of water in them. How to deal with this will be covered in more detail in the nitro section, but let me say right here that the more runny the glycerin is, the more water it contains.

Another very common method to keep the amount of water in the mix to a minimum is to add a substance which will soak up water in the reaction mixture. The most favored chemical for this purpose is concentrated sulfuric acid. This material has a great thirst for water, and performs its task admirably. It is usually added to a batch of nitro to the extent of one part nitric acid, two parts sulfuric acid. Fuming sulfuric acid works even better, but *is* expensive. This topic will be covered in more detail in the sulfuric acid section.

Other chemicals have been used to soak up water in these batches, but they are not so favored as concentrated sulfuric acid, because they cost too much. An example of such a substance is phosphorus pentoxide (P_2O_5) which reacts with water to make phosphoric acid (H_3PO_4).

The last easy method to control the amount of water in the reaction brew is to use as concentrated a sample of nitric acid as possible. This is because in nitric acid, whatever isn't pure nitric acid is water. For example, the usual concentrated nitric acid is 70% nitric acid and 30% water. Nitric acid called fuming nitric acid is 90% nitric acid and 10% water. The drawback to using the more concentrated forms of nitric acid is their cost, and their ease of availability. These last two factors are often enough to rule out their use. More on nitric acid in the nitric acid section.

The temperature at which the reaction is done is the next vitally important area of concern for the explosives manufacturer. There is great danger of not only losing the batch if the temperature of the batch is allowed to climb too high, but also of a disastrous explosion being the result.

At first glance, it may seem simple to keep the temperature of the reacting mix within the proper range. This impression can be of great danger to the novice experimenter. This is because the reaction producing the product makes a good deal of heat as it is progressing. If this heat does not have a chance to escape, regrettable consequences will ensue. There are some very simple tactics to follow to conquer this difficulty.

The first step in keeping reaction temperatures under control is to keep the acids used in the reaction in a freezer before use. This will cool them down well below the temperature required for any explosives production, and will make for quicker production because it will not be necessary to sit around and wait for the acids to cool down in an icebath, because they will already be cold when they go into the icebath. Some heat will be made by mixing the acids prior to use, especially if fuming sulfuric acid is used, but the experimenter will still be miles ahead by keeping his acids in a freezer. He will get the added benefit of helping his nitric acid to keep better than it would sitting around. Cooling glycerin and ethylene glycol down in a freezer before use is also good if nitro or ethylene glycol dinitrate is to be made.

Another important technique used to keep the temperature of the reaction cool enough is to add the alcohol to the acids slowly in order for the heat produced in the reaction to be given off gradually. For example, in the production of nitro, the glycerin is added slowly to the acid, taking a break between each addition of the glycerin. In this way the heat produced can be given off to the ice bath surrounding the flask with no problem. Exactly how fast the alcohol can be added depends on how large the batch is. I recommend mentally dividing the alcohol up into ten parts and adding one tenth at a time.

16 HOME WORKSHOP EXPLOSIVES

Good stirring is a crucial part of the temperature control strategy. This is because if there is not stirring while the ingredients are being added, local areas where the temperature is too hot will develop in the mix. With stirring, the heat made in the center of the mix will be able to find its way to the walls of the flask, and from there to the ice surrounding it. Good stirring has the added benefit of bringing all the ingredients into contact so they can react. This is crucial to getting good results.

Choosing a good vessel to make the explosive in is another aspect to the temperature control problem. The walls of the vessel should not be so thick that they act as an insulator to the flow of heat from the batch into the surrounding ice bath. For this reason, many heavy glass measuring cups are not suitable for use as reaction vessels. This insulation problem becomes more intense the larger the batch of explosive that is being cooked, because of the greater amount of heat given off.

On the other hand, measuring cups have a lip on their rims for pouring that comes in very handy in the production, explosives because the usual procedure for making nitric esters calls for the batch to be poured into water or through a filter when the reaction time is up. This little spout on the rim makes this part of the operation much safer and less messy than using a mason jar, for example.

An ideal reaction vessel, therefore, would be made of reasonably thin glass (about as thick as the usual drinking glass) and have a lip on the rim for good pouring. When making a batch, it should be no more than half full. This is so that good stirring can be done on the contents, and so that the top of the batch can be below the level of the surrounding ice bath. Glasses of this type can be found at fancy bars or in some stores.

Choosing a good thermometer to monitor the temperature of the batches is an area which cannot be ignored. A laboratory type thermometer, of course, will work just fine, but many kitchen thermometers will not. Any portion of the thermometer which

comes into contact with the batch must be completely covered with glass. Metal probes will not do because of the strong acids used in the production of the nitric esters.

In a pinch, the typical, cheap, outdoors type thermometer can be used. Here's how: This cheap type of thermometer is just a glass tube filled with mercury attached to a metal backing that has the temperatures printed on it. Generally, one side has °F and the other side has °C. One just takes such a thermometer, and with a three sided file, nicks the glass thermometer body at the maximum temperature allowed for the reaction it is going to be used in. The glass thermometer body is then removed from its metal backing. It can be used as a stirrer, so long as care is taken not to bang it around the inside of the glass reaction vessel when a batch is being made. As long as the mercury stays below the level of the nick, one knows that the maximum temperature is not being exceeded.

One last major area of potential trouble for the production of the nitric esters must be warned about. This is nitric acid that has gone bad, and developed a reddish tint. This is bad news because it means that the nitric acid has broken down into nitric oxide (NO_2) fumes. This acid will not work well for the production of explosives, and may very well cause a disaster. In the production of nitro, for example, it makes the reaction very difficult to control. Bubbling geysers of nitric fumes and detonation can result. How to prevent this and how to treat the problem in progress will be covered in the nitric acid section and the nitro chapter.

Once the ingredients have been mixed and the required amount of reaction time has passed, the most difficult and important part of explosive production must be tackled. This is the purification of the reaction mixture into a pure, refined product. The casual observer may be surprised that the purification of these materials is of such importance. However, it is an accurate assessment to say that the mixing and

18 *HOME WORKSHOP EXPLOSIVES*

reacting of the chemicals to make the nitric ester explosives is pretty easy. It is in the purification of the product that the batch is made or broken.

There are two routes to disaster for improperly purified explosives. Route number one, often taken by improperly purified nitro and its close relatives is the least dangerous. With nitro, at least in small quantities, if all the acid used in its manufacture is not removed from the product, then it begins to break down. Within a day or two, it is no longer explosive. In all probability, it reverts back to glycerin.

Route number two, taken by nitromannite and nitrocellulose, to name a couple, is much more dangerous. In these explosives, if all the acid is not removed from the product, the explosive becomes very sensitive and liable to explode unprovoked. At higher temperatures, they become wildly unpredictable.

For, these reasons, great care must be taken in the purification stage of explosive processing. The directions given in this book will result in pure, stable substances so long as reasonable care is taken. The point is to make the reader aware of the great danger involved in cutting corners on the purification of these materials.

With the major aspects of explosive manufacture discussed in a fairly general way, it is now time to move on to a specific example to illustrate the points that have been made. The example that will be used is methyl nitrate. This choice is not to be construed as an endorsement for methyl nitrate. On the contrary, methyl nitrate is an inferior explosive. While it is very powerful and made from very simple materials, it suffers from twin liabilities that make it unsuitable for most uses. Strike number one is that it is difficult to purify. It must be distilled to reach a good state of purity. This is definitely not recommended. In fact, it is a good recipe for a devastating explosion.

Strike number two is that the stuff evaporates away

too easily. This will ruin any gelatin or plastique that it is incorporated into because even in the bound up form of gelatin or plastique, the methyl nitrate will evaporate away, leaving nothing but the binders and fillers. The only way to stop this is to keep it in a freezer until use (thereby cutting evaporation to almost nothing because it is too cold to evaporate) or to seal the explosive in a container that will hold in the vapors against the pressure they will generate at normal temperature. A good choice for such a container is a champagne bottle with the cheap plastic stopper.

Strike number three, as if any more were needed, is that this explosive is very sensitive. In many respects, it is more sensitive than nitro, without the many redeeming graces of nitro. The one good point about this material is that the crude stuff before it is distilled (danger!) is very sensitive to heat, and can be used as a heat detonated explosive.

PREPARATION OF METHYL NITRATE

This is about the most complicated procedure used in making any of the nitric esters. If you feel confused when reading this, do not be discouraged. Many of the better explosives are made much more simply. The only special piece of chemical glassware that would come in handy for this preparation is a separatory funnel (unless distillation of the crude product is attempted - DANGER!). A good eyedropper can replace the separatory funnel in this procedure. I'll explain how in the text.

Methyl nitrate is made by reacting methyl alcohol (methanol, available very cheaply at the local hardware store) with concentrated nitric acid (70% nitric acid, density or specific gravity 1.42). The water absorbing chemical in this reaction is concentrated sulfuric acid.

20 HOME WORKSHOP EXPLOSIVES

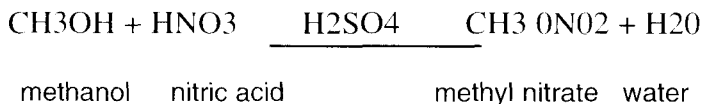

To begin preparation of methyl nitrate, all three ingredients, methyl alcohol, sulfuric acid, and nitric acid are cooled down in a freezer. Then a plastic or styrofoam tub is piled half full of ice. This is the ice bath which will be used to keep the reaction cold while it is being done. Next a 5 gallon plastic pail is filled 2/3 full of cold water, and placed next to the tub of ice. This pail is the preliminary disposal site for the used acids after the reaction is done, and also serves as the emergency safety dump to toss in runaway reactions before any serious damage is done. Finally, the ice is wetted with some water to make it work better at cooling down the reaction vessels.

Now the cold ingredients are measured out. With a glass measuring cup, measure out 300 c.c. of nitric acid, and 300 c.c. of concentrated sulfuric acid. (Note: 1 c.c. = 1 ml. It is also important that the nitric acid not have a reddish tint to it.) The nitric acid and sulfuric acid are then mixed together in a measuring cup. The cup filled with the mixed acids is then placed in the ice bath to keep it cold. In a second measuring cup nestled well within the ice bath, put 150 ml of methyl alcohol.

Then to the alcohol, add 50 ml of concentrated sulfuric acid. This must be done slowly, with good stirring so that the temperature of the mix does not go above 10° C (50° F).

Next three glass reaction vessels are put into the ice bath. They should be about one pint in size (500 ml) have a pouring spout on them and preferably be tall and thin like a drinking glass. Into each of these glass reaction vessels is put one third of the nitric acid-sulfuric acid mix.

With all in readiness, the methyl nitrate can be made. The most conveniently located reaction vessel is picked out, and to it is added 1/3 of the methyl alcohol-sulfuric acid mix. One third amounts to about 60 ml because of contraction of the solution during mixing.

This addition must be done slowly with good stirring. Care should be taken not to bang the glass stirring rod against the side of the reaction vessel during stirring. The temperature of the mix is allowed to go up to 40° C (104° F) fairly quickly, and then kept at this temperature by cooling in the ice bath. The rate at which the temperature rises can be controlled by how fast the ingredients are added.

When the full 60 ml has been added, the stirring is continued for another minute or two, then stopped. The product, methyl nitrate, rises to the top of the liquid as a clear oil. If one has a separatory funnel, one can wait for another ten minutes or so for the reaction to finish, then pour the reaction mixture into the separatory funnel, let it sit for a minute or two for the methyl nitrate layer to float up again, then drain off the acids into the 5 gallon pail and pour the methyl nitrate product into a small glass container that already has 20 ml of cold water and 5 grams of table salt in it. This salt water is the first step in the purification of the product.



Separatory Funnel

22 HOME WORKSHOP EXPLOSIVES

I must warn here against touching methyl nitrate or tasting it, because it will cause terrible headaches. Too much smelling of the product will cause the same effect.

If one does not have a separatory funnel, one can improvise. Once the mixing of the ingredients is done, and the product comes to the top, it can be sucked up in an eyedropper and squirted into the salt water. This must be finished before the ten to 15 minute time limit is up, because after that time great geysers of nitric oxide fumes are gushed up by the acids. They must be dumped into the pail of water by that time. Once the water dilutes them, the danger is past.

Nitric oxide is a pretty good poison. Breathing its fumes can easily lead to a delayed death. It burns the insides of the lungs, which then fill up with fluids leading to death. Symptoms often do not come on for a day or two. Whenever a batch starts to bubble up red fumes, it must be drowned in the pail of water to avoid severe danger!

With the first reaction vessel finished, one can then move on to the second one, and then the third one. The product layers from the second and third vessels are put in with the salt water wash that the product from the first vessel is sitting in. This salt water wash should be swirled around from time to time as the production is continuing to aid in getting traces of acid dissolved in the water. Since traces of acid are the enemy here, it is important that only the methyl nitrate layer be put into the salt water, not the acid it is floating on. One must take some care in separating the layers, or in *sucking* up the product layer with an eyedropper.

The salt water wash bottle has about 175 ml (a little over 200 grams) of methyl nitrate in it. It should be swirled around some more, then allowed to sit for a few minutes. If one has a sep funnel, it should be poured into it, and then the water layer (the bottom one) is drained off. If an eyedropper is being used, the water layer should be removed with it.

Now the remaining acid in the crude product must be removed.

To do this, some lye (a volume amounting to about 5 match heads) is dissolved in about 50 ml of water. This lye water is then mixed in with the crude methyl nitrate and allowed to react for about 10 minutes with some more swirling. At the end of this treatment, a drop from the water layer should still be basic (it should turn red litmus paper blue). Litmus can be obtained at the local drug store, or at any lab or chemical supply outlet, with no suspicion.

I cannot overemphasize the importance of removing the acid from the crude product. Traces of acid left in it will cause it to break down and become so unstable that it becomes too dangerous to be of any use. If one has a sep funnel, gentle shaking can be done for a few minutes to make sure that the methyl nitrate gets into good contact with the lye water. If one is not at hand, the stirring with the lye water must not be a slipshod job. Again I must emphasize that at the end of the lye water treatment, the lye water should still be somewhat basic. If the water is acidic (turns blue litmus red) a few more match heads worth of lye must be added, and the treatment continued.

When the lye water treatment is completed, the final purification of the product is next. The lye water is drained off by use of a sep funnel or eyedropper, and then, 30 ml of ice cold salt water (5 grams of salt) is mixed in with the methyl nitrate. After a few minutes of gentle shaking in the sep funnel, or good stirring, the mix is allowed to sit. The salt water will contain most of the unused lye that happened to find its way into the methyl nitrate. The salt water layer is separated, and thrown away:

Finally 30 ml of ice cold water is added to the methyl nitrate, and once again, stirring or shaking is done. The methyl nitrate is now practically pure, except for some water dissolved in it. The water layer is separated off of the methyl nitrate, and the product is ready for immediate use. The small amount of water dissolved in it will cause no real problems so long as

24 HOME WORKSHOP EXPLOSIVES

the product is used soon after making it. A more stable product results if it is distilled, but the great danger in doing this can't be under-estimated, especially for the unskilled. The product distills at 65° C. Heating must be gradual, and an oil bath must be used to heat the flask. The temperature of the oil bath must not get much above 65° C, or the contents of the distilling flask will superheat, leading to an explosion.

One can remove the water from the crude methyl nitrate without distilling the material. The result is still a crude methyl nitrate that doesn't keep well but it will keep better without the water. It will also form a gelatin more easily without the water contaminant. To remove the water from the crude product, spread some calcium chloride (ice melt, sold at the hardware store) in a thin layer in a glass baking dish. Bake it in an oven at 350 F for a couple hours to drive the moisture out of it. Then add some of this freshly dried calcium chloride to the methyl nitrate. Add an amount which corresponds to about one tenth the volume of the methyl nitrate. Put this mixture in the refrigerator and swirl every once in a while for better contact with the calcium chloride. After a few hours, the product can be considered to be dried. Now it can be filtered free of ice melt.

With the product in hand, storage can be done by pouring it, using a funnel, into a sealable bottle. The Grolsch beer bottle is a perfect container. No friction is produced opening and closing this bottle. One may wish to grease the rubber gasket with Vaseline to further reduce the danger from friction. Never use a screw on lid to store explosive materials like methyl nitrate.

Methyl nitrate is a use-it-as-you-make-it explosive. This substance should never be stored for more than a few days before use. The cold of a freezer slows down the decay of this substance, but doesn't stop it. Storage in a freezer is highly recommended.

USE OF METHYL NITRATE

Methyl nitrate becomes increasingly sensitive as its temperature is raised. It also does not age well. These facts are especially important for a product which has not been purified by distillation. One can take advantage of these facts by using methyl nitrate as a heat and vibration detonated explosive. For example, a half pint bottle (like a used liquor bottle) loosely attached with heat resistant tape to the exhaust manifold of an automobile is very likely to destroy the offending vehicle after a short warm up period. Similarly, a bottle which finds its way into an incinerator is very likely to destroy the incinerator.

More certain detonation can be obtained by leading a section of nichrome wire (toaster heating element) into the liquid. When current flows through the wire, the red hot heat of it will cause detonation. The variety of diabolical booby traps which can be constructed around this principle is limited only by the imagination.

A more convenient and safer form of methyl nitrate is gelatin. Gelatin is very easy to make from methyl nitrate, and is almost as powerful as the pure explosive. To make gelatin, a little bit of guncotton (a.k.a. nitrocellulose or smokeless powder) is mixed in with the methyl nitrate. A stiff jelly quickly forms which can be used as a plastic explosive. The resulting jelly is even more powerful than C-4. The keeping properties of this gelatin, however, are no better than the pure methyl nitrate. It must be used soon after production.

Since the production of gelatins by mixing a liquid explosive with guncotton will be seen repeatedly in this book, something must be said about guncotton. There are a wide variety of sources one can go to, to get guncotton. For example, cans of guncotton can be obtained at sporting goods stores. This material is stocked because some people "reload" their own ammunition for higher performance or to save money, or just to have fun. Large drums of guncotton (labelled nitrocellulose, with a, second rating which tells how finely divided it is) can be found at any factory which makes varnishes. Nitrocellulose

26 HOME WORKSHOP EXPLOSIVES

is a key ingredient of varnish. This material works great, but it comes packaged in the drum soaking wet with isopropyl (rubbing) alcohol because it is safer in this state. The alcohol must be allowed to evaporate off before it can be used to make gelatin. Guncotton can also be obtained by taking apart bullets or shotgun shells. In this source, however, as with the "reloading" supply route, one must avoid buying what is called "double based" guncotton. Double based guncotton has a few percent nitroglycerin added to it to give it an added punch. This material should be avoided unless one is prepared to do the necessary calculations to compensate for the nitro already in the product. 12 gauge shotgun shells almost always have a double based propellant.

To make the gelatin, one first measures out how much methyl nitrate is going to be jelled. This can be done by weighing it on a scale, or measuring its volume in ml and multiplying by 1.2. The result will be its weight in grams. The methyl nitrate is then poured into a plastic dish. Then a quantity of guncotton amounting to one tenth the weight of methyl nitrate is weighed out. For example, with 250 grams of methyl nitrate, one weighs out 25 grams of guncotton. The guncotton is then added slowly to the methyl nitrate with gentle stirring with a glass or wooden rod until a uniform mixture results. Alternative mixing bowl-mixer combinations would be; stainless steel bowl with plastic or rubber stirrer, or glass bowl with wooden stirrer. Avoid the plastic bowl-rubber stirrer combination as this could generate static electricity, and a tiny spark could set the guncotton off.

The resulting fairly stiff jelly has 9% guncotton, and will be set off with a number 4 blasting cap when it is fresh. The use of a little bit less guncotton produces a much more sensitive jell which can be set off with the weakest of all caps, a number 1. A good firecracker will set off the pure methyl nitrate.

This gelatin has a severe drawback that the other gelatins

do not have. The methyl nitrate will evaporate out of it on storage. This can be slowed up by keeping it in a freezer until use. Storage must be very short-term because of the bad keeping qualities of the methyl nitrate. It should be noted that frozen gelatin is more sensitive than gelatin at normal temperatures. Avoid screw type lids. I recommend a zip lock baggie. Before moving on to the good explosives, some discussion is called for here on an alternative process for making methyl nitrate, and on the general topic of distilling methyl nitrate. As you saw repeatedly pointed out in the above text, one of the big drawbacks of methyl nitrate is that it does not store well unless it has been distilled. An alternative process for making methyl nitrate centers around distilling the product directly out of the reaction mixture (i.e. the methyl alcohol-nitric acid-sulfuric acid mix), thereby avoiding a lot of the washing hassles that are the main sticking point of the production method given here.

This method has obvious advantages for industrial-scale production because it is faster and simpler. For this reason, it was adopted by the Nazis in the closing days of W W II to make methyl nitrate. Before rushing off and following their lead, keep in mind that life was cheap in Nazi Germany, especially the lives of industrial slave laborers. Even in skilled hands, the distillation of this material is not to be taken lightly.

The foremost precaution which must be taken in distilling methyl nitrate is to have all traces of nitrous acid removed from the mixture. This is done by adding urea to it. The fertilizer grade of urea will do for this purpose, but before rushing off and tossing any nitrogen fertilizer into the brew, make sure that the nitrogen fertilizer is made of urea, and not the much more common ammonium nitrate.

28 *HOME WORKSHOP EXPLOSIVES*

The second precaution is to prevent overheating of the mixture while distilling it. There are a couple of angles to approach this problem from. Step number one is to heat the distilling flask using an oil or hot water bath. Direct exposure to the source of heat is a no-no because that will cause local overheating and result in an explosion. The temperature of the bath should be just a few degrees higher than the boiling point of the product. At normal atmospheric pressure, the boiling point is 65° C. A more effective method for keeping the temperatures safe during a distillation is to distill under a vacuum. There is a problem with this approach because the normal boiling point of methyl nitrate is not very high to begin with. If it is lowered very much by applying a strong vacuum, a condenser, or even a collecting flask packed in ice will not suffice to turn it back into a liquid. With the strong vacuum that an aspirator or laboratory vacuum pump produces, dry ice would be required to condense the product. For those not intimately familiar with vacuum distillation, I must explain that the boiling point of a substance rapidly falls off as the vacuum becomes stronger. The vacuum distillation problem can be solved if the source of vacuum is not very strong. One wants to reduce the pressure inside the flask to about half normal pressure (a vacuum of 15 inches of Mercury). This will lower the boiling point of the substance 15 or 20° C, making it about as hard to condense as ether. A good source of such a weak vacuum is a water bed drainage pump. This T-shaped plastic vacuum source produces just the right vacuum for the job when cold water is flowing through it. Alternatively, cheap workshop pumps will do, although one must be wary of the fumes of methyl nitrate they will exhaust into the air. The water bed pump is far superior for the job. The condenser must also be efficient. My recommendation is a Graham condenser which has ice water siphoned through it as a coolant.

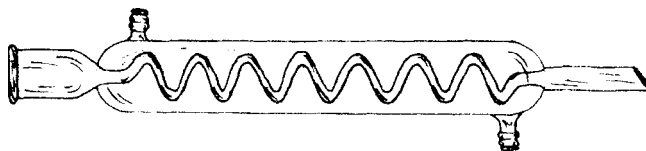

Graham Condenser

The Graham condenser has a spiralled central tube for maximum efficiency. Again, I must warn that this method is dangerous and should only be attempted by skilled professionals.

NITRIC AND SULFURIC ACIDS

Before moving on into the manufacture of some of the really good explosives, it would be best to make the reader familiar with the two ingredients which will be used over and over in the processes described here. They are nitric and sulfuric acid. A familiarity with these two substances will take much of the mystery out of explosive manufacture.

NITRIC ACID

Nitric acid is the key, indispensable ingredient in the manufacture of the explosives found in this book. The sulfuric acid can often be made do without, if one is willing to use a greater amount of the most concentrated nitric acid, and accept a lower yield of product in the process. Not so with the nitric acid. Only nitric acid in the specified or higher strengths will give that desired product.

With the premium thereby placed on nitric acid, it is a fortuitous circumstance that nitric acid is such an important industrial material with a wide variety of uses ranging from the exotic to the mundane. It can be found in the pint to quart range in any chemical laboratory (most abundantly in those labs doing metal analysis) and in the 55 gallon drum volume in plants involved in the manufacture of explosives(!), fertilizers, dyes and fabrics. Jewelers and others involved in trading or handling precious metals often have some on hand, too, because the best test for determining whether something is made of the "noble metals" (i.e., gold or platinum) is to apply some nitric acid to the metal and see if there is any reaction. Only the noble metals stand up to nitric acid. A further test mixture such as a jeweler is likely to need is aqua regia. This is a mixture of nitric and hydrochloric acid (mixed on the spot, not purchased mixed) and is the only liquid which dissolves gold or platinum.

Nitric acid can be obtained in reasonably large amounts, by anyone who does not look like a refugee from the local insane asylum or drunk tank, at drug stores or chemical supply outlets. In most cases, a drug store will have to send out for it, and small chemical suppliers may have to also. Fuming nitric acid is less likely to be on the shelves than the standard concentrated nitric acid.

Mail order outfits are another useful source for nitric acid, and for that matter, sulfuric acid. These two acids, along with hydrochloric acid, are so widely used that no serious suspicion can be put upon the buyers of just these materials. There was a scandal a few years back concerning mail order chemical-outfits being set up by the DEA to entrap wanna-be drug chemists, but to the best of my knowledge, their games did not extend to the explosives field. A possible exception to this is a chemical supplier I saw advertise in *Soldier of Fortune* magazine a few years ago offering "explosives manufacture chemicals." Such brazen advertising is cause for suspicion. My judgement on the matter is that since neither nitric nor sulfuric acid play a central role in "controlled substance" manufacture, orders for these two materials shouldn't set off too many of the alarm bells of suspicion, even in these crazed times.

Nitric acid is a liquid that should be clear if it is the 70% grade, and yellow colored if it is the 90% grade. The color in the higher strength acid is caused by the acid breaking down to NO_2 . This small amount of breakdown can be tolerated in most instances. The condition that cannot be tolerated in either strength of acid is when the acid takes on a pink or reddish brown color, and a cloud of reddish gas can be seen inside the bottle of acid. In this case, it has broken down so much that it can't be used for manufacturing explosives. This breakdown process can be largely stopped by keeping the acid cold and in the dark. A freezer meets these conditions nicely. Being careful to keep traces of dirt out of the acid bottle or jug is another big step towards keeping the contents in a usable condition.

32 HOME WORKSHOP EXPLOSIVES

Occasionally, directions will call for what is called “white fuming nitric acid.” This is the 90% fuming nitric acid which has been treated with urea to remove the traces of NO_2 and the yellow color that comes with small amounts of it. Urea can also be used to clean up nitric acid that has a darker color to it, but a point comes where this should be considered futile. When the red cloud shows up above the surface of the acid, it should be considered ready for flushing down the toilet. The procedure used to knock out the NO_2 contaminants calls for adding a little bit of urea to the nitric acid, stirring it in and warming the mixture gently. If the color persists, dry air is blown through the liquid, and if there is still color, some more urea is added.

As was hinted at before, the 90% (or higher) strength fuming nitric acid is not so easy to casually pick up as the standard 70% concentrated nitric acid. It is also much more expensive to get the fuming acid instead of the 70% acid (\$7 per pint vs. \$35 per pint). Industrial grade 70% nitric acid can be obtained in drums for around 30 cents per pound. With a little bit of subterfuge and connivance, one could set up a front company and get drums of this bargain material. It is the aim of this book, however, to use hardware store chemicals whenever possible. That way, possibly unsettling paper trails are avoided. For these reasons, it is sometimes necessary or advantageous to make the high strength acid oneself.

The procedure for making high strength nitric acid is pretty simple, but some chemical glassware is called for to do a good job. Various pamphleteers have included directions for making high, strength nitric acid in their books, leaving out a crucial aspect of the process. This crucial aspect is that the nitric acid formed must be distilled under a vacuum. Without the vacuum, a reddish colored product is made that is not very suitable for use in making explosives.

To make this good quality high strength acid, the following materials are needed: concentrated sulfuric acid, sodium nitrate, and dry ice. Also required is a distilling kit with ground glass joints and a vacuum adapter so the product can be distilled under a vacuum. The best vacuum source is an aspirator (cost: \$10) because the acid fumes will not harm it, and the water flow will flush them down the drain.

The distilling kit is set up as follows:

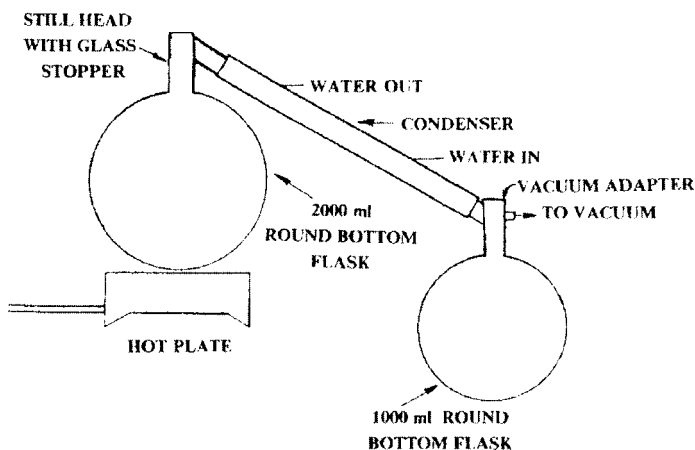

The distilling kit is a substantial investment at a few hundred dollars, so one should not be purchased unless it is going to get enough work to make the investment worthwhile. Laboratory supply companies will either carry the equipment or can get it in a few days. Check the Yellow Pages. The ground glass joints must be greased up with stop-cock grease before assembling the glassware to keep the joints from getting

34 *HOME WORKSHOP EXPLOSIVES*

frozen together, and to make for a good vacuum seal, free from leaks. No parts may be made of cork or rubber, because the nitric acid will destroy them, and become polluted in the process. Only glass or teflon parts are allowed.

Now to begin: Into the 2000 ml distilling flask is put 685 grams (365 ml) of concentrated sulfuric acid. Then 600 grams of sodium nitrate is mixed in with the sulfuric acid. Simply swirling the flask as the sodium nitrate is being added will do an acceptable job of mixing. Sodium nitrate is pretty easily available. I always used to find it on the shelves of my local Walgreens store, labelled saltpeter (technically this is the wrong name because saltpeter is potassium nitrate). It sat on the shelf right next to sublimed sulfur. Very interesting combination.

There will be no obvious reaction as the two ingredients are mixed. The glassware is assembled as shown in the diagram, and the 1000 ml receiving flask is packed in dry ice (styrofoam tub suggested) and the dry ice is wetted with rubbing alcohol. Now water is turned on to the aspirator. (See a college level organic chemistry lab manual for more on aspirators, but they work just like water bed drain pumps, only better. The threaded end is the water inlet, the water comes out the opposite end, and the vacuum is produced at the side arm of this T-shaped device.) The water must be cold for good results. An automotive type vacuum hose is led from the side arm to the vacuum nipple on the vacuum adapter, and within seconds a strong vacuum develops inside the glassware. It should be strong enough that the glassware can't easily be disassembled. Eye protection is required as always when dealing with caustic chemicals.

Some bubbling will begin in the 2000 ml flask as nitric acid begins to boil out. Heat should be applied from the hot plate to keep the process going. A good , but not violent rate of boiling is

what the doctor ordered. In about 20 minutes, close to 300 ml of pure nitric acid will collect in the dry ice cooled flask. It will freeze shortly after its arrival there. Since nitric acid contracts on freezing, there is no danger of breaking the glass. The heat applied to the distilling flask should be gentle. There is no need to make everything red hot. When the bubbling of the distilling flask slows, and the expected amount of product has been collected, the heat is turned off and the vacuum hose removed.

As soon as the distilling flask cools off, it is advisable to rinse out the distilling flask (it contains sodium hydrogen sulfate, a solid often used as a drain opener) and fill it with a fresh load of sodium nitrate and sulfuric acid. By repeating de vacuum and heating on this load, another 300 ml of product will come over to the 1000 ml receiving flask. Repeating the process yet one more time will leave the receiving flask nearly full. This is a good time to break. A quart of fuming nitric acid is enough to produce a very useful amount of explosive. Store the product in the freezer until use.

Fuming nitric acid is very aptly named. Regular 70% nitric acid fumes a lot, but the nearly water free acid made here fumes at least ten times as much. These fumes are dangerous to breathe in! When doing this process, always have plenty of ventilation. Taking apart the distillation apparatus and rinsing it out will allow lots of fumes to escape. Be warned!

Before leaving this topic, I should mention one more thing about the cheap drug store grade of sodium nitrate ("saltpeter"). The product I found at Walgreens was nearly soaking wet. In this state it, it was useless for making gunpowder, and not so good for making nitric acid either. Before using a wet material in this process, spread it out on a teflon coated cookie sheet or a glass pan and bake it in the sun on a hot dry day. Do not bake it in the oven because too much raw heat will break it down into the red poisonous gas, NO_2 . A microwave oven is a good and fast alternative to sun drying sodium nitrate. On a reasonably

36 HOME WORKSHOP EXPLOSIVES

humid day, sun drying would be just an impossible task. All one would get is a puddle of water as it sucked up moisture from the air and melted.

Should one's local drug store not stock sodium or potassium nitrate, I've found an alternative source at the hardware store. Stump remover is generally fairly pure potassium nitrate. Just check the label to see if the brand you find contains potassium nitrate. This nitrate reacts in the same way as sodium nitrate to produce nitric acid when mixed with sulfuric acid. It has the added advantage of not drawing water out of the air and melting itself.

The two brands of stump remover with which I am personally familiar are the GreenThumb brand and Rigo's Best. Both of them sell for around \$5 per pound. The GreenThumb stump remover is an off-white substance which is pure enough to use directly from the can. Rigo's Best is a yellow colored material that isn't sufficiently pure for use in making nitric acid, nor for use in the Hardware Store Nitro recipe which you will find in the next chapter. Whatever that yellow additive is, it amounts to about 10% of the product, and doesn't dissolve in water. Maybe it is sulfur! To check an unknown product for purity, put about a gram of it into 10 ml of water. With some stirring, it should all dissolve. There should be no solid residue left on the bottom of the container.

To purify an unacceptable brand of stump remover, put a pound of it into a glass coffee pot, then mix in a pint of boiling hot water. Stir the mixture for a few minutes to dissolve the potassium nitrate, and then while still hot, filter the solution through a doubled up coffee filter. This will remove materials which don't dissolve in water.

Next, to recover crystals of pure potassium nitrate, return the filtrate to a glass coffee pot. Now heat it to a gentle boil on the stove, and boil away a little over half a pint of water. The mixture is now concentrated enough that crystals will form upon

cooling. Allow it to cool in the refrigerator. A large mass of clear potassium nitrate crystals will form. Filter them out with doubled up coffee filters. The coffee grounds holder of a Mr. Coffee works really well for this process.

The liquid which filters through still contains a lot of potassium nitrate. This can be recovered either by repeating the boiling down and cooling cycle, or by adding one volume of denatured alcohol with stirring to the filtrate. Either way, add this second crop of potassium nitrate to the original crop, and dry them. Again, either sun drying or microwave drying will work to remove the water from the product. If one wants to use the nitrate to make gunpowder, it should be ground in a blender once dried, and then stored in a sealed glass or plastic container.

One more tip is called for on the nitric acid production process. The best type of vacuum adapter for use in the distilling set-up shown on page 31 is one that has a drip tip that extends past the ground glass joint. This will ensure that the nitric acid fumes make it down into the flask and are condensed and frozen there. Too short a drip tip can lead to the acid getting condensed in the area of the ground glass joint, and if it freezes there it could plug up that part of the apparatus. This will choke off the source of vacuum to the glassware, and may even block the flow of nitric acid into the receiving flask.

SULFURIC ACID

Like nitric acid, sulfuric acid is an extremely common chemical, both in laboratories and in industry. Its wide variety of uses makes obtaining sulfuric acid a very easy task. For example, any shop doing electroplating (especially plating chrome) will go through large amounts of sulfuric acid. Plating shops also use a lot of nitric acid, especially if they are plating aluminum objects. It is easy then to see how a plating shop can be a one-stop shopping center for all one's acid needs.

38 HOME WORKSHOP EXPLOSIVES

Home hobbyist electroplaters need these acids as well, so this can be a good and believable cover story for anyone who runs into the embarrassing situation of being asked what the materials are needed for by a nosey druggist or other small-time chemical supplier. Mail order outfits may also be considered safe for ordering sulfuric acid from because of the commonness of the chemical and because it plays no central role in drug manufacture.

This is by no means a complete list of all the places that use sulfuric acid and are likely to have it on hand. Virtually every large-scale manufacturing process uses sulfuric acid at some point or another. A much more important question is: Will the material at hand be good enough for use in explosives manufacture? Here let the reader recall the great importance of keeping the amount of water present in the reaction mixtures to an absolute minimum, lest the yield of product be reduced to nearly zero. With this in mind, it should then be obvious that battery electrolyte sulfuric acid is not acceptable because it is mostly water. In theory, the water can be cooked away, but this produces dangerous fumes and results in an inferior product.

Similarly; a lot of industrial sulfuric acid has a strength of around 80%, with the other 20% being water. This grade will not do, either. The materials that are acceptable are concentrated sulfuric acid, or fuming sulfuric acid. Fuming sulfuric acid will be clearly labelled as such and may list what percent by weight SO_3 (a.k.a. oleum) it contains. More on this later. Concentrated sulfuric acid may only be recognizable as such by a density (or specific gravity: sp. gr.) reading printed on it. Concentrated sulfuric acid has a density of 1.85 to 1.91, whether this value is given in pounds per pint or grams per ml.

Both the fuming and concentrated acids are likely to be kept in glass bottles, jugs or carboys because these corrosive acids have bad effects upon metal. Plastic containers are another possibility.

As was mentioned earlier, there are two useful types or grades of sulfuric acid. They are concentrated sulfuric acid (H_2SO_4) and fuming sulfuric acid (H_2SO_4 , SO_3). To get an understanding of the

difference between the two, one should look to how sulfuric acid is made. Huge plants produce the gas SO_3 (sulfur trioxide) by burning sulfur to SO_2 , and then inducing it to pick up another oxygen atom by high heat and catalysts to form SO_3 . SO_3 reacts with one molecule of water to form pure sulfuric acid. So these plants just mix the SO_3 they make with water and turn out pure concentrated sulfuric acid.

If they leave in a little extra SO_3 , (i.e., they don't add enough water to completely turn the SO_3 to sulfuric acid), fuming sulfuric acid results. This fuming sulfuric acid is even better at soaking up water from one's explosive batches. First it scavenges furiously for enough water to turn its SO_3 to sulfuric acid, and then when this is accomplished, the resulting concentrated sulfuric acid picks up from there. So fuming sulfuric acid is a dehydrated sulfuric acid that is even better at soaking up unwanted water than concentrated sulfuric acid.

Fuming sulfuric acid, like fuming nitric acid, is aptly named. The stuff actually does fume. These fumes are very dangerous to breathe in because they form, sulfuric acid with the moisture in the lungs and throat, producing acid burns. For the same reason, rubber gloves must be worn when handling fuming sulfuric (or nitric acid) acid because the fumes will likewise burn any skin they come in contact with.

Whenever a fuming acid is to be used in a reaction, it is very important that good ventilation be provided. The experimenter should be upwind from the chemicals to ensure safety. This is most important when measuring out the chemicals, and during the early stages of the reaction. Once the chemicals have had a chance to react together for a while, and the acid loses some of its strength, the danger from acid fumes decreases.

There is no really good or practical method for the home experimenter to make his own sulfuric or fuming sulfuric acid. It would be way more bother than it is worth, and the product is more than likely going to be of an unacceptably low grade.

40 *HOME WORKSHOP EXPLOSIVES*

Sulfuric acid should either be purchased through the previously mentioned commercial sources, or obtained from labs or industries. Good sulfuric acid is clear as water and is almost as thick as lightweight motor oil. Prices vary with the outlet, but one can expect to pay in the neighborhood of \$15 per gallon for concentrated sulfuric acid, and \$35 per pint for fuming sulfuric acid.

Sulfuric acid keeps really well, so it needn't be treated so gently as nitric acid. Light and heat have no real effect on it. It is advisable to cool it down in the freezer before use to cut down on the amount of time which would otherwise have to be spent cooling the ingredients before they are mixed to react. The only important storage tip is for the caps to be kept tightly closed on fuming sulfuric acid so the SO₃ fumes do not escape into the air.

An open container of sulfuric acid will also pull water out of the air and dilute itself.

There are a couple of very important exceptions to this requirement for high grade sulfuric acid, and a great hardware store product which can thereby become quite useful. That product is Liquid Fire drain opener. It is roughly 80-85% sulfuric acid, and sells for about \$7 per quart. Crude as it is, it is perfectly suitable for use in making fuming nitric acid by the distillation method given earlier in this chapter. It also works just fine in the Hardware Store Nitro recipe which you will find in the next chapter.

NITROGLYCERIN

If one was for some reason forced to choose a single all-purpose explosive or if one were to wish away all the explosive substances save one, nitroglycerin is the chemical to clutch close to one's heart. This popularly, and for the most part unjustly, maligned explosive is so powerful, versatile, and easy to make that it is far and away the number one choice for a Home Workshop Explosive manufacturer.

There are a variety of reasons for this assessment. First and foremost, the materials to produce it are easily available. So long as one works with smaller size batches, the dangerousness of the process is greatly overstated. Add to that the fact that the power of a small amount of nitro can be multiplied greatly by incorporating some of it into a mixture with ammonium nitrate, then you will see my point on this matter.

We've all seen the Hollywood hogwash a million times where the hero thrusts himself into "mortal danger" with nitro. Small droplets of nitro oozing from old sticks of dynamite fall to the ground and explode on landing, like souped up firecrackers. Let me tell you right up front that this is the purest form of bull. Some of my fondest adventures centered around nitro, and it is nowhere near that easy to set off. There is no reason why anyone who takes reasonable care and does not suffer from a terminal case of the shakes cannot handle nitro safely. I have had occasion to fall while in a state of high inspiration on broken sidewalks, and my vial of nitro land on the sidewalk next to me. No explosion. I have dropped quantities of nitro from a height of several stories and had it land in a couple inches of snow with no detonation. It has been my experience that so long as one works with fairly limited quantities of nitro at a time, and then processes the product into gelatin or plastique, the dangers one faces are minimal and manageable.

42 *HOME WORKSHOP EXPLOSIVES*

This isn't to say that a case full of spoiled dynamite isn't a very dangerous item. With a case one has the mass of the whole load grinding and jostling upon each step taken. That is a recipe for disaster. The individual stick just isn't particularly dangerous so long as it is handled gently.

The need for small batches may at first seem discouraging for those special applications where a large amount of blasting power is required. It should not be. This drawback can be conquered by running one's batches serially. A large part of the nitro manufacturing process is sitting around waiting while the various cleansing operations work. This dead time can be profitably filled by starting another batch to feed into the clean-up section of the operation. It has been my experience that a couple ounces of product can be routinely run with none of the complications that can arise from runaway reactions with larger loads. Since only about 45 minutes is needed to do a batch, a healthy rate of production can be maintained. With a competent and trustworthy helper at hand, these serial production techniques are vastly simplified. In the production section of this chapter, I'll provide my suggestions on how to organize this serial batch production effort.

Still not convinced? Some of the most gripping TV watching I have ever had the pleasure to do was FBI surveillance tapes of Moslem guerrillas cooking large batches of nitro. While guerrillas number one and two were busy mixing chemicals from a drum guerrilla number three was busy on the prayer rug turning out incantation after incantation. Save yourself some time on the prayer rug, and keep the big batches for DuPont.

Now it is time to delve more deeply into exactly how nitro production is set up and why one should regard nitro as the explosive of choice. To answer the last question first, one only has to consider the extreme simplicity of making and purifying nitro. It was first made in the middle 1800s. This speaks volumes when you consider the crude materials and equipment available at the time. It has been my experience that anyone who is not brain damaged can easily

master the process. So long as attention is paid to following the directions, there is virtually nothing that can go wrong.

Nitro is a member of the nitric ester family, and is made the same way as the rest of the family. Nitric acid is reacted with an alcohol (in this case glycerin) to form the ester nitroglycerin.

Sulfuric acid is added to the mixture to soak up water, and thereby increase the amount of nitro produced:

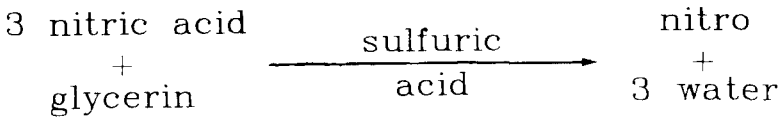

Both sulfuric and nitric acid have already been covered, so no more will be said about them other than to say that both concentrated and fuming nitric acid can be used to make nitro. Same with the sulfuric acid, both concentrated and the fuming acids will work for making nitro. The procedures are a little different depending on what strength acids are being used, but that will be covered in detail in the production section of this chapter. Let me just say up front that the best yields of product are to be had when one of the acids used is of the fuming grade. It doesn't matter which one of the acids is of fuming strength, so cost or ease of availability is the overriding factor in choosing which acid to get in the fuming strength. Results are better with the fuming grade because of the smaller amount of water added to the reaction mixture.

Glycerin is the other ingredient for nitro manufacture. As luck would have it, it is very easy to find. Look on the shelves of any drug store, and you will find it. They have it in little bottles for use as an "emollient" to help dry skin. The problem with just going to the drug store and picking out a few bottles of whatever is handy is that many brands of glycerin are cut with water. Since glycerin is a clear liquid, it doesn't show up just by looking at it.

44 *HOME WORKSHOP EXPLOSIVES*

The first step to bypassing this potential pitfall is to pick up a few different bottles of the competing brands, and check them for their water content. The easiest way to do this is to see how runny the glycerin is. Adding water to glycerin makes it runnier. The difference can be made more obvious by cooling the bottles down in a refrigerator. Good glycerin will get thick like honey.

If no brand is clearly superior to the others, one must check to see if all the brands are garbage, or if they are all good. To do this, the glycerin is cooked to see how much water will boil out of it. The best way to go about this is to pour the contents of a bottle of glycerin to be tested into a glass measuring cup (best if it is made out of pyrex or kimax so it will withstand the heating) and then place the glass measuring cup into a small pan or other metal container that is filled with enough cooking oil to reach about half way up the sides of the measuring cup. This is placed on a stove and heated. The temperature of the glycerin is monitored by use of any convenient sized cooking thermometer. The glycerin should be stirred regularly to make sure that it gets heated evenly. There is no danger in this process since glycerin is no more unstable than the cooking oil. When the temperature of the glycerin reaches 100° C (212° F), boiling may be noted in the glycerin. If it does boil, that means there is water in it. Glycerin does not boil until a temperature of 290° C is reached. The heating should be continued until a temperature of around 200° C is reached, and then the heat can be turned off and the contents allowed to cool.

To interpret the results, simply read on the measuring cup how much of the glycerin has boiled away. Some small amount of boiling can be expected because glycerin will soak up water from the air just by being exposed to humid air. If, however, more than a few percent of the glycerin boils away, there is too much water in the glycerin for best results. In making these volume measurements, it is important that the glycerin be at

about the same temperature for both the before and after reading. This is because glycerin expands quite a bit when it is heated, so taking one reading while the glycerin is hot will give inaccurate results.

If the glycerin has an unacceptable amount of water in it, one has a couple of choices. The first and easiest choice is to just keep shopping until a good grade of glycerin is found. If you do not strike paydirt by this method, the more difficult route of distilling the glycerin must be followed.

Industrial manufacturers of nitro almost always distill their glycerin before using it. This puts their worried little heads to rest on the water issue. It is pretty safe and easy to do, but the distilling equipment described in the nitric acid section is needed to do a good job. An alternative is to follow the procedure described just above for testing the amount of water in the glycerin. If the temperature of the glycerin is held in the 150° C range for an hour or so, almost all the water will boil out of it. It will pick up a yellowish color during the heating process due to the formation of acrolein compounds, but this does not cause any harm. Industrial distilling techniques give the same yellow color. It just means that the nitro will be yellow colored instead of the nice clear product that could be had with better glycerin. If this clear product is desired, a vacuum distillation of the glycerin will give it. If the experimenter has experience doing vacuum distillations, this is the best route to follow. I must warn that glycerin has a tendency to bump during vacuum distillations. Adding a healthy amount of glass wool (angel's hair) to the distilling flask will keep this under control. Boiling chips do not do a good job with glycerin.

So with the preliminaries taken care of, it is time to move on to the actual nitro production process. To start with, a 5 gallon plastic pail is filled about 2/3 full of cold water and placed next to the production area. It serves the same purpose that it did in the methyl nitrate section. If in the unlikely event that the

46 HOME WORKSHOP EXPLOSIVES

batch gets put of control and begins gushing out the red fumes of poisonous NO_2 , the batch can be drowned in the water and the danger averted.

Then on a table next to the water pail is placed a styrofoam tub or other suitable container about half filled with crushed ice. Into this ice, a glass vessel is nestled. It should be about a pint in volume and have the thin glass and pouring lip mentioned earlier when describing the ideal reaction vessel.

Into this glass vessel, put 100 ml of concentrated nitric acid and 200 ml of concentrated sulfuric acid. These acids should be cold to start with by being stored in a freezer. They are mixed together by swirling the container, or mixing with a glass rod or thermometer. This mixing will warm them up a little bit, but they will quickly cool again in the ice bath. When the temperature of the acids is under 40°F (4°C), the glycerin can be added. To do this, about 50 ml of glycerin is measured out. It is then added to the acid mixture 5 ml at a time. The best way to do this is to let the glycerin portions run down the side of the glass. This ensures that the glycerin enters the acid mixture gradually rather than in lump sums.

The mixture must be stirred during the addition to keep the glycerin from building up in one particular spot. If it should build up in one spot, a runaway reaction would result. There are several choices for stirring techniques. My favorite is to tilt the container at about a 45 degree angle and then rotate the vessel in a manner similar to a cement mixer. This very gentle technique works well. Another alternative is to swirl the vessel. It could also be stirred by using the glass thermometer. Doing this, it is important not to bang it around or to create friction by scraping it on the walls of the vessel. This is an inferior technique. Nitro factories stir their batches by blowing a stream of dry air through the reaction mixture. The rising bubbles do the stirring. If a person should want to copy this stirring technique, I would suggest using some stiff plastic tubing inserted about two-thirds of the way to the bottom of the reaction mixture. One should check beforehand to see if the plastic will stand up

to exposure to the strong nitric/ sulfuric acid mixture. I would never use glass tubing as an air bubbler. It might fall out of place, bang the bottom of the reaction vessel, and cause problems.

The addition of the glycerin to the acids should take about 25 minutes, adding ten portions of glycerin of about 5 ml each. The temperature of the reaction mixture should be watched during the addition of glycerin. It should not be allowed to rise above 50° F. If it gets too close to this temperature, the additions of glycerin should cease, and the mixing continued with the vessel nestled in the ice bath until the temperature drops back down to around 40° F.

Under no conditions should it be contemplated to just add all the glycerin, nitric and sulfuric acid together all at once "to save time." To add them all together at once will result in a geyser of red fumes in a small batch, and possibly an explosion in a large batch. Likewise, it should not be contemplated to add the acids to the glycerin. This chapter will cover all the good variations on nitro production.

When all the glycerin has been added, a milky colored solution will have been formed with little globules of pure nitro dispersed throughout the mixture. After the glycerin has been added, the mix can be allowed to warm up a little bit. It can be taken out of the ice bath, and its temperature allowed to rise into the 50's F. Stirring should be done occasionally during this period.

About 20 to 25 minutes after the last addition of glycerin, the reaction can be considered to be finished, and purification and processing commenced. The first step in processing the nitro is to pour the whole batch into a little over a quart of cold water. Most of the acid dissolves in the water, and crude nitro settles out at the bottom of the container as an oil. It goes to the bottom because it is heavier than water. A small amount of nitro stays floating on the surface of the water due to surface tension, but the amount is not that great. Some of the droplets can be sunk by splashing around on the water surface with some type of stirring rod.

The fact that the nitro sinks to the bottom presents the first obstacle in the purification of the nitro. It is obviously going to

complicate things getting the nitro off the bottom of the container for further purification. The best solution is to get a 2000 ml separatory funnel. A quart or so of cold water can be put in it, and the batches poured into it when they are done. When the nitro settles to the bottom of the sep funnel, the stop cock can be opened, and the nitro drained out. The leftover acid water can then be poured down the drain. It is important here that the separation between nitro and acid water be as sharp as possible because the whole idea of the purification process is to remove this acid from the nitro.

If a sep funnel is used for the purification of nitro, one should make sure that the stopcock and the stopper are both well greased. If regular stopcock grease is unavailable, substitute Vaseline. This will prevent grinding friction during the use of the sep funnel, and make accidents less likely. When one is finished with the sep funnel work, it should be cleaned out. A cold water rinse followed by a rubbing alcohol rinse will remove nitro residue from the glassware.

Another possible method of getting the nitro off the bottom of the container is to tilt it to one side to pool the nitro, and then suck it up with a plastic turkey baster.

Whichever method is used, the separated nitro is then added to about a cup of clean, cold water and allowed to sit there for a while. This clean water will soak up more acid from the nitro. It is good to cause the nitro to flow around on the bottom of its new container every once in a while, so that it is not the same old surface exposed to the water all the time. This water bath should take no more than about an hour.

Next, the nitro must be carefully separated from the water once again, and added to about a cup of bicarbonate of soda solution. The bicarb solution is made by adding about 10 grams of Arm & Hammer® to a cup of water, and mixing until it is dissolved. The importance of this step cannot be underestimated. The nitro, even after the water washing it

has received up to this point, still contains some acid. If the acid is not knocked out, the nitro will not keep. The breakdown of the nitro is fairly rapid. Within a few days of being made, almost all of it will have decayed without this bicarb treatment to neutralize the excess acid in it. With small batches, this breakdown is a quiet process, resulting in a non- or poor explosive mixture. What happens to larger batches is problematic.

When the nitro is added to the bicarb solution, it sinks to the bottom of the container again because it is heavier than water. It should have a milky appearance and an oily consistency. It will usually cause the bicarb solution to start giving off little bubbles, or even some fizzing. This is the bicarb neutralizing the acid. Acid reacts with bicarb to make CO_2 gas. This is the reason a person belches after drinking some bicarb to treat heartburn.

The best way to handle this acid-neutralizing process is to rotate the container so that the nitro rolls around on the bottom of the container, exposing fresh surfaces to the bicarb solution. Swirling may also be attempted, as may gentle stirring with a wooden swizzle stick or plastic straw. A glass stirring rod should not be used because this could result in grinding friction between the stirrer and the bottom of the container, with the nitro trapped in between. This could have disastrous consequences.

If one has a sep funnel, it is most convenient to do the neutralizing process in the sep funnel. This is because, once the nitro has been treated with the bicarb solution, it must once again be separated from the water. So if the bicarb treatment is done right in the sep funnel, one avoids the hassle of transferring the liquids from one container to another, or using a turkey baster. When using a sep funnel, it is best if the funnel is tilted at about a 45 degree angle to expose a greater surface area of the nitro to the bicarb solution.

However one chooses to do the bicarb treatment, one should spend at least a couple hours on this step. Letting it go overnight

50 HOME WORKSHOP EXPLOSIVES

does not hurt. This does not mean that it must, or even should, be constantly attended, stirred, swirled, or fussed over. An occasional agitation is enough to do the job well. More agitation and warmer water will get the job done more quickly, but why be in a hurry when one is having such fun?

At the end of the bicarb treatment, the nitro does not look any different from when it went into the process. It still has a milky appearance. This is caused by water trapped inside the nitro, and it should be removed before the nitro can finally be called pure. If it is left in the nitro, it could cause problems with detonating the nitro, or with further processing it into gelatin or dynamite.

The best way to remove the water from the nitro is to let it sit in contact with a saturated salt solution. This sucks up water from the nitro in the same way that drinking salt water dehydrates shipwrecked sailors. Saturated salt solution is water that is holding dissolved in it all the salt (regular table salt) that it can. The best way to make saturated salt solution is start with hot water in any container, and add salt to it until no more will dissolve in it. Good stirring or shaking is essential to getting the maximum amount of salt to dissolve in the water.

When the water cools down, the clear colored saturated salt solution (i.e., no crystals of solid salt floating around) is poured off of the excess salt sitting on the bottom of the container. This is put in a suitable container and the nitro is separated from the bicarb solution by use of a sep funnel or turkey baster as described earlier. Then the nitro is put in contact with the salt solution. There should about two volumes of salt solution to one volume of nitro. After they sit together in contact for a few hours, the salt will suck the water out of the nitro, resulting in a clear product. The product will be yellow if the glycerin was yellow to start with due to water removal processes. The yield of nitro is about 50 ml, the same volume of nitro as glycerin used in the manufacture. This process can be shortened if the bicarb solution is also saturated with

salt. This will dehydrate the nitro at the same time it removes the acid from it.

This yield of nitro can be improved greatly by using the higher grades of acids. If one of the fuming acids is used, the amount of nitro obtained from the same sized batch is approximately doubled. This is due to the lesser amount of water in the mixture, and the higher concentration of nitric acid. This method using the common concentrated acids was given first because these acids are the most easily available and cheapest. We shall now cover the small difference in processing when using the fuming acids versus the plain concentrated acids.

Before moving on to production processes using the fuming acids, one more point should be made. Since the amount of nitro produced corresponds to the amount of glycerin used, a person may be led to believe that by using more glycerin in a batch of nitro, more product could be obtained. This is wrong. It does not work for reasons I shall explain.

Below is the molecular structure of glycerin:

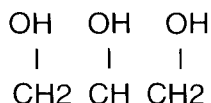

Notice that it contains three alcohol groups (the OH sections of the molecule). Each one of these must react with nitric acid for the product to be nitro.

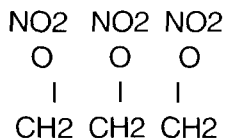

nitro

52 HOME WORKSHOP EXPLOSIVES

If the amount of nitric acid in the reaction mixture becomes stretched too thin, as will happen if too much glycerin is added to the mix, then by-products will begin to be formed where one or more of the alcohol groups of the glycerin has failed to react:

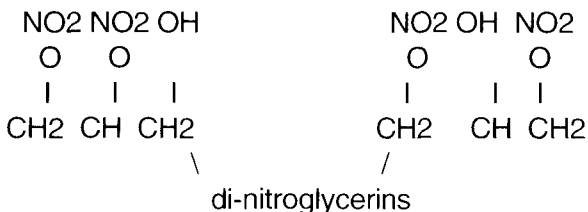
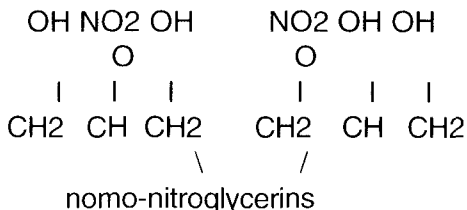

So the use of more glycerin is self-defeating. These mono and diglycerins are explosive compounds, but are not so good as nitro itself. Some of these compounds will be formed in any nitro process, but the aim should be to keep their numbers as small as possible.

The natural next question is: How careful do I have to be at measuring out the ingredients to get good results? The answer is that, one can always use extra acids and still get good results. It's just that after a certain point, it gets wasteful. As for the glycerin, so long as the amount used is within 10% of the prescribed amount, no problems will be encountered. The familiar TV and movie image of chemistry requiring to-the-drop accuracy in measurement is true for doing analysis, but not usually for making chemicals.

Now let's move on to the variation of nitro production using fuming

nitric acid and concentrated sulfuric acid. This process is no more difficult than the previous process, but fuming nitric acid is more expensive and more difficult to obtain. As was mentioned earlier, the yield of nitro is double the amount of glycerin used.

One starts this process with the same set-up as used in the first method. The tub of ice sits on the table top and the pail of water sits nearby for dumping out-of-control reactions into. The same type of reaction vessel (thin walled glass with a pouring lip) is set into the ice bath, and 100 ml of fuming nitric acid is measured out of the bottle or jug of fuming nitric acid that was previously cooled down in the freezer. Put the fuming nitric acid into the reaction vessel, then measure out 200 ml of concentrated sulfuric acid. Add the concentrated sulfuric acid to the nitric acid, slowly and with stirring. This addition will produce a bit of heat.

When the acid mixture has cooled back down to ice temperature, addition of glycerine can commence. A total of 50 ml of glycerine should be added to the reaction vessel. The addition of glycerine should be done in small portions, just as in the previous example. The same stirring procedure should be used as in the previous example, and the addition of glycerine should again take about 25 minutes to complete.

The big difference in procedure using the fuming acid is the need to more closely watch the temperature of the mixture. The fuming acid will produce twice as much nitro product, and it will also produce twice as much heat of reaction while doing it. Effective stirring of the mixture while keeping the reaction vessel in contact with ice will assure that the heat of reaction makes its way out of the mixture, and into the ice.

Once the addition of glycerine is completed, the stirring of the reaction can be continued in the ice bath for a few more minutes, then the reaction vessel can be taken out of the ice, and allowed to warm up into the 50's F. It should be held there for about 10 minutes with mixing, then the whole batch is poured into some ice water just like in the first method. From here, processing into pure nitro is

54 HOME WORKSHOP EXPLOSIVES

handled exactly as in the first method. The only difference is that 100 ml of nitro results instead of 50 ml.

There is another variation on nitro production that one could choose to use.

This is when the acids used are concentrated nitric acid (i.e., 70%) and fuming sulfuric acid. There are a couple complications to this method. First of all, there are two common grades of fuming sulfuric acid, one contains 20% SO_3 (oleum) and the other contains 40% SO_3 . So separate directions will have to be supplied for each grade of fuming sulfuric acid. Secondly, fuming sulfuric acid reacts pretty vigorously when it comes in contact with water, so it must be mixed up front with the nitric acid, rather than added last as in the previous method. If it was added last, the heat it would produce would send the reaction over the limit. These complications are easily overcome.

So to start, the same setup is used as in the previous batches. Then into the reaction vessel nestled into the ice bath is put 100 ml of concentrated nitric acid (70%). This is ice cold stuff fresh from the freezer. Then to this is added slowly with good stirring 115 ml of 40% SO_3 fuming sulfuric acid, or 200 ml of 20% SO_3 fuming sulfuric acid. This fuming acid will react vigorously when it hits the nitric acid because the nitric acid is 30% water. It may even splatter, so the opening of the vessel should point away from the experimenter. It is best if the fuming acid is allowed to run down the walls of the reaction vessel into the nitric acid. Stirring is called for during this operation to keep the reaction dispersed.

When all the fuming acid is added to the nitric acid, they must be mixed thoroughly, then allowed to cool down in the ice bath until the temperature of the mixed acids is under 40° F. Then it is time to add the glycerin. 50 ml of cold glycerin is measured out and added in 5 ml portions over a 20 minute period, just as in the first method. The cement mixer stirring technique is once again

king. When all of it has been added, mixing is continued for a few minutes, then the brew is taken out of the ice bath and allowed to warm into the 50's F for a while as before. Then it is poured into water, and purification to pure nitro is done exactly as in the previous methods. Yield of product is a little over 100 ml if 40% oleum is used, and about 100 ml if 20% oleum is used.

HARDWARE STORE NITRO

As you have seen, all of the nitro recipes given up to this point assume that the person has easy access to good grades of the necessary acids, nitric and sulfuric. Not many of us are so blessed by circumstances. No need to lose heart, however, as there are alternatives. Your Uncle thought up this recipe while on one of many shopping trips to the hardware store. I just know you are going to love it! Turn back to the nitric acid section of this book. There was a procedure given for making fuming nitric acid by mixing potassium nitrate with sulfuric acid, and distilling out the fuming nitric acid. The first thing I noticed at the hardware store was that one could easily buy fairly pure potassium nitrate in the form of stump remover. The next thing I noticed was that a reasonable technical grade of sulfuric acid was also to be had at the hardware store. This product is Liquid Fire drain opener. The next thing I wonder was whether or not it was really necessary to distill out the nitric acid. Couldn't one just use the nitric/sulfuric acid mixture that results when potassium nitrate is mixed with sulfuric acid? Some experimentation proved that not only is this hardware store nitro recipe super clandestine, but it also gives results which are superior to the standard concentrated nitric acid and concentrated sulfuric acid recipe. This is because the nitric acid produced by this method contains less water than commercial con-centrated nitric acid.

56 HOME WORKSHOP EXPLOSIVES

To do the Hardware Store Nitro recipe, one starts with a glass container. It should preferably be made of Pyrex glass to withstand some heating, and it should have a smaller size opening so it can be stoppered to keep in fumes. A flask of any type will do, but if those are unavailable, one can improvise.

Into the flask, put about 150 ml of Liquid Fire drain opener. Next add 100 grams of potassium nitrate. This should either be a reasonably pure stump remover such as the Green Thumb brand, or a dirtier brand purified by the directions given in the nitric acid section. Lumps in the stump remover should be broken up so that a fine powder is added to the acid drain opener.

When the two materials are mixed together, there will be no obvious reaction, but there will be some heat generated. To get the reaction to become complete, the mixture must be heated. A pan of boiling water is the perfect heating source.

Now stopper the flask loosely with a cork or other stopper, and immerse the flask into the boiling water. A stopper should be used because as the mixture is heated to produce nitric acid, a fair amount of nitric fumes may escape an unstoppered flask. As the flask warms up in the boiling water, the white crystals of potassium nitrate dissolve to produce fuming nitric acid. Some swirling of the mixture helps speed along the process. If there are lumps of potassium nitrate in the mixture, it is a good idea to break them up using a glass rod. Within about 15 minutes of heating, a transparent yellowish colored solution will result. No more solid will be seen in the mixture. A very good nitration mixture for nitro production has just been made.

Now cool down the flask. If the flask is made of Pyrex, it can be immersed directly into ice water. Less robust glass should be just allowed to cool off on its own, and then put into ice water.

Once the fuming nitric acid mixture has cooled down to ice temperature, it should be used immediately for making a batch of nitro. For the particular batch size given in this example, roughly 40 ml of glycerine should be used. It should be added in

small portions, with mixing, just as in the other examples. Then, just as in the other examples, the reaction mixture is poured into about a quart of ice cold water. The purification of the product is then done, exactly as given in the other examples in this chapter. The yield will be around 60 to 70 ml of nitro. Take special care with this method that all acid gets removed from the product!

So, as one can see, making nitro is not an especially difficult procedure, if one has at hand the required chemicals. Equally easy is gearing this process up for turning out substantial quantities of nitro.

As was alluded to earlier, larger batches of nitro have dangers inherent to their production that the smaller batches do not. For instance, a runaway big batch may blow up rather than just make poisonous gases. So the aim of the Home Workshop experimenter should be to organize his production process to take advantage of the dead time in the purification of the nitro to start new batches, rather than to try to push out monster batches.

The longest stretch of dead time in the production process is the acid neutralization with Arm & Hammer® bicarb. This several hour long wait would be a tremendous bottleneck in the production process if one would just sit around and wait for it to get done. On the other hand, if the waiting time for the acid to get neutralized is spent starting another batch, no bottleneck is experienced. All one would have to do is clean up and dry the reaction vessel, run another batch, and then put it through the purification process. In this way, one would have several batches running at once, all at different stages of the production and purification process.

The longest stretch of dead time in the production process is the acid neutralization with Arm & Hammer® bicarb. This several hour long wait would be a tremendous bottleneck in the production process if one would just sit around and wait for it to get done. On the other hand, if the waiting time for the

58 *HOME WORKSHOP EXPLOSIVES*

acid to get neutralized is spent starting another batch, no bottleneck is experienced. All one would have to do is clean up and dry the reaction vessel, run another batch, and then put it through the purification process. In this way, one would have several batches running at once, all at different stages of the production and purification process.

Another section of the purification method that involves a lot of just sitting around and waiting is when the nitro is put in contact with saturated salt solution to remove the water from it. This dead time can be profitably used in the same manner. It is obvious that a fair number of containers of crude nitro will be employed in such an operation. They should all be clearly labelled so that mix ups are avoided. Organization and logical thinking are indispensable in this situation, but using this method of organization, production levels in excess of a pint a day of pure nitro are easily obtainable.

Production can be further increased if there are two people to man the production line. The most fruitful way to divide labors in such a situation is for one person to devote himself to running the synthesis reaction between the glycerin, nitric acid and sulfuric acid, and for the other person to man the purification operation. With this division of labors, production can easily exceed a quart per day without resorting to larger batch sizes.

GELATINS

When the nitro has reached the end of the purification process after the saturated salt treatment, a perfect place to store the nitro is in the freezer. The colder the nitro is, the more stable it is. Cold nitro is difficult to detonate, and frozen nitro is harder still to detonate. A glass container is wonderful for this purpose. As subsequent batches get finished, the product can simply be poured in with the rest of the nitro in the freezer until the container is filled.

Avoid instances of grinding friction with frozen nitro, such as ungreased stoppers, or screw caps. It can detonate frozen nitro!

An alternative to freezer storage is to simply accumulate the nitro product in the refrigerator. Some people feel that freezing and thawing cycles may present an element of danger. I'm not in agreement with that theory, but it has its adherents. In this particular case, it would be a good idea to sprinkle a small dusting of bicarb in with the liquid refrigerated nitro. The bicarb will react with any acid generated from the breakdown of the nitro, and thereby greatly slow any decay of the product. Nitro breakdown is autocatalytic in the sense that the acid produced from its decay greatly speeds further decay. A drop of ammonia could be substituted for the bicarb.

When the desired amount of product has accumulated, or when the freezer is full, a decision must be made. That is whether to keep and use the nitro in its pure liquid form, or to convert it to blasting gelatin, or to multiply the power of a small amount of nitro incorporating it into mixtures with ammonium nitrate.

In making this decision, the full range of factors have to be weighed. For instance, one has to consider what is going to be used as a detonator for the explosive. If one has access to blasting caps, or can improvise a low-powered cap, gelatin is the nitro-based explosive of choice. Gelatin, when fresh, retains the full power of the nitro, and yet is a good deal safer than the pure nitro.

On the other hand, when all one can procure for detonating the explosive is a strong firecracker, such as an M-80, then one may have to consider using the liquid nitro as is. More on this when detonation systems are discussed later.

If gelatin is the chosen route, one can take heart from the fact that gelatin is very easy to make from nitro, and that so long as it is fresh, it packs an amazing punch. What is meant by "fresh" is that the little air bubbles that get whipped into it in the process of making it are still visible. Once they disappear, half the power is lost because the detonation rate goes down.

60 HOME WORKSHOP EXPLOSIVES

The presence of air bubbles in liquid explosives like nitro, or in semi-liquid explosives such as gelatins, or foams has a huge effect on both the sensitivity and the power of the explosive. This subject will come up a lot later in the ammonium nitrate mixtures section, but let's deal with it now. For good reading on this topic, see Chem Abstracts, Volume 41, column 3628. For even more go to the original article in the Proceedings of the Royal Society of London, Volume A188, pages 291-311 (1947). Small air bubbles or other gas bubbles trapped inside the liquid explosive greatly increase the sensitivity of the explosive to detonation.

It is believed that this works because the small gas bubbles greatly compress upon either a striking blow or the shock wave from a detonator. When they compress, they heat up to a remarkable degree. This local heating then facilitates the detonation of the explosive.

It is not only gas bubbles inside the liquid explosive which may produce this effect. Let us say for example that one has placed a large drop of nitro onto a smooth steel surface. If one were to then strike this drop with a hammer that had a few small pits in its surface, the force required to detonate the drop of nitro would be much less than if the surface of the hammer was smooth. The pits on the hammer surface trap air pockets, which then compress and act the same as gas bubbles inside the explosive itself.

Now for how gelatin is made. You may be surprised after reading this and say; "What? There's got to be more!" Really, there is just nothing to the process. First of all, a suitable mixing bowl and stirrer combination is rounded up. A really good combination is a stainless steel bowl and a rubber spatula (small size). Also workable is china with wooden stirrers. What must be avoided at all costs is a hard bowl with a hard stirrer, like a glass stirrer on metal or china bowl. The grinding friction during the mixing could easily set off the gelatin. A combination that generates static electricity such

as plastic on rubber must also be avoided because a little spark could set the guncotton to burning.

Now into the stirring bowl is put 93 grams (58 ml) of nitro. Then 7 or 8 grams of nitrocellulose (guncotton: see methyl nitrate section for a discussion of guncotton) is stirred into the nitro. If the nitro is cold, adding an ml or two of acetone (available off the shelf at the local hardware store, check in the paint section) to the mix will help a lot in forming a good even mixture. The use of acetone can be avoided if the nitro is warmed gently by setting the bowl in warm water before adding the guncotton.

When the guncotton is all mixed in, a white jelly will result. The more guncotton that is added, the stiffer the jelly will be, the harder it will be to detonate, and the weaker it will be. Gelatin with 7% guncotton (i.e., 7 grams guncotton to 93 grams nitro) when fresh can be set off with a # 1 blasting cap (the weakest) and with a #4 when it has set long enough that the gelatin has turned from white to clear yellow. 9% guncotton in the gelatin requires a #3 or 4 cap when fresh, and stronger caps when aged.

The gelatin formed in the mixing bowl can be removed using the spatula and stored in ziplock bags until ready for use. Larger batches of gelatin can be easily made, so long as care is taken to ensure that the mixing is complete and even. A uniform product should result.

NITROGLYCOL

Nitroglycol (or ethylene glycol dinitrate) is an excellent alternative to nitroglycerin. It combines almost all of the good points of nitro with a few further unique advantages of its own. Its easy manufacture (just like nitro!) and high power make nitroglycol an attractive choice for any job requiring shattering explosive power:

One could go on endlessly expounding the points in favor of recommending nitroglycol, but there is no need to go into such detail. By knowing the major advantages of nitroglycol, the reader will be able to make his own informed choices.

The first and foremost advantage of nitroglycol is that it is less sensitive than nitro. It requires three or four times the force to set it off. This should be very reassuring to all the timid hearts contemplating entering the explosives manufacture field. On the serious side, this difference in sensitivity becomes very important when large amounts of the pure liquid explosive are being handled.

Another good point about nitroglycol is that it has better storage qualities than nitro does. Nitroglycol is much better able to withstand a sloppy purification job. This is because traces of acid left in the product will not bring nitroglycol to as rapid a ruin as nitro. This should not be interpreted as an endorsement of sloppy purification methods. It just means that with nitroglycol, there is more room for error.

For arctic blasting operations, or just the dead of winter, nitroglycol has the advantage of being explodable at temperatures which would freeze nitro into a harmless solid mass. This is because nitroglycol freezes at a much lower temperature than nitro does. Nitroglycol is also much runnier than nitro is. This low temperature explodability can also be viewed as a disadvantage since freezer storage can't be considered as safe as with nitro.

Finally, nitroglycol is very easy to use. It can be used in all the ways that nitro can. It forms gelatins with guncotton much more easily than nitro does. No warming or addition of acetone is required to get a gel to form.

Nitroglycol is not without its weak points, however. One bad thing about nitroglycol is that exposure to it brings on headaches much easier than does nitro. Contact with the skin can bring them on, as can breathing the vapors. When working with the substance, one should be wearing rubber gloves. Surgical type gloves are best because they do not interfere with manual dexterity like the heavier gloves do.

This is a minor drawback. A much more serious difficulty is that the starting material for making nitroglycol, ethylene glycol, is not available directly off store shelves. This complication would be very frustrating were it not for a couple of ways around it.

The first and simplest way around this problem is to order the chemical from the various chemical supply outlets. Since ethylene glycol has no major drug production usages, major hassles should not be expected. A reasonable price is about \$30 per gallon. Any orders for this substance should be placed at a different outlet than the source of the acids.

In many cases, it is the wisest route to avoid chemical purchases when possible. The paper trail they can leave is unsettling for covert operations. Luckily for these situations, there is an easy and cheap alternative source of ethylene glycol: antifreeze.

Other publications have suggested making ethylene glycol by warming ethanol with sulfuric acid to convert the ethanol to ethylene gas and then passing this gas through a bed of coke impregnated with phosphoric acid, and then feeding this product into nitroglycol production. This 'route is silly for the Home Workshop Explosives manufacturer. It is much too involved and subject to failure for workshop use. This method would be much more at home in a large factory manned by a

64 HOME WORKSHOP EXPLOSIVES

staff of experienced chemists. The motto to follow is “keep it simple.” Anything that can go wrong is likely to, over the long haul.

A quick lesson in antifreeze formulations will well serve the experimenter interested in obtaining usable ethylene glycol from it. Antifreeze has as its major ingredient ethylene glycol (unless you live in Russia where vodka is popular). In addition to the ethylene glycol there is an additive package in the antifreeze. This package varies with the brand of antifreeze, but the major additive is triethanolamine. This ingredient is universally used to inhibit rust formation in the radiator. The better brands will have in addition to triethanolamine, substances intended to plug small leaks, and other additives as well to extend rust protection to aluminum radiators and so on. These more complex additive packages are bad news to the Home Workshop manufacturer, because the lengthening list of additives make the job of getting pure ethylene glycol from antifreeze very troublesome.

To avoid these difficulties, the cheapest brand of antifreeze is sought out. Generic antifreeze is ideal. It is likely to contain only triethanolamine as an additive. Now the manufacturer is faced with only the problem of removing the triethanolamine from the mixture. The triethanolamine must be removed because it will not stand up to the mixed acids used to convert the ethylene glycol to nitroglycol. Triethanolamine will break down under those conditions and cause the formation of the dreaded red gas, NO_2 , if it is left in the mixture. To obtain pure ethylene glycol from the cheap antifreeze, distillation is used. This is the way to go because ethylene glycol boils at 197°C , while triethanolamine boils at 335°C . A very good separation of the two substances can be obtained by this method without resorting to fractionating columns.

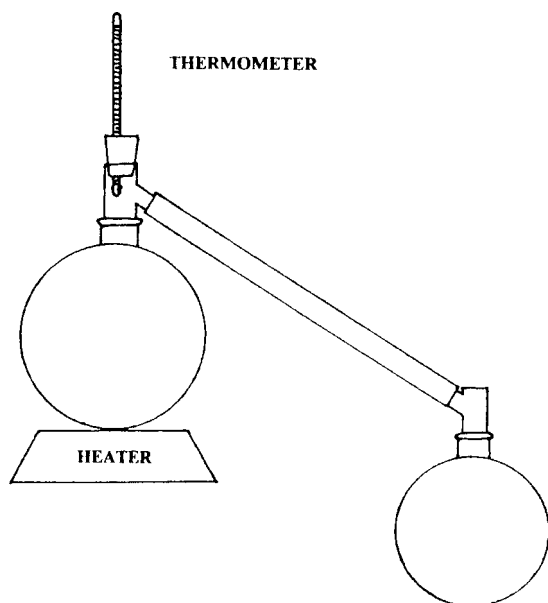

The best and simplest way to do this distillation is if the Home Workshop experimenter has invested in the distillation kit described in the nitric acid section. Such glassware comes in handy again and again for the serious experimenter.

There are more than a few distressing aspects, however, to obtaining and possessing such nice chemical glassware. Due to the widespread success of my drug manufacture books,

66 HOME WORKSHOP EXPLOSIVES

central authority responded during the 1990's by passing a series of laws controlling the sale and possession of glassware. The unwary buyer can now be faced with a crocodile filled swamp, laden with demands for identification and other intrusive questions. For a complete coverage of these laws and how to skirt them, I suggest the book "Sources" by Strike.

Using the chemical glassware, obtaining pure ethylene glycol can proceed very simply. See the drawing on page 59. The larger distilling round bottom flask sits directly on the electric hotplate. The so-called "fifth burner" unit bought at the local hardware store for \$20 is perfect for this job. It should have an infinite control knob to regulate the amount of heat it gives off. The antifreeze is put in this flask, filling it about half or 2/3 full. A few pea sized chunks broken off of a Dr. Scholl's® pumice footstone should also be put in this flask to ensure a smooth boil during the distillation.

The way the distillation is done is as follows: First the flask sitting upon the heater element is filled about 1/2 or 2/3 full of antifreeze. The heat is applied from the fifth burner unit until some boiling begins in the heated flask. These vapors will work their way up through the neck of the flask, and droplets will begin to appear on the thermometer, and in the area of the stillhead where it makes the turn to deliver into the condenser. When these droplets appear, which is soon after boiling begins in the heated flask, water flow should begin through the condenser. This will cool off the vapors and turn them back into a liquid. These condensed vapors will flow down into the other flask where they can be collected when all the product has arrived. The rate of boiling in the heated flask should be controlled by varying the amount of heat applied to it so that a slow trickle of about one drop per second appears in the other flask.

Let's now focus in on the stillhead, because it plays such a crucial role in the distillation. See the drawing below:

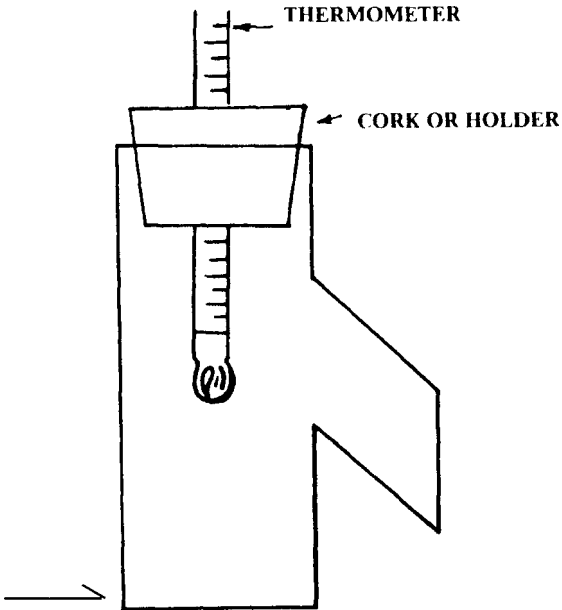

Area for addin pieces
of broken glass
or stainless
steel pad.

The thermometer should extend precisely to the position shown in the drawing. Any other placement will give false temperature readings. Pushed down lower, it will give false readings on the high side. Placed higher up, it will read too cold.

The second thing which can be done with the stillhead is that its lower end can be packed. This will result in a much purer product because a little bit of packing will act as a fractionating column. To do this, a glass bottle is smashed on

68 HOME WORKSHOP EXPLOSIVES

a cement floor, and the resulting pieces are picked over to find a few small enough to fit in through the top, yet big enough to keep from falling through the bottom. A few pieces of glass are enough to do the job.

Alternatively, a little bit of a stainless steel scrub pad can be pulled into this area.

When distilling the antifreeze, the temperature showing on the thermometer should be watched closely. Since ethylene glycol boils at 197° C, the liquid appearing in the collecting flask should only be saved when the thermometer indicates that the vapors entering the condenser are close to that temperature. To clear up any misunderstanding, let's go through a typical distillation.

When the vapors first reach the thermometer, the temperature shown on the thermometer will rise quickly. It is unlikely, however, to scoot up immediately to 197° C. First the ingredients in the antifreeze with lower boiling points will distill off. For example, if it is really cheap antifreeze, some water will boil off at 100° C. None of this lower boiling material should be saved. It should be collected in a separate container and thrown away. Only when the temperature shown on the thermometer gets into the 190° C range, should the liquid appearing in the collecting flask be considered to be ethylene glycol.

When the ethylene glycol begins appearing, the heat should be turned down some on the fifth burner unit to avoid superheating the antifreeze and giving false high readings on the thermometer. Collection of ethylene glycol should continue until the temperature shown on the thermometer goes above 205° C. About 2/3 of the antifreeze put in the distilling flask will be collected as pure ethylene glycol in this manner. When the temperature goes above 205° C, the heat should first be turned down further on the fifth burner unit to see if slower distilling will produce more ethylene glycol. If the temperature persists above 205° C, then all the ethylene glycol has been collected. When

this point has been reached, the heat should be turned off, ethylene glycol should be poured into a clean, dry glass container and the top tightly closed. It must be closed because pure ethylene glycol will soak up water from the air and dilute itself. The presence of water in the ethylene glycol will have the bad effects on yield of product already discussed in the previous sections of this book. The slop antifreeze material left in the distilling flask should be poured down a drain when it cools off. Then another run of fresh antifreeze may be distilled if desired.

It is not necessary to possess chemistry glassware to distill antifreeze. The stuff is not corrosive, or otherwise particularly dangerous (so long as it is not drunk, or the hot fumes sniffed!) so a homemade still can be constructed and used for the process with good results so long as care is taken in its construction and use. A workable still can be built along the lines shown in the drawing below:

COILED METAL TUBING

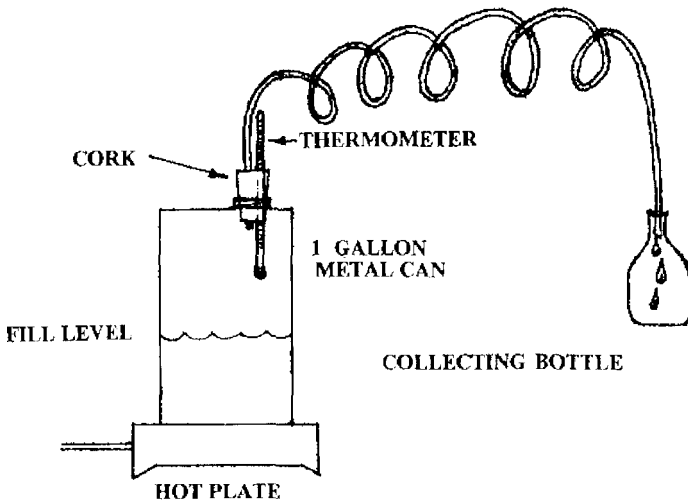

70 *HOME WORKSHOP EXPLOSIVES*

An antifreeze distillation using this setup will proceed in the same manner as described for the chemical glassware version, with the difference that it will not be possible to as closely monitor the process. With some practice, and using the same brand of antifreeze, it should be possible to get as good results using this apparatus as with the chemical glassware.

A few words are in order on the construction of this still, as there are a few trouble spots. First and, most important is the cork or rubber stopper in the metal can. It must fit tightly into the opening in the metal can so that the vapors are forced up the tubing. Leakage here can result in fluid running down the side of the can, posing a fire hazard.

The holes in the stopper must be exactly the right size to hold the tubing and the thermometer. Ragged edges on these holes are not acceptable, as the resulting leakage could pose the same fire hazards. Cork borers are available which do a good job of punching clean holes through corks. In their absence, a very careful job must be done in making these holes. Loose spaces and ragged edges can be mended by use of silicone bathtub caulk just prior to inserting the tubing and thermometer.

The coiled portion of the metal tubing can be made by wrapping the copper tubing around a sturdy round object. Care must be taken to avoid kinking the tubing shut during this process.

Finally, some support must be provided for the copper tubing so that its weight does not cause the metal can to tip over, or cause damage to the cork. Any type of support is OK for this purpose, so long as it does the job. This requirement for support is not unique to the homemade still, as the chemical glassware set-ups also need clamping into place or other measures to hold the pieces together.

Doing a distillation using this homemade still works almost exactly the same as with chemical glassware. There are only two areas where the method differs. The first difference is that the thermometer inserted into the top of the can will measure the

temperature of the vapors there, not at the top of the metal tubing where it begins its descent. This means that temperature readings on the thermometer are likely to be falsely high. With some practice and always using the same brand of antifreeze, this can be corrected for on an empirical basis.

The second, and potentially more troublesome problem has to do with the design of the coiled condenser portion of the copper tubing. As shown, it relies solely on air cooling for the vapors to give off their heat and become liquids once again. This will be sufficient during cold weather in the workshop, if the rate of distilling is slow enough: Otherwise some plastic tubing can be wrapped around the coiled portion of the metal tubing, and a flow of water run through the plastic tubing. The bottle into which the product drips can also be cooled off by packing it in ice. Under no conditions is it acceptable for steam to be escaping from the end of the metal tubing. Enough cold must be applied to the condenser to turn the vapors back into liquids.

MAKING NITROGLYCOL

With the ethylene glycol in hand, one is ready to turn it into nitroglycol. This process is very easy and almost identical to the procedure used to turn glycerin into nitro. To illustrate just how similar this process is to the nitro manufacture process, see the formula below:

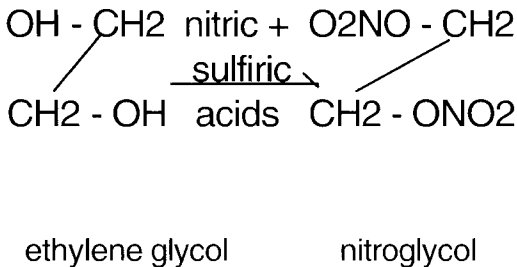

72 HOME WORKSHOP EXPLOSIVES

Compare this to the reaction for making nitro. Here the alcohol is ethylene glycol. For nitro, the starting alcohol is glycerin. The only difference in this reaction is that ethylene glycol is one carbon atom shorter. As far as the practical detail of making the two substances go, there is very little difference. All three of the variations on the nitro making process work for making nitroglycol, just by substituting ethylene glycol for glycerin. The same amounts of all ingredients are used.

There are only two small details where the production of nitroglycol differs from nitro. The first difference is that nitroglycol is more prone to form the red gas, NO_2 during its manufacture than is nitro. Because of this tendency, the ethylene glycol should be dripped directly into the acids rather than allowing the stuff to run down the sides of the glass into the acids. More attention should also be paid to getting the ethylene glycol promptly stirred into the acid mixture: It may also prove to be more fussy about the quality of the nitric acid used in the process than is the case with nitro.

The second detail in which nitroglycol manufacture differs from nitro production is the greater ease with which nitroglycol dissolves in water. As a result of this, less water must be used in washing up the nitroglycol than was the case for nitro. If the full amount of water was used, excessive amounts of product would be lost by getting dissolved in the wash water, and thrown away. To minimize these losses, the final wash with saturated salt solution should definitely be combined with the bicarb wash. This is done by the method described in the nitro chapter. The bicarb solution has salt added to it until it can't dissolve the added salt anymore. Then this wash water is used on the crude nitroglycol.

A fairly obvious question is likely to pop into the head of the serious reader at this point. That question is: "Can the Hardware Store Nitro recipe be used to make nitroglycol?" The answer to that is of course it can. If one were to turn back to that recipe and

simply substitute ethylene glycol for the glycerine used in that recipe the result would be pretty good yields of nitroglycol without having to procure ready made nitric acid. That is a hoop we can all do without jumping through.

NITROMANNITOL

Nitromannitol (a.k.a. nitromannite) is the third most difficult to make of the good high explosives. Other factors being equal, then nitromannitol would seem to be a good third choice for the Home Workshop Explosives manufacturer when setting up shop.

The production of nitromannitol is fairly easy because the starting material for its manufacture, mannitol, is fairly easily available at moderate prices from headshops. It may be labelled as baby laxative, but it is stocked as cut for cocaine and other white powders. The person behind the counter is likely to give you a knowing wink while making the transaction, but have no idea of its usefulness in explosive manufacture. If there are no head shops in your area, a check of the classified section in High Times may turn up a supplier or two.

The production of nitromannitol is not without its unique pitfalls, which combine to make the manufacture of nitromannite about twice as difficult as making nitro or nitroglycol. Foremost of these difficulties is the sensitivity and poor keeping properties of nitromannite. Under the best of conditions, it is about as sensitive as nitro, but if it is not completely freed of all traces of acid during the purification process, it will rapidly become too dangerous to handle.

Removing these last traces of acid is difficult because nitromannite is a solid, and so can lock the acid inside its crystals, beyond the reach of wash water or bicarb. To get at these locked-up acid residues a new chemical technique must be introduced here. This chemical technique is called recrystallization. Recrystallization involves dissolving the nitromannite in a solvent, like alcohol, and then allowing the crystals to reform from this solvent. This results in the garbage which was formerly locked up inside the crude crystals being

released into the solvent. The new crystals which form are largely free of their former pollutants. This may sound complicated but it is surprisingly easy to do. Complete, detailed instructions will be given in the text.

The other new technique which must be mastered to produce nitromannite is vacuum filtration. This technique is needed because nitromannite is a solid with very fine fluffy needlelike crystals. It has to be separated from its reaction mixture or recrystallization liquors by filtration. These long, fine needle crystals can only be filtered properly by having a vacuum force the flow of material through the filter. Without this, filtering the batches could take hours, and the results would be poor. This technique is very simple and can be improvised using household equipment. It too will be explained in detail when the time comes.

The bottom line on this explosive is that the recipe which follows here should just be considered as an introduction to the different techniques which must be used to purify an explosive product which is a solid rather than a liquid like nitro. The bad storage properties and unpredictability of this explosive make it unsuitable for use.

Making nitromannite proceeds in a remarkably similar manner to the manufacture of other explosives covered to this point. It is a nitric ester like the rest, and so is made by reacting an alcohol, in this case mannite, with nitric acid. See the reaction on next page.

As can be seen from the drawings, mannitol has 6 alcohol groups (OHs) which react with nitric acid to form nitric ester groups (ONO₂s). Other than the large number of alcohol groups, mannite is almost identical to glycerin or ethylene glycol.

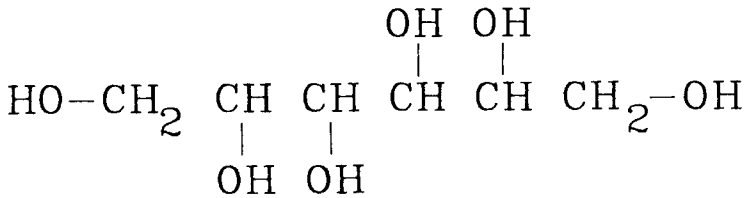

mannitol

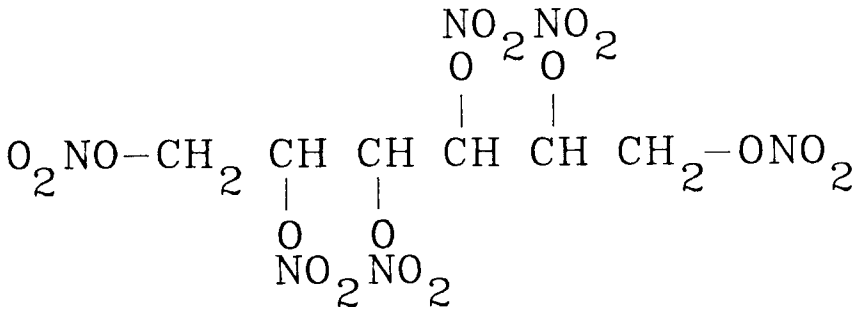

nitromannitol

nitromannitol

This large number of alcohol groups has an important practical effect upon what strength acid may be used in its manufacture. Referring back to the equilibrium equation given in the nitric ester section for nitroglycerin, the same equation can be written for nitromannite simply by raising the nitric acid terms and the water terms to the 6th power instead of the third power. This means that it is crucial in making nitromannite that the strongest possible nitric acid is used, and as a natural consequence (since the diluent for nitric acid is water) that the amount of water in the mixture be held to an absolute minimum.

For this reason, only fuming nitric acid (at least 90% strength, density 1.5) can be used to make nitromannite. This fuming nitric acid must either be obtained through commercial sources, or made according to the directions in the nitric acid section. The absolute need for the high strength acid is one of the roadblocks to putting nitromannite into production in the workshop.

To set up for making nitromannite, one begins with the same equipment as used earlier. The glass reaction vessel, pail of water and tub filled with ice are all needed. The important difference is that the temperature of the reaction must be held to 0° C (32° F) or below, so the ice must be a good deal colder than usual to keep the reaction at such a cold temperature. The way this is done is to mix the ice with about half its volume of table salt. This will drive its temperature down to around -20° C (0° F) which is cold enough to do the job against the heat given off in the reaction. An alternative is to pour a bottle of rubbing alcohol onto the ice and mix it around. This will also lower the temperature of the ice greatly.

Then into the reaction vessel, nestled deeply into the ice bath, 100 grams of fuming nitric acid (66 ml) is poured into the reaction vessel. Of course, the nitric acid should come directly from the freezer so that the ice does not waste itself cooling down the nitric acid. To this nitric acid, 20 grams of mannitol is added a little bit at a time. Between each addition of mannitol, the contents of the reaction vessel should be mixed by swirling. It is best to move the whole tub when swirling the reaction so that close contact of the reaction vessel with the ice bath is not broken. A thermometer should be in the reaction at all times, and it should be watched so that the temperature does not go above 0° C. If it does, the reddish brown fumes of N₂O are likely to follow. In that event, the batch gets dumped into the pail of water. So long as the addition of mannitol is slow, and the temperature is watched, this event is unlikely. The addition of the mannite should take

20 or 25 minutes.

The mannite should dissolve quickly as it is added to the nitric and mixed in. To ensure rapid dissolving and quick reaction, the mannitol should be finely powdered before it is used. Often-times, mannite is sold in head shops in quarter-ounce pressed blocks. These blocks will have to be mashed with a fork to break them up.

After all the mannitol has been added, and the last of it has dissolved into the nitric acid, it is time to finish up the reaction. This is done by adding concentrated sulfuric acid to the reaction mixture. This has the effect of sucking up whatever water is present in the mixture, thereby forcing the reaction to completion, and also causing the nitromannitol which has been produced to come out of solution and form crystals which can then be filtered out.

To finish off the reaction, 200 grams (110 ml) of concentrated sulfuric acid is measured out. The sulfuric acid should be ice cold, fresh from the freezer. It is then added a drop or two at a time with an eyedropper (glass stem!) to the reaction mixture. Between each drop or two, the acid should be mixed in by mixing with the eyedropper or the thermometer. The temperature should be watched closely during the addition of the sulfuric acid to make sure the temperature does not go above 0° C. As the temperature nears 0° C, the addition of sulfuric acid should be stopped until the mixture cools off again.

As the sulfuric acid is added, crystals of nitromannite will appear, slowly at first, and then quite rapidly. By the time half of the acid is added, the mixture will be getting pretty thick from the large mass of crystals formed. As the mixture gets thicker, it will be harder to mix in completely the added acid, so extra effort must be put into ensuring an even mix as the last of the acid is added. Care must be exercised in using the thermometer as a mixer here so that it is not banging the sides of the glass reaction vessel, or grinding the bottom.

This grinding could provide the friction to set the whole batch off.

Finally, when all the acid is added, a mixture with the appearance of a good heavy slush will be formed. Now the challenging part of the operation begins. The crystals of nitromannite must be filtered out of the highly corrosive nitric and sulfuric acid mixture in which they are floating, quickly enough that they do not rise above the red gas-forming temperature before they are rinsed with water and thereby rendered more stable. This operation is complicated by the fact that the nitric and sulfuric acid mixture in which they are floating will fairly quickly react with filter paper to form guncotton. This will cause most of the filter paper to dissolve, and ruin its effectiveness at catching the crystals.

There are a few ways around this problem. The most important part of the solution is to get the filtering done as quickly as possible. At least the first part of the filtering must be done very quickly, the filtering out of the crystals from the acid reaction mixture. Later, when it is rinsed with water and rendered less corrosive, a more leisurely pace can be taken. To make this filtration a quick process, there is only one way to go. That is to have a vacuum pulling from the underside of the filter, dragging the liquids through as fast as possible. Actually, this would be the only way to go even if the acids didn't eat filter papers. Packing the stuff inside a large coffee filter and wringing it out by hand is madness. Allowing it to sit in a funnel and drip through a filter is silly as well because the combination of fluffy crystals and viscous acids (concentrated sulfuric acid is about as thick as light motor oil) will make this take so long that it is unreasonable, even if one did not have to worry about the temperature of the mixture rising above 0° C. Genuine chem. lab experience is what separates this book from many pretenders out there, most of which merely feature reprints from scholarly works which assume the reader has

80 HOME WORKSHOP EXPLOSIVES

a high level of chemical skills and can solve these problems for himself without giving all the details. Place your wild-eyed trust in Uncle Fester. You won't be disappointed.

Let us first see how this rapid filtration problem would be handled using chem lab equipment before looking at ways to improvise for the same effect. To begin with, a source of vacuum would be close at hand on the lab bench, such as an aspirator. A water bed pump would serve the same purpose just as well since a really good vacuum isn't needed. From this vacuum source, a vacuum hose similar to an automotive vacuum hose would be led to the glassware set-up shown below:

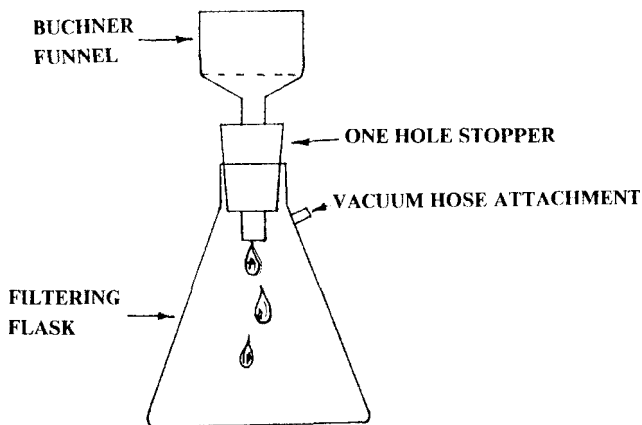

The filtering flask has a side tube to which a vacuum hose attaches, producing a vacuum inside the flask. This vacuum serves to rapidly pull fluids that are poured into the Buchner funnel down into the flask. This Buchner funnel normally has

a flat bottom inside it at about the level shown by the dotted line in the drawing. The flat bottom is perforated with many holes, and this is the place where a filter paper is laid, so crystals are stopped at the filter paper. The fluid proceeds through down into the filtering flask, and the crystals pile up in the buchner funnel above the filter paper.

Now using this chem lab equipment, the problem of filtering would either be handled by piling up several filter papers, soaking them wet and hoping that the wetness would protect them through a rapid filtering (bad solution), or by using something other than filter paper to catch the crystals, something which would stand up to the acids without being eaten away.

A great alternative to ordinary filter paper for this job is asbestos paper. This useful material used to be very easy to get at hardware stores, but has since been outlawed, along with virtually anything else made of asbestos, in the U.S. It has since been replaced with a woven glass sheetlike material which works almost as well as asbestos paper. Its only drawback is that it tends to be thick and stiff, and so is not so easy to work with. To use this woven glass sheet as a filter, one would only have to 'carefully cut' a piece out of it with a scissors that exactly fits the bottom of the Buchner funnel. Once in place, the slushlike nitromannite could simply be poured through it with the vacuum applied to the filtering flask, and all the acids would rapidly be pulled through to the filtering flask and the crystals of nitromannite would pile up in the Buchner funnel.

To modify this process for using common household materials, one should first look for a replacement for the Buchner funnel. This is easily enough done by heading to the hardware store and getting a plastic funnel with a long narrow stem and a plastic screen in the bottom. This funnel very closely approximates a Buchner funnel. Cost: about \$2.

82 HOME WORKSHOP EXPLOSIVES

Next, to replace the filtering flask, one can use a Mickey's Big Mouth malt liquor bottle. This rather sharp-tasting brew is made by the Old Style Brewery. Cost: nothing, if you like beer.

Finally, to replace the one-hole stopper, a two-hole stopper of the correct size is needed to fit in the top of a Mickey's Big Mouth bottle. If easy access is not available to an assortment of different size stoppers so that you can choose the right one, the Edmund Scientific catalog usually has quite a variety to choose from with no suspicion involved. This improvised equipment can be set up as shown on following page.

This is basically the same set-up as with the chem lab glassware except that the vacuum hose does not attach to the Mickey's Big Mouth bottle since it has no side tube to put a vacuum hose on. Instead the vacuum hose attaches to a stiff plastic or wooden tube (no copper allowed! improvise!!) inserted through one of the holes in the two hole stopper.

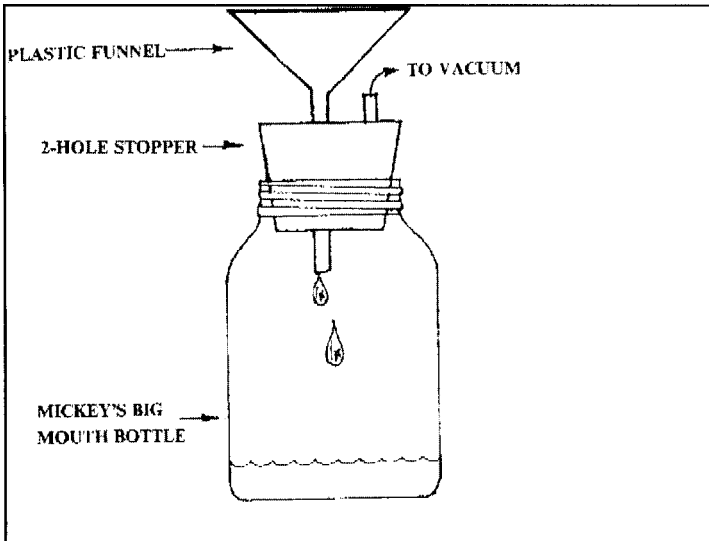

This is the source of the vacuum inside the Mickey's Big Mouth bottle. The stem of the plastic funnel goes through the other hole in the two hole stopper. Greasing the stem of the funnel with vaseline will greatly ease its passage through the two hole stopper.

Next a section of the woven glass material mentioned earlier must be picked up at the hardware store. A section should be carefully cut out of it so that it exactly covers the plastic screen in the bottom of the funnel. Good fit is essential here as any loose spots or uncovered areas or points of buckling of the filter will be places where nitromannite crystals can escape being caught, and end up going through with the acids. It may help to wet the filter and push it into place just prior to filtering the slush.

The procedure to use in filtering the material is this: First of all, the filtering apparatus is set up as shown in the pictures. Then the filter is put into place and wetted, then pushed down securely into place, making sure that the filter lays flat with no buckles or loose edges. Now the vacuum source is turned on, and the vacuum hose attached to the glassware.

Next, the slushlike nitromannite mixture is poured into the funnel. Not all of it should be poured in at once, of course, because this is likely to overflow the funnel unless the funnel is very large. At first, the acids will quickly rush through the filter, but as a bed of nitromannite builds up in the funnel, it will slow up, and a greater vacuum will accumulate in the glassware to pull it through. The first rush of liquid through the filter should be watched closely to make sure that no significant amount of nitromannite crystals is coming through. If there is, this indicates that the filter is poorly cut or placed. It should get better as a bed of nitromannite builds up above it, but in any case the material which passed through will have to be refiltered separately at the end of the process.

The filtration will proceed rapidly if a reasonable

vacuum is applied to pull the liquids through. The bed of nitromannite in the funnel (generic term: filter cake) will rapidly shrink as the acids are filtered out. If the right size funnel is chosen, all of the batch of nitromannite will fit in the funnel. As the last of the acids in the slush are filtered out, cracks will appear in the filter cake. Now it is time to move on to the next step, rinsing off the crystals.

The aim of all the purification steps in nitromannitol processing is to remove the residual traces of acids from its manufacture. The first step in this process is to rinse the crystals with water. To do this, simply pour cold water into the funnel on top of the nitromannite. It is convenient to rinse out the crystals clinging to the walls of the reaction vessel at the same time as the first rinse. This gets them in with the rest of the product with a minimum of hassles. This first rinse of cold water should be followed with a couple more, each one amounting to a couple hundred mls of water. For these last couple of rinses, it is good to turn off the vacuum (remove vacuum hose first to avoid water backup into acids) and just let the water move through the crystals slowly. Stir around the bed with a toothpick to avoid channel formation.

The next rinse for the crystals is a weak bicarb solution. This will get most of the remaining acids. A few grams of Arm & Hammer® in a couple hundred ml of water will serve the purpose nicely. It is poured through the filter cake in the same manner as the water rinses were. Finally, another rinse of cold water is poured through the crystals. When the vacuum pulls most of the water out of the filter cake, it is time to move on to the recrystallization of the product.

A glass, china, or plastic plate is a convenient place to dump the product out of the funnel onto. The best way to do this is to carefully (after the vacuum is removed) pull the funnel and the stopper out of the glassware, and then tip the funnel upside down an inch or so above the surface of the plate.

Some gentle tapping with the hand on the side of the funnel should be enough to make the filter cake fall out of the funnel. Avoid the temptation to bang the funnel on the surface of the plate to dislodge the filter cake. When it falls out, a plastic spoon can be used to scrape out whatever clings to the funnel. The filter should be picked out of the cake by hand.

To recrystallize, a heat resistant glass container must be obtained. A good choice is a one-cup size pyrex measuring cup. The crystals are put into the cup. Next some alcohol is added to the cup to dissolve the crystals. The best choice for alcohol is 190 proof grain alcohol. The next best choice is 91 % isopropyl alcohol, available at the corner drug store right off the shelf. Unsuitable for use are denatured ethyl alcohol (because acid may have been used to denature it) and 70% isopropyl alcohol (because of too much water in the alcohol). Methyl alcohol (wood alcohol) is not a good choice because it dissolves the crystals too well, and so causes loss of product, and a poorer job of removing the last traces of acids.

The procedure used to dissolve the crystals is as follows: First, 100 ml of alcohol is added to the crystals. They will not dissolve noticeably in the alcohol because it is cold. A pan of water is boiled, and when it boils it is brought over to the table in the workshop and the measuring cup is put into the pan of hot water. This work should not be done on the stove because when the alcohol heats up, it will give off fumes which could be ignited on the stove. The hot water will quickly warm up the alcohol in the measuring cup, and it will start to dissolve the crystals of nitromannitol. The alcohol should be stirred to help with the dissolving of the nitromannitol. A perfect tool for this job is a plastic coffee stirrer from McDonald's®. After a few minutes, the water will have cooled off to the point where a fresh pan of boiling water should be used for the heating of the alcohol. Soon after putting the measuring cup in the second pan of hot water, all the crystals of nitromannitol should be dissolved. If they have

not all gone into solution, then some more alcohol should be added to the measuring cup to dissolve them. Since the added alcohol is cold, a third pan of hot water will then also be needed to bring the temperature of the alcohol up to the required level to dissolve the nitromannite.

When all the crystals have dissolved, the cup should then be removed from the pan of hot water and allowed to cool. As the alcohol cools, crystals of nitromannite will reappear. This is because cold alcohol does not dissolve nitromannite very well, so they are forced to come out of solution. These recrystallized crystals of nitromannitol are much purer than the crude material that was started with because the acids that were formerly locked inside the crude crystals remain in the alcohol.

The colder the alcohol gets, the less nitromannite it will dissolve so the measuring cup should find its way to a freezer, or be packed in ice. This will get the largest amount of product out in this step. The nitromannitol should be white and the crystals should be long and needle shaped.

Now the pure product can be collected. To do this, the same filtering setup described earlier is used, except that a regular coffee filter can now be used, since there are no strong acids left for it to be dissolved by. All pieces, of course, must be clean and dry to avoid contaminating the product.

The alcohol which filters through contains some more nitromannite in it. To get this second crop of crystals out of it, the alcohol is simply poured back in the measuring cup (or beaker, which could easily be ordered from the Edmund Scientific catalog) and heating is recommenced. The heating must be stronger this time. If grain alcohol (190 proof ethyl alcohol) was used, the mixture should be brought to a boil. This can be done safely for small batches like this one on an electric stove top by setting the cup in a pan of hot water and bringing the water to a boil with the overhead fan running to suck up the alcohol fumes. If isopropyl alcohol was used, no

attempt to bring the alcohol to boiling should be made because isopropyl alcohol boils at the same temperature that the crystals melt at. This high temperature will prevent their formation during the crucial water-adding step to follow. For the isopropyl alcohol, just heat the alcohol up in the boiling water.

When the grain alcohol starts to boil, or when the isopropyl alcohol gets hot, water should be dripped into the alcohol. In the case of isopropyl alcohol, it will also be necessary to stir the water into the mix. The mixture should be watched closely during this addition. When the mixture starts taking on a milky color, stop adding water. This means when the whole solution gets milky, not just little areas, because local milkiness in the area where the drops of water land will be seen soon after starting the water addition. This milkiness is termed "turbidity."

Other publications have erred seriously on this point. They defined turbidity as a churning, as if it was going to get up and do a dance for them. It makes one wonder.

When this milkiness is seen, the heat should be removed, and the mix allowed to cool. Crystals of nitromannite will soon be evident. The milkiness was caused by small crystals of nitromannite forming in the solution. They formed because water is an even worse solvent for nitromannite than is cold alcohol. As the alcohol became progressively more watery, its ability to dissolve nitromannite went from bad to worse.

When this mix gets cold in the freezer or by packing in ice, the last of the nitromannitol crystals will have formed. They should be filtered out like the rest, and the alcohol which filters through should be thrown away.

The combined yield from the two crops of crystals is close to 50 grams. This packs the explosive punch of a comparable amount of nitro. For long term storage, the

crystals should be soaked with water to absorb any acids they might generate during storage. It can then be filtered before use

USE OF NITROMANNITE

In many respects the use of nitromannite is similar to the use of nitroglycerin. It requires about the same amount of force to set it off, and it delivers about the same yield of explosive power when compacted to rock form. There is a large difference, however, caused by the fact that nitromannitol is a fluffy solid, whereas nitro is a liquid. This fluffiness means that nitromannite is nowhere near as dense as nitro is. As was mentioned earlier, to get maximum detonation velocity, and therefore explosive power, the explosive must be as dense as possible. So the big problem with nitromannite is to get its density high enough to deliver its full explosive potential.

The most effective way to compact nitromannite is to melt the substance by packing it into a glass vessel which will be its ultimate container, and melt the crystals by setting the glass container in warm to fairly hot cooking oil. The crystals melt at about 110° C. When they cool down again, they will freeze into a solid rock. The same effect can be seen by packing snow into a container, melting the snow, and refreezing. The ice formed will take up quite a bit less space than the packed snow, so the substance is then much more dense.

This method is not to be recommended, because of the great danger involved. Nitromannitol becomes very sensitive at elevated temperature, so the heat required to melt large amounts of nitromannite could precipitate an explosion. The Home Workshop experimenter will have to settle for the increase in density which can be obtained just by packing the crystals into place. Care must be taken to avoid friction during the packing

process.

The serious experimenter may wish to try packing the crystals into a vessel, then wetting the crystals down by spraying them with some ether (starting fluid). This will melt them, and when the ether has evaporated from the container, they will be rocked and take up less space.

A different approach takes advantage of the properties of nitromannite to create a self-detonating booby trap device. In the methyl nitrate section, mention was made of an attack plan featuring a bottle of methyl nitrate taped with heat resistant tape or other loose yet durable attachment to the exhaust manifold of a car. Nitromannite is much more suitable for this usage for several reasons. First of all, it is safer to make. Secondly, the heat from the exhaust will first melt the crystals, making them much more dense and more powerful. Finally, nitromannite will not half boil away before it explodes like methyl nitrate will (boiling point of methyl nitrate, about 65° C). For these reasons, nitromannite is much more likely to give satisfactory results in this attack plan.

In a similar vein, attack plans utilizing fuses in contact with exhaust manifolds leading to detonators, and nitrogen triiodide crystal laid down to set off the nitromannite from the vibration of the engine cannot be ignored. A fertile imagination is not only a joy for life, but also the key to improvised detonation systems. Good results can be obtained by routes other than the standard blasting cap-explosive charge combo.

A pretty good plastique can be made from nitromannite, just by mixing it with vaseline. Other, more advanced plastiques can also be made with nitromannite by preparing silicone polymer gels and so on, but the marginal advantages of these plastiques (they can be used under water, and in very hot places) are hardly worth the greater difficulty of preparation they present. Also, the ingredients used to make these gel matrixes are not the type of things you go down to the hardware store to get. Unless you

90 *HOME WORKSHOP EXPLOSIVES*

work in the plastics or coatings field, you are unlikely to have easy access to them in less than 5 gallon pail quantities.

To make the plastique with vaseline, just mix 95 grams of nitromannite with 12 grams of vaseline in a stainless steel bowl. They can be mixed together by use of a rubber spatula. When a uniform mixture is made, the plastique can be wrapped in wax paper until use. A number 5 blasting cap or equivalent will set it off.

When making plastiques, one should use the small crystals of explosive produced by the recrystallization process. Using larger crystals made by melting the explosive or by means of solvent adds unneeded danger to the operation. The large crystals have a tendency to grind together too much during the mixing of the plastique. This could cause an unwanted and very unfortunate detonation.

Another helpful plastique mixing tip is to warm up the vaseline enough that it becomes kind of runny. Then when one adds the warmed vaseline to the solid explosive crystals, the mixing process is much faster and easier.

PETN

PETN, or pentaerythritol tetranitrate, is considerably more difficult to make than the other explosives considered to this point. Its preparation is not recommended for the casual experimenter, or for those with a clumsy streak in them. Its power and sensitivity is comparable to the other explosives in this book. It is also a crystalline solid, so it offers the same difficulties as nitromannitol in getting it compacted to maximum density for maximum power. If it were not for an extremely powerful and versatile plastique which can be made by mixing PETN with nitroglycerin, it would not be covered in this book.

There are several new difficulties encountered in the manufacture of PETN which combine to make this process a good deal more difficult than the preceding ones. First and foremost of these obstacles is the starting material, pentaerythritol (pentaerythrite). While it may be commercially available at about \$20 per pound, its purchase is definitely not advisable for the Home Workshop Explosives manufacturer. Its purchase would leave an all too recognizable paper trail, and could easily lead to suspicion or investigation either before or after usage. This leaves as the only viable alternative, making the pentaerythritol from simpler materials which are not subject to scrutiny, a tactic well known to drug manufacturers. This necessity to first make pentaerythritol makes this process a two-stage affair, with all the problems inherent to this approach. The biggest difficulty, other than all the work involved, is that the pentaerythritol must be refined to a high degree of purity before it can then be fed into the final stage of the process for conversion to PETN. The old computer programming slogan "garbage in, garbage out" holds doubly true in synthetic chemistry.

Another bad point about the two-stage nature of this process is the great amount of time which is required to make

allows himself to breathe in the fumes of formaldehyde and acetaldehyde. This reaction is best done outside with a steady breeze, the “cooker” keeping himself upwind throughout the process. If the watchful eyes of neighbors preclude this, a garage with a strong wind flow is acceptable. This may obscure the view of civic-minded citizens, but their noses are another enemy to be remembered. This process is best done in a secluded area.

To begin production, a clean plastic 5-gallon pail is filled with 2160 grams (2000 ml) of 37% formaldehyde solution, 210 grams (275 ml) of acetaldehyde, and 4 quarts of water. These chemicals do not need to be of a particularly high grade, so if money can be saved by using technical grade chemicals instead of reagent grade, then do so. Also, the formaldehyde solution can be replaced by 800 grams of paraformaldehyde. This solid form of formaldehyde does not have the powerful smell of the formaldehyde solution, but is much more expensive than regular formaldehyde. The 37% formaldehyde solution may be sold under the name of formalin, so be aware of this example of the proliferation of chemical synonyms.

Next, a clean wooden stick must be obtained. A section of broom handle minus the finish is a good example of what is called for here. This wooden stick is used to stir the solution.

First mix the ingredients already in the pail, then begin adding powdered quicklime (CaO , calcium oxide) to the pail in small portions with vigorous stirring. When the calcium oxide goes into solution, it first picks up a molecule of water, becoming $\text{Ca}(\text{OH})_2$, and then takes part in the reaction shown above. The CaO should be added at such a rate that the temperature of the mixture rises to 50°C (a little over 120°F) within the first half hour of adding the CaO . Then the CaO is continued to be added at such a rate that the temperature of the mixture does not go over 55°C (about 130°F). As can easily be imagined, the fumes of formaldehyde and acetaldehyde get pretty intense as the

solution gets hot. They get less revolting as the reaction nears completion and the aldehydes get consumed. The total amount of CaO added is 180 grams.

When all the CaO has been added, the stirring is continued at a more leisurely pace for another three hours. This long stretch of stirring is bound to tire even the most dedicated explosive manufacturer so an alternative which can be used where electricity is available is to suspend an electric drill or similar motor over the pail, and use a clean paint stirrer attachment to stir the solution. The fumes are not especially flammable, so fires are not the hazard they often are when dealing with more flammable chemicals. Even so, rigging an extra long stem for the stirrer, so the motor is elevated above the pail rim, is a wise precaution.

When the stirring is done, it is time to filter the now yellow-colored solution. A large coffee filter fitted inside a plastic funnel will do a good job of this. The total volume of liquid amounts to about 3 gallons. Contained in this 3 gallons, is about 3/4 pound of pentaerythritol. Now the real work begins as the workaholic explosives manufacturer isolates his product from the mixture.

First, the mixture must be made slightly acid. To do this, hydrochloric acid (the 28% strength material available from hardware stores is good enough) is diluted 50-50 with water. Then this diluted HCl is added to the mixture with stirring until the mixture is acid to litmus (turns blue litmus paper red). A good way to do this is to add 100 ml of the dilute HCl right away, and then after stirring and checking for acid reaction, add smaller amounts of acid until an acid condition is achieved. This will convert the calcium formate made in the reaction to formic acid and CaCl, and also knock out left over CaO. In these forms they are more easily gotten rid of.

Next, the yellow color can be removed by adding 30 grams of activated charcoal powder (Norite brand is usually used in the lab) and stirring it around for a few minutes. Then the solution is

once again filtered so as to remove the charcoal, and the filtrate is clear once all the charcoal has been successfully filtered out. Until then it is black, and the pail is a holy mess. Get a clean pail. This step can be omitted, but a yellow product will result which will be more touchy to convert to PETN without the dreaded red gas being formed. It will also not keep so well.

Now the solution must be reduced in volume so that crystals of pentaerythritol can form. To do this the water and other assorted smelly gunk must be boiled away under a vacuum. Formic acid and the unreacted aldehydes will be eliminated in this process. The first step in this adventure is to get a large enough container to hold the reaction mixture for the boil down. 5-gallon flasks are not commonly available to the public, but a good substitute is one of those thick glass water jugs often seen in offices for the water cooler. This is about 5 gallons in volume, and has a narrow opening which can be plugged with a one-hole rubber stopper, and attached to the vacuum source (either aspirator or water bed pump).

To get this process going, put the reaction mixture into the glass jug along with a couple small pieces of a Dr. Scholl's® pumice footstone (to ensure an even boil) and a chunk of paraffin wax the size of a small grape (to control frothing). The jug should be heated by means of steam, which can be supplied from a pressure cooker by filling it half full of water, clamping a section of automotive hose to the outlet on the lid where the weighted pressure control usually sits, and piping the steam produced from heating the pressure cooker into a cowling surrounding the jug.

See the drawing below:

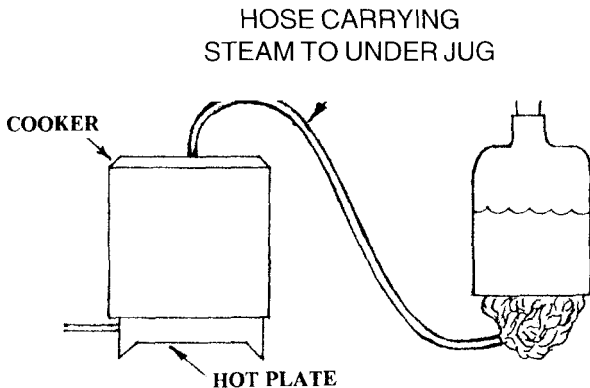

The jug should sit in a large pan and be lifted off the bottom an inch or so by use of a few wooden blocks. The steam hose is run under the jug so that the steam rises up around the jug to heat it. The cowl can be as simple as a plastic garbage bag draped around the jug. A drain hose should run from the bottom of the pan to a drain or sink to carry away the water formed from the condensing steam.

When the jug is reasonably warm, vacuum should be applied to it and the heating continued. The contents of the jug will begin to boil away. This should be continued until the volume of liquid in the jug is reduced from 3 gallons to one gallon. Then the heating is stopped, and when the boiling ceases, the vacuum is removed.

Now that the liquid has been concentrated, crystals of pentaerythritol can form. Just let the jug cool off in the refrigerator overnight. In the morning, the crystals can be filtered out.

The liquid that filters through contains more product. This can be obtained by boiling away until the volume of the liquid is halved,

i.e., reduced to 2 quarts. Upon cooling, a new crop of crystals can be filtered out. Repeating the process again, and boiling away the liquid down to one quart gives, upon cooling, another set of crystals. The remaining liquid can then be flushed down the toilet.

The crude product should be purified before use in PETN production. To do this, it is weighed, and an equal weight of distilled water is put into a stainless steel pan, or large pyrex beaker. The volume of water will be about a pint. The water is heated up on the stove, and the crystals are put into the water, along with 10 ml of hydrochloric acid. Mix them around until they dissolve, and boil just a little bit. Upon cooling, a large mass of crystals will appear. Filter them out. The liquid should then be concentrated down to about half its starting volume, and then cooled. Another crop of crystals will appear. By repeating this process a couple more times, about 350 grams of pure pentaerythritol will be obtained. It may be somewhat yellowish, but will work for making PETN. This product should be spread out on wax paper and allowed to dry thoroughly before use.

CONVERSION TO PETN

Compared to making pentaerythritol, PETN manufacture is a breeze. The amount of labor in the process is much less, and the volumes of chemicals which need to be handled are trivial in comparison.

The reaction here is the standard nitric ester reaction. In this case, pentaerythritol is the alcohol, and it is nitrated by means of nitric acid to form the nitric ester pentaerythritol tetranitrate (PETN). Here four molecules of nitric acid are needed for each molecule of pentaerythritol.

See below:

98 HOME WORKSHOP EXPLOSIVES

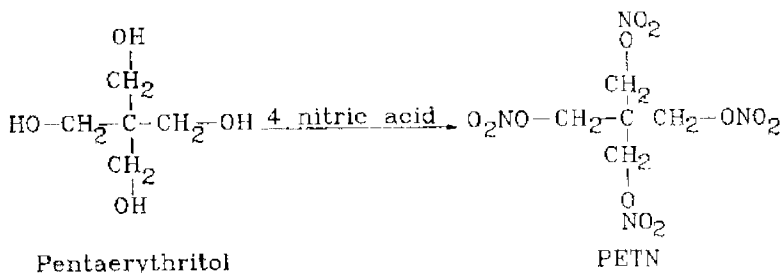

Yields are very good, with one gram of pentaerythritol giving 2 grams of PETN.

To begin manufacture, the nitric acid is first checked, It must be fuming nitric acid (90%) and the acid must be completely water white. Any traces of yellowish or reddish pink color, and the stuff must be purified according to the directions below. The fuming nitric acid made according to the directions in the nitric acid section is usually water white, especially if the vacuum used was strong.

To decolor nitric acid, 800 ml of the fuming nitric acid is poured into a clean, dry 40 ounce beer bottle, and warmed up by setting the bottle in a sink of hot water. When it is warm, a gram or so of urea is added to the bottle and mixed in. to stopper. . Through one of the holes, a section of glass tubing is run. It should be long enough that it extends into the middle of the acid. To get air flow, apply a vacuum to the other hole. This will pull air down through the glass tubing into the acid. Continue the airflow for a couple minutes and the color will be gone. Watch out for acid splashing up the tubing when the vacuum is removed.

Once the acid is clean enough to use, making PETN with it is fairly easy. First the 800 ml of nitric acid is poured into a large reaction vessel made of glass, with a pouring lip. A beer pitcher is a natural choice as the reaction vessel. The beer pitcher is nestled into a tub of ice. The ice should be heavily salted as in the nitromannite process in order to lower the temperature of the ice. The reaction temperature must be kept below 5° C (about 41° F) so salted ice is required to do this cooling job. As in the other processes, a pail of cold water should be close by to dump the batch into if it should go out of control. Next, 200 grams of pentaerythritol is weighed out. It is then put onto several clean plates and ground up into a fine powder by crushing the crystals with the bottom of a drinking glass, or other handy object. Once they are ground up, the temperature of the acid should be checked to make sure it is below 5° C. The temperature of salted ice can get down to 0° F, so the acid should cool quickly.

When the temperature of the acid is low enough (stir the acid to get an even temperature throughout the pitcher) pentaerythritol can be added to the acid in small portions with good stirring. The temperature must be closely watched during the addition to make sure it does not go above 5° C. Using the thermometer as the stirrer takes care of both problems at once. The reaction gives off heat, so the pentaerythritol must be added fairly slowly, especially if the acid was not very far below the 5° C upper limit to begin with. When the upper limit is neared during addition of pentaerythritol, stop adding it, and continue stirring until the temperature falls enough to allow putting more pentaerythritol into the batch.

When all of the pentaerythritol (200 grams) has been added to the acid, continue stirring it in the ice bath for another 15 or 20 minutes. Acceptable colors for the reaction mixture are clear, white, and yellow. If its color is red or pink, be careful as an

100 *HOME WORKSHOP EXPLOSIVES*

eruption of the dreaded red gas may be about to ensue. Be watchful for fumes bubbling from the batch.

At the end of the 15 to 20 minute stir period, it is time to end the reaction and begin to collect the product. To do so, the first step is to dump the batch into about a gallon and a half of ice water. Ice cubes should be floating around in the water because when the batch is dumped into the water, a good amount of heat will be given off. This is the heat of dilution of the nitric acid. A plastic pail with a pour spout is a good choice because after the batch is dumped into the ice water, it must be filtered, a job requiring it to then be poured out of the pail into a funnel.

So the batch is dumped into a gallon and a half of ice water. It is a good idea to stir the ice water as the batch is poured in to get the acid dispersed throughout the water. As the batch is dumped into the water, crystals of PETN will form. They will be white to yellow in color. They should be allowed to sit until the ice cubes melt in the pail.

Now it is time to filter out the crude crystals of PETN. A large coffee filter (cafeteria coffee maker size) put into a large plastic funnel will work well. Pour the batch into the funnel at whatever rate it can handle. The acid, water that filters through can be thrown away. The crystals in the filter are rinsed by pouring cold water over them while still in the funnel. About a quart of cold water, slowly poured, trying to reach all crystals will do the job.

Some crystals will still be clinging to the sides of the pail into which the batch was dumped, so a good idea is to flush them out of the pail with some portions of water and add them to their brothers in the funnel. The best time to do this is just before the one quart cold water rinse.

Now the coffee filter is bundled into a ball and the water is squeezed out of it. After the water is squeezed from the crude crystals the traces of acid on the crystals are eliminated. To do this, a couple quarts of distilled water are mixed with 20 grams of Arm & Hammer® bicarb and then the bicarb water is heated

almost to boiling. This is poured into a clean beer pitcher, and the crude PETN crystals are mixed in. They are kept in contact with the bicarb water with some stirring for about an hour. It is not required that there be constant stirring. Just enough to keep the crystals floating around (once every 5 minutes or so will give good results) is all that is needed. Then the crystals are filtered again, rinsed over with some more distilled water (about a cup or two), and then squeezed out. These crystals are then spread out on some wax paper and allowed to dry before moving on to the final stage in the purification scheme, recrystallization.

Recrystallization must be done because of the traces of acid locked inside the crystals from when they were originally formed when the batch was dumped into the gallon and a half of ice water. All of the rinses have not been able to get at the insides of the individual crystals. Also, the yellowish crud which was tainting the pentaerythritol will be removed during the same process, resulting in a fairly white PETN. The purer PETN keeps better and stores more safely.

The solvent used to recrystallize PETN from is acetone. A good quality acetone can be purchased by the gallon at the local hardware store. Look in the paint section. PETN is very soluble in acetone, so it is not the ideal recrystallization solvent, but it is common and cheap. Besides, the suggested method found in the scientific books can be modified to give better results.

To start the recrystallization, the crude crystals of PETN, amounting to around a pound of product, are put into a glass container of about a quart capacity. An equal weight (about 600 ml) of acetone is added to the crystals of PETN, and they are mixed with a glass or wooden rod. Do not use plastic as the acetone dissolves most plastics. A great deal of the PETN will quickly dissolve into the acetone.

Next, the acetone must be heated to dissolve the rest of the PETN. Since acetone is very flammable, great care must be used during the heating to avoid a fire. This operation should be

102 HOME WORKSHOP EXPLOSIVES

done in a garage or other structure that is open to wind blowing through it. Good ventilation is a must! Smoking is an invitation to disaster! Direct heat must also not be used to warm up the acetone. For example, setting the container holding the acetone-PETN mixture on a hotplate is a no-no because the fumes of acetone will come into contact with the burner and ignite. Likewise, a double boiler set-up is not going to work.

The acetone can be heated by boiling a large pan of water in another room, and carrying the boiling water to the garage and placing the container into the hot water. As an alternative, a pressure cooker half-filled with water can be set onto a hotplate upwind from the acetone, and steam from the pressure cooker can be carried via hose to the acetone solution, just as was shown in the drawing in the pentaerythritol section of this chapter.

When the acetone gets hot, the remainder of the PETN should dissolve with some stirring. If it fails to all dissolve, add some more acetone. The acetone should be heated to boiling (56° C) for maximum dissolving power.

Once all the PETN dissolves into the acetone, the first crop of pure PETN can be obtained. To get this first crop of crystals, just let the acetone solution cool down, first by removing it from the heat, then by packing the container in ice, and finally by putting it in the freezer. As the acetone gets colder, its ability to dissolve PETN decreases, and crystals of PETN form.

These crystals of PETN are filtered out either by using a vacuum system as shown in the nitromannite section (best) or by pouring them through a coffee filter and wringing them out. Plastic funnels must be avoided, of course.

The acetone which filters through still contains a very large amount of PETN. It is returned to the quart-size glass container and half the acetone is boiled off. This is best done by means of steam directed at the bottom of the glass container, via a hose from a pressure cooker. Acetone boils away quickly and easily.

When half of the acetone has boiled away, the heat is

removed, and once again the acetone solution is cooled down. This results in a second crop of crystals. They are filtered out, and the acetone which filters through is returned to the glass container.

This acetone which remains still contains a lot of PETN. The best way to get the PETN out of the acetone which remains is to drip 190 proof grain alcohol (vodka) or 91% isopropyl alcohol into the acetone with stirring. As alcohol is added to acetone, its ability to dissolve PETN decreases. This is because PETN doesn't dissolve well in alcohol, so adding it to the acetone makes the solution lousy at dissolving PETN. This method is much better than boiling away more acetone because that method leads to a final crop of crystals that are dirty. When the solution is about half alcohol, all the PETN should be out of solution in the form of crystals. This is filtered out, and the acetone-alcohol mix is then tested to see if all the PETN is out of it by adding some more alcohol to see if more crystals form. If they do, alcohol is added until no more crystals form.

If the PETN is coming out of solution in the form of an oil that sinks to the bottom of the container, this indicates that it is pretty impure, and that the alcohol was added too fast without enough stirring. All that can be done in these cases is to put it in the freezer, and wait for it to solidify into crystals.

The PETN crystals are transferred to a large sheet of waxed paper, spread out and allowed to dry. When the solvents have evaporated from them, the PETN can be processed into plastic. My favorite PETN plastic is made by mixing PETN with nitroglycerin. I like it because it is extremely powerful (more powerful than C-4), easily detonated, and made from readily available materials. Its lone drawback is that the ease of detonation also means that rough handling could set it off. It must be treated with respect.

To make this plastic, 80 grams of PETN are put into a stainless steel bowl, and then 20 grams (12 ml) of nitroglycerin is poured

over the crystals. This mass is mixed with a rubber spatula until an even, uniform plastic mass resembling Play-Dough is made. This substance can be wrapped in wax paper until used. A M-80 or cherry bomb will set it off. Nitroglycol can be used in place of nitroglycerin to give a material which works at low temperatures and which is somewhat harder to detonate.

Another plastic can be made from PETN by mixing 98 grams of PETN with 12 grams of vaseline in the same manner as with the previous plastic. This forms a plastic which is almost as powerful as C-4 and is able to withstand rough treatment like C-4. A number 6 blasting cap is required to set this plastic off.

This plastic has the disadvantages of not tolerating high temperatures well (the vaseline starts to melt and run away) and also not being usable underwater since the plastic will disperse into moving water.

Other plastics can also be made from PETN, and they can be made to very closely resemble C-4, but their manufacture requires the use of materials which are not readily available to the typical consumer. Since ordering these materials would leave a paper trail leading to the workshop, it is not recommended to try to duplicate C-4. The very minimal advantages are far outweighed by these other, more pressing considerations.

One very useful plastic formulation, however, uses very commonly available materials and produces an explosive mixture that increases the explosive power of the PETN, rather than decreasing it like vaseline does. The formula for this plastic can be found in US Patent 3,477,888, and it is just so simple that I know you will love it.

First the plastic binder is prepared. To do this put 100 ml of water into a pyrex or other heat resistant glass container. Heat up the water to boiling, and then add 200 grams of sodium nitrate or stump remover. One could substitute ammonium nitrate for the sodium nitrate or stump remover if one would prefer, but

then the amount added to the water should be doubled to get a saturated solution.

After some stirring, the chosen nitrate will all dissolve into the hot water. Then one should add 5 grams of potato starch to the boiling hot mixture. The best way to add the starch to avoid getting lumps is to put the starch on a small piece of wax paper. Hold it over the beaker and squirt the starch into the boiling water with a stream of water from a wash bottle, a squirt gun, or anything else handy for shooting a fine stream of water.

Stir the mixture, and make sure that there are no lumps of starch floating around. If there are, continue heating and break up the lumps. Then let the mixture cool. A sort of jelly will have been formed.

Now that the binder has been made, the plastic can be produced. Mix 20 grams of this binder with 80 grams of PETN. The usual mixing precautions should be adhered to. No rough treatment, and avoid grinding. Putting the materials inside of a baggie and kneading the mixture with your fingers outside the plastic bag is a good technique. The result is a plastic with a detonation rate of 8800 m/s. This is much more powerful than C-4! The same general plastic formulation can also be used with RDX, and other solid high explosives.

The biggest fault with this plastic formulation is that it is not at all water resistant. Exposure to rain will just wash away the binder in the mixture. A humid day is likely to cause it to absorb water from the air and become runny. One is therefore advised to keep the plastic inside the zip-lock baggie until it is time to use it.

RDX, also called cyclonite or cyclotrimethylenetrinitramine, is the last pure, single ingredient explosive which makes it into our fine family of easily prepared, high power explosives.

In many ways RDX bears a striking resemblance to PETN. It is about as sensitive and powerful as PETN, and both are crystalline solids which can be made into plastics. Beyond

this, the manufacturing processes for these materials are quite similar as well. In both instances, a two-stage manufacturing process is called for because the starting material for making RDX may be difficult to obtain without causing suspicion.

The starting material for making RDX is a substance called hexamethylenetetramine. It may also be sold under such names as methenamine or urotropine. If it can be quickly purchased on a cash basis, a price of about \$15 per pound is reasonable. If, on the other hand, this substance can't be so easily obtained, then once again, the route to follow is to make the starting material from simpler, non-suspicion-arousing materials. Luckily, hexamethylenetetramine is much quicker and easier to make than pentaerythritol.

There is another completely different method for making RDX, and it does not make use of hexamethylenetetramine as the starting material. However, that process requires acetic anhydride as a key ingredient. Acetic anhydride is central to the manufacture of several drugs, for example heroin and phenylacetone (the starting material for methamphetamine). For this reason, acetic anhydride purchases, and that whole other method of RDX production are to be avoided.

One could conceivably produce the acetic anhydride from simpler materials and then feed that material into RDX manufacture, but that is not such a good idea. The reason for this is because acetic anhydride manufacture centers around first making a substance called ketene (not ketane as was written in a pretender publication). This ketene stuff is god awfully nasty, fearfully poisonous, and to make things worse, is a gas. Its preparation is something which should only be attempted by a real pro with proper equipment. Its preparation is nowhere near so simple as would be inferred from reading those pretender publications. To get an idea of what is really called for in ketene production, check *Organic Syntheses*, collective volume 1, pages 330 to 334. Also, using the ketene to make acetic anhydride

is not so simple because an extremely effective fractionating column, almost a yard long, is required to get a clean product.

The method given here is much better because it uses simple and cheap ingredients that are easy to obtain. They are also pretty safe as far as chemicals go, with the exception of the fuming nitric acid. Also, these reactions are fairly easy, and result in mixtures that are pretty easily purified.

A well-ventilated garage is a good site for making the hexamethylenetetramine. The neighbors should not pay this process so much attention as the pentaerythritol process because the odor here is less intense and much shorter-lived. No special equipment is needed for this reaction either. All that is required is an electric hotplate with variable heat control, and a large enamelled dish to do the reaction in.

This large enamelled dish should be at least a gallon or so in capacity, and built to be able to withstand some heating and rough treatment. A very good choice is one of those roasting pans built to hold turkeys or hams. Look for one that is square or rectangular in shape so that the liquid may be poured out of the pan at the corner. The enamel can be substituted for with teflon coating.

To make hexamethylenetetramine, 2000 grams (1850 ml) of 37% formaldehyde solution is poured into the enamelled dish. Then to this is added 1100 grams (1200 ml) of ammonium hydroxide solution. As was mentioned before, this material is just ammonia dissolved in water, and may be sold under such monikers as strong ammonia solution 27%, or 58% NH_4OH or ammonia water 26 degree balme. The ammonia solution should either be cooled down in the freezer before use, or have 250 grams of ice added to it.

The ammonia is added slowly to the formaldehyde with good stirring. A fair amount of heat is given off in the reaction, and the reek of formaldehyde and ammonia will get intense for a while until all the ammonia has been added. Then all the formaldehyde

will be tied up, and only a weak smell of ammonia will remain. Stir some more to be certain that an even solution has been obtained.

The solution in the pan or dish contains about a pound and a quarter of product dissolved in a bunch of water. The task now is to obtain the hexamethylenetetramine, which is a crystalline solid, from the water. To do this, first the dish is placed on the hotplate, then heat is applied to it to bring it to a slow boil. As the water boils away, portions of about 15 ml of the ammonia solution are added to it every ten minutes or so. This is to ensure that enough ammonia is present to keep any formaldehyde which may be floating around unreacted, tied up.

When about half of the solution is boiled away, the heat should be removed from the pan and the solution is allowed to cool down to the point where it is about as hot as hot tap water. Then it is filtered through a coffee filter placed inside a plastic funnel. This is to remove any gummy material which may have been formed from the formaldehyde. This gummy stuff will quickly plug the filter, so be prepared to change the filter several times.

The liquid which filters through still contains the product. It is returned to the pan. Its volume should be a little over 2000 ml. It is once again boiled away until its volume is around 800 ml (1/3 or so of the previous volume). Now the first crop of product can be obtained. Remove the pan from the heat and allow it to cool, then cool it further either by packing the pan in ice or putting it in the freezer. As it cools, a large mass of crystals will appear.

These crystals are then filtered out by filtering them through the vacuum filtering apparatus shown in the nitromannite chapter. Feel free to pack them down a little with a spoon to help squeeze the liquid out of them. Then the crystals are dumped out onto wax paper. The liquid should go into a separate jug for temporary storage until all the crystals are cleaned out of the pan. A rubber spatula will be very handy for scraping the cling-ons off the walls of the pan.

When the first crop has been collected, the liquid is returned to the pan. Then the crystals of product are rinsed off. To do this, they are packed back into the filtering funnel; and rinsed off with 190 proof grain alcohol. A few rinses should remove the smell of ammonia from them. Then they should be spread out on fresh wax paper until they are dry. They should have no smell. They should also be clear or white in color.

The liquid which has been returned to the pan still contains a lot of product. To get it, first pour the liquid into a glass beer pitcher or similar container. Then about 10 grams of powdered activated charcoal is added to the liquid. If the lab brand of charcoal called Norit® is available, this is best. Otherwise, the various other types of activated charcoal will work so long as they are powdered up before use.

This activated charcoal will take up the yellowish color from the solution. First stir it in for a few minutes. Then set up the vacuum filtration system again, with double layers of filter paper. Pour the solution through it. A clear solution should result. If it is still black, all the charcoal isn't out of it. Wash up the system, change the filters, and filter some more. If it is still yellowish, add some more activated charcoal and continue.

The clear solution can now be returned to the original dish, and heat reapplied to it. The goal here is to evaporate the liquid to dryness and collect the crystals which are left when the water is gone. Heat it reasonably strongly at first, then steadily back off on the heat as the volume of liquid goes down. One does not want to burn the crystals. Finally, end up with just a warm setting, and drive off the last of the water. Then scrape out the crystals of product from the pan. The total yield of hexamethylenetetramine should add up to around 560 grams.

All the hexamethylenetetramine should be spread out onto wax paper sheets and allowed to dry. When it is thoroughly dry, it is ready to be turned into RDX. Very humid weather may cause

the crystals to soak up water from the air and melt, so beware of spreading them out to melt instead of dry.

PREPARATION OF RDX

Once the hexamethylenetetramine is dry, one is ready to proceed to turn it into RDX. This reaction is a good deal more touchy than the ones covered in the earlier sections of this book. If directions are not followed concerning acid strengths, temperatures, and reaction times and conditions, the dreaded red gas is likely to appear, or at least the yield of product will be ruined. Have no fear, however; all the little things which are likely to go wrong will be covered, along with the several right ways to do this reaction. So long as one stays on the right path, and off the road leading to disaster, all will be well.

RDX, unlike the other explosives covered in this book, is not a nitric ester. This means that the equilibrium equation presented back in the early part of the book can be ignored for this explosive. Instead, the factors most influencing yields in this reaction are kinetic. This means that there are several side reactions which occur at the same time as the desired reaction, and getting a good yield depends upon suppressing these side reactions, and encouraging the desired reaction.

One encourages and suppresses reactions by carefully controlling the time of reaction, the temperature(s) at which it is run, and the concentration of the ingredients, among other ways. Just how this strategy works for RDX production must now be explained.

First, we have the desired reaction, producing RDX from hexamethylenetetramine and nitric acid:

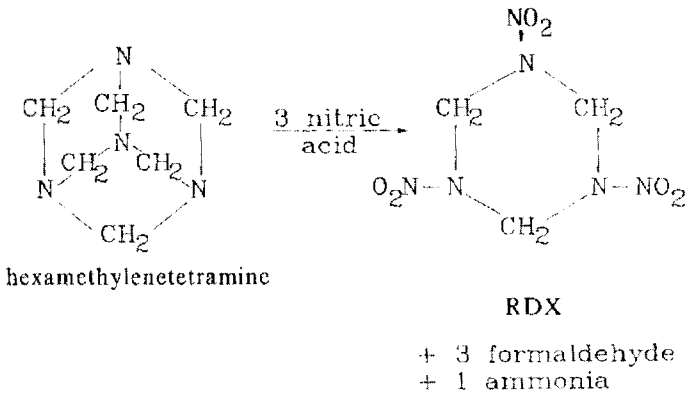

A very important competing reaction is the breakdown of the hexamethylenetetramine by water into its hydrolysis products, formaldehyde and ammonia:

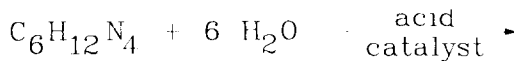

6 formaldehyde + 4 ammonia

The water finds its way into the mixture because water is the diluent for nitric acid, and even the 90% fuming acid obtained commercially is going to have 10% water as the diluent. The nitric acid made as directed in the nitric acid section will have next to no water in it, so long as the saltpeter was dry, and the glassware was dry. This is anhydrous nitric acid, and so avoids this side reaction, so long as the hexamethylenetetramine is dry, and the glassware is dry.

This side reaction is also greatly slowed down if the batch is

made at a low temperature. The cold temperature slows down the unwanted reaction quite a bit more than the desired reaction producing RDX. By doing the reaction at -20°C (0°F), an additional one sixth of product is obtained. This side reaction is further curtailed if the batch is not allowed to sit around any longer than is absolutely necessary before pouring it into water and ending the reaction. The best waiting period after the end of adding the hexamethylenetetramine to nitric acid, before dumping the batch into water, is about 15 minutes. This is about the length of time required for the last of the hexamethylenetetramine to dissolve into the nitric acid, with slow stirring.

Another side reaction involves nitric acid adding to the hexamethylenetetramine to form a salt. This side reaction is not so easily controlled as the preceding hydrolysis reaction. It just has to be lived with, and is the reason that the best yield one can get is around 75% of the theoretical yield.

With a good grounding in the ins and outs of this reaction, let's go on to see how these principles are put into practice. Using the commercially available fuming nitric acid of 90% strength (density 1.51), the same set-up is used as for the previous reactions. A beer pitcher makes a good reaction vessel, and it should be nestled in a tub of ice, with a 5 gallon pail of water nearby to dump the batch into in case it goes out of control and begins spouting red gas. One must be especially on guard when doing this reaction, because the onset of the dreaded red gas can be the result.

Then into the pitcher, 770 ml of the fuming nitric acid is placed. This acid should be cooled down beforehand by storing the acid in the freezer. Then 100 grams of hexamethylenetetramine is weighed out, and it is added to the acid slowly, in small portions, with slow stirring. A good tool to do this stirring is a section of glass rod, bent at a right angle about an inch before its end. This stirrer will look like an overly long hockey stick, and works like an agitator when slowly twirled

between the fingers. Overly fast stirring is to be avoided, because this contributes to an overly fast reaction which may get out of control and start to fume. The temperature of the mixture should under no circumstances be allowed to go above 20° C; and it would be best if it were held well below that temperature. Since one is starting with acid from the freezer, where its temperature should be around -20° C, this should be no hard task. The amount of time required to add all the hexamethylenetetramine to the acid is going to be about half an hour.

Then the slow stirring is continued, while a close watch is kept on the crystals of hexamethylenetetramine in the acid. When the last of them has dissolved, wait 5 minutes, then pour the whole batch into a gallon of cold water. The length of time between the end of adding the hexamethylenetetramine, and the point when it has all dissolved, is around 15 minutes. As was stated earlier, it is bad idea to let the batch sit around any longer than the recommended period. Once it has all dissolved, wait a few minutes, then pour it into the gallon of water.

When the batch is poured into water, crude crystals of RDX will form. They must next be filtered out, so for this reason, it is wise to choose a water container which will easily pour into a funnel for the filtering process. Three beer pitchers, each holding an equal volume of cold water ready to accept 1/3 of the batch, is a good arrangement.

Next the crude crystals of RDX are filtered out of the water by using the vacuum filtration set-up described in the nitroman-nite chapter. The best filter to place in the funnel is a piece of glass wool. This material can be found at any place selling aquarium supplies. It is called angel's hair. A piece of it is pushed down into place over the filter holes, and then wetted into place with water before beginning the filtration. This can be used for the nitromannite filtration as well.

Unlike the earlier explosives, the crude RDX can be kept and

used as is, once it has been well washed down with water while in the funnel. Some litmus paper comes in handy to tell when the last of the acid is being rinsed from the RDX. If a drop or two of the rinse water doesn't turn blue litmus paper red, then the acid is rinsed off the crystals. If this crude RDX is stored for any length of time, it should be stored underwater.

This crude RDX can be purified very well by recrystallizing it from acetone. For every gram of RDX, 10 grams of acetone should be used. Ten grams of acetone is 12.7 ml. The recrystallization is done like the previous recrystallization from acetone. The acetone-RDX mixture is heated by setting the container in hot water, and the mixture is stirred until the RDX dissolves. Then the solution is cooled down by packing the container in ice. A large amount of really nice looking RDX crystals form. They are filtered out, and the acetone solution is then boiled down to half its previous volume. Upon cooling, another crop of crystals form. Finally, water is added to the acetone solution to get the last of the RDX to precipitate out. This RDX has no acid in it, and stores really well.

The yield of RDX by this method is about 60%, which translates to about 95 grams of RDX per batch. The yield can be increased by a few grams if double the stated amount of nitric acid is used, but this is bad strategy considering the cost of fuming nitric acid. A much better strategy for increasing yields is to use the anhydrous fuming nitric acid that can be made according to the directions given in the nitric acid section. Use of this material gives a yield of around 110 grams per batch. To use the anhydrous nitric acid, one sets out pretty much as in the previous example, except that the ice must be heavily salted. This is because the reaction must be done at a much lower temperature. A temperature of around -20°C (0°F) is needed to use the anhydrous nitric acid. If the temperature of the batch goes much above this, the familiar penalty of the dreaded red gas is promptly dished out. Dry ice soaked down with rubbing

alcohol or acetone would do a great job of keeping the batch cold, if the dry ice is easily available in your workshop. Naturally, the nitric acid is taken straight from the freezer, and not allowed to warm up. The same quantities of ingredients are used in this method as in the previous one. A big difference, however, comes in the length of time required to add the hexamethylenetetramine to the acid. This time period should be roughly tripled to 90 minutes, so that the heat given off from the reaction doesn't get too intense. Then the stirring is continued slowly until all of the crystals are dissolved. After waiting a further 5 minutes, the batch is dumped into water as before and the previous instructions can be followed the rest of the way. When contemplating RDX production, one may be tempted to try to use the cheaper 70% strength nitric acid (density 1.42) instead of fuming nitric acid. This just does not work. At the usual temperatures, no reaction results, and at higher temperatures, red gas is made. There is an alternative method starting with 70% nitric acid, which is then watered down further, and hexamethylenetetramine is added to this. The resulting product is the nitrate salt which was briefly mentioned earlier as an unavoidable side reaction. This salt can then be isolated and added to fuming nitric acid to give RDX.

This route is not so good as the ones given above because more steps are involved, and the process is wasteful of hexamethylenetetramine. Also, the total yields are lower. Its only good point is that it uses roughly half as much fuming nitric acid. Since high strength nitric acid is easier to make than hexamethylenetetramine, the scales tip heavily towards the processes given here.

A very nice plastique can be made from RDX by mixing it with vaseline in the same proportions as for PETN. It is a little more difficult to detonate than the PETN plastique. A number 8 blasting cap is called for in this case.

If the material is being used straight, it can be set off with a

firecracker which has had some nitro soaked into the wrapping paper. To get maximum firepower out of the charge, it must be compacted to a higher density than the fluffy crystalline state.

Those who are very brave may wish to try melting the explosive into a solid rock. Those who are more sane may wish to try wetting the crystals with some acetone, and then allowing the acetone to evaporate away. When the crystals no longer smell like acetone, the acetone is gone. In no case would I try packing the crystals to compress them! The friction and rough handling may set them off!

AMMONIUM NITRATE MIXTURES

Ammonium nitrate has long been known to be capable of detonation. Its use dates back into the 1800's. Prior to roughly 1960, its main attractive feature was the fact that it is very cheap and easy to make. This feature brought it widespread use in quarries as the ammonium nitrate/fuel oil (ANFO) explosive. It has also been widely used in dynamites and in military explosives as a diluent and extender for more powerful and expensive explosives like nitroglycerine and TNT. If this was the extent of ammonium nitrate's usefulness, it wouldn't even be mentioned in this book. The old ammonium nitrate/fuel oil mixture has a detonation rate of 1500 m/s. When ammonium nitrate is mixed with high performance explosives such as nitro, TNT or RDX, the detonation rate of the mixture falls in a linear manner with increasing amounts of ammonium nitrate in the mixture. A 50-50 mixture of a high performance explosive with ammonium nitrate has a detonation rate half way between that of the powerful explosive and ammonium nitrate's value of 1500 m/s. Starting around 1960, a series of patents were issued for mixtures in which ammonium nitrate was the main ingredient, but yet the mixture detonated at rates comparable to military high explosives. One patent produces a mixture with a detonation rate of about 7000 m/s, which is greater than C-4. Now this is a topic worth writing about! Good quality ammonium nitrate isn't so easily available in large amounts as it was in the days before Tim McVeigh and his co-conspirators packed a Ryder truck full of it. The old ammonium nitrate fertilizer formula has been changed to a mixture containing ammonium nitrate, urea, ammonium sulfate, and other ingredients. To use such a fertilizer as a source of ammonium nitrate, one must extract the ammonium nitrate from the fertilizer mixture.

EXTRACTION OF AMMONIUM NITRATE FROM FERTILIZER

The first step in extracting ammonium nitrate from commercial fertilizer is to find a suitable fertilizer source. Pure ammonium nitrate would be labelled as 34-0-0, with the 34 representing the nitrogen content, and the two zeroes representing the potassium and phosphorus content, respectively. The old ammonium nitrate fertilizer which used to be quite suitable for direct conversion to explosive mixtures was labelled as 32-0-0. Good luck finding any of that anymore. If you can, you just saved yourself a lot of work.

In my fertilizer shopping quests, the most common fertilizer suitable for explosives manufacture was 15-0-0. If you can find a bag or box of fertilizer with a higher nitrogen number than 15, by all means choose that product. When shopping for fertilizer, read the ingredient list carefully! Be careful to pick out a product which supplies nitrogen primarily from ammonium nitrate. It will be listed first in the ingredients. If urea is listed first, then the nitrogen predominately comes from that ingredient. Always pick a product that has zeroes for the potassium and phosphorus content. One's aim should be to make the extraction process as simple as possible.

Now to extract the ammonium nitrate from the fertilizer, first crush the fertilizer granules using a rolling pin or any other suitable tool. This will expose the ammonium nitrate inside the granule and allow easy extraction. Next place the crushed fertilizer in a plastic pail or glass container. Never use metal containers. In particular, contact with copper must be avoided because a reaction will occur forming a copper azide which is dangerously unstable.

Then for each pound of ground fertilizer in the container, add a pint of hot water. Boiling hot water fresh off the stove would be

best. Stir the mixture for about 5 or 10 minutes. The ammonium nitrate will all dissolve into the hot water, and leave a lot of inert ingredients behind, undissolved in the pail.

Once the water has cooled down a bit, the mixture should be filtered. A doubled up coffee filter works pretty well at removing the undissolved fertilizer sludge. For larger runs, a pillow case should work almost as well. The filtered water should look clear. If there is suspended gunk floating around, filter it again.

The amount of liquid which filters out of the fertilizer will be less than one pint per pound of fertilizer. To recover the ammonium nitrate left trapped in the fertilizer sludge, add about one-half pint of water to the sludge for each pound of fertilizer originally used. Stir it around for a couple minutes, then filter again.

Now the amount of water filtrate should be at least one pint for each pound of fertilizer originally used. The fertilizer sludge can be thrown away, because now all the ammonium nitrate is in the water filtrate.

If 15-0-0 fertilizer was used, and if all the nitrogen came from ammonium nitrate, and if all the active ingredient was extracted from the fertilizer, each pint of filtrate would contain about 200 grams of ammonium nitrate. In the real world, extraction will be less than 100% efficient. Also, urea and ammonium sulfate will extract right along with the ammonium nitrate. Now one must go about isolating fairly pure ammonium nitrate from the extract.

Ammonium nitrate dissolves amazingly well in water. It dissolves so well that on a humid day it will suck water out of the air and dissolve itself, forming a wet puddle. It doesn't dissolve very well in ethyl alcohol, the "denatured alcohol" found in the paint section of the hardware store. Urea, on the other hand dissolves well in both water and alcohol. This will form the basis of our isolation procedure.

To begin isolation of ammonium nitrate, put the filtrate into a teflon coated pan or kettle, depending upon how much liquid one is dealing with. Now boil away the water until the liquid is

reduced to about 1/4 of its original volume, or until white crystals of ammonium nitrate form in the boiling liquid, whichever comes first.

Next, remove the pan or kettle from the heat, and let it cool down. When the liquid starts to reach room temperature, add two volumes of denatured alcohol for each volume of liquid in the pan. The alcohol should be added fairly slowly with strong stirring of the mixture during the addition of alcohol. Cold alcohol only dissolves 4 grams of ammonium nitrate per 100 ml of solution. By changing the solution to predominantly alcohol, most of the ammonium nitrate is thrown out of solution as white crystals. Chill the mixture down in the refrigerator to complete the crystallization of the ammonium nitrate product.

Once the mixture is cold, filter out the crystals of ammonium nitrate using doubled up coffee filters or a pillow case, depending upon how large the batch is. Squeeze the liquid out of the crystal mass, then put the crystal mass onto a plate. Spread it out to air dry. Obviously, this can't be done on a humid day.

When the crystals have air dried, put the plate into a microwave and heat it for about 5 minutes, or until the crystals are very dry and crunchy. Then finally put the product into a blender and grind the crystals while shaking the blender to get a nice and fine crystal size.

The crystals should now be poured into a plastic ice cream container or other plastic container with a lid which will seal against moisture from the air. This is important because of the ease with which ammonium nitrate absorbs water from the air.

The product obtained by this extraction will be pretty pure ammonium nitrate, contaminated to some extent with urea and ammonium sulfate. A little bit of urea doesn't hurt. In fact, some very powerful ammonium nitrate explosives purposely contain urea. See for example US Patent 3,546,035 and US Patent 3,546,034. The ammonium sulfate will probably not interfere

much with the explosive properties of the mixture, so long as it isn't present to a large extent.

AMMONIUM NITRATE FROM NITRIC ACID AND AMMONIA

The method of extracting ammonium nitrate from fertilizer is a fair amount of work, and gives an impure product when ammonium sulfate is present in the fertilizer. Fertilizer formulations may also be further messed with in the future in attempts to frustrate fertilizer extractions. This could happen very easily, as I've seen the same things happen in other areas in which I write. As a safeguard against that, and as a way to more easily make large amounts of ammonium nitrate, I will give to you Plan B, the direct synthesis of ammonium nitrate from two very cheap industrial chemicals. The low cost and ease of this procedure is the reason why ammonium nitrate became popular as a blasting agent, and as a diluent for military explosives.

Roughly equal volumes of concentrated nitric acid (70%) and strong ammonia (30% NH_3 , 56% NH_4OH) will react together to make a solution of ammonium nitrate in water. You already know that the other 30% in 70% nitric acid is water. The same is true with the strong ammonia. It is 70% water. After reaction, all that is required is to boil off the water. This is a nasty, violent, fume filled reaction, so I would make fertilizer extraction my first choice. To do this reaction, especially on a larger scale, you need good ventilation to keep yourself upwind from the fumes. You also need protective eyewear, and maybe an apron.

To do the reaction, take a glass or plastic container, and fill it no more than one-third full with nitric acid. Now procure a roughly equal volume of strong ammonia solution. Ace Hardware store sells an industrial strength strong ammonia solution as a janitorial supply. It contains no soap or other contaminants. Ask to see the MSDS to make sure you have the right product. Getting

122 *HOME WORKSHOP EXPLOSIVES*

industrial ammonium hydroxide, aka NH_4OH in a drum, would be best. This is some fuming stuff! Stay upwind, and wear eye protection!

This reaction is much too violent to just add the ammonia to the nitric acid. Some dilution to calm things down a bit is called for. Remove 25% of the ammonia solution which is destined to react with the nitric acid, and dilute it 50% with water. After good stirring to mix the water in, this ammonia solution can slowly with good stirring be added to the nitric acid. They react together violently, and produce a bunch of white fumes. This cloud of fog is nitric acid fumes reacting with ammonia fumes to make a bunch of small particules of ammonium nitrate in the air. Stay upwind of it! When the slow addition of the first 25% of the ammonia solution is complete, let the mixture cool back down. It is very easy to cause the whole mixture to come to a boil.

When the mixture has cooled back to near room temperature, measure out the next 25% of the ammonium hydroxide solution, and slowly begin to add this to the reaction mixture without first diluting the ammonia. The same violent reaction occurs, along with the cloud of white fog. The mixture will again heat up, and good stirring during the addition of the ammonia is required. Let the mixture cool down after this addition of ammonia.

When the mixture has cooled down once again, take the final 50% of the ammonia solution, and again slowly with stirring add it to the reaction mixture. The same white fog will be generated, along with lots of heat. When enough ammonia solution has been added to react with all the nitric acid, the smell of the solution should be fairly weakly like ammonia. A little bit extra ammonia won't hurt, but too little ammonia added will give a bad product.

Now we are ready for the boil down of the product. Put the reaction mixture into a teflon coated pan or kettle, and begin to boil away the water. Boil it down until crystals of ammonium

nitrate begin to appear in the solution. Ammonium nitrate loves to climb the walls of whatever container you put it in and crystallize there. That's not what I'm talking about. I mean crystals floating around in the boiling mass of liquid.

When this point has been reached, stop heating the mixture. Let it cool down to room temperature. The whole mass of solution will just set up as an ammonium nitrate cake. As it is setting up, one would be well advised to add one volume of denatured alcohol to the mixture, and continue the cooling in the refrigerator. Strong stirring during the addition of the alcohol!

Now that the mixture is nice and cold, filter the crystal mass. As in the fertilizer extraction, squeeze out the liquid from the filtered crystal mass, and put it on a dish for air drying. Once air dried, microwave the mass until dry and crunchy. Then blender grind it with shaking, and pour the powder into a sealable plastic container. The yield is about 600 grams of ammonium nitrate for each pint of nitric acid used.

ANFO

The simplest and most widely used ammonium nitrate explosive is the ammonium nitrate/ fuel oil mixture (ANFO). This material has long been a staple for miners and quarry workers because it is very cheap, and because the low rate of detonation characteristic to it produces a breaking and heaving effect upon the rock in which it is placed. They prefer this result over the great masses of pulverized rock which would be produced had a more brisant explosive been used.

When ammonium nitrate is detonated through the use of a sufficiently strong initiator it breaks down along the lines of the following equations:



The fuel-oil in the mixture serves twin purposes. First of all, the presence of the fuel oil makes the ammonium nitrate more sensitive and easily detonated. Secondly, once the ammonium nitrate is detonated, the fuel oil reacts with the oxygen produced by the ammonium nitrate and in essence burns. This produces some extra heat and “kick” for the explosive mixture.

Often, the detonation of this mixture is a good deal less than complete. Incomplete detonation can be caused from a number of things. If the initiating charge is not strong enough, the breakdown of the ammonium nitrate can take different courses than the one shown in the equation. Nitrogen oxides will be produced instead, and less energy released. Also, since the blast produced by this mixture isn't particularly strong, the detonation has trouble propagating itself through a fairly large mass. It just peters out and weakens as it goes. This effect is most noticeable when the explosive charge isn't confined inside a strong container, such as a mass of solid rock. To assure complete detonation, miners often run a section of explosive detonation cord (PETN) through the mass of the ammonium nitrate/ fuel oil mixture. An example of incomplete detonation comes to us from the reports of eyewitnesses to the Oklahoma City truck bombing. They reported that not only was a large cloud of nitrogen oxides produced by the blast, but also that the ground was littered with unexploded fertilizer prills.

It is very unlikely that Timmy and his friends were using the old ANFO recipe in their

truck bomb. Unfortunately, he didn't say much after being caught, and now he is incapable of saying anything. It is much more likely that Timmy was using some variation of one of the better ammonium nitrate recipes given later in this section. In that case, his incomplete detonation was most likely due to incomplete mixing of the ingredients in his charge. This practical demonstration of the difficulty of producing several tons of evenly mixed explosive using makeshift equipment is a lesson which

shouldn't be lost on the reader.

The ammonium nitrate/ fuel oil explosive mixture is made by mixing 94-96% by weight of ammonium nitrate with 4-6% by weight of fuel oil or diesel fuel. In European terminology, fuel oil is often called liquid paraffin. If you should happen to own a book by an author who didn't know what liquid paraffin is, now you have a leg up on that author.

The ammonium nitrate must be almost completely free of traces of moisture, otherwise it will not detonate. This same general rule is also true when ammonium nitrate is used as a diluent for high performance explosives. Anything in excess of 1/2 to 1% absorbed moisture will result in detonation failure. It is very easy for ammonium nitrate to pull that much moisture out of the air, so it is good practise to freshly rebake or remicrowave just before mixing it with fuel oil. Once mixed with the fuel oil, the explosive is largely protected from the effect of atmospheric moisture.

The amount of force required to detonate the mixture depends upon how finely ground the particles are. A fine powder will detonate if about an ounce of high explosive is put into it. Of course, one will then need a suitable detonator for the high explosive "booster charge". If fertilizer prills are used, one will likely need closer to a pound of high explosive to bring the mixture to detonation. A fine powder produces a higher rate of detonation than what results from larger particles. In any case, the maximum rate will be around 1500 m/s. When using finely ground particles of ammonium nitrate, beware of packing the mixture too tightly. This will make it very hard to detonate properly. This is probably the effect of the small gas pockets first mentioned back in the nitro section. Much more on this later.

The proper containers for all ammonium nitrate explosives are plastic, rock, or aluminum. Contact with copper or brass is especially dangerous! If a brass detonator is only in contact with the booster charge, this precarious situation may be tolerated in

a pinch. Assuring that no ammonium nitrate ever comes into contact with the brass requires more prayers to the explosives gods than I would prefer.

The low performance of the ANFO mixture can be improved a bit by mixing into the explosive about 10% by weight of aluminum powder. We'll cover this topic a lot more later. In the case of this explosive mixture, it just isn't worth the bother.

HYDRAZINE EXPLOSIVES

This mixture is a big step up from the ANFO recipe. By substituting a little bit of hydrazine and water for the fuel oil in the ANFO recipe, an explosive results which has a detonation rate roughly double that of ANFO. This mixture can be directly detonated with a larger 6 cap or larger, and the explosive wave propagates itself well through the mixture. That means that one is not limited in the diameter or the explosive charge which can be constructed.

The best thing about this recipe is that it purposely incorporates water into the explosive mixture. That means one doesn't have to go through elaborate drying procedures and moisture precautions to use homebrewed ammonium nitrate in an explosive charge. I like that point a whole lot, and this section will focus upon mixtures in which water is permissible.

The hydrazine / ammonium nitrate mix is essentially just a big oxidation / reduction reaction set to be kicked off with the addition of a detonator. Ammonium nitrate is an oxidizer, and hydrazine is a reducer. Fuel Oil, on the other hand is just an oxidizable substance. That in short explains why this mixture is so much more energetic than the ANFO recipe.

The recipe which will be used here is taken from US Patent 3,768,410. It is a very simple mixture. So simple that the inventors recommend that the ingredients just be taken to the

plasting site and mixed on the spot. This adds quite a layer of safety because then explosive mixtures don't need to be transported. The ingredients being transported by themselves are pretty resistant to detonation.

The mixture that the inventors recommend is 90% by weight ammonium nitrate, and 10% by weight of a liquid which consists of 50% hydrazine and 50% water. Hydrazine is a liquid which is sold commercially in a variety of concentrations. Hydrazine hydrate is the most concentrated of the commonly available hydrazine solutions. It is roughly 85% hydrazine and 15% water by weight. One could use that material just by diluting the hydrazine hydrate with some water until 50% by weight water mixture has been reached. Other hydrazine solutions are more dilute. A 50% hydrazine solution in water is the most commonly available mixture in commerce. 55 gallon drums of it are routinely sold every day. The most common industrial use for hydrazine is as an oxygen scavenger in boilers.

Before rushing off thinking that this mixture is the ultimate in clandestinely produced explosive materials, there is a strong warning which must be issued! Hydrazine is some god awfully noxious stuff! Contact of this liquid with the skin, or God forbid, eyes, will produce severe burns. The stuff also fumes. More so when it is warm than cold. The fumes also attack the eyes and the respiratory tract. The effect is often delayed, so there is no direct warning. Fumes in contact with the eyes will often produce necrosis of the surface tissues of the eyes. The effect is blindness, although with milder exposures this is temporary. The fumes have a similar effect upon the respiratory tract. In that case, the outcome is often fatal! If one is planning to mix significant amounts of hydrazine solution into ammonium nitrate, one would be well advised to do it outdoors and upwind from the mixture. Protective gear is strongly recommended. Once the mixture is made, it should be kept sealed up to prevent fumes from escaping.

The actual production of this explosive mixture is the

ultimate in simplicity. One simply adds 10% by weight of the 50% hydrazine solution in water to 90% by weight of ammonium nitrate. After mixing to get the hydrazine evenly spread throughout the ammonium nitrate, it is ready to go. The result is a fairly strong and very cheap explosive.

To make the explosive stronger, one might want to add roughly 10% by weight of aluminum powder to the finished product. The aluminum will cause a lot more heat to be produced during the detonation, and therefore more force from the blast. A reasonably fine aluminum powder can be obtained at auto parts stores. The product is called Alumaseal, and it is used to plug up leaky radiators.

Alumaseal produces OK results, but a much better and more finely ground product can be had from suppliers to people who do T-shirt silk screening. Aluminum powder is one of the things used to get shiny, sparkly effects. The two best ways to get this product are to either go to your local silk screener and talk him out of a fresh can, or alternatively talk him out of a couple of supply catalogs and order a can yourself.

In all cases, aluminum powder must be fresh to get maximum results. If the surfaces of the particles have oxidized, most of the effect will be lost. A fresh, unopened can of aluminum powder will give the boost this explosive mixture needs to make it roughly as powerful as TNT.

Another way to boost this explosive can be found in US Patent 3,419,443. By partially neutralizing the hydrazine with one quarter volume of nitric acid, a stronger explosive which can be "overdriven" with a quarter pound of booster results. The detonation rate then is around 7000 m/s. The neutralization is a very fume filled and dangerous operation which should be done in a set of glassware. A round bottom flask with stirring, claisen adapter and reflux condenser are required to partially neutralize the hydrazine with nitric acid.

When the hydrazine is partially neutralized before addition to the ammonium nitrate, the mixture doesn't fume nearly as intensely, nor does it bubble off ammonia gas when mixed with ammonium nitrate. If such glassware is handy, this is the way to go.

NITROMETHANE EXPLOSIVES

The explosive mixtures using nitromethane are the crown jewels of this section, the meat for our stew, if you will. The reasons for the primacy of the nitromethane formulas are twofold. First of all, the explosives produced using nitromethane are exceedingly powerful. They are much more powerful than the hydrazine based recipe just given, and they can even exceed the performance one would get from such staples of military hardware as C-4 or even pure RDX.

The second great advantage of the nitromethane mixtures is their ease of procurement. Hydrazine can be rather difficult to obtain, and once one has it, working with it can be a life threatening ordeal. In contrast, nitromethane can be easily purchased in gallon jugs at hobby shops, and neither its fumes nor skin contact with the material are particularly dangerous. Saints preserve us, one can even get drums full of the stuff at filling stations catering to racing enthusiasts!

The nitromethane products found at hobby shops are methanol solutions of nitro-methane, with the nitromethane content ranging from 10% up to 50%. The usual container is a one gallon plastic jug. That's enough to keep the typical model air plane flying for a while, so if one desires multiple jugs of product, it is a good idea to split up the shopping spree among multiple stores.

The presence of some methanol solvent in the nitromethane isn't harmful to explosive applications of the product. In fact, there are several patent formulations specifically calling for a mixture

130 *HOME WORKSHOP EXPLOSIVES*

of methanol with nitromethane and ammonium nitrate. It's just that after a certain point of dilution, the mixture isn't going

to give the desired results. As a general rule, any methanol solution of nitromethane stronger than 25% nitromethane will give that all encompassing KA-BOOM.

Weaker solutions of nitromethane can easily be strengthened just by distilling off the methanol solvent. Methanol boils at 65 C (150 F) while nitromethane boils at 101 C, so it is pretty easy to distill the mixture until the remaining liquid in the distilling pot is almost pure nitromethane. A crude distilling set up such as shown in the nitroglycol. section would work, but real chemical glassware is far preferable. Distilling a methanol/ nitromethane solution isn't dangerous other than the fact that both ingredients are very flammable. So long as there are no leaks in the still, and so long as the distillate is all condensed back to liquid before it exits the still, and so long as there are no open flames to ignite flammable fumes, all will go well.

Distilling nitromethane/ methanol mixtures is complicated by the formation of the methanol/ nitromethane azeotrope. This mixture boils just a couple degrees cooler than pure methanol, and will always distill out first until the methanol is all gone from the mixture. The azeotrope consists of 92% methanol and 8% nitromethane.

The practical implications of this azeotrope are twofold. The first implication is that any attempt to distill down weaker solutions of nitromethane is going to result in significant losses of nitromethane because the distillate is going to contain at least 8% nitromethane. It also means that attempting to distill down 10% nitromethane solutions is just a total waste of time. My advice is to buy the strongest nitromethane solution available.

To obtain larger amounts of nitromethane solution from a filling station or other fuel supplier to racers requires that a

deeper level of subterfuge be practised than is necessary at the hobby shop. You see, these suppliers have been informed by the authorities that nitromethane racing fuel can have other applications besides making one's engine run very fast. When approaching a supplier to obtain nitromethane, one's goal should be to look as much as possible like someone who spends half his waking hours either under a hood or at a track.

Rule number one is to dress the part. If your standard daily attire includes a towel wrapped around your head, the chances of success are near zero. On the other extreme, a suit and tie will likely induce a state of cognitive dissonance in the supplier, and that could easily lead to suspicion and reporting. Similarly bad attire would be a brand new racing suit fresh from the Nascar circuit, complete with car numbers and advertisements.

Correct dress for the part would include dirty and grease stained work clothes and hands. Either sneakers or work boots may be worn, and a racing hat is optional. A really effective ploy is to bring along a prop. The prop I have in mind is some old beater of a car, the hood removed, and the engine half torn apart. This prop should be towed on a trailer behind a pick up truck. A fairly large amount of work goes into producing such a prop, but when the goal is to obtain drums full of nitromethane solution at a reasonable price, the effort is well worth it.

Membership in the assorted subspecies of humanity also plays a large role in the probability of success of this acquisition plan. Play PC nitwit all you want, but first take a good look on TV at the NASCAR pit crews. After that, go to the local racetrack, and take an even harder look at the racers and the pit crews. The typical racer or crew member is white. There are some blacks, and if there are any of the Mexicans we now find ourselves up to the armpits in, I've never seen them. Other races are totally absent. In this respect, Tim McVeigh was the perfect customer for nitromethane. He was white and redneck looking. Even still,

132 *HOME WORKSHOP EXPLOSIVES*

his efforts to get nitromethane generated a report to the FBI. Whether this was before the actual fact of his bombing or after, I can't tell you. What I do know is that being white, knowing the difference between a carburetor and fuel injection, and preferably having a prop to how around are crucial to the success of this scam.

It is possible to make pure nitromethane explode. To make this happen, one needs a very strong detonator charge, and the nitromethane has to be confined in a container that will not burst easily. Without the strong walled container, the explosive wave just dies out. That's why nitromethane by itself isn't generally considered to be an explosive. The stuff is transported every day in drums by rail and highway without incident. If there should be a crash, it would burn like gasoline, and that's about all that would happen.

Then back in 1945, a man named Ed Laurence discovered that by mixing a small amount of an amine into the nitromethane, an easily detonated explosive more powerful than TNT is produced. Ed's patent application was immediately stamped "Top Secret" and kept under lock and key until 1966.

The military realized the great implications of this discovery. Nitromethane is very easily and cheaply made in potentially massive quantities by the vapor phase reaction of nitric acid and methane. This is a process which is far simpler and quicker than the production of any other of the high explosives. In the interests of national security, we had to keep this discovery for ourselves, and out of enemy hands. Then, beginning in about 1960, a series of patents were issued detailing basically the same invention. The cat was now out of the bag, so in 1966 he finally had US Patent 3,239,395 issued to him. By then it was too late for him to enjoy all the millions of dollars to-be made from this invention. That, however, doesn't mean that we can't enjoy the fruits of his labors.

Like a lot of great inventions, the body of Ed's patent is pretty simple. What he discovered was that by adding 2-5 0/0 by volume of an amine to the nitromethane, a mixture was produced which was fairly easily detonated, and which produced spectacular explosive results. To detonate his mixture he used a number 8 cap, the strongest commercially available. The cap had to be completely submerged in the liquid. Partially submerged caps failed to bring about detonation.

Virtually any amine will work, so long as it dissolves freely into the nitromethane. Better results are obtained from aliphatic amines than from aromatic amines. The amines which the inventor preferred are diethylamine and morpholine. Morpholine is a reasonably common industrial solvent used with waxes and resins, but for Home Workshop Explosive purposes one would be better off looking for ethylenediamine or diethylaminoethanol instead.

Ethylenediamine is a chemical used in photography. A well stocked supplier to photographers will have bottles full of this chemical sitting right on the shelf. It will have that brand name on it which begins with an "E" followed by the trade name of the product. I will not give out the product name here to avoid a panic which would result in this product being pulled from sale. All one needs to do is get a product catalog and some MSDS sheets to find which product I am referring to.

Diethylaminoethanol is even more easily available, and in large amounts. It's most everyday usage is as an additive to boilers to keep the steam they generate alkaline. This prevents the steam lines from rusting out. Drums full of the stuff with concentrations ranging from 10% in water up to 100% diethylaminoethanol are easily obtained from suppliers of boiler chemicals. A little bit of water is not harmful to the operation of this invention, so the 10% product is just as useful as the pure chemical.

Similarly, dilution of the nitromethane mixture with methanol

or petroleum doesn't prevent the invention from working. The dilution just makes the mixture more difficult to detonate, and the explosive force released is correspondingly reduced. To detonate a methanol solution of nitromethane, about one ounce of high explosive booster is needed. Really dilute solutions, such as one would get from the 10% nitromethane product would need even more booster.

If the liquid form of this explosive is inconvenient, one can simply mix it with sawdust. The exact amount of sawdust required will depend upon how finely ground up it is. The sawdust is mixed in until the product no longer drips liquid. This mixture keeps really well so long as it is sealed up to prevent the nitromethane and amine from evaporating away. Roughly one ounce of high explosive booster is required to detonate this mixture as well.

A relatively small amount of nitromethane can be parlayed into a veritable explosive bonanza by mixing it with ammonium nitrate. A LOT of patents have been issued for mixtures of nitromethane with ammonium nitrate. For example, US Patent 3,255,057 teaches that by mixing 84 parts by weight ammonium nitrate with 16 parts by weight of a 50% solution of nitromethane in methanol, an explosive is produced which is as powerful as high grade dynamite. Weaker concentrations of nitromethane could be used instead of the 50%, but performance would suffer. I wouldn't bother with any product under 30% nitromethane.

In their patent, they specify using fertilizer prills of ammonium nitrate, but finely ground ammonium nitrate made according to the directions in this section would also work. To enhance the performance of this mixture, one could mix in up to 10% by weight of aluminum powder. One could also try adding 2-5% of: an amine to the nitromethane solution as in the previous example. According to the patent, this mixture can be detonated with a number 8 cap, and doesn't need confinement for complete detonation.

A somewhat more complex mixture which packs an amazing wallop can be found in US Patent 3,419,444. This mixture is mainly ammonium nitrate and nitromethane, along with a few other easily obtained ingredients. The result is an explosive which detonates at a rate comparable to the highest quality military explosives. The reason for the great speed and power of this mixture is that it purposely incorporates tiny air bubbles into the explosive. As was mentioned before in the nitro section and other places in this book, air bubbles increase the sensitivity and the power output of an explosive.

In their standard recipe using pure nitromethane, they first put 17 parts by weight of nitromethane into a mixer, and then added one part by weight of nitrocellulose, and mixed the two until a gel was formed. Nitrocellulose is another name for gun cotton or smokeless powder, and it is easily purchased from reloading suppliers. Be sure not to get black powder for a muzzle loader. Read the label before buying!

Once the gel had been formed, they then added 60 parts by weight ammonium nitrate to the mixer, followed by two parts by weight of finely ground cork or balsa wood. The cork or balsa wood is the source of the entrapped air bubbles in the mixture.

Then with continued stirring, they added 19 parts by weight of water, followed by 2 part by weight of guar gum. The guar gum can be replaced by gum arabic, or even starch. If starch is used, it should be mixed into the water and heated until a uniform gel is formed. See the plastique recipe in the PETN section for the best methods of mixing starch into water.

They then just let the mixer continue to run until a mix. of "substantially uniform viscosity had formed". This means that the runny parts and the dry parts had all mixed together to get an even mixture.

When using nitromethane solutions in methanol, they followed the same procedure but cut back on the amount of water they used. For example, if the nitromethane was added as a 50%

solution in methanol, they cut in half the amount of water they put into the mixture. Nitromethane solutions down to about 30% strength will probably work fine in this formula.

To detonate this mixture, the patent specifies using 2 pounds of high explosive booster. That is no great problem if several hundred kilos of mixture are going to be detonated at once. However, for many applications that booster is going to be as big as the charge itself. How then would one make the mixture more sensitive to detonation?

One easy way to do it is to mix in some aluminum powder to the final product. That would not only make the mixture more sensitive to detonation, it would also increase the power output of the product.

Another approach would be to add 2-5% of an amine to the nitromethane prior to preparing this mixture. That would not only make the mixture more sensitive, but it too would increase the power output of the mixture.

Finally, one could try using a double base smokeless powder rather than straight nitrocellulose in the recipe. The double base powder contains nitroglycerine as well as nitrocellulose for some added WHOOMP! Such powders are commercially available, and are popular with large bore shotguns. To add some WHOOMP to a disappointing powder, simply add 5 parts by weight of nitro to 95 parts by weight of smokeless powder. Mix the two on some wax paper until they are evenly mixed, then mist the mixture with acetone until it is sort of moist. Then mix some more, and allow the acetone to evaporate away. The change is quite noticeable. If 5 parts by weight nitro in the powder isn't enough, one can easily go up to 10% or more.

The recipes given here are by no means all of the easily prepared high performance ammonium nitrate mixtures. One very popular "underground" recipe mixes 15% by volume of Bullseye brand reloading powder with 5% by volume aluminum powder and 80% by volume finely ground ammonium nitrate. In

this recipe, the ammonium nitrate must be very carefully dried, or the mixture will not detonate properly. A blasting cap by itself will bring this mixture to detonation.

A plastique version of this recipe uses roughly 20% by volume Bullseye powder, 5% aluminum powder by volume, 60% by volume finely ground and very dry ammonium nitrate, and finally 15% by volume of warmed up Vaseline is mixed in to make a putty of the mixture. A pan of hot water can be used to heat up the Vaseline.

Before leaving this topic, let's do some speculating as to what exact recipe Tim McVeigh and his co-conspirators used in their truck bomb. My reasonably educated guess is that they were using the formulation in US Patent 3,419,444, or some close variation on it. I say this because we know he was at least looking for nitromethane, and we also know from the reports of fertilizer prills on the ground that, ammonium nitrate was used. We had court testimony that he and his co-conspirators were at some backwoods location using a cattle feed mixer to grind together the ingredients of the explosive. US Patent 3,255,057 doesn't require a mixer. That nitromethane recipe just calls for the nitromethane to be poured on top of the fertilizer prills. By elimination, I come back to US Patent 3,419,444.

There is only one hole that I can think of in my theory. That is the existence of the fertilizer prills. The recipe in the patent calls for finely ground ammonium nitrate, not fertilizer prills. That's because in the recipe, they want the ammonium nitrate to quickly dissolve in the water portion of the mixture. Prills are designed to do just the opposite. They are designed to resist water.

Perhaps he overlooked this detail, or maybe he thought that the grinding action of the mixer would break up all the prills. He may even have thought that pre-grinding the prills would expose them to excessive moisture absorption from the air. I don't have a weather report handy for the day in question, and Timmy's lips are very tight these days.

In any case, even with incomplete detonation of his load, he still produced quite a blast. The nature of this blast has produced loads of conspiracy mongering over the years. That's because an overhead view of the blast shows that much more damage was done to the target courthouse than was done to neighboring buildings in other directions. This has caused speculation that in addition to the truckbomb, there were also charges placed inside the building on the support columns.

I rather doubt that because Tim McVeigh was a military man, and as such is aware that all good attack plans should be as simple as possible and yet still work. Getting people inside the courthouse with boxes of explosives would have greatly complicated the operation. It would have made it more likely to fail than to succeed.

How then was directionality of the blast achieved? Shaped charges have been in widespread use for well over 50 years now. The basic theory goes that if you take a block of explosive, and push a cone shaped indentation into the block, then the blast from that block will shoot mainly through the cone indentation. On a larger scale, if one stacked drums of explosive material into the back of a truck, and left a vacant area in the stacking in the shape of a "V", that is the direction the blast will mainly fire.

There are also reports of secondary explosions inside the courthouse. Isn't that evidence that charges were planted inside? Not necessarily, because that building was the headquarters for the FBI team which burned down the Mt. Carmel church in Waco. It's very conceivable that they had an arsenal inside their headquarters which was set off by the blast from outside.

There is one point on which I agree with the conspiracy theorists. The point is that there were more than two people involved in the construction of the explosive mass. So much work would more than wear out two persons during the course of a day. We are told that after the mixing of the several tons of explosive, it was loaded into 55 gallon drums. Each drum would

weigh around 500 pounds! If there was any testimony about forklift rental I never heard about it. To lift such a heavy drum onto the back of a truck and then stack it into place is a four man job. Just running that amount of material through a mixer would have left two people too worn out to continue.

GREAT BALLS OF FIRE... FUEL AIR EXPLOSIVES

The Army's 15,000 pound Daisy Cutter bomb and the spectacular fireball explosions we see in the movies are the two most familiar examples of the phenomena known as the fuel air explosive. The internal combustion engine could be added to this short list of familiar examples, but its workings are out of sight of the driver. Most people are not conscious of the fact that when they step on that accelerator pedal, they are gliding along due to the force generated by a series of fuel air explosions.

The mechanism of action in all three examples is remarkably similar. In the case of the engine, a little gasoline is squirted into the cylinder, mixed with air and vaporized. Then the spark plug ignites the mixture to produce an explosion which drives down the piston. In the movie special effect explosion, some gasoline is misted inside a wooden shack while the characters outside run for their lives. Then the fuel air mix inside the shack is detonated. In the ensuing pyrotechnic orgy, a giant mushroom cloud of flame rips the wooden shack into bite size pieces as the characters outside are tossed through the air like rag dolls. The orgasmic climax to the scene is then followed by a more quiet interlude as the prostrate people outside the shack are gently rained upon by the descending debris of the now demolished shack.

The military fuel air bomb is more complicated, but works along the same principles as the first two examples. The typical fuel air bomb consists of a mass of fuel which surrounds a core of conventional explosive. This core is the bursting charge for

the bomb. Its function is to produce an atomized cloud of fuel mixed with air. Then, just as the cloud has expanded enough to produce an explosive fuel air mixture, one or a series of secondary explosive charges go off which detonate the deadly cloud. The time elapsed between the bursting of the core and the ignition of the cloud is measured in milliseconds.

At first glance, it is surprising that the initial bursting charge doesn't also ignite the fuel air cloud it produces. The reason why it doesn't is the same reason why an engine requires a carefully controlled fuel air mixture. The fuel is only detonable within a certain range of mixtures with air. By the time that the initial bursting charge has expanded the cloud of fuel to the point that it is mixed with enough air to be explosively ignitable, the blast cloud has cooled down. The cooling is due to expansion, and the work done in atomizing the load of fuel. That's why very precisely timed secondary charges are used by the military to ignite their fuel air bombs.

One could easily devote an entire book to the intricacies of the military devices. Just the variety of fuels, from nitroethane and propylene oxide through polymeric mixes and thermite is a weighty subject. Each individual fuel has its own characteristic range of dilution with air in which it forms an explosive mixture. For example, acetylene is explosive when diluted with air anywhere in the range of from 2% up to 80% acetylene. On the other hand, heptane, which is basically gasoline is only detonable when it comprises 1 to 7% of a mixture with air. The timing then of the secondary charge has to be adjusted to fit the fuel so that it goes off when the cloud of fuel is diluted to the explosive range. I won't even begin to address the topic of how the delayed charges are scattered through the cloud of fuel and set to go off at the right time. The matter is beyond the scope of this book.

The simplest large scale fuel air device which one could construct is a few cylinders of acetylene and oxygen nestled into a mass of high explosive. Acetylene is explosive in its own

right. If one were to place a ring of plastique about an inch thick and four inches in length around the cylinder and detonate it, the blast would burst the cylinder and cause the acetylene to explode. The detonation rate of compressed acetylene is about 1800 m/s, so by itself it is a respectable explosive. By interspersing oxygen cylinders with the acetylene, the soot which is formed by the exploding acetylene will be ignited. In effect, this is a fuel air bomb coupled to a conventional explosive. It is a cheap and easy way to boost the effect of a limited amount of explosive.

“That was interesting to know” you might say, “but it doesn’t sound like much fun!” If it is fun with fuel air explosives that you want, check out this toy. With this you can amaze your friends and confound your enemies while at the same time singeing off some unwanted body hair. You will like this toy, I’m sure!

To construct this really amusing fuel air device, head down to the grocery store, and pick out a wide mouth plastic container with a screw on plastic lid. Glass and metal containers should be avoided. That’s because being shredded with shrapnel would detract from the joy of the toy. The size of the container can be anywhere from a quart up to a gallon, depending upon the size of the explosive fireball that one would like to enjoy. This design works with even larger containers, but they would cease to be a toy. The giant balls of fire they would produce would likely bring complaints from even the most tolerant neighbors.

Once the container has been emptied, drill a small hole through the center of

the lid. This hole should be just large enough for the fuse of an M-80 to fit through. Then take the M-80, and lay it on the inside surface of the lid with the fuse extending out through the hole in the lid.

Glue the M-80 into place on the inside of the lid using Elmer’s Glue, bathtub caulk, or epoxy glue. The glue should completely seal off the fuse from contact with the atmosphere which will be formed inside the jug. It would be anticlimactic for premature

detonation to ruin the experience of a properly formed fuel air blast.

When the glue has dried and one is ready to have a blast, add 25 ml of 190 proof vodka to the container for each quart of its capacity. The ethyl alcohol found in vodka is a good choice for this device because it forms an explosive fuel air mix when diluted anywhere from 3-19%-into air. Methyl alcohol would be even better because its explosive range is 6-36%. Poorer choices would be iso-propyl alcohol (2-12%) and gasoline.

Screw the lid onto the container, and lay it on its side. The wait a while for the alcohol to evaporate up into the air in the container. The amount of time required for enough alcohol to evaporate to make an explosive mix will depend upon how warm it is. It can be as short as a few minutes up to an hour in cold weather. Warm water can be used as a heater in the latter case.

Finally, we are ready for detonation. The fuse on an M-80 is much too short to simply light an run away. One would be caught up in the fireball, and this perspective is less enjoyable than viewing it from the outside. A delay can be rigged by lighting a cigarette and laying the body of the smoke against the fuse. Then as the devil stick burns down, a retreat to a safe distance can be executed. A more reliable method is to intertwine the fuse with some of the heating element wire covered in the detonator section. Then by passing some electric current through the wire, it will heat up and light the fuse.

In either case, the amazing sights and sounds produced when the M-80 goes off to send a cloud of fire expanding in all directions will have your friends talking about it for years to come. If there is any other toy which gives back so much fun while requiring so little effort to construct and use, I haven't found it. One can try enhancing the effects by elevating the container off the ground or by placing large objects near the container to see how far they are blown. The hours of fun can be endless.

A more serious fuel air device can be constructed almost as

easily as this toy. While still using commonplace items to construct the device, and not at all increasing its size, the output can be boosted from ten to one hundred fold. The plans for this "firework" can be found in US Patent 5,841,061 and US Patent H1457. The plan presented here is a hybrid of the two designs, incorporating the best parts of both.

To construct the Goliath fuel air bomb, start with a one or two liter soda pop bottle. The bigger bottle of course produces the bigger effect. All pop bottles of this size have the standard half inch diameter spout, so after drinking the pop get a section of half inch diameter PVC pipe. Now fill the pop bottle with water and tightly plug the end of the pipe with a rubber stopper. The stopper should be just a little bigger than the inside diameter of the pipe so that it sets really tightly in place and so that the head of the stopper isn't bigger around than the pipe.

Now insert the PVC pipe into the bottle until you reach the bottom. Mark the spot on the pipe where it emerges from the top of the bottle. Then pull out the pipe and mark the bottle at the top surface of the water. This mark on the bottle is the fill line showing the maximum amount of fuel which can be put in the bottle without dangerous and wasteful spillage.

Next one should proceed with making the PVC pipe into a bursting charge for Goliath. The stopper should be very securely glued into place at the bottom of the pipe, and the section of pipe sawed off at the point marked where it exited the bottle.

When the glue has dried, the pipe should next be filled just short of full with flash powder. The flash powder is very important because ordinary explosive would just blow up and atomize the fuel without then igniting it. Flash powder contains aluminum powder, and the lingering burning of the aluminum powder embers serve to then ignite the atomized cloud of fuel. Genuine flash powder is made from 7 parts by weight of potassium perchlorate and 5 parts by weight of aluminum powder. If these are unavailable, an improvised substitute can be made by mixing

aluminum powder into reloading gunpowder.

Then the powder should be packed down. The packing assures that the bursting charge will blow up rather than act as a rocket nozzle. Packing can be a touchy operation because unduly rough handling of the powder can cause it to explode with regrettable consequences. Take a round wooden stick just a bit smaller than the internal diameter of the pipe. Cover the end of the stick with some cloth, then push down on the powder with about 100 pounds of force. The stoppered end of the pipe should be on the ground or floor, and the pipe should be held upright by means of a sturdy support. The final packed volume of the powder should be just low enough to let another stopper be inserted in that end of the pipe. If that means adding some more powder and repacking, then do so.

Now take a one hole stopper, and run a section of fuse down through the hole so that about 2 inch of fuse extends past the bottom of the stopper. Rubber stoppers are for sale at the hobby shop. Bend the fuse around the bottom of the stopper so it doesn't fall out, then glue the stopper in place at the top of the pipe just as, at the bottom. Goliath is now ready for loading!

Fill the pop bottle with fuel up to the fill line. The fuel can be diesel fuel, gasoline, denatured alcohol, or methyl alcohol. None of these fuels will have bad effects upon the plastic pop bottle over a short period of time, so they are preferred. Other solvent fuels may dissolve a hole through the bottle, so experiment carefully. The alcohols have the advantage of wider air fuel explosive range, while diesel fuel has the advantage of less flame danger while launching due to leakage.

Wrap some teflon tape around the top of the pipe so that a very tight seal is formed as the PVC pipe is reinserted into the pop bottle. Now Goliath can be ignited. For maximum effect, it should be at least ten feet off the ground when it goes off. The most safe way to use such a large device is to light the fuse and

then launch the bottle skyward using an air mortar or related mechanical method such as a catapult. The fuse should be at least ten seconds long, and the moment of launching adjusted depending upon where one wants the detonation high in the air or closer to the ground. The launching mechanisms should be thoroughly tested using pop bottles filled with water before moving on to the real McCoy. If a misfire should occur, the only recourse is to run for cover as fast as possible before the fuse hits paydirt. See the Fun With Explosives section for details on air powered mortars and cannons. Be aware that once the PVC pipe is loaded into the bottle, there is only a limited period of time before the solvent works its way through the stopper and glue at the bottom of the pipe. The fuel will foul out the powder, and then there will be no BANG! The bottles should be assembled just before launching.

DETONATION SYSTEMS

Without a means of detonating an explosive, the products described in this book are nothing more than dangerous curiosity pieces. This often overlooked facet of explosive use generally is the point that trips up newcomers to the field. To procure or make explosive substances is a pretty straightforward operation. Rigging a detonation system, on the other hand, can seem mysterious by comparison. For this reason, conventional and improvised detonators must be covered. Since all explosives in this book are detonable by these methods, reference to this section can be made throughout the book. All explosives can be set off if they are struck with a sufficiently strong blow. The exact force required for detonation varies with the explosive in question. For instance, take the example of half frozen nitro slush. This is the most sensitive explosive covered in this book. It can be set off just by shaking the bottle which contains it. On the other extreme, many ammonium nitrate mixtures require the force of an exploding stick of dynamite or other high explosive to awaken their explosive properties. The other explosives fall somewhere in between these two examples. For instance, nitro or gunpowder can be set off with a moderate blow from a hammer or similar metal object, while TNT and military plastics require a heavy whack with a sledge hammer to bring them to life. Electric shocks can also produce detonation in many explosives. Among the most sensitive to electric sparks are guncotton and aluminum dust. The static electricity generated by walking across a carpet can easily cause these two to detonate. Most other explosives are far more resistant to electric discharges and require something near lightning bolt voltages to initiate detonation.

With this superficial intro to the topic behind us, let's move on to applying these principles to the practical task of detonating a Home Workshop Explosive. The simplest, safest and most reliable route to follow is if one has access to blasting caps. These little wonders are made specifically to do the job in question, and their performance is hard to top. So long as one uses the required size or larger, no problems will be encountered. The body of the blasting cap should be inserted into the explosive. With a large pile, a spot near the bottom is preferred.

Commercial blasting caps are some dangerous items because they are in essence small pipe bombs. Handling them is considerably more dangerous than handling most of the explosives covered in this book. They are susceptible to initiation either through rough treatment or by static electric discharges and should be used with the respect they are due.

When I was a youngster, explosive use was far more widespread than it is now. Many farmers had a case of dynamite sitting around in their shed to blast out stumps or large rocks. To use the dynamite, they of course had blasting caps.. Inevitably, the farmer's kids got into the blasting caps and set about detonating them because they were really great firecrackers. A few tragic incidents ensued involving blown off fingers and missing eyes, and so we were treated to public service commercials on the TV warning kids of the dangers of blasting caps. I remember well the sinister music playing in the background as a couple kids walked down the railroad tracks to come across a blasting cap. The explosive flash on the screen was followed by a warning to not touch the cap, and to call police right away. TV hyperbole aside, a commercial blasting cap is no toy. It is, however, far safer than attempting to rig up a homemade detonator.

The simplest and probably the most reliable improvised detonator is an M-80 firecracker. It very easily detonates liquid nitro, and is also strong enough to cause freshly prepared blasting

gelatin to explode. If one coats the outside of the M-80 with some wax, it can be largely submerged in the nitro or gelatin without the powder inside becoming wetted and fouled.

To detonate the more sleepy explosives such as ammonium nitrate with an M-80, one needs only to allow the M-80 to set off a charge of gelatin in the ammonium nitrate mixture, and then that charge of gelatin becomes the booster for the mixture setting it off.

The M-80 system has a couple of obvious drawbacks. First of all, it has a fuse that takes only a few seconds to burn down and set off the firecracker. This is far too short a period of time to allow one to escape the blast of any serious charge which may be set off by the M-80.

One can work around the short fuse problem by lengthening the fuse. Homemade fuse can be produced by wetting a section of string, rolling it in stump remover, and then hanging it up to dry. Such homemade fuse has a very unpredictable burn rate and so is not recommended. A more predictable delay for the M-80 fuse would be to light up a cigarette, then lay the body of the cigarette across the fuse and run away while the cancer stick burns down to light up the fuse. The amount of delay produced by both of these methods is limited, and neither of them can be considered to be "professional".

Another approach would be to intertwine the fuse of the M-80 with a section of toaster heating wire. Then by simply flicking a switch one could cause current to flow through the heating wire which would then light the fuse. An unlimited amount of delay can be had by this method, but it brings up the subject of the second objection to the M-80 detonator method.

The second objection to the M-80 detonator scenario is that it requires that one produce nitro, or its derivative, blasting gelatin, for the plan to be operable. Let's say, for example, that one is working with nitromethane mixtures. The mixtures can be either straight nitromethane/ amine, or nitromethane mixed with

ammonium nitrate. In either case, the chemicals required have nothing to do with making nitro for a booster charge. In this situation, one may be best served by using those small homemade pipebombs, the improvised blasting caps.

I'm not sure which of the two alternatives are more dangerous. I've made many small batches of nitro without incident. I feel comfortable with the stuff. So right now, I feel more apprehensive about the idea of stuffing an aluminum tube full of very detonatable materials, and then jamming an ignition wire down into the mass than I do with the idea of dealing with nitro, and all its temperamentalities. Let the reader be the judge here.

To construct an improvised blasting cap, one starts with thin walled aluminum tubing roughly one-quarter inch diameter. This tubing can be found at almost any hobby shop in roughly two foot long sections. The price is very reasonable. Don't even consider using other metals. In particular, copper must be avoided to prevent this very dangerous operation from becoming suicidal. Once the tubing is obtained, it should be cut into three inch lengths. These are the blasting cap bodies.

Now take each cap body, and pinch one end very tightly shut with a pliers. That is the bottom of your cap. Hold it up to the light to make sure there are no holes in the bottom. Then take a plastic straw of a size chosen to just barely fit inside the tubing, and put it inside your cap. This is the liner for your cap. Cut the straw so that none of it extends beyond the top of your cap. Finally, drip some model glue down into the bottom of your cap, and let it dry overnight. This will hold the straw liner in place, and also serve as a plastic liner for the bottom of the cap.

Once the glue has dried, and the cap bodies have been checked to make sure the liner is stuck in place, it is time to move on to making the igniter for the caps. Let's ignore the use of fuse in this section and only consider electric means of ignition. The simplest and most available electric igniter is heating element wire from an old toaster. By taking apart an old toaster, one can

150 *HOME WORKSHOP EXPLOSIVES*

get lots of this nichrome wire at no cost. This kind of heating element wire can also be found at hobby shops. If one goes shopping for it, one would be well advised to pick out the thinnest diameter wire they have. Thicker wire requires more current to heat up to a glowing red. When dissecting toasters, only choose junkers which have straight wire heating elements. Never mess with the coiled ones.

The sections of wire one would want would be roughly 8 inches in total length, and doubled up on itself so that it is shaped like a bobby pin or something similar. In this way, the loop of wire will extend down to the bottom of the cap, and still have about an inch of wire from each leg extending out the top of the cap. That's where the electrical contacts will be made on the wire. The typical toaster has lots of wire already bent in just the right shape, and the sections of wire are just a little bit longer than we want. Cutting is easy. The wires are wrapped around a heat resistant insulating board inside the toaster.

When the sections of heating wire have been dissected out of the toaster, the central section of the heating wire should be lightly spray painted. Leave the bottom half inch which has the loop bare, and leave the top half inch of the legs bare. The paint acts as electric insulator so that if the two legs come into contact inside the cap, they don't short out at the contact point. The point that we desire to become very hot is the bottom of this loop of wire. That's where it will be in contact with the primer.

To assure that this spot becomes very hot, one should next take a wire cutter and at the bottom of the loop of wire cut half way through the wire. If very thin nichrome wire is being used this step should be skipped because the wire will just break. The idea behind cutting a nick in the wire is pretty simple. This spot will be hotter than the rest of the wire because a smaller amount of wire will be forced to carry the current at that point.

If one is planning to use a battery to heat the ignition wire, the next step is to take one of the igniters for a test run. Simply wire

up one leg of the igniter to the plus pole of the battery, and the other leg to the negative pole. The amount of current required to quickly heat the igniter to glowing red hot depends upon the thickness of the wire. A very thick wire will be heated by nothing less than household AC current, while a flashlight filament will glow with a AA battery. A 9 volt battery is a good place to start experimenting with the wire in question. The spot *which* has been nicked should almost immediately glow red. It's best if within a few seconds it starts to melt. If one 9 volt battery isn't enough to quickly heat the wire, try two batteries hooked in series.

A 9 volt battery can push out a surprising amount of current when it is shorted. A few years ago, I put a battery into my pocket. There was also some change in my pocket. The prongs on the battery shorted against the change, and in no time at all the mass of change became uncomfortably hot. The fact that this is also a reflection of how debased modern coinage is with zinc replacing silver and copper doesn't detract from the large amount of current which was needed to heat up those coins. Nichrome wire is a far worse conductor than are coins, and the amount of current which can be pushed through it is primarily determined by the applied voltage.

Once a suitable power source has been determined, it's time to move onto cap assembly. First one puts the igniter wire into the cap. It should be positioned along the wall of the cap body so there is room to add other ingredients to the cap. Next add enough reloading powder to fill the cap about one-quarter full. The relatively safe part of the job is now done. From here on out, it's into the danger zone!

To journey into the danger zone, one should suit up. A heavy plastic face shield, leather jacket and leather gloves are a good start. Get some three inch long sections of one inch diameter pipe. Stand them upright on a work bench, then stand the caps upright inside them. The sections of pipe act as shrapnel catchers if the cap should decide to blow during the rest of the

loading operation. If one believes in the power of prayer, this is a great point to begin churning them out.

The powder must next be tamped down into the bottom of the cap. This is done so that when it is ignited it blows up rather than just fizzle away. To do this insert a Q-Tip into the cap body. Then grab the opposite end of the Q-Tip with a pliers and push down until the Q-Tip starts to buckle on you. By all that is right and good, the packing should be even tighter than this. One should use a metal rod and pack it with about 100 pounds of force. The danger inherent in *such* a reckless course should be obvious. Q-Tip packing will be tight enough to set off the main charge in the cap.

“Main charge! What the hell are you talking about?” you may ask at this point. To produce a number 8 cap, simply loading powder into the cap will not do. One must also add a charge of high explosive sensitive enough to be set off by the hot wire and the powder. Legit manufacturers generally use PETN as their main charge, but making that explosive requires high strength nitric acid and the procedure is fairly complicated. For this clandestine cap, I’ll illustrate construction using that old Moslem guerrilla favorite- acetone peroxide.

The notorious shoe bomber, the guy the media insists on calling Richard Reid while never showing a picture of his face, had shoes packed full of a plastique made with acetone peroxide. Those guys have developed a fondness for the material over the years. It’s a strong high explosive which is made from easily available materials. No nitric acid is required to make it. It is also very easily detonated stuff. The wonder is that the shoe bomber doesn’t have two stumps protruding from his hips.

Acetone peroxide is made by the reaction of peroxysulfuric acid with acetone. The peroxysulfuric acid is generated in situ by the slow addition of sulfuric acid to a mixture of acetone and hydrogen peroxide. To make this dangerously unstable explosive put 30 ml of acetone into a glass container. Acetone can be

obtained at the hardware store in the paint section. Then nestle the glass container in ice. Some salt can be sprinkled into the ice to make the cooling more intense. When the acetone has cooled down to about 50 F, add 50 ml of 6% hydrogen peroxide to the acetone. 6% hydrogen peroxide can be made by adding 4 volumes of water to one volume of 30% hydrogen peroxide. The strong hydrogen peroxide is available by mail order from a variety of outlets. The best ones are those catering to "alternative health" concerns. The 3% hydrogen peroxide found at the drug store will work to make the explosive product, but isolating the product crystals from such a dilute solution would be difficult.

When the acetone and peroxide solution has cooled down to 40 F, the sulfuric acid can be added. Liquid Fire drain opener found at hardware stores will work in this reaction, but the concentrated lab grade is better. Measure out 2.5 ml of sulfuric acid. Then with stirring, add the sulfuric acid one drop at a time. Watch the temperature of the mixture during the addition of sulfuric acid. One should not allow it to rise above 50 F. If it gets close to 50 F, stop adding sulfuric acid and allow the mixture to cool back down before adding any more sulfuric acid.

When all the sulfuric acid has been added, continue stirring for a while. Then put the container into a refrigerator for about one day. Crystals of acetone peroxide will form in the solution.

The next step is to filter out the crystals. A doubled up coffee filter is tight enough to catch almost all of the crystals. A buchner filter is far preferable to any sort of gravity filter. The filtrate should be flushed down the toilet, and the glass container should be immersed in water prior to a more thorough cleaning.

When the crystals on the filter have drained free of the reaction mixture, they should be rinsed off with about 10 ml of ice cold water. A mister is the best way to apply a good and even wash to these crystals. The rinse water should be allowed to drain free of the crystals, and it too should be flushed down the toilet.

The crystals should not be allowed to dry prior to loading them

154 *HOME WORKSHOP EXPLOSIVES*

into the caps. The crystals are very liable to detonation through friction, and loading them while moist (not slopping wet!) desensitizes them during this procedure. Scoop up some bits of the moist acetone peroxide using a plastic shovel. A section of plastic straw works well as a shovel. Avoid contact of the explosive with metal as it may adversely effect its storage characteristics. Load each cap with a volume of moist acetone peroxide roughly equivalent in volume to several split peas. This will be about one gram of wet weight.

Now once again don the suit of armor. Take a Q-Tip. Grab it at one end with a pliers, and use it to push the various pieces of acetone peroxide down into the powder at the bottom of the cap. Once you have pushed the mass down, leave the Q-Tip in place. The cotton swab will serve to absorb the residual moisture on the crystals, while slowing up the evaporation of the acetone peroxide. Yes, the stuff does evaporate, albeit fairly slowly.

Finally, take each leg of the igniter wire, and position it on opposite sides of the Q-Tip shaft. Cut a section of speaker wire roughly one inch long. Pull the wire out of it, then with a razor blade slit it down the middle so that one has two separate hollow insulator tubes. Slide these tubes down the two legs of the igniter wire until half of it is inside the cap body, and half outside. Then with a pliers crimp the top of the cap body loosely shut so that the wires, the Q-Tip, and the insulators are held firmly in place. Then apply some bathtub caulk around the top of the cap so that everything is sealed in place.

That completes construction of an improvised blasting cap. To use it, one simply attaches a wire to each leg of the igniter wire. Then by using AC household current or battery power, the igniter wire heats up and sets off the cap. The improvised cap should be handled at a distance using a cloths pin or pliers to manipulate it while wearing the suit of armor. Its shelf life is probably no more than a few weeks as a result of using that Moslem peroxide main charge.

Is this improvised cap an improvement over the M-80 and nitro or blasting gelatin system? I would say not. In my estimation, making nitro and then converting it into a sensitive gelatin is not only such safer, but also quite a bit easier. If a booster charge is needed to set off the explosive in question, then one would be looking at producing some gelatin for that purpose anyway.

One last word on gelatin before we leave this topic. The sensitivity of gelatin is strongly dependent upon just how much nitrocellulose has been mixed into the nitroglycerine. Freshly mixed up gelatin containing 7% nitrocellulose and 93% nitroglycerine can be detonated with a number one cap. If one increases the amount of nitrocellulose to 9%, then a number 4 cap is required to detonate the freshly prepared product. For the purposes of detonation, I would use from 5 to 6 per cent nitrocellulose in the mixture and just take the added precautions in handling it. Stuffing those little pipe bombs called improvised blasting caps is too much of a walk on the wild side for my tastes.

FUN WITH EXPLOSIVES

Fun and explosives are two words that are not generally associated together in the popular consciousness. However, one needs look no further than the large crowds which turn out for a good fireworks display to show that reality belies the conditioned perception of the masses. The TV news barons, anxiously clawing for anything which will gain a ratings point or two, are quite well versed in the true state of human *psyche*. That's why on the news shows in the past several weeks, I've seen aerial shots of Daisy Cutter bombs exploding at least a dozen times. That's why The History Channel just loves doing programs on the history of cannons, tanks, submarines, atomic weapons, and anything else which will allow them to flash explosive film footage on the screen. The truth is that people love explosions so long as they far enough away to enjoy the effect of the blast from the outside rather than being caught up in the tumult which surrounds the detonation point.

Nitrogen triiodide crystals are among the most amusing explosive toys. These crystals have the queer property of exploding at the slightest touch once they are dry. It's easy to imagine the hours of hilarity which could be generated by sprinkling some on an unsuspecting person's chair. The laugh riot could continue by spreading a few out in an area traversed by some particularly annoying cat or dog. Just as the possibilities are endless, so too are the comedic scenes which can be produced using these crystals.

Nitrogen triiodide is often made by high school chemistry teachers as a class demonstration to impress the students. Considering the sorry state of secondary education in this country, you can get an idea of just how easy this stuff is to make. If you are not brain damaged, you will have no problems.

To make nitrogen triiodide (NI₃) one first gets iodine crystals.

Iodine crystals (I₂) are black and heavy. A quarter pound should cost around \$20. If much more than this is charged, you are being ripped off. The crystals should be spread out on a plate, and ground finely using the bottom of a small glass. It is very important that a fine grind is obtained, or the product is likely to go off by itself during the drying process.

The other required ingredient is ammonium hydroxide. This is just a strong solution of ammonia in water, and it can be obtained with ease from mail order suppliers, or a pharmacy. The product one needs here is called ammonium hydroxide (NH₄OH). The strength level should be about 58% NH₄OH or 28% NH₃ or 26 degrees balme. All these mean the same thing; just one of the ways that chemists have to confuse the general public. Cost: no more than \$10 per pint.

A product that will just not do is the ammonia which can be picked up in the grocery store. This stuff is just 3% ammonia, and is loaded with soap to boot. It can't be made to work, either, by distilling the ammonia out of it. The soap in it begins foaming like crazy as it is heated up, making this operation futile.

With the supplies on hand and ready, NI₃ is made just by mixing one volume of iodine crystals with about ten volumes of NH₄OH. A glass measuring cup is perfect for this reaction. They should be allowed to react for ten or 15 minutes with occasional stirring. Beware of breathing in ammonia fumes from the ammonium hydroxide during this process. Good ventilation is a must.

Then a drip type coffee filter is placed in a funnel or other suitable holder. The funnel is then placed in the mouth of a beer pitcher, or other suitable container to catch the ammonia water which will filter through.

Then the batch is stirred up well to suspend all the crystals in the liquid, and quickly poured into the filter. Any crystals sticking to the cup can be rinsed out with some more ammonium

hydroxide, or scraped out with a rubber spatula.

The crystals of NI₃, which are black, should be lightly squeezed in the filter to free them from excess solvent. Then the paste-like product should be loaded, while still wet and stinking like ammonia, into the corner of a zip lock baggie. Here they may be stored for a while in the refrigerator to await further experimentation.

To get the feel of this substance, a few lumps should be taken out of the baggie and spread out to dry on a tabletop or cement floor. When it is dry, the smallest touch with any stick or similar probe will set it off. The blast which results can be really surprising. Another good line of experimentation is to stretch the stuff out in a long thin line and see how thin it can be spread and still get the whole line to blow off when any part of it is touched. Also, you should practice to see how long it takes to dry out larger lumps of the material. As should be obvious from the preceding sections, the NI₃ must be put into place while still wet, and have time to dry in place before it becomes activated for use. This is the reason why attention must be paid to drying times for various size lumps of NI₃. The time will vary with temperature and humidity because water is the main ingredient to evaporate off from the NI₃. NI₃ can be carried around safely in a baggie so long as it is still wet from being made. Once it dries, it is set to explode!

WARNING! The filter used in this process will itself become explosive when it dries because of the small pieces of NI₃ caught in it. It should either be flushed down the toilet immediately, or saved and treated like the dangerous explosive it is.

A much more serious level of explosive divertitude can be had with a remote control model airplane. These planes come ready built in a variety of sizes, or they can be custom built with kits available at hobby shops. The radio remote control allows these planes to be flown accurately a considerable distance from

the point of control. By boosting the power output of the remote, or by improving the antenna on the receiver, even greater radii of accurate control can be had.

If a person was to put a load of explosive into the fuselage of such a model plane, one would have in effect a remote controlled cruise missile. To complete the package, one would need a reliable detonator cap, batteries to set off the cap, and some means of causing the load in the fuselage to detonate at the desired moment. The method of causing detonation can range from the complex, such as a remote control radio detonator, to the very simple. A simple method would be a mechanism which closes the circuit between the batteries and the detonator cap when the front end of the plane crumples in as it hits paydirt. Such simple sliding mechanisms aren't hard to imagine but won't be detailed here. The title of this book is Home Workshop Explosives, not Homemade Bomb Workshop.

Along a similar vein, radio remote controlled boats ranging in length from two feet upwards are commonplace items in the hobby world. By packing the hull full of an explosive charge, one would then have a remote controlled torpedo capable of reaching out and touching targets in the water at a great distance.

Crowd control can be a nightmare in today's world. Just ask the victims of the 1992 LA riots who were sacked, killed, maimed and looted while the police hid out in their station houses. Luckily, the Army has experience with turning back rushing hoards and have developed a simple, portable device for the job called a claymore mine. In essence, the claymore mine is a mass of BBs or steel ball bearings placed in front of a sheet of plastique. When the sheet of plastique is detonated, the BBs or ball bearing are propelled forward into the marauders turning them into beneficial mulch. The design of the claymore is so simple that I won't devote any space here to drawings. Rather, the interested reader can feel free to experiment on his own. My only comments on the subject are that the sheet of plastique

should be at least a quarter inch thick, and that ball bearings take a larger amount of explosive force to propel forward than do BBs. The ball bearings would of course have a longer range while BBs would be more suitable for close in defense.

For those deeply concerned about perimeter defense of their property, there is the Queen of Battle, artillery. A compressed air powered cannon is easily constructed. Building them is so simple that I've seen them featured on the Junkyard Wars TV show. The bore size of the cannon can be chosen so that the common aluminum soda pop can will fit perfectly. This can, once loaded with an explosive charge, makes an efficient projectile. Air cannons easily propel a loaded soda can 100 yards or more. For details on building an air cannon, see US Patent 4,703,869. Your local library will gladly send for a copy of the patent upon your request. You can also read the body of the patent minus the drawings by going to the US patent office website, and typing in the patent number.

I have a couple of comments on the subject of air cannons. The bad thing about them is that they are muzzle loaders. If a person is using a lit fuse to detonate the propelled charge, the fuse must be long enough to allow one to light it, ram the can down the barrel of the gun, and then fire it before it explodes. The detonator must be jammed safely inside the can so that it doesn't fall out during the loading, launching, and landing. In effect, one is firing a grenade that will go off some time after landing and bouncing around on the ground. Accurate targeting could be a challenge. My second comment is that the outside surface of the pop can should be greased with Vaseline to make for a good air seal during launch, and to help lubricate the charge on its journey skyward. More consistent results will be obtained with a greased projectile.

For more close quarters defense, the air powered mortar is the perfect tool for the job. The muzzle of the mortar is shorter,

so the fuse length can be cut to get air bursts of the projectile. If the projectile is the Goliath fuel air explosive, great clouds of fiery devastation can be visited upon dug in besiegers. The siege will be lifted in short order, I assure you.

These few devices I've described here are by no means the end of the toys and practical tools which can be made using Home Workshop Explosives. This is the point at which the imagination and the ingenuity of the reader should take over. Fun with explosives can be as limitless as the human mind.

APPENDIX I: SAFETY

The acids used in the manufacture of these explosive compounds are dangerous and caustic materials, so a small bit of preaching is called for here to help prevent needless accidents from befalling careless experimenters. We all like to imagine that nothing bad can happen to us, but all it takes is a moment of inattention to result in a lifetime of misery.

The most crucial area of the body to protect when working with chemicals is the eyes. In comparison to the eyes, damage done to other parts of the body is minor and short-lived. For this reason, the sensible experimenter will wear clear plastic goggles. The best goggles are sold in college bookstores for use by chemistry students in their lab courses. These are cheap, easily bought and perfect for the job. An OK alternative is the large plastic eyeglasses with side shielding often used with chainsaws.

Eye protection should be worn whenever acids are being measured out, and while batches are being made. Not until the acids are washed away by flushing the product with water can the goggles be removed.

Some of the reactions in this book call for the use of chemicals like formaldehyde or acetaldehyde or ammonia. The same rules

must be followed for these materials. They *will* cause damage if splashed into the eyes. Beyond that, their fumes can cause similar damage. Good ventilation must be provided for their use.

The acids used to make explosives can also cause serious skin burns if they are allowed to sit on the skin for more than a minute or so. Vigilance is the best protection against this hazard, along with a willingness to rinse one's hands regularly when working with the acids. Rubber gloves can also be worn to protect the skin. Surgical gloves are the best because they leave the experimenter with a degree of nimbleness in the fingers. Next best are the "living gloves" popular with dishwashers fearful of "dishpan hands."

When fuming acids are being used, gloves are a must. This is because the acid fumes will settle on exposed skin and begin to burn. The arms should be similarly protected in these cases by wearing long-sleeved shirts. The importance of good ventilation, and of keeping upwind of the air flow is obvious here.

If the unthinkable should happen, and large volumes of acids are splashed upon your body, time is of the essence. You must run directly to the shower, jump in with all your clothes on, and flood the affected area with cool or lukewarm water while peeling your clothes off. A good rinsing for 10 minutes or so is called for, and can be followed with a rinse of bicarb solution.

At the end of a day's work, or just while on break, you can bet there are droplets of acid on your skin you didn't notice. These can be wiped out with a leisurely shower. The clothes should go directly to the wash, or they are going to have holes eaten in them.

Glassware coated with residues of acids or explosives are a very real, but often overlooked, source of danger. All utensils used in these processes should be thoroughly rinsed with water as soon as possible after use. When the items in question have been in contact with substances that don't dissolve in water, they

should be further rinsed down with rubbing alcohol or acetone until clean. When explosives are in solution, they are usually very hard to detonate. We can then consider these rinse materials safe to flush away. They may reprecipitate in the lines, but a good follow up with bleach should destroy most of them.

Major spills of explosives should never happen to the careful and conscientious manufacturer. Minor spills can be dealt with by following some general guidelines. If it was batch material before drowning in water, dilute it with some water, then soak it up in a bunch of Kleenex[®]. Follow this with some alcohol or acetone, depending upon what solvent the explosive dissolves in, and mop it up with some more Kleenex[®].

If it is more refined material, dilution with alcohol or acetone and mopping up with Kleenex[®] is the first step. Then for the solid explosives, rub in some vaseline on the area, and continue wiping it up. If you don't get it all, at least it will be made more shock resistant. In all cases, the dilution and mop up should be continued until it looks like all of the explosive is gone. The Kleenexes[®] can then either be flushed away, or carefully burned outside. An explosion may result from this latter course, so be prepared for the fireworks.

APPENDIX II: ASPIRATORS AND WATER BED PUMPS

The use of vacuum to filter liquids and to distill materials at more reasonable temperatures is central to many of the processes in this book. With the great importance assumed by a reliable source of vacuum for these operations, it would well serve any explosive manufacturer to become familiar with convenient sources of vacuum, and the hidden problems they pose.

The best source of vacuum for the lab operations described in this book is the aspirator, also called the water pump. Its bastard cousin, the water bed drain pump works the same way, but produces a weaker vacuum due to inferior engineering and construction. Let's take a quick look at these two devices to see how their performance can be optimized.

These devices work by running a cold stream of water through them. The rush of water down the body of the aspirator produces a vacuum in the side arm portion of the device. An automotive vacuum hose of the appropriate size can be attached to the side arm and led to the glassware needing vacuum. This hose should not be more than 3 feet long for highest strength vacuum.

Most aspirators and water bed pumps have a threaded section at their top to allow them to be screwed onto the end of matching threaded faucets. If this is not convenient or possible,

then a section of hose or plastic tubing can be fitted to connect the aspirator and faucet. A couple of hose clamps to keep everything together are called for when doing this. The water exit of the aspirator must also have hose connected to it to lead to the drain. This cuts down on splashing from the stream of water, and also results in a better vacuum. The flow of water out of the aspirator should be unimpeded, and the exit hose should be of larger diameter than the input feed line.

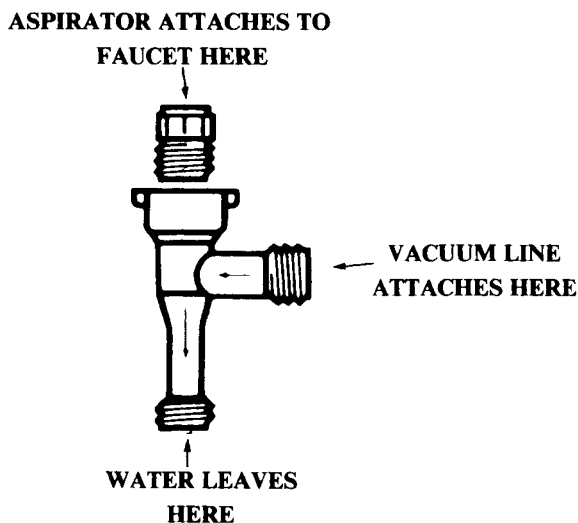

Water for the aspirator should be as cold as possible for best results. This is because the vapor pressure of water at the particular temperature of water being used is the best possible vacuum from an aspirator. Since cold water has a lower vapor pressure, the best vacuum will come with cold water.

A most annoying habit that these type of vacuum devices have is their propensity to puke water back into their vacuum lines. The root cause of this behavior is usually traced back to variations in water pressure or flow rate. Things like a toilet flushing or a well pump kicking on and off are typical culprits.

The way this back puking works is that a pretty good vacuum will get built up in a piece of glassware, just about equal to the maximum the aspirator can deliver. Then the water flow slows down and the amount of vacuum being produced by the aspirator goes down. The next thing that happens is that the stronger vacuum in the glassware proceeds to pull water down the vacuum line from the aspirator to the glassware. When the product one wants is anhydrous nitric acid or glycerin or ethylene glycol, this is a disaster. Good aspirators have valves to make this a less routine occurrence.

There are a few steps one can take to make this puking a very rare happening. First of all, city water supplies tend to have the pressure variations ironed out of them. No well pumps kicking on and off. This is the ideal water system for aspirators. Just turn the water on strong at the start and leave it there.

Secondly, the aspirator should be at a lower level than the glassware it serves. Six inches to a foot is a convenient level. This positioning of the aspirator forces any water that pukes back into the line to crawl uphill to get to the glassware. The delay won here is often enough to get the situation to straighten itself out.

Finally, watchfulness can catch a problem before it develops into a disaster. Be aware of the problem, and it cannot catch you by surprise.

BOILING POINTS UNDER VACUUM FOR ETHYLENE GLYCOL AND GLYCERIN

Since the best way to get a great quality ethylene glycol or glycerin from crude commercial mixtures is to vacuum distill the mixture to get the pure product, a table of boiling points for these two substances at various strengths of vacuum will be given to make it simpler to spot the product fraction. A fair amount of practice at vacuum distillation is generally needed

before one becomes a pro at it. See a college level organic chemistry lab text for a detailed discussion of vacuum distillation. Both ethylene glycol and glycerin are good substances to practice with because they are pretty safe materials.

Perfect vacuum = 0 mmHg Normal Pressure = 760 mmHg

mmHg	Ethylene Glycol (boiling points)	Glycerin
1	53° C	125° C
10	92° C	167° C
40	120° C	198° C
100	141° C	220° C
400	178° C	263° C
760	197° C	290° C

A well working aspirator running on cold water will give a vacuum of from 10 to 25 mmHg. Of course, the temperature at which the product will boil in any particular experiment depends upon the strength of the vacuum being produced by the aspirator on the given occasion. This can typically vary by about 10 mmHg. Very bad vacuums should be dealt with by looking for leaks at the ground glass joints (always use stopcock grease on these joints!). Other culprits can be collapsed vacuum hoses or ill-fitting rubber, glass or teflon stoppers. Corks can never be used because they always leak. Sometimes, the aspirator will be installed upside down. The threaded end should always be up.

APPENDIX III: OF INTEREST TO ALL

	
Glycerine 99.5% USP	
Used to make teat dip, or wherever glycerine is needed.	
#560A Quart	*6.95
#49960 Gallon.....	*18.25
FOB weight 12 pounds 4 or more gallons,	
each.....	*17.25
FOB weight 12 pounds per gallon	

This 99.5% pure USP grade glycerin is available by mail, no questions asked, from:

Northern Wholesale Veterinary Supply

PO Box 7526

Omaha, NE 68107

The toll free number is:

1-800-356-5852

I'm sure they would be more than happy to send a catalog of all their products to anyone who asks for one. The company does most of their business with farmers, veterinarians, and

others engaged in animal husbandry, so they are not what you would call world famous. Their extensive selection of high quality antibiotics are also a must for those of us into survival. After all, you can't run a protracted guerrilla resistance without a nice stockpile of antibiotics. It is also safe to say that after the big ones land, production of antibiotics will fall sharply. The farsighted man will stock his freezer now. Look for USP grades; they are fit for human use.

YOU WILL ALSO WANT TO READ:

- **34044 SILENT DEATH, Second Edition, by Uncle Fester.** Underground chemist par excellence Uncle Fester turns his attention to poisons — and the result is *Silent Death*. A complete guide to poisons, their administration and detection. *Sold for informational purposes only. 1997, 5½ x 8½, 149 pp, illustrated, soft cover. \$16.95.*
- **25081 VEST-BUSTERS: How to Make Your Own Body-Armor-Piercing Bullets, by Uncle Fester.** What do you do when you're attacked by armed invaders who are wearing Kevlar body armor? If you followed this book's clear, concise instructions, you're ready to drop them in their tracks! Don't be a victim... be a victor instead! Give yourself the winning edge, and learn how to make your own body-armor-piercing bullets! *Sold for informational purposes only. 1996, 5½ x 8½, 72 pp, soft cover. \$12.00.*

Check out my website! www.unclefesterbooks.com

Home Workshop Explosives is a guide to making demolition-strength explosives. It contains detailed, illustrated instructions for fairly simple procedures using readily available materials and supplies.

The explosives in this book are not the weak kind used in rock quarries. Rather, they are powerful mixtures with dramatic explosive properties. Explosives covered are:

- Fuel Air Explosives
- Nitroglycerin
- Nitroglycol
- Nitromannitol
- PETN
- RDX (cyclonite)
- Ammonium Nitrate Mixtures

Home Workshop Explosives also covers the main ingredients for most of these explosives: nitric acid and sulphuric acid. It includes a chapter on detonation systems, and detailed safety instructions.

Powerful explosives cannot be purchased without a well-documented need. But they can be made at home. *Home Workshop Explosives* is sold for informational purposes only.

\$20



Powells.com
SINGLE
3935-337 \$20.00
Home Workshop Explosives