

*Black Book Companion:*  
*State-of-the-Art Improvised Munitions*  
Copyright © 1995 by Paladin Press

ISBN 0-87364-577-4  
Printed in the United States of America

Published by Paladin Press, a division of  
Paladin Enterprises, Inc., P.O. Box 1307,  
Boulder, Colorado 80306, USA.  
(303) 443-7250

Direct inquiries and/or orders to the above address.

All rights reserved. Except for use in a review, no  
portion of this book may be reproduced in any form  
without the express written permission of the publisher.

Neither the author nor the publisher assumes  
any responsibility for the use or misuse of  
information contained in this book.

# Contents

Preface	vii
Lead Nitrate	1
Lead Azide	4
Mekap Primary Explosive	9
Sulfuric Acid	11
Explosive "D"	14
Starch Nitrate	16
Optimized Process for RDX Manufacture	20
PETN	22
Semtex	26
Furnace	29
Hydrogen Azide	33
Ethylene Glycol Dinitrate	38
Dynamites	42
Castable Impact-Sensitive Explosive	45
Copper-slug Charge	47
Shotshell Antipersonnel Mine	54
Canister Grenade	57
Canister Grenade Launcher	62
Counterforce Charges	65
Det-cord 55-gallon-drum Charge	68
Offensive Hand Grenade	70
Poison-filled Hollowhead Ammunition	72

**FOR INFORMATION PURPOSES ONLY**

HC Smoke . . . . .	76
Simplified Compound Detonators . . . . .	79
Fuming Sulfuric Acid (Oleum) . . . . .	84
Potassium Cyanide . . . . .	87
Hydrogen-cyanide Grenade . . . . .	91
Chlorine Generator . . . . .	96
Appendix A: Amendments . . . . .	101
Appendix B: Chemicals . . . . .	111
Appendix C: Primary and Secondary Explosives . . . . .	117

# Preface

*Black Book Companion* is written to amend and add to the information covered in *Black Book*, volumes 1, 2, and 3. It can be used by itself or in conjunction with the *Black Books* and other books of the same nature. The authors have compiled a mass of information, added their own ideas, and have organized it all into the easy-to-use *Black Book* format.

We at G&T are constantly on the lookout for new ideas and information. We would greatly appreciate receiving any new ideas or comments about our work. Please keep a copy for yourself, as we will not be able to return anything sent to us.

Send correspondence to:

G&T  
*Black Book Companion*  
% Paladin Press  
P.O. Box 1307  
Boulder, CO 80306

## LEAD NITRATE

Lead nitrate is used in the manufacture of lead azide, and can be used as a strong oxidizer.

# Warning

The procedures in this manual, the inherent toxicity of the materials, and the resulting end product are *extremely dangerous*. Whenever dealing with high explosives and potentially harmful chemicals, special precautions *must* be followed in accordance with industry standards for experimentation and production. Failure to strictly follow such industry standards may result in harm to life and limb. Furthermore, the manufacture of the products in this manual is illegal and will result in stiff legal penalties to the offender.

Therefore, the author and publisher disclaim any liability from any damages or injuries of any type that a reader or user of information contained within this manual may encounter from the use of said information. Use this manual and any end product or by-product at your own risk. *This manual is for information purposes only!*

## MATERIALS

Lead metal pieces, lead shot, or pellets

Nitric acid

Glass or ceramic jars

Glass stirring rod

Heat source

Paper towels

## SOURCES

Sporting goods outlet, small lead scrap

Field grade (Sec. I, No. 4)

Hot plate, etc.

## PROCEDURE

1. Fill jar half full with nitric acid. Place jar on hot plate and heat gently (do not bring to simmer).

**CAUTION:** Acid will destroy clothing and burn skin. If any is spilled, wash it away with a large quantity of water. *Do not inhale fumes.*

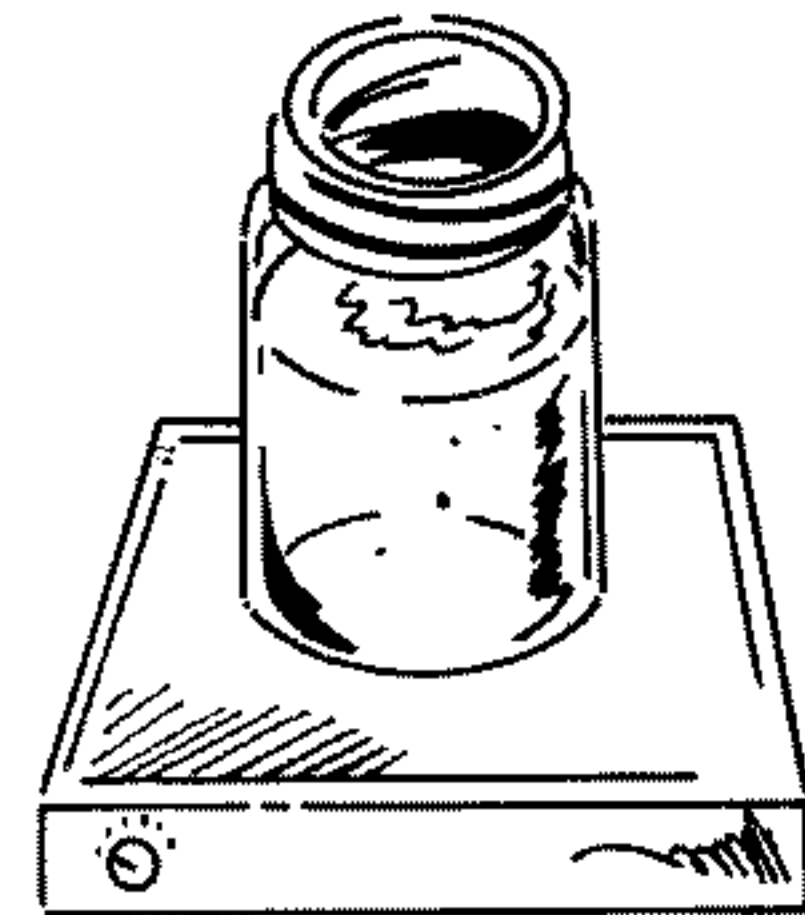

FOR INFORMATION PURPOSES ONLY

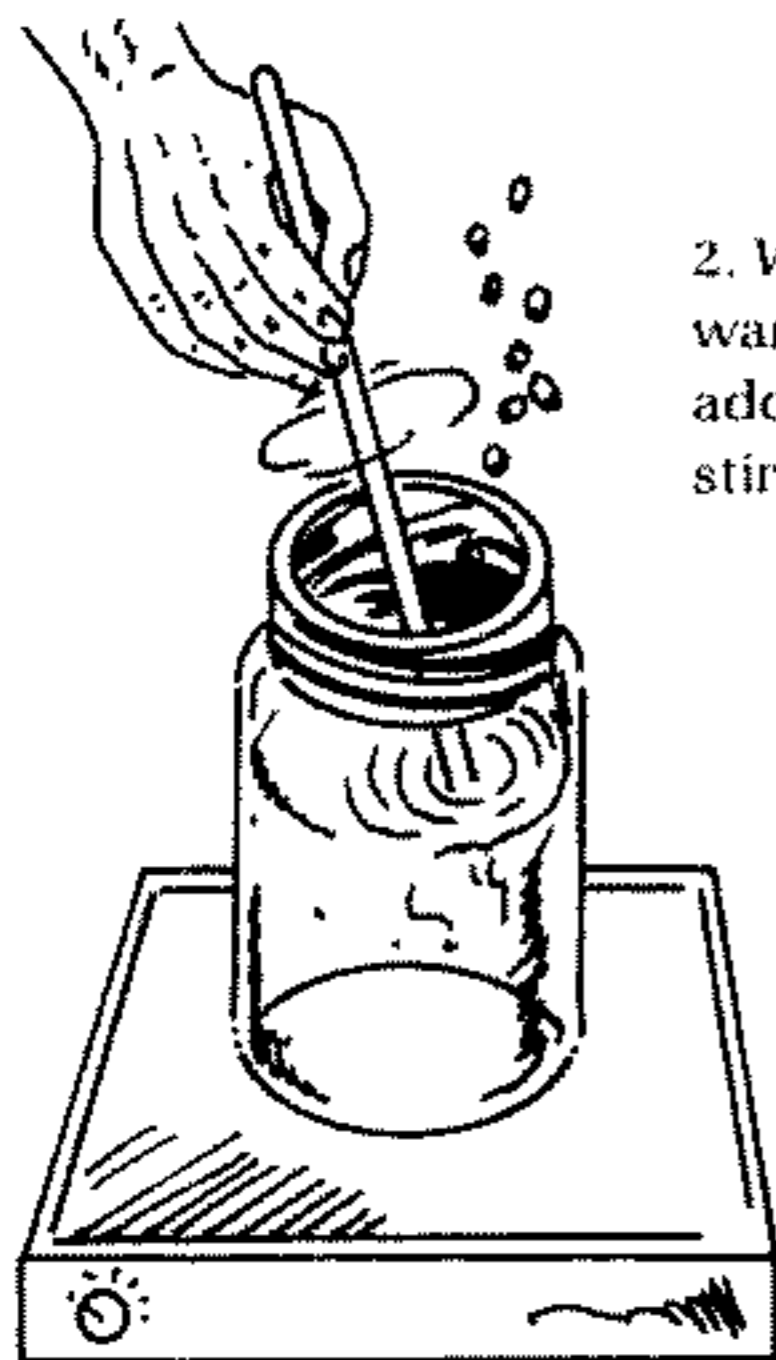

2. When outside of jar is warm to the touch, slowly add lead pieces while stirring.

3. Continue to add metal while stirring until no more dissolves. Increase heat but do not allow liquid to boil. Continue to add the lead.

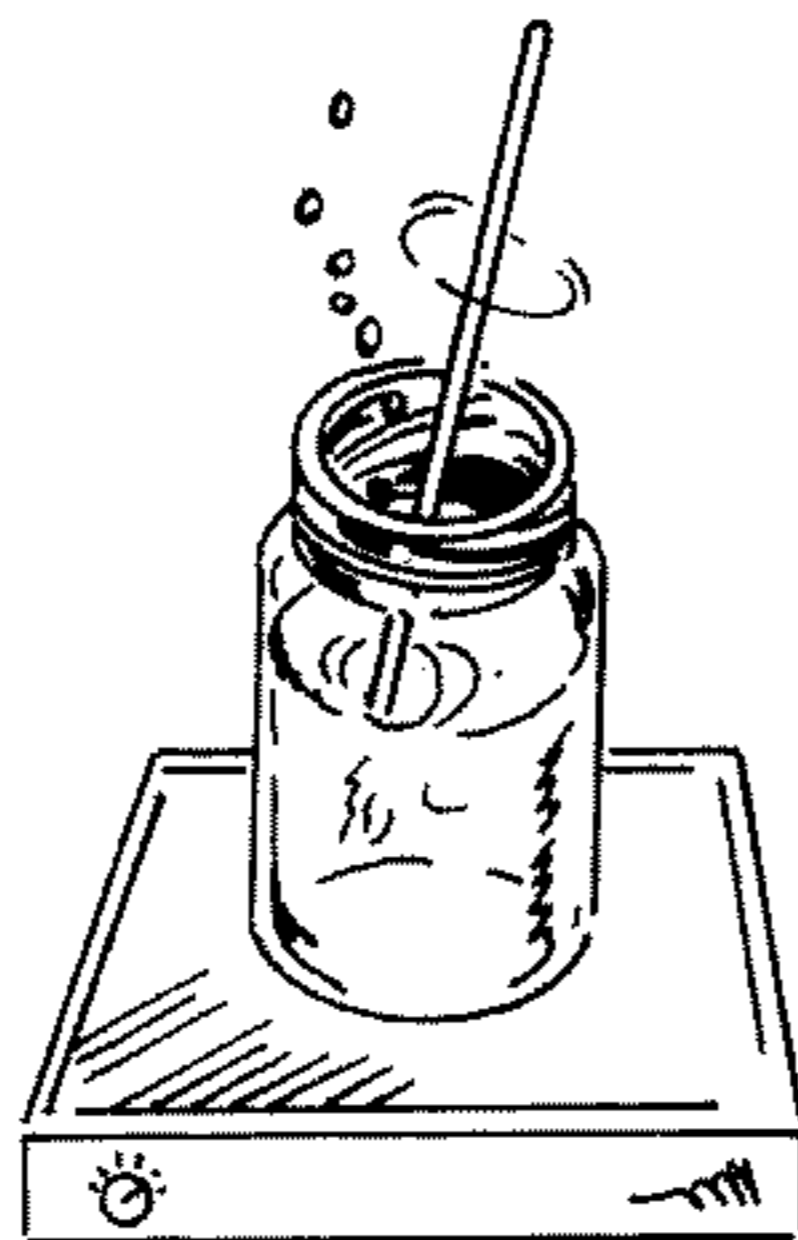

2

FOR INFORMATION PURPOSES ONLY

4. When metal no longer dissolves, take jar off of heat and allow to cool. Let it rest at least 6 hours.

5. Filter liquid through paper towel into a glass container and discard unreacted metal.

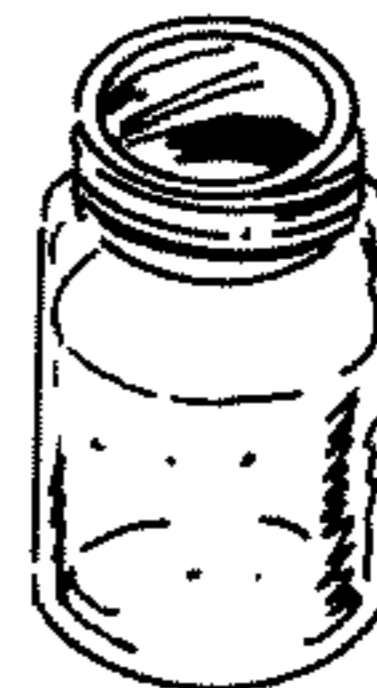

6. The liquid can be used to make lead azide, or it can be evaporated to obtain lead-nitrate crystals. To make crystals, put solution in warm (200°F) oven until liquid is gone.

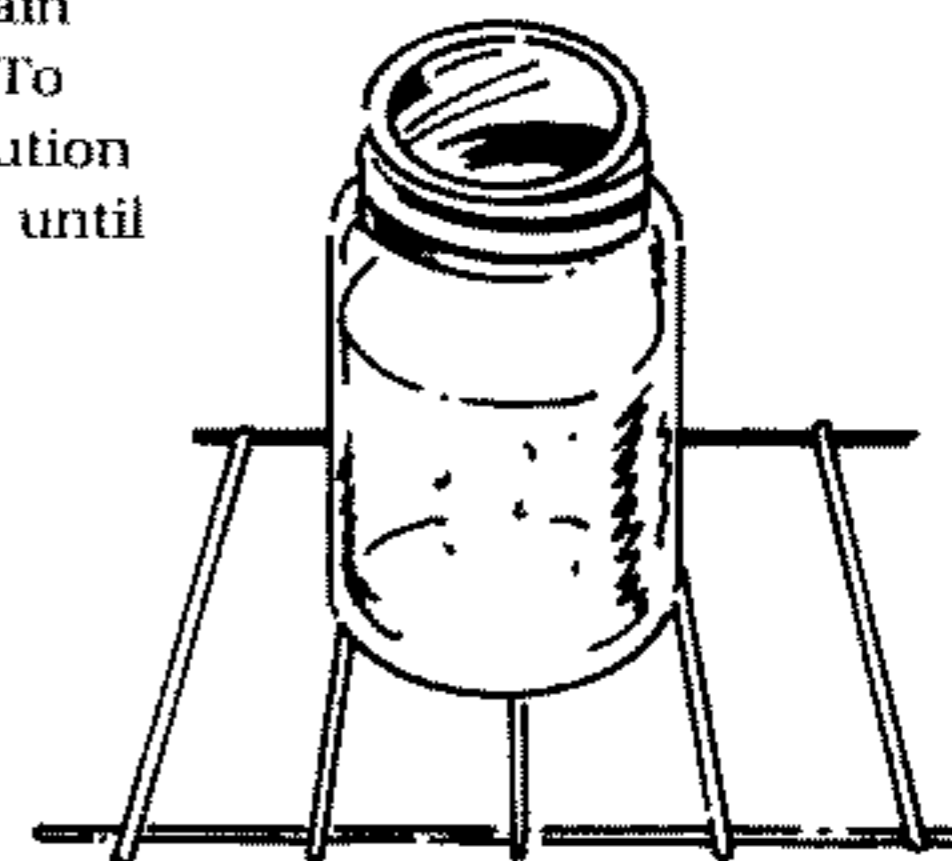

3

FOR INFORMATION PURPOSES ONLY

Section I  
No. 41

LEAD AZIDE

Lead azide is a powerful primary explosive that is well suited for improvised detonators because it is relatively easy to make and is the second most effective initiating explosive for improvisation (next to DDNP, Sec. I, No. 19). However, lead azide is not very flame-sensitive, especially when compressed. Therefore, it is necessary to add to the lead azide a small amount (a  $\frac{1}{8}$  to  $\frac{1}{16}$ -inch layer) of another flame-sensitive primary explosive or sugar-chlorate igniter mix to insure ignition.

MATERIALS

Lead nitrate

Sodium azide

Sodium hydroxide

Dextrin or corn starch

Large jar

Large Pyrex bowl

Water

Paper towel

Thermometer

Container

SOURCES

Improvised (Sec. I, No. 40)  
or chemical supply store

Chemical supply or  
photography supply store

Crystal drain opener

Chemical supply or  
grocery store

FOR INFORMATION PURPOSES ONLY

PROCEDURE

1. Put 2 cups of the lead-nitrate solution in the bowl and add a teaspoon of the sodium hydroxide. Heat gently to 50-60°C.

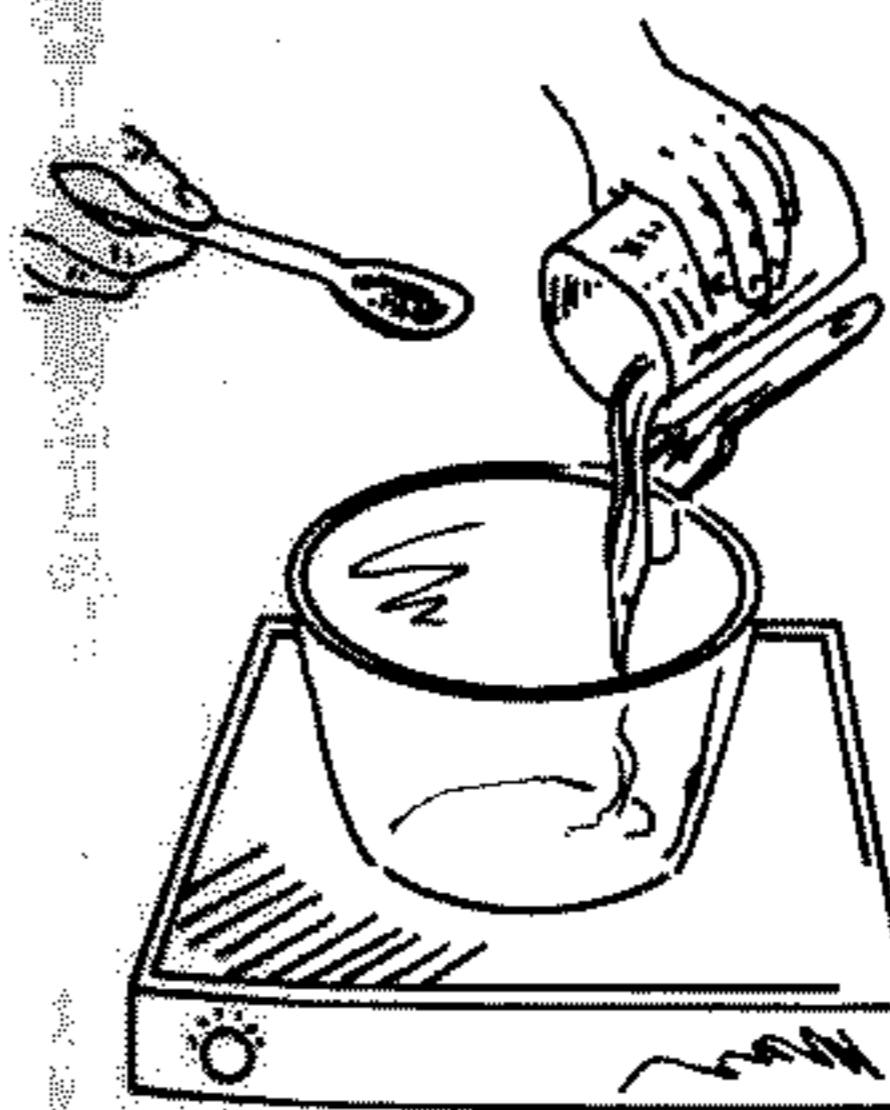
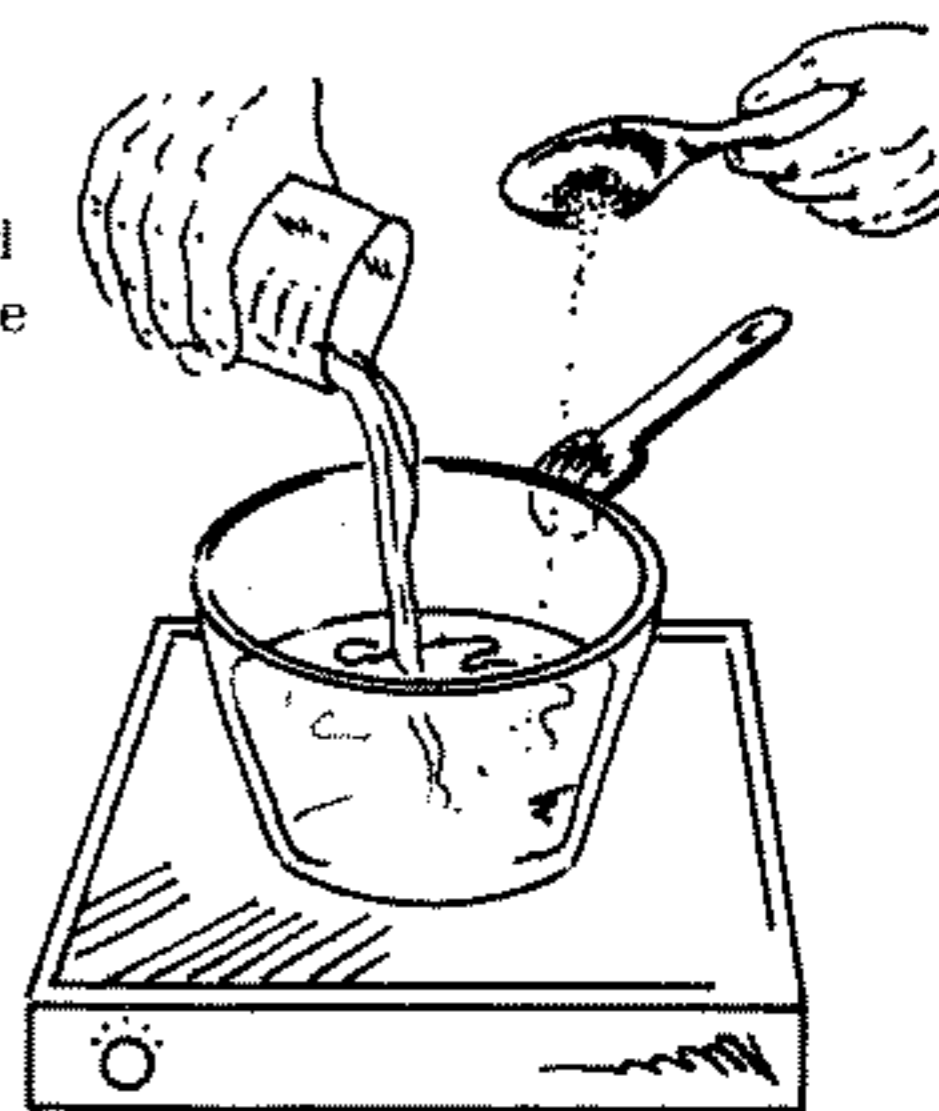

2. If crystalline lead nitrate is used, dilute 40 grams of the crystal in 2 cups of warm water.



FOR INFORMATION PURPOSES ONLY

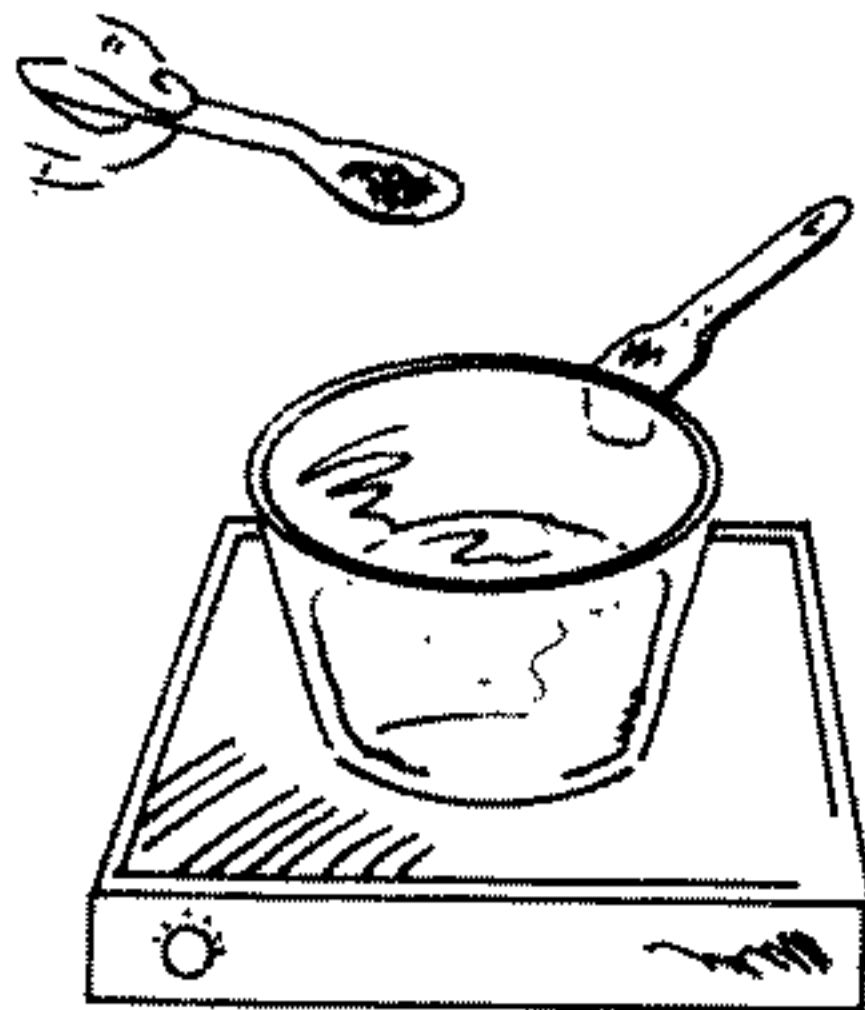

3. Dissolve 2 grams of the dextrin or cornstarch into the lead-nitrate solution.

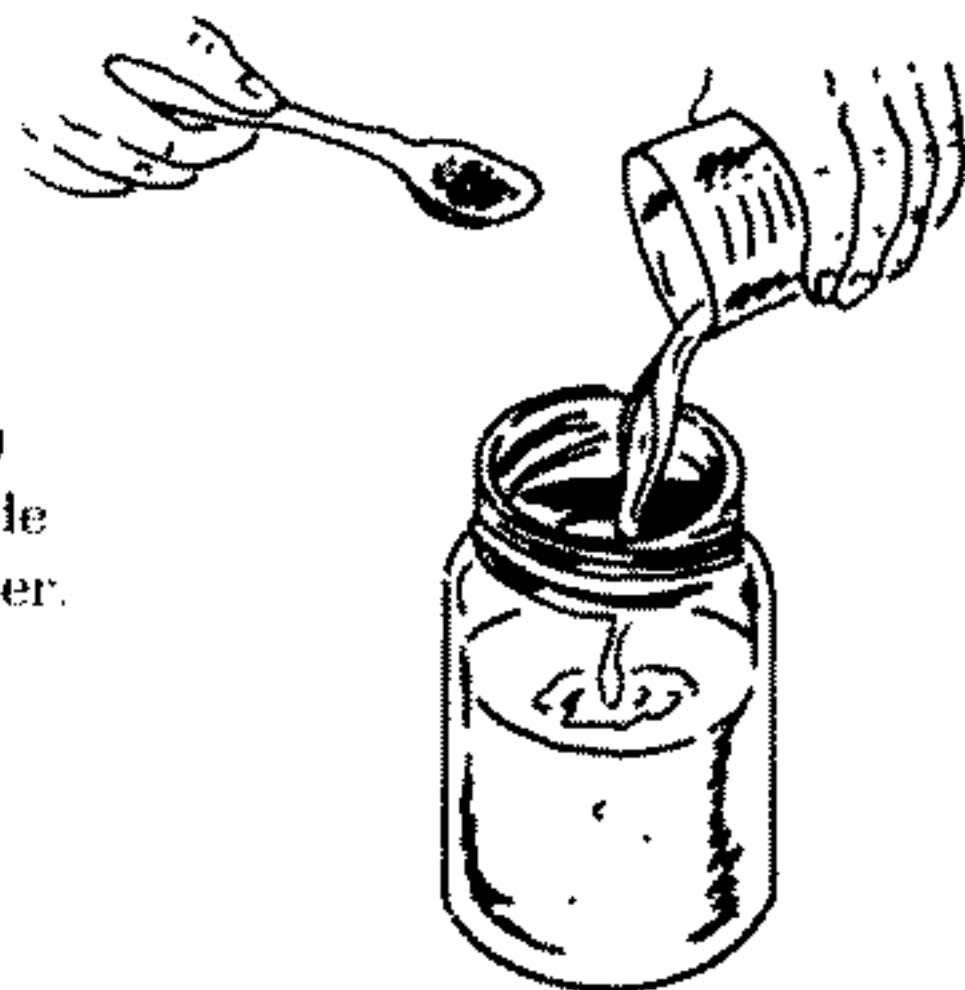

4. In the jar, dissolve 20 grams of the sodium azide into 1 cup of warm water. Set aside.

FOR INFORMATION PURPOSES ONLY

5. Heat contents of bowl to  $70^{\circ}\text{C}$  while stirring constantly.

**CAUTION:** Filter out all pure lead before proceeding to step 6. Pure lead will explode on contact with sodium azide.

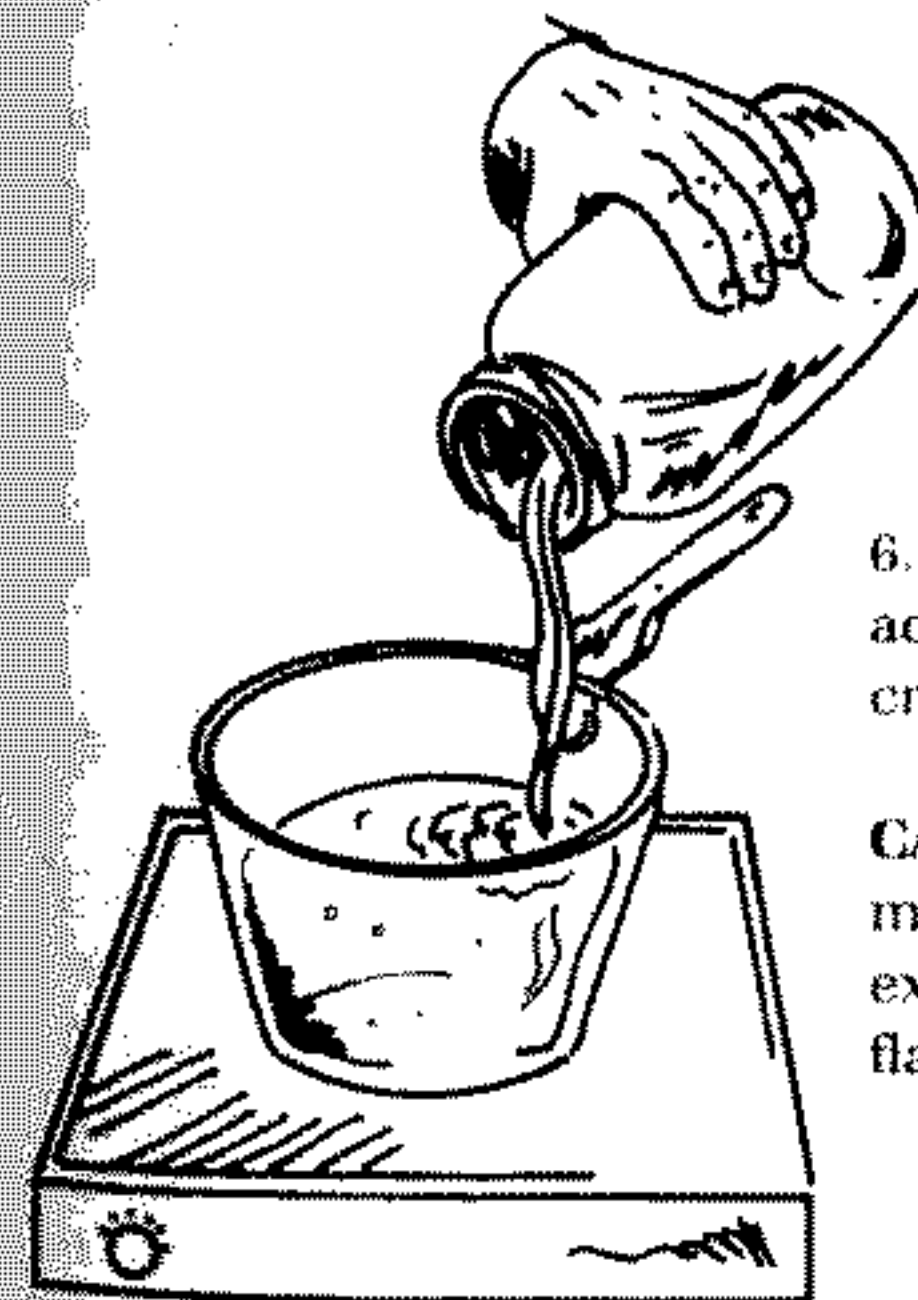
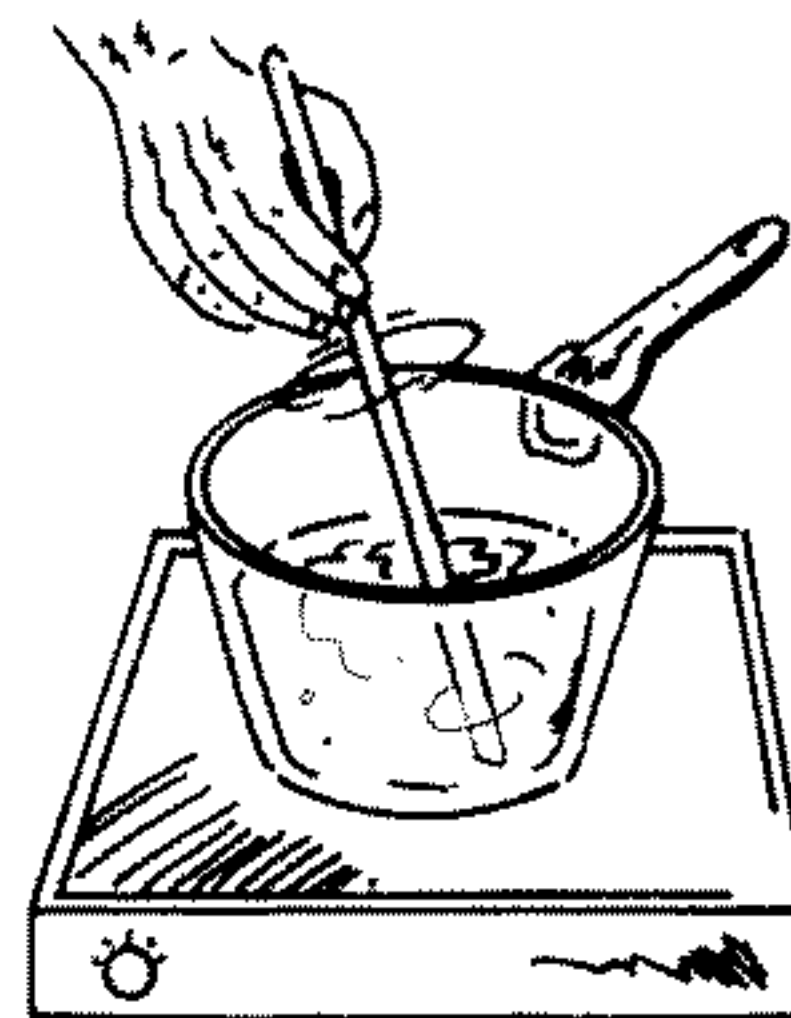

6. While stirring vigorously, add contents of jar. A white crystal will precipitate out.

**CAUTION:** At this point the mixture is a primary explosive. Keep away from flame.

FOR INFORMATION PURPOSES ONLY

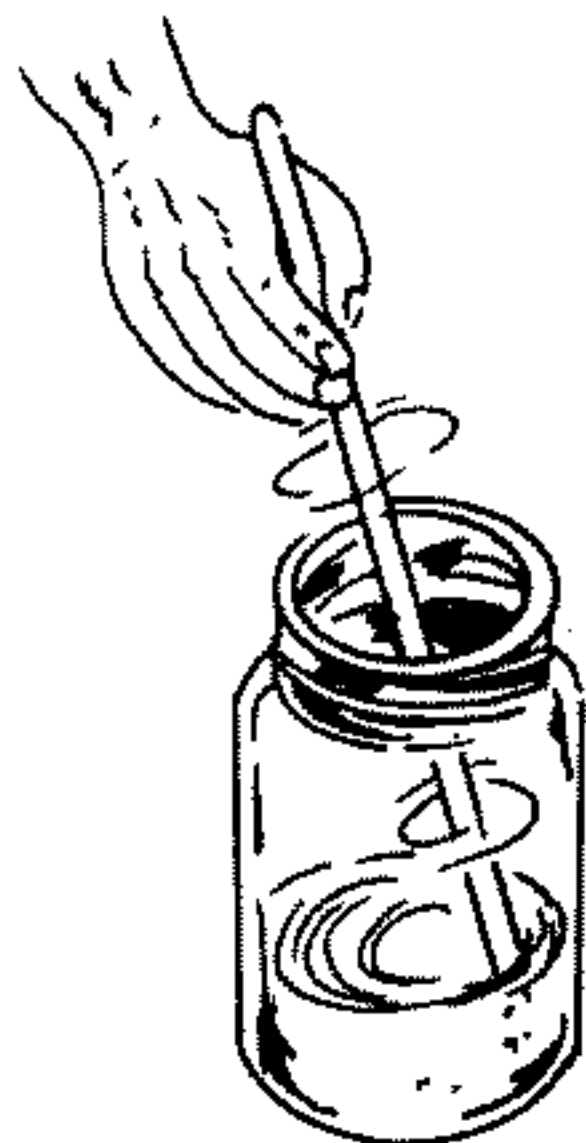

3. Slowly add 2.5 parts sulfuric acid while stirring vigorously.

4. Cover with plastic wrap and place in the refrigerator. After at least 24 hours, remove and let stand at room temperature for 6 hours.

5. Filter through paper towel and collect crystals.

6. Let crystals dry and store in an airtight jar.

The product is a flame-sensitive primary explosive that has about the same power as acetone peroxide and HMTD.

*Note:* Detonators made with this explosive should be used within a week of their manufacture, as the explosive tends to react with the other chemicals present in the detonator (secondary explosive, casing, fuze, etc.).

*Note:* Mekap's shelf life as well as power can be improved by the addition of a small amount (20% by weight) of potassium chlorate to the explosive.

FOR INFORMATION PURPOSES ONLY

Section I  
No. 43

SULFURIC ACID

This process was covered briefly throughout *Black Book*, volumes 1, 2, and 3. Here it is given in more detail so that the final product is sure to be suitable for improvised weaponry use.

MATERIALS

Battery acid or other dilute form (25 percent) of sulfuric acid

Large Pyrex container

Heat source

Large glass or plastic container (for storage)

Thermometer (at least 100°C)

PROCEDURE

1. Battery acid is about ¼ sulfuric acid, so start out with four times as much battery acid as you will need concentrated acid. If you are using something other than 25-percent strength, adjust amount of starting acid accordingly.

SOURCES

Auto or chemical supply store

Hot plate, etc.

FOR INFORMATION PURPOSES ONLY

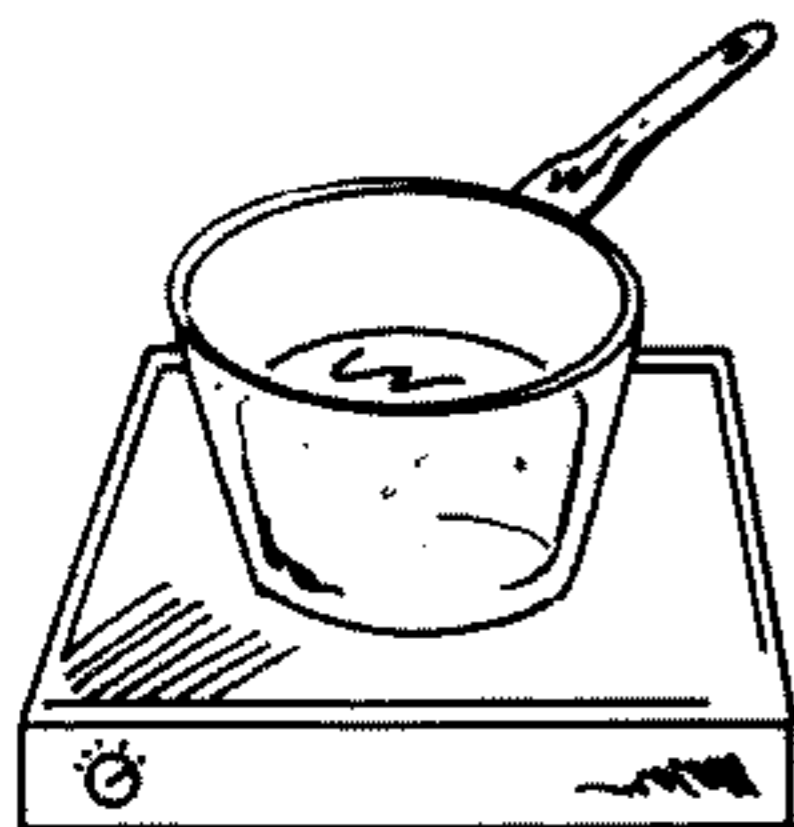

2. Pour desired amount of acid in Pyrex container and place on high heat.

3. Heat acid to  $100^{\circ}\text{C}$  and allow water to boil off. As the water boils off, the temperature will rise. At about  $300^{\circ}\text{C}$ , dense white fumes will be generated. Remove immediately from heat source.

**CAUTION:** Acid will destroy clothing and burn skin. If any is spilled, wash it away with a large quantity of water. *Do not inhale fumes.*

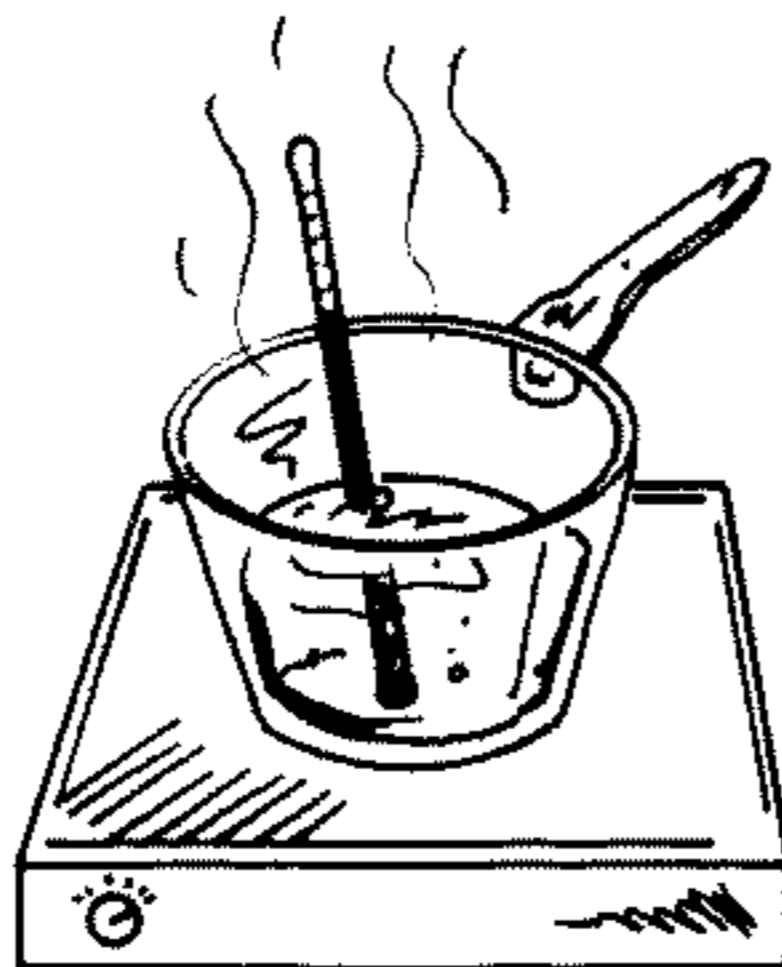

FOR INFORMATION PURPOSES ONLY

4. Allow acid to cool to room temperature ( $27^{\circ}\text{C}$ ) and transfer to storage container. Close tightly. The acid readily absorbs moisture from the air, and it will dilute rapidly if left uncovered.





**EXPLOSIVE "D"**

Explosive "D" (ammonium picrate) exists in two forms: yellow (stable), which is very insensitive and needs a compound detonator to initiate it, and red (metastable), which is more sensitive and can be detonated with a No. 8 blasting cap. Both will be covered.

**MATERIALS**

Picric acid

Aqueous ammonia  
(ammonium hydroxide)

Glass saucepan

Stirring rod

Pan

Salt/water/ice mix

Paper towels

**PROCEDURE**

1. Add  $\frac{1}{2}$  cup picric acid to 1 pint boiling water and stir vigorously. (Picric acid will not dissolve completely.)

**SOURCES**

Sec. 1, No. 21

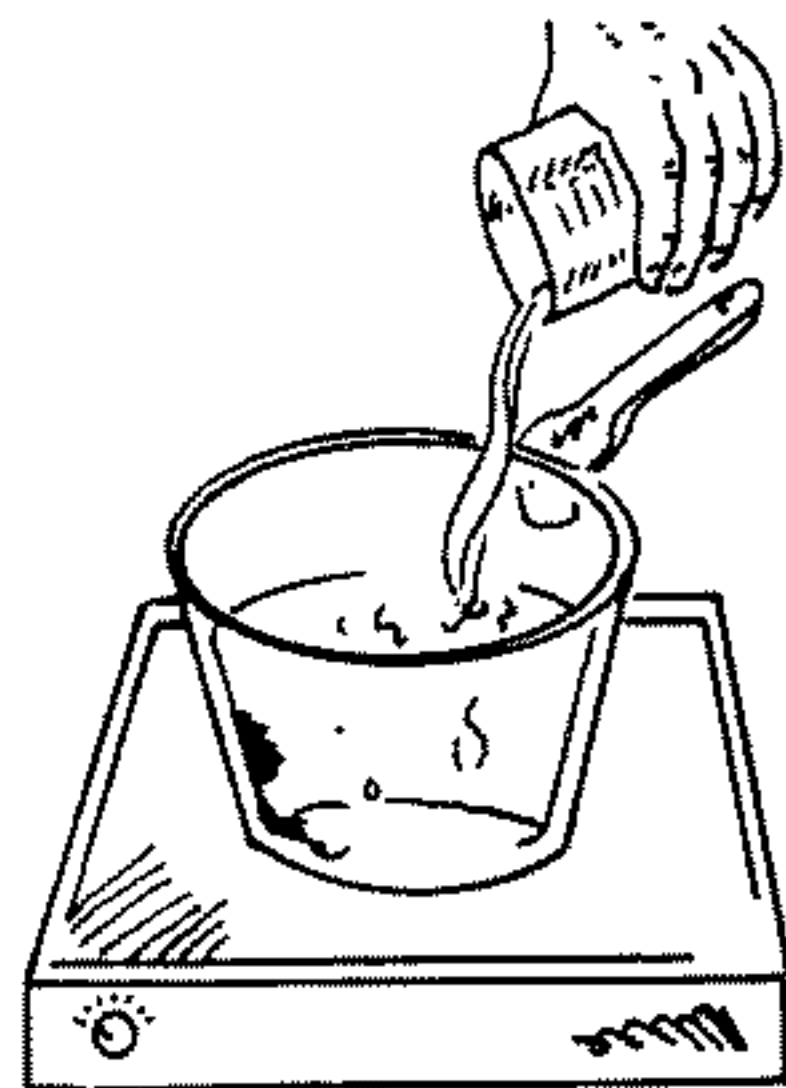
Household ammonia from  
grocery store

2. *To obtain yellow form:* Add ammonia, a teaspoon at a time, while stirring until all crystals have dissolved. Go to step 3. *To obtain red form:* While stirring, add 2 cups of ammonia all at once. When crystals have dissolved, go to step 3.

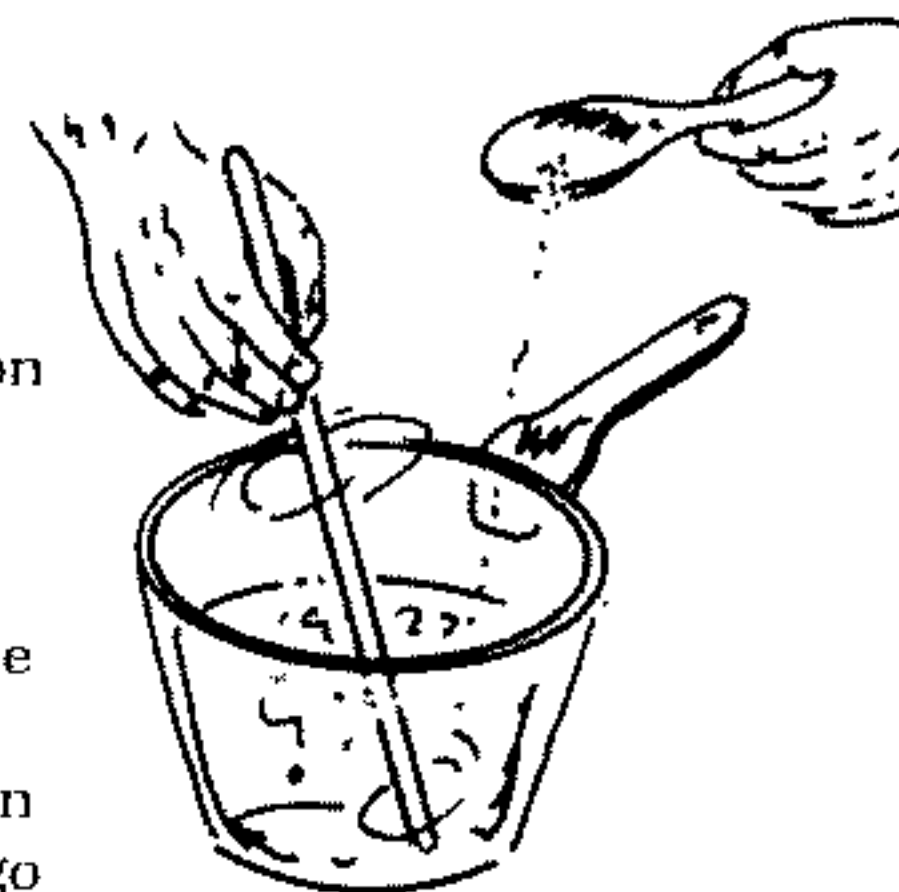

3. Allow solution to cool until it reaches room temperature ( $27^{\circ}\text{C}$ ), then place in pan with salt/water/ice mix and cool further for about 30 minutes.

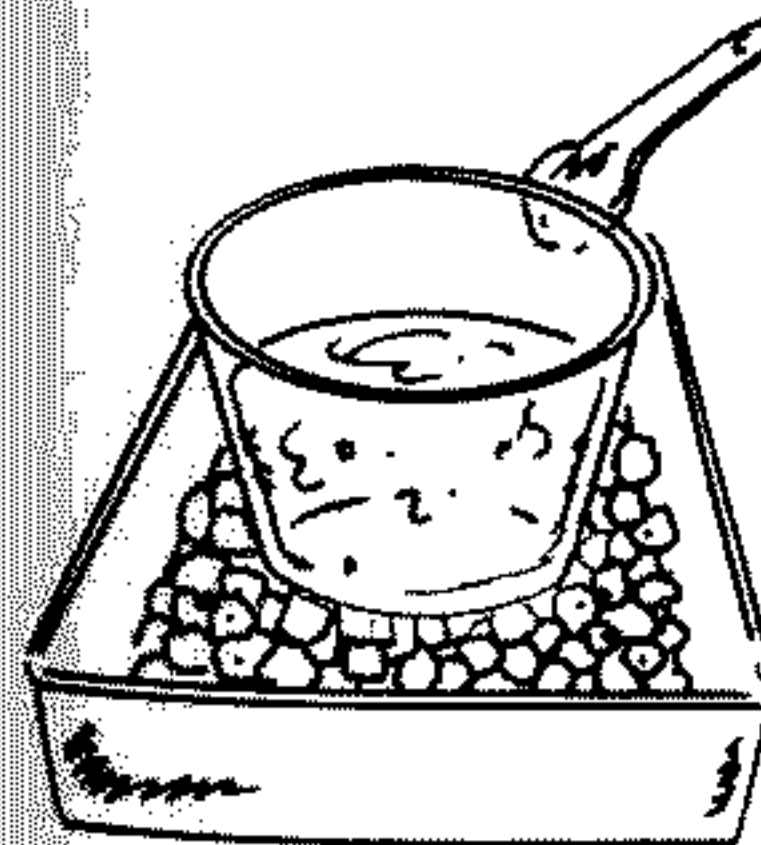
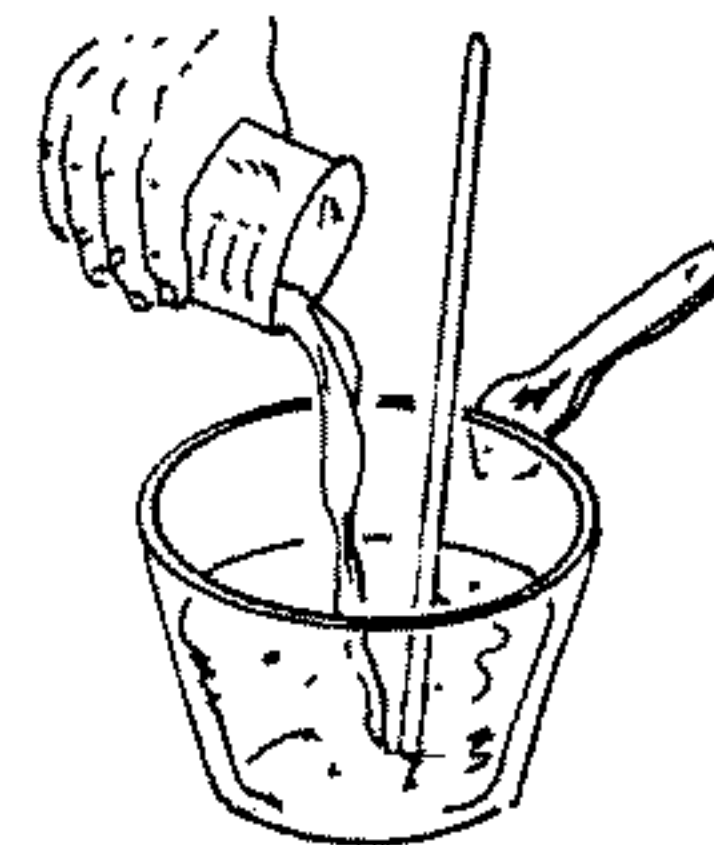

4. Filter through paper towel and allow crystals to dry. Store covered in a cool, dry place until ready for use.

## STARCH NITRATE

Starch nitrate is a stable explosive that can be used by itself, or small quantities of it can be mixed into other high explosives to increase their volume without significantly decreasing their power.

## MATERIALS

Potato starch or cornstarch

Nitric acid

Sulfuric acid

Household ammonia

Several glass jars

Glass thermometer

Deep aluminum tray

Large bowl

Salt/water/ice mix

Cloth

## SOURCES

Grocery store

Field grade (Sec. I, No. 4) or  
90-percent concentratedSec. I, No. 43 or chemical  
supply store

Grocery store

Pillow case, etc.

## PROCEDURE

**CAUTION:** Nitric and sulfuric acids will destroy clothing and burn skin. If any acid is spilled, wash it away with large amounts of water.

1. Carefully mix 2 cups of sulfuric acid and 1 cup of nitric acid in a jar. Place the jar in the aluminum tray of salt/water/ice mix.

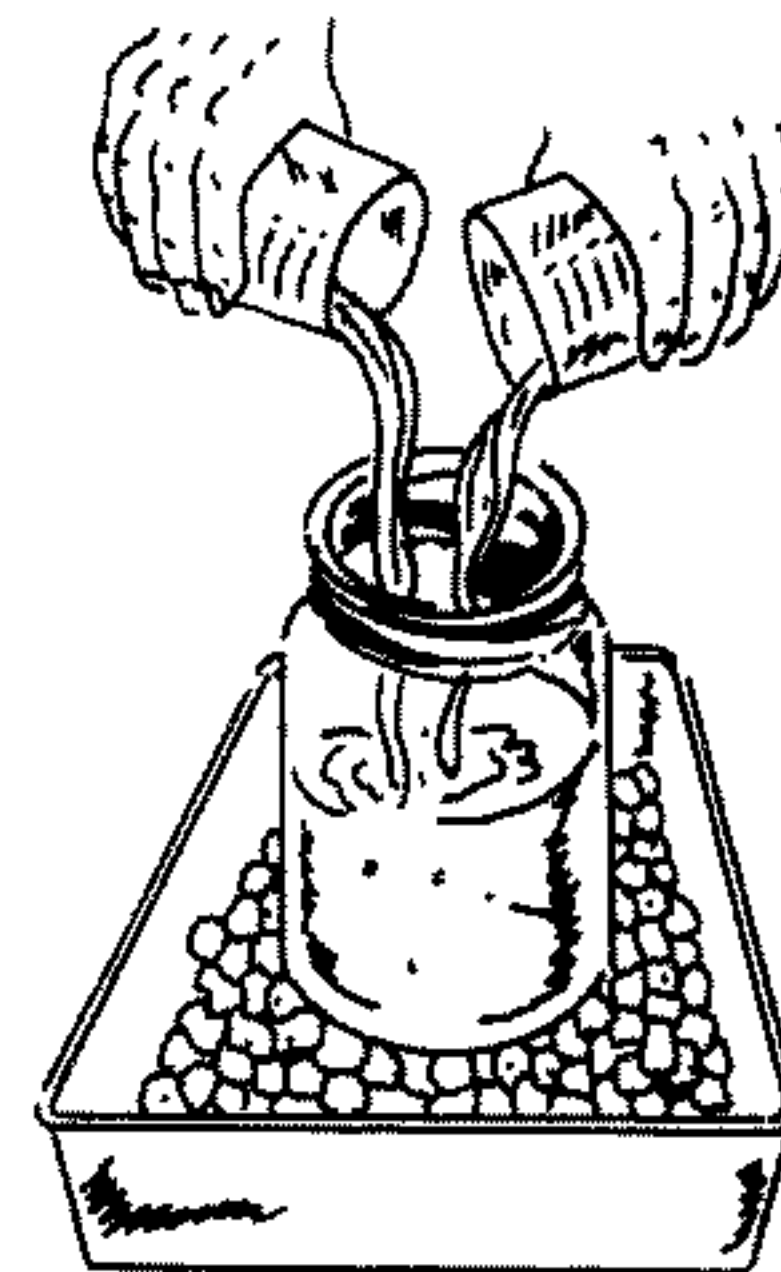

2. When the acid mix cools down to 20°C, slowly add ½ cup of starch while stirring. *Do not* allow the acid temperature to exceed 30°C.

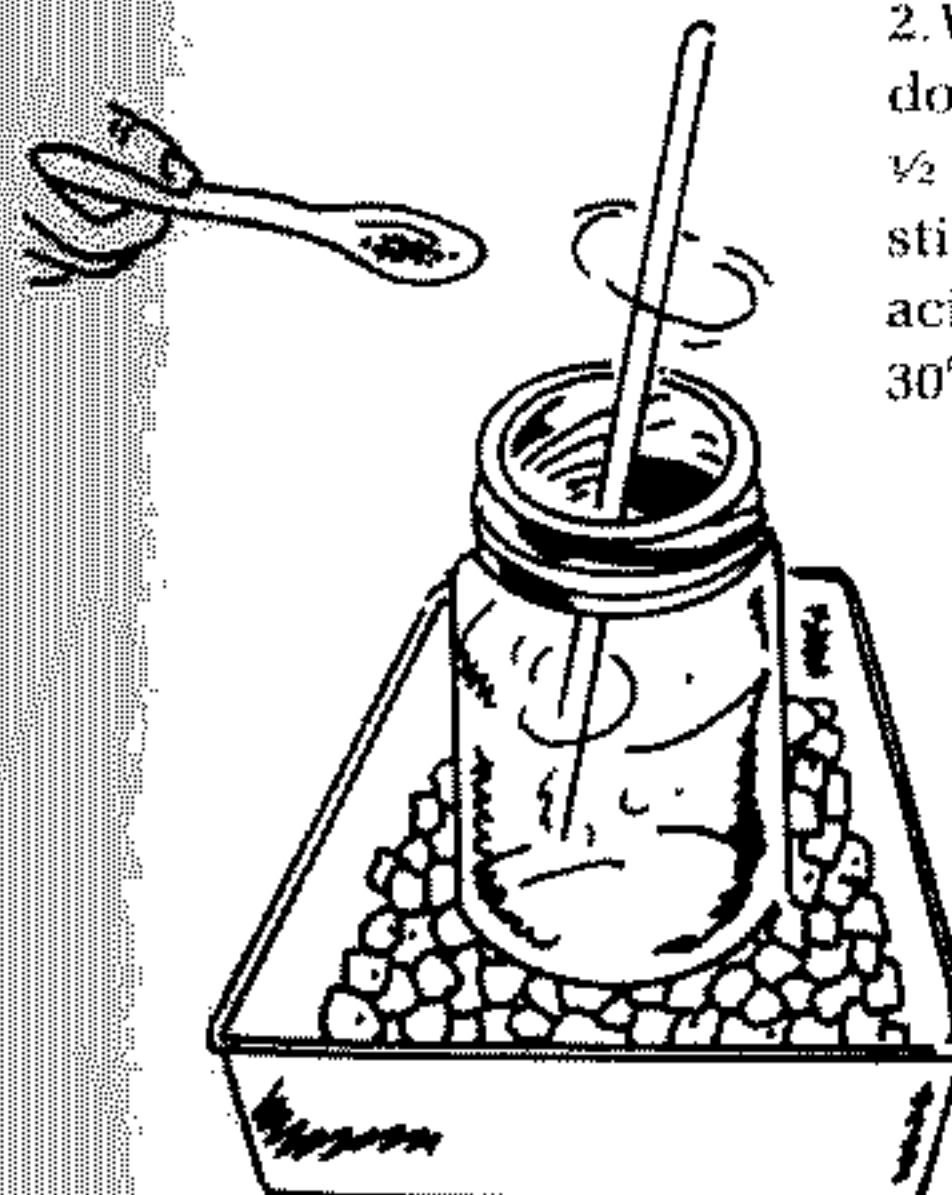

**FOR INFORMATION PURPOSES ONLY**

3. When all the starch has been added, stir for 5 minutes, then let the mixture stand for 30 minutes.

4. Pour the acid/starch nitrate mix into the bowl containing fresh cold water and stir for 5 minutes.

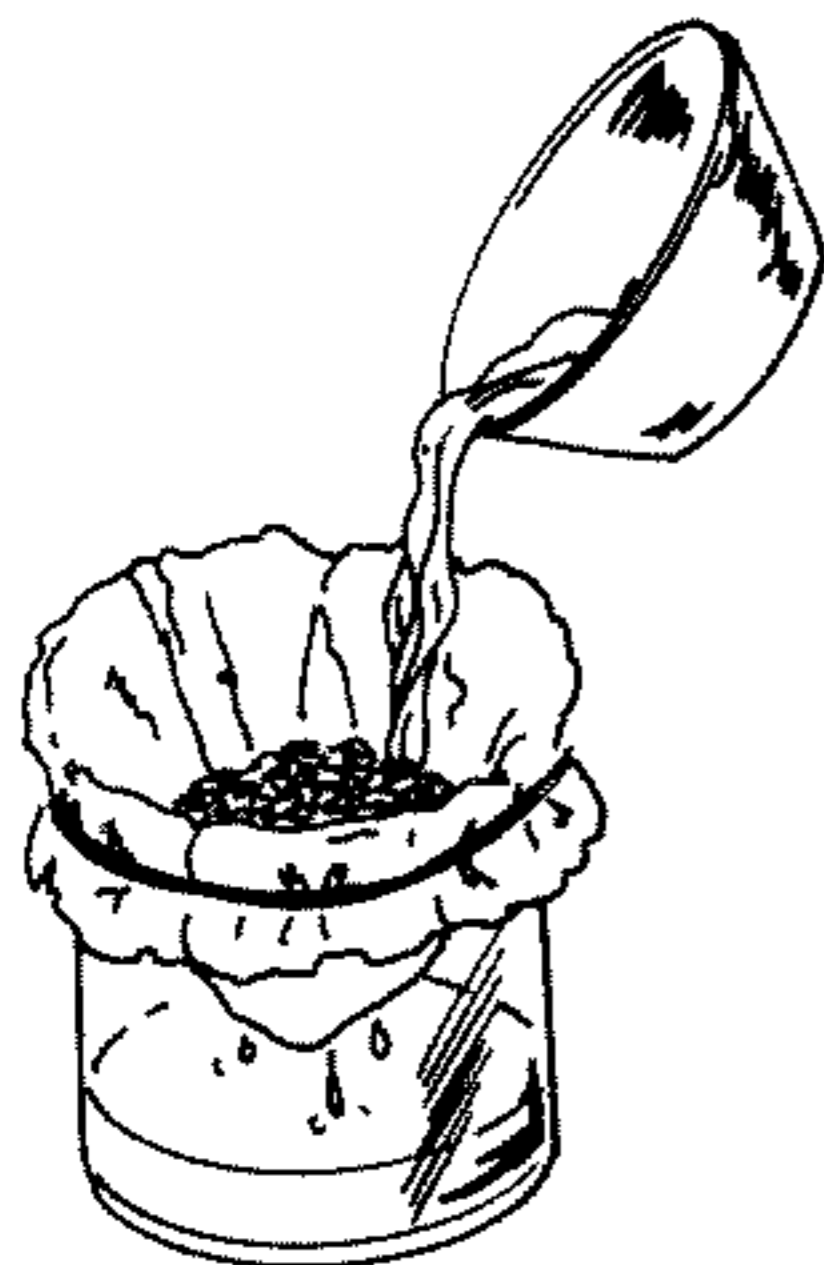

5. Filter the acid/starch nitrate/cold water mix through the cloth and discard the liquid.

**FOR INFORMATION PURPOSES ONLY**

6. Repeatedly wash the starch nitrate with household ammonia, then wash it with fresh cold water to remove the excess ammonia.

7. Leave the starch nitrate out to air dry. To store, place in an airtight container, preferably while still damp.

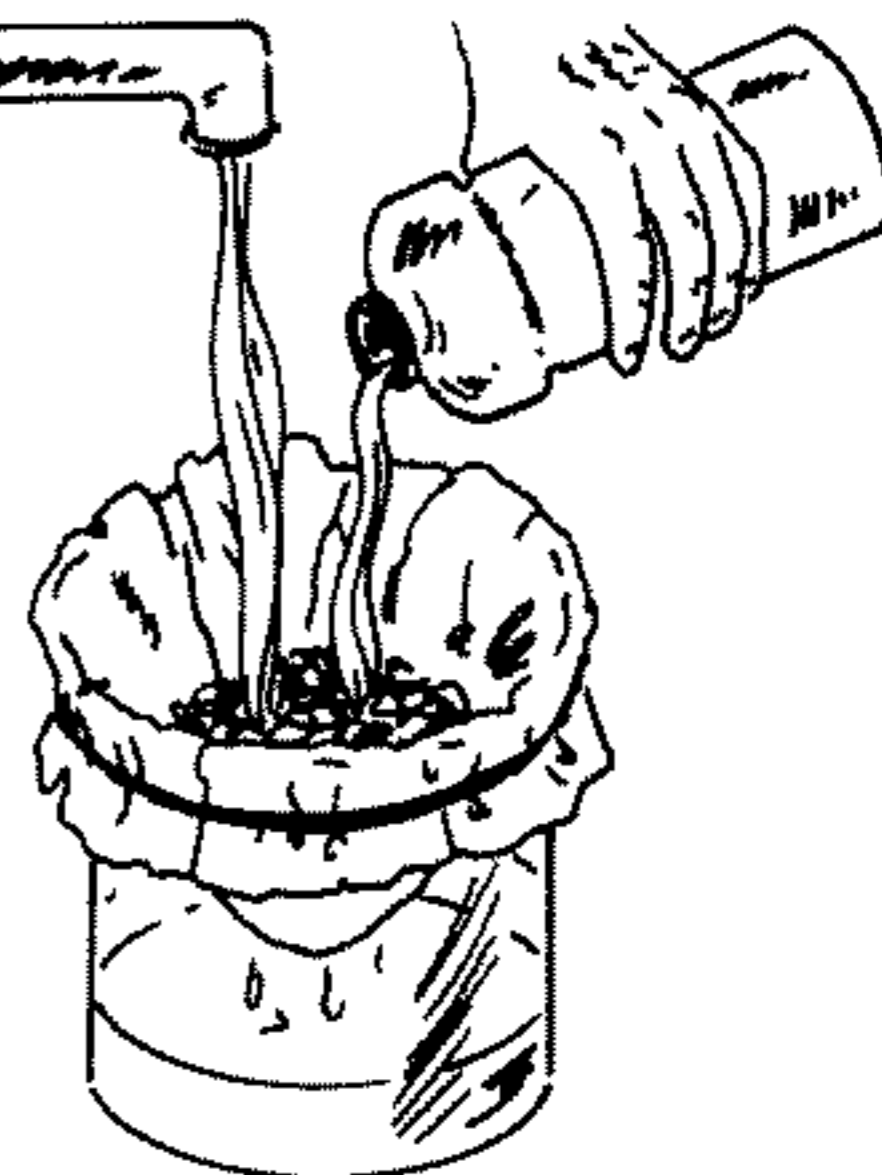

**HOW TO USE**

Spoon the dry starch nitrate into an iron or steel pipe with an end cap on one end. Place the detonator just beneath the surface of the starch nitrate and screw the other end cap on.



FOR INFORMATION PURPOSES ONLY

Section I  
No. 46

OPTIMIZED PROCESS FOR RDX MANUFACTURE

This process produces twice as much RDX as the procedure outlined in Sec. I, No. 38. This product also contains larger amounts of the high explosive HMX than the simple nitric acid/hexamine process.

MATERIALS

Ammonium nitrate

Acetic anhydride

Formaldehyde or  
(preferably) para-  
formaldehyde

Acetone

Glass or ceramic container

Thermometer

Pan

Salt/water/ice mix

Paper towel

Heat source

PROCEDURE

1. Mix 260 milliliters of acetic anhydride with 100 grams of ammonium nitrate and place in a pan of boiling water. Allow temperature to reach and remain at 90°C.

SOURCES

Garden or chemical supply  
store

Chemical supply store

Pharmacy or chemical  
supply store

Hardware store

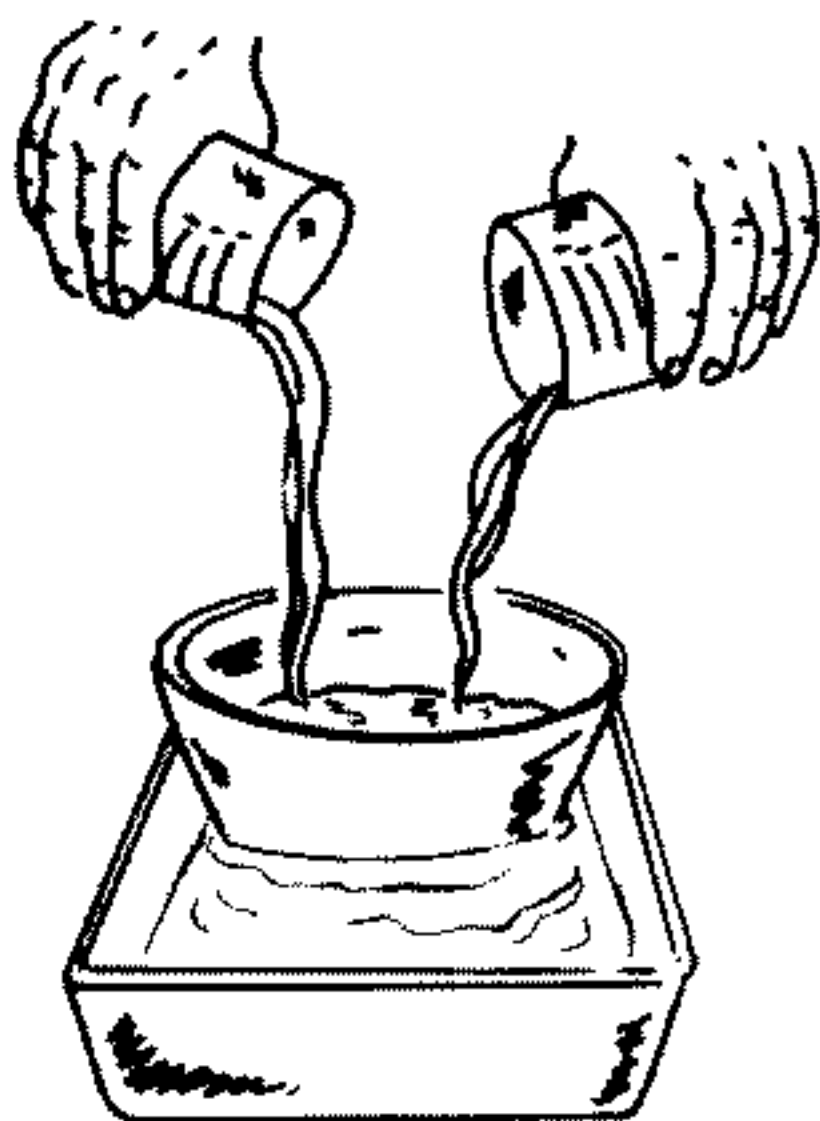

FOR INFORMATION PURPOSES ONLY

2. Add 38 grams of paraformaldehyde to the mixture, ½ teaspoon at a time, stirring constantly. If using 40-percent formaldehyde solution, use 95 grams.

**CAUTION:** At this point, toxic, flammable fumes are released. Avoid inhalation and contact with exposed skin.

3. Once all the formaldehyde mix has been added, remove from heat and allow to cool to room temperature (27°C) and then cool further by placing in a pan of salt/water/ice mix.

4. Filter through paper towel, save liquid, and thoroughly wash the resulting crystals with water. Dump the liquid into a gallon of cold water. More crystals will precipitate out. Filter these out, discard the liquid, and wash with clean water.

The explosive can be used as is or purified:

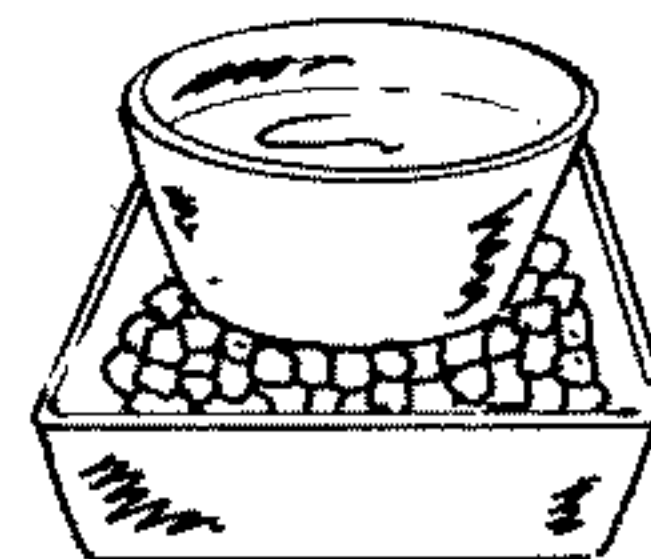

5. Dump crystals into a quart of 50°C acetone. Cool in salt/water/ice bath and filter out crystals that precipitate out of the solution.

6. Store the crystals in a cool, dry place in a covered container.

FOR INFORMATION PURPOSES ONLY

Section I  
No. 47

PETN

PETN can be used to manufacture explosive paper (Sec. I, No. 37) or anywhere else that a powerful, sensitive explosive is desirable.

MATERIALS

Nitric acid

Pentaerythritol

Lye

Acetone

Glass or ceramic container

Thermometer

Pan

Salt/water/ice mix

Cloth

Buckets

Bowls

PROCEDURE

1. Place 1,400 milliliters of nitric acid in the bowl and cool to 18°C with the salt/water/ice mix.

SOURCES

Field grade (Sec. I, No. 4) or 90-percent concentrated

Chemical supply store

Crystal drain opener

Hardware store

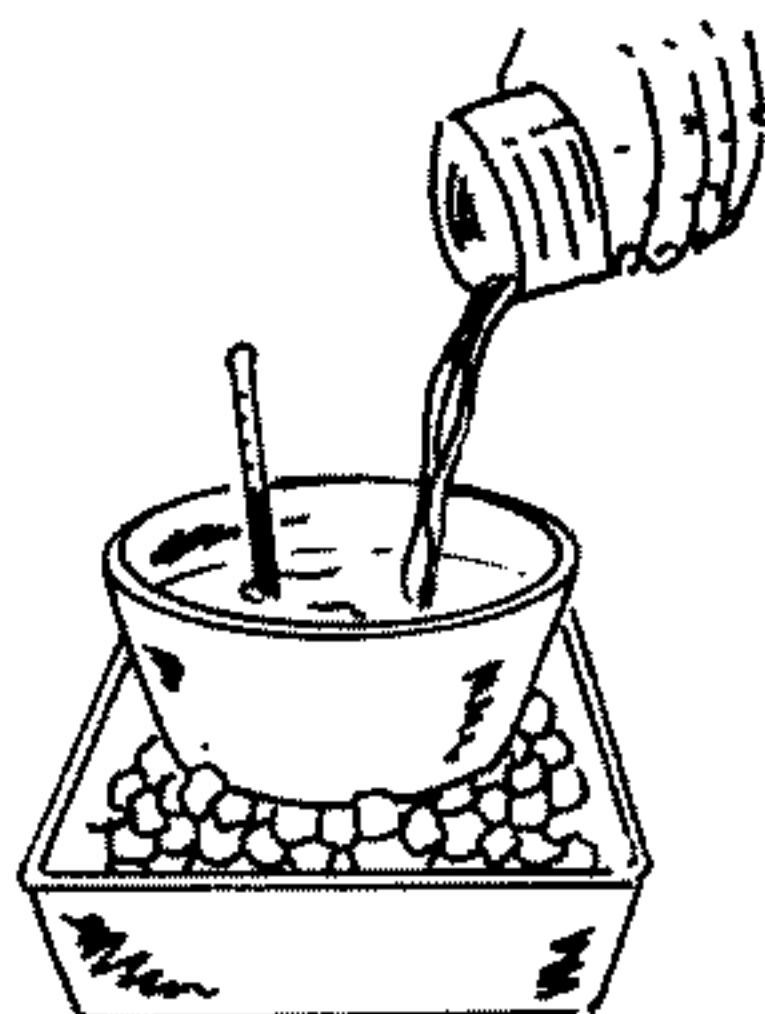

FOR INFORMATION PURPOSES ONLY

2. Slowly add 1 lb. pentaerythritol while stirring gently, not allowing the temperature to go above 23°C. If it does, stop the flow of pentaerythritol and stir the solution gently until the temperature drops. Resume flow.

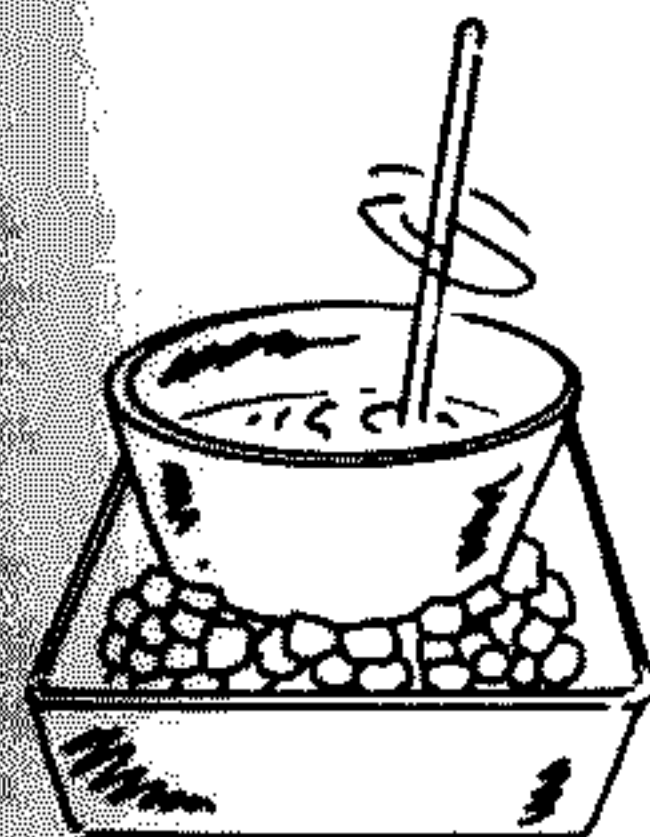

3. Continue to stir for 20 minutes more, keeping the temperature at 23°C.

4. Pour the acid into a bucket filled with 6 liters of cold water.





FOR INFORMATION PURPOSES ONLY

5. Filter precipitated crystals through cloth and wash them with 10 liters of water with 2 oz. of lye mixed in. Wash again with water.

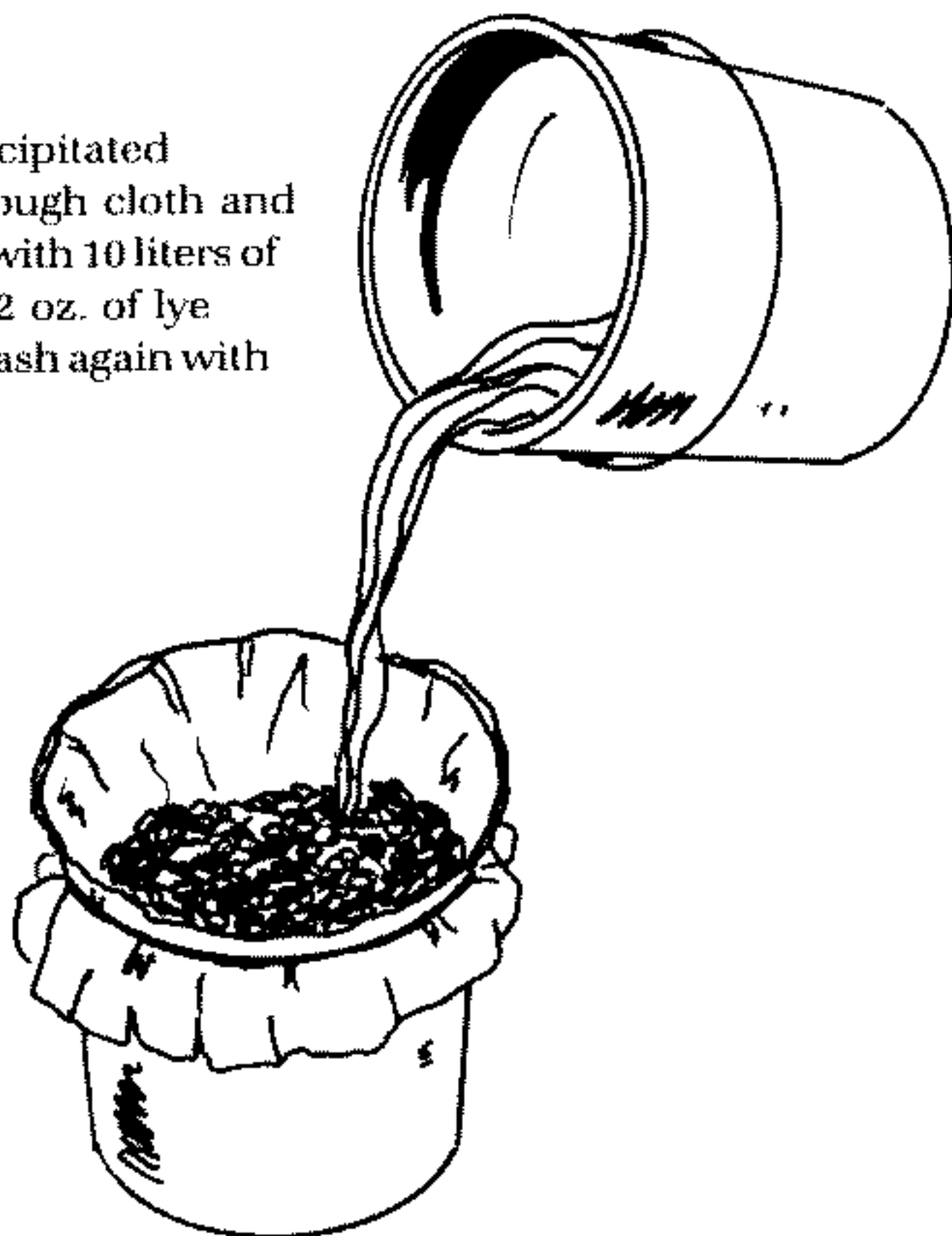

6. Heat 3 liters of acetone to 50°C by very carefully placing a bowl of it in a hot water bath.

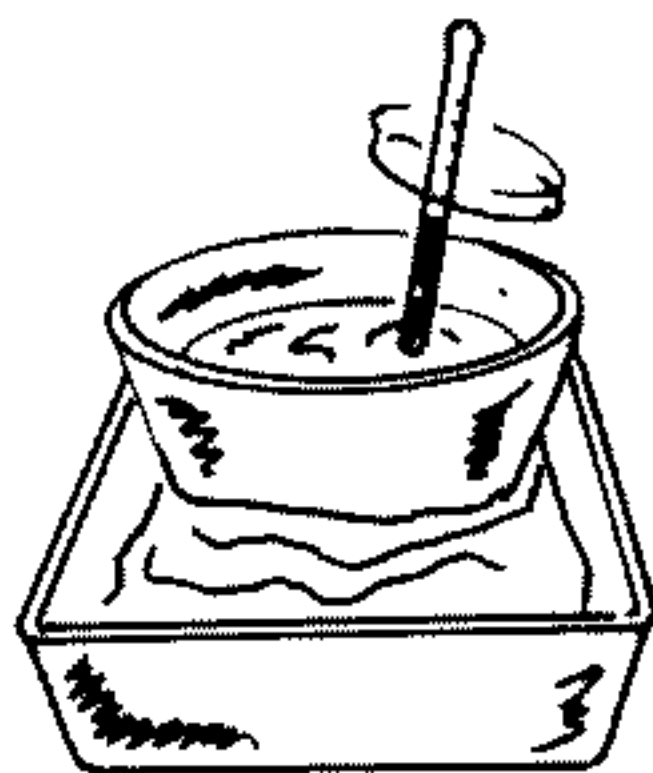

FOR INFORMATION PURPOSES ONLY

7. Add crystals to acetone while stirring until all the crystals have been dissolved. If necessary, heat the acetone further until all the crystals dissolve.

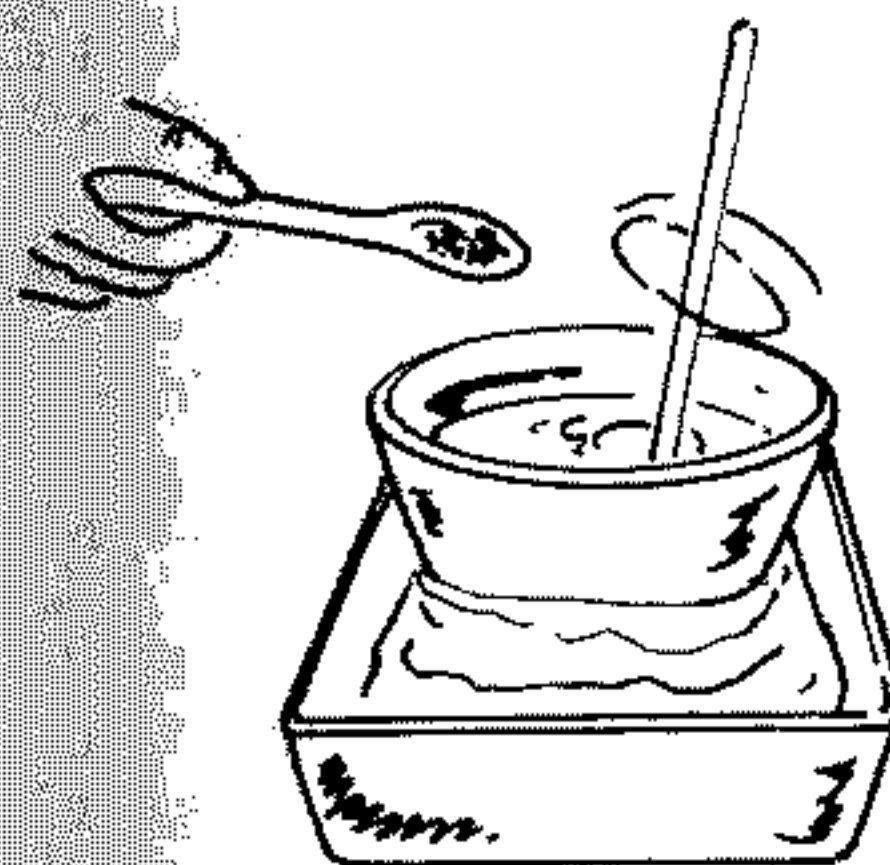

8. Pour the acetone mix into 10 liters of water; PETN crystals will precipitate out.

9. Filter through cloth. Store dried crystals in a tightly covered container in a cool, dry place and protect from shock and friction.

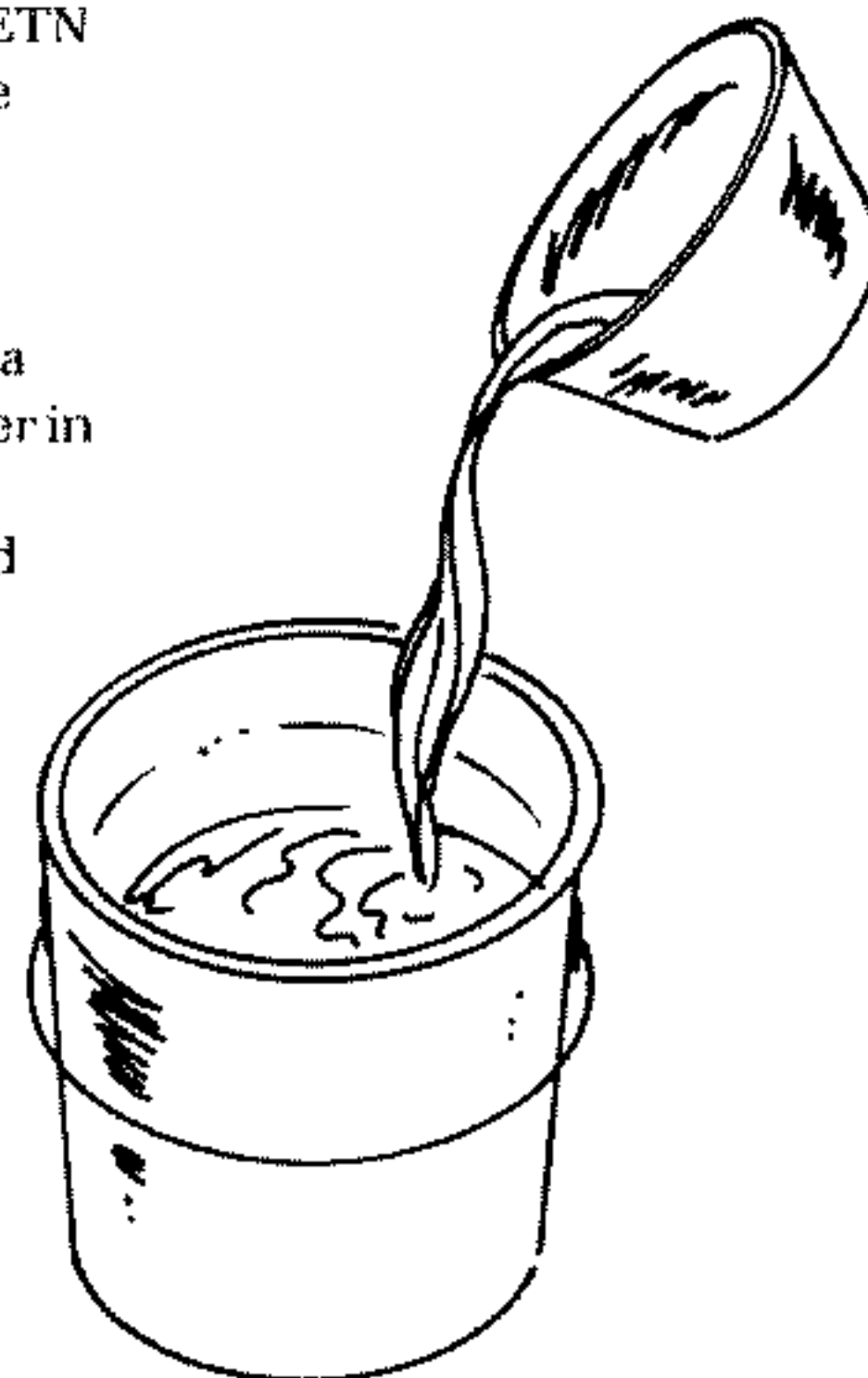

**SEMTEX**

Semtex is a powerful plastic explosive that is more sensitive than, and can be used as a replacement for, military C-4. A No. 8 blasting cap should be used for optimum performance.

**MATERIALS**

RDX high explosive

PETN high explosive

Motor oil, petroleum jelly,  
or vegetable oilMeasuring device (cup,  
spoon, etc.)Wooden dowel or spoon  
for stirring

Rolling pin

Wooden board or hard  
surface

Bowl

Wax paper or plastic wrap

Glass jar with lid

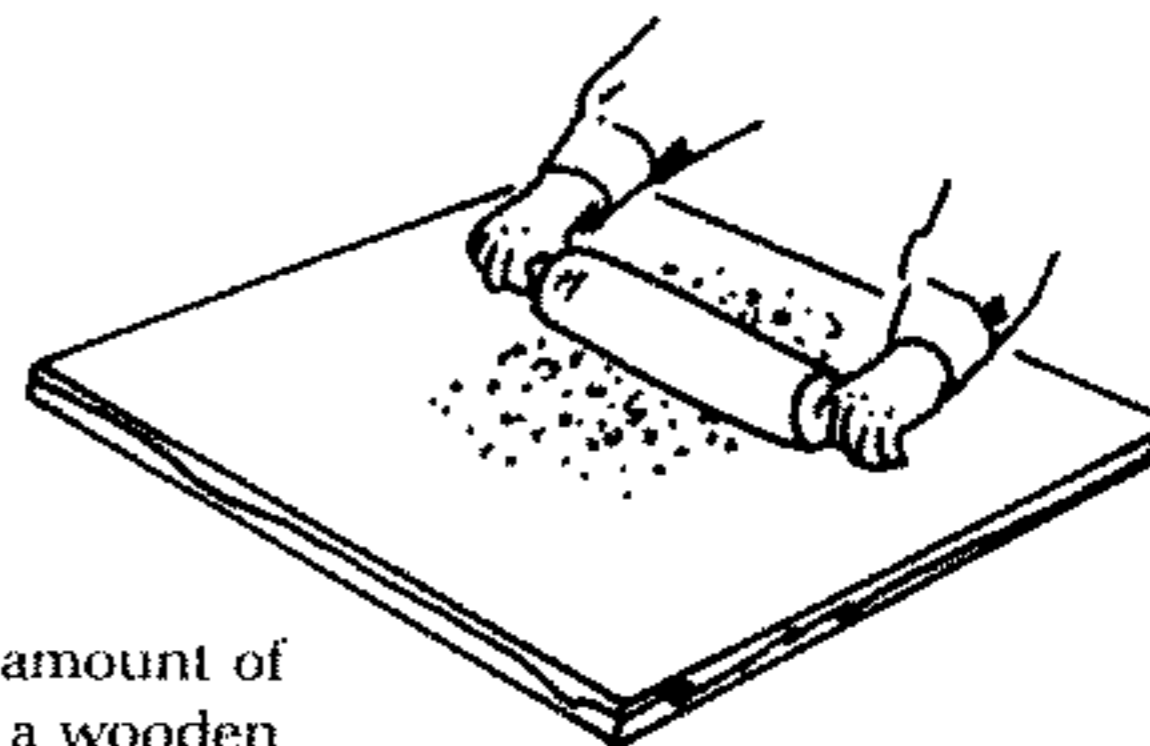
**SOURCES**Section I, No. 38,  
Section I, No. 15, or Section  
I, No. 46Section I, No. 47 or  
extracted from detonating  
cord as in Section I, No. 37Auto supply or drug store,  
grocery store**PROCEDURE**

1. Place a small amount of RDX crystals on a wooden block or hard countertop. Using a rolling pin, crush the crystals into a fine powder, having the consistency of flour.

**CAUTION:** Use a rolling pin only, not a block of wood. It is important to crush the crystals rather than using friction between two rubbing surfaces.

2. Repeat process until desired amount of RDX has been powdered. Then, using the same process, powder the same amount of PETN.

3. Mix 9 parts (cups, etc.) of RDX and 9 equal parts of PETN in a jar and shake for 5 minutes.





4. Pour the RDX/PETN mixture into a bowl and add 2 equal parts of motor oil, petroleum jelly, or vegetable oil. Stir vigorously until a uniform paste is obtained.

5. Semtex can be used immediately for any task requiring a high explosive. If it is to be stored, however, mold the Semtex into a brick and place it in the middle of a square piece of wax paper or plastic film. Wrap tightly and seal it with rubber bands or adhesive tape to keep the brick airtight.

6. Store in a cool, dry place. The explosive should have almost unlimited shelf life, but it will lose its plastic properties after a while.

*Note:* In general, it is always preferable to mix explosives just before use to avoid the problems and dangers of storage.

**FURNACE**

This furnace reaches temperatures of about 1,200°C and can therefore be used for potassium cyanide manufacture as well as melting copper for the copper-slug charge.

**MATERIALS**

Shovel

Two-inch iron or steel water pipe, at least 3 feet long

Hammer or mallet

Air source

Broomstick

Charcoal briquettes and charcoal lighter

Crucible

Block of wood

**PROCEDURE**

1. Using the shovel, dig a hole 1 foot deep and wide in a dry place, far away from flammable materials.

**SOURCES**

Hardware store

Hair dryer, leaf blower, vacuum cleaner, etc.

Chemical supply store, hardware store, etc.





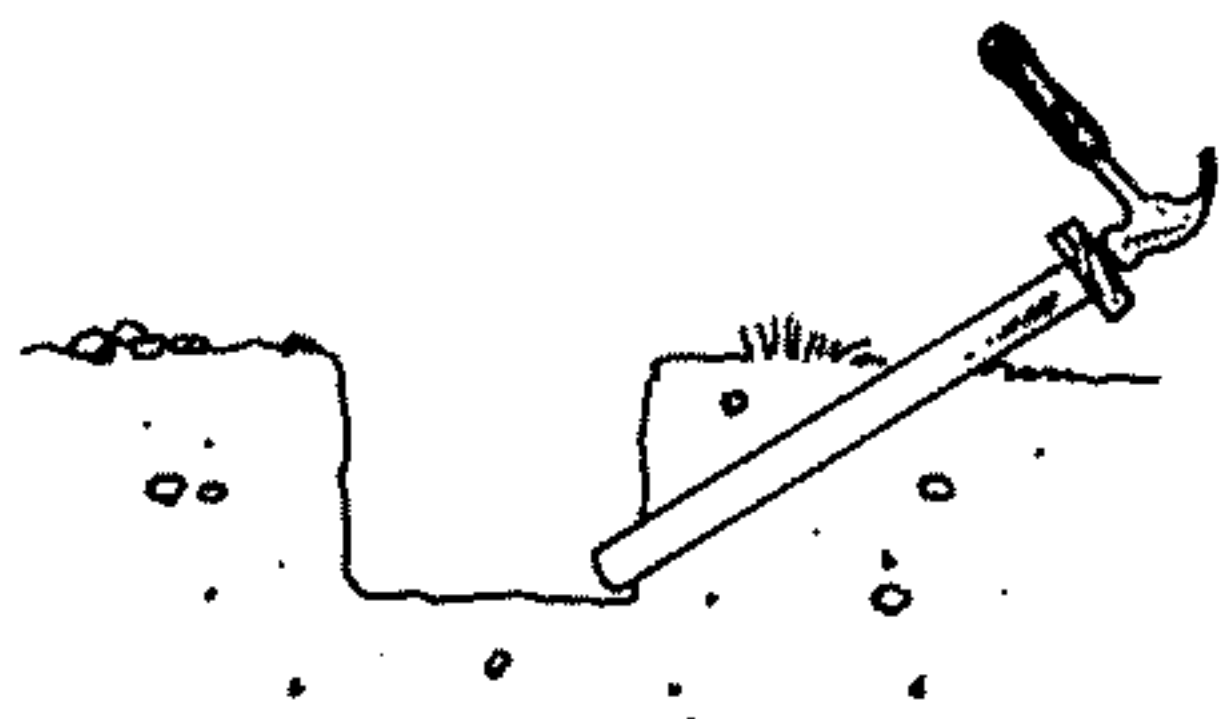

2. Hammer the piece of pipe into the ground using the block of wood as shown.

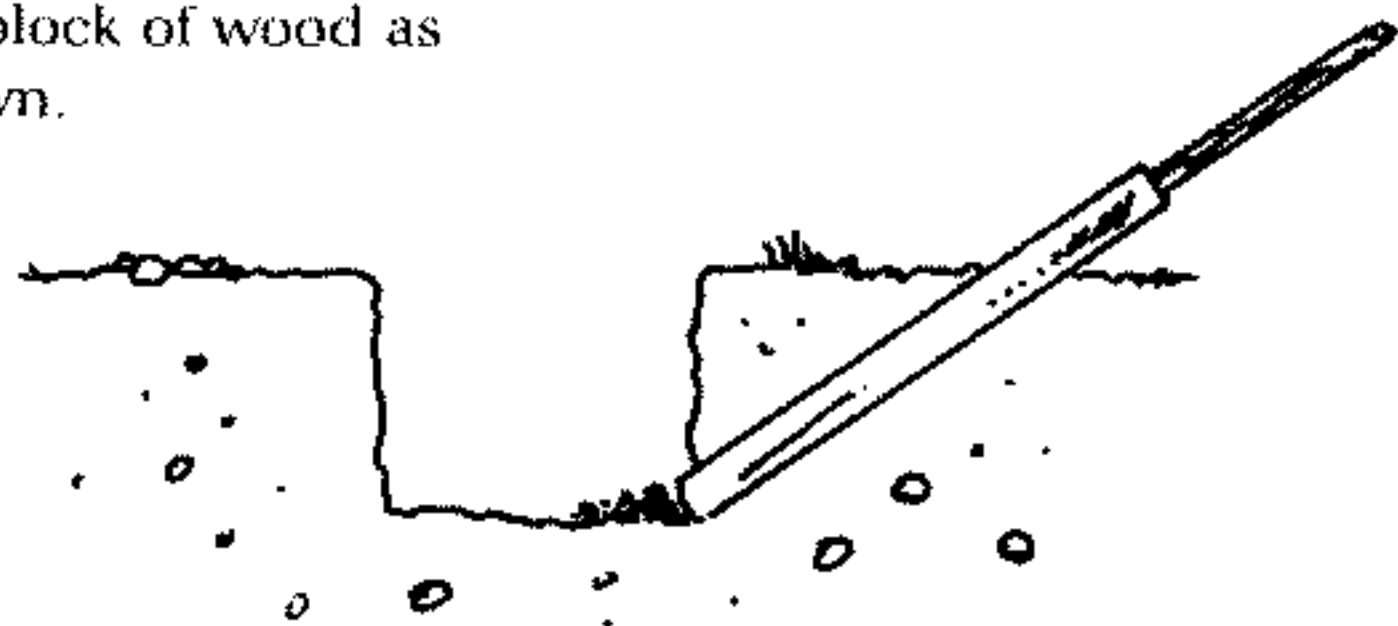

3. Using the broomstick, clear out the inside of the pipe of any dirt or other debris.

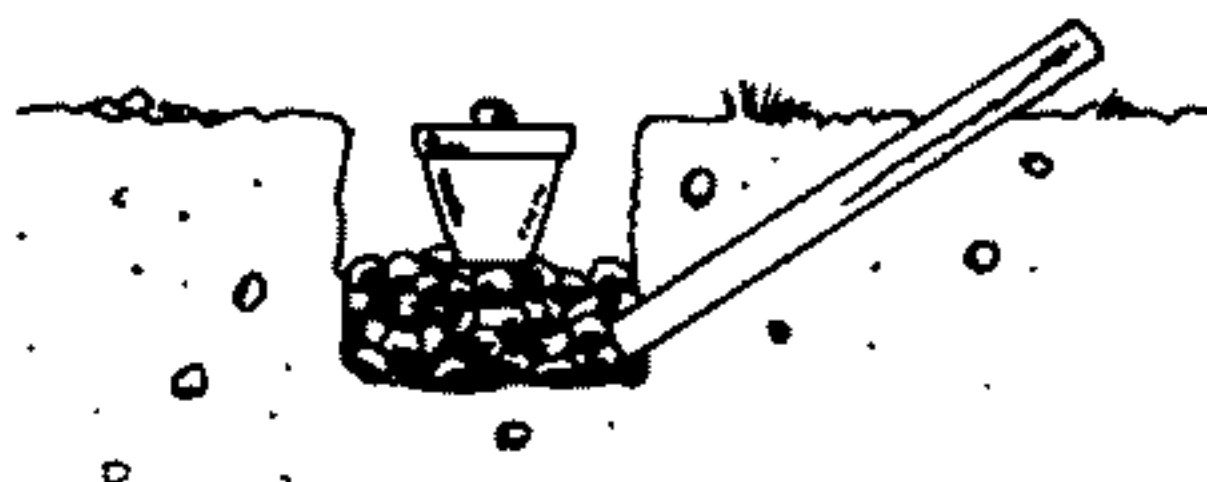

4. Fill the hole  $\frac{1}{3}$  to  $\frac{1}{2}$  full with charcoal briquettes and place the covered crucible on top.

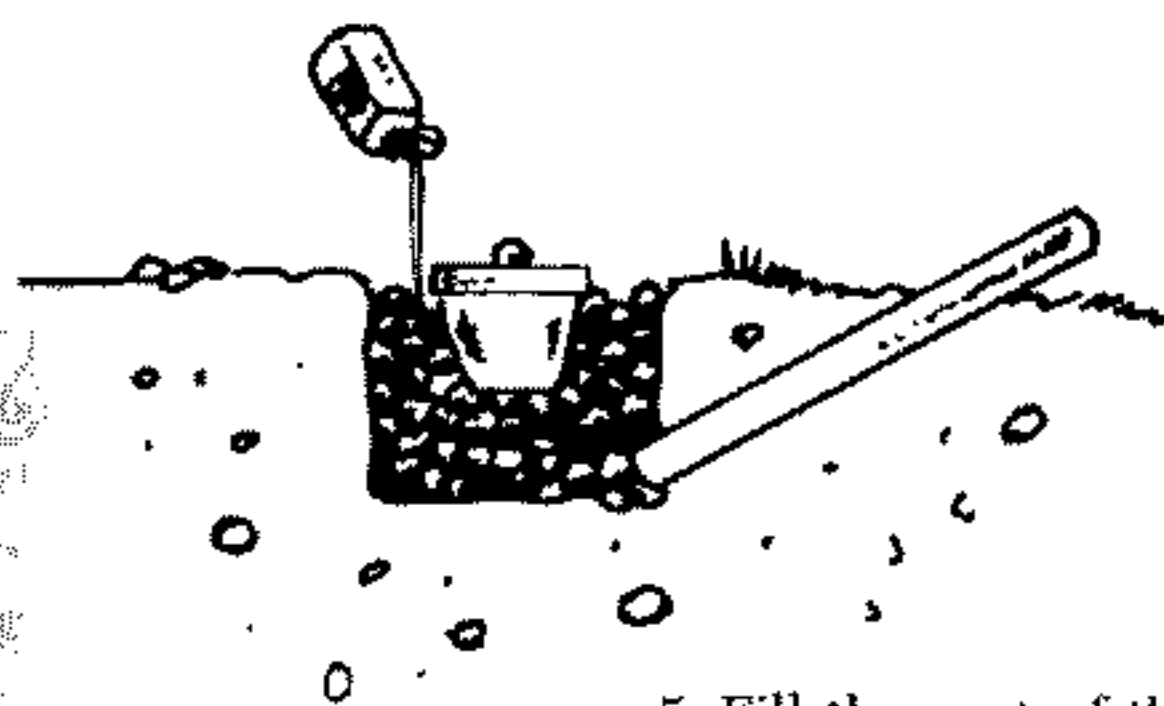

5. Fill the rest of the hole with briquettes and saturate them with charcoal lighter.

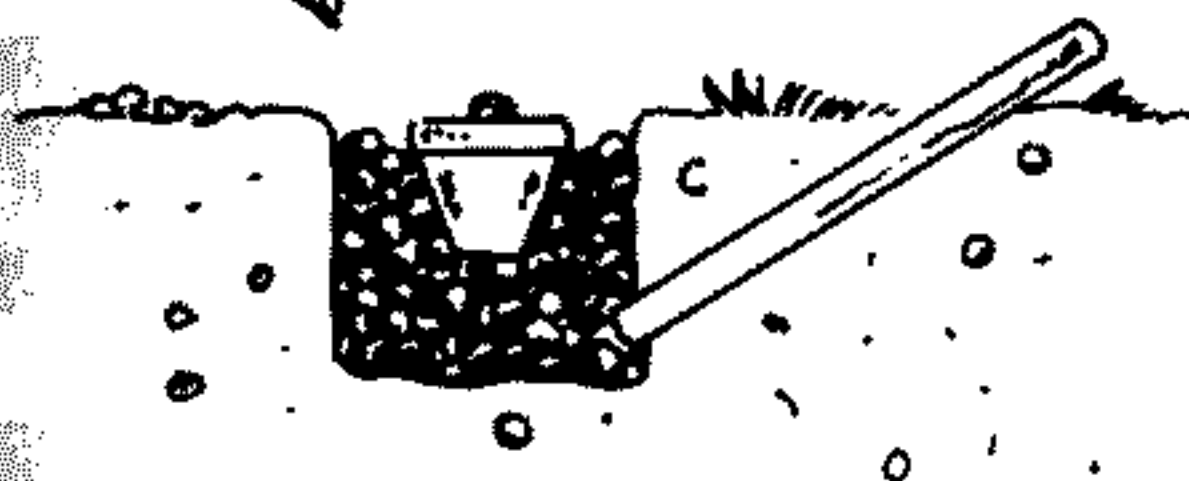

6. Light the briquettes and wait for them to catch.



7. Once most of the briquettes have caught fire, turn on the air supply at the mouth of the pipe.

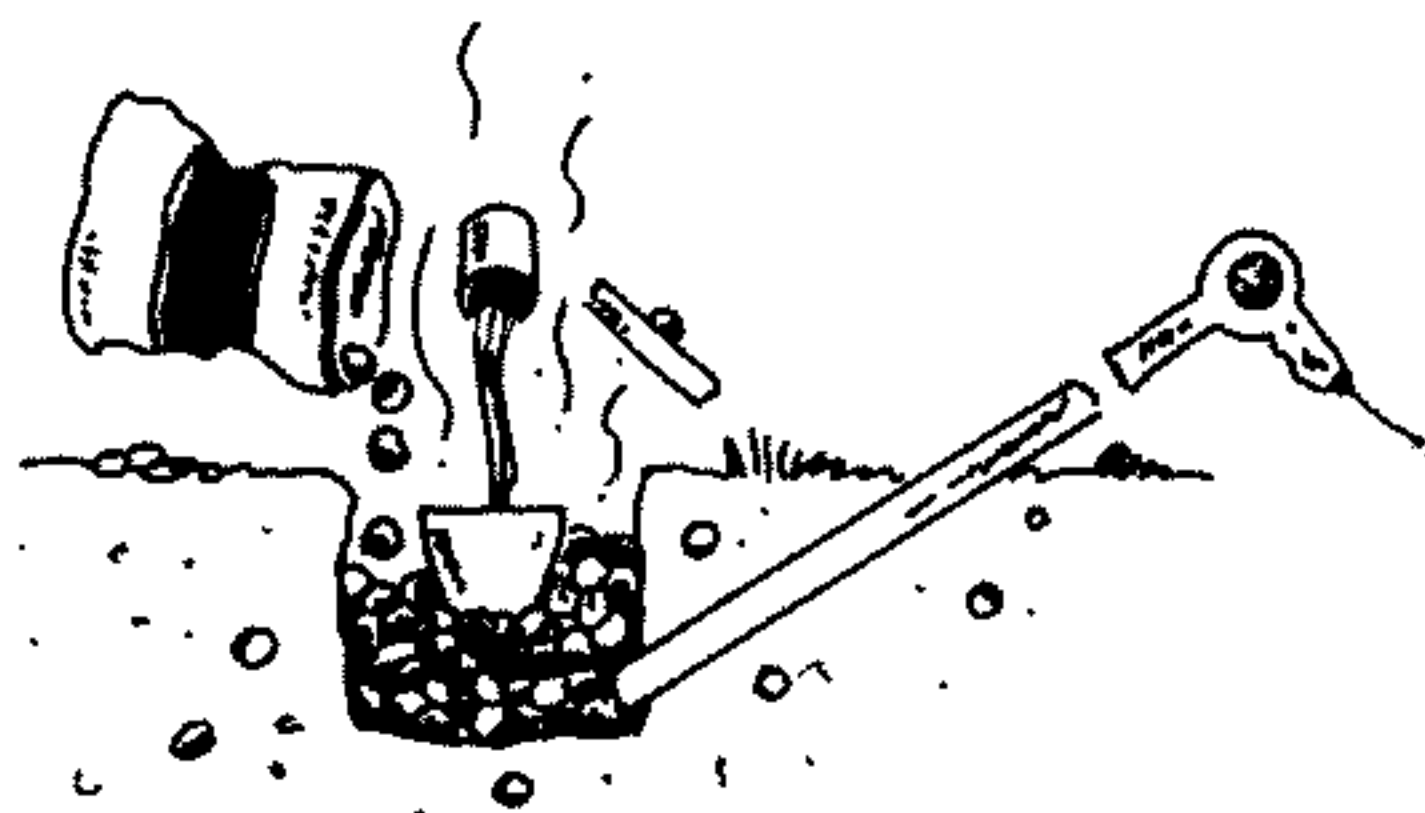

*Note:* Make sure that if you are using a hair dryer, it is set on cool. If you are using a vacuum, be sure the hose is in the exhaust hole. If not, the appliance will burn out in a short time.

8. Remove the cover of the crucible with tongs or long-handled pliers and add the desired material to the crucible. Replace the cover. Top off the charcoal if necessary.

*Note:* An iron or steel tripod is helpful for keeping the crucible steady during firing. Place it in the hole before proceeding with step 4. Then pile the briquettes around it until they reach the ring of the tripod.

**HYDROGEN AZIDE**

Hydrogen azide is a low-boiling liquid that is similar to hydrogen cyanide in toxicity, in addition to having an unbearable odor. In that respect it can be used as a noxious gas. It is also, however, a flame-sensitive high explosive that is slightly less powerful than military RDX. It decomposes fairly rapidly, so manufacture it within a day of use.

**MATERIALS**

Sodium azide

Sulfuric acid  
(concentrated)

Small-mouth bottles

Thermometer

Glass or acid-resistant  
plastic tubing

Hot water source

Rubber stoppers, clay, wax,  
etc.

Bowls, etc.

Salt/water/ice mix

Gas mask and gloves

**SOURCES**

Photo supply store

Section I, No. 43



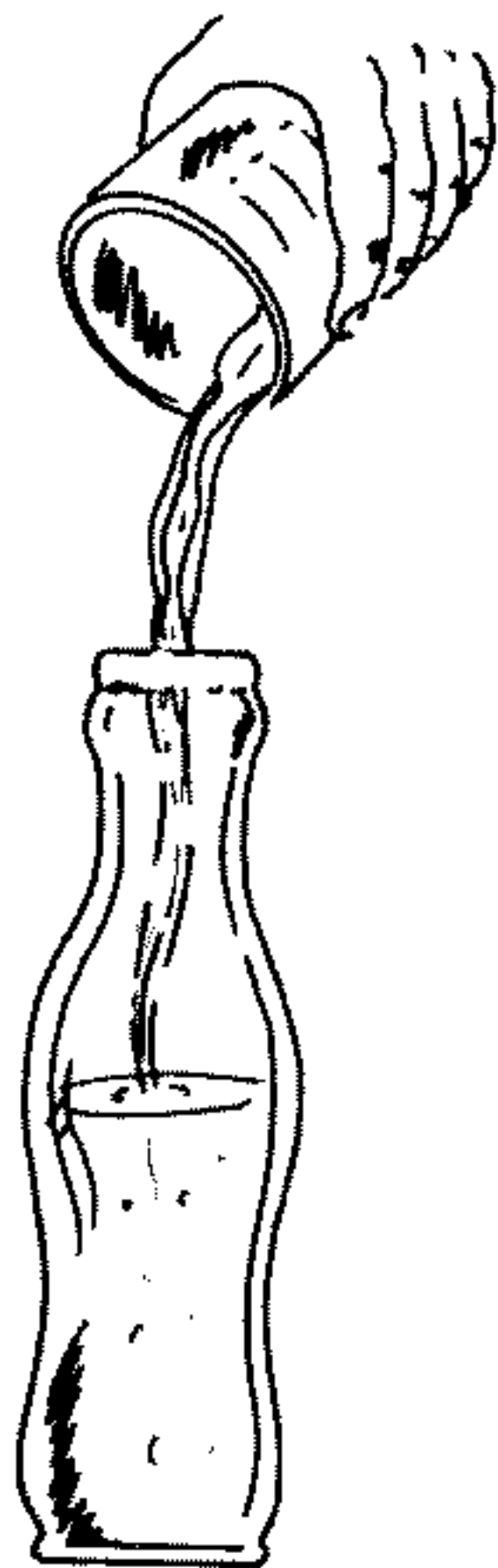

**PROCEDURE**

1. Fill a bottle  $\frac{1}{4}$  of the way with sodium azide. Fill to the  $\frac{1}{2}$  way mark with refrigerated sulfuric acid.

**CAUTION:** At this point, the hydrogen azide is synthesized. Avoid inhaling any of the fumes or coming in contact with any of the liquids formed.

2. Insert the thermometer and one end of the tubing into the mouth of the bottle and seal around them with clay or wax. If a two-hole rubber stopper is available, use it instead.

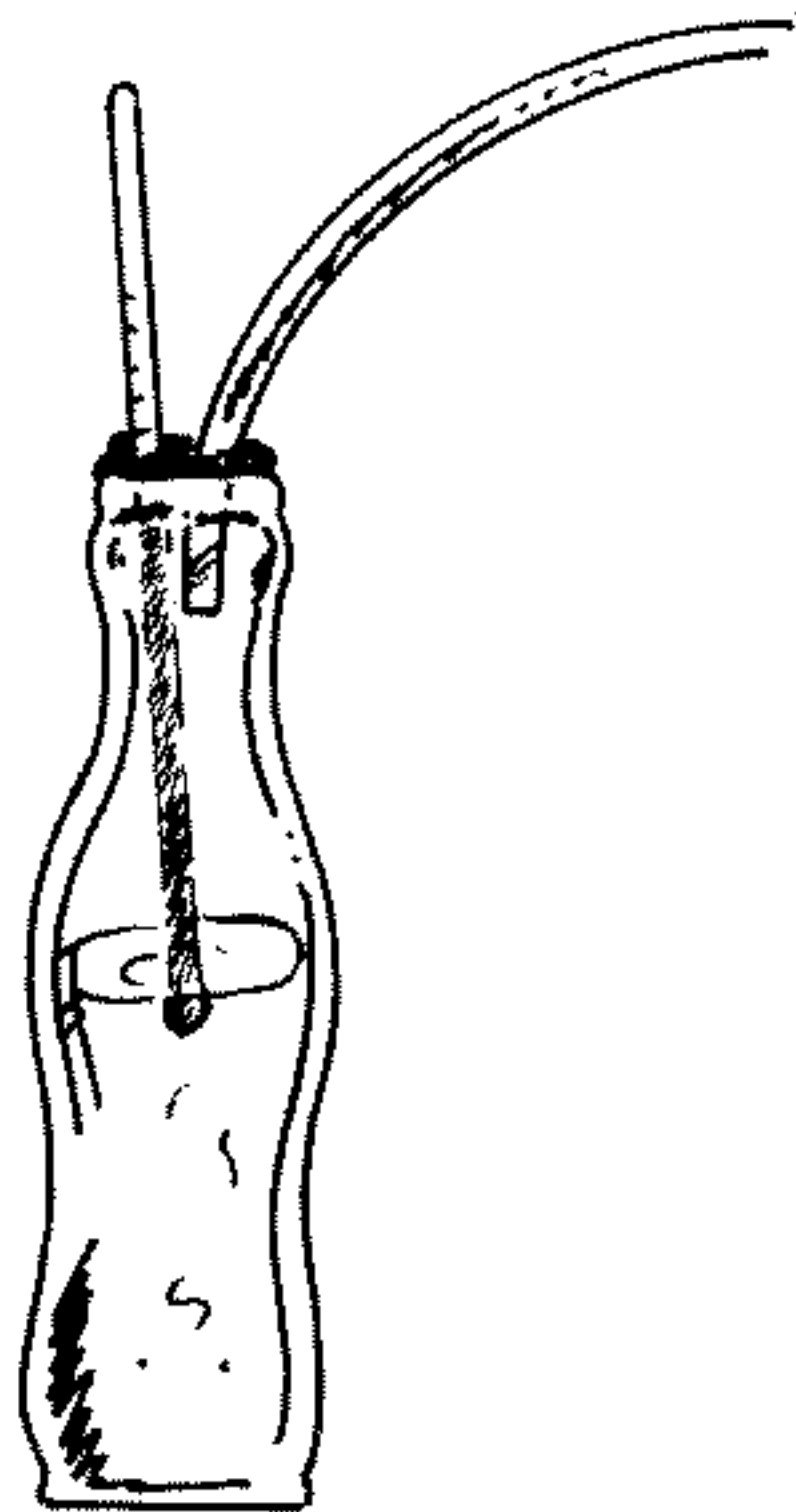

3. Place a second bottle in the salt/water/ice mix and insert the other end of the tubing into the bottle, preferably resting the end of the tube on the bottom of the bottle.

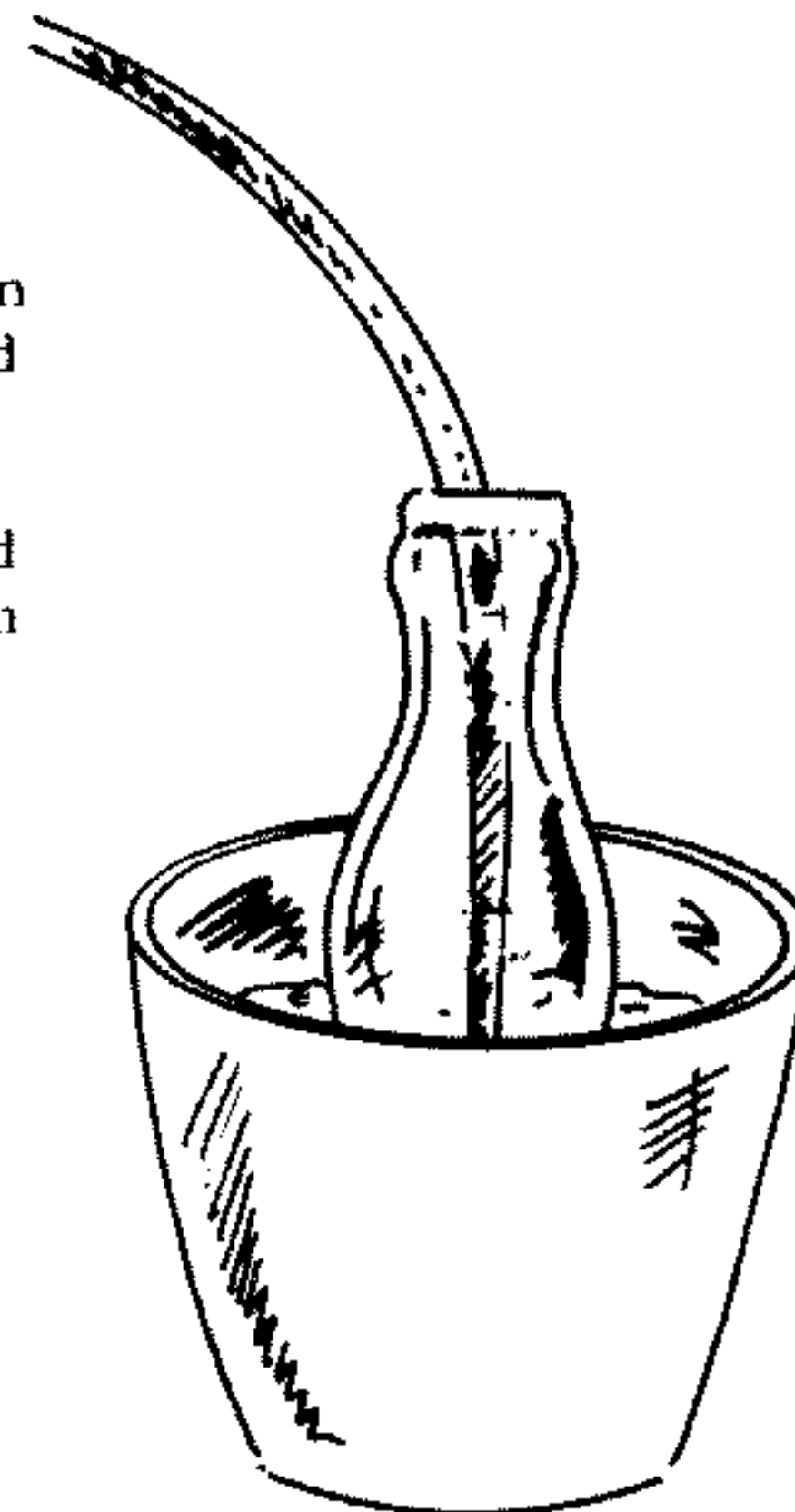

4. Once the second bottle has been sealed with a single-hole stopper or clay, place the first bottle in a bowl containing 50°C water. As the water cools, replace it. Liquid should start condensing in the

second bottle within a few minutes. If not, increase slightly the temperature of the water in the bowl until it does. Continue replacing the cool water until liquid no longer condenses in the second bottle.

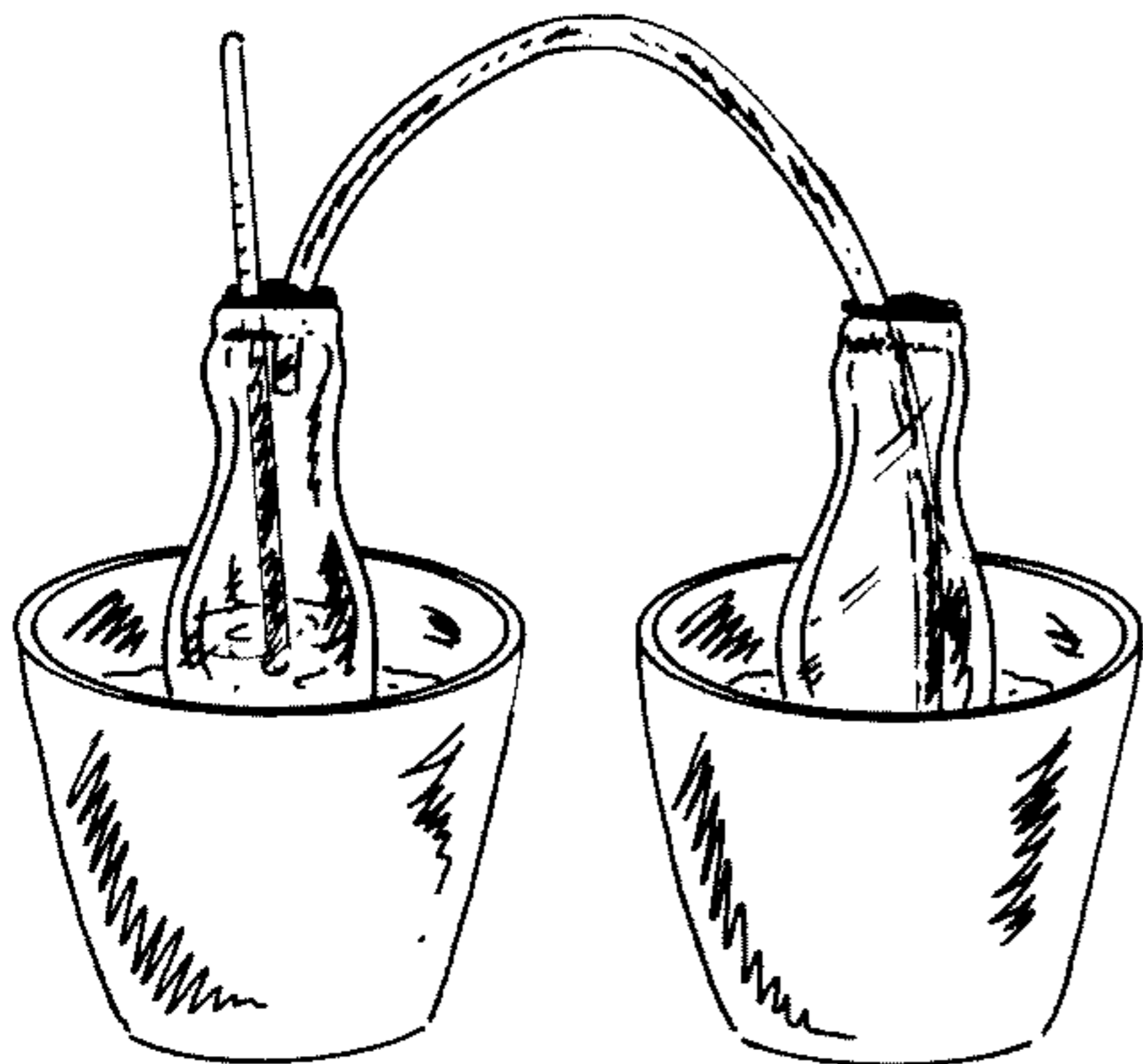

5. Wearing a gas mask and gloves, remove the stopper from the second bottle and replace it with a solid one. Next, place the bottle into a plastic bag and close it tightly. Refrigerate until needed.

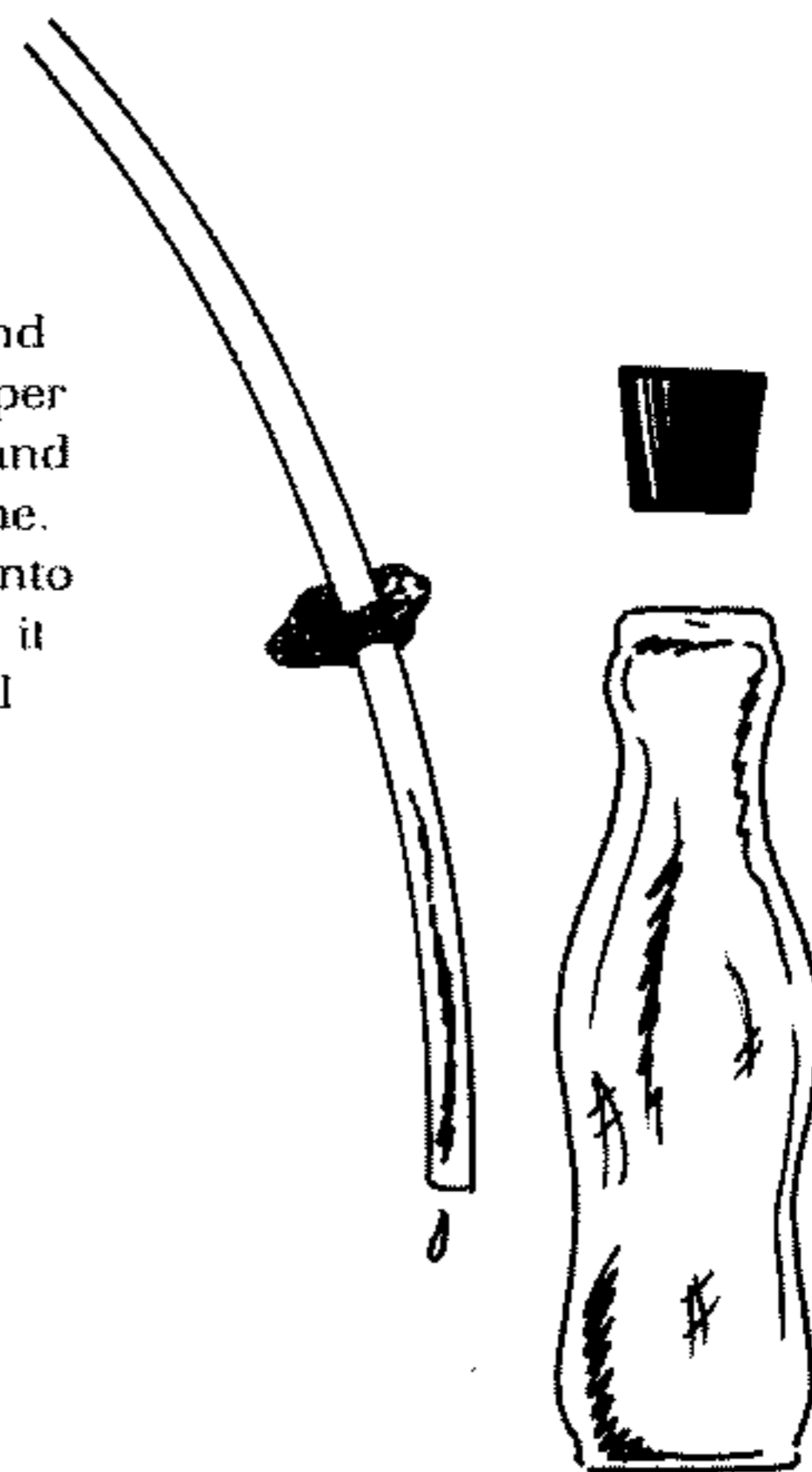

#### HOW TO USE

Hydrogen azide is probably best suited as a vapor explosive that can be detonated either by delay incendiary (Sec. I, No. 50), pressure pad (Sec. VII, No. 3), or trip wire (Sec. VII, No. 6) hooked up to a battery and an electric-bulb initiator (Sec. VI, No. 1). When left to evaporate in a warm room, it will form an explosive gas that can be set off by flame or by another explosive. It also has the advantage that, even if it doesn't explode for some reason, it will likely incapacitate and then kill any person entering the target room.

Section I  
No. 51**ETHYLENE GLYCOL DINITRATE**

Ethylene glycol dinitrate is quite similar to nitroglycerine, being only slightly less powerful due to its neutral oxygen balance, but is considerably more stable and has a lower freezing point.

**MATERIALS**

Nitric acid  
Sulfuric acid  
Ethylene glycol  
Baking soda  
Acid-resistant jar, etc.  
Large bowl  
Bucket, etc.  
Thermometer  
Bulb baster or syringe  
Salt/water/ice mix  
Pan

**SOURCES**

Field grade (Sec. I, No. 4)  
Sec. I, No. 43  
Some antifreezes or  
chemical supply store  
Grocery store

**PROCEDURE**

1. Place the mixing jar in the pan full of the salt/water/ice mixture. Add 1¼ cup concentrated sulfuric acid and ½ cup concentrated nitric acid into the jar and let sit until the temperature drops below 20°C.

2. While stirring, add ¼ cup ethylene glycol, ½ teaspoon at a time, to the mixed acids, not allowing the temperature to exceed 25°C. Once all the ethylene glycol has been added, leave mixture alone for 15 minutes to set.

**CAUTION:** Ethylene glycol can react violently with sulfuric acid.

**CAUTION:** At this point, the explosive is synthesized. Avoid any shocks or increases in heat of the work area, as it might cause the explosive to detonate. Also, avoid contact with the acids or the explosive, as they are both highly toxic. Exposure to ethylene glycol dinitrate will cause short-lived but severe headaches. If these occur, get victim to fresh air immediately.

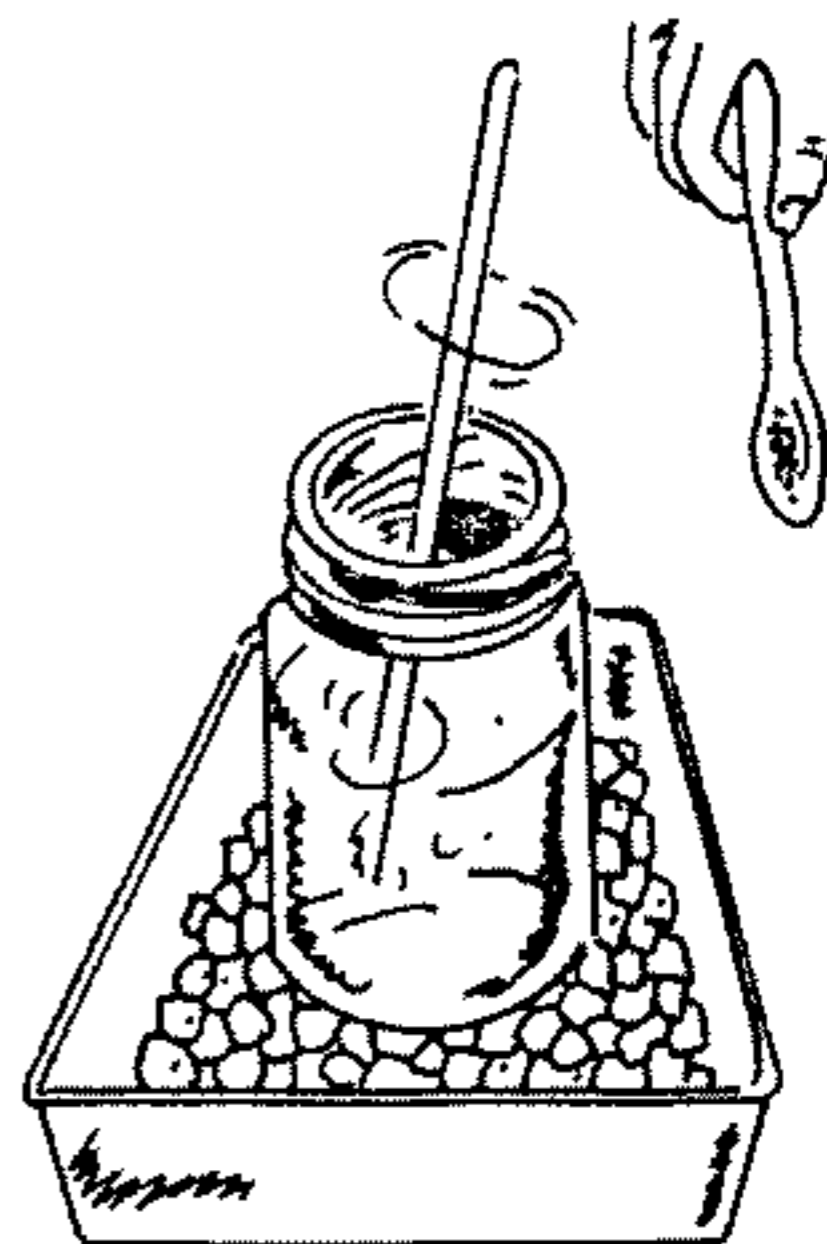
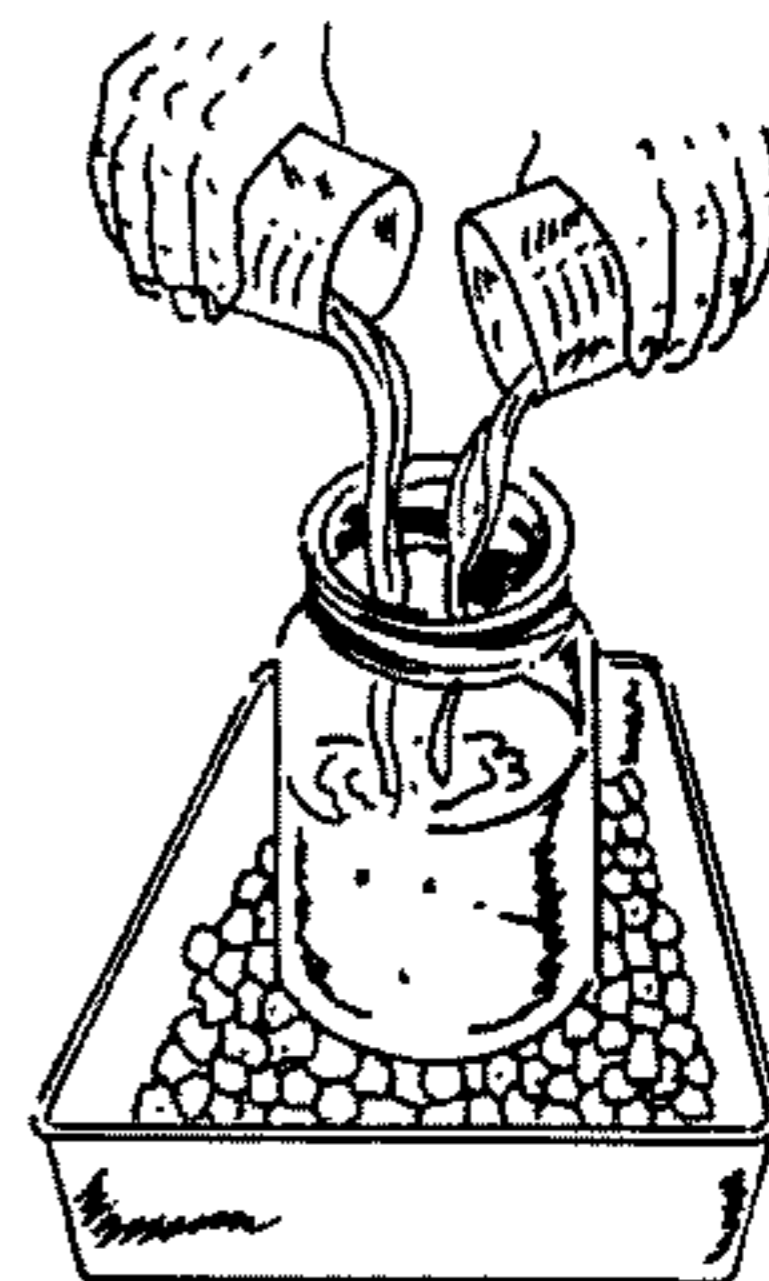



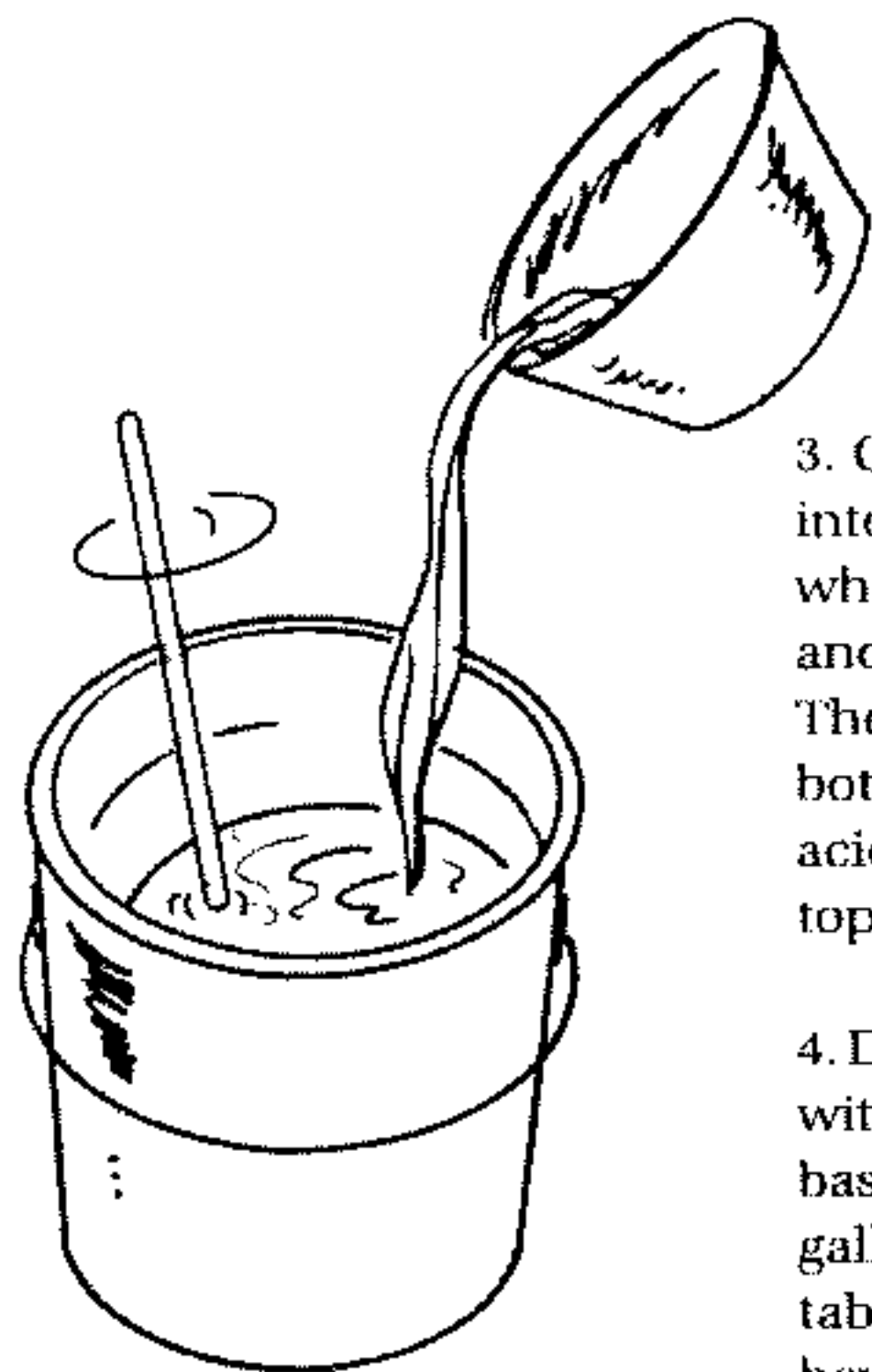

3. Carefully pour the mix into 1 gallon of clean water, where it is stirred gently and then allowed to settle. The explosive forms a bottom layer and the spent acid/water solution forms a top layer.

4. Draw off the bottom layer with the syringe or bulb baster and place it into 1 gallon of water in which 5 tablespoons baking soda have been dissolved.

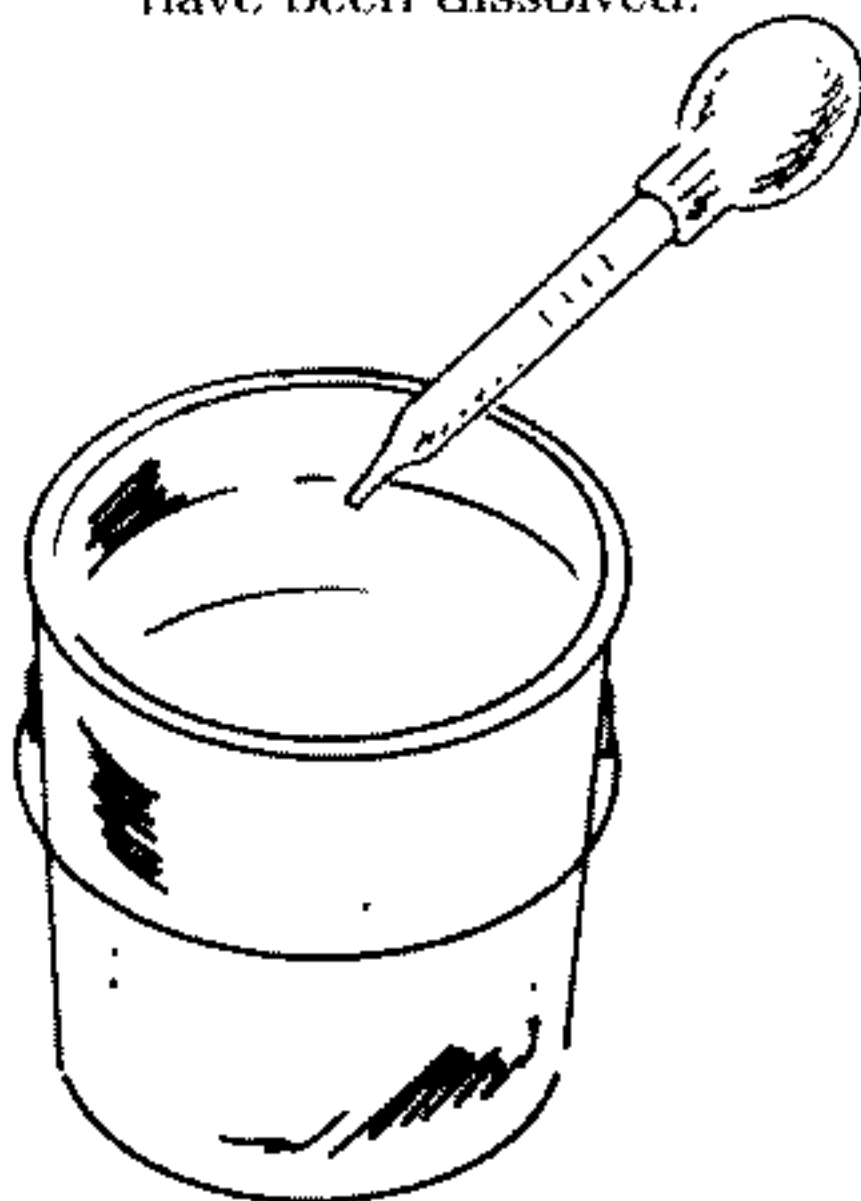
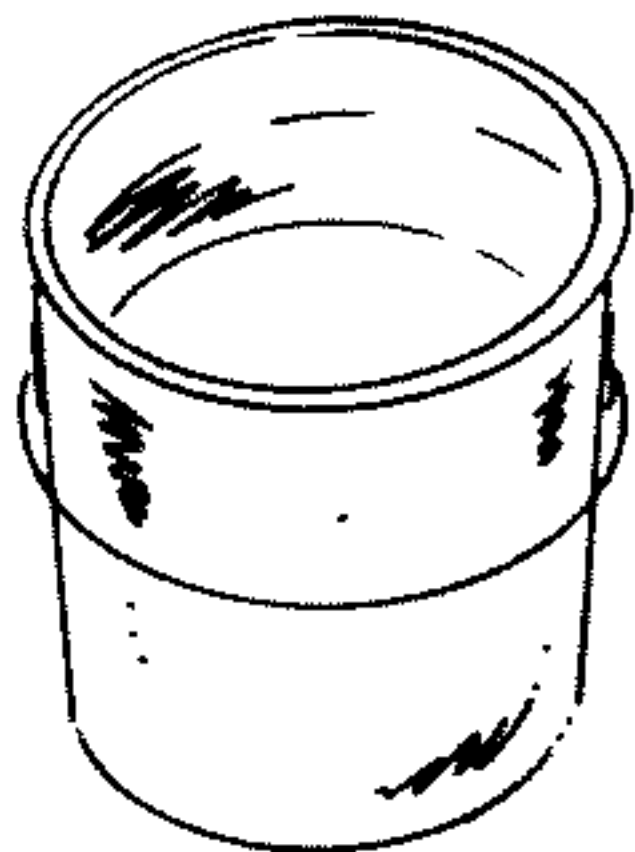

5. Once again, stir, let settle, and remove bottom layer with a syringe or bulb baster.

The explosive is now completed. It may be used straight in its highly shock-sensitive liquid form, though it is recommended that it be used as a dynamite.

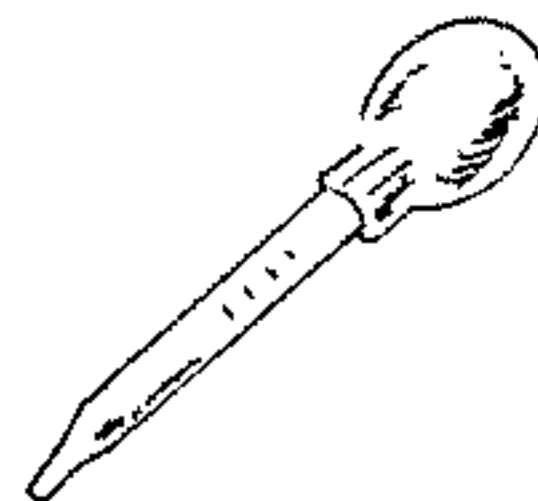
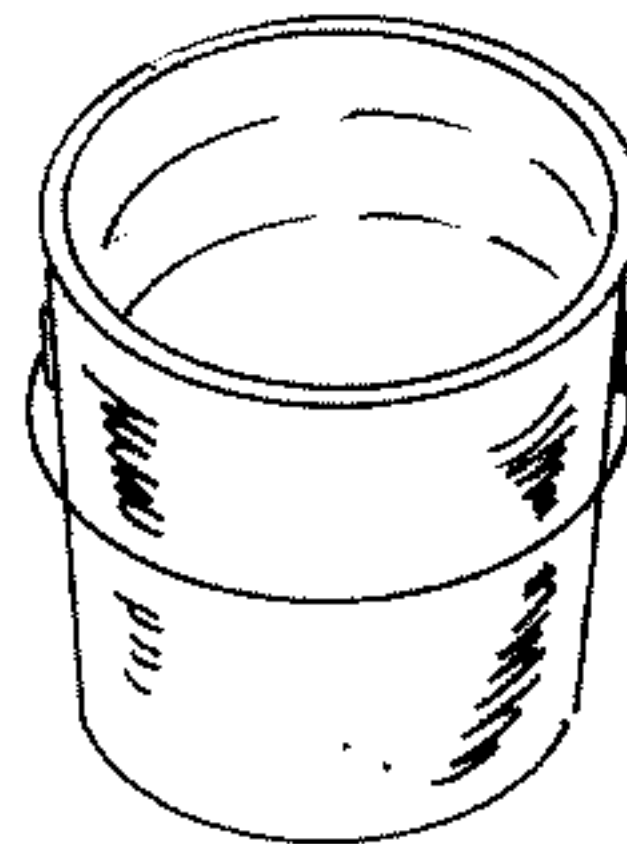

## DYNAMITES

A good way to use sensitive nitric esters like methyl nitrate (Sec. I, No. 12) and ethylene glycol dinitrate (Sec. I, No. 52) is in combination with other nonexplosive or less sensitive ingredients to form dynamites. Depending on which mix you decide to use, you will need only some of the following materials.

MATERIALS	SOURCES
Methyl nitrate	Sec. I, No. 12
Ethylene glycol dinitrate	Sec. I, No. 52
Nitrocellulose	Single-base smokeless powder
Ammonium nitrate	Garden supply store
Potassium nitrate	Sec. I, No. 2 or chemical supply store
Sodium nitrate	Chemical supply store
Sawdust, wood meal, etc.	Lumber yard
Diatomaceous earth	Pool supply store
Baking soda	Grocery store
Pan	

## PROCEDURE

Percentages of ingredients by weight for different mixes:

*Straight dynamites*

Nitric ester	20	25	30	40	50	60	75
Potassium nitrate	70	50	62	45	30	20	
Wood meal	10	25	8	15	20	20	
Diatomaceous earth							25

*Ammonia and semigelatin dynamites*

Nitric ester	10	20	33		25	30	75
Cellulose nitrate					1	1	5
Ammonium nitrate	83	75	30		64	30	15
Potassium nitrate			27			30	
Wood meal	7	5	10		10	9	5

*Blasting gelatin and gelatin dynamites*

Nitric ester	93	92	37	47	56	65	75
Cellulose nitrate	7	8	3	3	4	5	5
Potassium nitrate			48	40	30	22	16
Wood meal			12	10	10	8	4

*Note:* Each group has its advantages, and in each group there are more and less powerful mixtures.

For the straight dynamites, the 60-percent dynamite is the most powerful. This group requires few ingredients and is therefore relatively cheap to make.

For the semigelatin dynamites, the last composition is the most powerful and water resistant while still having a relatively cool flame, which is the advantage of all semigelatin dynamites.

For the gelatin dynamites, the first two mixtures are the most powerful not only of their group but of any dynamites.



FOR INFORMATION PURPOSES ONLY

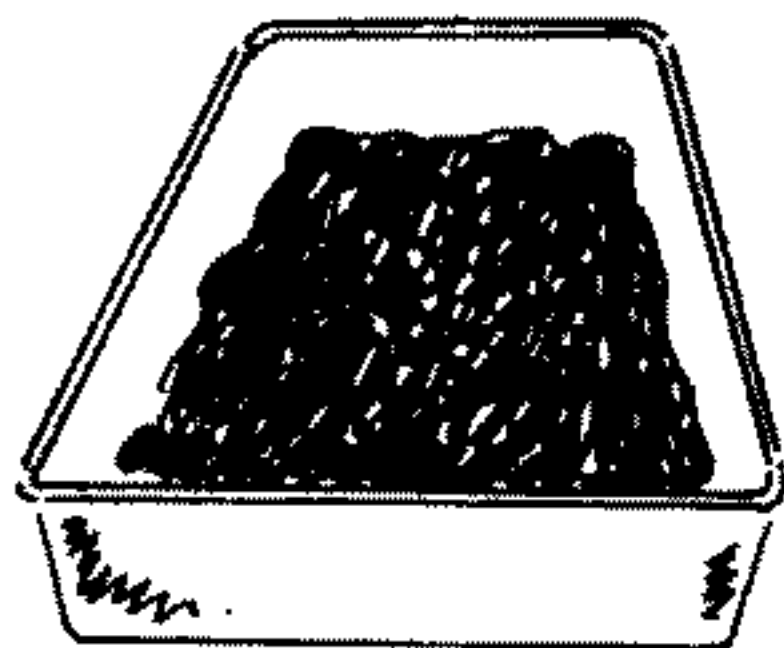

1. In order to manufacture any of the dynamites, simply place in the pan the appropriate percentages by weight of the dry ingredients and spread them out evenly.

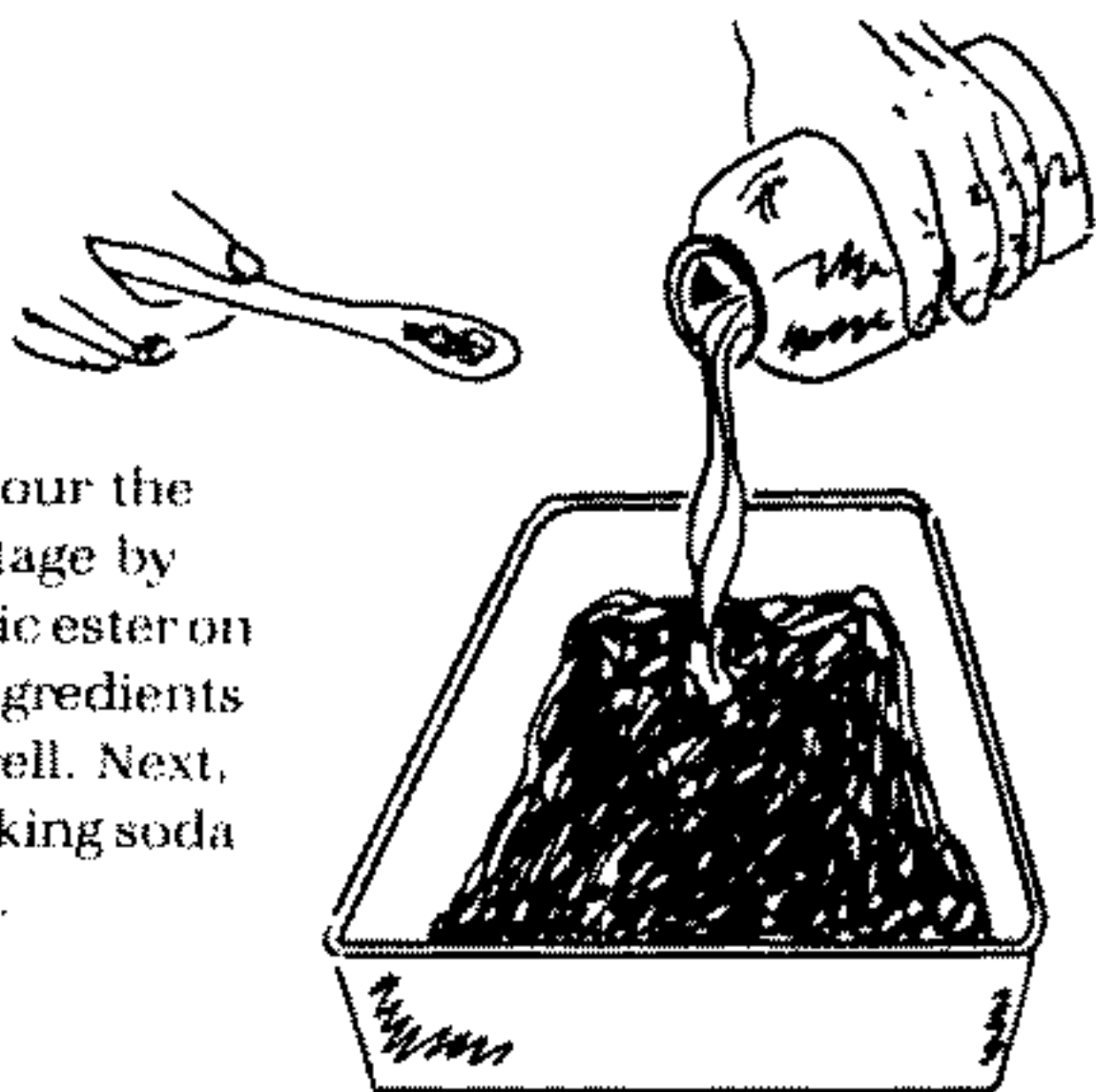

2. Next, slowly pour the required percentage by weight of the nitric ester on top of the dry ingredients and mix them well. Next, add 5 percent baking soda as a preservative.

3. Finally, place the damp explosive into a pipe nipple and insert a blasting cap. Confine both ends for best performance.

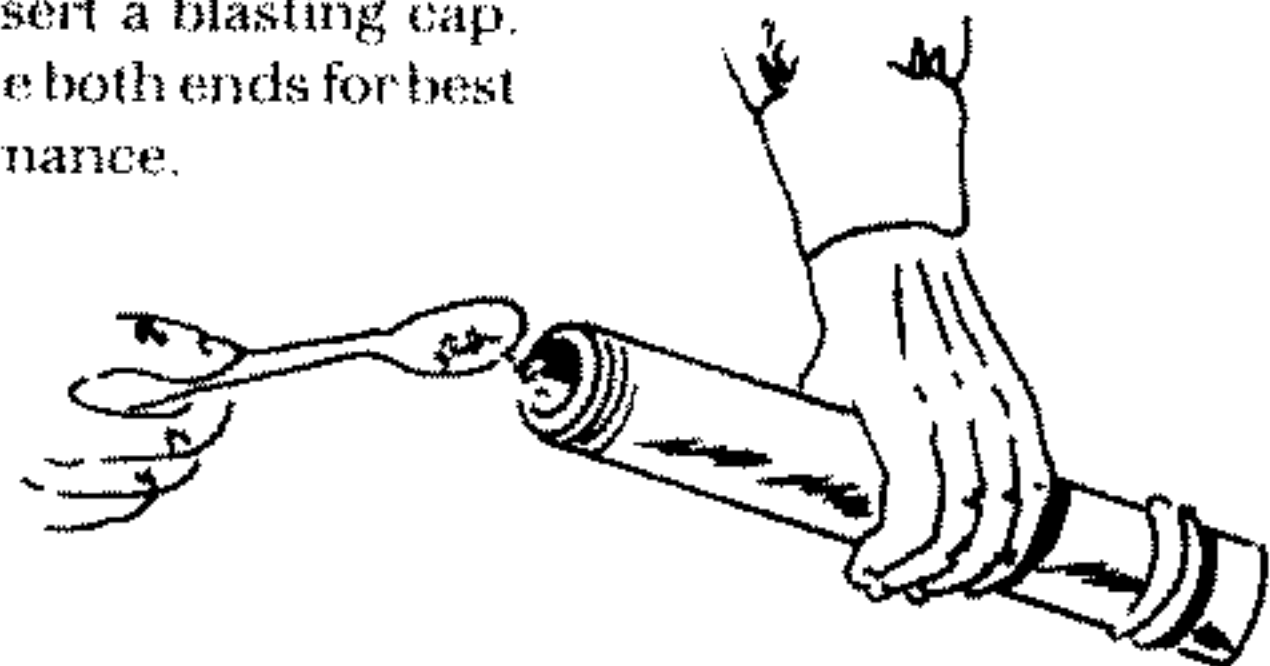

FOR INFORMATION PURPOSES ONLY

Section I  
No. 53

**CASTABLE IMPACT-SENSITIVE EXPLOSIVE**

This explosive is more stable than the potassium chlorate/sulfur explosive (Sec. I, No. 30), due to its final solid form. It is best suited for making molds that are then detonated, or for using in pipe hand grenades that are dropped from great heights.

**MATERIALS**

Potassium chlorate

Dusting sulfur

Elmer's glue

Chalk

Sand

Bowl, etc.

Spoon, etc.

**SOURCES**

Chemical supply store

Garden supply store

Office supply store

Office supply store

**PROCEDURE**

1. Place 20 parts potassium chlorate in the bowl and add 18 parts glue. Mix well and add 2 parts powdered chalk.

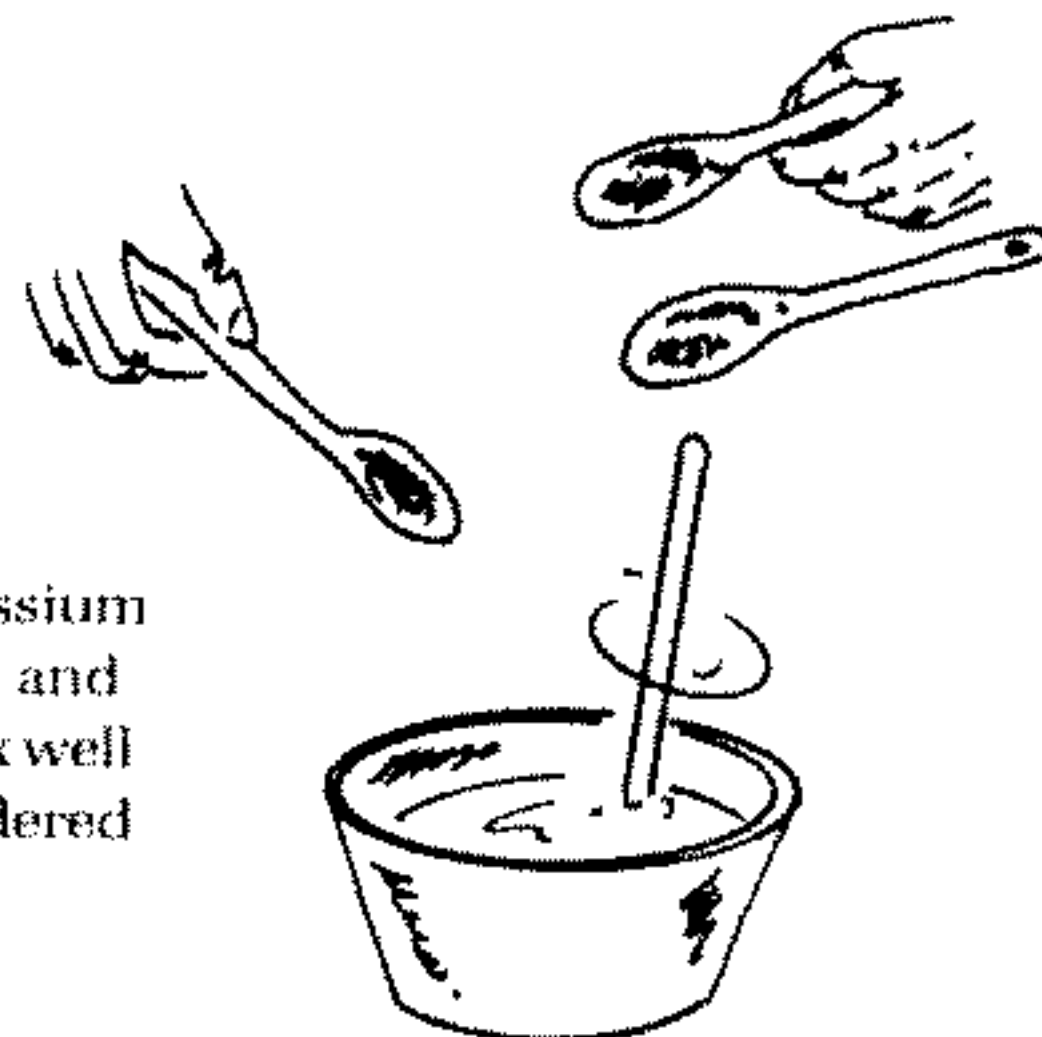

## FOR INFORMATION PURPOSES ONLY

2. In another bowl, mix 8 parts each of sulfur and sand and enough water to moisten it.



3. Add the sulfur/sand mix to the chlorate/glue mix and stir until all ingredients are well combined. If necessary, add more water to reach desired consistency.

4. Now, either pour the mix into pipe nipples and let dry, or place in a mold and let harden.

**CAUTION:** Do not expose the finished product to friction, as it may explode.

### HOW TO USE

1. To use as regular explosive, simply confine and detonate with a compound detonator.
2. To use as an impact explosive, either propel a filled pipe nipple against a hard obstacle using, for example, a grenade launcher (Sec. IV, No. 5), or drop a similar pipe nipple from a considerable altitude (a high building, aircraft, etc.).
3. If fine sand or ground glass is used, this mixture can be used to make reusable primer (Sec. III, No. 5).

## FOR INFORMATION PURPOSES ONLY

Section II  
No. 17

### COPPER-SLUG CHARGE

When this charge detonates, the heat and pressure of the explosion melts and shoots out the piece of copper on the front of the charge. The copper-slug charge is most useful for destroying lightly armored (or unarmored) vehicles. Aimed at the engine or passenger compartments, it will do extensive damage.

#### MATERIALS

Large steel aerosol can at least 2½ inches in diameter

Hacksaw

Furnace

Copper

Tongs or long-handled pliers

Wood disk ½-inch thick and 1 inch less in diameter than can

Drill

Wood screws

Wood disk, same diameter as can

Caulking or electrical tape (as sealant)

Epoxy cement

#### SOURCES

Shaving cream, insect spray, etc.

Hardware store

Kiln, improvised (Sec. I, No. 49)

Pennies, copper wire, etc.

Hardware store (necessary only if liquid explosive is used)

## FOR INFORMATION PURPOSES ONLY

### MATERIALS

High brisance explosive  
(RDX, Composition B, etc.)

Appropriate detonator

Spacer

Sand

### SOURCES

Chopstick, etc.

### PROCEDURE

1. Fire up the furnace or kiln and allow to heat.
2. Check to see that the can is steel; it should have seams at the top and bottom and the bare metal at the bottom should not be scratched by a penny.
3. Cut the top off the can with the hacksaw, as shown. Also, scrape any paint or lacquer off the outside of the can.
4. Once the kiln is hot or the air supply is started on the furnace, place about 150 grams of copper (60 pennies) in the crucible if using a 2½-inch diameter can. If using another size, adjust amount accordingly.

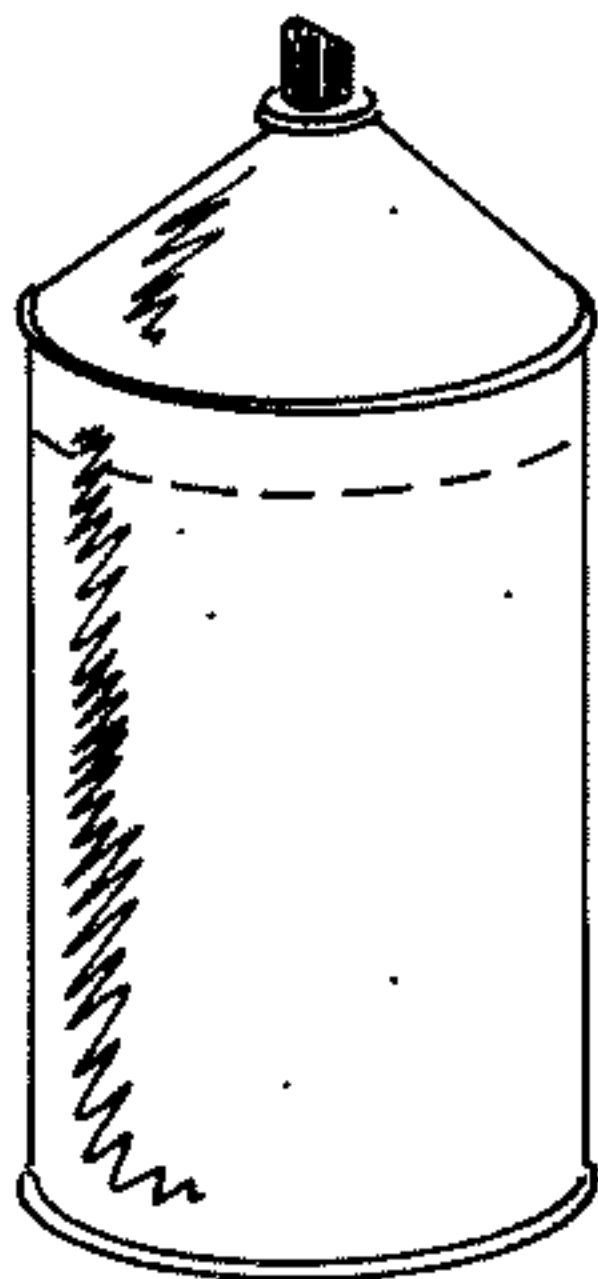

## FOR INFORMATION PURPOSES ONLY

5. When the copper is completely melted, remove the crucible from the furnace with tongs or long-handled pliers and pour the molten copper into the bottom of the can, as shown. Let cool.

If powdered or plastic explosive is used, go to step 6. If liquid or castable explosive is used, go to step 8.

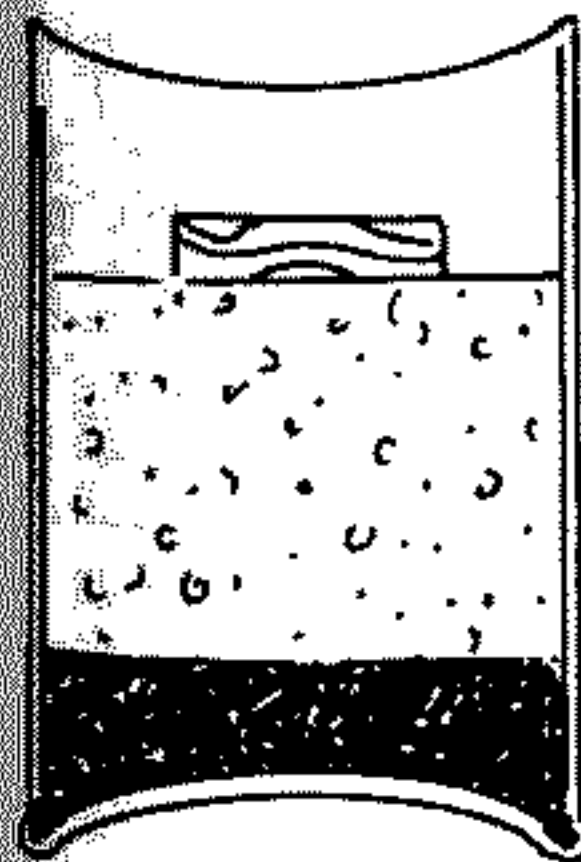
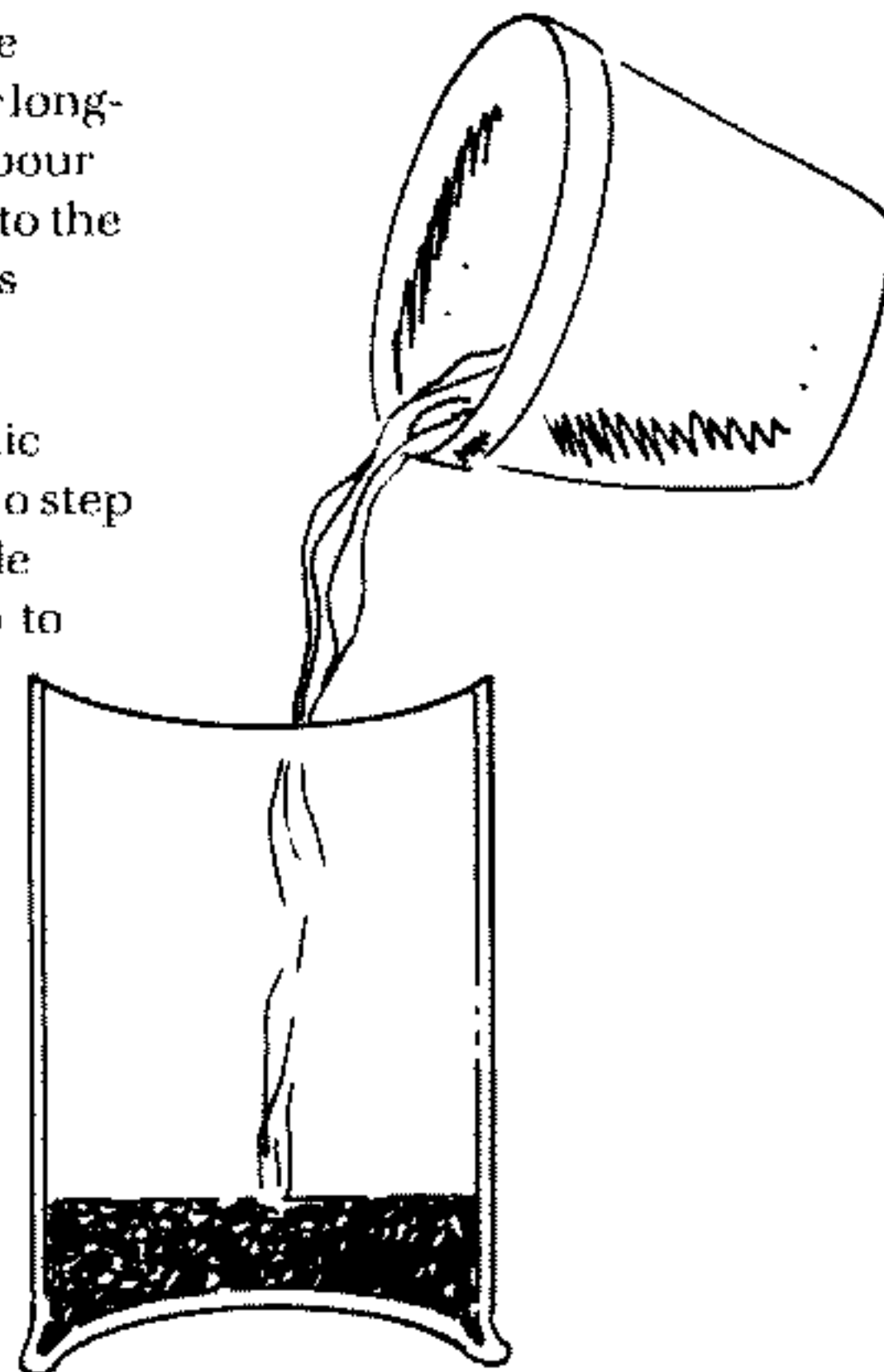

6. Now fill the can  $\frac{3}{4}$  of the way with explosive. Place the smaller wood disk in the middle of the explosive and press down firmly to pack it.



FOR INFORMATION PURPOSES ONLY

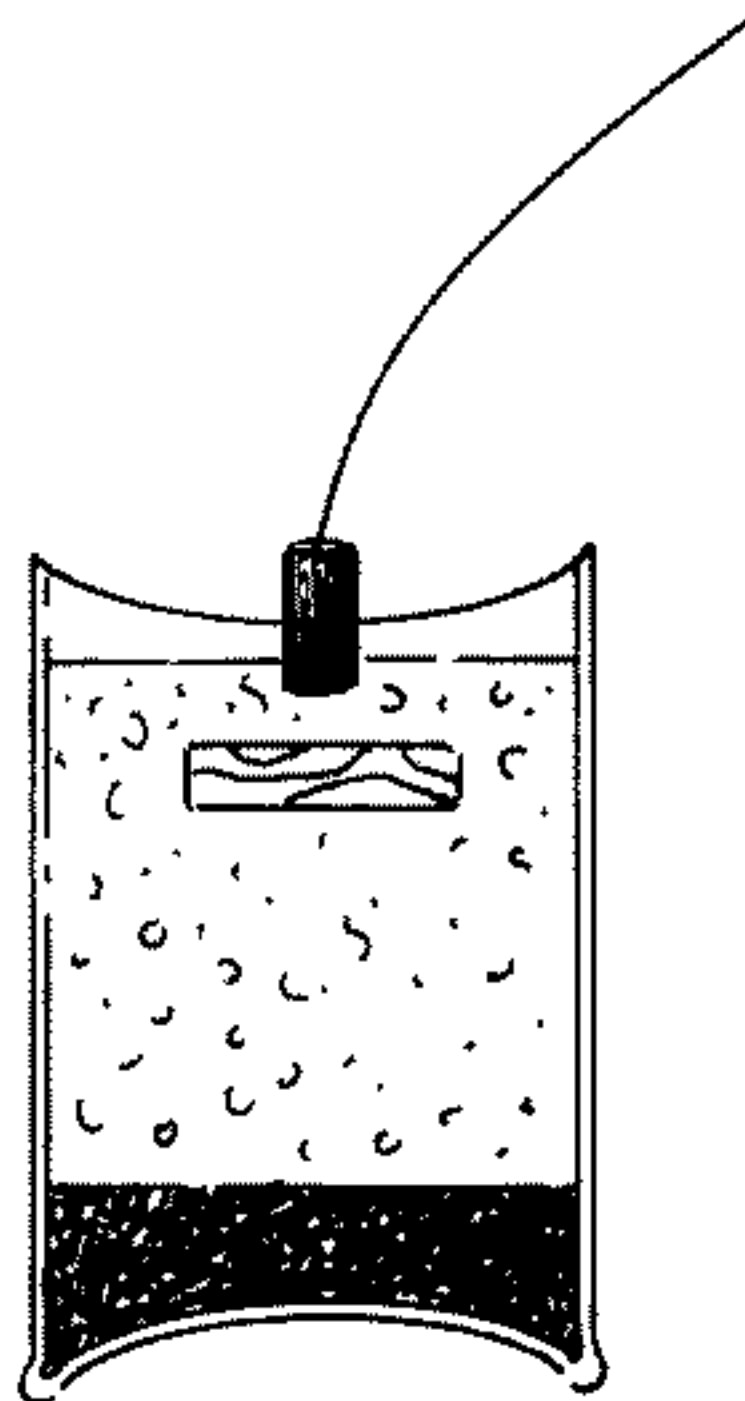

7. Fill the rest of the can with explosive to within  $\frac{1}{2}$  inch of the top. Make sure to pack explosive in the space between the disk and the can. Insert a spacer for detonator in the middle and pack explosive around it. Remove spacer and insert detonator.

8. Mark the can on the inside  $\frac{3}{4}$  of the way to the top. Fill can with sand up to  $\frac{1}{4}$  inch of the line.

9. Place the disk on top of the sand and drill through both the can and the disk in 3 or 4 places. Remove the disk and empty out the sand.

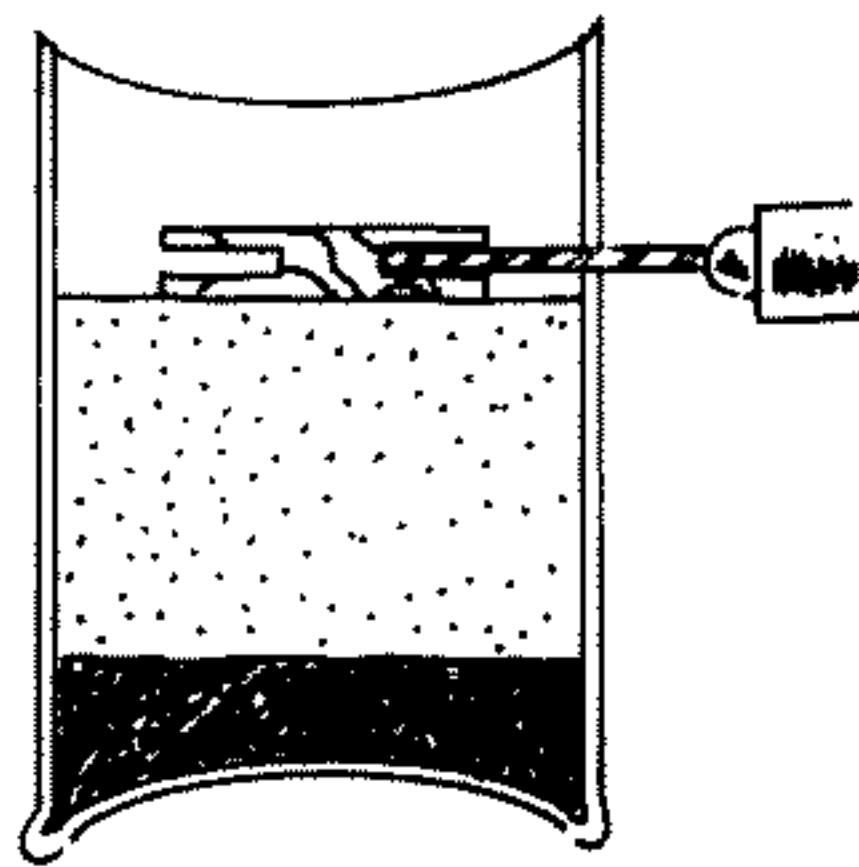
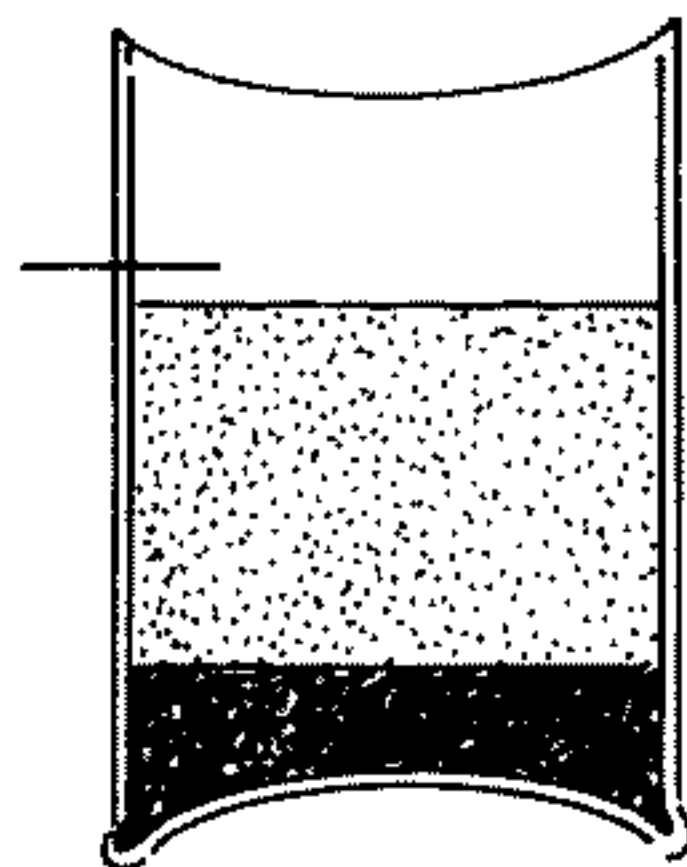

FOR INFORMATION PURPOSES ONLY

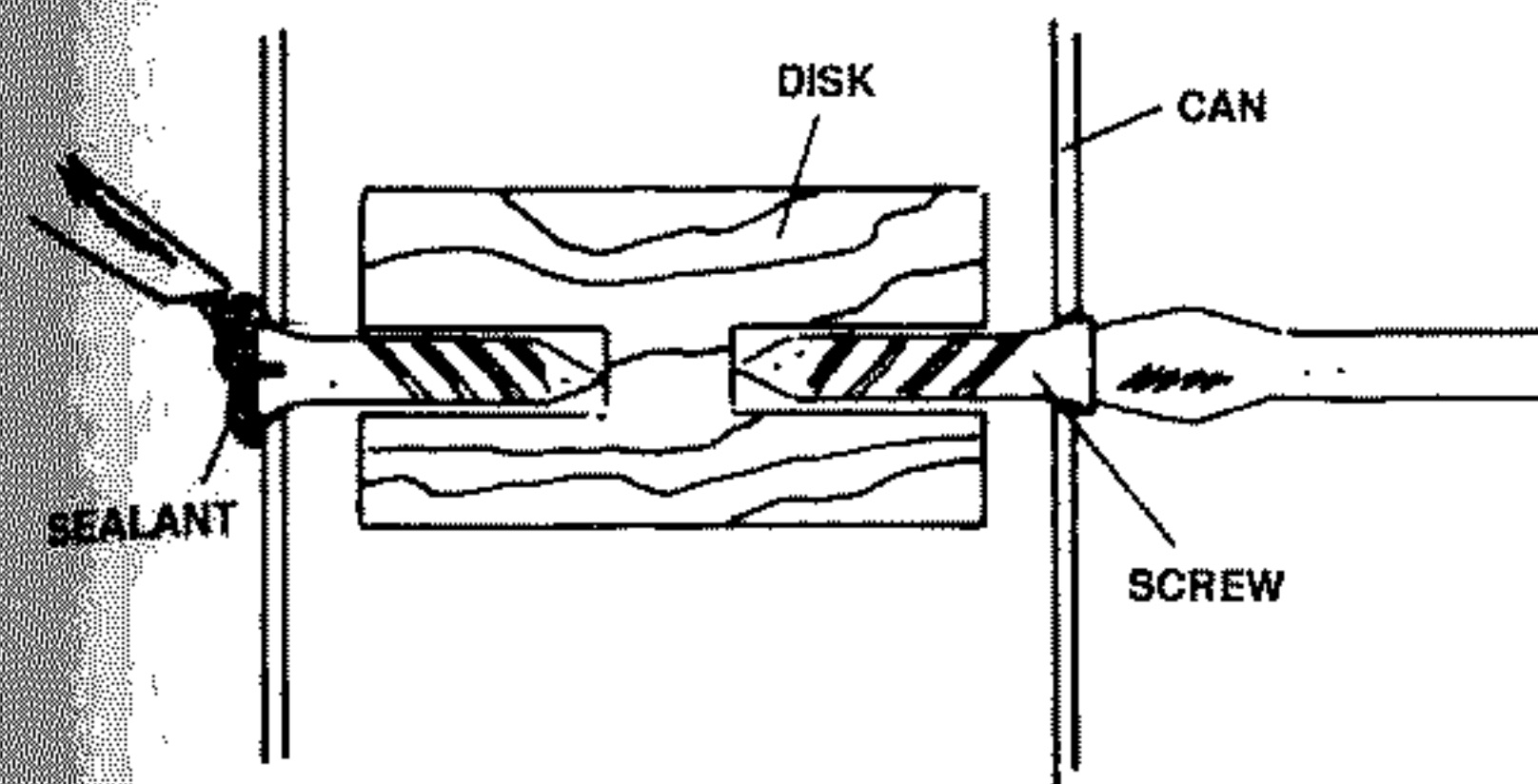

10. Next, drive the screws through the can and disk as shown. Seal around the screw holes on the outside of the can.

11. Drill a  $\frac{1}{2}$ -inch hole in the larger disk and apply epoxy around the edges. Insert it into the can as shown and leave upside down until glue is hard.

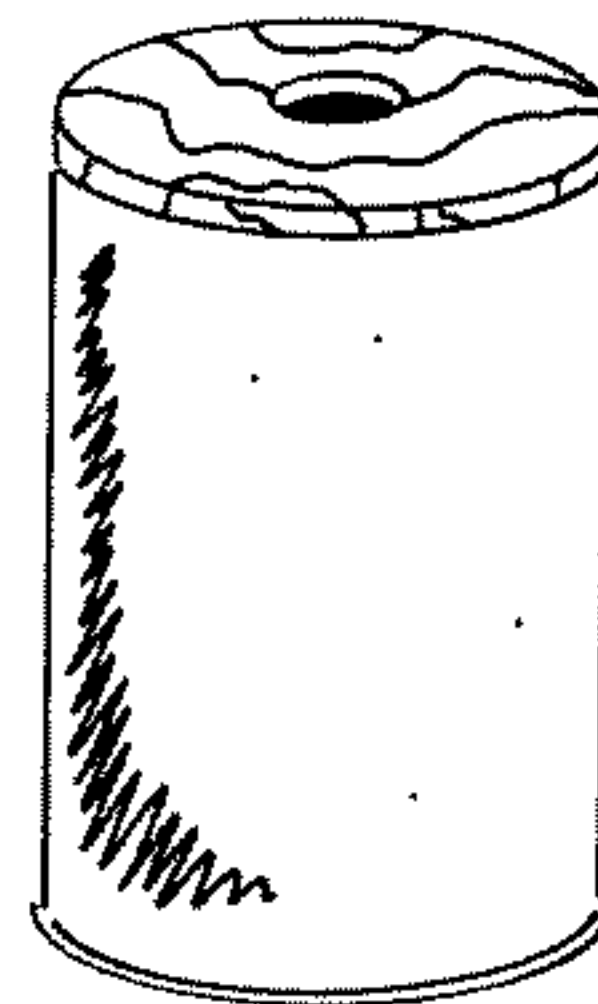

## FOR INFORMATION PURPOSES ONLY

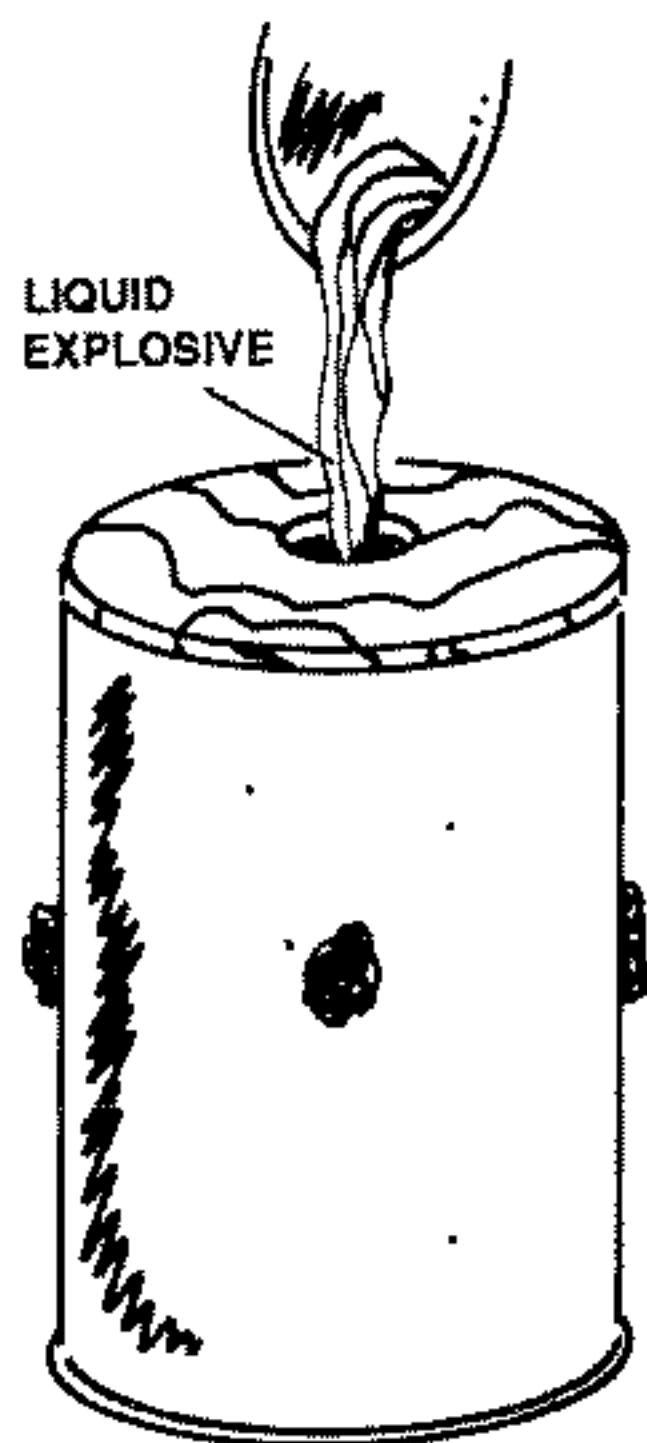

12. If castable explosive is used, melt it as outlined in Sec. II, No. 3, step 4. Now pour the explosive into the hole, shaking the can and stirring with a stick to prevent air bubbles from forming.

13. Insert detonator into the hole, leaving only the top out, and seal around it with either sealant or epoxy.

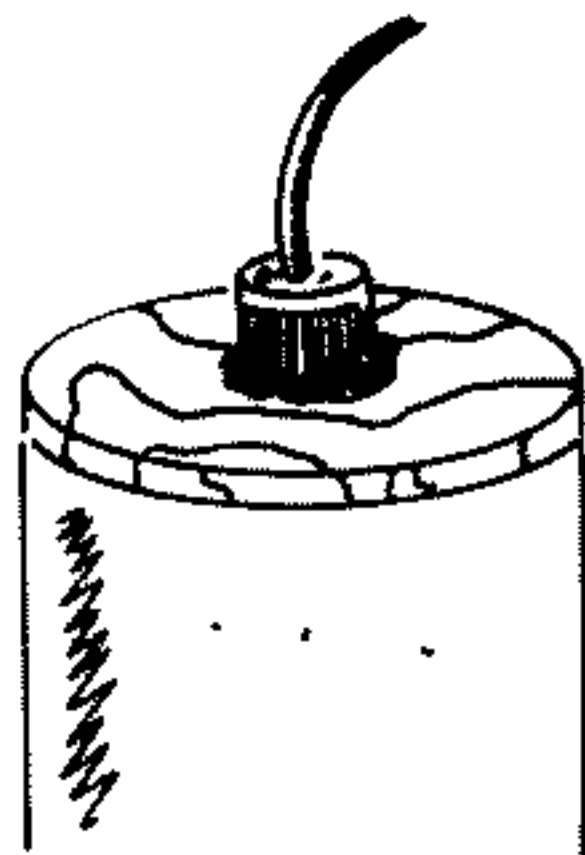

## HOW TO USE

1. Place the copper-slug charge so that it points in the direction of the expected path of the target vehicle. If possible, suspend the charge *over* the road, as any vehicle always has its thinnest armor on top. If not, bury or somehow conceal in road.

## FOR INFORMATION PURPOSES ONLY

2. If an electric blasting cap is used, connect it appropriately to a pressure pad and battery, as outlined in Sec. VII, No. 3, or use any other suitable triggering system.

3. The optimum range is between 1 and 5 feet. At distances less than 1 foot, the slug will not have time to form or accelerate. At ranges greater than 5 feet, the slug starts to lose speed and temperature, though it is still useful at ranges of over 10 yards.



**SHOTSHELL ANTIPERSONNEL MINE**

This mine can be used as either an antipersonnel or antivehicular weapon. It will incapacitate or possibly kill a man stepping on it. It will also destroy the tires of a vehicle running over it.

**MATERIALS**

**SOURCES**

$\frac{3}{4}$ -inch pipe nipple	Hardware store
$\frac{3}{4}$ -inch pipe coupler	Hardware store
$\frac{3}{4}$ -inch pipe plug	Hardware store
$\frac{1}{8}$ -inch bolt and matching nut	Hardware store
File	
Drill with $\frac{3}{16}$ bit	
12-gauge shotgun shell	
Craft glue or wax	

**PROCEDURE**

1. Cut a 2-inch piece off one end of the nipple.

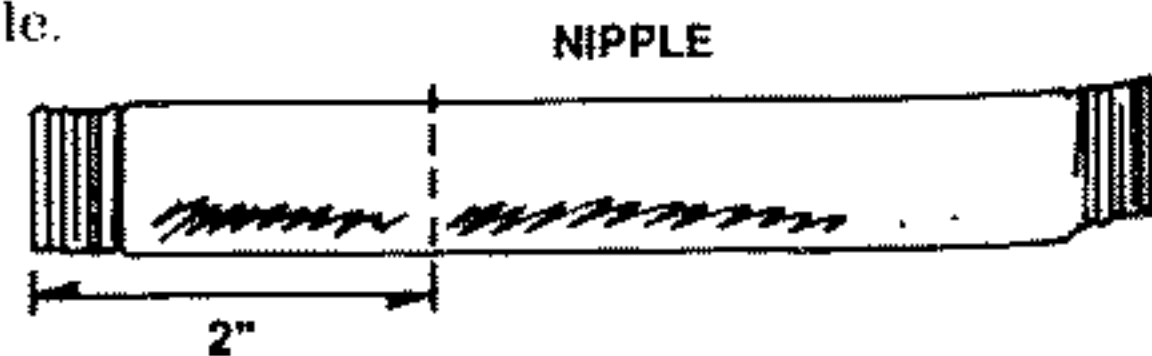

2. Screw nipple into coupler.

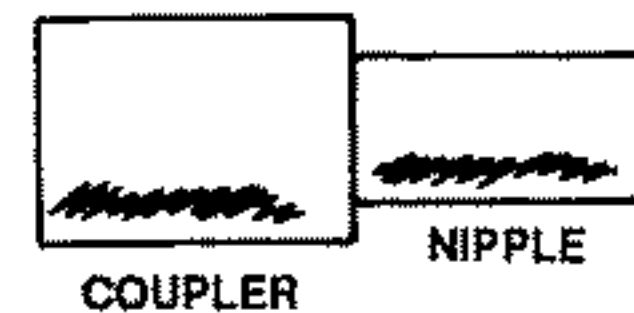

3. Apply a bead of glue or molten wax to the rim or the shotshell.

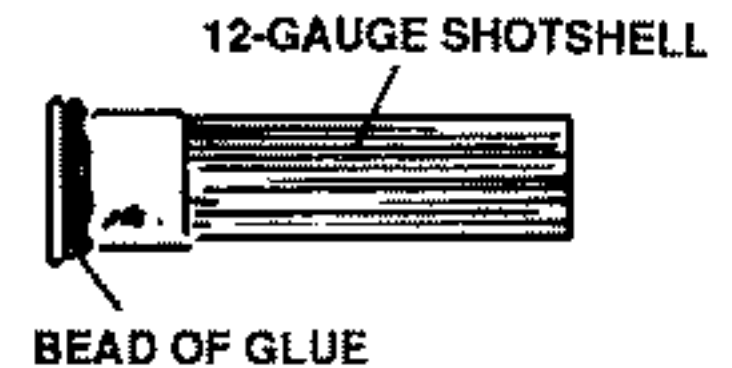

4. Press the shotshell into the threaded end of the coupler/nipple assembly, as shown.

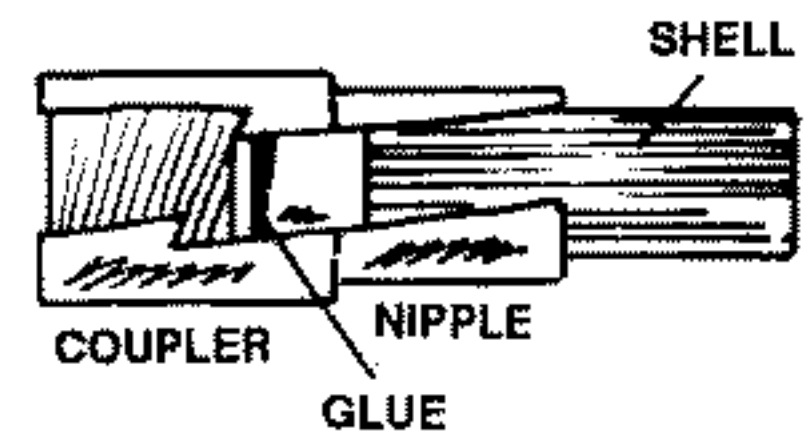

5. Drill a hole through the middle of the plug.

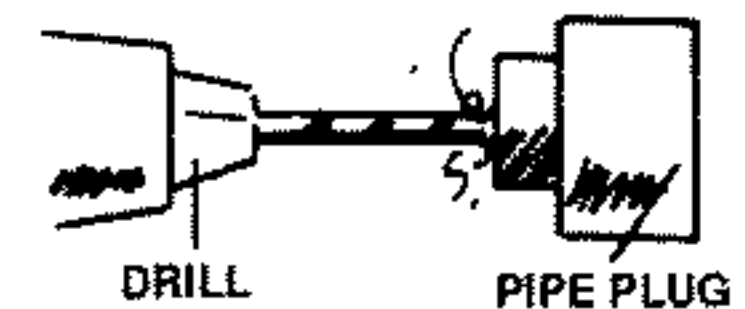

6. File the bolt down so that it is  $\frac{1}{4}$  inch longer than the plug.

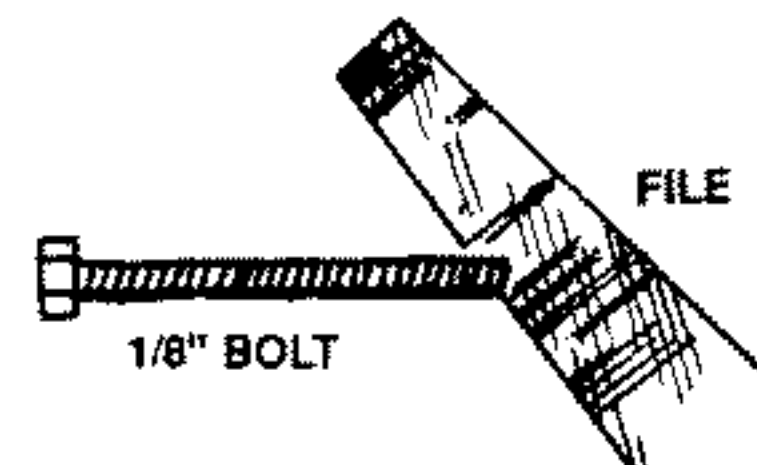

7. Insert the bolt into the hole in the plug and screw the nut on.

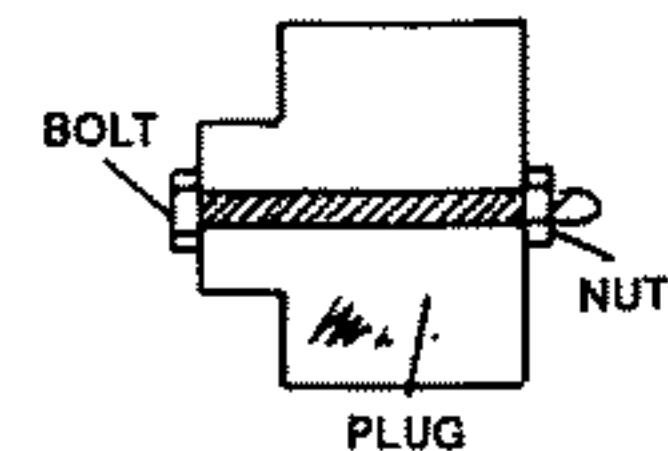

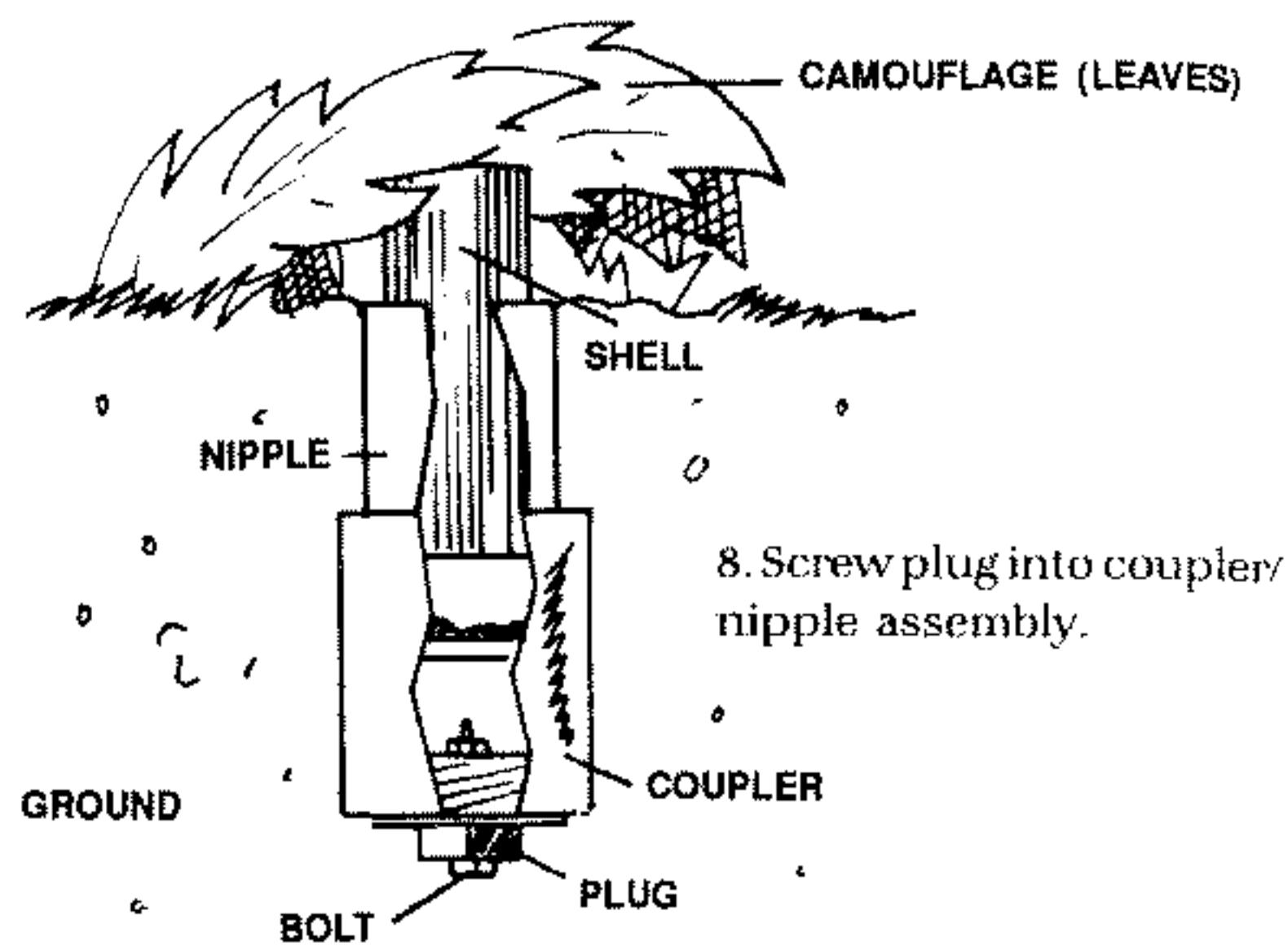

### HOW TO USE

Bury the shotshell mine in the ground up to the top of the nipple, as shown in the illustration. Make sure the plug is resting on a hard surface.

*Note:* To increase the effectiveness of this weapon, remove the shot, wadding, and powder as outlined in Sec. III, No. 3, and replace the powder with an equal volume of flash powder or a primary explosive. Replace the wadding and shot and recrimp the shell as shown in Sec. III, No. 3

### CANISTER GRENADE

An empty CO<sub>2</sub> canister can be used to make a grenade of considerable power that is light and easy to carry. Canister grenades can be used by themselves or in the canister grenade launcher (Sec. II, No. 20).

#### MATERIALS

Empty CO<sub>2</sub> canister(s)

Vise or holding pliers

Hacksaw

Blasting cap and/or fuze

Epoxy

Coat-hanger wire or heavy solder

Eyedropper (if liquid explosive is used)

Paper sheets

Wooden dowel

Any explosive (liquid or granular)

*Note:* Although any explosive can be used in canister grenades, a high explosive, such as starch nitrate (Sec. I, No. 45) or RDX (Sec. I, No. 46) will provide much greater power

#### SOURCES

Sporting goods store (CO<sub>2</sub> canisters are also used in pressurized seltzer bottles)

Hardware store

**FOR INFORMATION PURPOSES ONLY**

than a low explosive such as black powder, flash powder, or sugar-chlorate explosive. These less-powerful explosives can be used, but grenades made with them will generally do less damage and their shrapnel will have less range.

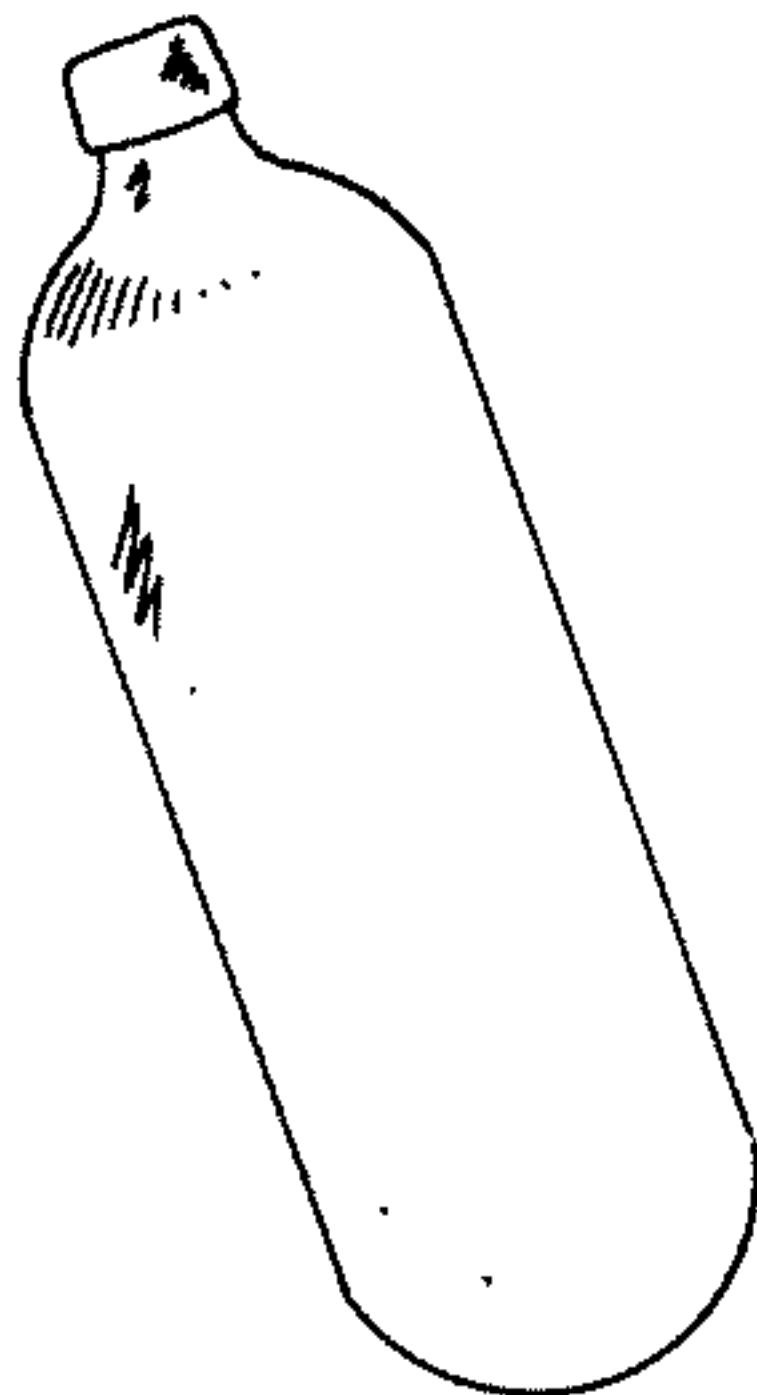

**PROCEDURE**

1. Cut the top off an empty CO<sub>2</sub> canister so that the fuze and/or blasting cap will fit it snugly. (A smaller hole will result in a more powerful grenade.)

**FOR INFORMATION PURPOSES ONLY**

2. Place canister lengthwise in the vise. Using a hacksaw, cut shallow (no more than  $\frac{1}{16}$  of an inch) grooves into the canister along its length and width.

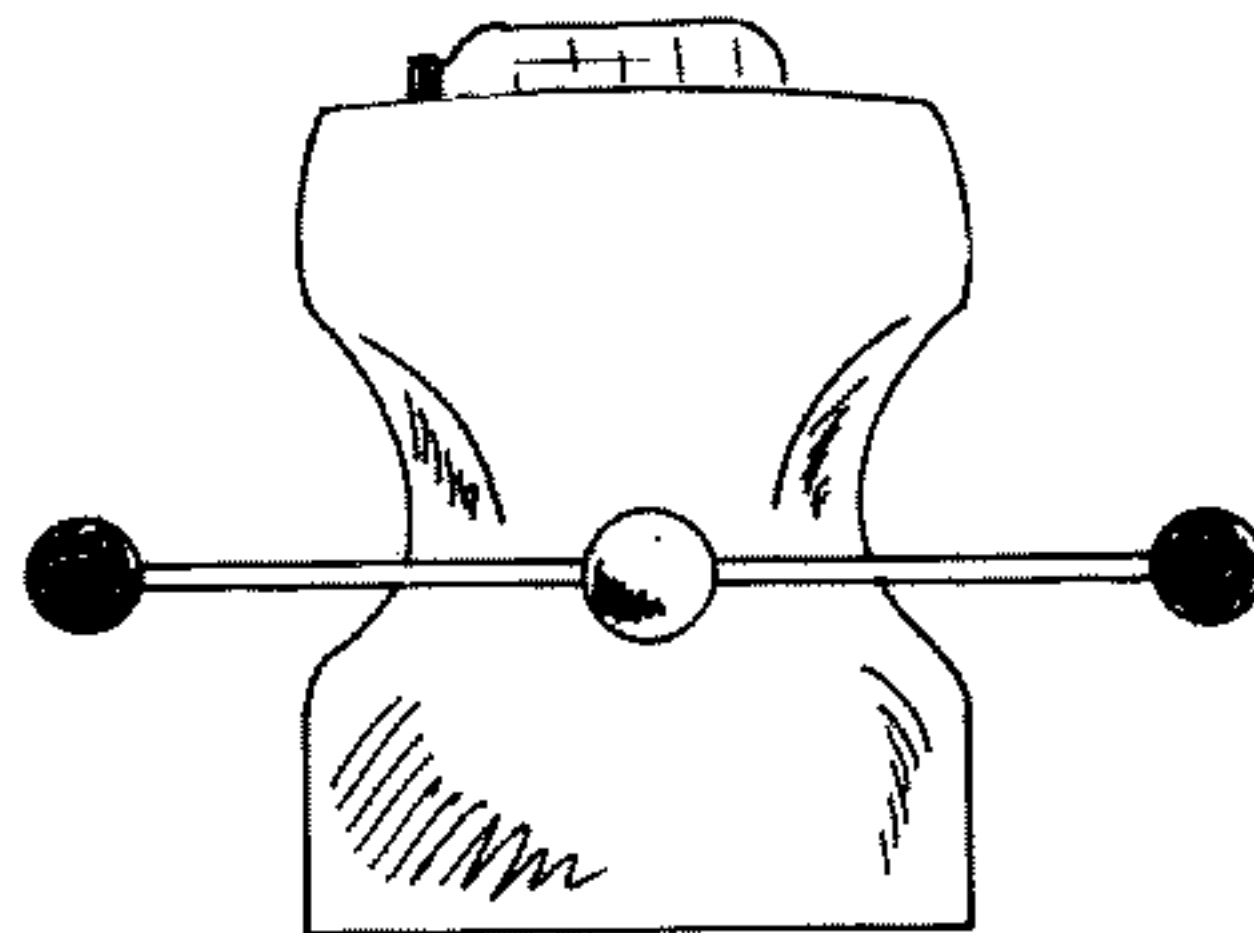
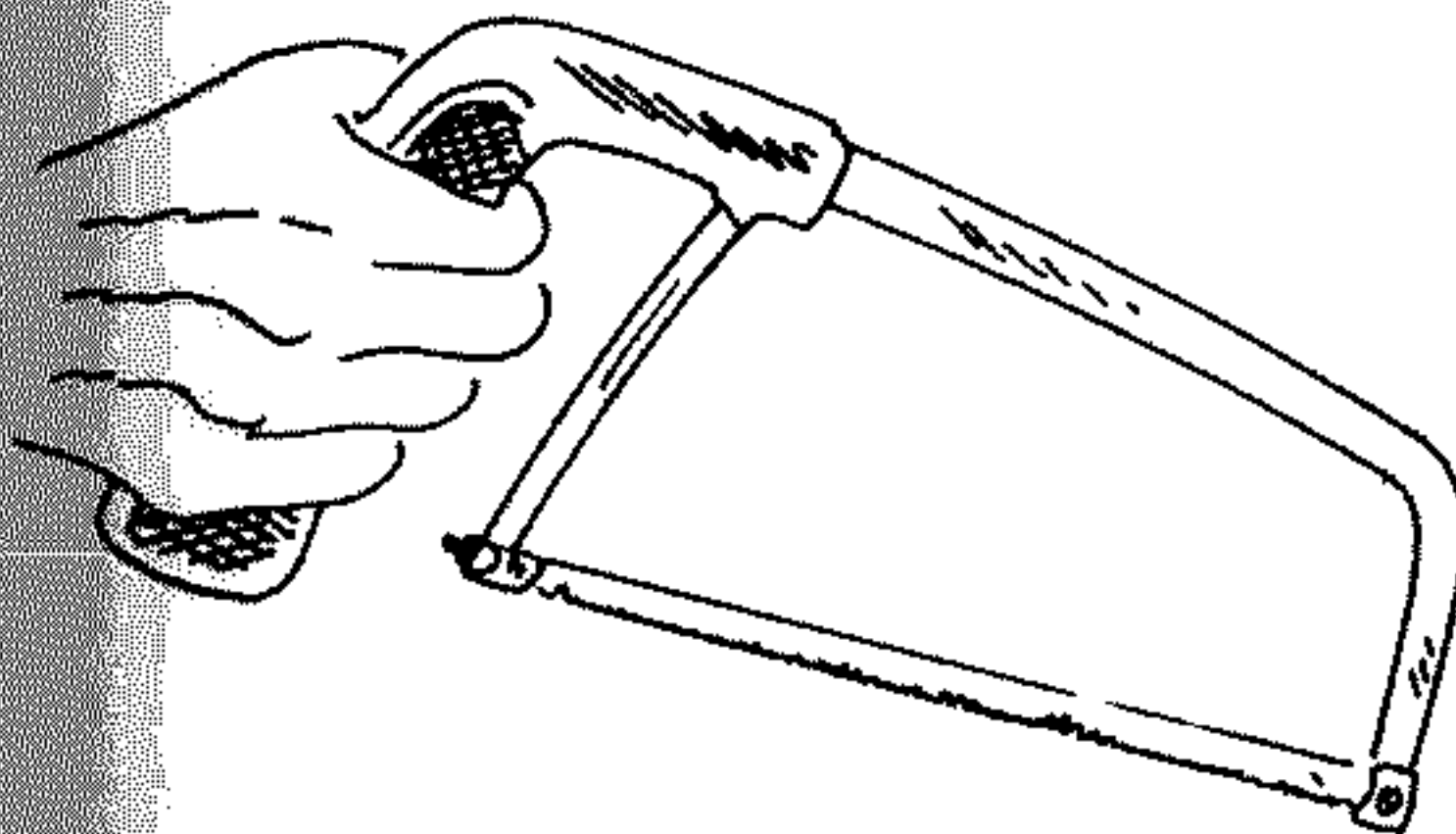



**FOR INFORMATION PURPOSES ONLY**

3. Stand canister, open end up, in vise and fill with explosive. If a plastic or granular explosive is used, pack it firmly with a wooden dowel. If a liquid explosive is used, use an eyedropper to load the canister.

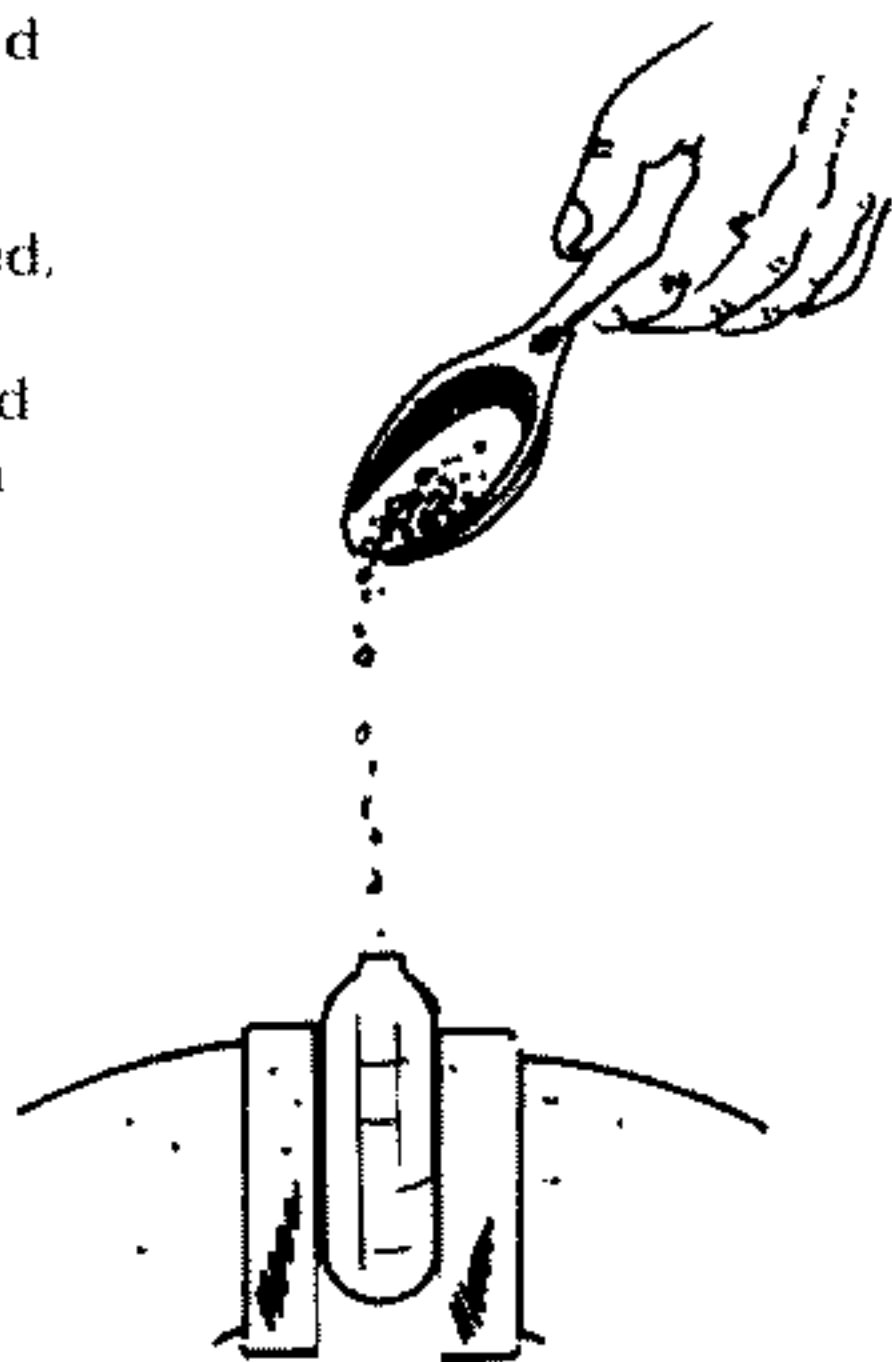
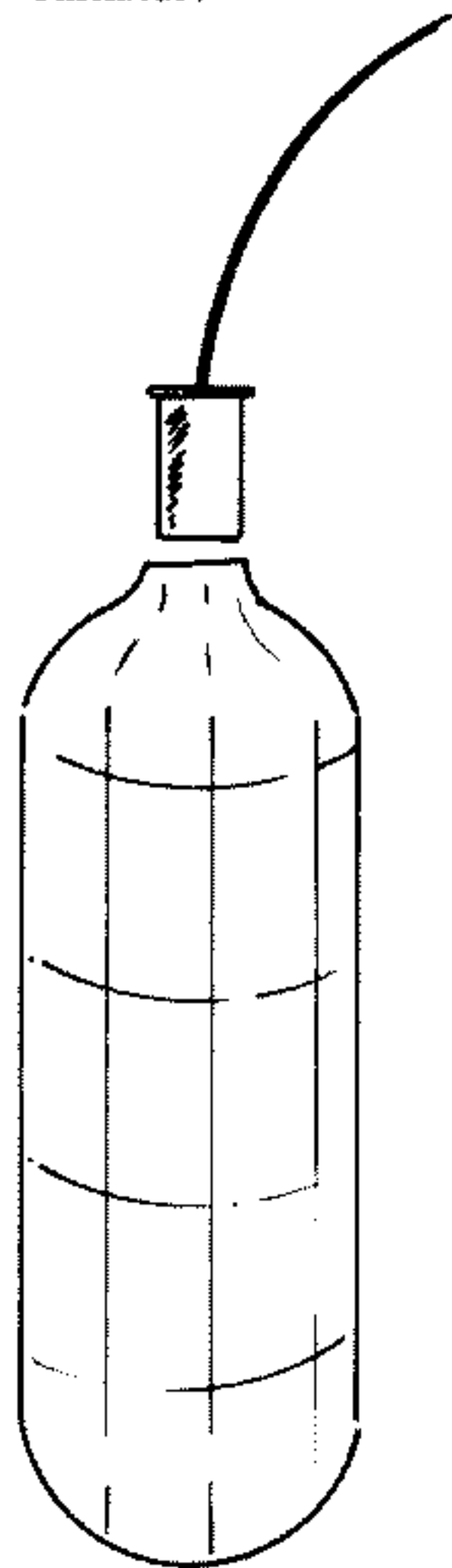

4. Once the canister is filled, insert the blasting cap or fuze in the hole and seal around the base with epoxy or a similar cement that will not be damaged by the explosive you are using.

**FOR INFORMATION PURPOSES ONLY**

**HOW TO USE**

In order to create maximum damage, throw the grenade within a yard of the target. Any farther away decreases the probability that fragments will hit. Even if high explosives are used as a filler, the grenade has a limited blast effect at short ranges.

**CANISTER GRENADE LAUNCHER**

This launcher can be used to launch canister grenades (Sec. II, No. 19) over long distances and even through light obstacles (windows, brush, etc.).

**MATERIALS**

3/4-inch pipe section, 3 feet long, with end cap

3/4-inch corks

Canister grenade with external-burning fuze

Flash powder

Drill

Epoxy

**SOURCES**

Hardware store

Hardware store or wine bottles

Sec. II, No. 19

Sec. III, No. 13

**PROCEDURE**

1. Check the pipe and end cap for cracks or other faults. Proceed with the next step *only* if they are undamaged.



2. Drill through the center of the end cap with a bit slightly larger than the fuze that will be used.

3. Drill a hole in the center of the corks.

4. Use a canister grenade with a fuze that is the right length for the desired time delay. The end of the grenade should be coated with a thick layer of epoxy so there is no danger that the launching charge will ignite the grenade prematurely.

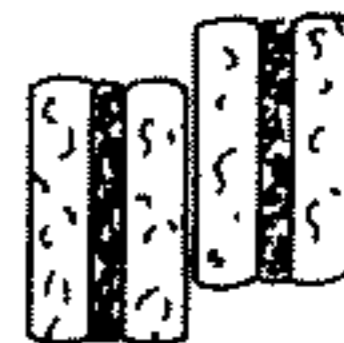

5. String the fuze through several corks so that about 3 inches extend.



6. Insert the grenade and corks into the threaded end of the launcher and push it in about 1 inch.

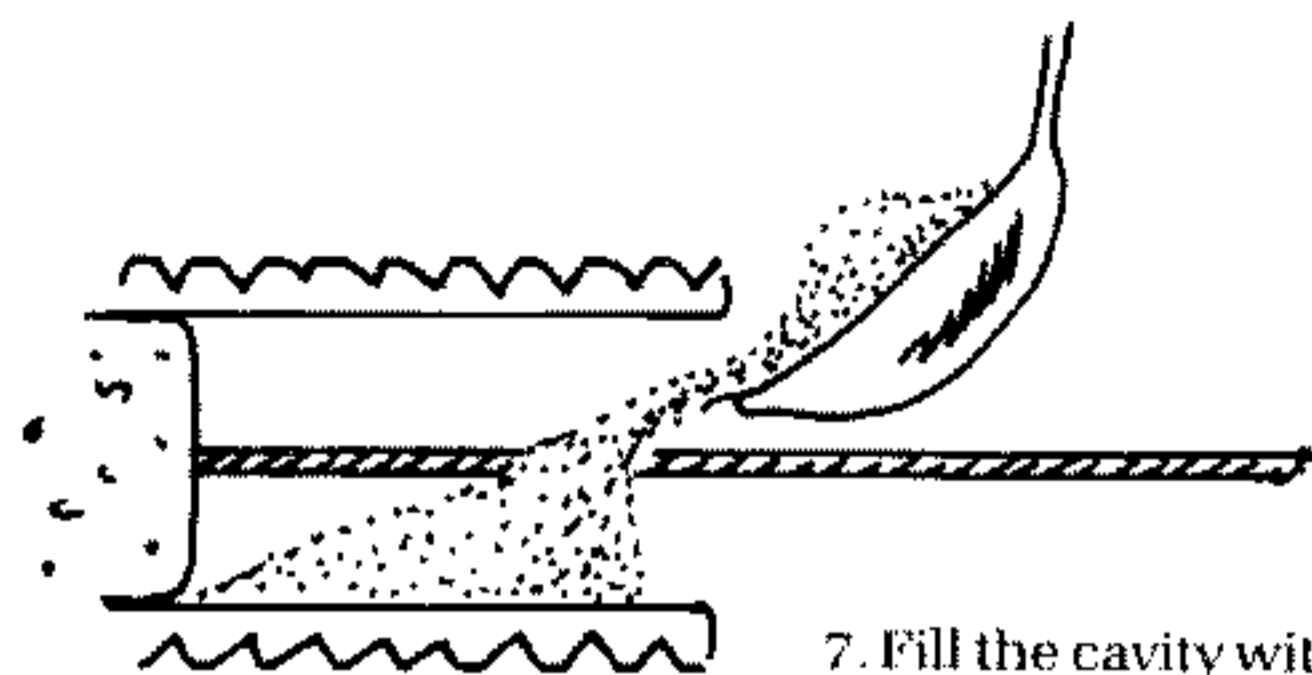

7. Fill the cavity with about a tablespoon of flash powder.

8. Thread the fuze through the hole in the end cap and screw the end cap onto the launcher.

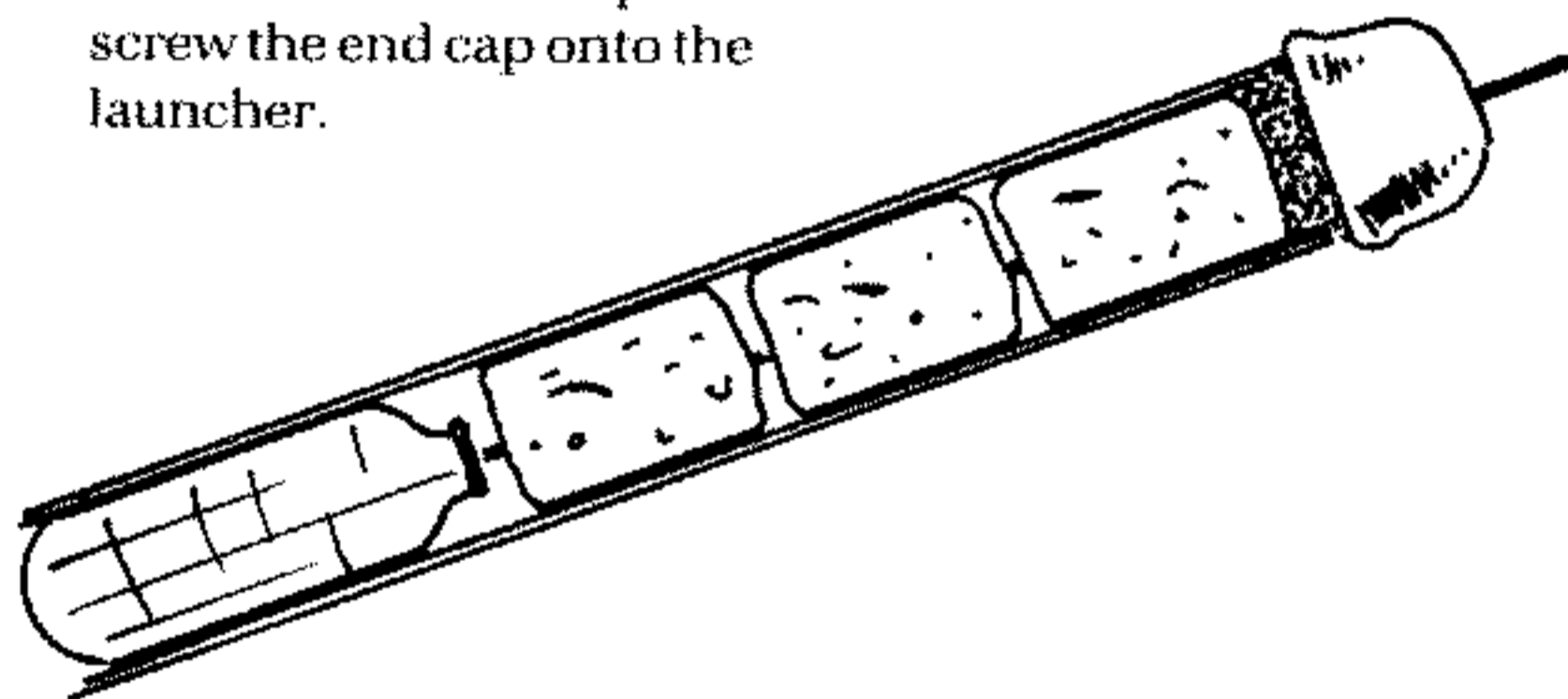

#### HOW TO USE

1. Secure to an immovable object and point the muzzle toward the target.
2. To ignite the fuze, use either an electric-bulb igniter (Sec. VI, No. 1), a cigarette delay (Sec. VI, No. 3), or a match.
3. When the flame of the fuze enters the powder cavity, the launcher will fire. The fuze will continue to burn and will detonate the grenade after the preset time.

#### COUNTERFORCE CHARGES

When these two charges detonate on opposite sides of the target, the shock waves they produce collide in the middle of the target, thus causing far greater damage than if a single charge of the same weight is used.

#### MATERIALS

High-brisance, high-power explosive (RDX, Astrolight G, etc.)

Compound detonators; two without fuze, one with

Detonating cord

6½-ounce tuna cans (discard contents but save lids)

Epoxy

Nail, knife, etc.

Electrical tape

#### PROCEDURE

1. Using a nail or knife, punch a hole in the sides of the two empty tuna cans large enough to accommodate a compound detonator.

#### SOURCES

Sec. VI, No. 16

Grocery store





FOR INFORMATION PURPOSES ONLY

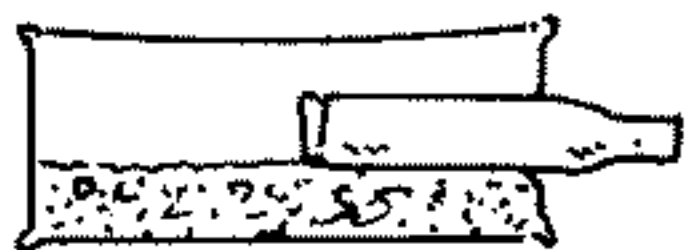

2. Pack the powdered or plastic explosive into the tuna cans up to the bottom of the detonator hole. Insert the two fuzeless detonators.

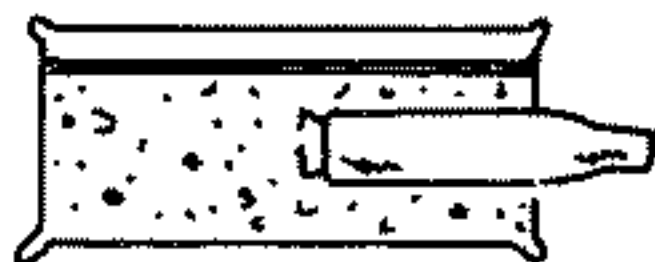

3. Pack the explosive around the detonators and to within  $\frac{1}{4}$  inch of the top of the cans. Replace the lids.

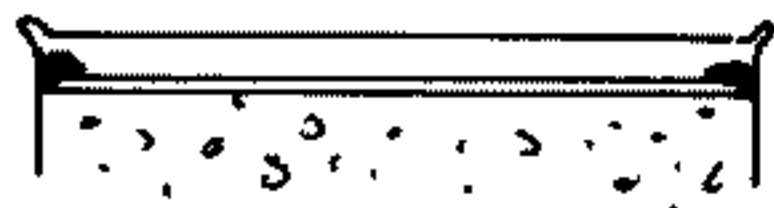

4. Apply epoxy cement to the edges of lids, sealing them.

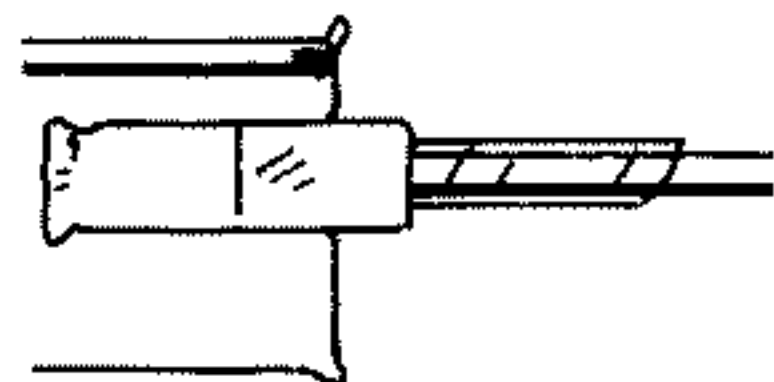

5. Cut a length of det cord equal to  $\frac{2}{3}$  the circumference of the target. Insert the det cord into the detonator and secure it with tape. Repeat with the other end of the det cord in the second countercharge.

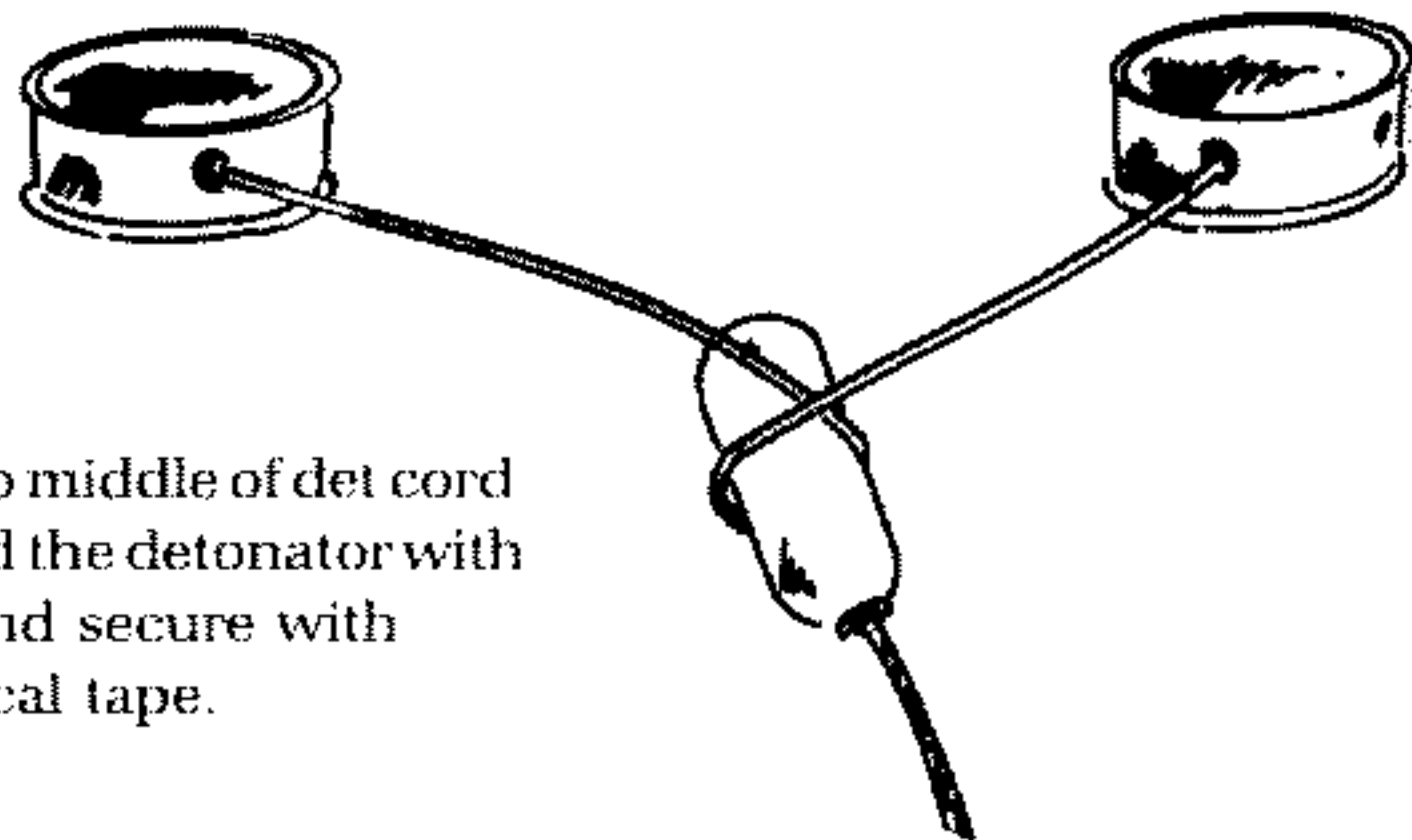

6. Wrap middle of det cord around the detonator with fuze and secure with electrical tape.

FOR INFORMATION PURPOSES ONLY

HOW TO USE

Tape or otherwise secure the two charges to opposite sides of the target, as shown, and detonate.

*Note:* If only one detonator is used, follow the procedure outlined above; simply tie the det cord in a triple-roll knot at the end and use this as a detonator.

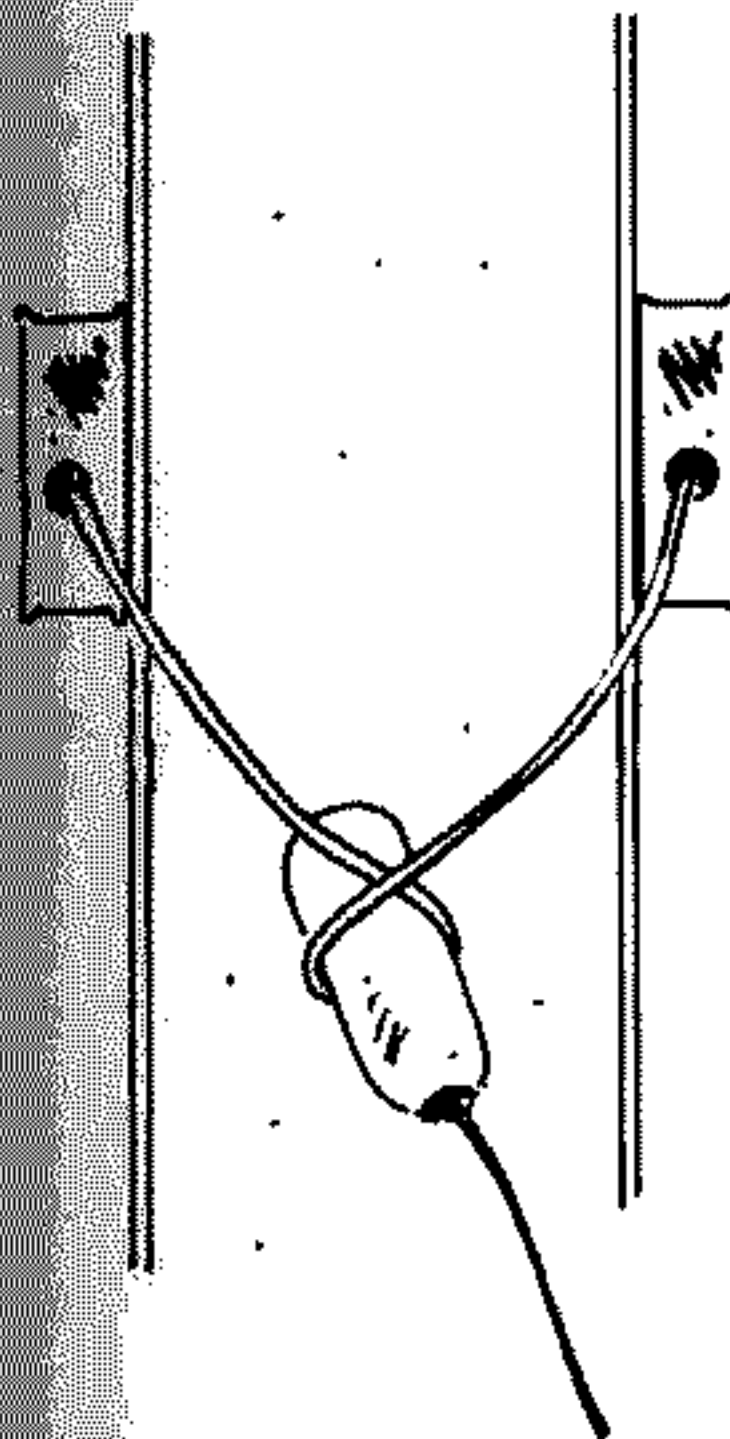

**DET-CORD 55-GALLON-DRUM CHARGE**

This charge uses a ring of det cord to neatly cut and ignite a 55-gallon fuel-storage drum.

**MATERIALS**

**SOURCES**

Detonating cord

Compound detonator

Tape

Sec. VI, No. 14

**PROCEDURE**

1. Cut a piece of detonating cord slightly longer than twice the circumference of the drum. Wrap one end several times around a detonator and secure with tape.



2. Wrap the det cord tightly around the base of the drum as shown. Secure both ends to the drum with additional tape.

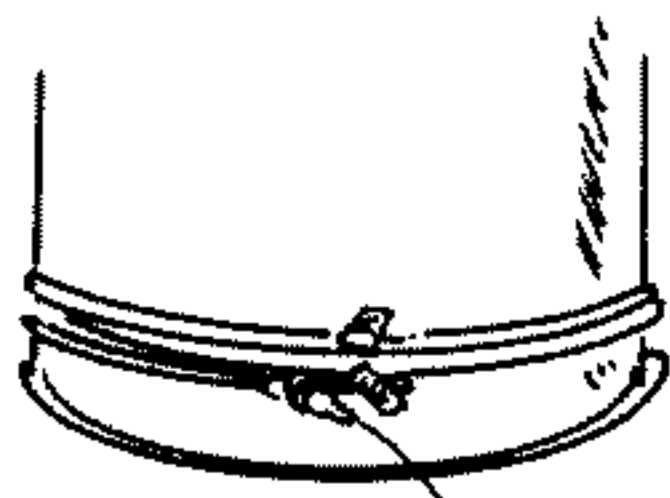

**HOW TO USE**

1. Simply hook up a timing system to the detonator and start it.
2. When the detonator explodes, it initiates the det cord, which in turn detonates, cutting the bottom of the drum off and igniting the material inside.

*Note:* To increase the effectiveness of this charge or to use against targets with thicker walls, knot the det cord at intervals and mold small amounts of plastic explosive around the knots.

**OFFENSIVE HAND GRENADE**

The pipe hand grenade (Sec. II, No. 1) is a defensive hand grenade in that the user has to take cover when the grenade detonates. The following is an offensive hand grenade. Its only means of causing damage is its blast effect, which is confined within a 3- to 4-foot area. The thrower can continue to advance after throwing the grenade and not worry about shrapnel hitting him.

**MATERIALS**

High-brisance, high-power explosive (Astrolight G, RDX, PETN)

Compound detonator

Plastic container, about 3 ounces

Epoxy resin cement

**SOURCES**

Sec. VI, No. 16

**PROCEDURE**

1. Fill the container with high explosive.

*Note:* The explosive used has to be sensitive and powerful. Ammonium-nitrate explosives, for example, will not do because they need strong confinement to detonate.

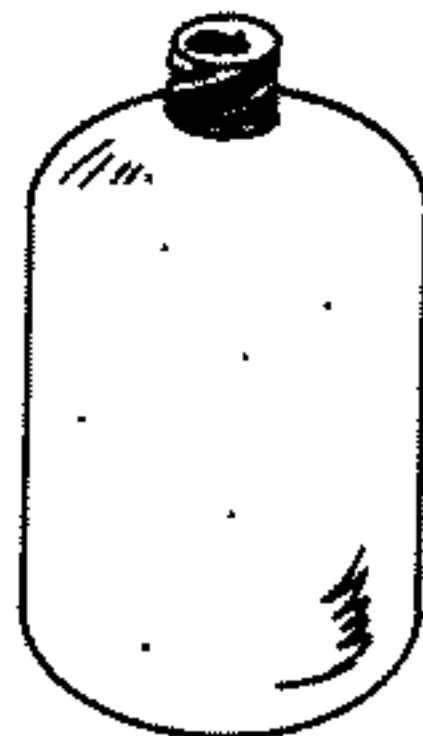

2. Insert compound detonator and seal around the container opening with epoxy resin cement.

**HOW TO USE**

1. Simply light the fuze and throw the grenade in the direction of the enemy. Depending on the size of the grenade and on what terrain it is used, the blast radius is usually under 5 feet.

2. Exercise judgment as to your safety in the open. The blast can severely damage the eardrums, so protection should be worn. Pebbles and the like can also be kicked up and act as shrapnel, so avoid targets where small objects are loose.



**POISON-FILLED HOLLOWHEAD AMMUNITION**

Common hollowhead ammunition can be filled with potassium cyanide, greatly increasing its deadliness toward human beings. Do not eat the meat of an animal that has been hit by poison rounds.

**MATERIALS**

Hollowhead round(s) (any caliber)

Potassium cyanide

Epoxy

Eyedropper

Heat source

Small glass or ceramic bowl

Drill with small bit

Paper towel

**SOURCES**

Sporting goods store

Sec. VIII, No. 2



**PROCEDURE**

1. If the hole in the tip of the round is too small, enlarge it slightly using the drill with a 1/16-inch bit.

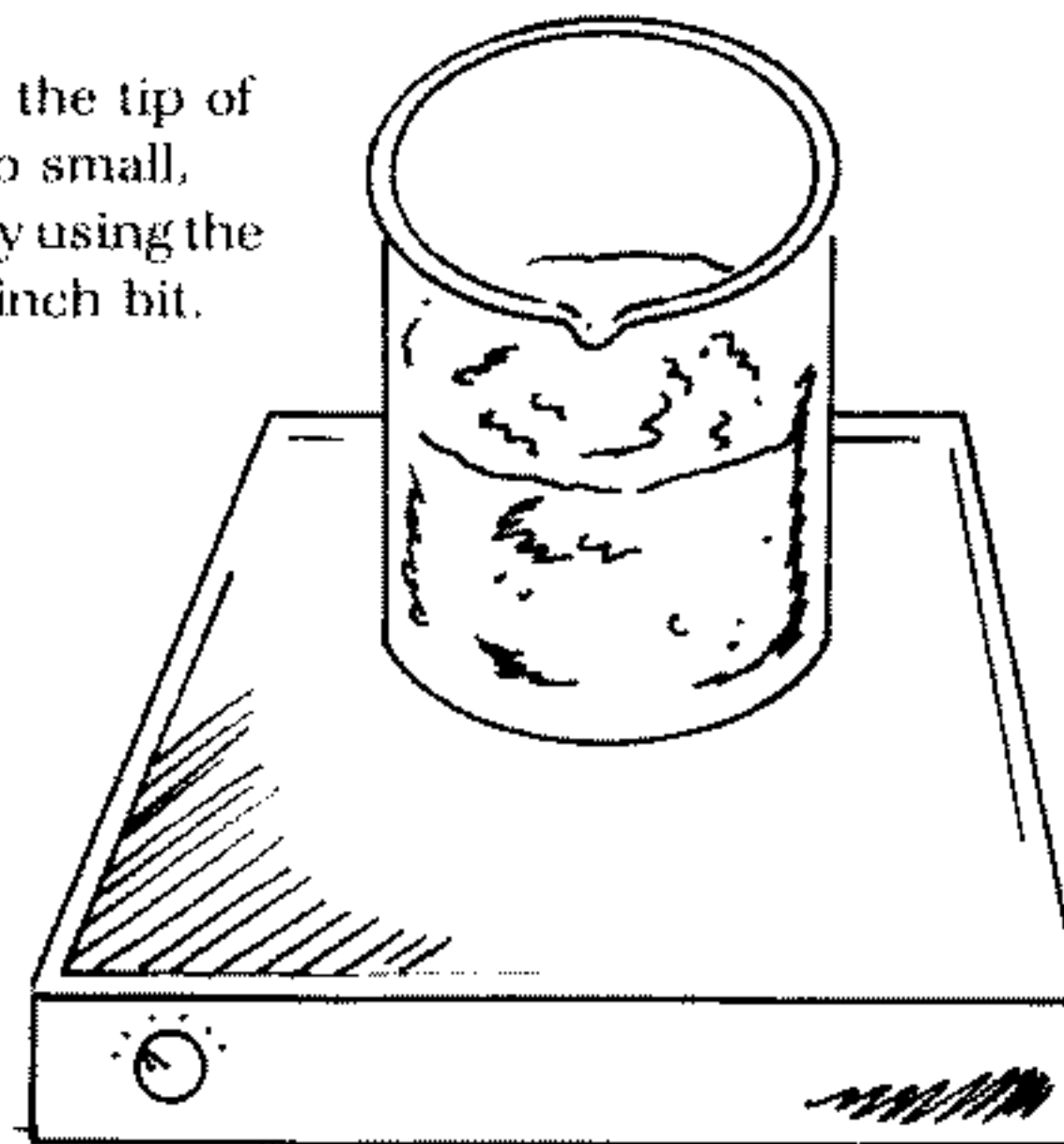

2. Heat about 1/2 cup water to boiling. Dissolve as much potassium cyanide in the water as possible (4 to 5 tablespoons).

**CAUTION:** Be very careful when handling materials that come in contact with the cyanide. If any come in contact with skin, immediately wash away with lots of water.

FOR INFORMATION PURPOSES ONLY

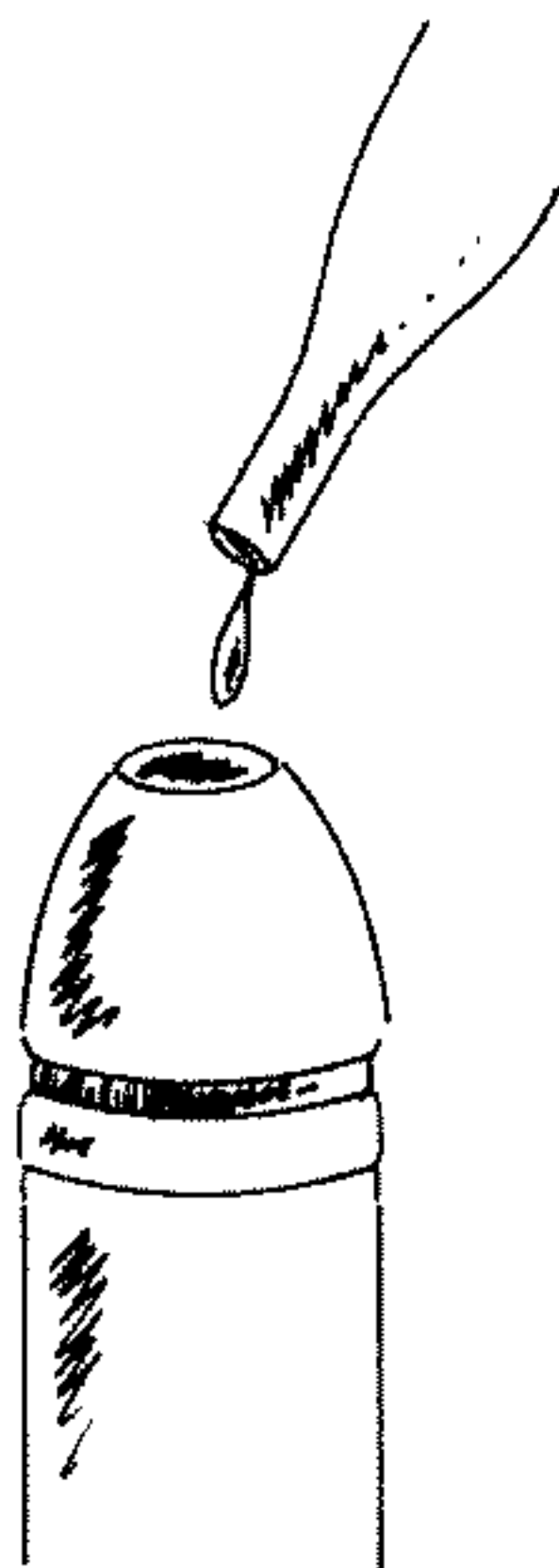

3. While the solution is still hot, take several drops of the liquid with the eyedropper and place them carefully in the hole in the slug, filling it almost to the top.

4. Let the water evaporate completely and wipe the slug off with a paper towel.

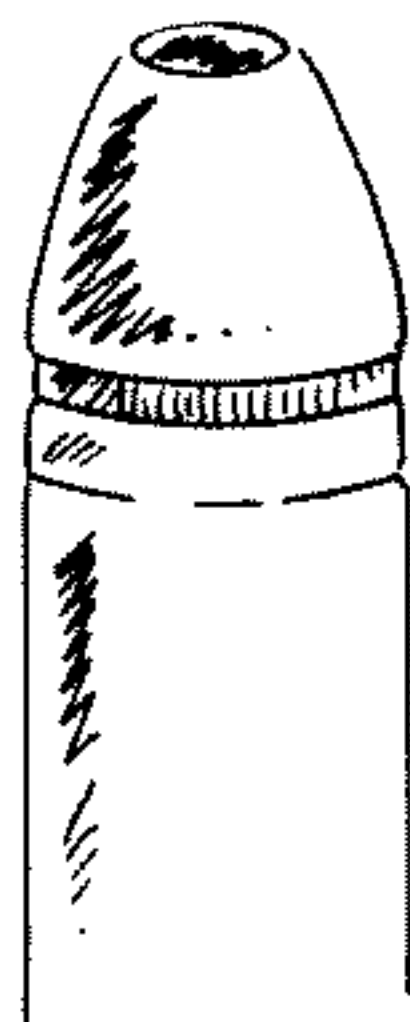

FOR INFORMATION PURPOSES ONLY

5. Apply a small amount of a wax agent to the tip of the slug as shown. Let the wax agent dry.

The slug is now ready for use.

*Note:* The slug will most likely be unbalanced, resulting in decreased accuracy.



FOR INFORMATION PURPOSES ONLY

Section V  
No. 24

HC SMOKE

This smoke mixture uses fewer ingredients and delivers more smoke pound-for-pound than the mixture outlined in Sec. V, No. 11. This mix is used in military smoke munitions due to its low toxicity, long shelf life, and high output of dense, white, safe smoke that tends to cling to the ground.

**MATERIALS**

Hexachloroethane

Zinc oxide

Aluminum powder, fine

Improvised white-flare mix  
or sugar-chlorate igniter  
mix

Fuze, 1 foot

Jar with lid

Screwdriver

Tin can, 2½-inch diameter  
x 5 inches long

Aluminum foil

**SOURCES**

Chemical supply store

Chemical supply store

Chemical supply store

Sec. V, No. 6; Sec. V, No. 11

FOR INFORMATION PURPOSES ONLY



**PROCEDURE**

1. Place 8 level teaspoons hexachloroethane in the jar. Add equal amounts of zinc oxide and aluminum powder.

*Note:* The aluminum powder must be over 300 mesh for this mix to work. Reactant flake or dark powders are recommended.

2. Place lid on jar and shake vigorously for about 5 minutes.

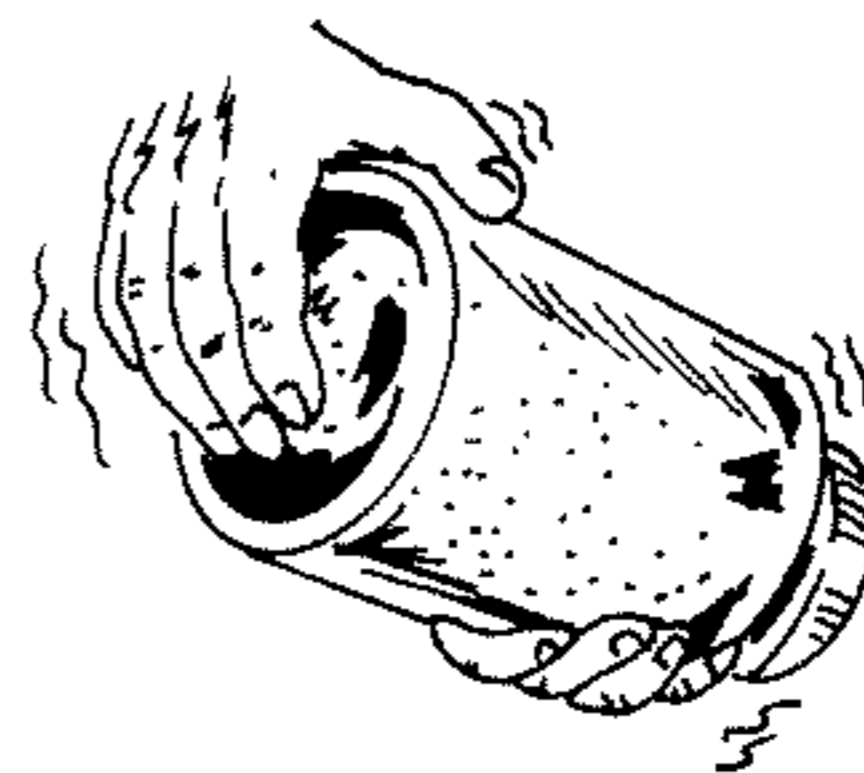



## FOR INFORMATION PURPOSES ONLY

### HOW TO USE

1. Place a heaping teaspoon of either the white flare or sugar-chlorate igniter on a 4-inch square of aluminum foil.
2. Insert fuze in the middle of the powder and fold the corners of the foil tightly around the fuze.
3. Pour roughly one half of the smoke mix into the can and pack it tightly with the handle of a screwdriver.
4. Place the igniter packet in the middle of the can, add the remaining smoke mix, and pack it down tightly.
5. To use, either light the fuze or, in the case of the sugar-chlorate igniter, add a small amount of concentrated sulfuric acid.

## FOR INFORMATION PURPOSES ONLY

Section VI

No. 16

### SIMPLIFIED COMPOUND DETONATORS

This process for manufacturing detonators is much faster and requires fewer tools than the one outlined in Sec. VI, No. 13. The final product, while a little less powerful than a regular compound detonator, is a good substitute and will detonate most explosives in this book. The only exception is AN explosives; those will need regular compound detonators at the very least.

#### MATERIALS

9mm or larger rounds,  
regular or magnum load

Primary explosive

Black powder

Potassium chlorate

Fuze (for fuze-type only)

Ball bearing (for impact-  
type only)

Pliers

Drill

Vise

Wooden or aluminum  
dowel (1/4 inch)

Wooden or aluminum  
block

Epoxy

#### SOURCES

Sporting goods store

Any in Sec. I except lead  
azide

Sec. I, No. 3

Chemical supply store

**PROCEDURE**

1. Using the pliers, remove the slug from the shell, taking care not to spill the powder or strike primer.

2. Drill a hole in the block a little larger than the detonator.

For fuze-type detonator, continue with step 3. For impact-type detonator, go to step 8.

3. Pour out the powder and remove primer, as shown in Sec. III, No. 5.

4. To the powder add 1 gram of the primary explosive to be used and mix well to insure proper detonation. Replace a little of the powder into the shell, insert the dowel, and put the assembly in the block and then into the vise as shown. Carefully tighten the vise as much as possible and release it slowly. Repeat several times until all of the powder has been pressed into the shell.

5. Measure out the approximate amount of primary explosive by using the table in Sec. VI, No. 13. Now place a small amount of the primary explosive in the detonator and press it as in step 4. Repeat.

6. Place about ¼ teaspoon of black powder into the top of the detonator and insert the fuze.

7. Crimp the detonator closed. To make the detonator weatherproof, use an internal burning fuze and apply epoxy around the top of the detonator and in the primer hole.

**CAUTION:** Take care at all times not to strike or apply pressure to the primer area of an impact-type detonator.

8. Pour out the powder and add 1 gram of primary explosive and mix. Place about ¼ teaspoon of black powder into the bottom of the shell and set it in the block. Press it as detailed in step 4.

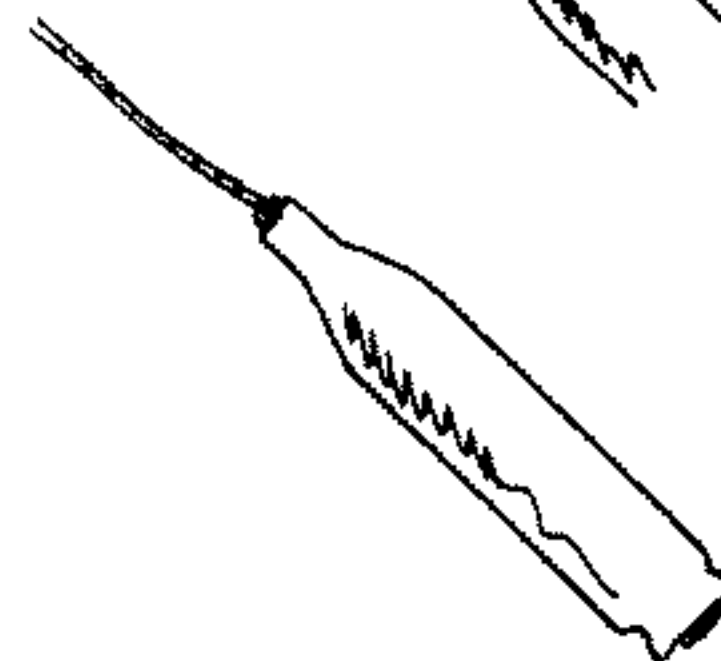
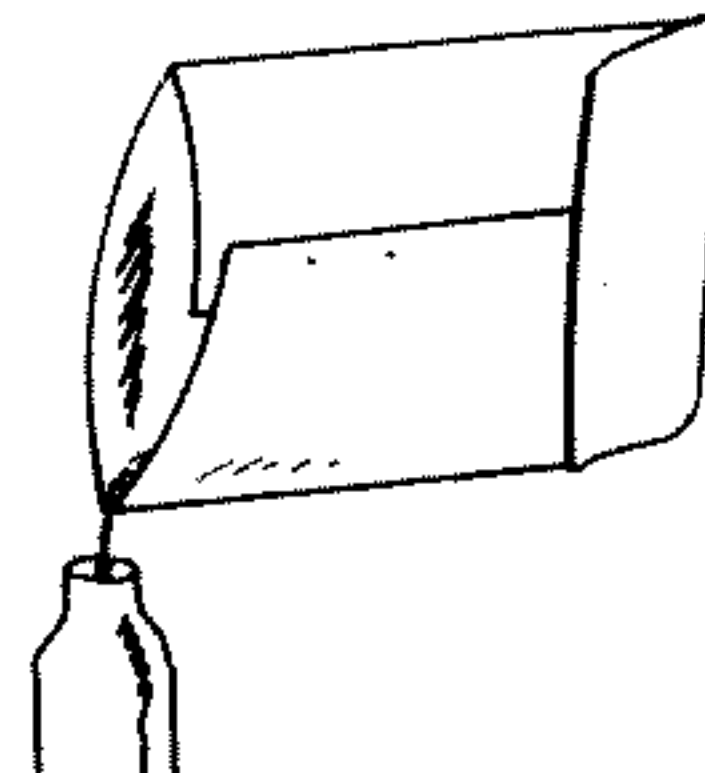
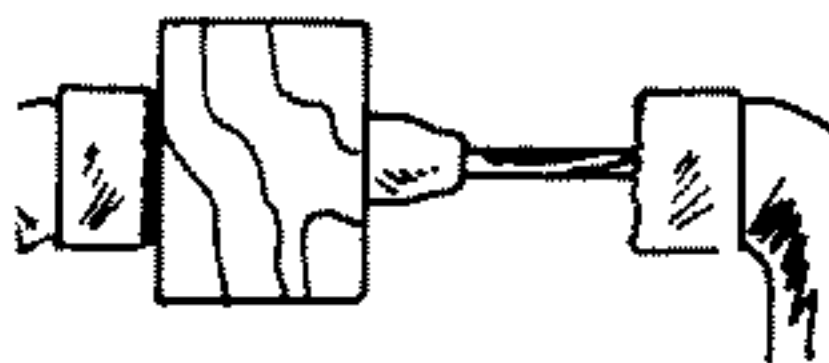
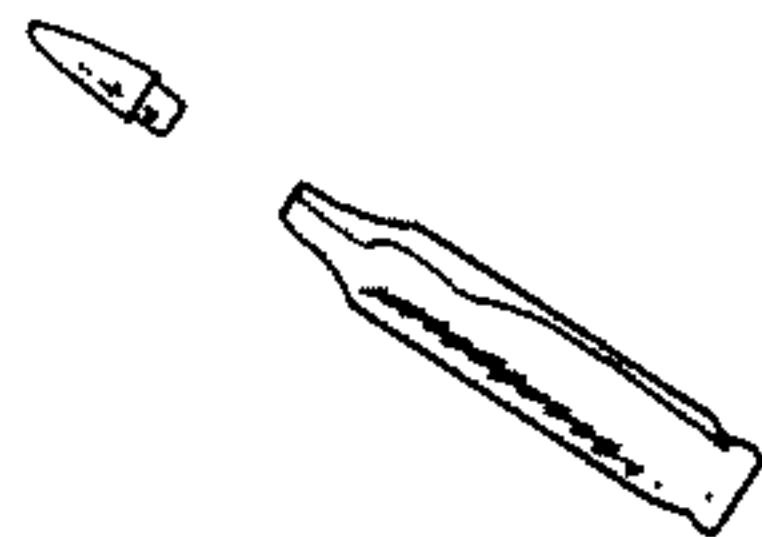

FOR INFORMATION PURPOSES ONLY

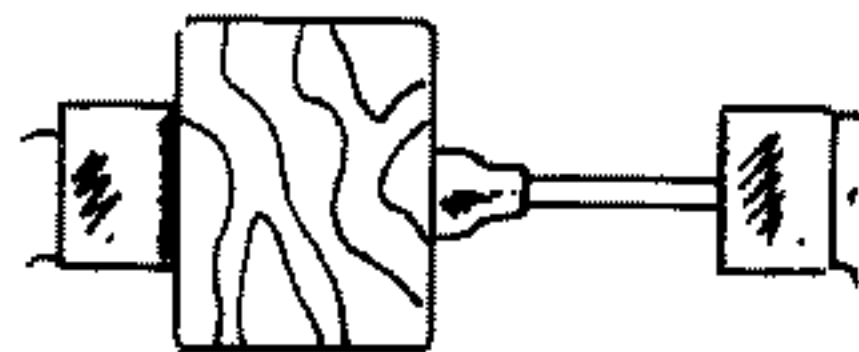

9. Measure out the appropriate amount of primary explosive according to the table in Sec. VI, No. 13. Now pour a small amount of the explosive in the detonator and press it. Continue to add and press the explosive until all of it has been used up. Repeat the process with the powder that was removed from the shell at the beginning.

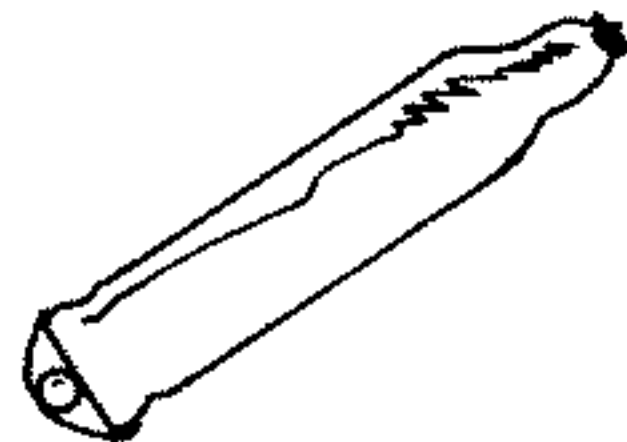

10. When all of the powder has been added and pressed, crimp and epoxy the top of the shell.

11. Tape a ball bearing to the primer as shown.

*Note:* With the addition of potassium chlorate or other primary explosive, the smokeless powder should detonate most of the time. Unfortunately, proper detonation cannot be guaranteed. Therefore, it is suggested that the powder be replaced with a Bullseye-type powder (Sec. 1, No. 27).

FOR INFORMATION PURPOSES ONLY

HOW TO USE

1. The fuze-type detonator can be used anywhere a compound detonator or blasting cap is required.
2. The impact detonator can be inserted in a pipe hand grenade with streamers attached to it, as shown. When thrown, the grenade will point detonator forward. When the ball bearing strikes a hard surface, the grenade will detonate.

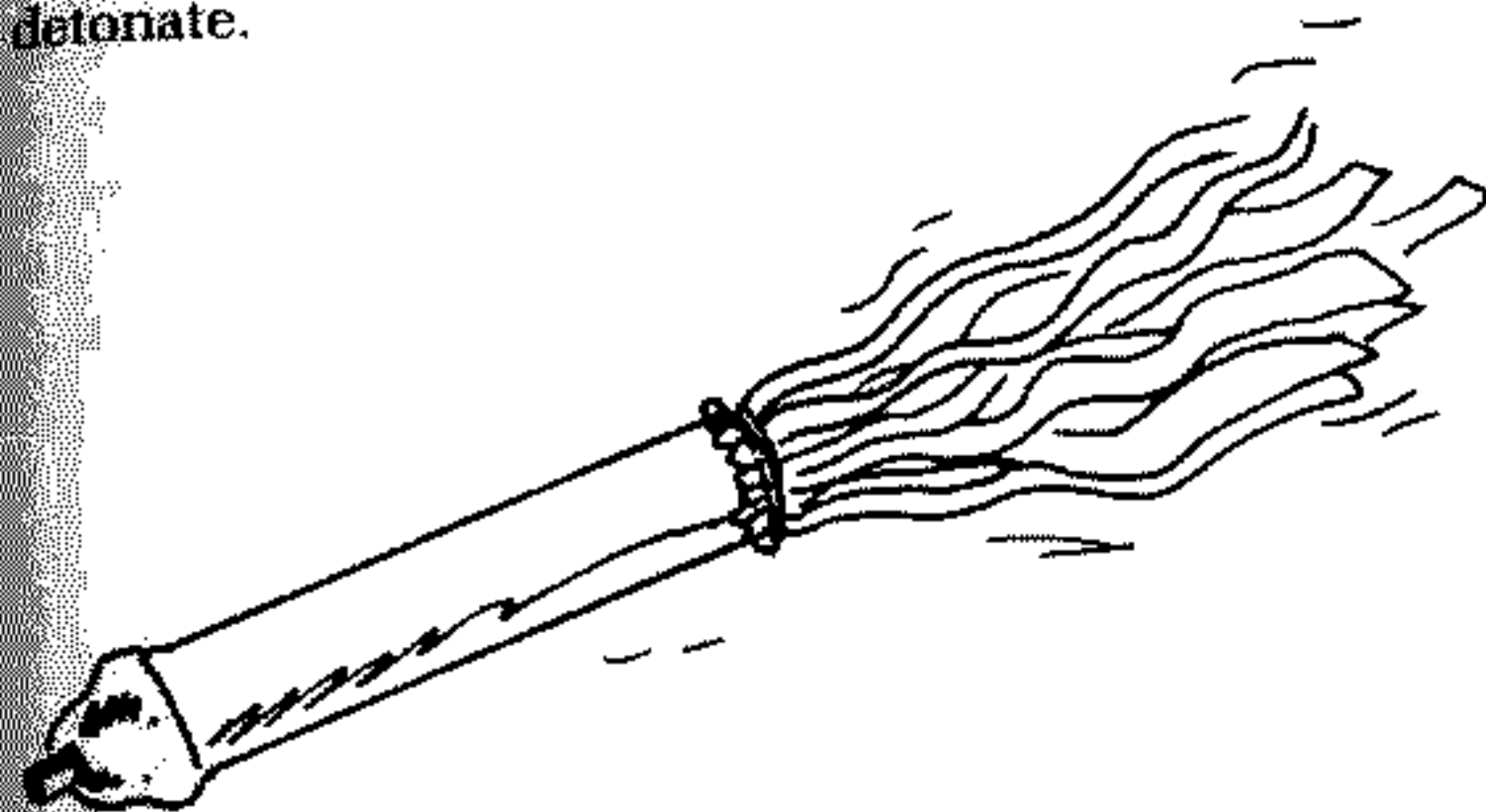

**FUMING SULFURIC ACID (OLEUM)**

Oleum is used in manufacturing phosgene.

**MATERIALS**

- Sulfur
- Iron oxide (rust) or platinum catalyst
- Concentrated sulfuric acid
- Small, heat-resistant, shallow container
- Funnel
- Heat source
- Pyrex tubing
- Small-mouth bottle with cap
- Plastic tubing

**SOURCES**

- Garden supply store
- Rusting iron or catalytic converters (from mufflers or kerosene heaters)
- Sec. I, No. 43
- Butane or propane torch (not acetylene), candle

**PROCEDURE**

1. Place several teaspoons of sulfur on the shallow dish and place or hang the funnel over it so that there is space for air to enter around the bottom of the funnel.

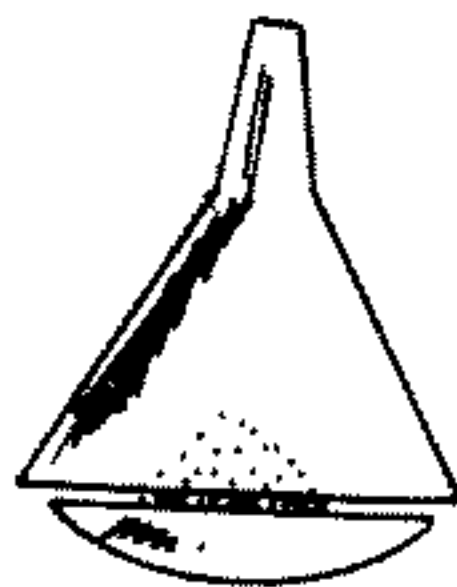

2. Attach a piece of plastic tubing to the cap of the bottle and the other end to one end of the Pyrex tube. Put a small amount of catalyst (rust or platinum) in the Pyrex tube. Using a piece of plastic tubing, connect the funnel and Pyrex tube.

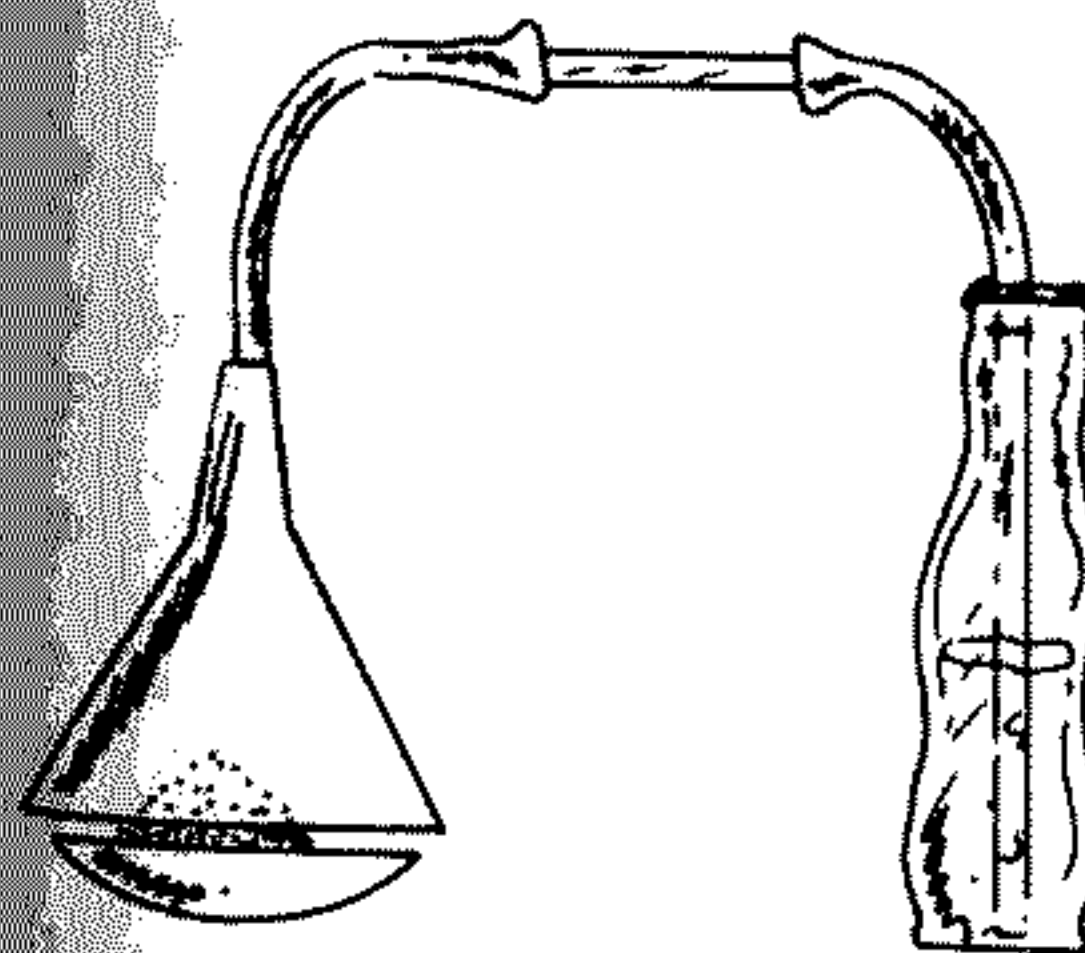

3. Fill the bottle halfway with concentrated sulfuric acid, put cap on bottle, and extend the tube so that it is below the surface of the acid.



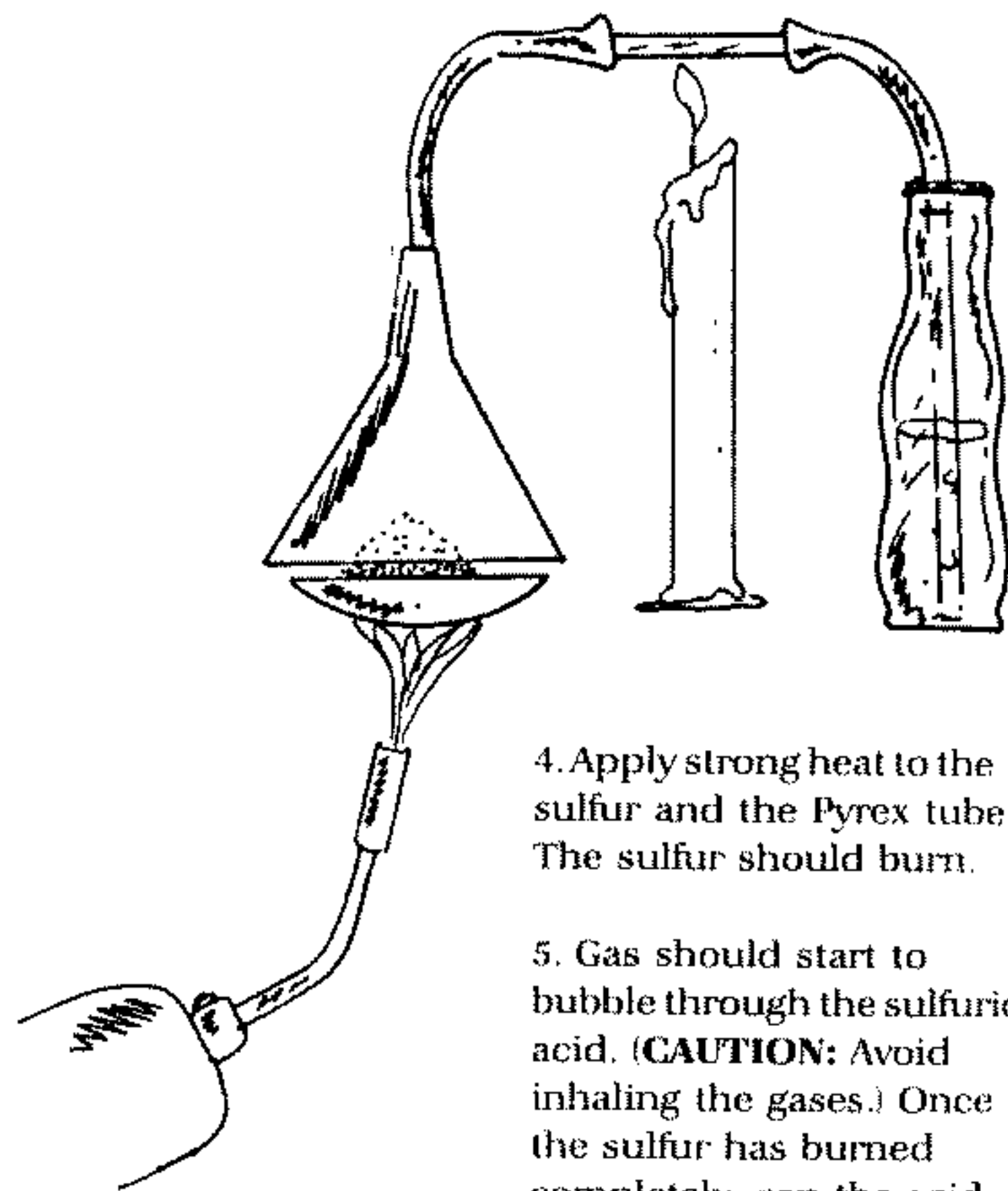

4. Apply strong heat to the sulfur and the Pyrex tube. The sulfur should burn.

5. Gas should start to bubble through the sulfuric acid. (CAUTION: Avoid inhaling the gases.) Once the sulfur has burned completely, cap the acid bottle tightly, and store in a cool, safe place.

**POTASSIUM CYANIDE**

Potassium cyanide is a potent cellular poison that can be used as is or in the manufacture of hydrogen cyanide gas or poison-tipped bullets. As a rule, always wear appropriate protective gear when making and handling cyanide products.

**MATERIALS**

Potassium carbonate

Potassium ferrocyanide

Crucible

Furnace

Tongs or long-handled pliers

Iron pan, etc.

Hypo solution

Sodium nitrate

Hypodermic needle

Jar

**SOURCES**

Chemical supply store

Chemical supply store

Chemical supply store

Sec. I, No. 49

Photography store

Chemical supply store (Sec. I, No. 18 is *not* acceptable)



**PROCEDURE**

1. Ignite the furnace as outlined in Sec. I, No. 49.

2. Place 8 parts by weight of potassium ferrocyanide in the crucible for 5 minutes without the air supply.

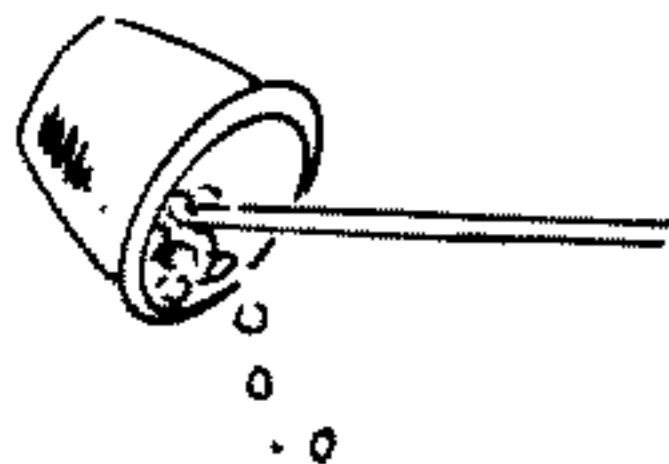

3. Remove the crucible from the furnace and scrape out the ferrocyanide.



4. Repeat steps 2 and 3 with 3 parts by weight potassium carbonate. Mix the ferrocyanide with the carbonate.

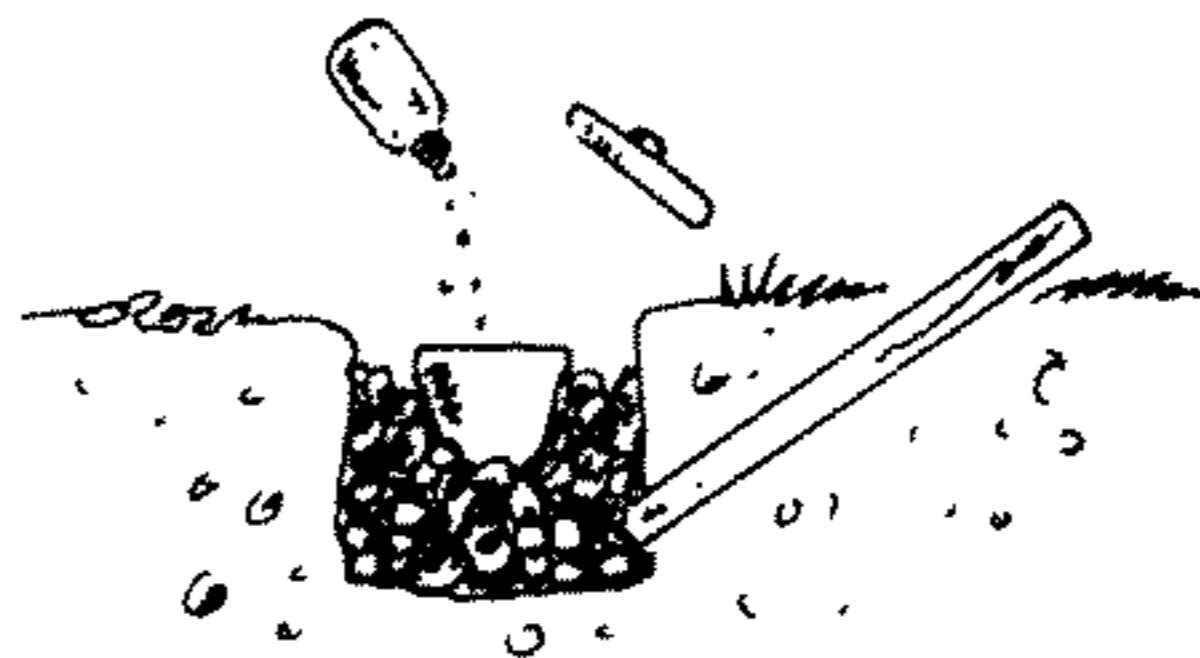

5. Put the crucible in the furnace, put the cover on, and start up the air supply. After about 10 minutes, remove the cover with tongs and add the ferrocyanide/carbonate mixture. Soon the powders will melt and then start to boil.

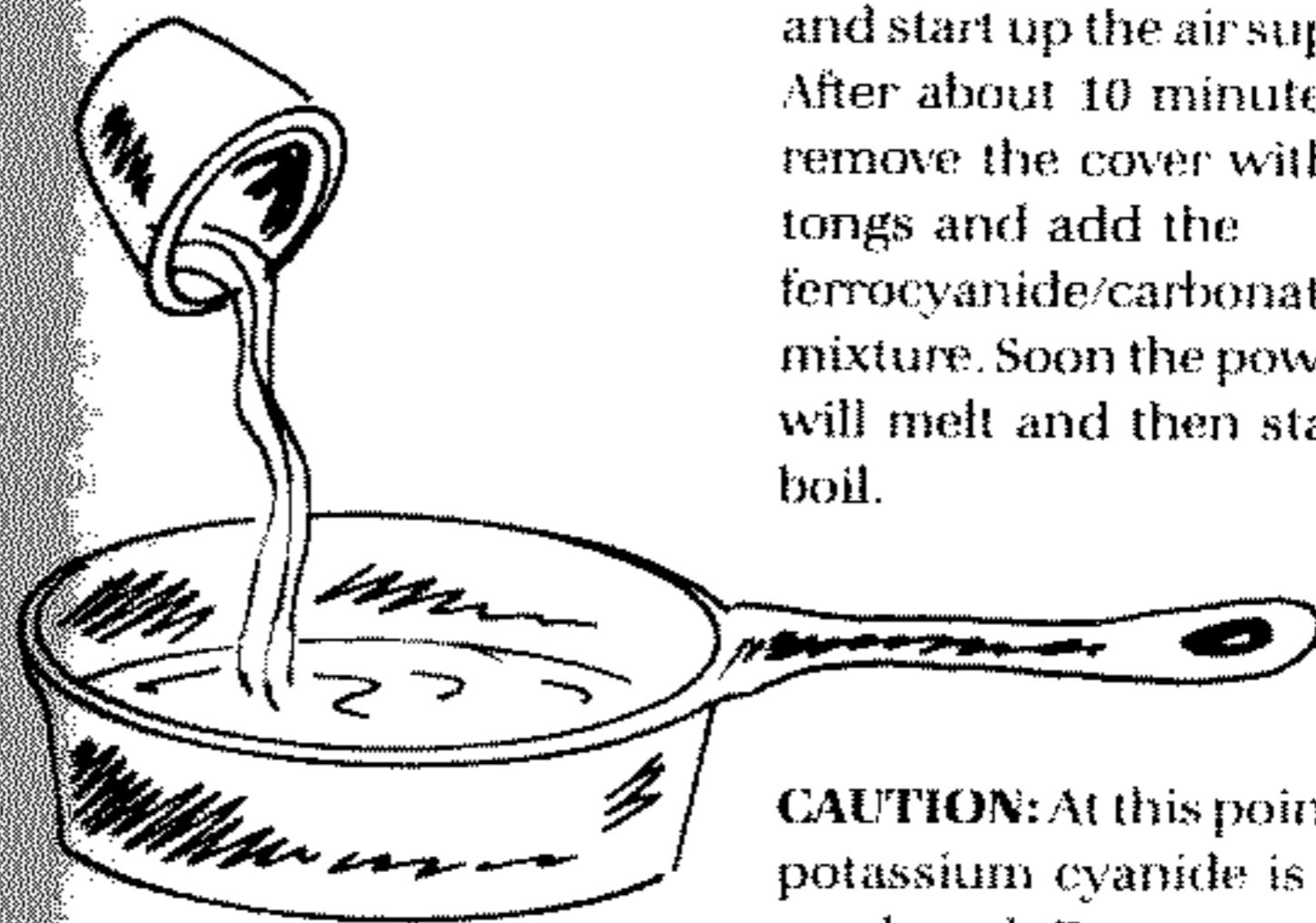

**CAUTION:** At this point the potassium cyanide is produced. Be very careful when handling the materials that come in contact with the cyanide. If any come in contact with skin, immediately wash it away with lots of water.

6. As soon as the bubbling stops after the gases have been driven off, remove the crucible from the furnace with tongs and pour the clear liquid only onto the cool iron pan.

## FOR INFORMATION PURPOSES ONLY



7. Pulverize the white mass that crystallizes on the pan and place in a jar for storage.

*Note:* In order to make tablets of potassium cyanide, add just enough Elmer's glue to the desired amount of powder to moisten it. Next, press it into a mold, such as a ring of  $\frac{3}{8}$ -inch copper tubing, and let the glue dry.

### ANTIDOTE FOR CYANIDE POISONING

In case of cyanide poisoning, give the victim an injection of 10 milliliters 25-percent hypo (sodium thiosulfate) solution and 10 milliliters water in which 1 teaspoon sodium nitrite has been dissolved. If possible, get victim medical attention as soon as possible.

## FOR INFORMATION PURPOSES ONLY

Section VIII  
No. 3

### HYDROGEN-CYANIDE GRENADE

The hydrogen-cyanide grenade is a reliable way to generate a cloud of extremely poisonous hydrogen-cyanide gas. A small amount of this gas can incapacitate or kill anyone breathing it. Hydrogen-cyanide grenades are most effective when used in an enclosed area; there the gas cloud will dissipate slowly and remain effective for a longer time.

#### MATERIALS

Potassium cyanide

Sulfuric acid (90-percent concentrated)

Sodium chlorate

Sugar

Paper, uncoated

External burning fuze

$\frac{1}{8}$ -inch copper or aluminum tubing

Primary explosive

Epoxy resin

#### SOURCES

Chemical supply store or Sec. VIII, No. 2

Sec. I, No. 43

Chemical supply store or Sec. I, No. 23

Sec. VI, No. 7  
Firecracker fuze

Hardware store

Mekap, acetone peroxide, or HMTD

Hardware store

FOR INFORMATION PURPOSES ONLY

**MATERIALS**

Screwdriver or awl  
Tin can with lid  
Test tubes with stoppers  
Adhesive tape  
Wooden dowel  
Water  
Heat source  
Pot or pan

**SOURCES**

Chemical supply store

**PROCEDURE**

1. Cut off a 2-inch section of the 1/4-inch tubing. Seal one end with epoxy resin and let dry.

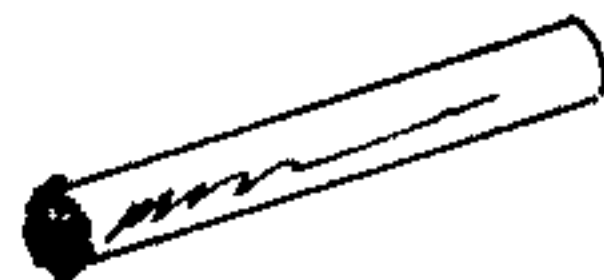

2. Fill the 2-inch section of tubing with primary explosive and carefully pack it with a wooden dowel. Place 4- or 5-inch fuze in the open end and seal with epoxy.

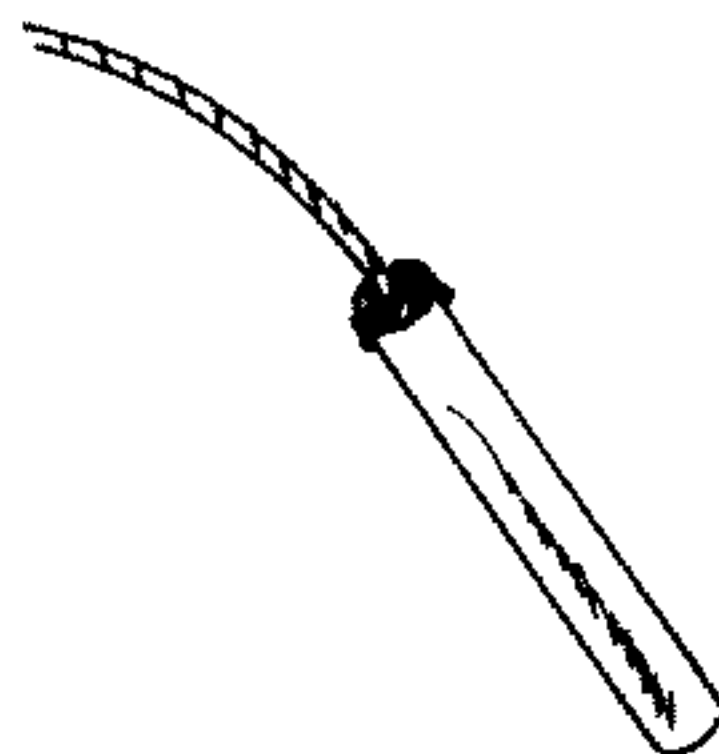

FOR INFORMATION PURPOSES ONLY

3. Remove the lid of the can. Using a pen or pencil, trace the outline of the lid on a piece of blank paper and cut out.

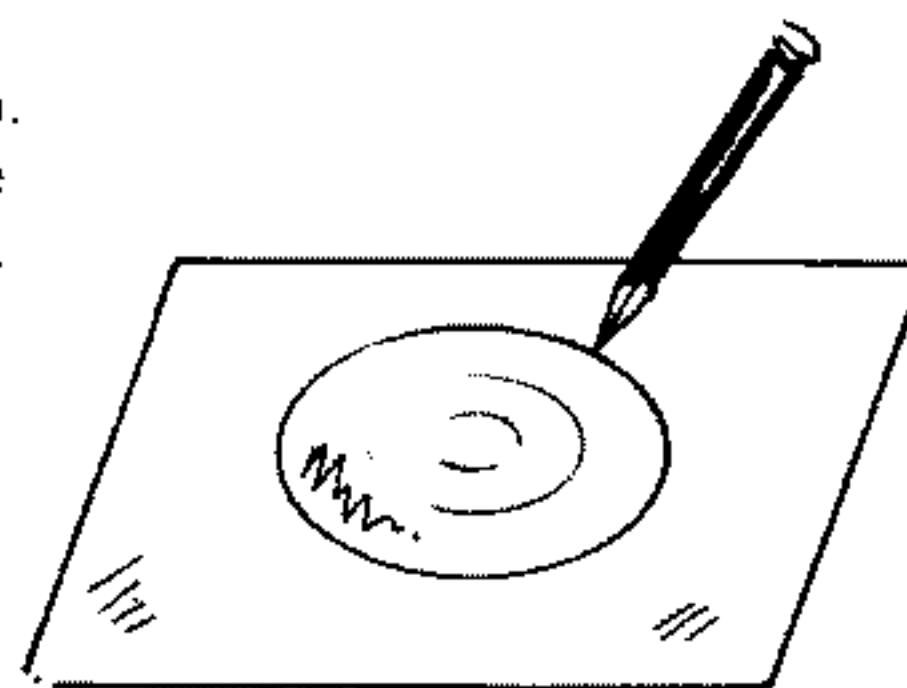

4. Dissolve 3 parts sodium chlorate and 2 parts sugar into some hot water. When dissolved, put the paper cut-out into the solution and gently stir for 5 minutes. Remove it from solution and let dry.



5. Using the screwdriver or awl, punch many small holes in the can lid. Make sure to punch a hole in the center big enough to fit the fuze. Do not bend or damage the outer edge of the lid.

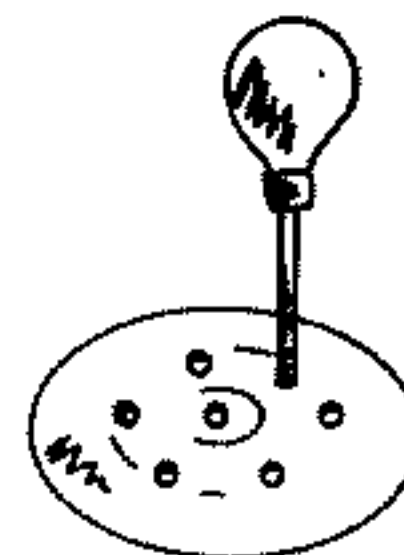



**FOR INFORMATION PURPOSES ONLY**

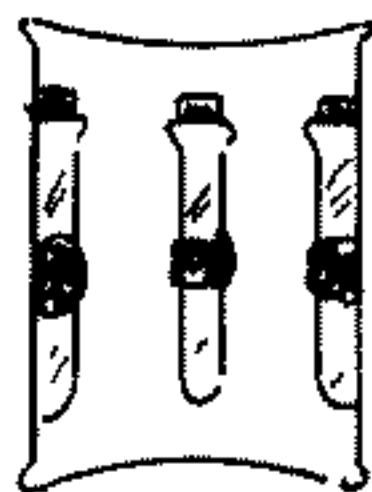

6. Fill 3 or 4 test tubes with sulfuric acid. Place the stoppers in firmly and clean off all excess acid. Epoxy the test tubes to the inside of the can.

7. Fill the bottom of the can with a ½- to 1-inch layer of potassium cyanide.

**CAUTION:** Potassium cyanide is extremely poisonous. Always wear gloves when handling it. Refer to the information on Potassium-cyanide safety in Section VIII, No. 2.

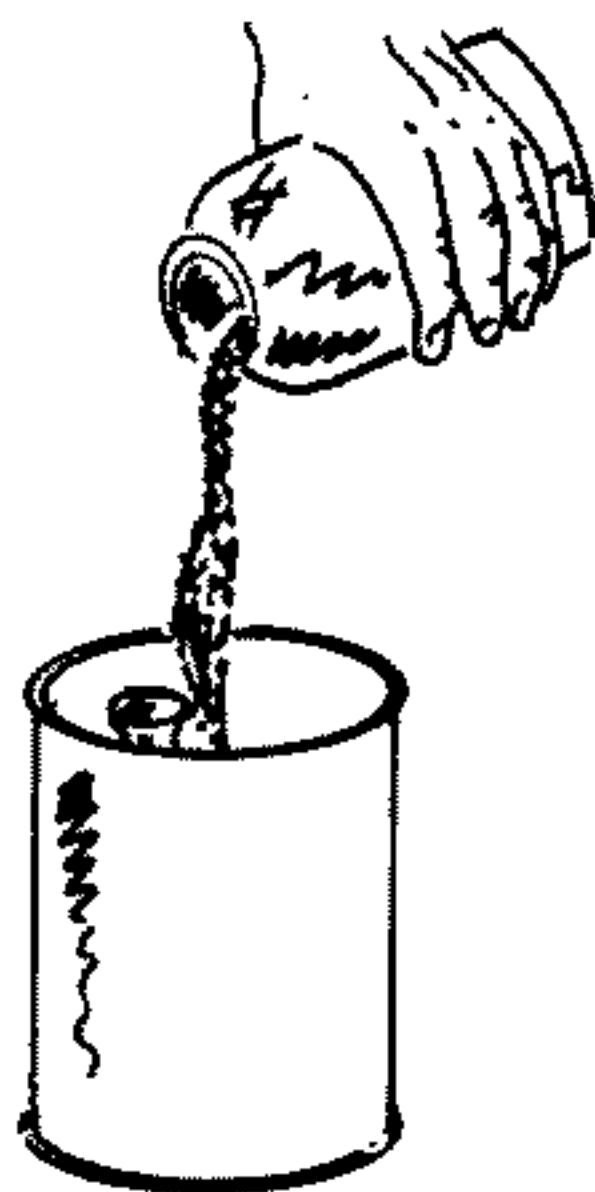

8. Place the fuze through the center hole in the lid so that the detonator is on the lid's underside. Tape the detonator in place.



**FOR INFORMATION PURPOSES ONLY**

9. Punch a hole through the center of the sodium-chlorate/sugar paper. Slide it over the fuze so it rests flat against the lid, covering the holes. Tape it securely in place.

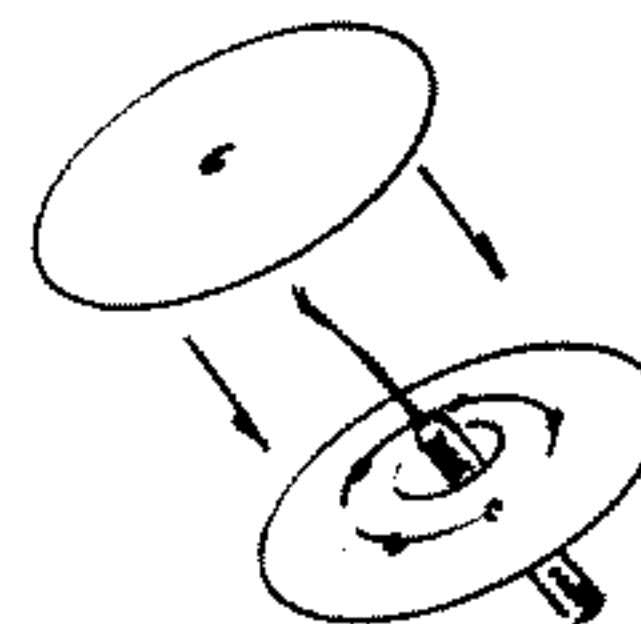

10. Epoxy the lid to the can, leaving no spaces for the potassium cyanide to escape from. Let the epoxy dry. The grenade is now ready for use.

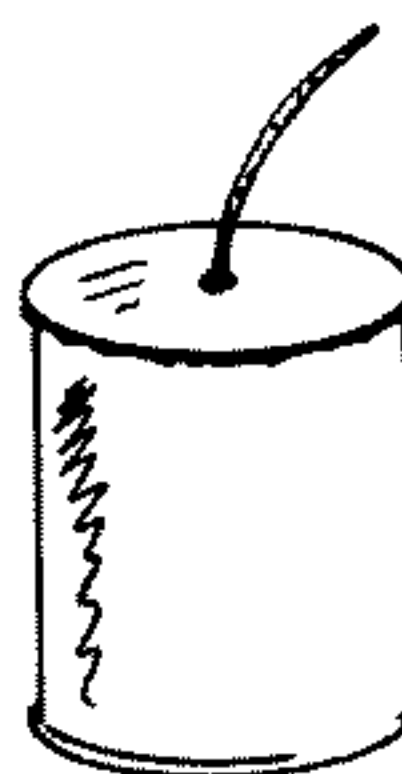

**HOW TO USE**

Positioned upwind from the exploding grenade, light the fuze and throw towards the target area. When the fuze burns down to the paper disk, it will ignite and burn away, leaving the holes exposed. The detonator will then explode, breaking the test tubes open and mixing the acid and potassium cyanide. Hydrogen cyanide will be produced and will escape through the holes. These grenades are best used as defensive weapons to block entrances and exits or cover a retreat.

**CHLORINE GENERATOR**

This device can be carried in three or more separate parts (the two buckets and the glass separator with the explosive device taped to it) and can be set up at the target area in seconds. It produces a very large amount of chlorine gas, which is a simple suffocating agent. Placed in a large enclosed area or in the ventilation system of a large building, it will cause panic and varying degrees of casualties, depending on how quickly the area is evacuated.

**MATERIALS**

HTH pool cleaner (pellet form is best)

Hydrochloric acid (muriatic acid)

2 large plastic buckets with lids

Large square of glass

CO<sub>2</sub> canister grenade or compound detonator

Any time-delay device

**SOURCES**

Pool supply store

Hardware or chemical supply store

Sec. II, No. 19 or Sec. VI, No. 16

**PROCEDURE**

1. Remove the lid from one of the plastic buckets and fill it halfway with HTH pellets.

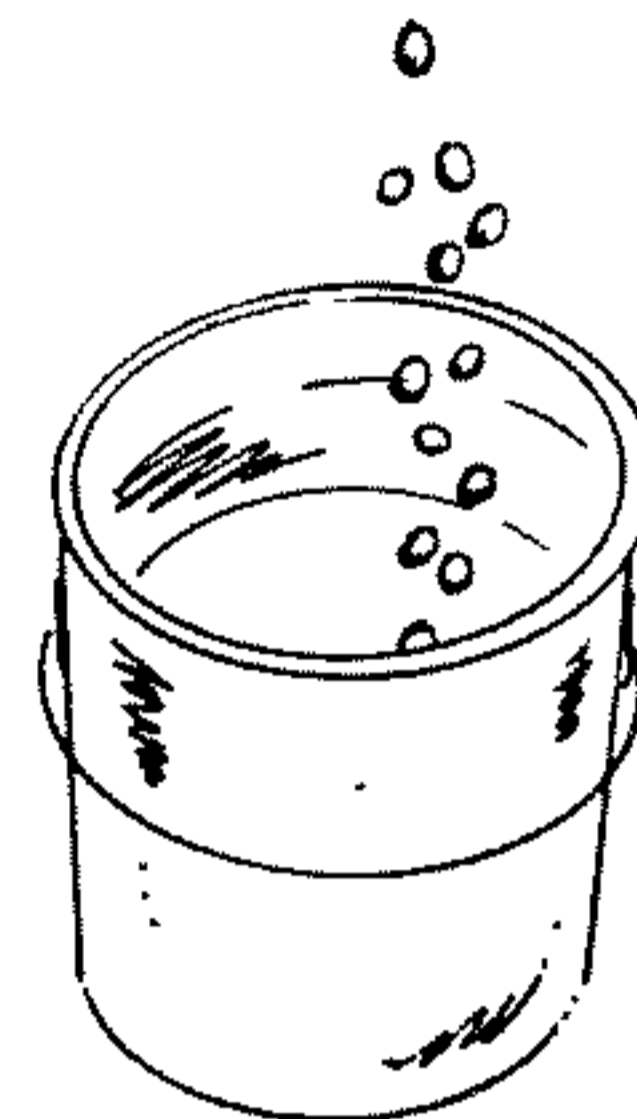

2. Fill the other bucket most of the way with hydrochloric acid.

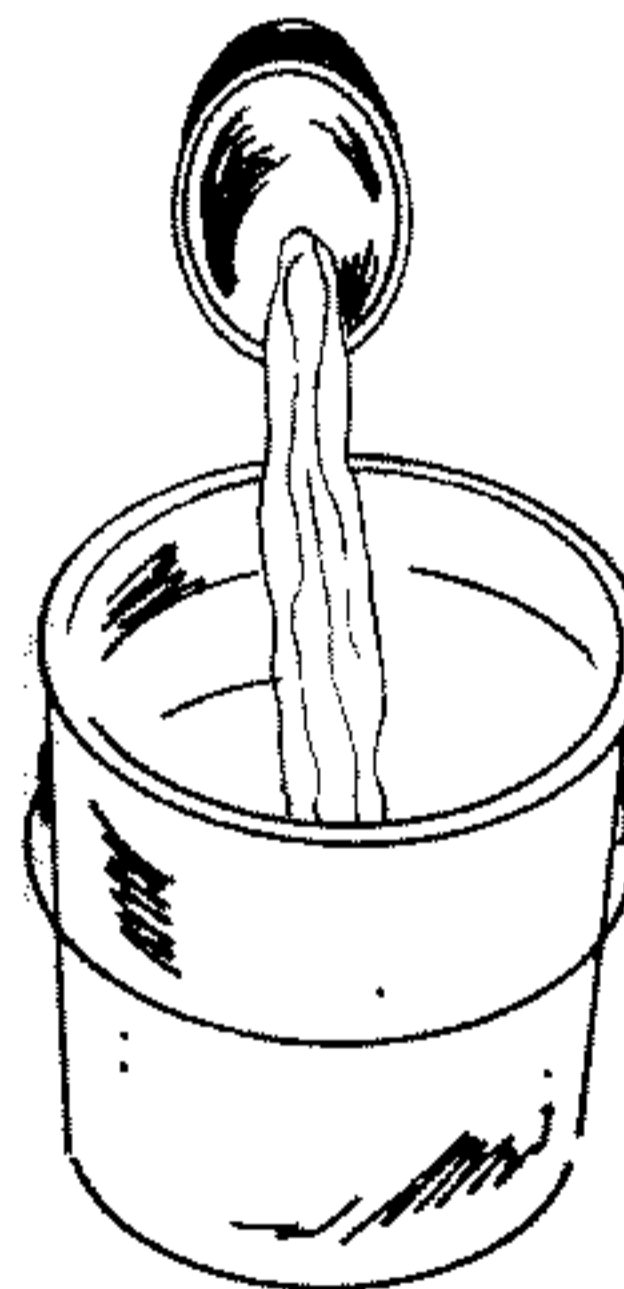

The lids can now be replaced if the equipment is to be transported. If the manufacture is being done at the target area, they can be discarded.

3. Tape either a compound detonator or a CO<sub>2</sub> canister grenade and the time-delay device to the center of the glass square.

FOR INFORMATION PURPOSES ONLY

HOW TO USE

1. Place the bucket of acid on a flat, stable surface and remove the lid.

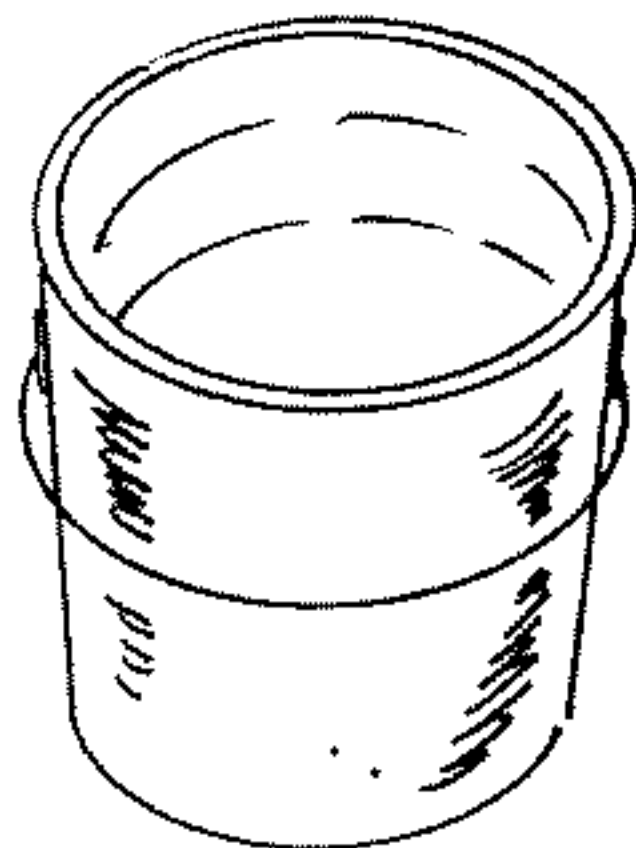

2. Remove the lid from the HTH bucket and place the glass square over the mouth with the explosive device on the bottom. If a fuze is being used as the time delay, cut a small notch in the side of the HTH bucket and run the fuze through it.

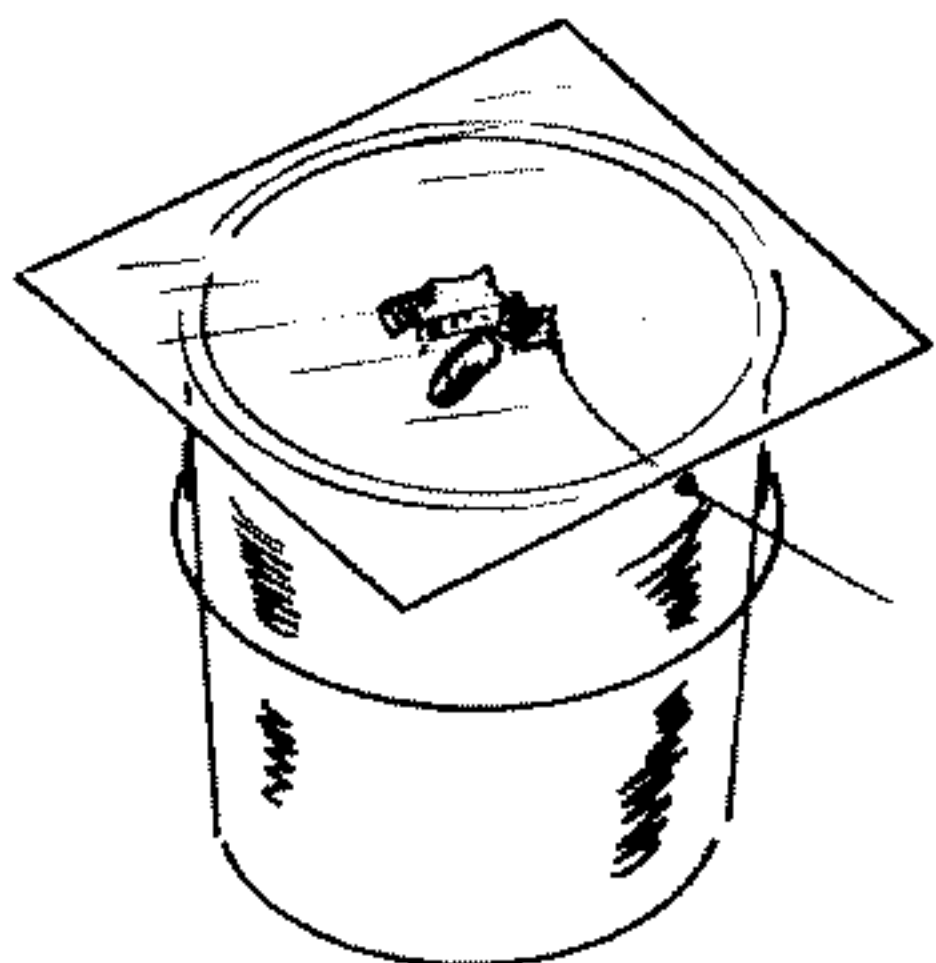

FOR INFORMATION PURPOSES ONLY

3. Carefully invert the HTH bucket, making sure that the weight of the HTH does not break the glass. Place the structure onto the acid bucket and tie the two buckets together as shown. Activate the time-delay mechanism and take cover (unless gas masks are worn).

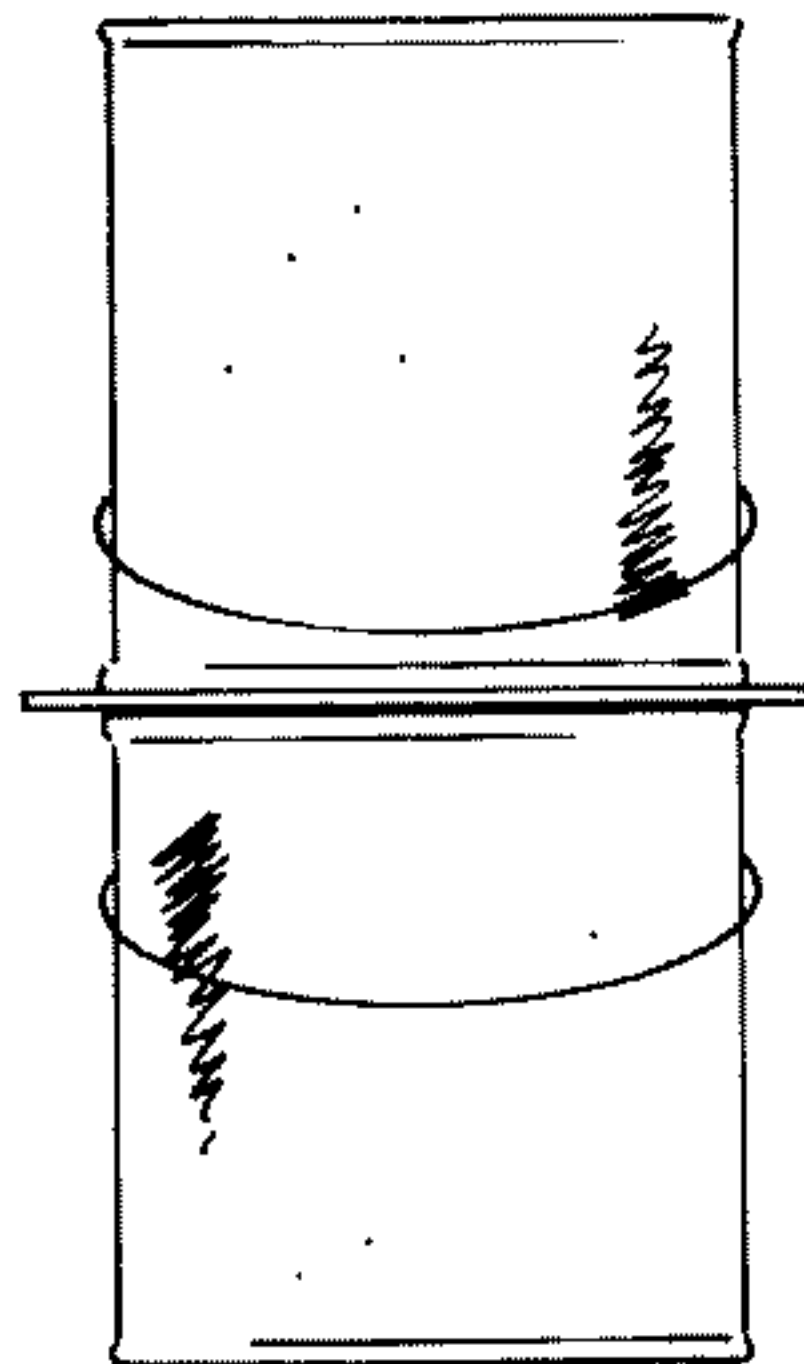

When the explosive device explodes, the glass is shattered and the HTH pellets fall into the hydrochloric acid. The reaction causes the entire mass to boil violently and releases a large amount of green chlorine gas.

*Note:* The same system could conceivably be used with potassium cyanide and sulfuric acid, though finding or manufacturing such large quantities of the cyanide would be very expensive.

## Appendix A

# Amendments

This section presents various additions, options, and comments on the information in *Black Book*, volumes 1, 2, and 3.

### Sec. I, No. 1: Plastic explosive filler

1. First, we recommend using a compound detonator, as we have found that No. 8 blasting caps occasionally fail to detonate the plastic.
2. Second, instead of using plain petroleum jelly, we recommend the following process:
  - a. Place the desired amount of petroleum jelly in a heat-resistant container.
  - b. Add an equal volume of acetone.
  - c. Heat on high heat until the petroleum jelly has melted.
  - d. Add the hot mix to the potassium chlorate.
  - e. Knead well.
  - f. Let the rest of the acetone evaporate off.
3. An alternative to petroleum jelly that works equally well, if not better, is castor oil. Use the system outlined in comment 2.
4. Let us stress that the potassium chlorate must be the consistency of flour — otherwise, the plastic will not be a plastic and might not detonate.
5. To make a C-4-like plastic explosive, simply mix a little more than 9 parts RDX and a little less than 1 part petroleum jelly or castor oil using the process described above.



## FOR INFORMATION PURPOSES ONLY

### Sec. I, No. 3: Improvised black powder

1. The mixture listed in volume 1 is not oxygen balanced because there is not enough fuel for the oxidizer.
2. The following ratio is recommended:
  - 3 cups potassium nitrate
  - 3 cups finely ground charcoal
  - ½ cup finely ground sulfur
3. On the other hand, if somewhat coarser powders are used, the quantities given in volume 1 are satisfactory.

### Sec. I, No. 4: Nitric acid

1. If possible, use a 500 milliliter or larger glass retort with a glass stopper (obtained from a chemical supply store) instead of the sulfuric-acid/potassium-nitrate bottle. Its shape will allow you to place the receiving bottle in a container of cold water, which is better than splashing water on hot glass, possibly causing it to shatter.

### Sec. I, No. 5: Initiator for dust explosions

1. A good material to use with the dust initiator is either butane or propane. Simply place a canister of the gas on top of the initiator and detonate it.

### Sec. I, No. 6: Fertilizer explosive

1. This is the famous ANFO commercial explosive (Sec. I, No. 6). It generally works best if a stick of high explosive, such as dynamite, is used to initiate it.
2. Add 10-percent ammonium perchlorate to any ammonium-nitrate explosive, if possible. This will increase the power of the explosive considerably, but more importantly, it will sensitize it more than any other compound. This does not mean you shouldn't use a compound detonator; it simply means that it will be detonated a higher percentage of times.
3. See comments, Sec. I, No. 8, for AN purification.

## FOR INFORMATION PURPOSES ONLY

### Sec. I, No. 7: Carbon-tet explosive

1. Recently, the EPA came out with a report stating that carbon tetrachloride is a carcinogen. Therefore, all of the industries that previously used it, such as dry cleaners, stopped doing so.
2. The only establishments that continue to sell carbon tet are the scientific supply companies that sell to schools and research firms. In most cases, you have to be a part of one of these institutions to obtain carbon tet from a supply company.
3. One last warning about carbon tet. Both the liquid and its fumes are extremely toxic. It is absorbed easily through the lungs and skin. Being in direct contact (i.e., touching any amount with any part of your body) with carbon tet for a half hour can be deadly.
4. Therefore, it would be best to use another explosive.

### Sec. I, No. 8: Fertilizer AN-AL explosive

1. See comments, Sec. I, No. 6, for sensitizing AN with AP.
2. Another process that greatly sensitizes and improves AN explosives is using chemically pure ammonium nitrate. While it would be immensely expensive to buy 80 pounds of AN from a hobby store, the fertilizer grade can be purified in the following manner.
  - a. In several liters of gasoline antifreeze (methanol), dissolve as much fertilizer-grade ammonium nitrate as possible. You might want to heat the solution slightly to dissolve even more.
  - b. Skim any of the coloring agents and other insoluble matter from the top of the solution.
  - c. Meanwhile, prepare an iron pan or similar device by placing it on a block of dry ice.
  - d. When the pan is sufficiently cold and the solution is finished, pour the liquid onto the pan. Pure ammonium nitrate will crystallize out and stick to the pan. Immediately pour off the liquid that remains. Repeat the process until all the liquid has been processed.

## FOR INFORMATION PURPOSES ONLY

- e. Keep the material that sticks to pan. Dry it, pulverize it, and place it in an airtight jar until use.
3. Once you obtain pure ammonium nitrate, you will want to keep it that way. Ammonium nitrate readily absorbs water from the air, and this does nothing to help its performance. To avoid this, always store it in an airtight container along with a packet of silica gel to absorb any water that does get in.

### Sec. I, No. 11: Optimized process for cellulose/acid explosives

1. This process produces a highly toxic and corrosive product. The following procedure yields a final product that is much safer to handle.
  - a. In an acid-resistant container, place 2 parts by volume nitric acid and 1 part by volume sulfuric acid.
  - b. Prepare pure cellulose as described in Appendix B.
  - c. Add 1 cup of the powdered cellulose to the acid mix and allow it to soak for 30 minutes, stirring occasionally.
  - d. Dump the mix into 1 gallon of clean water, filter out the powder, and let dry.
  - e. The product can be used now, or purified for later use.
  - f. To purify cellulose nitrate:
    - 1) Add as much warm acetone to the powder as needed to dissolve most of it.
    - 2) Filter out and discard insoluble matter.
    - 3) Dump solution into 1 gallon of clean water and filter out the crystals that precipitate.
    - 4) Dry the crystals and store in a closed jar in a cool place.

### Sec. I, No. 13: Urea-nitrate explosive

1. You will obtain a purer product if you use commercial urea. This can be purchased in a crystalline form from chemical supply stores. Use about  $\frac{1}{3}$  cup urea-nitrate crystals instead of the urine in step 3. Otherwise, use the same process.

## FOR INFORMATION PURPOSES ONLY

### Sec. I, No. 14: Preparation of copper sulfate (pentahydrate)

1. It is much simpler to obtain cupric sulfate from any hobby shop. It will give the final product a greater degree of purity and will not expose the maker to the dangerous fumes produced during its manufacture.

### Sec. I, No. 17: HMTD

1. While army heat tabs contain hexamin, they also contain other impurities, which may make the final product useless. The safer route is to use hexamin obtained from a drug store or a chemical supply store.

### Sec. I, No. 18: Potassium or sodium nitrite and litharge

1. Again, the simpler route is to obtain the chemicals from a chemical supply store. If you do opt to make the chemicals yourself, just use the potassium or sodium nitrates to obtain the respective nitrites. Don't bother with the lead picrate. It is much too complicated a process, yielding much too weak an explosive.

### Sec. I, No. 19: DDNP

1. DDNP is, by far, a superior primary explosive to all the others mentioned in the *Black Books*. While it is more complicated to manufacture than lead azide or similar primary explosives, it is far more powerful and has a higher detonation velocity.
2. Certain chemical supply stores sell a 9-percent (super saturated) solution of picric acid. Using the recommended amount of this solution and adding  $\frac{1}{2}$  teaspoon of lye will give you a satisfactory mixture.

### Sec. I, No. 20: Lead picrate

1. This process is fairly complicated to follow and it yields a relatively weak primary explosive. If you have the picric acid necessary to manufacture it, you might as well make DDNP, which will give you about 10 times the power of lead picrate.

## FOR INFORMATION PURPOSES ONLY

### Sec. I, No. 22: Double salts

1. A simpler way to manufacture double salts is to obtain silver-nitrate crystals and bottled acetylene from a chemical supply store and a welding supply store, respectively.
2. Simply make a 1:1:1 solution of silver nitrate, water, and nitric acid; run a tube from the acetylene bottle to the silver-nitrate container; and open the valve. Continue with step 5.

### Sec. I, No. 24: Mercury fulminate

1. Add  $\frac{1}{4}$  teaspoon hydrochloric acid to the metal/acid solution if possible. This acts as a catalyst and results in a better yield.
2. Two great additives to plain mercury fulminate are lead azide in a 2:3 ratio (2 parts mercury fulminate, 3 parts lead azide), and potassium chlorate in a 1:4 ratio. The former increases the power and prevents mercury fulminate from becoming "dead-pressed," while the latter increases the power as well as the volume very economically.

### Sec. I, No. 25: Sodium chlorate/sugar or aluminum explosive

1. The following system creates a more even mixture of the ingredients, thus yielding a faster-burning product.
  - a. If sugar is being used, pulverize it in a coffee grinder.
  - b. Add 1 volume water to the sodium chlorate and mix well, making a paste.
  - c. Add to the other ingredient (sugar or aluminum) and mix thoroughly.
  - d. Proceed with steps 6 and 7 of Sec. I, No. 3.
2. The final product can be used as a flash powder; in other words, it can be ignited with a flame. In a pipe grenade or similar device, however, using a detonator is best.

### Sec. I, No. 26: Acetone peroxide explosive

1. We found that the procedure outlined under Mekap

## FOR INFORMATION PURPOSES ONLY

(Sec. I, No. 42) works well with acetone peroxide also; namely the refrigerator/room-temperature process.

2. Potassium chlorate in a 1:4 ratio with acetone peroxide considerably improves the power as well as increasing the detonator's shelf life to about 10 days.

### Sec. I, No. 28: HTH/naptha explosive

1. The authors tried this mixture several times and were given no indication that it would work.

### Sec. I, No. 29: Potassium permanganate/aluminum explosive

1. The authors attempted to detonate a pipe grenade filled with this material with a simple acetone-peroxide detonator and discovered that it worked well only as a rocket fuel, propelling the pipe nipple several feet as the gases escaped through the fuze hole. Let us therefore stress that a compound detonator is necessary for the proper detonation of this explosive.

### Sec. I, No. 33: Nitromethane/sawdust explosive

1. Nitromethane attacks epoxy resin cements and copper. Therefore, avoid using these compounds when dealing with nitromethane explosives.
2. The highest proportion of nitromethane that law permits in model engines is 55 percent. Therefore, be sure to boil off the other 45-percent worth of methanol and skim off the remaining lubricating agents with an eyedropper or bulb baster before using it as an explosive.

### Sec. I, No. 34: Nitromethane/ammonium-nitrate explosive

1. Using ammonium perchlorate for this explosive is not recommended. Do, however, use the purified ammonium nitrate if possible.
2. The authors have come upon situations where a regular blasting cap failed to detonate this mix; therefore, contrary to the instructions in volume 3, we recommend using a compound detonator.
3. See comments, Sec. I, No. 33, concerning nitromethane.



## FOR INFORMATION PURPOSES ONLY

### Sec. I, No. 35: Nitromethane liquid explosive

1. Unfortunately, model-engine fuels have a color added to them that does not boil off with the alcohol. Therefore, this explosive will not be disguisable as water. Perhaps you could convince someone that it's a soft drink.
2. Using a compound detonator is strongly recommended.

### Sec. I, No. 36: Fertilizer/hydrazine liquid explosive

1. This explosive is in fact the most powerful non-nuclear explosive discovered to date, having a detonation velocity of about 8,600 meters per second as compared to the next most powerful, RDX, at 8,180 meters per second. It is also known by the name "Astrolight G."
2. To make a plastic explosive out of Astrolight G, simply add enough flour to the unaluminized liquid to reach the desired consistency.
3. Explosive flour (Sec. I, No. 39) can be used to increase the total amount of explosive in the final product, but it should be mixed up immediately before use because there is evidence that RDX and Astrolight G react when they come in contact with each other.

### Sec. II, No. 1: Pipe hand grenade

1. To increase the shrapnel effect, wrap the outside of the grenade with a thin chain. When the explosive detonates, the chain is ripped apart, adding to the amount of metal in the air.
2. To increase the distance that a pipe grenade can be thrown, secure a 10-inch piece of PVC or other pipe to the fuze end of the grenade. This will act both as a handle and as protection for the fuze. To use, just light the fuze at the bottom of the PVC pipe and throw.
3. Using the above system with a handle, you can attach a no-flash fuze igniter (Sec. VI, No. 5) at the bottom of the handle. The key is for the grenade end to be considerably heavier than the handle end, or the whole handle assembly will be useless.

## FOR INFORMATION PURPOSES ONLY

### Sec. II, No. 9: Funnel-shaped charge

1. A good substitute for a funnel is a martini glass. Simply cut or carefully break the stem off and follow the directions and specs for a glass funnel.

### Sec. II, No. 13: Cherry-bomb flechette gun

1. First of all, we have found it helpful to grease the inside of the mold with petroleum jelly. This permits the round to be extracted without breaking the plaster.
2. Second, we found Durham's Rock Hard Water Putty to work much better than plaster of paris in that it didn't break nearly as often as the plaster upon extraction from the mold.
3. Of the three flash-powder mixes, we have come to the conclusion that the permanganate/aluminum is in fact better than perchlorate/antimony sulfide/aluminum because it is cheaper and works arguably better in certain instances.
4. The chlorate/sulfur still remains at the bottom of the list due to its dangerous sensitivity.

### Sec. VI, No. 7: Fuze cords

1. From the authors' abundant experience with these fuzes, they are not good enough to bet one's life on. You would be much better off with commercial fuze. If that is unavailable, the better of the two is the fast-burning fuze. You'd be better off making a longer length of this than trying the slow-burning variety.

### Sec. VII, No. 8: Improvised scale

1. If handbook pages are unavailable, make the scale as shown with two pockets and make sure it is even.
2. Then place a nickel in one pocket and enough copper wire in the other to even it out.
3. Next, cut the wire into 5 equal pieces. Each piece will weigh 1 gram.
4. To use the scale, simply place as many pieces of wire as necessary in one pocket and add the material being weighed to the other until it evens out.



## Appendix B

# Chemicals

This glossary covers the trade names and sources of the chemicals mentioned in this and other *Black Books*.

*Acetone* — Acetone, nail-polish remover, ketone. Used as a paint thinner. Found in hardware stores.

*Aluminum Powder* — Aluminum bronzing powder, flitters; reactant flake or powder aluminum, etc. Rarely found in paint and hobby stores. Used as a bronzing powder and in fireworks manufacture. Best sources are the companies that actually manufacture the powders.

*Ammonium Chloride* — Sal Ammoniac. Ice-melting chemical for de-icing roads, driveways, etc. Hardware or auto stores.

*Ammonium Hydroxide* — Household ammonia, clear ammonia. Found in hardware and grocery stores. *Do not* use ammonia with added soap, detergent, coloring, or fragrances.

*Ammonium Nitrate* — Thirty-four percent nitrogen ammonium-nitrate fertilizer, ammonium nitrate. Found in gardening supply stores, farm and feed stores.

## FOR INFORMATION PURPOSES ONLY

- Aniline* — Aniline. Found in chemical supply stores.
- Anhydrous Hydrazine* — Anhydrous hydrazine, hydrazine, diamine. Found in chemical supply houses.
- Calcium Carbonate* — Chalk. Found in art supply stores. Use plain white, not the dustless kind. Pulverized chalk sticks in a coffee grinder.
- Calcium Hypochlorite* — HTH pool cleaner, Sock-IT! pool cleaner. Found in hardware and pool supply stores. Quite common. Use the powdered type for explosives and tablets for chlorine generation.
- Carbon Tetrachloride* — Carbon tetrachloride, carbon tet. Carbon tetrachloride is hard to find in stores and dry cleaners because it has been labeled a carcinogen by the EPA.
- Cellulose* — Cellulose, Plastic Wood. Found in hardware stores. Used as wood-filling putty. It is pure cellulose with a solvent. Let the solvent evaporate and pulverize the solid in a coffee grinder.
- Copper Sulfate* — Blue vitriol, cupric sulfate. Hardware, hobby, drug stores, or Sec. 1, No. 14.
- Ethyl Alcohol* — Ethanol, denatured alcohol, grain alcohol, liquor that is 180-proof or greater. Hardware stores carry denatured alcohol as a lacquer thinner.
- Ethylene Glycol* — Antifreeze. Found in hardware and auto supply stores.
- Formaldehyde* — Formaldehyde. Drug stores, chemical supply stores.
- Fuming Sulfuric Acid* — Oleum. Chemical supply stores.

## FOR INFORMATION PURPOSES ONLY

- Fuming Nitric Acid* — Fuming nitric acid. Add a small amount of formaldehyde to concentrated nitric acid. Chemical supply stores.
- Glycerine* — Glycerine. Found in drug or grocery stores.
- Hexachloroethane* — Hexachloroethane. Used in plastics industry. Chemical supply stores.
- Hexamethylenetetramine* — Hexamine, urotropine. Army solid-fuel tabs. Camping or outdoor stores.
- Hydrochloric Acid* — Hydrochloric acid, muriatic acid. Chemical supply, hardware stores.
- Hydrogen Peroxide* — Hydrogen peroxide, peroxide, hair bleach. Whenever discussed in the *Black Books*, it concerns a product 20 volume (6 percent) or greater. If a more concentrated solution is obtained (30 percent, for example), dilute it to about 10 percent by adding clean water.
- Iron Oxide, Black* — Ferrous oxide, magnetic iron oxide. Chemical supply stores or Sec. 5, No. 7.
- Iron Oxide, Red* — Ferric oxide, hematite. Occurs naturally as the mineral and rust. Chemical supply stores.
- Lead Acetate* — Lead acetate. Veterinary and chemical supply stores.
- Lead Monoxide* — Litharge, lead monoxide. Plumbing and chemical supply stores, or Sec. 1, No. 18.
- Lead Nitrate* — Lead nitrate. Chemical supply stores.
- Mercury* — Mercury, quicksilver. Found in thermometers and mercury switches. Hardware and electronics stores, respectively.

## FOR INFORMATION PURPOSES ONLY

*Nitric Acid* — Nitric acid. Chemical supply stores or Sec. I, No. 4.

*Nitrobenzene* — Oil of mirbane, nitrobenzene, mononitrobenzene. Chemical supply stores.

*Nitrocellulose* — Nitrocellulose, cellulose nitrate, single-base smokeless powder. Gun shops, sporting goods stores.

*Nitromethane* — Nitromethane, 55-percent Nitro racing fuel. Chemical supply stores, hobby stores, respectively. Heat to 100°C for several minutes to allow methanol to evaporate out; you will be left with ½ the original volume when alcohol is gone.

*Potassium Carbonate* — Potassium carbonate. Chemical supply stores.

*Potassium Chlorate* — Potassium chlorate, potcrate. Chemical supply stores, some fireworks supply stores.

*Potassium Ferrocyanide* — Potassium ferrocyanide. Chemical supply stores.

*Potassium Nitrate* — Potassium nitrate, saltpeter, saltpetre, nitre. Drug stores, garden supply stores, fireworks supply stores, or Sec. I, No. 2.

*Potassium Nitrite* — Potassium nitrite. Chemical supply stores or Sec. I, No. 18 (not for internal use). Potassium nitrite can also be obtained by heating a small amount of potassium nitrate gently for about 5 minutes and let cool.

*Potassium Perchlorate* — Potassium perchlorate. Chemical and fireworks supply stores.

## FOR INFORMATION PURPOSES ONLY

*Potassium Permanganate* — Potassium permanganate. Chemical supply stores.

*Sodium Azide* — Sodium azide. Chemical and photography supply stores (manufactured by Kodak).

*Sodium Chlorate* — Sodium chlorate, solid O<sub>2</sub> pellets used in arc welding. Chemical and welding supply stores, some fireworks supply stores.

*Sodium Metal* — Sodium, metallic sodium. Chemical supply stores.

*Sodium Nitrate* — Sodium nitrate, chile saltpeter. Garden, chemical, or fireworks supply stores.

*Sodium Nitrite* — Sodium nitrite. See potassium nitrite, as the preparation and use are the same.

*Sulphur* — Sulphur, sulfur, etc. Dusting sulphur found in garden supply stores is probably best.

*Sulphuric Acid* — Sulphuric acid, sulfuric acid, etc. Found in chemical supply stores or Sec. I, No. 43.

*Zinc Metal* — Zinc, metallic zinc, zinc strips, mossy zinc, etc. Chemical supply stores.

*Zinc Oxide* — Zinc oxide. Chemical supply stores.

Notes: Chemical supply stores are companies that supply lab equipment, including a large assortment of chemicals, to schools and research institutions on a mail-order basis (e.g., Sargent Welch, Sigma Aldrich).

Chemical supply houses provide chemicals to industry. They deal in large quantities and sell only to companies.

## FOR INFORMATION PURPOSES ONLY

Fireworks supply stores sell the chemicals, tools, and other hardware necessary to make class-C fireworks. They also work on a mail-order basis, but the catalogs tend to have a limited variety of chemicals, carrying only those that are used extensively in the production of display-type fireworks (e.g., Square Lake Enterprises, Firefox).

Naturally, the authors do not advocate the use of the above companies for the purpose of obtaining chemicals for the sole purpose of manufacturing illegal explosives. They are given as examples for information purposes only.

# Appendix C

## Primary and Secondary Explosives

This appendix ranks the various primary and secondary explosives outlined in *Black Book*, volumes 1, 2, and 3 and in the *Black Book Companion* in order of suitability for use in compound detonators.

### PRIMARY EXPLOSIVES

DDNP	HMTD
Lead azide	MEKAP
Mercury fulminate	Acetone peroxide
Double salts	

### SECONDARY EXPLOSIVES

RDX	Double-base powder
PETN	Single-base powder
TNT	(nitrocellulose)
Picric acid	Ammonium picrate
Starch nitrate	DDNP