

UNIVERSITY OF TORONTO



3 1761 00327216 8



Presented to the
LIBRARY of the
UNIVERSITY OF TORONTO
by
ROBERT H. MORRIS



INTERNET ARCHIVE

Digitized for Microsoft Corporation
by the Internet Archive in 2007.

From University of Toronto.

May be used for non-commercial, personal, research,
or educational purposes, or any fair use.

May not be indexed in a commercial service.

INTERNET

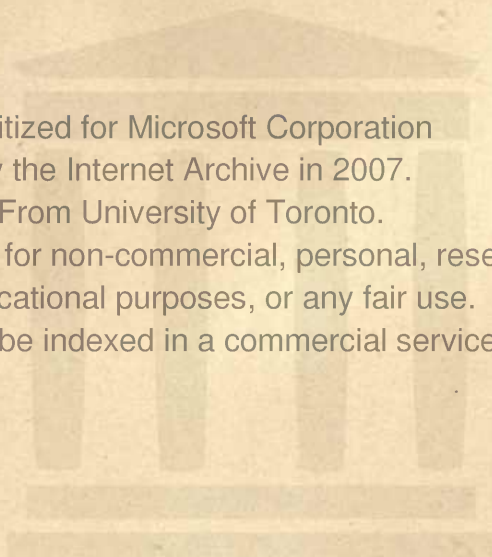

I. C. S. REFERENCE LIBRARY

A SERIES OF TEXTBOOKS PREPARED FOR THE STUDENTS OF THE
INTERNATIONAL CORRESPONDENCE SCHOOLS AND CONTAINING
IN PERMANENT FORM THE INSTRUCTION PAPERS,
EXAMINATION QUESTIONS, AND KEYS USED
IN THEIR VARIOUS COURSES

WOOD WORKING
WOOD TURNING
PATTERNMAKING
GREEN-SAND MOLDING
CORE MAKING
DRY-SAND AND LOAM WORK
CUPOLA PRACTICE
MIXING CAST IRON

31591B

SCRANTON
INTERNATIONAL TEXTBOOK COMPANY

52



Copyright, 1901, by THE COLLIERY ENGINEER COMPANY.

Copyright, 1903, 1905, by INTERNATIONAL TEXTBOOK COMPANY.

Entered at Stationers' Hall, London.

Wood Working: Copyright, 1903, by INTERNATIONAL TEXTBOOK COMPANY. Entered at Stationers' Hall, London.

Wood Turning: Copyright, 1903, by INTERNATIONAL TEXTBOOK COMPANY. Entered at Stationers' Hall, London.

Patternmaking: Copyright, 1901, by THE COLLIERY ENGINEER COMPANY. Copyright, 1903, by INTERNATIONAL TEXTBOOK COMPANY. Entered at Stationers' Hall, London.

Green-Sand Molding: Copyright, 1901, by THE COLLIERY ENGINEER COMPANY. Copyright, 1903, by INTERNATIONAL TEXTBOOK COMPANY. Entered at Stationers' Hall, London.

Core Making: Copyright, 1901, by THE COLLIERY ENGINEER COMPANY. Copyright, 1903, by INTERNATIONAL TEXTBOOK COMPANY. Entered at Stationers' Hall, London.

Dry-Sand and Loam Work: Copyright, 1901, by THE COLLIERY ENGINEER COMPANY. Copyright, 1903, by INTERNATIONAL TEXTBOOK COMPANY. Entered at Stationers' Hall, London.

Cupola Practice: Copyright, 1901, by THE COLLIERY ENGINEER COMPANY. Copyright, 1903, by INTERNATIONAL TEXTBOOK COMPANY. Entered at Stationers' Hall, London.

Mixing Cast Iron: Copyright, 1901, by THE COLLIERY ENGINEER COMPANY. Copyright, 1903, by INTERNATIONAL TEXTBOOK COMPANY. Entered at Stationers' Hall, London.

All rights reserved.



CONTENTS

WOOD WORKING	<i>Section</i>	<i>Page</i>
Bench and Bench Equipment	32	1
Laying-Out Tools	32	7
Cutting Tools	32	13
Clamps	32	36
Horses	32	39
Sharpening Bench Tools	32	40
Machine Tools	33	1
Trimmers	33	1
Sawing Machines	33	3
Surfacing Machines	33	9
Grinding Devices	33	11
Glue and Gluing Apparatus	33	15
Bench Work	33	17
Joints	33	31
WOOD TURNING		
Tools and Equipment	34	1
Wood-Worker's Lathe	34	1
Turning Tools	34	8
Turning Operations	34	14
Cutting Speed	34	14
Rough Turning	34	16
Turning Grooves	34	24
Turning Beads	34	29
Turning Across the Grain	34	34
Inside Turning	34	38
Turning Compound Beads and Grooves	34	31
General Turning	34	33

<i>WOOD TURNING—Continued</i>	<i>Section</i>	<i>Page</i>
Turning Built-Up Work	34	43
Turning a Ball	34	45
 PATTERNMAKING		
Patterns	35	1
The Core	35	2
Core Boxes	35	3
Core Prints	35	6
Patternmaking Materials	35	10
Wood	35	10
Metal and Other Material	35	15
Sandpaper	35	16
Metal Fastenings	35	16
Adhesive Fastenings and Protective Coatings	35	17
Fillets	35	20
Dowels	35	23
Provision for Rapping and Drawing Patterns	35	25
Pattern Letters and Figures	35	27
Patternmaker's Tools	35	29
Allowances Necessary in Patternmaking	35	32
Draft	35	33
Shrinkage	35	33
Finish	35	34
Shake	35	35
Warp	35	36
Marking and Recording Patterns	35	37
Small Rectangular Patterns and Core Boxes	36	1
Pattern Turning	36	4
Example of Simple-Turned Pattern	36	5
Large Cylindrical Patterns	36	9
Core Boxes for Cylindrical and Tapered Cores	36	15
Patterns and Core Boxes for Bent Pipes	36	24
Patterns and Core Boxes for Elbows	36	31

CONTENTS

v

PATTERNMAKING— <i>Continued</i>	<i>Section</i>	<i>Page</i>
Patterns and Core Boxes for Branch Pipes	36	36
Built-Up Annular Patterns	36	43
Selecting Stock for Patterns	37	1
Skeleton Patterns	37	2
Patterns Involving Auxiliary Parts	37	8
Patterns and Core Boxes for Three-Way Cock	37	17
Patterns for Wheels and Gears	37	24
Patterns for Shaft Coupling	37	27
Pattern for Cylinder Head and Cover	37	29
Pattern for Crank-Disk	37	32
Pattern for Steam-Chest Cover	37	34
Patterns for Corliss Engine Valve-Gear Details	37	36
Pattern for Slide-Valve Engine Cylinder	37	38
Pattern for Stop or Throttle Valve	38	1
Special Three-Way Stop-Cock	38	7
Pattern for Small Bell	38	11
Patterns and Core Box for Casting Chain	38	16
Patterns for Spur Gear and Rack	38	18
Miter and Bevel-Gear Patterns	38	24
Worm and Worm-Gear Patterns	38	29
Flywheels with Hollow Arms	38	36
Patterns for Screw Propellers	39	1
Stove Patternmaking	39	7
Stove Models and Drawings	39	7
Special Tools Used for Stove Patternmaking	39	10
Processes Used in Making Stove Patterns	39	20
Examples of Stove Patternmaking	39	22
GREEN-SAND MOLDING		
Introduction	40	1
Definitions	40	2
Materials	40	6
Molding Sand	40	6

GREEN-SAND MOLDING— <i>Continued</i>	<i>Section</i>	<i>Page</i>
Tempering the Sand	40	11
Preparing the Mold by Rolling Over	40	17
Deep Molds	40	22
Shallow Molds	40	36
Molding by Bedding in	41	1
Making the Bed	41	3
Molding Plates with Projections in Open Sand	41	12
Hard Beds for Cope Molds	41	16
Bedding in	41	19
Clamping and Weighting the Mold	41	27
Clamps for Flasks	41	35
Joints in Mold	42	1
Follow Boards	42	7
Gaggers and Soldiers	42	14
Finishing the Mold	42	21
Skin-Dried Molds	42	31
Gates for Molds	42	38
Chaplets	43	1
Drawing Down of the Cope	43	10
Pressure of Gases in Mold	43	12
Blowholes	43	14
Shrink Holes	43	16
Shrinkage and Contraction	43	19
Feeding the Mold	43	20
Bench Molding	43	24
Protecting the Mold Against Fusing	43	35
Preparing Facing Sand	43	37
 CORE MAKING		
Introduction	44	1
Green-Sand Cores	44	2
Making Green-Sand Cores in Boxes	44	5
Making Core Arbors and Square Cores	44	7
Ramming Cores and Gating Molds	44	8
Comparison of Dry Sand with Green- Sand Cores	44	9

CONTENTS

vii

	<i>Section</i>	<i>Page</i>
CORE MAKING—Continued		
Ovens for Drying Small Cores	44	13
Pasting Cores	44	14
Daubing Joints	44	15
Blackening Cores	44	15
Rodding or Barring Cores	44	17
Venting Cores	44	19
Materials Used in Making Cores	44	22
Core-Sand Mixtures	44	26
Blackening Mixtures	44	29
 DRY-SAND AND LOAM WORK		
Dry-Sand Molding	45	1
Loam Work	45	10
Construction of a Cylinder Mold	45	10
Skeleton Pattern Loam Molds	45	24
Sweeping a Conical Drum	45	29
Details of Loam Work	45	32
Backing Loam Molds	45	36
Making Chilled Castings	45	42
 CUPOLA PRACTICE		
Cupolas	46	1
Construction of Cupolas	46	2
Lining Cupolas	46	11
Cleaning the Cupola	46	16
Melting Zone of a Cupola	46	17
Daubing the Cupola	46	19
Cupola Bottoms	46	22
Making the Breast, Tap Hole, and Spout	46	24
Charging Cupolas	46	26
Slagging Cupolas and Fluxes Used	46	33
Fuel Combustion in Cupolas	46	37
Tapping Out a Cupola	46	41
Stopping a Cupola	46	42
Capacity of a Cupola	46	44
Coke and Coal in Melting	46	46
Economy of Fuel in Melting Iron	46	48

<i>CUPOLA PRACTICE—Continued</i>	<i>Section</i>	<i>Page</i>
Melting Iron in Small Cupolas	46	49
Air Furnaces	46	51
Oil-Burning Furnaces	46	55
 MIXING CAST IRON		
Making Cast Iron	47	1
The Blast Furnace	47	1
Construction of the Blast Furnace	47	2
Operation of the Blast Furnace	47	3
Casting Pig Iron	47	7
Calculating Cast-Iron Mixtures	47	13
Composition of Cast Iron	47	13
Elements Contained in Pig Iron	47	13
Kinds of Pig Iron	47	14
Effect of Impurities on Pig Iron	47	17
Melting Point of Cast Iron	47	29
Specifications for Foundry Pig Iron	47	32
Mixtures of Cast Iron	47	42
Testing Cast Iron	47	48
Physical Tests of Cast Iron	47	51

PUBLISHERS' STATEMENT

The publishers desire to acknowledge the assistance of the following in the preparation and subsequent revision of this volume:

P. S. Dingey (deceased), Professor of Patternmaking and Foundry Work in the Chicago English High and Manual Training School, author of "Machine Patternmaking"; Professor M. J. Golden, member of the American Society of Mechanical Engineers, Professor of Practical Mechanics, Purdue University, and author of "A Laboratory Course in Wood Turning"; Thos. D. West, Past President American Foundrymen's Association, member of the American Society of Mechanical Engineers, author of "American Foundry Practice," "Molders' Text Book," and "The Metallurgy of Cast Iron," and Manager of the Thos. D. West Foundry Co.; C. C. Hodges, Designer and Modeler for Walker & Pratt Mfg. Co., Watertown, Mass.; W. J. Keep, member of the American Society of Mechanical Engineers, American Foundrymen's Association, Manager of the Michigan Stove Works, Detroit, Mich.; A. D. White, Vice-President and Treasurer of the Williams Foundry and Machine Co., Akron, Ohio; Henry Hanson (deceased), Associate Editor of *The Foundry*; G. J. Cory, Foreman Patternmaker, Allis-Chalmers Co., Scranton, Pa.; G. W. Lewis, Foreman of the Foundry, Allis-Chalmers Co., Scranton, Pa.; and Thos. Pole, Richmond Iron Works, Richmond, Va.

The following members of the regular staff have also assisted in this work: J. J. Clark, M. E.; H. M. Lane, M. E. (now Editor of *The Foundry*); A. B. Clemens, M. E.; F. W.

PUBLISHERS' STATEMENT

Brady, M. E.; E. P. Powell, B. S.; F. B. Hamilton; B. R. Hall; R. T. Strohm, M. E.; and David Petri-Palmedo (now with Mergenthaler Linotype Co., New York, N. Y.).

The publishers also desire to acknowledge their indebtedness to the following firms for courtesies extended: Allis-Chalmers Co., Milwaukee, Chicago, and Scranton; The International Harvester Co., Chicago, Ill.; Whiting Foundry and Equipment Co., Harvey, Ill.; The J. A. Fay & Eagan Co., Cincinnati, Ohio; The Brown Hoisting Machinery Co., and the Taylor & Boggis Foundry Co., Cleveland, Ohio; B. F. Avery & Sons, Louisville, Ky.; Michigan Stove Works, and C. A. Strelinger & Co., Detroit, Mich.; Scranton Stove Works, Scranton, Pa.; J. W. Paxson Co., The S. Obermayer Co., and Henry Disston & Sons, Philadelphia, Pa.; Veeder Mfg. Co., Hartford, Conn.; Walker & Pratt Mfg. Co., Watertown, Mass.; Manning, Maxwell & Moore, New York, N. Y.; The Westinghouse Machine Co., Westinghouse Electric Co., and Westinghouse Air Brake Co., Pittsburg, Pa.; The Thos. D. West Foundry Co., Sharpsville, Pa., and many others who have shown courtesies to their representatives and have sent catalogs, drawings, or other material for use in the preparation of this volume. They also extend their thanks to the *American Machinist*, *Machinery*, *Engineering Magazine*, and *The Foundry* for information gleaned from their files and other favors rendered.

WOOD WORKING.

(PART 1.)

BENCH WORK.

BENCH AND BENCH EQUIPMENT.

THE BENCH.

1. Woodwork done at a bench by the use of hand tools is usually called **bench work**. The work to be done is first **laid out** by making measurements and drawing lines upon the rough pieces of wood where these may be necessary; the parts are then shaped to the required form and fastened together. Of these two operations the first is equally as important as the second.

2. **Patternmakers' Benches.**—A number of varieties of patternmakers' and other wood-workers' benches are now in use. The type shown in Fig. 1 is one of the most simple and serviceable. The top is made about 2 feet 8 inches wide and about 8 feet long. The front half is built up of 2" × 4" birch, as shown, bolted together with $\frac{1}{2}$ -inch bolts. The back half of the top is made of pine $1\frac{1}{2}$ inches thick. The legs and braces should be made of stiff and heavy material, oak or ash being found the most serviceable, and the legs are made of 3" × 4", and the braces of 2" × 4", stock. The joints should be bolted together. The work is held in a vise *a*, which will be described later. A tool board *b*,

COPYRIGHTED BY INTERNATIONAL TEXTBOOK COMPANY. ALL RIGHTS RESERVED

made of 1-inch pine, attached at the back of the bench top, and provided with suitable supports, forms a rack for the most commonly used tools. Upon the hooks and other supports are kept the hammers, saws, auger bits, brace, measuring tools, draw-knife, hatchet, gouges, chisels, and sometimes the common planes. The supports should be so made that the tools will not fall from them, owing to the jarring, when the bench is in use.

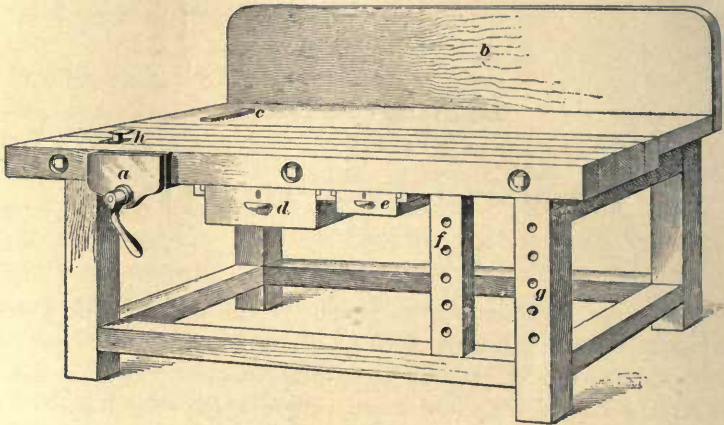

FIG. 1.

A strip of wood or leather *c* about $\frac{3}{8}$ inch thick forms a convenient support for the planes, which will keep them from resting upon their cutting edges when not in use. Other tools may be kept in a large drawer *d* about 6 in. \times 24 in. \times 16 in. long, while a smaller drawer *e*, about 3 in. \times 15 in. \times 8 in. long, provides a separate place for screws, brads, and other small tools.

An upright *f*, with suitable holes bored at regular distances apart, may be placed at the right of the drawer, to receive pins for the purpose of supporting the free ends of pieces, the other ends of which are held in the vise. Similar holes may be bored in the leg *g* for the same purpose. A bench stop *h*, described later, is also a necessary part of the bench. The built-up portion of the bench top is frequently

made a little higher than the other part of the top to allow for planing off when it wears unevenly.

3. A Cabinetmakers' Bench.—Another suitable bench for wood workers is a regular cabinetmakers' bench

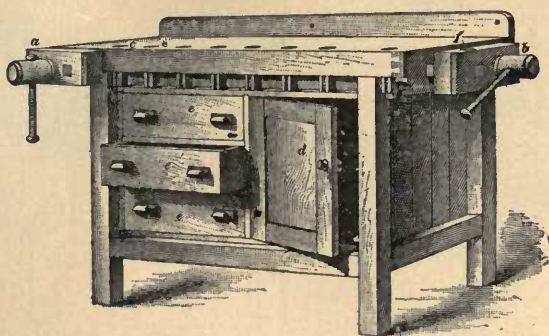

FIG. 2.

shown in Fig. 2. This bench is provided with two vises, one at *a* and one at *b*, and a series of holes at *c, c* to receive movable stop-pins. A cupboard *d* and drawers *e*, with suitable locks, are also provided for the purpose of storing tools and light work. Fig. 3 shows a common form of stop-pin for use in holes *c, c*. The pin is held at any desired height by means of the spring *x* and the work is placed against the face *b*. The vise *b* carries a stop-pin *f*, and by using this pin and another in the bench, it is possible to clamp long pieces of work flat upon the surface of the bench.

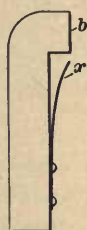

FIG. 3.

BENCH EQUIPMENT.

4. Adjustable Bench Stops.—While the form of bench stop shown in Fig. 3 is very useful, it is well to have an **adjustable bench stop** of a form similar to those shown in Fig. 4. These are intended to keep the work from slipping on the bench while it is being planed. The one shown in Fig. 4 (*a*) has a cylindrical bar, or stem, *b*, which carries the stop-head *a*. The stop can be secured at any height by

means of the screw *c*, the head of which projects through the front of the bench. This form is useful on account of the fact that by loosening the screw *c*, the stop can be turned so as to engage the end of work that is not sawed off square. Fig. 4 (*b*) shows another form of bench stop in which the

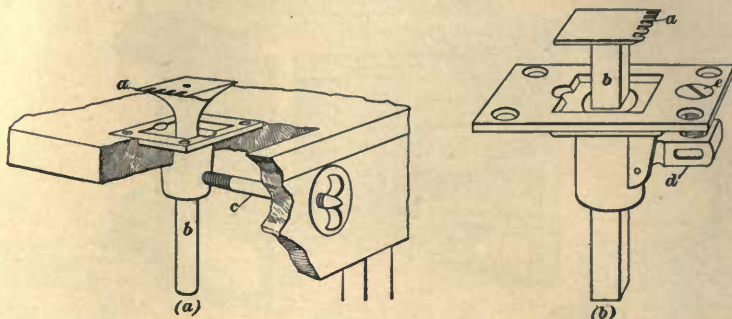

FIG. 4.

head *a* is mounted on a square bar *b*. This bar can be clamped in place by means of the clamping lever *d*, which is operated by the screw *e*. Usually, one such stop is placed at the left-hand end of the bench, as shown at *h*, Fig. 1. These stops may be lowered, when not in use, so that their heads lie below the surface of the bench.

5. Vises.—The vises shown at *a*, Figs. 1 and 2, are used to hold the material while the work is being done. For this class of work they should be so constructed that the piece can be readily released, or gripped, and should hold it firmly when closed, as any movement of the work might cause it to be spoiled. The jaws should be parallel in all positions in order that they may have a good bearing upon the piece.

Fig. 5 shows a vise that fulfils these conditions. The inner jaw *a* is attached to the bench, and carries a fixed nut in which the screw *bb* rotates. This screw controls the outer jaw *c*, and is turned by means of the handle *d*, which passes through a sleeve on the end of the screw, as shown. Two guide rods *e*, passing through bearings on the rear jaw, assist the screw in holding the two jaws parallel. The jaws

are faced with wood, the facings being so attached that they can easily be renewed when they become worn.

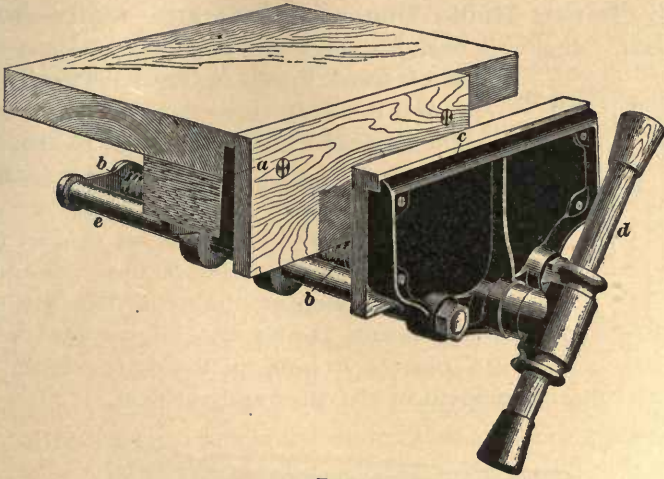

FIG. 5.

6. For general patternmaking, the forms of vises shown are frequently replaced by a quick-closing vise. Fig. 6 illustrates a vise of this class. The jaws are controlled by the lever *a*, which operates a cam *b*. This cam controls a block *c* working against the toothed rack *d*. When the lever is brought to one position, the block *c* drops out of contact with the rack, and the jaw can be moved to approximately any desired position. The first action that results on turning the lever is the raising of block *c* into contact with the rack *d*, and after it is in contact, the cam draws the movable jaw *e* toward the fixed jaw *f*. Such a vise as this can be very quickly adjusted and is extremely useful for many classes of work. Similar vises using screws are manufactured, and are so arranged that the nuts can be temporarily separated for quick adjustment.

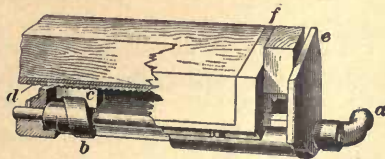

FIG. 6.

It is always a wise precaution to face an iron vise with wooden or leather facings, the latter being usually preferred.

7. Bench Hook, Bench Brush, and Sharpening Outfit.—One very useful accessory to the work bench is the

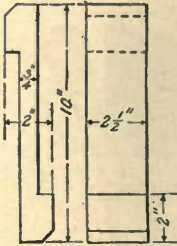

FIG. 7.

bench hook shown in Fig. 7. This really forms a movable stop that can be used at right angles to the front face of the bench. When it is desired to saw off a piece of stock, the bench hook is placed on the bench, one shoulder being set against the edge of the bench, while the upper shoulder serves as a stop for the stock while sawing. The bench should also be provided with

a **bench brush** of the form shown in Fig. 8, for the removal of shavings and sawdust.



FIG. 8.

On a ledge at one side of the bench it will be convenient to keep the **sharpening outfit** shown in Fig. 9 and

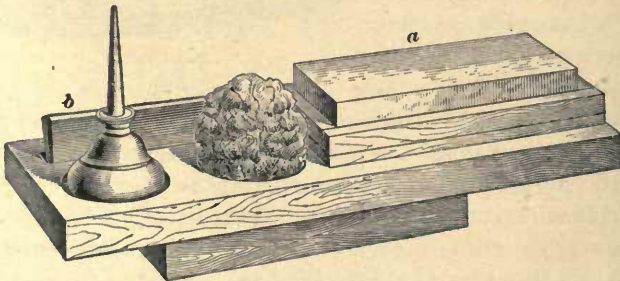

FIG. 9.

described in the following pages. The recesses in the ledge serve to keep the different pieces in place.

BENCH TOOLS.

8. The tools used in patternmaking are described under two headings—*Laying-Out Tools* and *Cutting Tools*. Under the first heading will be included those used in making measurements and laying out, and under the second heading, those used in shaping the work. These tools should be kept in convenient places upon or near the wood-workers' bench.

LAYING-OUT TOOLS.

THE RULE.

9. The most common and useful measuring tool used in wood working is the **folding rule**, shown in Fig. 10. These rules are usually made in two-foot lengths, and are hinged, sometimes at one point and sometimes at three points, so

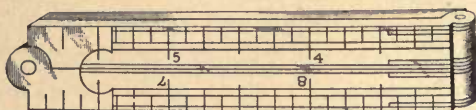

FIG. 10.

that they may be folded, for convenience in carrying. Rules with one hinge are known as *two-fold*, and those with three hinges, as shown in Fig. 10, are known as *four-fold*. These rules are made of wood and are either plain or bound with strips of brass, which increase their durability. They are graduated to eighths of an inch on one edge and to sixteenths on the other. Besides these common graduations, they may be provided with twelfths, and with still other divisions for special purposes.

FRAMING SQUARES.

10. **Steel Framing Square.**—The **framing square** shown in Fig. 11 is made of sheet steel and is often nickel-plated, as this keeps it free from rust and permits the figures

to be read more easily. When the square is made for carpenters' use, the arms are 24 and 16 inches in length, respectively. The divisions on the one side are in eighths and sixteenths of an inch, besides the larger divisions that are multiples of these, and are read from the corner along the arms. On the other side are tables of board and of brace

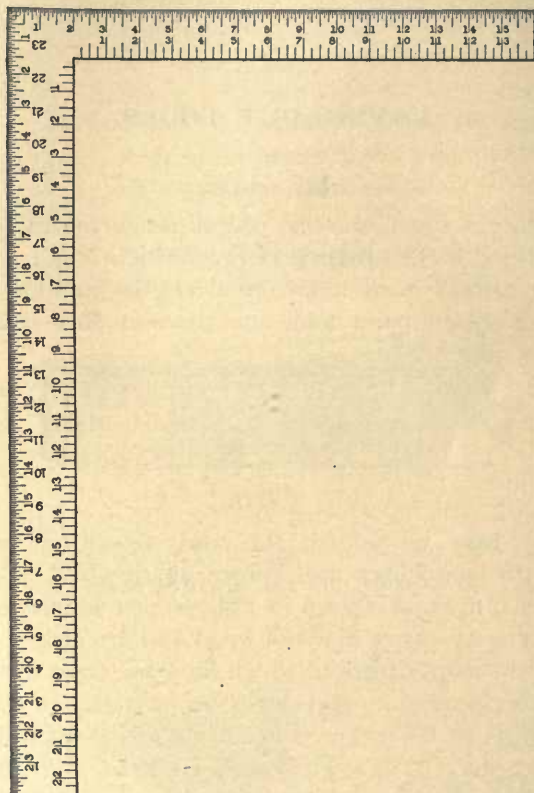

FIG. 11.

measure, which are intended especially for the convenience of carpenters. This style of square is used principally to draw lines at right angles to, or square with, the edges of wide boards. In using the framing square, care must be taken that one arm is held firmly against the edge of the board.

11. Wooden-Head Square.—The usefulness of the steel framing square is increased by attaching a wooden

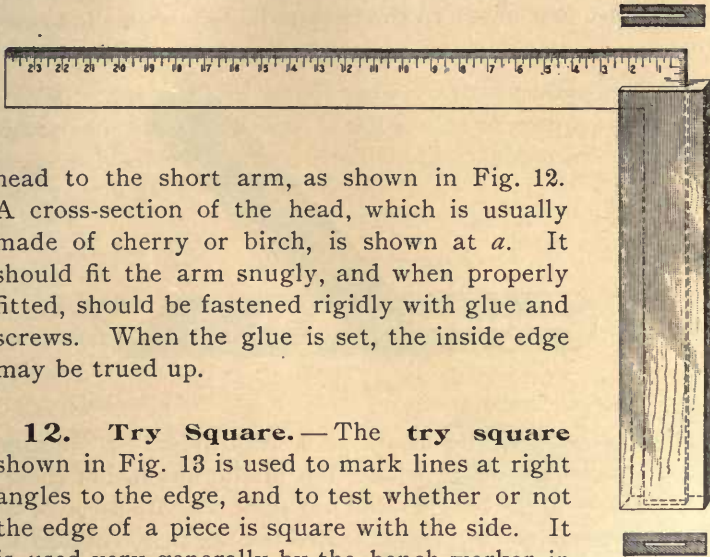

FIG. 12.

head to the short arm, as shown in Fig. 12. A cross-section of the head, which is usually made of cherry or birch, is shown at *a*. It should fit the arm snugly, and when properly fitted, should be fastened rigidly with glue and screws. When the glue is set, the inside edge may be trued up.

12. Try Square.—The **try square** shown in Fig. 13 is used to mark lines at right angles to the edge, and to test whether or not the edge of a piece is square with the side. It is used very generally by the bench worker in making joints of all kinds. It is usually graduated on the outer edge, as shown. In the form shown, the

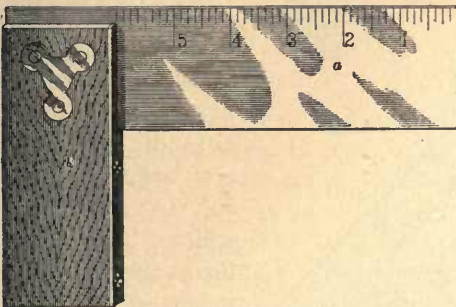

FIG. 13.

blade *a* is of steel and the head, or beam, *b* is of wood, with a brass face. In many cases the head is made of cast iron.

13. Bevel.

When a mark is to be made on some piece of work, that is, at some other angle with the edge than a right angle, the **bevel** is used. One form of this instrument is shown in Fig. 14, and consists of a steel blade attached to a wooden

beam faced with brass. The blade is movable upon the beam and may be set at any angle to it. Some bevels are provided with cast-iron beams. In using the bevel, the blade must first be set to the required angle with the beam.

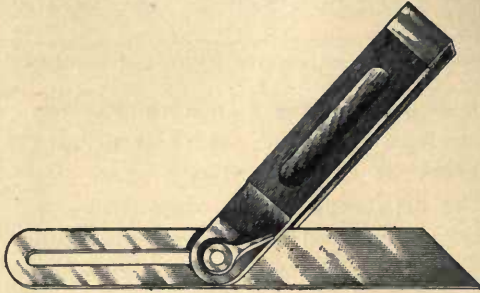

FIG. 14.

This may be done by means of a protractor, or suitable angles made for this purpose, but in the absence of these, the required angle may be laid out upon a board or piece of drawing paper and the bevel set to the lines thus obtained.

14. Miter Square.—The 45° angle, or **miter**, is used more in bench work than any other angle, and the **miter square**, shown in Fig. 15, is an essential part of a wood-workers' outfit. This tool consists of a blade set accurately at 45° to the beam, which beam also forms the handle by means of which it is held to the work.

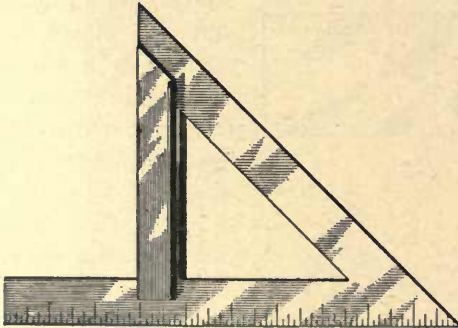

FIG. 15.

15. Combination Square and Bevel Protractor.—The **combination square** is also frequently found in a wood-workers'

outfit. It may take the place of some of the tools just described, although it is generally thought best to have these as well.

THE PROTRACTOR.

16. The form of **protractor** with a center guide pin, described in *Measuring Instruments*, is perhaps the most serviceable for the wood worker, although other forms are frequently used.

MARKING TOOLS.

17. Marking Gauge.—Lines are marked parallel to an edge of a piece of wood by means of a **marking**, or **scratch**, **gauge**. Ordinarily, the scratch gauge shown in *Measuring Instruments* is used. Another form, shown in Fig. 16, possesses some advantages. In this style there are two beams *a* and *b*, both of which are fixed by means of the setscrews *c*

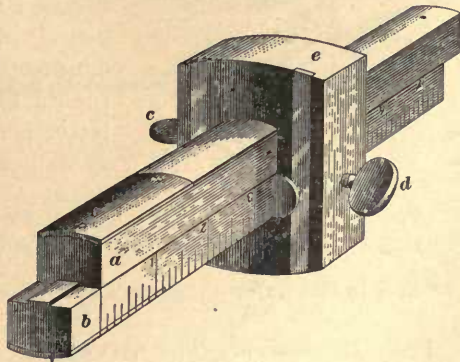

FIG. 16.

and *d*, thus providing two independent gauges upon the same head. In using this gauge, the head *e* is set so that its distance from the pin or disk is equal to the distance at which the mark is to be drawn from the edge of the piece. The mark is made by allowing the gauge to rest on a lower corner of the beam, with the pin pointing back toward the workman and the head in contact with the edge of the work. The gauge is then pushed away from the workman and at the same time the pin or spur is rolled forwards into the wood.

It takes some practice to use the marking gauge freely, as the pin is liable to catch in the wood, making a rough,

irregular line. The head is held between the thumb and first finger, and the second or third finger is pressed against the side of the head, holding it firmly against the edge of the wood while the tool is moved along. Where two marks are made parallel to each other and to the edge, the form of gauge shown in Fig. 16 is used, one pin being set for each mark. This is especially useful in making frames for panels and other work of this character.

Another method of drawing a line parallel to an edge is shown in Fig. 17. The rule is held in the left hand, as

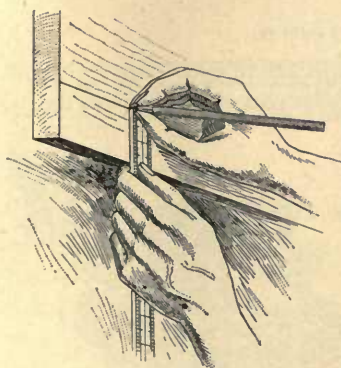

FIG. 17.

shown, at such a distance from the end that, when the first finger moves along the edge, the end will be at the desired distance from it. A carpenter's pencil may then be held against the end of the rule in such a manner that, when the latter is moved along the edge as indicated, the pencil will draw a line parallel to the edge. This method is sufficiently accurate for rough

work, and is used very generally for cutting out stock.

18. Dividers.—The **dividers** shown in *Measuring Instruments* are used for scribing circles or arcs of circles

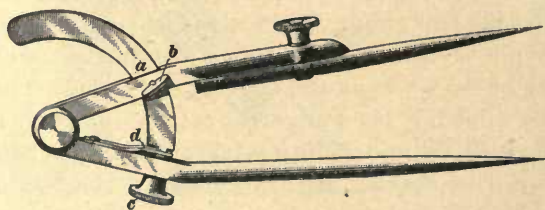

FIG. 18.

and marking off spaces. The form shown in Fig. 18 is known as **wing dividers**, the rough adjustment being

obtained by clamping one of the legs against the wing *a* by means of the thumbscrew *b*, and the finer adjustment, with the thumb nut *c* and spring *d* against the other leg. For convenience in making marks on the wood, one of the legs can be removed and a lead pencil inserted.

19. Trammels.—When arcs must be drawn that are larger than can be drawn with dividers, the **trammels**, shown in *Measuring Instruments*, are used. The metal pins can be removed from the sockets shown and a lead pencil inserted for either of them. They are used for marking spaces or laying out arcs in the same way as dividers.

20. Scribes.—A **scriber**, or **scratch awl**, shown in Fig. 19, consists of a pointed awl fixed in a convenient handle.



FIG. 19.

The scribe should be used in laying out fine work, because a lead-pencil mark would be too coarse for very accurate work.

CUTTING TOOLS.

REQUIREMENTS OF CUTTING TOOLS.

21. The cutting edge must invariably be a part of some tool that has a supporting body, and after the edge has separated the fibers of the wood, room must be made for the body of the tool to follow the edge. This involves bending or crushing the separated parts away from the material which remains, and, usually, the more bending or crushing that is required, the greater the pressure required to force the cutting edge forwards. From this it would seem apparent that the smaller the angle of the tool back of the edge,

the less pressure will be required, and that a wedge like that of a razor would be the best to use. This would be so if the wood pressed equally on both sides of the tool after the cut was made, but in practice it is practically impossible to have this condition, as the workman does not push the cutting tool forwards in a manner that will give a constant pressure on both sides, either from lack of skill or the conditions under which he is working. The wood fibers are also constantly changing their direction, which in itself causes considerable variation in the pressure exerted. These and other considerations make it necessary to increase the bluntness of the wedge on which the cutting edge is formed.

Another important factor in this consideration is the skill of the workman, as one of the principal differences between skilled and unskilled workmen is made apparent in their ability to handle tools so as to produce the least amount of strain on the cutting edge. For these reasons the cutting wedge in most tools is much more blunt than is required by average conditions. The angle of the wedge should, however, in every case be as small as the average conditions will permit. As these conditions vary very greatly, no definite angles at which tools should be ground can be given. In general, however, tools for soft wood are made keener than those for hard wood.

It is well to remember, in connection with the tools described in the following pages, that skill in using a small number of tools is more desirable than a great variety of tools, when the workman depends on the special tool rather than on his individual skill, and, also, that a workman must keep his tools sharp and in good working condition, in order to do good work.

In the selection of tools by the beginner, it is best to rely on the advice of an experienced workman, and if such advice cannot be obtained, only such tools should be bought as are made by the most reliable makers, and purchased only from dealers of the best reputation. The following are the tools in most common use in bench work, with a short discussion of each tool where it seemed necessary.

CHISELS AND GOUGES.

22. The chisels shown in Fig. 20 are those in most common use. Of these, (a) is a **socket firmer chisel**, which is used for paring and in cases where the handle of the chisel may be struck with the hand. The bevel at the cutting edge is made so long that if a mallet were used in forcing it into the wood, the edge would be in danger of breaking. When the angle at the edge of this form of chisel is too

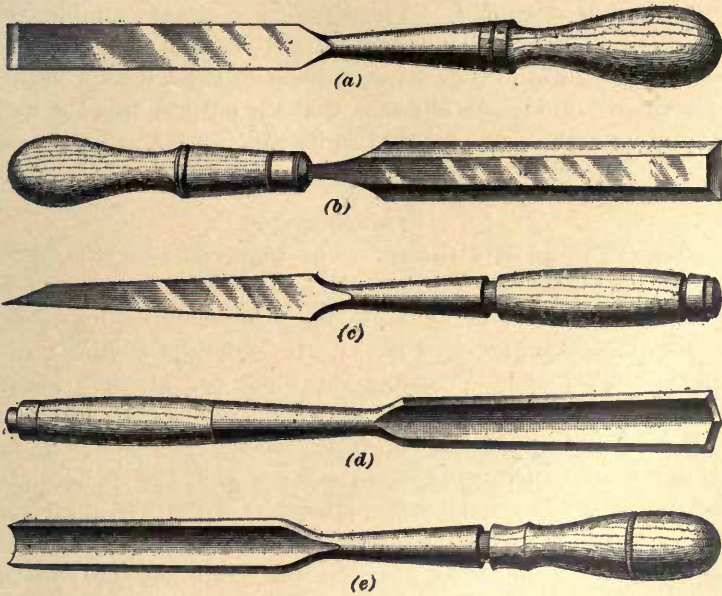

FIG. 20.

small and the blade is made too thin to be struck in this way without danger of breaking it, it is called a **paring chisel**. The sides are sometimes beveled, as shown at (b), for lightness and convenience in sharpening. When the blade is made so stout that a mallet may be used without danger, as shown at (c), it is called a **framing chisel**, and is used by carpenters in house framing and similar work.

When there is much framing to be done, as in making panel frames, a chisel of the form shown at (*d*), called a **corner chisel**, is sometimes used. The form shown at (*e*), where the edge forms an arc of a circle, is called a **gouge**. It is ground either from the back or from the front, and is designated as **outside ground** or **inside ground**. The outside ground, shown at (*e*), is the more common of the two. All these chisels come in sets, and range in width from $\frac{1}{8}$ inch to 1 inch, by eighths of an inch, and from 1 inch to 2 inches, by quarters of an inch. These tools are of very simple construction, but great skill may be acquired in their use, and they have a wide range of usefulness in the hands of skilful workmen. It is generally true that the more simple the tool, the greater the skill required in its use.

PLANES.

23. Types of Planes.—The plane may be considered as a chisel set in a frame in such a way that the depth of its cut cannot exceed an amount that is determined by its set. Four planes, shown in Fig. 21, are generally included in a bench set for ordinary use, a short one (*a*), about 8 inches long, used to make surfaces smooth and called a **smooth plane**; one of medium length (*b*), about 14 inches long, for rough work, called a **jack-plane**; one about 20 inches long, of the same type as the jack-plane, for planing straight surfaces, called a **fore plane**; and a very short one (*d*), about 7 inches long, for cutting across the grain on the ends of boards, called a **block plane**. The size may vary to suit the taste and convenience of the individual workman, while the width also varies with the length, from $1\frac{1}{4}$ inches to $2\frac{1}{2}$ inches in smooth planes, and from 2 inches to $2\frac{1}{2}$ inches in fore planes and jack-planes.

24. The parts of the planes are similar in all these styles, and a description of one will do for all.

In Fig. 21 (*a*), in which a smooth plane is shown, the parts are as follows: *a* is the **handle**, *b* is the **plane iron**, *c* is the **cap**, *d* is the **adjusting nut**, *e* is the **knob**, *f* is the **sole**,

and *g* is the **wedge** by which the iron is held in place. There is an opening in the sole, as shown in Fig. 21 (*c*), called the

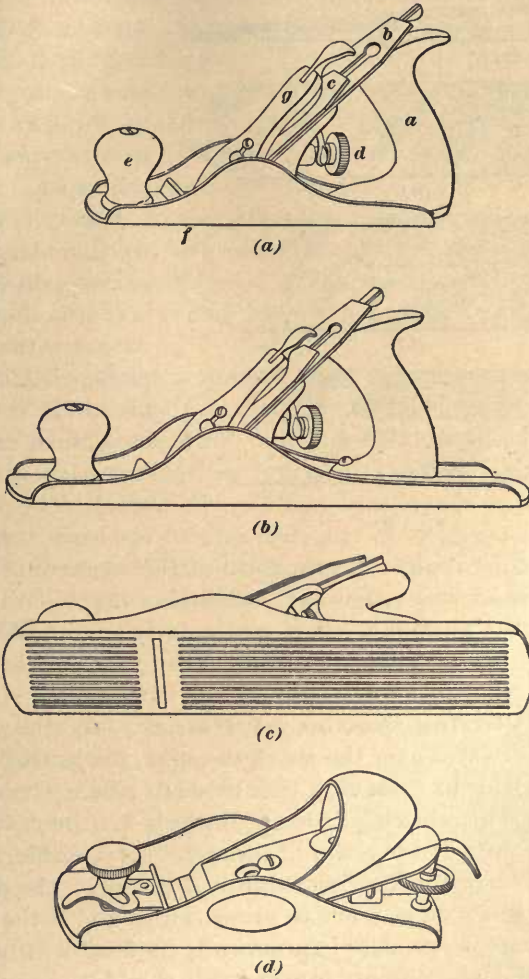

FIG. 21.

throat, through which the plane iron projects, the amount of projection, called the **set**, being regulated by means of the thumb nut *d*, Fig. 21 (*a*). When the plane is made of

iron, the sole sometimes has a series of grooves running lengthwise, as shown in Fig. 21 (c), to lessen the friction

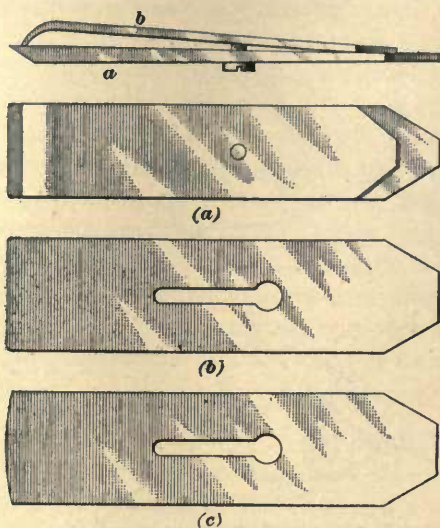

FIG. 22.

between it and the surface of the wood. The iron consists of two parts, as shown in Fig. 22 (a), the iron proper *a*, and the cap *b*.

For very rough work, a plane called a **scrub plane**, which is both shorter and narrower than a jack-plane, is frequently used. It is intended to remove rapidly an excessive amount of stock. The plane iron is made with the cutting edge rounded in the form of the segment of a circle, the radius of which, however, depends entirely on the judgment of the workman. It is particularly adapted for roughing work before using the jack-plane.

25. Cutting Action of Planes.—As the plane is pushed forwards over the wood, the edge, projecting through the sole, will cut a shaving that tends to pass up through the throat. This shaving is bent upwards by the cutting iron and the cap. If the grain of the wood is favorable, it might split ahead of the cutting edge. The sole of the plane, by pressing down on it, tends to prevent this, and if the opening is very narrow, renders it practically impossible, thus giving a smooth surface where otherwise it would be rough. The cap also assists in accomplishing this end, by quickly bending the shaving back and breaking it between the cap and the front edge of the throat. When a very smooth surface is desired, a plane with a narrow throat is used, the iron is

set to project but a short distance, and the cap is set very close to the cutting edge, usually about $\frac{1}{2}$ inch away from it.

When it is desired simply to produce a smooth surface, as in smoothing a board, the smooth plane is used because of the convenience in handling it. The edge of the plane iron is made straight and at right angles to the sides, and the corners are rounded for a very short distance, as shown in Fig. 22 (b), in order that no sharp lines may be left on the surface.

When it is desired to cut away the stock quickly and produce a fairly smooth surface, the jack-plane is used, and the cutting edge is allowed to project through the sole a greater distance. The cutting edge is given a curved outline, as shown in Fig. 22 (c), as this has been found to make the cutting action easier.

When it is desired to produce a long, straight surface, the fore plane is used. The great length of the sole in this plane prevents it from descending into any hollow places in the wood, and so only the high parts are cut away and gradually the surface is made straight. This plane is used in jointing edges so that they will fit together, and in straightening the tops of counters, and in similar work. It is ground and adjusted in the plane stock in the same manner as the smooth plane.

When the end grain of a piece of wood has to be planed, the block plane is used. In this case there is no tendency for the grain of the wood to split ahead of the cutting edge, and there is very little need to make the shaving curl back quickly, so the cap is omitted from the plane iron, and the latter is often turned over in the stock, bringing the bevel uppermost. The plane is made short, and rounded at the back end so that it will fit snugly into the palm of the hand when in use. The edge is ground square with the sides, as in the smooth plane.

26. Molding Planes.—In addition to the planes described above, there are sets of planes called **molding planes**, the irons of



FIG. 23.

which are given the shapes of the wooden moldings in common use. An end view of one of these, a plane for cutting beads along a board or panel, is shown in Fig. 23.

27. Adjustable Circular Plane.—The plane shown in Fig. 24 differs from the ordinary form of smooth plane in

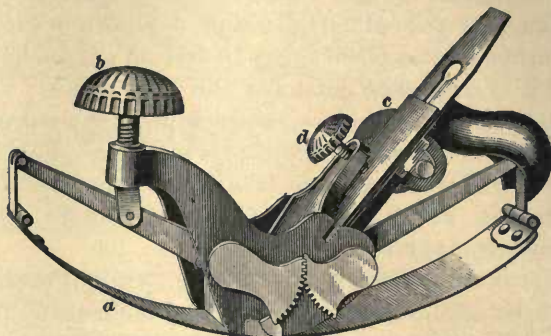

FIG. 24.

that the sole is not rigid but is made of a flexible strip of steel that may be adjusted to fit circular pieces, either on the inside or on the outside. It is called the **adjustable circular plane**. The curve of the flexible steel face *a* is adjusted by

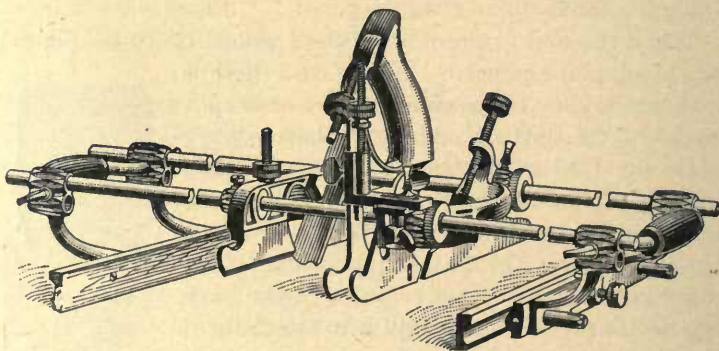

FIG. 25.

means of the screw *b*, and the plane iron and wedge by means of the screws *c* and *d*. Adjustable circular planes with heavier bodies are sometimes preferred by wood workers, while others prefer the form shown, because of its lightness.

28. Universal Plane.—Because of the ease with which any required molding can now be obtained from a planing mill, and because a separate plane is required for each style of molding, and for each size of that style, bench workers at the present time seldom have sets of these planes, but use instead the **universal plane** shown in Fig. 25. In Fig. 26 are shown some of the separate blades that go with it. The adjustments of this plane are such that it can be made to do the work that used to be done with the molding and other special planes, as the *plow*, *dado*, *beading*, *rabbet*, etc.

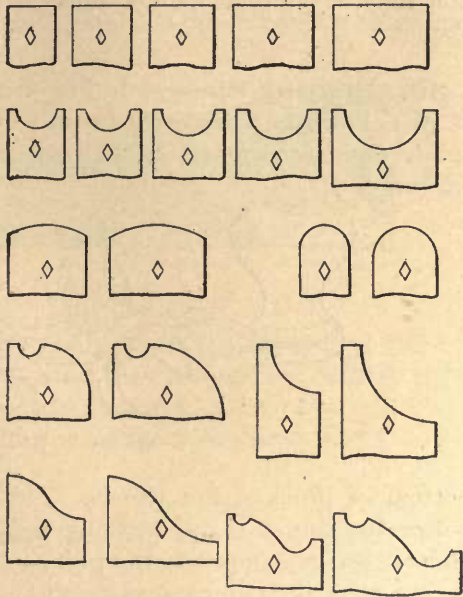

FIG. 26.

29. Rabbet Plane.—In patternmaking it is generally thought best to have a separate **rabbet plane**, of the form

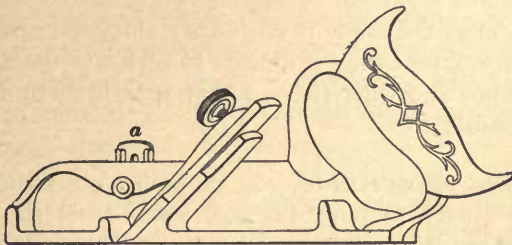

FIG. 27.

shown in Fig. 27. The body of the plane is open on one side, and the plane iron extends to the outer edges, so as to

enable the workman to plane to a sharp corner. An adjustable stop *a* on the far side of the plane shown in the illustration may be used to gauge the depth to which a recess is planed.

30. Routing Plane.—In Fig. 28 is shown another form of plane, called a **routing plane**, which is used in cutting out recesses, or depressions, in wood, and in smoothing the

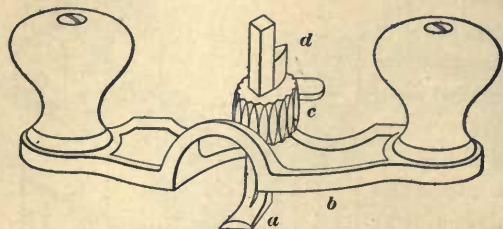

FIG. 28.

bottom of grooves and panels. The depth of the tool *a* below the sole *b* is adjusted by means of the screw and collar *c*, which clamp it to the post *d*. The plane is operated by means of the two handles shown.

SAWS.

31. Wood-cutting saws are made in two forms, each quite distinct from the other, and each suited to a special service. They are made to cut either along the grain of the wood or else across the grain, and to separate the wood with as little labor and with the removal of as little of the material as possible.

32. The Saw Blade.—In making a cut along a given line, it is easier to push the saw away from the operator than to draw it toward him. The saw blade is therefore given a suitable form for taking the cut while the saw is moving away from the operator, that is, with a wide blade, of tapered form, and considerable thickness. If the cut

were made by drawing the saw toward the operator, the blade might be made narrow and thin, and a large proportion of the force used might be saved, but the lines could not be followed so accurately, neither could the required

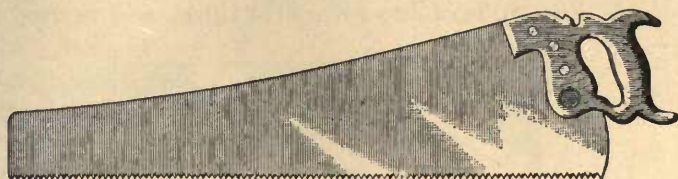

FIG. 29.

power be applied so easily, since the weight of the body could not be brought into play during the cutting stroke, when the greatest force is required. For these reasons, the form of saw blade shown in Fig. 29 has been found the most suitable.

33. Saw Teeth.—The part of the saw with which the cutting is done consists of a number of small cutting points called **teeth**, set one behind the other. The spaces between the teeth are determined by the pressure applied to the saw. When the force applied is relatively great there must be suitable room for the shaving to curl up in front of the tooth until it has passed out of the cut. Each point must be forced into the wood, and the greater the number of points, therefore, the greater the pressure required. So, when it is necessary to have a smooth, well-directed cut, the teeth are made comparatively small and close together; and when speed of cutting is the principal consideration, they are made large and spaced farther apart.

34. Sizes of Saws and Saw Teeth.—Saws are made of various lengths and sizes of teeth, the number of teeth to the inch usually varying with the length of the saw. The usual number of teeth to the inch in hand saws is either four, six, or eight, the number being stamped on the blade

near its end. The length of the blade for common work is 28 inches; for finer work, the saw is often made shorter, 26 inches and 24 inches being ordinary sizes.

35. Ripping Saw.—The simplest form of saw tooth, shown in Fig. 30, is of the form of a chisel, and is used in

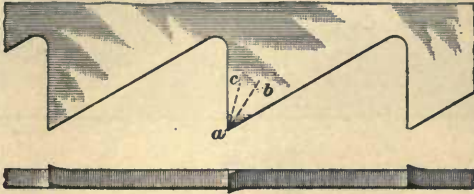

FIG. 30.

cutting along the grain of the wood. The saw used for this purpose is called the **ripping saw**. It will be seen that the advancing face of the tooth stands at right angles to a line passing through the tooth points. At first thought it may seem as if it would be better to give it about the angle indicated by the line *ab*, but it must be remembered that the tooth must take the strain produced by the resistance of the grain of the wood, which frequently includes knots and extremely hard places, and it must be strong enough to withstand these strains. To give this strength and provide room for the shaving, it is necessary to make the advancing face of the tooth almost perpendicular to a line passing through the points of the teeth. When the wood is soft and easily cut the advancing face may be given the angle shown by *ac*. Room for the shaving might be provided by cutting away the back of the tooth near the root, as in saws driven by power, making what are known as **gullet teeth**, but the trouble encountered in shaping these teeth and in maintaining the form while in service is too great to permit their use in the ordinary hand saw. The form shown is easily preserved, readily sharpened, and is sufficiently strong for any pressure that will be put upon it by the average workman.

36. Cross-Cutting Saw.—The cross-cutting saw, as its name indicates, is used in cutting across the grain of the wood. As the chisel form of the ripping-saw tooth is not suitable for this work, another form, shown in Fig. 31, is adopted. The points are similar to lancet points, with the cutting points alternately on opposite sides. As



FIG. 31.

these teeth are pushed across the wood, they cut two marks side by side upon the surface. As this movement of the saw is repeated these cuts become deeper, until a depth is reached where it would seem impossible with any ordinary force to press the teeth deeper into the wood. The marks are so near to each other, however, that, as the wood fibers are cut in two places, close together, the portion between the cuts is easily removed by the sides of the teeth as they pass over it.

It will be apparent, upon inspecting the teeth shown in Fig. 31, that the more nearly perpendicular the advancing edge is, the deeper the point will cut into the wood, but the greater the force required. This fact may be demonstrated by holding a pocket knife, with the cutting edge at the point perpendicular to the surface, and pushing it across the piece of wood while the point is in contact with it, and then repeating the operation with the cutting edge slanting forwards from the point, in the direction of the motion. The sides of the teeth must, however, not be filed back too far, as they will then not break off the wood between the cuts, and the saw will **ride**. The angle that the front, or cutting edge, of the tooth makes with a line passing through the point is ordinarily about 60° .

37. Back and Keyhole Saws.—For fine bench work, saws are made of the form shown in Fig. 32, called **back**

saws. These have very thin blades, which are stiffened with a rim at the back; the teeth are small, there being ten, twelve, or fourteen to the inch, and are of suitable form for

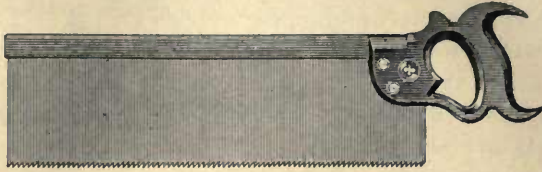

FIG. 32.

cross-cutting. Another saw which is constantly used by the bench worker is the **keyhole saw**, shown in Fig. 33. It is



FIG. 33.

used for cutting curves and keyholes, as the name indicates. Because of its use in cutting curves, the teeth are given excessive set.

BORING TOOLS.

38. The Spur Auger.—Tools used in boring circular holes are known as **boring tools**. They must be so constructed that they will make a perfectly round hole in the



FIG. 34.

desired position, will run in the direction at which the hole is started, and will not split the wood. These conditions are fulfilled in the simple tool shown in Fig. 34, called the **center**

bit. The **spur** *a* is set at the center of the desired hole and guides the bit in the proper direction; the **scorer** *b* makes a circular scratch, or score, in the wood, with the spur *a* as a center; and the **lip** *c*, following inside the scored circle, removes the shaving, acting as a rotating chisel. It is held firmly in a socket or brace by means of the **shank** *d* while in use. This tool, while very simple in construction and easily forged, contains all the features of the best wood-boring tools.

39. Double-Twist Spur Auger.—The tool most commonly used for making round holes in wood is the **double-twist spur auger**, shown in Fig. 35. When made with a



FIG. 35.

square shank to be used in a brace, this style of auger is commonly called a **bit**. The spur *a*, which is made in the form of a screw, guides the auger and assists in feeding the tool into the wood. The **nibs** *b, b* score the wood and the **lips** *c* cut away the wood inside of the scored line made by the nibs, while the shavings are carried up the spiral surfaces of the twisted body.

These augers come in sets, varying in diameter by sixteenths from $\frac{1}{4}$ inch to 1 inch. The number of sixteenths, or size of the bit, is stamped on the shank; the stamped number 8 means that the size of the bit is $\frac{8}{16}$, or half an inch.

40. The Bit Brace.—The augers, or bits, when in use are held in the jaws of a small clamp at the end of the **bit brace**, shown in Fig. 36. In this figure, the jaws of the clamp are shown at *a*; *b* is a screw sleeve by means of which the jaws are closed; *c* is the handle, which turns loosely on the brace; *d* is the breast piece or cap, which also

turns loosely on the end of the brace; *e* is a ratchet, by which the brace can be made to operate when turning in

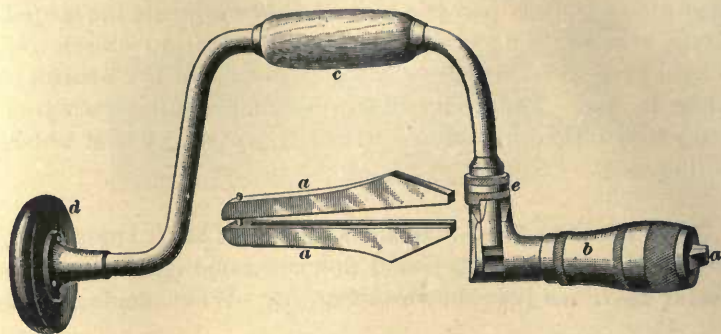

FIG. 36.

one direction only. This style of brace is made with or without the ratchet.

41. The Expansive Bit.—The holes made by the auger bit, shown in Fig. 35, as already stated, vary in diameter from $\frac{1}{4}$ inch to 1 inch; when larger holes are used, they are bored with the **expansive bit** shown in Fig. 37. In this bit



FIG. 37.

the body piece will bore a hole of a certain size, and by adding the adjustable cutter *a*, the hole may be varied in diameter from this minimum size to a certain maximum size, for the given size of cutter, as, for instance, from $\frac{3}{4}$ inch to 2 inches; then, by removing this cutter and inserting a larger size, the hole may be varied from the last size to a larger one, as, say, from 2 inches to 3 inches. The adjustable cutter is fixed firmly in place by means of the clamp and screw shown at *b*. It will be seen from the illustration

that the smaller auger runs ahead of the movable one, first making a hole its own size. The size of the hole is then increased by means of the movable cutter to the larger diameter, for which it is adjusted.

42. Twist Drill.—A form of boring tool used for the smaller sizes of holes is shown in Fig. 38, and is called the



FIG. 38.

twist drill. While this is a rapid-cutting tool, it has not the tendency to split the wood that some other small bits have. It is made for wood boring, in sizes that vary from $\frac{1}{16}$ inch to $\frac{1}{2}$ inch. Besides the form shown, there is a great variety of small bits made for boring the smaller-sized holes.

43. Foerstner Bit.—The bit shown in Fig. 39, called the **Foerstner bit**, deserves special mention. It is a very

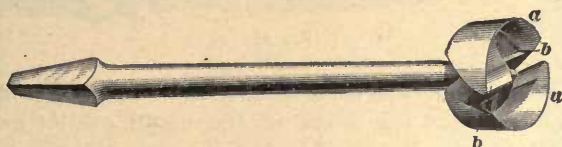

FIG. 39.

slow-boring tool, but has very little tendency to split the stock. For this reason it can be used on small pieces where the ordinary augers could not. This is due to the fact that the scoring parts, or nibs, *a* extend almost entirely around the hole, and instead of pushing the wood outwards, it encloses it and presses it inwards, where it is shaved off by the cutting lips *b*, which act precisely as the cutting edges in the common auger. This bit can also be used to bore a hole along the edge of a piece of stock where a portion of the bit is not working in the stock, or to bore two holes that partly lap or cut into each other.

44. Spoon and Nail Bits.—Other forms of bits in common use for boring small holes are shown in Fig. 40.

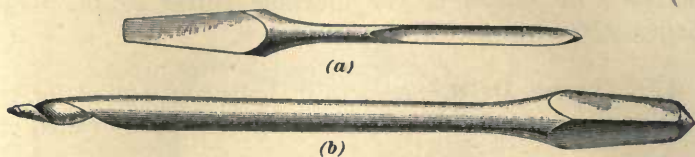

FIG. 40.

Fig. 40 (a) shows the **spoon bit**, and Fig. 40 (b) the **nail bit**. These come in sets that vary in size by sixteenths from $\frac{1}{16}$ to $\frac{1}{2}$ inch.

45. Automatic Boring Tool.—The **automatic boring tool**, shown in Fig. 41, is used for boring the small holes

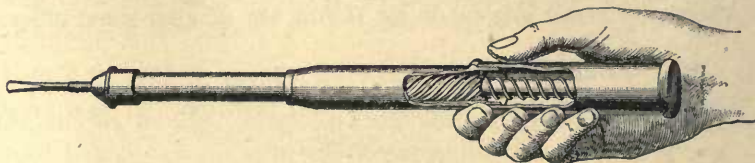

FIG. 41.

in finishing work, such as setting brads, finishing nails, and screws, and takes the place of the small gimlet and brad awl. It consists of a hollow handle containing a helically fluted spindle, and inside of that a helical spring. The end has a pair of clamp jaws in which is clasped a fluted drill. By pressing the point of the drill against the wood, the spindle is forced into the hollow handle, the helical flutes giving it a rotary motion during this time. When the pressure is relieved, the spring forces it out again, the motion of the drill being reversed. In the end of the handle there is a set of holes provided with a cover for carrying the drills, which usually come in sets of eight. This tool seems to combine the handiness of the brad awl and the efficiency of the gimlet, and small holes can be quickly and safely bored with it.

MISCELLANEOUS TOOLS

46. Screwdriver.—The most common form of **screwdriver** is shown in Fig. 42. This tool is given a variety of

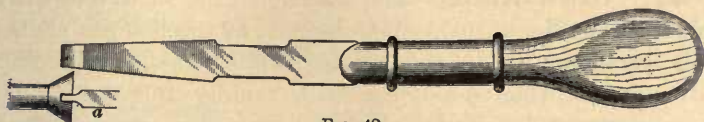

FIG. 42.

forms; it is adapted to use in the brace by substituting a square shank for the handle, and is given the automatic turning feature of the automatic boring tool, by adapting it to a handle similar to the one shown in Fig. 41. The engaging end of a screwdriver should be given such a shape that it will fit properly into the slot in the screw head, as shown at *a*, Fig. 42. The sides of the part which enters the slot should be made parallel, in order to prevent the tendency to slip out of the slot and injure both screwdriver and screw.

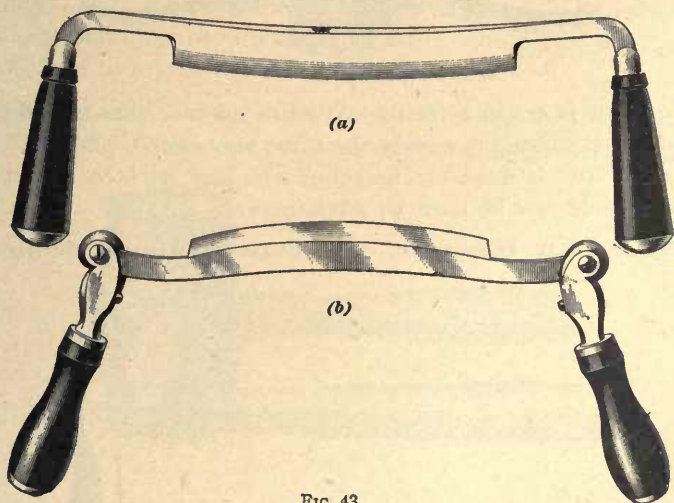

FIG. 43.

There should be three or four different sizes of screwdrivers in a set, so that one which will fit any ordinary screw sufficiently well may at any time be selected. The

handles may also be made of such form that the blade may be changed to fit the work at hand. These are usually made with a set of four blades.

47. Draw-Knife.—The common form of **draw-knife** is shown in Fig. 43 (a). The position of the handles enables the workman to do the cutting while drawing the knife toward him, thus removing stock rapidly and with a fair degree of control of the cutting edge. The form shown in Fig. 43 (b) has reversible handles, which may be folded over the cutting edge when not in use, thus protecting it from injury and enabling the workman to keep the tool in order more easily than with the ordinary form. The draw-knife is used for removing stock rapidly, as when roughing out the general form of a pattern.

48. Spoke Shave.—The **spoke shave**, shown in Fig. 44, may be considered as a smaller form of draw-knife.



FIG. 44.

The blade is set in a frame in such a manner that the depth of cut is regulated in nearly the same way as in a plane. The spoke shave is used for finishing irregular surfaces where a plane could not be used to advantage.

49. Claw Hammer.—The **claw hammer** shown in

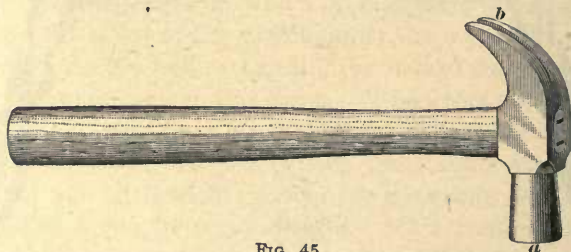

FIG. 45.

Fig. 45 is the one in common use among wood workers. The head is made of steel, with the **face** *a* hardened to

stand the bruising action of the nail head when in use. The weight varies from 7 to 18 ounces, the most common weight being 14 ounces. The claws *b* are intended for the purpose of drawing nails.

50. Nail Set.—The **nail set** is shown in Fig. 46, and is used to set the nails so that the heads will be below the



FIG. 46.

surface of the work. When the hammer is used with the nail set, care should be taken to have the set softer than the face of the hammer. When two bodies are struck together, the softer one will show the effect of the blow more than the harder one. Workmen sometimes grind an old file which is very hard, for service as a set, or have the regular set made very hard. This should in every case be avoided, as it is certain to injure the hammer. The woodworkers' hammer should never be used upon metal work, as it is liable to injure the face of the hammer.

51. Mallet.—The **mallet** used in bench work is shown in Fig. 47. There are various styles and sizes of these



FIG. 47.

mallets, the weight being made to suit the individual workman and the character of the work in hand. It is used principally to drive the chisel in making mortises and in framing work generally. It is used instead of the hammer for this

purpose, because the unyielding character of the hammer would tend to shatter the handle of the chisel. Owing to the less yielding character of the material in a hammer, the force of the blow is expended on the surface struck, and as it must be struck hard in order to produce the required results, the force of the blow is largely absorbed by the tool through which it should be transmitted. With the more yielding character of the material in the mallet, the first impact is not so great, but the force of the blow is continued longer, and, instead of being absorbed by the tool, it is transmitted through the tool and expended in cutting the material at the cutting edge. By using a chisel with a handle of the form shown in Fig. 20 (*c*) and a wooden mallet, the tool handle will last for a long time, whereas if a hammer were used, the handle would soon be shattered. When a chisel is used much with a mallet, the end of the handle should be protected by a ferrule, as shown in Fig. 20 (*c*).

52. Hatchet.—The form of **hatchet** of the greatest use to the bench worker is shown in Fig. 48, and is called a **shingling hatchet**.

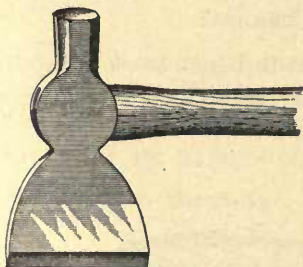

FIG. 48.

53. Scraper.—Where a smooth surface must be produced on wood having crossed grain, or where, for any reason, it is difficult to produce a smooth surface by the use of the plane, the **scraper**, shown in Fig. 49, is used. It consists of a steel blade made of the same material and of the same degree of hardness as a saw blade. It is rectangular in form, as shown in Fig. 49 (*a*) and has its corners rounded very slightly. By making the edges square with the sides, as shown in Fig. 49 (*b*), very fine shavings may be scraped from a wooden surface without danger of scratching it. The cutting power of the edge is sometimes increased by drawing one side of some round steel tool over it. This bends the corner over slightly, as shown at *a*, Fig. 49 (*b*), and gives

a better cutting edge, but makes the tool more difficult to resharpen. For convenience in handling, the blade is sometimes fastened in a frame of the form shown in Fig. 49 (c),

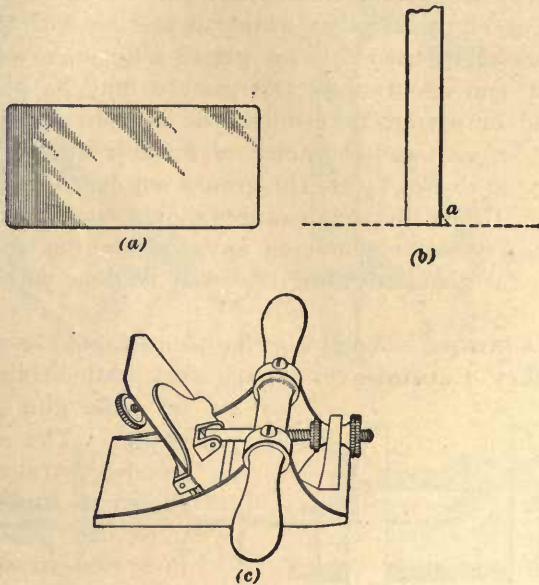

FIG. 49.

the cutting edge being set so that it projects slightly below the sole of the frame, like a plane iron.

SANDPAPER.

54. A list of the parts of an outfit used by bench workers would not be complete without making mention of **sandpaper**, as by its use the finishing of the work of the cabinet-maker and the patternmaker is very often accomplished.

Sandpaper is composed, as its name implies, of sharp sand (quartz or garnet) glued on paper. It can be purchased in rolls or sheets, the most convenient size for patternmaking being the sheets, which are 9 inches by 11 inches. The grades

are designated by the following numbers: Nos. 00, 0, $\frac{1}{2}$, 1, $1\frac{1}{2}$, 2, $2\frac{1}{2}$, and 3, No. 00 being the finest and No. 3 the coarsest grade. In patternmaking, sandpaper should be used with great care; the patterns should be formed as nearly to shape and size and finished as accurately as possible with the tools, sandpaper being used only for giving a finish, as otherwise the draft and accuracy of the pattern may be destroyed. The kind of pattern determines the fineness of the sandpaper to be used and character of finish required; usually from No. 00 to No. $1\frac{1}{2}$ are the grades employed in this class of work. Under no circumstances should sandpaper be used for cutting down or removing any considerable amount of stock, or for doing anything that may be done with tools.

55. Clamps.—Wood-working shops should be provided with plenty of **clamps** for holding work while being shaped,

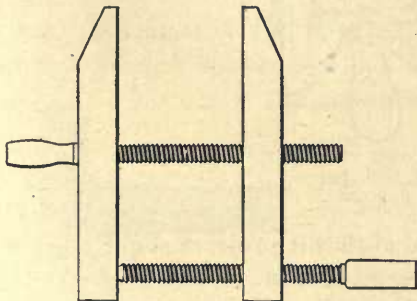

FIG. 50.

or while glue is hardening. The form of wooden parallel clamp shown in Fig. 50 is the most serviceable, and in a pattern shop several dozen of these should be on hand. Malleable-iron clamps of the form shown in Fig. 51 (a) are also used to some extent, and are

very serviceable. Another malleable-iron clamp, which is capable of more rapid adjustment, is shown in Fig. 51 (b). In this form of clamp the arm *a* may be moved along the beam *b* by simply tilting it forwards toward the fixed arm *c*, thus permitting a more rapid adjustment through a wide range than if the arm *a* were fixed.

The clamp shown in Fig. 51 (c), known as a door clamp, is used by cabinetmakers in framing and fitting, and especially in gluing large pieces. This style of clamp is frequently made by placing one fixed and one adjustable jaw

on a piece of timber 5 or 6 feet long, the adjustable jaw being so arranged that it can be moved 2 or 3 inches at a time and

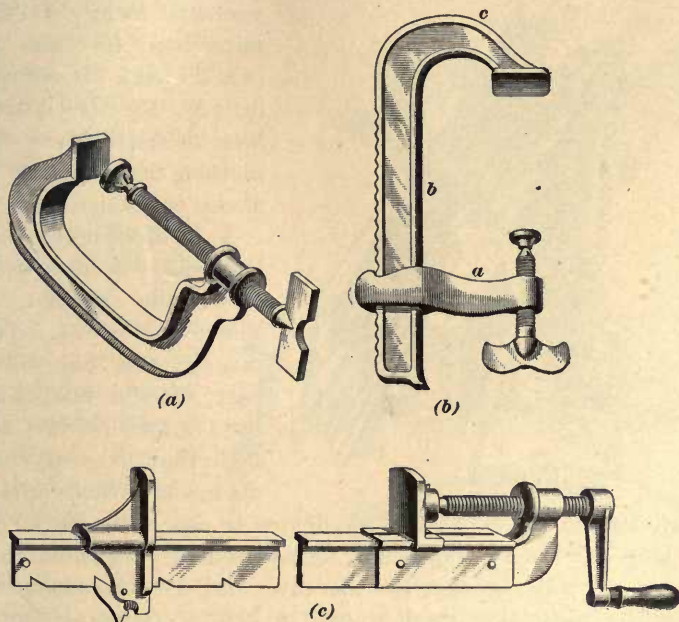

FIG. 51.

secured in the desired position by means of a pin or notches. The finer adjustments are obtained by means of a screw carried by one of the jaws.

56. Miter-Box.—Owing to the difficulty of cutting strips of wood to given angles, as in the case of picture-frame corners, so that they may fit when they are brought together, a special device, called a **miter-box**, is used. One form of this device is shown in Fig. 52, and consists of an open-end trough, with cuts made down the sides with a saw, as shown. The cuts are made at such angles that a strip of wood held against the inside and sawed with the saw blade guided by the cuts will have the required angle. By this method

greater accuracy is obtained than if the workman had only the ordinary lines by which to work.

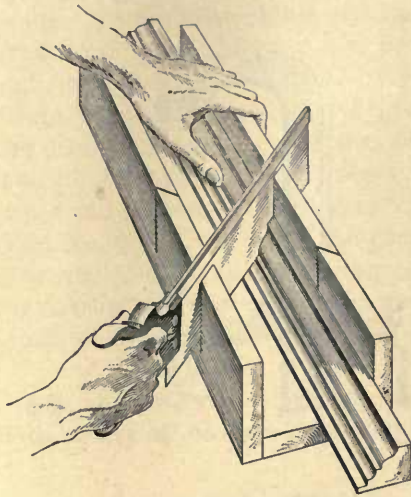

FIG. 52.

A simple and convenient form of the miter-box for use in bench work is shown in Fig. 53, the dotted lines of which show the method of holding it in a vise for bench use.

A form of miter-box that has been placed upon the market is shown in Fig. 54. The saw in this case is a part of the box, and the adjustments are such that cuts may be made at other angles

than the miter, or 45° . This device is especially useful in making the various polygonal forms used in patternmaking. There are roller guides for the saw, and a combination of stops by means of which it can be set for certain definite angles, which are used most frequently. It also has a universal adjustment, by which any required angle may be obtained. For general adjustment, however, the workman must find the proper position of the stops, but for the angles in most

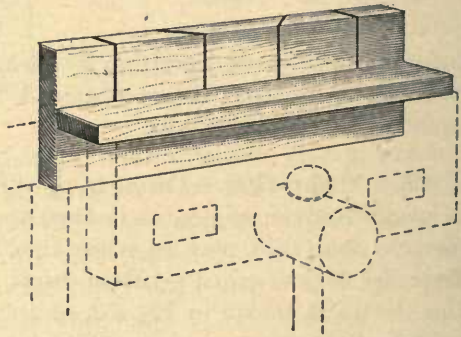

FIG. 53.

common use, there are lines laid off on the frame that enable him to adjust the guides instantly. Any angle

between 90° and 45° is obtained by adjusting the saw, but if an angle of less than 45° is required, the saw is adjusted to 45° and then the special stop a is adjusted as shown, so as to hold the piece in the required position.

57. Bevel Board.

Board.—Where the edges of a large number of pieces must be cut to a definite angle, the **bevel board** shown in Fig. 55 is found very serviceable. The device consists of a flat plate of iron a

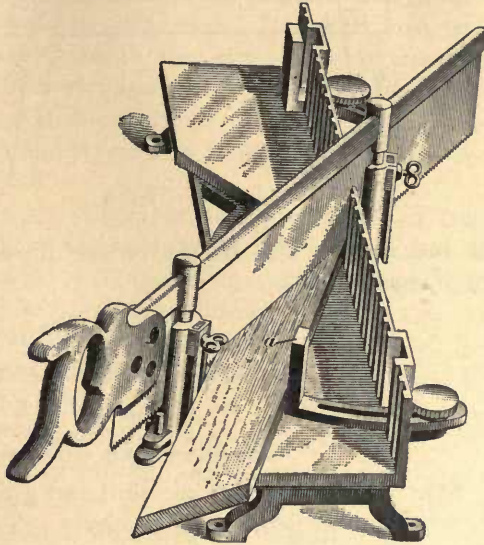

FIG. 54.

attached to the side of a plane b , so that when the plate is held to the work as shown, the plane will cut the edge to the desired angle.

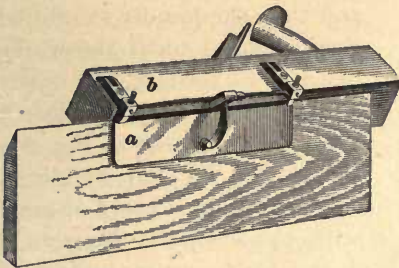

FIG. 55.

HORSES.

58. Wooden horses

of the form shown in Fig. 56 are used to support the larger pieces of wood while they are being laid out, or marked for cutting, and while being sawed or worked upon by means of other tools. The cross-beam is usually made of $2'' \times 4''$ or $2'' \times 6''$ stock, from 3 feet to

4 feet long, and the legs are made of stock ranging from 1 in. \times 3 in. to 1½ in. \times 4 in., depending on the weight

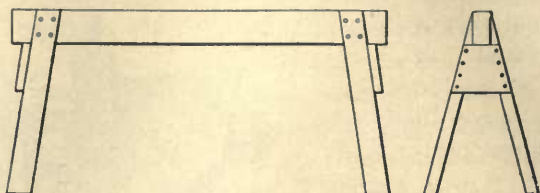

FIG. 56.

of the work. The height of the horses is usually about 24 inches.

SHARPENING BENCH TOOLS.

CHISELS AND GOUGES.

59. Grinding.—Some skill and great care are required in order to sharpen chisels properly. The chisel should be

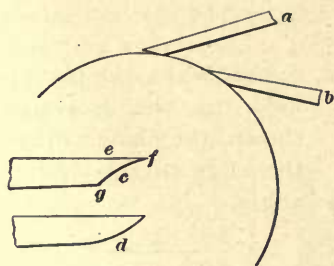

FIG. 57.

brought into contact with the grindstone, or wheel, in such a way that the back of the bevel touches the stone first, and then the handle should be slowly raised until the whole bevel is in contact, the chisel at the same time being drawn back from position *a*, Fig. 57, to position *b*. The handle is

held in the right hand, the right forearm is pressed against the side of the workman, and with the left hand the edge is steadied and moved slowly back and forth across the face of the stone. By looking directly at the edge, when the chisel is held so that the light strikes upon it, the workman will be able to tell whether or not it is properly ground. Experience in this direction may be acquired by comparing well-ground chisels with others that are not well ground. The

bevel should be ground slightly hollow, as shown in exaggerated form at *c*, Fig. 57. There is always a tendency to grind the bevel round, as shown at *d*, Fig. 57. The greatest care should be exercised to avoid this. It is well, also, to be careful to return the chisel to the same position upon the stone, when it has been removed for the purpose of examining it, and to adjust it carefully to the same angle. This applies to gouges and other cutting tools, like the plane iron, as well as chisels.

When the grinding is continued for any length of time, as in taking a nick from the cutting edge, the metal immediately back of the edge is frequently ground so thin that it will not withstand the pressure necessary to grind the tool properly, and will bend away, forming what is known as a **wire edge**. The harder the tool is pressed against the stone, the greater the wire edge will be. It may be removed by pressing the tool against the stone very lightly during the last few moments of grinding, and when the grinding is finished, drawing the edge in the direction of its length across a piece of wood. This will not wholly remove the wire edge, but will reduce it so that it may be taken off with the whetstone. It is necessary to exercise care during the operation of grinding so that the chisel edge does not become so hot as to draw the temper. There should be a plentiful supply of water on the stone, and the workman should assure himself, by frequent trials, that the tool is not heating.

60. Using the Whetstone.—As the edge left by a grindstone or emery wheel is rough, because of the coarseness of the stone, it is necessary to finish it on a finer stone. This is usually done on the **whetstone**, shown at *a*, Fig. 9. The tool is applied to the whetstone in the same way as to the grindstone, by bringing the back of the bevel into contact first and then raising the handle until the whole bevel



FIG. 58.

is in contact. The first position is shown by the dotted outline and the final position by the full lines in Fig. 58. The tool is held as shown in Fig. 59, and is rubbed regularly

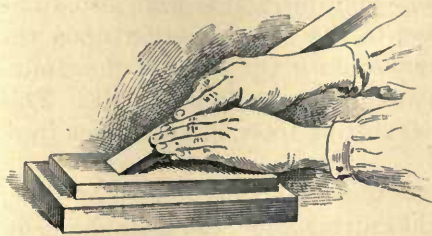

FIG. 59.

back and forth on the face of the stone.

When the chisel has been properly ground, it will touch the stone only at the points *f* and *g*, Fig. 57. The whetting is finally finished by turning the

chisel so that the flat surface *e*, Fig. 57, rests upon the stone, and moving it forward, in the direction of the cutting edge, then turning it back to the original position, and again moving it forward. By repeating this operation several times, giving successive strokes on opposite sides, the wire edge may be removed and the cutting edge made smooth. When very great keenness is required, this process may be repeated upon a leather strap, the chisel, however, being drawn toward the workman or away from the cutting edge. No whetting should ever be done upon the flat side of a chisel after the wire edge is removed and a smooth cutting edge obtained.

61. A little oil on the whetstone will tend to keep the cutting edge cool and will also carry off the small particles of steel and stone which have been separated, thus keeping the surface in good working condition. The oil can shown in Fig. 9 is intended for the purpose of supplying oil to the stone. The cotton rag or waste shown in the same illustration is used in keeping the different parts clean.

Instead of the stone shown in the illustration, emery bricks, which may be lubricated with water or oil, are now used a great deal because of their rapid cutting qualities. The edge they leave is not so fine as that left by a good whetstone, but it is smooth enough for most purposes. With the increased speed in cutting, however, comes a

greater tendency to heat the edge of the tool, and increased care to prevent overheating is necessary.

62. Grinding Gouges With Emery Cone.—Inside gouges may best be ground by means of an emery cone, shown in Fig. 60.

A piece of hard wood is turned to a conical form, as shown at *a*, the taper of which corresponds to the average taper of the



FIG. 60.

bevel of the gouge. The other end *b* is turned to fit the taper in the lathe spindle. The part *a* is then coated with glue, inserted in finely ground emery, and immediately withdrawn. When the glue has hardened, another coat is put on and the cone is again inserted in the emery as before. This operation is repeated three or four times. In this way enough emery may be made to cling to the surface to make a very serviceable grinder, when the glue has hardened. By inserting the taper *b* in the spindle of a lathe and setting it in motion, the gouge may be held upon it and ground as desired. Special care must be taken, however, in using this grinder, to prevent overheating the cutting edge. Emery cones of this character are kept in stock by dealers in this line of supplies.

The whetting of an inside gouge may be best accomplished by means of a stone slip shown at *b*, Fig. 9.

PLANE IRONS.

63. The **plane iron** is sharpened in the same way as a flat chisel. The angle of the bevel depends on the style of plane and the material to be planed, and must be determined for different conditions by observation. When the iron has been ground and whetted, the front corners of the side edges should be rounded very slightly. This precaution will prevent scratching the surface of the work by sharp corners that might otherwise exist.

SPOKE SHAVE.

64. The blade of the spoke shave is so narrow that it cannot well be held in the hand when sharpening it, and the device shown in Fig. 61 is frequently employed. It consists of a piece of wood cut to the form of the handle of a flat brush, with a slot *a*

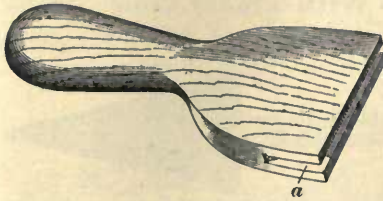

FIG. 61.

cut across the lower end, into which the blade may be placed while sharpening.

AUGER BITS.

65. The principles on which the process of sharpening auger bits depend are the same as those involved in sharpening other wood-working tools. Owing to the form of the cutting end, however, fine files or whetstones only can be used.

Owing to the great variety of forms of these bits, no definite rules can be given for each class, except that in cases where there is more than one cutting edge, care must be taken to have them perfectly symmetrical, so that each edge will take the same depth of cut. The particular form of the cutting edges of each bit must be determined by the beginner, by examining well-sharpened tools of the same class, and reproducing these as closely as possible. A little experience will make the best forms apparent.

SAW SETTING AND SHARPENING.

66. **The Set of the Saw.**—It is found in practice that the fibers of the wood are not cut off cleanly from one another during the operation of sawing, and that enough of the roughened surface of the sides of the cut will spring

back on the saw blade to make it difficult to force it through the cut made by the teeth. This difficulty is overcome by bending every second tooth slightly to one side and the remaining teeth to the other side, as shown in Figs. 30 and 31. This bending is called **setting the saw**. The distance through which the teeth are bent is determined by the character of the wood to be cut, being greater for soft and wet wood and less for dry and hard wood. In order that this may be done evenly and the best results obtained, an instrument called a **saw set** is used.

67. The Saw Set.—One form of this tool is shown in Fig. 62. The frame and handle *a, a* carry a disk *b*, which is

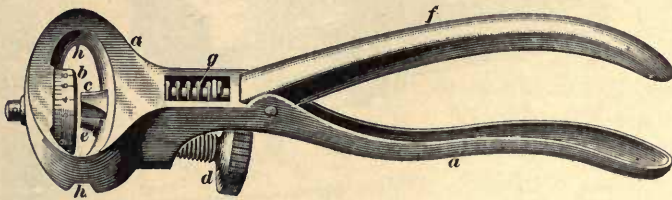

FIG. 62.

so constructed and marked that when the figure representing the number of teeth per inch of the saw which it is desired to set is brought immediately in front of the plunger *c*, it is in adjustment for that particular saw. The amount of set is gauged by means of the screw *d*, the point *e* of which determines the angle at which the saw blade stands to the front of the disk *b*. By pressing the handle *f* toward the handle *a*, the plunger *c* is moved forward against the disk, and when the pressure is relieved, the plunger is brought back and the handles separated by the spring *g*.

68. The Saw Clamp.—A clamp in which to hold the saw while sharpening and jointing it is shown in Fig. 63. The saw blade is clamped between the jaws *a* by means of the screw *b*, and may be set at any desired angle by

means of the ball-and-socket joint at *c*, which may readily be changed by loosening the nut *d*.

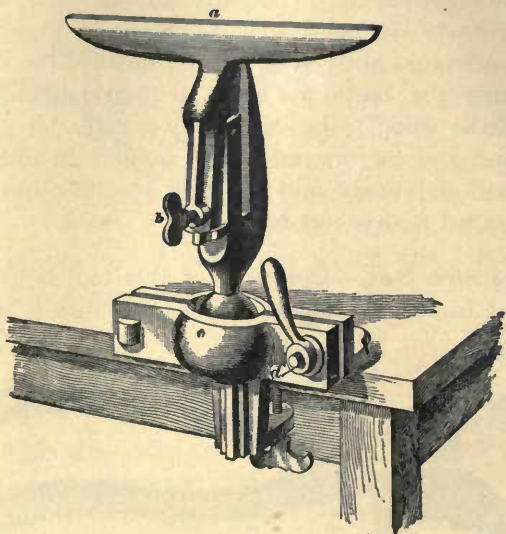

FIG. 63.

69. Setting the Saw.—In order to set the saw, the blade is placed in the saw clamp, so that the jaws are sufficiently near the teeth to prevent objectionable spring. The disk *b* of the saw set, Fig. 62, is then turned so that the number corresponding to the number of teeth per inch stands immediately in front of the plunger. The saw set is then placed over the teeth so that the frame *a* rests upon them at *h, h*, and one tooth stands before the plunger *c*. The screw *d* is then adjusted, so that in the opinion of the operator it will give the required set. The lever *f* is then pressed down upon the handle *a* and the effect on the tooth observed. If it is seen that the set is not right, the screw is again adjusted and the operation repeated until the desired result is obtained. Every second tooth is then set in the same direction, after which the saw is turned so that the other side stands toward the operator and the remaining teeth set.

The set, or bend, of the teeth must be sufficiently wide to keep the fibers from springing in on the blade and binding it. For ordinary use, the workman may test the saw by putting a needle between the points, as shown in Fig. 64, and then tilting the saw toward either end.



FIG. 64.

If it is properly set, the needle will slide to the end toward which it is tilted. The points of the teeth should lie in a smooth, continuous line from one end to the other, and no tooth should have more side projection, because of the setting, than its neighbors. When this condition is fulfilled, the saw is said to be well jointed.

70. Swedge Setting.—Ripping saws are frequently set by means of **swedge sets**, an example of which is shown in

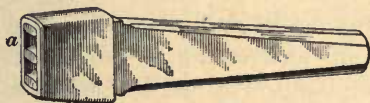

FIG. 65.

Fig. 65. These sets are used especially on large saws. There are two V-shaped openings in the lower end, as shown at *a*.

By setting these in turn over a tooth and striking the set with a hammer, the edge is driven back and spread lightly. The middle of the edge is driven back with one opening, and with the other the points are forced out. The swedge set should be so held that when the tooth has been set, the cutting edge will stand at right angles to the plane of the saw. This will enable the tooth to cut along its entire width, thus giving it an advantage over the tooth that has been set by bending.

71. Jointing.—When the saw has been set, and before filing, the points of the teeth should be brought accurately in line by passing a file lengthwise of the saw over them, the file being held at right angles to the blade. As it is a very difficult matter to hold the file positively at right angles to the blade, a jointer is made by setting a flat file *a*

into a block of wood *b*, as shown in Fig. 66. The block is made about 1 in. \times 2 in. and $3\frac{1}{2}$ inches long, and the file is set in about half its width, as shown, and about $\frac{3}{4}$ inch from one end. The wood is cut away immediately below the file, as shown at *c*, so that the teeth will not touch the block when the saw is being jointed. While jointing the saw, the block *b* is held carefully against the saw blade *d* and moved lengthwise along the saw, so that the face of the file stands at right angles to the blade at all positions. The recess in the block should be cut very carefully, so that the face of the file and the face of the block may stand at right angles to each other. A 10-inch, fine flat file is commonly used for this purpose. Other types of jointers may be purchased of dealers in wood-working tools.

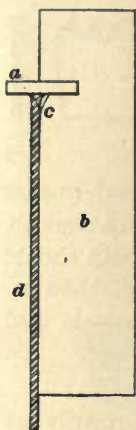

FIG. 66.

72. Filing the Saw.—Having set and jointed the saw, the next step in the process of sharpening is the filing. The saw is clamped in the saw clamp, Fig. 63, in the same manner as in setting, the jaws being placed very close to the bottom of the teeth. A suitable three-cornered tapered file, about 6 inches in length and moderately fine, is usually selected for this purpose. The angle at which the file is held to the saw depends on the kind of saw and the hardness of the wood to be cut. For a ripping saw, as has already been stated, the point of the tooth should be of a chisel shape, the front being usually filed almost perpendicular to a line drawn through the points. In this case the file is held at right angles to the plane of the saw blade.

For a cross-cutting saw, the angle depends on the material. When it is desired to cut soft wood, the angle may be made greater than when the wood is hard. As the angles vary considerably, no definite rule can be stated. Only experience and careful observation will enable the workman to determine the best angles for any given material. The

best form of tooth for the work in hand being known, the file must be held to give that form. A few strokes will usually indicate to the observing workman the correct angles. The beginner can usually, by examining a well-filed saw, observe the best form of tooth. Having determined the correct angle at the beginning, he may place a board beside the saw and draw a series of lines at intervals along the board, parallel to a line representing the direction of the file. These lines will act as a guide that will enable him to keep the sides of the teeth parallel throughout. Every second tooth should be filed first, then the saw should be turned and the remaining ones filed from the opposite direction.

73. When the saw has been jointed, small spots will be noticed upon the points of most, if not all, the teeth, and the filing should be continued until these are reduced to a sharp point. This should, however, not be attempted while filing the first set of teeth. The workman must use his judgment as to the amount that should be removed before the saw is turned, as a corresponding amount will be removed when the second set of teeth is filed, after the saw is turned. When the saw is in a very bad condition, so that large spots appear on some teeth, while others are very small, it is best to reverse the saw several times before bringing the teeth to a point, and take off a comparatively small amount at each reversal. Great care should be taken to keep the pitch of the teeth even throughout the entire length of the saw. The handle of the file should be held freely in the right hand, and the point between the thumb and first finger of the left hand. The file should be given a free and steady motion, and the stroke should be as long as the file will permit. Short, quick strokes should be avoided, as they do not give good results. When the filing is finished, the teeth should be rubbed lightly along the sides with a fine file or whetstone, in order to be sure that the points are absolutely in line with one another.

Saws should always be kept well jointed and set, and sharp. It is better to file them frequently, and have them in good working condition at all times, than to allow them to become very dull, and then spend a great amount of time in putting them in order. The time gained by always having them in good condition will more than compensate for the additional time required to file them at frequent intervals.

WOOD WORKING.

(PART 2.)

GENERAL TOOLS AND EQUIPMENT FOR BENCH WORK.

MACHINE TOOLS.

TRIMMERS.

1. Bench Trimmer.—While wood may be cut to any angle by means of saws, they do not make good surfaces for gluing, especially on the end grain. Owing to the fact that it is difficult to produce good surfaces with hand tools, **trimming machines** have been placed on the market. Fig. 1 (*a*) illustrates a front view and Fig. 1 (*b*) a back view of one of these trimmers intended for use upon a bench.

The stock to be trimmed is placed against one of the adjustable wing guides *d*, which may be set at any desired angle, and the end trimmed by one or the other of the knives *a*, *b*, which are operated by means of the lever *c*. The bed of this machine has various angles marked on it, which enable the trimmer to finish the ends of pieces to form segments for figures having any desired number of pieces in the circle. These bench trimmers are generally a part of the shop equipment, but are sometimes owned by individual patternmakers and are kept on their own benches.

§ 33

For notice of copyright, see page immediately following the title page.

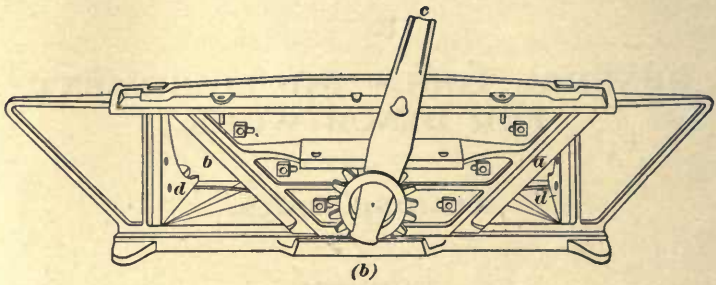
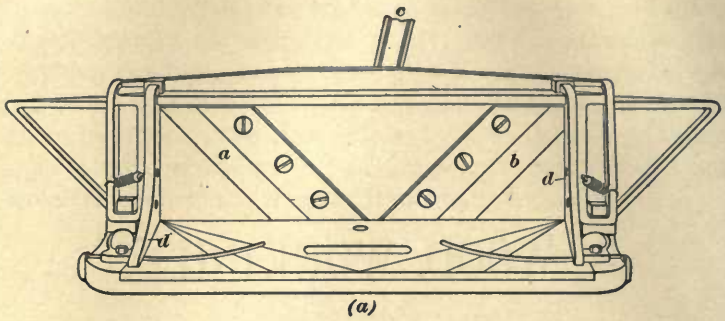

FIG. 1.

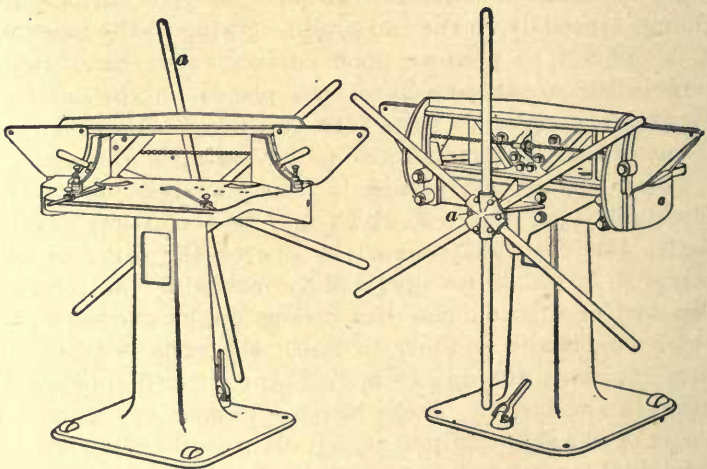

FIG. 2.

2. Large Trimming Machine.—Fig. 2 shows front and back views of a large trimming machine similar in action to the bench trimmer. This machine has a much larger capacity and is mounted on a rigid base. Instead of operating the knives by means of a lever, they are operated by the capstan wheel shown at *a*. As in the smaller machine, the table is provided with adjustable guides, so that any desired angle may be cut. Large machines of this class are a portion of the regular equipment of the shop and are supplied by the owners.

SAWING MACHINES.

3. Universal Circular-Saw Bench.—Wood-working shops, and especially pattern shops, should be provided with one or more circular saws. A good machine for general pattern work is shown in Fig. 3. It consists of a heavy

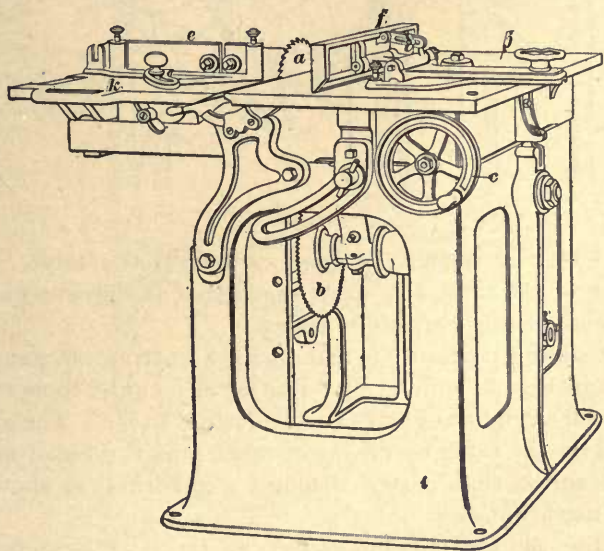

FIG. 3.

cast-iron frame, or base, *i* which carries a stationary table *j* and a movable, or sliding, table *k*. Two saws are mounted on parallel arbors, and are so arranged that either of them

can be brought above the table, and also so that the depth of cut or amount of saw exposed can be controlled. The ripping saw is shown at *a* and the cross-cutting saw at *b*. The hand wheel *c* on the front of the machine controls the the worm *h* and gear *g*, shown in Fig. 4, and by this means serves to rotate the frame carrying the two saws and to

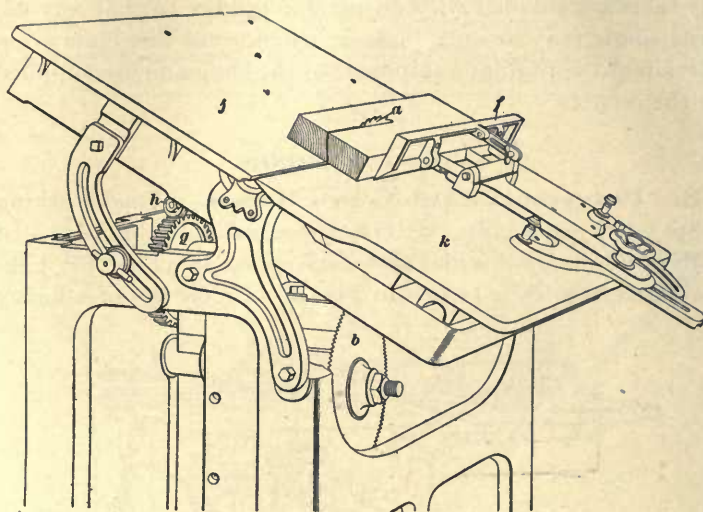

FIG. 4.

bring either of them above the surface of the table. The portion of the table *k* is so arranged that it slides on guides, the weight being carried on rollers.

The sliding portion *k* is fitted with a cutting-off gauge *e*, shown in Fig. 3, which can be set at any angle, so as to cut the stock at right angles or to any desired bevel. The gauge is held on the table by means of taper pins and an adjusting clamp screw that passes through a quadrant, as shown in the illustration.

In Fig. 3, the slitting gauge, or fence, *f* is shown in place. This gauge is used for ripping, and is so arranged that it can be tilted to various angles. The portion of the table *k* can be locked in place, and the entire table tilted as shown in Fig. 4. In this illustration, the fence *f* has been

placed on the movable portion of the table *k*. This tilting of the table is very convenient when sawing out staves for cylinders, columns, and similar work. The table can be tilted to any desired angle up to 45° . One advantage of setting the gauge, or fence, as shown in Fig. 4, is that the weight of the stock tends to keep it against the gauge. By means of this saw and its attachments, a patternmaker can save a large amount of time, as it will cut practically all angular forms.

4. Band Saws.—All machines employing circular saws are suitable only for cutting along straight lines and for

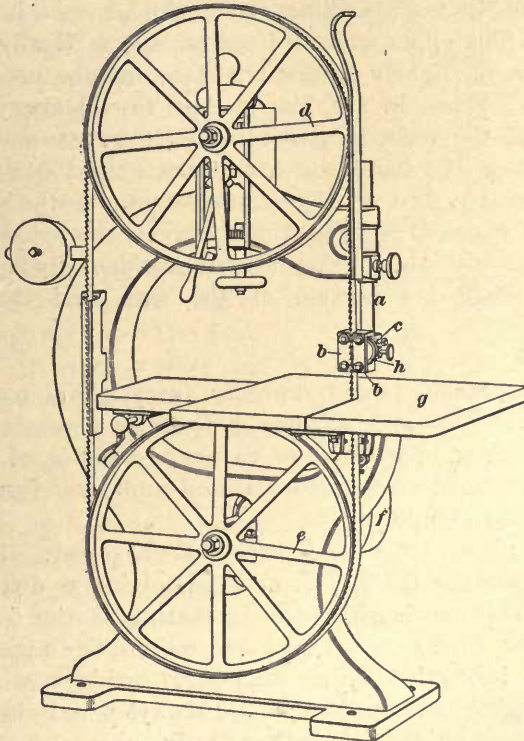

FIG. 5.

angular work. For cutting irregular or curved lines, the **band saw**, shown in Fig. 5, is very useful. In this

machine, the stock to be cut is supported on the table *g*. The saw is in the form of a band and runs on the wheels *d* and *e*. One wheel *e* is driven by a belt running on the pulley *f*. In order to prevent the saw from crowding back and running off the carrying wheels *d* and *e*, a special guide and support *c* is provided. This guide is carried on an adjustable arm *a*.

The saw is held in place by means of two adjustable blocks *b, b*, between which it runs, and the backward thrust is taken by the disk *h*, across one edge of which the saw travels. This disk has a slow rotary motion, caused by the friction of the saw traveling on it, which causes it to wear evenly. The upper wheel *d* is adjustable vertically, so that band saws of slightly different lengths may be used on the machine. When in use, the guide *c* should always be set as close to the work as possible. It is well to enclose the space below the band-saw table with a tight box, in order to prevent the dust from being blown about the shop and pieces of material from getting between the spokes of the wheel and also the workmen from accidentally coming in contact with this portion of the saw, and thus being injured.

5. Jig Saw.—Band saws are very useful for sawing most curved work, but when it becomes necessary to saw out the center of a piece, or to operate inside of a closed figure, the band saw cannot be used and some form of **jig saw** must be employed.

Fig. 6 illustrates a machine of this character. The work is supported on the table *t* and the cutting is done by the saw *c*. This saw is given a reciprocating motion by means of the crank-disk *a* and pitman rod *b*. The upper end of the saw is carried by an adjustable guide *d*, which, like the guide of the band saw, should always be set close to the work. The guide *d* is adjusted by means of the hand wheel *e*. The upper end of the saw is attached to a bar or a strap carried by springs *g*, which serve to keep the saw taut.

The framework carrying the guide and springs is supported by a brace *h*, hanging from the ceiling. This brace is steadied by three rods *f*, which can be adjusted by means of turnbuckles, as shown. The jig saw is not as convenient as the band saw and will not work as fast, because it only cuts during the down stroke. In other words, it only saws half the time, while the band saw cuts continuously. When working inside of closed figures, the jig saw is detached at one end and passed through a hole in the work, after which it is again attached and the work continued.

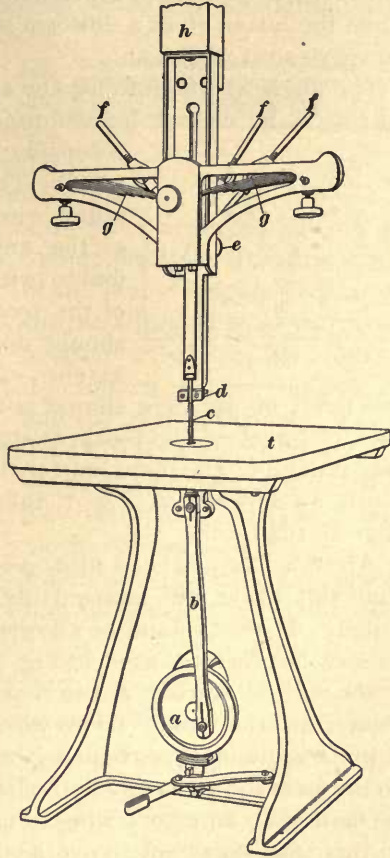

FIG. 6.

6. Setting and Filing Circular and Band Saws.

—The first step in the process of sharpening circular and band saws is to bring all the teeth to the same length, which may be done by holding a piece of grindstone or emery wheel against the points while the saw revolves. If this is not done, the saw will be subjected to unequal strains, because some of the teeth project farther than others, and cause trouble and bad work. The set of the teeth depends largely on the nature of the wood, and should never be greater than that required to give clearance to the disk. In most cases $\frac{3}{32}$ inch,

equally divided, is ample. For hard woods it may be much less.

For setting the teeth, the swedge set or the saw set shown in *Wood Working*, Part 1, may be used. The former requires considerable skill and experience to obtain good results, while the latter gives a uniform set, even in the hands of an inexperienced workman.

The angle at which to file the edge of the tooth of a cross-cutting saw cannot be definitely stated, since it varies according to the hardness of the wood. The correct angle should be noted when the saw is new, as well as the angle that the cutting edge makes with the direction of motion of the tooth. In filing, these angles should not be changed to any great extent. Also, on cross-cutting saws,

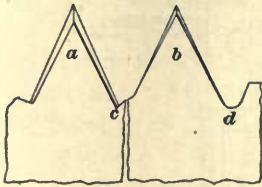

FIG. 7.

the bevel of the edge should not be carried down into the root, or gullet, of the tooth, as shown at *a*, Fig. 7. The cutting is done by the point, and if the bevel is carried half way down, as shown at *b*, Fig. 7, there will be sufficient cutting edge to the tooth.

After a saw has been filed several times, it will be found that this bevel will unavoidably be carried down to the gullet. If this should be allowed to continue until a sharp groove has formed, as at *c*, Fig. 7, the probability is that a crack will be started at the root of the groove, which will soon ruin the saw. To prevent this, the gullets are kept round by gumming, or reaming, or by filing with a round file, to the form shown at *d*. Both sharpening and gumming may be done with an emery wheel, but it is necessary to use care in this case, so as not to overheat the tooth or the steel of the disk, and so draw the temper.

In filing ripping saws, the cutting edge must be filed so as to run squarely across the face of the tooth, in order that the cut may be made clean and even, with no tendency to push the saw laterally on its mandrel. In all cases, too, where the gullets are undercut, the filing should be done

principally on the under, or front, side of the tooth, and not more on the back, or top, of the tooth than is necessary to preserve its original shape.

7. Set Gauge for Circular Saws.—After the teeth of a circular saw have been set by bending or swedging, the set is usually made uniform by filing the outside edge of the teeth. If the body of the saw runs true, the form of gauge shown in Figs. 8 and 9 may be used. This consists of a small

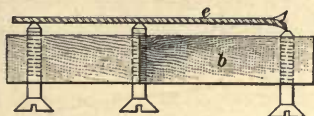

FIG. 8.

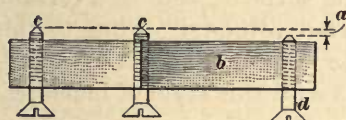
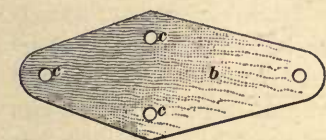

FIG. 9.

block of wood *b*, having three screws *c* arranged in such a manner as to hold the block a short distance from the face of the saw. A fourth screw *d* can be adjusted so as to leave a space *a* between the plane determined by the screws *c* and the point of the screw *d*. This distance *a* is the amount of set on one side of the saw. The method of applying the block is shown in Fig. 8, in which *e* represents the saw.

By adjusting the screw *d* in or out, the amount of set defined by the gauge can be varied.

SURFACING MACHINES.

8. Rotary Planer.—Fig. 10 shows a typical **planing, or surfacing, machine** that is well adapted for work in a pattern shop. The machine shown is carried on a heavy cast-iron base *g* and is provided with a two-part adjusting table, the parts *a* and *d* being separately adjusted by means of the hand wheels and screws shown at *e* and *f*. The portion *a* is so adjusted as to receive the work after it is cut; the table *d* should be adjusted lower, so that the difference in elevation between the two tables represents the depth of cut being taken. The work is held by hand against the

guide *c*. Various special attachments and guides may be used in connection with these planers. They are especially serviceable for truing up and smoothing work. Among the operations that may be easily performed on this style of

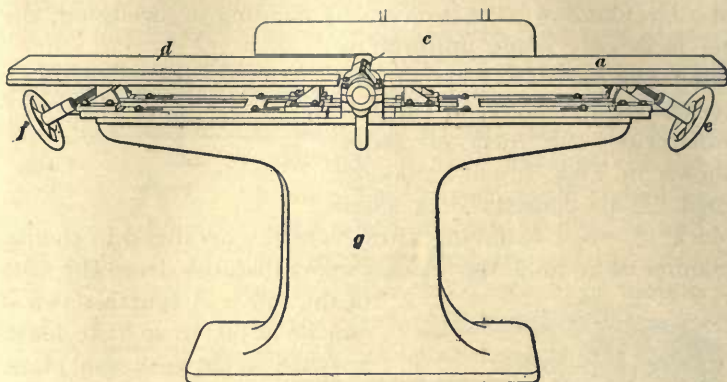

FIG. 10.

machine are chamfering, beveling surfaces, and, to a certain extent, taking a piece out of wind, although owing to the fact that the work is fed over the table by hand, it is impossible to remove entirely the wind with this style of machine.

9. Daniels Planer.— This machine is used almost entirely for taking work out of wind, but differs from the one illustrated in Fig. 10 in that it is provided with a movable bed similar to that of an iron-planing machine. The piece of wood to be planed is secured to this bed by suitable dogs, or clamps, and the work is passed under the rotating knives. These knives are usually rotated in a horizontal plane on the end of a vertical axis. A planer of this kind will take wind out of timber perfectly, since the timber is held rigidly in place while being operated on. The **Daniels planer** is, however, not suitable for work on very thin stock, nor will it answer for the large variety of work performed by the form shown in Fig. 10. Owing to the danger of injury to the workman, by the hands coming in contact with the revolving knives, a guard is frequently provided with this class of machines.

GRINDING DEVICES.

GRINDSTONES.

10. Composition.—Grindstones are simply natural sandstones of such texture that they are suitable for grinding operations. The cutting material is oxide of silicon SiO_2 , or *quartz sand*, as it is commonly called, held in a calcareous or lime cement, or in a silicate bond, which is of such a nature and strength that the dull grains of sand are torn from the stone by friction and fresh, sharp grains uncovered for the work of grinding.

11. Action of Water on a Grindstone.—As grindstones cut more freely when wet, they are generally used with water, which carries off the heat resulting from the friction between the stone and the tool, and washes away any particles of the stone and the steel that are dislodged by the grinding. If these were not carried away, they would tend to fill up the small spaces between the grains of the grindstone, and thus glaze its surface.

Grindstones are softer when wet than when dry; hence, they should not be left standing with only one side in water, as this will cause the wet side to be worn away faster than the other when the stone is again used.

12. Grade of Stone Required for Thin Work. For grinding such pieces as mowing-machine knives or any other pieces having sharp, thin edges that the stone must cut freely in order not to heat the work and draw the temper, it is necessary that the stone be soft enough to wear away with such rapidity as to keep the cutting particles at the grindstone surface always sharp.

13. Tool Rests for Grindstones.—For general tool grinding, a rest is commonly used. A temporary or movable rest, such as a block of wood, is regarded by some workmen as being the most desirable, because in case the tool should catch, the rest would be thrown out, and the

danger of damage to the stone or to the operator would be less than if a solid, permanent rest were used.

14. Grindstone Mountings.—In mounting the stone, it is desirable to use iron flanges, about one-third the diameter of the stone, that are so hollowed on the inside as to bear upon the stone for an inch or more near their peripheries. It is, however, quite common to mount the stone without flanges, in which case the stone has a square hole in its center, and the shaft, which is also square where it passes through this hole, is surrounded by a bushing of wood or Babbitt.

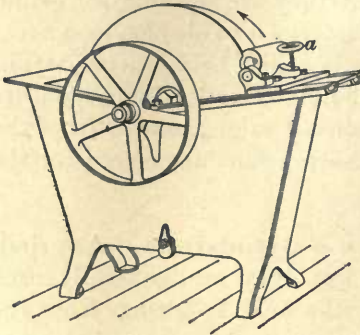

FIG. 11.

Fig. 11 shows a grindstone mounted on a frame that has a trough for water, and also a truing device attached to it.

15. Truing Grindstones.—The truing device shown on the frame in Fig. 11 works automatically, and can be applied while the grindstone is in use and removed when the stone has been trued. It is applied to the face of the stone that moves upwards. By turning the hand wheel *a*, the threaded roll is brought into contact with the stone and kept there until the stone is trued, the water, meanwhile, being left in the trough. When the screw threads become dull, they can be recut. Fig. 12 shows the truing device apart from the frame, *b* being the threaded roll.

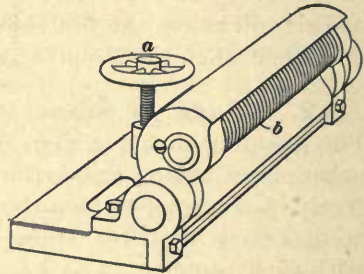

FIG. 12.

All grindstones work out of true, and in the absence of an automatic truing device, the stone is sometimes trued by the use of an old file and a piece of gas pipe, or by using a

piece of gas pipe alone. If the stone is badly out of true, it will be well to turn off the surface with the tang of an old file held firmly on a rest against the face of the stone, as shown in Fig. 13 (a). This will remove the high parts of the stone quickly, but will leave the surface quite rough. A smooth surface may then be produced by turning the face with a piece of gas pipe, the size that is commonly used being $\frac{3}{8}$ inch to $\frac{3}{4}$ inch. The pipe is held on the rest, but

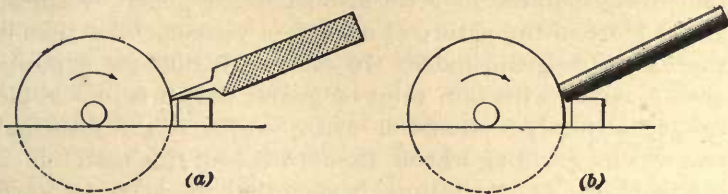

FIG. 13.

rolled across the face of the stone, as shown at Fig. 13 (b). The finishing and turning on the stone is really done by the sand that is cut from the face of the stone and that lodges in the soft iron of the pipe, so that the process is actually that of stone cutting stone. In both cases, the stone should revolve in the direction indicated by the arrow.

16. Speed Used in Grinding Tools.—For tool grinding, grindstones are run at much less than their maximum speed. For machinists' tools, the peripheral speed should be 800 to 1,000 feet per minute; for carpenters' and other wood-workers' tools, 550 to 600 feet per minute. Another rule frequently given is to run the stone at the highest speed at which the water will not be thrown from its face by the centrifugal force. The maximum speed is limited by the safe working strength of the stone.

17. Artificial Grindstones.—A few **artificial grindstones** have been made that have the advantage of being more uniform in texture than natural stones. At the present time, most of the artificial grinding disks are made of emery or corundum, and are generally known as *emery wheels*. They have largely taken the place of sandstones

for grinding, except in some special lines of grinding, particularly where even a little heat injures the work, as in the grinding of glass lenses.

OILSTONES.

18. Composition.—Natural oilstones, like grindstones, are composed of quartz sand SiO_2 , but the grains are finer and are bound together in a different manner. The cementing material or bond in oilstones is generally silica, and is more in the nature of a glass or vitreous bond than is the case with grindstones. In fact, most oilstone deposits are so seamed with thin veins of quartz that it is impossible to get any large stones or slabs, which is the principal reason why grinding wheels are not made of this material.

The nature of the oilstone is such that the particles worn from the stone are best removed, and the stone cuts best, when supplied with oil. Generally speaking, sperm oil is the best grade to be used on oilstones, though a good grade of machine oil can also be used.

19. Kinds and Qualities.—The classes of oilstones on the markets in the United States may be generally divided into Arkansas stones and Washita stones. The Arkansas stones are very fine-grained and appear like white marble. They are used for sharpening the finer grade of instruments, and produce remarkably keen, fine edges. The Washita stones are much coarser in grain, with the color sometimes white, but frequently having a yellow or red tinge. The Washita stone is coarser than the Arkansas and cuts more rapidly, but with greater delicacy than would ordinarily be expected from one having so coarse a grain. The Washita stones are, as a rule, better for sharpening wood-working tools than the Arkansas stones, while the Arkansas stones are used more frequently in the machine shop. The Washita stones can be obtained in larger pieces than the Arkansas stones and are less expensive.

20. Artificial Oilstones.—Artificial oilstones are now on the market. They possess several advantages over the

natural stones. Those sold under the name of *India oil-stone* are composed of a peculiar grade of Indian corundum, and hence have very good cutting qualities. One special advantage is that some stones are manufactured having one coarse face and one medium face, i. e., one half of the stone is of one grade and the other half of another grade, thus giving the advantage of two stones with only one piece to look after. Then, too, the artificial stones can be made in special forms, such as slips, cones, etc., easier than natural stones. The artificial oilstones are also made in any size, and, as a consequence, the larger sizes are not so extremely expensive, as is the case with the natural stones. The artificial oilstones are also made in the form of wheels similar to emery wheels, and either in the form of wheels or flat slips, they can be used with oil or water as a lubricant. At present they are manufactured in three grades—fine, medium, and coarse. The fine grade is approximately equivalent to the Arkansas stones, the medium grade to the Washita stones, and the coarse grade cuts freer and faster than either.

GLUE AND GLUING APPARATUS.

21. Glue.—In wood working, and especially in pattern-making, **glue** is used very largely for adhesive fastenings, although at times small parts, or fillets, may be secured by means of varnish. Much depends on the character of the glue used, especially in patternmaking, because many patterns cannot be nailed or screwed, and as they must be held together while being subjected to the action of damp sand, it is essential that only first-class glue be employed. Many qualities of glue are on the market, including liquid, pulverized, and sheet. The liquid glue is good in quality and very handy for small work, as it is always ready for use. The sheet, or flake form, dissolved and used hot, is, however, preferred for general work. Animal glue is the best; it comes in thin sheets and is the most expensive. As a rule, the best quality of glue is of amber color and has rather thin flakes. Glue should be soaked in cold water before

being placed in the glue pot, but the soaking should never be continued for a great length of time, as it injures the quality. Glue is strongest when freshly prepared, and, if of good quality, may be drawn out into very thin threads. As a rule, the harder the glue, the better it will resist moisture.

22. Glue Pot.—Glue should be used while hot, and that it may be kept in this condition without danger of burning, some form of **glue pot** becomes a necessity. The glue pot is usually water-jacketed; that is, it is surrounded with hot water. Fig. 14 shows a very common and handy

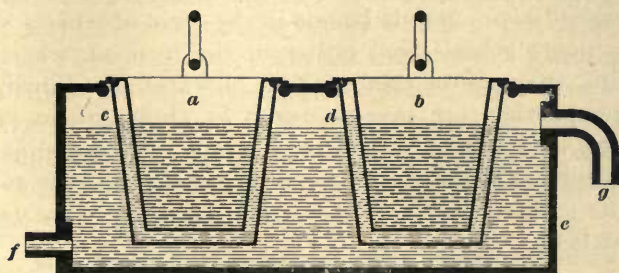

FIG. 14.

device. The two glue pots *a* and *b* are set in two other pots *c* and *d*, with a water space about 1 inch wide between them. The larger pots are so supported that they rest in a bath of hot water in a vessel *e*. A very small stream of steam is introduced through the pipe *f* and the water gradually escapes through the pipe *g*. This device keeps the glue constantly warm and ready for use.

23. Glue Brushes.—Glue is usually applied with an ordinary paint brush, though in cases where a patternmaker can obtain pieces of basswood bark, he can make his own **glue brushes** cheaply. The desired form is cut out of the basswood bark; the brush end is then soaked in hot water and hammered until it becomes soft. Owing to the fibrous nature of the basswood bark, it makes a soft and fine brush, but one that is usually rather short-lived.

24. Precautions Necessary in Gluing.—In gluing two pieces together, the hot glue should be thin enough to spread easily; and if the surfaces to be glued are hot or warm, a better joint may be obtained. Before applying glue to any surface, the latter should be wiped clean of any dust. This is especially true in the case of surfaces that have been prepared by sandpaper, for in this case the dust has probably been rubbed into the pores of the wood and would not allow the entrance of the glue into these pores.

When the end grain of wood must be glued, it is best to give the material a sizing coat first. That is, the end of the grain is coated with glue to fill the openings among the fibers. After the glue has dried, the surfaces are given another coat and are then united. If this is not done, the open grain of the end is liable to absorb the glue so rapidly as to weaken the joint. Immediately after the glue is put on any pieces that are to be glued together, they should be pressed firmly together with clamps and held in this manner while the glue is setting. Plenty of time should be given for the glue to set; in most cases, 10 to 12 hours in a dry place is sufficient.

BENCH WORK.

USE OF TOOLS.

25. Marking.—**Marking**, or **laying out**, consists of locating definitely and accurately the lines to be afterwards used in giving the desired form to any piece of wood. **Marking** a point consists of locating it definitely, which is done by making a V-shaped mark with a pencil, the apex of the V being the required point. Where a number of such points are to be located from a given point, as from the end of a piece, the better way is to measure each one from the end and not to lay it off from the last one marked. When each one is marked separately, there is a chance for only a slight error in each, whereas if each one is laid off from the adjoining one, the error may be so multiplied that the work will not be sufficiently accurate for the purpose for which it was intended.

When the measurement is made on the edge of a piece, it may be marked by nicking the edge with a knife blade. The point made with the end of a pencil is not so reliable as the arrowhead described.

26. Jointing.—**Jointing** a face consists of making it as nearly a true plane as possible. The face that is first jointed is called the *working face*, and the other faces or sides that must be made to fit it are laid off from this one.

In squaring and laying off the piece of stock shown in Fig. 15, for instance, the face *a* would first be jointed and then marked with a cross, as shown at the right-hand end, for a working face. The edge *b* is then made square with *a*, the



FIG. 15.

try square being used to test the right angle, and the edge is made straight from end to end; then *c* is treated in the same way as *b*, and *d* is made straight and square with *b*. The measurements for the lines *e* and *f* are both made from the end *a*, and *g* and *h* from the side *b*, unless the lines are made for a mortise or some such cutting in which they have reference to each other. In jointing operations, one face, or edge, is first jointed, and all the after work of squaring, jointing, and lining is done from this face. For accurate work, the lines used in laying out should be made with a sharp-pointed tool, such as a knife blade or scriber.

27. Common Tools.—The following tools are continually used by the bench worker: The *rule, square and bevel, chisel, plane, saw, and hammer*, and the greatest effort should be made to acquire skill in the use of these. Although this skill cannot be acquired in any other way than by actual use of the tools, some suggestions may assist the beginner in acquiring the correct method, and may prevent him from making mistakes.

28. The Rule.—Very little can be said as to the use of the **rule**, except that its edge should be as nearly as

possible in contact with the surface on which the measurements are being made, and that in making a series of measurements the position of the rule should be changed as small a number of times as possible, for each time the rule is moved there is an additional chance of introducing error.

29. Square and Bevel.—In using the **square and bevel**, shown in *Wood Working*, Part 1, the beam or handle must be held firmly against the face or edge that is used as a guide, and while sufficient pressure must be given to the marking tool to keep it against the edge of the blade and not permit it to follow any irregularities of the grain, there must not be enough pressure to crowd the beam away from the face of the work.

30. Setting the Bevel.—The bevel may be set to any required angle by finding the run and rise that will give the required angle.

To set the bevel, take a piece of board with one edge straight, as shown in Fig. 16 (a), and from this straight edge square the line ab across the face with the try square and scribe, or a sharp pencil, then lay off on the edge the distance bc equal to the run, and along the perpendicular line the distance ba equal to the rise. Then by placing the bevel in the position shown, with the handle firmly against the straight edge, the blade can be adjusted so that the edge

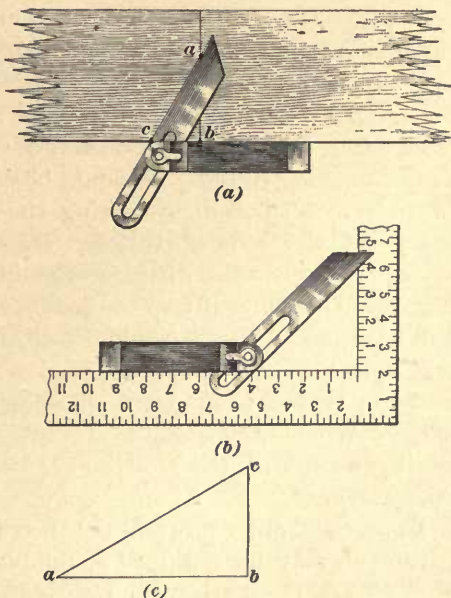

FIG. 16.

coincides with the marks a and c , and the required angle lies between the handle and the blade. When the run is equal to the rise, the angle is 45° , or a *miter*. This adjustment of the bevel may be obtained by the use of the framing square, as shown in Fig. 16 (*b*).

The angles of 30° and 60° , much used in patternmaking, may be found as follows: Joint the edge of a piece of board, and with the scratch gauge mark a line parallel to this edge, as $a b$, Fig. 17. Mark a point c on this line, and with the

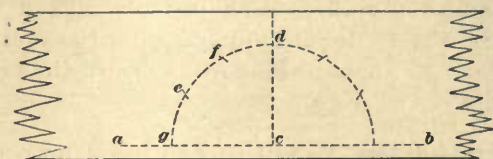

FIG. 17.

try square draw a line cd perpendicular to it. Now setting the dividers to some convenient space, say 6 inches, draw a half circle, as shown, cutting the line ab in g ; without changing the setting of the dividers, put one point at g and mark off f , and in the same way mark off e from d . The distances ge , ef , and fd should be equal; it is a wise precaution to test them by setting the dividers to one of the spaces and checking the others. By placing the beam of the try square in contact with the edge of the board and adjusting the blade carefully to the points c and f , an angle of 60° will be obtained; if the blade is adjusted to c and e , the angle will be 30° . These angles are used in laying out pulley arms and rim segments in patternmaking and in various other ways. When other angles are required, the bevel may be set by means of the protractor, described in *Measuring Instruments*.

In cases where a protractor is not available, the rise for a given run may be obtained as follows: In a right triangle, Fig. 16 (*c*), the horizontal side ab is known by the wood worker as the run, and the perpendicular bc as the rise. The ratio of the length of the rise to the length of the run, that

is, bc to ab , is known as the **tangent** of the angle bac . Similarly, the ratio of ab to bc is the tangent of the angle bca . The tangent of either of the acute angles of a right-angled triangle is the ratio of the side opposite the angle to the side between that angle and the right angle. The word tangent is commonly abbreviated and written \tan . Thus,

$$\tan bac = \frac{bc}{ab}, \text{ and } \tan bca = \frac{ab}{bc}.$$

It is also true that the length of the line ab multiplied by $\tan bac$ is equal to the length of the line bc , or for convenience we may write $ab \times \tan bac = bc$. By referring to a table of tangents, the tangent of any angle may be obtained. Thus, $\tan 30^\circ = .57735$.

We may now assume the condition in which ab is always 10 inches long, and that bc varies for different angles; then when the angle $bac = 30^\circ$, $bc = 10 \times .57735 = 5.7735$ inches, or $5\frac{3}{4}$ inches, nearly.

A complete circle contains 360 degrees, the word degrees being, however, ordinarily represented by the symbol $^\circ$. Thus, 30 degrees is written 30° . The number of degrees contained in one-twelfth of a circle is, therefore, $\frac{360}{12} = 30^\circ$. Thus, in a wheel with 12 arms, the angle between the arms is 30° .

Table I gives the angles corresponding to the divisions of the circle most commonly used by wood workers, and rise for a run of 10 inches, the line adjoining the given angle being taken as the run and the side opposite as the rise.

31. The Chisel.—If, in using the **chisel**, the cut be made along the grain, as shown in Fig. 18 (a), it will be very difficult to prevent the wood from splitting ahead of the cutting edge. This difficulty may, however, be largely overcome by cutting across the grain, as shown in Fig. 18 (b). The chisel is held with the flat face upon the wood, and very light cuts are taken, the edge of the chisel at the same time being given a sidewise movement so that it will make a shearing cut.

TABLE I.

NOTE.—In this table the *angle* represents the acute angle adjoining the *run*.

Divisions of Circle. <i>A</i>	Angles in Degrees = $\frac{360^\circ}{A}$. <i>B</i>	Tangent of Angle <i>B</i> . <i>C</i>	Rise in Inches for a Run of 10 Inches, to Nearest 64th Inch, = $C \times 10$.
5	72° 00'	3.07768	30 $\frac{2}{3}\frac{5}{2}$
6	60° 00'	1.73205	17 $\frac{5}{16}$
7	51° 26'	1.25417	12 $\frac{3}{8}\frac{5}{4}$
8	45° 00'	1.00000	10
9	40° 00'	.83910	8 $\frac{2}{6}\frac{5}{4}$
10	36° 00'	.72654	7 $\frac{1}{6}\frac{7}{4}$
11	32° 44'	.64281	6 $\frac{2}{6}\frac{7}{4}$
12	30° 00'	.57735	5 $\frac{2}{3}\frac{5}{2}$
13	27° 42'	.52501	5 $\frac{1}{4}$
14	25° 43'	.48163	4 $\frac{1}{16}\frac{3}{6}$
15	24° 00'	.44523	4 $\frac{2}{6}\frac{9}{4}$

EXAMPLE.—Set the bevel for the angle between the arms of a wheel with 9 arms.

SOLUTION.—Assuming a run of 10 inches, lay off a rise equal in length to the number of inches indicated in the last column, opposite the number 9 in the first column, which is 8 $\frac{2}{6}\frac{5}{4}$ inches. A line drawn through the ends of the run and rise will indicate the angle to the run, at which the bevel should be set. The angle thus obtained will be the angle between the arms of the wheel.

When it is desired to remove only the corner, the stock may be cut away across the grain, as shown in Fig. 18 (*c*). By marking lines along the side, top, and end of the wood, showing the depth to which the cut is to be made, and using the corner of the chisel as shown, the stock may be safely and rapidly cut down, and the finishing can be done as shown in Fig. 18 (*b*). In all cuts intended to produce a finished surface, it is better to rest the chisel on the face than to try

to work with the bevel side down and to depend on one's skill to guide it.

When making holes, such as mortises, with the chisel, it is well when possible to bore auger holes in the wood first, and to finish the opening with the chisel. Whether this be done or not, the edge of the chisel should be placed square across the grain of the wood when making the cut. In doing this kind of work, the mortising chisel and mallet

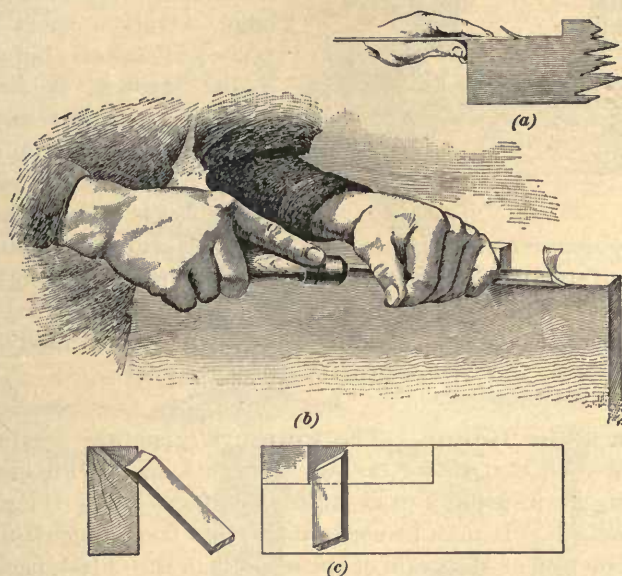

FIG. 18.

are used, instead of the lighter chisels. The chisel edge is set slightly back of the line to which the cut is to be made, with the face toward the line, and is then struck with the mallet. It is next turned around and a series of light cuts taken toward the other end of the opening to be made, as shown in Fig. 19, in which *a* shows the first position of the chisel and *b* the reversed position for the cuts that follow. At each stroke, after the chisel has been driven into the wood, it is bent back to the

position shown by the dotted outline *c*. With hard wood, it is better to start the mortise with a V-shaped opening, as

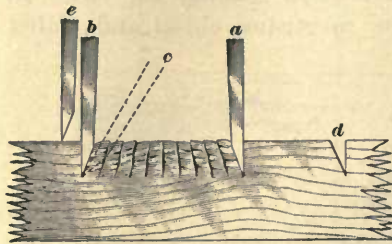

FIG. 19.

shown at *d*, by making the second cut start toward the first, instead of depending on crushing the wood at the first stroke. Bending the chisel backwards might break off the edge. Only a short distance is taken between mallet strokes, as shown by the positions *b* and *e*; the distance between cuts and the depth to which the chisel is driven depend

on the character of the wood and the form of the chisel. The strain on the chisel should not be nearly enough to break it. The cuttings made in this way are removed and the sides of the hole trimmed with the chisel used as a paring tool, and without the use of the mallet.

32. The Gouge.—The **gouge** is generally used as a paring tool, that is, for taking light cuts, as in whittling or planing or in using a draw-knife, the bevel being the guiding surface. It may be used much more freely in cutting in the direction of the grain of the wood than the chisel, because there is less tendency for the wood to split ahead of the cutting edge. This is due to the form of the edge, which leaves the fibers of the wood in such shape that they support one another better.

33. The Saw.—The handle of the saw should be grasped lightly and easily, with the forefinger extended along the side, as shown in Fig. 20. The general tendency when first using the saw is to hold it too tightly and to depend too much on the muscles of the arm to give it movement and direction. The general position of the workman

when using the ripping saw is shown in Fig. 20. As the saw cuts during the time when it is being pushed away from the workman, the tendency at first is to press the teeth forcibly into the wood during this part of the movement. This is unnecessary, as it does not increase the cutting speed and makes it difficult for the workman to guide the saw properly.



FIG. 20.

By grasping the saw lightly, in fact, in what seems at first to be a loose manner, and putting no more pressure on the teeth than comes naturally with the back-and-forth movement of the body, the best results in the way of speed in cutting and guidance are obtained. By observing an expert workman

using the saw, it will be seen that the force is applied in such a way that the movement seems to be that of leaning against the saw rather than that of forcibly pushing it.

In starting to make a cut, the left hand grasps the wood and the thumb of the left hand guides the saw, as shown in Fig. 21. The right shoulder is directly in front of the



FIG. 21.

cut, so that the saw handle can be moved back and forth in a plane perpendicular to the face of the work and thus have a tendency to make the cut in that line, directly from the shoulder and with the least possible expenditure of strength. The stroke should be as long as possible, and all the teeth in contact should press with the same amount of force. When the teeth are in the proper place, on one side of the line to which it is desired to saw, the cut is started by drawing the saw toward the operator, as this gives a groove of sufficient depth to keep the saw in place. The cut is made along one side of the marked line, and just touching it; with a wide penciled line or a chalk line, this leaves enough of the mark on the stock to serve for a *witness*.

At times, the saw may tend to run off the line, or the cut may not be perpendicular to the face of the work. In the first case the blade should be twisted gently, so as to change the course to the proper one; in the second case, the blade is first brought from the angle that has been found most convenient to a position in which the line of the teeth is perpendicular to the face of the work, then with the blade in this position it should be bent to the side necessary to correct its line of movement. The position of the blade should be tested occasionally with the try square, until the operator can judge the angle with sufficient accuracy.

It should be noted that the more nearly the line of the saw teeth is perpendicular to the face of the work, the smaller is the number of teeth that are actually cutting and the smaller is the effort required to do the work. This is true of both the ripping and the cross-cutting saws. By lowering the handle and putting more teeth in action, the workman will find that his labor is increased, as the effect is then the same as if he were cutting through thicker stock. The precise angle that will be best for a workman to use depends on his height and other physical qualities, and must be determined by trial; in general, however, the more nearly upright is the position of the saw, the less will be the effort required to do the work. An angle of 45° with the surface of the work may be taken as a good angle for ripping saws.

In using the cross-cutting saw, lines that serve as guides in making the cut are usually drawn across two adjacent faces of the work. In using the ripping saw, where there is a great deal of work to be done, expert workmen often use both hands on the handle.

34. The Plane.—The beginner will generally experience more difficulty in getting a satisfactory planed surface than in doing any other piece of bench work. It being so much easier to plane at the ends of a piece of wood than at the middle, there is a tendency to reduce the ends too much. To overcome this difficulty, the beginner is sometimes

directed when planing a long edge straight, or planing a board to a plane, to try to make it hollow at the middle.

Again, in jointing an edge, to make it square with the side, the ability to hold the plane square across the edge is only acquired after considerable practice, and the beginner must depend on frequent tests with the try square to keep his work right.

In using the jack-plane, the object is to reduce the surface rapidly from the rough condition in which it was left by the saw teeth to a comparatively smooth one, or to cut off high places that can best be reduced in this way. The plane iron is made to project as far beyond the sole as the condition of the work and the strength and endurance of the workman will allow. If it projects too far, the plane will chatter when in use, and the surface left will be too rough. The amount of projection, therefore, depends on the character of the wood, as well as the strength of the operator. With the smooth plane and the jointer, the projection of the iron is much less, the object being to produce a smooth, straight surface. When it is desired to produce a large smooth surface, the projection is made very slight.

Plane irons are given somewhat different shapes at the edges, but they should never be allowed to project farther on one side of the sole than on the other. When the iron is being adjusted, the amount of projection can be observed by looking along the sole from the front to the back. If the iron is higher on one side than the other, it can be adjusted in some planes by means of a lever that is provided for the purpose. It is usually adjusted, however, by tapping the end of the iron nearest the handle of the plane to one side or the other with a hammer until the proper projection is obtained.

35. The position of the operator when starting a cut is shown in Fig. 22. The left hand is placed on the front end of the plane stock, and as the plane is pushed forwards with the right hand, the left keeps the cutting edge pressed into the wood. The stroke is started from the position shown.

and by exerting a pressure against the plane with the right arm, it is pushed to the position shown in Fig. 23 at the end of the stroke. The plane is lifted slightly at the rear end, so that the edge may rise gradually out of the wood, instead of finishing the stroke at the full depth of the cut, as in that case the shaving would not be cut off clean. The slight lifting movement of the right hand, which accomplishes this, is a natural and easy one.



FIG. 22.

In drawing back the plane for a new stroke, if the surface is clean and smooth, it is necessary only to relieve the pressure of the left hand, and although the contact of the edge with the wood on the return movement tends to dull it

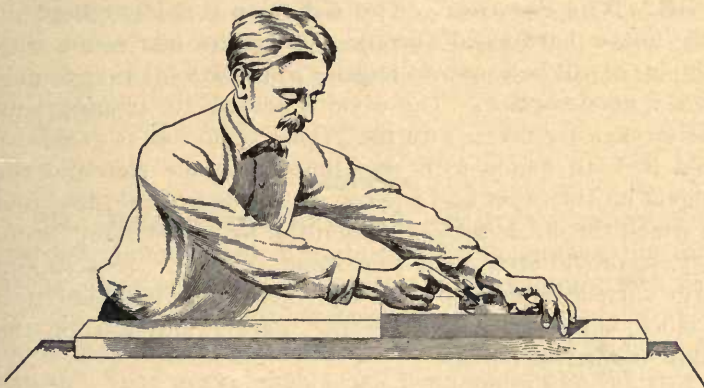

FIG. 23.

slightly, the time and care required to sharpen it is less than would be required to adjust the plane properly at the

beginning of each stroke if it were raised so as to bring the edge out of contact. If, however, the work is rough or gritty, it is better to raise the edge out of contact during the return stroke either by tilting the plane slightly on the outside corner of the sole, or by lifting the back end.

In planing a narrow surface, as the edge of a board, the position of the left hand, shown in Figs. 22 and 23, would not steady the plane sufficiently, and it is changed so that the thumb rests on the top and the palm of the hand against the side of the stock. The tips of the fingers extend beyond the bottom of the plane and touch lightly the side of the work. The plane is thus kept in a position in which it will remain on the edge of the board and can be kept square with the side.

One of the difficulties encountered in planing is the clogging of the shavings in the mouth of the plane. This is usually due to the parts not being properly adjusted when they are put together after sharpening the iron. The cap may not fit closely against the iron, or the cut may be too heavy to allow the shaving to pass freely through the mouth. In either case the trouble is easily remedied by readjusting either the cap or the iron, or both. It must be remembered, however, that too wide an opening tends to produce rough work.

36. The Scraper.—The **scraper** is seldom used on any but a hard-wood surface. While its use seems very simple, it will be found to require some skill in order to produce a good surface. The wood is held as for planing, and the strokes are taken with the grain. The tool is generally held in both hands with the thumbs on one side and the fingers on the other and the top edge tilted in the direction in which the cut is taken. When the tool is working properly, it should produce a thin clean shaving. In scraping large surfaces, like a counter top, the scraper is mounted in a stock, shown in *Wood Working*, Part 1, and used in the same manner as a plane.

37. Sandpaper.—When a surface is planed or scraped, it will be found to have minute fibers projecting from it; these are usually removed by the use of sandpaper. The

paper should be fastened to or wrapped around a block of wood, similar in shape to the surface to be dressed. The direction of motion of the sandpaper should be with the grain. It will be found that if the strokes are parallel and light, a very smooth surface can be produced, but if the strokes are not parallel, the appearance of smoothness is lost.

Sandpaper should not be used to take out irregularities in a surface. This should be done with a plane or scraper, the sandpaper being used only to remove the projecting fibers. A few strokes should be sufficient, as prolonged use tends to produce unevenness and to offset the good results of the first few strokes.

38. The Hammer and Other Tools.—In using the hammer, the tendency at first is to grasp it too tightly. The grasp should be firm enough only to direct the blow properly. The speed of movement of the head of the hammer should be the means of giving force to the blow, rather than the force conveyed directly by the arm. In using the hammer to withdraw nails, the head should not be in direct contact with a finished surface; a piece of board or a block should be placed between them to prevent injury to the surface. This will also assist in withdrawing the nail.

No directions are needed for the use of such tools as the brace and bits or the screwdriver, except that the axis of rotation of the tool must coincide with the axis of the hole or screw.

JOINTS.

39. Preparation of Stock.—A large measure of the success in making good joints consists in getting the faces to be joined straight and having the sides square with each other. In getting out the material in the first place, allowance must be made so that every part can be properly finished. Four pieces, each 1 foot long, cannot be cut from a piece of stock 4 feet long; enough stock must in each case be allowed for cuts and finish. Care must, however, be taken not to waste more stock than is necessary. A good

workman will always cut his stock so that there will be as little waste as possible, and his ability in this direction is frequently taken as an indication of his value as a workman.

Two pieces may be joined edge to edge, as on a table or counter top; at an angle, as in drawers and boxes; and in frame joints, as in making house frames, doors, and similar work.

40. Plain-Edge Jointing.—In **plain-edge jointing**, the edges are simply made straight and square with the sides. Where two long pieces are joined, as in a counter top, a shaving is taken along the middle of the edges after they have been made straight and before they are fastened together, so that they are very slightly hollow. Before they are glued, the edges should be tried together by placing one in the vise and resting the other on it so that the edges come together as in the finished product. By looking through the joint, toward the light, any imperfections may be seen. If the edges are not square with the sides, this will be apparent, and by moving the upper piece back and forth, lengthwise, a few inches, a peculiar resistance to the motion will be noticed when the joint is good.

When fastening such a joint with glue, the latter should be applied hot, and if the edges are warmed, a better adherence is obtained, as the glue is not chilled when it touches the wood. When the edges are brought together, one should be moved back and forth upon the other, lengthwise, a few inches, so as to distribute the glue properly and insure a good contact along the entire length. The two pieces should then be clamped together for 4 or 5 hours, and no strain ought to be put on them for a day.

When such a joint is made on a piece of furniture, it is customary to glue strips of wood along the back to strengthen the joint. These strips, or blocks, should have the grain running in the same direction as the pieces they join.

When dowels are used, the holes are laid off by putting the edges together and making a series of marks at the places where the dowels are to be located, usually about 18 or 24 inches apart. The two pieces are then separated

and lines drawn square across the edges from these marks by means of the try square. The centers of the dowel-holes are then laid off from the face of the board by means of the scratch gauge and holes are bored with an auger bit, the depth being usually made about 1 inch. If the holes are not bored perpendicular to the edge of the board, or if the corresponding holes are not exactly opposite each other, the joint will not be a good one. Better results can usually be obtained by reaming the edges of the holes slightly.

The pins or dowels are driven into the holes with a little glue, and cut off to the proper length with a saw. The ends of the dowels are next rounded with a rasp, and glue applied to them and to the edge of the board into which the dowels have not yet been driven. The edges are then brought together and clamped and the glue allowed to set.

Several types of edge joints commonly used are shown in Fig. 24. In (a) is shown a plain **butt joint**, in which the edges are simply jointed and glued together; in (b), (c), (d), (e), and (f) are shown other edge joints, known as **tongued joints**. For these styles of joints the edges of the boards are usually shaped in a planing mill, although occasionally they must be planed by hand; in order to be prepared for such an emergency, there is in the bench worker's kit a plane, or pair of planes, by means of which the edges may be given the desired shape. These planes are called the **tongue-and-groove planes**; they are often combined in one plane. The tongue may be made on one edge and the groove on the other, as shown in Fig. 24 (b), (c), (d), and (e), or both edges may be grooved and the tongue made as a separate

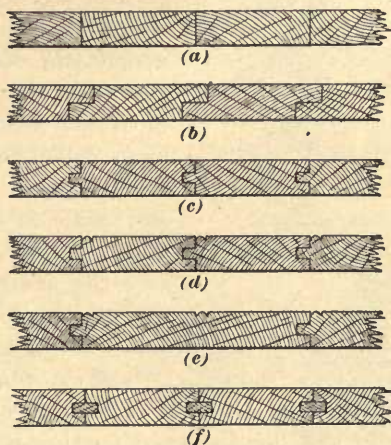

FIG. 24.

piece and inserted, as shown in (*f*). When the tongue is separate from both boards, it is called a **feather** or **fillet**.

The **beads** shown in (*d*) and (*e*) are made beside the joint, so that where shrinkage takes place the opening thus caused will be matched by another one, or a *quirk*, as it is called, on the other side of the bead, thereby making it less noticeable. Joints made in this way are said to be **matched** and **beaded**. All these joints but the one shown in (*a*) allow for shrinkage without leaving an opening.

41. Corner Joints.—In Fig. 25 are shown some of the more common forms of joints by which two pieces of wood are joined at right angles to each other. At *a* is shown the ordinary **butt joint**, the pieces being fastened together with nails or screws. The form shown at *b* is a modification of this, in which there is greater strength and a better appearance; this is further modified as shown at *c*, in which the corner is rounded where the end grain would show. This joint is used in cabinet work, where the end grain is to be in evidence as little as possible. At *d* is shown another form in which an end of one piece is halved and *housed* into the other, giving a strong and stiff joint, and at *e* the same idea of housing is carried further, giving a strong joint, but one

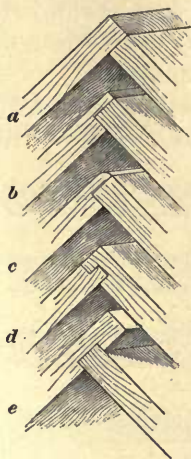

FIG. 25.

that, because of the projecting end, is unsightly.

The strongest and stiffest joint of this kind is the **dove-tail joint**, Fig. 26 (*a*). The joint is made by first laying out the piece *a*, then cutting it to shape, and using it as a templet to mark *b*. In laying out *a*, the line *ef*, Fig. 26 (*b*), is first marked, the distance from the end being equal to the thickness of *b*. Next the ends *d* of the lines are laid off and squared across the end, as shown. The bevel is then set to the desired taper, usually 3 inches to the foot, and the lines for the sides are marked back from *d* to the line *ef*.

One method of removing the stock in the openings is to first bore holes near the bottoms, as shown at *c*, Fig. 26 (*b*),

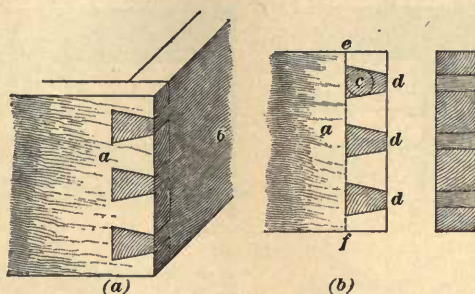

FIG. 26.

and then cut out the remainder with a chisel. When the piece *a* is finished, it is used as a templet in marking the end of *b*; from these marks on *b* lines are scribed with a try square to meet a line that is marked a distance back from the end of *b*, equal to the thickness of *a*, which corresponds to the similar line that was marked on *a*. The piece *b* is then cut along the lines that were made on it with a back saw, the cut being carefully made inside the line, so that the stock left will fill the openings in *a*. The stock between the saw cuts is then removed with a chisel. When pieces *a* and *b* are fitted with sufficient accuracy, they are put together with glue.

A modification of this joint, which is generally used on drawers and other places in which one of the pieces joined must have an unbroken front, is shown in Fig. 27, and is called the **drawer dovetail**.

Another form of joint used in making corners, shown in Fig. 28 (*a*), is called a **miter joint**. Modifications of this joint are shown in Fig. 28 (*b*), (*c*), and (*d*). Fig. 28 (*b*) illustrates a method of strengthening the joint, by sawing into it at an angle, as shown, and

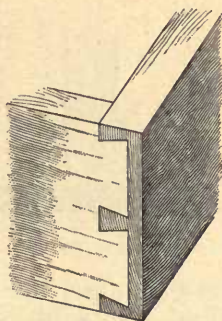

FIG. 27.

inserting a thin strip of wood, which is glued into place. In Fig. 28 (c) a feather is inserted, as shown, which also

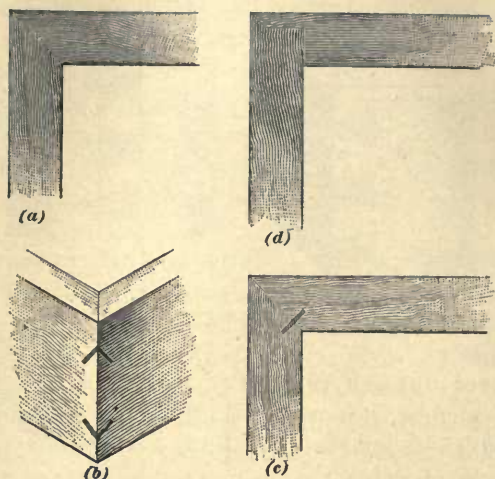

FIG. 28.

assists in strengthening the joint. Fig. 28.(d) is a combination of the joints shown at b, Fig. 25 and Fig. 28 (a).

42. Mortise-and-Tenon Joint.—The most common joint used in framing doors and bench framing generally is the **mortise-and-tenon joint**, shown in Fig. 29. The method of construction is quite similar in all the joints of this description, and that used in making the mortise-and-tenon joint can be modified so as to be applicable in any of the others.

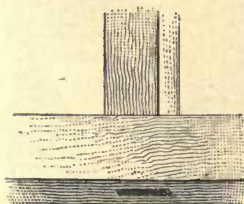

FIG. 29.

In Fig. 30 (a) is shown the piece in which the mortise is to be made, and in Fig. 30 (b) the one on which the tenon is to be formed. Let *a* and *b*, Fig. 30 (b), be the working faces. From the end of the piece measure the distance to the center of the mortise and scribe the line *c* square around the piece. Now, lay off lines *d*, *d* on each side of *c*, so that the distance *c d* is

equal to one-half the width of the tenon, and scribe lines square around the piece, as shown at *d, d* and *e, e*. In Fig. 30 (*b*), lay off the line *g*, to indicate the length of the

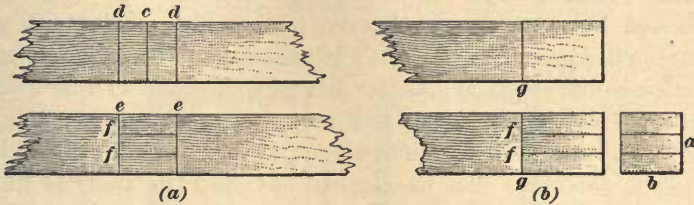

FIG. 30.

tenon, and with the scratch gauge mark the lines *f, f* from the working face on both of the pieces, to indicate the thickness of the tenon and the width of the mortise. As

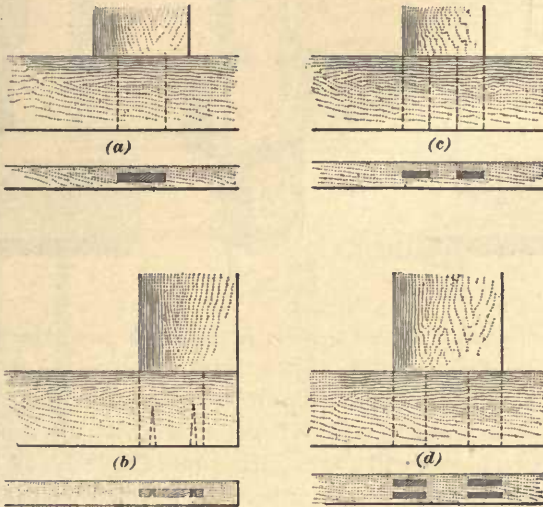

FIG. 31.

the mortise and tenon have both been laid off with the same gauge setting, when they are cut to shape the working face of each piece should come even with the working face of the other.

The mortise is cut by means of a chisel of the same width as the tenon. Beginning near the middle of the mortise, the workman cuts first to one end and then to the other in the manner illustrated in Fig. 19. The chisel should always be loosened by drawing the handle backwards. After a few lighter cuts have been taken, the chisel may, when working in the ordinary soft woods, be driven to a depth of 1 inch or more. The mortise is cut half way through from one side, then from the other. When the mortise is cut through roughly, the chips can be cleaned out, and the mortise finished with the chisel used as a paring tool.

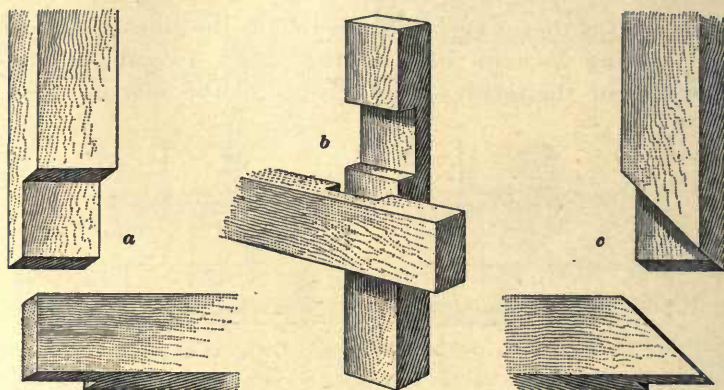

FIG. 32.

The tenon may be cut out with the back saw, the saw cut being made close enough to the lines to leave the work in a finished condition. The tenon is generally made longer than necessary and the end beveled slightly all around, so that the two pieces will slip together more readily. When the two parts have been put together, the beveled part is cut off.

When the tenon does not go quite through, the mortise being made to go only part of the distance through the piece, it is customary to make the mortise slightly wider at the bottom than at the top, and the end of the tenon is split with the back saw and a wedge inserted in such a manner that when the tenon is driven home the wedge will spread

the end and fasten it in place. The wedge and tenon are in this case covered with glue.

The application of the mortise-and-tenon joint to the

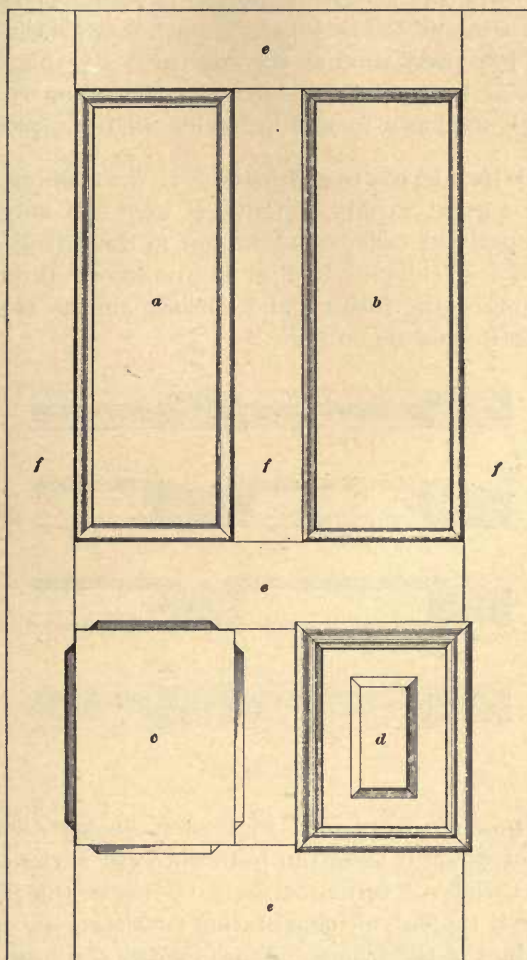

FIG. 33.

framing of cabinet work of the kind ordinarily done on the bench is shown in Fig. 31 (*a*), (*b*), (*c*), and (*d*). The method

of laying out the joints shown is nearly the same as in the case of the joint just described. The center of the mortise is found and the ends laid out, half on each side, and the distance of the sides from the face of the stock marked with the scratch gauge. The tenon is marked with the scratch gauge at the same time as the mortise. By this means a good fit may be secured. Sometimes the tenon is finished first, and is used as a templet in laying off the mortise.

43. Other Framing Joints.—In the framing of cabinet work, a great variety of joints is used, not only in what might properly be called a frame, but in the fitting of parts that are not so called. In Fig. 32 are shown three of the framing joints, the forms *a* and *b* being almost as common as the mortise-and-tenon joint.

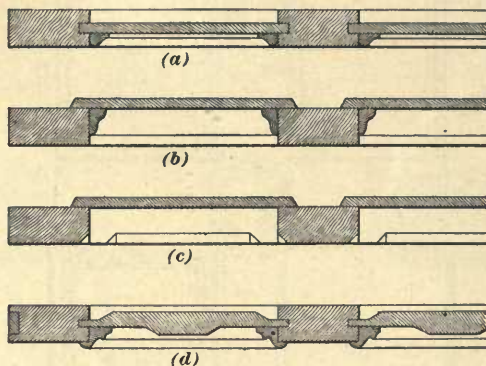

FIG. 34.

44. Door Panels.—In Fig. 33 is shown a door, the paneling of which is shown in four different styles, to illustrate the variety of forms in use. Of these, the panel *c* is the plainest, the only ornamentation consisting in chamfering the edges of the frame. At *a* is shown the form in ordinary use; *b* is constructed to give the appearance of depth to the frame; and *d* is the most elaborate. Fig. 34 shows the construction of these four panels, the letters being made to correspond with those in Fig. 33.

45. Door Frames.—The **door frame**, Fig. 33, is made with mortise-and-tenon joints. In the frame the upright pieces *f* are called **stiles**, and the horizontal pieces *e* are called **rails**. When the ends of the tenons extend through the frame, the ends are covered in the better qualities of doors by a strip, which is let in as shown in Fig. 34 (*d*).

WOOD TURNING.

TOOLS AND EQUIPMENT.

WOOD-WORKER'S LATHE.

1. Introduction.—Nearly all the circular forms that are required in patternmaking, or other constructive work, are obtained by placing the piece to be shaped in a lathe and cutting it to the desired form while revolving at a high speed. This operation is known as **turning**. Occasionally the circular form is given by sawing, or by dressing with planes or other tools, but these methods are inaccurate and comparatively expensive. In turning, the piece of wood is rotated about an axis by means of a rapidly revolving spindle, to which it is securely fastened. A high speed is necessary in order that a smooth surface may be made, as a high cutting speed will give a smoother cut in wood than a slower speed.

There are two distinct ways in which wood is turned: first, along the grain; second, across the grain, sometimes called *plankwise*. By the first, the usual cylindrical and irregular shapes, as balusters, are made; and by the second, circular disks and thin parts of large diameters are turned.

The tools used in wood turning are a lathe, such as is shown in Fig. 1, and some especially shaped chisels and gouges and measuring tools. The kind of tool or quality of lathe is, however, not so important a factor in good turning

as is the skill of the workman. Very fine work is sometimes done on a block of wood held between two pointed nails,

and made to revolve by drawing back and forth a string that is wrapped around it. The workman should, whenever possible, provide himself with a good lathe and a variety of chisels and gouges. The lathe is usually made of iron, although it is not unusual to find the bed, or shears, made of wood, because of the lower cost.

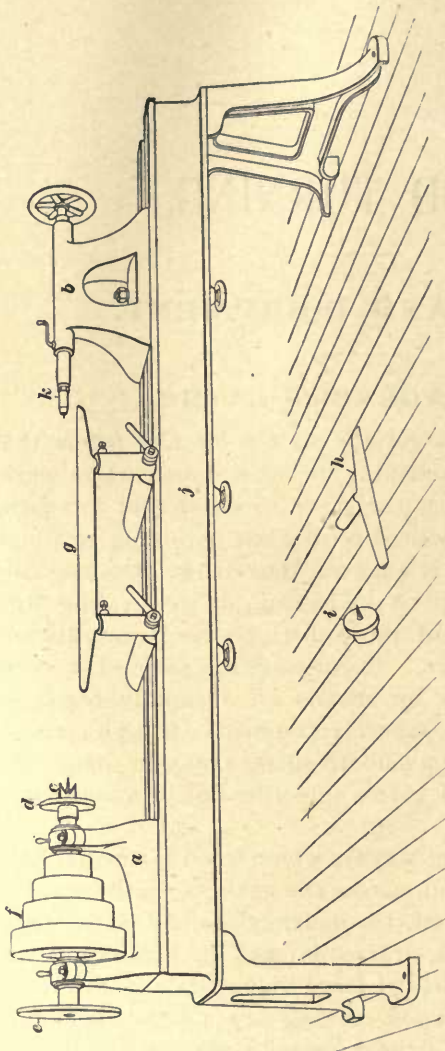

FIG. 1.

2. Description of Lathe and Names of Parts.

In the lathe shown in Fig. 1, *j* is the bed. In large lathes, this part is frequently made of wood, when it is called the *shears*; it is supported on legs, and serves as a support for the headstock *a*, the tail-stock *b*, and the

rest *g*. The headstock is fastened firmly at one end of the bed, and with the tail-stock forms the support for the part

which is being turned. The tail-stock is adjustable along the bed to suit the length of the wood, and the rest is adjustable both along and across the bed and as to height, to suit the different conditions necessary to support the cutting tool properly.

3. The Headstock.—The **headstock**, shown in section in Fig. 2, consists of an iron casting *a*, fitted with two

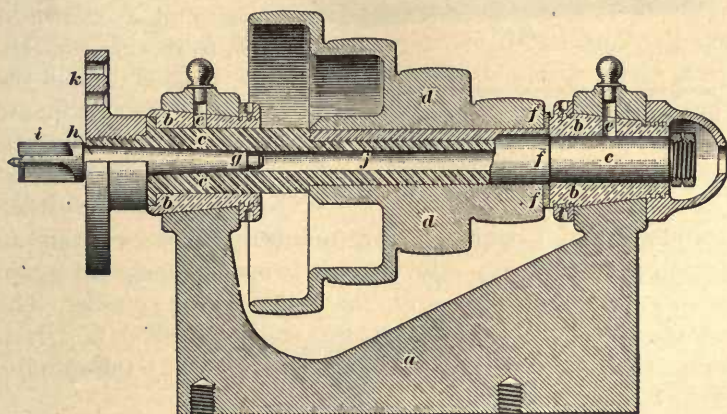

FIG. 2.

gun-metal bearings *b, b*. These bearings support a hollow spindle *c*, which is made to revolve by means of a belt on the cone pulley *d*. The speed of the spindle is regulated by shifting the driving belt to the different steps on the cone pulley. In shifting the belt to a larger step on the upper cone, it must first be moved to the smaller step on the lower cone, as shifting to the larger one first will stretch, and possibly break, it. The bearings for the spindle should be kept well oiled, provision being made for this by the oil holes *e*, while the spindle should revolve at such a rate that a surface speed of from 1,200 to 1,500 feet per minute will be obtained at the point at which the turning is done. This may be exceeded where small solid pieces of stock are being turned and there is little danger of the work breaking or flying off the fork, or chuck.

The general construction of the headstock is evident from Fig. 2. It will be seen that the end thrust of the spindle is

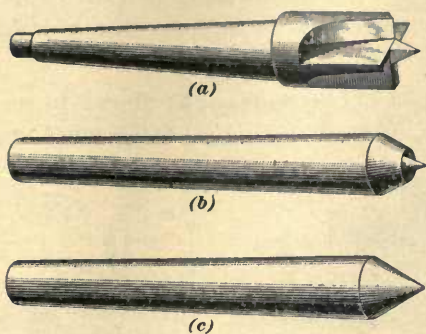

FIG. 3.

received on a shoulder at *f*. The spindle is made hollow, a hole being bored through it, which is made to taper slightly at its front end, as shown at *gh*, to receive the center *i*, used to hold the work. The tapered form is given to the center so that the pressure of the tail-stock

spindle, which is transmitted through the work, will tend to fasten it more firmly, and so that it may be loosened again with a rod inserted through the hole *j* in the spindle. The center *i* has a forked form at the end; the wood is driven on to this fork and thereby made to revolve with the spindle. This fork center is shown in Fig. 3 (*a*).

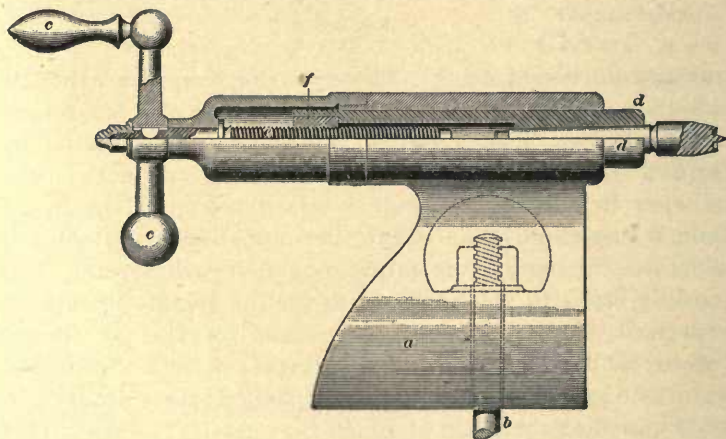

FIG. 4.

4. The Tail-Stock.—The work is held in place on the headstock center, and supported at its other end by the

tail-stock, shown in Fig. 4. An iron casting *a* is fitted to slide back and forth on the shears, and held in any desired place by means of the clamp bolt *b*. The upper part of this casting is bored for the tail-stock spindle *d*, and the parts are made so that after a rough adjustment to the work has been made and the tail-stock clamped on the shears, a further adjustment can be made by turning the handle *c* and advancing the spindle *d*, by means of the screw *e*, which runs in a nut *f*. The centers ordinarily used in the tail-stock are shown in Fig. 3 (*b*) and (*c*), and are called *cup* and *cone centers*, respectively. An eccentric clamping device is frequently used for clamping the tail-stock of small lathes upon the bed. By this device the tail-stock may be clamped, or released, instantly, by the simple motion of a short lever. It does, however, not hold it as securely as a screw clamp.

5. The Rest.—The **rest** shown in Fig. 5 is used to support the tool during the turning operations. The casting *a*,

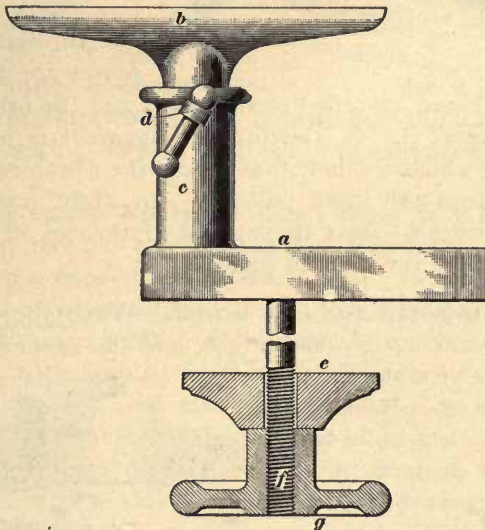

FIG. 5.

which reaches across and rests upon the bed of the lathe, supports the tee *b* by means of the vertical sleeve *c*, into

which the shank of the tee is made to fit. The height of the tee may be adjusted by means of the screw and handle *d*.

The rest may be moved to any desired position between the headstock and the tail-stock, and clamped in any position by the clamp *c*, which is operated by the screw *f* and hand nut *g*. An eccentric clamping device is frequently used for the tool rest, as well as the tail-stock. A double rest, which is very convenient for long work, is shown at *g*, Fig. 1, the single rest being shown at *h*.

6. Countershaft.—The lathe is usually provided with a **countershaft**, shown in Fig. 6, through which power is transmitted to it.

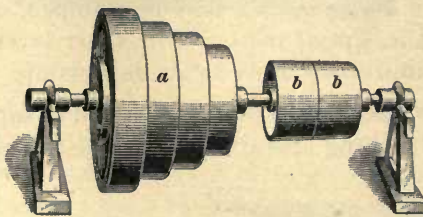

FIG. 6.

On this countershaft is a cone pulley *a*, which forms a pair with the one on the headstock spindle, and two pulleys, shown at *b*, the one through which the power for the lathe is

received being fastened to the shaft, and the other turning loosely upon it. A shifting arrangement is provided, by means of which the belt that drives the countershaft can be shifted from the loose pulley to the tight one when the turner wishes to start the lathe, and thrown off when he is through with the work in hand.

7. Supports for the Work.—When the piece to be turned is of considerable length, and the grain of the wood lies in the direction of its length, it is placed between the headstock and tail-stock centers and is held by them during the operation; but when it is of the form of a disk, or wheel, it is fastened, by means of screws, to an iron plate, shown in Fig. 7. This plate is fastened to the end of the

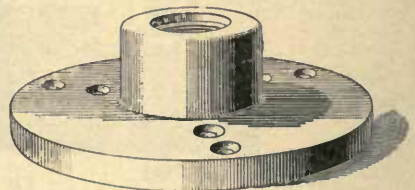

FIG. 7.

headstock spindle, as shown in Fig. 2, by means of a screw formed upon the end of the spindle for that purpose. Some lathes have screws and face plates on both ends of the headstock spindle, as shown at *e*, Fig. 1, so that any piece of work that is too large to be turned over the lathe bed may be attached outside of the end of the lathe and turned in the usual way. In that case, a special support for the tool of the form shown in Fig. 8, called a floor rest, is used. When the diameter of the work is just a little larger than a lathe will swing, the headstock and tailstock may be blocked up so as to receive it. If the piece is much too large, however, it is not wise to attempt to increase the swing of the lathe in this way, as the spring may be so great as to cause trouble.

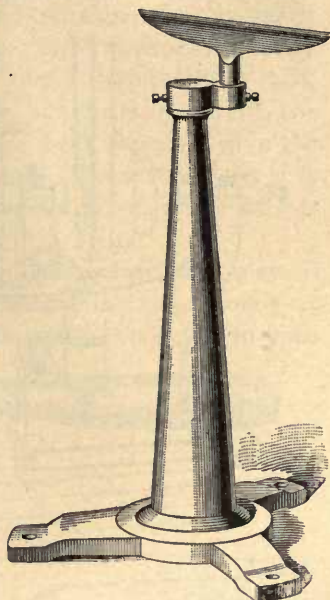

FIG. 8.

8. Face-Plate Lathe.—When there is much large work to be done, a special lathe, of the form shown in Fig. 9, called a **face-plate lathe**, is used. In this form, the lathe is supported on a heavy base *a* and is provided with a short, rigid shaft running in bearings *b*, *b*. Power is furnished by a belt running on the cone pulley *c*. On the end of the spindle is placed an iron face plate *d*, to which are screwed boards, which are then turned off to form a wooden face plate of larger diameter. The work to be turned is bolted or screwed to this large wooden face plate. Turning tools are used over the hand rest *g*, which, in this case, is carried by a support *h*, which is pivoted at *i* so that it can be swung away from the front of the lathe. This bridge, or support, is provided with a leg *j*, which can be adjusted

directly beneath the rest *g*. When turning very large work,

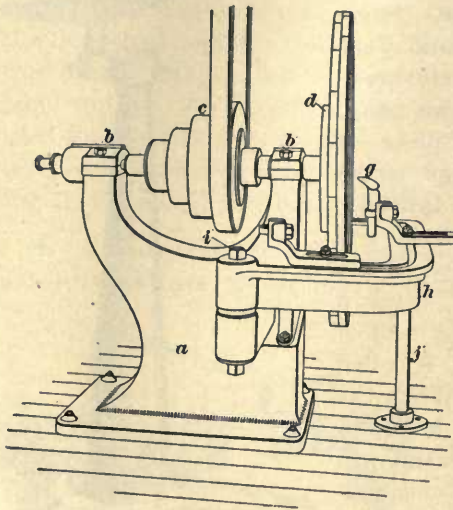

FIG. 9.

or work that projects some distance from the face plate, it is frequently necessary to swing the arm *h* out of the way, and to arrange a temporary rest on a wooden horse, or to use a floor rest, of the form shown in Fig. 8. Every pattern shop where work of any size is done should be provided with one or more of these faceplate lathes.

TURNING TOOLS.

9. Chisels and Gouges.—In wood turning, the cutting is done by means of chisels and gouges of different forms, each form being adapted to a special class of work. The

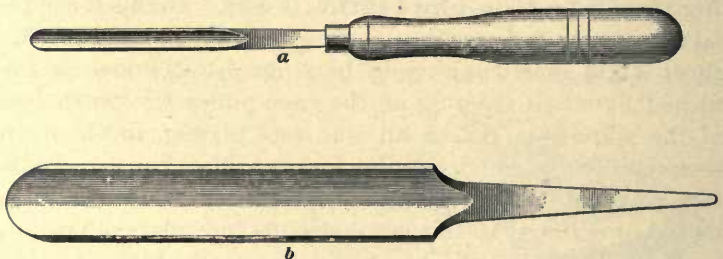

FIG. 10.

gouge shown in Fig. 10 is used for the first roughing cuts and in cutting concave surfaces. The end is given the

elliptical form shown, and the bevel is made straight from the cutting edge back to the unground portion; this makes it easier to guide the cutting edge. The workman usually keeps three or four sizes of this tool at hand—the $\frac{1}{4}$ -inch, $\frac{1}{2}$ -inch, 1-inch, and $1\frac{1}{2}$ -inch. The handle is made in the form shown, because this form has been found to give the workman easy guidance and control of the tool. At *a* is shown the form of one of the smaller sizes, while at *b* is shown one of the larger sizes.

In Fig. 11 are shown two sizes of **skew chisels**, a small one at *a* and a larger one at *b*. The cutting edge stands at an angle to the two sides, as shown, and has a bevel on both

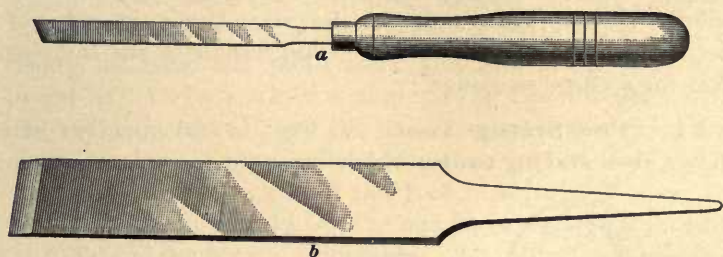

FIG. 11.

sides. This bevel should be quite flat. The handle is of the same shape and size as that for the gouge. Convenient widths for this tool are $\frac{1}{4}$ inch, $\frac{1}{2}$ inch, 1 inch, and $1\frac{1}{2}$ inches. It is used in turning cylinders, beads, and convex surfaces generally.

In Fig. 12 is shown a **round-nose chisel**, which is used in turning grooves and hollows when these cannot be safely



FIG. 12.

made with the gouge. The work is done by scraping rather than by cutting, as is the case with the gouge. The work is done much slower than with the gouge, but it is much

safer, not having so great a tendency to catch and tear the wood. The most common sizes of these tools are $\frac{1}{4}$ inch and $\frac{3}{8}$ inch wide.

10. The Parting Tool.—The **parting tool**, shown in Fig. 13, is used for separating finished work from the rest of the stock. It is made thicker along the middle than



FIG. 13.

at the edges, as shown at *a*, and the cutting edge is at the middle, so that there may be clearance along the sides of the tool as it enters the wood. The handle is the same as that for a chisel or gouge.

11. The Sizing Tool.—In Fig. 14 (*a*) and (*b*) are shown two **sizing tools**, which are used to cut grooves in

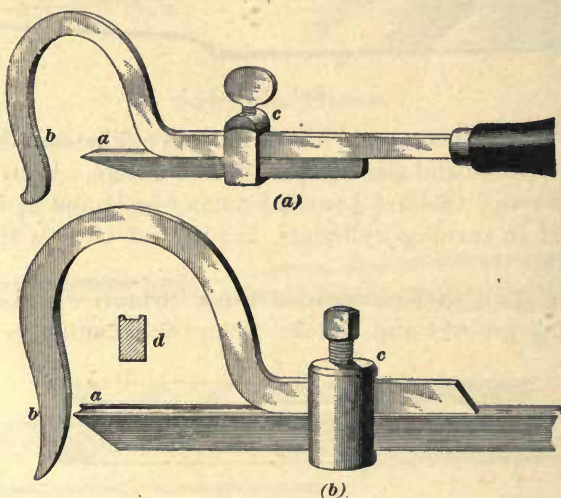

FIG. 14.

the work. The cutting edges are at *a*, and may be adjusted at any distance from the hook *b*, within the range of the tool. The thickness of the hook is a little less than the

width of the tool, so that it will readily drop into the groove cut by the latter.

When it is desired to use the tool, the cutting edge is set at a distance from the hook equal to the required diameter at the bottom of the groove, the adjustment being made by means of the clamps *c*. The tool is then held upon the work, at the place at which the groove is to be cut, with the inside of the hook resting upon the back of the piece and the tool against the front. By putting just enough pressure upon the tool it makes it cut freely, and by holding the hook against the bottom of the groove, it moves down gradually until the diameter at the bottom of the groove is equal to the space between the tool and hook, when it may be removed.

In Fig. 14 (*a*), the cutting edge is quite keen, the tool being intended for small work and soft wood. For hard wood and large work, the angle of the bevel is greater, as shown in Fig. 14 (*b*), and the cross-section is made as shown at *d*. In Fig. 14 (*a*), it will be seen that the handle is rigidly attached to the hook, and the tool is adjustable upon the latter; while in Fig. 14 (*b*), the handle is rigidly attached to the tool and the hook is adjustable. The object of the hollow surface on the top of the tool in Fig. 14 (*b*) is to form narrow, projecting cutting edges at the front, which will cut small grooves ahead of the main cutting edge on both sides of the main groove and enable the body of the wood to be removed without tearing into the sides, thus leaving a smooth surface.

These tools are used in turning grooves, called *sizing grooves*, into a piece of stock, to indicate the depth to which the stock is to be removed, as shown in Fig. 15, where the dotted lines indicate the outline to which the piece is to be turned, and the sizing grooves indicate to the workman the depth to which the stock is to be removed with the chisel and gouge at their respective locations. The

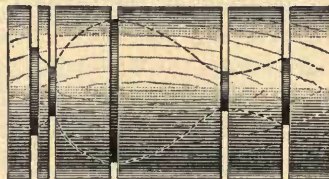

FIG. 15.

sizing tool, as in the case of round-nose chisel, is made with a thicker body than the ordinary bench-worker's chisel.

12. Cutting-In Tool.—A special tool, the cutting end of which is shown in Fig. 16 (a), which resembles the cutting edge of the tool shown in Fig. 14 (b), is used very frequently for turning grooves, and is called a **cutting-in tool**. It is especially serviceable when a large number of grooves must be made.

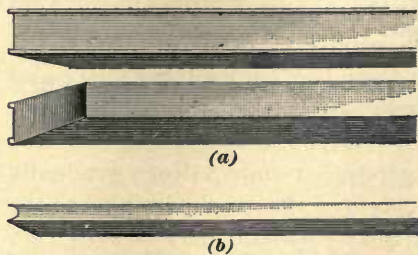

FIG. 16.

13. Beading Tool.

Another tool, the cutting end of which is illustrated in Fig. 16 (b), is used when a large number of beads must be turned; it is therefore called a **beading tool**. Tools of this class must always be made of such form that the desired shape will be cut. A special tool must, therefore, be made for each size or special form of bead, and for this reason it should only be used when enough duplicate parts are required to justify the expense of either making or purchasing one. When the required tool is at hand, a large amount of time may be saved by its use.

14. Sharpening Chisels and Gouges.—In **sharpening chisels and gouges**, it is necessary to keep the bevel straight, as a straight bevel assists very materially in the operations of the turner.

In grinding the skew chisel, the cutting edge should be square across the wheel or stone. To hold it in this position, it will be necessary to have the handle project on one side of the stone, while one side of the chisel is being ground, and to turn it over so that it projects on the other side of the stone during the grinding of the other side.

In grinding the gouge, it is necessary to roll it slowly from side to side, at the same time swinging the handle across from one side to the other, keeping the edge at the

part being ground square across the stone. When a grindstone is used a great deal for sharpening gouges, it will be found convenient to allow a groove to form near one side, in which the gouge may be more quickly and conveniently sharpened. In using an emery wheel, it is necessary to be very careful not to draw the temper of the tool. It should not be pressed too hard against the wheel, and plenty of time should be given for the water to carry away the heat developed. It is, of course, necessary to exercise equal care in using the whetstone. An oilstone slip with rounded edges will be found very useful in whetting the gouges.

15. Calipers.—The diameter of the work is measured by means of calipers, which are described in *Measuring Instruments*. When it is desired to measure the diameter of a piece, the caliper is adjusted so that the two points will just touch on opposite sides when passed over it. The diameter may then be determined by measuring the distance between the points. When it is desired to turn a piece to a given diameter, the calipers are set so that the distance between the inside of the points will be equal to the diameter. The piece is then turned down until it is found, by trial, that the points of the calipers will just touch the two sides. Care must be taken to hold the calipers at right angles to the axis of the work. The points should also be rounded and smoothed, so that they will not scratch the work.

16. Dividers and Mallets.—**Dividers**, of the form shown in *Measuring Instruments*, are used to draw circles

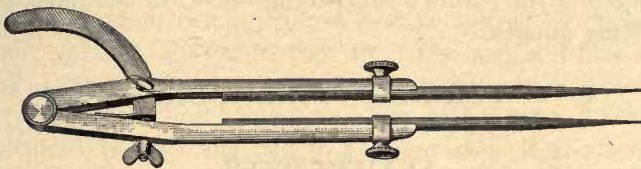

FIG. 17.

and space off distances. Another form, shown in Fig. 17, is used very frequently by wood turners. In this form either of the points may be removed and a pencil inserted instead.

A **mallet** of the kind described in *Wood Working*, Part 1, is used to drive the stock on the fork center.

17. Miscellaneous Equipment.—In addition to the tools mentioned, the wood-turner's equipment would not be complete without an oil can, folding rule, several whetstones, a bench brush, and some cotton waste or waste cloth. These

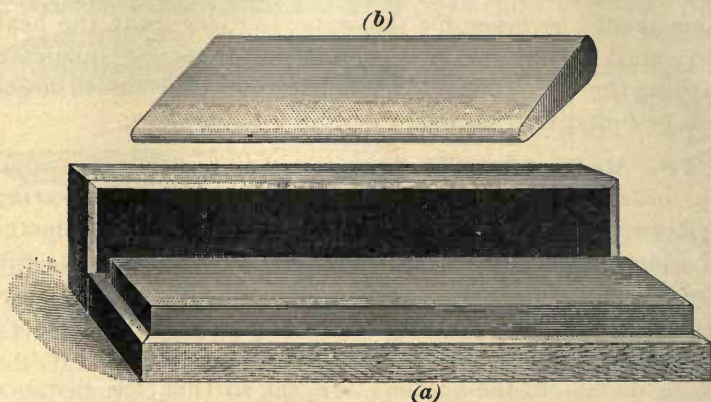

FIG. 18.

have been described in *Wood Working*, Part 1. The whetstones used by the turner may, however, be somewhat different from those used by the bench worker, since it is more convenient for the turner to be able to carry them from place to place. The stone for this purpose is usually mounted in a box, as shown in Fig. 18 (a). A slip of the form shown in Fig. 18 (b), with the edges rounded, should also be included in the turner's sharpening outfit for the purpose of whetting gouges.

TURNING OPERATIONS.

CUTTING SPEED.

18. Cylindrical Turning.—In turning wood with the grain when the piece does not exceed 1 inch in diameter, it may be given a speed of about 3,000 revolutions a minute. For a diameter of 2 inches, reduce the speed to

2,500 revolutions a minute; for 3 inches in diameter, not more than 2,000 turns should be used. From this diameter up the speed should be decreased as the diameter is increased, so as to maintain a surface speed of about 1,500 feet a minute. This speed is used only after the work has been roughly turned to the cylindrical form. While the work is being *roughed* to shape, the surface speed should not be more than 1,000 feet a minute.

When the surface speed of the countershaft of a wood-turning lathe is known, the speed of the lathe spindle may be found for any step of the cone by means of the following rule: *Multiply the revolutions per minute of the countershaft by the diameter of the step on the countershaft cone, on which the belt is to run, and divide by the diameter of the corresponding step on the lathe cone. The result will be the revolutions per minute of the lathe spindle.*

19. Changing the Speed.—The speed of the lathe is regulated by shifting the belts on the cone pulleys. When the ceiling of the shop is high and the countershaft is far from the floor, this is sometimes a troublesome matter. The belt should in each case first be thrown to a smaller step on the lower cone than that on which it is to run. When the belt is comparatively short, it can be thrown either to a larger or smaller step on the upper cone by a quick motion of the hand, against the belt, in the direction in which the belt is to be shifted. The correct motion of the hand can only be acquired by observation and trial, and considerable experience is usually necessary in order to do it skilfully.

When the belt is long, it can best be shifted by means of a belt pole, as shown in Fig. 19. The rod *a*, which has a hook at its upper end, as shown at *b*, is put between the two sides of the belt and hooked over the shifter rod *c*. When it is desired to shift the belt to a larger step, it is placed as shown and the lower end drawn out so that the rod rests against the belt, about in the position shown; the end is then drawn over in the direction in which the belt is to be thrown. The cone must be running during this operation, and the rod applied on the up-going side of the belt.

Sometimes it is desirable to attach the pole permanently to the shifter rod; this may be done by bending the hook, when it has been put in place, as shown by the dotted lines at *b*. It may then be allowed to hang from a convenient place on the shifter rod when not in use, and can be moved to any position when it is desired to shift the belt.

A belt pole with a wooden piece, of the form shown at *e*, attached near the upper end is also frequently used and has

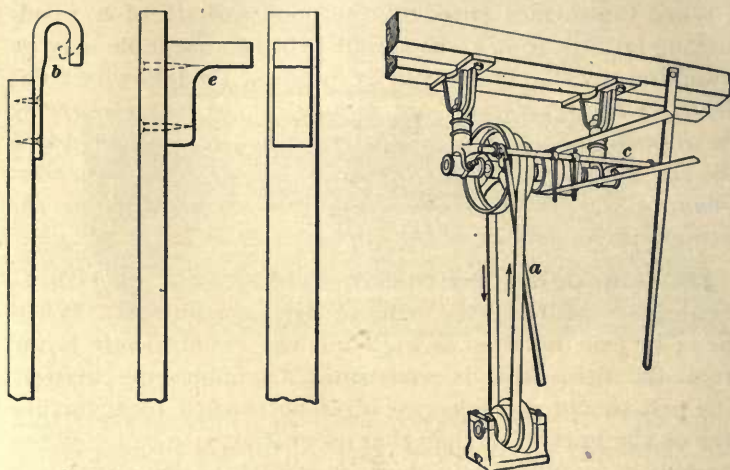

FIG. 19.

been found very satisfactory. When this style of belt pole is used, the projection *e* is simply hooked over the up-going side of the belt, near the top, while the belt is in motion, and drawn in the direction in which the belt is to be shifted. It must be remembered in each case, first to throw the belt on a smaller step on the lower cone, especially when it is to be shifted to a larger step on the upper cone, as failure to do this is liable to cause injury to the belt.

ROUGH TURNING.

20. Introduction.—The first operation that a wood turner learns to perform, as it is usually the first turning operation on any piece of work not turned across the grain,

is to roughly turn a plain cylinder. This operation, generally called **roughing**, is usually performed with one of the larger gouges.

21. Preparation of Stock.—The piece of wood is first prepared for turning by locating the centers of the two ends; in patternmaking especially, the centers must be located very accurately. If the piece is square or rectangular, the centers may be found by drawing diagonals across the ends, as shown in Fig. 20. If the piece of wood is large, the corners are usually removed by means of a hatchet or draw-knife, as shown by the dotted lines in Fig. 20, but if the block is less than 6 inches square, this is not necessary.

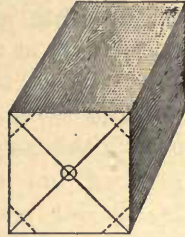

FIG. 20.

22. Centering in the Lathe.—The piece is then placed between the headstock and tail-stock centers of the lathe, so that the center of the one end rests upon the head-center. It is then driven on with a mallet until the fork enters the wood far enough to cause the piece to turn with the spindle while the turning is being done. The tail-stock is then brought up so that the center almost touches the end of the wood and is clamped in place by means of the hand wheel, which extends below the bed. The tail-stock center, or tail-center, is then advanced by means of the handle at the outer end of the tail-stock, with one hand, and the piece guided with the other, so that the tail-center will enter the piece at the center mark. The center should be forced into the piece until the latter is held so firmly that it will not turn, even when the driving belt is pulled with considerable force. The tail-center is then turned back until it is nearly free of the piece, when a few drops of oil may be placed in the conical hole formed by the center. A little tallow, kept in a depression in the tail-stock, is frequently used for this purpose. The center is again advanced until it engages the block firmly, and eased off just enough to allow the work

to turn freely, and is clamped by means of the small hand clamp on the side of the tail-stock.

The head-spindle must revolve freely, or its bearings will become hot, but the revolving stock must be held firmly between the centers, for considerable pressure may be put on it by the cutting tool, and if it should be forced off the centers, the rapidity of its motion would cause it to be thrown with, what might be, a dangerous force. There is also danger at all times of the tool catching in the revolving work and so putting a heavy strain on the centers. The freedom of motion of the head-spindle may be tested by pulling the cone belt around by hand.



FIG. 21.

23. Adjusting the Rest.—When the work has been properly placed between the centers, the rest is brought to

one end of it and the tee adjusted so that when the back of the gouge is resting upon it and the handle held slightly below the cutting edge, the latter will be slightly below the top of the stock to be cut. The general position of the operator and of the tool is shown in Fig. 21. It is well to have the end of the tee rest project somewhat beyond the end of the stock, as the tool may then be carried to the end during the cut without danger of its slipping off and catching in the wood.

24. Holding the Tool.—In describing the operations of the turner, it is assumed that he is right-handed. The handle of the tool is held in the right hand and the right arm is steadied by holding the forearm, near the elbow, against the side. The side of the left hand rests on the tee and the fingers are thrown around the tool, as shown. The left hand serves to steady the tool and to guide it along the work; its contact with the tee enables this to be done quite accurately.

25. The Roughing Cut.—The lathe is now started, and the belt shifted to the steps on the cones that will give the proper speed. Usually, during this first operation on any piece, the proper place for the belt is on the largest step of the lathe cone, or for very small work, on the next step, and the large gouge is used.

The cutting edge of the gouge is cautiously advanced against the revolving stock at a distance of 3 or 4 inches from the end and a light cut started, and with the depth of cut kept as nearly constant as possible the tool is carried along to the nearest end; this is continued until the stock at that end is round and only slightly larger than the required diameter. This operation is repeated on the other end, and the stock then cut between the ends. The calipers are then set to the size to which the stock is to be turned, and as the work proceeds, the lathe is stopped every now and then and the size of the work tested. The calipers will also indicate whether or not the sides of the stock are kept parallel. It

is well for the operator to proceed with caution at first and to take light cuts, but as his experience gives him confidence, he can increase the depth of the cut and so decrease the time taken for any given piece of work. This applies to all the operations of turning.

The operation just described is called **roughing**, and the cut a **roughing cut**; it is always done with the gouge. It

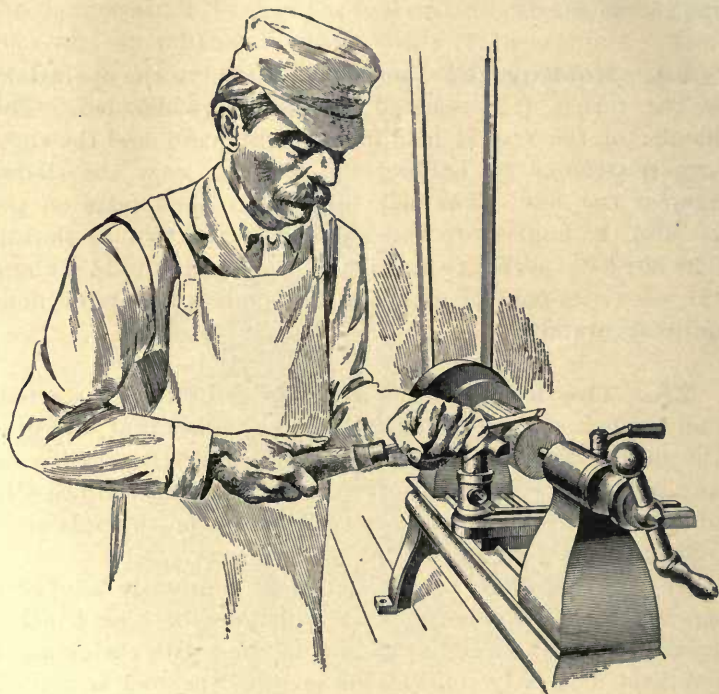

FIG. 22.

is to be noted that the gouge more than any other tool is the turner's tool, and a skilful wood turner may use it almost exclusively in turning cylindrical as well as curved surfaces. As the diameter of the cylinder is reduced, the rest is lowered so that the tool may be held in the position most convenient to the operator.

FINISHING CYLINDRICAL WORK.

26. Holding and Manipulating the Tool.—If it is necessary to produce a smooth clean surface, free from hollows, it is finished more easily with the skew chisel than with the gouge. In using the skew chisel for this class of work, the speed is first increased from that used for roughing, and the tee rest raised until the most convenient position for the workman is found. The cutting tool is then

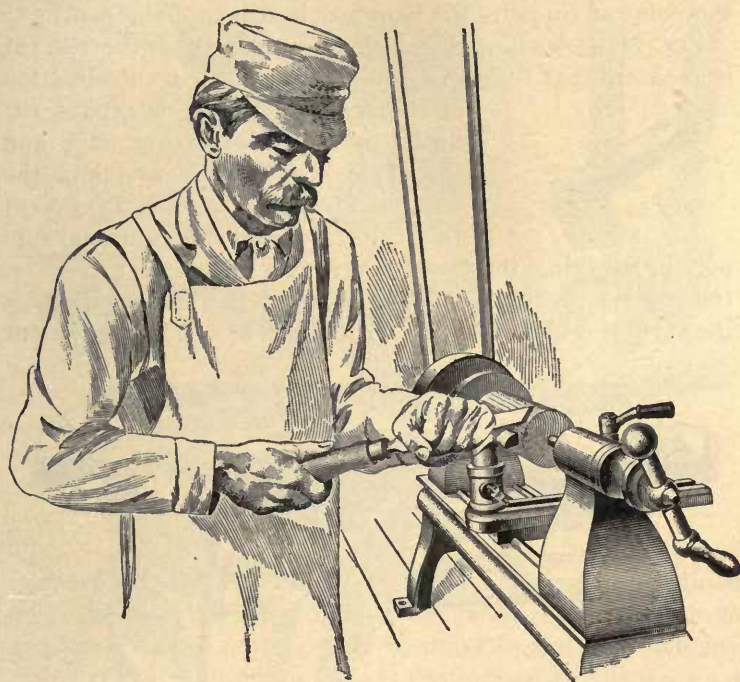

FIG. 23.

laid across the top of the revolving work in the position shown in Fig. 22, a couple of inches from the tail-stock end. It is then drawn backwards and the handle carried to the left, until the chisel has the position shown in Fig. 23. This movement is one of the most difficult of those used in turning for the beginner to acquire. As the chisel is drawn

back and the handle swung to the left, it is rolled on the rest in such a way that the bevel is brought into contact with the revolving surface and the cutting edge is made to cut in the position shown in Fig. 23. The obtuse corner of the chisel is the lower one, and the part of the edge that is used for cutting must be near this lower corner, as shown in the illustration. As the chisel now rests on its corner, it may be rolled backwards very easily, and so rolled into the work, and the farther the cutting part of the edge is from the point of support, the more easily it is pulled down.

Fig. 24 shows how the chisel is supported on the rest; it is apparent that it is very easily pulled down in the direction of the arrow. When this occurs, the upper part of the cutting edge and the acute corner are drawn into the work and tear it. In order to prevent this, the chisel is given additional support



FIG. 24.

by allowing the lower bevel, near the edge, to rest on the revolving surface. The portion of the bevel resting on the surface is shown by the dotted line at *a*, Fig. 25, the cut

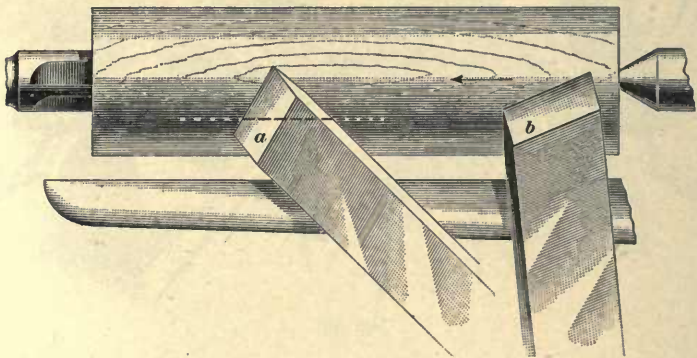

FIG. 25.

being taken in the direction shown by the arrow. When the chisel is held in the position shown at *b*, the acute corner is very easily drawn into the work, with disastrous results. When the chisel is held properly, it is largely supported on

the portion of the bevel back of the cutting edge and along the line shown at *a*.

The position shown in Fig. 26 is that used when smooth cylindrical surfaces are wanted; but when the work is not true to its axis, or when because of a knot or some other reason it has a tendency to become eccentric, the lower

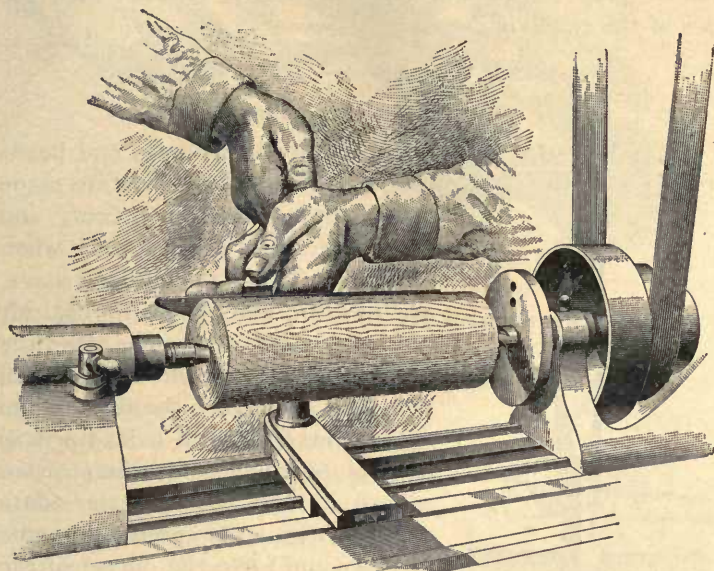

FIG. 26.

corner is used for cutting. While the advantage obtained by supporting the chisel on its lower bevel is lost, there is no tendency for the cutting edge to move in and out with any eccentricity that may exist on the surface of the work, as the tool is now supported by the rest alone.

27. The Cut.—In using the skew chisel, the cutting is started some distance from the end, and is carried out to the end; as this involves cutting first toward one end, then toward the other, it is necessary that the chisel be turned over on the rest when the direction is changed, and that both bevels be used during the progress of the work. For

this reason the skew chisel is beveled from both sides instead of from one side only, as in the case of the carpenter's chisel.

The special points to be borne in mind in connection with the use of the skew chisel, in turning plain cylinders, are to keep the corner of the chisel in contact with the tee rest, to keep the bevel in contact with the surface being turned, and not to have the cutting edge too nearly parallel with the axis of the revolving stock.

TURNING GROOVES.

28. Angular Grooves.—Angular grooves and beads are cut with the skew chisel, while curved grooves are made with the gouge, when cut, and with the round-nosed chisel when scraped. To cut an angular groove, such as the one shown in Fig. 27, the method of operation, after the surface has been made smooth with the skew chisel and the sides of the groove marked with a lead pencil, is to place the chisel in the position shown in Fig. 28, with the acute corner down, and to raise the handle slightly and force the corner of the chisel into the wood. This must be done carefully, since if the pressure is too great or continued too long, the chisel corner will become heated and the temper drawn.

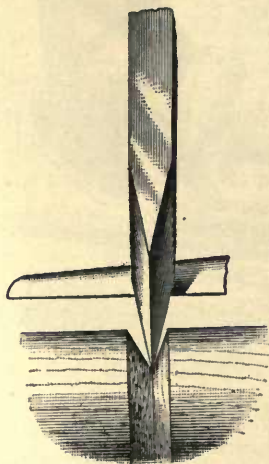

FIG. 27.

The corner of the chisel is then placed about $\frac{1}{8}$ inch to one side of the cut thus made, and with the edge pointing in the direction in which the cut is to be made, and the one side of the bevel being used as a guide, as shown in Fig. 29, the chisel is forced into the wood. The handle is raised and the cut taken as though the corner of the chisel were to be pushed into the center of the wood. This is repeated on the other side of the mark, the other side of the bevel being used as a guide.

There will now be a small angular groove extending around the piece. The remaining part of the operation

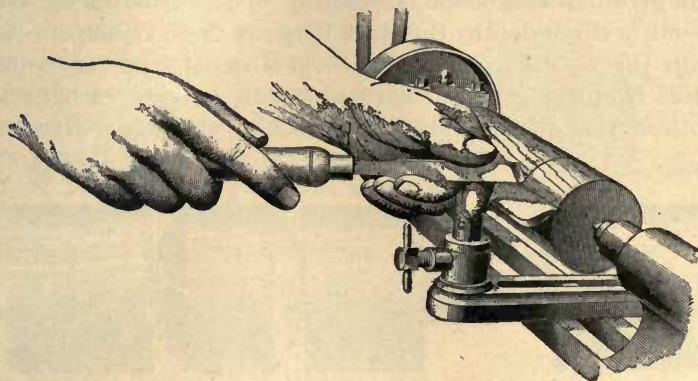

FIG. 28.

consists of taking successive cuts, first on one side and then on the other side of this groove. As the groove grows deeper, it will be necessary to exercise greater care in handling the chisel. As the cutting is done by the lower corner of the chisel, and the unengaged portion of the cutting edge slopes upwards from this corner, this cutting edge must not be allowed to come into contact with the sloping side of the groove, but must be kept slightly away from it, as shown in Fig. 29. If the edge were brought into contact with the sloping side, it would be drawn into the wood, thus injuring the work. Some workmen prefer to cut such grooves with the obtuse corner or head of the chisel, but the method of carrying on the work does not differ from that already described.

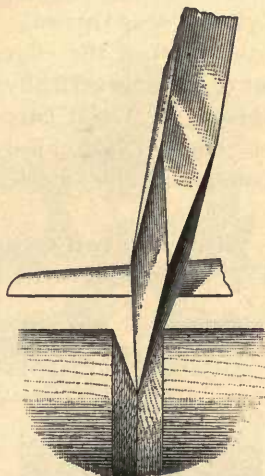

FIG. 29.

29. Square Grooves.—When the groove has its sides perpendicular to the axis, as shown at *a*, Fig. 30, the work

is done by first cutting triangular grooves *b* at the sides, the outside being made perpendicular to the axis and the inner one given an easy slope, as shown. These grooves are cut to only a slight depth; the stock between them is then cut out with the obtuse corner of the skew chisel, the cut being made from the center toward each side, in turn. It will be noticed that the operation of removing the stock between

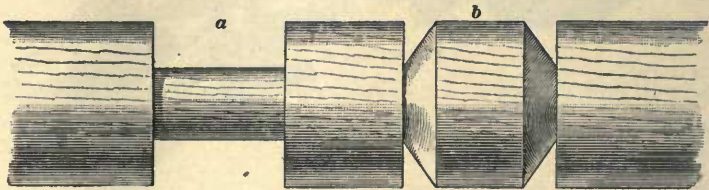

FIG. 30.

the grooves is performed with a corner of the chisel and not with the edge between the corners, as in the case when the cylinder was turned. It is safer to use the corner than any other part of the edge, and with deep grooves of this character, it is practically impossible to use any other part of the edge. Great care must be taken in cutting in to keep the edge of the chisel sloping slightly away from the perpendicular side, as shown in Fig. 27.

30. Curved Grooves.—Grooves of the form shown in Fig. 31 are cut with the gouge, the tool being selected of such a size that there will be ample freedom of movement in the groove while the cutting is being done. A groove 1 inch wide would be cut with a $\frac{1}{2}$ -inch gouge, and a $\frac{1}{2}$ -inch groove with the $\frac{1}{4}$ -inch gouge. The sides of the grooves should be indicated by marking the revolving stock with a lead pencil, or, if there are many to be cut, they may be marked or laid out with

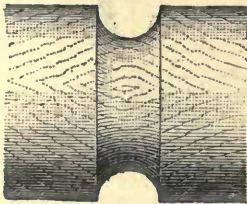

FIG. 31.

the dividers, the points being adjusted to the proper distance apart.

In using the dividers to mark revolving stock, it is well to remember that if held in the position shown at *a*, Fig. 32, with the work revolving in the direction indicated by the arrow, the point may catch in the surface and tear it, or the dividers may be thrown violently out of the hand. If held as shown at *b* this cannot occur.

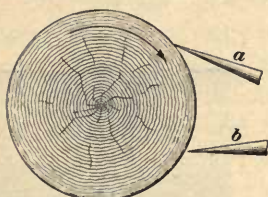

FIG. 32.

In starting the cut with the gouge, it is first held in the position shown in Fig. 33, the part of the edge in contact

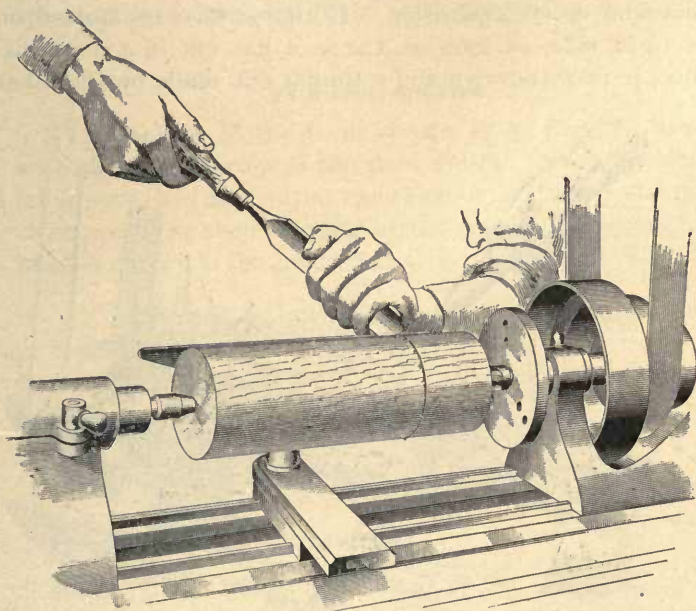

FIG. 33.

with the wood being held at right angles to the axis. If it is held so that the cutting edge stands at any other angle to

the axis, it will, as soon as it is pushed into the wood, travel along the surface in the direction of the edge and spoil the work. The gouge must rest firmly on the tee rest while it

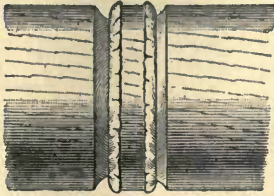

FIG. 34.

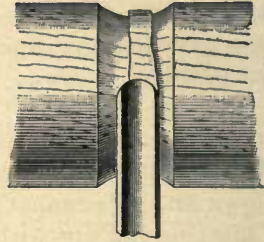

FIG. 35.

is being advanced into the wood, and also during the remainder of the operation. If the groove be started on the right side, as soon as the tool has cut in a short distance, it is withdrawn and a similar cut made on the other

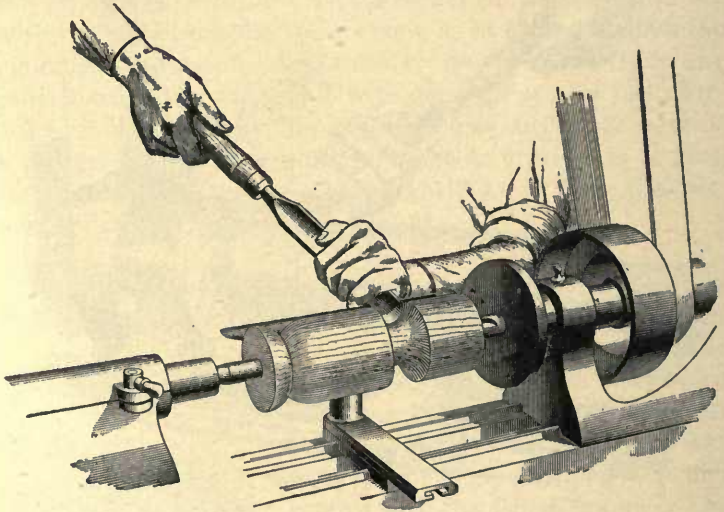

FIG. 36.

side, making the work appear as shown in Fig. 34. The tool is then again started on the right side, and as soon as it begins to cut it is slowly rolled over on its back and the

cutting edge pushed to the left. This must be done slowly and cautiously until the operator has had enough practice to be sure that he can do it correctly.

While the gouge is being rolled over on its back, the handle must be lowered so as to raise the cutting edge out of the work, as shown in Fig. 35. A light cut is taken, and when the tool edge has been rolled so that it does not touch the work, another cut is started on the left side and the operation repeated. The two cuts taken in this way will meet each other in the center of the groove. Another cut is then started on the right side and carried to the middle, and this is then repeated on the left side, and so on, cutting on alternate sides until the groove has the desired form and depth. Fig. 36 shows how the gouge is held and the appearance of the piece as the work progresses.

TURNING BEADS.

31. Beads of the form shown at *a*, Fig. 37, are cut with the acute corner of the skew chisel. Narrow, triangular grooves are first cut at each side of the bead to be made, as shown at *b*; then starting at the center of the ridge, the bead is cut with the acute corner of the chisel. The chisel

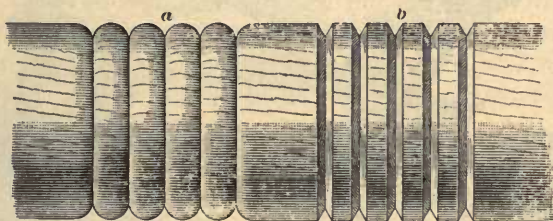

FIG. 37.

is started in the position shown at *a*, Fig. 38, and gradually rolled over on the lower corner to the position shown at *b*, the handle being swung across from one side to the other, and at the same time raised so as to permit this movement. Special care must be taken during the performance of this operation to see that no part of the cutting edge but the

corner comes in contact with the revolving wood, and that the lower edge of the chisel is kept in contact with the tee

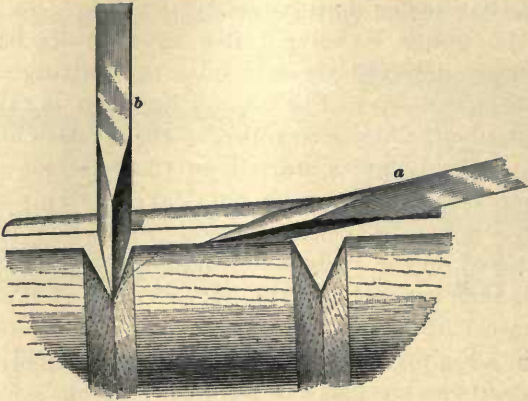

FIG. 38.

rest. Fig. 39 shows the manner in which some workmen hold

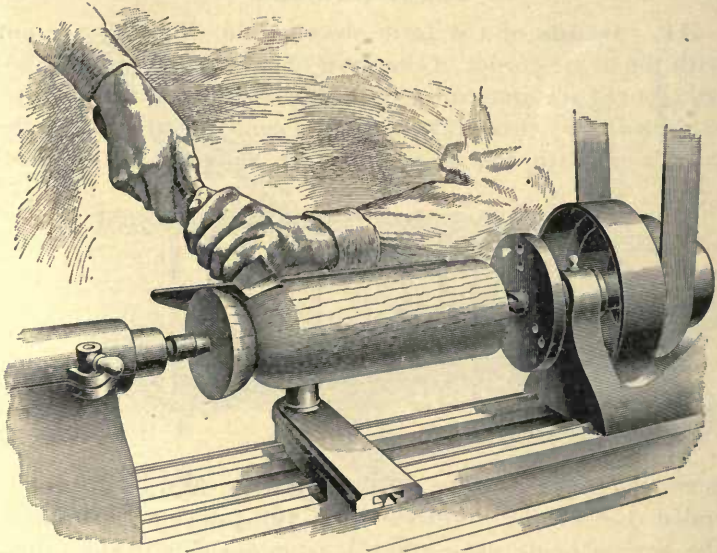

FIG. 39.

the tool when turning the bead. In this case the turning is done with the heel of the chisel and not with the point.

This is one of the most difficult operations to perform in elementary turning, as in order to make a good bead, it is necessary to move the chisel with a smooth, continuous motion. This motion is rather difficult, and there is always danger of the cutting edge catching in the wood—either because the chisel is not rolled over on its lower edge rapidly enough or because the handle is not swung around to follow the edge. In cutting from the center to the left side, the chisel may be manipulated much more easily than when cutting to the right side, since the right hand has greater freedom of movement in swinging the handle around when it is free of the body—as in cutting to the left—than when cutting to the right. In cutting to the right, the hand must start the cut from a position close to the body and directly in front of the center of the body. However, practice will make the cut to one side as safe as to the other.

The operation just described when thoroughly mastered gives special confidence in handling wood-turning tools, and the turner should practice it until he can perform it safely and easily.

COMPOUND BEADS AND GROOVES.

32. Compound curves of the form shown at *b*, Fig. 40, are cut with the gouge. The method of operation is to first mark off the sides with a lead pencil, and then cut the curved grooves shown at *a*. These grooves are cut to

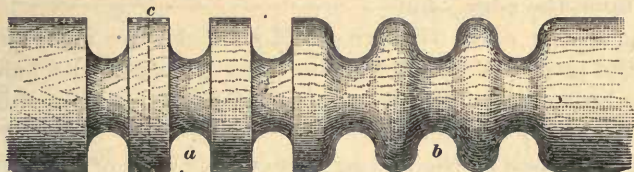

FIG. 40.

the required depth and the bottom finished carefully. The center of the cylindrical part is then found and marked with a pencil, as shown by the dotted line at *c*. The

cylindrical part is then turned to the curved form with the same gouge that was used in cutting the grooves.

The curved form may be obtained by resting the gouge on the tee rest, squarely on its back, as in cutting across

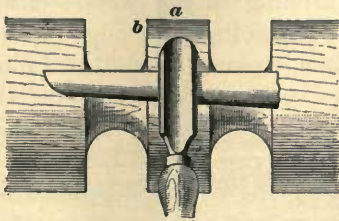

FIG. 41.

the wood in plain turning, shown in Fig. 41; then when the edge begins to cut, the tool is rolled over on the rest, turning the edge in the direction in which it is desired to cut. The cut is started at the center and carried over

toward the side, as from *a* to *b*. At first, great care is necessary with this method, although, owing to the rapidity with which the work may be done in this way, it is the method used by skilled turners.

A safer way is to swing the gouge from the position shown in Fig. 42 to that shown in Fig. 35, and to do the cutting very nearly at the center

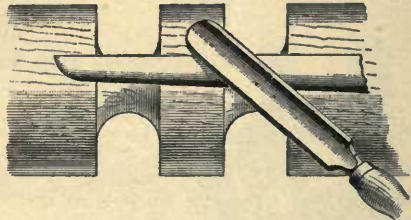

FIG. 42.

of the edge. By this method, there is no danger of the gouge quickly rolling over on its back and catching in the work when the pressure of the cutting is put upon the edge; but

owing to the extra time required to make the movement, and the increased motion of the hand grasping the handle with the consequent movement of the body, some modification is usually adopted.

The common method in use is a combination of these two, the handle being carried through a modified path, and the gouge being slightly turned over on its back, though not to the extent necessitated by the first method. This seems to combine the safety of the second method with the speed of the first.

GENERAL TURNING.

33. The every-day work of the wood turner involves a combination of the various forms of exercises discussed, and the scheme of work adopted is usually that which will give the most speed. In baluster turning, for instance, where a great number of beads of a given size is to be made, instead of making them in the way described, with the corner of the skew chisel, a special beading tool is used, and the work is scraped to shape, instead of being cut. A good wood turner will work almost as rapidly, however, with the chisel and gouge as he could with special tools. Nevertheless there are certain commonly adopted schemes, as the use of sizers and templets, to facilitate the work, that are used by all turners.

BALUSTER TURNING.

34. When a number of **posts** and **balusters** or similar pieces must be made alike, a templet of the form shown in Fig. 43 is prepared and the work laid out from it. The templet may be made of a thin strip of wood with the form penciled on the side, and notches made in the edge opposite

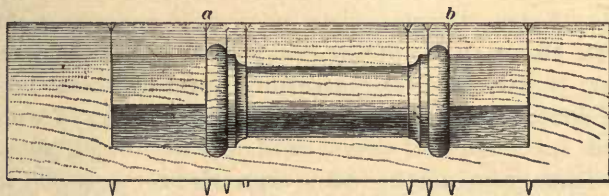

FIG. 43.

the lines where the form changes; or a paper drawing may be pasted on the side and the notches made. The notches in the edge of the templet are to guide the pencil while laying out the work. When the piece to be shaped is turned throughout its entire length, the templet may be made by driving brads in the edge, and then filing the projecting parts to a point, as shown in the lower part of the templet. The marking is done by scoring the revolving stock with

these pointed ends. Care must, of course, be taken to have the projecting ends of a suitable length.

Where there is a square piece left on a post, its sides are first cut in with the corner of the skew chisel, as at *a* and *b*, Fig. 43, and the circular parts are then turned to the cylindrical form before they are laid off for the special forms to



FIG. 44.

be turned. Grooves are next cut at the principal places, as shown in Fig. 44, either with the cutting-off tool, Fig. 13, or with the special sizing tool, Fig. 14. The wood may then be quickly roughed to shape with the gouge and finished with the gouge and skew chisel.

TURNING ACROSS THE GRAIN.

35. A very large variety of work is done by **turning across the grain**, and a great deal of the ornamental turning that is done for recreation is of this class, the work being done with special tools. When flat pieces of wood are turned into rosettes, disks, and other circular shapes in which the grain of the wood runs across the piece, in the direction of a diameter, the turning is sometimes said to be plankwise. In turning pulley patterns and many other forms of pattern work, it is necessary to turn across the grain.

The piece to be turned is fastened to a face plate, or is fastened to another piece of wood, which is, in turn, fastened to the face plate. The face plate is always used in turning work of this class, and as it must usually be screwed on and removed from the spindle very often, care must be taken to prevent injury to the thread, and to prevent sticking so hard that it cannot be readily removed. It should

always be screwed on by hand while the spindle is at rest, and never by holding the plate to the spindle so that the threads meet and then starting the lathe. The latter method is liable to force the face plate on the thread so hard that it cannot be removed by hand, as it should be. This same trouble is sometimes caused by the tool catching in the wood, even when the face plate has been screwed on properly, but this cannot always be avoided and is likely to occur with the most careful and skilled workman.

For ordinary rosette work, or other work to be finished on one side only, the face plate shown in Fig. 45 may be used, and the wood fastened to it by turning it on to the screw spur *a*, a small hole being first bored in the back of the wood at the center. When the spur is so long that there is danger that it may project through the wood, a washer, shown by the dotted line, can be placed between the plate and the wood. This washer may be made of wood or of leather.

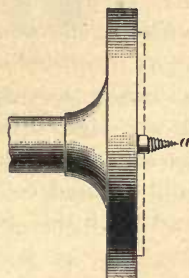

FIG. 45.

When the piece to be turned is large or heavy, a face plate of the form shown in Fig. 7 is more suitable, the work being fastened to it by means of screws. These face plates are made in a variety of sizes and the proper one to use is determined by the size of the work in hand and the size of the lathe. When very large ones are used, as on face-plate lathes, several rows of screw holes are drilled through them to suit the requirements of the work. When a piece *a*, Fig. 46, is to be turned on both sides, one side is turned, if possible, in such a way that it can be fastened to another piece of wood *b*, which has been turned to receive

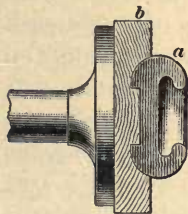

FIG. 46.

it, then *b* is carefully turned to fit the face already made on *a*, and *a* is fitted to *b*, as shown in Fig. 46, without removing *b* from the face plate. The fit must be very snug, as the firmness with which the piece is held generally depends

entirely on the fit. In some cases, however, the two pieces are glued together with strips of paper between them. When they are fixed together the first piece may be finished. The piece *b* is commonly called a **chuck**.

During all work of cutting across the grain, the chisel or other tool employed is used as a scraping tool instead of a cutting tool. When there is much work of this class to be done, it is well to have some special tools for the purpose. Three or four sizes of chisels that have the edge square across the end, as the carpenter's chisel, but having the bevels ground on both sides, as in the ordinary skew chisel, are very useful for this service. These will last longer without sharpening if they are turned over on the rest at short intervals while in use, so as to have first one face up and then the other, in order to take advantage of the turned-down edge caused by the grinding effect of the revolving wood. There may be added to these a few sizes of the round-nosed tool, shown in Fig. 12, for cutting out hollows and for inside turning.

TURNING A ROSETTE.

36. To make the **rosette** shown in Fig. 47, a piece of wood of the required thickness and with one face smooth is selected and sawed to the circular form; a circle a little larger than the outside diameter of the finished piece is marked on one side and the piece sawed to this circle. It

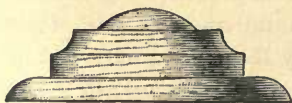

FIG. 47.

is made a little larger than the rosette will be when finished, in order that there may be some stock to be turned off, so as to insure a smooth surface. If the rosette is only 3 or 4 inches in diameter, it is not necessary to saw it to the circular form, and a square piece of wood, a trifle thicker than the finished rosette, may be used and the corners turned off in the lathe with the cutting-off tool, as shown in Fig. 48. After the face plate to which the wood is attached has been screwed on the

headstock spindle, the tee rest is adjusted a little lower than the center of the revolving stock, as shown in Fig. 48, and the excess stock cut away with the cutting-off tool, sometimes called a parting tool, as shown. When the piece is large enough to make it advisable to saw it to the disk form on the scroll saw, it is so sawed, and this part of the operation is then, of course, unnecessary.

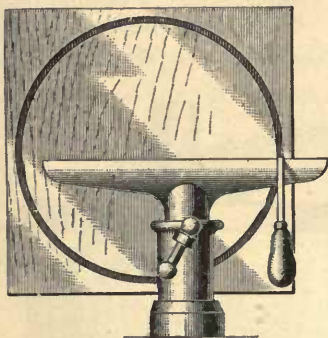

FIG. 48.

If the disk to be turned is over 4 inches in diameter, and it has been sawed to the circular form, the edge must be

turned smooth, and any eccentricity that may occur in fastening it to the face plate must be corrected. This is done with the acute corner of the skew chisel. The rest is adjusted to the position shown in Fig. 48, and with the chisel held almost in a horizontal position, the corner is pressed into the wood, as shown in Fig. 49, until the edge of the wood is finished across the piece.

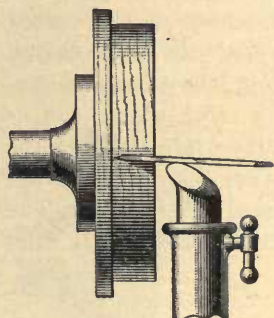

FIG. 49.

In turning the rosette, the next step is to cut the wood to the form shown in Fig. 50. This

is done with the skew chisel or with one of the square-end chisels, the tool being held in the position shown in Fig. 51. First the part marked *a* is cut and then the part marked *b*. The cut is started at the pencil mark that indicates the diameter of *a* and is continued to the outside of the wood, the chisel being held in such a way that one corner is slightly in advance of

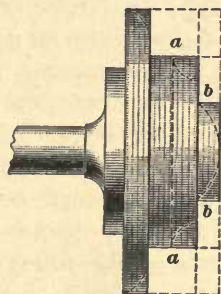

FIG. 50.

the other, the cut being taken in the direction of this corner.

With large disks, it is necessary to face them before cutting them to special forms. This is done after the edge has been dressed, as shown in Fig. 49; it consists of making the front face as flat as possible by starting at the center of the disk, and continuing the cut from the center to the edge, the tool being held as shown in Fig. 51. If the surface is uneven, or the wood has hard spots, it may best be turned true by means of the corner

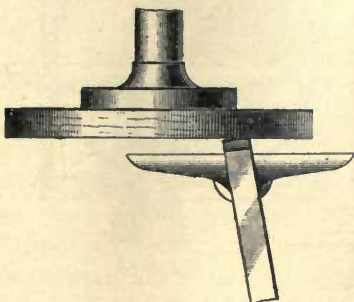

FIG. 51.

of a skew chisel and finally smoothed with the skew chisel, the cutting being done at the middle of the edge. Sometimes a tool with a serrated edge, like a tooth-plane iron, is used for the rough cut. The convex curves are cut with the chisel held as indicated in Fig. 51, and the concave curves are cut with the round-nose tool held in the same manner. The tools should be sharp and the cutting done slowly and carefully.

INSIDE TURNING.

37. A large part of the work done on the wood lathe consists of turning the interior of hollow pieces; this is especially true of the work of the patternmaker. This inside work usually requires the use of chucks, either of wood or metal, and occasionally of some special tools. Some of the finest work of the amateur turner is of this class. Cups, vases, frames for pictures, chains, and other pieces of

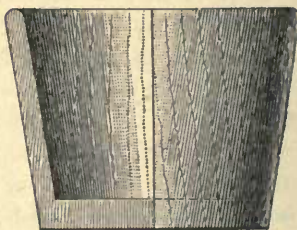

FIG. 52.

a similar character are made, and for more advanced exercises, spheres turned inside of other hollow spheres, and the various geometrical forms are made.

In order to make a cup form, as shown in Fig. 52, a piece of wood is turned between the lathe centers to the form shown in Fig. 53.

As the grain runs lengthwise, this is turned in the ordinary way, and by methods already described, the gouge and chisel being used. Extra care must be taken, however, to have the sides of the smallest step *b* parallel, and it is well to undercut slightly the shoulder on the intermediate step *c*.

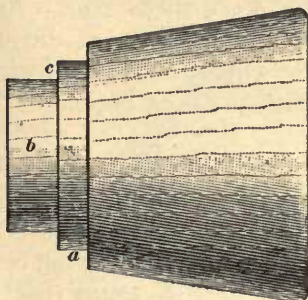

FIG. 53.

Next, a piece of board that is thicker than the length of the smallest step, is cut to a circular form, the diameter being great enough so that a cup-

shaped hole may be turned in it to receive the smallest step of the piece, and this piece is then fastened in it in the manner indicated by the dotted lines in Fig. 54. The piece of board is fastened with screws to a face plate of the form shown in Fig. 7. It is then faced and the recess turned in it with one of the chisels held in the manner shown

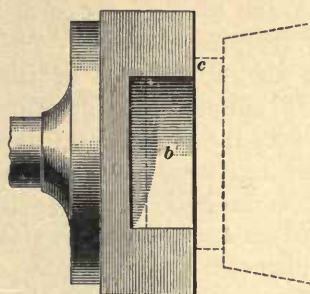

FIG. 54.

in Fig. 49. The recess is made small enough so that the turned piece will fit tightly in it, and the shoulder of the intermediate step will give it a good bearing, especially if the shoulder has been undercut as suggested. The end *b* does not extend quite to the bottom of the hole made in the chuck, and the work is supported and made to turn true to the axis of the lathe spindle by the bearing of the shoulder *c* against the face of the chuck. For this reason it is necessary to face the chuck carefully. The fit of the

piece in the chuck must be tight enough to hold it firmly while the turning is being done.

If any slight eccentricity of the work should appear when the lathe is started, owing to the chuck not fitting the work properly, it should be dressed out with the skew chisel until the work turns true. As little as possible of the material should be removed during this operation. The hollow in the cup is roughed out with the round-nosed tool and finished with the skew chisel.

38. For all hollow turning, the cutting edge of the tool should be at the same height as the center of the work. If it is held above the center, it is difficult to make the tool cut properly; if below the center, there is danger that a false motion of the hand that grasps the handle of the tool will lower the cutting edge and cause it to catch in the wood, and so destroy the piece. When the hollow has been roughed out with the round-nosed tool, the skew chisel is used to smooth the sides and bottom and to make the corner where the sides join the bottom of the proper shape. The cutting edge is used at the same height as that of the round-nosed tool, and the cut is a simple scraping cut. The round lip of the cup is made with the skew chisel, the position of the tool during the cutting being the same as when cutting the inside. The cup is finished by cutting it off at the shoulder, between the bottom and the chuck, this shoulder having been left for that purpose.

When there are a large number of pieces like the one described, but having a greater depth, to be made, the wood turner can save time by boring them with a twist drill after they are fitted to the chuck, and before the inside turning has been started. When the work has been fitted in the chuck, as shown in Fig. 54, the lathe is started and a small V-shaped opening is made at the center of the front end of the wood with the acute corner of the skew chisel. The back end of the drill is then placed against the tail-stock center, and the cutting end is started in the V-shaped hole made at the center of the wood. The drill is prevented from

turning by means of a wrench that grasps the flattened portion, and is forced into the wood by advancing the tail-stock center, the work being slowly revolved by pulling the belt around by hand.

Skilful wood turners do all the cutting that is here described as being done with the round-nosed chisel by the use of the gouge, because it may be done more quickly in that way. The use of the gouge in inside turning, however, is attended by constant danger, as any false motion will cause it to catch in the work. With the tool in the position shown in Fig. 55, it will tend to roll into the wood as soon as the cutting edge is brought into contact with the revolving wood, and as it rolls to the left, more of the edge is thrown into the work and the pressure that tends to roll it is increased.

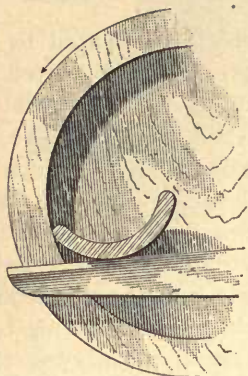

FIG. 55.

As all this occurs instantly, there is no chance to correct any wrong move that may be made, before the work is spoiled. By resting the gouge on its back in such a way that the cutting edge will have no tendency to be drawn farther into the wood, as shown in Fig. 56, and, when the cut has started, rolling it to the position shown by the dotted outline, the gouge may be used with comparative safety. Accidents are likely to occur and work will probably be spoiled while learning to do this work with the gouge, but the extra speed attained compensates for the trouble and loss of stock.

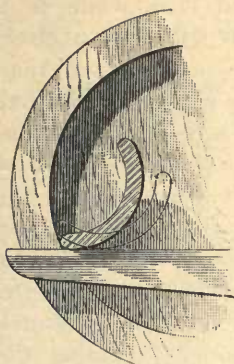

FIG. 56.

It is often necessary to turn curves on the inside of the work, especially in making patterns. The methods by which this is done are similar in most respects to the methods employed in turning the sides straight.

39. The following exercise in turning **semicircular hollow rings** indicates the methods by which pulley pattern rims and other pattern parts are turned. This form of the ring is shown in Fig. 57. The



FIG. 57.

stock is prepared by first sawing out a ring that is slightly greater in diameter and thickness than the finished ring is to be. A wooden chuck, which has a smaller diameter than the ring, but is enough greater than the hollow through the ring to allow the chuck and ring to be fastened firmly together, is then made on a face plate. This chuck is turned true on its rim and then carefully faced.

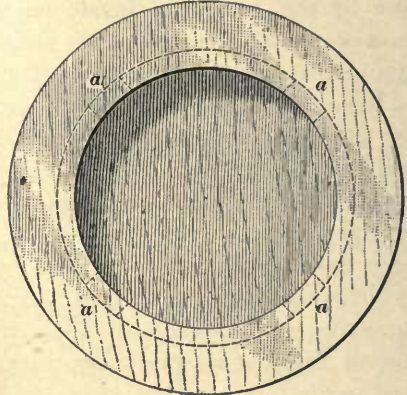

FIG. 58.

A pencil mark is made on the finished face, while it is revolving, which will give a circle slightly smaller in diameter than the inside of the ring. Four or five strips of thick wrapping paper *a*, Fig. 58, are glued to the back of the ring and cut off flush with the inside edge, and the ring is then glued to the face of the chuck by gluing the strips of paper to the chuck, the pencil mark on the chuck serving as a guide in placing the ring.

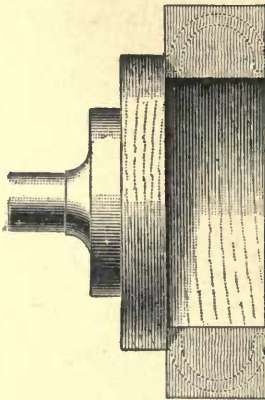

FIG. 59.

The whole will appear as shown in Fig. 58, the four sets of radial dotted lines showing where the paper strips are located.

When the glue has set, the ring is turned to the form indicated by the dotted lines in Fig. 59, the outside being first turned with the skew chisel, held as shown in Fig. 51, and the inside shaped with the round-nosed tool, which is held and supported in the same manner. The rounded lip on the outside edge is shaped with the skew chisel. When this is done the piece is detached from the chuck, which is made easy by the fact that it is fastened only at the paper strips.

The edge by which the ring was fastened to the chuck is unfinished still, and the next step is to finish it. For this purpose a shoulder is turned on the face of the chuck that is just large enough that the part of the ring on the outside may be pushed over it, as shown in Fig. 60. The unfinished edge may then be given the proper shape with the skew chisel.

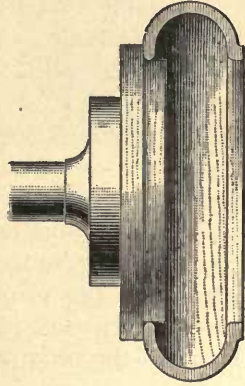

FIG. 60.

BUILT-UP WORK.

40. A great variety of shapes can be made by building up the piece to be turned. Fig. 61 indicates how this may be done.

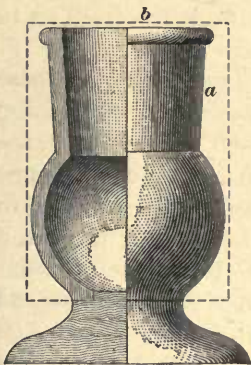

FIG. 61.

In the particular piece shown, the upper part *a* may be made by first turning it to a cylindrical form, as indicated by the dotted lines, between the lathe centers; then fitting the end *b* of the cylinder into a chuck and turning out the inside, the spherical part being placed on the outside, and turned out inside with the round-nosed tool. The straight part is turned out inside with the skew chisel. The part projecting from the chuck, usually the

spherical part, is next turned on the outside. The work is now removed from the chuck and put on a wooden spindle that has been turned to fit the tapered part of the inside and revolved between the lathe centers, thus permitting the outside to be finished. In fitting the piece on the wooden spindle, care must be taken so that the piece will not be split. The base is turned separately in the ordinary way.

Fig. 62 shows how the wood turner sometimes avoids having to use a very thick piece of stock in order to produce a form of which the greater part is comparatively slender. In the case illustrated, the main part is the spindle, and recesses with square sides are cut in the spindle where it turns into the projecting parts. The projecting parts are made as separate pieces, as indicated, that is, two pieces of board of the required thickness have an edge of each made

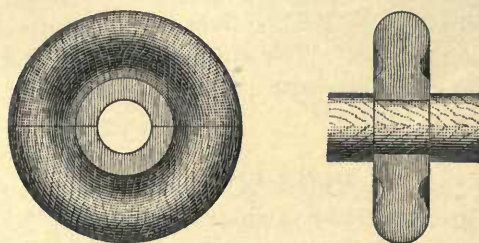

FIG. 62.

square and straight. They are fitted to each other on these finished edges and are fastened to a wooden chuck and turned to shape across the grain. When turned, they are removed from the chuck, separated, and then brought together again around the recess made on the body piece to which they are to be attached, and are fastened in place and to each other permanently, with glue. When the glue has set, the whole piece is put between the lathe centers and finished to remove any eccentricity that may exist.

An examination of turned furniture will show a variety of ways in which pieces may be built up, and the work of the patternmaker constantly involves such building up.

BALL TURNING.

41. When **balls** are turned on pieces of furniture or on balusters and newel posts, they are made in the same manner as any other convex curve, that is, with the skew chisel. When they are turned as separate pieces, and a great degree of accuracy is not required, as in the case of ordinary

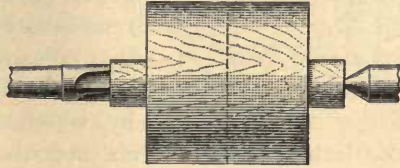

FIG. 63.

croquet balls, the same method is adopted, the work being tested occasionally with the calipers so that a fair degree of

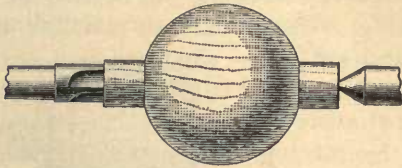

FIG. 64.

accuracy may be obtained. The general method of procedure is to turn the stock to the cylindrical form, and then to lay off, with two pencil marks, a

length that is equal to the diameter. The piece is then cut to the form shown in Fig. 63, and the center of the short cylinder marked with a pencil line, as shown by the dotted line in the illustration. This center line is used as a starting place for the convex curves of the sides, and the wood is cut to the form shown in Fig. 64.

It will be found that there is a constant tendency to cut down too quickly on the sides, and this must be guarded against, for if the sides are too full, it is easy to cut them down more, but if they have been cut down too much, the fault cannot be corrected. The work must be tested frequently with the calipers during the progress of the cutting.

42. When a greater degree of accuracy is required than can be obtained by this method, a different method is employed. Usually this is on the finer quality of croquet balls, on bowling balls, and on balls for which a very hard wood is used. The wood is first turned to the form shown in Fig. 63, by the method described above. A templet of

sheet metal is then made of the form shown in Fig. 65, the lines on the hollow side being the sides of a regular polygon.

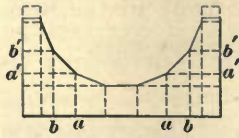

FIG. 65.

The number of these sides may be as great as convenient, but it must be remembered in making the templet that allowance must be made for the projections at the ends of the wood by which it is to be held between the lathe centers. The lines that mark the corners of the polygon are carried to the straight side of the templet, as shown by the dotted lines in Fig. 65; and are also carried out to the ends. When the wood has been cut to the form shown in Fig. 63, these marks are laid off on the face and sides of it while it is revolving. By taking a corresponding pair of these marks a, a' and cutting down from a , and in at the side from a' , a step is cut in the cylinder, as shown at a , Fig. 66; then by placing a mark on the new surface for b , and cutting in from b' to meet it, and so continuing as far as may be made necessary by the number of sides on the polygon, the stock will have a number of steps across it, as shown in Fig. 66. These steps may be cut off by beveling from inside corner

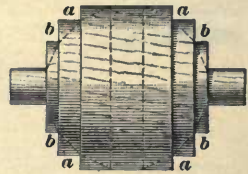

FIG. 66.

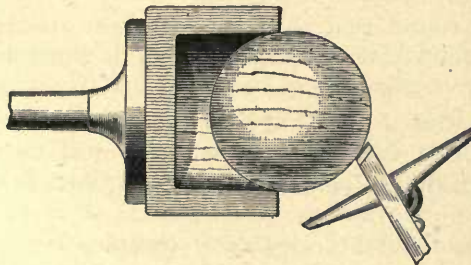

FIG. 67.

to inside corner, leaving the wood of such shape that it will fit the inside of the templet, as shown by the dotted lines in Fig. 66. The corners are next dressed off with the chisel,

held as shown in Fig. 67; the end pieces are then cut off, care being taken to leave the ball full enough at the ends.

A wooden chuck of the form shown in Fig. 67 is then prepared, the recess in it being a little less than the diameter of the ball and a trifle narrower at the bottom than at the top. The ball is pushed into this chuck, as shown, and when it is firmly attached the lathe is started and any irregularities are dressed out of the surface with the chisel, which is held as shown. The chisel is moved slowly over the surface from the chuck out to the center and back again, and a very light scraping cut taken where it is needed. Too deep a cut here will make it necessary to cut a corresponding amount from the rest of the surface and may make the ball so small that it will not fit in the chuck. When the projecting part of the ball has been gone over, it is turned slightly in the chuck and cut again; this operation is repeated until the whole surface runs true when it is revolving.

If there should be any difficulty in holding the ball in the chuck, this may be remedied by putting a piece of thick leather in contact with the outside of it and bringing the tail-stock center against the leather. The center must not be pressed too hard against the leather, or it may cause it to burn the wood and so leave a bad spot on the surface. The leather should be just large enough to keep the center from coming in direct contact with the wood.

43. Another method of turning a sphere is frequently used. The rough stock is first turned to a cylinder, Fig. 63. A layout is then made upon a smooth piece of board or a piece of paper, as shown in Fig. 68. A circle is first drawn equal in diameter to the diameter of the sphere, and a diameter ab drawn approximately parallel to one edge. At the center c , draw a line cd at right angles to ab . Draw the lines ae and bf tangent to the circle and parallel to cd , and ef tangent to the circle and parallel to ab . The rectangle $ae fb$ then represents one-half of the piece shown in Fig. 63, the line ab representing the axis about which it is turned. Then draw a line gh tangent to the circle and at

an angle of 45° to the line ab . Set dividers with the one point at e and the other at h , and draw two lines around the piece at this distance from the ends. Since eh equals eg , circles may be scribed on the ends to represent the point g . The corners egh and fij may then be turned off. Lines may then be drawn tangent to the circle at points midway

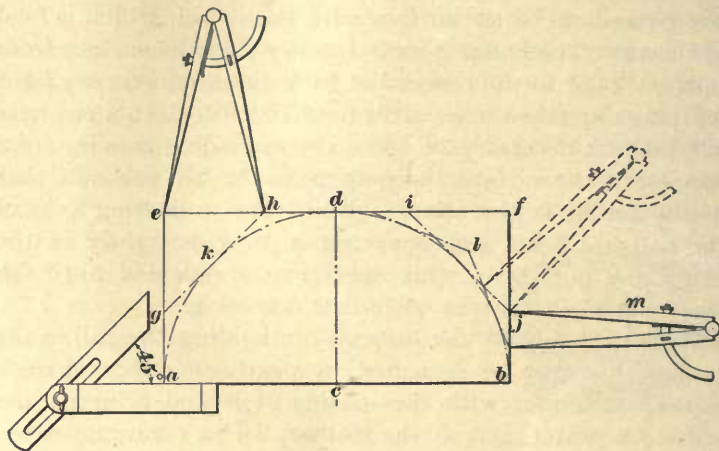

FIG. 68.

between the point a and k and the dividers set as shown at m . Points may then be stepped off, lines drawn around the work, and the corners turned off as before. If the diameter of the sphere is large, further subdivisions may be made, if it is thought advisable. Finally, the angles may be removed and the surface smoothed and finished as described.

PATTERNMAKING.

(PART 1.)

PATTERNS AND CORE BOXES.

PATTERNS.

1. Introduction.—The production of ordinary metal castings, as iron or brass, involves three distinct operations. First, a form very nearly like that required in the casting is made of wood or some other easily shaped material, and is called the **pattern**. Next, from this pattern a mold is made in sand or in some other substance that is refractory enough to withstand the action of molten metal. Lastly, the metal is melted and poured into this mold. Each of these operations requires special skill, and has given rise to special trades, though the molding and founding are often performed by the same person.

These operations are sometimes so intricate and admit of so much variety that the above statements are true only in the main. The molder may make his own pattern out of clay, or, if it should be necessary to use it a large number of times, he will make it of some hard metal; or, he may make the mold itself, or a portion of it, of metal; and so on through a multiplicity of changes that are constantly occurring where a business is made of producing a variety of castings. Nevertheless, the main facts hold true, and the patternmaker is understood to be a wood worker; the molder, the one that makes the molds; and the founder has charge of the furnace and melts the metals.

§ 35

For notice of copyright, see page immediately following the title page.

In the first of these operations, that of the patternmaker, there is needed a fair degree of skill in the arts of cabinet-making and of wood turning, for patternmaking consists largely of fitting joints and making circular forms; consequently, the patternmaker must be familiar with the use of the tools of these trades.

So-called patterns are often not actual patterns of required castings, therefore the following may be accepted as a definition of a pattern:

In connection with the foundry and machinery business, a **pattern** is understood to be a form by the use of which a mold may be made.

2. The cost of a pattern or the amount of work bestowed on it should depend on the number of castings to be made. When but one casting is wanted and the pattern is not likely to be required again, the pattern or device required for making the mold should be as inexpensive as possible, both as regards labor and material. To fulfil this requirement, skeleton patterns, or part patterns in the case of symmetrical work, are very largely used; these will be described in detail later.

Standard patterns, or those that are often used, should be made with great care, always having in mind that the cost of the casting depends as much on the pattern as on the work of the molder. If the molder must patch up each mold on account of the fault of a cheaply made pattern, it will pay to destroy such a pattern and make a better one, if there is no other remedy for the trouble.

CORES AND CORE BOXES.

THE CORE.

3. When hollow castings are wanted, or castings with holes through them, it is customary to make a pattern of such form that it will leave a body of sand in the mold about which the metal will run. The body of sand left in

the mold forms the desired hole or opening, as shown at *a*, Fig. 1. Such a body of sand projecting into the mold to form an opening in a casting is called a **core** and may be left by the pattern itself, as shown in Fig. 1, or it may be formed in a *core box*, and placed in the mold after the pattern is removed.

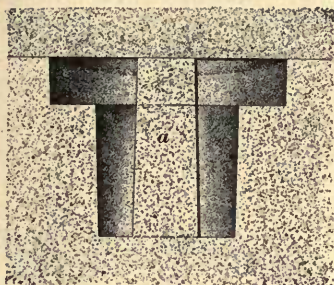

FIG. 1.

CORE BOXES.

4. When it is not possible or when it is not convenient to have the cores left by the pattern, they may be formed in separate devices called **core boxes**. The core box is considered a part of the pattern, or patterns, with which it goes, the pattern and core box together forming a set. In Fig. 2 (*a*) is shown a pattern having *core prints* *b* and *c*.

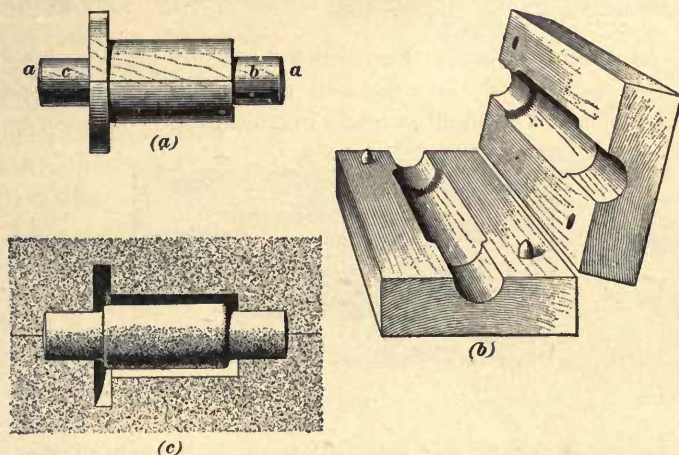

FIG. 2.

The core box, by means of which the core is made, is a mold, usually made of wood, and in two parts, as shown in Fig. 2 (*b*). The mold with the core in place is shown in

Fig. 2 (c). It will be noticed that the ends of the core prints *b* and *c* are rounded slightly, as shown at *a*, so as to enable them to be withdrawn from the sand easily.

5. Metal Core Boxes.—When a large number of standard cores of the same size are required, as, for instance, the small cylindrical cores used in making holes through the hubs of pulleys and in similar work, metal core boxes are employed, which may be purchased from supply houses. These are of standard sizes and are made of iron or brass.



FIG. 3.

One form of metal core box is shown in Fig. 3. At *a* both portions of the core box are shown together, while at *b* one half of the box is shown, illustrating the manner in which the halves are joined together by means of two long tongues and grooves.

Iron core boxes are sometimes made by first making a wooden pattern of the core, and then making a plaster-of-Paris mold. The mold is made in a temporary wooden box,

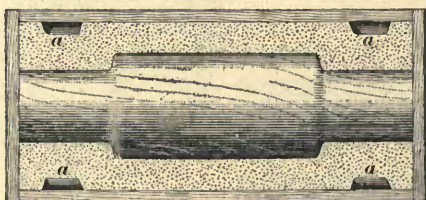

FIG. 4.

which holds the plaster until it is set. Enough plaster to rise to the middle of the pattern is put in the box, the pattern being so placed that a suitable thickness of plaster is beneath it. The surface of the plaster is then smoothed carefully and allowed to set around the lower half of the

pattern. Spaces that taper toward the sides are cut out at *a*, Fig. 4, and the surface and wooden core greased. The other half of the box is then filled with plaster, which is allowed to harden thoroughly and the two parts of the plaster mold are removed from the box, put together with the core pattern inside, and wound with a piece of cord to hold them together. They are then centered in a lathe and turned to any desired thickness. The two parts are now used as molds and an iron box cast from them.

It will be seen that when the second half of the plaster mold is made, the plaster enters the spaces *a*, thus forming projections which will take the place of dowel-pins for the purpose of centering the boxes.

6. Partial Core Boxes.—Very often in the case of symmetrical cores, the box is made for a portion of the core only. In the case of cylindrical cores, only half boxes need be made, and two of the cores from such a box may be pasted together, as shown in Fig. 5 (*a*). Fig. 5 (*b*) shows the box in which the half cores are made.

This same principle may be used in the case of very heavy work, as, for instance, the rims of flywheels, which may be formed by placing large cores in the mold. In fact, sometimes a symmetrical mold like a flywheel is built up almost entirely from cores.

Core boxes require as great care in their manufacture as patterns, and as much thought must be given to their shape, durability, and finish. The shape of the pattern is

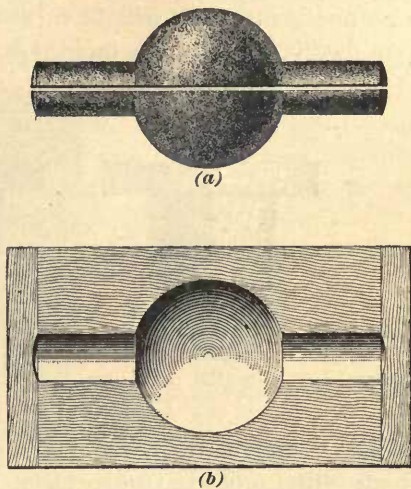

FIG. 5.

nearly like that of the required casting, except that it may have no holes in it. The openings in the core box resemble the openings in the casting.

7. Burning Irons.—Where small holes are required in patterns that are intended to form their own cores, they are frequently formed by means of **burning irons**. This is resorted to especially in the case of small vertical cores. The burning irons are round or square, according to the shape of the hole desired, and are given a great deal of taper lengthwise, about 1 inch in 9 inches. They should be finished evenly on their surfaces and not heated above a cherry red when in use.

CORE PRINTS.

8. When the cores are made in boxes and inserted in the mold, it is necessary that they should be supported in such a manner that there will be no chance for a change of position during the time the mold is being filled with the molten

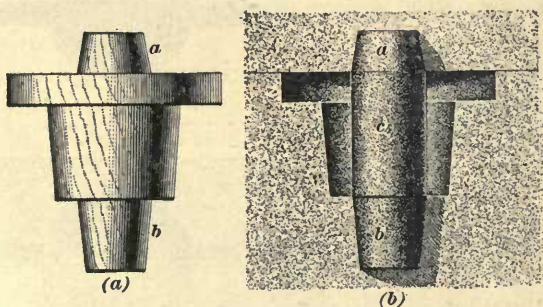

FIG. 6.

metal. To give the cores this support, special recesses are made in the mold to receive them. These recesses are made by attaching pieces called **core prints** to the pattern, as shown at *a* and *b*, Fig. 6 (*a*).

9. Core prints are usually colored differently from the rest of the pattern so that the molder may easily distinguish where the cores are to be placed. As cores are always a source of more or less trouble in a mold, the print should be

made of such a shape and size as will give the least inconvenience to the molder. The core should exactly fill the recess left by the print, and the core print should be of such a size that the recess left in the sand will not be crushed out of shape by the weight of the core or the action of the molten metal. Core prints should be tapered, so that the trouble of withdrawing the pattern from the sand may not be increased by their presence, and also that a core may be easily adjusted in place. Prints for vertical cores should be tapered in their length, and some patternmakers prefer to give the most taper to the upper core print, as shown at *a*, Fig. 6 (*a*). In Fig. 6 (*b*) is shown a mold made by the pattern illustrated in Fig. 6 (*a*). The ends of the core *c* fit in the recesses left by the core print, as shown at *a* and *b*. Some patternmakers make the lower print almost parallel and of the same diameter as the core, so that different lengths of core can be made in the same box.

10. Standard Core Prints and Hubs.—It is always best to adopt a standard system for core prints, especially for those intended for vertical cores. These core prints may be turned up in pairs, having small projections on them that act as dowel-pins to locate them correctly in the

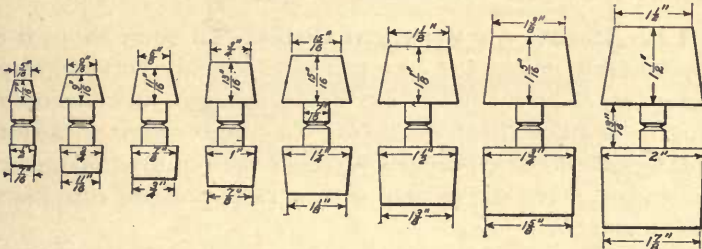

FIG. 7.

hubs. Fig. 7 illustrates a set of core prints ranging from $\frac{1}{2}$ inch to 2 inches in diameter at the large end, and all having $\frac{7}{16}$ -inch pins for locating them.

In like manner, the hubs required on pulleys and gears should be reduced to a standard, and Fig. 8 shows four

standard hubs arranged according to such a system. It will be noticed that each hub has a $\frac{7}{16}$ -inch hole in one face to receive the pin on the core print, while on the opposite face there is a 1-inch pin that fits into the pattern and locates

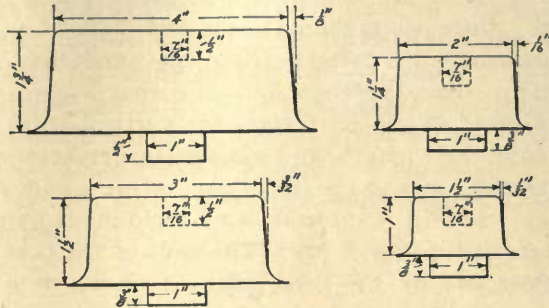

FIG. 8.

the hub. By adopting such a series of standards as this, it is very easy to change the size of hub or core in gears or pulleys within quite a wide range, and thus make the regular patterns that the shop may have available for a much wider range.

The taper shown on the upper core prints in Fig. 7 has been adopted in some shops, in others a smaller taper is preferred.

11. Prints for Straight Cores.—In some shops it is customary to make the core prints taper only very slightly. Cores of different sizes are made straight in convenient lengths and kept in stock. When a core is required, a suitable length is cut off from a piece of the required diameter, the ends tapered sufficiently with a rasp, and put into place in the mold.

Sometimes, in the case of vertical cores, the upper core print is omitted. A standard hole is drilled in the pattern at the center of the desired core and the size of the desired core marked on the pattern. The foundry is provided with a series of parallel print pieces, having diameters equal to the different sizes of cores. These print pieces have standard pins on their ends corresponding to the standard print

holes drilled in the patterns. When molding the pattern, the molder simply places the proper sized piece upon the pattern where the core is to go. The pieces are made of sufficient length so that they project above the top of the mold. After the mold has been rammed up, the piece is withdrawn, leaving a parallel hole from the face of the mold

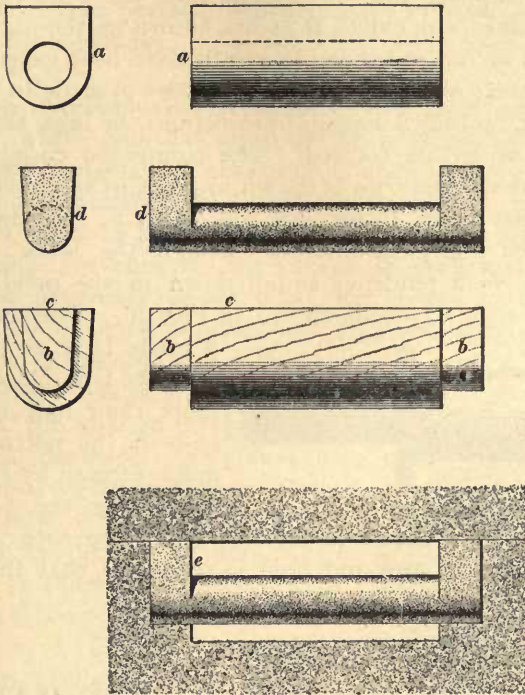

FIG. 9.

to the pattern. This print piece is usually made slightly smaller in diameter than the diameter of the desired core. After the pattern has been removed a piece of standard parallel core is taken, the upper end slightly tapered with a rasp so that it will enter the hole left by the print piece. The advantage of the long parallel print piece over an ordinary core print is that the molder can see whether or not the core

enters the hole properly and the hole also provides a ready escape for the gases issuing from the vents in the cores.

12. Special Core Prints.—Very often the shape of the core print is changed to fit some condition in the molding, as, for instance, in Fig. 9; *a* illustrates a required casting in which the core is some distance from either face. In order to support the ends of the core, the prints are made of a special form, called **D** prints, shown on the pattern at *b*.

It will be noticed that the prints have been carried to the upper face *c* of the pattern. The core is made in a special core box, so that it has end projections, or lugs, that will fit the special prints formed. The completed core is shown at *d*, and at *e* the core is shown in place in the mold.

At other times, it becomes necessary to introduce a core that does not pass entirely through the work and that might have a tendency to fall down in the mold. A pattern for such a piece is shown in Fig. 10. The core print *a*

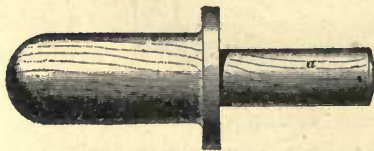

FIG. 10.

is made long, so that when the core is in place, a little more than half of it will rest in the portion of the mold formed by the print. By having the core print a very little smaller in diameter than the core, the mold will pinch the core and hold it so firmly that there is no danger of its slipping out into the mold.

PATTERNMAKING MATERIALS.

WOOD.

13. A pattern is usually made of *wood, metal, rubber, or plaster*. By far the most common are the wooden patterns, because of the comparative cheapness of this material, the ease with which it may be given required shapes, its lightness, firmness, and the possibility of preparing its surface to withstand the action of the moist sand as it is packed

against it in the mold. The use of wood in making patterns is so nearly universal that the patternmaker is always understood to be a wood worker.

Where patterns are required to preserve their exact shapes during constant use, they are made of metal, by first preparing wooden patterns and finishing the castings obtained from these to be used as patterns. In making a wooden pattern for an iron pattern, it is necessary to make a *double* allowance for shrinkage.

14. Characteristics of Wood.—For patternmaking, clear, dry, white pine has generally been found to be the most suitable material. Occasionally, when a large number of castings is required from a small pattern, it is made of hard wood, such as mahogany or cherry. The high cost of mahogany prevents its use except in very rare cases. Of the less expensive woods, good dry cherry makes the most durable patterns, but the cost of production is quite high, owing to the difficulty with which it is worked.

One of the difficulties with which wood workers must contend is the change in shape due to the warping and shrinking of the wood. As pine is the chief material used for patternmaking, a brief study of its nature and the reasons for its warping are here taken up. Fig. 11 illustrates a section of a log. It will be noticed that the end grain shows a series of concentric rings. The number of these rings corresponds approximately to the number of years that the tree has lived. Running at right angles to these rings are other lines commonly called *medullary*, or *silver*, *rays*. All logs are also composed of two parts, called the *sap wood* and the *heart wood*. The sap wood is the more recent growth and forms a comparatively thin layer at the outside of the log. It is usually not so firm as the heart wood, but is more liable to change its shape and to decay, hence its use should be avoided whenever possible.

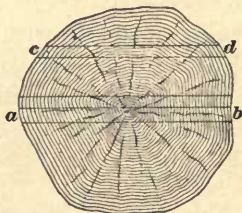

FIG. 11.

15. Microscopic Section of Wood.—Fig. 12 illustrates a microscopic section of pine wood magnified seventy-six times. The dark line of cells from *b* to *c*

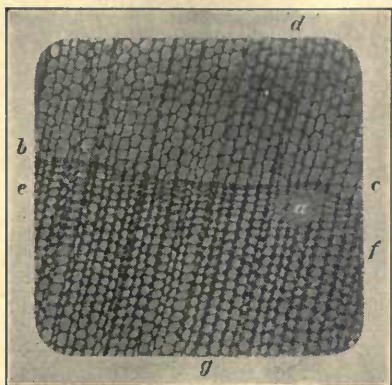

FIG. 12.

indicates the line between two of the concentric rings of the tree. In the portion *bdc*, it will be noticed that the cells are large and open. This represents the summer growth. In the portion *bcfe*, the cells are small and close. This portion represents the fall and winter growth, while the portion *efg*

represents the spring and summer growth. The large opening at *a* is a resin duct. The small spaces enclosed by the cell walls are filled principally with water, which must be almost entirely driven out before the wood is fit to use in making patterns. As the water leaves the wood, the cell walls shrivel slowly and the wood as a whole shrinks, this shrinkage taking place mostly across the grain of the wood. The amount of shrinkage along the grain is so small that it need not be considered. This driving out of the moisture and the consequent shrinkage of the wood is called **seasoning**.

16. Seasoning Wood.—Wood intended for patternmaking should be well seasoned; that is, it should be kiln-dried, or kept from 1 to 2 years before using, according to the thickness of the pieces. This seasoning helps considerably in preventing a piece of wood from warping, but though this precaution be taken and the wood well seasoned, unless it is coated with some protecting agent, it will still be subject to change, owing to atmospheric changes, for it will absorb moisture in damp weather and give it up in warm and dry weather.

17. Laws Governing Warping and Cracking of Wood.—The workman has little control over the shrinking and swelling of wood that is unprotected;

but there are certain conditions that tend to warp a piece from its original shape, a study of which will enable the pattern-maker to overcome the difficulties to a considerable extent.

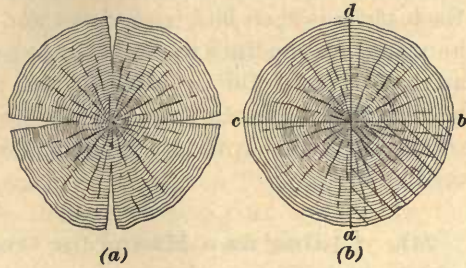

FIG. 13.

As has already been stated, Fig. 11 represents a cross-section of a log of wood showing the annular rings. If the tree is cut when the microscopic cells shown in Fig. 12 are full of sap or moisture and is then allowed to dry, it is probable that the log will split from the outside toward the center, as shown in Fig. 13 (a). It will be noticed that this cracking takes place across the annular rings, but parallel to the medullary rays, and it may be stated that this is true in practically all cases.

18. If a board were to be sawed from very near the heart of a log, as shown at *a b*, Fig. 11, it would not have a great tendency to warp, but would remain approximately straight, as shown at *a*,



FIG. 14.

Fig. 14, while if a board were sawed from the log at some distance from the heart, or center, of the log, as shown at *c d*, Fig. 11, it would have a tendency to warp, as shown at *b*, Fig. 14; that is, the wood would draw together at right angles to the medullary rays, thus throwing up the outer corners. By taking advantage of this fact, and selecting lumber from comparatively near the heart, the tendency to warp can be reduced.

19. Quarter Sawing.—In order to reduce the tendency to warp by having the boards practically all sawed at

nearly right angles to the annular rings, **quarter sawing** is sometimes resorted to. In this case a log is sawed into four pieces, as indicated by the lines bc and ad , Fig. 13 (*b*). Each piece is then laid back down and sawed into boards, as indicated by the lines in the quarter between a and b . This method is wasteful in lumber, but reduces warping to a minimum, and in certain kinds of wood produces very beautiful results, owing to the manner in which it intersects the medullary rays.

20. Gluing as a Means for Overcoming Changes of Shape.—The tendency of lumber to warp can be partially overcome by properly gluing the pieces. For instance, the plank shown at *b*, Fig. 14, could be sawed into pieces as shown at *c*, the adjacent pieces laid in opposite directions and glued together, as shown. This would reduce the total tendency to warp to a minimum by causing the adjacent pieces to warp in opposite directions and within comparatively narrow limits. Sometimes a large solid piece that



FIG. 15.

will not warp is needed in patternmaking. It is, of course, absolutely impossible to get one that will not warp at all, but by gluing several planks together, as shown in Fig. 15 (*a*), this tendency is greatly reduced. It will be noticed that the boards or planks have been laid in reversed directions, that is, so that one board will have a tendency to warp toward the other. It is not, as a rule, good practice to lay the planks together in such a manner that the grain of one piece is at right angles to that of the other, as shown in Fig. 15 (*b*), for when this is done, the pieces a and b will shrink in such a way as to leave the ends of c and d projecting on the sides of the piece, while at the front

and back ends the pieces *a* and *b* will project. In other words, each plank would shrink the most across its grain and it would be practically impossible to keep the surface of the block smooth. This tendency is, however, largely overcome by covering the pattern with a coat of paint or varnish.

In some cases the tendency to warp is overcome by sawing in the direction of the grain, about one-half or two-thirds through each plank, as shown in Fig. 15 (*c*), before gluing. When this is done, the saw cuts should not be allowed to extend quite to the ends, or the ends should be plugged so as to prevent the inner surfaces from being affected by the moisture in the air.

METAL AND OTHER MATERIALS.

21. Special Patterns. — Special patterns are often made of iron, brass, white metal, or aluminum. With a few exceptions, original patterns are all made of wood. Ornamental work and statuary are usually modeled in wax or clay.

Rubber patterns are made from vulcanized india rubber. These may be prepared by first taking enough sulphur to equal 15 per cent. of the weight of the rubber and dissolving it in oil of turpentine and then dissolving the rubber in this mixture and allowing the oil to evaporate. After the oil has evaporated, the mixture of sulphur and rubber may be pressed into molds made of metal or plaster and vulcanized by subjecting it to the action of steam at a temperature of 280° F., or, as it is usually done, putting it in a closed vessel and admitting steam at a pressure of about 50 pounds or a little more. If the temperature is increased (by increasing the steam pressure), the pattern may be made harder. These patterns are especially adapted to light match-board work, but owing to the trouble of making them, they are not generally used.

SANDPAPER.

22. The sandpaper used in patternmaking has been described in *Wood Working*, Part 1. The kind of pattern determines the fineness of the sandpaper to be used and the character of the finish required; usually from No. 00 to No. 1½ are the best grades to be employed in this class of work.

PATTERN FASTENINGS.

METAL FASTENINGS.

23. Nails.—The **nails** most commonly used in patternmaking are the bung-head steel-wire nails, as they have less tendency to split the wood than the tapered cut nails. The sizes of nails to be kept in stock in a pattern shop doing a general class of work are as follows: No. 20, $\frac{3}{8}$ inch, $\frac{1}{2}$ inch, $\frac{5}{8}$ inch; No. 18, $\frac{3}{4}$ inch, $\frac{7}{8}$ inch, 1 inch; No. 16, $1\frac{1}{4}$ inches, $1\frac{1}{2}$ inches; No. 14, 2 inches; No. 12, $2\frac{1}{2}$ inches; No. 11, 3 inches.

The nails should be kept separate and in good order, as this saves much time. Every patternmaker should have a nail box with compartments for the various sizes, for, if they become mixed, much valuable time will be lost in searching for the required size.

24. Screws.—Owing to the necessity for hammering patterns when drawing them from the sand, it is always better to use **screws** instead of nails in securing the parts of a pattern. The use of screws also facilitates the altering of patterns whenever it becomes necessary. The sizes of screws required in general pattern work are as follows: No. 5, $\frac{1}{2}$ inch, $\frac{3}{4}$ inch, 1 inch; No. 8, $\frac{3}{4}$ inch, 1 inch, $1\frac{1}{4}$ inches; No. 10, 1 inch, $1\frac{1}{4}$ inches, $1\frac{1}{2}$ inches; No. 12, $1\frac{1}{2}$ inches, $1\frac{3}{4}$ inches, 2 inches, $2\frac{1}{2}$ inches; No. 16, $2\frac{3}{4}$ inches, 3 inches, $3\frac{1}{2}$ inches, 4 inches.

The screws should be kept in drawers, or in a case having proper compartments, and each size should be labeled. It

will be noticed that the numbers designating the sizes of the nails run in a direction opposite to those designating the sizes of the screws; i. e., the larger the nail is in diameter, the smaller is the number by which it is designated, while, with screws, the larger the diameter of the screw, the larger is the number that designates it.

ADHESIVE FASTENINGS AND PROTECTIVE COATINGS.

25. Glue.—The adhesive fastening in general use in the pattern shop is **glue**. Its general use and the equipment required are treated in *Wood Working*, Part 2. In pattern-making, as a rule, only animal glue, which comes in sheet or flake form, is used, on account of the fact that it resists moisture better than the liquid, or fish, glue. Liquid glue is sometimes used on patterns that are only intended for immediate use, but not on permanent work.

26. Pattern Varnish.—All wooden patterns should be covered with some protective coating so as to prevent warping and cracking from the influence of the moist sand in the mold, and to prevent the glued joints from coming apart. This protective coating is also made of such a nature that it is not affected by moisture and insures a smooth surface that draws easily from the sand. In practice, there are two general classes of **pattern varnishes**. The first is composed of *shellac*, with or without some coloring ingredient. The second comprises the better grades of *copal varnishes*, which may also be colored. By changing the color of the varnish used for this protective coating, it is possible to distinguish between core prints and the main body of the pattern, and also between patterns for different purposes; as, for instance, patterns for brass, iron, steel castings, etc.

27. Yellow Shellac Varnish.—Shellac varnish is the most common protective coating used for patterns. It is made by dissolving gum shellac in alcohol. The orange

shellac, which comes in thin plates, is employed for this purpose, the white shellac being more expensive and not as well suited to the work of the patternmaker. The shellac varnish is commonly called **yellow varnish**.

Gum shellac may be dissolved either in wood (methyl) alcohol, about 95 per cent. pure, or in grain (ethyl) alcohol. The grade of shellac used should be good, as it is not economy to buy cheap material for this purpose, as it is not as durable as a better grade. Care should be taken not to use mixed wood and grain alcohol with shellac, as it will form a varnish that does not dry quickly and is more easily affected by moisture.

28. Frequently, yellow varnish changes to a muddy color by leaving the cover off the varnish pot, or from other causes. Such varnish may be restored by stirring a little powdered oxalic acid into it.

NOTE.—Varnish that has been cleared by the use of oxalic acid should never be used on a cut finger, as it is poisonous; in fact, the use of shellac as a protective covering on cuts and bruises is always more or less dangerous, for, while the alcohol kills the germs, the varnish is liable to have foreign substances in it that may be introduced into a wound and cause blood poisoning. Wood alcohol is always poisonous if taken into the system. For these reasons it is best to prohibit entirely the use of shellac for this purpose.

29. Black Shellac Varnish.—Black shellac varnish may be made by adding lampblack to the yellow shellac. The lampblack employed should be of the finest quality and free from grit. The quality may be tested by rubbing a little of the material between the thumb and finger, when no grit whatever should be felt. A better grade of black varnish may be made by dissolving black aniline in shellac. Only the brand of aniline soluble in alcohol can be used.

30. Red Shellac Varnish.—This varnish may be made by adding red powder, usually Indian red, to yellow shellac. The use of either lampblack or red powder in shellac seems to give it a better body and greater durability.

31. Copal Varnishes.—Copal varnish is very much like shellac in color, though it usually has a slightly greater luster. The objection to copal varnish is that it is very

slow in drying, compared with the shellac varnishes prepared with alcohol. Black and red varnishes may be made from yellow copal varnish by adding lampblack or red powder. Where there is plenty of time available in the making of patterns, and the patterns are to undergo hard service, it is best to employ the better grades of copal varnish, for, while it is slightly more expensive and takes longer to dry, it is very much more durable and will outlast several coats of shellac.

32. Application of Varnish.—In applying the varnish, the pattern should be wiped clean and free from dust. This is especially necessary if the surface has been finished by sandpapering. The first coat of varnish should be a liberal one, applied smoothly, and allowed to soak well into the pattern. When the varnish is thoroughly dry, the pattern will feel rough to the touch on account of the fact that the varnish has hardened any projecting particles or loose grains of the wood. The first coat of varnish should be rubbed smooth with a well-worn piece of fine sandpaper, care being taken not to disturb the general surface any more than is necessary. The pattern should then be wiped free from dust and given another coat of varnish, the second coat being lighter than the first. After the second coat is dry, the pattern is again rubbed down and given another coat, this process being repeated until the desired surface is obtained, or until sufficient coating has been applied to render the pattern impervious to moisture. With yellow shellac varnish, three coats are usually enough. Several thin coats are better than a small number of thick coats, but, of course, the use of thin coats requires more labor.

33. When patterns become rough from use in the foundry, they should be cleaned and varnished, for if the pattern is smooth and well finished, it will give the molder but little trouble, and, hence, will not receive such hard usage. If the pattern is rough, the molder must rap and jar it a great deal in order to insure its drawing properly, and this treatment frequently injures it.

34. Varnish Brushes and Varnish Cans.—Pattern varnish can be best applied with a flat bristle brush. A new brush should be kept in alcohol some time before using, and when the brush is not in use, it should be kept either in the varnish or in alcohol. Yellow varnish is usually best kept in an earthenware jar or mug, on account of the fact that metal will discolor it.

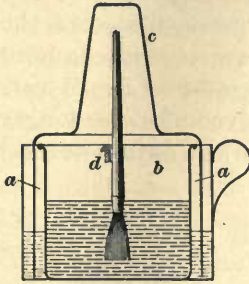

FIG. 16.

Fig. 16 illustrates a very handy form of can for keeping black varnish. The can proper is made double, the varnish being kept in the inner portion *b*, while the annular space *a* is partially filled with water. The cover *c* fits into the water space, thus sealing the varnish airtight, and yet removing all danger of the cover sticking to the varnish pot. The brush is kept suspended by means of a hook on a rod *d*, the rod being also useful for cleaning the brush.

FILLETS.

35. Necessity for Round Corners in Castings. Sharp corners, whether inside or outside of a pattern, should

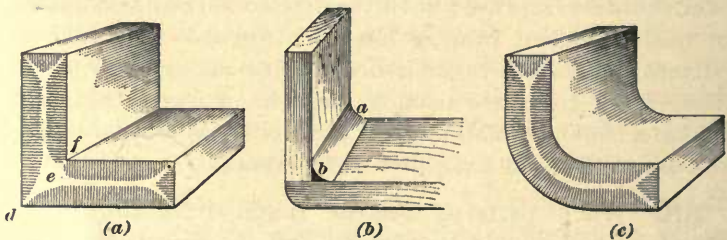

FIG. 17.

be avoided, and whenever there is nothing to interfere, all corners should be rounded. Sharp corners on the inside of a pattern form sharp corners of sand when molding, and these give the molder a great deal of trouble. Sharp

corners, as a rule, detract greatly from the appearance of a casting, and also injure its strength. This weakness is shown by the three illustrations in Fig. 17. At (a) is represented a casting having a sharp corner. As the iron hardens, the crystals seem to form in such a manner that their lines of strength are perpendicular to the faces, as indicated by the lines in Fig. 17 (a). This will leave an open space, or a space of irregular crystallization, at e , and the casting is liable to break along the line df . To overcome this, a **fillet** is usually placed on the inner corner, as shown at Fig. 17 (b), ab being the fillet. The outside corner of the pattern is also rounded, as shown. Fig. 17 (c) shows a casting from a pattern having a carefully rounded corner, and it will be noticed that there is no open space of irregular crystallization as occurred at e , Fig. 17 (a).

36. A good illustration of the faulty results that may arise from sharp corners is shown in the two cylinders represented in Fig. 18.

The one at (a) was cast with sharp corners and a square bottom. If pressure is applied to the interior of the cylinder, the head h will be forced out, as shown in the illustration, the break occurring along the lines de and fg . If the cylinder had been cast, as shown in Fig. 18 (b), with a round end, one portion of it would be as liable to break as another, and, in fact, the end would be the strongest part of the cylinder.

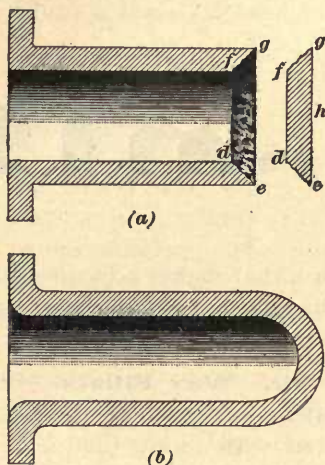

FIG. 18.

Fillets for patterns may be made of leather, wood, metal, wax, or any suitable material that can be worked into the desired form.

37. Wooden Fillets. — Wooden fillets are usually employed only in straight corners, and it is often better to

glue a square or triangular strip in place and hollow it to the desired curve after the glue is dry. The advantage of this procedure is that thin edges are not so liable to curl up as they are if it is attempted to glue a wooden fillet of the desired shape into place.

38. Leather Fillets.—Leather makes the best material for fillets on account of the fact that such fillets can be



FIG. 19.

applied to any form of corner, no matter whether straight or curved, or no matter how irregular the curve may be; also, the leather is

light, durable, and neat. Leather fillets may be made by cutting shavings from leather with a plane of the form shown in Fig. 19, but it is best to buy the fillets ready cut from some

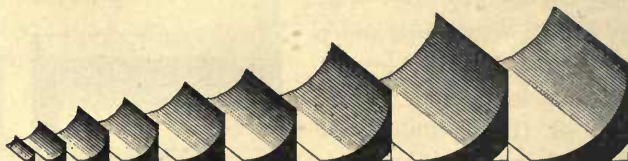

FIG. 20.

firm that makes a business of supplying them, on account of the fact that a much more uniform product may be obtained. Fig. 20 shows a set of such standard leather fillets.

39. Wax Fillets.—Beeswax is used for making small fillets, but much of the beeswax of commerce is so adulterated with tallow that it is difficult to obtain a satisfactory grade. It is also used for filling nail holes, etc. A good substitute for beeswax is made by mixing whiting, resin, and linseed oil with beeswax in the following proportions: 1 pint of linseed oil, 4 pounds of beeswax, 4 pounds of whiting, and $\frac{1}{2}$ pound of resin. This mixture should be made in a pot similar to a glue pot, and should be used when warm, as it

becomes hard when cold. Nail holes in patterns are sometimes filled with common putty, which is a mixture of whiting and linseed oil.

40. Wax is also used for coating iron patterns to prevent their rusting, and to allow them to be drawn from the mold easily. To apply wax to an iron pattern, the pattern is first polished and then washed with a dilute solution of sal ammoniac, which will coat it with rust. The pattern is then warmed until it will melt the wax, and the wax rubbed over it. It is usually best to brush the hot wax with a soft brush so as to distribute it evenly.

41. Metal Fillets.—Metal fillets of a form similar to the leather fillets shown in Fig. 20 have been made and are on the market, but in the case of patterns that are to receive rough usage, they are not usually successful, owing to the fact that the rapping of the pattern jars the fillet loose, the metal stretching and hanging loosely on the nails or other fastenings.

DOWELS.

42. Wooden Dowels.—Wood is the material most commonly employed for making dowel-pins, which are intended to keep the separate portions of patterns or core boxes in their proper relation to one another. The wood for this purpose is placed on the market in sticks of the required diameter, and all that the patternmaker has to do is to point the dowel and cut it to the right length. The objections to wooden dowels are that the dowel-pins swell on exposure to moisture and also the holes in which they fit may close in, owing to moisture. This causes trouble in the foundry, and to overcome it, the molder often whittles the point down too small or makes the hole too large, thus allowing the pattern to shift sidewise.

43. Metal Dowels.—To overcome the difficulties arising from wooden dowels, various forms of metal dowels have been brought out. Brass dowels seem to give the

greatest satisfaction, on account of the fact that they do not rust. Fig. 21 illustrates a set of solid brass dowels turned from bars and intended simply to be driven into holes drilled in the pattern. Fig. 22 illustrates a similar set

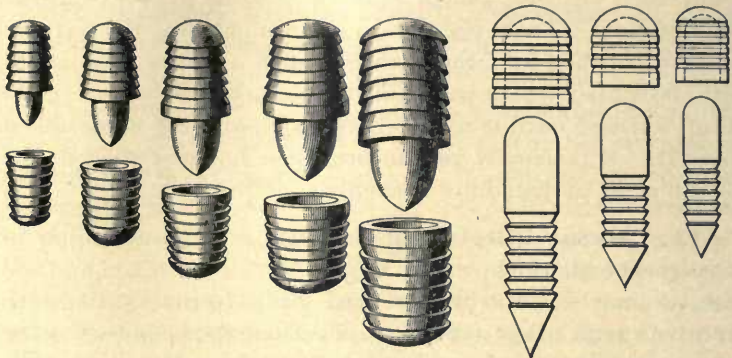

FIG. 21.

FIG. 22.

of brass dowels in which the points are made of smaller material than the sockets into which they are to fit. Either one of these forms is very satisfactory for light work on small patterns. Fig. 23 illustrates a dowel pressed from sheet brass and intended for screwing to the face of a pattern. These are for use on medium-sized work. Fig. 24 illustrates

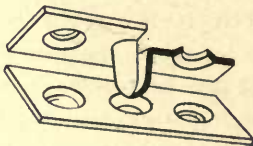

FIG. 23.

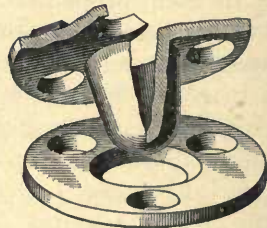

FIG. 24.

a cast-iron dowel and plate intended for use on large or heavy patterns. The methods of inserting these dowels in the patterns will be considered later. One great advantage in the use of any regular system of dowels is that it insures

uniformity, and it is possible to replace a lost pin or socket without any difficulty, while in some cases, one part of a pattern may be made to serve with several other patterns by simply arranging it so that it may be doweled to any one of them.

PROVISION FOR RAPPING AND DRAWING PATTERNS.

44. Rapping and Drawing Plates and Rods.

To aid in the rapping and withdrawing of a pattern from the sand, it should be fitted with iron or steel plates. These plates are sunk into the pattern and are provided with suitable holes for rapping and lifting the pattern.

In the case of large patterns, two or more holes are provided in each plate. One is usually threaded to receive a draw-rod similar to that shown in Fig. 25 (a), and the other hole or holes are used for inserting pins by means of which to rap or shake the pattern so as to loosen it in the sand.

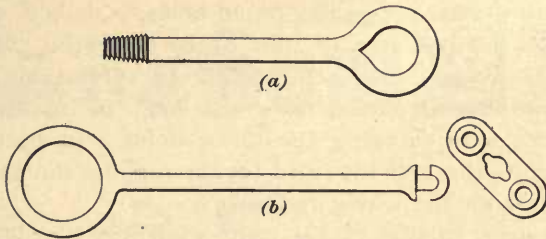

FIG. 25.

For long, narrow patterns, the holes for the drawing rod, the rapping pin, and the screws, of which there are three in number, are all in line with each other. The rapping plate is made long and narrow, and one of the three screws is located between the drawing-rod and rapping-pin holes. Sometimes the lifting plates and the rapping plates are made separate, and in the case of very large patterns, the rapping plates may be of considerable size, so that a sledge or heavy mallet may be used on them. Such large plates should be made of wrought iron or steel.

45. Sometimes, to avoid the difficulty arising from the use of screw threads, lifting plates similar to that shown in Fig. 25 (*b*) are employed. The lifting rod has a key on the end, which is inserted into a slot in the plate and then given a quarter turn before lifting the pattern. Fig. 26 illustrates two forms of rapping plates, both of which can be let into the pattern entirely by boring. In the case of Fig. 26 (*a*), four small holes are bored to receive the ears

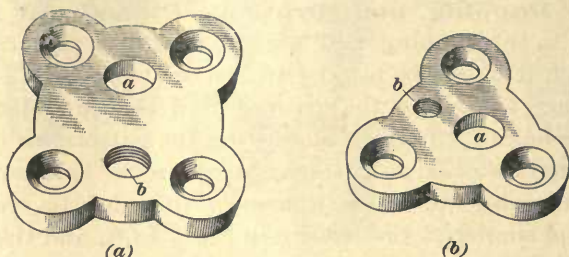

FIG. 26.

that carry the screws, and then one large hole, cutting away about half of the previously bored holes, is drilled with an expansion bit to receive the balance of the plate. A Foerstner bit has also been found very serviceable for the purpose of boring these holes. In Fig. 26 (*b*) there are only three ears carrying the screw holes. In both views *a* represents the hole intended for the rapping pin and *b* the thread hole for the lifting rod.

When using plates of the form shown in Fig. 26, it is a good idea to take a blank plate of the exact outline of the one used and insert pins opposite the center of each circle. These pins are sharpened and allowed to project about $\frac{1}{8}$ inch. By placing this plate upon the pattern and giving it a rap with a hammer, the pins will mark the centers of the holes that must be bored to locate the plate.

The location of rapping and drawing plates should be made a matter of considerable study, for, when the pattern is supported by the drawing irons, it should be well balanced, and usually the most effective rapping can be done from a point over the center of gravity of the pattern.

46. Draw-Nail.—When rapping and drawing plates are not used, as in the case of small patterns, the molder usually drives a small, sharp spike into the pattern for use in loosening the pattern by rapping against it; and also for drawing the pattern from the mold. The use of a **draw-nail** tends to destroy the pattern and should only be used when a comparatively small number of castings are required from a rather small pattern.

PATTERN LETTERS AND FIGURES.

47. Letters Made From Soft Alloys.—In order to enable the manufacturer to keep track of the castings and patterns, it is common to place certain letters and figures on them; these may be recorded, and serve to designate the different pieces. Letters are also used for placing the manufacturer's name on patterns for advertising purposes. The

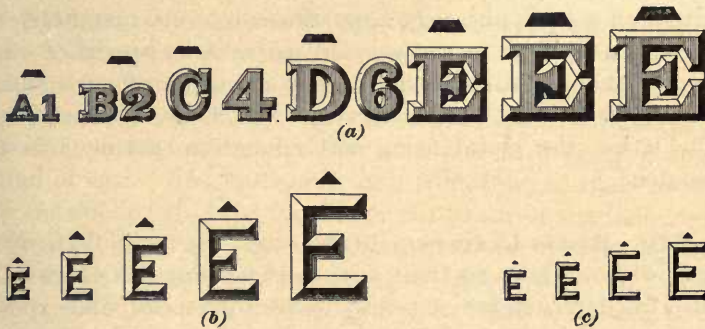

FIG. 27.

letters most commonly used for this purpose are made from an alloy of lead and tin, and the sides of the letters are given plenty of draft. The styles of letters most commonly employed are Roman and sharp Gothic. The thickness of the letter depends to a considerable extent on the size. Fig. 27 (a) shows examples of several sizes of Roman letters and figures. Fig. 27 (b) shows the ordinary sharp Gothic

letters, while Fig. 27 (c) illustrates the hair-line sharp Gothic. These letters are often used in making name plates to be fastened to castings.

48. The Roman style of letters is best suited for advertising purposes on castings, as the tops of the letters have a larger area than the Gothic, and so present a better appearance when polished. The sharp Gothic letters are best for marking patterns for the purpose of recording and ordering castings, on account of the fact that their sharp, beveled sides have a larger amount of draft than the Roman letters, and hence will leave the sand more freely.

49. The hair-line Gothic style of letters is employed for making the letters on the dies used for making stone-ware and similar articles on which the letters are to appear sunk. The soft-metal letters are not well adapted for use on iron patterns, though they are occasionally employed, and in such cases are usually stuck on with beeswax, although it is an unsatisfactory adhesive. The metal letters are usually stuck to the wooden patterns by means of varnish, although in some shops they are fastened with small brads which are driven through the heavier portion of the letter, the metal being soft enough to permit this to be done.

50. Brass Letters.—Brass letters are made both with and without pins on their backs. The pins can be driven into wooden patterns or riveted to iron patterns, while those without pins may be secured to iron patterns by soldering or sweating. The process of sweating letters to patterns is as follows: The place where the letters are to go should be thoroughly cleaned and tinned; the back of the letters should also be tinned. The letters are then placed in position and heated either with a hot soldering point or by means of a blowpipe. This heat will melt the tinned surfaces together. Sweating on the letters makes a much neater job than riveting, and usually takes less time.

PATTERNMAKERS' TOOLS.

HAND TOOLS.

51. Every patternmaker is supposed to provide himself with certain tools, and while many of them are of the same kind as those used by other wood workers, there are many others especially adapted for patternmaking. The patternmakers' kit of tools is probably more varied than that of any other wood worker, because of the endless variety of work he has to do.

Patternmakers themselves differ greatly in their choice of tools, as well as in their manner of work; hence, it is impossible to enumerate all the tools that may be used in patternmaking. Very often the patternmaker thinks that a certain way of executing a piece of work is best, but he may not be able to find a tool to suit his purpose, in which case he frequently makes one himself or has it made.

52. Patternmakers' Tool Kit.—In the following list, the tools named must not be considered the only ones that can be used. In several cases, the makers' names have been given in connection with the tools mentioned, although in most instances there is more than one firm making each kind of tool. The costs may vary from time to time, owing to the condition of the market or the grade of the tools, but ordinarily, such a set may be obtained for about sixty dollars.

One tool box, 32 inches long, 18 inches wide, 16 inches deep, with trays; one 24-inch 10-point hand saw; one back saw; one 12-inch compass; one iron jack-plane; one iron jointer plane; one iron smoothing plane; one iron block plane; five round planes, as follows, No. 1, $\frac{1}{4}$ inch width and $\frac{1}{2}$ inch circle, No. 3, $\frac{1}{2}$ inch and 1 inch, No. 5, $\frac{3}{4}$ inch and $1\frac{1}{2}$ inches, No. 7, 1 inch and 2 inches, No. 9, $1\frac{1}{4}$ inches and $2\frac{1}{2}$ inches; three rabbet planes, $\frac{1}{2}$ inch, 1 inch, $1\frac{1}{2}$ inches; one 2-inch round-face boxwood spoke shave; one No. 0 combination India oilstone; one each of No. 14 and No. 22 combination India oil slips; seven paring chisels with shanks

of $\frac{1}{8}$ inch, $\frac{1}{4}$ inch, $\frac{3}{8}$ inch, $\frac{1}{2}$ inch, $\frac{3}{4}$ inch, 1 inch, $1\frac{1}{2}$ inches width; nine paring gouges, $\frac{1}{8}$ inch, $\frac{1}{4}$ inch, $\frac{3}{8}$ inch, $\frac{1}{2}$ inch, $\frac{3}{4}$ inch, 1 inch, $1\frac{1}{4}$ inches, $1\frac{1}{2}$ inches, 2 inches; one $2\frac{1}{2}$ -inch sloid knife; one No. 19 Adis $\frac{3}{8}$ -inch carving gouge; one No. 28 Adis $\frac{1}{2}$ -inch carving gouge; one each of No. 31 $\frac{3}{8}$ -inch, $\frac{1}{4}$ -inch, $\frac{1}{8}$ -inch carving gouge; one 12-ounce ball-faced claw hammer; one small long-peen hammer; one 8-inch try square; one carpenters' steel square; one 8-inch T bevel; one 12-inch Starrett's combination square and center head; one No. 65 Stanley's boxwood marking gauge; one folding draw-knife, 8-inch blade; one 4-inch shingling hatchet; one set screwdrivers; one 2-foot folding rule, standard; one 2-foot rule, not folding, shrinkage; one 8-inch wing dividers; one excelsior pencil attachment; one 5-inch spring dividers; one 5-inch outside calipers; one 5-inch inside calipers; one ratchet brace; one set auger bits, $\frac{3}{16}$ inch to 1 inch; four twist drills with square shanks, $\frac{3}{32}$ inch, $\frac{1}{8}$ inch, $\frac{3}{16}$ inch, $\frac{1}{4}$ inch; one set adjustable-leg trammel heads; one malleable-iron oil can; one extension bit with two cutters, to bore from $\frac{7}{8}$ inch to 3 inches; one double-cut countersink; one dozen assorted brad awls; two 3-inch malleable-iron C clamps; one $1\frac{1}{4}$ -inch turning gouge; one $\frac{3}{4}$ -inch turning gouge; one 1-inch turning chisel, ground on both sides; one $1\frac{3}{4}$ -inch extra heavy turning chisel, ground on one side only; one each $\frac{1}{4}$ -inch right-hand and left-hand turning chisels, ground on one side only and on the skew; one nail set; one 8-inch carpenters' pincers.

53. Care in Use of Tools.—The patternmaker is supposed to have a knowledge of the use of the ordinary wood-working tools; and hence this matter will not be taken up in detail, but a few hints concerning the care of tools may be of assistance.

All tools should be kept sharpened and in good order, if good work is to be produced by them. This fact cannot be too strongly impressed on all that use tools of any kind.

54. Wood-Working Tools.—Hand wood-working tools, such as chisels, gouges, etc., are usually ground on a

grindstone and finished on an oilstone. Care should be taken in grinding not to overheat the edges, so as to draw the temper, and in both the grinding and the sharpening on the oilstone, attention should be given to the angles at which the tools are sharpened so that these are uniform and suited to the material being worked.

55. Dogs and Driving Plates.—Where two pieces of wood are to be fastened together, **dogs** similar to that shown at *a*, Fig. 28 (*a*), are frequently employed, which are driven into the end of the grain as indicated by the dotted

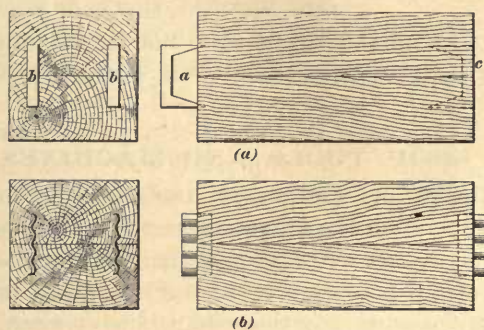

FIG. 28.

lines at *c*; *a* shows the general shape of the side of the dog and *b* the back face. Such dogs should be kept on hand in a variety of sizes, and used in securing the parts of sectional patterns temporarily in place while they are being operated on.

Another form of dog, which is frequently used, consists of a corrugated-steel plate, sharpened on one side to a cutting edge, as shown in Fig. 28 (*b*). These dogs are driven into the ends of the two pieces to be fastened together, as shown, and have given excellent satisfaction.

56. When patterns are to be turned, metal plates are sometimes screwed to the pieces in place of dogs, and if the pieces are large and heavy, the centers on which the work is to be turned may be formed in the plate, as shown

in Fig. 29, *a* being the plate screwed to the end of the pattern in such a manner as to join the halves *b* and *c* together.

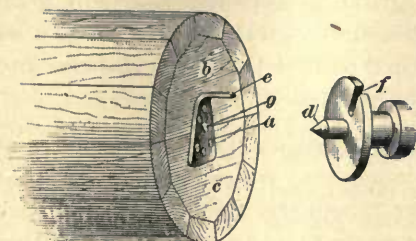

FIG. 29.

In this case, a portion of the plate has been bent to form the driver *e*, which engages the slot *f* of the lathe face plate and serves as a driver for rotating the work, which is supported on a center *d*, which enters the hole *g* in the plate.

These dogs and plates are usually not furnished by the patternmaker himself, but belong to the pattern shop.

SHOP TOOLS AND MACHINES.

57. The variety and size of tools used in any pattern shop will depend on the amount of work being done and the character of the patterns being made. In the case of small pattern shops, comparatively few tools are required, while in large ones, and especially those doing heavy work, it is more economical to have a large number of machines. The machines necessary for patternmaking have been considered in *Wood Working*, Part 2, and *Wood Turning*. Those required for cutting down, ripping, and resawing stock, and preparing it for patternmaking, will not be taken up in this connection, though in some cases large pattern shops are provided with such machinery.

ALLOWANCES NECESSARY IN PATTERNMAKING.

58. In practice, it has been found that a casting obtained from a pattern is rarely, if ever, of exactly the same size and shape as the pattern itself, and to overcome this difficulty, certain allowances must be made. In order to understand the conditions that exist and to make these allowances

properly, it is necessary to study the causes of the different variations. The principal allowances necessary are for *draft*, *shrinkage*, *finish*, and *shake*. Each one of these will be taken up separately.

DRAFT.

59. The pattern is usually given a slight taper so that it may be more easily withdrawn from the mold. This taper is called the **draft**. The surface from which the draft runs is called the *face* of the pattern, and is usually the uppermost surface of the mold when the pattern is drawn. Fig. 30 shows the manner in which the allowance for draft is made. The shape of the required casting is indicated by the dotted lines. It will be noticed that the draft has been given by increasing certain dimensions of the pattern. For instance, the diameter of the flange *cd* has been increased at the face to *ab* and the diameter of the hole *gh* has been decreased at the face to *ef*, thus increasing the thickness of the pattern. No unvarying rule as to the amount of draft can be given. On comparatively small work, a taper of $\frac{1}{16}$ inch per foot represents, approximately, an average amount, but in some cases very much less is employed, while in other cases a greater amount is given. Some patterns are of such form that they do not require an allowance for draft, because of the fact that none of the surfaces is at right angles to the face.

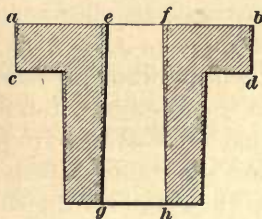

FIG. 30.

SHRINKAGE.

60. An iron casting is always smaller than the mold in which it is made, and this is true of castings made from any of the metals in common use. This difference in size is due to the **shrinkage** of the metal when cooling. The amount

of shrinkage varies with the shape and size of the casting and with the kind and quantity of metal employed. Brass, for instance, will shrink more than iron; and, again, iron that is very hot will shrink more than iron that is comparatively cool when poured.

61. Allowances for Shrinkage.—The shape and size of a casting have so much to do with the amount of shrinkage that an iron that will shrink $\frac{1}{8}$ inch to the foot in light work may only shrink $\frac{1}{10}$ inch or less in the case of heavy work. For heavy wheels, $\frac{1}{12}$ inch is sometimes used. For instance, when casting large cylindrical or box-shaped iron castings, an allowance of $\frac{1}{10}$ inch to the foot in length and from $\frac{1}{16}$ to $\frac{1}{20}$ inch to the foot in diameter is usually a sufficient allowance for shrinkage. The reason for the difference in the allowance for length and diameter is due to the fact that the castings are practically unrestricted in their length and are comparatively free to shrink in this direction, while in the diameter the shrinkage is restricted by the cores and internal parts of the mold.

The usual allowances that patternmakers make for shrinkage for ordinary purposes are as follows: Iron, $\frac{1}{8}$ inch per foot; common brass, $\frac{3}{16}$ inch per foot; yellow brass, $\frac{7}{32}$ inch per foot; aluminum, $\frac{1}{4}$ inch per foot; steel castings, from $\frac{1}{8}$ to $\frac{1}{4}$ inch per foot, depending on the kind of casting and the temperature at which it is to be poured.

When metal patterns are cast from wooden patterns, double shrinkage must be allowed in making the original pattern.

FINISH.

62. When the surface of the casting is to be cut away, or finished, an allowance equal to the amount removed is added to the pattern and is called an allowance for **finish**.

The allowance made for finish must always be sufficient so that all the scale will be removed and clean metal exposed. For iron, an allowance of from $\frac{1}{16}$ to $\frac{1}{8}$ inch is sufficient in the case of small work, but as the size of the casting

increases, its irregularities and the total amount of shrinkage increase, and a greater allowance for finish must be made. In the case of heavy engine beds and similar large castings, an allowance of from $\frac{3}{4}$ to 1 inch is frequently made. Steel castings are usually very rough, especially when large, and they also become more or less distorted in casting and annealing. For this reason, an extra allowance is made for finish. Each individual shop must determine its own system of allowances for finish, as it is dependent in part on the manner in which the work is machined and the molding done.

SHAKE.

63. The molder usually loosens the pattern in the mold by rapping it before it is withdrawn. As this tends to increase the size of the mold, it may become necessary to make an allowance for **shake** in some cases, especially when dealing with small castings, or the small details of large castings.

If small castings are intended to fit together without finish, as shown in Fig. 31, the dimension a on the piece c is increased by shake, while the space a on the piece b is reduced, and, as a consequence, the two pieces will not fit together; hence, the patterns should be

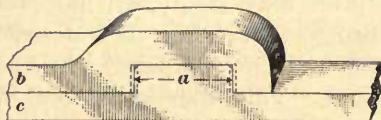

FIG. 31.

made with an allowance for shake, the dotted lines indicating such allowance. In this case, the two patterns would go together loosely, but the two castings would probably go together tightly. It is very rare that the attempt is made to fit castings together without some finish, but very frequently it is necessary to make an allowance for shake. It is impossible to give any definite amount as the proper allowance for shake, as this must be determined by experiment in almost every case. Usually, an allowance for shake is only made on small patterns, and it is not often required in cases where the dimensions of the pattern exceed 4 inches. On

small pieces, shake and shrinkage tend to neutralize each other, and in many cases they are supposed to do so between the limits of 4 and 6 inches. On dimensions of over 6 inches, an allowance is usually made for shrinkage.

WARP.

64. Some castings will become distorted in the mold when cooling, owing to their varying thickness or to one

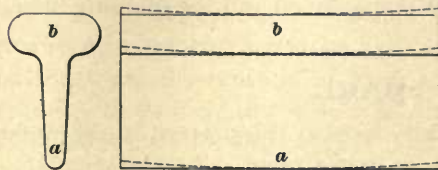

FIG. 32.

surface being exposed more than another so that it cools more rapidly. For this reason, it is frequently necessary for the patternmaker to make

some allowance for **warp** by changing the shape of the pattern. The amount of allowance necessary must be determined by trial in almost every case, but there are some general rules or laws that govern such cases, and, by studying them and exercising a little care in molding, these difficulties may frequently be overcome. If a casting of the form shown in Fig. 32 is desired, it will be noticed that the web *a* is thin compared with the upper portion of the casting *b*. This web would cool first and thus determine the length of the lower portion of the casting. The portion *b* would cool more slowly and would contract somewhat after the web *a* had become permanently set.

The shortening of the upper face of the casting would tend to warp it as indicated, somewhat exaggerated, by the dotted lines. In other words, the portion that contains the largest body of metal cools last and tends to become the shortest. In order to make this casting straight, it is necessary to make the upper face of the pattern convex or to cause the upper face to cool more rapidly than the lower portion. The latter may be accomplished in molding by bedding the web *a* deep in the sand and having only a thin layer of sand on top of the portion *b* so that the heat will

radiate and escape from it rapidly. Frequently, molders uncover or partially uncover large masses or heavy irregular parts of castings so as to cause them to cool more rapidly and thus reduce the strains caused by irregular cooling. When casting plates that are strengthened by means of ribs, care should be taken to make the ribs approximately the same thickness as the plate, as otherwise they will have a decided tendency to warp the casting.

MARKING AND RECORDING PATTERNS.

65. Where a large number of patterns must be stored and taken care of, it is important to have some system by means of which any given pattern can be immediately located and by means of which castings can be ordered from any given pattern. The system in most common use is to fix some mark or symbol upon each pattern and then make a record of this symbol. It would be impossible to give examples of all the different systems employed for marking and recording patterns, but the following general description can be applied in most cases, or a modification of it can be worked out for any given case. The advantages of having a system are as follows: The marks facilitate the ordering of castings and help to prevent confusion in the foundry and the mixing of patterns. When the order for a casting is written out (as it always should be), the mark corresponding to that on the pattern is put on the order, so that the molder and the patternmaker cannot misunderstand each other by naming parts differently.

66. Marking Patterns.—To mark a pattern, a letter and number may be fixed upon each pattern so that they will appear on the casting. The letter is to designate the class of machinery, or it may be used for a certain machine. The number is to designate one part of the machine from another.

In the case of large manufacturers that have patterns for a number of different classes of machines, and often a

number of different sizes of machines in each class, the question may arise as to what should be done when the alphabet is exhausted. In this case, two letters can be used to designate a machine or class, commencing with *AA*, *AB*, *AC*, and so on through the alphabet again; then begin with *BA*, *BB*, *BC*, etc. Thus it will be seen that it is possible to have a large combination of distinct and separate classes without confusion. The mark placed upon each pattern should also be entered on the drawings. This is frequently neglected, but where it is done, it greatly facilitates the work in the machine shop.

In the case of patterns having core boxes or loose pieces, each piece or core box should receive the mark, as this will enable the foundry man to keep the pieces together and to avoid mistakes.

67. Recording Patterns.—The accompanying sample entry, taken from a pattern-recording book, will serve to illustrate the manner in which this work may be carried out.

68. The column marked "Pattern At" will be found very useful when patterns are sent to outside foundries, as it will enable the patternmaker to locate all his patterns accurately. In connection with this column, an index is made showing the names of firms to whom patterns have been sent. Each firm is given a number, as shown. When a pattern is sent out, the number corresponding to the firm to whom it has been sent is marked with a lead pencil in the number column and opposite the pattern that is sent out. When it is returned, the lead-pencil mark is erased, showing that it has been returned and restored to its place.

It often appears that in a set of patterns for a certain machine, there are some parts that can be used on other machines. In such cases, entries should be made in the schedule of each machine, stating that these pieces can be used and giving the letter and number upon each piece.

69. Miscellaneous Patterns.—There is always a large number of miscellaneous patterns that cannot well be classified, yet many of them are frequently recorded and

SPECIMEN ENTRY FOR PATTERN RECORD BOOK.

18-INCH AND 20-INCH CORLISS ENGINES.

Pattern Mark.	Name of Part.	Castings Wanted.	Weight.	Pattern At	Remarks.	
A 1	Engine frame, 18" × 36"	1	3,555	2	This pattern is constructed so that it can easily be changed to different strokes and sizes.	
A 1	Engine frame, 18" × 42"	1	3,905			
A 1	Engine frame, 18" × 48"	1				
A 1	Engine frame, 20" × 36"	1				
A 1	Engine frame, 20" × 42"	1				
A 1	Engine frame, 20" × 48"	1				
A 2	Main pillow-block	1	2,015	3		
A 3	Cap for block	1	475			
A 4	Oil cover	1	10			
A 5	Corliss cylinder, 18" × 36"	1	3,790	2		
A 5	Corliss cylinder, 18" × 42"	1	4,290		Patterns are arranged on the telescopic principle.	
A 5	Corliss cylinder, 18" × 48"	1				
A 6	Corliss cylinder, 20" × 36"	1	4,125			
A 6	Corliss cylinder, 20" × 42"	1	4,280			
A 6	Corliss cylinder, 20" × 48"	1				
A 7	Frame foot	1		1		
A 8	Cylinder feet (20" cylinder)	2				
A 8	Cylinder feet (18" cylinder)	2				
A 9	Crank, 36" stroke	1			Strong bronze. Crank end. Crosshead end.	
A 10	Crank, 42" stroke	1				
<i>Brass.</i>						
A 70	Key heads	12				
A 71	Knock-off latches	2				
A 72	Connecting-rod box	1				
A 73	Connecting-rod box	1				
A 74	Bushing for piston rod	1				
A 75	Bonnet bushings	4				
A 76	Eccentric strap shims	2				
<i>Steel Castings.</i>						
A 100	Crosshead nut	1		4		Nov. 3, 1892.
A 101	Cheek pieces for pattern block	2		4	Nov. 3, 1892.	

INDEX OF FIRMS TO WHOM PATTERNS ARE SENT.

- 1 Eddy Foundry Co., Chicago, Iron Foundry.
- 2 Chicago Foundry Co., Chicago, Iron Foundry.
- 3 Bouton Foundry Co., Chicago, Iron Foundry.
- 4 Pittsburg Steel Casting Co., Pittsburg, Steel Foundry.

should be marked so that they can easily be found. These may be given a symbol and entered under the head of miscellaneous.

70. Rough Patterns.—There are always some rough patterns made that are wanted simply for a single casting and are frequently of the skeleton type. These patterns are usually not recorded and it is generally best to destroy them as soon as they have served their purpose.

71. General Remarks on Recording.—As a rule, the billing and shipping clerks that handle patterns are not familiar with the names of the parts of the machines; hence, matters are greatly simplified by having these parts recorded by letter and number, and by adopting such a system it is possible even for a stranger to find any desired pattern, provided the shelves or bins where the patterns are stored are marked with the letter corresponding to the class belonging there. The system described is intended simply as a suggestion in order to show how the work may be carried out. Every pattern shop should have some definite system of its own and a definite order for storing and keeping the patterns. Sometimes, shops adopt a system of painting all outside faces of patterns a different color from the faces that come in contact with other portions of the pattern, so that the molder can tell at a glance whether some piece of the pattern is lacking or not.

PATTERNMAKING.

(PART 2.)

MAKING PATTERNS.

SMALL RECTANGULAR PATTERNS AND CORE BOXES.

I. Patterns for Solid Castings.—Patterns of this kind are usually made solid by first sawing the stock to approximately the required size and then finishing it with a plane or such other tool as may be most convenient. In getting out the stock from which to make patterns, it is necessary to take into account not only the allowances for draft, shrinkage, shake, and finish, but also the allowance for sufficient material for the finishing of the pattern with the planes, chisels, or other tools employed.

When a pattern is thin and flat, as shown in Fig. 1, the allowance for draft may be disregarded, since the rapping will be all that is necessary to free the pattern from the sand so that it can be removed from the mold, and, in the case of small patterns, that is, up to 6 inches, the rapping will also enlarge the mold sufficiently to compensate for the shrinkage of the casting due to cooling.



FIG. 1.

When the depth of the pattern is comparatively great, as in the case shown in Fig. 2, an allowance for draft must be made. The face *a* of the pattern is larger than the required size of the casting by the amount necessary for draft. The opposite end *b* of the pattern is made of the required size, the dotted lines indicating the amount that has been added to provide for draft.



FIG. 2.

In the case of large solid castings, the patterns are sometimes made hollow like wooden boxes, so as to make them lighter for the molder to handle and also to reduce the amount of timber necessary in the pattern. In the case of a very deep mold, the face *b* of the pattern is sometimes made slightly smaller than the required size. In such cases the molten iron is depended upon to strain, or enlarge, the bottom of the mold enough to make the lower part of the casting of the desired size. Such an allowance is called an allowance for straining.

2. Patterns for Hollow Castings.—When it is required that there shall be openings in or through the casting, the pattern is made to leave its own core when possible. Fig. 3 illustrates a cross-section of a mold containing a pattern. At *a* the pattern leaves a mass

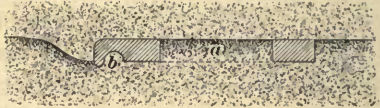

FIG. 3.

of sand forming a core that will make a hole entirely through the casting, while at *b* simply a small ridge of sand is left as a core to form a depression in the metal. Both of these cores are left by the pattern. In such cases as this, the inside of the opening for forming the core and the outside of the pattern are both given a slight taper from the face, for draft.

When the core becomes long, so that it is impossible to draw the pattern from around it, or when the core is of such a shape that a pattern cannot be drawn, it becomes necessary to use a separate core. Short square cores may

be formed in a simple core box like the one shown in Fig. 4 (a) and short cylindrical cores in a box similar to the one shown in Fig. 4 (b). In this case, the opening for the core is simply an opening bored through a block of

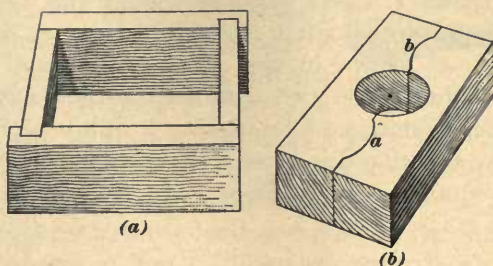

FIG. 4.

wood that has been sawed apart to facilitate the removing of the core. In sawing, the parting line has been made irregular, as shown at *a* and *b*, these curves serving to properly locate the parts of the core box. Other devices for accomplishing the same purpose will be illustrated later.

3. Rounding the Corners.—It has already been explained that no sharp corners should be made on castings. The process of rounding the corners therefore becomes one

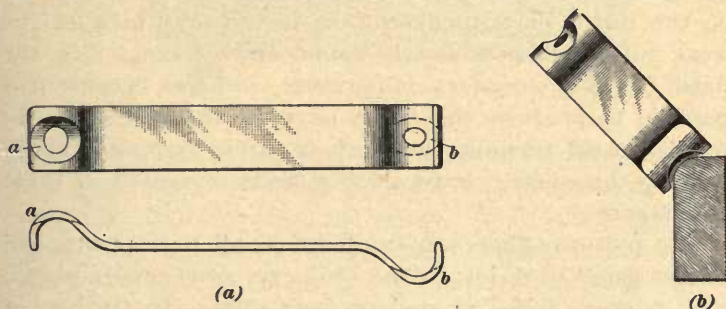

FIG. 5.

of the essential parts of patternmaking. When done with ordinary tools, it requires considerable time. By the use of the simple tool shown in Fig. 5 (a), however, the time may be shortened considerably.

This tool consists of a piece of steel about $\frac{1}{4}$ inch thick and of suitable width, bent to the form shown in Fig. 5. Circular grooves are ground out at *a* and *b*, the curvature of these grooves being made so that it will produce the required round. These grooves should run through the metal so as to form cutting edges, which, when drawn over the corner, as shown in Fig. 5 (*b*), will round it to the required radius. The two ends of the tool may be made for different rounds, and by making a number of them for the most common radii, so as to have them on hand when they are required, a large amount of time may be saved.

PATTERN TURNING.

4. Distinctive Features of Pattern Turning.

The operation of pattern turning is carried on in a different manner from the ordinary work of the wood turner. Ordinarily, the patternmaker does not use a tool ground on both sides and held sidewise for finishing, as does the wood turner, but uses a thick chisel ground on one side only, with which he scrapes the work by firmly holding the chisel flatwise on the rest. Patternmakers turn in this way because the work must be approximately round and of exact size, the finish being of secondary importance, and also because it is possible to produce the finish later by other means. In regular wood turning, the work is rarely required turned to exact dimensions, but a smooth finish is usually of great importance.

The patternmaker usually turns small core prints and similar small work just as the ordinary wood turner would, with a skew chisel, ground on both sides. In the case of heavy work, especially when turning built-up patterns, the work is frequently firmly secured in a lathe, and a sliding rest, similar to that employed in the metal-working lathes, placed before it, the turning being done by means of tools held in the rest.

EXAMPLE OF SIMPLE TURNED PATTERN.

5. Pattern for Solid Roller.—The pattern shown in Fig. 6 may be taken as a fair representative of this class. The kind of pattern made to produce this roller will depend largely on the number of castings required and the facilities at hand. When but a few castings are wanted, a pattern will be turned out of one piece having the same shape as the casting. This simplification of the work of the patternmaker throws additional labor on the molder, since it necessitates his cutting down the parting line of the mold, as shown in Fig. 7. The pattern is shown at *r*, and it



FIG. 6.

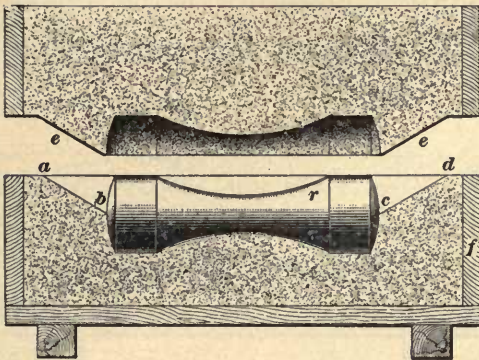

FIG. 7.

will be noticed that the molder has been forced to cut away the sand along the lines *ab* and *cd* so as to enable him to draw the pattern from the mold. This leaves the lower portion of the mold comparatively simple, but the cope, or upper portion, will have a body of sand hanging from it, as shown at *e*, and this is objectionable in most work.

6. If a great number of castings is wanted, the patternmaker may still make a solid pattern and, in addition, make what is called an *odd side* or *match*. This is illustrated in Figs. 8 and 9. In Fig. 8, the pattern *a* is shown

embedded half its depth in plaster or oil sand, the latter consisting of a mixture of 1 part, by volume, of oil and 25 parts of sand. The odd side is made in a box *c*, which must be of the same size as the mold. If it is made of plaster, it is allowed to harden, and if made of oil sand, it is dried until

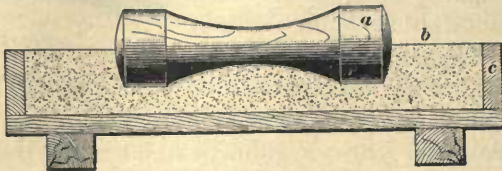

FIG. 8.

the material has become firm. The plaster or sand is usually made to adhere to the box *c* by means of nails driven on the inside of the box. The method of using the odd side is shown in Fig. 9, in which *a* is the pattern, *b* is the sand or plaster of the odd side, *c* is the box containing it,

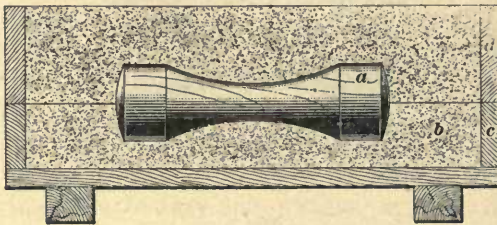

FIG. 9.

and *d* is the drag of the flask. The drag is placed upon the box *c* and sand rammed in as shown, after which the whole is turned over, the odd side removed, and molding continued as usual. If it is so desired, several solid patterns may be made and an odd side provided that will accommodate all of them.

7. Jointed Roller Pattern.—When there is only a moderate number of castings required, the patternmaker usually provides a jointed pattern. This is also frequently done owing to the fact that odd sides or matches are large

and awkward and inconvenient to store, also the odd side, or match, can only be used with a flask of the same size as the box containing it, while, with a jointed pattern, any form of flask of sufficient size may be used. In a jointed pattern, the molding is facilitated by making the pattern in halves. To make a pattern for the roller illustrated in

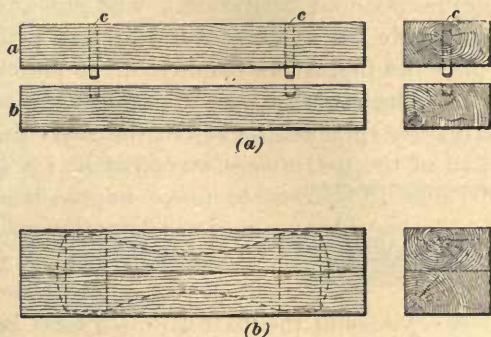

FIG. 10.

Fig. 6, two pieces of wood should be prepared, as shown in Fig. 10 (a). These pieces are sawed from a board or plank and are larger than the required pattern, so as to allow for finishing the pattern. Fig. 10 (b) shows the two pieces face to face and the outline of the required pattern drawn upon them, thus illustrating the allowances that are ordinarily made.

8. The pieces should next be doweled together. If wooden dowels are used, they may be put in place by clamping one piece on top of the other and boring through the first and partly through the second, as shown by the dotted lines at *c, c*, Fig. 10 (a). If it is desired to keep the outside surface of the pattern unbroken, the holes may be located by laying two small wire nails between the pieces and then tapping the other piece with a hammer, or mallet. The heads of the nails will make impressions in each piece, which will indicate the centers of

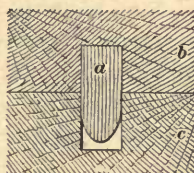

FIG. 11.

the holes to be bored. Fig. 11 illustrates a dowel that has been put in in this manner, *a* being the dowel, which is glued to the portion of the pattern *b* and fits into the hole in *c*. The pins should not be placed at equal distances from the ends of the pattern, but one should be nearer the center than the other, so that the molder can put the pattern together without hesitation. The pins must be put in and glued before the turning of the pattern is done.

If brass pins and plates are employed, the plates with the dowel-holes are inserted into one half of the pattern first. The pin plates are then put on top of the inserted ones and the other half of the pattern set on top of it. A tap with a mallet will cause the pieces to make impressions on this upper piece of the pattern, and will thus locate the holes that must be bored.

9. The two pieces of the pattern must next be fastened together in such a way that they can be turned as one piece.

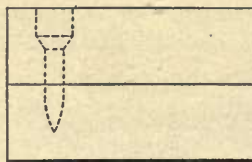
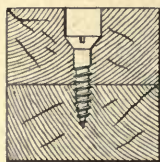

FIG. 12.

This can be done by inserting screws near the ends, as shown in Fig. 12, or by inserting dogs, as shown in Fig. 28, *Patternmaking*, Part 1.

Another method that is commonly employed for holding the pieces together while being turned, is to glue a piece of paper on one of the pieces and then glue the other piece on to this paper. Sometimes the entire surface of the pattern is not covered with the paper, but strips are simply glued between the ends. If pieces have been joined by gluing paper between them, after the pattern is finished, they may be separated by inserting a knife blade or chisel between them, leaving one-half of the paper on each piece. When patterns are secured by glue and paper, care must be taken in turning to avoid accidents because of the tendency of the glued pieces to fly apart, owing to the great speed at which they are revolving

in the lathe. After the pieces are secured together, the pattern is turned to the form shown in Fig. 6; it is then removed from the lathe and the parts separated. The ends should never be turned entirely off in the lathe, but should be turned to a thin neck, which is subsequently sawed off and finished with a knife or chisel.

LARGE CYLINDRICAL PATTERNS.

10. Built-Up Patterns.—Large cylindrical patterns of the class illustrated in Fig. 13 are generally built up of staves that are carefully jointed and fastened to supports or guides. The general method of jointing staves and attaching them to supports is shown in Fig. 14, in which *a, b* are the

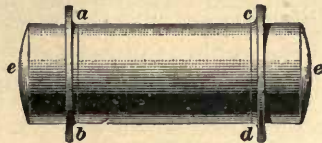

FIG. 13.

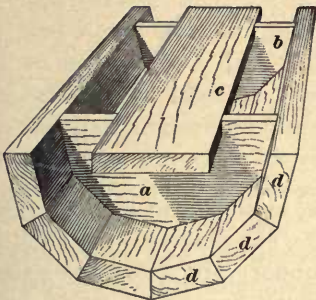

FIG. 14.

supports and *d, d* the staves. In the illustration, the board *c* has been let into the supports *a* and *b* in order to give additional stiffness to the pattern while it is being built up. This is not always done, and sometimes when it is done, the board *c* is allowed to stop at the end supports *a* and *b*. In the case of long patterns, it becomes neces-

sary to use more than two supports for the staves.

Before proceeding with the pattern, a drawing should be made as shown in Fig. 15. This drawing is made on stiff paper or on a thin piece of wood. The half circle for the outside of the pattern is drawn and on this the staves are laid off, enough stock being left on the outside, as shown at *c d*, to provide for turning.

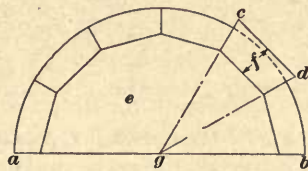

FIG. 15.

The staves are laid off with sufficient thickness to give the pattern the required strength and the lines of division between the staves are drawn toward the center g . The thickness of the staves f is determined and the polygon for the support e laid off as shown.

11. Cutting Stock for the Pattern.—After the drawing is completed, the polygon e is cut out of the drawing and used as a templet to mark the partition pieces or supports a and b , Fig. 14. The staves are then sawed to the proper angles and width from a plank that has been planed to the required thickness, as shown at f , Fig. 15. These staves may be sawed upon a circular saw having a tilting table as illustrated in *Wood Working*, Part 2. They may also be cut out, by fixing them at the proper angle,

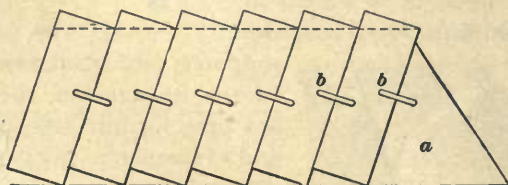

FIG. 16.

upon the table of a Daniels planer, as shown in Fig. 16, and planing them to the desired form. The pieces rest against a support a and are held to the support and to one another by dogs b . After one set of edges has been cut to the dotted line, the pieces are turned over and the other edges treated in the same manner. Two sets of supports or partitions a and b , Fig. 14, should be sawed out and doweled together after the sides are prepared.

12. Building Up the Pattern.—After the staves and stave supports have been prepared, each half of the pattern is built up separately. If a stiffening piece c , Fig. 14, is used, it will hold the supports a and b in place, and it will simply be necessary to screw and glue the staves in place. When no stiffening piece, as c , is used, it will be

necessary to mount the pieces *a* and *b* in their proper relation, and this may be done by surfacing a plank, drawing a line down its center, and placing the supports so that the center of their bases, as *g*, Fig. 15, comes upon a line drawn upon the plank, care being taken that the pieces are at right angles to this line. When properly placed, the supports are toe-nailed or skew-nailed to the plank, allowing the heads of the nails to project so that they may again be drawn out. After the partitions are set, a stave is fastened on each side by nailing or screwing, as desired; the joints are also glued. Other staves are added until the last stave of the half pattern is fitted, but before this stave is fastened in place, the skew nails must be drawn so as to remove the pattern from the supporting plank.

When one half of the pattern is built, the other halves of the partitions are placed with the dowels on their mates in the built-up half, which has been removed from the plank and turned over. The halves of the supporting pieces *a* and *b* may be held together by driving some dogs into them on each side of the partition. Staves are now fitted as before. In case the dogs have been used on the inside of the partitions, the last stave must not be glued in place, but can be secured by screws until the turning is complete, after which the screws may be removed, the dogs taken out, the pattern taken apart, and the stave returned to its place and glued and screwed on permanently. The advantage of placing a stiffening piece on the inside of a pattern, as shown at *c*, Fig. 14, is that it supports the inside of the partitions and reduces the liability of their being pounded out of position by the molders. It also gives the molder a convenient means for handling a half pattern.

When patterns of this character are intended for continued use, or where the shrinkage of the supports would produce undesirable results, it is better to build up the supports by gluing three thicknesses of stock together with staggered joints. By this means a pattern that will maintain the correct size and form is obtained, and although the first cost is somewhat greater, it is a means of economy in the end.

13. Turning the Pattern.—Before turning a pattern of this class, iron plates containing centers are fastened to the partitions *a* and *b* or the ends of the planks *c* so that the centers are at the center of the pattern and in the plane of the parting line. One of these plates may be provided with a projection on one end, as shown in Fig. 29, *Patternmaking*, Part 1, which serves as a driver for revolving the pattern. This plate, with the projection, is called a tail-dog. Both plates are provided with cone-shaped centers to receive cone-shaped lathe centers. As the plate at the tail-stock end revolves around a fixed center, it should be well oiled where the contact occurs. Sometimes, pieces of hard wood are placed upon the pattern instead of the metal center plates, and in this case, a pin is fastened upon the end of the pattern to serve as a dog or driver. After all is ready, the piece is turned so as to form a plain cylinder like the portion between the lines *ab* and *cd*, Fig. 13.

14. Preparation of the Flanges.—The flanges for the ends may be made as follows: Two pieces of stock of sufficient size to make the flange are prepared by planing one face and one edge smooth and jointing the edges together. The jointed edges are put together and the center of the surface so made is found as at *a*, Fig. 17, *bc* being the jointed face between the two blocks or pieces of wood. With the point *a* as a center, a circle is scribed having a diameter slightly greater than that of the finished

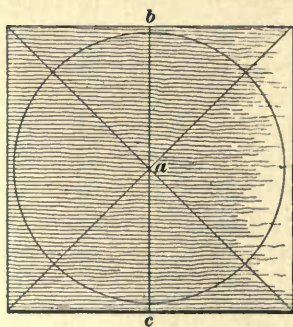

FIG. 17.

flange and the pieces are cut to this line with a band saw. The edges may now be glued together with a strip of paper between them, so that the turning operation may be more safely performed, although this is not always done.

The pieces are then fastened to a large face plate, as shown in Fig. 18 (a), the marked center *a*, Fig. 17, being placed carefully in the center of the plate. The flange is

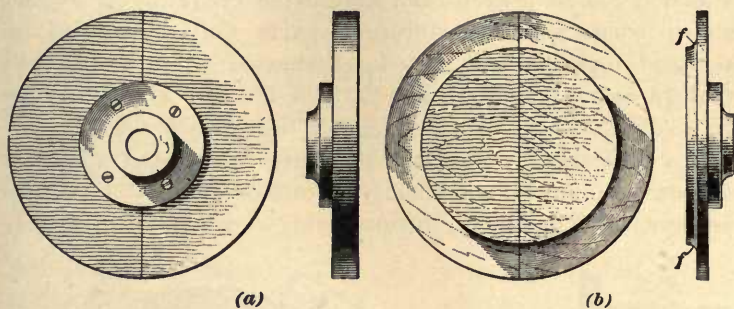

FIG. 18.

then turned to the form shown in Fig. 18 (b). The fillet joining the flange to the body of the pattern may be turned on the flange, as shown at *f*, Fig. 18 (b). A slight taper for draft should be given from this fillet to the outside edge of the flange; a taper for the same purpose should be given to the other side of the flange by first marking on the revolving disk a line where the outside of the core print will come and tapering the flange from this line to the outer edge.

15. When the pattern is to be used for only a few castings and then destroyed, the core print is frequently made of solid stock and the flange and core print may be

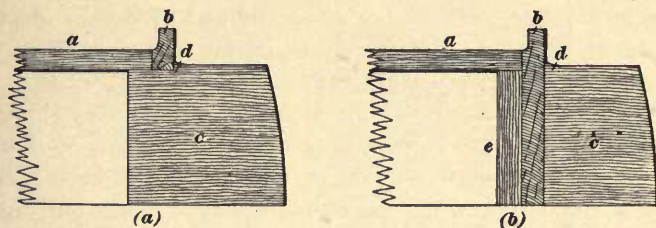

FIG. 19.

made according to one of the two forms shown in Fig. 19. In Fig. 19 (a), the staves *a* and the flange *b* are supported directly upon the core print *c*, while in Fig. 19 (b) the staves

are attached to a head e , and the flange b and core print c are attached in turn, as shown. In both cases the core prints are turned with a slight increase of diameter at d , which tends to prevent the sand from breaking off at the sharp corners. The different parts may be nailed or screwed together and glued. Either of these forms will make a comparatively cheap pattern, but one which is liable to be distorted by the shrinkage of the parts.

For better grades of large patterns, the supports for the staves, the flanges, and the core prints are generally built up as shown in Fig. 20 (*a*), the end being closed with a board a ,

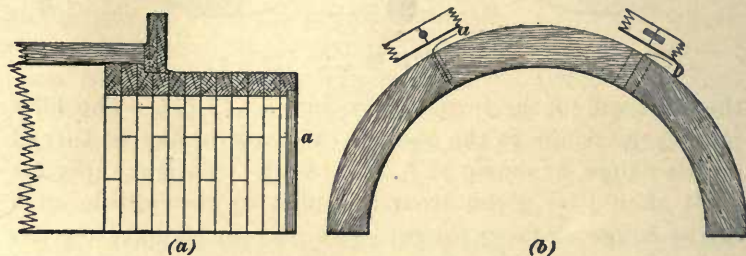

FIG. 20.

which is nailed or screwed, but not glued, to the built-up part of the print. This makes a durable pattern, the form of which will not be affected by the shrinkage of any of the parts.

In some cases the flange is made of segments as shown in Fig. 20 (*b*), the joints being strengthened by means of pins, as shown at a , or by means of feathers, as shown at b ; the grooves in the latter case being cut upon a circular saw.

When a pattern is long, one or more built-up rings may be placed between the ends and stiffened by means of one or two supporting planks, as shown in Fig. 14. These planks may be fixed to cross-pieces attached to the heads and rings.

16. Special Tool for Turning Large Patterns.

When large and heavy work is to be turned in the lathe, it is sometimes difficult to do good work with hand tools, and a slide rest may be employed. In this case, a tool

of the form shown in Fig. 21 (*a*) may be used for turning the pattern. This form of tool is not only suitable for roughing, but will do very good work on a finishing cut if the

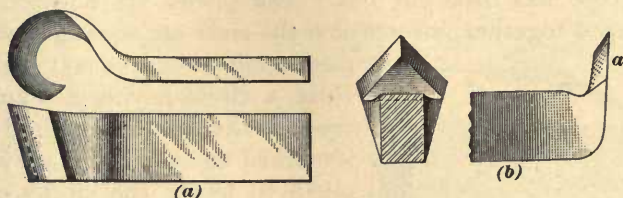

FIG. 21.

feed is not too coarse. The tool is usually fed along the slide rest by hand.

Another form of tool that produces a good finishing cut is shown in Fig. 21 (*b*). The cutting edges are at *a* and by rounding the front slightly and setting the tool so that it will cut at about *a*, it will make a clean, smooth surface. The action of this tool resembles that of the skew chisel.

CORE BOXES FOR CYLINDRICAL AND TAPERED CORES.

17. Small Core Boxes.—When small cylindrical cores are required, a core box of the form *b* and *c*, shown in

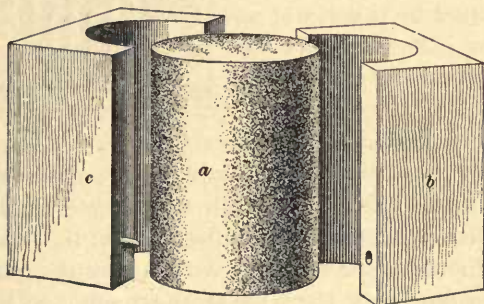

FIG. 22.

Fig. 22, may be made in cases when the core *a* is of such proportions that it can stand on end while being dried. To

make such a core box, two pieces of stock are cut a little longer than the required length of the core, or of such a size as to leave ample stock for strength after a space for the core has been cut out. The pieces are doweled and clamped together, after which the ends are squared and the

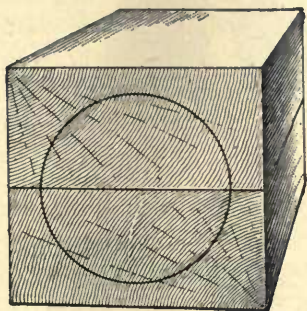

FIG. 23.

pieces cut to the exact length. Next, a circle having a diameter equal to that of the required core is marked on each end, care being taken to locate the circles equal distances from one side and to have the centers on the line of division between the two pieces, as shown in Fig. 23. The pieces are then taken apart and lines drawn across the face of each piece joining the ends of the half circles.

The material between these two lines and between the two semicircles on the ends must now be cut out. This operation can be hastened by sawing long grooves from end to end of the piece, as shown in Fig. 24. These cuts can be made of suitable depth by raising or lowering the saw, and care must be taken not to cut beyond the semicircular lines scribed on the ends of the stock.

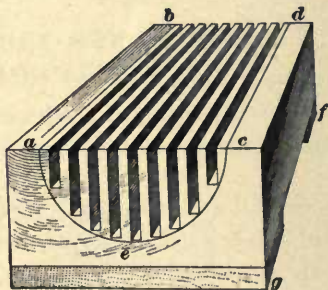

FIG. 24.

The narrow sections of stock thus formed may be quickly and easily removed with a chisel. This will leave a rough and approximately cylindrical surface, which may be smoothed and finished with the gouge, or, if the work is large, with a circular plane. The back of the box may then be strengthened with strips of wood, shown at *f* and *g*. A more accurate, and much more rapid, method, however, is to use the core-box plane, shown at *a*, Fig. 25.

This plane consists of two flat plates that stand at right angles to each other and form one solid sole piece. The plane iron, which is very narrow, is set so that the point

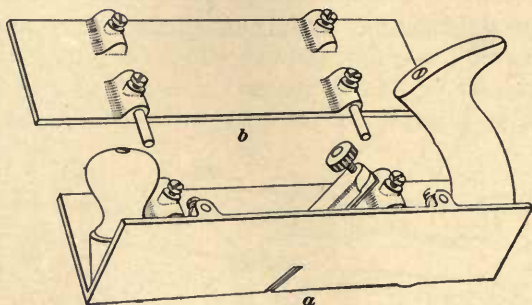

FIG. 25.

coincides with the apex of the angle. By means of extra sections, one of which is shown at *b*, Fig. 25, the width of the sides can be increased, thus enabling the plane to cut a groove of larger diameter.

To use the core-box plane, first cut away the stock to the lines *ab* and *cd*, Fig. 24, with an ordinary jack-plane, leaving two perfectly straight and parallel edges. Then, with the core-box plane, beginning at *a*, Fig. 24, take strokes from end to end of the groove, cutting down into the stock until the sides of the plane sole rest upon, and are guided by, the edges *ab* and *cd*. Working thus from *a* to *c*, a perfectly semicircular groove is secured.

That this groove is a perfect semicircle in section may be easily shown by the construction shown in Fig. 26. In this figure, *aec* is a semicircle, corresponding to the semicircle *aec* of Fig. 24, of which *ac* is the diameter. Now, by geometry, it may be proved that the angle *aec* is a right angle. For, if two lines, as *ae* and *ec*, are drawn from opposite ends of a diameter *ac*, and meet at a common point *e*, on the circumference, the angle between these two lines is a right angle. Consequently, the angles *ae'c*, *ae''c*, and *ae'''c* are also right angles.

Now, the lines ae and ec correspond to the sides of the sole of the core-box plane, and the point e corresponds to the cutting point of the plane iron. As the plane is tilted from one side to the other in the groove, the sides lie at ae'

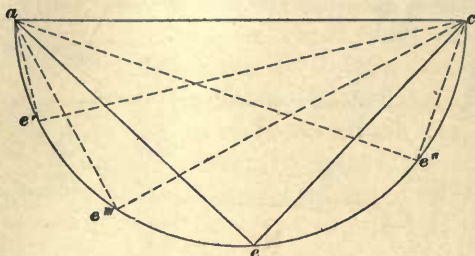

FIG. 26.

and $e'c$, or at ae and ec , or at ae'' and $e''c$, while the cutting edge of the plane iron lies at e' , e , and e'' , respectively, and by tilting the plane into successive positions, the plane

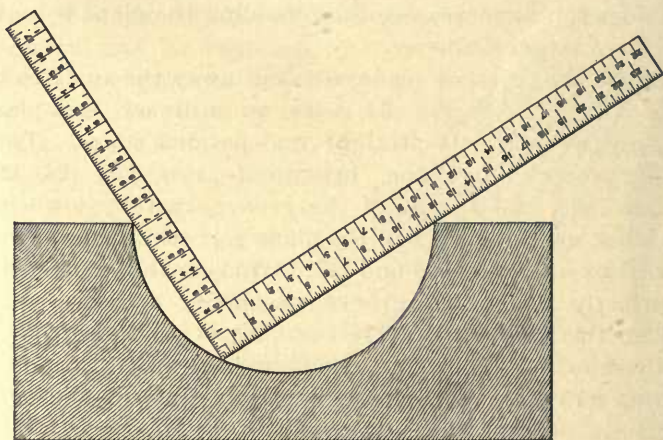

FIG. 27.

iron can be made to cut at all points along the curved line $ae'e''e''c$, making a perfectly semicircular groove.

If a core-box plane is not available, and the work is done either with a gouge or a circular plane, the accuracy of the

groove may be tested with the framing square in the case of large work, as shown in Fig. 27. The principle is the same as that shown in Fig. 26.

18. The Core-Box Machine.—For making core boxes quickly and with little labor, the core-box machine, shown in Fig. 28, is rapidly coming into use. The machine is driven by a belt, which runs on a pair of fast and loose pulleys connected to the shaft carrying the cone pulley *a*.

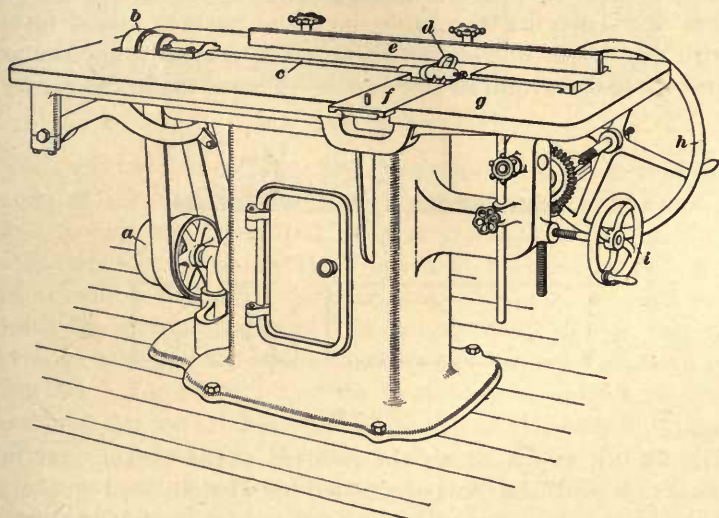

FIG. 28.

This cone drives the cone *b*, which is fastened to the spindle *c*. The speed of the cutting tool may be changed by shifting the belt on the cone pulleys. The spindle runs in two bearings, one at either end, each rigidly attached to the frame of the machine. The cutting tool *d* is detachable from the spindle, being held while cutting by a setscrew at the end of the arbor. These cutters, of which there are several with each machine, are of different sizes, for cutting boxes of different diameters.

The operation of the machine is very simple. First, a cutter of suitable size is attached. Then the fence *e* and

the plate *f* are set so as to clear the rotating cutter. The table *g* is now raised, by means of the hand wheels *h* and *i*, until the edge of the cutter, when in a vertical position, projects very slightly above the surface of the table. Then the stock to be grooved is moved across the rapidly turning cutter, guided by the fence *e*. A shallow groove will be thus made. Now, the table is dropped slightly, allowing the cutter to project a little farther, and a second cut taken, which deepens the groove. By repeating this operation and lowering the table until its surface comes level with the center line of the tool arbor, a perfect semicircular groove of the required size is cut. This is made clearer by

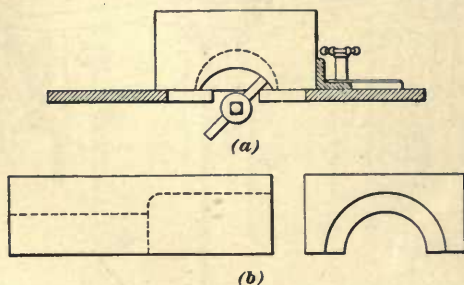

FIG. 29.

Fig. 29 (a), which shows the position of the cutter and of the stock and the dotted outline of the finished groove. The cutting tool generally has two arms of equal length, each with a cutting edge.

If the core box is to have grooves of different diameters, as in Fig. 29 (b), the smaller groove is first cut the entire length of the piece. The cutter is then removed and a suitable size is inserted and the larger groove cut to the desired point. Core boxes for bends and irregular curves may be made with this machine by workmen who have become expert in its use.

19. Tapered Core Boxes.—When a box is required for a tapered core, it is usually possible to produce the core by making a half box only, as shown in Fig. 30. The construction is as follows: A piece of wood having a length

equal to the tapered portion *ab* is prepared. The width and thickness of the block should be sufficient to allow ample stock about the large end of the taper, as shown at *a*. A center line should be drawn along the length of the upper face of this block and half circles drawn on the ends *a* and *b*.



FIG. 30.

The radii used in drawing the circles should be such that the ends of the box will have the desired form, as shown at *a* and *b*, and by the dotted lines at *g* and *h*. The ends of these semicircles should then be joined by lines *ij* and *kl*, after which the stock may be worked out to the desired form by means of gouges. It is impossible in this case to remove a large part of the stock by sawing, as illustrated in Fig. 24. The condition of the work may be judged by first working the material out to the circles on the ends and then using a straightedge through the box. After the tapered portion is complete, the pieces *c* and *d* for the prints are made. These can usually be turned upon the face plate, one-half of the block being used in each case. The ends *e* and *f* should have recesses turned in them, as shown, or the inside of the ends should be made to slant sufficiently toward the end of the box to allow for draft at the ends of the core.

20. Large Core Boxes.

Boxes for plain round cores of large dimensions may be built

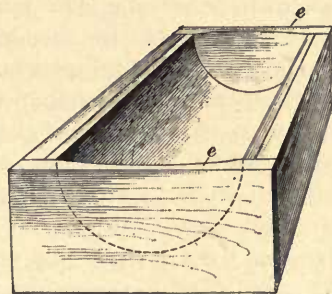
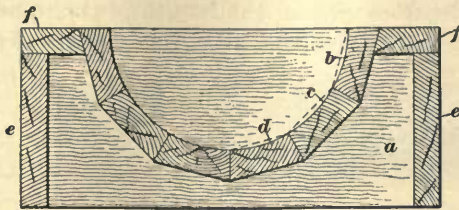

FIG. 31.

up with staves in a manner similar to that employed in

building up large cylindrical patterns. A core box of the form shown in Fig. 31 may be built up in this manner. Fig. 32 (a) illustrates a section of the core box showing the



(a)

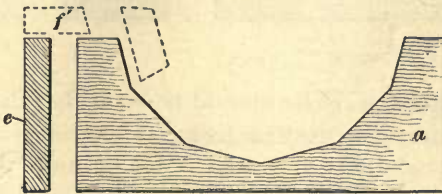

(b)

FIG. 32.

general construction and Fig. 32 (b) shows the method of putting the frame together. The supports *a* are cut out with a band saw to the desired form, a templet being used as in the case of large cylindrical built-up patterns. The staves are also made as in the case of large cylindrical patterns, but in this case it is the

inside face of the stave that is to be dressed off round instead of the outside face. This dressing may be done to the individual staves before they are fastened in place, as shown in Fig. 33, *a* being an end view of one of the staves, showing the manner in which saw cuts may be used for removing a part of the stock. The templet *b* is used in finishing the inside curve of the stave. This templet is provided with a shoulder *c* so that it can be used in drawing the curved line shown on the end of the stave at *a*, as well as for testing the curve when the work is finished.

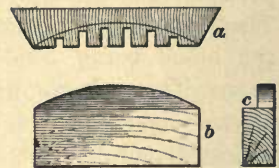

FIG. 33.

Much time may be saved, however, by hollowing out the staves with a core-box machine, when one is available. Cutters of the same radius as the inside of the staves should be selected up to the largest diameter of cutter that can be used in the machine. By making them narrow,

staves of a larger radius may be hollowed out with the largest cutter to a curvature that approximates closely enough to the desired curvature for some grades of work.

When a core-box machine is not available, it is possible to remove the excess of stock from the concave side of a stave quite rapidly by means of a circular saw. To do this, clamp the fence *a* at an angle, as shown in Fig. 34, and lower the saw *b* so that the points of the teeth project about $\frac{1}{8}$ inch above the top of the saw table. By feeding the stave *c* along the guide, across the saw, a shallow groove is cut. The saw is then raised another $\frac{1}{8}$ inch, and the operation repeated until the desired depth of cut is reached.

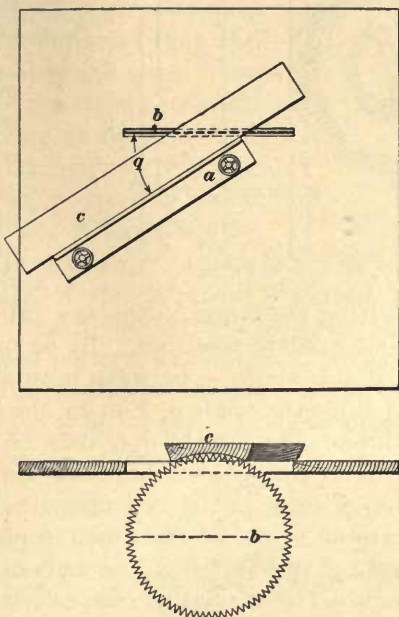

FIG. 34.

21. To find the angle at which the guide must be set, draw a portion of a circle *men*, Fig. 35, with a radius *r* equal to the radius of the saw to be used. Then draw the radius *oe*, on which lay off *ef* equal to the depth of the groove to be cut in the stave. Through *f* draw *ab* perpendicular to *eo*. The line *ab* represents the width of the groove that the saw would cut if the stave were moved at right angles to the saw. Suppose the width of cut desired was only *cd*. Lay off *cf* and *fd* each equal to $\frac{1}{2} cd$. Now, from *a*, *c*, *d*, and *b*, draw lines parallel to the line *eo*. Draw a line *g'o'h* perpendicular to *eo* extended. This line *gh* represents the position of the saw to cut a groove of the width *ab*. With *o'* as a center and *o'g*

or $o'h$ as a radius, strike arcs of a circle cutting the parallel lines drawn from c and d at the points k and l , respectively.

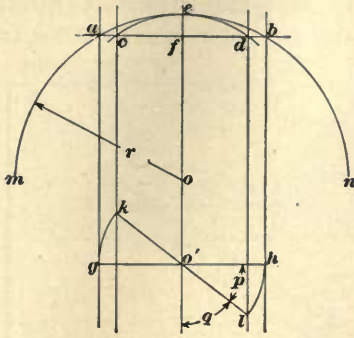

FIG. 35.

Join k and l by a straight line. Then kl represents the position of the saw to cut a groove of the depth ef and width cd , as required. This position of the saw makes an angle p with the former position gh , as shown. It is not convenient to change the position of the saw, but the same results can be obtained by

shifting the fence on the saw table, so as to give them the same relative positions. By setting the fence, therefore, so that the angle q , between it and the saw, Fig. 34, shall be equal to the angle q , Fig. 35, the saw will cut to the desired width. The sawing may then be done as explained above.

After the staves have all been formed to the correct shape, they are placed upon the supports a , Fig. 32, and screwed or nailed and glued in place, bcd , Fig. 32 (*a*), illustrating the staves. The outside of the core box is then enclosed in a suitable framework composed of the pieces f and e . If the core is long, it will be necessary to use a number of supporting boards a . The inside of the ends e of the box, Fig. 31, should be provided with sufficient draft so that the core may easily be removed from the box. These ends are usually made from thick plank, and the draft is turned upon them while they are attached to the face plate of a lathe.

PATTERNS AND CORE BOXES FOR BENT PIPES.

22. Half-Circle Pipe Bend.—This style of pattern may be taken as typical of that class which is circular in both cross-section and outline. In the construction of this class of patterns, nearly all the work may be performed on

the lathe. The pipe bend shown in Fig. 36 is a good illustration of this style of casting.

23. Preparation of Stock and Face Plate for Turning.

—To make a pattern for the pipe bend shown in Fig. 36, a circular disk of wood, slightly greater in diameter than the outside of the pattern, is first sawed out. This is to be used as a chuck in the lathe and must be fastened to the face plate so that its face can be turned smooth and flat. After the chuck is prepared and turned flat, a piece of thick paper is glued over the face. When the glue has dried, the center is marked while the chuck is revolving.

The material for the body of the pattern is prepared by getting out two pieces of stock slightly thicker than half the thickness of the finished pattern and large enough so that the outline of the pattern will go inside of the outer edge, as shown by the lines in Fig. 37 (a). The two pieces



FIG. 36.

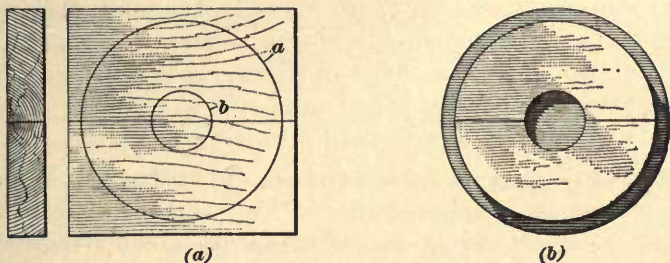

FIG. 37.

are planed smooth on one face and jointed on one edge of each, as shown. The jointed edges are placed together and a circle slightly greater in diameter than the finished pattern is marked on the faces, as shown at *a*. The corners of the pieces are sawed off to this mark. It is also good practice to draw the circle *b* with a radius slightly less than that of the inside of the bend and then remove the stock from the inside of this circle with a saw. After the pieces are thus prepared, they are glued to the paper on the face plate, the

jointed edges being set at the center of the chuck, this adjustment being made possible by means of the center mark that was made while the chuck was revolving.

24. Turning the Body of the Pattern.—After the glue has dried, the chuck is placed on the lathe and pencil marks are made on the face of the wood for finding the inside and outside diameters of the pattern, after which the faces determined by the lines *a* and *b* already referred to are

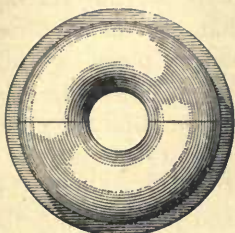
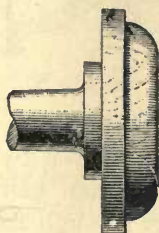

FIG. 38.

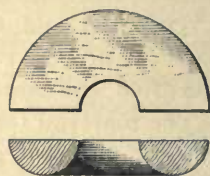

FIG. 39.

cut straight in to meet the chuck. The work will now be of the form shown in Fig. 37 (*b*). The rectangular section is then turned to a semicircular form, as shown in Fig. 38, a templet being used to determine the exact form desired. The pattern is then varnished and removed from the chuck, when each piece will be of the form shown in Fig. 39.

25. Flanges and Core Prints.—The flanges and core prints can be made together. To accomplish this, two pieces of stock having a width slightly greater than the diameter of the flange and a thickness slightly greater than half the diameter of the flange are finished and jointed together. They are then turned to the form shown at *e*, Fig. 40 (*a*). There are two pairs of these flanges and prints required for the pattern, and it is well to put one pattern pin in each pair before turning. The fillet *a* is turned with the flange *b*. Inside of the face *f*, a projecting piece *c* is turned, as shown. This projecting piece is employed for joining the print to the balance of the pattern. The print and flange are smoothed and varnished before they are taken from the lathe, care being taken to make the print a

different color from that employed on the flange and the balance of the pattern. The projecting piece *c*, by which

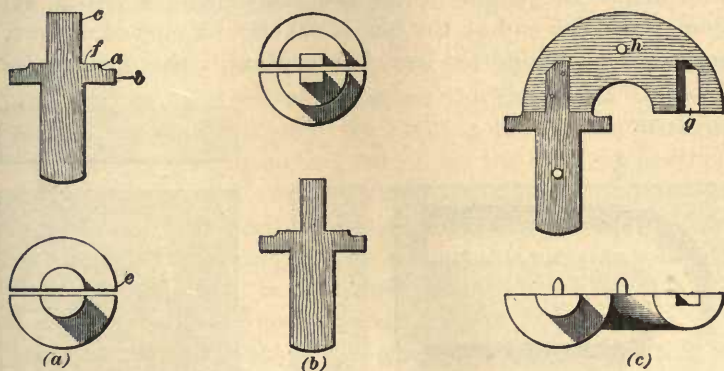

FIG. 40.

the flange is to be attached to the body of the pattern, is made rectangular, as shown in Fig. 40 (b), after the work is taken from the lathe.

To attach these parts to the pattern, the projection is laid in place on the body of the pattern and the outline carefully marked on the pattern with the pencil. With this outline as a guide, a recess is cut to receive the projection, as shown at *g*, Fig. 40 (c). The pieces are attached to the body of the pattern by means of screws and glue, as shown in Fig. 40 (c). Care must be taken so that the halves of the flanges and prints come exactly opposite each other. Usually, three dowel-pins are used, one in each print, and the third is placed in the body of the pattern, as shown at *h*, Fig. 40 (c). In the case of small-sized bends of this character, the prints are made long, as shown, in order that the portion of the core in the print may balance and hold firmly the overhanging portion in the mold.

26. Core Box.—The core box for a small pipe bend may be made as a half box of the form shown in Fig. 41, the operation being as follows: The stock for the curved portion of the box must be thick enough to leave the box

amply strong after the recess for the core has been cut, and long enough to allow the curved outlines of the core to come well inside the edges of the box, as shown at *f*, Fig. 41. Sometimes the end of the box is cut off to a curved outline, as shown by the dotted line, but ordinarily the corners are

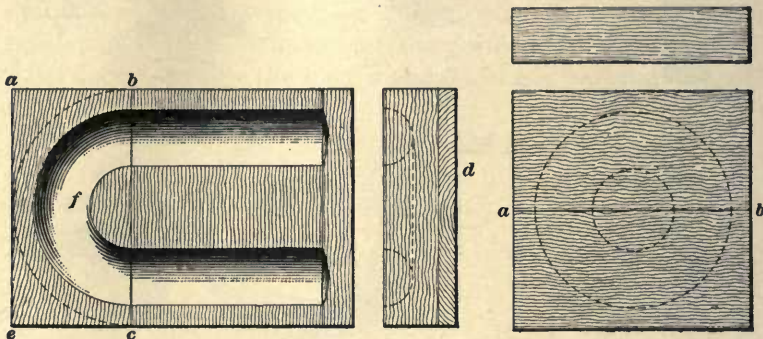

FIG. 41.

FIG. 42.

left square, as shown by the full lines. Fig. 42 illustrates the manner of laying out the piece. The piece is attached to a wooden chuck on the face plate of the lathe, as was done in turning the pattern, or in some cases it is screwed directly to the face plate, care being taken that the screws will not interfere with the turning.

The face of the block is first turned smooth and true, after which two circles are marked on it as it revolves, to locate the inner and outer edges of the core. These circles are shown by the dotted lines in Fig. 42. The line *ab* should also be drawn through the center of the block and is used later when sawing the block apart. The semicircular groove for the core is turned out to the desired form. This form may be determined by means of a templet of the form shown in Fig. 43. Before taking the piece from the face plate, it should be smoothed and varnished.



FIG. 43.

After the piece is completed, it is taken from the face plate and sawed in two on the line *ab*, which was drawn through the center. Care should be taken that the line comes just on one edge of the

saw cut, so that this piece will contain a portion of the groove forming a full half circle. The piece will now be of the form shown by the block *abce*, Fig. 41.

27. In order to form the straight portion of the core box, a piece of stock of the same thickness and width as that which has been used for turning the curved portion, and having a length sufficient to form the straight portions of the core, is next cut and shaped to the form shown in Fig. 44 (*a*). The position and depth of the grooves *a* and *b* may be marked on the ends by setting this piece against the piece that has just been turned, as shown in Fig. 41, and marking from the groove in that position.

The depth and shape of the groove may be regulated by a templet similar to the one used in turning, and shown in Fig. 43. The turned piece and the straight piece are next fastened together with glue along the line *bc*, Fig. 41. To close the other end of the straight piece, a third block of the form shown in Fig. 44 (*b*) must be made. This block is placed against the straight portion, as

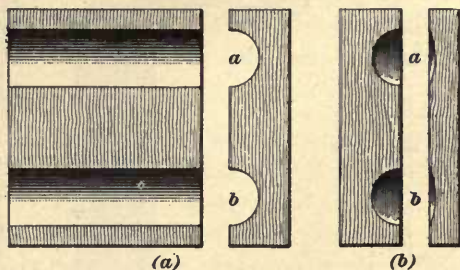

FIG. 44.

shown in Fig. 41, and curves marked so that the clearance spaces *a* and *b*, Fig. 44 (*b*), can be worked out. This piece is sometimes made in two portions, the pieces being jointed together, attached to the face plate of a lathe, and the clearance turned into them, this usually being easier than forming it with hand tools. When the end shown in Fig. 44 (*b*) is completed, it is glued on to the box, as shown in Fig. 41.

If it is desired to further strengthen such a box, this may be done by fastening a piece of board upon the back, as shown at *d*, Fig. 41, or strips may be fastened along the sides across the three pieces. Such strips are

usually attached with screws. If a box of this class is to be used much, it is well to have the grain of the

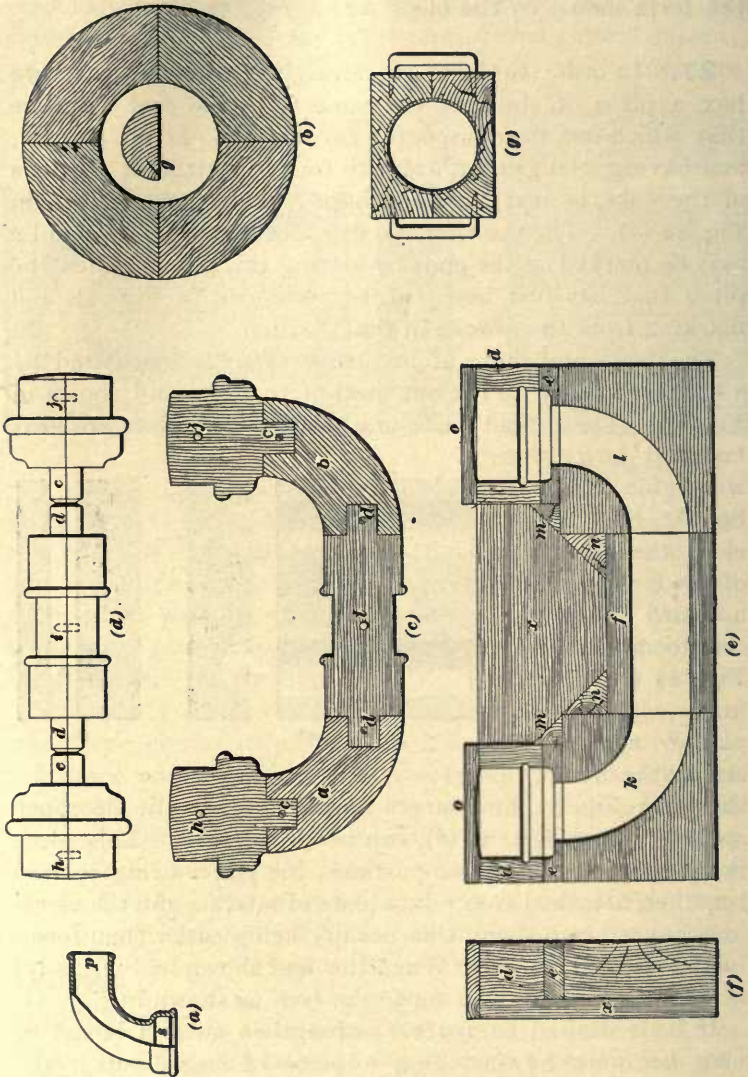

FIG. 45.

wood in the different pieces run in the same direction when practicable.

PATTERNS AND CORE BOXES FOR ELBOWS.

28. Small Elbow Pattern.—The pattern for an elbow of the style shown in Fig. 45 (*a*) can be produced by slightly modifying the methods used in making the half-turned pipe already described. The elbow shown is provided with one socket and one spigot end. When a comparatively large number of such castings is required, it is common practice to mold and cast two of them at one time, the pattern being made double, as this makes very little more work for the molder than would be required for the production of a single elbow and thus economizes both time and space in the foundry.

The different illustrations in Fig. 45 show the manner in which the pattern and core box are produced, and the following description will show that it requires very little more work to produce this double pattern than it would to produce a single elbow pattern. Another advantage is that the core balances better in the mold when a double pattern and core are used than it would if only one elbow were cast at a time.

29. The pattern is made as follows: A ring is made as shown at Fig. 45 (*b*), the cross-section being shown at *g*. This is made either by securing a solid piece to a chuck or face plate and turning to the cross-section shown at *g*, or by securing four pieces to the face plate, each piece being so secured that the grain runs in the direction of its length, as shown in the illustration. When this latter method is employed, the joints between the four pieces are carefully made so that when the work is turned and taken from the chuck, it will be complete and the ring will not have to be sawed into four pieces. The cross-section of the ring may be brought to the proper form by the use of a templet made of wood or metal. If the ring has been turned from a solid piece, it is then cut in quarters and the quarters are used for the part of the pattern marked *a* and *b*, Fig. 45 (*c*). It is always best to have the grain of the pattern running in the direction shown at *a* and *b*, and for this reason it is

best to turn the ring from four pieces, the grain of which runs in the direction shown at Fig. 45 (*b*).

After the curved portions for the elbows are finished, the portion of the pattern to produce the socket *s* and the spigot *p*, Fig. 45 (*a*), may be made as follows: These portions and the core print can easily be made at one time, provided the pattern is not of excessive size. Two pieces of stock, having a width slightly greater than the diameter of the socket *s* and a thickness slightly greater than one-half its width, are surfaced and jointed together. One dowel should be placed in the center, as at *i*, Fig. 45 (*d*), and one dowel near each end, as at *h* and *j*. These last dowels should come in the core prints at the socket ends of the elbows. After the pieces are glued up with paper between them, they are turned to the form shown in Fig. 45 (*d*), the fillets for the socket *s* and the spigot *p* being turned right on the stock. The projections *c* and *d* are intended for joining the parts to the curved portions of the pattern. After the pattern is completed, the pieces are sawed apart between *c* and *d*, and the ends *c* and *d* are dressed to a square cross-section and let into the curved portions, as shown at *c* and *d*, Fig. 45 (*e*). This work must be done accurately so that the dowels and portions of the pattern will all come opposite one another as they should.

30. Core Box for Elbow Pattern.—After the pattern is built, the core box is made as shown in Fig. 45 (*e*) and (*f*). The box can be put together in sections, as shown, and, as the core is symmetrical, it will only be necessary to make one-half of the core box. The blocks for forming the portions *k* and *l* are turned to form in a manner similar to that employed in producing the curved portion of the core box shown in Fig. 41, only two quarters of the block being used. The straight portion *f* is produced in a manner similar to that employed in producing the straight portion of the core box shown in Figs. 41 and 44 (*a*). The straight portion *f* furnishes both the core for the straight portion of the spigot and for the print between the two spigot ends of the pattern. The portions *d*, *d* of

the box, which form the cores for the outer part of the socket ends *s*, Fig. 45 (*a*), must be turned in the lathe. Two blocks are joined by means of dogs, as shown in Fig. 45 (*g*), or by means of screws. They are then fastened to a face plate or chuck and turned out to the required shape. A templet can be used to give the proper form and to locate the ring inside the end of the socket. The inner parts *e*, *e* are turned to the desired form upon a face plate, as in the case of the parts *d*, *d*, shown in Fig. 45 (*g*). When the pieces *d* and *e* are turned, they are glued to the curved blocks, as shown in Fig. 45 (*e*). In some cases the part *d* may extend to the piece *k*, the part *e* being omitted entirely. In such a case the corner is rounded with a leather fillet. The ends of the prints may now be closed by the boards *o*. These must either be provided with draft or made removable so that the core can easily be removed from the box. In order to strengthen the box, the board *x* may be glued and screwed on the back, and, in addition, corner blocks *m*, *n* may be glued into the corners, as shown at Fig. 45 (*e*).

31. Large Elbow Patterns and Core Boxes.—When large elbows are required, the patterns may be built up from curved staves, as shown in Fig. 46, the staves being cut from the lumber as shown in Fig. 47, as

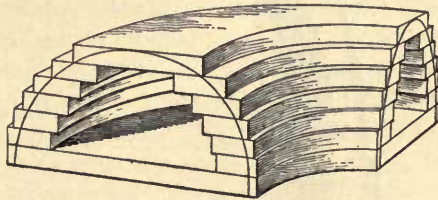

FIG. 46.



FIG. 47.

this will bring the grain in the proper direction and at the

same time save material. The finished pattern is worked down to the proper cross-section by hand tools, the shape being determined by templets. The cores for these large elbows are usually swept up. A description of the various classes of sweeps will be taken up later.

PATTERNS AND CORE BOXES FOR BENT PIPES.

32. Pattern for Bent Pipes.—When a pattern for a pipe having a slight bend, as shown at Fig. 48 (*a*), is required, the work may be done in a manner similar to that employed in the making of elbows for similar pipe, with the

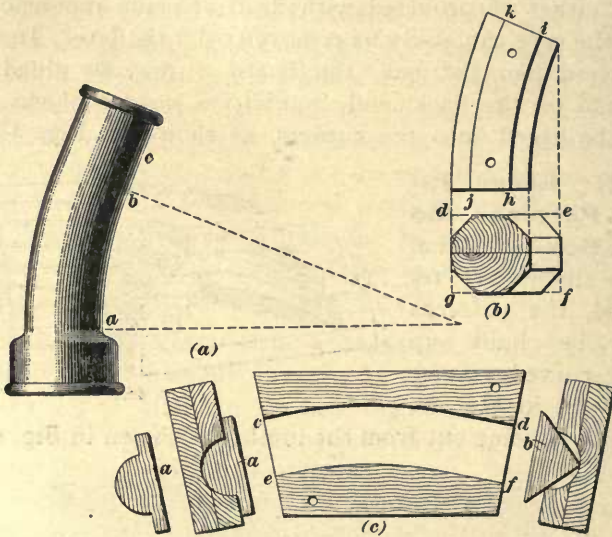

FIG. 48.

exception that the portion of the pattern from *a* to *b* is usually of too great a radius to be turned in the lathe, and hence must be worked out by hand. It is not necessary to show the parts of the pattern, as the socket and spigot and the core prints will be exactly like those illustrated in Fig. 45,

but some description of the method of making the portion of the pattern from *a* to *b* may be of interest. Such patterns as this are usually not made in pairs, but singly.

In order to make the required portion of the pattern, two blocks are fitted as shown at Fig. 48 (*b*), the blocks being secured together with dowel-pins. The stock is sawed to the desired curve, when it will have a rectangular cross-section, as shown at *defg*. After the pieces are fastened together, a circle is laid off on each end, as shown by the dotted line, and with the bevel set at 45° , the full lines on the end of Fig. 48 (*b*) are marked tangent to the circle, as shown. Lines *hi* and *jk* are then drawn upon the side of the pattern, from the points at which these 45° lines intersect the horizontal and vertical lines, as shown in the upper portion of Fig. 48 (*b*). Similar lines are drawn on all four faces of the rectangle and the stock is cut away to these lines so as to give it the form shown. After this, other lines may be drawn tangent to the circle, so as to remove another portion of each one of the eight corners. These points can be continued along the faces as lines and the material between them removed, thus giving a sixteen-sided figure, and this process may be continued until the outline is approximately circular, the last dressing being done by the eye and the piece being finished to a templet. When this curved portion of the pattern is completed, the ends, with their core prints, are turned up and attached as in the pattern illustrated in Fig. 45.

33. Core Box for Bent-Pipe Pattern.—A partially completed core box for a bent-pipe pattern is shown in Fig. 48 (*c*), the portion for the socket end having been omitted. The portion of the box shown is worked out to the proper form by hand. The curved portion corresponding to the part of the pipe *ab*, Fig. 48 (*a*), is laid out upon the surface of the block, which has been prepared for the core box by means of suitable curves, and the lines representing the straight part are drawn tangent to these curves. After this portion of the laying out has been done, a half circle

is scribed on each end of the block corresponding to the diameter of the required core. The stock between these two curved lines cd and ef , Fig. 48 (c), is then worked out to the required circular cross-section. This may be done by the aid of a templet, as shown at a , or by the use of a square, as shown at b , Fig. 48 (c). The core-box plane may be used for planing out the straight part, but is not suitable for the curved portion. Frequently, such a core box as this is made in three parts, each one of the straight parts being made separate so that most of the stock can be removed on a circular saw. After the core box is finished as shown in Fig. 48 (c), the piece for the end is turned up and put in position, this piece being similar to that shown at e or d , Fig. 45 (e). Since this core is not symmetrical, it will be necessary to make both halves of the core box.

PATTERNS AND CORE BOXES FOR BRANCH PIPES.

34. Pipes Having Branches at Right Angles to the Body.—The patterns for branch pipes have many features in common with the bent pipes that have already

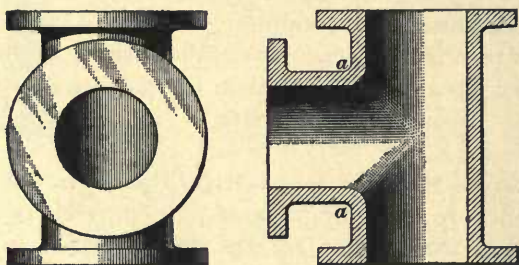

FIG. 49.

been described. The only difference presenting difficulty in making this class of patterns lies in the forming of the joint between the main body and the branch piece.

When the body and the branch have the same diameter, and stand at right angles to each other, as illustrated in

Fig. 49, the following construction for the pattern may be used for medium-sized and small patterns. The stock for the branch and the body is gotten out and doweled together as in the case already described, after which the two pieces may be turned to the form shown in Fig. 50 (a). The piece *a* for the body has a core print turned at each end, while

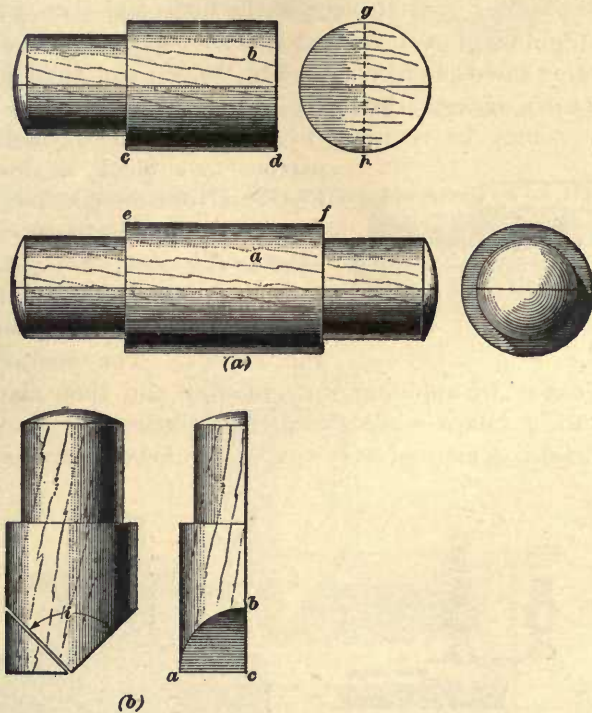

FIG. 50.

the piece *b* for the branch has only one core print and the opposite end is left square. The distance *cd* on the branch pattern should be equal to just half the length *ef* when the branches are all to be of the same length. The distance *ef* is not made equal to the entire length of the main body of the pattern, but is shorter by an amount equal to twice

the width of the flanges and the part necessary to make the fillet back of the flange.

After the pieces are turned, the line gh is drawn across the end of the branch pattern at right angles to the joint between the two pieces. The corners of the pattern are next cut off to this line, as shown in Fig. 50 (*b*), the angle i being made 90° . Some patternmakers cut the corresponding 90° from the center of each piece of the body and then join the parts together, but in the pattern shown the joint is made by cutting out the piece abc , Fig. 50 (*b*), and then joining the branch against the body of the main pattern. The part abc may be removed by clamping half of the branch pattern to a block, as shown in Fig. 51, after which the piece abc can be removed by means of the band saw.



FIG. 51.

The branch and body are fastened together by means of glue and screws. The operation is made easier by applying the glue first and then clamping them to a board while the glue is setting, as shown in Fig. 52 (*a*). A piece of heavy paper should be placed between

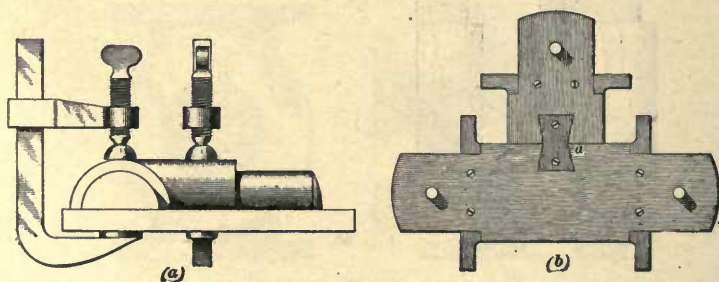

FIG. 52.

the board and the pattern to prevent the latter from adhering to the former. To further strengthen the joint, a dovetailed piece may be set in flush with the face of the pattern between the branch and the body, as shown at *a*, Fig. 52 (*b*).

35. The flanges may be turned to the form shown in Fig. 53, the opening through the center being made of such diameter that it will just fit the core prints. The fillet between the body of the pattern and the flange is turned upon the flange. The method of joining these flanges to the pattern by means of screws is shown in Fig. 52 (*b*). In this pattern, the dowels are usually put in the three core prints, as shown. The fillet at *a*, Fig. 49, may be made of leather or wax.

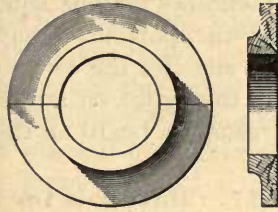

FIG. 53.

36. Core Box for Pipe Having Branches at Right Angles to the Body.—The core box used for this style of pattern does not differ materially from those already described and is of such form that it can be very easily constructed. Fig. 54 illustrates the core box for the casting

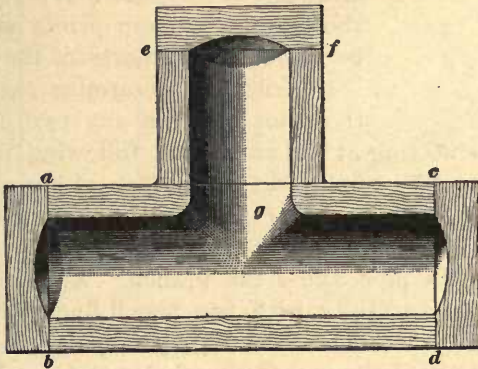

FIG. 54.

shown in Fig. 49. It will be noticed that it consists almost entirely of straight work. The portion between the lines *a b* and *c d* of the main body and between *a c* and *e f* of the branch can be worked out by removing the major part of the stock with a circular saw and finishing with gouges. A small portion of the branch at *g* can be formed by placing

the finished branch box against the outside of the portion for the body, and marking the curve upon the latter, after which lines may be squared across the surface of the body and the portion removed by means of gouges or chisels. The ends for the core boxes are provided with draft as usual, and the entire structure may be strengthened by screwing or gluing a board on the back.

37. Patterns for Pipes Having Branches Not at Right Angles to the Body.—When branch pipes of the

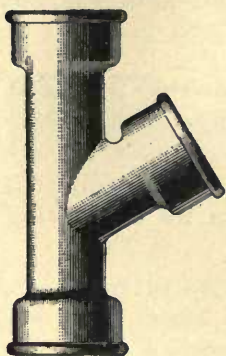

FIG. 55.

form shown in Fig. 55 are required, the method of procedure is somewhat different from that already described, the principal difficulty being to determine the form of the joint between the branch and the main pipe. The parts for the pattern may be turned out in a manner similar to that illustrated in Fig. 50, although in this case it is probable that the sockets and core prints would both be turned on the parts of the patterns.

In order to determine the form of the joint between any two cylindrical sections intersecting at an angle, the following method of laying out may be employed: On a piece of heavy drawing paper, lay off the outlines of the stem and branch in their proper relative positions, full size, as shown in Fig. 56, *i* being the main pipe and *j* the branch. All the drawing must be done carefully with fine pencil lines. Above the plan, a line *kc* should be drawn perpendicular to a center line of the body of the pattern, as shown at *lm*. Upon this line describe the semicircle *kmn* equal in diameter to the main body of the pattern, and at one side erect a perpendicular *lb* and upon it describe the semicircle *abc* equal in diameter to the branch pipe. Taking any point on the branch section, as, for instance, the highest point directly over *l*, draw the line *bb'* parallel to *ck* until it intersects the circle *kmn* at *b'*. This determines a line on the surface of

the body of the pattern at the top of the intersection with the branch. Draw the line $b'b''$, and somewhere in this line, on the body of the pattern i , can be found the highest point of the intersection between the main body and the branch. On the end of the branch lay off the point $1'$ in the center of the line $a'c'$ and draw the line $1'b''$ along the center of the branch j to the point where it intersects the line $b'b''$, which will give the desired point b'' .

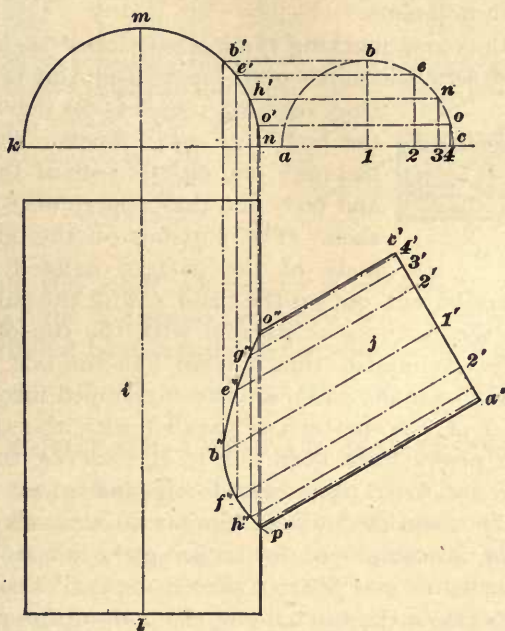

FIG. 56.

Proceed in like manner for any other point, but in all other cases two points will be obtained at each time, owing to the fact that any other plane nearer the line kc will intersect the branch in two points, as, for instance, if the point 2 is selected and the distance from 1 to 2 is made equal in both drawings, and a perpendicular $2e$ drawn until it intersects the curve representing the cross-section of the branch. By

drawing the line ee' parallel to kc , an intersection of the circle kmn at e' is obtained, and then the line $e'f'$ is drawn parallel to the center line lm . Now, lay off on the line $a'c'$ the distances $1'-2'$ each side of the center, and through these points draw lines parallel to $1'b''$. These will intersect the line $e'f''$ at f' and e'' , giving two more points in the intersection. In like manner, by taking points 3 and 4 and carrying the lines around as shown, the points g'' , h'' , o'' , and p'' may be obtained. A curve $o''b''p''$ is then drawn through these points.

When the curve marking the intersection of the two parts has been drawn, the paper must be carefully cut to this line, thus forming templets for marking both



FIG. 57.

the body and the branch. These templets are laid on the face of the branch and body and the proper curve drawn on each. The portions on the branch and body of the pattern defined by these curves may be cut out on the band saw if the parts are so held that the flat face is parallel with the top of the saw table. To accomplish this, a form like the one shown in Fig. 57 may be made and the pattern clamped into it so that the face a of the pattern is parallel with the saw table. After the pieces have been cut to the curves, the branch and body are fitted together closely and glued in place. Frequently dovetailed pieces similar to that shown at a , Fig. 52 (b), are employed for securing the pieces together, and a leather or wax fillet is placed on the outside at the junction between the branch and the body of the pattern.

38. Core Box for Pipes Having Branches Not at Right Angles to the Body.—Owing to the fact that the casting illustrated in Fig. 55 is not symmetrical, it will be impossible to use a half-core box unless some special provision is made for obtaining both halves of the core. Fig. 58 illustrates a special style of core box that may be used in such cases as this. The core box is constructed with two branches a and b and both branches are provided with

stop-off pieces *c* and *d*, which can be put in place and secured by pins in the holes *e* and *f*. For making one half of the core, one of the stop pieces is employed, and for making the

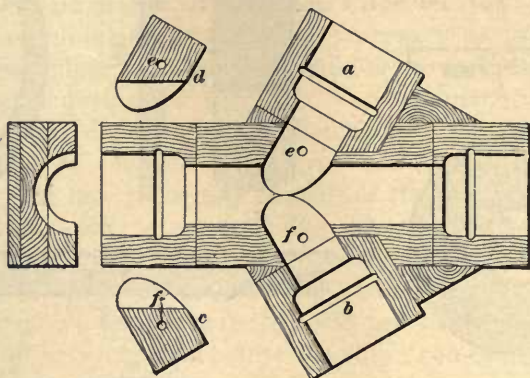

FIG. 58.

other half, the other stop piece is employed. The other features of the box are so similar to those already described that it will not be necessary to consider them in detail.

BUILT-UP ANNULAR PATTERNS.

39. Advantages.—When large patterns having the general form of flat rings, similar to the one shown in Fig. 59 (*a*), are required, they are commonly built up of segments. Such patterns are used for making pulley rims, ring forms, and for similar purposes. If the pattern is comparatively small and for temporary use, it is occasionally turned from one piece, as shown in Fig. 59 (*b*), but in this case the grain will run across the pattern along the line *a a*, and if the ring is thin, there is great danger of its breaking at this point, unless considerable care is exercised in its use. The shrinkage of the wood is always across the grain, and hence such a pattern as this would soon become smaller across the diameter *b b* rather than across the diameter *a a*, and the form would become elliptical. For these

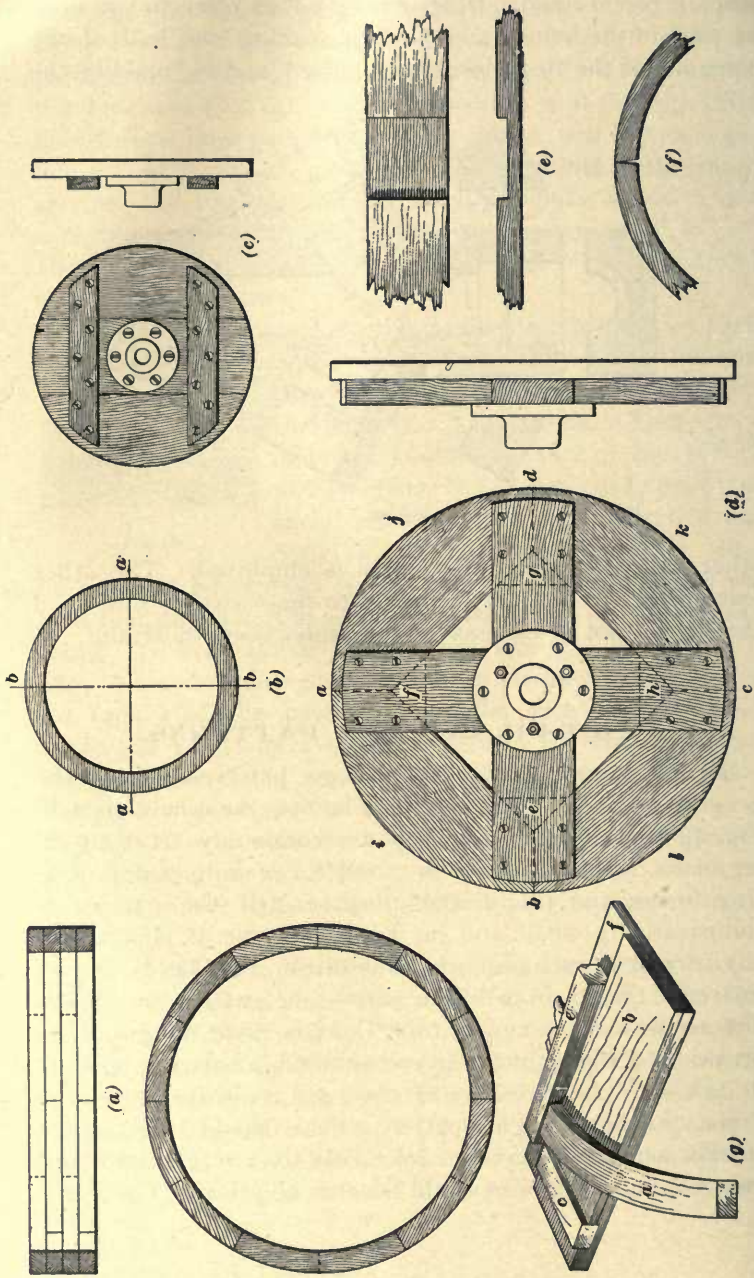

FIG. 59.

reasons, ring patterns are rarely turned from solid stock. Ring patterns must be turned on some form of large face plate, which is generally made of wood.

40. Preparation of Wooden Face Plates.—Before turning an annular pattern, it is necessary to prepare a wooden face plate upon which to build it up, and also to use as a support during the turning. The manner of making this face plate depends on the diameter of the pattern to be turned. In the case of patterns not over 20 inches in diameter, the face plate may be built of strips supported by cleats on the back, as shown in Fig. 59 (*c*). Heavy screws must be used for securing the cleats and for fastening the iron face plate to the wood. For ordinary work, No. 18 screws of such a length that they will permit the surface to be faced off several times before the chisel comes in contact with them are suitable.

41. Wooden face plates of large diameter may be constructed as shown in Fig. 59 (*d*). Two or more cross-pieces are placed across the face plate, and in case two are used, they are halved together as shown in Fig. 59 (*e*). The iron face plate is secured to these cross-pieces by means of screws and bolts. The ends of the cross-pieces can then be faced off so that they will run true when revolving in the lathe. The cross-pieces should be so balanced that they will not shake the lathe badly when the work is running. Care must be taken not to catch the turning tool in the cross-pieces while facing them.

After the cross-arms have been faced, the four segments *i*, *j*, *k*, and *l* can be fitted to them. The segments should be carefully fitted at *a*, *b*, *c*, and *d*, and firmly screwed and glued to the cross-arms. The segments should be made in such a manner that, when they are put together, the circle formed by them will be at least 1 inch larger in diameter than the length of the cross-arms. In order to strengthen the entire structure, four corner pieces *e*, *f*, *g*, and *h* may be fitted on the arms between the segments. After the glue is dry, the face plate may

be turned off and faced true, when it is ready to have the pattern built up upon it.

42. Building Up of Ring Patterns.—It will be noticed that the plain ring pattern shown in Fig. 59 (*a*) is built up of a series of segments placed one upon the other, and that the joints in any given course do not come directly over those in the adjoining course. This makes a strong pattern, as each course is made to bind the adjoining one. The grain of the wood is made to follow the circle as nearly as possible, which makes the shrinkage of the pattern uniform, thus maintaining a true circle. Before fitting the first course on the face plate, pieces of paper at least 2 or 3 inches wide should be glued to the face plate where the end joints will come. Some patternmakers prefer to cover the entire face plate with paper.

When the segments for the first course have been made ready, the under sides of the segments are glued to the pieces of paper on the face plate, care being taken not to allow any glue to run off the paper on to the face plate, so as to glue the pieces directly to the face plate. The ends of the segments must be fitted carefully, on account of the fact that if they are badly jointed, as shown at Fig. 59 (*f*), the corners will break out when the patterns are being turned on the inside. It is better that the joints should be open on the outside rather than on the inside, if they are open at all, since there would be less tendency for the corners to break off on the outside than on the inside, owing to the direction of the grain on the inside, as shown at Fig. 59 (*f*).

43. In order to true the ends of segments, a trimming machine may be used, and this will usually give the desired finish, but when very fine joints are required, they are frequently fitted by planing on what is known as a *chute board*. Fig. 59 (*g*) illustrates this method of doing the work, the segment *a* being laid upon the board *b* against the stop *c*; the plane *e* is placed on the side so that the weight of the

plane does not come upon the segment, the plane being guided by the shoulder *f*.

When the first course of segments has been fitted upon the face plate, it must be allowed to dry sufficiently to stand the strain of facing. When the glue is dry, the face plate is placed on the lathe, and a light cut taken off the surface of the segments, after which the face plate is removed from the lathe and the next course built on. When the second course is in place, and before facing it off, the ring should be screwed to the face plate from the back, as it is dangerous to trust to the paper alone for holding the pattern during turning.

The pattern shown at Fig. 59 (*a*) has six segments in each course. This number is often increased to eight, ten, twelve, or more, depending on the diameter. When the pattern has been built up and the glue well dried, it is turned to shape in the usual manner.

PATTERNMAKING.

(PART 3.)

EXAMPLES ILLUSTRATING PATTERN- MAKING.

1. Selecting Stock for Patterns.—It may seem unnecessary, after what has been said in *Patternmaking*, Parts 1 and 2, to lay emphasis on the necessity of using great care in selecting stock for patterns. In the case of a skeleton or makeshift pattern, second-grade lumber is good enough, but in the case of a pattern for machine parts, especially when a large number of castings are required, and when the pattern may have to be stored for quite long intervals, the selection of the stock becomes a very important item. In such cases, only well-seasoned and well-selected lumber should be used. It is probable that more money is wasted by the use of poorly seasoned or unsuitable lumber in patternmaking than by any other one cause affecting this part of the machinery business. The evil consequences of the use of bad lumber not only increase the pattern account of a firm, but add considerably to the cost of molding and, also, to that of finishing the castings in the machine shop, since a pattern that is warped out of its original shape because it was made of wet lumber will give the molder trouble in molding; and the casting, being like the pattern, will cause the machinist trouble, thereby increasing the cost of production in all the departments because the patternmaker was not careful enough in selecting his material.

COPYRIGHTED BY INTERNATIONAL TEXTBOOK COMPANY. ALL RIGHTS RESERVED

SKELETON PATTERNS.

2. General Consideration.—When only one casting or a very few castings are required from a large pattern, means are sometimes taken in both the pattern shop and the foundry to make the required pattern as inexpensive as possible. At times, the pattern is swept up from sand and baked, and, again, it is often made of cheap second-grade lumber in the least expensive manner. In either of these cases, the pattern is practically of one material, that is, it is made either of sand or wood. In the class of patterns commonly known as **skeleton patterns**, the pattern is made partially of wood and partially of sand.

3. Pattern for Pipe Bend.—Two views representing half of a skeleton pattern for a large pipe elbow are shown in Fig. 1. To produce a whole pattern, two boards *a* are sawed out to the shape of the pipe, including the core prints.

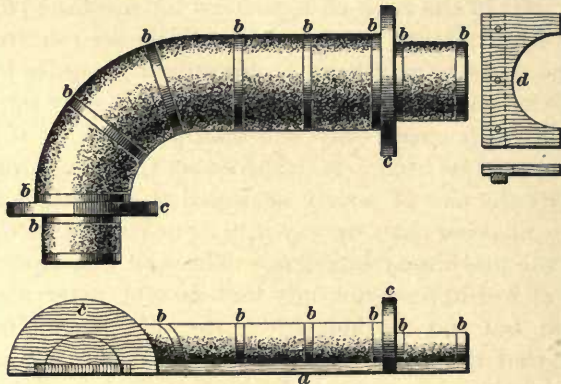
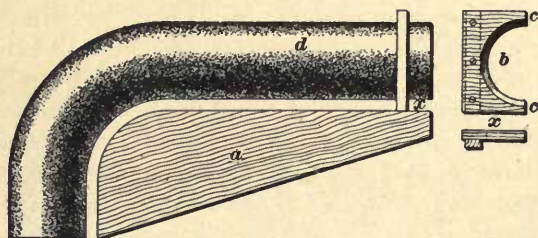

FIG. 1 (a).

The thickness of these boards depends on the size of the pattern and varies from 1 to 2 inches. The boards are doweled together and circular pieces *b, b*, having the form of the cross-section of the pipe and core prints at the places where they are introduced, are sawed out and fastened upon the boards, as shown. The flanges *c, c* are also prepared and cut out to fit over the boards *a*.

A strike, or strickle, for each diameter of the pattern, i. e., one for the portion between the flanges and one for the core prints, is also provided for the molder. One of these strickles is shown at *d*, Fig. 1 (*a*). The molder completes the pattern by laying down one of the boards, as shown in the lower part of Fig. 1 (*a*), and filling the spaces between the circular pieces *b*, *b* with sand, the sand being swept up by means of the strickle, which is guided by the board *a*. When the pattern is complete, the molder sprinkles parting sand over the outside so that it may leave the mold nicely. The flask for this first half of the mold is then placed in position, rammed up, and turned over, after which the other board *a* is placed on the one shown in the illustration, its half pattern finished up in sand, sprinkled with parting sand, and the second half of the mold rammed up. When the flask is taken apart, the cope usually draws off from the upper half of the pattern, after which the pattern is withdrawn from the mold and any loose sand that may have fallen from the pattern is removed.

The core for the skeleton pattern mold is simply swept up by means of a guide board and strickle. These are shown in Fig. 1 (*b*), *a* being the guide board and *x* the strickle. The

FIG. 1 (*b*).

guide board is clamped or weighted down on an iron plate and the half core swept up, as shown in the illustration, *d* being the core. The points *c*, *c* should be protected from excessive wear on the iron plate by driving one or more nails into them. After one half the core has been swept up, the guide board is turned over and the other half swept

up, to match the portion already made. During the work, one edge of the strickle is kept in contact with the guide board, care being taken to see that the strickle is always perpendicular to the guide board when following its straight portions, and perpendicular to a tangent, i. e., forming a radial line, when following the curved portions.

In some cases the plate on which the core is made is so shaped that the sides are parallel to the sides of the core, as

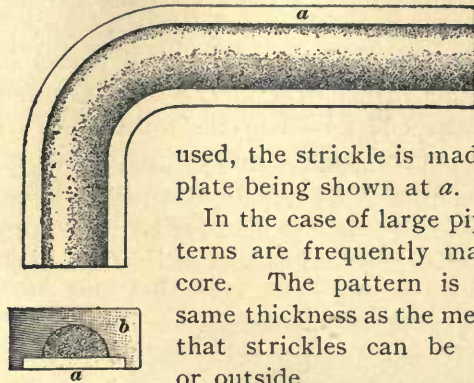

FIG. 1 (c).

shown in Fig. 1 (c), and the edges form the guides for the strickle. When this form of plate is

used, the strickle is made as shown at *b*, the plate being shown at *a*.

In the case of large pipes, the skeleton patterns are frequently made so as to leave a core. The pattern is a frame having the same thickness as the metal and is so arranged that strickles can be used on the inside or outside.

4. Green-Sand and Loam Patterns for Large Pipe Bends.—Large pipe bends are usually made by building a skeleton pattern, as shown in Fig. 2 (*a*) and (*b*). This form of pattern may be used for green-sand or loam molding, the former method being used for sizes up to about 24 inches or 30 inches, and in most cases larger sizes are made by the latter method. The strickles, or sweeps, required for green sand and loam differ somewhat. Fig. 2 (*a*) and (*b*) show a skeleton pattern and sweeps for a green-sand mold.

The process of molding may be briefly described as follows: The half pattern is imbedded in the sand in the floor, and the sand between the ribs swept out with the sweep *a*, the offsets on the ends of which are equal to the thickness of the pipe, which is also represented by the thickness of the ribs of the pattern. This sweep leaves a comparatively smooth surface of the form of the outside of the pattern.

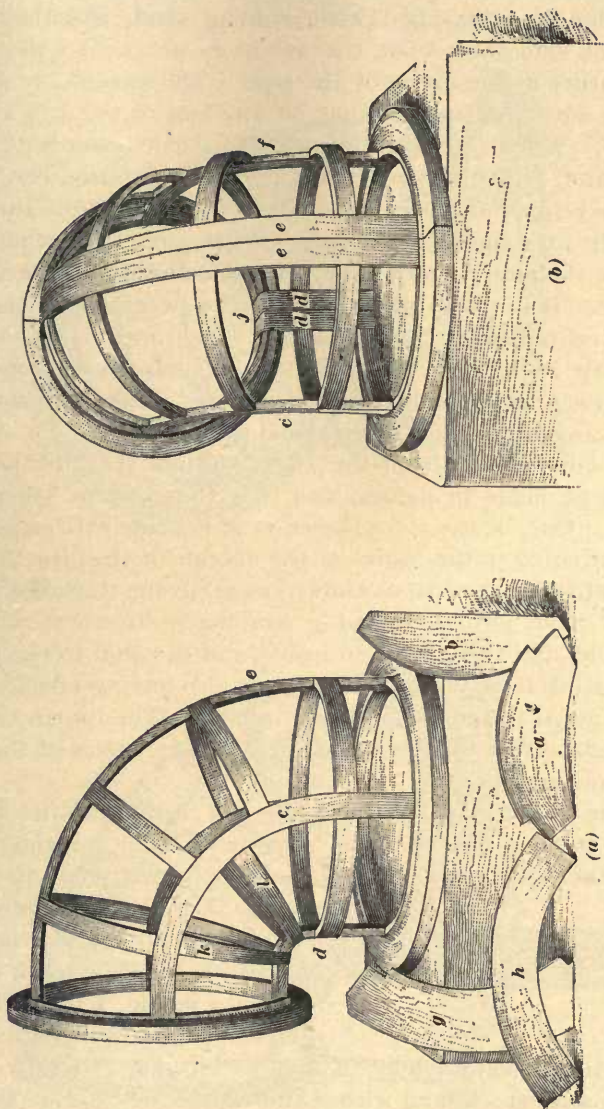

FIG. 2.

This surface is then covered with parting sand, the spaces between the ribs filled with molding sand, and the inner surface smoothed with the sweep *b*, which has the same curvature as the inside of the pipe. The sweeps are drawn along with the ends bearing on any two of the ribs *c*, *d*, *e*, and *f*. When this surface is smooth, it is covered with parting sand, and the core is made by placing an iron core crab in the center, and packing sand around it. When the core is built up roughly to the form of the pipe, the second half of the skeleton pattern is put in place, and the upper half of the core is swept up smoothly with the sweep *g*, and the surface coated with parting sand. The upper half of the pattern is then filled with sand, the surface swept up with the sweep *h*, covered with parting sand, and the remainder of the mold made up in the usual way.

It will be seen from the above outline that the pattern must be made in halves, and that four sweeps are necessary. One, of the form shown at *a*, is made with an outside radius equal to the radius of the outside of the pipe, and offsets at the two ends, as shown, equal to the thickness of the pipe. The sweeps *b* and *g* are made, the first with an outside, and the second an inside, radius equal to the radius of the inside of the pipe, the latter also having offsets at the ends equal to the thickness of the pipe. The fourth sweep *h* is made with an inside radius equal to the radius of the outside of the pipe.

The skeleton pattern is made by turning up the flanges and cutting out the ribs separately, then putting them together as shown. The pattern is parted along the lines *i* and *j*, Fig. 2 (*b*). The ribs *d* and *e* are usually built up in three widths that overlap each other,



(c)

FIG. 2.

as shown in Fig. 2 (*c*), although in the smaller sizes, *d* may be cut out of solid stock. The other ribs are generally made from solid stock, and with *d* and *e* are sawed to the required form. The joints are usually made with nails. The flanges are built up of three thicknesses of stock, and the fillets are

turned on them. It will be seen that the ribs *k* and *l*, forming the inside of the bend, are made with a taper. This is

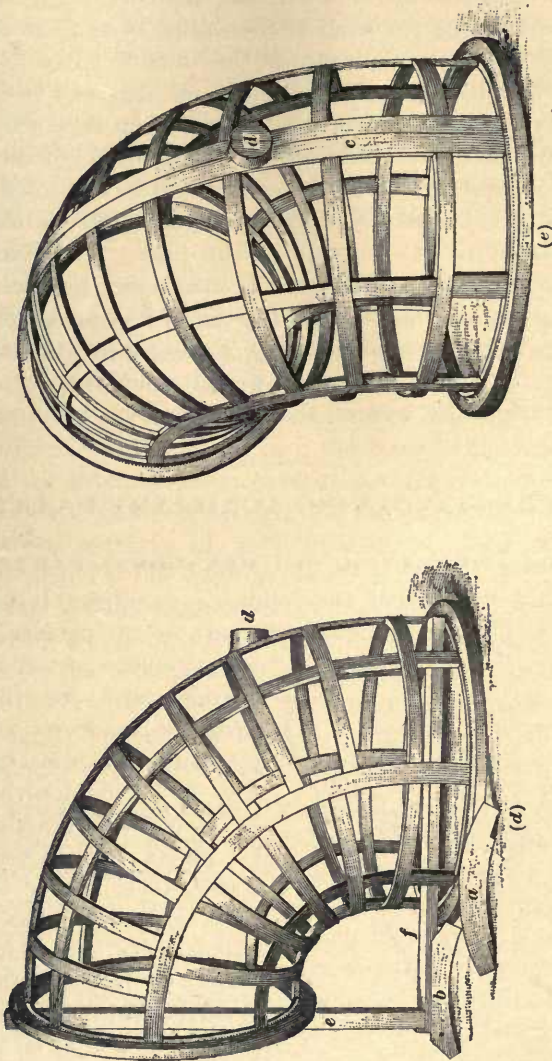

FIG. 2.

done in order to leave as wide a space as possible at the lower end, which makes it easier to ram in the sand.

In Fig. 2 (*d*) and (*e*) are shown two views of a skeleton pattern of a larger size, intended for loam work. In this case, the elbow is molded on end, the core being built up first in one piece; the sand is then filled in to form the pattern, and the mold built up on the outside in two or more pieces. It will be seen that in this case only two sweeps are necessary. The first *a* is used to sweep up the core, and is made with an inside radius equal to the radius of the inside of the pipe and offsets at the ends equal to the thickness of the pipe. The second *b* is made with an inside radius equal to the radius of the outside of the pipe. The pattern is parted along the line *c*, and is made in the same way as the green-sand pattern. The hub *d* is provided for a carrying bolt, to facilitate the handling of the finished casting. The supports *e* and *f* are provided for the purpose of preventing the end of the pattern from settling while in storage.

PATTERNS INVOLVING AUXILIARY PATTERNS.

TOOL FOR LAYING OUT HEXAGONAL PARTS.

5. In a number of the following examples, it becomes necessary to lay out a hexagonal part of the pattern, and a

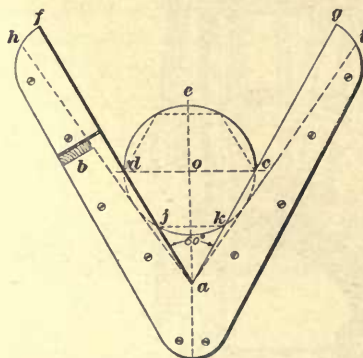

FIG. 3.

very convenient tool for this purpose, and one that can easily be made by any patternmaker, is illustrated in Fig. 3. This tool is made by fastening a metal plate or plates on a wooden frame, as shown, *b* being a cross-section at that point. In the metal plate, an angle *fag* of 60° must be cut. The wood mounting for the metal plate must be cut to another angle *hai*. In order to find this second angle, draw the line *ae* bisecting the angle *fag*, and at any point, as *o*, draw

the line dc perpendicular to ae at o and intersecting the lines af and ag at d and c . With a radius od , or oc , draw the circle dec . Then draw the lines ai and ah tangent to the circle dec , and cut the wood to this angle. When this tool is placed upon any circle, as shown, it will determine two sides of a hexagon, the distances dj , jk , and kc all being equal. The stock has then simply to be turned to the diameter over the corners of the hexagon, commonly called the long diameter of the hexagon, after which the hexagon can be laid out by using the tool, as shown in the illustration.

GLOBE-VALVE PATTERNS.

6. General Consideration.—Small globe valves are generally cast of brass, while the larger sizes are made of cast iron. The latter are also known as *stop-valves*, and sometimes as *throttle valves*. The method of making the smaller sizes differs from that of making the larger, the former being molded by machine from several patterns attached to the plate, with a gate connecting all the patterns. As many as eighteen patterns of very small-sized globe valves are often attached to one gate on the plate and molded together. When this is done, the portion of the pattern on one side of the parting line is mounted on one side of the board, and the portion on the other side of the parting line on the other side of the board, great care being required to place the portions exactly opposite each other. The methods of molding with this style of patterns will be treated in *Foundry Work*.

7. Pattern for Small Valve Body.—The method of making the pattern and core boxes for a $1\frac{1}{4}$ -inch globe valve will next be considered, only one pattern being treated, although two or more may be molded in one flask. The manner of making the pattern and core boxes is the same, whether one or more patterns are required, or whether they are required for matched-board work or not. Fig. 4 (*a*) and (*b*) represents two views of a globe valve, (*a*) being a section.

8. The making of the pattern for the body will be considered first. This pattern is comparatively simple, it being

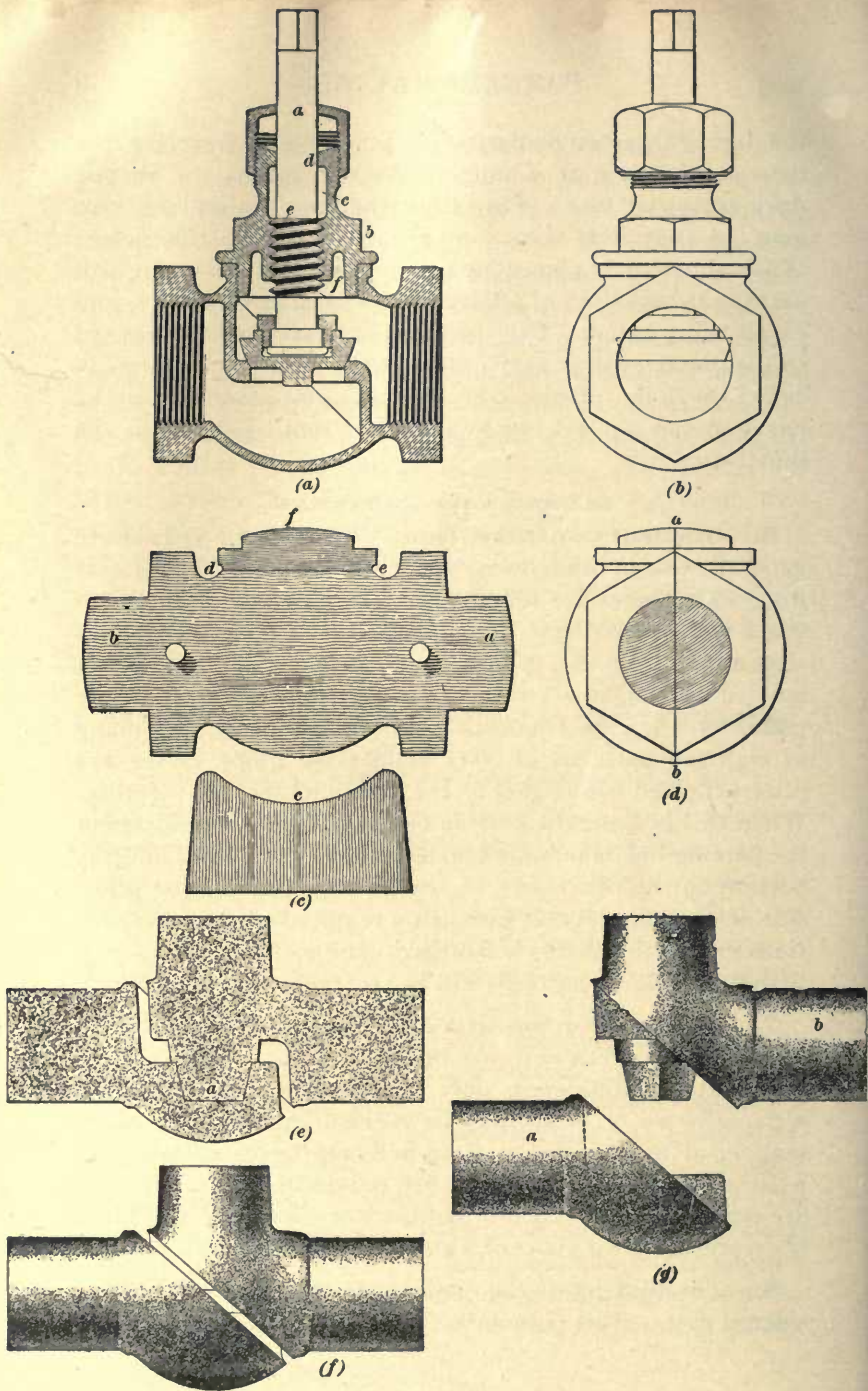

FIG. 4.

possible to turn most of it on a lathe. Fig. 4 (*c*) and (*d*) illustrates the pattern, together with several of the points in its construction. Two pieces of stock about 8 inches long, 3 inches wide, and $1\frac{1}{2}$ inches thick are cut out and jointed and doweled together carefully. The stock is made of this length in order to enable the patternmaker to glue the ends together so as to hold the pieces in place during turning. When this method is followed, care should be taken that no glue gets between the parts of the pieces that are to form the pattern. Sometimes a nail or screw is also placed in the end to aid the glue in holding the pieces together. If, however, good glue is employed, and it is allowed to dry before turning, these metal fasteners are not required in the case of small patterns.

A templet should be made as shown at *c*, Fig. 4 (*c*). This templet may be made from a board $\frac{1}{8}$ inch thick, or from a piece of sheet metal, and is used as a guide in turning the pattern to the right shape, the proper allowance being made for finish and shrinkage. The ends on which the hexagons are made are usually turned a little larger in diameter than the long diameter of the hexagon, as, otherwise, in forming the hexagon there is some danger of making it too small.

After this first portion of the pattern has been turned, the globe body must be planed off to the line *d**e*, as shown, and a piece turned and glued on to form that part of the valve into which the bonnet *b*, Fig. 4 (*a*), is screwed. The two core prints *a* and *b*, Fig. 4 (*c*), are turned on the body of the pattern, and the core print for the bonnet, *f*, Fig. 4 (*c*), is turned on a piece that is glued upon the side as shown. This piece should be turned from two pieces that have been jointed and fastened together on a chuck. Care should also be taken to see that the grain runs in the same direction both in the body of the pattern and in the piece that is glued to it.

9. Varnishing the Patterns.—After turning any pattern with core prints, and before taking it out of the lathe, it is well to varnish the core prints with yellow shellac varnish. If this is done, the unclean appearance that

they usually have as the result of handling before the varnish is applied is avoided. This precaution applies only in cases where the core prints are simply painted with yellow varnish and not with a color.

After the turning is completed, the hexagonal ends of the pattern are formed, as shown in Fig. 4 (*d*).

10. Core Boxes for the Body of Globe Valves.—

The core boxes and the core that forms the inside of the valve are not as easily made as the pattern. The exact shape of the core should be studied carefully before attempting to make the core boxes. In Fig. 4 (*e*) is shown

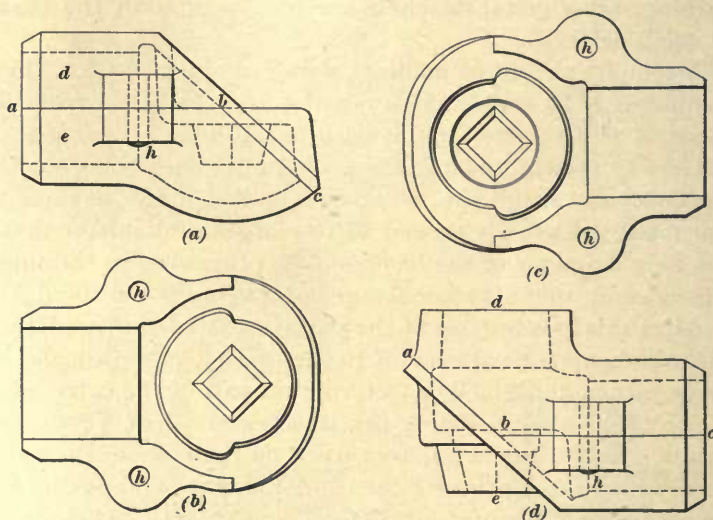

FIG. 5.

a section through the core; Fig. 4 (*f*) shows the completed core together; and Fig. 4 (*g*) shows the two parts *a* and *b* separated. It is practically impossible to make such complicated cores as these in ordinary wooden boxes, and hence it is necessary to make iron core boxes, and patterns for these must also be made. These patterns are called **auxiliary patterns**. The finished core box for making the core shown at *a*, Fig. 4 (*g*), is shown in

Fig. 5 (*a*) and (*b*), while in Fig. 5 (*c*) and (*d*) is shown the core box for making the core shown at *b*, Fig. 4 (*g*). These core boxes are usually made of cast iron or brass, nicely fitted and doweled together.

Four patterns for the boxes are made first, one for each half, and, as will be seen by referring to the inside views of both boxes, much cutting and fitting is necessary for their completion. Both boxes are parted along the lines *a b c*, and the joint between the two parts of the boxes must be made with great care, as the accuracy of the core depends very largely on it. The patterns for the core boxes should be made of well-seasoned blocks of pine or hard wood. No attempt should be made to carve the inside of the boxes to shape until the joint has been accurately formed, only enough work being done on the inside to enable the stock to be brought into place along the joint.

11. In making core boxes for the body of globe valves, it is sometimes best to make models of the required cores out of plaster of Paris or wood and then cut these models on different lines so as to obtain sections, or to make templets by simply projecting sections of the boxes upon a drawing. After the insides of the boxes have been carefully worked out to templets made from drawings, or to a model that has been prepared, castings are made from the patterns and fitted together with dowel-pins.

A projection of the upper part *d*, Fig. 5 (*a*), of the box for the core shown at *a*, Fig. 4 (*g*), is shown in Fig. 5 (*b*). It will be noticed that in Fig. 5 the halves of the patterns are joined together by dowel-pins *h*. After the castings for the core box have been made and fitted together, test cores are made from plaster of Paris or lead, put together, and located in the mold to see that the core gives the required thickness of metal. If it does not, the box is changed until it is right, or the pattern is changed and a new box cast. Frequently, cores are made in a new core box, placed in a mold and a casting made, from which sections are cut to see that the metal is of the desired thickness.

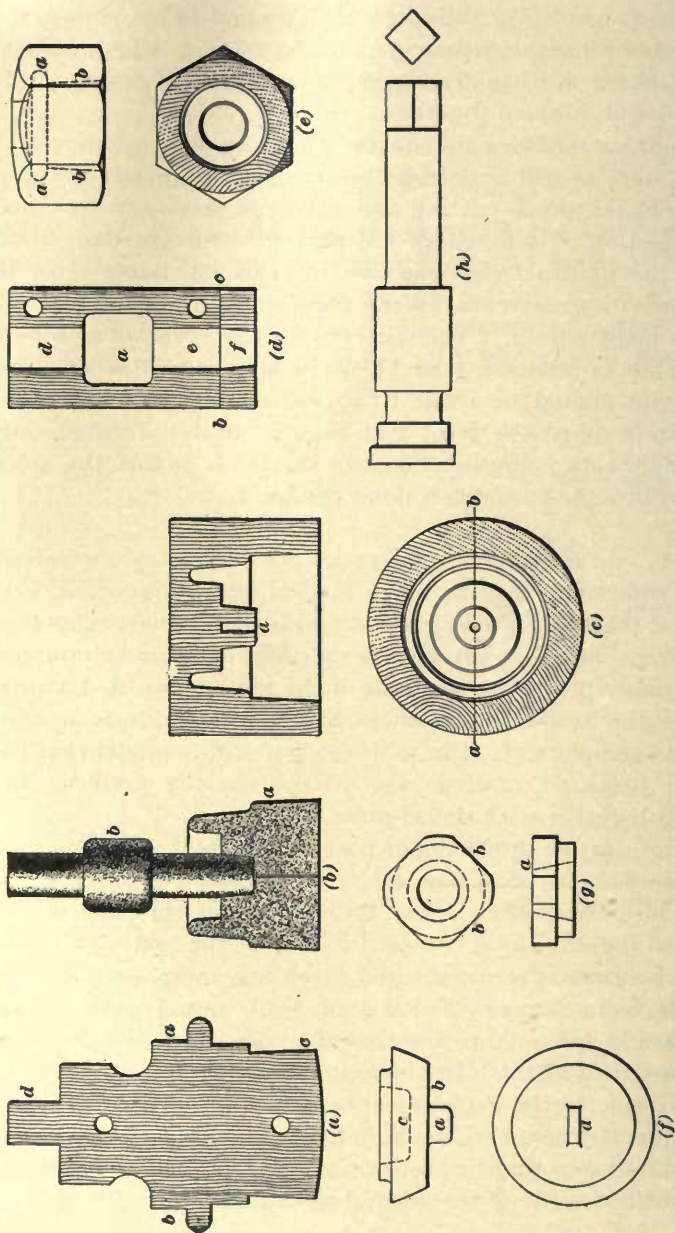

FIG. 6.

12. Manufacturers of valves spare no expense in making these metal core boxes and are very careful to get them correct, because of the large number of valves made. The core box for the core *b*, Fig. 4 (*g*), is shown at Fig. 5 (*d*), Fig. 5 (*c*) being a projection of the lower portion. It will be noticed that the core box shown in the two views (*a*) and (*b*), Fig. 5, has only one opening through which the core material can be introduced, this opening being at the end *a*, while the core box shown in Fig. 5 (*c*) and (*d*) has three openings, one at the end *c*, one at *d*, and another at *e*.

13. Pattern for the Valve Bonnet.—The pattern for the valve bonnet *b*, Fig. 4 (*a*), may be made as shown in Fig. 6 (*a*), which illustrates one-half of the pattern. In order to make the pattern, two pieces of pine should be jointed and doweled together in the ordinary way and the pattern turned to the form shown, necessary allowance being made for finish. After the pattern is turned, the core print should be varnished and the hexagonal portion *a b* given the required form, using the tool described in Art. 5. The large core print *c* is turned a little larger on the end than where it joins the pattern, for reasons that will be described later. The small core print *d* is turned parallel.

14. Core Boxes for Valve Bonnet.—By referring to Fig. 4 (*a*), it will be noticed that the bonnet *b* has a rather complicated core, the portion *c* being cored out for clearance, while finish will be required at *d* to form the bearing for the valve stem *a*, and at *e* for the thread, the lower portion *f* being cored out both for clearance and lightness. In order to produce this complicated series of openings, two cores are necessary. These are illustrated in Fig. 6 (*b*), the larger core *a* being represented in section, and the smaller core *b*, solid. When similar cores are made larger, the smaller one should be arranged to go through the larger one, so as to give it better support, but for small work, such as is here illustrated, the method shown will give sufficient strength.

15. The core box for the larger core is shown in Fig. 6 (c). This may be turned up on a screw chuck from a single piece of wood, the grain running in the direction shown in the illustration. The reason for making the large print *c*, Fig. 6 (a), on the pattern tapered is that this box must be given draft on the inside, to allow the removal of the core. The small print *a*, Fig. 6 (c), is to receive the end of the small core, as shown in Fig. 6 (b). When making a core from these boxes, a nail or wire should be inserted into the hole in the end of the print *a*. When the core is rammed up, this nail is withdrawn, leaving a hole through the core, as shown in Fig. 6 (b).

Owing to the small size of the core *b*, Fig. 6 (b), it is well to make both halves of the box, for, if such small half cores were pasted together, they would not be as strong as the solid core. Fig. 6 (d) illustrates one-half of the necessary core box. The chamber *a* may be cut out with a carving gouge, or a box may be made in several pieces and each worked or turned out by itself. It is customary to make the box of at least two pieces, dividing it on the line *b c* so that the straight portions *d* and *e* can be worked out parallel and the tapered portion *f* turned out by itself.

16. Patterns for Small Details of the Valves.—

The pattern for the packing nut can be made as shown in Fig. 6 (e), which gives both a plan and an elevation of the nut. This pattern can be made to leave its own core by turning it out on the inside, as indicated by the straight dotted lines *b* in the upper view, the recess *a a* being omitted. In such a pattern as this, the grain is usually allowed to run lengthwise of the nut, the end grain being shown in the lower view. To make this pattern, a piece of wood is placed on a screw chuck and the outside turned to a diameter sufficient to allow the hexagon to be formed. Sometimes, a more elaborate solid pattern is made for the nut and a separate core box used. This is always done when it is desired to core out a clearance at the upper end of the nut, as shown by the dotted lines at *a*, Fig. 6 (e).

17. The patterns for the valve and valve nut may be turned from one piece of wood, the wood being screwed on to a small face plate or screw chuck, and the valve pattern, Fig. 6 (*f*), is turned as shown in the illustration, with the exception of the portion marked *a*. In turning, the face *b* should be toward the chuck, so as to enable the pattern-maker to turn out the recess *c*. After the pattern is turned nearly off, it should be smoothed and varnished and then cut off. The rectangular projection *a* is fastened on afterwards, it being intended for the use of the machinist while grinding in the valve. After the valve has been cut off, the nut, Fig. 6 (*g*), can be turned, the face *a* being nearest the chuck during the turning. After the piece has been turned, smoothed, varnished, and cut off, the flats *b* for the wrench may be formed with a plane or chisel. The valve spindle, Fig. 6 (*h*), can be turned from one piece as shown. Patterns of small diameter like the valve spindle are not usually made in halves, because they would be too weak, and liable to break.

18. Where a large number of castings is to be made, it is very common practice to make such pieces as the valve nut and valve spindle in halves and to place them upon a card or a match board. At other times, the patterns are all made solid and a match, or odd side, is made from plaster or oiled sand, separate places being made to receive each pattern.

PATTERNS AND CORE BOXES FOR THREE-WAY COCK.

19. **General Consideration of the Valve.**—Before attempting to make the patterns for this valve, it is well to look somewhat into its characteristics. In Fig. 7 (*a*) is shown a plan of the top of the valve, and in Fig. 7 (*c*) is shown a front view, while Fig. 7 (*b*) shows a section of the valve on the line *AB*. It will be noticed that there are stops *s*, *s'* on the casting, against which the pin *a* on the plug or

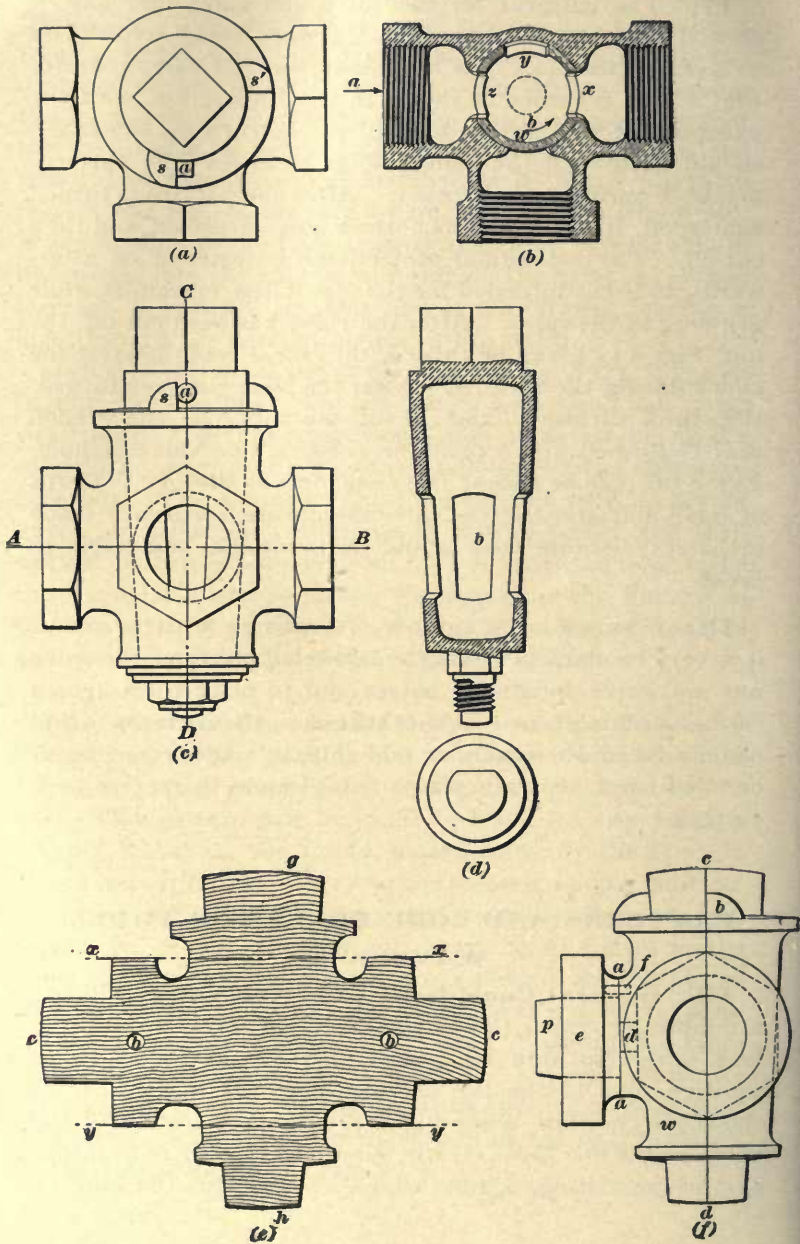

FIG. 7.

valve comes to rest. These stops are so placed that the plug cannot make more than a quarter of a revolution. The construction and operation of the valve can be best understood by referring to the sectional view shown in Fig. 7 (*b*). As shown in this illustration, the plug is in such a position that the openings *x* and *z* are in line with the straight portion of the body, so that water or steam entering at *a* passes straight through the cock. By turning the plug one-fourth of a revolution, as indicated by the arrow *b*, the opening *x* will come to the position *y*, the opening *y* will come to the position *z*, and the opening *z* to the position *w*, thus turning the flow at right angles and out through the side of the cock at *w*.

20. In making patterns and core boxes for this cock, the necessary allowance for shake, shrinkage, and finish must be made in each case. The outside of the main body of the pattern and much of the inside will require no finish, and, also, in many cases, the hexagonal parts are cast to their finished size; but the portions that have to be threaded and the portion of the body that is to receive the plug must be provided with sufficient stock for finishing.

21. Pattern for Valve.—The pattern for the valve is made in two parts, with a third part fitted to one side, as shown in Fig. 7 (*f*). One half of the pattern is shown in Fig. 7 (*e*). The pattern is parted on the line *c d*, and the hexagonal side piece *e*, with its fillet, is made separate from the body of the pattern, the division being made along the line *a a*. This piece *e* has a hole turned through it that fits over the core print *p*.

To make this valve pattern, two pieces of stock of sufficient size to make the piece shown in Fig. 7 (*e*) must be gotten out. These pieces are jointed and doweled together, the dowels being located at *b* and *b*, as shown in Fig. 7 (*e*). The pieces of stock may be gotten out somewhat longer in each direction than the pattern, and secured together by glue at the ends, or they may be glued together with paper between them.

If it is intended to make the body of the pattern without fastening on separate pieces, all the work cannot be done by turning, but a portion of it will have to be done with gouges and chisels after the turning is completed. Before turning, two lines should be laid off on the block at right angles to each other. These will correspond to the center lines AB and CD , Fig. 7 (*c*). A portion of the pattern along the line AB may be turned first. While in this position, only the core prints and the pieces from which the hexagonal ends are formed, together with their fillets, can be turned. When this operation is completed, the pattern is placed in the lathe at right angles to its former position and the other two core prints, and the part of the pattern outside of the dotted lines xx and yy is turned. It should be noticed that the core prints g and h are turned tapered and that the taper of the two prints is in line; that is, their outside surfaces will form a portion of the surface of a cone. The reasons for this will be explained later.

22. After the pattern is turned, the portion of the body that could not be finished in the lathe is formed by means of chisels and gouges, but, before proceeding with this work, it is best to true up the surface aa , planing it off parallel to the joint of the pattern along the line cd and allowing the proper distance between these two faces. After the surface aa has been planed, a circle is struck on it with a diameter equal to the distance aa . The body of the valve is then carved to the desired shape. The print p is shown by the dotted lines as extending to the surface aa . This print is turned with the small pin d on the end, which is glued into a hole drilled in the surface aa . The loose piece to form the hexagonal flange e can be turned up with a hole in it that will just fit over the core print. This piece is kept in its proper relation to the body of the pattern by means of the small dowel-pin f .

It will be noticed in Fig. 7 (*a*) and (*c*) that the stops s and s' are slightly removed from the center lines. If it is attempted to mold the stop s' in its proper position, the molder will

meet with considerable difficulty, but as the distance of the stop from the center line CD is only equal to half the diameter of the pin a , Fig. 7 (c), it is possible to place the stop on the pattern flush with the joint, as shown at b , Fig. 7 (f), the stop being filed back the desired distance after the casting is completed.

23. Method of Molding.—Before proceeding with the discussion of the core box, it may be well to notice the method of molding this pattern, as this has considerable bearing both on the construction of the pattern and on the core box. The portion of the pattern marked w , Fig. 7 (f), is supposed to go in the **cope**, or top part, of the mold and is shown there in Fig. 8 (a). In this illustration, the bottom part of the mold, or **drag**, has been omitted. The slab core c is shown as fitting over the core print p' . In the process of molding, before the slab core is placed in position, the pattern with the loose piece about the core print is placed in position and sand rammed up in the cope as far as the surface pp , flush with the top of the loose piece of the pattern. This sand is then struck off and the loose piece withdrawn, after which the slab core is placed over the core print, the surface resting on the surface of the sand pp . The ramming of the cope is then continued, care being taken not to strike the slab core while this is being done. This method may be pursued where only a comparatively small number of castings is to be made. When a large number of castings is being made, it is usual to provide the mold with an extra parting line; in other words, to mold the casting in a three-part flask. The slab core is made in a simple rectangular core box with one print in the bottom.

24. Core Box for Three-Way Cock.—One of the core boxes for the body of the three-way cock is shown in Fig. 8 (b). It will be noticed that the main portion of the core is tapered, and from this it will readily be seen why the core prints g and h in Fig. 7 (e) were tapered. By making these core prints tapered, and having this portion of

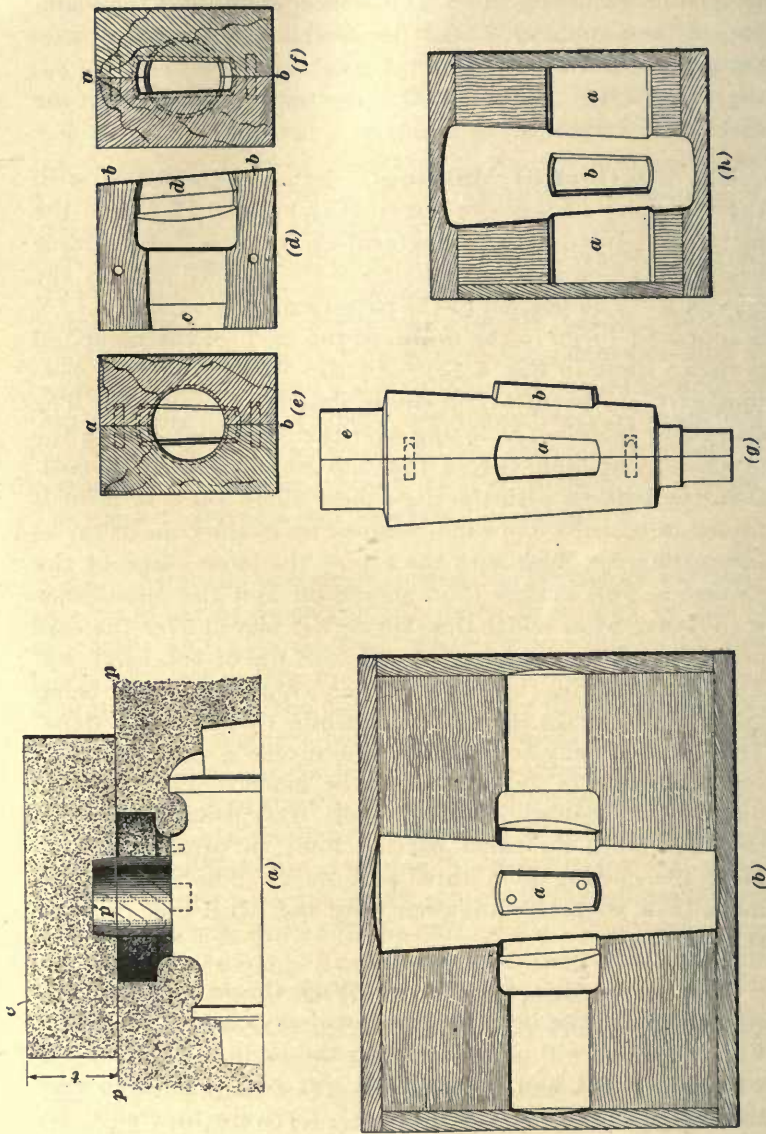

FIG. 8.

the core box formed as shown, it is much easier to work out the material to the desired form.

A one-half box is sufficient for this core, as both half cores are similar, the only difference being that one half core must be made without the print *a* shown in the box. The print *a* is, therefore, doweled on so that it may be removed and readily set in place again. This print is intended to receive the end of the side core that is made in the box shown in Fig. 8 (*d*).

The stock for this core box, Fig. 8 (*b*), must be thick enough to leave sufficient strength in the back after cutting away the material at the largest diameter. Four pieces are secured to the outside of the box, as shown, and clearance for draft on the ends of the core is cut from these pieces.

25. The core for the side opening is made separate. Fig. 8 (*d*), (*e*), and (*f*) shows three views of the box intended for this purpose. A complete box should be made for this core, the parting being on the line *a b*, and the two pieces doweled together, as shown. The end *b b*, Fig. 8 (*d*), must have the same taper as the plug part of the main box. The portion *d*, which is intended to form the projection that goes into the print left by the piece *a*, Fig. 8 (*b*), must be shaped to correspond with the print it is intended to fit, and the end *c* must be formed to correspond with the print *p* on the pattern Fig. 7 (*f*). The general construction of the box needs no comment, as it is similar to the core boxes already described.

26. Pattern for Plug.—The pattern for the plug is shown in Fig. 8 (*g*) and is made in halves, being parted diagonally across the square head, as shown. This pattern has three core prints, the two prints *a* on the parting line, and the print *b* on the side. The two prints *a* may be formed by letting in a piece of wood that will go directly across the pattern, the grain being at right angles to the main portion of the pattern. This is the strongest construction. The print *b* can be made of a separate piece of wood and be attached to the main portion of the pattern. On the square end *e* of

the pattern no allowance for finish will be required, but on the rest of the surface an allowance must be made.

27. Core Box for the Plug.—The manner of coring out the plug is shown in Fig. 7 (*d*). If a half box is made to serve for making both halves of the core, it will be necessary to fit a loose piece into the recess *b*, so that one half of the core can be made without the projection that forms the side opening *b*, Fig. 7 (*d*). One point that must be observed in making the core and locating the core prints for the plug, is that the core is supported by the prints *a, a*, Fig. 8 (*h*), and hence this portion of the core box and pattern must be made very carefully, so that the prints will make a good fit in the mold, for, if they do not, the plug is liable to be thin on one side and thick on the other.

PATTERNS FOR WHEELS AND GEARS.

28. Wheels or Gears Having a Web or Plate in Place of Arms.—When the diameter of wheels is not great, as, for instance, in the case of small gears or pinions,

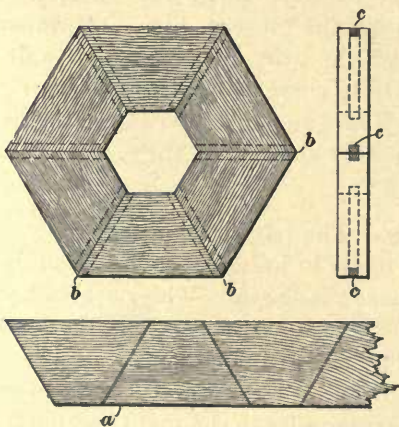

FIG. 9.

a plate or web takes the place of a series of arms. In case the pattern is divided into two parts, the web, if thin, may be placed entirely on one part, the other half of the rim and the hub being made loose, or each half of the pattern may be made with one-half of the web. In either case, the stock for the web can be joined up as shown in Fig. 9. When the web is composed of six parts, as shown in Fig. 9, these parts may be sawed out from the board or plank, as shown at *a*. The

ends of the pieces should be finished on a trimmer and shoot board, so as to make perfect joints at b , b .

29. In order to strengthen these joints, a tongue c should be introduced into each joint. These tongues should be made of hard wood with the grain running at 45° to the joints. Any number of pieces can be gotten out in a manner similar to that shown at a . After the pieces are glued together, as shown, they may be sawed to approximately the required diameter with a band saw, and the courses, or segments for the rim, built up on the disk. It is usually unnecessary to have the pieces extend to the center, as the hub will cover this central opening, although there are times when it becomes necessary to make a solid web without the hole in the center. In such

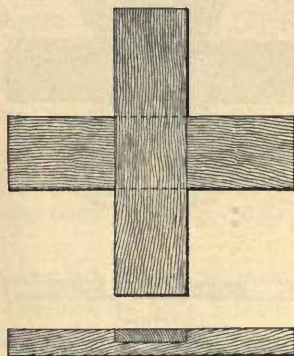

FIG. 10.

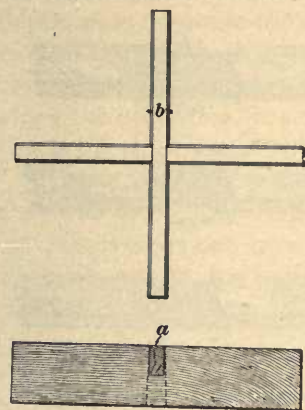

FIG. 11.

a case, it is easier to leave a small opening at the center and stop it by gluing in a separate piece.

30. Wheel Patterns Having Four Arms.—When four arms are required, they are usually half checked together when the thickness at the center will permit doing so. Figs. 10 and 11 illustrate two methods of checking together two forms of arms. In Fig. 10 the arms are broad and flat and the pieces are simply checked together. In

Fig. 11, the required arms are of considerable depth, and hence must have considerable draft. It will therefore be necessary to make the joint between them at a equal to the width b of the narrowest side of the arm.

31. Wheel Patterns With Six or More Arms.—

When six or more arms are required, they may be joined

together as shown in Fig. 12. When this method is employed, the pieces are prepared as shown in Fig. 12 (a), each piece being wide enough to form the round corners of the arm near the hub and rim, and long enough to allow the ends of the arms to be built

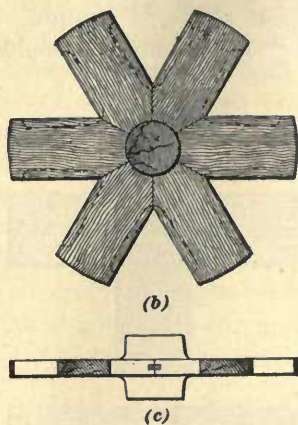

FIG. 12.

into the rim of the wheel. The pieces are joined together with tongues, as shown, the joints at the center being made by means of a trimmer and shoot board. The outline of the finished arms is shown in the dotted lines, Fig. 12 (b), and the hub is shown in Fig. 12 (b) and (c).

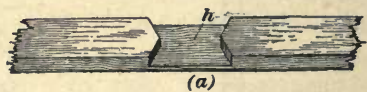

FIG. 13.

32. When the stock of the arms is thick enough to allow it, the method of joining shown in Fig. 13 may be employed. In this case, the joint is made as follows: The stock for the arms is dressed to the required width and thickness and a line made lengthwise on the center of both faces of each piece with a gauge. At the middle of the line on one side of the pieces shown in Fig. 13 (a) and (c), and at the middle of the line on both sides of the piece shown in Fig. 13 (b), a circle equal

to the width of the piece is struck with a pair of dividers. In the case of six arms, a bevel is set to 60° and one set of lines laid off tangent to the circle and, in the case of (*a*) and (*c*), the bevel is then reversed and two other lines are laid off on the same side, which will cross the first ones at the center. The piece shown in Fig. 13 (*b*) is marked in the same way, except that instead of the four lines being on one side, two are on one side and two on the other, as shown. The gauge is now set to one-third the thickness of the stock and marks made along the edges of the arms. The pieces shown in Fig. 13 (*b*) and (*c*) are gauged from both sides, while the one shown in Fig. 13 (*a*) is gauged from one side only.

The first operation of checking is carried out as follows: The piece shown in Fig. 13 (*a*) is checked on both lines to two-thirds its depth in the first operation. The piece shown in Fig. 13 (*b*) is checked on alternate sides to one-third its depth, as shown, while in the case of the piece shown in Fig. 13 (*c*), the checking is carried out in two operations. In the first operation, the checking extends to one-third the depth, so as to obtain the surfaces *a* and *b*, which shall be equal in depth to the check shown at *e*, Fig. 13 (*b*). After this portion of the material has been removed, the stock is checked along the other two lines to the gauge lines representing two-thirds the thickness of the stock, so as to obtain the surface *c*.

If these three pieces have been accurately cut as described, they will fit together so as to form six arms. Before gluing the pieces together, care should be taken to see that the joints do not fit too tightly, as this may distort the arms, tending to bend them out of the plane in which they belong.

PATTERN FOR SHAFT COUPLING.

33. General Consideration of Casting Required.

The finished casting is shown in Fig. 14 (*a*) and (*b*). This casting is to be finished all over, with the exception of the recess *a*, and hence stock must be allowed on all surfaces to be finished both inside and outside. No allowance is

made for the bolt holes *b*, as these will be drilled subsequently through the solid metal.

34. Construction of the Pattern.— Fig. 14 (*c*) shows a section of the pattern, and Fig. 14 (*d*) a view of the lower side. It will be noticed that the disk is built up of two layers, or courses, *a* and *b*, the courses being joined together like those shown in Fig. 9, except that the tongues are omitted. These tongues are unnecessary in this case,

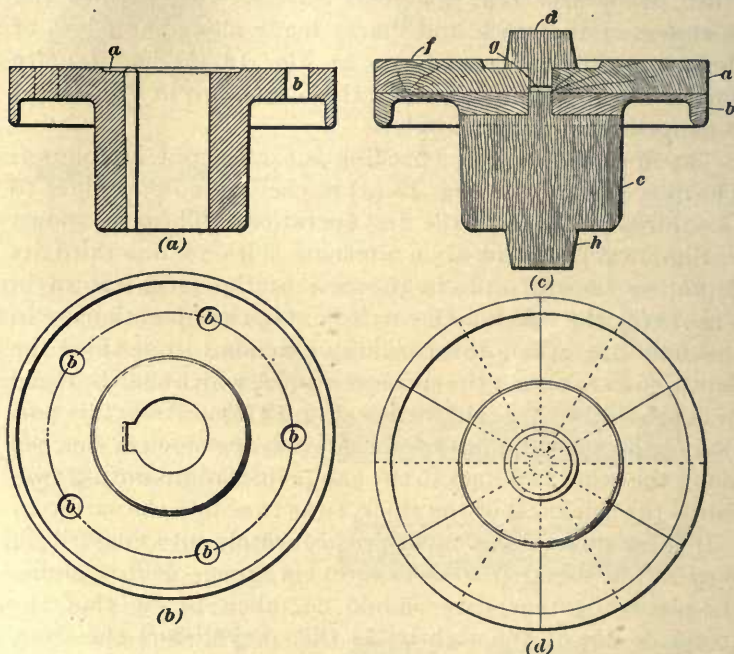

FIG. 14.

because the two courses are arranged so as to break joints, as indicated by the dotted lines in Fig. 14 (*d*). The hub *c* and the core print *d* are turned separately, with pins on them to fit the hole *g* in the disk, thus making it easy to have them concentric with the outer circle of the coupling. The core print *d* should remain loose so that it may be removed for laying the pattern flat on the board in the first operation of molding.

The hub is glued in place. In this pattern, draft is allowed on all surfaces from the face *f*. The core print *h* is turned with the hub *c*.

PATTERNS FOR CYLINDER HEAD AND COVER.

35. Construction of Cylinder Head.—The cylinder-head cover chosen to illustrate this style of pattern is shown at Fig. 15 (*a*) and (*b*), the cylinder head being intended for

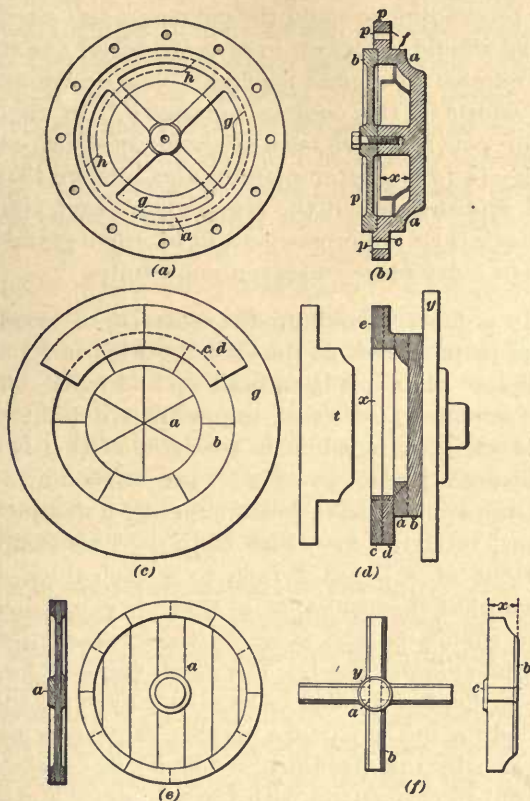

FIG. 15.

a Corliss engine. Fig. 15 (*b*) shows a section of the head with the cover *b* in place. This same head may also be used

for a slide-valve engine by filling up on the pattern one of the spaces marked *a*. These spaces are also shown by dotted lines in Fig. 15 (*a*).

36. Pattern for Cylinder Head.—Having selected dry lumber, proceed to build the pattern for the cylinder head as shown in Fig. 15 (*c*) and (*d*), remembering to allow stock for turning or finishing where the marks *f* and *p* appear on the drawing, Fig. 15 (*b*), *f* standing for finish and *p* for polish.

Before proceeding to build the pattern, a full-sized section of the head should be drawn in order to determine the thickness and number of courses needed. This drawing will also give the width of the courses necessary. In the case in hand, four courses have been selected, as shown at *a*, *b*, *c*, and *d*, Fig. 15 (*d*). After planing the lumber to an even thickness, and sawing out the segments for each course, it is well to stack them up crosswise and let them stand for several days in a dry place to season more fully.

37. In order to build up the pattern, a wooden face plate must be prepared, as shown at *g*, Fig. 15 (*c*) and (*d*). After this face plate has been built up and faced off in the lathe, the successive series of segments are built upon it, each segment being faced off in the lathe after it is in place, so as to insure a perfect bearing for the succeeding segment. After all the courses have been built up, a templet should be cut out, as shown at *t*, Fig. 15 (*d*). This templet may be made out of a board $\frac{1}{8}$ inch to $\frac{1}{4}$ inch thick, with the edges somewhat sharpened, or a thin sheet of metal, and the shape should be the same as the cross-section of the inside of the cylinder head. The small step on the face of the cylinder head, intended to receive the cover, should not be provided for in the pattern, as this can easily be turned in afterwards by the machinist. The inside of the pattern is turned out to correspond with the templet *t* and the outside of the segments *c* and *d* turned to the proper diameter, after which the pattern should be taken off from the face plate and the face *e* screwed to the face plate so as to

permit the back side of the pattern to be turned. Care must be taken to center the outside of the segments *c* and *d* accurately. It will be seen by the dotted lines in Fig. 15 (*a*) that the grooves *a* do not extend entirely around the pattern, but in turning they are turned all the way around and the portion *g h*, Fig. 15 (*a*), is subsequently filled in.

38. After the pattern is turned, the ribs and the hub in the center must be made. The stock for the ribs is checked together as shown at *a*, Fig. 15 (*f*). Before half checking the pieces together, it may be well to roughly cut the ends to fit the templet *t*, after which care must be taken to see that, in half checking the pieces, they are joined exactly in the center, so that when the ribs are located as shown in Fig. 15 (*a*), the small boss will be exactly concentric with the head. The ribs should have a little taper to allow for draft, and should be made of such a height that the dimension *x*, in Fig. 15 (*b*), will correspond with that shown in Fig. 15 (*f*). Instead of gluing fillets into the corners at the base of the ribs after the latter are fastened in place, it is better to glue the fillets to the ribs, as shown in Fig. 15 (*f*). The hub at the center should also be formed by gluing corner pieces into the corners of the ribs, as shown, and turning a small hub to go on top of the pattern, as shown at *c*, Fig. 15 (*f*). After the ribs are completed, they are placed in the pattern, glued in position, and the fillets at the ends of the ribs made and glued into place.

39. Pattern for Cover.—The pattern for the false cover of the head is made as shown in plan and section in Fig. 15 (*e*). The plate is made of strips to prevent it from warping, and if the joints are not glued, the danger of the pattern cracking is greatly reduced. The strips are held together by two courses of segments, one on each side, as shown in the cross-section. Two small bosses *a* are turned and located in the center of the plate, as shown. The pieces for this pattern are gotten out in the usual manner and turned to proper form upon a wooden face plate. In the case of large engines, when very thin false covers are used, it is

sometimes necessary to make the wooden pattern very carefully and to make a supporting form for it; then make one casting from this and finish it carefully so that it may be used as an iron pattern for all future castings that may be required. It is usually best to do this in the case of all large, thin castings. The supporting form for the wooden pattern may be so constructed as to fill all the space beneath the pattern, or it may be a frame supporting the pattern at frequent intervals.

PATTERN FOR DISK CRANK.

40. General Consideration of Casting Required.

In Fig. 16 (*a*) are shown an elevation and two sections of a disk crank, one section being taken on the line *CD* and the other on the line *AB*. It will be noticed that the crank is provided with a counterbalance *d*, which is placed opposite the hub *e* for the crankpin. This hub *e* on small disks would be cast solid and the hole in it subsequently drilled and bored. The hub for the shaft *h* would always be cast with the hole cored through it.

41. Construction of Pattern for Disk Crank.

The general construction of the pattern for this disk is shown in Fig. 16 (*b*), (*c*), and (*d*). The main web of the crank is composed of narrow boards, as shown in the elevation and section, Fig. 16 (*b*). These narrow strips *a* should not be glued together along their joints, but should be held in place by the segments *b* and *c* of which the rim is built up. After having built up the courses or segments of the plate, they should be allowed to dry for some time before turning, and, while this is going on, the counterbalance, hub, and crankpin hub may be made. It will be noticed in the sections shown in Fig. 16 (*a*) that the hubs project on one side of the crank. It is more convenient to make the projecting portion of the hubs separate, and hence the first pieces for the hubs are turned to the same thickness as the counterbalance, as shown at *a*, Fig. 16 (*c*).

be screwed to the face plate of a lathe and turned up. In turning, the diameter should be made smaller on the plain side of the pattern for draft. The crank is molded in the position shown in the lower section, Fig. 16 (*a*), that is, with the hub up. The casting is made with this side up because the plain surface must be free from scum and dirt, in order that it may have a good smooth surface when machined.

42. Allowance for finish must be made on all the surfaces that are marked *f* in Fig. 16 (*a*). After the main portion of the disk is turned, the separate pieces are secured to it, care being taken to see that the grain in these portions runs in the same direction as the grain in the strips forming the web of the disk, as this will allow the parts to shrink uniformly. After the hub *h*, counterbalance *d*, and crankpin hub *e*, Fig. 16 (*a*), are in place, the web *i* and the fillets between the hub *e* and the outside of the disk are formed and glued in place. The reason for making the projecting portions of both hubs detachable is that this surface of the pattern may be placed in contact with the molding board during the first operation of molding.

PATTERN FOR STEAM-CHEST COVER.

43. General Consideration.—A steam-chest cover for a slide-valve engine is shown in Fig. 17 (*a*), the upper view being an elevation, and the lower one a section on the line *AB*. This cover is strengthened by cross-ribs in order to enable it to withstand the steam pressure to which it will be subjected. This is a very simple casting for which to make a pattern, and there is a number of ways in which it can be made. If it is desired to make it quickly, and make but one casting from it, a square piece of board with ribs and strips nailed on the outer edges will answer the purpose, but this will not do for a pattern in frequent use, because it will probably split and warp out of shape. When the pattern is intended for continuous use, it is better to build it up of separate pieces.

44. Construction of a Pattern for Steam-Chest Cover.

—Fig. 17 (*b*) shows two views of a partially completed pattern for a steam-chest cover, the upper one being an elevation and the lower one a section.

The central part, or web, is made up of narrow strips, as in the case of the pattern of the disk crank. These strips are fitted into a groove in the outer frame surrounding them.

It will be noticed that this frame is mitered at the corners and joined together by tongues, as indicated by the dotted lines at *a*. The pattern is molded and the casting poured with the side that is to go next to the cylinder, down, that is, the side *c*, Fig. 17 (*a*). This is done to insure clean iron on this surface, because it is to be planed.

Stock must be left to allow for finish on all the surfaces marked *f*, Fig. 17 (*a*).

The four corners of the pattern are rounded, as indicated by the dotted lines, Fig. 17 (*b*), after which the cross-ribs are made by joining two pieces together at the center and cutting them to the desired form. These ribs should be doweled to the cover so that they may be taken off to allow the molder to lay the pattern flat on the board during the first operation in molding. The construction of the ribs is very simple, and hence they are not shown in the illustration.

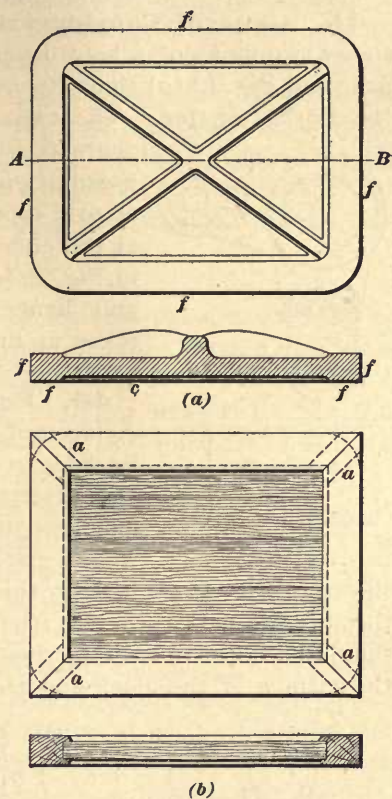

FIG. 17.

PATTERNS FOR CORLISS ENGINE VALVE-GEAR DETAILS.

45. General Consideration of Castings.—Fig. 18 shows two views of a hook lever for a Corliss engine valve gear and Fig. 19 (a) shows two views of an exhaust arm for the Corliss engine. The two castings have very similar characteristics, that is, each is composed of one or more flat levers having an oval cross-section and bosses or hubs at the ends.

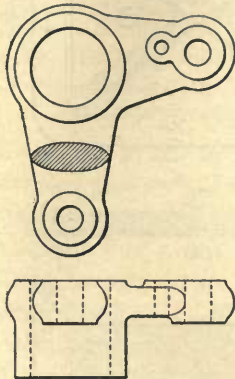

FIG. 18.

The exhaust arm shown in Fig. 19 (a) is the simpler of the two, and hence its construction will be taken up first.

46. Pattern for Exhaust Arm.

A piece of wood is planed parallel on its sides to the thickness a , Fig. 19 (a), and, after the outline of the arm is laid out upon it, it is carefully sawed out with a narrow band saw to the shape shown in Fig. 19 (b). After this, two $\frac{3}{4}$ -inch holes are bored through the pattern, one at the center of each hub. Care should be taken to see that these holes are perpendicular to the surface of the block and parallel to each other, so that

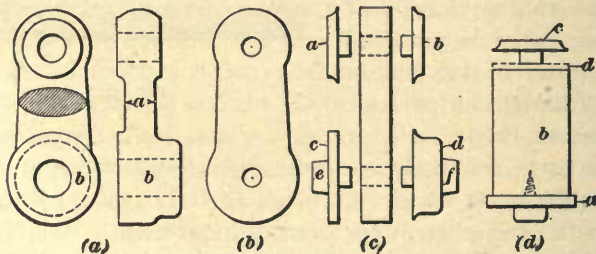

FIG. 19.

the distance from center to center shall be the same on both sides. After these holes have been bored, the four small bosses a , b , c , and d , Fig. 19 (c), are turned as shown.

These bosses are provided with pins that fit tightly into the holes bored in the arm. Owing to the fact that the larger end *b*, Fig. 19 (*a*), contains much more metal than the smaller end, it is necessary to make provision for cooling it as rapidly as possible, in order to prevent the smaller portion from drawing metal from it as it cools. This is accomplished by coring a hole through the larger end, the hole through the smaller end being drilled through the solid metal after the casting is completed. To provide for this core, two core prints *e* and *f* are provided on the bosses *c* and *d*, Fig. 19 (*c*).

47. To turn the bosses for this pattern, first saw out, from a thick plank, a rough piece large enough in diameter to turn the largest boss, and screw it to the screw chuck of the lathe, as shown in Fig. 19 (*d*), *a* being the screw chuck and *b* the block. In this way, the bosses may be turned and cut off with a narrow cutting-off chisel. One completed boss is shown at *c*, and the dotted lines at *d* represent the amount removed by the parting chisel. The grain in this piece should run crosswise and not in the direction of the center line of the boss, as the latter arrangement would make it difficult to turn the fillets without breaking their outer edges. When the bosses are completed, they are glued in place on each side of the arm, care being taken to locate them so that the grain of the wood in the bosses and the arm runs in the same direction. The arm is next worked to an oval shape between the bosses, as shown in Fig. 19 (*a*). The corners should be carved carefully to size. Sandpaper should be used only for the final finishing; it is not good practice to do with sandpaper what should be done with tools. As shown in the illustration, this pattern is made solid or without a parting line. When many castings are required, it is well to make a match of oil sand or plaster, or metal patterns may be made in halves.

48. Pattern for Hook Lever.—The pattern for the hook lever shown in Fig. 18 is made in the same manner as

that for the exhaust arm, except that the plate forming the two arms is made in two pieces and fastened together with a tongue, as shown in Fig. 20. In this case, the bosses will serve to hold the joint together when glued on each side.

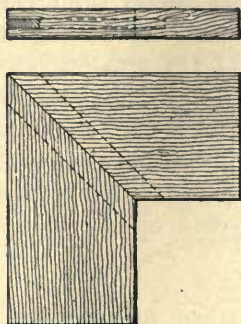

FIG. 20.

PATTERN FOR SLIDE-VALVE ENGINE CYLINDER.

49. Construction of Cylinder.

Slide-valve engine cylinders are made in a variety of forms. The one chosen and explained here is of a well-known type and is illustrated by the three views shown in Fig. 21, (a) being a longitudinal section through the cylinder, steam chest, and ports, (b) a section on the line *AB* showing the

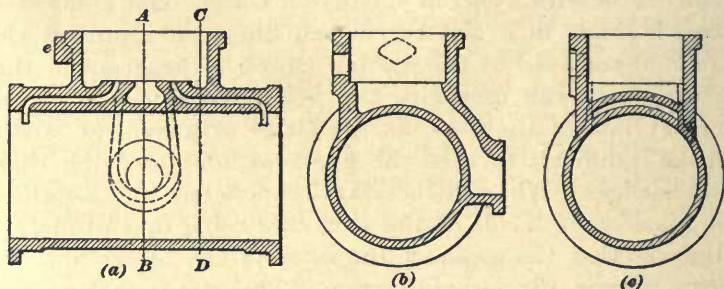

FIG. 21.

exhaust port, and (c) a section on the line *CD* showing the steam port and steam chest. From this it will be seen that quite a complicated system of coring is necessary.

50. Pattern for the Cylinder.—The making of the pattern for this cylinder depends largely on its size. When the diameter is to be less than 12 inches, the body may be built up solid, but, when above that size, and is intended for constant use, it is better to build it with staves, as shown in Fig. 22 (a) and (b). In this case, only one-half of the pattern is shown, as that is all that will be needed for explanation.

For the cheaper grades of patterns the body of the cylinder may be built up as shown in Fig. 22 (a), the stave supports, or heads, *a* being sawed out in the form of polygons to receive the staves *b*. The supports *a* should be built up and the sections so placed that the grain of the wood runs approximately in the direction of the circumference of the cylinder, as shown in Fig. 22 (c), for if made of single pieces, they will shrink across the grain and cause one diameter of the cylinder to be reduced more than the other.

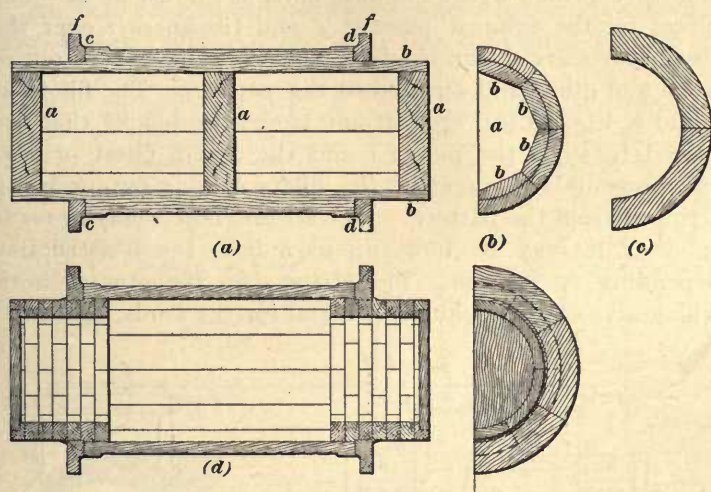

FIG. 22.

The staves are so placed that the core prints at the ends of the pattern can be turned from them. This method makes a stronger pattern than can be formed by fastening the prints on the ends with screws or glue. The flanges *f* are made thick enough so that the fillets on the back can be turned from the stock of the flanges. The flanges should be made with the grain running diagonally, as shown in Fig. 22 (c), as this method of placing the wood will prevent the shrinkage from affecting the flanges to any great extent.

The better grades of patterns are made as explained in *Patternmaking*, Part 2, the stave supports and core prints being built up as shown in Fig. 22 (b). The flanges may be

built of segments, of one thickness of stock, as shown, or of two or three thicknesses, with staggered joints, depending on the intended use of the pattern.

51. The cylinder body is built up and turned before the steam chest is made and fitted. The steam chest is then fitted on as shown in Fig. 23 (a) and (b). Only one half of the pattern will have to be fitted with the steam chest, the other half simply requiring one-half of the flange and core print for the exhaust port, as shown at *h*. The pieces for the exhaust passage *g* and thickness *i* over the steam ports are shown in place; they must be carved out of wood and glued and screwed to the pattern. The fillets at *a* and *b*, Fig. 23 (a), are cut out from solid blocks that are placed between the pieces *i* and the steam chest proper; this prevents all danger of the fillets coming out or being stripped from the pattern. The steam chest *s* may be made solid or it may be built up as a box, the construction depending on its size. The strips *e* on the steam chest, which give extra thickness of metal for the studs, are made

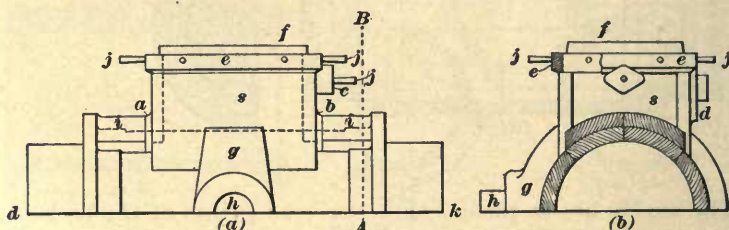

FIG. 23.

loose, being held in place during molding by long dowel-pins *j*. Also, the valve-stem stuffingbox *c* and the facing *d* around the live-steam opening are loose and fastened in the same way. In Fig. 23 (b), a portion of the strip *e* has been broken away to show the manner of letting it into the pattern. This is to prevent its being moved out of place during ramming, after the dowel-pins have been taken out.

52. This pattern is molded in a two-part flask, parted on the line *dk*, all the loose pieces mentioned being made in

sections and so placed that the main pattern will draw away and leave them in the sand. They can then be drawn into the opening left by the pattern and removed, one piece at a time. The core print *f* for the steam chest should be doweled on also; because if made fast, the molder will probably tear it off, as it is a great convenience to have this print loose so that it can be placed back in the bottom of the mold while drawing the loose pieces and dressing up the mold.

Another method of making a cylinder pattern is shown in Fig. 24 (a). The pattern is in this case parted along the

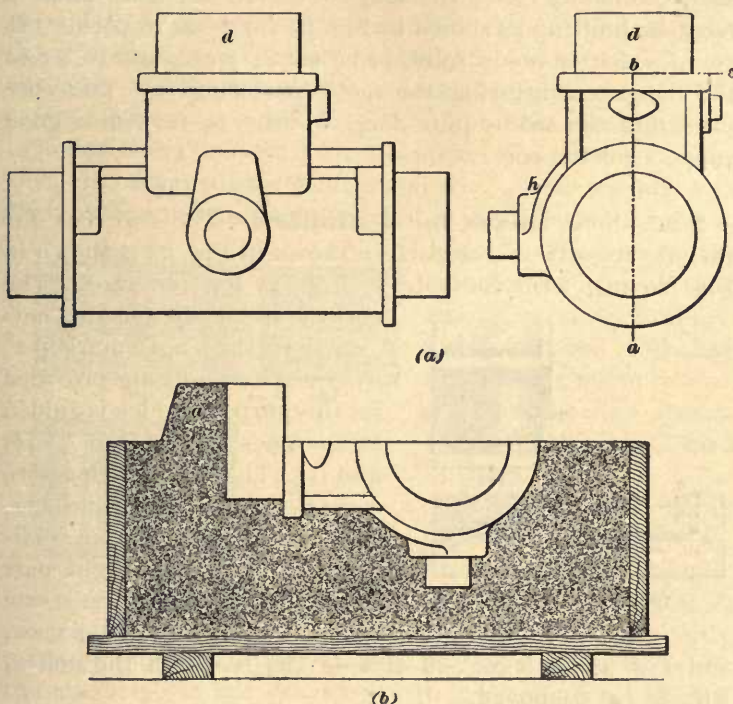

FIG. 24.

line *a*, *b*, *c*, and the core print *d*, for the steam chest is attached to the lower half of the pattern. This method will enable all the parts of the steam chest to be fixed

rigidly to the pattern, will make the setting of the cores easier, and the expense of making both the pattern and the mold will be somewhat smaller and they can be made in less time. It has the disadvantage of not having the valve face at the bottom of the mold, where the best iron is obtained, and for this reason it is not generally adopted. It is, however, sometimes used for repair or other emergency work, where the casting must be made in the shortest possible time.

With this pattern the mold must be made with the half to which the steam-chest core print is attached, in the lower half, commonly called the *drag*, or *nowel*. A sand pillar *a* must be built up as shown in Fig. 24 (*b*), so as to permit the core, which is made solid, to be set in place, and to avoid the danger of injuring the mold in closing it. The core print must be made quite long, in order to furnish a good support for the core.

53. Core Boxes for Cylinders.—The core box for the steam ports of the pattern shown in Fig. 23 is shown in Fig. 25 (*a*), with the side *a*, Fig. 25 (*c*), removed.

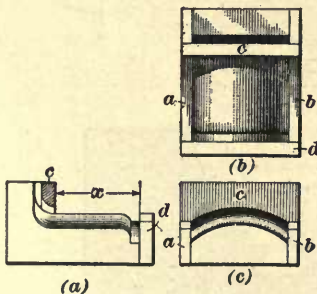

FIG. 25.

The core is swept up on the outside along the length marked *x*, a special sweep being provided for this purpose, which is guided by the sides *a* and *b*, Fig. 25 (*b*) and (*c*). The piece *c* is made to form the upper part of the core, because it changes from a circular shape to a straight part just where it enters the steam chest. Fig. 25 (*b*) is a top view, and Fig. 25 (*c*) is an end view of the box with the end *d*, Fig. 25 (*a*), removed.

54. The exhaust-port core box is made in halves, and one half is shown in Fig. 26, the other half being like this, except that it is made left-handed, so that the two halves

will fit when put together. The dotted line in Fig. 26 (a) shows how the passage is widened to maintain a constant area throughout, that is, it is cut down along the part of the passage occupied by the arrow in Fig. 26 (b).

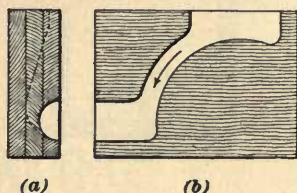

FIG. 26.

55. The core box for the steam chest may be made as shown in Fig. 27. In (a), the side of the box, and in (b), the end of the box, have been removed to show the inside. The piece *d*, which forms the valve face, is screwed to the bottom of the box and the sides fitted around it. The core prints 1, 2, and 3 are to receive the ends of the steam-port and exhaust-port cores. The steam-chest core is the first that is set in the mold, the cylinder being molded with the steam chest down. After this, the exhaust-port and steam-port cores are set with their ends in the openings left by the prints 1, 2, and 3,

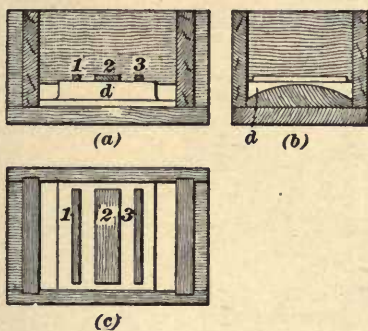
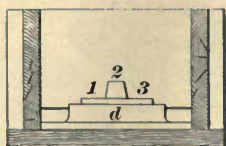

FIG. 27.

Fig. 27. The core for the cylinder body is usually swept up on an iron cylinder wrapped with hay rope, the prints to receive the ends of the steam-port cores being formed in the core.

In the case of small cylinders, the prints for the end of the port cores, as shown at 1, 2, and 3, Fig. 27, are frequently made of the form shown in Fig. 28 (a), and the cores for the steam ports are provided with projections to fill the space between the steam-port print and the exhaust-port print. The general form of the cores is shown by Fig. 28(b), in which *a* is the exhaust-port core print and *b* and *c* the projections on the end of the steam-port cores. When this

method is employed, the core box shown in Fig. 25 is made in such a manner as to provide for the projections on the cores as shown at *b* and *c*, Fig. 28 (*b*).



(a)

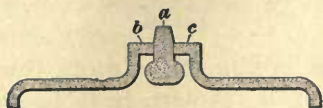

(b)

FIG. 28.

56. It is possible to make the mold with a half-cylinder pattern, by making all the parts for the steam chest, port passages, etc. detachable, and arranging the pattern so that only the portion for the print *h*, Fig. 23, and the flange that surrounds it will

be used in molding the second half. It will, of course, be necessary to place these on the opposite side of the pattern, so that both halves will come together properly. When this is done, each half of the mold can be made separately and then put together. Patterns for Corliss engine cylinders may be constructed in a similar manner.

PATTERNMAKING.

(PART 4.)

PRACTICAL EXAMPLES OF PATTERN- MAKING.

STOP OR THROTTLE VALVE.

1. General Consideration of the Castings Required.—A stop, or throttle, valve is shown in section

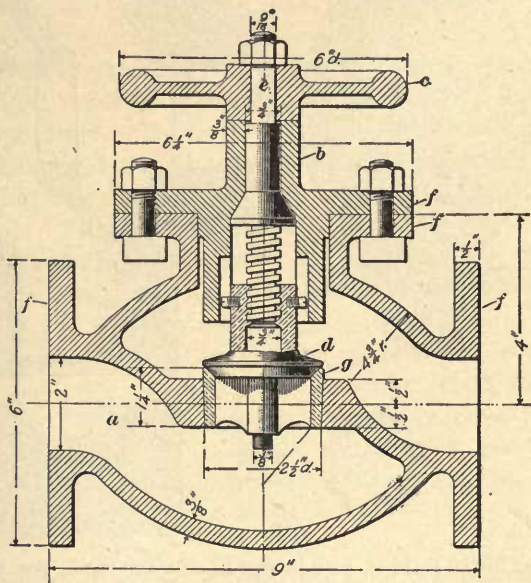

FIG. 1.

in Fig. 1. The body *a*, the bonnet *b*, and the hand wheel *c*

§ 38

For notice of copyright, see page immediately following the title page.

52-19

are all made of cast iron, while the valve *d*, valve stem *e*, and seat *g* are made of brass. Finish must be allowed for all joints and for all faces marked *f*.

2. Pattern for Valve Body.—This throttle valve is similar to the ordinary globe valve shown in Fig. 4,

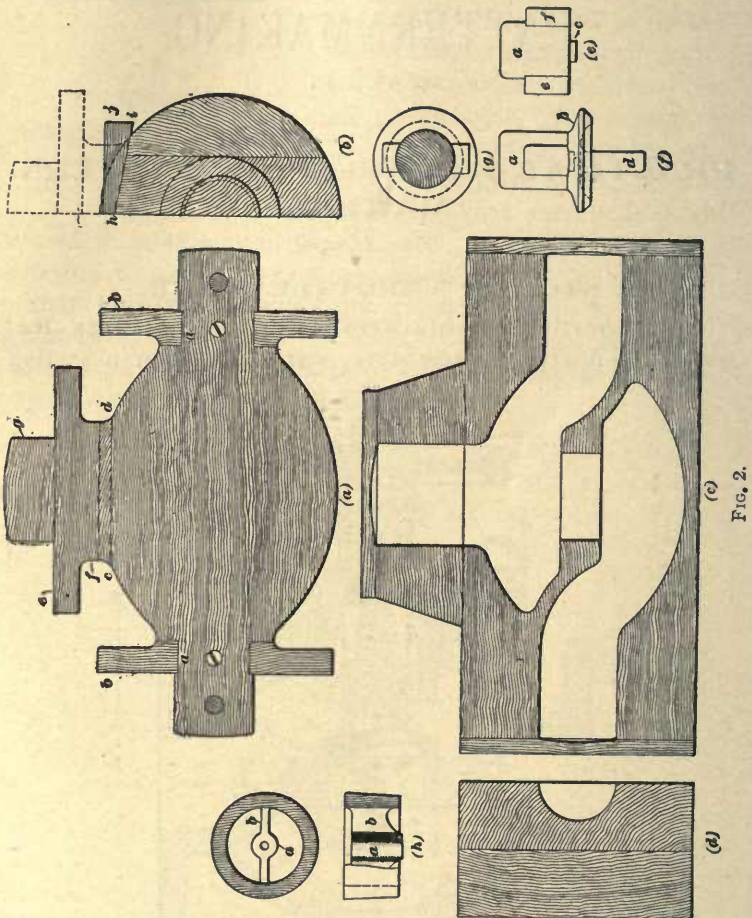

FIG. 2.

Patternmaking, Part 3, but is made of cast iron, and the patterns for it differ somewhat in construction from the globe-valve pattern. Fig. 2 (*a*) shows one-half of the pattern and

illustrates the method of joining the different parts. The stock for the main portion of the valve should be sawed out about 16 inches long, which will allow about $1\frac{3}{4}$ inches on each end for screwing the halves together while turning. The halves of this pattern should not be glued together, as they must be taken apart and put together again before the turning is finished. The end flanges fit in recesses formed in the core prints, as shown at *a*, Fig. 2 (*a*). The flanges *b*, Fig. 2 (*a*), are turned on the pattern, that is, they are first bored and faced to fit the recesses in the core prints, after which they are screwed and glued in place and then turned up or finished during the work of finishing the valve body. This insures their being concentric with the body of the pattern. The body should be turned to a templet cut to a $4\frac{3}{4}$ -inch radius.

Owing to the fact that the body is oval and not round, the side flange *e*, together with the portion of the pattern connecting it to the body, has to be joined in a special manner. If a flat surface were formed on one side of the body of the pattern, it would have an oval outline; hence, the surface must be formed in such a manner as to have a circular outline. This is accomplished by cutting the faces of the halves of the pattern at an angle, as seen in the end view, Fig. 2 (*b*), which shows the pattern with the flange *b* removed. Two wedge-shaped blocks *j* are fitted to the pattern, being joined along the line *h i*, Fig. 2 (*b*), and along the line *c d*, Fig. 2 (*a*). Upon the back of these blocks *j*, the flange *e* and the portion *f* joining it to the pattern are secured, they having previously been turned. After this, the necessary fillets are worked out of the wedges *j*, Fig. 2 (*b*), the form of the half pattern when completed being indicated by the dotted lines. In the illustration, the core print *g* is represented as being simply glued and screwed to the flange *e*.

3. Core Box for Valve Body.—One-half of the core box for the valve body is shown in Fig. 2 (*c*) and an end view with the end board removed and the side projection

omitted is shown at Fig. 2 (*d*). From this it will be seen that the core box is built up from two or more flat pieces glued together. In the illustration, the separating bridge is shown as being carved out of the piece forming the core

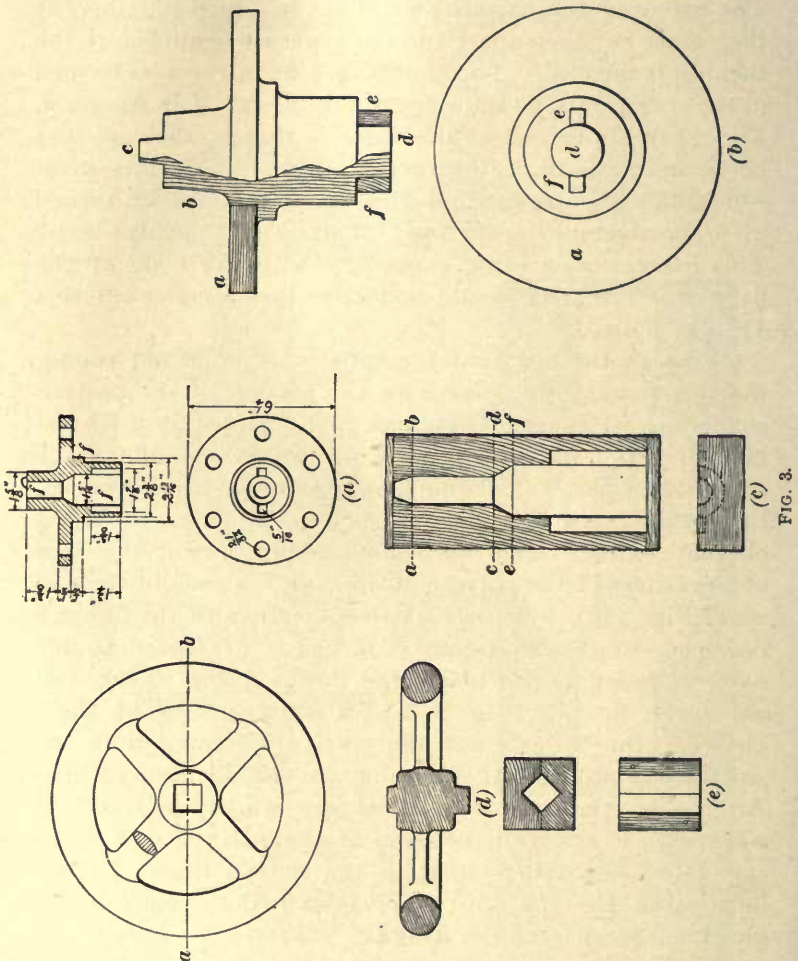

FIG. 3.

box. This bridge is cut down almost perpendicular to the surface of the box, very little draft being allowed on the sides and a small fillet being made at the bottom. It will

be seen that in order that the cores may match when pasted together, another half box is needed. One half is, however, sometimes made to answer by making two separating bridges, one right-handed and one left-handed, which are doweled in place, so that, when the cores are being made, the bridges are used alternately. This apparently accomplishes the same purpose as two completed half core boxes, but in practice it does not give the same satisfaction, as the bridges are liable to be broken, lost, or rammed out of place when making cores, resulting in an imperfect casting, and, as this kind of pattern is liable to be used constantly, it will be more serviceable to make two complete half boxes with bridges as represented. The ends and side of the box are closed with boards, as shown, the necessary draft being formed in these boards for the ends of the cores. For carving such a box, it will be necessary to make templets for the various cross-sections.

4. Bonnet Pattern.—A detail of the bonnet casting is shown in Fig. 3 (*a*) and the pattern is shown in plan and elevation at Fig. 3 (*b*). The upper view shows an elevation of the pattern, a portion of which has been broken away to illustrate the construction. The pattern is drawn to a larger scale than the casting. The flange *a* for the pattern is turned after it is fitted and fastened to the main portion of the pattern. As shown in the illustration, this pattern is not parted and is made to mold endwise. It will be necessary to have a molding board with a hole in the center for the portion *b* to project through during the first operation of molding. The main body of the pattern, including the core print *c* and the cylindrical portion of the print *d*, is turned from one piece. The auxiliary core prints *e* and *f* are glued and screwed in place.

5. Core Box for Bonnet Casting.—A core box for the bonnet pattern is illustrated by the two views shown in Fig. 3 (*c*). This pattern can all be carved from one block of wood, with end boards as shown. The proper draft must

be allowed on the inside of the end boards. The core box can be made from several pieces with divisions along the dotted lines *ab*, *cd*, and *ef*. This latter construction will permit the turning or working out of each portion of the box separately, which will somewhat simplify the construction, though, in most cases, the large number of joints adds complications that more than overbalance the gain. When the box is made of separate pieces, the various pieces are secured in place by gluing a board on the back of the box.

6. Pattern and Core Box for Hand Wheel.—The pattern for the hand wheel is shown in the two views given in Fig. 3 (*d*), the lower one being a section on the line *ab*. The pattern being only 6 inches in diameter may be turned from one solid piece of wood, but, when forming the arms, care should be taken to cut them so that the grain of the wood runs at an angle of 45° to the arms, which will make them of uniform strength. Another way is to turn the rim from a single piece and then let the arms into it. Square core prints are formed on the pattern, as shown in the illustration. The core prints are turned to a diameter equal to the diameter across the corners of the squares, and are subsequently cut to a square form.

The square core box for the hand-wheel core is illustrated in Fig. 3 (*e*); it is made in halves and doweled together, being parted at the two corners, so that when the core is rammed up, the box can easily be taken apart without breaking the corners of the core.

7. Patterns for Valve Details.—The pattern for the valve is shown in Fig. 2 (*e*), (*f*), and (*g*). The upper, or nut, part of the valve pattern *a* is not made fast to the valve *b*, but is located by a $\frac{1}{2}$ -inch pin *c* that is turned on it, as shown in Fig. 2 (*e*). The guide *d* is made in the same manner, but is secured permanently to the valve pattern, as shown in Fig. 2 (*f*). The pieces *e* and *f* are glued and screwed to the piece *a* after the latter has been turned.

The pattern for the valve seat is shown by the two views given in Fig. 2 (*h*). In the lower view, a portion of the

pattern has been broken away so as to show the hub, or guide, *a* for the spindle on the lower portion of the valve. This hub is supported by the web *b*, as shown. The grain in this pattern should run in the direction of the axis of the seat, as indicated by the lower view. The outer ring of this pattern may be turned from a block of wood and the bridge *b* and hub *a* glued in place afterwards.

No pattern is shown for the valve spindle, as it will be similar to the one shown in *Patternmaking*, Part 3. The valve seat, valve, and spindle are made of brass, and it is therefore not necessary to allow as much stock for finish on the pattern as in the case of iron castings, owing to the fact that brass castings are usually smoother.

SPECIAL THREE-WAY STOP-COCK.

8. Construction.—The three-way stop-cock described in *Patternmaking*, Part 3, is of such construction that all the angles are right angles. The one illustrated in Fig. 4 is a special design, having the three passages 120° apart. The general construction of the valve will be understood by reference to Fig. 4 (*a*), (*b*), and (*c*). Fig. 4 (*a*) is an elevation of a complete cock; (*b*) is a section on the line *lm*; while (*c*) is a section on the line *jk*. In Fig. 4 (*c*) the cock is not shown as it would appear if projected from (*b*); the plug has, however, been given a portion of a revolution so as to bring one of the openings to the front. Owing to the shape of this design of cock, it cannot be molded and cast like the one shown in *Patternmaking*, Part 3.

9. Appliances for Dry-Sand Mold for Body.—For a straight-way cock there is no better way of obtaining a casting than by making a pattern; but for a three-way body or shell of the design shown, a core box may be substituted for the pattern and made to answer the molder's requirements better than the pattern. The disadvantages of a pattern for the shell arise from the fact that it is practically impossible to part the pattern in such a direction that it can be molded in any but a complicated flask.

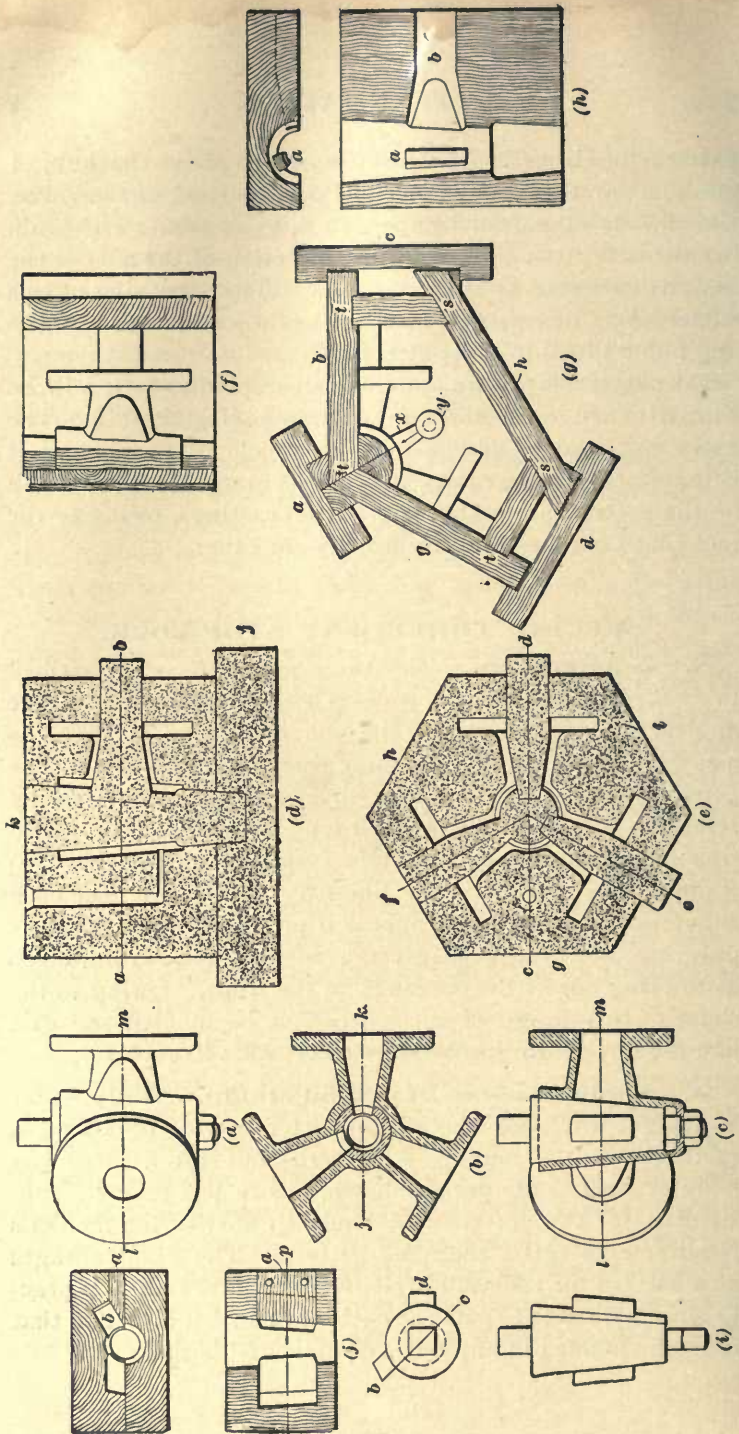

FIG. 4.

10. Fig. 4 (*d*) is a vertical section of a mold for such a valve body, and Fig. 4 (*e*) is a horizontal section of the same mold. The outer part of this mold consists of three cores *g*, *h*, and *i*. These cores are joined on the radial lines passing through the points *d*, *e*, and *f*. The center and passage cores on the line passing through the point *f* are made in one piece. The passage cores on the lines passing through *d* and *e* are made separate from and set into the center core. The three cores *g*, *h*, and *i* rest upon the slab core *j*, shown in Fig. 4 (*d*) but omitted in the plan in Fig. 4 (*e*). When locating the cores, the center core *k* is first set into the slab core *j*, as shown in Fig. 4 (*d*), then the cores *g* and *h* are set. These, being joined at *f*, will support the passage core on that center line. Before core *i* is set, the cores on the lines *e* and *d* are located. The ends of these cores are made to project so that the molder may either block up the ends or have a helper hold them while setting the core *i*. When all the cores have been properly set, a flask is dropped over them and sand rammed about them to keep them in place.

The core box for making the cores *g*, *h*, and *i* is shown in Fig. 4 (*f*) and (*g*). In Fig. 4 (*f*), the portions *g* and *h* of the core box have been removed, only the portion *b* being shown in place. The joints at *t*, *t* are left loose while the joints at *s*, *s* are secured by glue and screws. The parts of the box *b*, *g*, and *h* are secured together by clamps *a*, *c*, and *d*, so that, after the core is completed, the clamps may be removed and the different parts of the box drawn away from about the core, thus leaving it standing upon the core plate. The gate shown is used for only one core; *x* is separate from *y* and is drawn out in the direction of the arrow, when all the parts of the box have been taken away from the core.

11. The core box for making the center *k* and the passage core on the line *f*, Fig. 4 (*d*) and (*e*), is shown in the two views given at Fig. 4 (*h*). The print *a* must either be given sufficient draft to allow the core to be drawn away from it, or it must be so arranged that it can be drawn out of the core through the back of the core box. Another half box to

match the one shown will be necessary in order to make a complete core, or a wide box may be made having provision for two projecting arms b , either one of which can be stopped off at will. When this is done, it will also be necessary to construct the core print a so that it can be changed from one side to the other. On the whole, it is usually best to construct the two half boxes.

The core box for the passage cores on the lines d and e is not shown, as it is very simple in construction and similar to others that have already been described. Its general form is very similar to the portion b of the core box shown in Fig. 4 (h), only it will be necessary to make the box longer so as to allow the cores to project as shown in Fig. 4 (e).

12. Pattern for Plug.—The plug for the three-way cock has only two openings placed at an angle that coincides with the two passages of the shell, which are 120° apart. The thickness of the metal in the plug is the same as that in the shell. To make this casting, a pattern is used, though it can be made all together with cores like the shell, but a pattern in this case is probably the better method. The pattern is shown in the two views given in Fig. 4 (i). The pattern is parted on the line bc shown in the upper view. It will be seen that the core print d would not draw if fastened to the pattern. It should therefore be located with loose pins or wires that can be withdrawn during the process of molding, leaving the piece loose in the sand. After the pattern is withdrawn, this piece can be withdrawn also. In some cases, a section of one-half of the pattern may be arranged to be drawn separately and at an angle so that the print can be attached to it.

13. Core Box for the Plug.—The core box is made as shown in the two views Fig. 4 (j), the piece a being put on with two pins and held in place by means of a screw or clamp while making the core. After the core is complete, the piece a is removed so as to allow the finished core to be turned out. If the upper half of the core shown in the upper view Fig. 4 (j) were being dried by itself, the core maker

would place a little green sand between the core plate and the projecting portion *b* so as to support it during drying. In the illustration, the lower view shows one-half of the core box, while the upper view shows the entire core box, both halves having been made. The core can be made in halves or in one piece, depending on the manner in which it is to be dried.

PATTERN FOR SMALL BELL.

14. General Consideration.—Molds for large bells are swept up in loam, but for small bells of such dimensions as that shown in Fig. 5, patterns are usually made. This also applies to any similar shape, such as ladles, kettles, pots, etc. In some cases the patterns are made for relatively large castings, especially when the metal of the casting is comparatively thick, as, for instance, slag pots for copper and lead smelters are usually cast from patterns, the castings weighing from 400 to 600 pounds, some of them being as much as 30 inches in diameter. The bell shown in Fig. 5 would be cast from bronze or bell metal and the nut *a* from brass or iron. The washer *b* might be cast from brass or made from sheet metal.

15. Making Pattern for Bell.—The right-hand side of the bell, Fig. 5, is shown in section so as to illustrate the thickness of the metal and the method of laying out the pattern. From the point *g*, on the upper corner of the bell, to *h*, at the edge, a straight line is drawn and divided into equal spaces. From each of these points, perpendicular lines are drawn and on each of these perpendicular lines a circle is laid off that represents the thickness of the bell at the point where the line intersects it. The distance on these perpendicular lines from the straight line to the center of the circle is carefully determined. This information is generally furnished on the drawing for the bell. The pattern-maker lays out these lines, circles, and the outline of the bell to full size, and thus determines the thickness of the

courses or segments as shown on the left-hand side. As shown, the first four courses are $\frac{3}{4}$ inch thick and all the others $\frac{1}{2}$ inch. The sizes of segments and the number required are given at the right of the illustration. The

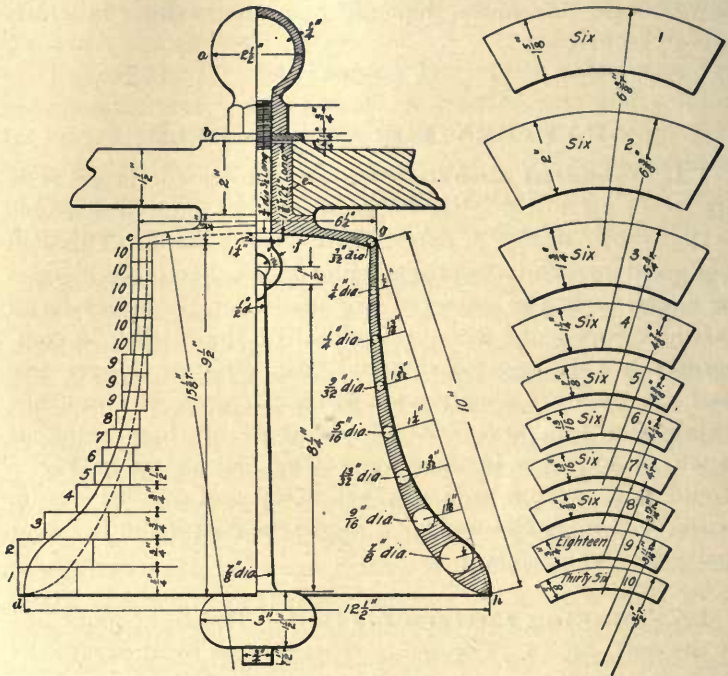

FIG. 5.

proper allowance has been made for turning after the segments are in place. The segments marked 10 are for six courses and those marked 9 for three courses, each course being made up of six segments. In each of the other courses the segments are different.

16. After the segments are sawed out, they should be stacked up crosswise and allowed to dry thoroughly before being built up. When they are dry, the part that forms the top of the bell is cut to a circular form from a

well-seasoned solid piece, enough stock being allowed for finish. It is then screwed to a face plate, the front faced off, and the part that forms the inside of the top turned hollow, as shown at *f*.

The segments marked *10* are glued on, one by one, until as great a distance as can conveniently be turned out on the inside is reached. The glue is then allowed to set, and the inside turned out to the required form. Other segments are now added until another suitable depth for turning is

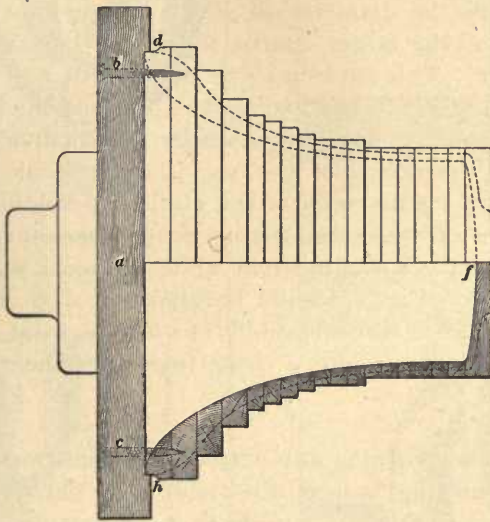

FIG. 6.

reached, and the turning done as before. This operation is repeated until the entire body of the bell is built up and turned on the inside. The outside is also turned a short distance from the edge *d h*, as shown in Fig. 6. The pattern is then detached from the face plate and a chuck *a*, Fig. 6, turned to receive the turned part of the outside, and the pattern inserted and fastened with screws, two of which are shown at *b* and *c*. The outside is now turned to the required form, which is indicated by the dotted lines.

17. In building up the body of the pattern, the different courses must be faced off to the required thickness, and measurements must be made from the back of the bell to the front of the segments at frequent intervals, in order that the succeeding courses may occupy their correct positions in the pattern. If the different courses are allowed to remain too thick, the larger courses may be carried forward so far that the required form cannot be obtained.

When passing from a smaller to a larger course in building up the pattern, it is necessary to scribe a circle on the smaller one, the diameter of which is equal to the inside diameter of the larger course, to which the larger course may be set. This circle may be drawn either by placing a temporary piece of wood across the partially made pattern, for the purpose of providing a center for the dividers, which are set to the radius of the required circle, or by setting trammels to the diameter of the circle and holding them so that the two points stand diametrically opposite each other and will scribe a single circle while the work is revolving. The spindle *e*, Fig. 5, should be glued on after the pattern is turned, in a manner similar to a core print, a pin on the spindle fitting into a hole turned in the top of the pattern.

18. When turning any pattern from built-up stock that requires finishing both on the inside and the outside, it is usually best to finish the inside first, on account of the fact that the pattern is always stronger to resist injury from the outside than from the inside, and hence if the inside were turned last, there would be danger of breaking out some of the segments.

19. The patterns for the nut *a* and the washer *b* are so simple that they need not be illustrated. The pattern for the nut would be parted through the center line, and must be made with a long core print for supporting the core, similar to the pattern shown in Fig. 10. *Pattern-making*, Part 1.

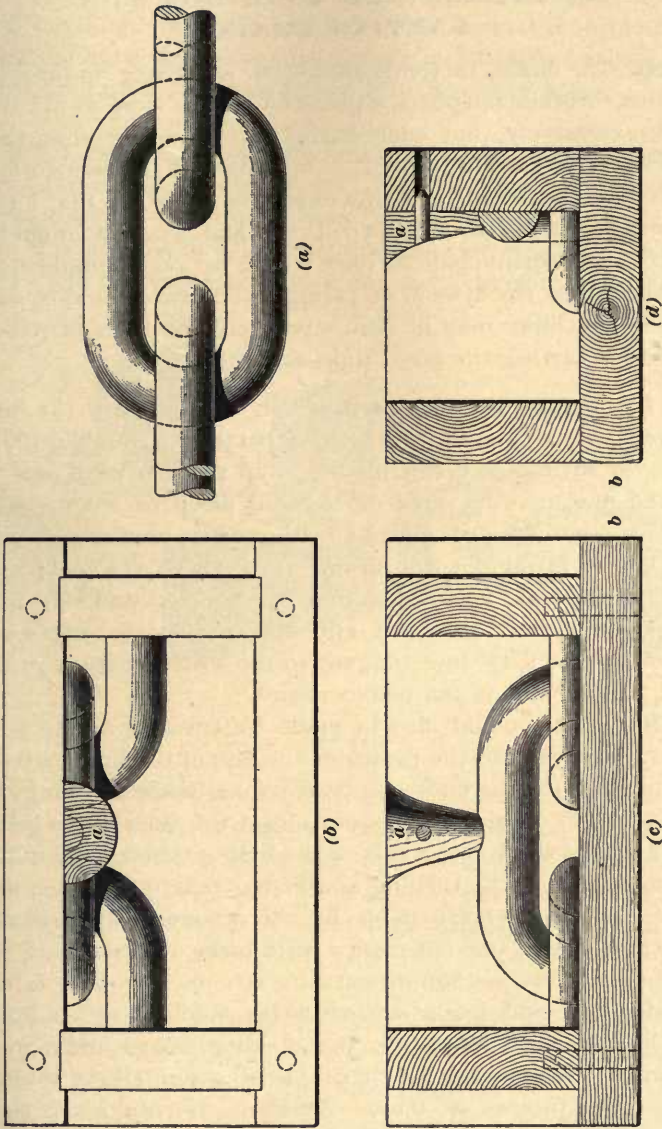

FIG. 7.

PATTERNS AND CORE BOX FOR CASTING CHAIN.

20. A chain is sometimes cast of strong bronze for marine or other purposes, especially where iron would corrode excessively, but such chains are so costly that they will never be generally used. One link and the connections to the two adjacent links of a chain are shown in Fig. 7 (a). Each link passes through two others, and hence the mold for casting the entire chain at once would be very complicated, as would also the system of gating. To overcome this, one-half of the links may be cast separately and then provision made for casting the other links through these.

21. Patterns for Links.—In constructing the link pattern, wood is used for the first pattern, a double allowance for shrinkage being made. The pattern need not be parted, but may be cut from a solid piece of wood. The allowances for shrinkage should be one for aluminum ($\frac{1}{4}$ inch to the foot) and one for bronze ($\frac{3}{16}$ inch to the foot). In making the link, its form is first marked out and cut to a square cross-section inside and out. Then the edges are chamfered to a 45° line tangent to the circle of stock in the link, after which it can be cut round.

This pattern could also be made by turning a ring with the radius equal to the radius of the end of the link, cutting it in halves for the ends and then joining these half rings by two straight cylindrical pieces to form the sides of the links, but there is much less work in the first method than in the second, because the turning and fitting take more time, and then, too, the pattern made by the second method is not as strong as the one cut from a solid piece of wood.

Four or more aluminum patterns are now cast from the wooden one and made smooth, after which they are sunk one-half of their depth into the molding board and a gate fastened on the latter. This simple provision allows several links to be molded at once. At times, the links are split and attached to the opposite sides of a card pattern owing to the fact that one-half of all the links of the chain must

be cast in this way and the card pattern greatly facilitates the molding. The bronze links cast from the aluminum patterns have the gates cut off and are partially finished and smoothed up before being cast into the chain proper.

22. In order to join the bronze links already cast, special dry-sand molds are employed. Fig. 8 (*a*) shows two bronze links *a* and *b*, which have been placed between the cores of the dry-sand mold. The link *c* is then cast in such a position as to join the separate links *a* and *b*. One of the four cores

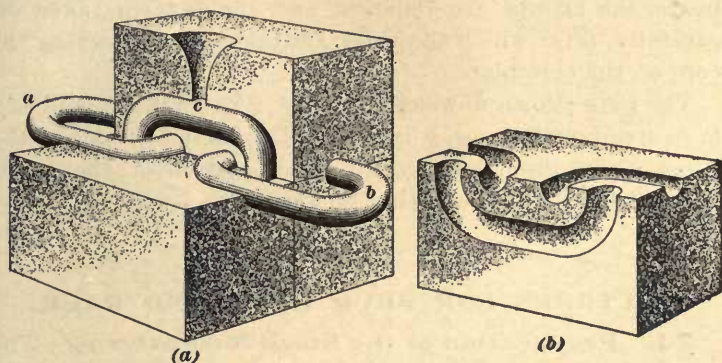

FIG. 8.

has been removed so as to show the arrangement of the links, and one of the separate cores is shown at Fig. 8 (*b*). Several links *c* are cast at one time by setting a number of cores in a long box made for the purpose, and having the corresponding number of links in the positions occupied by the links *a* and *b*, Fig. 8 (*a*).

23. The core boxes for forming the cores shown in Fig. 8 are illustrated in Fig. 7 (*b*), (*c*), and (*d*). These core boxes should be made of hard wood, or if a great number of castings is required, from metal. When they are made from metal, it is necessary to make patterns for them and to allow the necessary shrinkage on the patterns.

The link portions of the core box are made of aluminum and secured to the wood. It will be seen that the link parts in the box must be accurately located or they will not coincide when the cores are placed together. The ends, sides, and bottom of the box are so arranged that they may easily be removed when the core is rammed up and turned over on the core plate.

The bottom *b*, shown in Fig. 7 (*c*) and (*d*), is secured to the sides by clamps, and the four dowel-pins shown in the sides are for the purpose of locating them each time a core is made. When it is desired to remove the cores from the boxes, the clamps are removed and the bottom taken off carefully, after which the sides are taken away, leaving the core on the core plate.

The gate shown doweled on at *a*, Fig. 7 (*b*), (*c*), and (*d*), is so arranged because it is required in only one-half of the cores, those intended for the lower portion of the molds shown in Fig. 8 (*a*) requiring no gating.

PATTERNS FOR SPUR GEAR AND RACK.

24. Preparation of the Stock for Patterns.—The patterns shown in the views in Fig. 9 are those of a spur gear and rack. The circular pitch is $1\frac{1}{4}$ inches, the face $2\frac{1}{2}$ inches, the rack 25 inches long, and the pinion has 21 teeth, which will give it a pitch diameter of 8.387 inches.

The stock should be carefully selected, first-quality clear pine. The segments of the rim of the gear should be sawed out and the lumber dressed $\frac{1}{8}$ inch thicker than the finished thickness of the segments, after which the pieces should be stacked crosswise and allowed to dry thoroughly. After this, the stock for the hubs and rack is prepared from the same quality of lumber.

25. Rack Pattern.—The plate, or back, *a* for the rack is about 25 inches long, $\frac{7}{8}$ inch thick, and $2\frac{1}{4}$ inches wide, and should be carefully planed straight, parallel, and square with the edges. To make the teeth of the rack,

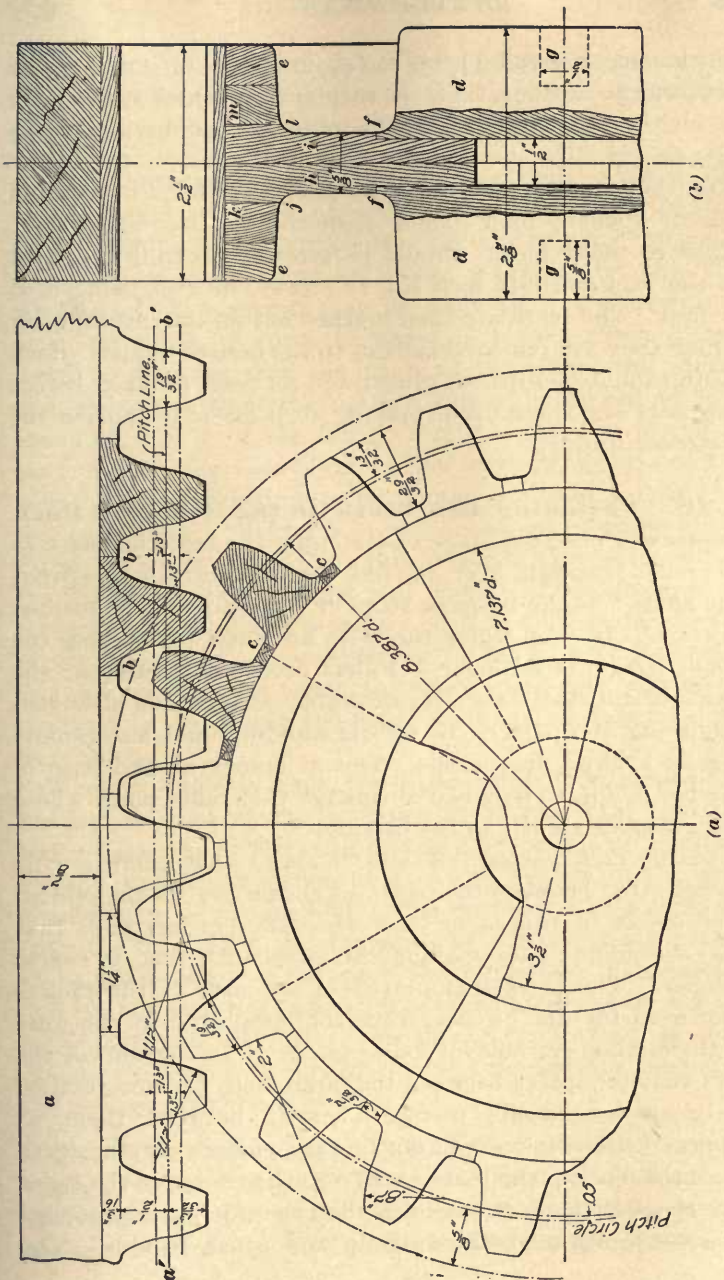

FIG. 9

blocks are dressed $1\frac{1}{4}$ in. \times $1\frac{3}{8}$ in. \times $2\frac{1}{2}$ in. long. The best way to cut out these is to plane up three sticks each 16 inches long, from which the required number of blocks may be cut. To allow for dressing off the ends of the blocks after they are fastened to the plate of the rack, they should be cut about $\frac{1}{8}$ inch longer than the width of the rack. Each of these blocks should be screwed on from the back of the rack with $1\frac{1}{2}$ -inch No. 10 screws, no glue being used at first. The teeth are then marked out on the blocks, after which they are removed and cut to the desired shape. Each tooth should be formed, glued, and screwed in place before the next one is removed, making it possible to replace the teeth accurately.

26. Fastening the Teeth on the Gear and Rack Bodies.—The advantage of fastening the teeth of gears in the manner shown, over the old way of dovetailing, is that the fillets *b* at the bases or roots of the teeth can be formed in the blocks from which the teeth are cut, thus making the whole structure stronger. Fillets or round corners at the bases of the teeth are very desirable, as they add strength, rendering the pattern better for molding, and also removing, in a large degree, the effect of cracks at the base of the teeth, due to irregular shrinkage that takes place where sharp angles are left in the casting.

In the rack pattern, it will be seen that there are no pieces fitted between the teeth, as shown at *c* on the pinion. The object of this is to show the different methods that may be adopted for making the gears with fine or coarse pitches. The method employed in the case of the rack is that used for fine pitches, while that employed in the gear is the method suitable for coarse pitches. On account of the fact that the spaces between the large teeth become greater, it becomes necessary to insert a strip between them, as shown, otherwise it would not be easy to work out the teeth from the blocks, which are carried to the center of the space like those in the rack; besides this, the thin parts produced thereby would probably curl up and cause trouble. The

strips put between the teeth not only make it convenient to shape them, but act as guides for locating them again after they have been removed for shaping.

27. Building Up the Gear Pattern.—When the rack is completed, and the blocks for the teeth and strips that go between them are prepared for the pinion, the hub should be turned as represented at *d*, Fig. 9 (*b*). After this, the six courses or segments may be built up. A wooden face plate, on which to turn the wheel, is turned about $\frac{1}{4}$ inch larger in diameter than the inside of the rim of the pinion, and, as both sides of the pattern cannot be turned without chucking, either of the faces *jk* or *lm* may be placed in contact with the face plate. The segments *h* or *i* of the web should be the first to be jointed and laid in place on the face plate. Before doing so, six pieces of paper about $1\frac{1}{2}$ inches wide should be glued on the face plate where the joints of the segments will come. Then the ends of the segments should be glued by putting a little glue on the paper. The first course will then be held to the face plate by these six pieces of paper, and when dried may be faced off true and to the proper thickness in the lathe, ready for the next course.

When one side is built, the inside should be turned and finished to dimensions, as shown at *e*, Fig. 9 (*b*), and the web recessed to fit the edge of the fillet on one of the hubs already turned, as shown at *f*. The outside of the gear should also be roughed off. The pattern is now removed from the face plate, and the edges of the face plate turned to fit the inside *e* of the part just removed. The pattern can be fastened to the face plate with three screws and the other half built up. After this side of the pattern is completed, the inside is turned out and the outside turned to the correct diameter.

28. The blocks that are to form the teeth and the strips that go between them should now be fitted and fastened on, the blocks and the strips being placed alternately around the circumference. The blocks on the rim are secured by

screwing them on from the inside with 1-inch No. 8 screws. The strips are fastened in place with glue and fine $\frac{1}{2}$ -inch wire brads. All this should be done before taking the pattern from the face plate, because the ends of the blocks must be turned off flush with the rim, and the circles on which the tooth-curve centers are located, marked in the lathe. Before facing off the ends of the blocks, pieces that will just fill the space between the blocks must be fitted and glued between the ends to prevent them from splitting while turning. The grain of the wood in the pieces should run in the same direction as that in the tooth. These pieces will also serve to support the points of the compasses when laying out the curves for the faces of the teeth. When the curves for the teeth are marked out, the filling pieces placed between the teeth should be taken out and the tooth blocks removed and numbered consecutively on the inside, and their places on the rim should be marked with corresponding numbers. The teeth are then worked off, after which they should be glued and screwed back in their respective places.

29. One way of finishing the tooth surfaces to the correct form is as follows: First cut down the blocks until their

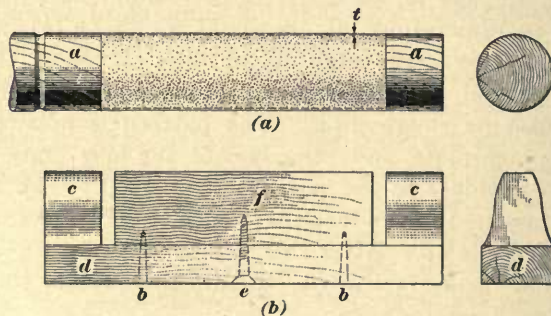

FIG. 10.

surfaces are nearly correct. Then make two tooth templates and fix them at opposite ends of a strip *d*, Fig. 10 (*b*), so that the faces *c, c* of the curves shall be in line and parallel

with each other. Now turn up a wooden roller, as in Fig. 10 (a), having the same length as the strip *d*, Fig. 10 (b). At the middle of the roller cut away the stock to a length equal to the distance between the templets *c, c* and to a depth *t* equal to the thickness of a sheet of sandpaper. This leaves shoulders at the ends, the length of each of which should be equal to the width of each tooth templet *c*, Fig. 10 (b). Glue a piece of fine sandpaper on the roller between the shoulders, and then put the roller into the lathe and rotate it rapidly.

Now take one of the roughly shaped tooth blocks *f*, and by means of a screw *e* and brads *b, b*, Fig. 10, fix it firmly to the strip *d* between the templets *c, c*. Then place the templet faces *c, c* against the shoulders *a, a* of the rotating roller, and move the tooth block back and forth. The shoulders will guide the templets, and the sandpaper will cut away the tooth block until it assumes a curve parallel to, and exactly like, the tooth curves on the templets. The other side of the block is treated in the same way without removing it from *d*.

30. Another method of holding the tooth blocks to the rim is shown in Fig. 11. The outside diameter of the rim is

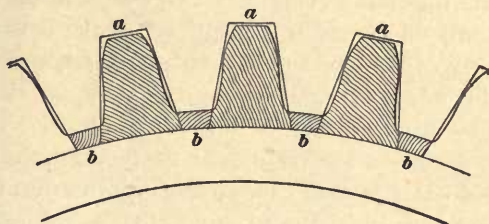

FIG. 11.

made slightly less than would be the case if the teeth were to be dovetailed into it. Then, by means of strips *b, b* of trapezoidal section placed between the teeth and nailed to the rim, the blocks are held to their places as by a dovetailed joint. The tooth blocks *a, a* can now be numbered and corresponding numbers placed on the rim opposite the blocks.

The latter may then be driven out, shaped as previously described, and put back again permanently by gluing and screwing in place. This method requires less time and labor than the method of dovetailing each tooth into the rim. It will be seen that the outer faces of the strips b, b form the bottoms of the tooth spaces; and they must therefore be of uniform thickness.

31. The hubs may also be glued in place after the teeth are completed, but the core prints should be left loose, as the size of the bore is frequently changed, making other core prints necessary. Sometimes the hubs of gears are also left loose for this same reason. This enables one to introduce larger or smaller hubs that will admit of being bored to larger or smaller diameters. In Fig. 9 (*b*), the hubs are shown in place and the dotted lines at g indicate the position of the holes for receiving the pins for the core prints, but the core prints are not shown in place.

MITER AND BEVEL GEAR PATTERNS.

32. General Consideration.—To cast a pair of miter gears (gears making an angle of 45°) that will mesh and run together, only one pattern is required, while, in order to cast a pair of any other bevel gears, two patterns are necessary, because the angle in each is not the same on the face and they each contain a different number of teeth.

When looking for a certain gear pattern among others, an experienced patternmaker can generally distinguish the difference between a miter and any other bevel gear without trying the angle, but where there is only a small difference, it is not easy to distinguish between them without testing their angles or referring to the records. For this reason, it is well to stamp the word *miter* or 45° on all miter-gear patterns. The method of constructing a pattern for either miter or bevel gears is the same, and only one example need be considered.

dovetailed into the rim, as shown at *b*, Fig. 12 (*a*), the dovetail being made with a slight taper so that the teeth can readily be driven out and replaced. Another method sometimes employed consists of gluing the blocks for the teeth on the rim without dovetailing them and then shaping them while in place. The rim of the wheel in both instances is turned to the correct diameter at the root of the teeth. In the method shown at *a*, Fig. 12 (*a*), it will be seen that the rim is turned under the size and then the blocks for the teeth are formed so as to make up the difference.

The first of these three methods has many points to commend it, as it allows the blocks to be removed for dressing the teeth separately. It does not, however, permit the fillet to be worked out at the bottom of the tooth. The second method is not good, because if the fillet is made at the root of the tooth, the feather edge thus formed is liable to curl up. Another bad feature of this second method is that all the teeth must be dressed off in place, which is not so easy to do as when the blocks are removed or when every second one is removed. The method shown at *a* has the advantage of having a fillet at the root of the tooth without the feather edge, and of permitting every second block to be removed for the purpose of shaping the teeth. It will also be seen that all the joints of the segments forming the ring are covered between the teeth, which is a desirable feature.

34. To make a bevel-gear pattern, a full-sized section of the rim must first be drawn, as shown at *g*, Fig. 12 (*b*), in order to lay out the width, thickness, and diameter of the courses of segments. In the pattern illustrated, six segments are used.

The profiles of the outer and inner ends of the teeth that are shown at *c* are drawn in the same way as the teeth for two spur gears whose radii are xy and xy' , with pitches corresponding to the inner and outer ends of the tooth. It is seldom that the two circles y and y' can be spaced without a remainder, but this fact is of no account, as they are only

auxiliary circles that are used for convenience in laying out. In building up the rim, a wooden face plate *h*, Fig. 12 (*c*) is employed. This is screwed to an iron face plate *i* and the segments are glued to the wooden face plate, the course marked *1* being glued on first with a piece of paper under each joint.

The course of segments *2* is next glued on course *1* and faced off, and the succeeding ones added until all are in place. The rim is then turned inside and roughed off on the outside. Before removing the pattern from the face plate, the four arms should be let in and glued to the rim, as shown at *d*, Fig. 12 (*a*), the arms having been previously half checked together and formed to the required shape. The hub is turned on a screw chuck and left a little larger than the required size. It is then glued to the arms, and when the glue is thoroughly dry, the arms are faced off and the hub finished so that it will run exactly concentric with the rim, thus enabling the patternmaker to chuck the pattern by means of the hub. The wooden face plate *h*, Fig. 12 (*c*), used in turning up the outside and inside of the pattern, is made smaller than the diameter of the gear at the small end, so as to allow the outside of the gear to be roughed off during the first operation.

35. After the pattern is removed from the face plate, a larger wooden face plate is provided, having a piece at the center so as to allow a greater thickness of stock to receive the hub. The center part of the face plate is turned to receive the hub *i*, Fig. 12 (*b*), and the corner of the pattern *j* is allowed to rest against the face plate so as to act as a support and prevent the pattern from trembling while turning the outside of the teeth. After the pattern is chucked, the face *k* and the outside are turned to the required dimensions, ready to receive the teeth. The hub and the core print may also be added and turned.

36. Fastening and Forming the Teeth.—In getting out the blocks for the teeth, they should be made about

$\frac{1}{16}$ inch longer than those shown at *e*, in order that the ends may be turned off. The rim having been turned, it is spaced off on the face for the teeth, the lines being drawn toward *z* by the use of a center square. The blocks for the teeth are fitted on the rim, as shown at *f*, Fig. 12 (*a*). All the blocks are glued together above the root of the finished tooth, on the sides, near the outer ends, but only every alternate one is glued to the rim. They are thus secured for turning. Particular care must be taken when gluing, to prevent any glue from getting on the sides of the blocks near the rim, as at *a*, Fig. 12 (*a*), or below the bottom of the finished tooth, and only freshly made, thin glue should be used.

When the glue is thoroughly dry, the ends and faces of the blocks may be turned. To make a good surface for marking the teeth, a light coat of yellow varnish should be given to the blocks and when dry they should be sandpapered. The pitch circle *l* and the circles *m* and *n* for the centers of the arcs forming the tooth curves are drawn on both ends of the gear, after which the profiles of the teeth are laid off on the inside and outside.

After this laying out is done, the joints of the blocks are sawed down all around to the bottom of the glue, relieving them and allowing every alternate one to be removed, thus rendering the paring of the teeth much easier than if all were glued on the rim. When removing the blocks for paring, they should be numbered so that they can be properly replaced. After all the teeth are completed, those that have been removed are replaced and glued to the rim. The fillets at the bottoms of the teeth are formed from the blocks from which the teeth are formed. In the case of gears of large pitch, it may be necessary to introduce strips of wood between the teeth, as in the case of the gear illustrated in Fig. 9. The ribs *p* are fitted in place after the turning is complete, because, if they were introduced before the chucking, they would interfere with the chuck.

WORM AND WORM-GEAR PATTERNS.

WORM-PATTERN.

37. Preparation of the Stock.—If it is required to make a pattern for a worm 4 inches in diameter with a single right-hand thread having $1\frac{3}{4}$ inches pitch, the following course may be pursued. First, turn the pattern, which

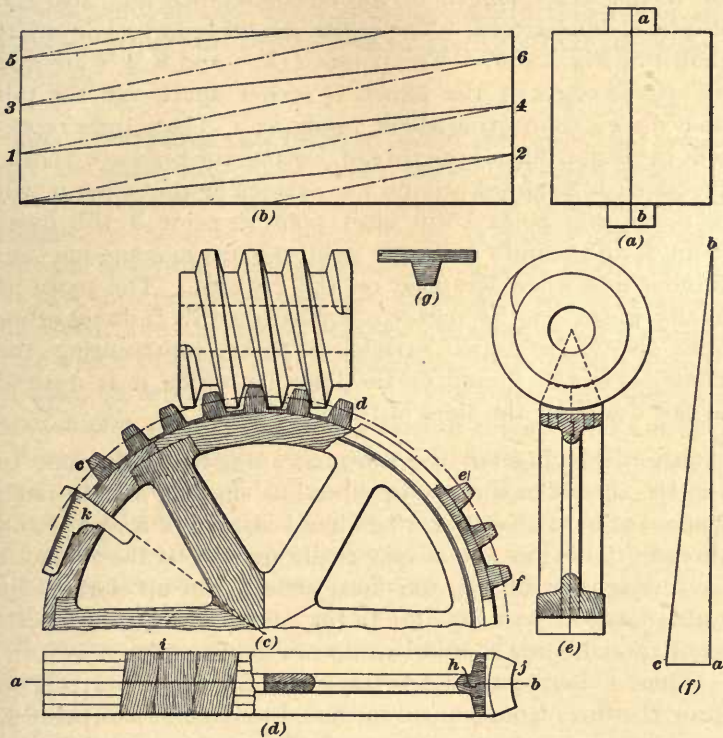

FIG. 13.

should be in halves, to the required diameter and length, as shown in Fig. 13 (a). The core prints *a* and *b* may be turned on the pattern, as shown, or they may be turned afterwards and attached to the pattern. When turning

such a pattern as this, it is best to have metallic plates attached to the ends and to use conical centers. This will enable the work to be returned to the lathe after the threads are cut, so that the threads may be sandpapered while the lathe is revolving at a slow speed. A much better job of sandpapering than could otherwise be done is thus insured.

38. Laying Out the Thread.—After turning the pattern, a piece of paper should be wrapped around it and cut to the exact length of the circumference and also the length of the pattern. The paper should then be laid off as shown in Fig. 13 (*b*). The points 1, 3, 5 and 2, 4, 6 are laid off on the edges of the paper $1\frac{3}{4}$ inches apart and the full lines drawn connecting them, as shown. These lines represent the center line of the thread. After the lines are drawn, the paper is wrapped around the pattern again, when it will be found that point 1 will meet point 2, point 3 will meet point 4, and point 5 will meet point 6, thus making one continuous line when wrapped on the pattern. The paper is finally glued on the pattern, but before this is done, other lines should be drawn parallel to these, representing the thickness of the thread or the lines on which it is desired to saw down for the sides of the thread.

39. In laying out the lines, care must be taken not to run the thread in the wrong direction, making a right-hand instead of a left-hand or a left-hand instead of a right-hand thread. This mistake is very easily made. If the thread is to be a right-hand one, the lines should run up toward the right hand, as seen in Fig. 13 (*b*), and if it is to be a left-hand thread, they should run up toward the left.

When a double thread is required, instead of starting to draw the lines from point 2 to the corner, point 1 to point 4, point 3 to point 6, etc., they should be drawn as indicated by the broken lines, so that each line advances two divisions instead of one. By following out this system, any number of threads can be drawn. If the lines advance three points, a triple thread would be formed; if they advance four points, a quadruple thread, and so on, until the number of threads

and the angle are so great that it is called a spiral gear in place of a worm.

40. If the entire surface of the paper were covered with glue, the moisture of the glue would stretch it so that the ends, instead of meeting, would overlap. This can be avoided by simply placing a little glue along the ends and a spot here and there on the inside of the paper, and not covering the entire surface with glue. After this is done, the paper should be laid down and the pattern rolled over it, when the paper will adhere to the pattern and take its proper position.

41. Forming the Thread.—The cutting of the thread may be done with a back saw, but before beginning the work, two pieces of hard wood about $\frac{1}{4}$ inch thick should be fastened to the sides of the saw to act as guides and to prevent the saw from cutting beyond the desired depth. With the saw thus prepared, two spiral lines may be sawed about the worm and the space between removed with a chisel, after which the form of the thread can be finished out to a templet, shown in Fig. 13 (*g*). The form and angle of this templet will depend on the kind of thread to be cut.

Some patternmakers have two small holes drilled through their back saw to enable them to fasten wooden guides on it, while others allow the guides to project beyond the ends of the saw to secure them together by means of screws. After the thread has been formed to the desired shape, the pattern may again be placed in the lathe and sandpapered.

A worm, especially if it is long, may be roughed out on a circular saw. The worm is turned to the desired outside diameter, the spiral laid out on it, and one or two turns worked out $\frac{3}{16}$ or $\frac{1}{4}$ inch deep at one end, so as to form a guide. A wooden box or guide is so placed on the saw table that when the worm rests against the guide the saw will enter the groove parallel to the thread of the worm. A small pin one turn in advance of the saw blade engages the groove that has been worked out by hand. The operator

rotates the worm against the guide by hand, and the small pin feeds it along the guide. The saw cuts a groove that is a continuation of the groove worked out by hand, and after the guide pin has passed the portion worked out by hand, it engages the portion cut by the saw, and the work becomes continuous. A groove from $\frac{3}{16}$ inch to $\frac{1}{4}$ inch deep is sawed down on each side of the thread the entire length of the worm. The saw is then moved over and the table lowered slightly so that another cut can be taken next to the one previously made. The guide pin must be readjusted each time so that the saw will rough out the stock almost to the face of the thread. By repeating this operation, practically all the material in the groove can be sawed out in a very short time.

PATTERN FOR WORM-GEAR.

42. Requirements and Form of Tooth.—If a worm-gear is to mesh with the worm described in Arts. 37 to 41, the wheel being $21\frac{3}{4}$ inches in diameter, $1\frac{3}{4}$ inches pitch, and having 39 involute teeth, the work may be done as here described. Involute teeth may be laid out by the Willis odontograph, as described further on. Many patternmakers shape the thread of a worm the same as that of the tooth of the gear in which it is to work, but in this case the sides of the thread have the form of involute teeth and should be straight and at an angle of 75° with the axis of the worm. This is the correct form for the involute rack tooth, and the worm is similar to the rack in this case.

43. Building Up the Body of the Pattern.—A section of a worm-gear pattern is shown in Fig. 13 (*d*), the pattern being parted on the line *a b*. In turning the pattern, the face plate should be the same diameter as the rim so as to allow the ends of the teeth to be turned off. Each half of the pattern should be built up separately with the parting joint of the pattern against the face plate. The outside of both halves of the pattern should be roughed off

and the inside faces of the arms finished carefully, care being taken to turn the inside of both halves to the same diameter so as to make the chucking easier. When this is done, the rings are chucked by the inside of the rim so that the parting face of the pattern is on the outside. If the arms have already been placed in the pattern, this chucking may be accomplished by means of segments nailed or glued to the face plate, and so placed that they will fit between the arms. The outside of these segments is then turned so that the pattern will just fit over them. The outside of the rim should then be finished to the required size and blocks for the teeth fitted upon the periphery.

44. Fastening and Facing the Teeth.—The blocks for the teeth should be fitted and glued on with the grain of the wood running at the same angle as the teeth at the pitch line, the width of each block being equal to the pitch. The angle of the teeth is laid out as shown in Fig. 13 (*f*), in which *ab* represents the circumference of the worm on the pitch line and *ac* the pitch, while the angle *abc* represents the angle of the teeth at the pitch line. The three blocks at *i*, Fig. 13 (*d*), are shown fastened on at the proper angle. These blocks are fastened on before taking the first half of the pattern from the lathe, and they should be faced off true with the parting line of the pattern. The groove shown at *h*, Fig. 13 (*d*), may also be turned at this time.

After the first half of the pattern has been turned and removed, the second half is chucked and turned and the blocks for the teeth fitted on, care being taken to place the blocks so that they will come in line with those on the first half when the arms of the pattern are in their proper position. A projection should also be turned on this half of the pattern to fit the groove *h*, Fig. 13 (*d*), and this groove and projection will serve to locate the halves of the pattern concentric with each other when they are brought together.

The halves should now be put together before the second half is removed from the lathe, the second half being secured to the first half by means of screws or clamps. The blocks

for the teeth should be turned off on the ends and finished to the proper form, as shown at *j*, Fig. 13 (*d*). To provide a good surface for laying out the teeth, the blocks should be varnished yellow and sandpapered.

45. Laying Out and Forming the Teeth.— In Fig. 13 (*c*) a series of teeth is shown from *c* to *d* with one-half of the gear pattern removed so that the section of the teeth on the center line and their contact with the worm may be more clearly illustrated. The projection of the portion of the teeth that extends beyond the center line is not drawn in. In the portion of the figure from *e* to *f*, three teeth are shown, illustrating an end view of them. Owing to the fact that the teeth on the outside edge of the worm-wheel have a greater pitch diameter than those in the throat, they will have a greater chord pitch, and hence if the teeth are formed of the same cross-section clear across the face of the worm-wheel, the worm will not fit them perfectly. The longer the portion of the worm that engages the worm-wheel, the greater the error that can be produced from this cause. To remedy this, the outer ends of the teeth should be cut thinner than the theoretical thickness. In order to determine the amount to be pared off from the outer ends of the teeth, it should first be determined how many of the teeth of the worm-wheel are in contact with the worm at one time, and a pair of dividers should be set to this contact distance. This distance can then be compared with the thickness of the teeth at the outside edge, when it will be found that the dividers are set to a considerably smaller dimension than the over-all dimension of the corresponding number of teeth. One-half of the difference between the divider setting and the over-all distance of the teeth at the outside of the worm-wheel should be pared off from each side of the teeth at the outer edge, and this amount should taper to nothing at the center. In laying out the amount to be removed, measurements may be taken at two or three points along the teeth. This error is much more noticeable in worms having a long contact.

46. In the form of teeth shown, the tooth curves may be struck in with the compasses, provided the proper center has been ascertained. This is done by means of the odontograph, which is shown at *b*, Fig. 13 (*c*). The odontograph is shown more plainly at *a*, Fig. 14. The instrument consists of a 75° angle divided off into $\frac{1}{4}$ -inch spaces on one side for 4 inches in length, the $\frac{1}{4}$ -inch spaces being subdivided. When in use, the zero point of the instrument is placed at a point on the pitch line that corresponds with an intersection

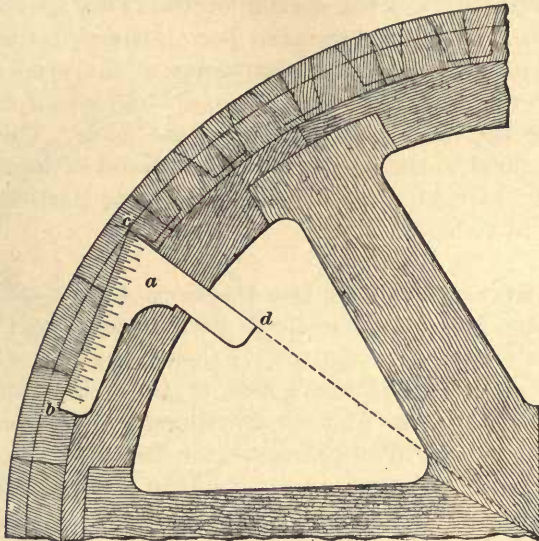

FIG. 14.

of the face of one of the teeth with the pitch line, and the plain side *cd* of the instrument is placed on a radial line, as indicated in Fig. 14. A distance corresponding to the radius of the gear is then read off on the graduated side of the instrument, the $\frac{1}{4}$ -inch spaces being read as inches. This will locate a point from which the tooth curve can be struck. In the case of the wheel under consideration, the diameter is $21\frac{3}{4}$ inches and the radius $10\frac{3}{8}$ inches. This is so near

11 inches that, for practical purposes, 11 inches could be read off on the odontograph and the point placed for the center of the tooth curve. This method is continued around the entire gear. The diameters of the circles containing the centers of the circles forming the tooth curves are usually furnished by the drawing room and placed on the drawing. When this is not done, the odontograph may be used.

47. To insure the proper angle on the face of the tooth, the center of one of the blocks on each side may be located on the pitch line and the spacing on the two sides continued from this. If the blocks have been placed at the proper angle, this will insure the teeth being at the proper angle. It is also well to take the pattern apart and lay off the tooth curves at the center on one-half of the gear. This half is then trimmed to the proper form and placed in contact with the other half, after which the remaining portion of the teeth can be shaped.

48. Strengthening the Pattern Arms.—Since the arms of the pattern are made in halves, they are thin, and therefore weak. In order to give them the greatest possible amount of strength, the joints at the center should be tongued and the hub on each side glued and screwed to the arms, which will, in most cases, give the requisite amount of strength. Only one dowel-pin will be necessary to insure the halves of the pattern going into their correct positions, as the annular groove and tongue shown at *h*, Fig. 13 (*d*), will center them, and all that is necessary is to bring the teeth into the correct relationship on both halves.

FLYWHEELS WITH HOLLOW ARMS.

49. Advantages of the Different Designs of Flywheels.—Many persons contend that flywheels whose rims are made in eight or ten sections would be just as strong if cast in halves. When the rim is made in a number of sections,

the arms and hub are made separate and the parts bolted together; while, when the wheel is cast in halves, the arms and rim are usually cast together. It is certainly cheaper to cast wheels in halves than in a large number of segments. The matter of first cost, however, should always be made secondary to that of durability and strength, on account of the fact that a bursting flywheel is liable to cause great damage.

50. The method of making the wheel in sections possesses certain advantages, among which may be named the

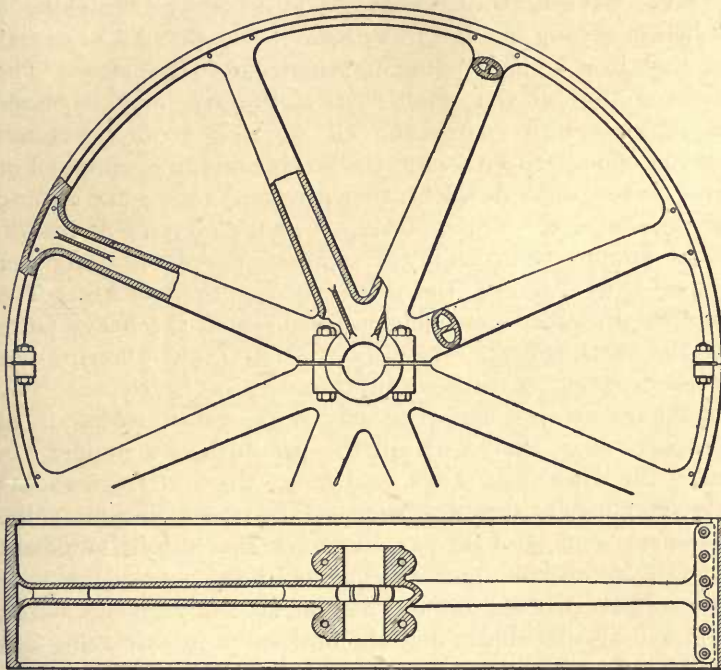

FIG. 15.

fact that it is more easily handled in the shop and is not subject to as great strain from shrinkage as one made in

halves. On the other hand, when the wheel is made in sections, there is danger of the loosening of the bolts and joints, and a wheel built in sections is generally more difficult to balance than one cast in halves. Flywheels with solid arms are often cast in halves, especially when of comparatively small diameter. The flywheel described in the following articles and illustrated in Fig. 15 is 20 feet in diameter, with a 50-inch face, and weighs about 22 tons. It was successfully cast in the kind of mold described and has been running for several years. Ordinarily, such a large wheel would have been cast in sections.

51. Strength of Arms.—The necessity of making a flywheel strong enough to withstand the shrinkage strains of cast iron while cooling is sometimes overlooked. The cross-section at the small part of the arm may be made large enough to withstand all working strains, but not strong enough to withstand the strains due to cooling. For this reason, most flywheels that give out crack while cooling in the foundry. This cracking is usually due to an insufficient amount of metal in the arms compared with the other parts, thus causing the arms to cool too quickly. The molder often prevents this by uncovering the heavy parts of the casting first, especially the hub, thus allowing the whole casting to cool simultaneously, or nearly so. The shrinkage strains, however, may be so great, owing to ill proportioning, that, with all the precautions a molder can take, the wheel will break, and hence the draftsman should always consider the shrinkage strains when designing the flywheel arms, and the patternmaker should have sufficient knowledge of molding so that he will be able to judge as to the results that will occur when making any given casting and will also be able to help the draftsman in correcting any faulty designs.

52. General Consideration of Flywheel Mold. The flywheel shown in Fig. 15 may be molded as shown in Fig. 16, the greater part of the mold being composed of dry-

sand cores. The portion of the mold for the arms is formed by the outside cores shown at *a*, Fig. 16 (*a*) and (*b*). The cores to form the inside of the arms are shown at *b*. The space *c* between the cores *a* and the rim of the wheel *d* is

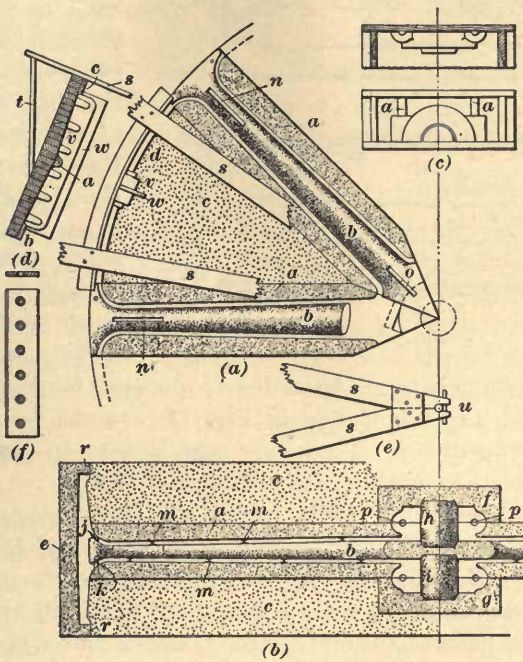

FIG. 16.

filled with green sand, which is rammed against a part pattern, as shown. The outside of the mold is composed of curved cores *e*, Fig. 16 (*b*); the portion of the mold for the hub is formed by the cores *f* and *g*, while the opening through the hub is made by the cores *h* and *i*.

53. Appliances for Making Cores for the Outside of the Arms.—A core box for the outside of the arms is shown in Fig. 17 (*a*) and is fitted with interchangeable pieces *a* in the end of the box. These interchangeable

pieces are for forming the hub, or rather for forming the space for the hub cores. In Fig. 17. (*b*) is shown a plan of the hub cores, and three sections must be made to correspond with those

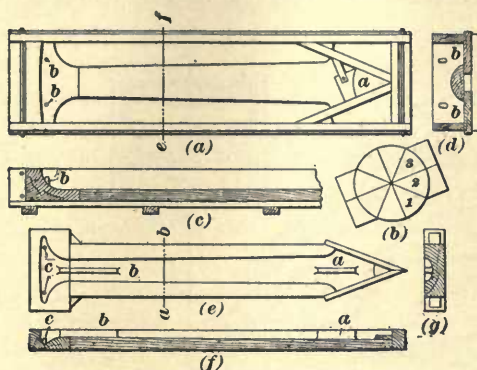

FIG. 17.

numbered 1, 2, and 3. These three sections are used at *a*, Fig. 17 (*a*), in forming the arm cores. By referring to Fig. 16 (*b*), it will be seen that the cores *b* are supported at their outer end on the cores *j* and *k*, and

also by chaplets *m*. In order to provide for the cores *j* and *k*, the core box shown in Fig. 17 (*a*) must be provided with core prints *b*. These are also shown in the partial sections of the core box, Fig. 17 (*c*) and (*d*).

54. Core Box for Inside Arm Cores.—A core box for making the cores *b*, Fig. 16 (*a*) and (*b*), is shown in the three views, Fig. 17 (*e*), (*f*), and (*g*). It will be noticed that the pieces *a* and *b* are fastened into these core boxes to form openings for the stays or webs *o* and *n*, Fig. 16 (*a*); core prints *c* are provided to receive the ends of the cores *j* and *k*, Fig. 16 (*b*). In the case of the cores for both the inside and the outside of the arms, only half core boxes are necessary.

55. Core Box for the Outside of the Rim.—The core box for making the core *e*, Fig. 16 (*b*), for the outside of the rim is shown in Fig. 18. The box is very simple in construction, being composed of a simple rectangular box having perpendicular ends *a* and *b* and inclined sides *c* and *d*. The face *e* of the box is open, so that the core can

be readily removed in this direction. The upper faces of the ends *a* and *b* are shaped to the same curve as the ends of the core *e*, Fig. 16 (*b*). There are also two ribs *f* and *g*, which are placed across the box at a sufficient distance apart to form the inside of the core. It will be noticed by reference to Fig. 16 (*b*) that the cores are longer than the width of the rim, and the distance from outside to outside on the ribs *f* and *g* is equal to the width of the rim, a proper allowance for shrinkage having been made. Instead of making the entire upper surface of the core box and ramming the core between it and the back plate on the ribs *f* and *g*, the sand between them is swept out by means of the strickle *h*, which runs on the ribs *f* and *g*. The core is all rammed from the upper or inner face, the central portion swept out with a strickle, and the core box then lifted off, thus leaving the finished core on the core plate ready for drying.

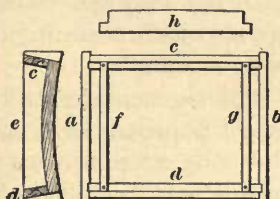

FIG. 18.

56. Core Boxes for the Hub.—The cores *i* and *h*, Fig. 16 (*b*), are made in ordinary circular core boxes or swept up on iron arbors, and hence no description of the core boxes need be given. The cores *f* and *g* are made in halves in the box shown in two views in Fig. 16 (*c*). The cores for making the bolt holes *p*, Fig. 16 (*b*), are supported in the recesses left by the core prints *a*, Fig. 16 (*c*). These bolt cores are made larger in the center so as to chamber out a portion of the hole and thus reduce the work necessary in drilling and reaming the holes and fitting the bolts. Making the cores *f* and *g* in halves greatly facilitates the placing of the cores for the bolts *p*, Fig. 16 (*b*).

57. Green-Sand Work in Connection With the Mold.—The mass of green sand between the rim and cores *a* is rammed against the part pattern shown in place at *d*, Fig. 16 (*a*), and also shown in section at Fig. 16 (*d*).

The inside rib *a* is not built up with the segment or part pattern, but is separate and screwed on after working off the inside of the segment, this being a much easier way than building the rib in the pattern. The two ribs *b* and *c* are also made separate and screwed on the segment after the body is completed.

The segmental pattern is made wider than the face of the wheel required, in order to make allowance for the ends of the core, as shown at *r*, Fig. 16 (*b*). The segmental pattern is held in place by two wooden arms *s*, Fig. 16 (*a*), and the lower portion of it is braced by suitable braces *t*, Fig. 16 (*d*). At the center of the mold the arms *s* are attached to a center pin *u*, as shown in detail, Fig. 16 (*e*).

The segmental pattern is represented with the lug *v* for bolting the wheel together on it. This lug is removed when ramming up the space between any two arms whose centers do not come on the joint line of the wheel. After the green-sand portions *c* have all been rammed up, the cores *e*, Fig. 16 (*b*), are placed in position. The mold, if above the floor of the foundry, is surrounded with a ring of boiler iron, and green sand is rammed in back of the cores *e*. In some cases, the mold is built in the foundry floor and sand is simply rammed back of the cores *e* so as to fill the remainder of the pit. This wheel could also be made by building up the outside portion with brickwork and sweeping loam on it, instead of using the cores *e*, Fig. 16 (*b*). As the wheel is to be turned on the outside, it is not important that it should be smooth, and the method here illustrated is in many cases cheaper and more convenient.

58. In order to form a joint for the wheel, cast-iron plates, similar to those shown in Fig. 16 (*f*), are introduced into the joint to fill the space left by the core print *w* on the segmental pattern. These plates have a series of holes in them through which the cores for the bolt holes are to be placed. The holes in the plates should be $\frac{1}{4}$ inch or so larger than the cores for the bolt holes, so that some metal may flow through the holes and around the cores, thus giving

an abutting surface surrounding each bolt. The hub of the wheel is also split by means of cast-iron plates, but no allowance is made in the case of the holes in these plates to have an abutting surface of metal about the cores for the bolts. All the venting from the cores in this mold is taken care of through the center cores *h* and *i*.

The patterns, core boxes, and molds for wheels with solid arms may be made as just described, except that the cores in the arms are omitted. Solid arms are now generally used.

PATTERNMAKING.

(PART 5.)

PATTERNS FOR SCREW PROPELLERS.

1. Development of the Curve for the Blades.

In order to lay out the curve representing the pitch of a **propeller screw**, the following method may be used. If a cylinder were drawn with a diameter as shown in Fig. 1 (*a*), the diameter being equal to the distance across the points of the blades of the propeller and the line *ab* equal to the pitch of the screw, then the curved line joining these two points would represent the course of the blades if they were continuous. In order to determine the angle that these blades make, lay off *bc*, equal to the circumference of the cylinder, perpendicular to *ab*, and join the points *a* and *c*. The line *ac* will represent the length of the screw between *a* and *b*, and the angle at *e* will represent the angle that it makes at any point on the surface of the cylinder. If a piece of paper of the form *abc* were cut out and wound around the cylinder, it would form the helix shown, and the point *c* would come around to the point *b*. If it were desired to continue this helix about the cylinder, other lines parallel to the line *ac* could be drawn as represented by the dotted line *y*, and if this were wound around the cylinder, it would form a continuation of the helix, the point *d* coming to the point *a*, etc., thus making a continuous thread. This method is the same as that used in laying out the threads on worms. The curved line representing the thread about the cylinder shown in Fig. 1 (*a*) is of no use in laying out the drawing,

COPYRIGHTED BY INTERNATIONAL TEXTBOOK COMPANY. ALL RIGHTS RESERVED

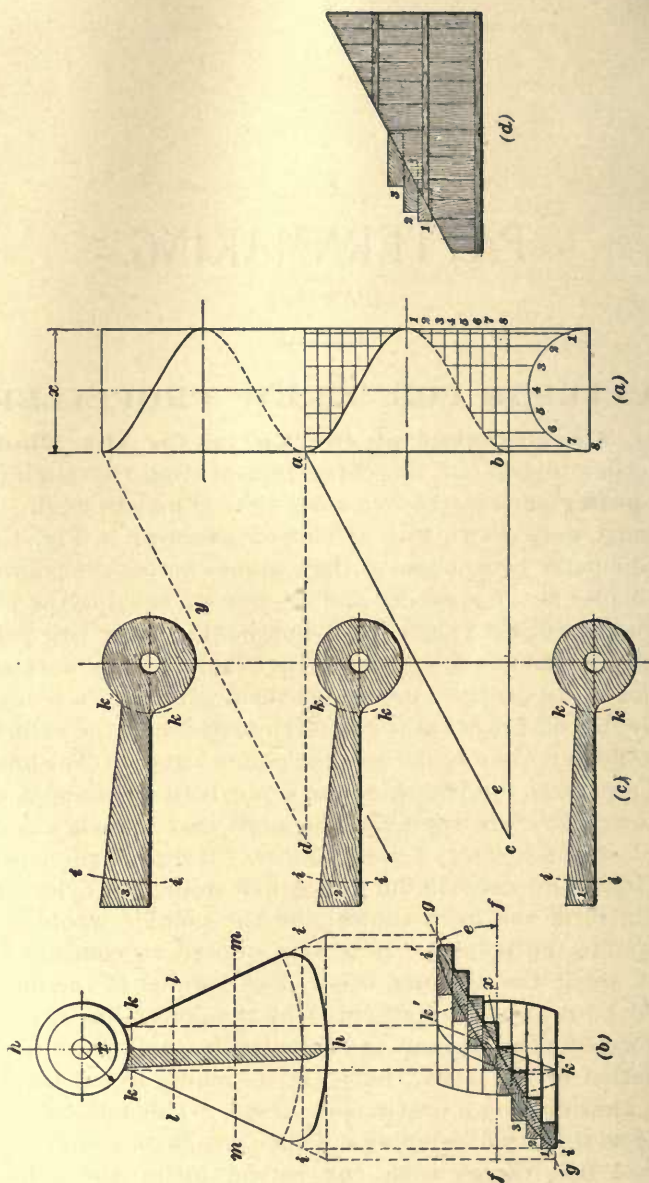

FIG. 1.

but has simply been projected for the purpose of illustration, the projected points being numbered the same in the half plan of the cylinder and in the elevation, so that the method of projecting may easily be understood. The angle e that the outer end of the blade makes with the direction of its center line is the important point in the laying out of a screw propeller wheel.

2. Styles of Propeller Patterns.—Usually, a whole pattern is made for a small propeller wheel having three or four blades, as such a pattern saves much time in the molding, but when the pattern is 5 or 6 feet in diameter or is not liable to be used often, the molder can make a pattern for one blade answer the purpose for three or four by moving it around the spindle and ramming up the cope and drag in sections. The principles here given for building up one blade will also apply to a pattern having three or four blades.

3. Laying Out the Blade.—Fig. 1 (*b*) shows one manner of laying out a propeller blade when there is no rake aft. Having obtained the angle of pitch e , Fig. 1 (*a*), it is an easy matter to transfer it to the blade. To accomplish this, draw the line ff across the center of the hub, and draw the line gg at an angle e with ff , the intersection being at the point x upon the vertical center line of the hub. Where the lines ff and gg intersect at x is the center of the blade represented by the line hh in the plan, and through this line the face must pass.

Having located the lines hh and ff and the angle e on the hub, the outline and longitudinal section of the blade are laid out, the longitudinal section of the blade being shown cross-sectioned in the upper view and the outline of the end being shown in full lines intersecting the line gg . It will be noticed that the outline does not exactly coincide with the line gg . This is so because the ends ii recede from the line gg in order to conform to the surface of the cylinder, and hence appear above and below the line gg .

The section on the line hh shows the actual thickness of the center of the blade lengthwise, while the outline on the line ii does not show the actual thickness, because it is projected. The shape of the outline of the blade is drawn on the pattern after it is built up. Different designers hold various opinions as to the best outline for a propeller, and the one chosen has simply been adopted for the sake of illustration.

To get the cross-section of the blade at the hub, the angle that the blade makes at the hub must be determined. This is done by drawing the lines from kk in the upper view until they cut the same upper or lower lines that gg do in the lower view, as shown at $k'k'$. Then $k'k'$ will be the angle, but the intersection of the blade at kk , falling as it does on the round surface of the hub, will not appear straight as shown. It is drawn so in order to simplify the drawing, and, as it is intended for the patternmaker's working drawing, will answer all practical purposes. The cross-sections at ll and mm are omitted, but they may be obtained by projecting lines from the points at which these intersect the lines bounding the sides of the blade on to the lower view, and drawing diagonal lines similar to $k'k'$, on which the sections may be drawn.

4. Building a Propeller Pattern.—Having obtained all the lines needed, the material for the pattern may be gotten out. Care must be taken to see that each course is parallel, for, if it is not, the building up will give trouble and cause the pitch to vary from that desired. In the lower view, Fig. 1 (*b*), it will be noted that the patternmaker is guided, in forming the straight face of the blade, entirely by the positions of the corners of the segments as they are laid up, these segments being brought into contact with the line $i'i'$. For the sake of illustration, the material is cut as close to the line on the back of the blade as it is on the face, but there ought to be more stock allowed on the back than is represented in the drawing. In Fig. 1 (*c*) are illustrated the first three courses of the pattern numbered 1, 2, and 3. The width of each course is determined by the end view,

Fig. 1 (*b*), and the width at *kk* is obtained by drawing a circle on each course with a radius equal to *r* in the plan in Fig. 1 (*b*), and then transferring the different widths as seen at the section *k'k'* in the end view and adding enough stock to form the fillet at the hub.

In cutting out the courses, the grain of the wood should run as indicated by the arrow shown opposite segment 2, Fig. 1 (*c*), as this will make the cutting and shaping of the blade much easier than if the material were sawed out with the grain running straight.

A wooden pin should be turned the same diameter as the spindle on which the pattern is to be used, and a hole bored in each segment to fit this pin. The courses of the blade are then slipped over the pin in their proper order, thus keeping all the courses parallel to one another, and at the same time permitting them to be swung to their proper positions.

Although each course may be of even thickness and the correct bevel laid off on the end of each piece, there is danger in the building up of the courses that they may lean over too much. To prevent this, it is a good plan to make an angle piece as shown in Fig. 1 (*d*). This angle piece is laid off with the same angle as that shown at *e*, Fig. 1 (*a*), and is used for a guide and support while building up the blade. The angle piece is built in the form of a cylinder, having a circumference equal to that of the periphery. Each course for the periphery of the blade is beveled off for a short distance in from the end so as to rest on the incline of the angle piece, care being taken not to destroy the upper radial edge of each course in doing so.

After the courses are all placed in position and glued together, the straight face represented by *i' i'* on the outer edge and *k' k'* on the inner edge is worked off to the proper curves, the patternmaker being guided by the edges of the courses. When this is complete, the back of the blade is worked off to a templet, different templets having been made for several cross-sections, as, for instance, on the lines *ll* and *mm* in the plan shown in Fig. 1 (*b*).

While this pattern is shown built face down, with the ends of each course resting on the angle piece, it may be built face up, and, by some patternmakers, the latter method is preferred, because it is plain that they can see better to guide the face edges right when they are on the upper side than when they are on the lower, but this is only a matter of individual preference.

5. Practically all propeller wheels are constructed with a slight rake aft, and this has to be taken into account in building a pattern. To allow for this rake, it may be necessary to use one or more segments that do not extend to the hub, or to cut away the hub end of some of the segments after they are in place. Propeller wheels are also frequently constructed that do not have a constant pitch. In this case the pitch is specified for certain points, and the intermediate points are worked down so that the surface at one point blends into that at another without any sudden changes in form. To construct a pattern for a propeller wheel having a variable pitch, it is necessary to construct templets for several points at the face of the blade. Both in the case of propeller wheels having a constant pitch and in the case of those that have a variable pitch, some patternmakers construct a series of forms and build the pattern upon them. When this method is followed, a series of concentric circles is drawn on the board on which the pattern is to be built, and the angle for the blade at each one of these circles is calculated and a piece of metal cut out similar to the wooden form shown at Fig. 1 (*d*). Wooden guides are then sawed to the radius of the circles drawn and the metal forms fastened to these. The propeller wheel is then laid up, each succeeding segment being fitted against all the guides; after the pattern is built up, the material between the guides is worked off. This finishes the flat side of the propeller wheel. The form of the blade is then laid out upon this surface and the stock surrounding it cut away. In order to give the proper form for the other side, either one of two methods may be followed. In the first, a series of templets is made and the back of the blade worked down to these

templets. In the second, the thickness of the blade at different points is calculated, small holes are bored through the blade at these points, and pegs are cut off to a length that will correspond to the thickness at these various points. These pegs are glued in the holes so that one end is flush with the flat side of the blade. After this, the other side of the blade is worked off flush with the ends of the pegs.

6. Molding a Propeller Without a Pattern.—Propeller wheels are also sometimes molded in loam, the lower face corresponding to $i' i'$ and $k' k'$, Fig. 1 (*b*), being swept up with the aid of a guide similar to that shown at Fig. 1 (*d*). The blades are then built up from molding sand by means of templets, after which the cope is rammed. The cope is then lifted, the molding sand occupying the place of the blades cleared away, and the mold made ready for casting. When this method is followed, the casting is really obtained from a sand pattern. As this matter interests the molder more than the patternmaker, no further description of it will be given here.

STOVE PATTERNMAKING.

STOVE MODELS AND DRAWINGS.

7. Stove Models.—When the manufacturer desires to bring out a new design of stove, the general scheme is usually first developed in the form of a drawing, but before deciding definitely on the exact form of the stove, a model is sometimes worked up in clay or plaster. This enables the designer to study the exact outline of the stove and see just how the various parts will fit together, and especially to study the general artistic effect. This method of procedure is especially advantageous in the case of heating stoves or stoves having considerable ornamental work on them. Plain work, such as that on cook stoves and ranges, is generally carried through without making the model. In case the design in hand has for its object the remodeling of an

existing design, many of the castings of the old design will, if possible, be worked into the new design.

There are usually some castings that can be used on the stove, or some of the castings are made first and utilized in connection with the design. Fig. 2 (a) shows a stove in the process of being modeled. It will be noticed that some of

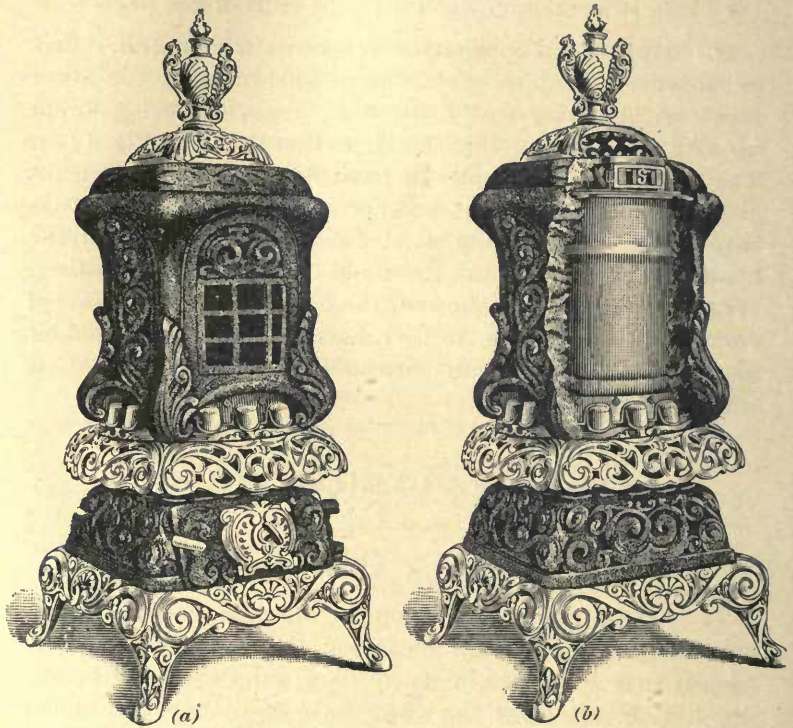

FIG. 2.

the castings, such as the base and top, have a finished appearance, which indicates that they have already been decided on, and used in the model. For the purpose of supporting the remainder of the stove, a set of somewhat smaller stove castings and a sheet-iron drum are used. Sometimes it is necessary to model only one-half of the stove, especially in round work or in work that has two or more sides alike. In Fig. 2 (b) is shown the other view of the same model as that

shown in Fig. 2 (*a*), with the two sides of the stove completely modeled. A specially prepared clay that dries very slowly is used for the modeling. The clay is applied as shown in Fig. 2 (*b*). After the model is completed, the drawings, which are usually only partially worked up first, are finished, and the patternmaker makes the patterns or completes those that are not already made. The modeling is usually done by a specialist in this work, who may also be a good draftsman.

8. Stove Drawings.—Stove drawings differ in a great many respects from ordinary mechanical drawings of machinery. The stove drawings are generally made full size. A good grade of detail paper that is but slightly affected by the moisture in the atmosphere is selected on which to make the drawing. The plan is usually laid down first, and from this the sections and elevations are projected and drawn as the idea develops. All views are placed one on top of the other, that is, the elevations and sections are all drawn on or across the plan, so that only a person thoroughly familiar with stove work can read one of these drawings rapidly. Usually the different sections are colored differently, and, as a rule, no dimensions whatever are put on the drawing. Most mechanical drawings have to go into the machine shop to have the machine made, some of the drawings going first to the pattern shop and some to the forge shop, but in the case of a stove drawing, it goes to the pattern shop only. The patternmaker prepares the patterns directly from the drawing. Wooden patterns are first made, and from these the iron patterns are cast, which serve for making the final castings of the parts of the stove. On this account, at least double the shrinkage usually allowed for castings must be allowed on the original patterns. In this work the stove draftsman uses a rule that gives the proper shrinkage, so that the patternmaker simply has to make the patterns the same size as the drawing. On account of the fact that drawings are generally made full size, they are always large, and in making them the draftsman usually works from one edge of the board only.

SPECIAL TOOLS USED FOR STOVE PATTERN-MAKING.

9. Shrink Rules.—Stove patterns are all made of metal, and these metal patterns are made from other metal patterns called **master patterns**. It is therefore necessary to make the original wooden patterns with more than the usual cast-iron shrinkage allowance or with more than one shrink. In some cases the master patterns are made from white metal, which shrinks only one-half as much as

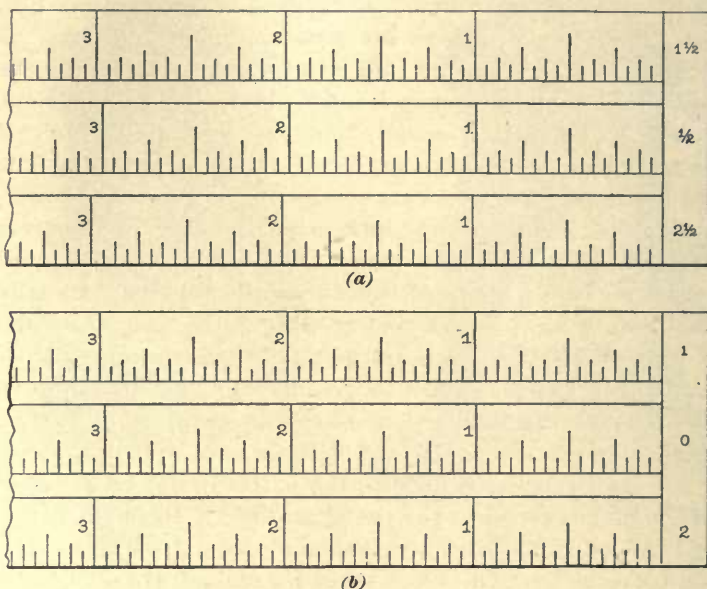

FIG. 3.

iron, necessitating the use of a set of shrink rules, called *half-shrink rules*. In order to be able to make any kind of a pattern that may be called for, a stove patternmaker should have at least five rules, and they may have as many as seven. In case seven are used, they are one standard rule graduated to 16ths of an inch, and the following shrink rules: $\frac{1}{2}$ shrink, 1 shrink, $1\frac{1}{2}$ shrinks, 2 shrinks, $2\frac{1}{2}$ shrinks,

and 3 shrinks. In this connection a shrink is understood to mean the amount of shrinkage per foot in cast iron, which is $\frac{1}{8}$ inch. In constructing the first of these rules, that is, to produce the $\frac{1}{8}$ -shrink rule, a space that is intended to represent 12 inches would be made $12\frac{1}{8}$ inches long. This would be divided into 12 equal spaces to represent inches, and these subdivided into 16ths. In like manner, any of the other shrink rules would be made by taking 12 inches plus the shrinkage allowance and dividing it into 12 parts and these into 16ths. These shrink rules are usually at least 24 inches long and are made of wood. Most of the measurements in stove patternmaking are taken by means of a pair of trams from the shrink rules; hence, the end of the rule is allowed to project beyond the graduations, as shown in Fig. 3. This illustrates a set of five shrink rules and a standard rule all made on one piece. In Fig. 3 (*a*), the upper rule is made for $1\frac{1}{2}$ shrinks, the next $\frac{1}{2}$ shrink, and the bottom one for $2\frac{1}{2}$ shrinks. The back side of this rule would be graduated as shown in Fig. 3 (*b*), the upper scale being for 1 shrink, the center scale a standard rule, and the lower scale for 2 shrinks. In order to avoid confusion, however, it is best to have each of the rules on a separate piece.

10. Stove Bevels.—Where the various plates that compose the stove are united, the edges of the plates are usually beveled. One plate has to be beveled so as to match the bevel of the other, so that they may come together properly. Stove patternmakers have found it advantageous to have a set of bevel gauges so that these bevels shall be uniform. Mr. Nicholas Vedder, formerly a stove designer and patternmaker of Troy, N. Y., originated a set of bevels that have come into quite extensive use among stove manufacturers. There are eight of these bevels, although at first only four were laid out, and they were numbered 1, 2, 3, and 4, as shown in Fig. 4 (*a*). Subsequently experience showed that other bevels would be advantageous; hence, the space between the No. 1 bevel and the vertical line *a* was divided

into five equal spaces, thus giving four more bevels, which are made and numbered 0, 00, 000, and 0000, as shown in Fig. 4 (b). The bevels are shown in Fig. 4 with the angle of each bevel marked in degrees.

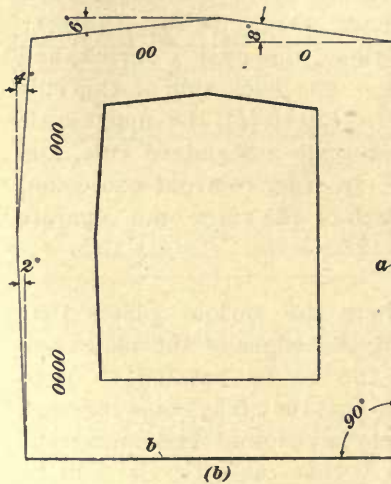
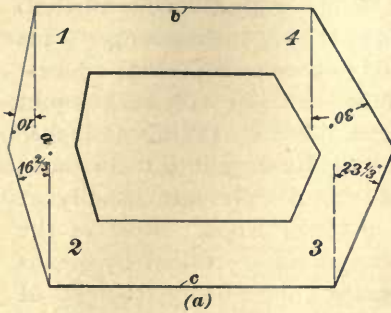

FIG. 4.

of each bevel marked in degrees. For convenience in use, these bevels are ordinarily made of thin wood or metal pieces similar to the triangles used in making mechanical drawings. Fig. 4 (a) and (b) shows the two of these gauges in most common use by stove pattern-makers and draftsmen. In using the gauge, Fig. 4 (b),

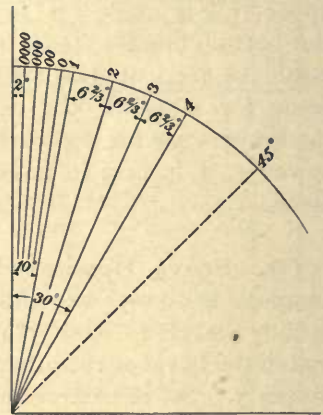

FIG. 5.

the draftsman places one of the straight sides *a* or *b* of the gauge against a T square and then draws the desired lines along the bevel side corresponding to the bevel he wishes to use. In the form shown in Fig. 4 (a), the two opposite sides *b* and *c* are parallel and are used against a T square in laying off the bevels. These bevels, or gauges, are made of any convenient size.

The number of the bevel only is put on the gauge; the degrees have been added in the illustrations to make clear the angle of each. Fig. 5 shows how the angle would look if laid off successively from the least to the greatest.

11. Stove-Patternmakers' Curves.—In a great deal of stove work, especially in heating stoves, some of the surfaces are curved. These curves are usually regular curves, but on account of the fact that it would be very inconvenient indeed to use trams in constructing these curves, Mr. Vedder also brought out a set of curves drawn with standard radii. To these curves he gave arbitrary numbers as follows: $2\frac{1}{2}$, 3, 4, 5, 6, 7, 8, 9, and 10. They are usually made with the general form shown in Fig. 6. The length b is the

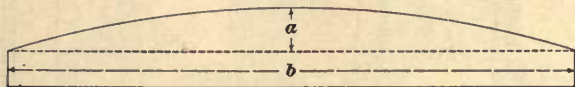

FIG. 6.

same on each one of an entire set, while the distance a has values that are different on each one, varying according to the radius of the desired curve. The value of a is greatest on No. $2\frac{1}{2}$ and least on No. 10. On a set actually measured b was $22\frac{1}{8}$ inches and a was 2.28 inches for No. $2\frac{1}{2}$, 1.86 inches for No. 3, 1.34 inches for No. 4, 1.09 inches for No. 5, .91 inch for No. 6, .81 inch for No. 7, .69 inch for No. 8, .61 inch for No. 9, and .55 inch for No. 10.

These curves may be made from thin wood or from sheet metal. It is best to make them of metal on account of the fact that metal is not so liable to change its shape. Like the bevels, they are used by both the draftsman and the patternmaker.

12. Vertical Plumb.—In stove patternmaking it is frequently necessary to draw a center line over an irregular surface, and in order to do this a device known as a **vertical plumb** has been invented. This is illustrated in

Fig. 7, and consists of two boards *a* and *b* secured to each other at right angles and held in position by braces *c, c*. The outer faces of the boards *a* and *b* are carefully planed at right angles to each other. For use in connection with the plumb, a pair of wooden parallel blocks *d, d* is provided. The casting or pattern on which the center line is to be placed is laid between the parallel blocks and under the board *b*, as

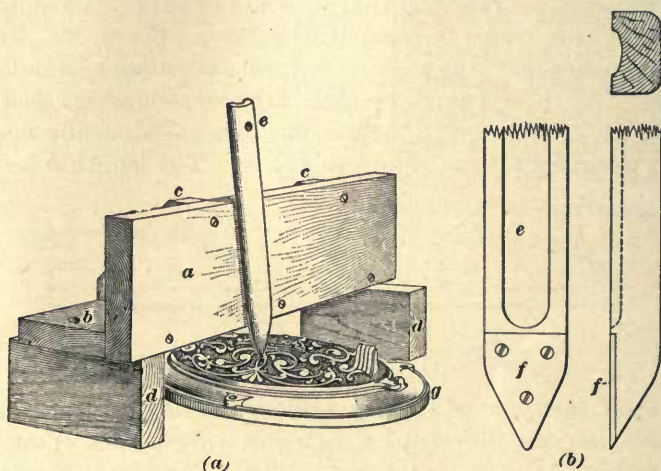

FIG. 7.

shown in Fig. 7 (a). A special scriber, as shown at *e*, is used for drawing the center line. This scriber consists of a piece of hard wood *e* with a steel scribing plate attached to the end, as shown at *f*, Fig. 7 (b). By means of this device it is possible to draw a straight center line across a piece of work, no matter how irregular it may be, or how much carving there may be on its surface.

13. Thickness and Marking Calipers.—Stove patterns have to be carved very thin, and it is necessary that the patterns be of uniform thickness throughout, for if this is not the case, some parts of the casting will cool more rapidly than others and result in the springing or cracking of the casting. Most stove-plate work is more or less

irregular in outline, and in order to make sure that the thickness at different points is the same, various forms of calipers are in use for measuring the thickness. Fig. 8 (a) shows a simple stove-patternmaker's caliper, which consists of two brass castings joined together like a pair of ordinary shears. The measuring is done with the points shown at *a*, while an adjusting screw is placed as shown at *b*. This screw *b* is so adjusted that when it comes in contact with the other portion of the handle, the points

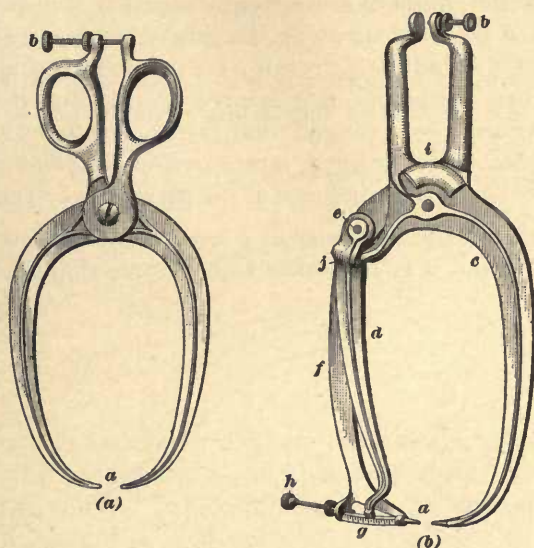

FIG. 8.

at *a* will stand at the desired distance apart. By passing the points *a* over the work, the patternmaker can see what parts have been brought to the desired thickness. Any parts that are not thin enough will prevent the screw *b* from coming in contact with the other leg of the handle and so indicate what portions of the pattern must be carved thinner. For somewhat more accurate work, a pair of calipers of the form shown in Fig. 8 (b) may be used. These calipers are made of aluminum, and are provided with steel measuring points as shown at *a*. As in the previous case, an adjusting

screw *b* is provided at the back end of one of the handles. A spiral spring is located in the pocket *i* and keeps the points of the calipers apart unless they are brought together by hand. This caliper is also provided with an attachment for indicating the exact amount of excess thickness at any point. This is done with an extra arm shown at *d*, pivoted at *e* to the arm *f* of the calipers. A projection on the arm *c* comes in contact with the arm *d*, and a spring located at *j* keeps the arm *d* in contact with this projection. As the points of the calipers are brought together, the point *g* of the arm *d* is forced up along the graduated scale shown on the arm *f*. An adjusting screw *h* is provided for stopping the arm *d* when the points at *a* are the desired distance apart. The leverage is so arranged that the point *g* moves several times as far as the point *a*, and, as a consequence, registers any variation in the thickness of the pattern very accurately.

14. When the front side of a stove pattern is carved into scrollwork, and it is necessary to back out, that is, cut out,

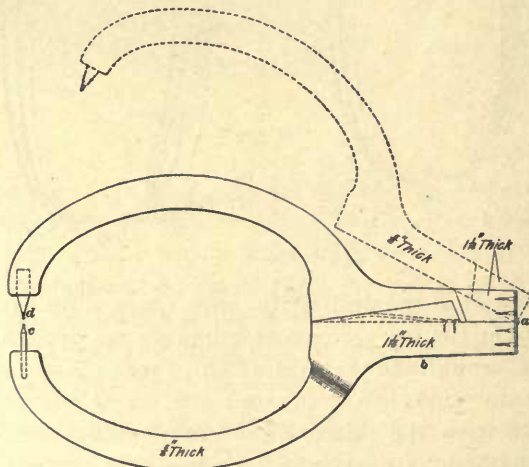

FIG. 9.

the pattern behind this scroll, it is convenient to be able to trace the scrollwork on the back of the pattern. In order to accomplish this, a pair of **marking calipers**, as shown

in Fig. 9, is used. They are made of hard wood and are joined with an ordinary hinge at *a*. The hand grasps the two pieces at the point *b*, with sufficient pressure to bring them together, although a flat spring in the joint tends to keep them apart. The point of one caliper leg is provided with a steel tracing point *c*, and the other is provided with a lead pencil *d*. By following the outline of the carving with the point *c*, and keeping the pencil *d* in contact with the back of the pattern, the outline of the carving can be transferred from one side of the pattern to the other very quickly and accurately.

15. Chute Board.—Many portions of a stove pattern have to be joined on an angle, and as the pattern stock is

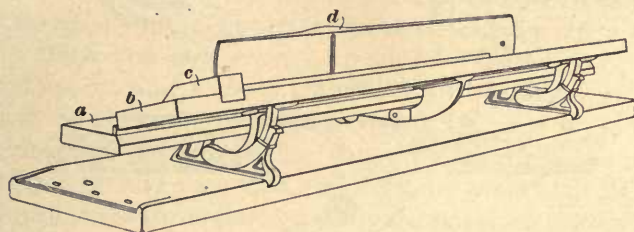

FIG. 10.

very thin, it is extremely difficult to plane the edges of the pieces to the proper angles, without some special device for holding the work. To accomplish this, the **chute board**, one form of which is illustrated in Fig. 10, is usually employed. It consists of a flat board or gauge *a* on which the plane *d* slides, resting on its side, as shown in the illustration. An inclined board, as shown at *b*, is so arranged that it can be adjusted so as to make any desired angle with the board *a*, and a stop, as shown at *c*, is provided for holding the end of the work. The work or stock to be operated on is laid on the board *b*, brought against the stop *c*, held there by hand, and the edge dressed to the desired angle by means of the plane *d*.

16. Carving Tools.—In stove patternmaking, a large amount of carving is necessary, which could not be done

advantageously with the chisels in an ordinary patternmaker's outfit. Hence, the stove patternmaker has to provide himself with a series of carving tools, which usually consist of 18 or 20 small chisels in the form of gouges, paring chisels, and gravers. In large stove-pattern shops the carving is usually done by men especially skilled in this work, and in some cases a stove pattern passes through the hands of three or four men, each doing his own special work.

17. Planer Attachment for Making Thin Stock.

In stove patternmaking it is necessary to use a great deal of

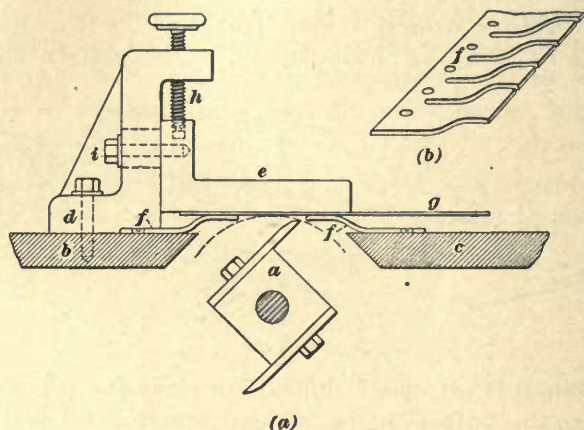

FIG. 11.

very thin stock, some of it being less than $\frac{1}{16}$ inch in thickness. In order to produce this thin stock on an ordinary planer, some special attachment is necessary, and the one shown in Fig. 11 has been used very successfully. At *a* is shown the cutter head of the planer, and at *b* and *c* the ordinary cast-iron tables. On each side of the table *b*, an angle bracket $2\frac{1}{4}$ inches wide, shown at *d*, is fastened, and between these two angle brackets the angle plate *e* is supported. This angle plate is clamped to the brackets by the clamp screws *i*, and can be adjusted vertically by two $\frac{3}{4}$ -inch adjusting screws *h*. In order to hold the stock being operated on in contact with the angle plate *e*, the springs *f, f* are

attached to the tables *b* and *c*. A detail of one of these springs is shown at (*b*). It consists of a piece of spring steel that is shaped to the desired form and tempered. The edge of the spring is split in such a way as to form a series of carrying springs, each about 1 inch wide, which hold the work in contact with the angle plate *e*. By this device it is possible to plane thin stock smoothly to a uniform thickness with very little trouble, and the form of the attachment avoids all danger of injury to the workman's hands.

CHARACTER OF STOVE PATTERNS.

18. Comparison of Stove Patterns and Ordinary Patterns.—Ordinary patterns for machine parts are usually fairly thick and stiff enough to support themselves. The skilful application of the principles of joinery in the production of the desired form plays an important part in the work of a machine patternmaker. Stove patterns, on the other hand, are usually very thin and must be practically of uniform thickness throughout, and as a consequence such patterns require special treatment. Stove patterns are rarely stiff enough to support themselves; hence, for all but small parts of the stove it is necessary to have a match or support for the wooden pattern for use while making the metal pattern. In many cases the match is made first and the wooden pattern is then made on the match. These patterns are frequently very intricate, having a large amount of carving on them. On account of all these facts, stove patternmaking differs greatly from ordinary patternmaking and is a peculiar branch by itself. There are, however, many points concerning stove patternmaking that the ordinary patternmaker could use with advantage when producing thin or intricate patterns.

19. Materials Used for Stove Patterns.—The original pattern used for stove work is usually made of wood, but in some cases it is modeled in clay or plaster. From the

original pattern a metal pattern is usually made as a master pattern, which is to be preserved. The wooden patterns cannot be preserved and relied on for future work on account of the fact that they are so thin and delicate that they are almost sure to change their shape. Some foundries make their master patterns from iron, and others make them of a white-metal alloy, this white metal consisting of 9 parts of lead to 1 part of antimony, and having a shrinkage of $\frac{1}{16}$ inch per foot. Particular attention, however, is called to the fact that in order to obtain uniform results one brand of lead and one brand of antimony must be adhered to, as different brands have different physical properties. It does not make so much difference what brand is adopted, but one should adhere to the brand first adopted. After the master pattern has been made, and the ordinary working patterns of iron are made from it, the master patterns are preserved in a suitable room or storage. In some cases they are kept in fireproof vaults, as they become the ultimate standards of reference in relation to any given stove.

PROCESSES USED IN MAKING STOVE PATTERNS.

20. Carving and Backing Wooden Patterns.

The simplest method of making a stove pattern is to carve it from wood, backing it out, that is, carving out the back so that it is of uniform thickness throughout. If the pattern is small, like a stove leg, it is not always considered necessary to make a match for it, but the pattern may be tucked up in sand, that is, a sand match may be tucked up for the pattern and the master pattern made directly from the wooden pattern. In the case of all the larger patterns, it is necessary to carve an accurate match that will fit the patterns at all, or practically all, points, and support it while ramming up the drag of the flask when making the master pattern. In the case of regular work, such as stove bases, etc., the match is usually made first and the parts of

the pattern laid on it. The joints are glued together, and the pattern is kept in contact with the match throughout all the work. The match is oiled at any point where glue is used in the pattern, in order to prevent the glue from adhering to the match. After the pattern and match are completed, the iron pattern is made, when both match and wooden pattern are discarded.

21. Carving and Blocking a Wooden Pattern.

In order to avoid the work of backing out a pattern, a system is quite frequently employed in which the face of the pattern is carved and finished to the desired shape, and then the casting produced by so blocking the pattern on a board that a drag can be rammed up from it. This drag is then used as a match, and a cope is rammed up in the usual manner. While the original drag was being rammed, the pattern was surrounded with a thin layer of blocking just the thickness of the desired casting. This blocking is removed and another drag rammed up to be used with the cope already made. By this method the pattern is made to project farther from the molding board in the second case, so as to produce the required thickness of metal. This process will be thoroughly illustrated in connection with a stove pattern later on.

22. Wax Process to Avoid Backing. — In some cases, in order to avoid backing out the pattern, one side only is carved, and from this a plaster-of-Paris cast is made. The pattern is then built up on this cast by pressing some material of uniform thickness into the space covered by the pattern. This is usually accomplished by rolling clay into a thin layer of the desired thickness, cutting it into small strips and pieces, and fitting these into the area covered by the pattern. After the pattern has been built up in clay on the plaster match, the surface of the plaster and the clay is prepared with oil, and the other half of the mold poured in plaster. The two portions of the plaster mold are then taken apart and the filling material cleaned out. Gates and

vents are cut, and a hard-wax pattern made by pouring the space between the halves of the plaster mold full of hard wax. After this, either half of the plaster mold may be used as a match board to support the wax pattern while preparing the sand mold for a metal pattern.

EXAMPLES OF STOVE PATTERNMAKING.

BASE PANEL BY THE BLOCKING PROCESS.

23. The Block Pattern.—The **blocking process** is used by many stove patternmakers for producing metal patterns. As far as the actual work of the patternmaker is concerned, patterns may be made by this process much more simply and with a great deal less work than by the ordinary method of procedure. The first outline pattern made of wood is called a **block pattern**, and is made with 2 shrinks. The drawings for such patterns should be made with measurements taken from a 2-shrink rule, as this will greatly simplify the work of the patternmaker, who also uses a 2-shrink rule. For the block pattern, the best of pine should be chosen, except for the scroll ornamentation, which may be made of mahogany. Pine, being a soft wood, splits and crushes easily, while mahogany, being a medium hard wood, cuts easily and retains the edges given it by carving tools better than pine. For this reason mahogany is preferred for those parts of wooden patterns on which carving must be done. By carefully selecting the stock, a good deal of very delicate carving can be done on pine patterns, and hence some good stove patternmakers use no mahogany.

24. Preparing the Block.—A block composed of pieces glued together is first made of the required length, width, and thickness, which may be 36 inches by 8 inches by $2\frac{1}{2}$ inches. In Fig. 12, the joining of the pieces for the blocks is shown at *b*. In the case illustrated, eight strips 36 inches long, $2\frac{1}{2}$ inches wide, and 1 inch thick, have been

glued together to form the block from which the pattern is to be made. The block is made in this manner to prevent the pattern from warping or getting out of shape. Wood changes its shape from time to time when exposed to the



FIG. 12.

atmosphere, and while the gluing of the pieces does not prevent them from changing, yet the pattern as a whole retains its shape much better than when made of a solid block. After the glue has dried, the block is squared up on all sides and is then ready for the outline of the design.

25. Laying Out the Scroll.—In laying out the section of the pattern on the block, the first thing to do is to trace the shape of the molding and swell, by the use of carbon paper, on a thin piece of board or metal, large enough to cover the end of the section of the panel, as shown at *b*, Fig. 12. The entire outline of the end of the pattern from the top of the molding *d* to the bottom of the swell at *e* must be carved out of the piece of board or metal, so that it can be used as a templet to lay out the outline of the figure on each end of the block with a sharp hard pencil. When the form is laid out harmoniously on both ends, the block can be cut into shape by the use of molding planes. The pattern is now ready for the addition of the ornamentation, which is a scroll of the design shown at *a*. A mahogany strip large enough to take the entire scroll is then prepared, which is laid out directly from the drawing. The mahogany piece should be thick enough to take all the carving, but

need not be any thicker, as it is a rather expensive wood. A thickness of $\frac{3}{8}$ inch is sufficient to give good relief in the carving, and is not so deep that it will interfere with the molding of the piece in the sand, provided easy drafts are given to the pattern. By *easy draft* is meant that the top edges of the pattern should be enough smaller than the bottom edges to allow the pattern to draw out of the sand freely. In Fig. 13 is shown a section of the pattern with proper



FIG. 13.

draft given to all the faces. The bottom surfaces of the mahogany pieces are shaped to the various swells and curves of the pine part of the pattern by rubbing blue chalk on the parts of the pine pattern where the scrolls are to be glued. The chalk blues the mahogany just where it touches the pine and thus shows where the material should be cut away to insure a more perfect fit of the pieces. When the proper fit is obtained, the unnecessary parts are removed and the pieces glued and fastened to the pine pattern. The scroll is then laid out and the carving done. It is the finishing strokes on the pattern by the trained hand of the expert carver that give life and relief to the panel.

26. Finishing the Wooden Pattern.—When the carving is completed, the pattern is prepared for the mold by applying three coats of shellac to the surface of the pattern, with sandpapering between to give a smoother finish. After the first coat of shellac has dried and been sandpapered, the brad holes and other small holes are filled with beeswax and the second coat of shellac applied. When that is dried, the surface is again sandpapered and shellaced, which is the final operation. When dry, it is ready for the molder to make the metal pattern. This operation is frequently called *reversing the pattern*.

27. Preparing the Pattern for Reversing.—The term **reversing the pattern** means the process by which the molder changes the block pattern into an iron-shell

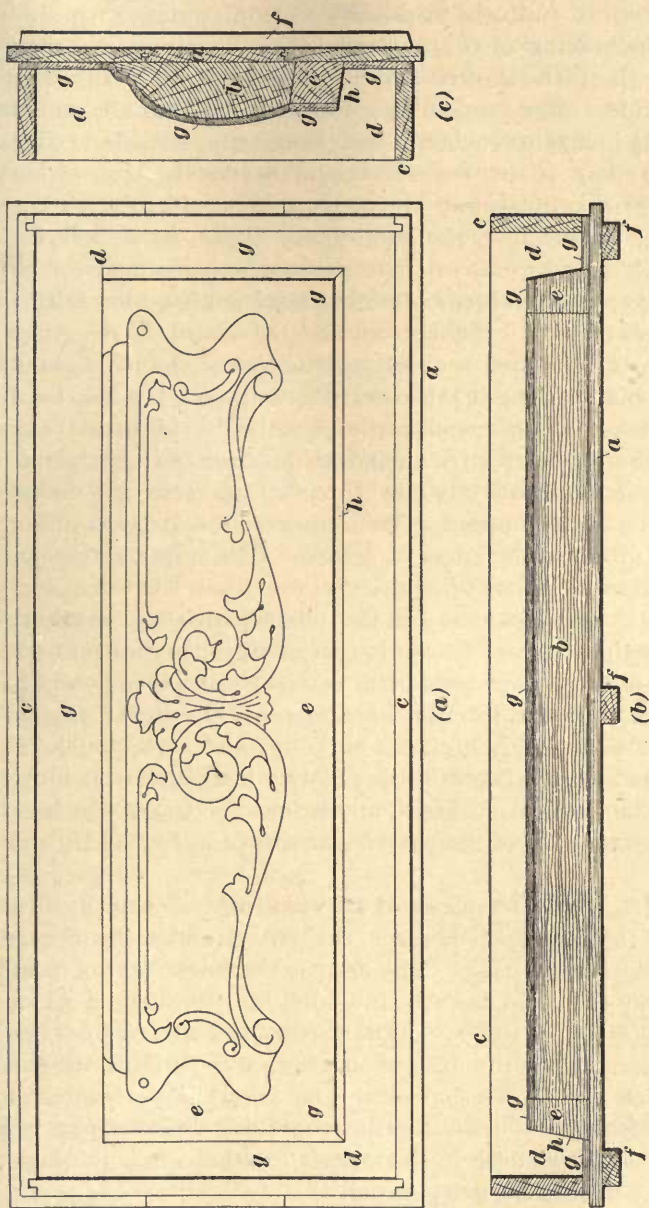

FIG. 14

pattern of uniform thickness. The first step in the process is the making of the pattern board, as shown at *a*, Fig. 14. The pattern shown here is the same as that shown in Fig. 12. The pattern board is made with an allowance of 3 or $3\frac{1}{2}$ inches at each end and at the top, outside of the pattern; but at the bottom the allowance is $4\frac{1}{2}$ or 5 inches. This margin around the pattern *b* is left to allow for the flask shown at *c*, the sand space shown at *d*, and for the blocking shown at *e*. The pattern board is made of two or three pieces of $1\frac{1}{8}$ -inch lumber fastened together with three cleats nailed to the bottom side, as shown at *f*. After the boards are nailed securely to the cleats, the nails should be set and the top of the board trued and leveled, as much depends on the accuracy of the board in these respects. Next, the pattern is fitted to position on the board and fastened there by two or three screws from the under side of the pattern board. The required iron pattern is to be of the uniform thickness of $\frac{1}{8}$ inch. The upper surface of the blocking *e* is made just $\frac{1}{8}$ inch lower than the top of the pattern. The blocking fits the pattern on three sides, and is given plenty of draft on its outer edges, as shown at *h*. On top of the blocking and the pattern board thin pieces $\frac{1}{8}$ inch thick, called thickening, are fastened, as shown at *g*. The *thickening* is stock planed to $\frac{1}{8}$ inch and tacked all over the horizontal surfaces of the pattern board and blocking, but not on vertical surfaces, and brings the top of the blocking up to the face of the pattern, as shown in Fig. 14 (*b*) and (*c*).

28. The Process of Reversing.—When the blocking and thickening are in place, the pattern and pattern board are ready for the flask. The *drag* is the lower part of the flask when the mold is cast, and contains the sand in which the impression of the face of the pattern is made. The *cope* is the upper part of the flask in casting, and contains the sand in which the impression of the back of the pattern is made. Flasks are provided with dowel-plates and dowel-pins to hold the cope and drag in the proper relation when put together after having been separated.

The pattern, pattern board, blocking, and thickening being all ready, the drag is placed upside down on the pattern board and thickening. Fine sand is sifted all over the pattern, and then the drag is filled up with heap sand rammed hard, and struck off in the usual manner. A bottom board is placed on top, rubbed down to a firm bed on the sand and flask, and the whole clamped together and rolled over. The clamps are removed, and the pattern, which is now upside down, is ready for removal. The pattern board is loosened from the flask and sand by wedges placed between it and the flask. When the pattern is started squarely all around, it is lifted off by hand and leaves in the drag an impression of the face of the pattern. The cope of the flask, which has ribs in it crosswise with edges projecting to within about $\frac{3}{4}$ inch of the pattern, is placed on the drag. Parting sand is then sprinkled all over the drag, and whatever does not adhere to the moist mold is blown off with a bellows. The sprue pins, which are conical pieces of wood, are set on one or more parts of the flat sand face of the mold, not on the pattern. These sprue pins are as long or a little longer than the cope is deep, so that when the cope is filled up with sand they can be withdrawn, leaving holes through the cope for the metal to enter. When the cope part of the mold is completed, it is lifted off and placed to one side. The drag is shaken out because it is necessary to make a new one with the thickening removed from the pattern board and blocking. By removing this thickening the second drag is made $\frac{1}{8}$ inch deeper than the first on the horizontal planes, but the curved or vertical parts will not be $\frac{1}{8}$ inch thicker. This is illustrated in Fig. 15, where *a* is lifted above *b*, giving a $\frac{1}{8}$ -inch space where the lines are horizontal, but approaching nothing as they approach the vertical. In order to have a $\frac{1}{8}$ -inch space on the sides, it is necessary to cut away the sand

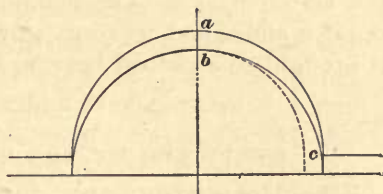

FIG. 15.

of the mold along the dotted line *b c*. This same operation must be performed in the mold for the piece shown in Fig. 14, and it requires great care and good judgment to cut away the sand so as to give the exact $\frac{1}{8}$ -inch thickness to the curved parts of the mold. The second drag part of the mold is made in the same manner as the first; the sand is removed as just described and gates cut from the sprues so as to form shallow passages for the iron on its way to the mold. Leaving the drag on the bottom board, the cope is now placed on the new drag, and when clamped down appears as shown in Fig. 16, which is a section of the mold.

The impression of the pattern is shown at *a*, the gate at *b*, the sprue at *c*, the sand at *d, d*, the cope part of the flask at *e*, the drag part of the flask at *f*, the clamps at *g*, and the bottom board at *h*.

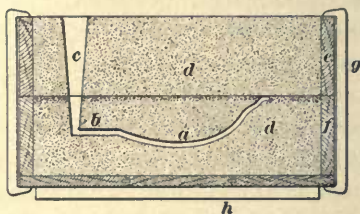

FIG. 16.

The mold is now completed and ready to cast a metal pattern for the panel. After the metal pattern is cast, it is finished by filing and scraping and then varnishing. It is necessary to make a wooden match board for the pattern to keep it from springing during molding. A plain molding board is made, a piece of wood fastened to it and carved to approximately the shape of the under side of the pattern. Blue chalk is then rubbed on the pattern and it is fitted on the match board. The chalk marks the high parts, which require additional carving. By repeating this, the pattern is brought to a perfect bearing on the match board.

STOVE LEG BY THE BLOCKING PROCESS.

29. Preparing the Stock.—Prepare a block of mahogany as long as the leg is to be high, and as square as the fulness of the leg requires. The block should be made of 1-inch stock glued together, as indicated by the parallel lines in Fig. 17. When the block is made and squared up

on all sides, it is to be split diagonally with a saw and glued together again as shown by the dotted line *ab* in (b). The reason for splitting diagonally and gluing together again, is to establish a center line all through the block for convenience in making measurements. No matter where a cut is made in shaping the face of the pattern, the diagonal joint line will be present as a center line.

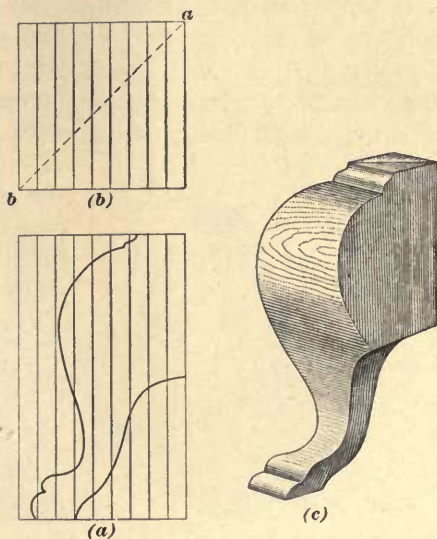

FIG. 17.

30. Forming the Leg.

— Having completed the block, trace from the drawing the outline of the leg on two sides of the block, as shown in (a), at right angles to each other, and proceed to saw out from one side. By so doing the saw will cut into lines on the other side, and when the pieces leave the block they should be tacked back temporarily and the second side sawed. Then, after removing all the tacks, all the waste parts will fall off, leaving the leg in the shape shown at (c).

Continue to shape the leg, principally with the gouge and the spoke shave, using a templet of the leg as a guide. The back corner of the block is the axis of the center corner of the range or stove body, and is shown at *a*, Fig. 17 (b). All projecting parts of the pattern are measured from the center line, which is sometimes called the 45° line, of the leg. The lower sides of the leg are shaped to conform to the ends of base panels.

The *grace lines*, as they are called, are given to the foot of the leg according to the width at the point *a*, as shown in

Fig. 18 (a), and the sides of the leg are shaped to meet the design of base panels.

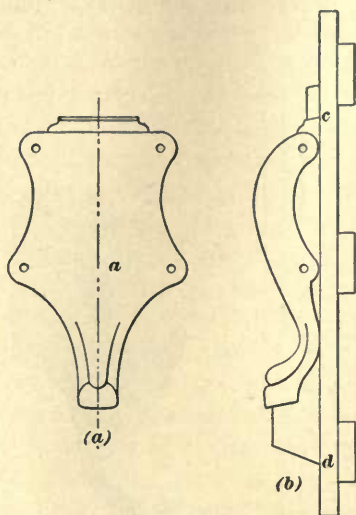

FIG. 18.

In shaping the pattern, care should be taken to leave the proper thickness of stock for carving the ornamental part, which should be about $\frac{3}{16}$ or $\frac{1}{4}$ inch. The depth of the carving cannot be as great on a leg as on the panel previously considered on account of its shape, making it difficult to give draft to deep carving. To prepare a leg pattern to be fastened to the pattern board, the back corner is cut away to as near the finished line as possible, as shown at *cd*, Fig. 18 (b),

so as to have the projecting parts as near the same height above the pattern board as possible.

31. Blocking the Leg.—This pattern is blocked on the pattern board, as shown in Fig. 18 (b), for it is to be reversed, the process being the same as for the base panel. This leg pattern is made with a 3-shrink rule, because it is to be molded on a match plate, which is a plate of iron on which two leg patterns are cast, so as to make two legs at one ramming on in one flask. Hence, there would be 1 shrink for the reverse from the block pattern, 1 shrink for the match plate, and 1 shrink for the finished casting.

STOVE-LEG PATTERN AND BASE PANEL BY THE BACKING PROCESS.

32. Stove-Leg Pattern.—The term **backing** comes from the method of making the pattern by carving out the back to resemble the front of the pattern and thus making in wood a finished pattern of the piece having a uniform

thickness. The front of the leg, with scroll or whatever figure it may have, is carved out first, as shown at *e*, Fig. 19 (*a*). This pattern may be made entirely of pine, the piece being glued up, the stock cornered, and the sawing done as described in Arts. 29 and 30. The back, shown at *f*, is still to be removed. At *d*, Fig. 19 (*b*), the same pattern is shown partly backed out, and at (*c*) the backing has been completed.

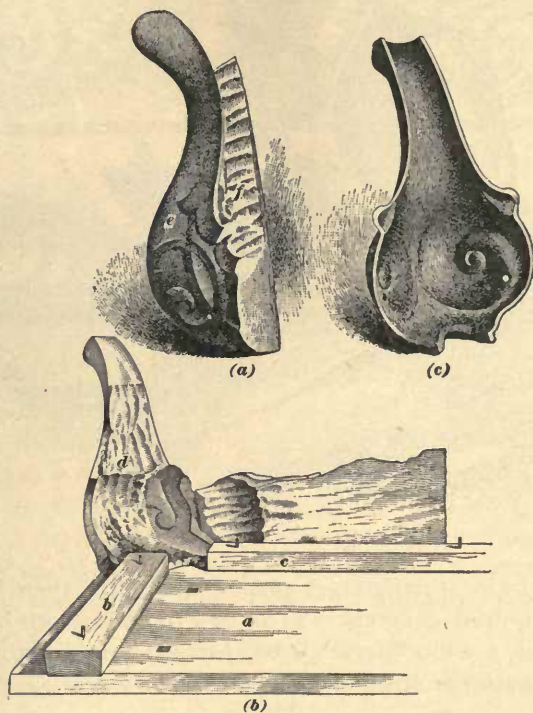

FIG. 19.

While backing out the pattern it is held in the left hand, while the patternmaker holds the carving tool in the right as he manipulates it in and out of the curves, as shown in Fig. 20. Experience and judgment have taught the workman what shape the casting will have, so that the pattern can be made to overcome any warping tendency by giving it an opposite curve. The marking calipers previously

explained are used to trace the figure of the carving on the back from the front. When the back is carved as near to the correct size as can be with the eye, the thickness calipers



FIG. 20.

are used to locate any thick places, which are then brought to the required thinness. Soon after this pattern has been completed, a white-metal master pattern is made from which the iron patterns are molded and cast.

33. Base-Panel Patterns.—The stock for the front base panel is glued up and worked to the general form of the panel, as described in Art. 24. If the block is made entirely of pine, allowance for carving must be made when working the block down to the general shape of the panel. The front panel of the base is carved out in the same manner as the leg, and is shown at Fig. 21 (*a*). This must be trimmed around the outside, which is usually done on the

band or jig saw, and then backed out in the same manner as the stove leg. At (b) is shown the back of the same panel, showing how the pattern is backed out to the outline of the front or face side. This panel is fitted to the leg patterns by rubbing blue chalk on one pattern and then rubbing the patterns together to show where the trimming must be done



(a)



(b)

FIG. 21.

to bring them to a good fit. The device shown in Fig. 19 (b) will be found useful in doing this work. It consists of a base board *a* on which two strips *b* and *c* are secured at right angles to each other. The leg is placed at one corner, as shown at *d*, and the panels placed against the strips *b* and *c*. The use of this device secures not only an accurate fit, but makes it easy to produce a base with square corners.

MAKING A PATTERN FOR THE FRONT JAMB OF A RANGE.

34. Preparing the Pattern Board.—The front jamb of a range is the part where the oven door is located. Such a jamb is shown in Fig. 22, with the elevation at (a), a section on *ab* at (b), and a section on *cd* at (c). The first step in the process of making the pattern for this jamb is to make a pattern board, on which the pattern is to be fastened, $3\frac{1}{2}$ inches larger all around than the pattern. This board should, if possible, be made of $1\frac{1}{8}$ -inch pine boards

5 inches wide, that have been thoroughly seasoned or kiln dried. If wider pieces are used, saw cuts should be made two-thirds of the way through the boards and sufficiently close together to allow the board to be easily bent to the

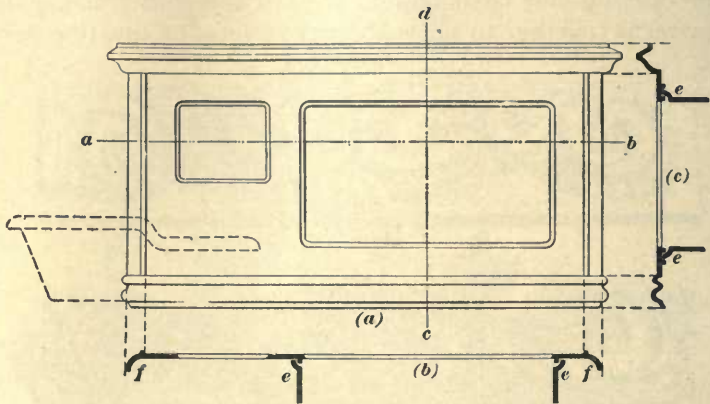

FIG. 22.

desired shape. Three cleats are then nailed to the boards, five nails being used to fasten each board to each cleat, as shown at *a, a*, Fig. 23 (*a*). The casting made from a straight pattern often comes out warped or with a bend in it, and so it is sometimes necessary to bend the pattern in the

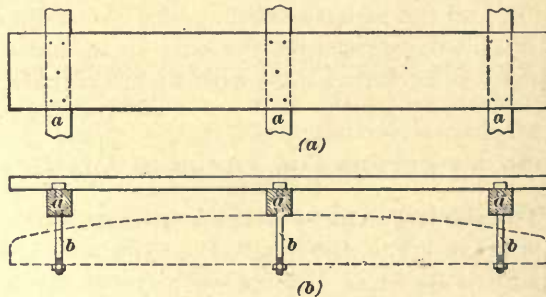

FIG. 23.

opposite direction so that the casting will come out straight. In such a case the mold board shown in Fig. 23 is arranged with bolts, shown at *b, b*, through the cleats and pulling against a curved piece shown by the dotted lines, so as to

give the mold board the desired shape. This same method is used to prevent the pattern from warping after coming in contact with the wet sand. Before putting the pattern together on the pattern board, the pieces are all prepared so that they may be put on in a short time.

35. Preparing the Moldings.—A number of thin pieces, 4 inches wide and $\frac{1}{16}$ inch thick, of different lengths,

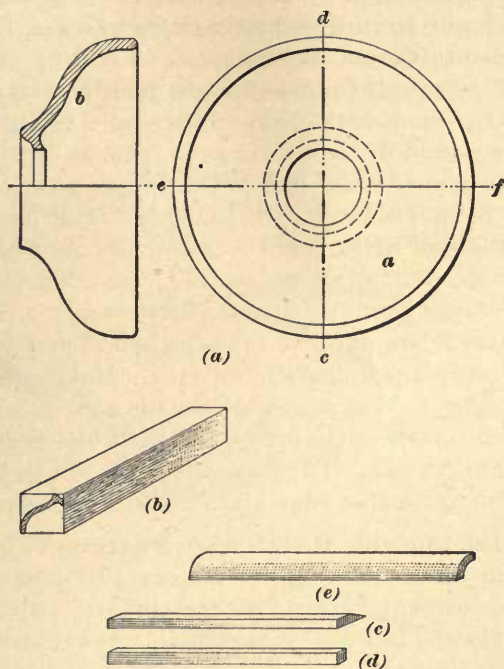

FIG. 24.

are prepared, special care being taken to have all the thin parts just $\frac{1}{16}$ inch thick. The straight moldings for the sides and ends are then made, and a piece of the same cross-section turned for the corners. This is done for each different style of molding, and the turned pieces are each cut into four pieces. Each turned piece is made as shown in Fig. 24 (a), where *a* shows the entire piece, and *b* a half-section of it. The pieces *a* are then cut into quarters along

the lines *cd* and *ef*. One of these quarter pieces can be used as a templet by which to lay out the straight moldings.

To make the straight moldings, prepare pieces of the proper length, thickness, and width, according to the dimensions given on the drawing. Lay the templet on the end of the piece, mark around it with a fine hard pencil, as shown in (*b*), and work off the outside to the shape thus marked, by means of saw, rabbet plane, rounds, and gouges. Then mark out the inside by the same process, being sure to have even thickness throughout.

In order to prepare the match to fit these pieces, take rectangular strips and mark them on the end with the inside of the moldings, and fit the moldings to them until they will fit the templet corner when laid in the proper position. Next make the flanges shown at (*c*) and (*d*). The flange at (*c*) supports the flue strips, and the one at (*d*) goes around the oven-door opening, as shown at *e*, Fig. 22. Then make the corner moldings as shown at (*e*), also shown at *f*, Fig. 22.

To construct the pattern, take the board prepared in the first place and plane it up perfectly true. Make one edge perfectly straight, so that it can be used for a guide edge; then any number of lines can be drawn parallel, which is very essential to a true pattern. These parallel lines can be laid off at right angles to the true edge and scribed with a sharp knife.

36. Making the Match and Pattern.—The match is now built up on this board of the exact form of the under side of the pattern. Start with the corners, which are laid out carefully and followed with the moldings that have been fitted to the inside of the molding of which the pattern is to be made. When the match is finished, it is oiled all over, and the pattern proper is built up of the moldings that have been prepared and any flat pieces of the same thickness that may be necessary. They are glued together on the pattern board, and hence the pattern always fits the match. The oil on the match prevents the glue from causing the pattern and match to adhere with any great tenacity. When the pattern is put together, it is sandpapered, coated with shellac varnish, and sandpapered again. Beeswax is then put into

any small holes, and two more coats of shellac are given the pattern. It is now finished, having a hard smooth surface, and is ready for the molder. In making the iron pattern, the molder uses the wooden match to support the wooden pattern while ramming up the nowel. If it is necessary to have the finished iron pattern curved to make the castings come out straight, it will be necessary to construct the wooden pattern with double the amount of curve necessary in the iron pattern, as the iron pattern will spring in cooling just as a casting would. After the iron pattern is made and finished, a wooden match board is made for it.

MAIN TOP OF RANGE.

37. Preparing to Make the Pattern.—The main top of a range or stove is made in one casting, although it

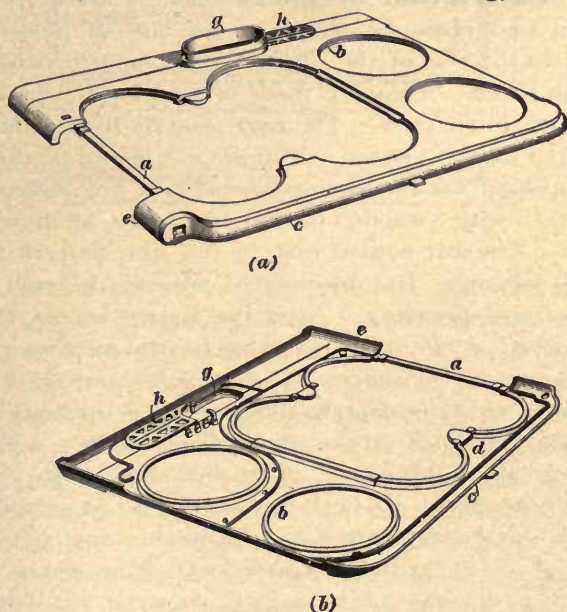

FIG. 25.

is often found to be of advantage to have the pattern in parts, so that by different combinations of parts a variety of

tops are available without having a separate pattern for each. In Fig. 25 is shown the iron pattern of a range top; at (a) the top side is shown, and at (b) the under side. The first pattern for this top is sometimes made entirely of pine. The different parts are prepared before the pattern is put together in a manner similar to that explained in connection with the range jamb. The match is also prepared in a similar manner, building up on the board the corners and moldings to the exact form of the under side of the top. This is smoothed off and oiled, and the pattern is glued together on the board, giving it a good bearing at every point. It would be impossible to make the pattern first and then build a board to fit the pattern accurately without a great waste of time.

38. Description of Parts.—Range tops are often made in four sizes, according to the size of holes in the top and to the size of the oven of the range for which the top is prepared. They are made of a uniform thickness of, say, $\frac{1}{8}$ inch in all sizes. The front end of the top is where the broiler door is located. Flanges are placed on each side of the opening for the broiler door, which are connected in the pattern with a wooden bar called a *splice*, as shown at *a*, Fig. 25. The bar is also cast in the iron pattern and in the final casting. Its object is to prevent the end of the casting from spreading. After the casting is cool, the bar is broken out. The splice is merely for the purpose of holding the pattern in shape. The rabbet shown at *b* is the cover seat, which is depressed below the main body of the top. The moldings on the edges, as shown at *c*, are made separately and fastened on. The small ribs shown at *d* are for the side plates to butt against. The front moldings are shown at *e* and fastened on in a manner similar to those shown at *c*. On the back edge is located the smoke collar, shown at *g*, and the check-damper, shown at *h*. The work of putting the parts together and finishing the pattern ready for the molder is the same as that described for the jamb pattern. The central portion of the top that contains

the openings for the lids is often made separate, so that different combinations of tops or side flanges can be obtained to suit different sizes of stoves without having entire patterns for each size.

RANGE BOTTOM.

39. The pattern for a range bottom is made on a match in a manner very similar to that of the other range patterns.

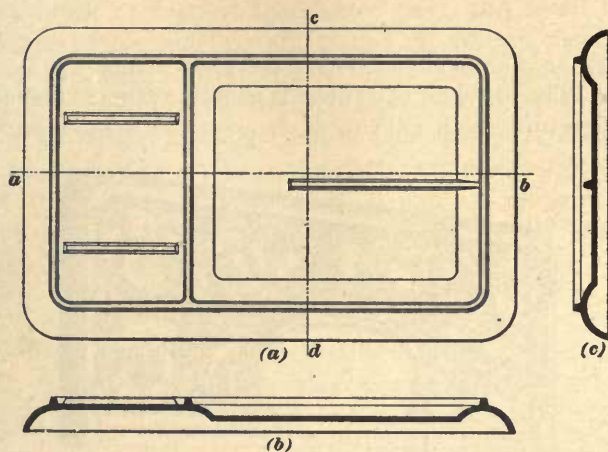

FIG. 26.

The corners are turned and cut into quarters, as for the range top, and they are the first pieces located on the match. The main part of the stock is $\frac{1}{16}$ inch thick and should be very uniform. The pattern appears as shown in Fig. 26, with the plan at (a), a section on *a b* at (b), and a section on *c d* at (c). When the wooden pattern is completed, it is placed on the match and the drag of the mold is made in the usual manner. The match is removed and the cope of the mold made with the pattern still in the drag. When the cope is taken off, the mold is finished in the usual way. Sometimes a gate is cut all around the mold for the metal to flow through, with smaller gates at intervals, to the mold. When this is done, it is not necessary to bend the pattern board, as these gates tend to keep the casting in shape by

drawing against any internal warping action. The casting may be taken out of the sand before it is entirely cooled, to be watched, and when it is bent a little more than is required, the gates are knocked off. This need only be done in making the pattern, for if that is properly shaped, the final castings should come out perfectly flat and true. Experience is the only thing that can be counted on as a guide as to the proper curve to give the iron pattern.

TOP RANGE SHELF.

40. The top shelf of a range is usually rather ornamental, and therefore much carving is done on the wooden pattern.

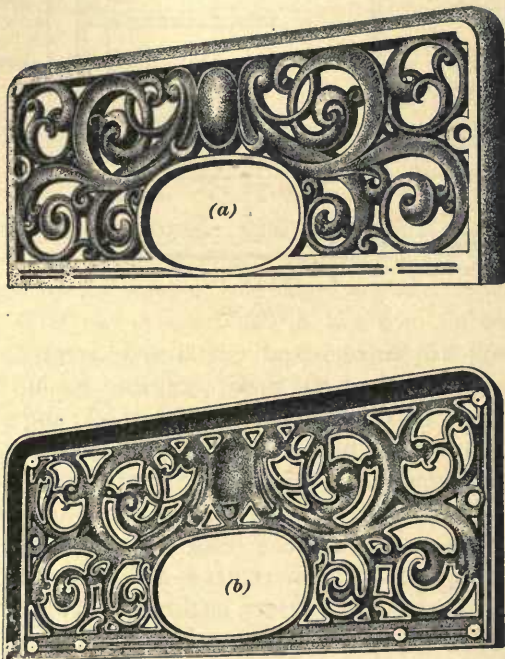

FIG. 27.

This pattern is frequently made of mahogany, and is cut out of a block formed by gluing small pieces together to

prevent warping in a manner similar to that already described. The thickness of the stock should be about $\frac{1}{2}$ inch, in order to give good relief to the design and to allow proper backing. The design is transferred to the finished block and carved out accurately by the skilled workman who carves the face work, and then it is backed out by a workman who makes a specialty of this work. When the pattern is finished, the pattern board is prepared with a block to support the carved part, and small blocks the shape of the molding are placed all around the curved edge of the shelf. When the pattern board is finished, all is ready for making the iron pattern, which is shown in Fig. 27 (*a*) and (*b*). The front or face side is shown at (*a*), and the back at (*b*). When the pattern is finished, it should be of the uniform thickness of $\frac{1}{16}$ inch on all iron parts except the bottom edge of the molding. After the iron pattern is made, a wooden match is carved for it.

STOVE DOOR BY THE WAX PROCESS.

41. As has already been explained, the wax process involves the making of a wax pattern by casting it in a plaster mold. A pine pattern is first made and carefully carved on the front face, as shown in Fig. 28 (*a*), but the back is left untouched, as shown at (*b*). This pattern is fastened to a mold board, thoroughly greased, and a frame placed around it. A mold is cast in plaster of Paris, which, when the pattern is removed, appears as shown at (*c*). Then specially prepared clay that dries slowly is rolled out between two thin pieces, to give it the correct thickness; this is done with a rolling pin in a manner similar to rolling out pie crust. This is cut into strips and carefully pressed into the face of the plaster cast left by the wooden pattern, one strip at a time, until it has the right thickness all over. It is then trimmed up, any imperfections pressed out, and the hinges and other parts are carefully built up to the shape desired, after which a plaster cast of this is made. This forms the

back part of the plaster mold, as shown at (*d*), and when put together with (*c*), so that the projections *a*, *a* fit the holes *b*, *b*, the mold has the proper thickness for a pattern of the desired door. Gates *c* and vents *d* are then cut in the plaster. Wax is heated and run into this mold and takes the shape of the mold quickly. The front face of such a wax pattern is shown at (*e*), and the back face at (*f*). This wax

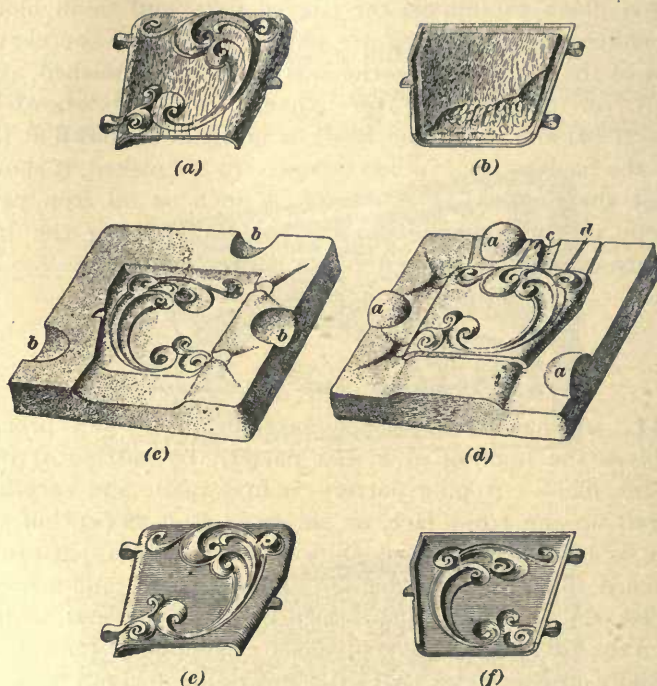

FIG. 28.

pattern is quite substantial and can be used almost like a wood pattern. From this wax pattern a master pattern is cast in white metal by using one of the plaster-cast molds as a match in ramming up the sand mold. Sometimes the wax pattern is used as the master pattern, and the iron patterns are made from it direct, but in such case the wax

pattern must be made with 2 shrinks instead of $2\frac{1}{2}$, as would be needed if making a white-metal master pattern.

Considerable practice or experience is necessary to work this method successfully, but when the peculiarities of the process are mastered, it gives very satisfactory results. The same brand of plaster of Paris should always be used if uniform results are desired.

GREEN-SAND MOLDING.

(PART 1.)

IRON AND BRASS MOLDING.

INTRODUCTION.

1. Founding is a trade that involves some knowledge of almost every operation required in the making of machines; and men well versed in the mechanic arts assert that the art of founding demands greater mechanical skill, caution, and good judgment than any other of the allied trades. The art of founding is largely dependent on the hand, eye, and mind for results, machinery having played but a small part in the work of molders compared to what it has done for workers in most other trades.

2. There are three branches of molding, termed, respectively, *green-sand*, *dry-sand*, and *loam molding*. **Green-sand molding** involves the making of castings in molds that are composed entirely of sand in a damp state, or that have their surfaces "skin dried."

Dry-sand molding involves the making of castings in molds that are made with sand in a damp state, after which the sand is dried in an oven, or otherwise, so as to remove all moisture and leave the body of the mold dry and firm.

In **loam molding**, the castings are made in molds constructed with sweeps and skeletons of patterns; a mixture of loamy sand and other material is used to form the face of the mold, brickwork forming the outer and inner supports.

This class of work, like dry-sand molding, requires thorough drying before pouring the metal into the molds.

3. The practice of some shops embraces all three branches, but most foundries make only green-sand molds. There is generally more risk in making medium and large castings in green-sand molds than in dry-sand or loam molds. In many cases a poor class of molders or inexperienced men may be employed for making dry-sand molds, but it is seldom wise to trust other than skilled workmen with the construction of green-sand molds, especially in heavy work. Loam work varies greatly in the degree of skill required. Some classes of loam molds permit the employment of inferior workmen, while others demand extraordinary experience, skill, and good judgment in their production.

DEFINITIONS.

4. The following are the definitions of some of the most common terms used in founding. They are given at this point so that they can all be found readily in case a student should care to refer to them and find the exact meaning of the terms when they occur later in the work.

A **flask** is a frame or box that keeps the sand in place while the casting is being made. Flasks may be made of wood or metal. A flask is composed of two or more parts. When composed of two parts, the one that stands underneath while the mold is being poured is called the **drag**, or **nowel**, while the portion that is molded last, and that stands uppermost while the casting is being poured, is called the **cope**. When a flask has more than two parts, the portions between the cope and the nowel are called **intermediate parts**, or **checks**. These terms are applied both to the parts of the flask and to the parts of the mold contained in the flask.

The **molding board**, sometimes called the **follow board**, is the board or plate on which the pattern is placed while ramming the sand into the drag.

The **bottom board** is the board or plate that is placed on top of the drag and fastened there before rolling it over, and hence it becomes the bottom of the mold during the subsequent molding and casting operations.

A **pattern** in connection with the foundry and machinery business is understood to be a form by the use of which a mold may be made.

A **sprue pin** is a wooden or metal pin used for making an opening in the cope through which the metal may be poured while casting. The opening formed by a sprue pin is called a **sprue** and connects the upper surface of the mold with a system of *gates* beneath. The sprue is sometimes called a **vertical runner**. The term is also applied to the body of metal that occupies the sprue passages after the casting is made.

A **gate** is an opening in the sand that connects the sprue, or **runner basin**, with the pattern. Gates may be horizontal or vertical, and in the case of some vertical gates may take the place of the sprue or runner basin. In fact, the terms gate and sprue are frequently used interchangeably. The term is also applied to the body of metal that occupies the gate passages after the casting is made.

A **draw-nail**, or **draw-spike**, is a sharp piece of metal used in drawing a pattern from the mold. It is driven into the pattern and holds by friction.

A **draw-hook** is a metal hook with a handle, used for drawing patterns that are supplied with special **drawing plates** to receive the end of the hook.

A **draw-screw** is a rod having a thread at one end, and is used for drawing patterns when they are provided with draw-plates attached to receive the draw-screw.

Drawing and rapping plates are metal plates fastened on patterns and intended to receive the ends of draw-hooks, draw-screws, or rapping irons. Frequently a draw-screw is used by screwing it into the hole in the draw-plate. The pattern may be loosened by rapping sidewise on the draw-screw, but it is better practice to use a rapping iron in a separate and unthreaded hole in the drawing plate.

A **riser**, or **feed-head**, is an opening from the cope face of a pattern to the face of the mold into which the surplus metal rises above the face of the casting.

Shake is the allowance that is made in the size of a pattern to permit its being rapped sidewise in order to loosen it in the mold so that it may be removed. Such an allowance is generally made only on patterns under 4 inches across.

Shrinkage is the allowance made on a pattern to compensate for the shrinkage of the metal in cooling.

Draft is a term used to denote that a pattern is tapered, the larger face of the pattern being at the parting line or surface of the mold. An allowance for draft is made to facilitate the withdrawing of the pattern from the sand, and results in the increase of certain dimensions of the pattern.

Molding sand is any sand used to make molds. It usually consists of a natural mixture of sharp sand and clay, the latter being necessary to make it adhere, or stick, together.

Parting sand is a general term applied to any material used to prevent two surfaces of a mold from adhering. It is usually sharp or burned sand.

Fireclay is any clay capable of withstanding intense heat. It is used for lining ladles, lining cupolas, and any place where great heat must be resisted.

Facing is a general term applied to any material used for lining the walls of a mold for the purpose of improving the surface of the casting.

A **rammer** is a tool used for tamping the sand in the mold. There are two classes of rammers—**hand rammers** and **floor rammers**. Hand rammers are used for light molding, and are only from 16 to 20 inches in length. Floor rammers are intended for heavy molding, and are usually several feet in length. One end of the rammer has a small rectangular point called the **peen**, and the other end a large flat surface called a **butt**. Rubber-tipped rammers are made, which are excellent for ramming close to the pattern and to insure even ramming.

A **sieve** is a tool used for sifting sand or for removing coarse material from the sand. The hand sieve is composed of a circular frame, the bottom of which is covered with wire cloth.

A **riddle** is a coarse sieve. The terms riddle and sieve are sometimes used interchangeably in the foundry.

A **trowel** is a flat metal tool provided with a suitable handle and is used in smoothing the sand in a mold or in place of a small shovel. There are a large number of forms of trowels used in molding that will be illustrated and described in connection with the work on which they are required.

Slickers are small trowels, or trowel-like tools, used for finishing the face of the mold, and will be illustrated in connection with the work on which they are required.

Gate cutters are small trowels or bent pieces of sheet metal employed for cutting the gates from the bottom of the sprue or down-gating to the opening left by the pattern.

A **vent** is any opening in the mold provided for the escape of gas or steam.

A **vent wire** is a small rod or wire used for forming the vent.

Rolling over is a term applied to the method of making a mold by making part of it in the drag, turning it over, and making the balance or upper portion of the mold in the cope.

Bedding in is a term applied to the making of a mold without rolling over, the first portion of the mold being made in the floor of the foundry. When all the casting is below the level of the floor, the cope is sometimes omitted, when it is said to be *open-sand casting*. In other cases, a portion of the casting may project above the floor, or a good surface may be required on the upper face of the casting, when it will be necessary to use a cope on top of the floor. In this case the floor mold is said to be *coped*.

A **core** is the name applied to any body of sand that projects into a mold. A core may be left by the pattern or may be formed separately and placed in the mold. In the

latter case it is necessary to provide the pattern with core prints or projections to receive the ends of the core.

A **core box** is a box or frame in which sand is packed to form a core. The core box and the pattern are usually considered together as patterns for making a given casting.

MATERIALS.

MOLDING SAND.

5. Adhesive Qualities.—Molding sand is a mixture of sand or silica with a certain amount of clay or binding material that aids the sand in retaining any shape given it by pressure. The term molding sand is used to cover a large variety of sands employed in the different branches of green-sand molding. Sand is said to be *sharp* when its individual grains are angular, and *dull* when its individual grains are round. Sand is said to be *strong* when a body of it manifests a disposition to retain any shape that may be given it, and *weak* when it tends to fall apart and will not retain a given shape. Other things being equal, the sharper the sand, the stronger it is; but the sharpest sand is weak without some cementing material, as clay. Sharp sand alone will not hold its shape, while too strong a sand will not permit the gases to escape through it during the casting.

6. Grades of Sand.—The sand for making green-sand molds should vary in its physical qualities according as the castings to be made are light or heavy. For light castings the sand should be of a fine grain, while heavy castings require sands that are of an open, coarse-grained texture. If the sands that are best fitted for heavy work are used in making light work, the castings will have a rough skin, or surface. If the fine sands suitable for light castings are used for making heavy ones, there will be great danger of creating scabs or causing the castings to blow, on account of the sand being so fine in texture that it will not allow the gases (created at the face of the mold by heavy bodies of

molten metal) to escape freely through the sand and vent holes of the flasks. There is also a tendency for fine sand to form a vitreous coating or scale on large castings, which can only be removed by pickling in acid.

7. Chemical and Physical Properties of Sand.

Sand varies more in its physical properties than in its chemical composition. The chief constituent of sand is silica, though it contains alumina, magnesia, lime, iron, soda, and combined water. Different sands vary in the proportion in which these elements are combined. This affects the character of the sand for molding purposes to a large extent, which will be explained later. The variation in physical properties is more apparent and greater, but no more important. The sand may be fine or coarse, according to the size of the grains. The class or grade to which a certain sand belongs depends on this property in the sand. A detailed method for determining the fineness will be given later.

8. Silica.—Silica is the fire-resisting element; it has no bond, that is, it has no binding property; consequently, in a sand where adhesiveness is required, alumina must be present. Silica alone is very refractory, but in the presence of fluxing elements, it forms silicates that fuse or melt about as follows:

- Silicate of alumina melts at 4,350° F.
- Silicate of magnesia melts at 3,960° F.
- Silicate of lime melts at 3,810° F.
- Silicate of iron melts at 3,270° F.
- Silicate of soda melts at 1,500° F.

When soda or potash is present, silicates are formed at low temperatures. Iron melts at 2,200° to 2,300° F.; consequently, a sand containing much iron, lime, and alkali will burn or fuse into the molten metal. In other words, the more lime or alkali present, the more easily is the sand converted into slag.

9. Alumina.—Alumina causes the particles of sand to hold together; hence, a sand high in alumina is said to be

strong, or possess bond. Alumina is very refractory, but, unlike silica, it bakes altogether like pottery at a high temperature; consequently, too much alumina must not be present in molding sand.

10. Lime.—Lime may exist in sand as oxide, hydrate, carbonate, or sulphate, but usually as carbonate or oxide. The carbonate is the most objectionable. Most of the lime salts are converted into oxide on burning; consequently, excess of lime will cause a mold either to drop or to crumble.

11. Iron, Manganese, and Magnesia.—If combined iron is present, it may be converted into ferric oxide by heat and, in the presence of silica, produce slag. Manganese in sand acts in a similar manner to iron, but is not so energetic. Magnesia is very similar to lime, but less harmful on account of its being more refractory.

12. Organic Matter.—Organic matter gives bond to sand, but the bond is destroyed by the burning of the organic matter as soon as it comes in contact with the molten metal, causing the sand to shrink and fall or crumble.

13. Combined Water.—Combined water is always present in high alumina sands, and is one reason for the shrinkage in a strong bonded sand.

14. Fineness.—Fineness of sand can be determined by the use of sieves, when a standard has been decided on. A good standard, and one that has been used to grade fineness, is to sift the sand through five sieves of 100, 80, 60, 40, and 20 mesh. Exactly 100 grams of sand is sifted 1 minute in the 100-mesh sieve; the part that goes through is weighed, and the balance sifted in the 80-mesh sieve, and the process repeated on all the other sizes of sieves. Any loss is credited to the 60-mesh sieve, and any that does not go through the 20-mesh sieve is credited to a 1-mesh sieve. The weights of sand going through each sieve are then multiplied by the mesh and the total divided by 100, which gives the degree of fineness.

The following example will more clearly illustrate the method and calculations:

WEIGHT OF SAND PASSING THROUGH	NUMBER OF MESH OF SIEVE	
55.22 grams	by 100 mesh	5,522.00
20.89 grams	by 80 mesh	1,671.20
11.64 grams	by 60 mesh	698.40
10.57 grams	by 40 mesh	422.80
1.20 grams	by 20 mesh	24.00
.06 gram	by 1 mesh	.06
.42 loss	by 60 mesh	25.20
<hr/> 100.00 grams		<hr/> 8,363.66

Thus, 8,363.66 divided by 100 gives 83.64 per cent. as the percentage of fineness.

By this method the sand is graded into five grades according to its fineness.

GRADE	DEGREE OF FINENESS
No. 1. Superfine.....	Above 100 per cent.
No. 2. Fine.....	90 to 100 per cent.
No. 3. Medium.....	75 to 90 per cent.
No. 4. Coarse or heavy.....	55 to 75 per cent.
No. 5. Extra coarse.....	30 to 55 per cent.

15. Quality of Sand.—Besides grading sand according to its degree of fineness, its quality should be determined for classification according to its chemical composition. A sand will then have a grade and a class that, taken together, will give a good idea of its value for foundry purposes. Three kinds of sand cover the field almost completely for classification as to quality. They are: *silica*, or *fire-sand*, *molding sand*, and *core sand*.

16. Silica, or Fire-Sand.—Silica, or fire-sand, is used for steel castings and where very high temperatures are necessary. Good fire-sand will usually run about 98 per cent. of silica, with very little alumina, lime, magnesia, or

combined water, and not more than a trace of iron. The following is an analysis of a good fire-sand:

Silica	98.04 per cent.
Alumina	1.40 per cent.
Iron06 per cent.
Lime20 per cent.
Magnesia16 per cent.
Combined water14 per cent.
Total	100.00 per cent.

Specific gravity, 2.592.

17. Molding Sand.—Molding sand for ironwork generally contains from 75 to 85 per cent. of silica, 5 to 13 per cent. of alumina, usually less than 2.5 per cent. of lime and magnesia, not over .75 per cent. of fixed alkali, generally less than 5 per cent. of iron, and seldom more than 4 per cent. of combined water.

18. Core Sand.—The quality or chemical composition of a core sand according to some authorities is of minor importance, the degree of fineness being the main feature. As a rule, a good core sand should be high in silica and low in alumina. The bond for core sand is obtained by adding resin, flour, etc.; consequently, the desired effect is produced with a high silica sand or with sand low in alumina and iron. A sand low in alumina and iron will permit the gases to escape rapidly, whereas a high alumina or a clay sand bakes and holds back the gases.

19. Localities in Which Molding Sand Is Found. Molding sand, suitable for medium-weight and heavy green-sand castings, is found in almost every part of the United States. Sand for light work is the most difficult to obtain; for many years light-work foundries were compelled to rely wholly on the fine sand found in and around Albany, New York, but sand suitable for such work is now found in many states. Sand for statuary work in bronze is still imported from France, no suitable substitute having been discovered.

TEMPERING THE SAND.

20. Meaning of Term.—In mixing or tempering sand by hand, the shovel should be used in such a manner as to scatter the sand, as shown in Figs. 1 and 2. This is done by giving the shovel a twist with the hand that holds the handle end. When shoveling sand from one place to another without attempting to mix it, the sand is sometimes allowed to leave the shovel in a solid mass, as shown in Fig. 3. This method of shoveling permits the



FIG. 1.



FIG. 2.

sand to be thrown to a greater distance, and hence is used when shoveling sand from place to place, as from a car to a bin.

A molder or helper should learn to shovel either right-or



FIG. 3.

left-handed, so as to be able to take either side of a sand heap when working with an assistant; note the different



FIG. 4.

relative positions of the two men in Figs. 2 and 4. A clear

space of 1 or 2 feet should be maintained between the pile from which the sand is being shoveled and that on which it is thrown, as shown in Figs. 3 and 4. If this is not done, much of the sand will escape through mixing.

21. Shovels.—In Fig. 5 are shown the two kinds of shovel in general use, (a) having a flat blade, while (b) has



FIG. 5.

turned edges. The flat shovel is generally used for light floor work and bench molding, while shovel (b) is used for heavy molding and digging out holes.

A molder should never work with a dirty shovel. When in use the shovel should be kept clean by scraping as shown in Fig. 6. When put away for the night, or if not in constant use, a shovel should be cleaned of all dirt and oiled with a greasy rag to prevent its getting rusty. There is nothing that denotes the poor or slovenly molder more than working with a dirty shovel.

22. Wetting Down the Sand.—In throwing water on a sand pile with a bucket or hose, it should never be thrown in a body on one spot, as that will form mud-holes and involve a loss of time and labor in mixing the mud with drier sand in order to temper it. If the sand is very dry, water should be sprinkled upon it from a hose, or by being thrown from a bucket, as



FIG. 6.



FIG. 7.



FIG. 8.

in Fig. 7. When the sand has been dampened nearly to its right temper, so as to require but little more wetting, it should be sprinkled by hand from the bucket, as shown in Fig. 8.

23. Sieves and Riddles.—The meshes or openings of a **sieve** range from the fineness of a flour sieve up to openings $\frac{1}{8}$ inch square; when the openings are above $\frac{1}{8}$ inch square, the implement is called a **riddle**. In Fig. 9, (a) shows a sieve and (b) a riddle. In sieving or riddling sand by hand, the riddle should not be held rigidly, as shown in Fig. 10, but should

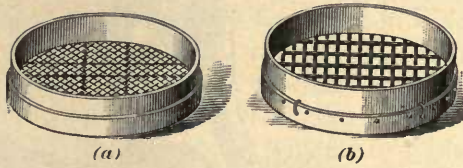

FIG. 9.



FIG. 10.

be held loosely, so that the butt of the hand can strike, or jar, the rim of the riddle as it is swung from one side to the other, after the manner shown in Fig. 11. Hitting the rim of the riddle or sieve with the butt of the hand causes a jar

over the whole face of the meshes, and this causes the sand to pass through the meshes much more freely than if it were held rigidly, as in Fig. 10.



FIG. 11.

When sieves or riddles are not in use, they should not be thrown on the damp ground or on a sand pile with the mesh side down, as such a practice will clog the meshes with sand in such a manner as to hinder the passage of sand through the screen and also cause the wires to rust away very rapidly; they should be placed either on the sand heap with the mesh side up, or else hung upon a nail, as shown in Fig. 12. A skilled molder can be detected by the way in which he handles his sieve and riddle, as well as his shovel.

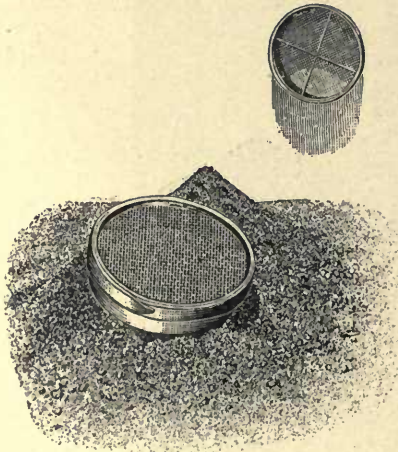

FIG. 12.

A skilled molder can be detected by the way in which he handles his sieve and riddle, as well as his shovel.

PREPARING THE MOLD BY ROLLING OVER.

24. Distinction Between Methods.—The term *rolling over* comes from the fact that one of the processes of making a certain class of molds consists in turning the lower part of the mold completely over, so that what was the bottom is the top. As used in foundry practice, it refers to all molding in which the lower part of the mold is turned over, and distinguishes this class of work from that in which the lower part of the mold is made in the foundry floor without a flask. The molds so made cannot be rolled over, but as they are rammed in the sand of the floor, the term *bedding in* is used and seems especially applicable. Molding by rolling over will be considered in the following pages, while bedding in will be discussed in following sections.

25. Flasks are open frames of wood or iron, usually consisting of two parts, though sometimes of three or more, so arranged that they may be taken apart and then returned to exactly the same relative positions that they had before they were separated. For this purpose they are provided with special projecting pins and sockets. There is at least one molding board for each style of flask and as many bottom boards as there are flasks. When there are two frames (the cope and the drag) to the flask, it is called a "two-part flask"; when three frames, a "three-part flask"; and so on, for four or more. There is a great variety in the shapes and sizes of flasks; the molder usually takes the smallest flask in which he can safely make the mold for any given casting. There is also a special type, known as a "snap flask"; this opens at one corner and has a hinge on the opposite corner, so that the flask may be removed from a mold, after the mold is completed, and used over again instead of remaining until the metal is poured into the mold.

RAMMING THE MOLD.

26. Use of Rammer.—Fig. 13 (*a*) represents the ramming up of a deep pattern *P*. The mold is rammed up in courses, and the depth of the ramming courses varies from

4 to 8 inches, according to the strength of the molder and the character of the work he has in hand. For the pattern shown, a depth of 5 to 6 inches of loose sand will work well in the ordinary molder's hands.

In starting on a mold, the patterns should be faced with a proper **facing sand** that has passed through a No. 8 sieve, so as to have an even surface on the face of the mold. The facing sand is applied to the face of the pattern for a thickness of from 1 to $1\frac{1}{2}$ inches, as shown at *h, h*, Fig. 13. After

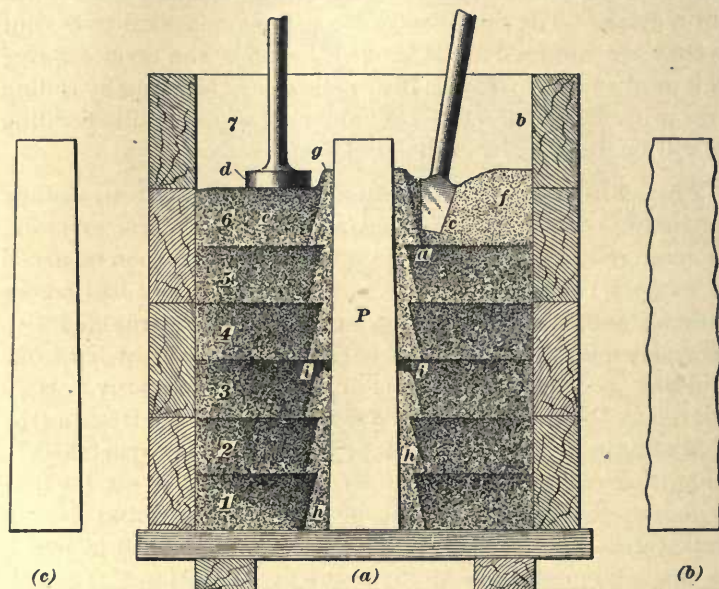

FIG. 13.

this facing sand has been banked against the face of the pattern, common heap sand is filled in to the level of the facing sand, and the whole is then rammed down with the peen and butt of the rammer. In banking facing sand against a pattern, it should be carried as high as the common sand is intended to go. If this is not done, the result will be a seam of common sand, as at *i*, Fig. 13, separating the parts of the facing sand at the surface of the pattern *P*. If the facing sand is not thoroughly united at the seams of

each course, the castings will be rough and will often have "burned sand swells" at the seams of all such courses. This will make a casting look almost as badly as do swells caused by uneven ramming, as shown in Fig. 13 (*b*).

In learning how to use the **floor rammer**, beginners generally handle it by placing one hand on top, as shown in Fig. 14, which is wrong; the proper way to handle it is



FIG. 14.



FIG. 15.

illustrated in Fig. 15. In starting to ram a course of sand, the peen end is used first and should be struck down with sufficient force to compress the sand until it feels solid, showing that it is down to a bottom. This bottom may be either the mold board *c*, Fig. 15, or it may be the course of sand that has just been rammed, as *b* in Fig. 13, where the peen end of the rammer is shown at *c* and the rammed sand of the previous course at *a*. In ramming the space between the pattern and the inside of the flask *b*, Fig. 13, the peen is first carried along the face of the pattern, as shown at *c* in the illustration, and then used promiscuously over the

remainder of the space until it has been rammed down fairly well with the peen; then the rammer is reversed and the butt *d* used on the surface.

After the butt has been used to ram down a course of sand 5 or 6 inches thick, it leaves that course from 1 inch to



FIG. 16.

1½ inches lower than when finished by the peen, as will be seen by comparing the portions *e* and *f* of course *b*, Fig. 13. The mound next the pattern seen at *g*, Figs. 13 and 16, is then rammed down lightly with the peen. After this, the hand is used, as shown on the right of Fig. 16, to level down and clean away the facing sand lying against the pattern (which is liable to have common heap sand mixed with it), to prepare for another course of facing and ramming. In using the rammer for the first

peening and the butting, care should be exercised to keep the peen and butt about 1 inch from the face of the pattern during the ramming. When driving the peen down, it is liable, if forced up against the pattern, to make a hard spot in the face of the mold that may cause a scab on the face of the casting at that point. If the courses of sand are not rammed evenly, after the manner just described, the castings are very liable to be badly swelled at the line of union of the courses, and thus appear as shown at (*b*), Fig. 13; whereas, if the courses of sand are rammed evenly, the casting should appear as shown at (*c*).

27. Hardness Required in Molds.—As a rule, the sand on the sides of molds will stand harder ramming than

that on the bottom or the top; and again, the deeper the mold, the harder the ramming required at the lower courses. As an example, in ramming the mold shown in Fig. 13 (which is rolled over when rammed full), the courses 5, 6, and 7 will require harder ramming than the courses 1, 2, 3, and 4, because the pressure of the metal is greater near the bottom. Molten metal behaves like water in this respect; if we fill a barrel with water, there is greater pressure on the sides near the bottom than near the top. It is the same with molds; the deeper they are, the harder should the sand be rammed and its support strengthened to prevent the static pressure of the metal bursting the bottom of the mold and letting the metal run out. The extra degree of hardness at the bottom portion of the mold, as compared with that near the top, depends on the power and time applied in ramming with the butt of the rammer. The face of the mold should not differ very much in hardness at any point in the height of the mold. This evenness is obtained by treating the mold with the peen in the same manner at the bottom as at the top. If the mold is very high, the lower portion should be rammed a little the harder. By keeping the edge of the butt of the rammer back about 1 inch from the face of the pattern, as already explained, some hard butt ramming can be given to the common sand back of the facing sand without getting the face of the bottom portion of the mold so hard that the metal will not lie against it. By butt ramming all the surface, up to a point about 1 inch from the face of the pattern, until it is hard, it is possible to make the entire face of the mold harder than if lighter butt ramming were done close to the face of the pattern. Nevertheless, this plan will not make the face of the mold as hard as if greater force were also applied to the peen when ramming. Castings having a depth of 4 or 5 feet have been made in green-sand molds; at these depths the back support of the molds must be very rigid and the ramming nearly as solid as it can be made with the butt. Were the upper portions of such molds rammed as hard as the bottom must be, the castings would blow and scab.

The reason why the lower portion of a mold will permit so much harder ramming than the top portion is that the greater pressure of the metal at the lower portion forces the steam and gases to escape through the pores and venting of the sand. At the top of the mold there is not sufficient pressure to do this. If a mold is not sufficiently soft at its upper end to allow the steam and gases formed at the face of the casting to escape freely through the facing sand to the rear sand and its vents, they will pass out through the metal. When steam and gases escape in this manner, they are liable to cause a mold to blow. This may result in scabbing a casting or in spoiling it. It should always be remembered that steam and gases will pass off in the direction in which they meet with the least resistance.

DEEP MOLDS.

28. Sand Required.—While it is true that the lower part of deep molds requires hard ramming to prevent the molds from bursting or being changed materially from the size of the pattern, there are conditions other than that involved in the ramming that must be provided for and controlled. In using facing sand, as well as in using common heap sand, in ramming deep molds, the sand must be worked as dry as possible and must be freely vented. If the damp sand that can be safely used on the sides of shallow molds is used for deep molds, and rammed as hard as it should be, it becomes a source of danger. The chances are that the moment the metal flows into the deep mold, it will commence to blow and may throw out the metal with considerable force, spoiling the casting and possibly burning the workmen standing near by. The sides of a mold may be rammed much harder if the sand is comparatively dry than if it is wet. The reason for this will be explained further on.

29. Venting the Mold.—The sides of all deep green-sand molds must be well vented. The harder the ramming, or the damper the sand, the greater is the amount of venting required. There are several methods used in providing

these necessary vents. Suppose the pattern in Fig. 17 to be bedded in instead of being rolled over, as in Fig. 13. In

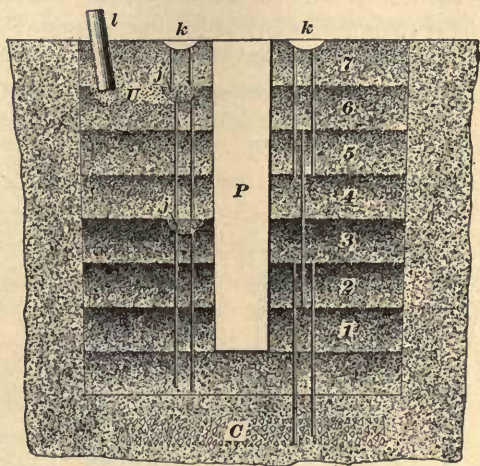

FIG. 17.

ramming the mold, the same plan is followed as in Fig. 13, the only difference being that the courses 1, 2, and 3 are rammed the hardest, being the ones that must stand the greatest strain; whereas, the courses 4, 5, 6, and 7, in Fig. 13, being the uppermost when cast, are rammed the lightest. In ramming up the pattern, Fig. 17, by bedding in, the sides can be vented in the following manner: After three to four courses have been rammed, a channel or groove is cut out of the solid rammed sand, as shown by the letter *j* in the course marked 3, Figs. 17 and 18.

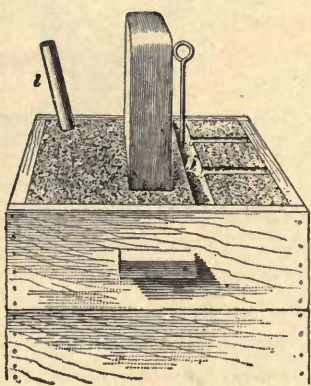

FIG. 18.

This being done, the channel is vented with two rows of $\frac{1}{4}$ -inch vents. These vents are put in 2 inches apart and are kept back about 2 inches from

the face of the pattern; their position is shown by the rods seen projecting from the sand at *j*, Fig. 19, in which illustration the molder is shown in the act of venting with a vent wire. Two rows of vent holes are shown. These are used in cases where extra-good venting is required, as when the sand is of a fine close grain and has to be rammed hard,



FIG. 19.

or when it is wet. When the sand is fairly open in texture, or when hard ramming is not necessary, and the sand is not too wet, one row of vents will be sufficient. In some cases the venting is done with a single wire, which is forced down into the sand and drawn out at once as shown on the left of Fig. 19. In other cases several rods are forced down and none withdrawn until all are in place, when they are drawn

one by one. The advantage of the latter method is that the vents already made are not exposed to the danger of being crowded full of sand as the vent wire is thrust down near them. After the venting has been done, the vent channel at *j* is filled with cinders, the pattern is again banked with facing sand, and common sand then filled in for backing. Cinders are a necessity on some castings, but not always, and judgment is required in their use, as they increase the work of cleaning the sand for the next molding. This course is then rammed up in the usual manner, and so on until two more courses are completed, when another vent channel, as shown at *j* in the course marked *6*, Fig. 17, is made and vented as above described. These courses of vents may be repeated any number of times until the top of the pattern is reached. Some molders lead the gases from these vent channels *j* into straight vent channels *k* at the joint of the mold. This is a bad plan, for if there is any breaking of joints by drawing the pattern or from a straining of the cope, allowing large fins or a run-out, the metal will run into the vent channels at *k* and fill them with iron; this may cause the loss of a casting by scabbing or blowing. In most cases of deep-sided molds, it is best to lead the gases from courses of cinder vents up to the joint by separate outlets, made by ramming up gate sticks in a mold, as seen at *l*, Figs. 17 and 18. These openings should be placed as far as possible from the face of the pattern and provision made for conducting the gases to them, as shown by the channel *U*, Fig. 17. To insure the best possible venting, the molder vents each course as it is rammed with a $\frac{1}{8}$ -inch wire. These fine vents will give relief to the gases working through the sand to the large, or $\frac{1}{4}$ -inch, vents shown leading to the channels *j*. Should these $\frac{1}{8}$ -inch vents meet the pattern, the iron will not run into them and do damage as it would if the vents were $\frac{1}{4}$ inch.

30. Difficulties in Venting.—Where the sand can be worked fairly dry, or where it is of a very open texture

so as to permit the gases to penetrate for a considerable distance, the method of venting illustrated on the right of Fig. 17 can be used with safety. This plan consists merely in using a $\frac{1}{4}$ -inch vent wire, keeping it about 2 inches away from the face of the pattern, with the vents about 2 inches apart. In using the vent wire, it should be passed through the last two courses laid, and half way through the one under them. This is repeated at every other ramming until the joint on top of the mold is reached. In some cases a $\frac{1}{8}$ -inch vent wire is used after ramming every course, and the $\frac{1}{4}$ -inch vent wire after every other course, as just described. In case there is a cinder bed *C*, Fig. 17, under the mold, the vents may be made to connect with that bed, and may also be carried to the top joint.

31. Complicated or difficult cores are best made in dry sand, but they are sometimes made in green sand. Where difficulty is experienced in venting crooked bodies or long horizontal green-sand cores, the venting may be done with a special device. Instead of using the ordinary vent wire or rod, which is difficult to remove if long, and which cannot be removed if at all crooked, a vent rod is made by pushing a braided sash cord through a piece of rubber tubing and inserting the tube instead of the rod when making the core or mold. The act of forcing the braided cord through the tube pushes the cord together, making it somewhat thicker, which in turn expands the tubing and makes it practically solid. When this vent rod is to be removed it is done by first pulling out the sash cord, which allows the tube to collapse, so that it may be easily removed. Vents made in this manner may be carried long distances, and even around considerable bends that could not be dealt with by ordinary methods. The labor of pushing the sash cord through the tubing may be materially reduced by pouring a handful of fine graphite through the tubing before inserting the cord, and also rubbing the cord with the same substance.

32. Venting Shallower Molds.—Where molds are not over 20 inches deep, vents may be driven straight from

the joint after the cope has been lifted, as shown by the vent wire in Fig. 18. This avoids any venting while ramming the courses. If there is a cinder bed under the pattern, the vents should be carried downwards to the cinders, and the top outlets *k*, Fig. 17, can be stopped up or dispensed with. This is a good scheme where there is any liability of the pattern breaking the joint and leaving a fin while being drawn, or any danger of the cope straining so as to let iron run into the vents when they are left open.

33. Using a Slanting Vent Wire.—In venting directly from the joint, care must be taken not to let large vent wires be driven in a slanting direction, as they may strike the pattern, as shown at vent *v*, Fig. 20, leaving a sharp point of sand at *a*; this may cause a slight blow at that point and burst the vent hole inwards, and thus cause a flaw that may spoil the casting. Such slanting vents are apt to fill with iron and cause scabs, or, worse still, cause a mold to start blowing. A mold would be far better without a vent than to have a lot of vents like those shown in Fig. 19 filled with iron, as in such a case they only help to create gas.

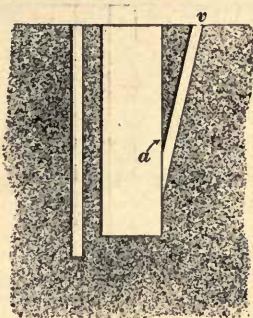

FIG. 20.

34. Cinders for Vent Channels.—In obtaining fine cinders for filling such vent channels as those shown at *j*, Figs. 17 and 19, the following plan is generally adopted: Cinders from an ash or coke pile are first placed in a $\frac{1}{2}$ -inch riddle that is shaken to get the fine cinders and dust separated from the coarse material. The stuff that stays in the riddle is thrown away, and what has passed through is again riddled through a $\frac{1}{4}$ -inch riddle. What passes through this second riddle is thrown away, and what stays in it are the cinders that are used for filling the vent channels at *j*. In obtaining such cinders, the two riddles can, if desired, be

attached together and used at the same time, each being emptied when full. The cinders thus obtained will be of a uniform and clean character.

EXAMPLE ILLUSTRATING DEEP MOLDING.

35. The Pattern.—The pattern shown in Fig. 21 illustrates a number of points that should be observed in deep molding, and would be an excellent example for a beginner to practice on. It gives sufficient depth for three courses of ramming, and will afford good practice in learning to ram evenly.

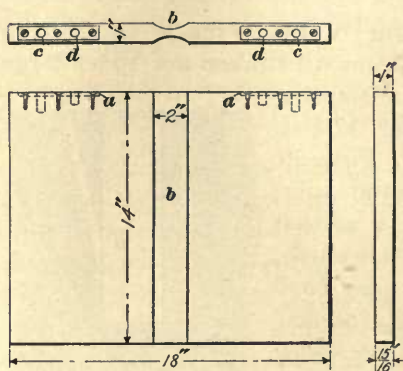

FIG. 21.

It gives sufficient depth for three courses of ramming, and will afford good practice in learning to ram evenly. This pattern can be molded in a flask and then rolled over, as in Fig. 13, or it can be bedded in, as in Fig. 17. The pattern is made with a good taper

to facilitate its being drawn from the sand. This taper, or reduction in size of the pattern as it recedes from the face, is called **draft**. For convenience in handling the pattern while drawing it from the sand, iron draw-plates are screwed to the pattern, as shown at *a, a*, in which are the rapping holes *d, d*, and the screw holes *c, c* for the draw-screw. The groove *b* provides a little irregularity in the pattern that will the more thoroughly test one's ability to ram evenly. Castings of the form of Fig. 21 are sometimes molded with one of the long dimensions vertical, in order to get smooth castings.

36. Making the Drag.—The principles involved in ramming and venting the sides of deep patterns have been described and illustrated in Arts. 25 to 34, and the detail

of ramming up the drag will therefore be omitted. Fig. 22 shows the drag rammed up, the bottom board bedded on

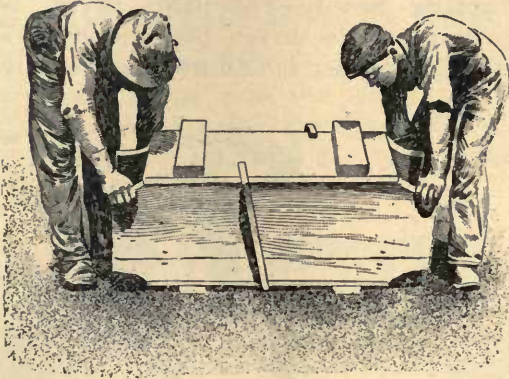

FIG. 22.

solidly, and all clamped together ready to roll over. Fig. 23 shows the flask rolled over, the molding board removed, and

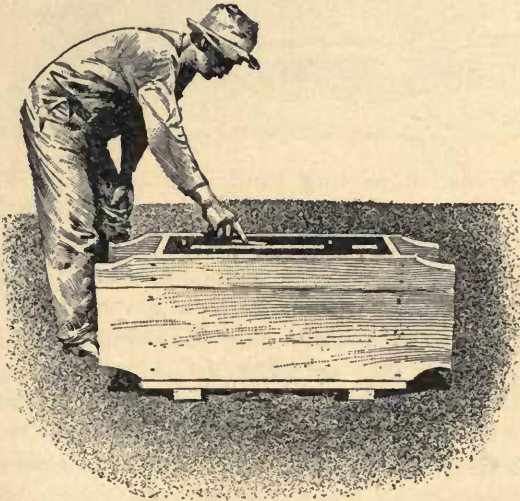

FIG. 23.

the molder making the joint by *sleeking* it over firmly with a trowel. After the joint is thoroughly sleeked so as to

give the sand a fine finish, a brush is used to free the surface of all dust.

37. Parting Sand.—The joints having been thus finished, parting sand is shaken from the hand, as seen in Fig. 24, in such a manner as to distribute it evenly over the



FIG. 24.

joint. The use of parting sand is to cover the joint with some material that is not adhesive, so that when it is spread between the bodies of damp sand, it will allow them to separate without pieces of one body adhering to the other. Material for making parting sand is generally obtained in foundries from the fine dry sand that sticks to the surface of castings before they are cleaned. All the clay contained in this sand has been burned hard, and for this reason when placed between two damp bodies of green sand it will prevent their sticking together. Another kind of parting sand is obtained by using fine grades of lake, river, or seashore sands that have been dried on a plate over a hot fire. Before using this shore sand or the dry burned sand from castings, it is passed through a sieve as fine as can be used—in some

cases a flour sieve. After the parting sand is placed on the drag in such cases as Fig. 21, where there are cross-bars in the cope, a small amount of facing sand is sifted over the parting sand and cleaned off around the joints of the flask.

38. Ramming the Cope.—After the joint is made and covered with facing sand, the cope is put on and the pins or patterns for forming the gates are set ready for ramming, as shown at *e* and *f*, Fig. 25. While ramming

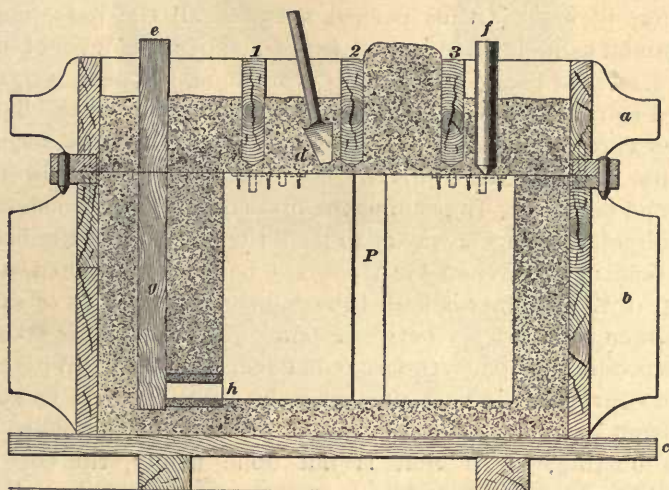

FIG. 25.

the drag, the pattern *g* and the hollow core *h* for the thin rectangular gate were put in place, as shown in Fig. 25. This form of gate is used to introduce the metal near the bottom of the mold. Before the cope is put on, its bars 1, 2, and 3 are thoroughly wetted with water, to make the sand stick to them. If the sand is not of such a loamy nature as to hang well, a clay or loam wash or a thin flour paste is often used instead of water on the face and sides of the bars. After the cope is in place, a riddle is used in filling the cope to a depth of about 2 inches. This operation is followed by tucking the sand under the bars with the fingers of each hand, until the sand is as solid as the fingers

can ram it. Unriddled sand is then filled into the cope to the level of the top of the bars. The peen end of the rammer is now used to ram the sand firmly between the various bars, which will pack the sand to about the level seen between bars 1 and 2. It is very important to peen the first course thoroughly. If this is not done, there may be soft spots in the face of the mold under the bars; or the sand at the bottom of the bars may be so soft as to drop out when lifting off or closing the cope. After the first course of sand is thus peened between all the bars, more common sand is filled in and heaped above the level of the bars, as seen between 2 and 3. This done, the peen is again used to ram the second course of sand between all the bars. Less care and time can be spent in peening this second course, because the butt of the rammer is to follow the second peening. In peening the first course, the peen should be directed in such a way as to pack the sand under the bars, as seen at *d*. When both courses have been peened, the butt of the rammer is used to ram down the mounds of sand between the bars, as between 2 and 3. The butt is struck down solidly to pack the sand between the bars. With the first course it is important that it be firmly peened to keep it from dropping out, and this is also true with regard to the butting, for if that is not done firmly, the cope is liable to drop out.

In ramming the cope, care must be taken not to strike the bars, as that might loosen the sand and cause it to drop out when lifting off the cope or closing the mold. After the cope has been rammed, any excess of sand is removed by striking off the top of the mold with a piece of board or with the handle of the floor rammer. The mold is then vented with a $\frac{1}{8}$ -inch wire, the vents being about 2 inches apart all over the area covered by the pattern. This done, the sprue pin *e* in the pouring gate and riser pin *f* are withdrawn. Then the tops of both gate and riser are reamed out funnel-shaped, and all loose sand firmly tamped down with the fingers and then dampened lightly with the swab, so that in pouring the metal, it cannot wash any dry dust

or sand into the mold along with it. The mold is now ready to have the cope lifted off, which is done, and the cope placed on any suitable support, as the box shown in Fig. 26.

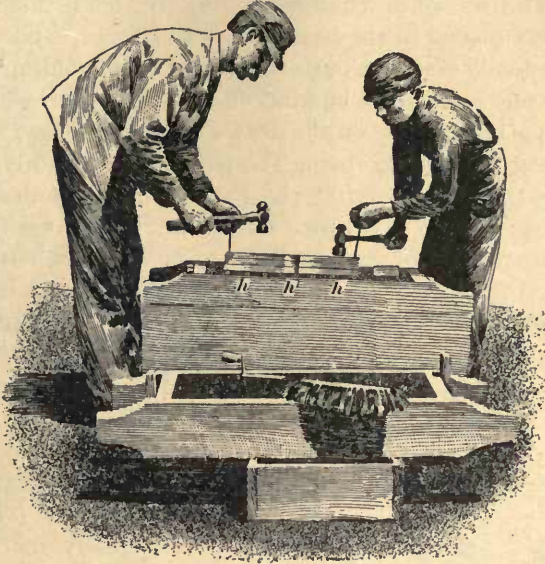

FIG. 26.

39. Venting the Drag.—After the cope is lifted off, the parting sand is carefully brushed off the joint and the joint swabbed, care being taken not to get too much water on it around the edges of the pattern. This being done, a $\frac{1}{4}$ -inch vent wire is used to vent the sides opposite the places marked *h, h, h*, Fig. 26, and a groove is run from each vent to the outside of the mold. It will be noticed that this method of leading away the gases from the joint differs from that illustrated in Fig. 18.

In the case of molds having joints that are liable to be broken in drawing the pattern, the method of venting just described should be used, because if the iron should get in the joint at any one point of a vent channel, as at *k*, Fig. 17, it might readily fill all the vent holes.

40. Drawing the Pattern and Finishing the Mold.—After the mold is vented, the pattern is loosened by **rapping**. This is accomplished by placing a pointed iron bar in the rapping holes shown at *d, d*, Fig. 21, and rapping it with an iron bar or a hammer. Where this is done, lifting screws are placed in the holes *c, c* of the draw-plates and two men gradually start the pattern, each of them holding a lifting screw in one hand and a hammer in the other, with which they tap the pattern lightly on the draw-plates *a, a*, Fig. 21. Care must then be taken to bring the pattern up steadily until it is out of the mold. After the pattern has been drawn out, the gate *g*, Fig. 25, is drawn. The trowel is next used to press down any portion of the joint that may have been started in drawing the pattern, to smooth up the cope part of the mold. The top of the pouring gate and riser are then reamed out funnel-shaped. Should any dirt have fallen into the mold, a lifter is passed into the mold and the dirt removed.

41. Closing and Casting the Mold.—The mold is now closed and clamped with two clamps, as shown at *i* and *j*,

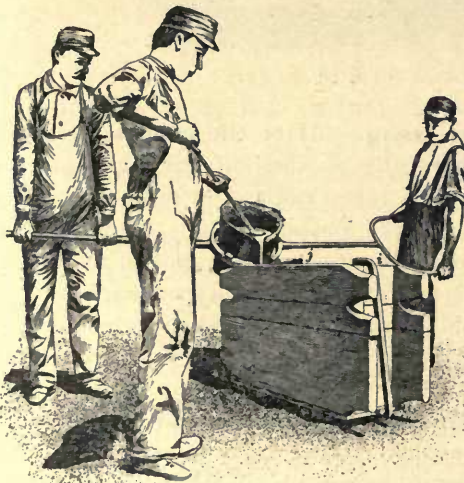

FIG. 27.

It is now ready for casting, which is done by two men holding the ladle and pouring the mold, while a third one is skimming. Molten iron always contains more or less scum or dirt, which, if allowed to pass into the casting, will make flaws that will impair its strength and finish, and may even cause its loss. For this reason when molten iron is being

poured from a ladle, a skimmer should always be used to hold back the dirt.

42. Shaking Out the Casting.—About 30 minutes after the casting has been poured, it can be **shaken out**, which means that the cope may be taken off the drag and the drag itself removed from the mold, care being taken not to disturb the sand about the casting. After some hours the casting may be removed from the sand, when, with the gate and riser attached, it will appear as in Fig. 28. The thin rectangular gate is shown at *g*, the vertical portion of the gate at *e*, and the riser at *f*.

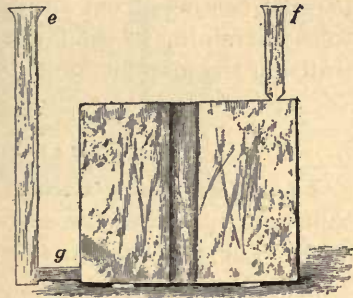

FIG. 28.

The pouring gate can be freed from the casting with a fair blow of a hammer. When the gate is removed and the casting cleaned, the job is finished. By measuring the casting and comparing it with the pattern, the molder can tell how well his ramming prevented the distortion of the casting due to the pressure of the metal in the mold.

43. Allowance in Pattern for Distortion.—While it is true that hard ramming tends to decrease the amount of distortion that occurs in the lower part of deep molds, it is nevertheless impracticable to ram very deep molds hard enough to prevent more or less distortion. Few experienced molders ram alike, and some produce castings more distorted than others. No definite rule can be given for the allowance to be made for distortion in deep castings due to the straining of the mold by the increase of pressure in the lower part of the mold. In the case of experienced molders who are recognized as hard rammers, an allowance of $\frac{1}{32}$ inch per foot would be sufficient, while equally experienced men who do not ram their molds as hard might require an allowance of $\frac{1}{16}$ inch per foot. In the case of a pattern 5 feet deep, if

an allowance of $\frac{1}{16}$ inch per foot were made, it would decrease the dimension of the pattern at the bottom of the mold $\frac{5}{16}$ inch. From this it will be seen that the allowance for distortion tends to give draft to the pattern. Where the conditions are all known, it is possible to produce practically parallel castings from a tapered pattern, the distortion due to the straining of the lower portion of the mold just neutralizing the amount of draft necessary on the pattern.

SHALLOW MOLDS.

44. The Horn Gate.—In Fig. 29 a shallow mold is shown to illustrate the use of a horn gate, which is shown at *b*. The pattern *a* is of a small toothed gear-wheel, and

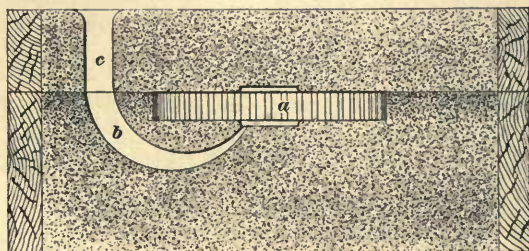

FIG. 29.

the horn gate *b* connects the lower boss with the gate *c* in the cope. A horn gate is only used where the circumference of a small casting is of such a delicate nature that it does not afford a place to gate the casting on the side, such as the gear-wheel shown in the illustration. If this should be gated at the center on top, there would probably be danger of the iron splashing over and knocking down some of the teeth. For this reason the horn gate *b* is used and the casting is made without great difficulty. A gate of this kind can be readily removed from the casting on account of the small connection with the casting.

45. Ramming a Flat Surface.—The molding and casting of a square, flat plate, about 10 inches square and

1 inch thick, will be considered next. In ramming flat or plate surfaces like the pattern shown at *P*, Fig. 30, the peen

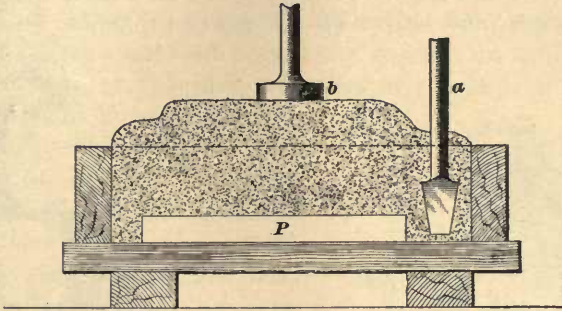

FIG. 30.

a should never be used over the face of the pattern during the ramming of the first course; if this is done, it causes uneven ramming and may make hard spots in the mold, and so cause scabs or indentations that may spoil the casting. In the case of flat or plate work, the sand is rammed up in courses from 4 to 5 inches thick.

Besides ramming with the floor rammer *a* and *b*, as shown in Fig. 30, it is very common for the molder to ram with his feet, as shown in Fig. 31. After peening around the mold next to the flask, he steps on top of the sand heaped up on the middle of the mold and moves across in a series of short jumps, keeping both feet together. He then steps to one side and treads across again,

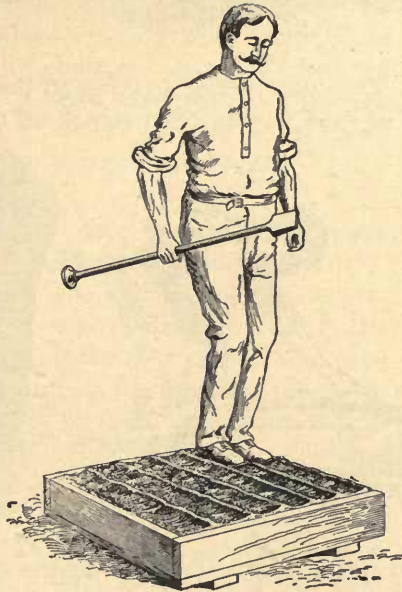

FIG. 31.

jumping in the same manner. This is done until the molder has covered the whole area of the top of the mold, when he steps on the ground, rams the surface with the butt of the rammer, and strikes off the top of the mold.



FIG. 32



FIG. 33

The operation of striking off the drag is shown in Fig. 32. The sand having been struck off as shown, the hand is used



FIG. 34



FIG. 35

to sprinkle molding sand to the depth of about $\frac{1}{4}$ inch all over the surface of the struck-off sand, as shown in Fig. 33. This is done to allow the bottom board to be rubbed down to a solid bearing when in place, as shown in Fig. 34.

46. Venting the Drag.—After the bottom board has been bedded on solidly, it is taken off again and a rod, rammer, or strike is used to form creases or indentations in the sand, as shown at *a*, Fig. 35. These creases are placed about $1\frac{1}{2}$ inches apart and permit the gases from the $\frac{1}{8}$ -inch under vents to escape along the face of the bottom board when the mold is being poured. The vent passages having been made, as at *a*, Fig. 35, a $\frac{1}{8}$ -inch vent wire is then used, in the manner shown at *b*, to vent the drag all over the surface covering the pattern. The vent wire should not be driven down until it strikes the pattern; if it comes within $\frac{1}{2}$ inch of the face of the pattern, it is sufficient.



FIG. 36.

The entire area over the pattern having been vented, the bottom board is replaced and clamped, so that the novel may be rolled over, as shown in Fig. 36.



FIG. 37.

47. Venting the Cope.

The drag being rolled over, the joint is prepared as previously described. The cope is then put on and the sprue pins for forming the pouring gate and riser set in place, as shown at *e* and *f*, Fig. 37. After this, the cope is filled with heap sand, rammed as described in Art. 38, and vented over the part above the pat-

tern with a $\frac{1}{8}$ -inch vent wire. It is then lifted off and finished.

48. Swabs and Swabbing.—The cope having been finished, the joint is brushed off and dampened with the **swab** shown in Fig. 38 (a). The swab is dipped in water and then lightly squeezed out,

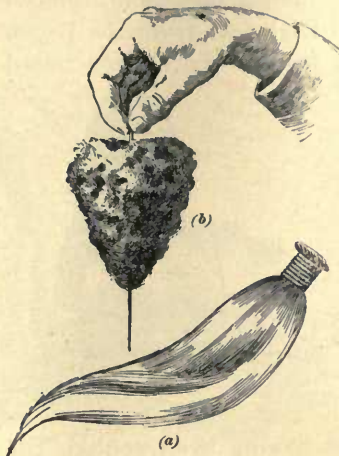

FIG. 38.

after which it is passed over the joint, as shown in Fig. 39, care being taken not to get the sand too wet along the joint between the pattern and sand. Where delicate swabbing is required, as in bench molding, or the wetting of small bodies of sand, a sponge with a wire or long thin nail passed through it, Fig. 38 (b), is often used, as shown in Fig. 40. The sponge holds the water until squeezed out with the hand, and the wire or nail directs the

water to the spot to be dampened. In making the swab shown at (a), a piece of fine-grade, long-fiber hemp rope is

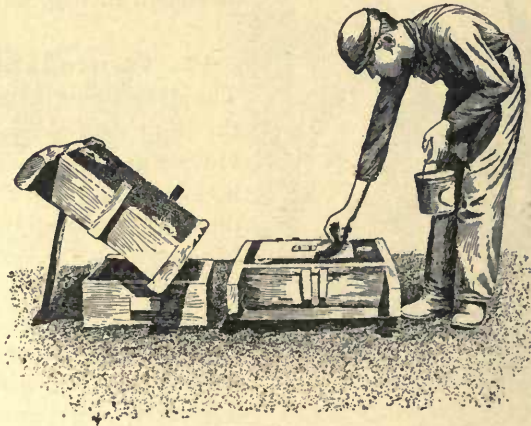

FIG. 39.

tied at one end with a fine wire or string to form a handle, and the other end *teased out* by pulling it through a comb

made by driving some nails through a board and allowing the points to extend beyond the board. While in use, the board forming the comb may be fastened to a bench or table. In making such swabs, some molders use a fine string that will not unravel in water or when dampened.

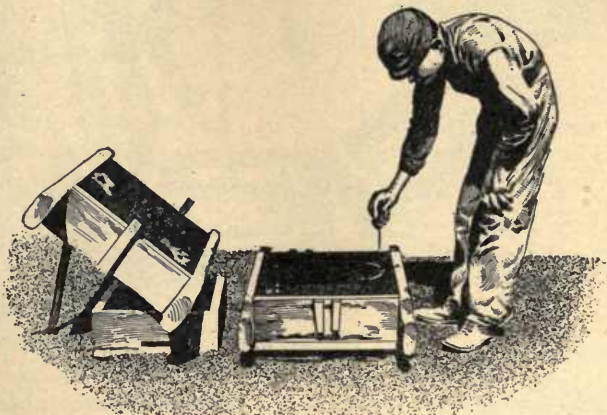

FIG. 40.

This string is cut into lengths of about 1 foot, and a bunch of them tied at one end to form a handle, as described. Good swabs can, however, be obtained very cheaply from any foundry supply house.

49. Rapping and Draw-Plates.—After the pattern has been swabbed, it is rapped by pounding on the side of a bar that has been inserted in the hole in the rapping plate, as shown in Fig. 41. It is better, however, to have two holes in the rapping plate, one for the rapping bar, and the other for the draw-screw. Some persons make the draw-screw serve for both purposes; this may answer where the patterns are light, but for large patterns there should be a rapping hole as well as a draw-screw hole. If the screw hole is made to serve for the rapping hole also, the thread in the screw plate is soon destroyed, even if the rapping is done on the draw-screw. Too much care cannot be taken

to have good arrangements for rapping and drawing patterns, for this not only prevents the wear of the pattern,



FIG. 41.

but also saves labor in molding. After the pattern has been loosened by rapping, it is drawn by introducing the draw-hook or draw-screw, as shown in Fig. 42. While drawing



FIG. 42.

the pattern, it should be rapped gently, as shown in the figure. The rapping plate on the pattern shown in Fig. 42 is made large enough to contain two holes, one for the draw-screw and one for the rapping bar.

50. Cutting the Gates and Riser.

The pattern having been rapped and drawn, the mold is finished with the trowel and the double ender, the latter tool being shown at (b) in Fig. 43. The

“Yankee,” shown in Fig. 43 (c), is used for removing any loose sand from the mold or for finishing corners. The gates for connecting the sprue and riser with the mold are cut by means of a gate cutter. The form of gate cutter illustrated at Fig. 43 (a) consists of a thin blade of brass or steel bent to the required form and provided with a handle. Another form of gate cutter is shown in use in Fig. 44. This form of cutter consists of a thin sheet of tin or brass bent to the required form and is used as shown in the illustration. After the gates *f* are cut to the bottom of the sprue or riser *e*, Fig. 44, they should be smoothed firmly

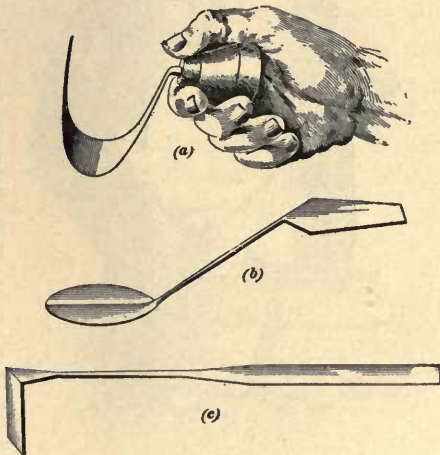

FIG. 43.

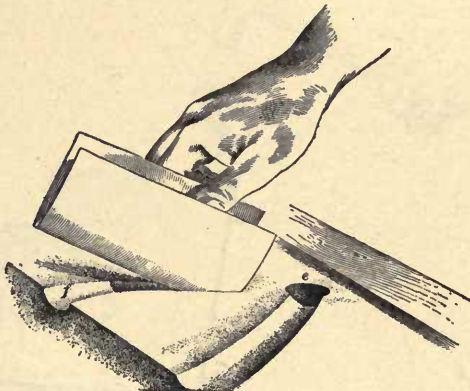

FIG. 44.

with the fingers, so as to press down all the loose sand. If this is not done, the iron, when running through them,

will carry dirt into the casting. Before smoothing down



FIG. 45.

the pouring gates, it is well, with some molding sands, to wet the top edge of the gates by carefully using a swab or sponge, as shown in Fig. 40. In using water in this way around gates, extra care must be exercised not to make any portion of the sand too wet; for this might cause the iron to blow as it passed into the mold and result in spoiling the casting.

51. Closing and Pouring the Mold.

The mold having been finished, it is closed, and the flask

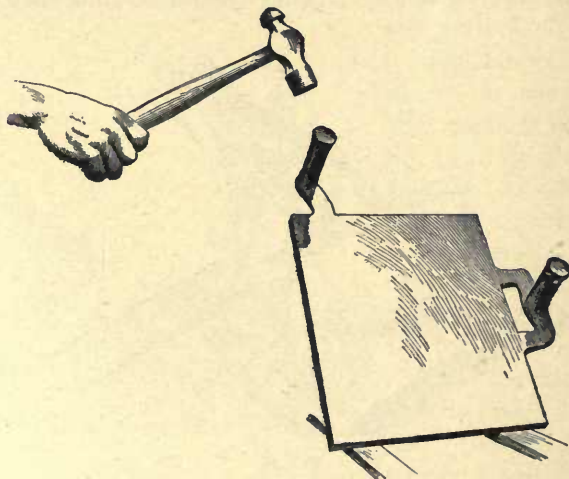

FIG. 46.

clamped ready to be poured, as shown in Fig. 45. In

20 minutes after the casting is poured, the cope and drag may be removed. After a few hours, or on the following day, the casting may be taken from the sand, when it will appear as in Fig. 46, which shows how the pouring gate and riser are connected with the casting. After the casting is cool, the gate and riser are knocked off by means of a hammer, as shown in the upper left-hand portion of the illustration, and the casting is then cleaned up, thus finishing the work so far as the foundry is concerned.

GREEN-SAND MOLDING.

(PART 2.)

MOLDING BY BEDDING IN.

LEVELING.

1. Using Straightedges.—Having described the casting of flat surfaces in green sand by rolling over, we shall now deal with the making of a casting by **bedding in**. A bed for a flat plate may be made at the top of the molding floor or at any desired depth below it. In any case it will be necessary to have some guide to form the bed; this guide generally consists of straightedges, arranged as shown at *a*, *b*, and *c*, Fig. 1.

In leveling up the straightedges, the first one *a* has a mound of sand placed under each end, so as to keep its under edges free from the floor, and is made as nearly level as the eye can judge. A spirit level is then placed on it and the high end driven down with a wooden mallet or a hammer, the pounding being done on a block of wood (to prevent the hammer marring the face of the straightedge), as in Fig. 2. The straightedge *b* is then placed on two mounds of sand, as was done with *a*, setting it by eye as nearly true with *a* as possible. The straightedge *c* is then placed on the ends of *a* and *b*, Fig. 1, and the spirit level used to make the ends of *b* level with *a*. This can be done by first bringing one end of *b* to the level of *a* by using the straightedge *c* as shown, and then carrying *c* to the other end and repeating the operation. Still another plan to get *b* level with *a* is to use *c* as

COPYRIGHTED BY INTERNATIONAL TEXTBOOK COMPANY. ALL RIGHTS RESERVED

shown, and then remove the spirit level from *c* to *b* and raise or lower the other end of *b* as may be found necessary.

It must be remembered that both edges of the straight-edge *c* must be parallel; this is not necessary, however, in

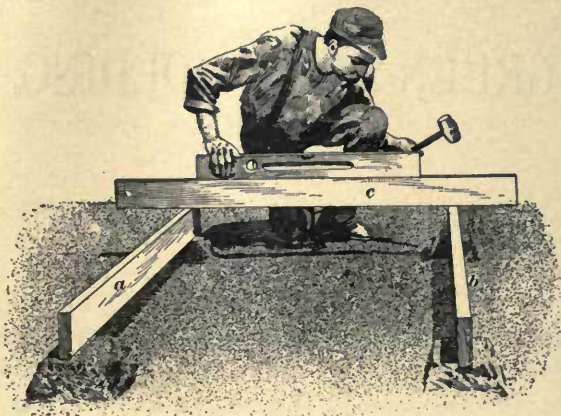

FIG. 1.

the case of *a* and *b*, the upper edges only of these two being required to be true. These straightedges should have a hole in one end so that they can be hung up when not in use.



FIG. 2.

They should not be left lying around on the floor, where they are liable to have their edges injured or to be bent or warped from exposure to dampness and uneven supports.

MAKING THE BED.

2. General Remarks.—The straightedges having been leveled as described, the work is proceeded with according as the thickness of the casting to be made requires the bed to be hard or soft. In pouring castings in **open sand**, that is, pouring flat plates without a cope covering, a soft bed is generally used. The bed, when down or under vents are not used, must be soft in order to permit the gases to escape freely from the sand, for there is no head pressure of metal on the bed to drive out the gases as there is when a plate casting is poured through a cope. In the latter case, the bed is generally made hard in order to withstand the head pressure of the metal. Much more labor is required in making a hard bed than a soft one.

3. Making a Soft Bed.—In making open-sand plate castings, the bed must be softer for a casting from $\frac{1}{4}$ inch to 1 inch thick than for one whose thickness is from $1\frac{1}{2}$ to 3 inches. The reason of this is that the thicker the casting, the greater is the pressure exerted by the metal on the bed, tending to drive the gases downwards into the lower part of it or to cause them to escape outwards at its sides. The same degree of softness necessary for the thin plate may sometimes be used for a thick one; but the harder the bed can safely be made, the better, as this prevents the pattern, or any other light body, from making impressions on it and causing an uneven face on the casting. It is well to have a bed as hard as practicable, still it is better to have the bed soft than too hard. By using care in smoothing soft beds with the trowel and in laying on the patterns, a casting can be produced with almost perfectly true surfaces.

In starting to make a bed after the straightedges have been leveled up, sand is tucked solidly under *a* and *b*, Fig. 1, so as to prevent the pounding action of the straightedge *c* from disturbing their level. After this is done, sand is shoveled on both the inside and outside of *a* and *b* until it is level with their tops. The sand on the outside is then packed down with a butt rammer or with the feet, to prevent the

pressure of sand on the inside of *a* and *b* from moving them outwards. Next, the straightedge *c* is used to strike off the sand level with the top of *a* and *b*. Sand that has been passed through a $\frac{1}{4}$ -inch riddle is now spread over the face of the bed to a depth of about $\frac{3}{4}$ inch, and then a flat piece of wood or iron about 8 inches long is placed on each of the straightedges. These pieces *d* and *e*, Fig. 3, should be



FIG. 3.

from $\frac{1}{4}$ inch to $\frac{1}{2}$ inch thick, according to the desired hardness of the bed; the thicker the piece, the harder will be the bed produced. On top of *d* and *e* is laid the straightedge *c*; a man is then stationed at each end, holding the pieces *d* and *e* and also one end of *c*. These men then pull the straightedge *c* and the pieces *d* and *e* along, sweeping to the end of the bed all sand that lies above the level of *d* and *e*. This leaves a body of sand, the thickness of the pieces *d* and *e*, projecting above the level of the straightedges *a* and *b*, which sand is next pounded down to the level of *a* and *b* by means of the edge of *c*. To do this, a man holds one end of *c* down on one of the straightedges *a* or *b*, while another man raises the other end from 4 to 6 inches and brings it down upon the raised sand so as to drive it down to the level of the top of *a* or *b* on his side, as shown in Fig. 4. When one man has gone a distance of about 12 inches, he returns about half way to his starting place and holds his end of *c* down on the under straightedge, *a* or *b* as the case may be, while the opposite man raises the other end of *c* and pounds down the sand on his side. This operation is continued by the two men alternately, until the whole surface of the raised sand is pounded down to a level. When the bed has been thus gone over, its surface will present a series of

imprints of the straightedge *c*. To remove these marks, the straightedge *c* is dragged in a seesaw manner across the



FIG. 4.

face of the bed, as shown in Fig. 5, each man being careful to have every stroke a forward one. If this were not done, marks caused by the backward motion of the straightedge

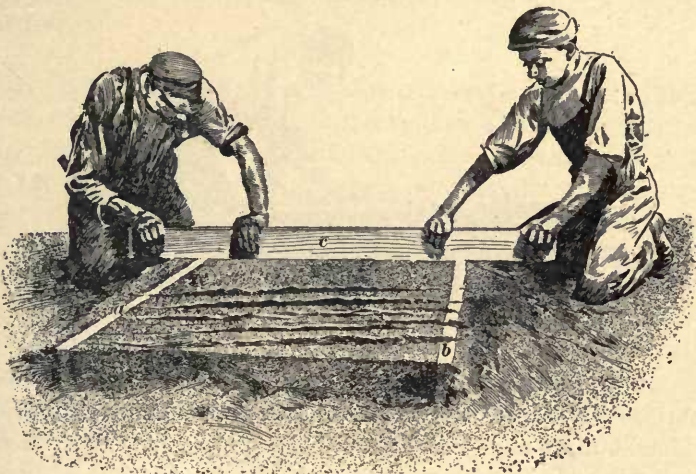

FIG. 5.

would be left on the surface, while the portion that was done properly would be smooth. The portion of the bed

shown in Fig. 5 that is nearest the straightedge has been done properly, while the portion near the front of the illustration has been struck off with alternate forward and backward movements of the straightedge so as to leave ridges of sand on the bed.

To accomplish this forward movement requires a little practice, as it is rather difficult to have every movement a forward one while seesawing the face of the bed. If the face of the bed is struck off by a *straight pull*, not only will the surface be left rough, but the operation is apt to loosen the face of the pounded sand from the underlying soft body, so that when the metal runs in over the sand, it is liable to loosen or lift the sand in such a way as to cause a rough and scabby casting. After the bed has been struck off as described, a fine sieve is used to shake a very thin coating of sand evenly over the face of the bed. A trowel is then used to smooth down the sieved sand, after which the bed is ready and the molder can proceed to build up the sides of the mold with sand, and so give any shape required in the

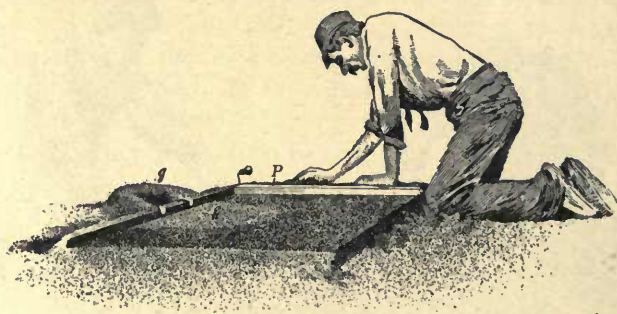

FIG. 6.

casting. A clear idea of this may be gained from Fig. 6, which shows a man packing sand against the side of the pattern *P* in such a manner as to form the sides of the mold.

The sides having been built up as described, a pouring basin *g* is made, and the mold is ready to have the metal poured into it. For pounding down with the straightedge

some molders use a sharp grade of bank or river sand, alone or mixed with common heap sand. This is only necessary where the molding sand proper is of a close, fine grain, as such fine sand is liable to cause scabs on account of its not being sufficiently open to permit the gases created at the face of the bed to escape downwards freely.

Where sharp sand is used to form the face of the bed, it may be omitted in front of the pouring basin, and this place filled in with a stronger and closer-grained sand, as shown at the light spot marked *h*, Fig. 6. For this purpose some molders use ordinary molding sand, or a regular facing sand, which is made by mixing sea coal with molding sand, in front of the pouring basin, in place of the ordinary sand just mentioned. The reason for using a stronger grade of sand in front of the pouring basin is that the metal, when flowing from the basin on to the face of the bed, is liable to break the latter where the sand is weak and cause it to be washed in along with the metal, the result being a rough or scabbed face (on the casting) in front of the pouring basin.

The subject of venting open-sand beds will be treated further on.

4. Thickness of Open-Sand Castings.—The thickness of open-sand castings is determined by the thickness of the piece *P* used in building up the sides of the mold, Fig. 6, by the fluidity of the metal when pouring the casting, and by the judgment of the molder in deciding when sufficient metal has flowed into the mold. An iron that is *dull* or not very fluid will readily pile up in an open-sand mold, so as to be from $\frac{1}{8}$ inch to $\frac{1}{4}$ inch thicker than the height of the sides of the mold, for which reason it is difficult to obtain open-sand castings within $\frac{1}{8}$ inch of any specified thickness. To attain even this accuracy, the metal used should be very fluid.

5. Venting Soft Beds.—When soft beds are made as here described, and the castings (where more than one is placed on the same bed) are from 8 to 12 inches apart, they

will seldom require any venting, except when it is necessary to use fine grades of sand. In such cases vents may be made as described further on. Where floor space is limited so that open-sand castings must be placed close together, say from 2 to 4 inches apart, it may suffice, where open grades of sand

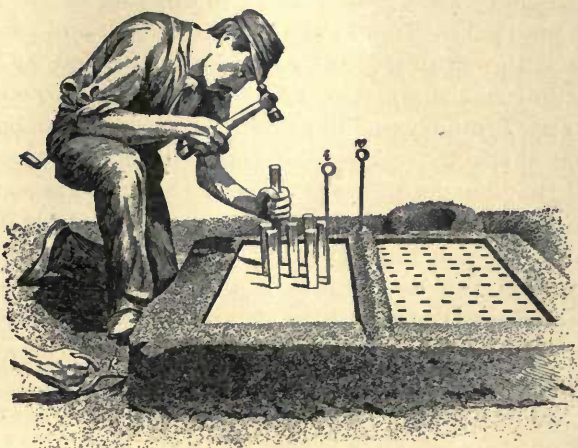

FIG. 7.

are used, to drive a row of vertical $\frac{3}{8}$ -inch vents down the center of the partitions of sand dividing the molds, as shown at *v*, Fig. 7. There should never be any difficulty in carrying off gases from soft beds when it is desired so to do.

6. Making a Hard Bed.—There are few things in founding in which molders differ so much as in their methods of making hard beds. It may be said that there are four degrees of hardness in making beds: The first is the soft bed for open-sand castings of plates ranging from $\frac{1}{2}$ inch to 3 inches thick; the second bed is of the character required for making the prickered plates used in loam molding; the third is for hard beds used for open-sand castings that must be well vented; and the fourth is for beds that are used for light and heavy castings in cases where the bed forms the bottom

part of a mold that is covered with a cope. The most difficult beds to make are those used for making loam plates requiring long prickers on them, as shown in Figs. 7 and 8, and also in the matter treating on loam molding.

7. Making Beds for Prickered Plates.—In making beds for plates having prickers, or prongs, on them, the depth of the tempered sand must be much greater than for plain plates. As an example, the plain plate to be cast in the bed shown in Fig. 6 can be successfully made with a depth of tempered sand ranging from 4 to 5 inches without any venting; but if it should be necessary to have prickers from 4 to 6 inches long on such a plate, the tempered sand

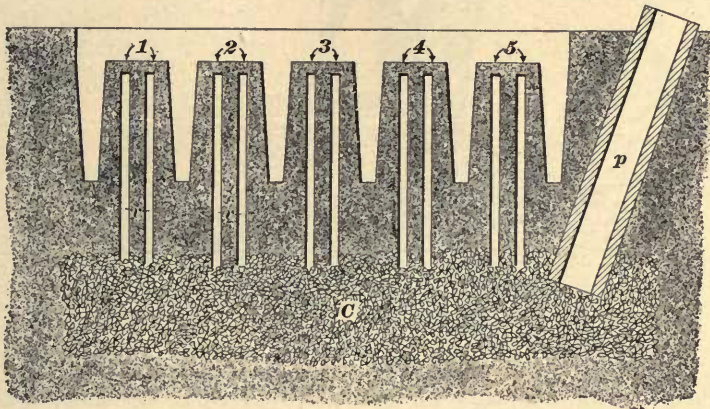

FIG. 8.

should be fully from 7 to 10 inches deep. This is due partly to the necessity for packing the sand firmly with the palm of the hand or the back of a shovel as every course of sand of from 3 to 4 inches deep is filled in. If sand were shoveled in loosely, as in the case of the soft bed just described, the prickers or prongs, if over 6 inches deep, would be liable to be strained at their bottom ends in such a manner as to burst into each other, or to swell at the end so badly as to raise the part of the mold above the lower end of the prickers,

thus spoiling the casting. Some loam plates require prick-ers or prongs from 12 to 30 inches deep. It is very difficult to make such deep-prickered plates in open sand without their blowing more or less when being cast. In some cases it is best to dig deep enough to permit a cinder bed being placed under such plates, as shown at *C*, Fig. 8, and then filling in the tempered sand in layers ranging from 3 to 4 inches deep, and venting each alternate layer of sand with $\frac{1}{8}$ or $\frac{3}{16}$ -inch vent wire down to the cinder bed, which is itself vented through vent pipe *p*. Another plan is to have six or ten pricker patterns instead of the one or two used in the



FIG. 9.

case of shallow prick-ers, and to press them all down one after the other, and then, before they are withdrawn from the sand, take a $\frac{1}{8}$ -inch or $\frac{3}{16}$ -inch vent wire, as seen at *i*, Figs. 7 and 9, and carefully vent down from the face of the mold to the cinder bed between all the pricker patterns, making the vents about 2 inches apart, as at *v, v*, Fig. 8. These vents, coming to the surface of the mold, must be stopped up with the end of the finger and then all the finger holes filled with sand and the surface sleeked over to make the face of the mold smooth, as at *1, 2, 3, 4, 5*, Fig. 8.

In some cases, instead of carrying the gases from these vertical vents through the cinder bed, the venting can be

done by using a long $\frac{1}{4}$ -inch or $\frac{3}{8}$ -inch vent rod driven in at the bottom of the tempered sand to bring the gases to the side of the bed, as seen by the vent wire *k*, Figs. 7 and 9. In packing the sand by layers or courses in these beds, care must be taken not to make them so hard that the molder cannot push the pricker pattern down by hand to a depth of from 6 to 8 inches. Beyond this depth it may often be necessary to use a hammer to drive the prickers, as in Fig. 7. Another point to be noted in making deep-prickered plates is never to use any sand but that which has been well tempered and passed through a $\frac{1}{4}$ -inch or $\frac{1}{2}$ -inch riddle.

Care must be taken to work the sand as dry as it can be used and give good results; it must not be so dry, however, that there will be any risk of the sand running back into the holes left by the pricker pattern after it has been withdrawn. The pattern used for making prickers or prongs on plate castings should always have a handle from 6 to 8 inches long and of convenient form for the hand. A good form of pricker pattern is illustrated in Fig. 10, where it is shown as generally held when being pressed into the sand.

Deep-prickered plates usually give trouble at the first attempts, but with some experience in molding them, and by following the directions here given, they should be made successfully.

8. Hard Beds for Open-Sand Castings.

—Castings with lugs or long projections on them may be cast in open-sand molds if it is not of much importance whether the cope, or upper side, of the casting is a little rough. In making such castings, the straightedges are leveled as already explained.



FIG. 10.

Then, tempered sand is filled in and rammed down evenly and firmly to nearly the top of the straightedge, using the butt of the rammer or the feet. When this is done, a straight-edge *c*, Fig. 9, with its lower edge cut down $\frac{1}{8}$ inch at each end, is used to strike off the bed so that its surface will be $\frac{1}{2}$ inch below the top of the straightedges *a* and *b*. Then the surface of the bed is vented all over with a $\frac{1}{8}$ -inch or $\frac{3}{16}$ -inch vent wire, the vents being made about 1 inch apart. These vents may be carried down to a cinder bed or led from under the bed with $\frac{1}{4}$ -inch or $\frac{3}{8}$ -inch vents leading from under the straightedge, as shown by the vent wire projecting at *k*. After the surface of the bed has been well vented, the palm of the hand is passed over it to close up the top of the vent holes. Riddled sand is then shoveled on to about $\frac{1}{2}$ inch higher than the top of the straightedges *a* and *b*. Pieces *d* and *e*, about $\frac{1}{4}$ inch thick, are now used in conjunction with the straightedge *c*, to strike off the bed as shown in Fig. 3. When this is done the surface of the bed is pounded down with the straightedge *c* and the face of the bed struck off in a seesaw manner and finished as already described.

MOLDING PLATES WITH PROJECTIONS IN OPEN SAND.

9. General Directions.—The hard bed, Fig. 9, having been completed, it may be used for casting plates having projections, flanges, lugs, etc., of which the pattern shown in Fig. 11 is a type. In bedding such a pattern on a level bed, it is first set on the bed and pressed down so as to leave an imprint of its projections; it is then removed and the shovel used to cut away the greater part of the sand where the lugs come, after which a trowel is used to cut away the sand to within about $\frac{1}{4}$ inch of the inside of the

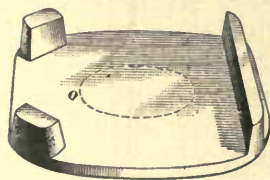

FIG. 11.

imprint. This leaves the bed as shown in Fig. 12. The pattern is next set back and hammered down solidly on the bed, the molder striking on a block, as shown in Fig. 13; after this, sand is rammed up against the outside of the lugs and the edges of the pattern and the mold vented, as shown at *k* in Fig. 14. Next the pattern is drawn and the mold finished ready for the metal, as shown. It is of special importance that a block of wood or a heavy plank be used to pound on when bedding in patterns; no sledge or heavy hammer should be used on the bare face of a pattern.



FIG. 12.



FIG. 13.

Another method of making a casting by bedding in, from a pattern like that shown in Fig. 11, is to have a hole cut in

the pattern about the size shown by the dotted line at o , and then to set its projecting lugs on mounds of sand and tuck up the pattern on the inside through the hole o , as shown in

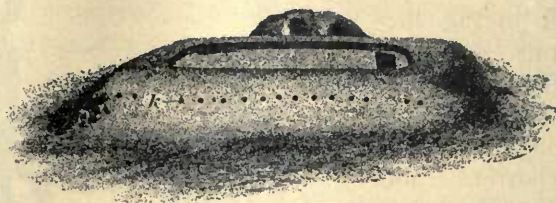

FIG. 14.

Fig. 15. This answers well where the patterns are not of large area, but for large plate surfaces with patterns having flanges or lugs, the plan shown in Figs. 12 and 13 is a good



FIG. 15.

one. One objection to this plan, however, is that the projections, flanges, or lugs are faced with common heap sand. In order to obtain a smooth surface throughout, such projections as shown in Fig. 11 should be faced on the inside

with sand mixed with finely ground coal, commonly called *sea coal*.

10. Facing Inside of Projections.—To face the inside of projections, flanges, etc., when the pattern has been bedded in the manner shown in Figs. 12 and 13, the pattern must be drawn before the outsides of the projections are rammed up, and then a section of the inner face of the projection cut out, as shown at *a*, Fig. 16. A piece of board or

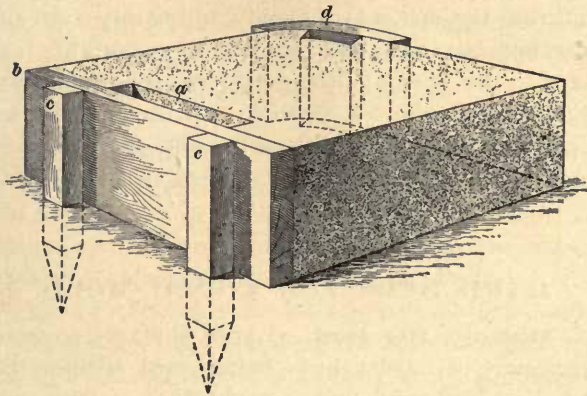

FIG. 16.

plank must next be laid against the projection, as shown at *b*, and then the cavity at *a* rammed up with facing sand that has been mixed with sea coal. A $\frac{1}{8}$ -inch vent wire is used to vent the face and sides of the projection, keeping the vents about 1 inch back from the face of the board *b*, and driving them to the cinder bed or horizontal vents, as shown at *k*, Figs. 7, 9, and 14. When this is done, the tops of the vent holes are stopped up with the finger and then filled with sand, and the face of the mold finished with a trowel, after which the board *b* is removed. If the section *a* is not long enough to cover the entire inner face of the projection, another section joining the portion just faced is cut out and the board *b* again replaced and the operation repeated as described. This operation is repeated until the

whole face of the projection has been lined with rammed facing sand from 1 inch to $1\frac{1}{2}$ inches thick. The length of a will depend on the length of the surface to be covered with facing sand; this can extend from 4 inches to 4 feet, so long as the board b is kept in the required position. To hold such boards, or **formers**, as b in the right position while the cavity at a is being rammed, stakes c are driven into the floor. The space or cavity at a is rammed with $\frac{1}{2}$ -inch to $\frac{3}{4}$ -inch rods, or with a small hand rammer having a peen $1\frac{1}{2}$ inches wide and $\frac{1}{2}$ inch thick. Care must be taken to face and ram the space at a evenly and firmly. In the case of projections having forms that are not straight, it will be necessary to use special pieces or patterns, as shown at d , the whole being rammed, vented, and finished the same as if the piece were straight. Boards used as formers b must be smooth on the side forming the face of the projection.

HARD BEDS FOR COPED MOLD.

11. Making the Bed.—Large surfaces covered with a cope permit of harder beds being used without causing the metal to blow and create scabs than can be used for open-sand work. In making these beds, it must be remembered that the sand should be as dry as can be easily worked, and should be vented as well as possible. The operations, so far as leveling the straightedges is concerned, are nearly the same as those described in Art. 1, the only difference being that the straightedges a and b will be set down into the floor about two-thirds of their depth, instead of being set up above the floor, as seen in Figs. 1 and 2. After the straightedges are leveled, sand that has been well tempered and riddled is filled in between them and struck off level with their top edges; the sand is then rammed down with the feet as far as possible, and then the whole surface of the bed is rammed with the butt of the rammer. This will bring the rammed sand down to about 2 inches below the top of the straightedges, when these are about 6 inches

deep, which is about as deep as such a course should be. The sand having been butted solidly, common sand is again shoveled in and struck off to the level of the top of the straightedges. This is then butted down lightly all over the bed and a straightedge *c*, Fig. 9, whose ends are cut down $\frac{1}{2}$ to $\frac{3}{4}$ inch, is used to strike off the bed, which is then closely vented all over the surface with a $\frac{1}{8}$ -inch or $\frac{3}{16}$ -inch vent wire, and the top of the vents stopped up with the palm of the hand; next, sifted sand, which for some classes of work may be mixed with sea coal, is shoveled in and struck off with the use of $\frac{3}{8}$ -inch strips on the straightedge *a* and *b*, Fig. 3, as described in Art. 3, and then pounded down and finished, as already described.

12. Objectionable Method of Venting.—Some molders make a practice of venting direct from the face of the bed and then closing each hole with the finger to stop the surface of the vents, instead of having the tops of the vents about $\frac{3}{4}$ inch below the surface of the bed. After the upper ends of the vents are all stopped with the end of the finger, facing sand is packed solidly into each hole with the fingers, and the bed is then smoothed with a **surface block** (preferably of hard wood), measuring about 3 inches by 8 inches, with the corners a little rounded. This plan will succeed if carefully carried out, but should the top of a few holes be carelessly stopped up, there is danger of the iron bursting through and running down the vents to the cinder bed, if there is one. Then, again, gas might become confined in the cinder bed and, by exploding, create an upward pressure in the vent holes and lift the sand from the top of those vent holes that have not been filled firmly with sand. A little study of this method of venting will make its objectionable features evident.

13. Surface Venting.—Where beds are desired with very hard surfaces, or where the sand is of such a nature as to scab readily, it is a good plan to bring the vents as close to the surface as practicable. The following is a plan for

surface venting that, if followed, will dispense with the finger poking of the vent holes and will insure hard beds being reliably vented. The plan consists in ramming up solidly and striking off the common sand within about $\frac{3}{4}$ inch of the top of the straightedges, Fig. 9, and then covering the surface of the bed with facing sand mixed with sea coal, so that it projects about $1\frac{1}{4}$ inches above the top of the straightedges, using pieces $1\frac{1}{4}$ inches thick under the straightedge *c*,



FIG. 17.

as shown at *d* and *e*, Fig. 3. After this is done, a butt rammer is used over the entire surface, in the manner shown in Fig. 17. In butting the surface of such a bed, the operator must make sure that no part of the surface is missed, and the butt rammer must be applied lightly so as not to make the face of the bed too hard. To insure a smooth surface to the bed, no sand should be allowed to stick to the face of the butt when ramming; a brass butt is

good for such work. The sand, after being butted, should project above the straightedges about $\frac{1}{2}$ inch. The bed having been butted all over, its surface is vented with a $\frac{1}{8}$ -inch wire, placing the holes about 1 inch apart, and driving the vent wire down to the cinder bed, should there be one under it. If there is no such bed, then $\frac{1}{4}$ -inch or $\frac{3}{8}$ -inch vent rods, set horizontally, as seen at *k*, Figs. 7, 9, and 14, will have to be used. After the venting, the bed is struck off in a seesaw manner, as already described, and facing sand sifted all over its face as thinly as possible. This done, a hard-wood finishing block is worked all over the face of the bed to make it smooth and ready for finishing with the trowel. The application of the smoothing block not only gives a finish to the surface of the bed, but it also assists in firmly stopping up the top of the $\frac{1}{8}$ -inch vent holes. This not only prevents any iron from bursting into them, but also prevents any confined gas from forcing its way through the holes into the mold, which would break the face of the mold, causing scabbing or lumps on the face of the casting. In some cases where there is extra danger of scabs being produced, the reliability of the bed may be increased by first venting it with a $\frac{1}{4}$ -inch vent wire, as shown in Fig. 9, before the $1\frac{1}{4}$ -inch depth of facing sand is shoveled on. When this latter plan is used, the vents from the face, made with a $\frac{1}{8}$ -inch vent wire, need not extend to the cinder bed.

BEDDING IN.

14. Objectionable Method.—The methods that have so far been described are the proper ones for forming the bottoms of molds that are bedded in; there are other methods in use, however, that are neither mechanical nor proper. Thus: A workman having to mold the pattern shown in Fig. 11, makes a hole in the floor and fills it with sand, without doing any packing; or else he builds a mound

of soft sand. On this he lays the pattern and jumps on it; after which he digs out the sand from the lugs, again jumps on the pattern, gets off, and digs out more sand from under the lugs, and so on until the whole of the under surface of the pattern is in contact with the sand, if the pattern does not break in the meantime. Then he lays a wooden block on the pattern, and pounds it with a heavy sledge hammer, as shown in Fig. 18, until the face of the pattern is bedded



FIG. 18.

into the sand to a depth of from $\frac{1}{2}$ to 1 inch, depending on the molder's weight and strength and the weight of the sledge. This operation is repeated until the mold is made or something breaks. This is an illustration of how molding should *not* be done.

Some patterns may be bedded in by merely forcing them into soft sand; but care and good judgment are required in doing such work. When a molder uses this method indiscriminately for all bedded work, the practice is certainly reprehensible.

15. Ground Beneath Prepared Beds and Molds.

Having dealt with the preparation of soft or hard beds to form the bottom of molds, attention is now called to the necessity of knowing, as far as possible, the condition of the earth or ground below the bed. Many castings have been lost because the ground underneath the beds of the molds was in a soft condition. The prepared bottom of the molds may be made as hard as possible and the casting be badly swollen or distorted or all the metal lost out of the mold if the under ground is not solid. If there is any doubt as to the solidity of the under ground, the only reliable procedure is to dig down and test the under ground with pick and shovel, or a fair idea of the condition of the ground may be obtained by driving down pointed iron bars. Where heavy or deep castings are to be made over untested ground, it may often be necessary to dig down from 2 to 4 feet below the level of the bottom of the molds, in order to be certain that the earth is sufficiently solid to withstand the pressure of metal that will be put on the mold when it is poured. A source of trouble in many foundries arises from the careless manner in which holes left by old molds have been filled up with sand. Some molders, after taking out a deep casting that has been made in the floor, will merely throw in some water and loose sand until the hole is filled to the level of the floor, and then in a few days, dig out the same hole to make a shallow casting, without going down to solid ground; many castings have been badly strained or lost on this account. When deep castings (or even shallow ones) are taken out of the floor, all the dry and loose sand should be shoveled out and then dampened and tempered before being shoveled back into the hole. This sand should be shoveled in in courses of from 5 to 8 inches deep, and butt rammed until solid. If this practice is followed, any molder who may desire subsequently to make other castings over or near the same place can rest assured that the ground under or at the sides of his mold will be solid, and if his mold also is firmly made, he can produce a casting free from swells or strains on its lower side.

16. Molds With Bottom Projecting Cores.—There are many molds having bodies of sand extending upwards from the bottom that are not covered with iron until the metal has nearly reached the top of the mold; flat-bottomed annealing pots afford an example of this. Figs. 19 and 20 illustrate this form of mold, Fig. 19 being partially broken away at *a* to show the projection in the mold.

The gases generated at the bottom of such molds when the pouring is commenced endeavor to rise upwards through the vents formed in the projection; this, together with the

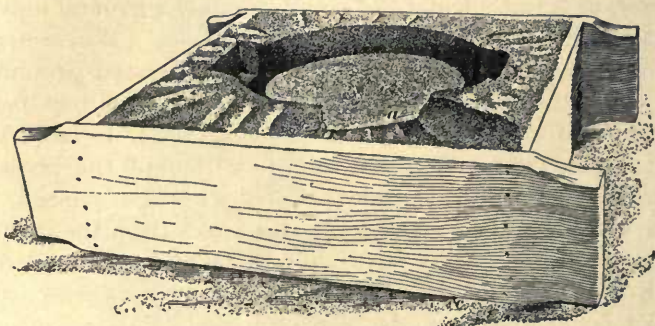

FIG. 19.

fact that the pressure of the metal over the top of the projection at *a*, Fig. 20, is less than at the bottom *b*, is liable to give trouble. Then, again, when the metal commences to cover the flat surface of such projections as *a*, its movement is much slower than the rise of the metal at the bottom of the mold; the result is that if there should be any blowing or bubbling of the iron as it comes to the top of the projection *a*, the rise of the metal will be so slow in creating pressure over the face of the projection that scabbing will take place, endangering the safety of the casting because of the liability of the iron getting into the vent holes leading down from the face at *a* to the cinder bed or other outlet for the vents. To prevent the projection from blowing the

casting, the surface at *a* is made as soft as practicable and the large vents not brought nearer than within $\frac{3}{4}$ inch of the top surface of the projection. This is done by ramming up the sand firmly to within $\frac{1}{2}$ inch of the top and then striking it off with a straightedge cut away at the ends, as in Fig. 9. The bed having been struck off $\frac{3}{4}$ inch below the top of the surface, a $\frac{1}{4}$ -inch vent rod is used to vent closely all over the area down to a cinder bed *C* or other outlet for the gases. The tops of these vents are then stopped up with the end of

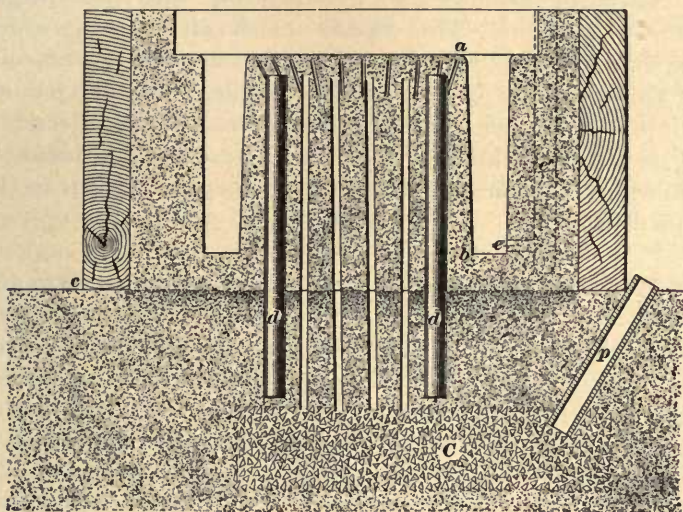

FIG. 20.

the finger, and a very open grade of facing sand shoveled in over them and pressed down with the fingers and palm of the hand as softly and evenly as can be done. This lightly packed sand should extend about $\frac{3}{8}$ inch above the level of the face at *a*, so that the top of the sand may be struck off to give a smooth and finished face to the projection. Before striking off this extra $\frac{3}{8}$ -inch thickness of sand, the face is closely vented with a fine wire, about $\frac{1}{16}$ inch in diameter,

to a depth of about 3 inches, thus connecting the face vents with the large $\frac{1}{4}$ -inch vents, as shown in Fig. 20. The $\frac{3}{8}$ -inch thickness of sand is struck off and the surface finished with a trowel, leaving the top of the projection as it appears at *a*. The mold is shown made above the level of the floor, but it can be made in a hole dug in the floor, so as not to require any part of the flask but the cope; in fact, it would be better to make such castings in the floor, if the shop arrangement permits digging, as then there cannot be any danger of a run-out at the bottom of the drag at *c*. This casting may be poured by an inlet gate *e* connecting with the upright gate, or sprue, *e'*. The cope is not shown; it is a wooden one, 6 inches deep, with bars about 5 inches apart. In pouring this mold, the cope is held down with about 800 pounds of iron. The riser should be kept closed during the pouring so as to maintain a pressure of gases in the mold, as this will assist the gases in finding their way down to the cinder bed.

17. Rodding Projections.—There are a great many projections like that shown in Figs. 19 and 20 that must be rodded in order to make sure that the buoyancy of the metal will not lift them. To make sure of this in the casting shown, six $\frac{3}{8}$ -inch round rods, as shown at *d*, are **clay-washed** or covered with flour paste to make the sand stick to them, and then driven at equal intervals around the circle to the depth shown in Fig. 20. In the hands of a good molder this projection may stand without rodding, but it is always advisable to take as few chances as possible. The question as to whether it is wise or not to rod a projection in this manner is often one of judgment, as the condition of the patterns, flasks, and sand often has much to do with determining what plan it is best to follow. All material that is lighter than liquid metal will rise to the top and float, just as cork will float on water. Sand is a lighter substance than iron, and for this reason, if the rammed sand is not held down the iron may get under it and cause it to float. The **specific gravity** of cast iron ranges from 6.9 to 7.4;

brass, from 7.8 to 8.4; whereas rammed molding sand ranges from 1.4 to 1.8.

NOTE.—The specific gravity of any substance is the ratio of its weight in air compared with the weight of an equal volume of pure water at 62° F. For example, 1 cubic foot of cast iron weighs about 450 pounds and 1 cubic foot of water about 62.355 pounds at 62° F. The specific gravity of cast iron is, therefore, about $\frac{450}{62.355} = 7.2$.

Taking bulk for bulk, a cubic foot of iron weighs about 450 pounds, whereas a cubic foot of rammed sand weighs about 100 pounds, the specific gravity of iron thus being about $4\frac{1}{2}$ times that of rammed molding sand. This means that a projection of rammed sand, such as that seen in Figs. 19 and 20, would have to be about $4\frac{1}{2}$ times heavier than it is before it would remain in position as molded were it not assisted by other forces. One aid to this is the adherence of the tempered and rammed sand. This prevents it from being readily separated. We find this principle illustrated in the necessity for using parting sand on sleeked joints, in order to separate the sections of molds, as previously described. This adherence in the sand of the projection would leave but little risk if the rods at *d* were omitted in this special casting, provided it was well rammed at the bottom. This is where the danger lies with all such work; any softness at the lower edge of such projections as this allows the metal to undermine the projection, and if the metal once gets underneath it, it will rise unless held down by rods or some other means. Then, again, it is necessary to guard against these projections being loosened at the bottom when jarring the pattern to draw it from the mold. Still further, patterns are often deficient in taper, so that in trying to draw them, the whole projection may be started or lifted from the bottom and so leave an opening for the metal to pass under. If any doubt exists as to the safety of a projection, it is better to use the rods *d*, and so prevent possible loss of the casting. Evidently no positive rule can be given for such work, but a study of the principles here outlined, together with his knowledge of the

work, will enable the molder to arrive at a right decision in any given case.

18. Taper on Patterns.—In the last article, reference was made to the danger of **starting** projections at the base

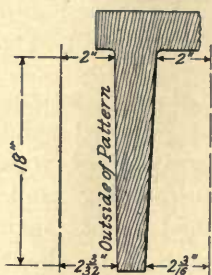

FIG. 21.

owing to a lack of taper on the patterns. As a rule, a pattern should be given all the taper that can be practically allowed. The greater the taper, the less labor will be required in finishing the mold, and, also, the longer the pattern will last. The deeper a pattern is buried in the mold, the more taper it should have. In cases where the bottom of a deep casting must be of nearly the same thickness as at the top, the pattern must not have more than a certain taper, as explained in Part 1. Where the conditions are not exacting, however, it would be much better to double the allowance of $\frac{1}{16}$ inch to the foot there given. This would give $\frac{1}{8}$ inch per foot of taper for whatever depth the patterns might be rammed in the sand. In designing work calling for such projections as are shown in Figs. 19 and 20, every effort should be made to have not less than $\frac{1}{8}$ inch per foot of taper on the inside projections. Such a pattern would, therefore, have its top and bottom dimensions as shown in Fig. 21, if the length of projection were 18 inches, as indicated. It will be noticed that $\frac{1}{16}$ inch per foot is allowed for the outside taper and $\frac{1}{8}$ -inch taper for the inside, where it is most needed. Not only should patterns have good taper, but they should also be well provided with arrangements for drawing the pattern. In deep patterns, this calls for draw-plates, which are screwed to the tops of the patterns.

19. Drawing Deep Patterns.—Where a deep pattern is used to give parallel castings, or where difficulty is apprehended in getting a pattern out of the sand, it is sometimes necessary to draw it with the foundry crane. The

foreman should give directions while the pattern is being drawn, in order that it may be raised evenly. If one side is drawn faster than the other, it not only causes the pattern to bind in the sand, but in the case of molds having projections, there is great liability of starting the projections from their bases, even though they be well rodded. Starting the base might permit the iron to pass in at the line of separation and so into the vents, even though it did not lift the whole projection. To have the iron run into the vents at the base of the mold is as bad as lifting the whole projection, for in either case the casting will be lost.

CLAMPING AND WEIGHTING THE MOLD.

BUOYANCY.

20. Lifting Pressure of Molten Metal.—When the molds have been closed, it is necessary either to clamp or weight down the copes, to resist the lifting force of the metal. This is readily understood when we consider that a liquid will support a body having a smaller specific gravity than itself. Sand is lighter than iron, and for this reason it will float on the surface of that metal, unless it is held down. The actual force required to hold rammed sand down depends on the height of the column of molten metal (that is, the head-pressure) and the weight of the core or cope that is liable to be floated by the metal; the cope or core, like a ship floating on water, will sink until it has displaced liquid iron equal to its own weight, when it will float. To make this subject as plain as possible, we will suppose that *A* in Fig. 22 is a tank instead of a mold, and has been filled with water to its top, as shown in Fig. 22 (*a*). If the block of wood *B* is placed in this tank, as shown in Fig. 22 (*b*), the water will run over its sides until the block comes to rest. If the water that ran over the sides were collected and

weighed, it would be found to equal the weight of the block *B*. In other words, this block, in coming to rest, sank to such a depth as displaced a body of water equal to its

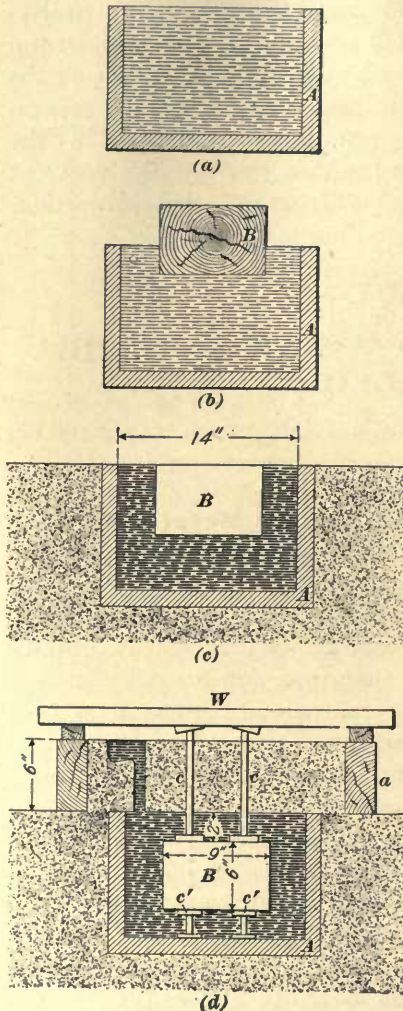

FIG. 22.

own weight. If we desired to sink this block *B* to the level of the top of the tank, as shown in (c), sufficient weight would be required on the block to equal the additional weight of the water that would be displaced by the block sinking to the depth shown. Carrying this illustration still further, it might be desired to submerge the block, as in Fig. 22 (d). To do this, but very little additional weight would be required, because as soon as the block was just covered, the weight of the water above it would be practically the same as the extra amount displaced below the block. This experiment illustrates the principle involved in weighting down cores or copes, the principle being the same both for water and for liquid metal. The only difference between the two is that if the block *B*

were a core submerged in liquid iron, more weight would be required to hold it down, because iron has a greater specific

gravity (or, is heavier) than water. A cubic foot of pure water at a temperature of 60° F. weighs about 62½ pounds, and a cubic foot of ordinary gray cast iron about 450 pounds.

21. Submerged Cores.—Suppose the liquid to be molten iron instead of water, and that the cope *a*, Fig. 22 (*d*), is placed on top of the mold; find the weight *W* that would, by means of chaplets *c*, keep the core *B* from rising. The weight is computed in the following manner: Assuming the core to be 24 inches long, 9 inches wide, and 6 inches deep (and its ends to be free), its volume is $24 \times 9 \times 6 = 1,296$ cubic inches. A cubic inch of cast iron weighs about .26 pound; hence, the weight of the iron displaced by the core is $1,296 \times .26 = 336.96$ pounds. The weight of the core itself is $1,296 \times .06 = 77.76$ pounds, .06 being the weight of a cubic inch of rammed sand. The buoyancy of the core is therefore the difference between these two amounts, or 259.2 pounds, which is the weight required to keep the core from rising.

If the core were supported by prints instead of being free at its end, its additional length and the sand over the prints required to stop them up would also have to be deducted from the 259.2 pounds; but as the core in the present case is supposed to be held up by the chaplets *c*, we have here only considered the length that is submerged. Having found the weight necessary to hold down the core, the next step is to find the weight of the cope.

22. The Cope.—Assuming the cope to measure 34 inches by 24 inches by 6 inches, its volume is 4,896 cubic inches, which multiplied by .06 gives 293.76 pounds as the weight of the cope. This is for wooden copes and is accurate enough; if it were iron, we should have to find the weight of the sides and bars separately, and then that of the sand, and add them together. Having now found the weight required to hold down the submerged core, and also the weight of the cope, the additional weight necessary to hold down the cope in connection with the core must now be computed. To do this, first find the area of the cope's

casting surface; this is 24 inches \times 14 inches = 336 square inches. This area is multiplied by 6, the height in inches of the head or gate, giving 336 square inches \times 6 inches = 2,016 cubic inches. This result is multiplied by .26, which gives $2,016 \times .26 = 524.16$ pounds, the fluid pressure tending to force up the cope. Deducting from this weight the weight of the cope, gives 230.4 pounds as the weight necessary to hold down the cope alone. Adding to this the weight necessary to hold down the core, we have $230.4 + 259.2 = 489.6$ pounds, the total weight to be placed on the cope in Fig. 22 (*d*).

23. Cores Partially Submerged.—There are cases where the cores are only partially submerged, their upper surfaces being in contact with the cope, as in Fig. 22 (*c*). In calculating the pressure on such a partly submerged core, we must compute the area of the lower surface of the core and also the area of that portion of the cope that has metal beneath it. Each of these is then multiplied by the distance to the top of the highest point to which the metal may rise in pouring the mold.

In the case of a core submerged as in view (*c*), and intended to be covered with a cope, as in view (*d*), the computation is as follows: The lower surface of the core has an area of $24 \times 9 = 216$ square inches. Multiplying this by 12, the height in inches from the bottom of the core to the top of the pouring basin, we have 2,592 cubic inches, which multiplied by .26 equals 673.92 pounds, which is the upward pressure on the core. From (*c*) we find that the width of the cope having metal in contact with it is $14 - 9 = 5$ inches; the portion of the cope surface in contact with the metal is therefore $24 \times 5 = 120$ square inches, which multiplied by 6, the height of the cope, equals 720 cubic inches, and this multiplied by .26 gives 187.2 pounds as the upward pressure on the cope. This added to 673.92 pounds gives 861.12 pounds as the total upward pressure. Deducting from this the weight of the core and cope leaves $861.12 - 371.52$, or 489.6 pounds as the weight to be placed on the cope.

METHODS OF COMPUTING WEIGHTS.

24. Chart Method.—The weight required to hold down the cope and core may also be ascertained by the method shown in Fig. 23. Here we merely draw an outline

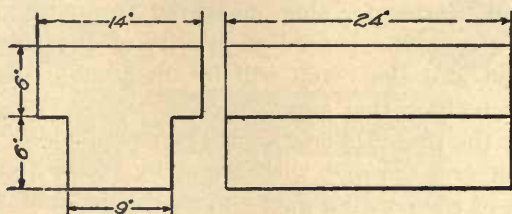

FIG. 23.

or chart of the form and sizes of the lifting surfaces, together with the height of the fluid head. This done, we compute the cubical contents of the form thus obtained and multiply it by the decimal .26. The volume of such a block as that in Fig. 23 is $24 \times (14 \times 6 + 9 \times 6) = 3,312$ cubic inches, which multiplied by .26 gives a weight of 861.12 pounds. Deducting 371.52 pounds (the weight of the core and cope), we have 489.6 pounds as the weight to place on the cope, the same result as by the former method. This method of drawing a chart block of the lifting surfaces and calculating therefrom the weight to put on the cope is a very convenient one and is the one that is adopted when computations are made from drawings.

25. General Rules.—To find the weight necessary to hold down submerged cores, first compute the cubical contents of the space occupied by the core and multiply it by .26; then deduct from this the weight of the core. In other words, the lifting or static pressure on a submerged core is the number of pounds of iron it displaces minus the weight of the core.

To find the weight in pounds required to hold down a cope, multiply the lifting surface of the cope by the height of the head above this surface and the product by .26.

Where one wishes to compute the weight approximately, let him imagine a weight having a face like the lifting surface, and its sides extended up to the top of the pouring gate, according to the scheme shown in Fig. 23.

To find the pressure on the sides of the mold, multiply the vertical height of a side, measured from the top of the pouring gate to the center of gravity of the side, by the decimal .26, and the result will be the pressure in pounds per square inch on that side.

To find the pressure on the bottom of a mold, multiply the bottom area covered with metal by the vertical height to the top of the pouring gate and by the decimal .26, which gives the pressure in pounds.

26. Extra Weight Required on Cope.—While it is true that the foregoing rules for weighting down copes, etc. will give just the weights required under the simplest conditions, there are other conditions affecting the results that must be considered and that will often demand more weight than that given by the rules. This is due to the fact that there is an instant when the metal comes up suddenly against the lifting surface, during which a sudden pressure is exerted that is greater than that due to the height of the head, the latter being merely the steady pressure that will be exerted by the liquid when at rest. When pouring a mold, it generally takes from 10 to 50 seconds (sometimes more) to fill it with metal, whereas when the mold itself is filled, the pouring gate may fill in less than a second, thereby obtaining a head-pressure in a moment's time that, owing to the suddenness of its creation, may in some cases be so great as to call for one-fourth to one-third more weight than the static-head pressure obtained by the rules just given. The higher the top of the pouring gate is above the cope's lifting surface, the greater will be this extra pressure.

Then, again, some molds will be poured with more than one ladle, and the more ladles that are used, the greater will be the pressure; this is due to the increased pressure created by the metal as it flows from the ladle directly into a

gate, as shown at *e*, Fig. 24. This increased pressure may be equivalent to the pressure of a head of one-fourth to one-third the height of the ladle's lips from the top of the gate.

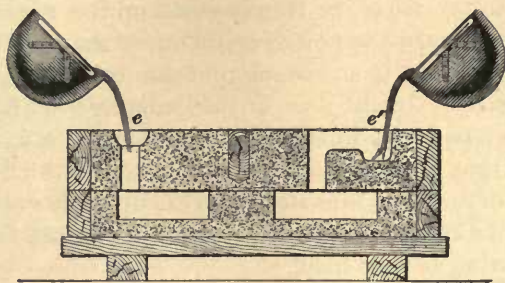

FIG. 24.

If the pattern is gated and poured as shown at *e'*, less weight will be required to hold down the cope.

27. Momentum Lift.—In addition to the weight rendered necessary by the head-pressure, extra weight is required to allow for the **momentum lift** caused by the sudden stopping of the inflowing iron at the moment the mold is filled. The amount of this depends, briefly, on the character of the pouring system, the speed of pouring, the number of ladles, and the square inches of lifting area that the metal will suddenly rise up against, as well as the height of the pouring gate or flow-off risers above the face of the cope's lifting surface. Enough has been said to demonstrate the wisdom, and often the necessity, of placing more weight on a cope than is called for by the head-pressure, and the molder must exercise good judgment in this matter.

28. Effect of Dull Iron on Buoyancy.—The lifting force of the molten metal depends in a measure on whether it is hot or dull. If the metal is dull, in most cases it will exert less pressure than if it were hotter and therefore more fluid. On the other hand, the duller the iron is, the more

apt it is, in molds having risers or flow-off gates, to have its pressure approach that due to the pouring basin's height, which is generally higher than that of the top of the risers or of the flow-off gates. Often the metal will *freeze* at the entrance to the risers, or it may come up the risers so sluggishly as to retard the flow of metal out of them and so cause the head-pressure to approach that due to the height of the pouring basin. In the case of thin castings, if the metal is dull enough to freeze in the risers, it is not very apt to exert a great lifting pressure on the mold. If, with thick castings, the risers or flow-off gates should freeze up or flow sluggishly, there will be exerted a lifting pressure due to the full height of the pouring basin's head.

29. Computing the Static, or Head, Pressure.—

Some molders compute the **head-pressure** on the cope by taking the height from the top of the riser or flow-off gate, the top of which is often located 4 to 6 inches below the level of the top of the pouring basins or gates. This is rarely a safe practice, as risers or flow-off gates may solidify or be blocked up so that the metal cannot flow freely through them. If it were always possible to count on having hot iron and enough room in the risers or flow-off gates to carry off the metal as fast as it could be poured into the mold, the height of risers would then, as a general thing, determine the pressure. Nevertheless, the safe plan is to figure from the highest point it is possible for the metal to reach in the pouring gates or risers, and then allow extra weight on the cope.

30. Weights for Holding Down Copes.—

In weighting down molds, many foundries use pig iron piled in separate pigs on the cope, or else place the pigs in stout wrought-iron rings, to be hoisted into position by a crane. Others, improving on this, cast bars ranging from 1,000 to 2,000 pounds in weight and from 3 to 6 feet in length, with hooks cast in them for convenience in handling with a crane. Other foundries preserve bad castings or take lumps of

heavy scrap iron for flask weights, and handle them in the best way they can. When flask weights are required, it pays in the end to have them as handy in form and size as possible; this refers to weights for medium and large castings. For small castings, light weights for snap flasks, etc., are required; these latter are generally made about $1\frac{1}{2}$ inches thick and of a size to cover the entire surface of the cope, if they are not burdensome for one man to handle. These weights generally have holes in their centers and outer corners for pouring through, as shown in Fig. 25, which shows a section of a weight w and a snap-flask mold. The under surface of these weights should be as smooth and true as they can be cast. A snap flask rarely requires more than one such weight.

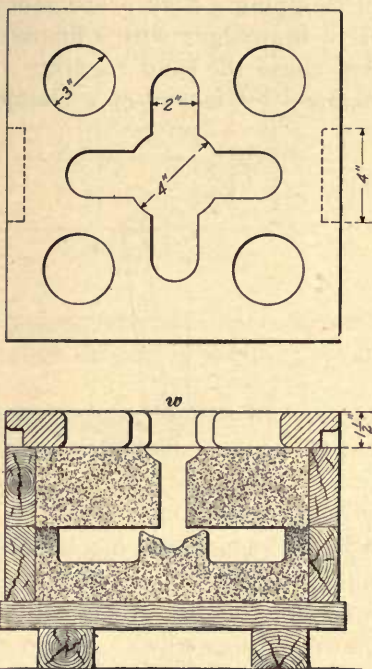

FIG. 25.

CLAMPS FOR FLASKS.

31. Types of Clamps and Their Use.—Shops that do much roll-over work should have a number of **clamps** that are adapted to their needs. These clamps are made both of cast and of wrought iron and should be as handy in size and form as conditions will permit. Clamps of the forms generally used in rolling over the drags and in holding flasks together when a mold is being poured are shown in Figs. 26 to 28. Many patents have been taken out for

improvements in clamps, the chief features being that their length can be changed or they can be used without wedges. In clamping a flask preparatory to casting, it is not safe to drive in wedges with a hammer, as this may jar the cope and cause the sand to drop. As a rule, flasks should be clamped by means of a clamping iron, as shown at *c*, *c'*,

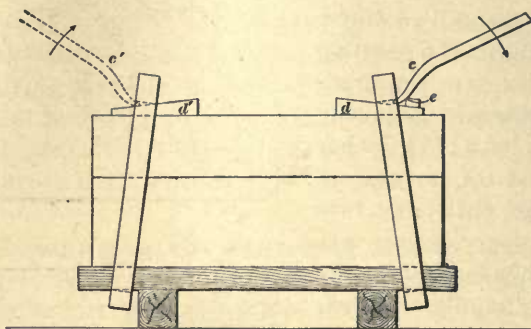

FIG. 26.

Fig. 26. The clamping irons are made with wedge-shaped points, so as to enter the small openings between the cope and clamp, and to give good leverage in either direction, as shown by the arrows. These clamping irons are, as a rule, made of old files, the points of which are turned up and sharpened.

In Fig. 27 are shown a wrought-iron clamp (*a*) and a cast-iron clamp (*b*), such as are commonly used for clamping

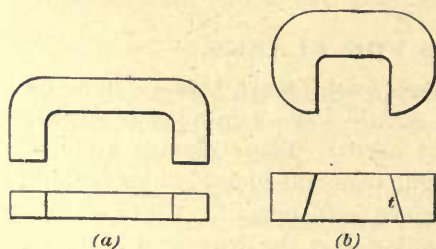

FIG. 27.

flanged flasks, as shown in Fig. 28. Such flasks are generally used for dry-sand molding. Cast-iron clamps are usually tapered on the inside to permit of their being molded, the taper being shown, somewhat exaggerated, at *t*, Fig. 27 (*b*). In placing clamps on

the flanges, they should be set so that the wedge will enter them at their largest side, as at *c*, Fig. 28, which shows

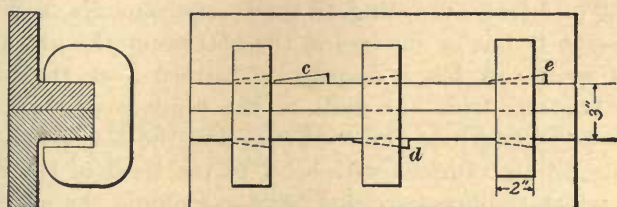

FIG. 28.

the wedge about to enter the space between the clamp and the flange of the iron flask; when driven, it should appear as shown at *d*.

Molders frequently try to clamp flasks by driving wedges at the top of the clamps, as shown at *e*. This is wrong; for by trying to drive a wedge in at the top, the weight of the clamp must be lifted, and in doing this a constant jarring takes place, making it difficult to get the clamp to a solid bearing. Not only is it difficult to tighten a clamp by top wedging, but it also requires much more time.

32. Strength of Clamp.—Where the work is such that the clamps must resist a heavy pressure, as in the case of casting rolls, pipes, etc. on their ends in dry sand, the wrought-iron clamp should be given the preference, as cast-iron clamps are not to be relied on in such work. Owing to the breaking of cast-iron clamps, castings have often been lost and men have been burned.

The proper thickness for clamps can be obtained by figuring the pressure on the flasks to be held together, and then deciding the distance apart that the clamps will be set along the flange of the flask. Knowing this, and allowing a stress in the clamp of 15,000 pounds per square inch for good wrought iron and 5,000 pounds per square inch for good cast iron, one can form a very good idea as to the proper thickness for clamps.

33. Floors for Holding Down Copes.—Many foundries that handle a standard class of work that can be bedded in have a large part of their floor area dug to a depth of from 3 to 6 feet, according to their requirements, and then place iron beams or binders in the bottom of the pit, about 3 feet apart. A plank flooring is formed over the top of these binders; from the ends of the binders wrought-iron straps or bolts are run up to the level of the floor. This pit is then solidly rammed with sand to the level of the floor, after which the holes are dug out for molding the patterns. The molds are made after the usual manner, and binders are placed across the top of the cope directly over those in the bottom of the pit; after which, bolts are extended from the top binders to connect with those extending from the bottom ones, and the cope is bolted down in such a manner that the bolts will have to be broken before the cope can be raised by any pressure that might come on it. The practice of using these bolting-down floors instead of weights is a good one.

GREEN-SAND MOLDING.

(PART 3.)

IRON MOLDING IN GREEN SAND.

DETAILS OF THE MOLD.

JOINTS.

1. Joints for Parting Circular Forms.—The simplest form of **joint** and the one most used is the straight joint, the manner of making which was described in *Green-Sand Molding*, Part 1. Joints for parting circular forms are shown in Figs. 1 and 2. When the pattern is divided as shown in Fig. 1, it is customary to make the mold with half the pattern in the drag and half in the cope. The parting line of the pattern and the parting line of the mold are made to lie in the same plane, so that in lifting the cope, half the pattern is lifted with it and the other half remains in the drag. If the solid pattern shown in Fig. 2 is to be used with a straight joint in the mold, it is necessary to bed half the pattern in the cope temporarily. The drag is then put on and rammed up, the mold rolled over, and the cope shaken out, placed on the drag, and rammed up again. The solid pattern can also be used in the bedding in process as explained in *Green-Sand Molding*, Part 2, and the sand is smoothed down to the level of the middle of the pattern. A cope can then be placed over it and rammed up in the usual manner.

COPYRIGHTED BY INTERNATIONAL TEXTBOOK COMPANY. ALL RIGHTS RESERVED

While the method of dividing the pattern as shown in Fig. 1 can be followed to advantage in many cases, there are others where it is better to make the pattern of one



FIG. 1.



FIG. 2.

piece. Another method of molding when a solid pattern is used is to place the pattern on a follow board and ram up the drag in the ordinary way. The mold is then turned over and the joint cut down to one of the two forms shown at x and y , Fig. 2.

The joint shown on the right at x is bad practice, as some sand will often be left sticking in the sharp angular pocket formed against the pattern at z . When sand does stick in such pockets, it is difficult to patch them without causing a heavy "fin" on the casting or taking chances of a "crush" at the joint. Then, again, such a form gives a very poor bearing for gagers, the setting of which is explained later.

By making a joint as at y , on the left of Fig. 2, every opportunity is afforded for a good bearing for gagers and for obtaining a clean lift. Should any of the joints break and require patching, this can be done without much danger of leaving large fins on the casting or causing the mold to crush, owing to the flat surface at the joint, which gives a good guide for patching any broken edges. It is chiefly in heavy castings that cutting down in this manner is practiced.

These two methods of parting the mold when using a solid pattern are rarely employed except when the cope is shallow or it is desired to avoid cutting the bars of the flask to conform to the shape of the pattern. Small patterns are usually divided as in Fig. 1 or provided with follower boards.

2. Joints for Irregular Forms.—Fig. 3 illustrates a method of making joints by having the parting line of the

cope and nowel conform to the shape of the joint of the pattern. The illustration represents the end view of the cope *a*, drag *b*, and bottom board *c*, the cope being in place for ramming up. The dotted line at *d* shows the lower line of

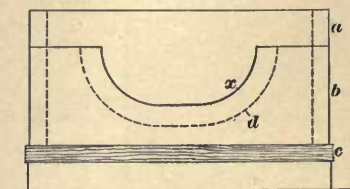

FIG. 3.

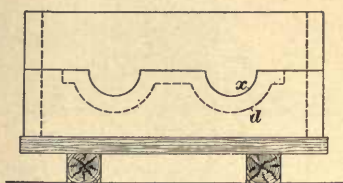

FIG. 4.

the pattern, while *x* is the face line of the pattern and the line of separation between the cope and nowel. Another example of this is seen in Fig. 4, which shows the side view of a cope and drag, the lines of the pattern being at *d* and *x*, as in Fig. 3.

3. Three-Part Molds in Three-Part Flasks.—

Many patterns are of such a form as to require two or more parting lines. Sheave wheels and wheels having flanges are the most common representatives of this class of castings. The most common way of casting such pieces is to have as many parts to the flask as there are parts in the mold. One method of molding and casting a flanged pulley is illustrated in Figs. 5 to 7. The part of the pattern *p* is placed

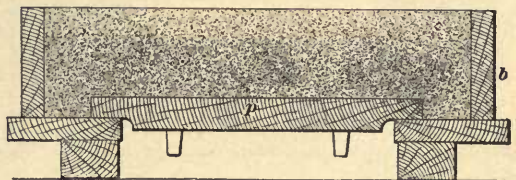

FIG. 5.

on the follow board and the drag *b* is placed around it. This part is rammed up and struck off as shown in Fig. 5. The bottom board is then put on, the mold turned over, the pattern section *q* put on, parting sand sprinkled on the mold,

and the cheek or intermediate part of the flask *f* put in place. This part of the mold is then filled up with sand, rammed, and struck off, as shown in Fig. 6. Parting sand is then sprinkled over the joint, the cope put on, the sprue pin

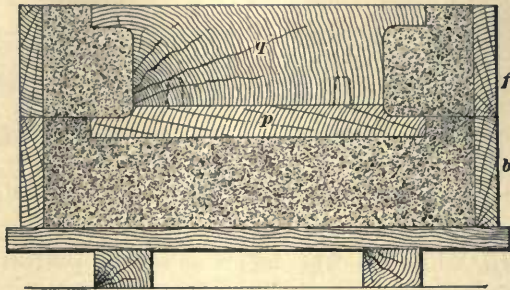

FIG. 6.

located, and the cope rammed. The sprue pin is then removed and the pouring basin *e*, Fig. 7, formed. The cope *a* is lifted off and the pattern *q* withdrawn from the cheek. The cheek *f* is then lifted and the pattern *p* withdrawn

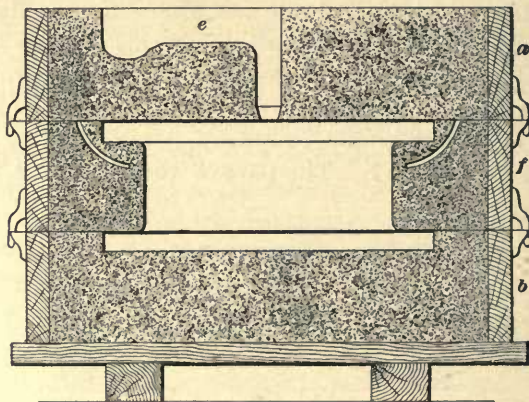

FIG. 7.

from the drag. The drag is finished, the cheek put in place, the groove of the pulley vented, the cheek and cope finished, and the cope placed in its position, as shown in Fig. 7. The mold is then complete and ready for the metal to be poured.

4. Making Three-Part Molds in Two-Part Flasks.

A three-part mold may be made in a two-part flask by having an intermediate body of sand between the cope and the

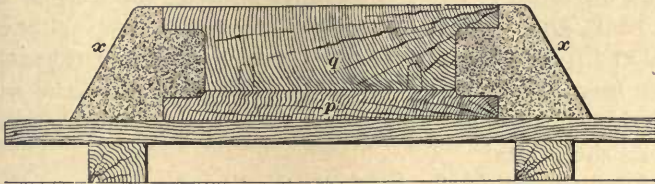

FIG. 8.

drag. This is illustrated in Figs. 8 to 10, in which the

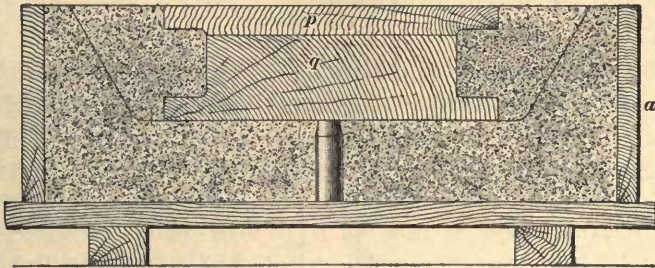

FIG. 9.

pattern described in Art. 3 is used. The pattern is placed

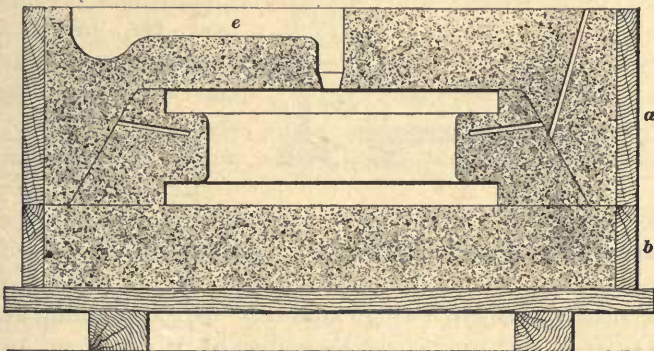

FIG. 10.

on a mold board and weighted down, after which sand is packed around it to form a joint, as shown at *x*, Fig. 8.

The cope *a* is now set on and rammed up, after which the whole is turned over, when it will appear as shown in Fig. 9. Next, the drag *b* is set on and rammed up, after which it is lifted off and the pattern section *p* drawn; the drag is then set back, and both parts clamped and rolled over. The cope is next lifted off and the pattern section *q* drawn; the mold is then finished and the cope set back in place, when the whole will appear as shown in Fig. 10. Parting sand must be used on all the joints.

In venting the cope, it is only necessary to run vents from the parting line with the intermediate section to the top of the cope. The gases will find their way along this parting line and out through the vent.

5. Starting the Joint in Lifting.—It is important not only that the joint in the mold be properly constructed,

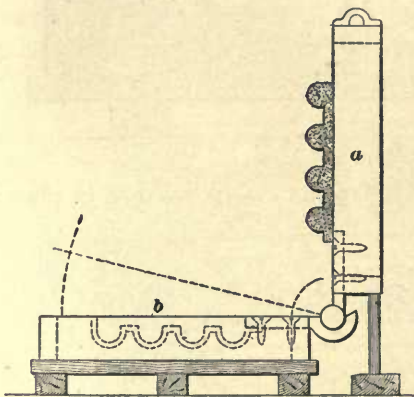

FIG. 11.

but also that means be provided for properly separating the parts, as a good lift often depends on the manner in which the cope is started. It is necessary to start some copes evenly all over the joint, while others part better by starting one side before the other. In light work, there are many copes that are best

raised by being rolled up, as in Fig. 11. In rolling up a cope, it may be advisable to have it go upwards and toward the hinge, as shown by the dotted lines in Figs. 11 and 12; or on the other hand, it may go upwards, first describing an arc away from the hinge and then toward it, as shown by the dotted line in Fig. 13. This movement can be given by arranging the hinges as shown in Figs. 12 and 13, from which it is clear that the matter of having a cope go upwards

from or toward the hinged side can be controlled, thereby assisting in getting good lifts when a movement in either

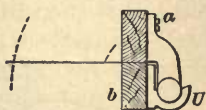

FIG. 12.



FIG. 13.

direction will do this. Of course, the farther from the joint the center of the hinge is, the more rapid will be the outward or inward movement.

FOLLOW BOARDS.

6. Their Use in Forming Joints.—In making the mold for small castings (either of iron or brass) that have irregular joints, much time and labor may be saved by using a **follow board** that will form the joint; then, when the board is lifted off, parting sand can be sprinkled on and the joint is ready for the cope. Many persons making light work have the follow board so perfected that it is often difficult to perceive where the joint is on the casting. There are four classes of follow boards: (1) the *wooden* follow board, which is carved out to give the desired shapes to the joints; (2) the *sand-and-composition* follow board; (3) the *plaster-of-Paris* follow board; and (4) what is called the *match board* or *match plate*. The sand-and-composition follow boards are the ones generally used. Follow boards are sometimes called *odd sides* or *matches*.

7. Sand Follow Boards, or Matches.—The usual method of making sand follow boards is to ram up a drag (harder than usual), and then, after making a good firm joint, set upon it a frame having nails driven in at its sides, as shown at *n*, Fig. 14; these nails are driven into the frame to hold the sand when using the match. When this frame is set on, new molding sand (tempered with very thick clay

wash or else made up of 1 part flour to 10 parts sand) is shoveled in and rammed as hard as possible, after which a bottom board like the one shown at *c* is nailed on to the bottom of the frame and the frame and board then lifted off.

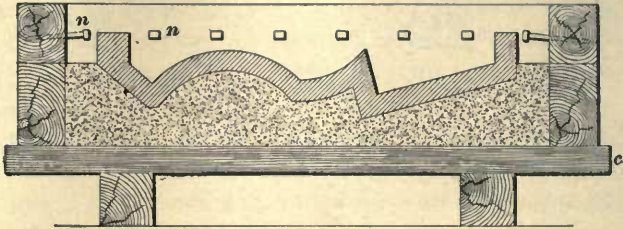

FIG. 14.

The surface of the match is now sleeked, to repair any broken edges or parts that may have stuck down in lifting it off, and a little molasses water is blown over the surface to strengthen the joint. The molasses water used in finishing the joint may be blown from the mouth or from a special

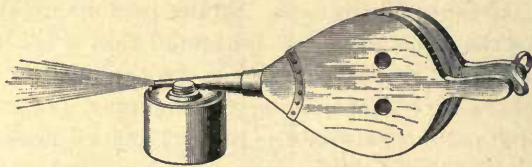

FIG. 15.

sprinkler attached to a pair of bellows, as shown in Fig. 15. Another form of sprinkling device, known as a blow pot, is shown in Fig. 16. Fine sprinkling may be done by tilting the pot and blowing with the mouth so that the current of air strikes the liquid as it escapes. When it has been sprinkled, the match should be set aside for a day or two to harden, after which it is ready for use. In light work it is of the utmost importance to preserve the joint edges of

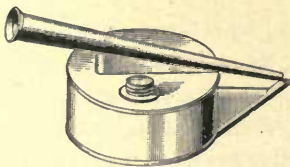

FIG. 16.

sand matches, so as to keep them sharp and unbroken. It will help to preserve them if all the sharp edges are stiffened with nails driven close together, allowing the heads of the nails to come flush with the face of the sand forming the match; even then, the edges may become ragged and cause bad joints. A match made from molding sand, or what is termed a green-sand match, is ready for use as soon as it is made. Most molders give these matches a slight sprinkling every day after the day's work is finished, for they do not work well when in a dry condition.

8. Composition Follow Boards.—In place of ramming the frame, Fig. 14, with molding sand, a composition may be used that will become harder and last longer than the sand match. A composition often used is one made up of fine sand, boiled linseed oil, and litharge. The sand should be very dry. Add 1 part of litharge to about 20 parts of sand, mix thoroughly, and then sift the whole through a fine sieve. Temper this mixture with the oil to the same temper as sand intended for ordinary green-sand molding. The mixture is rammed, as one would ram a mold, to a degree of hardness equal to that generally required in copes. After the ramming has been done, the bottom board is screwed to the frame. The match and the drag on which it is made are then rolled over together, the drag carefully lifted away, and the joint finally finished. Before these matches are dry, they are about as fragile as so much dry sand, and require the utmost care in handling, as well as in removing the pattern for the first time. When the match is dry its surface should be given a coating of shellac, which will prevent the sand from adhering to the surface. Before putting the match away, its edges and surface should be finished in the same manner as sand matches, using linseed oil instead of the molasses.

Molding sand should not be used for these matches, as it makes them weak; but some fine-grained sand can be used, and almost any sand of fine grain will do. If at any time the corners or edges are found to be broken, they can be

mended by patching with beeswax. To form the separation between this match mixture and the sand on which it is rammed, a regular parting sand is used. For very fine work a material known as lycopodium is used. Where the match is too large to lift off the drag, they can both be rolled over and the drag lifted from the match, and the sand then carefully removed from the face of the match.

9. Plaster-of-Paris Matches.—Plaster-of-Paris matches are often used where, from the crookedness of the pattern, other classes of matches cannot be made as cheaply or as perfectly fitted or kept as true during use. This material gives very hard matches on which to ram, but great

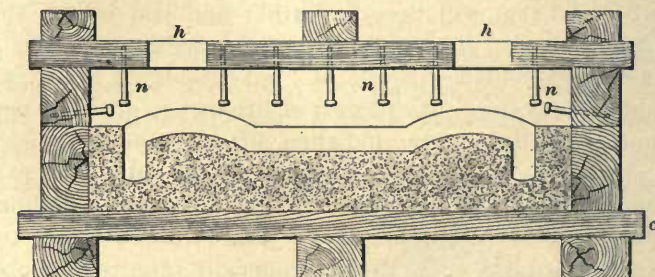

FIG. 17.

care must be taken not to break any of its edges, as, even with care, the working in and out of the pattern is very liable in a short time to cause the edges to become ragged and broken; and no durable method of patching such broken edges has yet been devised. Fig. 17 shows the match in

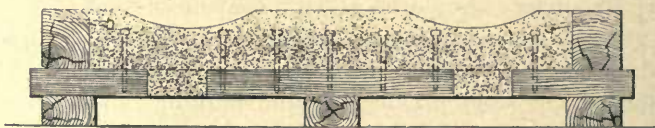

FIG. 18.

process of construction, while Fig. 18 shows it ready for use. In starting to make such a match, the pattern is rammed up in a drag and the joint made as in molding ordinary castings.

The joint should be carefully made so as to give it the best possible form, one that will give clean lifts and assist in obtaining finless and true-jointed castings. The patterns are treated with a good coat of oil to prevent the plaster from sticking to them. A wooden frame having a bottom board screwed on is then placed as in Fig. 17; both this frame and the bottom board should have plenty of nails *n* driven in them. In this bottom board are two holes *h* for the purpose of pouring in the plaster. Before pouring a plaster match, the outside of the joints should be carefully stopped up with clay, or else firmly banked up with sand, to prevent leakage. The plaster having been poured in, it is allowed to set until hard; then the drag and match are rolled over together, opened, and the sand removed from the face of the plaster with brush and water. After the face of the board is finished up smooth and the plaster is dry, it is given a coat of shellac varnish containing lampblack, and when this is dry the board is ready for use. Plaster of Paris is made by heating powdered gypsum, which consists of sulphate of lime and water. The heat drives the water out of the gypsum, leaving a powder that, when mixed with its own bulk of water, forms a creamy paste that becomes solid almost immediately.

In using plaster of Paris, the fluidity of the mixture should be regulated by the thickness of the body required. For thin bodies, 2 parts of water to 1 of plaster makes a good proportion, but for general work, 1 part of plaster to 1 part of water will be about right. The pouring holes should be as large as practicable, for in filling thin places or corners, the quicker the match is poured, the better. If a mold has any considerable body, it will shrink so much as to require being filled up with more plaster after it is poured. Before starting to pour a mold, therefore, there should be plenty of water and plaster at hand, to avoid any delay after the pouring has begun. With practice, one can estimate very nearly the amount of mixture required to fill a mold; it should be all mixed before starting to pour, especially in the case of light molds. For thick bodies one may partially fill

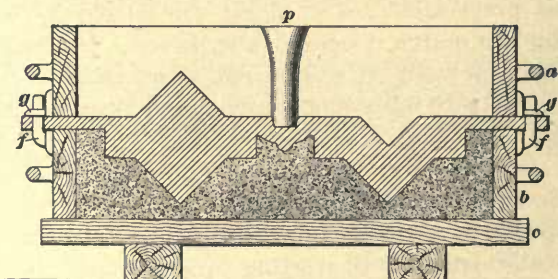
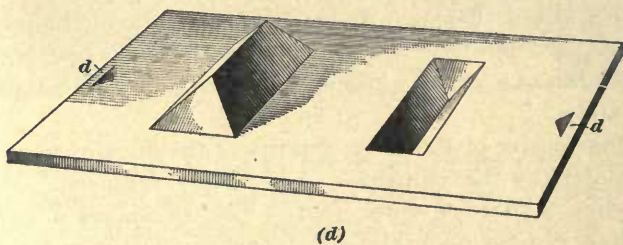
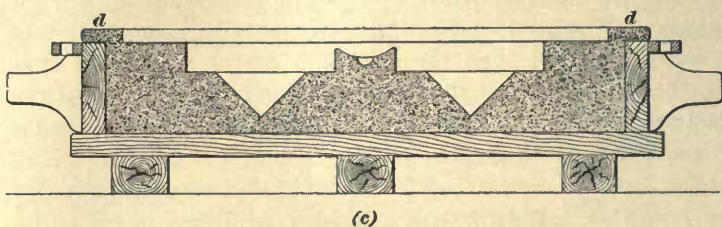
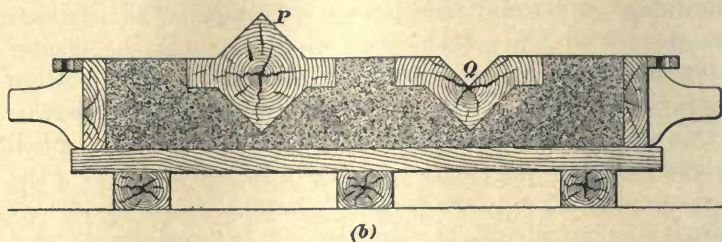
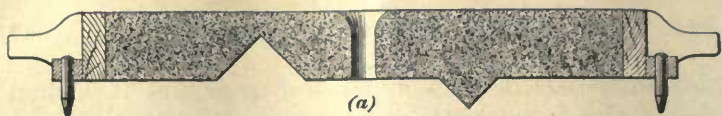

FIG. 19.

a mold and then complete the job by a second pouring; but generally speaking, plaster of Paris requires prompt handling.

10. Match Plates or Match Boards.—There are cases where **match plates**, as they are termed, will be found of value in expediting the making of joints; their construction is very simple. Fig. 19 shows the mode of constructing a match plate for two patterns, one of which comes wholly below the joint line and the other partly above and partly below it. In Fig. 19 (*b*) the drag is shown rammed up and the joint made, *P* and *Q* being the patterns. The cope when rammed up appears as shown in Fig. 19 (*a*). The manipulation so far is the same as that required for making a casting from each of the patterns. The next step is to mold the plate portion. This is done by banking sand against wooden strips from $\frac{3}{16}$ inch to $\frac{1}{4}$ inch thick. In this way the body of sand *d*, Fig. 19 (*c*), is formed. The thickness of this body of sand should be so chosen that it will make the plate strong enough. The gates are cut as though the casting was to be poured through them. The cope is then closed and the mold poured, the casting being the match plate shown in Fig. 19 (*d*). Fig. 19 (*e*) shows the drag rammed up, the cope set on, the gate pin *p* in place, and the cope ready to be rammed up. The ends of this match plate extend beyond the flask and contain holes for the flask pins to fit into, so that the mold may come together properly when it is closed. These holes are made by drilling and filing to fit the dowel-pins on the drag. This will be better understood by reference to view (*e*). The drag *b* has pins *f, f*, that are long enough to fit into the holes *d, d* in the match plate and also holes *g, g* in the lugs of the cope. This arrangement of pins and holes acts as a guide in setting both the cope and the match plate. Should there be any overlapping of joints in the castings produced, the trouble will generally be due to shaky or untrue pins. In making the match plate, as well as in using it, the pins on the flask must be carefully looked after, or properly jointed castings will not be obtained.

Wooden matches made by the patternmaker are also used. The match plate or board is of practical use only for castings that have plain outlines and are without sharp corners, cores, or projections.

GAGGERS AND SOLDIERS.

11. Use of Gagers and Soldiers.—Gagers and soldiers, which are described more fully in Arts. 12 and 13, are appliances used in combination with flasks and cross-bars to enable the molder to lift and suspend bodies of sand. This will be better understood by reference to Fig. 20, which represents a cope 16 inches square by 5 inches deep. If this cope were rammed full of good and properly tempered sand, having

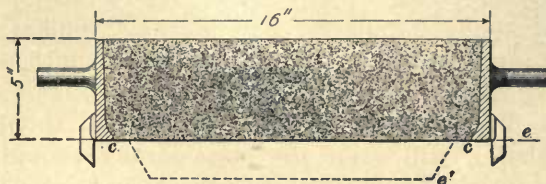

FIG. 20

its joint level with the bottom edge of the cope at *e*, the sand would lift and stay suspended. Instead of the joint being level with *e*, it may be desirable to have the cope sand project down into the drag, as shown by the dotted line at *e'*. Where the sand extends more than $\frac{3}{4}$ inch below the level at *e*, it might not lift with the cope, or if it did, it could not be safely suspended without the use of gagers or soldiers.

The volume of sand that can be carried without special securing varies with the condition of the sand. A coarse sand will not hold as well as a fine sand. A body of sand 16 inches square and level with the lower edge of the cope, as at *e*, is about as large a body as can be suspended without the use of cross-bars. Even with a body 16 inches square, it is sometimes necessary to have grooves along the sides of the flask or else projections like *c*, Fig. 20, as without one or the other of these the sand will be liable to slide out of the cope. While 16 inches square is given as being the largest

area of sand that can be safely suspended, even that area cannot be lifted in all cases.

12. Making Gaggers.—Gaggers are made of cast or wrought iron. Fig. 21 shows the form generally used. They can be made of either square or round iron, and are usually about 4 inches long at the toe *m*, with the shank *n* from 5 inches to 20 inches or more in length, according to requirements, and from $\frac{3}{8}$ inch to $\frac{1}{2}$ inch in diameter or square.

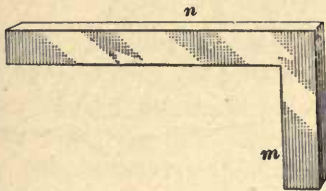

FIG. 21.

In some shops wrought-iron gaggers are used almost exclusively; while in others, cast-iron ones have the preference, as they will not spring, are cheaper to make, and have the advantage of being readily broken off to any desired length when shorter ones cannot be found.

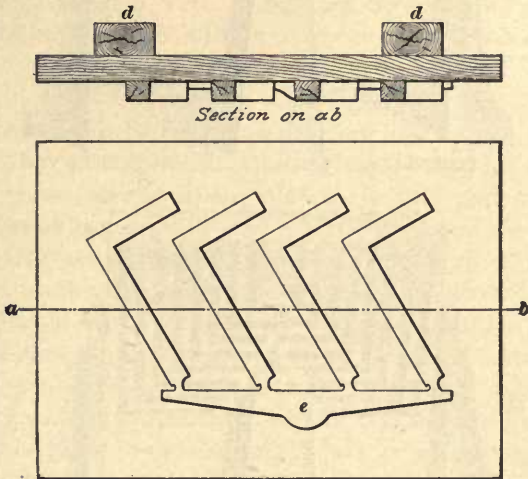

FIG. 22.

Wrought-iron gaggers are useful in work where the toe must be bent to suit slanting surfaces and joints. In some foundries objection is made to breaking cast-iron gaggers,

and to avoid breaking them, they are left sticking out of the cope. Gaggers sticking up in this way are liable to be hit

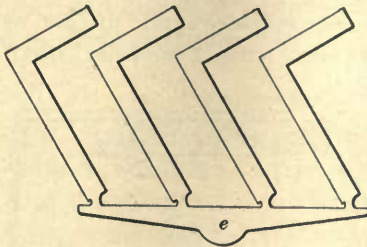
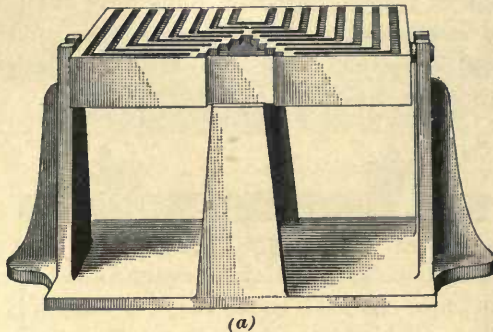

FIG. 23.

accidentally after the cope is closed, and this may result in the loss of the casting. It is bad practice to leave gaggers standing above the surface of the cope. Cast-iron gaggers can be made to good advantage in open sand by having from four

to twelve patterns on a board, as shown in Fig. 22, and pressing the board into a level bed of soft sand by pounding



(a)

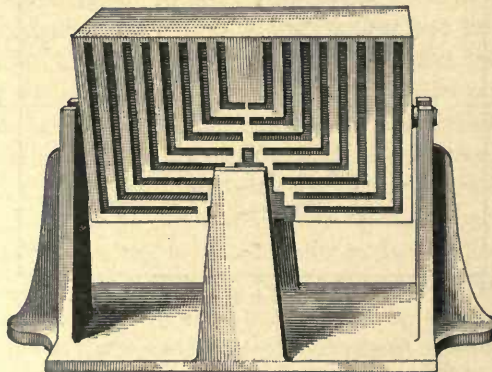

(b)

FIG. 24.

on the battens *d* with a light sledge. When the gaggers are cast, they appear as shown in Fig. 23; they are easily knocked off the runner *e* with a hammer. Wrought-iron gaggers are usually made by cutting straight bar iron into the required lengths and bending the toe *m*, Fig. 21, in a vise or over an anvil.

Cast-iron gaggers may be made very rapidly by the use of a chill mold, as shown in Fig. 24 (*a*) and (*b*). The illustrations show a gagger mold that can be used almost an unlimited number of times during the heat. It is swung on a cast-iron bedplate, supported by two trunnions that allow the mold to be turned over, as shown in Fig. 24 (*b*), which illustrates the process of turning it over for the purpose of dumping the gaggers. The metal is poured on the mold, which is then turned over, striking a stop when upside down so as to jar the gaggers loose and allow them to fall out. Both sides of the plate contain molds for gaggers, so that as soon as the plate is turned over the molder can pour the second set of molds full. This can be repeated until the mold gets hot, when it will be necessary to let it cool off for a time.

13. Making Soldiers.—Soldiers are merely strips of wood. They can be made by taking a piece of rough straight-grained board, sawed to any desired length, and cutting it into strips of any desired size. They range in size from a narrow strip to one 8 inches wide. Often these soldiers will be nailed to the sides of cross-bars, so as to assist in lifting deep bodies of sand. The soldiers, if well sustained between the cross-bars by nailing them or by ramming them firmly between the bars, will lift larger bodies of sand than if gaggers were used over the same area. In using soldiers, they must not be placed too near the surface of the casting, where there might be danger of the iron breaking the sand away from their surfaces, for if this occurred, the steam and gas from the wood would cause the mold to blow and spoil the casting. Then again, if soldiers are to remain bedded in the sand for more than a few hours, they should be well soaked

in water before being placed in position, for if they swell in the mold, they may cause bad castings.

14. Setting Gaggers.—The main thing to be kept in mind when setting gaggers is that, bulk for bulk, a gagger

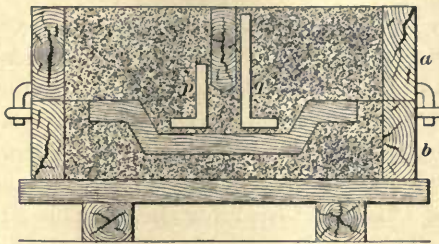

FIG. 25.

is about $4\frac{1}{2}$ times as heavy as rammed sand. Gaggers are used sometimes to aid in lifting bodies of sand that would have a better chance of being lifted were the gaggers omitted; this will be better understood by reference to Fig. 25, in which a body of sand about 3 inches deep is to be lifted. Gaggers set as at *p* will do more injury than good; to be of any service they should be long enough so that at least two-thirds of their length will be between the cross-bars, as at *q*. Then, again, where gaggers are expected to lift a heavy body of sand, not only should they come up well between the cross-bars or in the cope, but the sand should be firmly peened and rammed between them.

15. Setting Cross-Bars.—In putting bars into ordinary copes, a space of from 5 inches to 6 inches between each bar will answer for plain work; but for copes that have bars projecting into deep recesses in the drag, or that have them cut to permit projections to extend into the cope, different spacing and a different system of barring are often necessary. At *s*, *t*, and *u*, Fig. 26, is shown an objectionable method of setting cross-bars in the cope used for making a long casting of the general cross-section shown at *P*. One objection is that the flat side of a cross-bar is placed parallel with the flat face of the pattern, leaving a poorly supported, thin, flat body of sand *v*. In ramming sand in such narrow pockets as at *v*, good judgment must be exercised; if the sand is rammed too hard, the gases will not escape freely,

and scabbing or blowing is likely to result. Another objection to the method shown in Fig. 26 is that where it is necessary to roll the cope over, the thin flat cake of sand is liable to drop off unless securely rodded, which involves having straight rods of round iron coming from the face up between the bars. Bars used for lifting sand out of pockets or for carrying hubs or other projections should be arranged so as to have a considerable body of sand around them.

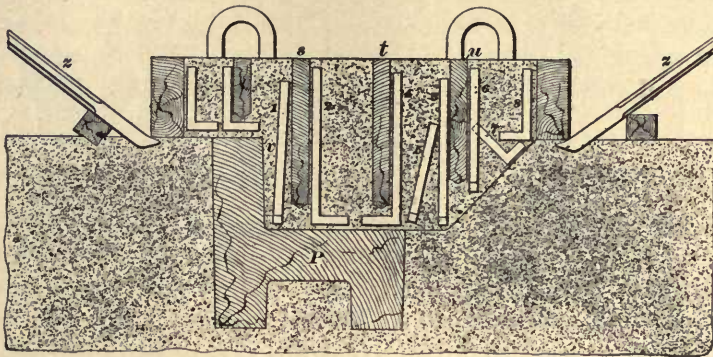

FIG. 26.

This not only lessens the dangers due to hard ramming, or lack of freedom in venting, but it gives more room for ramming up and seeing what is being done when setting gaggers, etc. Another objection to using bars as at *s*, *t*, and *u* is that the gaggers cannot be set very readily or firmly, and the danger of a *drop-out* is greatly increased. For work of the character here shown, the bars should be set across the mold, as indicated by the dotted outline *o o* in Fig. 27. The position of gaggers *1*, *2*, *5*, *7*, and *9*, Figs. 26 and 27, shows lack of judgment. The sand at *7* would be more likely to lift if the gagger were not used, as its length is only about that of the body of sand to be lifted, and iron, as already explained, is a great deal heavier than sand. If bars could not be placed as at *o o*, Fig. 27, and it were necessary to set a gagger as at *1*, Fig. 26, it would be better to keep it about 3 inches higher and reverse the toe of gagger *2*, bringing

the toe or point under the bar toward the face of the pattern. The position of gaggers *11*, *12*, *13*, and *14*, Fig. 27, in connection with the bars at *0*, *0*, represents good practice. Gagger *10* should have its toe moved very close to the face of the pattern at *v*, while *9* should be set between *10* and *11*,

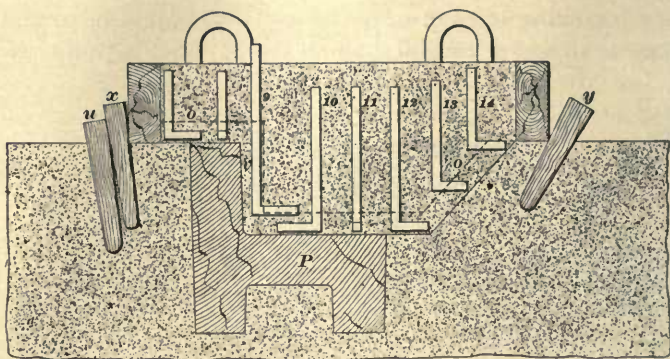

FIG. 27.

with its toe parallel to *11*. If the cope is to be rolled over, more gaggers (*13* and *14*) should be used as the height of the ramming increases. The points of gaggers against the surfaces of flat bodies of sand cannot do the harm that gaggers can when set as at *1* and *9*. The latter do not give good support and produce soft spots in the mold.

16. Driving Stakes and Starting the Joint.

Fig. 27 also shows right and wrong methods for staking copes that are used over bedded-in patterns. Stakes should be driven almost parallel to the side of the cope, as shown at *x*; it is bad practice to drive them at a considerable angle, as shown at *y*; a stake driven in this manner is liable to cause poor lifts and overshot castings, because of the great angle it makes with the surface of the floor. In staking flasks for ordinary work, at least two-thirds of the length of the stake should be driven into the ground. Sometimes, to insure greater certainty in large work, it is best to drive one stake behind another, as illustrated by *u* and *x*. To assist

in the lifting of such deep copes as are shown in Figs. 26 and 27, iron starting bars can sometimes be used, as shown at *z, z*, Fig. 26. It is important that the cope be started properly; for if it is started so as to raise one side before the other, or if it is started with a jerk, the most careful ramming and use of gaggers will be of little avail in giving a good lift. Where two or more men are required to lift the cope, it is often a good plan to first raise it an inch or two by raising each corner alternately from $\frac{1}{8}$ inch to $\frac{1}{4}$ inch and inserting a wedge to hold up the corner as it is lifted, or it may be advisable to raise one side of a cope at a time; the distance can usually be increased at each succeeding lift.

FINISHING THE MOLD.

17. Work Required After Drawing Pattern.—As a rule, all molds require more or less finishing after the pattern has been drawn, bench-work castings requiring the least of any. The majority of light-work patterns are so finely made and gated that the mold may be closed as soon as the pattern is drawn, there being no finishing whatever required; in heavy work, however, the reverse is usually true. In some cases it may take longer to finish a mold than it takes to ram it. This may be due to the intricacy of the design, or to bad work in drawing the pattern, or it may be due to the manner in which the mold was rammed up.

18. Care and Skill in Ramming.—Two molders may ram up the same pattern in the same flask, and yet one may take twice as long to finish the mold as the other. As a rule, the greater the care, skill, and time bestowed on ramming, the less time is required on finishing; the skilled and careful workman, generally speaking, so rams his mold as to require the least time in finishing.

In the case of many heavy-work molds, the insertion of a nail or rod at the corners and flanges when ramming will render them less liable to start or break when drawing the pattern; and there are but few such molds in which care in

ramming will not prevent their having soft places that require to be patched. In some cases, the soft places that occur from careless ramming may be so extensive as to cause large portions of the mold to break and fall while the pattern is being drawn. In the ramming of copes especially, there is an opportunity to save subsequent labor in finishing. Some molders use so little skill and care in ramming the cope, that when it is lifted off, the sand will be soft under all the cross-bars. Where this occurs, the soft places must be pressed down solidly with the fingers, sand filled in firmly by hand, and rubbed off level with the rest of the mold by using a finishing block or straightedge before the surface is ready to be sleeked with the trowel. All this extra work can be avoided by careful ramming. When a cope is poorly rammed, the sand under the cross-bars may have to be worked over to make it solid. A cope so treated rarely gives as good and true a surface as would otherwise be the case.

19. Nails and Rods at Joints and Corners.—A judicious use of nails or rods in ramming and finishing

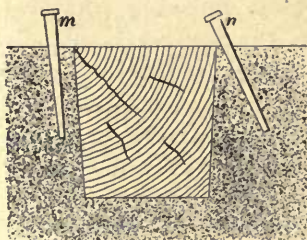

FIG. 28.

molds may prevent many castings from being defective. It is possible, however, to use them too freely or improperly. A nail should not be used as shown at *m*, Fig. 28, as when driven in this manner, it only adds weight to the edge of the mold, instead of giving it support to keep it from dropping. The proper way of

using such nails or rods is shown at *n*. Here the nail is driven in such a way as to take it away from the face of the pattern into the body of the sand, where it can have a firm hold and assist in keeping the edge from dropping.

20. Patching the Mold.—Often the mold is more or less broken in drawing the pattern. Whenever practicable the mold should be mended with the hand, and then

smoothed off with a finishing block or straightedge to as nearly the proper form as possible before a trowel or other finishing tool is used. Many molders patch such places with a trowel; but when one takes sand on a trowel and

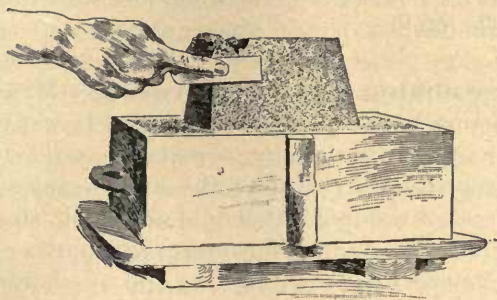

FIG. 29.

presses it on to the mold, he gives the face of the patched part a smooth surface, with which the next trowel of sand will not unite as well as when the broken parts are built up by using only the hands. The objection to patching with a

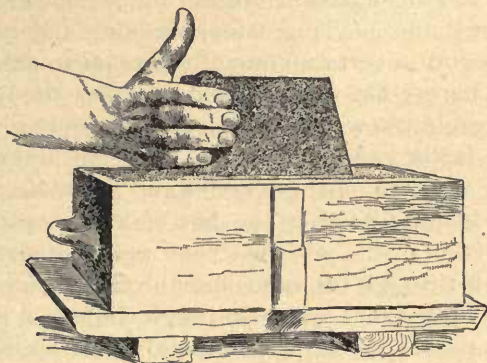

FIG. 30.

trowel is that the patched part may be easily loosened and is liable to drop if the cope is slightly jarred; or it may be washed off by the friction of the inflowing metal when the mold is poured. Fig. 29 shows a molder's hand patching

a broken corner with a trowel, while Fig. 30 shows the hand being used to get the part in proper form before the trowel is used. Patching of this kind may sometimes be done by placing pieces of straight boards against the sides of the mold, thus getting a perfect outline, and then pressing sand down on the mold.

21. Swabbing Broken Corners.—Many molders before starting to patch a broken mold freely wet the surface with water, thinking thereby to make the sand stick better to the broken body. Unless the broken surface is drier than the rest of the mold, it should not be moistened. If it should require moistening, however, the mouth or one of the spraying devices shown in Figs. 15 and 16 should be used; for when the water is put on with a swab or sponge, it is liable to make the surface of the broken part too wet, and this may do more harm than good.

22. Moisture in Molds.—In tempering green sand, it is given a certain degree of moisture, and when this is too great, the volume of steam created by the hot metal in the mold, during the pouring, may become dangerous. The sand will permit a certain amount of steam to pass through it without harm; but when a molder makes the under surface of his mold too wet, and then fills the mold with molten metal, the latter rapidly heats the sand to a temperature sufficiently high to change the water to steam, and this steam will liberate itself in the line of least resistance. If the wet portion of the mold has been well vented, the steam may pass off through the sand, but the chances are that the line of least resistance will be through the liquid metal. If the steam passes through the metal, it is likely to have enough force to raise (in part, at least) the body of sand that is covered by the metal. If it does this, we may expect lumps or scabs on the casting, making it defective. Or again, there may be so much steam created that it will start the mold blowing, and this may result in losing the casting; or worse still, in throwing the iron out of the mold at the

risk of life and property. As a rule, it is safe to mend a broken part of the mold without first wetting it, and then after the patching is completed, to take a swab and wet the surface of the finished part, in some cases quite heavily, and still have no injurious results from steam. This is owing to the fact that in order to escape, the steam will not have to raise a body of the sand. The steam being created at the surface, the portion that does not pass off through the sand has only the iron to pass through in order to escape. In doing this, it may make the casting blow to some extent, as it would if the steam had come from the lower parts of the mold; but if the blowing is not too great from this cause, the casting will not be injured.

An illustration of what is to be expected from steam confined under the surface of the mold is shown in the fact that one can cover the surface of a body of liquid metal with water without any injurious consequences, the reason being that the steam is created on top of the iron and has simply to pass off into the atmosphere in being liberated. Let one try, however, to place the same body of water in the bottom of a ladle and then pour liquid metal in on top of the water; the result will be an explosion that will drive all the iron out of the ladle, and possibly seriously burn those near by. Dampness can only exist with safety so long as it is on the top of the metal; if it occurs underneath the metal, serious results may be expected. If the molder will bear this principle in mind when swabbing any part of his mold, he will have very little trouble with scabs or blowing as a result of an excess of moisture.

Another evil resulting from the use of too much water in finishing a mold lies in its hardening the metal at the point of extra dampness. The edges of castings can be made so hard by extra dampness in the sand at such points that a file will not cut them. Another effect of excessive dampness is to give the iron an extra amount of combined carbon at such points; this alteration of its physical nature may cause a casting to crack when cooling, or break in pieces when put into use.

23. Venting Patched and Sharp Bodies of Sand.

It is always well to vent patched parts of a mold with a $\frac{1}{16}$ -inch vent wire, for usually the patched sand will be harder and damper than the rest of the mold. Again, in many large molds having corners, projections, etc., it is a good plan to pass a fine wire from the face downwards into the body of the mold to a depth of from 4 to 6 inches. These fine-wire vents will provide a means of escape for the gases to the larger vents, and if made about 1 inch apart over the surface most likely to scab, that evil will be avoided.

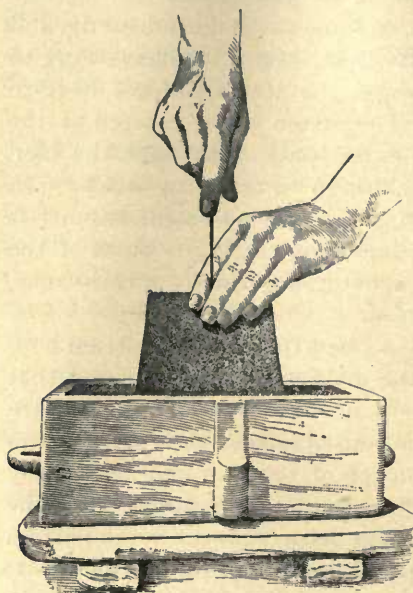

FIG. 31.

Many molders make a practice of venting almost every sharp corner or projection in large molds, and although this takes time, yet it pays in the end, for it is seldom that any delicate portion of molds so vented gives scabbed castings. To prevent such fine venting breaking the surface of the molds, the vent wire is run through the opening between two fingers, as shown in Fig. 31. The tops of the fine vent holes are stopped up by pressing the fingers or palm of the hand over them, and then going over the holes with a little finely sifted sand, rubbing it into them with the hand; after this, the surface is neatly sleeked and then dampened lightly with a swab, or sprayed. The success of some molders in getting large castings free from scabs, etc. is due in part to their habit of using the fine vent wire at corners when finishing their molds.

24. Using the Trowel.—Considerable skill is required in handling a trowel properly. When one first uses a trowel,

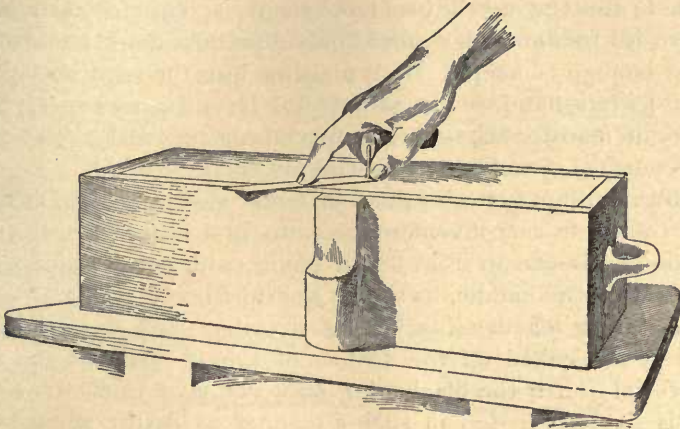

FIG. 32.

he is liable to dig into the sand and do more harm by loosening the sand than he does good by pressing it down to a

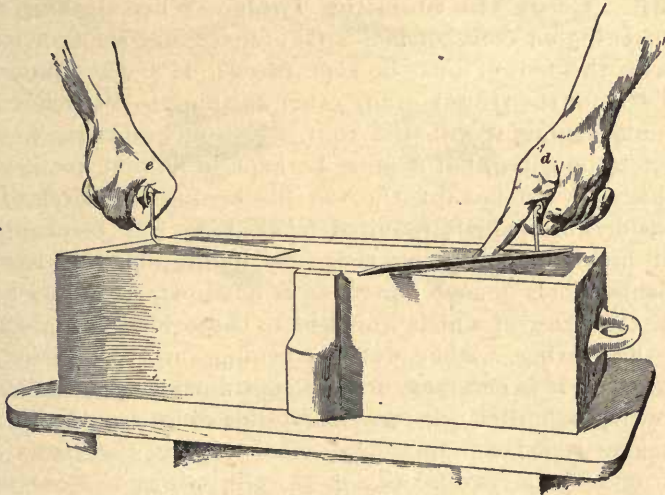

FIG. 33.

solid smooth surface. The trowel should never be kept flat on the body being sleeked, as in Fig. 32. The proper way

to use it is to raise one edge slightly, as at *d*, Fig. 33; it is here, however, elevated an excessive amount for the purpose of illustrating the idea more clearly. The trowel should have its forward edge raised only about $\frac{1}{16}$ inch, this being just enough to keep it from digging into the sand and yet not leave a flat face on the sand. If one is an expert, he may, in many cases, sleek green-sand surfaces with the whole flat surface of the trowel bearing on the sand.

In handling a trowel, the first finger should project as far on the blade as convenient, so as to give a pressure to the blade, as shown in Fig. 32; a novice will usually grasp a trowel by the handle, as shown at *e* in Fig. 33.

A facing of dry blackening or silver-lead dust should rarely be sleeked on the surface of a mold with the flat of a trowel; for if the blackening does not stick to the trowel, it is liable to loosen in such a manner as to lift when the mold is being poured and cause what are called **blackening scabs** to appear on the casting.

25. Using the Sleeking Tools.—When sleeking wet blackening on cores or molds (skin-dried, dry-sand, or loam work), the trowel must be kept tilted. If at any time the flat face of the trowel or any other finishing tool touches the wet blackening, it will stick to it. Not only must the finishing tool be tilted, but it must be kept in motion, for if stationary for an instant, the wet blackening will stick to it. Considerable skill is required in sleeking wet blackening, and much experience is necessary before one can handle finishing tools in such a manner as not to start the blackening, the effect of which would be to cause blackening scabs on the casting. Some wet blackenings are so difficult to sleek that it is necessary to keep constantly dipping the tools in water, in order that they may slide more easily over the blackened surface.

26. Other Finishing Tools.—A molder should have a good set of molding tools. Some shops demand that a molder be well equipped with tools; in fact, they often go so

far as to require the molders to have tools that will fit nearly every variation in the shapes of edges and corners that may exist in their patterns, and if these shapes are out of the ordinary line manufactured by regular toolmakers, they will have the special tools made.

The trowels, lifters, and double-enders are usually made of steel, while the other tools are often made of cast iron and brass. Brass tools will sleek wet blackening better than those made of iron or steel, although if steel tools are nicely made and finished, many molders can do better work with them than with those made of brass. Figs. 32 and 34 show the ordinary finishing tools. These can be obtained from dealers in different sizes. A tool box especially designed to

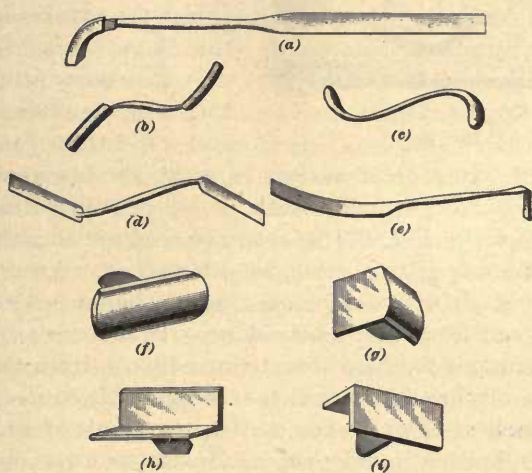

FIG. 34.

hold tools in such a manner that any one of them can be readily found is very desirable, and the tools should always be clean and in good order, ready for use. The names of the tools shown in Fig. 34 are as follows: (a), flange and lifter; (b), flute; (c), bead; (d), double square; (e), Yankee No. 1; (f), pipe slick; (g), half-round corner; (h), inside square corner; (i), square corner.

27. Sleeking and Printing Dry Blackening.

After the surface of a mold has been finished, it is often



FIG. 35.

necessary to blacken it, so that the casting will have a smooth surface and will peel better from the sand. The blackening may be dusted on or rubbed on with the hand and then sleeked down solidly with the same tools that were used in finishing the surface of the sand. For heavy castings, it is best to rub on the blackening with the hand; especially is this necessary when putting it on the sides of molds and copes that cannot be

rolled over. In a great variety of work, the blackening can be shaken out of a cheese cloth, or other thin cotton-cloth bag, as shown in Fig. 35; or it can be scattered by the hand in the same way that parting sand is spread. After a mold has been coated with dry blackening, it should be sleeked as soon as it can be conveniently done. If there is any delay, the blackening is likely to absorb the moisture from the sand; with some blackenings it will then be difficult to sleek them without their sticking to the trowel, the result of which will be a badly finished mold that may cause blackening scabs. Where trouble is caused by the blackening sticking to the tool, it is best to dust on a light coat of charcoal over the top of the heavy sticky blackening. Charcoal dust is very light and is slow to absorb moisture; this makes it an excellent material to aid in the sleeking of sticky grades of blackening. Where charcoal has been used, bellows are necessary to blow off all the dust that does not adhere to the surface of the mold; if this is not done, the loose dust will run before the metal when the mold is poured, and gather in lumps. In

fact, where it is desirable to have clean, sound castings, it does no harm, whatever the grade of blackening may be, to use the bellows to blow off the dust, provided the face of the mold is not broken by the force of the blast.

It is chiefly in medium-weight and heavy castings that it is found necessary to sleek dry blackenings. In light work, another plan, called **printing**, is largely followed. This consists in shaking the blackening from a bag evenly over the whole surface of the mold and then setting the pattern back carefully into the mold; the pattern is then rapped down lightly over the whole of its surface and in this way pressed into the blackening dust. It is again rapped lightly (to loosen it in the mold) and then withdrawn. If the above is properly done, the loose blackening dust will have been pressed down solidly on the face of the mold and will give form to the most delicate imprint of the pattern. In printing patterns, the molder generally has at least two bags: one holding a heavy blackening that he will shake on first, the thickness of this first coat being sufficient merely to cover the face of the mold about $\frac{1}{8}$ inch only; the other bag containing charcoal dust, or some other light grade of a specially prepared blackening. As soon as the dust from the first bag has settled, the second bag will be used, after which the pattern is *printed back*, as described. In doing this, the pattern must be perfectly dry. This is very important, for if there is the least moisture about the pattern, the blackening will stick to it when it is withdrawn from the mold. After a pattern has been imprinted, bellows are often used to blow off any blackening dust that may not have been firmly pressed on to the surface of the mold.

SKIN-DRIED MOLDS.

28. General Remarks.—Many large castings that it was formerly thought impossible to make except in dry-sand or loam molds are now made in green-sand molds by **skin drying**. Skin drying is also practiced with lighter work

for the purpose of giving green-sand castings the surface and color of dry-sand ones.

It may be advisable to skin-dry some molds because of the nature of the sand used; the sand may contain too much clay, or it may be of such a character that it would not otherwise withstand the heat and wash of the metal. The purpose of skin drying is to give green-sand molds a hard surface, devoid of moisture as far as possible and similar to the hard and dry surface found in dry-sand and loam molds. For this purpose special physical characteristics are required in the sand that is used for the *facing*, as common heap sand can be used only for the *backing*. The facing sand should be of a loamy open nature, hardening only when heated, and also sufficiently porous to permit the metal to lie against its surface without bubbling or boiling. When unable to obtain the right grade of sand for making facing, the ordinary grades may be used if mixed with flour, molasses water, or clay wash. When flour is used, the usual proportions are 1 part of flour to from 20 to 30 parts of sand, according to the nature of the latter. When flour is used in the sand, care must be taken in drying the mold, for if the heat is great enough to burn the flour, it will cause the surface of the mold to crumble. The molasses water or clay wash may in some cases be used for wetting sand that has been mixed with flour, or the flour may be omitted and the sand sufficiently strengthened by the aid of the washes. Again, some sands, on account of their closeness, should be mixed with a sharp sand. Some localities possess molding sand naturally adapted to skin drying, while others do not, and, therefore, in the latter, more or less *doctoring* will be necessary to make the sand serviceable. The thickness of the facing used against the pattern generally ranges from 1 to 2 inches. After the facing sand has been banked against the pattern, common heap sand is used for a backing, and the mold rammed in the manner generally followed in green-sand work. The facing for skin-dried molds is, as a general rule, used a little damper than facings would be for common green-sand work.

In cases where the sides of molds are very deep, and very heavy or deep copes are used, it is often well to ram up $\frac{1}{2}$ -inch to $\frac{3}{4}$ -inch rods with every other course, as at Nos. 1 to 10, Fig. 36. In this illustration the pouring basins are shown

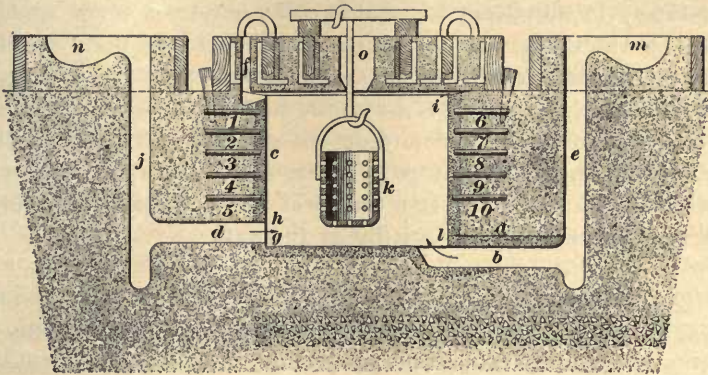

FIG. 36.

at *m* and *n*, the upright pouring gates at *e* and *j*, the inlet gates at *b* and *d*, the riser at *f*, the feeder at *o*, the fire-kettle at *k*; the dried crust at *c*, the lower corner at *g*, the inlets at *h* and *l*, and the inlet-gate top core at *a*.

Where the copes are skin-dried, they should, as a general thing, be very closely gaggered; and with some grades of sand, the surface should have nails between all the gaggers, with the heads coming even with the face of the mold and covered only with the blackening; for if this is not done, the dried crust on the surface of the mold may drop off easily. Not only is this practiced with copes, but in some cases molders will nail the side of drags that are over 6 inches deep as a protection against the dried crust falling away from its green backing. The gates and portions of the mold where the metal first enters are generally the parts that should be well nailed, for in skin-dried molds, if the surface once becomes broken, it soon washes the crust away, after which the material offers no greater resistance to the rushing metal than would so much dry dust.

In finishing the joints of skin-dried molds, it is essential that they be shaved as shown at *i*, Fig. 36, so as to prevent their crushing when the copes are closed, for the least pressure on the joint at the edge of such a mold may readily cause a **crush**. There is no class of molds that requires more delicacy in handling, for the surface is only a crust about $\frac{1}{2}$ inch thick that has but little union with the body of the mold, and may easily be separated from it by any jarring. Some molders will not trust to the nails for holding the portions of the mold surrounding the gates, but instead make cores the shape of that part of the mold and ram them up with the pattern. This is the best method for preventing skin-dried molds from cutting at the gates.

29. Finishing a Skin-Dried Mold.—After the mold has been made and its surface nailed over, as just described, it is finished by wetting the entire surface with molasses water. This is done lightly by means of a camel's-hair, or other soft, brush. After the surface has been moistened, it is sleeked up with finishing tools, as in finishing any green-sand mold. Where molds are very large, they are moistened and finished in sections, for if all the surface of a large mold were moistened at one time, portions of it would be too dry to finish well by the time the molder reached them; when there is more than one molder working on a job, this precaution may not be necessary. The mold having been sleeked with the finishing tools, the next proceeding is to blacken its surface, which may be done in one of two ways. One is to blacken the mold in the same manner that a dry-sand or loam mold is blackened; the other is to rub the blackening on dry in the dust form and then, after sleeking it as described in Art. 27, to moisten the surface heavily with molasses water, applying the liquid with a soft brush. Rubbing the blackening dust on is only necessary on the sides of the mold, as a bag can be used to shake it on the bottom. These two methods of blackening may often be used to advantage on the same mold. The plan of rubbing the blackening on dry and then going over it with the

molasses water, does not dampen the surface as much as when it is blackened with an all-wet blackening, as in the case of a dry-sand or loam mold. The reason why these two plans of blackening will sometimes work well together is because in skin drying the mold with fire-pans or sheet plates, there are some parts that will receive more heat than others.

By exercising care and judgment in dampening the sand and in blackening, all parts of the mold may become dry at about the same time; if the work is done in such a way that one part dries before the others, it may burn. In blackening the surface, it should be done as smoothly as possible, so as to avoid the necessity of much sleeking. By sleeking the wet blackening, a smoother casting may be produced; but unless it is carefully and skilfully done, there is more or less danger of the sleeking causing scabs. In putting the blackening on, it can be used thin enough not to be streaked, and with care in using a camel's-hair brush, no streaks need be shown, so that the castings can be made nearly as smooth as if the blackening were sleeked, and the danger caused by sleeking can be avoided.

30. Drying a Skin-Dried Mold.—In drying these molds, considerable judgment is required, for a scheme that will work well with one mold may not answer for another. That method must be adopted which is best suited for the work in hand. For example, some molds, such as those for anvil blocks, etc., may be dried by setting a fire-pot in them as shown at *k*, Fig. 36, where the cope is shown being dried above the drag. Sometimes the mold may be of such a form as to require a flat or square pan instead of the cylindrical kettle here shown; and with some molds this plan will not answer at all, because the mold is so shaped that kettles or pans cannot be used in them. These molds may be of such a form that their surfaces can be dried by laying sheet-iron plates, perforated with small holes, over them, and placing a fire on the plates; but this is a plan rarely used where kettles or pans can be employed.

The fuel commonly used in these appliances is charcoal; the fire should be mild and steady, especially at the start, since too strong a fire is apt to blister the face of the mold. Sometimes the cope and the drag may be dried together by having the cope propped up clear of the drag, and then heating between them by means of fire on perforated plates or in pans. Again, the mold may be such as to permit it to be closed while being dried, the riser and gates being left open to let out the steam, as shown in Fig. 36.

Natural or artificial gas may be used for drying molds. The gas is conveyed to the mold in a rubber tube having a piece of gas pipe in the end, and then burned against the face of the mold.

Green-sand cores or bodies forming the interior of molds are generally skin-dried by placing them in an oven and keeping the heat mild and uniform. To ascertain if a mold or core is skin-dried deep enough, it may be tested by cutting a small hole in the surface or by pressing the surface with the fingers. The most difficult places to dry by means of kettles or pans are the corners of a mold, as shown at *g*, Fig. 36. The sides of some molds might be baked and the binding material burned to ashes before the corners are dried. To get the corners dry, it is often necessary, after a kettle or pan fire has been taken out, to place hot coals or hot irons around in them to get them dry. It is here that the advantage of gas or hot air is apparent, as by either of them the heat can be directed to any given spot until it is thoroughly dried.

Any one wishing to acquire skill in skin-drying molds should begin on a small scale, as he is liable to make many mistakes at the start.

31. Gas Burner for Drying a Mold.—A good plan to follow when drying molds by means of gas is to substitute a Bunsen burner for the pipe. The objection to using an open pipe burner in the foundry is that usually a $\frac{1}{8}$ -inch or $\frac{1}{4}$ -inch pipe is used, which is not only wasteful of gas, but its flame deposits such a heavy coating of soot on the face

of the mold that the drying is not accomplished as fast or as economically as it should be with the amount of gas used.

The burner illustrated in Fig. 37 is a Bunsen burner that has been designed and used for this class of work; it is also

well suited for any work requiring a gas

heater. As ordinarily constructed, the burner

consists of a piece of $\frac{1}{2}$ -inch pipe *a*, 6 inches

long, threaded at one end and screwed into

a reducer *b*. The reducer has five $\frac{1}{4}$ -inch

holes *c* drilled into it to admit air. More

holes may be drilled if required; and if, on

the contrary, it is found that too much air

is being furnished, some of them may be

plugged up with wood, or, better, by tapping

the extra ones and putting in $\frac{5}{16}$ -inch screws.

A $\frac{1}{4}$ -inch pipe *d*, about 2 feet long,

is threaded on one end and closed with a plug *e*

driven or screwed into it. A hole is drilled

lengthwise through the plug *e*, and a tube *f*

of $\frac{1}{8}$ -inch bore fastened into it. This $\frac{1}{8}$ -inch

hole furnishes the right proportion of gas to

the burner. The tube *f* should extend at

least $\frac{1}{4}$ inch past the holes *c* through

which air enters. The lower end of the pipe

d is connected to the gas-supply pipe by

means of a rubber hose. When

constructed in this manner, the burner may

be used upside down or in any other

position. The air and gas mix in the

pipe *a* and the gas is completely consumed,

because there is plenty of air mixed with

it before it begins to burn. It

gives no light, the flame being blue, but

a great deal of heat.

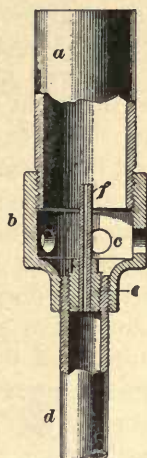

FIG. 37.

32. Gating a Skin-Dried Mold.—In gating skin-dried molds, the method that will cause the least friction between the flowing metal and the surface of the mold is, as a rule, the best one to adopt. In Fig. 36 are shown two methods of gating that can be used with a large variety of molds. With a gate like that marked *d*, the metal will flow in as shown by the arrow *h*. Such a gate as this will cause great friction between the metal and the face of the

mold, and unless the whole surface fronting the inlet gates is nailed very closely, with the heads of the nails even with the bottom face of the mold, the casting will scab at that point. Instead of nails, strong cores may be used to form all the surface fronting the inlet gate, thus preventing scabbing at that portion of the mold.

The best kind of gate to use for such work is shown at *b*, on the right of the illustration. Here the metal, on entering the mold, will come up from the bottom, as shown at *l*, and flow gently over all the face of the mold, causing little or no friction that might cause scabs. This form of gate is easier on the face of a mold than any other. It can be applied to a large class of molds. The only objection to it is that it does not distribute the dirt created in the pouring runner and gates or that may come from the scum of the ladle. As a rule, all such dirt will collect in a body and float right above the inlet *l*. In molds having cores or projections that will catch dirt and confine it in the parts especially requiring solid metal, this class of gate *b* would be undesirable. With an inlet gate as shown at *d*, the dirt is divided into fine particles and distributed to all portions of the casting, which, in some cases, may be preferable, even though there is a scab created in front of the gate.

GATES FOR MOLDS.

33. Pouring Gates for Catching Dirt.—The gate *b*, shown in Fig. 36, is very apt to collect and hold the dirt in one spot, but there are methods in use that serve to lessen considerably the amount of scum or dirt passing into these gates. Fig. 38 shows some of these methods, which may be modified as deemed desirable. In pouring a casting with a system of dirt catchers (commonly called **skimming gates**), shown in Fig. 38 (*a*), the metal first flows into the depression at *d*, filling it so that the core *h* holds back much of the dirt or scum coming from the ladle. Comparatively clean metal should pass from *d* down *e* through *g* to *f*. In the plan (*b*) it will be observed that the connection *g* between *e*

and f is led to one side of the latter, so that the metal is given a whirling motion on entering f , which causes the scum and dirt to rise up into f , and causes comparatively clean metal to pass through e' into the mold; e' here corresponds to the inlet gates b and d in Fig. 36. To make this form effective, the inlet gate e' , Fig. 38, which leads the metal into the mold, must have a smaller area than either

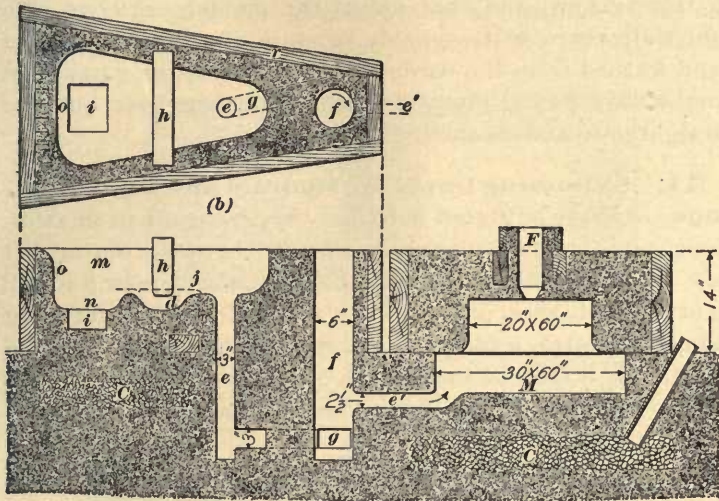

(a)

FIG. 38.

of the other openings. This is necessary so that the flow through e' will be *dammed* back and thus keep the riser f full of iron. Keeping f full of iron causes the dirt to float on top of it; whereas, did the metal in it descend to the level of e' , this dirt would then pass into the mold. The drawing in Fig. 38 is not to scale, and the gates, pouring basins, risers, etc. are magnified in order to illustrate their relation to the mold.

The sizes of the various gates are given so as to give an idea of proportions that work well. The parts of Fig. 38 that are lettered, but have not yet been referred to, are m ,

the pouring basin; i , a core; r , the runner box; and F , the feeding head. With such a system of skimming gates, the under inlet gate b , Fig. 36, can be used with very little risk of having much scum or dirt pass into the mold. If the molder desires to decrease his labor in making such a system, the core h and depression d , Fig. 38, can be omitted and a level bottom used, as indicated by the dotted line j .

A study of Fig. 38 will show that intricate work is involved in this system; and that unless the molder exercises care and skill, there will probably be more dirt created by the sand washed from the corners and surface of the gates than would have flowed into the casting had there been but one straight gate and no skimming gates at all.

34. Skimming Gates for Medium and Light Castings.—It may be stated here that the arrangement of skimming gates is based upon the principle that all scum or dirt has less specific gravity than iron, for which reason it will float to the highest point that it can reach. In arranging skimming gates, some part is constructed to catch and hold the dirt as it rises to the surface of the flowing metal before it can enter the mold. The skimming gates just described

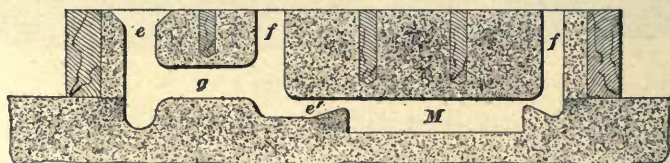

FIG. 39.

are for heavy castings; Fig. 39 illustrates a method suitable for medium and light castings. The sand is rammed around two sprue pins to form a pouring gate e and dirt riser f ; a dirt-collecting channel g is then cut between them. The higher and longer the channel g can be made, the better dirt collector it will be. The metal having passed g flows on through e' to the mold M . In flowing from the gate g to the mold M , the scum or dirt in the metal, as it rises, is

caught and held in the upper part of the channel *g* and dirt riser *f*. Sometimes the channel *g* is cut on a straight line to *f*, and sometimes on a curve, as at *g* and *f*, Fig. 38. If this is done properly, lumps of dirt should be seen whirling on the top of the metal in the dirt riser *f*, Figs. 38 and 39, and when breaking the channel *g* after the metal has cooled, dirt should be found in its upper part.

It is often desirable to have skimming gates for light work arranged so as to save as much labor as possible. This may be done by using the appliance shown in Fig. 40 (a), which is

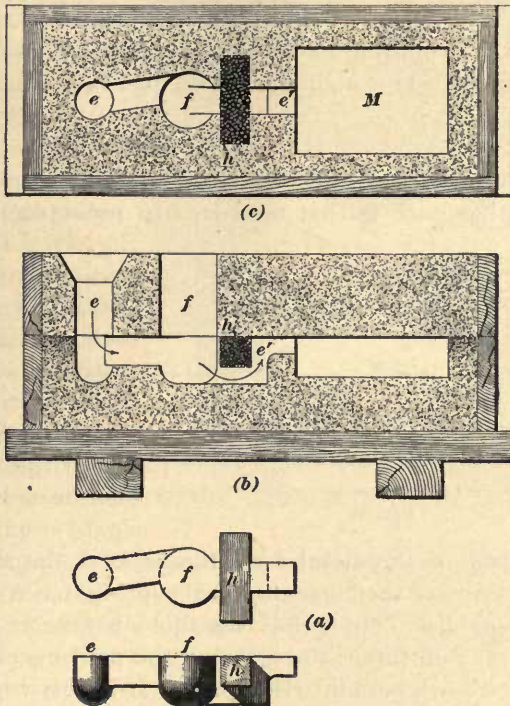

FIG. 40.

a small pattern so arranged that it can be rammed with the pattern in the novel of small boxes or snap flasks. Two patterns or sprue pins are used to form the sprue *e* and

riser *f*. When the mold is finished, the skimming gate should appear as shown in views (*b*) and (*c*), a small core being used as shown at *h*. The metal on being poured into the gate *e* flows into *f* with a whirling motion, and in going to the mold passes under the core placed at *h*, whence it passes through the gate at the entrance *e'* into the mold, as shown by the arrow.

The advantage of this skimming gate is that it can be formed very easily by means of the core *h*, which is set into the mold after the skimming-gate pattern is drawn. This core, being arranged to settle deeply into the gate, causes the iron that enters the mold to be taken from the lowest point of the skimming gate, which insures clean metal going into the mold. It is a simple device, but very effective in its results.

35. Top-Pouring Skimming Gates.—Another form of skimming gate is that used in **top pouring**, shown in

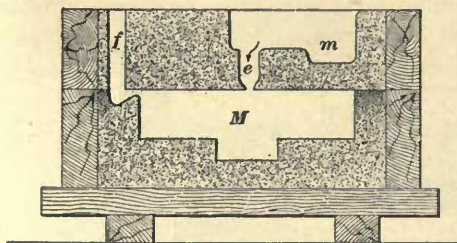

FIG. 41.

Fig. 41. This is applicable to a great variety of work in both light and heavy castings. In constructing such gates, a pouring basin *m* is made; the metal enters the mold through a gate or gates *e*. By

a quick dash of the metal from the ladle at the start when pouring, and by then keeping the pouring basin full until the flow-off risers show that the mold has been filled, the dirt will stay on top of the metal in the pouring basin, leaving clean iron to pass into the mold. It is only when beginning to pour that dirt should have any chance to enter the mold; and this is true to a greater or less extent of all forms of skimming gates. There are many forms of skimming gates, but those shown in Figs. 38 to 41 should be sufficient to indicate the principles involved.

Probably the easiest way to obtain clean castings is to keep the pouring basin full during the time of pouring. In these illustrations the gates are shown large in proportion to the balance of the mold in order to show their arrangement more clearly.

36. Dirt in Castings.—After scum or dirt has entered a mold, it must locate itself somewhere. Its natural tendency is to rise to the top of the mold, since it has a lower specific gravity than iron; but there are conditions that at times prevent this. When iron enters a mold, it rapidly loses its fluidity, and for that reason if dirt drifts to the side of the mold, it is liable, on account of the dulness of the metal, to stick there and let the metal flow over it. Again, molds often have projecting cores that, when the metal rises to the under side, catch the dirt and retain it.

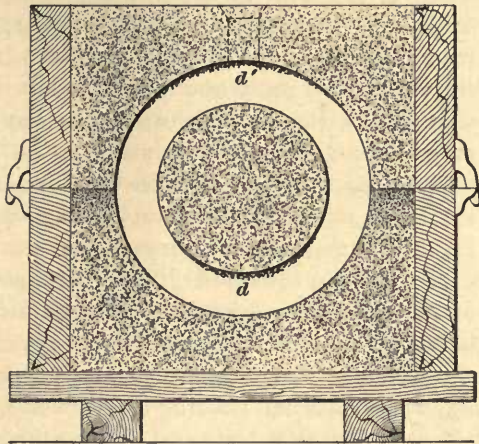

FIG. 42.

If we consider the case of cylinders or pipes cast horizontally, we shall find that the scum or dirt will lodge as seen at d , Fig. 42, and what passes this point will rise to the top and stay at d' . On this account it is often necessary, if the inside is to be bored out, to leave extra stock for finishing at d . If the castings are columns for supporting buildings, or similar pieces, it would be wise to make them thickest on the top or cope side at d' , to allow for the weakness that the dirt might cause at that point. Even with the same amount of dirt at d and d' , and with the nowel and cope parts of the

casting of the same thickness, the cope will be the weaker side of the casting, as there is less pressure at that point of the mold to make the metal solid.

37. Pouring Basins.—In making a mold, there are few things that require greater care and skill than the **pouring basin**. Here the greatest amount of friction, rush, and washing-out effect of the metal is produced; and if the basin is not well made, it will be easily cut by the falling metal. If the basin once starts to cut, considerable damage may result before the mold is filled. A molder may slight the rest of his mold and yet have his castings come out so that they will pass inspection, but any carelessness or ignorance in making basins, runners, or gates will cause trouble. In pouring a mold, the iron first drops from the ladle into the basin, from which it runs with more or less velocity into the upright sprues or runners, and from them into the gates that lead into the mold. With the exception of that portion of the mold into which the iron enters or drops, there is very little agitation of the metal as it gradually rises in a mold, compared to the rush and spattering that exists in the pouring basin. When making these basins, extra care should be taken to see that the sand has been well mixed and riddled before it is shoveled into the basin box. The use of poorly tempered sand for making basins has often caused bad castings. Some molders shovel a little sand into the box to form the bottom of the basin and then tramp it with their feet or pack it with a rammer, after which they press sand against the sides of the box with their hands to give shape to the pouring basin; this is a very bad practice to follow. To make a reliable basin, the box should first be evenly rammed full of sand, after which the shape of the basin can be dug out with a shovel or trowel. The ramming will give a firm, solid body to the sand. The point of danger in pouring basins is at the bottom *n*, Fig. 38. Here the force of the dropping metal has such a cutting effect that in the case of large basins, it is advisable to place a core at *i*; in some cases bricks may be used instead; or again,

green sand may be made to take the place of the core or bricks, by closely nailing the bottom where the iron will drop from the ladle, the heads of the nails being left even with the surface of the sand. It will be noticed that a well is formed around the core *i*, so that immediately after starting to pour, a body of metal will be formed into which the iron drops, and thus save the bottom of the basin *n* from receiving the full force of the dropping metal. In some cases the well at *n* can be made so deep that there will be no necessity for cores or bricks. However, it is well to secure this part of a basin as much as possible, for a sudden jerk of the ladle at the start, which often occurs, might prove very serious and result in the loss of the casting. There should never be less than 4 inches of good tempered sand between the bottom of the basin at *n* and the floor, or other bottom. In the case of very large basins, it is wise to have a cinder bed under them, as shown at *C*, Fig. 38.

If wooden basin boxes are used, it is well to have their fronts nailed, as shown at *o*, Fig. 38 (*b*), as the wash of the metal striking the front of the basin has been known to cut away the sand and cause a bad casting. Another point to be carefully watched in making pouring basins is to avoid having water carelessly swabbed around the edges of the gates or the bottom portion of the basin, as this may start the metal blowing, and when this has once commenced, it is hard to tell when it will stop. Any boiling of the metal in the basin will create more or less scum or dirt that must follow the metal through the gates into the casting.

GREEN-SAND MOLDING.

(PART 4.)

IRON AND BRASS MOLDING.

CHAPLETS.

1. Types of Chaplets in General Use.—Chaplets are used to support or hold down cores that, owing to their shape, are not self-supporting when placed in the mold. There is a large variety of such chaplets in use; those shown in Fig. 1 are called **single-headed chaplets**, and those in Fig. 2 **double-headed chaplets**. Fig. 3 (*a*) is a *spring chaplet*; (*b*) is a combination of *chaplet and stand*, a scheme often used to save labor and time in setting chaplets. The stand can be set in the novel under the pattern when it is being rammed up, and then when finishing the mold, the chaplet is set in place. Often iron cross-bars in both drag and cope are cast with bosses into which holes are drilled to allow chaplets to be inserted after the manner shown in Fig. 3 (*b*). The chaplet (*a*) in the same illustration is made of a piece of steel or iron that can be sprung to the desired form. There are places where these chaplets are of special value.

In Fig. 1, chaplet (*a*) is made of round iron cut to any desired length and having a solid head; (*b*) is a *chaplet stem*, on which, at the head *o*, any size of plate may be riveted.

§ 43

For notice of copyright, see page immediately following the title page.

Often larger heads are required than can be forged upon a chaplet, as in (a), and such chaplets as (b) can be fitted with a head of the size desired; (c) shows a stem with such a head *q* riveted on. There are times when the pressure on a chaplet will be so great, or when the cores require such a large bearing surface that the plate *q* on chaplet (c) would be

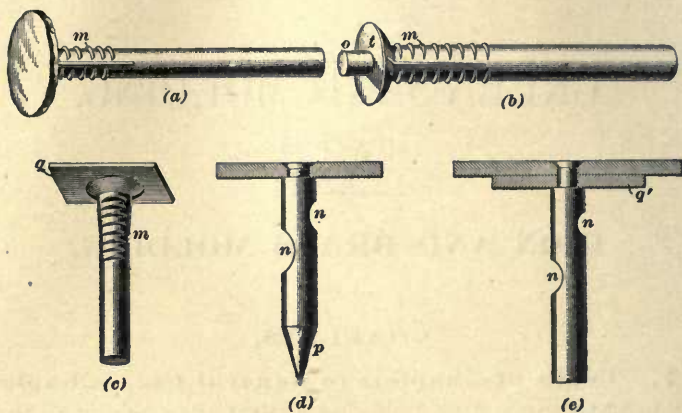

FIG. 1.

better if reenforced by a back plate, as shown at *q'*, chaplet (e). Chaplet (d) shows a sharp point *p*, which is sometimes necessary when it is desired to drive the chaplet into bottom boards, wooden blocks, etc., underneath the surface of the mold. In driving such chaplets, a depth of $\frac{1}{2}$ inch to $\frac{3}{4}$ inch is sufficient, as the driving is liable to force down the block or to jar the board and loosen parts of the mold.

Referring to Fig. 2, (a) is a *double-headed chaplet stem*, of any desired length, provided with pins, to which plates of any size may be riveted, as shown at (b). Double-headed chaplets often have to be fastened to the surface of the mold or core, so that any jarring of either may not move them; this is done by making the chaplet with a sharp stem, as shown at *p*, Fig. 2 (c). These sharp stems are driven into the face of the mold; they seldom need to be more than $\frac{3}{4}$ inch long. In chaplet (c) the heads *q* and *q'* are placed on after the stem has been made and the top head *q* is riveted on

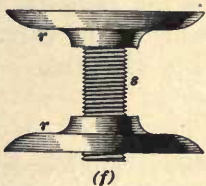
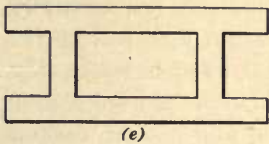
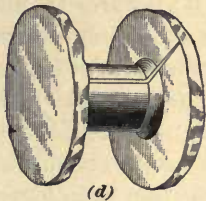
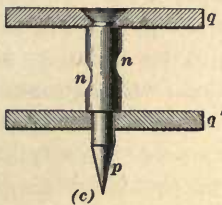
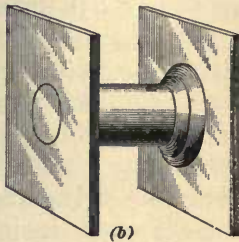

FIG. 2

A double-headed forged chaplet is shown at (d), while (e) is a cast-iron one. Cast-iron chaplets can often be used, but they must not be placed where they will be struck by the stream of metal from the pouring gates, as they melt more readily than wrought iron. This is a point that must be observed in the use of all chaplets, as many castings have been lost because molders have thoughtlessly set chaplets in front of gates that deliver large bodies of metal; or, again, the quantity of the iron may be small, but so hot as to melt the chaplets.

There are several firms in this country manufacturing chaplets, especially those shown at (a), (b), (c), Fig. 1, and (a), (b), and (d), Fig. 2. Chaplets can be purchased so cheaply that any person requiring only a few cannot afford to make them.

Fig. 2 (f) shows an *adjustable chaplet*, a very convenient appliance where odd lengths are needed. It consists of a stud or stem *s*, made by threading stock of the required size in the screw machine and cutting it to the most convenient lengths. Ordinary cast-iron washers *r* are drilled and tapped to suit the threaded stem *s*. An adjustment $\frac{1}{2}$ inch, more or less, may be made with the washers *r*, while a variety of lengths of stems permits the making up of any size. The stem here shown is $\frac{3}{8}$ inch in diameter and the washers $2\frac{1}{2}$ inches.

2. Precautions in Using Chaplets.—Chaplets are generally “necessary evils,” since they are very apt to weaken the casting more or less at the point where they are placed.

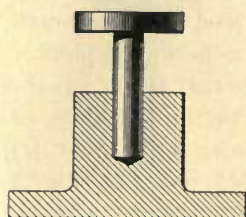
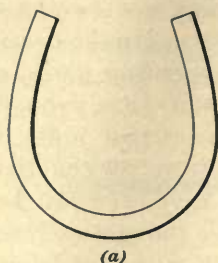

(b)
FIG. 3.

This may be done in three ways: *First*, by breaking the uniformity of the metal of the casting by the introduction of some other substance at the point occupied by the chaplet; *second*, by working loose and leaving holes in the castings, generally caused by blowholes around them; *third*, by causing porous or unsound metal to form around them. The first of these evils cannot be avoided; but by good design and care in the making and use of the chaplets, the second and third evils can be greatly decreased, and in many cases almost wholly avoided. In regard to the second evil, chaplets should be nicked or have depressions made in them, as at *n*, Fig. 1 (*d*) and (*e*), or else have burrs on them, as seen at *m*, Fig. 1 (*a*), (*b*), and (*c*).

Some molders, in making the stem, avoid the heavy shoulder *t* shown in Fig. 1 (*b*) and make the stem sufficiently large to give a good bearing to the head *q* in (*c*), as shown in Fig. 1 (*d*) and (*e*). Some persons cut a thread on the part of the stem that is cast in the metal, even in the case of chaplets that have fixed heads. This scheme is used also in making double-headers, as in Fig. 2 (*b*), and in such cases a thread will be cut the whole length of the stem and the heads screwed on, as in Fig. 2 (*f*). The screw stem has an advantage in another way, as the cutting of the thread removes all scale or rust from the surface of the stem, and this is very important.

3. Rust on Chaplets.—There is always more or less **rust** or **scale** adhering to the surface of both old and new

chaplets. As much of this as possible should be removed from the parts that are cast in the metal. When molten metal comes in contact with rust, a gas is created. It is calculated that 60 grains of dry rust will make 31 grains of carbonic-oxide gas, which at 2,800° F. (the temperature of molten iron) and the pressure of 1 atmosphere will occupy about 600 cubic inches of space. It does not require a very large piece of iron to give 60 grains of rust. The space that the gas occupies depends on the pressure; and the harm it can do depends on the rapidity with which the metal solidifies and prevents the gas from escaping. Blowholes are rarely found around the chaplets in the lower part of a casting; they occur in the upper part where there is very little pressure during the pouring. The part of a mold where the greatest pressure exists is usually the first to be filled, and the iron is also hotter and cleaner there than at the top of the mold. If, for any reason, the chaplets at the bottom should cause the iron to boil or blow, the gas will generally escape upwards through the metal and out at the top of the cope sand or out of the flow-off gates.

Chaplets may be free from rust when placed in the mold, but if kept there for two or three days before the mold is cast, they are very apt to become rusty, especially if the mold is a green-sand one. There are varnishes that can be used to prevent their rusting, and these will be dealt with further on.

4. Moisture on Chaplets.—A piece of polished iron, if exposed to moist air or otherwise moistened, soon becomes rusty. This is due to the affinity that iron has for oxygen. Under certain conditions, polished iron can be kept free from rust by keeping it in a dry atmosphere. Take polished iron from a cold room into a warm, moist one, and it will not be long before rust will be formed on it. This is caused by the cold iron condensing whatever moisture there may be in the air immediately surrounding it on its surface. The more rust there is on iron, the more moisture it will collect; and on chaplets, this moisture can do greater injury

than rust. To test this, take a rusty rod and heat it sufficiently to dry all its moisture, after which place it quickly into a ladle of molten iron. The metal will bubble around the rod, more or less, but it will not fly out of the ladle as it would if there were moisture on the rod. The steam from the moisture on chaplets may cause a great amount of bubbling or blowing, as can be seen by quickly immersing a damp rod in a ladle of iron.

The best thing that can be done to prevent chaplets from becoming rusty and collecting moisture is to tin that portion liable to be incased by the metal. Coating the iron body with tin not only prevents the oxygen or moisture from attacking the iron, but it has an affinity for iron that makes the iron more fluid when in a molten state, and this greatly aids the release of any gases that might be created around the chaplets.

Where chaplets are not tinned, their exposed parts may be covered with a coating of red lead mixed with turpentine. Asphaltum, coal tar, and chalk are often used as a coating. Where there is much moisture, these materials may collect sufficient dampness to cause injury, but not to such an extent as rusty chaplets.

5. Setting and Wedging Chaplets.—There are few things more annoying than to see castings lost by thoughtlessness or ignorance in setting and wedging chaplets. Chaplets are generally set into a cope by first passing a $\frac{1}{8}$ -inch rod or vent wire up or down through the cope at the spot where it is desired to place the chaplet. If the chaplet is larger than $\frac{1}{4}$ inch, then a $\frac{1}{4}$ -inch vent wire or rod is passed through the hole made by the $\frac{1}{8}$ -inch rod, and so on, increasing the size of the rods according to the size of the chaplet stem, the idea being to gradually enlarge the hole for admission of the stem without applying much pressure. After the stem has been pressed through the body of the cope, it should then be pulled out and the hole reamed out at the face of the mold, as seen at *c*, Fig. 4. Many molders having failed to do this when pressing down the chaplet to a good

bearing on the core, or in wedging it down to place, have caused the face of the mold around the bottom of the stem to be pulled down, as at *d*, thus resulting in the loss of the casting.

After the chaplets have been set and the cope closed, some molders drive in wedges with a hammer to fasten the chaplets, as at *e*. This results in displacing the chaplet, as shown. The chaplet should be placed solidly upon the core *A* and

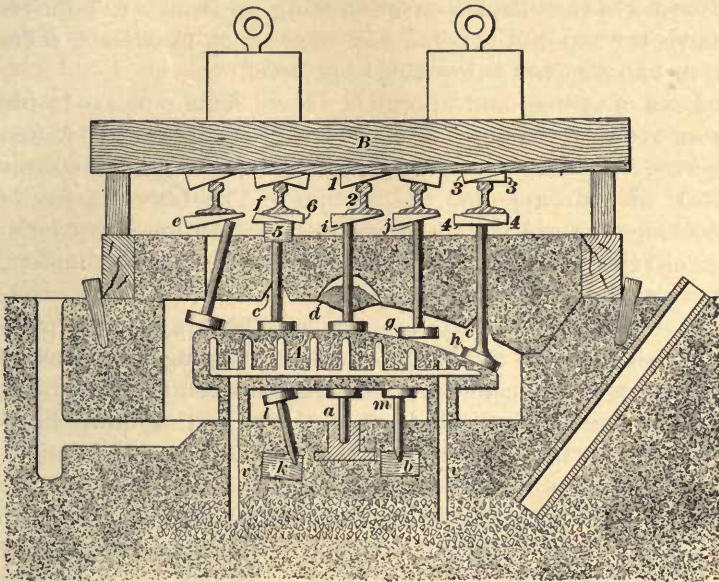

FIG. 4.

then wedged down, as shown at *f*. Then, again, some molders in fastening down cores having slanting surfaces use chaplets having the head at right angles with the stem, as at *g*. Where the surface of the core is slanting, the heads of the chaplets should be set on the stem at the same angle as that of the core; care should be taken that the slant of the head and core agrees, so that they may come solidly together when the cope is closed, as at *h*.

6. Blocking on Top of Chaplets.—Very often the chaplet stems will require some blocking on top of them, as at 5, Fig. 4, before wedges can be used. Where this is necessary, one must be sure that the blocking is over the center of the stem and also that there is sufficient space to use the wedges 6. While it is often necessary to use blocking, there are many cases where its use can be avoided if judgment is used in placing the rails, in weighting down the binder *B*, and in getting the chaplet stems the right length. Molders often leave the chaplet stems sticking up from 3 to 6 inches above the top of the cope; and sometimes they leave them from 1 to 3 inches below this same level.

Lack of system and judgment causes some molders to use from 100 to 200 pounds of small pieces of blocking to fasten down a half dozen chaplets, where others will do the same work without a pound of blocking. The fewer pieces of blocking that are placed between the weighting-down binders or rails and the wedges necessary to fasten the chaplets, the better it is for the safety of the mold. In many cases, with forethought and judgment the chaplets can be cut to such a length and the binders can be so arranged as to avoid the necessity of using any blocking between the top of the chaplet stems and the bottom of the weighting-down binders. Where this is possible it should be done; and in allowing space for wedges between the top of the chaplet stems and the bottom of binders, it should range from $\frac{1}{2}$ inch to $\frac{3}{4}$ inch. Before wedging the chaplets, the weights necessary to hold down the cope should be placed on it, as all the binders, etc. will spring more or less when weighted; and if the weights are placed after the chaplets are wedged, this springing may drive the chaplet heads into the face of the cores and cause damage. Just before pouring a mold having chaplets, it is good practice to go over it to test the wedges, as they sometimes work loose after they have been tightened.

7. Placing Chaplets in Bottom of Mold.—It is as important to have chaplets set correctly in the bottom as in the top part of molds. A large number of the chaplets used

in the bottom of molds are driven into the bottom boards or into wooden blocks. Where wooden blocks are used to support cores of any great weight, it is best to make them of hard wood, and set them with the grain up. In driving the points, as at *b* and *k*, Fig. 4, the molder must use his judgment in driving them the proper distance, taking into consideration the size of the chaplet stem, the weight of the core, and the nature of the block.

Some molders lose castings by the manner in which they set bottom chaplets. The block *k*, Fig. 4, is apt to split for two reasons: *first*, because the chaplet has been driven in too far, and, *second*, because the point is near the end of the block. The block *b* shows the proper practice in these respects. Where points are driven as at *k*, castings are very liable to be lost through the settling of the chaplet into the block. Even if the weight of the core does not do it, the wedging down of the top chaplets when the cope is closed will probably do so. A fine wire should be pressed through the sand to find the end of each block, so that the chaplets may be driven near the center of each block. The head of chaplet *l* is shown in such a position that it makes an angle with the core and has but one edge touching it. It is as important to have bottom chaplets set properly as top ones, and it can readily be seen that a core should set solidly on the chaplet, as at *m*. At *a* is shown a chaplet placed in a stand, the appliance being illustrated in Fig. 3 (*b*). These stands are very good for some classes of castings, as, for example, in cases where it does not matter if the face of the casting is chilled a little at and around the spot of the chaplet connection. By placing sand in the bottom of the hole admitting the chaplet's stem, any variation in the thickness of the metal can be arranged for in setting the chaplet.

8. Wedges for Setting Chaplets.—In making wedges of either wood or iron, it is best to make them with as little taper as practicable. The greater the taper, the more difficult it is to fasten the wedges and the more liable they are to work loose. The wedges shown in Fig. 5 represent what is

considered good practice. They can be fastened without much danger of their being loosened by jars when other wedges are being driven. Wedge (b) is generally used for

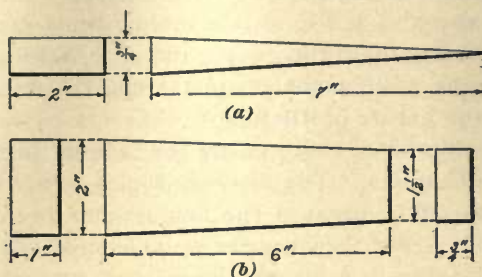

FIG. 5.

resisting great strains and to partly take the place of blocking; it can be made of any size to suit the conditions of the work. The quick-tapering wedge (a) is the one most commonly used, and the dimensions given can be applied to either cast-iron or wrought-iron wedges.

“DRAWING DOWN” OF THE COPE.

9. The phrase **drawing down of the cope** is applied to copes whose surface sand drops down upon the metal as the mold fills up. This is caused by the heat of the metal drying the surface of the cope. If the sand in the cope is not of such a nature as to bake solidly to the depth penetrated by the heat, and it does not hang well when one part is drier than another, then the sand will drop upon the metal in small quantities and cause lumps and dirt holes in the upper surface of the casting. This depends not only on the nature of the sand, but also on whether the mold is kept air-tight or not. With strong sand in the cope, some molds may be cast with their feeders, risers, etc. all open, and no injury will occur to the casting. If this were done with other grades of sand, the whole surface would be drawn down. It is chiefly with such castings as thick plates or

heavy blocks, where the cope surface is exposed to the direct heat of the metal from the moment it enters the mold until it comes against the upper surface, that difficulty is experienced by drawing down. Any part of the cope's surface that is exposed for $\frac{1}{2}$ minute to the direct heat of rising metal should have a strong grade of surface sand for the first $1\frac{1}{2}$ inches. In addition it should be closely gaggered, with the sand not more than $\frac{3}{8}$ inch thick under the gagers. The first course of sand in such copes should be evenly and firmly rammed; and the weaker the sand, the harder should be the ramming.

When the sand is weak, it may be strengthened either by mixing flour with it or by wetting it with clay wash or molasses water. After the surface of the mold is finished it should be sprinkled with molasses water; in fact, it is well to do this even with strong grades of sand, where they are expected to be exposed to the direct heat of the metal for more than $\frac{1}{2}$ minute. Use 1 part of flour to from 15 to 25 parts of sand, according to the strength of the latter; the weaker the sand, the more flour is necessary. In some cases where the copes are to be exposed to intense heat, as in very thick plates or anvil blocks, it is often advisable to nail all the surface between the gagers, keeping the nail heads either even with the face of the cope and covered with blackening or else $\frac{1}{4}$ inch away from the surface and covered with sand and blackening. In venting green-sand copes that are liable to be drawn down, the vents should not be carried any closer than within 1 inch to $1\frac{1}{2}$ inches of the surface. For if they are carried close to the surface, they will permit the escape of gases and relieve the pressure against the face of the cope.

Drawing down occurs not only in green-sand copes, but also in dry-sand and loam copes or covers. Both weak and strong sands are used in these latter molds, as well as in the green-sand molds. Where there are heavy bodies of molten metal directly under the copes, dry-sand and loam mixtures should also be strong, or else drawing down will occur, as in green-sand work.

PRESSURE OF GASES IN MOLDS.

10. Object of Maintaining Gas Pressure in Molds.—There is a great deal of difference in the practice of molders in leaving the feeders and risers open or closed while casting. In most cases it is best to pour large molds with all the risers and feeders closed perfectly air-tight. Molds that are liable to have the copes *drawn down*, or in which the rushing of hot gases upwards through the risers will have a tendency to draw the gases from the vents in the bottom, should be cast air-tight as far as possible. The rush of hot air and gases through open risers has a tendency to divert the gases generated in the bottom of the mold from going downwards, causing them to pass up through the under surface of molds and producing scabs on the bottom of the casting. This rush also relieves the mold of the internal air pressure that exists when the mold is kept air-tight; and this pressure is often sufficient to prevent weak grades of sand from being drawn down from the surface of the cope.

Air is like all other gases in that it expands with an increase of temperature. At a temperature of 500° F., air has about double the volume that it has when at 0° F. The temperature of the air and gases in a mold is perhaps about one-half that of the rising metal; it may safely be taken as at least one-third. This means that the air and gases in a mold would have a temperature of 600° to 1,000° F., and that the gases in a mold having open risers would be increased in volume to two or three times that before the liquid metal commenced filling the mold. In an air-tight mold this would cause the pressure of the air to increase with its temperature. In other words, the air in a mold before casting was begun would have the pressure of the atmosphere, which is about $14\frac{3}{4}$ pounds per square inch, but by increasing the temperature, the pressure of the air and gases in an air-tight mold would increase from 2 to 4 pounds per square inch over the atmospheric pressure. Such a pressure at the face of the mold is very effective in preventing the

surface of the cope from drawing down, and also prevents the gases from rising in the lower part of the mold where they might cause scabs, or worse still, start the mold blowing. In casting small molds the risers can sometimes be kept open without injury; this is also true in dry-sand and loam molds that have solid faces with little cope surface exposed to the metal. Aside from these, all risers and feeders should, as a rule (especially in heavy green-sand work), be closed air-tight and weighted down so that any increase of gaseous pressure cannot lift them.

Where risers are left open in any mold, they should be sufficiently large in area to allow the expanded air and gases to escape freely, as air rushing through these passages is apt to do damage by cutting away the sand around them.

11. Coverings for the Feeding Heads and Risers.

When covering the feeders and risers, as at *n* and *o*, Fig. 6, care should be exercised, as the smallest opening leaves room for the air and gases to rush out. This would wear the sand

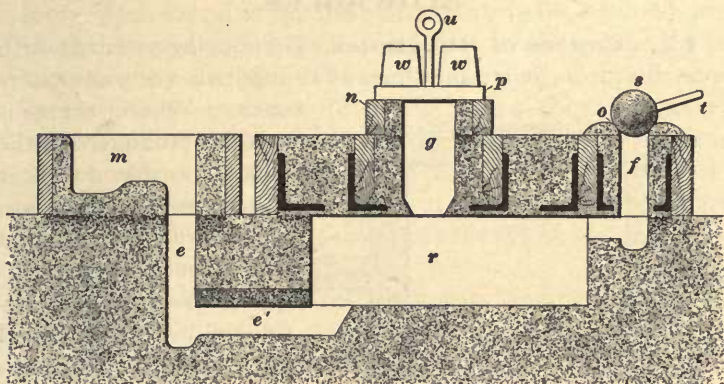

FIG. 6.

and increase the area of the opening for escape as long as the mold was being poured. In placing covers on the feeding heads, as at *n*, the covering plate *p* should have a good bearing over the top of the feeder box or projection, and to insure a tight joint, flour paste, parting sand, or dry

flour is put around the opening for the covers to bear on. Flour paste is the best, and should be used for all heavy castings or work having cope covers or projections where the liberation of compressed air or gases might cause the molds to scab or blow. After the feeding head g is covered it should be weighted as shown at w . The combined weight of the cover and weights placed on feeders or risers should be estimated according to the possible temperature of the air and gas inside. This point must be left largely to the judgment and experience of the molder. It is always best to have more weight on p than is really necessary, for an excess of weight can do no harm. Where feeders or risers are not more than $2\frac{1}{2}$ inches in diameter, balls of clay are often used, as shown at s . These balls of clay should be of such consistency as to hang together well. In some cases it is well to stick a rod in the ball of clay, as shown at t , and to have handles on the cover-plates, as shown at u .

BLOWHOLES.

12. Causes of Blowholes.—In pouring a casting with very dull iron, it is sometimes advisable to leave some risers

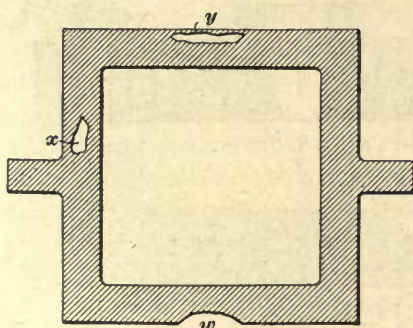

FIG. 7.

open. Where there is no great danger of the cope drawing down or the gases working upwards from the bottom of the mold this is desirable. Too close confinement of the air and gases may cause blowholes in the thinner parts of the casting. Castings frequently have what are called *shrink holes* and *blowholes*. The latter are generally holes having smooth surfaces and are rarely larger than would hold a teaspoonful of water. Castings may be so full of blowholes as to look like a honeycomb.

Blowholes, whether in large clusters or singly in a casting, are caused by the gas or steam (generated from the moisture in the sand, facings, etc., that compose the mold) endeavoring to escape. The gas or steam is caught because the metal is dull and solidifies before the gas can pass out entirely. Blowholes may be expected in any casting where the cores do not vent freely, or where the mold, for any reason, may cause the metal to kick or blow. Where the metal kicks or blows in a mold, the formation of blowholes may often be prevented by flowing metal through the risers. This is especially effective where the inlet gates carry the metal to the bottom of the mold, and flow-off gates or risers are placed at the top. Where hot metal fills a mold that blows or kicks and is slow in solidifying, the gases may free themselves without the flowing of much metal through the risers.

There are two kinds of blowholes: one is found in the interior of castings, as at *x*, Fig. 7; the other is found on or near the exterior, as at *w* and *y*. These exterior holes are more often found in the form of indentations, as shown at *w*. Such a formation on the bottom of a mold or casting may be caused by the heat of the metal drawing the gases to one spot. Gases are liable to collect when there are several vents leading to one main vent, or where there is a softness in the mold at that point. Where there is a hard spot in the face of the mold, the gases, not finding relief downwards, try to pass through the metal and are caught and imprisoned by the solidifying iron.

The form of blowhole seen at *y*, Fig. 7, is generally caused by gases passing from the bottom of molds or cores upwards through the metal in an effort to escape through the cope surface. If there is a damp or hard spot in the surface of the cope, it will chill the metal and form a thin crust through which the gases cannot escape, and being unable to go any farther, they will be imprisoned and form a hole, as shown. Such holes as at *y* are chiefly found in thin castings, ranging from $\frac{1}{2}$ to 1 inch in thickness; in such cases the cope exerts a greater chilling effect than it does where there is a thick

body of metal. Often the surface of a light casting appears solid until one passes a scraper over it, when, from the sound made, hollows may be detected. On breaking the crust, it will be found that these hollows or indentations are generally of a very smooth character, which shows that they were formed by imprisoned gases. A remedy for this is to have vents in the bottom of the molds of such a character as to allow the gases to pass off freely in that direction, and also to guard against copes having wet or hard surfaces. The drier the sand can be used and the softer it is rammed at the surface of copes covering thin castings, the better.

SHRINK HOLES.

13. Causes of Shrink Holes.—A shrink hole differs in appearance from a blowhole in that the former

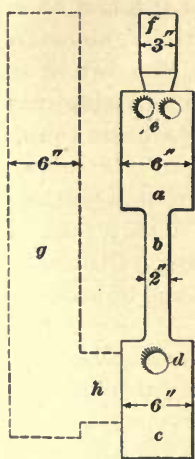

FIG. 8.

generally has a rough surface while the latter has a smooth one. The shrink hole generally looks as if a body of metal, of the same form as the hole, had been torn out, leaving a very rough open-grained fracture. It is caused by the parts that are the first to solidify shrinking and drawing metal from those that solidify last. This is due to the peculiarities in the cast iron that cause expansion at the moment of solidification, just before contraction takes place. It is also effected by the fact that thin or exterior portions solidify with a closer grain and possess more combined carbon and a greater specific gravity than interior or heavy parts, even when poured from the same ladle of iron. The harder the iron, the more noticeable will be these conditions. With very soft grades of iron little difficulty will be experienced from shrink holes, unless the castings are heavy. Where the iron is hard, either high in combined carbon or

low in graphitic carbon, the shrinkage will always be great compared to that in soft iron. This is so true that, unless hard-iron castings are very carefully proportioned, considerable shrinkage may be expected in the parts that are the last to solidify. These should be provided with feeders through which compensation for the shrinkage is made with good hot metal. This point is well shown in Figs. 8 to 11.

Molders are sometimes held responsible for shrink holes that it was impossible for them to avoid. For example, consider Fig. 8, which shows a section of a casting having a light body at *b* connecting two heavy ones, as at *a* and *c*. It is evident that the lighter body *b* will solidify before the heavier ones *a* and *c*. This means that such a piece, if cast in a vertical position, will probably have shrink holes at *d*. The reason for this is that after the light section *b* has solidified, the outer portion of *c* will draw metal from the portion that was the last to solidify, forming cavities, as shown at *d*. The holes *e* occur near the upper end of the casting, instead of near the light section *b*, owing to the fact that the metal commences to solidify at the bottom and then gradually works upwards until the whole body is solid. The heat in escaping from a casting moves upwards more freely than in other directions, and hence the topmost bodies are kept hot the longest. The holes at *e* in the upper end of such a casting can be prevented by having a feeder *f* through which, after the casting is poured, additional metal may be fed to replace that taken away from the portion at *e*. The only way to prevent holes at *d* in such a vertical casting is to have a feeder leading down to *c*, as indicated by the dotted part *g*, when this is practicable; but this is seldom possible in ordinary work. It should also be borne in mind that if the feeder *g* is to be effective in preventing holes *d*, this feeder must be larger than the section *c*, so that the feeder and its inlet *h* will be the last to solidify.

Another example of a shrink hole may be seen at the upper end of the vertical casting shown in Fig. 9. Here the riser head *f*, used chiefly to receive the dirt, has an area

at a larger than at any other portion of the section. A study of Fig. 8 should make it clear why shrink holes are formed at a , Fig. 9. To prevent the formation of such holes, perfect feeding is required. If the feeding is omitted, then the section at f should be enlarged to a thickness equal to that of the casting measured on the line $m m$. This would

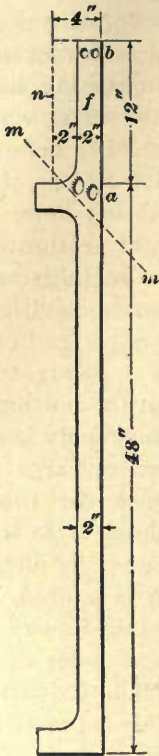

FIG. 9.

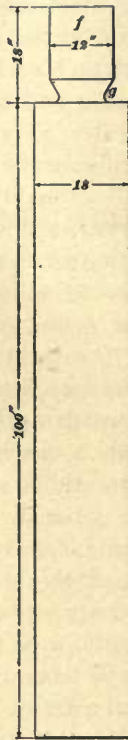

FIG. 10.



FIG. 11.

give us a *sinking head*, like that shown by the dotted line n , 4 inches thick instead of the original 2 inches. By having a sinking head 4 inches thick, it will be self-feeding, so that instead of the holes being at a , we shall find them higher up, at b . The principle involved in this scheme of self-feeding is also illustrated in Figs. 10 and 11. Here is shown

a roll supposed to be cast on end. Some molders, to save lathe work or labor in cutting off feeding heads from such castings, will place feeders as seen at f , coming down to a neck, as at g , and then feed the casting with churning rods and an occasional pouring of hot iron into the feeding head.

Instead of depending on care, judgment, and skill in feeding such castings, some molders avoid the neck at g and simply carry the casting up straight, and have it appear as shown in Fig. 11. After these molds are cast, the upper end is covered with blackening to prevent heat escaping, and then the extra length of the casting used for a sinking head is kept full of metal, by occasional pouring as it shrinks away. After the casting is cold, the extra length provided for a sinking head is cut off. The length of the sinking head from a to b , in some cases, ranges from 2 to 3 feet, in order to insure the body of the casting below the level of b being perfectly solid. A great many founders cast hydraulic cylinders, rolls, shafts, cannon, etc., on this plan, having learned from experience that this is the best way to obtain castings free from shrinkage defects.

SHRINKAGE AND CONTRACTION.

14. The actions of *shrinkage* and of *contraction* are distinct in their nature, and are separated by the act of expansion that takes place at the moment of solidification. **Shrinkage**, as here considered, is that property of the metal when liquid that causes it to decrease in volume while cooling, until the moment it becomes solid. At the moment the iron becomes solid there is a slight expansion, but as it is much less than the previous shrinkage, it is rarely noticeable, especially in large castings. After iron has solidified, it again decreases in dimensions until it reaches the temperature of the atmosphere; this is **contraction**. While this distinction is not always recognized, yet some such distinction is necessary, and these terms will be used as defined. Light-work molders and founders not having to make heavy

castings, in which the greatest shrinkage is displayed, are very apt to confound shrinkage with contraction. Nevertheless, there are two separate actions, and they should be recognized by distinctive terms.

FEEDING THE MOLD.

15. Importance of Proper Feeding.—Feeding can be properly done in many cases without the use of large **feeding heads**. One objection to large feeding heads is that it is expensive to remove them from the casting. Many molders think that as long as a casting has a feeder, no matter how small it is, that is all that is necessary. The man that thoroughly understands the principle of feeding will proceed with discretion in placing such feeders as shown in Figs. 10 and 11. If he has a feeder like that in Fig. 10, he knows that great care and skill must be used in order to get a sound casting. In contrast to this, it is no uncommon thing to see a molder using a feeding head that will solidify almost as soon as the mold is poured, although the casting underneath the feeder may remain in a fluid state from 15 to 30 minutes. Such castings would be better without any feeder, as by a small feeder a molder can draw out more iron than he puts in. Whenever a feeder is used, it should be sufficiently large to permit of feeding the body of metal below it as long as the latter remains in a fluid state. Some molders accomplish this by means of a smaller feeder than others, although the difference in size may not be great.

Usually, the greatest difficulty in feeding is to keep the smaller sizes of feeding heads open. A head from 2 to 3 inches in diameter should be kept open from 10 to 15 minutes, and the molder should be careful not to use too large a feeding rod. Sometimes a molder will take a $\frac{3}{4}$ -inch round cold-iron rod and use it in a 2-inch feeder. The result is that the cold rod chills the liquid metal the moment it is inserted, and being too large for the feeder, the chilling rarely permits the removal of the rod.

16. Use of Feeding Rods.—For a 2-inch feeder the diameter of the **feeding rods** should not be more than $\frac{3}{8}$ inch. For a 3-inch to 4-inch feeding head, a $\frac{1}{2}$ -inch rod will work well. For 4-inch to 6-inch feeders, $\frac{5}{8}$ -inch to $\frac{3}{4}$ -inch rods will work nicely. In all feeding heads above 6 inches in diameter, rods from $\frac{3}{4}$ inch to 1 inch in diameter can be used. Before being inserted into a feeder, the rod should always be well heated in a ladle of hot metal, so as to prevent its chilling the metal in the feeding head. The metal in the feeding head is generally dull on account of its having

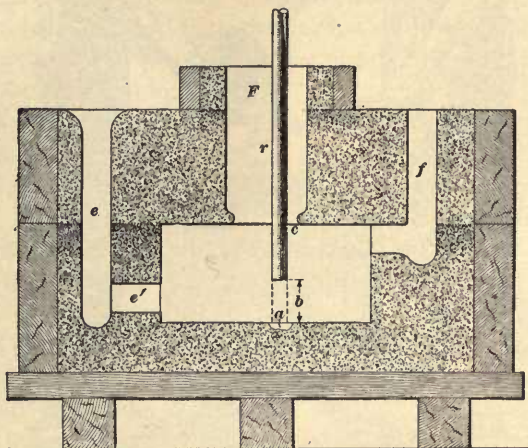

FIG. 12.

flowed upwards from the bottom to fill the feeder. When placing a rod in a feeding head, it should pass through the head and enter the casting to a depth that will insure hot iron being fed into the part that is going to shrink. Too many molders push the feeding rod no deeper than the bottom of the feeding head. Some do this through ignorance, and others to get rid of a hot job quickly. In the ordinary molds, one should, on inserting the feeding rod *r*, Fig. 12, be careful to pass it down gently until it is felt to strike the bottom of the mold, and then to draw it up a few inches, as shown at *b*, so as not to make a lump on the casting at *a*.

After the feeding rod has been raised off the bottom, it should be worked up and down, or churned, through a distance of from 3 to 5 inches, according to the character of the mold, keeping it near the outer sides of the feeding head *F*, as shown at *c*.

In feeding heavy castings, there should be several feeding rods on hand, a few of them smaller than the ones generally used, so that if one rod becomes badly clogged, it can be

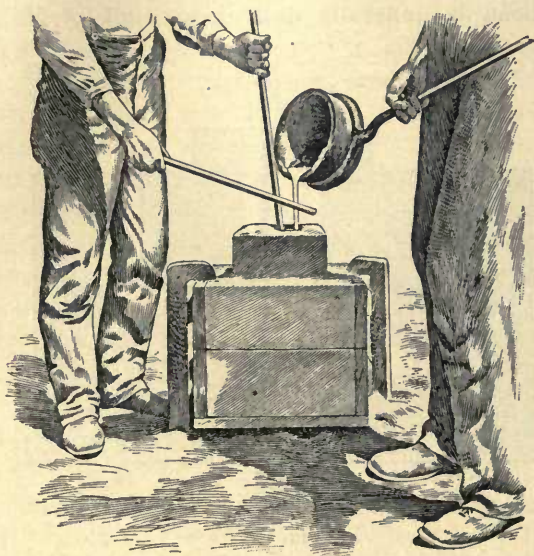

FIG. 13.

removed and a clean one used. Feeding rods may often be kept from becoming clogged by tapping them lightly with another rod held in the hand, as shown in Fig. 13. This jars off the metal that clogs the rod, and assists in keeping the feeding head open until the casting has solidified. The partially solidified iron that is jarred off the feeding rod can be worked into the casting; this takes it out of the way of the feeding and still benefits the casting by helping to cool the metal.

17. Hot Iron for Feeding.—In using feeding rods, care should be taken to have plenty of hot metal in order to keep the feeder open, so that the metal in the feeding head may be as fluid as that in the casting below the head. There is altogether too much disregard of this important point, and one frequently sees molders in difficulty from the start for want of hot iron to keep the feeding heads open. Where one has hot metal when necessary, feeding should be continued until the gradual solidification of the casting from the bottom upwards has pressed the feeding rod up to the lower edge of the feeding head. This stage reached, hot metal should be poured into the feeder while the feeding rod is being gradually removed. Any one feeding in this manner will obtain a solid casting.

Fig. 13 shows a molder in the act of feeding a mold and a second person pouring hot metal out of a hand ladle to keep the feeder open and supply the shrinkage of metal in the casting. With very large feeding heads, it is sometimes a good plan to use a small iron scoop and dip out the dull metal in the head for a depth of about 6 inches. The feeding head is then filled with hot metal as direct from the cupola as possible. This can be churned up and down with the feeding rod to open the feeding head, and so obtain a good clean hole to continue the feeding. If in feeding a casting the molder will keep his feeding rod hot and have a covering of powdered charcoal over the feeding head, he will experience little or no difficulty from iron adhering to the feeding rod. To be able to keep a feeding head open until the solidifying metal drives the rod out of the casting is an operation requiring skill on the part of the molder.

18. Use of Large Feeders.—Often with feeders over 8 inches in diameter, one will not need to insert a feeding rod for quite a time after the mold has been poured, for the reason that the iron does not commence to shrink until it is approaching the point of solidification. This is not until the metal in contact with the walls of the mold or core has cooled down considerably.

Many molders when feeding large heads like that in Fig. 10 cover the metal in the feeding head with dry blackening or charcoal dust as soon as the mold is poured, to keep the heat from escaping, and then pour in hot metal occasionally, as the feeding head settles. This may be continued in large feeders of over 12 inches in diameter for from 30 to 60 minutes, or as long as it is safe to do so. This can be determined by occasionally passing a hot feeding rod into the casting and observing whether any metal sticks to it when pulled out. When iron commences to stick it is time for the molder to put in the feeding rod for constant and careful operation, or until it is driven upwards and out of the casting by the solidifying metal, as already described.

BENCH MOLDING.

APPLIANCES AND PROCESSES.

19. Advantages of Bench Molding.—In order to save time and labor in making some kinds of small castings, benches are used to support the flasks during molding. There are many firms that make a specialty of bench molding with snap flasks only. The workmen are called **bench molders**. Some bench molders will make from 75 to 100 molds per day, according to the size of the flask and the character of the pattern used. The chief skill involved in bench molding generally lies in getting up the pattern and mold board. In some cases, a dozen or more patterns may be attached to a plate or pattern board, and the whole finished in such a manner that as soon as the plate is withdrawn from the mold, the cope can be put in place. While there are many foundries making a specialty of bench molding only, there are many large foundries that could utilize benches and snap flasks for making some of their very light castings, instead of molding them on the floor after the manner of heavy work. Not only are benches used for convenience in ramming up snap flasks, but also for the ordinary

small wooden and iron flasks, ranging from 12 to 14 inches, square or round. Snap flasks, however, are used very largely in bench molding and properly belong to this class of foundry work.

20. Snap Flasks.—A very large number and variety of small light castings are made in what are called **snap flasks**. For common use on the bench, these flasks range

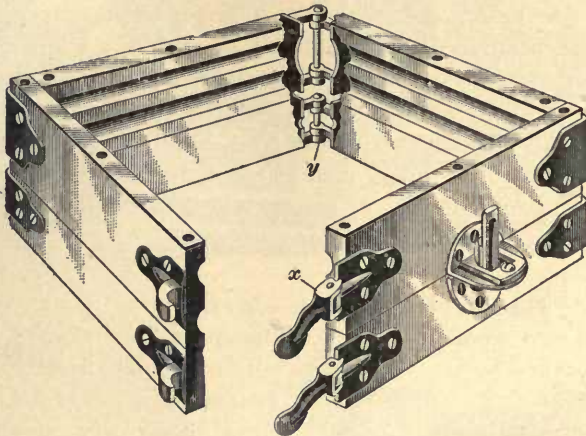

FIG. 14.

from 10 to 16 inches square, if of the form shown in Fig. 14, and from 10 to 16 inches in diameter, if of the form shown in Fig. 15. For ramming molds on the floor, larger sizes are used. Snap flasks may also be oblong or of any other shape desired. Those shown in Figs. 14 and 15 are constructed with clasps and hinges, as seen at *x* and *y*, so that they can be opened and removed from the outside of the mold without breaking it. This permits the use of one flask to make any number of molds.

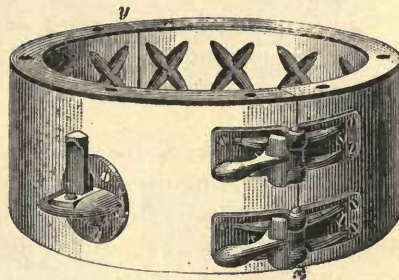

FIG. 15.

It is chiefly molds that have little side pressure when being poured that are cast in snap flasks; for when the flask is removed from the mold there is little to prevent the pressure of the fluid metal from bursting the mold outwardly. To prevent snap-flask molds bursting, the molder places cribs or frames around the mold, which keep the sand in place. Snap flasks have no cross-bars, and hence cannot be used for large flat work. Also, it is impossible to use snap flasks for any piece that has a large lifting area. For instance, a stove door should not be cast in a snap flask on account of the large area over which the iron can exert a lifting influence tending to separate the cope and drag. Large flat pieces that have a considerable portion of their area cut away by holes, such as stove-door frames, etc., can be cast in snap flasks on account of the small lifting area which they present to the cope.

21. Bench Rammers.—In ramming flasks on the bench, two wooden rammers, shown in Fig. 16, are generally used, one in each hand.

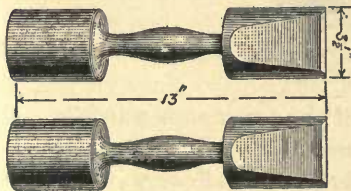

FIG. 16.

In ramming such flasks, the drag especially should be peened very solidly around the outer part of the mold, so as to give as much strength as practicable, to withstand the side pressure of the metal on the mold when it is poured.

In using a rammer in each hand, one should be as effective as the other; this requires practice.

22. Making a Bench Mold.—Fig. 17 (*a*), (*b*), (*c*), and (*d*) shows the first operations of bench molding as carried on in a stove foundry. The drag and cope of a snap flask are shown at *a* and *d*, Fig. 17 (*a*). The pattern *b* is placed on the molding board *c*, ready for use. The drag *d* is placed on the molding board with the dowel-pin *e* of the drag between the nails, or other fastening, on the molding

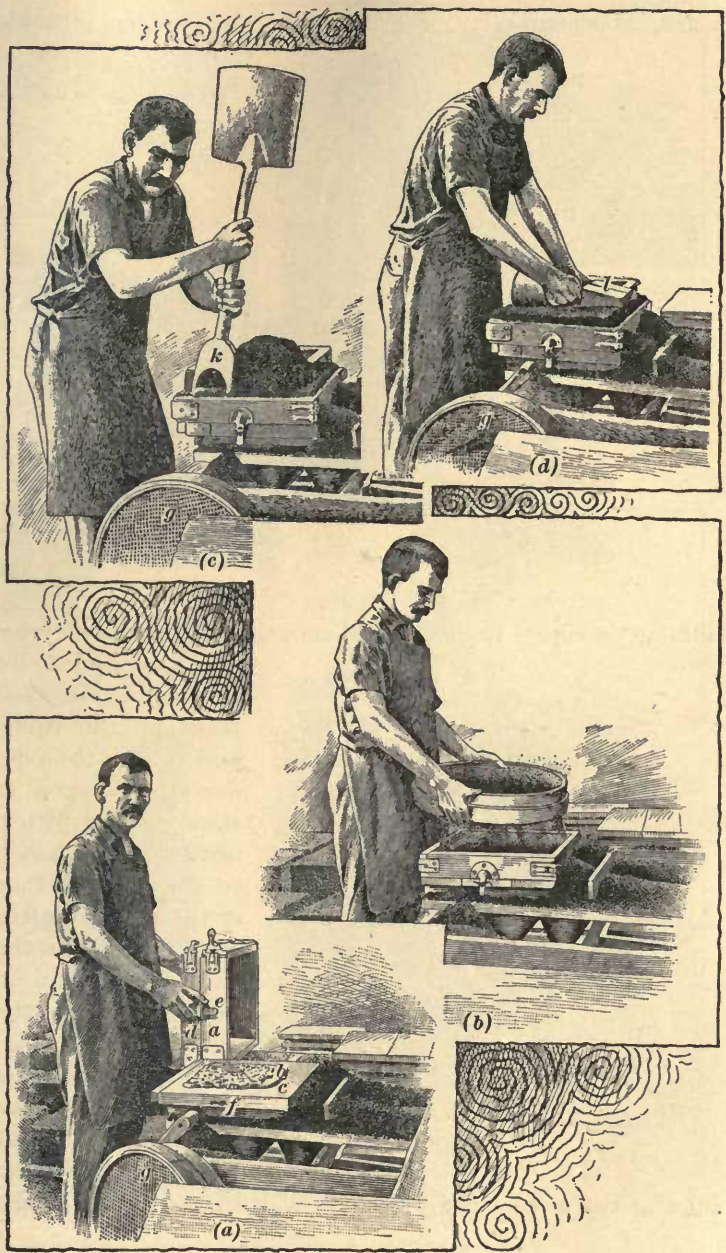

FIG. 17.

board, as shown at *f*, Fig. 17 (*a*). The molder sets his



FIG. 18.

riddle *g* on top of the flask and shovels it full of sand from

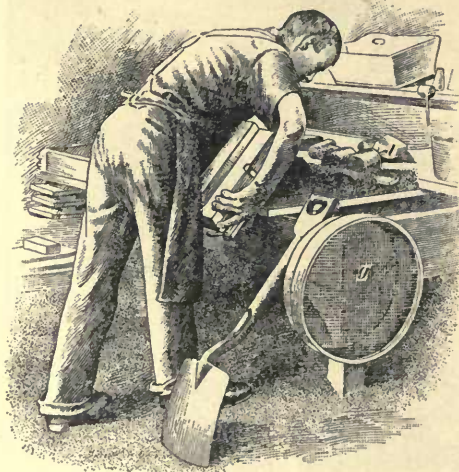

FIG. 19.

the pile under his bench. He then picks up the riddle and riddles the sand over the pattern, as shown in Fig. 17 (*b*), until there is an inch or so over the face of the pattern, after which he dumps the rest of the sand in the riddle into the flask and shovels in sand until there is quite a heap above the flask. He then

rams all around the edge of the mold close to the flask with the handle of the

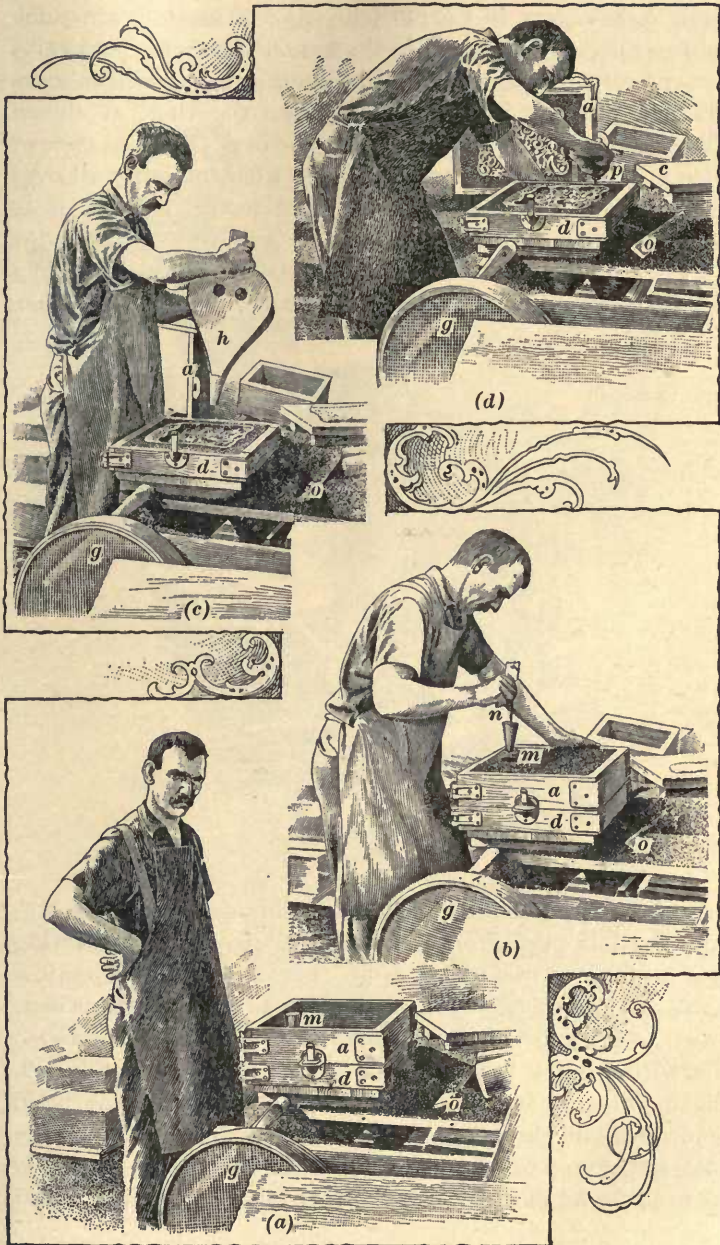

FIG. 20.

shovel *k*, as shown in Fig. 17 (*c*). All the motions are quick and forcible. Next he takes the bench rammers *l* and rams the sand all over the middle of the mold with these rammers held flat, pushing both rammers down together, as shown in Fig. 17 (*d*). As soon as he has gone over the mold once or twice in this way, he rams down hard with the butts all over the mold, as shown in Fig. 18. The next operation is to strike off the mold, which is done by taking a straightedge and sawing it back and forth across the top of the mold in a zigzag manner, leaving the top smooth. The top is then

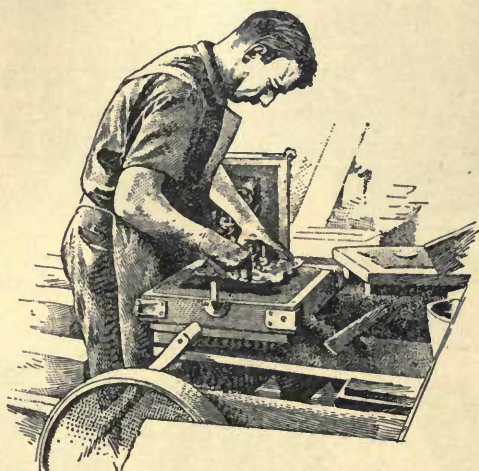

FIG. 21.

sprinkled over with a handful of molding sand, and the bottom board is placed on and rubbed down with a rotating movement to a good smooth bed on the sand and against the flask. The flask is then grasped firmly on both sides, drawn to the edge of the bench, and as it drops off is rolled over with a quick flop on to the bench, as shown in Fig. 19. The molding board is then removed, the top of the mold cleaned off and smoothed up, parting sand sprinkled over the mold, the cope *a* fitted on to the drag *d*, and the sprue pin *m* put in place, as shown in Fig. 20 (*a*). Sand is again riddled

all over the mold and rammed as before. The top is smoothed off with the strike *o* and the sprue pin *m* removed with a draw-spike *n*, as shown in Fig. 20 (*b*).

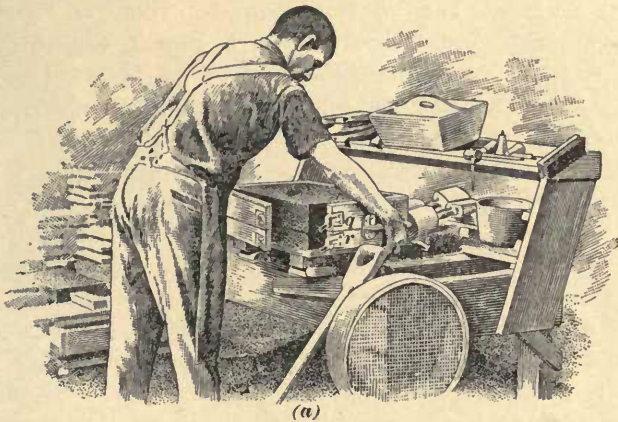
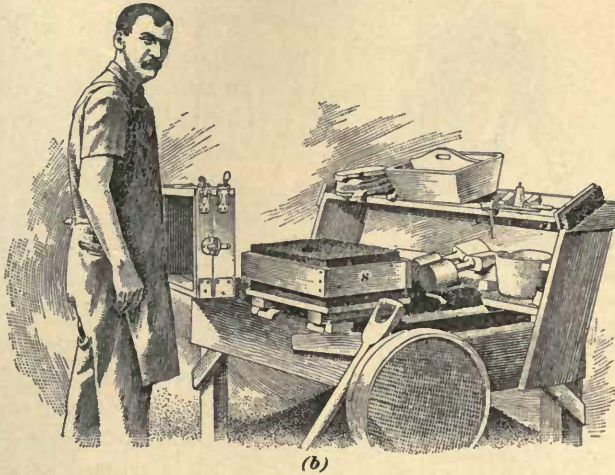

FIG. 22.

After the sprue pin is withdrawn, the sand around the top of the sprue is rounded off with the fingers and packed firmly. The cope is then lifted off carefully, so that the sand shall

not be loosened, and placed standing on edge on the bench, as shown at *a*, Fig. 20 (*c*). The bellows *h* is used to blow off any loose sand or dust around the pattern or on top of

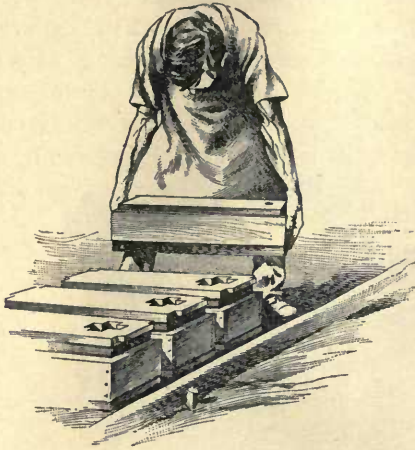

FIG. 23.

the drag, as shown in Fig. 20 (*c*). With the sponge and quill *p*, water is dripped all around the sand near the edge of the pattern, as shown in Fig. 20 (*d*). The sponge is fastened to the quill, so that when the sponge is full of water it can be squeezed in such a way as to let a few drops off the end of the quill or to let quite a little stream of water

from the sponge. This moisture on the sand makes it firmer, so that the pattern can be removed without displacing the sand. The pattern is now ready to draw, which is done very carefully with draw-pins, as shown in Fig. 21. The pattern for the gates is then removed, as gates are cut to connect the sprue with the mold, and the mold is smoothed with a finishing tool if there are any defects. The cope is then replaced, the snap flask removed by loosening the catches *q* and *r*, and both cope and drag are taken off at the same time, as shown in Fig. 22 (*a*). The flask is placed on its side in a convenient position, and a crib *s*, Fig. 22 (*b*), put on the mold to keep it in good shape while pouring. The mold is picked up, carried out on the floor, and placed in the row with the molds already there, as shown in Fig. 23. When the day's molding has been finished the molds are poured, as shown in Fig. 24. This illustration gives a good idea of how a foundry floor looks when the molds are being poured.

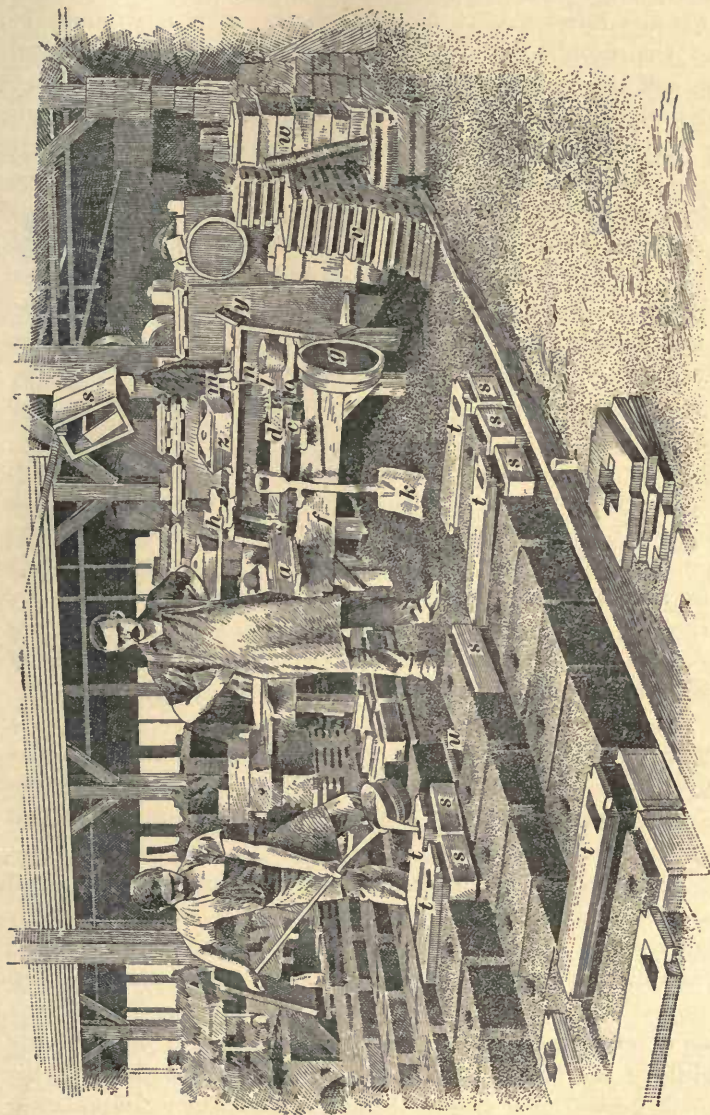

FIG. 24.

23. Pouring Off.—In foundries where small work forms the largest part of the output, it is customary to stop the molding in the early part of the afternoon and pour off the molds that have been made since morning. The molten metal is brought to the molder usually in traveling ladles, but sometimes by hand ladles. Any dirt that can be skimmed off is removed, and the molder pours the molten metal into the mold, as shown in Fig. 24. A cast-iron weight t is placed on the mold before pouring, and the molder holds the ladle as low as possible and takes care not to strike it against anything. He brings the ladle as close to the mold as he can without touching it, and turns the ladle gradually until a small stream of metal starts into the mold. By watching the metal closely, he is able to stop pouring before the metal runs over the side of the mold. When he has poured all the molds that he can pour completely with the one ladleful, the balance is poured into small pig molds, which are merely small cast-iron V troughs about 10 inches long. The weights t, t are then shifted to other molds before pouring the next ladle of metal. The purpose of these weights is to prevent the metal from lifting or displacing the copes on the molds. The letters in Fig. 24 have the same signification as in the previous figures.

24. Shaking Out and Tempering the Sand.—The pouring having been finished, the molder starts in to remove the castings from the sand. This process is commonly called shaking out the castings. The cribs s, s are removed from the mold and placed in a pile w . The casting is removed with tongs and placed to one side in a pile, and the sand is cleaned off the bottom board u , which is placed on the pile of bottom boards v . When all the castings have been removed and the sand cleaned off the bottom boards, the sand is tempered as previously explained, and piled in the middle of the floor. The bench on which the molder has his tools is moved over the sand pile, so that when commencing work the next day the molder has simply to turn around and put his first mold in place on the floor. As he works he

shovels the sand from under the bench, and the bench is moved along so that he can keep up with the sand as he uses it and at the same time have room for the molds as they are finished. By working in this manner the molder does not have to go far for his sand nor to place the molds. This is a great convenience and it saves the molder time. In some cases a wheel is placed on each of the back legs, so that the molder can move the bench back without the help of another man.

The arrangement of tools about the bench and on it is also for the purpose of saving time. The cope *a*, the drag *d*, the molding board *c*, the riddle *g*, the shovel *k*, the hand rammers *l*, the sprue pins *m*, the draw-spike *n*, the strike *o*, the cribs *s*, the bottom boards *v*, a brush *y* for clearing off dirt, and a tool box *z*, in which small finishing and other tools are kept, are all on or near the bench. In this way everything is convenient and handy for rapid and expeditious work. For some classes of bench molding, the benches are stationary, being placed along the wall near the windows. In such cases it is necessary to bring the sand to the bench and take the molds away.

PROTECTING THE MOLD AGAINST FUSING.

25. Composition of Sand and of Protective Material.—In order to obtain a smooth surface on the casting, it is essential that the sand forming the face of the mold should be well tempered and sieved. For a large class of work the sand should be mixed with some protective material to keep the sand from fusing. Molding sands are composed of silica and alumina, with small quantities of lime, oxide of iron, potassium, and magnesia. The three latter elements are easily fused; they combine with the silica to form silicates or a kind of glass that on heavy castings may form a scale varying in thickness from $\frac{1}{100}$ inch up to $\frac{1}{2}$ inch, if the face of the mold is not protected with some

non-fusible material. The face of the mold may be protected by mixing finely ground **sea coal** with the sand, or by facing the mold with blackening. In some cases a facing sand containing sea coal is used, and this surface is covered with blackening.

Sea coal in America outside the Pennsylvania coal district is obtained chiefly from the culm, or slack, of bituminous coal. In addition to mixing sea coal with the facing sand, the surfaces of molds are often covered with what is called **blackening** or **lead**. Blackenings and leads consist chiefly of carbon, the other ingredients being alumina, silica, lime, and iron. The less of these latter elements present, the more intense heat the blackenings and leads will stand before fusing. The cheaper blackenings are composed chiefly of coal dust, or culm, with the addition of various minerals. These blackenings when ground to a powder lack cohesion, and, therefore, they are apt to float or wash before the iron when the mold is being poured. To guard against this, various minerals or clays are ground in the blackenings to give them cohesion. The finer the pure coke or carbon is ground, the more adhesion will it possess; and when ground very fine, the adhesion may be sufficient to hold the material together without the use of any bond. Lehigh blackenings are made by grinding to a dust fine qualities of Lehigh coal. Coke blackenings are made from good grades of coke, selected from a grade having the highest fixed carbon, which at times runs as high as 90 per cent. Gas-house carbon being practically a pure carbon, makes excellent blackening; but, on account of its being a difficult material to grind and bolt, it is not in much favor with blackening manufacturers. In order that charcoal may make a good blackening, it must be made from some hard wood, as hard maple, and be carefully burned. Soft or stringy-grained wood is useless for making charcoal blackenings.

Plumbago or **graphite** is recognized as being the most non-fusible material used for blackening. The best grade of imported graphite comes from the island of Ceylon. In its crude state it looks like bright chips of burnished silver,

from which fact it is commonly called *silver lead*. This grade of graphite is not only very valuable for mixing with blackenings intended for green-sand, dry-sand, and loam work, but it is also good to dust in a dry state over the surface of molds, as it assists in sleeking the mold and peeling the casting. Of recent years, graphite has been extensively used in many foundries. In putting it on a mold, many molders use camel's-hair brushes, while others will shake it out of a bag or throw it on by hand. High grades of graphite excel all other blackening in peeling a casting and giving it a fine, smooth face, and bright color. Some grades of graphite are procurable in this country. North Carolina produces some graphite, but it is mixed largely with clay and other foreign substances. Graphite is also found in eastern Pennsylvania and Tennessee, but the best grade comes from Ticonderoga, New York.

Blackening materials are sometimes called leads, on account of the fact that graphite is called *black lead* or *silver lead*. Blackening materials never contain metallic lead.

PREPARING THE FACING SAND.

26. Percentage of Sea Coal in Facing Sand.—

As a rule, the heavier the casting, the more sea coal is required in the facing, the limit being 1 part of sea coal to 6 parts of sand. If more sea coal than this is used on any casting, it is very liable to make the surface streaked or veined, especially in heavy work. Where the molds are heavily coated with good graphite, or are poured with dull iron, this will not be so pronounced. If facing sand contains too much sea coal, it will prevent light castings running sharply, and is very apt to cause **cold shuts**. This is the condition induced when two bodies of fluid metal run together but fail to unite. The surface of the casting will be harder than if a weaker facing had been used; this is due to the gas that sea coal generates when the mold is being poured. This gas is liable to create a cushion between the

mold and the metal, and the amount of cushioning depends on the speed of pouring, the amount of pressure, and the fluidity of the metal. Where the facing sands contain too much sea coal and the castings are poured *dull*, the metal often becomes set before the gas cushions are all destroyed by the gas passing out through the vents. This prevents the metal from running into the corners and edges of the mold and may also cause cold shuts. Then again, these gases may make smooth concave indentations in castings, as seen at *w*, Fig. 7. Another effect sometimes produced by sea coal is the coating of the surface of the castings with what might be termed coal soot. However, in order that this shall take place to any great extent, a combination of conditions that seldom occurs must take place. While the objectionable conditions described are usually to be found in light-weight and medium-weight castings, still, heavy castings, when poured with dull iron, may also present some of them.

The proportion in which sea coal is mixed with sand ranges from 1 in 20 to 1 in 6. Castings under $\frac{3}{4}$ inch in thickness seldom require any facing sand. Below $\frac{3}{4}$ inch thickness, better and smoother castings are often obtained by using common heap sand, well tempered and sieved finely on the patterns, especially when the metal cannot be poured quickly. In general, castings from $\frac{3}{4}$ inch to 1 inch thick require facing sand having 1 part of sea coal to 12 parts of sand; above 1 inch and up to 2 inches, 1 part sea coal to 10 parts sand; from 2 inches to 4 inches, 1 part sea coal to 8 parts sand; all above 3 inches in thickness, 1 part sea coal to 6 parts sand. In mixing facing sand, some molders use common heap sand, or old sand mixed with new in varying proportions, according to the strength of the different sands.

It is not always the thickness of the casting that regulates the strength of the facing sand. There are many other things to be considered: (1) whether the casting is to be poured with hot or dull iron; (2) the distance of some parts of the mold from the point where the metal enters; (3) the

time it will take the mold to become filled with iron; (4) whether the metal is running over flat surfaces, and (5) is covering them slowly or quickly. Strong facings on the sides of a mold, where the iron runs in and rises slowly, may cause heavy castings to be cold shut. The square corners of castings should, generally speaking, have weaker facings on them than the straight plain surfaces, and the lower parts of high molds should have a stronger facing than the upper portion. If the strong facing suitable for the lower portion were used at the upper portion, the casting at the upper part would be curly or partly cold shut at the surface, owing to the dulness of the metal when it reached the upper portion of the mold. A new sand without mixture will require more sea coal than if it were mixed with old or common heap sand.

Where molds are long in preparation, or are to withstand rough usage in drawing the patterns, it is best, if there are no conditions prohibiting it, to use new sand in mixing the facings. For copes covering heavy castings, it is best to use all new sand. For light-work copes that cover flat surfaces it is best, when the new sand is strong, to use some old sand with it, sometimes using equal proportions.

27. Necessity of Thoroughly Mixing Facing Material.—It is not uncommon to find castings streaked, veined, cold shut, or not peeled, because the sea coal in the facing had not been thoroughly mixed with the sand. When castings are very massive, as great a percentage of sea coal as possible is mixed with the sand, in order to peel the casting. Much more sea coal can be added to some sands by thorough mixing than would otherwise be possible. In some cases it may be possible to mix facings for massive castings with as high a proportion as 1 part of sea coal to 5 parts of sand, provided the sea coal is thoroughly mixed with the sand. A good way to mix facing sands thoroughly is to tramp them with the feet for from 2 to 4 cuttings or turnings over of the sand, and then at the last cutting to riddle it through a $\frac{1}{2}$ -inch riddle and then through a $\frac{1}{4}$ -inch

riddle, and finally through the sieve before applying it to the face of the pattern. In cutting the sand, it should be well scattered, as shown in Figs. 1 and 2, *Green-Sand Molding*, Part 1. The best way to mix sand, however, is with a sand grinder, which is a machine for breaking up lumps and mixing the sand thoroughly.

CORE MAKING.

SAND CORES FOR CASTINGS.

INTRODUCTION.

1. Definition of Core.—Cores are bodies of *green sand*, *dry sand*, or *loam*, generally made separately from the molds and placed in them to form such interior openings or holes in the castings as cannot be economically or safely formed directly with the pattern. It generally requires greater experience and skill to make cores in green sand than it does in dry sand.

2. Advantages of Different Classes of Cores.—The cores for many castings can advantageously be made of green sand, especially when a large number of castings must have their core sections uniform in size. Dry-sand cores, especially large ones, are liable to sag or change their shape in drying the sand, whereas green-sand cores remain the size of the box in which they were made. Another advantage of green-sand cores lies in their permitting the making of thinner castings of pipes, etc. than can be made with dry-sand cores, especially in the larger sizes. Where there is danger of the gates cutting or scabbing, or where the casting is massive in its proportions, it is safer, as a rule, to use dry-sand or loam cores; this is also true of intricate shapes, or when it is difficult to vent a core.

§ 44

For notice of copyright, see page immediately following the title page.

GREEN-SAND CORES.

SWEEPING GREEN-SAND CORES.

3. Green-Sand Cores for Pipe.—In Fig. 1 is shown the side and end of a pipe or cylinder that might be cast by the use of **green-sand cores**. This casting may have a diameter of from 6 inches to 4 feet and a length of from 1 foot to 8 feet or more. The larger the diameter, the longer a casting can be made. Few pipes are now made with green-sand cores, as they require a higher degree of skill than loam cores. Occasionally a foundry doing only green-sand work finds it necessary to cast some pipe and uses green-sand cores.

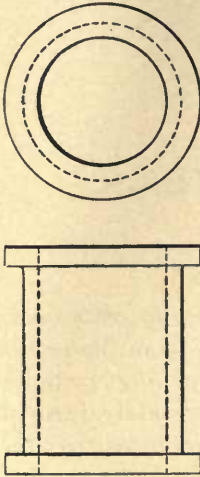

FIG. 1.

The pipe casting serves very well to illustrate the principle of making and setting green-sand cores.

There are two ways of constructing cores for such pieces as this. Cores from 6 inches up to 24 inches in diameter can be made after the manner shown in Figs. 2 and 3. An

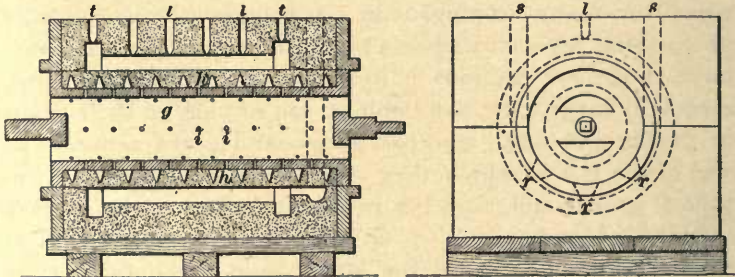

FIG. 2.

iron core barrel, as shown at *g*, Fig. 2, is sometimes used. This core barrel has prickers, as shown at *h*, from 2 to 3 inches

apart on the outside, to help hold the sand on the barrel when making the core. Core barrels should be perforated with vent holes from $\frac{3}{8}$ -inch to $\frac{1}{2}$ -inch in diameter, as shown at *i*, placed about 4 inches apart. Wooden core barrels with nails driven closely all over the exterior have been used for making pipes about 24 inches in diameter and 4 feet long. Wooden core barrels do not allow for proper venting of the core.

4. Cast-Iron Core Barrels.—There are two designs for **cast-iron core barrels** in common use. In one the barrel is cast with pricklers, as shown in Fig. 2; in the other design ribs are run the whole length of the barrel. As a rule, the ribs are used for the smaller sizes of barrels, on account of their making the barrels stiffer, thereby preventing the core from settling or raising and thus altering the thickness of the casting when the mold is being poured. The larger the barrels are in diameter, the more resistance they offer to settling or springing. As a rule, barrels over 8 inches in diameter are stout enough without ribs, unless they are more than 8 feet long. It is desirable to avoid the use of ribs and to give pricklers the preference whenever possible, since the latter hold the sand much better. The ribs separate the sand into sections, whereas the pricklers keep it more nearly in one body. The larger the pipes are in diameter, the longer can they be cast. Thus, in the case of pipe that is cast in a horizontal position, a pipe 1 foot in diameter might be 9 feet long, whereas a 3-inch pipe is rarely cast over 4 feet long, on account of its core barrel lacking stiffness. In making core barrels, the space allowed for sand usually varies from $\frac{3}{8}$ inch to 1 inch. Generally, the larger the bars are, the greater should be the space allowed.

5. Use of Chaplets With Long Cores.—In some cases it is practicable to use **chaplets** on the bottom and top of green-sand cores, thus permitting the use of slim core bars, and, consequently, the casting of long pipes; they may also be used to aid stout core bars should it be desirable

to do so. For this purpose, a knob is generally cast on the under side of a core bar and is made to come flush with the bottom face of the core. This knob is intended to come directly over a chaplet and so cause a connection of iron with iron to support the core. For chapleting the cope, a hole may be cut in the core down to the core bar, and loose pieces of iron or nuts may be inserted and made flush with the top face of the core. The cope chaplets may be set on these loose pieces, which should be as small as possible. When shaking out the core barrel, the loose pieces under the cope chaplets will work loose and permit the release of the barrel.

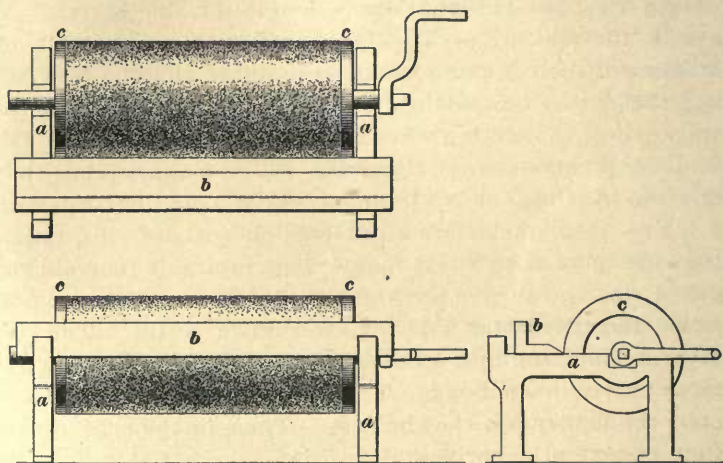

FIG. 3.

6. Sweeping of a Core.—Before starting to use core barrels, they are generally coated with good thick clay wash or thin flour paste, or they are wet with water to assist in making the sand stick to them. Where the sand is strong and open, water will generally suffice. The core barrel is set on the horses *a, a*, Fig. 3; the sweep board *b* is then adjusted, and sand is packed by hand upon the barrel. Next, with a man slowly turning the core, the sweep board is pressed lightly forwards until it strikes a stop, which

determines the diameter. In this case, the diameter is determined by the edge of the sweep board b coming against the flanges c, c of the core bar. While the flanges can be used to gauge the diameter, it is better to have the stop for the diameter independent of the barrel, since the friction of the flanges on the sweep board in turning will wear away the sweep board, and also cause the barrel to vibrate, which may cause the sand to drop while making the core. After the core has been swept, and before the last revolution is made, some well-tempered sand is sifted on the core from a $\frac{1}{8}$ -inch sieve to make it as smooth as possible.

7. Finishing Swept Cores.—For thin pipes, avoid as much as possible sleeking the surface of the cores. The metal will then lie more readily against the core, allow the mold to be filled better, and make the casting free from cold shuts. When pipes are over $\frac{3}{4}$ inch thick, the cores may be sleeked to advantage, and may even have blackening rubbed on the top and lower half, thus making the inside of the pipes peel smoothly. Should pipes be poured from top gates, as shown in Fig. 2, it is well to rub the surface directly under the gates where the iron will strike the core with a good coating of heavy blackening or silver lead.

MAKING GREEN-SAND CORES IN BOXES.

8. Large Round Cores.—Fig. 4 shows a method by which larger cores can be made than by the method illustrated in Fig. 3. Cores can also be made for small pipes and similar work in the same manner. The objection to making cores in this way is that it requires more sand, time, and labor than is needed with the method previously explained. For pipes or cylinders over 24 inches in diameter, this method is necessary with the general run of sand. When pipes larger than 24 inches in diameter are cast in a horizontal position, there is some danger of the pressure raising the upper half of the core off the barrel when the mold is being poured. The core arbor l is made in one

piece; the ends m and n are made circular and exactly true with the trunnions r, r . The end m is a little smaller than

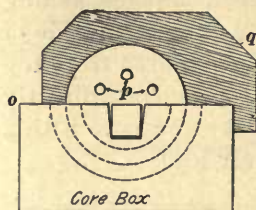
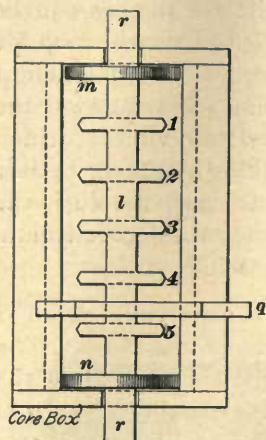

FIG. 4.

the inside of the pipe or cylinder, in order to allow the arbor to slide easily out of the casting when cleaning it. Between the ends m and n are the cross-bars 1, 2, 3, 4, and 5. These come only half way up in the core, which in ramming is made solid up to the line o . When the core is rammed this far, it is then vented down to the bottom, with cinders or fine coke placed over the vents, to connect with vent rods run through the holes p in the end of the arbor. Sand is next shoveled on, and the first course is lightly tamped with the butt of the rammer. The sand required to finish the top half of the core is packed down firmly with the hand after the butting; the top half is then closely vented down to the cinders. The vent holes having been stopped with the palm of the hand, a *strike* q is pulled gently from one end of the core to the other to give form to the top half. The first *striking off* of the core will leave it a little rough. This is smoothed by sifting on sand and packing it lightly with the hand, after which the strike q is worked from end to end. If the core is for thick castings, the top is sleeked, and, if necessary, blackened.

9. Setting the Core.—The top having been finished, the whole core is lifted out of the core box by the ends r, r , Fig. 4. The bottom of the core is next finished and then set into the mold. A section of the mold, with the core in half section, is shown in Fig. 5. In setting such cores into a large mold, plates and blocking, as s, s , are often provided, as there is a liability of such heavy cores, when left to

depend wholly on the sand for a bearing, crushing the sand, which causes it to drop into the mold at the ends near the

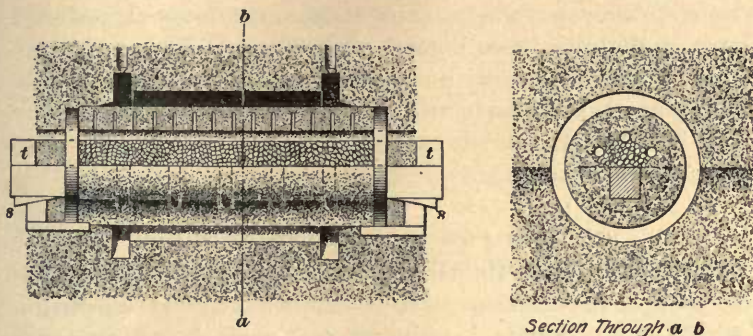

FIG. 5.

print bearings. By means of the blocks and plates *s, s*, solid bearings for the core are provided; wedges can be inserted to bring the core to its proper height.

MAKING CORE ARBORS AND SQUARE CORES.

10. In making square columns, green-sand cores can often be used to advantage. Fig. 6 shows one style of **core arbor** used for such work. In making such arbors, a stout rectangular bar shown at *n* is cast, and then loose cross-plates shown at *o* fastened to it by wedges shown at *p*. Wood

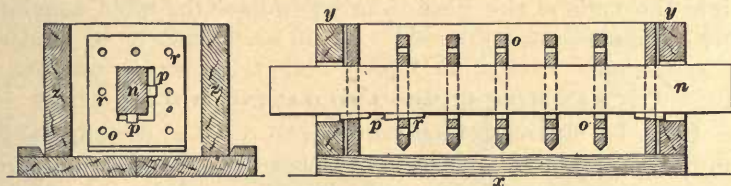

FIG. 6.

is used for wedges for the reason that it will char and leave the cross-plates free, thus permitting the core to be readily removed from the casting. Where there is a number of such castings to be made and they are not too long, the bars can be cast in one piece by providing prints on the cross-plates

to cast vent holes shown at r to admit vent rods. The core boxes for large round or square cores are generally made of wood. They have loose sides shown at z , loose ends shown at y , and also a loose bottom shown at x . The top of the core is struck off with a strike. These boxes are held together at their ends with screws or clamps, and, if they are long, clamps or stays are used at the center to keep them from springing.

BEARING FOR THE PRINTS OF PIPES.

11. In casting the larger sizes of pipes and cylinders, it is essential that the core barrels should have good **bearings**. Pipes and cylinders ranging from 3 inches to 6 inches in diameter may be cast by having sand-print bearings only, but above these sizes it is economical to have the ends of the arbors turned true, so that they may exactly fit the flask ends or fill the print. By having such rigid bearings, it is evident that the core will be kept in place. Where the ends of an arbor and flask cannot be made to fit each other closely, the blocking and wedges shown at s , Fig. 5, may be necessary; and to prevent the cores from raising, the blocking shown at t may be required. This blocking can be carried up under cross-bars or weights, which can be wedged to prevent the cores from raising. Where pipes are rolled over in molding, the pattern prints should be made to extend into the ends of the flask in order to have the mold central with the core.

RAMMING CORES AND GATING MOLDS.

12. In making green-sand cores, care and judgment must be exercised in making the bottoms to have them no harder than is necessary to hold the sand together well while casting. The upper part of such cores should, as a rule, be rammed so as to be firm but open, so that iron may have close contact with them. Where pipes or cylinders are poured with the gates, as shown at l , Fig. 2, arranged for the metal to drop from the top, the sand must be of a stronger character and should be rammed a little harder than would

be necessary if they were poured at the bottom, and the metal allowed to flow through the inlet gates shown at *r*. These gates are connected with the upright gates shown at *s* by a gate under the bottom print 3 or 4 inches back from the edge of the flange. In casting pipes it is wise to have risers or feeders as shown at *t* on the tops of the flanges, and when pouring the casting to cover them with balls of clay, as it is always better to have the molds air-tight when pipes are cast flat.

COMPARISON OF DRY-SAND WITH GREEN-SAND CORES.

13. Any core that is made of damp sand and baked hard with oven heat for the purpose of making it firm so that it will stand handling, is called a **dry-sand core**.

These cores can be used to produce intricate forms and can also be placed in positions where green-sand cores could not be used. For illustration, the ports *a* and *b* of a steam cylinder, shown in Fig. 7, require thin cores of a crooked shape that could not be made of green sand. This is a class of cores among those most difficult to make.

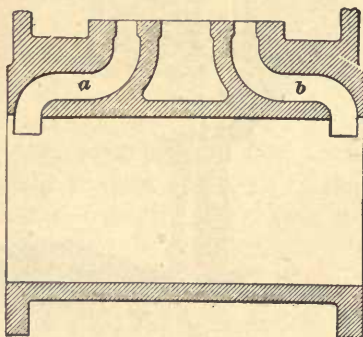

FIG. 7.

The simplest forms of cores are those having a plain round or square form. Fig. 8

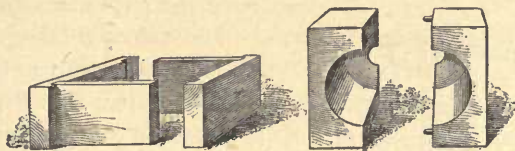

FIG. 8.

shows boxes for square and round cores. The boxes are jointed, so as to permit the easy removal of the core. Such boxes are made of iron and brass, and also of wood.

SMALL ROUND CORES.

14. Cores With Central Vents.—Nearly any one

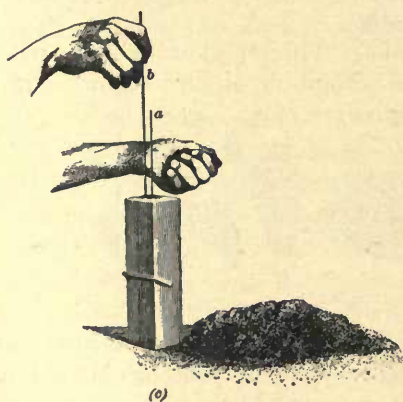
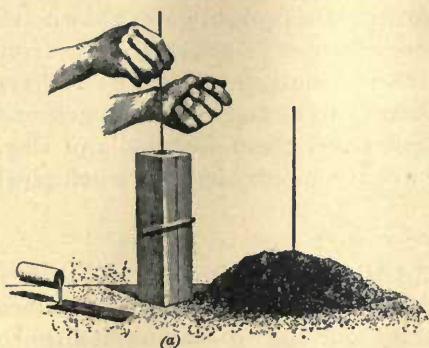

FIG. 9.

can be taught to make a small square core in a few moments, but since making round cores is somewhat more difficult, the method will be illustrated here. A knowledge of this method will also be beneficial when making more intricate cores. In Fig. 9 (a), a core box is shown clamped together and the core is being rammed. After about 2 inches of the core has been rammed, the box is turned end for end, and a vent wire pushed in through the center of the core as shown in Fig. 9 (b). After this is done, the box is turned back to the first position and the core is rammed up to its end, care being taken to keep the vent rod *a* in the center, as shown in Fig. 9 (c). Some core makers in trying to ram up such a core merely ram it up to the end without changing the position of the box, and after

the core is rammed shove a vent wire from the top to the bottom. This may give a vent running to the side of the core, as do the vents shown at *e*, Fig. 10, instead of its being central, as the vent shown at *f*. Cores vented as at *e* have often caused castings to be lost. To prevent this loss, patents have been taken out for a machine that insures all vents in round cores being exactly in the center. By following the directions given, there is no excuse for bad castings through the vents not being central. When small cores are used in considerable quantities, they are usually made in iron core boxes, making several at one time and of the proper length. The cores are

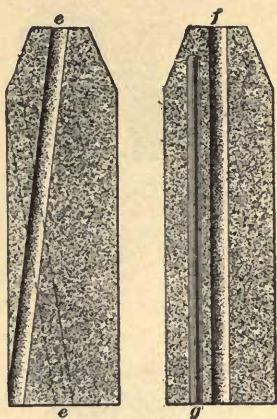

FIG. 10.

rammed by simply pounding the core box on the work bench, the jarring being sufficient to pack the sand to the proper density. Machines are also used for this class of core making.

15. Good and Bad Practice in Ramming Cores.

Another feature involving points of good and bad practice in ramming such cores is the size of the rod used to ram the sand as shown at *b*, Fig. 9 (*c*). It is not uncommon to see a molder using such a large rod that it nearly fills the box; it will be found that when such large rods are used, the cores when dried will often fall to pieces. By using rods so large as to nearly fill the core box, every ramming forms a smooth surface, and this prevents successive layers of sand from adhering; whereas if a small rod were used, the adhesion between the layers would be strong enough to stand rough handling. For ramming a 1-inch core, a $\frac{1}{4}$ -inch to $\frac{3}{8}$ -inch rod is large enough. For a $1\frac{1}{4}$ -inch to $1\frac{1}{2}$ -inch core, a $\frac{3}{8}$ -inch to $\frac{1}{2}$ -inch rod will do the work. This proportion between core and rod should be used in ramming cores so as to avoid the formation of joints and to have the layers thoroughly

united. Where cores of the smaller sizes are to be placed horizontally in molds, or are to stand rough usage when placed in a vertical position, rods as shown at *g*, Fig. 10, are placed in them. As a rule, there are a greater number of small cores used without rods than with them.



FIG. 11.

16. Rodless Round Cores.—In making rodless round cores, care must be taken to prevent their breaking when placing them on plates for drying. A smooth, straight plate, as shown in Fig. 11, is necessary for this purpose. In placing the core on the plate, the operator after having rapped the core box carefully turns over the half of the core box containing the core, as shown in Fig. 11 (a). Then with the core on the level of the plate, the box is inclined until the core will roll out on to the plate. The core box is then lifted off, as shown in Fig. 11 (b), and finally, with the edge of the core box, the

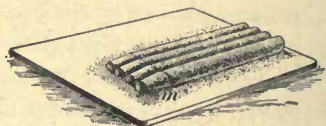

FIG. 12.

core is carefully rolled toward the edge of the plate, as shown in Fig. 11 (c). If one end of the core is tapering, it should have a little sand placed under it, as shown at *m*, Fig. 12, to

prevent the core from sagging out of shape. Sometimes the *core plate* is made with grooves that just fit the core. This gives a good support to the core and removes the danger of the under side becoming flat during baking.

OVENS FOR DRYING SMALL CORES.

17. When a plate has been filled with cores, it should be put into the oven as soon as convenient, since leaving cores exposed to the air dries them so slowly as to make them brittle and weak. Cores are dried in ovens that are so arranged as to maintain a high temperature and are provided with means for removing the vapor by a circulation of dry air. A high, even temperature must be maintained, because cores have to be *baked*. A detailed explanation of core ovens will be found in *Foundry Appliances*, Part 2. Ovens for drying small cores should be made as convenient as possible and arranged so that the heat can be regulated in such a way as not to burn the cores.

MAKING SMALL CORES IN FORMERS.

18. In making cores that cannot rest on straight plates, or that would sag out of shape if made in one piece, it is often desirable to make them in halves, as, for example, the two halves shown at *n*, Fig. 13, which, if



FIG. 13.

pasted together, would appear as at *o*. Many cores are so irregular in form that they can best be made in two or more parts and fastened together as shown in Fig. 13.

The plain, round core seen at *q*, Fig. 14, is an illustration of such cores when made in one piece. To dry such

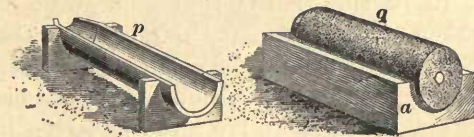

FIG. 14.

a core so that it will not sag out of shape, a former, such as

that shown at *p*, Fig. 14, is made of cast iron, as light as practicable; this is placed over the core *q*, and the whole is rolled over, leaving the core ready for the oven. In many cases, instead of turning the core into a former, the former constitutes half of the core box, and is so arranged that, when the core is rammed, but one-half of the box, as the part *a*, requires removing. This plan saves labor, and, besides, it gives cores free of joints, which is very desirable, not only in small cores, but also in large ones. Where there is any liability of the sand sticking to the iron formers, oil can be rubbed lightly over their surfaces, and in some cases, parting sand can be sprinkled over the oiled surface. This latter plan is generally followed when making large cores in formers.

PASTING CORES.

19. By **pasting** is meant the taking of both halves, as *n*, Fig. 13, and placing some material on the surfaces that meet that will cause them to stick when put together, as at *o*, so that they can be handled and placed in the mold without separating. The material generally used for pasting is wheat flour wet with water or molasses water to form a smooth, uniform paste. White wheat flour forms the most sticky paste, but for cores that are not to be handled roughly, a paste made from graham flour or buckwheat flour is often more desirable, since it can be handled more quickly and put on more evenly on account of its not being as sticky as a white wheat-flour paste. Molders sometimes call graham flour or buckwheat flour *meal*. It is well to apply the paste while the cores are hot, as they stick better in that case than if pasted cold.

In pasting joints that have vent creases, care must be taken to keep the paste out of the creases, as there have been many cases, especially with crooked creases, where neglect of this precaution has caused bad castings. In some cases, it is well to lay a rod or string in the vent, and when the core is joined to pull it out, thus insuring a clear passage. Cores should never be pasted unless the halves come

together closely all over the joint surface. In the case of medium and large cores, it may be necessary to rub the halves together, to grind down the irregularities, before a tight joint can be had; and often, where the cores are very uneven or crooked at their joint, the high places can be filed down before the halves are rubbed together to bring them down to a solid bearing. After rubbing the joints, the dust created should be brushed off, for if left on it prevents the paste from sticking to the surfaces.

DAUBING JOINTS.

20. After the cores are pasted, it is often necessary to fill in the joints to make the core as sound as if it were one piece. To do this, dry or stiff blackening is mixed with equal parts of fine parting sand and moistened with clay wash. After wetting the edge of the joint with a small brush dipped in thin blackening, rub in the **daubing** and sleek it off even with the body of the core. When this has stiffened a little, blacken over the line of the joint with thin blackening. In some cases the same sand used for making the core, if sifted fine and wetted to a mud, will answer for daubing. It is chiefly with medium and large cores that daubing mixtures are necessary, as small cores should come together so closely and be so nearly unbroken at the edges of the joints that a little wet blackening, applied with a brush, will close them.

BLACKENING CORES.

21. With most sands, castings exceeding $\frac{1}{2}$ inch in thickness need to be **blackened** in order to peel smoothly. Fig. 15 shows the method of blackening round cores that are to be dried on a plate.



FIG. 15.

About one-third of the core is blackened at a time. If the

cores are warm, they can be completed before being set back into the oven, but should they lack sufficient heat to dry themselves when one-third is blackened, it will be necessary to set them back to be dried before the other two-thirds can be completed. In some cases, cores may be dipped in blackening, as shown in Fig. 16. With any method of

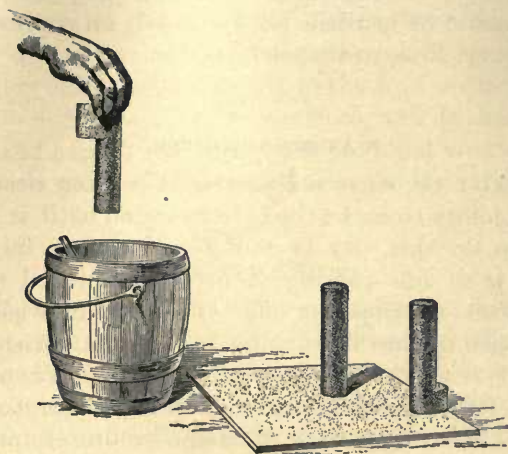

FIG. 16.

blackening, the cores should not be hotter than the hand can hold comfortably. If they are too cold, the blackening will wash the sand and make the surface rough, and if they are too hot, the heat will blister the blackening and cause a rough surface that may wash off when the iron fills the mold. In using a brush or swab to blacken cores, one should never rub the surface without having plenty of blackening on the brush, as rubbing a partly moistened brush on a core will give a rough surface, and may, by not thoroughly incorporating the blackening with the body of the core, cause it to peel off when the iron strikes it.

22. The colder the core is, the thicker can the blackening be used on it, but in no case should it be so thick that it will not run smoothly in following the brush or swab, and

it should not be so thin that the sand can be seen through it. Sometimes cores may be blackened with a brush or swab before being placed in the oven to dry. In blackening undried cores, they may be finished with one coat; but where they are to be used in heavy molds, it is best to apply two coats, the first one of thin blackening and the second coat as thick as will run smoothly. If sufficient thickness is given with one coat, it is liable to tear up the surface at places where the brush or swab may be a little dry. It will take a thicker coat of blackening on undried cores than on dried ones to give a good surface to a casting. Where undried cores are blackened, it may be desirable to sleek them in order to obtain a smooth surface. No blackening is necessary for small cores if these are made out of the proper material. In radiator cores and other similar cores that must leave the castings clean, the proper sand mixtures with no blackening is all that is necessary. It is much cheaper to make small cores of a proper mixture than it is to spend the time blackening them.

RODDING OR BARRING CORES.

23. Rods or bars are used to strengthen cores so that they can be handled or used in a mold without being broken. There are three plans followed: One is to use single or loose rods, another to have the rods welded, and the third to cast frames or skeletons. The loose rods are placed singly in cores, and may be straight, as the rod shown at *g*, Fig. 10, or the rods shown at *a*, Fig. 17; if in greater numbers, they are placed as shown in Fig. 18, the end views of which show rodding for both square and round cores.

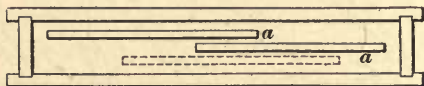

FIG. 17.

In making large cores, provisions must be made for lifting them. This is done by having lifting hooks, shown at *z*.

Fig. 18. Another plan is shown in Fig. 19, where a cast-iron frame, shown at *r*, with prickers, shown at *v*, is used.

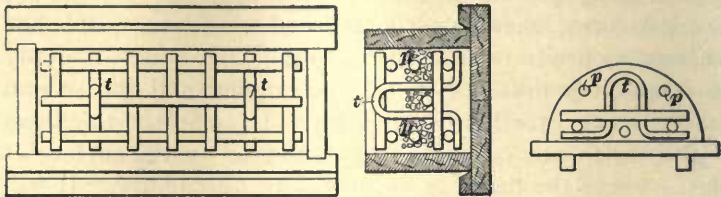

FIG. 18.

Lifting hooks, shown at *t*, are provided, and vent rods, shown at *p*, are put lengthwise of the core, both in Fig. 18 and Fig. 19.

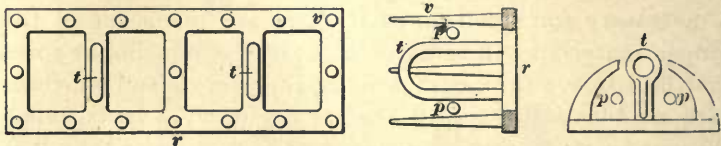

FIG. 19.

Welded core rods may be made as shown in Fig. 20 (a), which illustrates rods used for making thin, crooked cores,

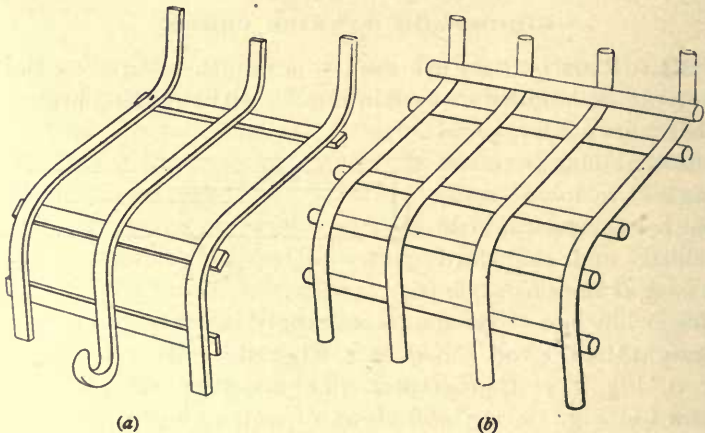

FIG. 20.

such as the cylinder-port cores of the cylinder shown in Fig. 7. In arranging stiffening rods in cores, provision

must be made to leave room for vent rods, in order to lead the gases from the cores to cinder beds or to the cavities in the cores themselves. When setting rods in cores, they should be bedded in firmly and without springing, for if they are not, they are liable to crack the cores, especially those of light weight. Often when long rods are not obtainable, short ones are spliced together, laying them as shown in Fig. 17. When this is done, care should be taken to see that the splice is sufficiently strong; that shown in Fig. 17, while better than nothing, would not stand much handling. One of the two rods shown in full should be a half longer than the other; or another rod should be laid alongside of them, as indicated by the dotted lines. The size of rods need not be more than sufficient to support the core in handling and in casting the mold.

There are a number of core forms where the rodding can be dispensed with by making the sand mixture of a certain nature and strength. For example, cores for the center plates of car wheels and also for radiators and similar work are often made without rods in them. The mixture of sand suitable for such cores is discussed later on.

VENTING CORES.

24. The more completely a core is to be surrounded with metal, the more thoroughly should it be vented and an opportunity given for the gas to escape when the mold is being poured. In making a large core, its body can often be filled with cinders; this not only saves sand and drying, but also gives freer vent to the core.

Venting with cinders and with rods are the methods generally followed in venting cores.

Occasionally, founders have crooked or thin cores that cannot be vented by the common methods just explained, and they must then use strings, ropes, or cross-rods so connected as to carry the gases out at one or two outlets.

RODDING, RAMMING, AND VENTING A CROOKED CORE.

25. General Method of Venting a Crooked Core.

In Fig. 21 a side and end view of a cylinder-port core box is shown. To rod this core, the general practice is to use a welded frame, as shown in Fig. 20 (a), or loose rods placed together, as shown in Fig. 20 (b). In making such cores, the core box is screwed or clamped together, and is then filled with sand to the height of the center shown at *g* by the section through *a b* in Fig. 21. This done, the rods shown

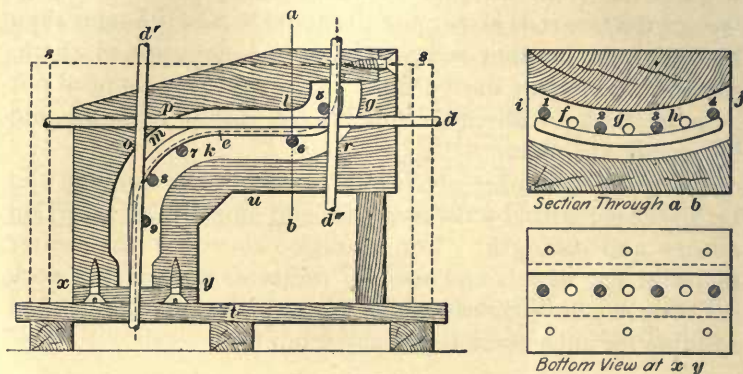

FIG. 21.

at 5, 6, 7, 8, and 9 are pressed into place, and vent rods shown at *d* are placed at the level of *g*. When vent rods cannot be used, a string shown by the dotted line *e* may be placed in the core box, having one end projecting from the box. The partially completed core is now rammed with sand to the height of the rod 2, and this rod having been set in, more sand is rammed to the height of the vent hole shown at *f*. The vent rod or string is then placed in position, and sand is rammed over it to the height of the rod 1. After the rod 1 has been located, sand is rammed to the top of the box and the surface *i* is sleeked off, after which the box is turned upon its side and the unvented and unrodded sand dug out to near the level of the vent *g*. This done, sand is rammed in to make a solid bearing for rod 3, and the same process in placing vents and rods is continued until the top *j*

of the box is reached. When this is sleeked off, the vent rods or strings, as the case may be, are pulled out of the core.

26. Use of Rope in Crooked Core Vents.—By noting the position of the cross-rods *5*, *6*, *7*, *8*, and *9* in the core, it will be seen that a string or rope having the position shown by the dotted line *e* cannot, in being pulled out of the core, cut away the sand at such points as *k* and *l*, and so bring the vent up against the face of the core box at these points. When vent rods are used in the place of strings, there should be a connection made between the vent holes left by the rods *d''*, *d'*, and *d*. In order to make this connection, grooves may be cut into the core at *m* and *r*, and a string covered with beeswax passed through the vent holes and grooves, or recesses, after which the grooves are filled up again with daubing or core sand. The openings at *g*, *r*, *p*, and *o* having been closed, the core is dried either in an oven or by holding hot irons over the places just filled up. After the core is dried, the strings are pulled out. This can be done easily on account of the melting of the beeswax when heated, leaving the hole larger than the string itself. A continuous vent is thus placed through the core.

27. Drying Crooked Cores.—To handle such a core for drying (after the top part of the core box is removed and the core is finished), a former may be placed on the core. Another way is to set the core into a wooden box or frame *s*, as shown by the dotted lines in Fig. 21, and to fill in the whole space around and above the core to the top level of *p* with green or common heap sand, rammed carefully so as not to break the core. After the frame has been filled, a plate is set on and clamped to the bottom board *t*, and then the whole box is rolled over. This done, the frame *s* is drawn off and the loose sand removed from the top and around the side *u* of the box, after which the core box is drawn, the core finished, and the whole set into the oven. Many difficult or crooked cores can be made in a similar manner. The majority of steam-engine cylinders are now

cast with the cores of the cylinder, steam ports, exhaust ports and steam chest all made in one piece, or rather in halves which are pasted together. By making these cores in one piece as far as possible, the danger of the iron finding its way into the vents is eliminated.

MATERIALS USED IN MAKING CORES.

KINDS OF SAND USED IN MAKING CORES.

28. The suitability of a core for any special line of work depends largely on the nature of the sand used and the binder mixed with it. Nearly all cores require that something be mixed with the sand that will cause them to be firm and hard when dried. There are two classes of sand used in making core mixtures. One is called **sharp sand** and the other **molding sand**. Small cores, as a rule, require the finest grades of sand, while large cores are made from coarse grades. The sands generally used for making small cores consist of fine grades of lake or seashore sands, river and bank sand, and also fire-sand or silica sand. Sometimes these different grades of sharp sand will be mixed in varying proportions with fine grades of molding sand; and, again, there are some small cores that may be made wholly of molding sand. Bank sands are, as a rule, inferior to the other grades of sharp sand mentioned above; still, there are cores in which bank sand, mixed with molding sand or alone, can be used. Bank sand should not be used alone for making such a core as that shown in Fig. 21.

BINDERS USED IN CORE-SAND MIXTURES.

29. The binders chiefly used to give strength to core mixtures are wheat flour, rye flour, rosin, glue water, glutrose, and linseed oil. Aside from these, there are several patent core compounds on the market, which are used for intricate cores that are difficult to vent. Some founders mix cement

with the sand used in cores as a binder. Flour is the most common of all the binders, and is mixed with sands, according to their character, in the proportions of from 1 part of flour to 20 parts of sand up to a proportion of 1 part to 8 parts. Cores made with flour swell and crack while drying more than those made with other binders; it is also the worst binder in use to create stifling gases when the molds are being cast. Some molders in using flour boil it with water in a kettle to make a thin paste, which is mixed again with water to make a thin solution for wetting the sand. If all the water that the sand required could be boiled with the flour, the result would be more satisfactory. Where the cores are required to be especially strong and are difficult to vent, it is much better to mix the sand with the boiled flour. On account of the expansive tendencies of the flour when being dried, care must be taken not to make the sand any damper than is necessary to keep it in solid form. Some molders use rye flour in preference to wheat flour, as it swells and cracks the cores less than does wheat flour.

ROSIN AS A BINDER.

30. Peculiarities of Rosin as a Binder.—Some founders use rosin altogether in their cores, while others will mix flour and rosin together in varying proportions, according to changes in the character of their cores. Rosin is largely used for small thin cores, which need not be blackened when so made, thereby saving time and labor. Rosin tends to preserve the sharp corners of cores better than most binders. A feature of rosin cores is that they cannot be handled hot, since the rosin keeps the mixture in a soft state until the dry cores are cold. In using rosin, one is confined to special sands more than when using flour. Molding and bank sands often work well together in making small cores with rosin mixtures, and sometimes small cores may be made by using molding sand alone, provided the mixture does not bake so hard that the gases cannot escape with freedom. Where it is desirable to save labor, venting

can often be dispensed with, by mixing the rosin with bank sand.

31. Mixing Binders.—Where the cores are especially hard to vent, rosin is an excellent binder, as gases caused by rosin escape and ignite very freely; another advantage of rosin-bound cores is their ability to withstand the dampness of green-sand molds for long periods without absorbing moisture.

If rosin comes in lumps, it must be pulverized to a fine powder; this may be done in an iron mortar, after which it is passed through a fine sieve. A foundry that uses rosin extensively for the making of cores should be provided with a rosin grinder. These machines grind and bolt rosin in a way that cannot be accomplished by hand. Besides, rosin that is finely ground will distribute much better in a core sand and a certain amount will go farther and make better cores than if it were improperly ground. The proportion in which to mix it with sand depends on the character of the sand and that of the cores to be made. For the general run of new sands, 1 part of rosin to 15 parts of sand should make good cores for ordinary castings. If very strong cores are desired, a larger percentage of rosin may be used, and such cores can be further strengthened by wetting with molasses water in place of clear water. A point that should be borne in mind while making strong cores is that the stronger the core, the more difficult it will be for its gas to escape. It may often be advisable to mix a small quantity of flour with the rosin. In the case of small cores, it must be remembered that if too much flour is used with the rosin, it may be necessary to blacken the cores.

It is often very desirable to have the surfaces of cores firm and hard, while the interior is of an open character. This provides for a smooth surface on a casting and at the same time gives freedom for the gases to escape. In such a case, the more open the sand is and the less flour or rosin used, the better. To insure firmness on the surface of cores, they may be sprinkled with molasses water before being placed

in the oven. When once in the oven, the quicker they are dried, the better, provided that the heat is not sufficient at the start to blister and crack them.

OTHER BINDERS.

32. There are several features about flour and rosin that are not satisfactory, and much experimenting has been done in the past few years to discover binders better adapted to suit the varying conditions in making cores. A number of founders have tried to replace flour or rosin with various compounds prepared and sold by foundry supply houses. They sometimes mix flour and rosin with some compound in varying proportions. Some of these compounds used alone work well in cores designed to crush easily and allow freedom for contraction when the casting is cooling, and they are excellent materials for permitting the escape of gases; in fact, they surpass flour in making cores that are difficult to vent.

GLUE WATER AND LINSEED OIL AS BINDERS.

33. A thin solution of glue with water for use as a binder is applied in the same manner as water for wetting the sand, and makes a firm core that is hard when hot as well as when cold. No more of the solution should be used than is sufficient to make the core hard enough to handle. It is an excellent binder in giving freedom for venting, and there is probably less gas generated by its use than by that of any other binder.

In some cases raw linseed oil is used for making delicate and difficult cores. It makes a very strong core and one that the dampness of green-sand molds cannot readily affect; this makes it a good binder for intricate, thin cores that are liable to be confined in a damp mold for several days before casting. Raw linseed oil is sometimes mixed in equal parts with a solution made by adding to benzine all the rosin it can dissolve. Cores made with this combination require

baking with a hot fire, and, like the former, they will vent freely and are proof against dampness even when left standing for a long time in green molds. In a general way it may be said that nothing equals linseed oil for making complicated cores, which must vent freely, be strong, and withstand moisture in a mold. Such cores will also leave the casting easier than those made with any other binder.

No matter how much one may be experienced in founding, he will find that on starting to use any of the binders mentioned, he will have to do some experimenting before he can get the best results.

LIQUIDS USED IN WETTING CORE SANDS.

34. Some core makers use clean water, while others make a practice of using a clay wash of varying consistency to strengthen the sands. The more the water is thickened with clay, the greater is its value as a binder. In some shops using intricate cores, the men will wet the sand entirely with glue water, or water sweetened highly with molasses. As a rule, wetting the sand in this way in place of with water should lessen the percentage of binding material required in the sand.

CORE-SAND MIXTURES.

35. Receipts for mixtures of core sand cannot be given satisfactorily, for the reason that there are few localities that have the same kinds of sand, or that have the same conditions to meet in making cores. For this reason, in the foregoing discussion, experience is presented as fully as possible, so that one may, with fair judgment and a few trials, establish his own receipts for core mixtures. In order to help the beginner in experimenting, a few receipts that have been successfully used and have given good results in making small and large cores are given herewith. Where cores are handled roughly, they should contain a greater percentage

of the binder used than where they are handled carefully, and the efficiency of binders can be regulated by the nature of the liquid used to wet the sand.

RECEIPTS FOR CORE-SAND MIXTURES.

36. Purpose of Receipts.—Before giving the following receipts, it will be well to state that where cores are dried while on their sides and do not exceed 5 inches in height, the sand mixtures can often be largely composed of sharp sands. Where the cores stand high, or have a poor bearing when drying, this does not apply. Where the cores stand high, so that the weight of the top may distort the bottom if it is not well supported, then the mixtures must contain more or less of molding or loamy sands and must be better rodded. These are cardinal principles, no matter what other conditions may exist.

Where seashore or lake sand is obtainable, mix sand for large cores by receipt No. 1; but cores thus made must be well rammed and rodded, especially if they are to stand very high in the mold. For ordinary cores, receipt No. 2 may be used. Receipt No. 3 makes a good mixture for small cores. This is intended to be wetted with molasses water in the proportion of $\frac{1}{2}$ to 1 pint of molasses to a pail of water. Receipt No. 4 is one that can be used with some prepared binder compound, such as glutrose, rosin, or flour as a binder, and makes excellent cores where they are not so high as to sag with their own weight while green and before being dried. The sharp sands mentioned in the following receipts include seashore, lake, bank, and crushed sands.

37. Statement of Receipts.—*Receipt No. 1.*—Mix 3 parts of sharp sand with 1 part of molding sand. For a binder, use 1 part of flour to 14 parts of sand. Wet with clay wash.

Receipt No. 2.—Mix 2 parts of sharp sand with 1 part of molding sand. For a binder, use 1 part of flour to from 12

to 18 parts of sand. Wet with water or clay wash, as may be desired, in order to obtain strength.

Receipt No. 3.—Mix 3 parts of molding sand with 1 part of sharp sand, and for a binder use 1 part of flour or rosin to 14 parts of sand, or use a binder composed of equal parts of flour and rosin, using 1 part of this to 14 parts of sand. Wet with molasses water.

Receipt No. 4.—Mix 1 part of bank sand with 3 parts of fine lake or crushed silica sand. For a binder, use a mixture of 1 part of rosin to 25 parts of sand, 1 part of flour to 25 parts of sand, and 1 part of some prepared binder compound, such as glutrose, to 30 parts of sand. Wet with clean water.

Receipt No. 5.—Mix 16 parts No. 2 molding sand, 24 parts No. 3 molding sand, 20 parts fire-sand, 54 parts bank sand, 5 parts sea coal, 6 parts flour, and 2 parts sawdust.

Receipt No. 6.—Mix 16 parts No. 2 molding sand, 28 parts No. 3 molding sand, 30 parts fire-sand, 48 parts bank sand, 8 parts sea coal, 6 parts flour, and 2 parts sawdust.

Many molders prefer to reduce slightly the flour in receipts Nos. 1 to 4, and to add 1 part of sea coal to 14 parts of sand, especially for heavy castings.

38. Explanation of Receipts.—In the receipt No. 4, the rosin and flour may be left out, if desired; but if the binder compound only is used, the quantity given must be doubled. Some founders are now making mixtures composed wholly of compound and sharp sand for cores that can stand up without requiring strong sands in the green form. When nothing but compound is used, receipt No. 4 makes cores that are exceptionally strong when dry, much more so than any made wholly with flour or rosin for a binder; besides, cores made of this mixture part very readily from the castings, as the sand when burned becomes loose instead of baking to a solid, as is the case when flour is used. Receipt No. 5 gives excellent results for medium-sized cores, and No. 6 for large or heavy cores. The molding sand in these last two is of the standard Albany grades.

BLACKENING MIXTURES.

UTILITY OF BLACKENING MIXTURES.

39. In order to peel any part or the whole of a casting formed in a body of dry sand, the sand must be blackened when the castings exceed $\frac{1}{4}$ to $\frac{1}{2}$ inch in thickness. If this is not done, the metal will fuse the sand forming the face of the mold and cause a scale or covering on the surface of the casting. This may be $\frac{1}{4}$ to $\frac{1}{2}$ inch thick on massive castings. In coating the face of dried cores or molds, the greater heat-resisting power the blackening has, the better will the casting peel.

MIXING BLACKENINGS.

40. How Blackenings Should Be Mixed.—In order to mix **blackenings**, some liquid is necessary to bring them to a fluid state. The mixture may range in consistency or body from that which will merely discolor up to that of paints. The liquids used for thinning dry blackenings are generally called **washes**, and are clear water, clay wash, diluted molasses, glue water, and in some cases beer (which may be fresh or stale, the latter being called sour). Where the blackenings are ground with clay when being made, they may serve for castings of medium or light weight by being wetted with clear water. Where castings are of heavy proportions, clear water will rarely answer, and either clay wash or molasses water will be required. Usually molasses water is used, but in some cases clay may be added to form a molasses clay wash. This makes a strong blackening, but it should be used with caution, as too much clay in the blackening retards venting. When blackening dries on a mold, forming a close, dense surface, it may cause *blackening scabs* by confining the gases that, in their effort to come to the face of the mold and passing through the iron, will blow off the coat of blackening. There is such a difference in the character of dry blackenings that a wash that will work well with one may not do so with another.

In using the different washes, none demands greater caution than diluted molasses, for if too much is used it will cause the blackenings to crack and flake off from the face of the mold. It may also cause a casting to look veined and streaked, after the manner of the seams formed on green-sand castings by using a too strong or badly mixed sea-coal facing. A half pint of molasses of ordinary strength, diluted with a pail of water, is about as strong as these washes should be made.

41. Details of Mixing.—When mixing blackenings, it is best to bring them to a pasty condition before adding a sufficient amount of the wash to reduce them to the right thickness for application to the core or mold. The finer the blackening is ground, the better mixture it will make, and if the quality of the blackening is good, it will not cause foaming or settle as sediment to the bottom of the mixture, but it will thicken in time. Where the blackening is light and floats on the top of the wash while being mixed, it is of an inferior quality, and should not be used on work demanding a good grade of blackening; again, should a blackening be so heavy as to sink to the bottom in such a manner as to leave the wash separated on the top, it should also be rejected. There is little difficulty in mixing blackenings to peel castings of ordinary thickness, but in massive, heavily proportioned castings, too much care cannot be exercised. For massive work it is a good plan to use fully one-third of plumbago mixed with two-thirds of Lehigh coal, coke, or good grades of prepared blackening, and then wet the mixture with molasses water having in it a small quantity of fireclay. After this has been applied to the mold and roughly sleeked, it helps the blackening in peeling the casting to go over it with a thin mixture of plumbago that has been wetted with molasses water. In some cases after this solution has been applied, it works well to dust on some silver lead out of a bag or by hand while the face of the mold is damp, and then to go over the surface with finishing tools. This treatment of molds has caused the sand to peel perfectly

from the face of massive castings, such as rolls for steel mills.

It is best, when practicable, to have all blackenings mixed a day or two before being used, and in taking them from the barrel or tub in which they have been mixed, to pass them through a sieve several times before they are applied to the mold or core.

Formerly every founder had his own secret mixture for making blackenings, but now facing manufacturers are making blackenings especially adapted to the various thicknesses and character of castings, and hence there should be no difficulty experienced by founders in mixing blackenings.

DRY-SAND AND LOAM WORK.

DRY-SAND MOLDING.

1. Difference Between Green-Sand and Dry-Sand Work.—Many of the processes used in green-sand molding are applicable to dry-sand work and also to loam molding. For example, it is necessary to properly handle the shovels, riddles, and rammers to avoid swells and scabs in dry-sand work, just as must be done with green-sand. The methods of venting are about the same for each, as are also those for making joints, setting gagers and chaplets, using finishing tools, clamping, weighting down molds, and making cores. In *dry-sand molding* there is less gas or vapor than in green-sand and consequently, with the proper sand mixture, that is, an open or coarse sand, very little venting is necessary. It is not necessary to secure the mold as tightly; less gagers need be used and the flasks do not need so many bars. In green-sand work, wooden flasks may be used, whereas with dry sand it is necessary to use iron flasks. This is on account of the molds being thoroughly dried by placing them in ovens having a temperature of from 300° to 400° F.

2. Sand for Dry-Sand Molds.—The sand that is required for dried molds must be of a more loamy nature than is permissible for green-sand work. This is due to the necessity of baking the sand until it forms a solid body in the dried molds. Most of the sand used for green-sand work, if thoroughly dried in an oven, would crumble to

a dust if the surface were broken or the mold jarred in the handling. In ramming the sand, the care necessary to obtain certain degrees of hardness is not so great in dried molds as in green ones. As a rule, dried work will stand much harder ramming than green-sand work. While this is true, it does not mean that one can be careless in ramming the bottom, sides, or copes of dried molds, as in a measure they require similar treatment to green-sand molds. It would not do to make the bottom of dried molds having flat surfaces as hard as their sides, as this might cause scabs on the bottom. The sides of a dried mold may, in some cases, be rammed as hard as a stone and have little or no venting, provided the mold is thoroughly dried and the sand is not of too close a character. Where sufficient time cannot be given to thoroughly dry a mold, open grades of sand should be used, which should be rammed more lightly and vented more freely. In lightly rammed dry-sand molds, care is necessary to ram evenly in the same manner as with green sand, for if this is not done, the sides may be strained or swollen. As a general rule, dry-sand molds may be rammed very hard if a proper sand mixture is used. Dry-sand molding is often resorted to for the purpose of permitting hard ramming, and usually the castings are nearer true to the pattern than in green-sand molding.

3. Venting Dry-Sand Molds.—Green sand requires much more venting than dry sand. This is due to there being no dampness in thoroughly dried molds to create steam when the mold is being poured. Wherever dampness exists, some steam must find relief outwardly from the face of the mold, and trouble in the way of scabs may be expected. Generally, the plain sides of dry-sand molds for castings over 3 inches thick require but little venting.

Where there are large bottom surfaces to be covered with metal, good venting is necessary; this is also true of corners and projections. Where small bodies of sand have two or more sides covered with metal, they require to be fairly well vented, either before the pattern is drawn or after.

4. Method of Molding Used in Dry-Sand Work.

The difference in making the two kinds of molds is in the finishing and in the dry-sand molds generally requiring to be "rolled over," due to the necessity for placing them in ovens for drying. The fact that nearly all dry-sand molds are rolled over and that the heat of the oven expels the moisture from them renders them less difficult to make, as a rule, than green-sand molds. In some cases, castings that can be made in either form of mold will require great skill and care if made in green sand, whereas if made in dry sand, common foundry help can be quickly trained to make them.

5. Flasks for Dry-Sand Work.—In making flasks for small work, the drag and cope are each generally cast in

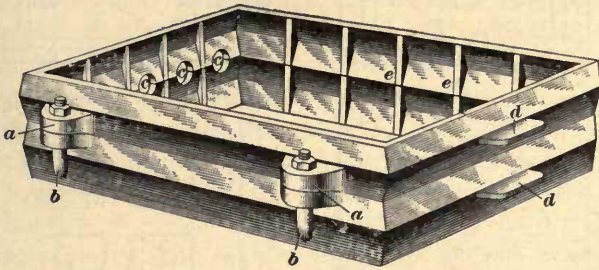

FIG. 1.

one piece, and range in thickness from $\frac{1}{4}$ inch for flasks of about 1 square foot in area up to $\frac{1}{2}$ inch in thickness for

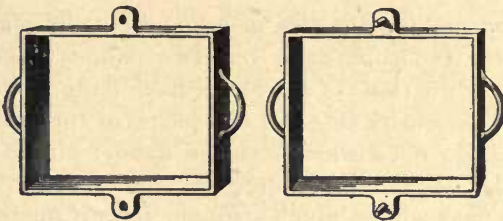

FIG. 2.

those of 3 square feet. Figs. 1 and 2 illustrate small flasks made in one piece. The ribbed flask shown in Fig. 1 is a

very good form. The shape of the sides with the ribs *e*, *e* serves to strengthen the flask and hold the sand in place. Lugs *a*, *a* are cast on the sides of each part and turned pins *b* are fastened into the lugs on one side. The other lugs are drilled to match the pins so that when the two parts of a flask are put together there is no lateral play. Handles are cast on both ends and pouring holes *c* in one end.

Flasks for larger work are generally made in sections and bolted together, as shown in Fig. 3, which also shows two

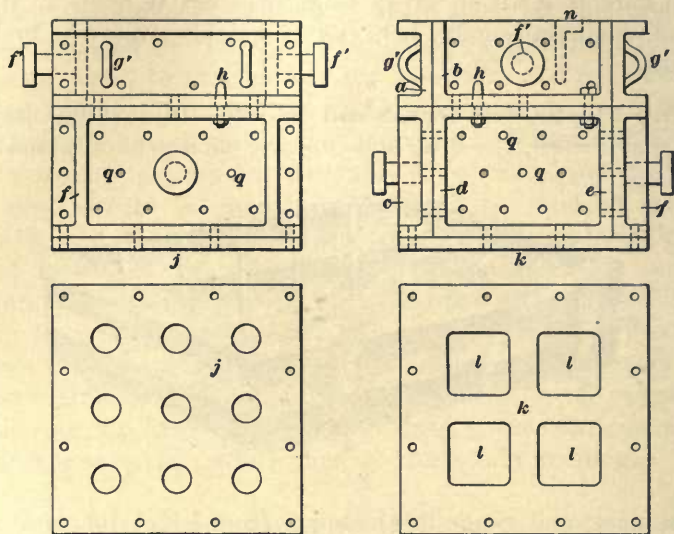

FIG. 3.

methods of making the side pieces and bottom plates. The sections for the cope have but two flanges *a* and *b* on a side piece, while those of the nowel have flanges *c*, *d*, *e*, and *f* all around the entire side and end pieces of the flask. Copes and nowels do not always have the flanges placed as shown in Fig. 3. Where the flanges extend around the entire flask, the flask will be much stronger than if made as shown at *a* and *b*.

Flasks always require handles by which they may be lifted. These are made differently for those flasks that are

to be lifted by a crane from those that will be lifted by hand. Their form for the latter purpose is shown in Figs. 1 and 2. For crane work the handles require to be much stouter and should be made in the form seen at f' and g' , Fig. 3. The handle f' is called a **trunnion**, and permits the flasks to be quickly rolled over when hoisted by a crane sling. At g' is a form of handle that may consist of wrought-iron pieces cast in the flask, or it may be of cast iron made with the flask.

All flasks need the dowel-pins h, h to guide the cope and nowel into place. These are generally from $\frac{1}{2}$ inch to $\frac{3}{4}$ inch in their largest diameter, and are fastened on the lower flanges with bolts, so that they can be taken off when not in use. The bottom plates j and k are bolted on after the nowel is rammed up. If the bottom of the pattern does not come too close to a plate, and thus cause the mold to be in danger of bursting out, skeleton plates like k may be used. The openings l, l are not to exceed 60 square inches in area. Such openings give a good chance to get solid sand bearing under the frames, and leave greater freedom for drying and venting than where the bottom is covered with a plate, as at j , that is solid with the exception of the vent holes.

Copes for dry sand require cross-bars as well as copes for green sand, but they do not need to be as close together, for when the sand between the cross-bars is dry, a much larger space can be safely used there than when the sand is green. Where there is danger that the internal pressure will force the sand out between the bars, they must be placed close together; and where flasks are stood on end, as in making rolls, shafting, and cylinder castings, it is generally necessary to bolt a plate over the cope as well as over the nowel. Cross-bars may be cast with a rib on top to prevent the sand bursting out, as shown in dotted lines at n , Fig. 3, instead of using flat plates, as j or k . It is well to state that where the sides are made in sections, as in Fig. 3, the cross-bars are also cast separately and then bolted in place when the cope and nowel are put together. When

casting the sides, it is generally advisable to cast them full of small vent holes, as *q*, *q*.

There is a variety of ways of making iron flasks that will conform to the conditions given. Some flasks are made from 1 inch to $1\frac{1}{2}$ inches in thickness when they are used for massive castings, such as rolls, etc. In holding the cope and nowel of such flasks together, either bolts or clamps, or a combination of both, are attached to the flanges.

6. Finishing Dry-Sand Molds.—After a pattern has been drawn from the mold, the first thing of importance is

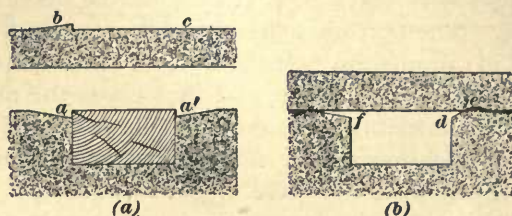

FIG. 4.

to sleek down the joints; for if this is not done, it may project in places and cause a crush when the cope is closed on the nowel. It must be remembered that when a mold is made of green sand and the joints come snugly together, they may be compressed a little without doing harm. With dry-sand work it is different, for if the faces of the joints press each other in the least, one of them must give way, and this may result in losing a casting. When making a joint, one plan to avoid a crush is to sleek down the joint, as shown at *a*, Fig. 4 (*a*), instead of leaving it flush with the patterns, and in finishing the cope to cut down the projection at *b* and leave it flush with the surface of the cope, as at *c*. Another plan is to make the joint of the mold even with that of the pattern, so that the cope will be level when it is lifted off, and then to cut down the nowel joint, as at *a'*, before drawing the pattern. Either of these plans will cause the joint to appear as shown at *f*, Fig. 4 (*b*), when the

cope is closed. The small ridge of metal that flows out along the joint of the mold is called a **fin**. Some molders in finning a joint will merely sleek the edge as at *d*, pressing it with a trowel. Such a joint is more liable to crush than if no attempt were made at finning, for the reason that the trowel is apt to raise the sand as at *e*. In making a fin, it should slope back gradually from 3 to 4 inches, as shown at *f*. The thickness of a fin at the front of the mold can range from $\frac{1}{8}$ to $\frac{1}{4}$ inch, depending on the liability of crushing due to a bad flask joint or to the poor drawing of the pattern. Whenever there is danger of crushing, the fin should be large. The molder should bear in mind the maxim, "It is better to have a fin than a crush."

The joint having been properly cut to form the fin, and the pattern withdrawn, the mold is then sprinkled lightly with water or molasses water (according to the strength of the sand), either by means of a brush, the mouth, or a spraying device. The mold is then sleeked up smoothly with finishing tools, after which a coat of blackening is applied with a soft brush or swab. If the casting is over 2 inches thick, it may require two coats of blackening. In putting on the blackening, it should be done as evenly as possible and in such a manner as not to show the streaks of the brush or swab, as these leave an uneven surface. After the mold has been blackened, it is sleeked over as evenly as possible, so as not to show the marks of finishing tools on the surface.

It is sometimes desirable to blacken the molds after they are dried, instead of doing so when they are green. In this case the mold is finished as though it were going to be blackened before drying, the only difference being that more care is necessary in finishing the surface, which should be quite damp. The extra dampness causes the surface to bake hard, so that when blackening the hot mold, a smoother surface will be obtained than can be done otherwise. In blackening dry molds while they are hot, the blackening must be thinner than if used for green molds. Dried molds do not require as heavy a coating of blackening or as much sleeking after the

blackening has been applied as do green ones. It may be well to state here that some molders avoid sleeking blackened green molds by being careful to blacken smoothly and evenly when blackening. This method is made more effective by going over the blackened surface with a camel's-hair brush kept moistened with a very thin mixture of blackening. There is generally little difficulty in *peeling* flat surfaces to get them smooth and true to form. The skill of the molder is largely shown in the finish of the corners, fillets, flanges, etc. of a casting.

7. Facing Mixtures for Dry-Sand Work.—The ideal material for dry-sand work is a sand that, when dried, will be firm and solid, like a solid core, and will be of so open a nature as to permit the free escape of the gases formed. If strength when dried were all that was desired, the common grades of clay could be mixed with molding sand and used, but, on account of the density of clay, it would not vent sufficiently, and the molds might blow and scab.

In some localities there is difficulty in procuring good grades of sand for dry-sand work, and there the ordinary molding sand may be used in a mixture, as by receipt No. 1 given in Art. 8. This mixture is used also for common sand, and used to fill in back of the facing by leaving out the flour. The sharp sands referred to in the following receipts are such as are used for making cores.

Loam sand is more gummy and contains more clay than ordinary molding sand, and as found in some localities is so suitable for dry-sand work that it can be used alone without mixture with any other sand. A facing mixture that may be made in some localities is given in receipt No. 2, Art. 8. Should this mixture be too close, use $1\frac{1}{2}$ parts of the bank sand to 1 part of molding sand. For a backing sand, the same mixture may be used by omitting the sea coal. It may be well to state that by **backing sand** is meant the sand that fills up the space between the flask and the mixture that faces the pattern, the latter mixture being commonly called **facing sand**, or often referred to as **facing mixture**.

Where a regular loam sand can be found, receipt No. 3 may work well where a strong facing mixture is desired. This is wetted with clay wash mixed to the thickness made necessary by the nature of the loam sand. The backing of this mixture consists of 5 parts of loam and 1 of lake sand wetted with clay wash. The three receipts referred to are those generally used in the regions bordering on the Great Lakes. In the East, a fire-sand and a Jersey sand are used, which are excellent for making dry-sand mixtures. The Jersey sand is somewhat like a fine grade of lake sand, except that it is whiter and has more body than lake sand. The fire-sand, so called, is similar to Jersey sand, excepting that it is of a redder hue. No. 4 is a mixture that has been proved in the East to work well. For a backing, the mixture should be made more loamy by an addition of loam or molding sand. As a rule, backing sand should be as open as possible, so as to allow the free escape of the gases. While it is desirable that it be of an open nature, it should at the same time be of sufficient strength to hang together well when rammed, in order to support the sides of molds and help retain the facing in form while baking. The dampness of either the backing or facing sands should not greatly exceed that of green sand, for the reason that the wetter the facing or backing sands are, the closer they will be when dried. It is often advisable to make the facing wetter than the backing, for where it takes a long time to ram the mold, the facing sand will dry out before the mold can be finished. In mixing dry-sand facings, they should be well tempered, as this toughens the mixture and causes a firmer surface on the mold.

The sea coal or coke dust used in receipts Nos. 2 and 3 is for the purpose of making an open facing, as this permits free venting and also assists in peeling the casting. Where the sands are weak, sea coal or coke dust cannot be used to advantage, as they would still further decrease the strength of the sand.

8. *Receipt No. 1.*—Mix 4 parts of molding sand with 1 part of lake or bank sand, and use 1 part of flour for 30 parts of sand. Wet with clay wash.

Receipt No. 2.—Mix 1 part of molding sand with 1 part of bank sand, and use 1 part of flour for every 30 parts of sand, and 1 part of sea coal to every 20 parts of sand. Wet with clay wash.

Receipt No. 3.—Mix 4 parts of loam sand with 1 part of lake sand, and use 1 part of sea coal to every 14 parts of sand. Wet with clay wash.

Receipt No. 4.—Mix 1 part of molding sand with 1 part of Jersey sand and 1 part of fire-sand. Use 1 part of sea coal to every 16 parts of sand. Wet with clay wash.

It must be understood that these receipts are given merely as an aid to the beginner in making mixtures. Even with experienced molders, it often takes some experimenting to obtain a mixture suited to a special job. A mixture that may work well for molding a cylinder would require to be changed for making an anvil block or a roll casting. The more massive the casting is in its proportions, the stronger should be the facing, provided there are no intricate and delicate corners to require free venting. If there are such delicate parts, then a weaker mixture should be used. The making and use of dry-sand facings call for judgment and experience, as is the case with green-sand facings.

LOAM WORK.

CONSTRUCTION OF A CYLINDRICAL MOLD.

9. General Description of Mold.—The methods used in making castings in loam differ radically from the methods employed in green-sand or dry-sand molding. A system of building molds with bricks and loam is used that would be impracticable in either of the other branches. This system is also used to save patternmaking, as molds can, in some instances, be made with sweeps and skeleton patterns, which would require elaborate patterns and core boxes were they made in either green or dry sand.

In order to present the methods used in *loam molding*, and to make them as plain as possible, the work of constructing

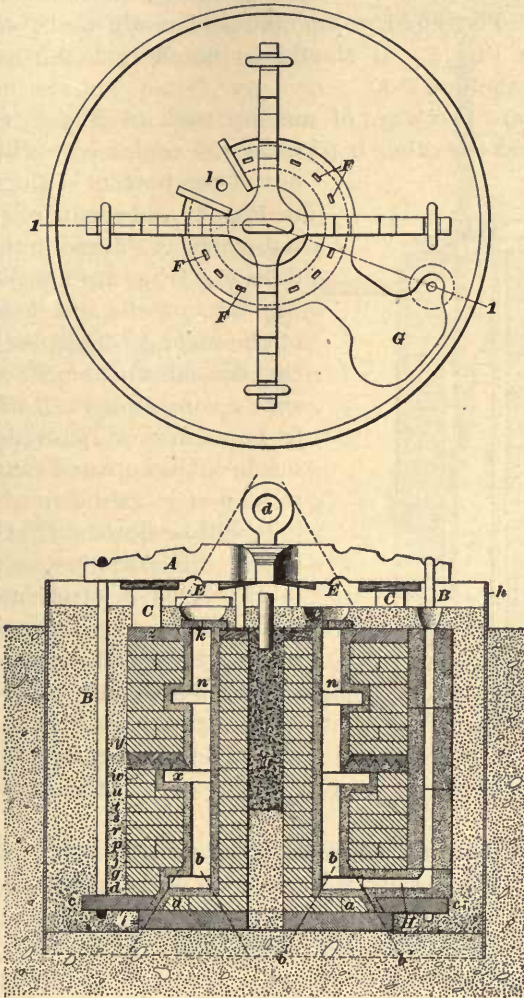

FIG. 5.

a cylindrical casting is given as an example. This will illustrate laying bricks, joint making, and the method of

supporting hanging bodies with loam plates, etc. There is also shown in the same mold the method of building on a square attachment to a circle by means of the section of a pattern. The mold, completed and ready to be closed, is shown in Fig. 5. It should be noted that the section is taken on the line *1 1*.

There are two ways of making such castings. One is as shown, and the other is to make the center core *a* independent of the bottom of the mold, as in Fig. 6, and set it into a tapering print, as shown by the dotted lines *b, b*, Fig. 5, instead of having the outside and inside parts of the mold jointed, as shown by the dotted lines *b, b'*. To lift such a core, slings *c, c*, suspended from a cross *d*, pass down the inside of the core and are fastened to lugs at *g*, as shown.

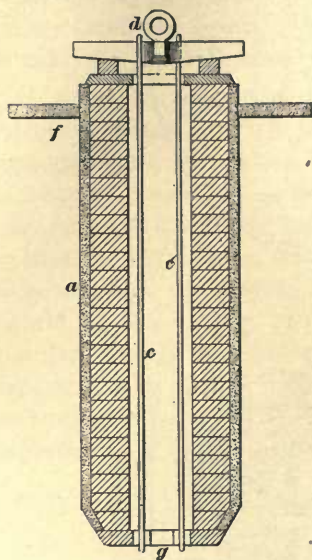

FIG. 6.

It will be noticed that the core in Fig. 6 is made longer than the mold. This is often done, and instead of covering the top of the mold with a flat cover *e*, Fig. 5, resting both on the mold and the inner core, a covering *f*, Fig. 6, is made to fit against the center core, with a bearing on the outside part of the mold only.

10. Spindles, Sweeps, and Arms.—The making of loam molds generally requires sweeps or spindles, or both. These are illustrated in Fig. 7, which shows the apparatus necessary for starting the mold shown in Fig. 5. At *g* is seen the spindle seat, or centering block, for guiding the spindle *h*. This block should be firmly embedded in the floor, as it is of the utmost importance that the center remain rigid. The spindle requires a rigid guide at its bottom to keep it central, and one at the top also, as shown at *i*. The

beam supporting the top center at *i* can be extended to timbers embedded in the floor or to the adjacent walls for support. In either case, provision should be made for its removal in order to permit the use of the crane in setting plates, etc. on the mold during its construction. All spindles should be turned and straight.

The diameter of a spindle will depend on the character and the length of the work. They can be made of gas pipe in cases where large diameters are permissible. Whatever the diameter is, it should be in whole inches, as fractional parts of an inch are apt to confuse some men in making measurements when setting sweeps.

The bottom of a spindle can be turned cylindrical to fit a similar spindle seat, or it can be made conical for a length of from 6 to 12 inches and fitted to a hole in the spindle seat that has a corresponding form. Some spindles are made to revolve when turning the sweep, while others remain stationary.

In constructing sweeps, they are made with a bevel, as seen at *j*, Fig. 8. In the case where a sweep is used much,

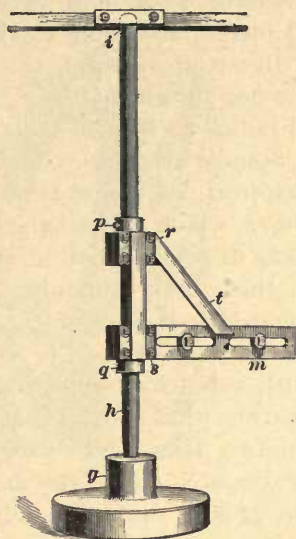

FIG. 7.

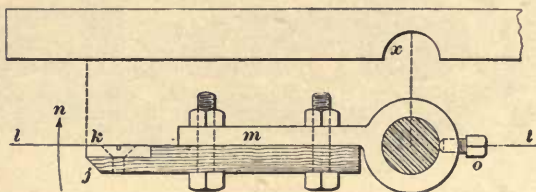

FIG. 8.

it is a good plan to fasten a piece of iron *k* to the front edge. Sweeps should be made so that their front face is in a plane passing through the center of the spindle, as shown by the

line ll , the spindle arm m being constructed in such a manner as to allow this to be done. Sweeps are generally made of wood, and vary in thickness from 1 inch up to $1\frac{1}{2}$ inches, according to the stiffness required.

In setting sweeps to the right diameter, a straightedge, like the one shown in Fig. 8, with a semicircular notch x , equal in radius to that of the spindle, cut into one edge, is used.

Spindle arms are constructed both of wrought iron and cast iron. A single arm, as shown at m , has a setscrew at o , Fig. 8, which permits the sweep to be clamped to the spindle so as to revolve with it, should this be desired. In the case of the spindle remaining stationary, collars p and q , Fig. 7, are required to hold the arms from working up or down. The arm m , Fig. 7, is seen to have two bearings r and s with a brace t connecting the two. Sometimes the upper bearing r has an arm that is parallel with the lower one, and the two arms are tied together. The distance between the bearings r and s can be varied. The longer the sweep, the greater the distance they should be apart.

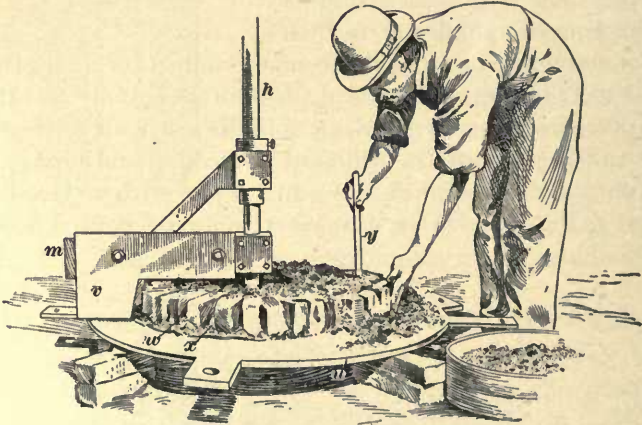
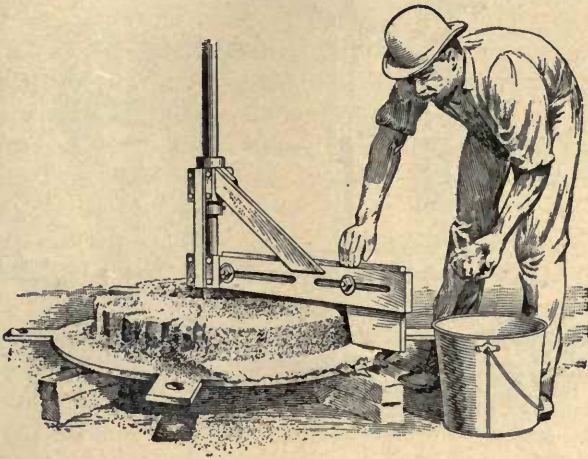

FIG. 9.

11. Making Foundation and Print for Mold.—The foundation center g and top support i , Fig. 7, having been adjusted, the next step is to set the bottom plate u on bearings, as shown in Fig. 9. This bottom plate is also seen at i ,

Fig. 5. The spindle *h* and the arm *m*, Fig. 9, which were removed to permit setting the bottom plate, are now replaced and the sweep *v* is bolted to the arm *m* in such a



(a)

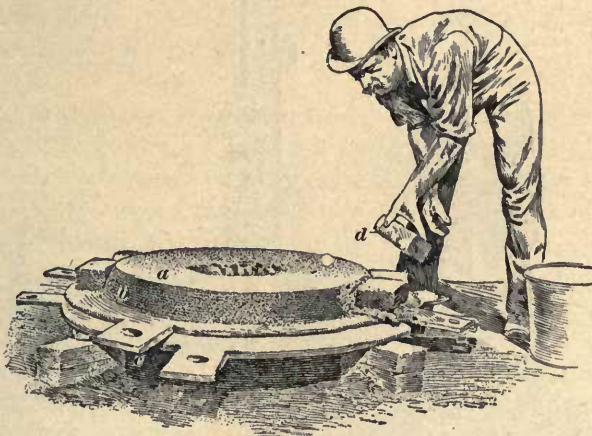

(b)

FIG. 10.

position as to give the diameter required. The parts are adjusted by the aid of a sweep-setting straightedge. Bricks *w* are then laid in a loam mixture. It will be noticed

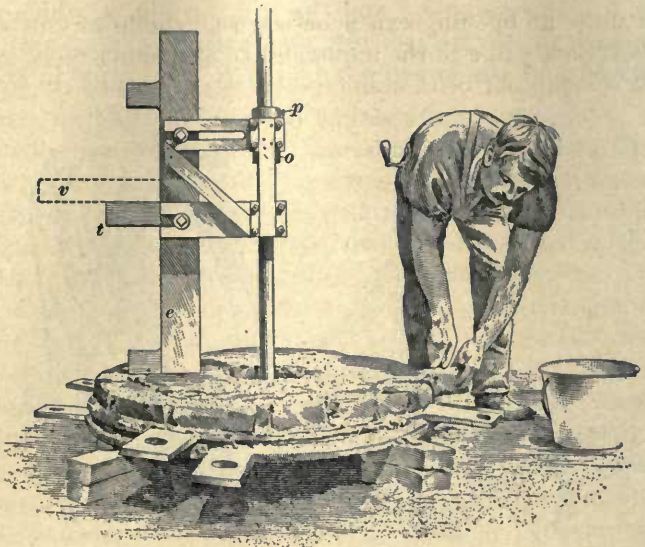

(a)

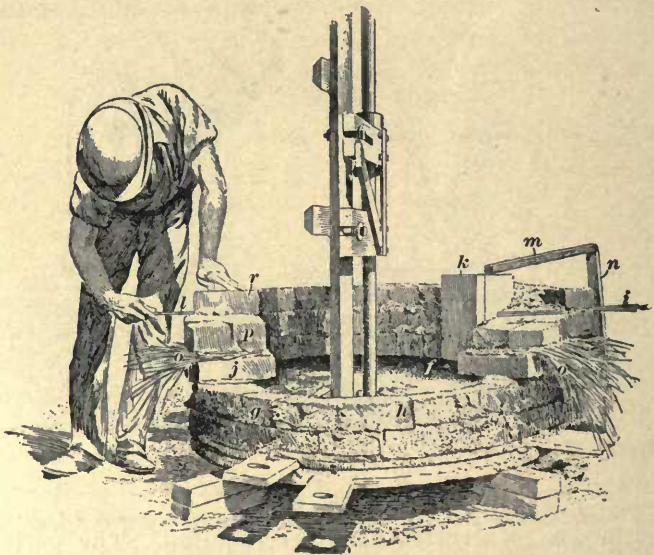

(b)

FIG. 11.

that quite an opening exists between all the bricks, as at *x*. This is partly due to the impossibility of making flush joints with rectangular bricks, and is also partly due to the necessity of having some opening between the joints to act as vents for the steam and gases. To aid in this venting, the spaces between the bricks are filled with cinders rammed in snugly with the end of a file or flat piece of iron *y*. This is one form of venting brickwork that is much used in loam molds. The cinders needed are obtained by using $\frac{1}{4}$ -inch and $\frac{1}{2}$ -inch riddles.

After the spaces have all been packed with cinders, the outer ends and upper faces of the bricks are cleaned free of cinders and a coarse loam mixture is daubed over them, as shown at *z*, Fig. 10 (*a*). The entire surface is swept up, using a fine finishing loam for the last coat and continuing until the mold appears as at *a*, Fig. 10 (*b*). This figure shows the bottom swept up, and the joint or bottom seat at *b* finished; also the lifting ring *c* placed on the mold and the molder laying bricks *d*. The bricks *d* are laid around the seat to complete the circle, as seen, after which the sweep *e* is set as shown in Fig. 11 (*a*).

12. Building Outside Body of Cylinder. — The sweep *e* having been set, a 4-inch wall *g* of half bricks is laid around the outer edge of the flange, as shown in Fig. 11 (*b*). The joints *h* between the bricks are daubed up with mud or loam to complete the circle. On top of the courses *g*, whole bricks *j* are laid, one half resting on the lower course of bricks and the other half projecting over the flange of the sweep. In laying the whole bricks over the flange, some of them may topple over on account of being overbalanced. To prevent this, a piece of brick may be placed temporarily on the ends resting on *g*, and then the space between the joints is filled with soft mud or loam. While laying the course of bricks *j*, the section pattern *k*, having first been oiled slightly to keep the loam from sticking to it, is set in place on a bearing of soft loam. To hold the top of the pattern in place until it is surrounded with sufficient brickwork

to keep it in position, a stick of wood m is screwed to the pattern at one end and to the stake n at the other. This method of holding similar sections of patterns in position is the one usually practiced in constructing loam molds. The course of bricks j having been completed, it may be advisable, where the mixtures of loam are liable to scab, to lay on a thin covering of straw, as seen at o . Where straw cannot be obtained, hay may be used as a substitute; straw is best, however, because it is hollow. Instead of using the straw or hay when approaching the section pattern k , $\frac{1}{4}$ -inch rods i are often laid.

After three or four courses of brick are laid up, the loam mixture is daubed under the bricks j into the space f , and this space is then swept up to form the bottom flange of the casting.

The use of cinders described in connection with Fig. 9, also the use of straw and rods mentioned above, and the method of venting between courses of bricks, as seen at l , Fig. 11 (b), constitute the different systems generally used in venting loam molds.

After the straw o , Fig. 11 (b), has been placed over the course of bricks j , a course p of bats and half pieces of bricks (by *bats* are meant irregular pieces of brick, that are smaller than half a brick) is laid, and the openings between the joints are all filled with cinders. This done, a course r of headers is laid.

After the course r has been laid, the courses of headers s and t are laid as shown in Fig. 5. The outer portion of the course u is laid with bats or half brick or with whole brick laid across the headers, and the inner portion of the course is laid with split brick, which brings the brickwork up to the under side of the belt flange x , leaving about $\frac{5}{8}$ -inch clearance between the edge t of the sweep, Fig. 11 (a), and the face of the bricks for daubing on loam to form the face of the mold. Before starting to lay the 4-inch course u , Fig. 5, straw is spread on the face of the course of bricks t , in order to form a vent for carrying the gases from the bottom of the belt. The course w is laid with whole bricks, placed lengthwise

around the mold. The bricks of the course *w* are set in such a manner as to break the joints of the course *u*. This brings the outside brickwork up to the top of the flange *x*. The lower half of the outside of the mold is now ready for daubing with loam, which should be swept to a smooth face. To form the joint on which the plate *y*, Fig. 5, is to be set, a strip *v*, shown by dotted lines Fig. 11 (*a*), is screwed on to the sweep. The mold and joint having been swept up smooth with loam to the top of the belt, the beam for the upper bearing of the spindle is removed and the pricker plate *y*, Fig. 5, which has been daubed with loam and dried, is set, removing the cross-beam from the spindle again to allow this to be done. Bricks laid as at *j*, Fig. 11 (*b*), are often used instead of a plate as at *y*, Fig. 5.

In daubing up such plates, they are turned with the pricker side up, and fine cinders are applied to a thickness of about $\frac{3}{8}$ inch. On top of the cinders, clay wash is sprinkled with a brush, after which soft loam is spread on by hand to the level of the top of the prickers, and then smoothed off by hand, the hand being wetted with water. At this stage the plate is dried either by a fire under it or in an oven, after which it is ready to be turned over and set in place in the mold. In some cases where such plates are set over patterns, they are set on while hot, so as to stiffen the loam underneath them quickly. The plate *y*, Fig. 5, having been set in place, the balance of the brick courses is laid. The plate *z* is also laid and the upper part of the mold is daubed up with loam and swept smooth.

The outside of the mold having been built up and swept, the lifting cross *A* and four slings, as *B, B*, Fig. 5, are hitched to the handles of the plate *c*, after which blocking *C, C* is wedged between the lifting cross and the top plate of the mold, in order to keep the mold from toppling over when being hoisted. The mold is then hoisted off the foundation plate *i* and finished with tools and blackening.

13. Building the Center Core.—The outside of the mold having been hoisted off the bottom, the sweep *b* for

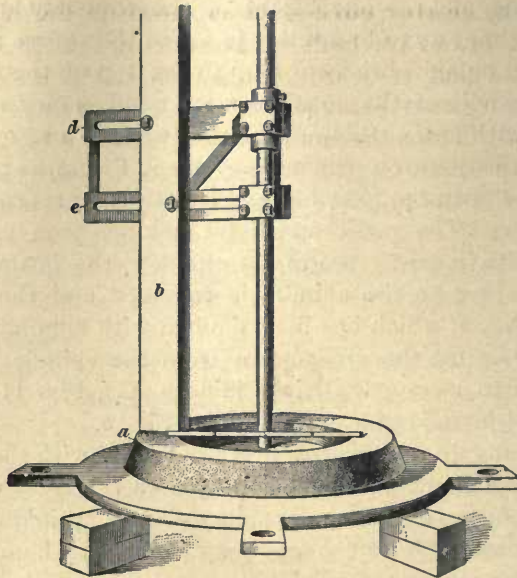

FIG. 12.

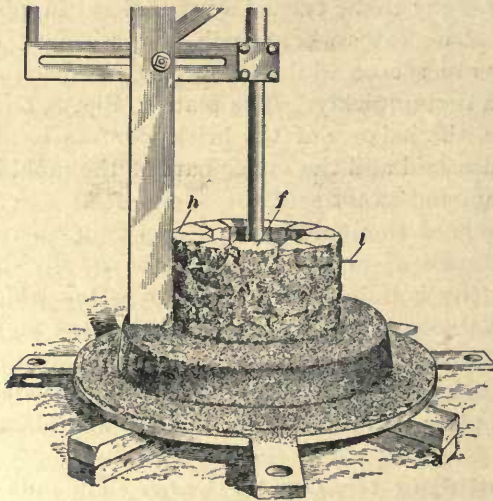

FIG. 13.

forming the **center core** is set as shown in Fig. 12. This done, half bricks are built up as seen in Fig. 13. As the courses are laid, they are vented with a $\frac{1}{8}$ -inch vent wire, the vent wire used being shown at *l*. The vent wire must be inserted before the mud between the bricks begins to stiffen, and in venting it is shoved through to the open space inside; the vent holes are placed from 2 to 3 inches apart.

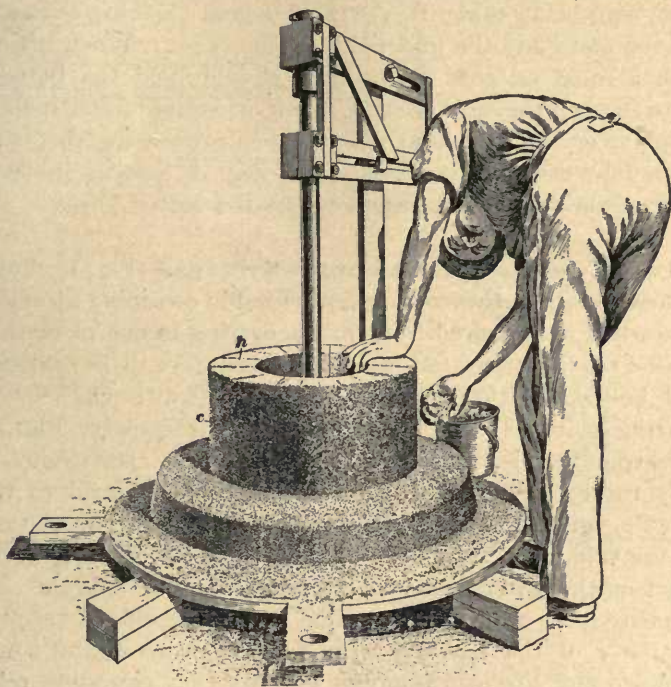

FIG. 14.

After the bottom has been built up four or five courses high, it is daubed with loam to the finished size, as shown in Fig. 14, which also shows the molder daubing on the last coat. The core being finished thus far and the loam having stiffened at the base *c*, courses of half brick are continued, as described, until the top is reached, and the balance of the core is daubed and swept, the whole core when the top plate is set appearing as in Figs. 5 and 6.

In sweeping such cores, the arms d and e , Fig. 12, are in some cases placed farther apart, to keep the lower arm near the bottom, and as the courses of bricks are continued on up and the sections swept with loam, the lower arm is raised until at last it is close against the upper arm d .

To lift such a core into the oven, the same lifting cross and slings seen lifting the outside mold in Fig. 5 can be used, care being taken to put wedges and blocking between the top plate and the under side of the cross. When lifting such a mold or core, three men should hold the bottom plate to keep the work steady, for if it sways much it may topple over. A plan that will assist in preventing this is to hitch hooks in the recesses E, E , Fig. 5, leading in on a slant to the crane hook, as shown by the dotted lines.

14. Cam-Arrangement for Sweeps.—Fig. 15 shows a **cam-arrangement** sometimes used in sweeping up cylinders when it is desired to form the casting in one piece that can be readily separated into halves that are to be finished and bolted together. The base plate a , with the central bearing g , takes the place of the center block g , Fig. 7. The spindle b is centered in g , and may be stationary or may rotate on its axis. The clamp c is fastened to the spindle rigidly if the spindle rotates, or fitted so as to turn on the spindle if the spindle is fixed. In either case, every point on the arm c moves in a circle about the spindle. In the base plate a is a groove f that acts as a guide to the projection e of the movable arm d . The arms d and c are tongued and grooved together so that they can slide relatively to each other as they turn about the spindle. The groove f lies around the spindle in two semicircular arcs connected by a short-curved groove. The semicircular arcs are usually made true semicircles, having the radius x , and the center of each is the distance y from the center of the spindle. In order to give the sweep a true circular movement, the groove f should not be a true circular arc, but should be plotted; and the groove cut by a templet, but this is not usually done. The sweep is fastened on the end

of d , and as the arms move around, it sweeps the mold in two semicircles connected by a short, straight or slightly curved portion. The distance y is usually small, seldom

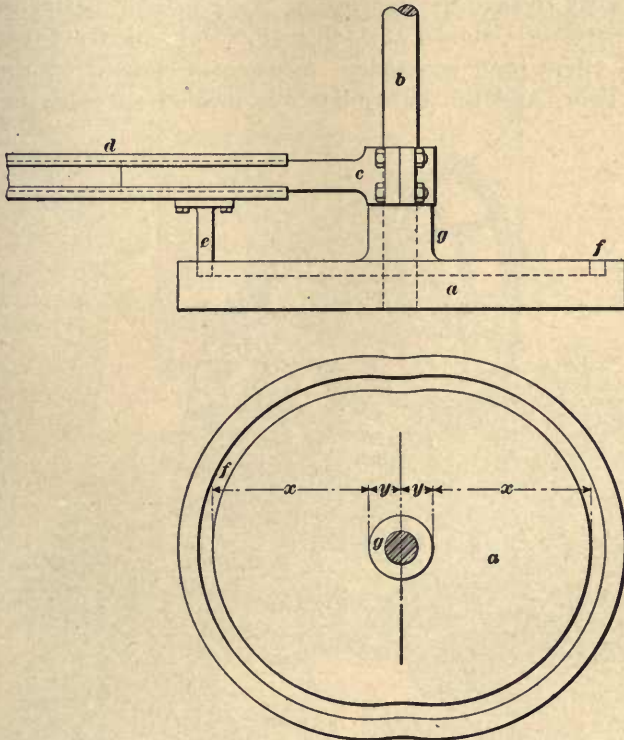

FIG. 15.

being over 2 inches, and x is seldom more than 10 inches, so that any variation from a circle in the travel of the sweep in the semicircular portion is not great, and is usually neglected.

When the outside of the mold is finished, the same arrangement can be used to sweep up the core. After the core is finished, it is placed in the mold with narrow core plates along the flat part, so as to leave only a very thin portion of the metal where the casting is to be separated.

SKELETON-PATTERN LOAM MOLDS.

15. Preparing a Skeleton Pattern.—It has been stated previously that **skeleton patterns** are often used in loam work to save the expense of large wooden patterns. Such a pattern is shown at *a*, Fig. 16, from which a 4-foot cast-iron elbow is to be made. A space is cleaned on the foundry floor, and the base plate *b* is leveled up ready for

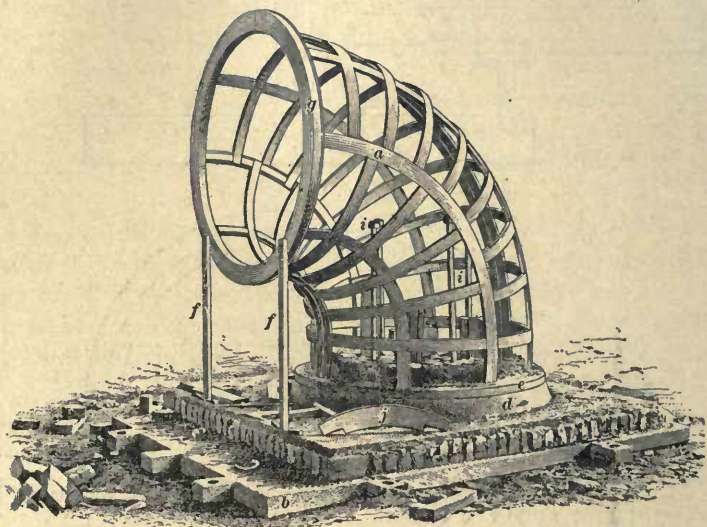

FIG. 16.

the bricks *c*, which are laid on edge in loam on the plate. A circular base *d* is made of brick and loam, with a covering of loam, and is swept up to the diameter of the lower flange *e* of the elbow. The skeleton *a* is then placed on the base *d*, and fastened there by the upright supports *f, f*, which are fastened to the vertical flange *g*, and by the brick inside the horizontal flange *e*. The bolts *i, i*, which can be seen coming up through the brick, are fastened to the base plate *b*. Railroad irons are set on end on the base plate and can be seen inside the skeleton. Two courses of brick are laid up in loam around the inside of the skeleton to the

height shown in Fig. 17 (a). A space of about 1 inch is left between the skeleton and brickwork to be daubed up with loam. Inside the brick and loam the space is filled with brick and cinders packed around the railroad irons to give firmness and porosity to the interior of the core. The

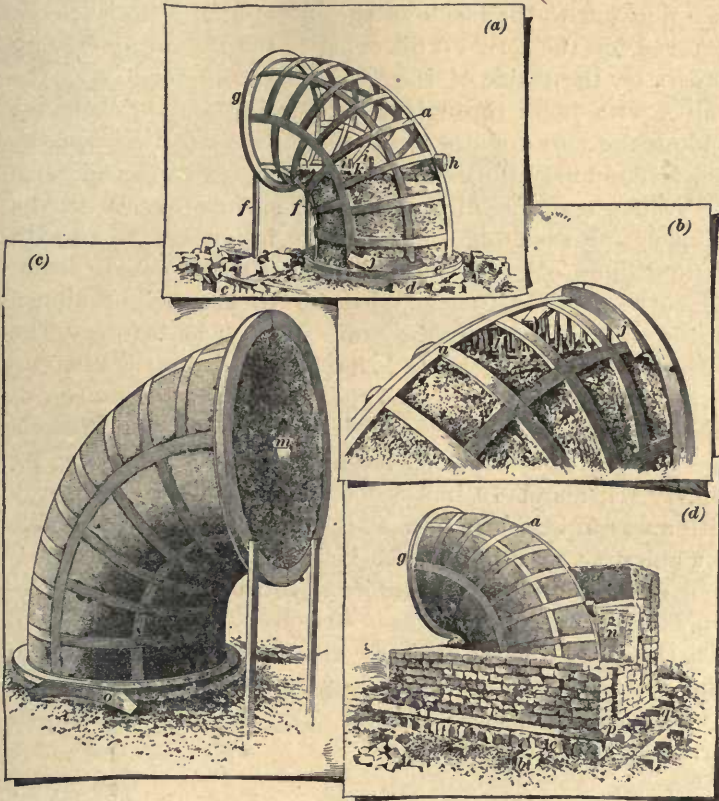

FIG. 17.

railroad iron is for the purpose of supporting a cast-iron plate, with holes through it and with pricklers on one surface, called a *crab*. The crab *k* is laid on top of the brick and railroad iron, and bolted down with the bolts *i, i*. The railroad irons prevent the crab from crushing the brickwork.

On the under side of the crab *k*, near the vertical flange *g*, the prickers can be seen. Their purpose is to hold the loam underneath from falling or sliding out of place. The reason for building up the pattern in this way is that it is to be used as a core as well as a pattern. The loam is built up to the size of the outside of the skeleton for the pattern, and then dug out to the inside of the skeleton and the skeleton removed for the core. This explains the reason for having cinders on the inside of the brickwork, and for having the crab *k* with holes through it for venting and prickers for holding the core together. The 1-inch space between the skeleton and brickwork is daubed with loam and swept with the inside sweep *j*, which makes the surface even with the inside of the skeleton. The surface is not smoothed with any finishing tool, but left rough for the next coat of loam. The brickwork is then carried up to the height shown in Fig. 17 (*b*) in much the same manner as before. The outside is built of brick and loam, and the center is filled up with brick and cinders. Another crab *l* is built on top to give firmness to the loam that is built in to fill the rest of the space inside the skeleton. The 10-inch pipe *m*, Fig. 17 (*c*), about 10 inches long, is set in the brickwork with a screen behind it to keep the cinders in place, and acts as a chimney, or vent, for the inside of the core. Loam is then daubed in all the spaces between the ribs of the skeleton, nailed to the loam already in place, and swept up even with the outside of the skeleton with the sweep *o*, Fig. 17 (*c*). The pattern is then smoothed off, finished with tools, and given a coating of parting sand. Fig. 17 (*c*) shows the pattern ready for the mold.

16. Making the Mold.—When the loam pattern is in place and ready for use, the plates *p* and *q*, Fig. 17 (*d*), are placed on the brick *c* and around the base *d*, Fig. 17 (*a*). On these plates the mold is built up in halves, as shown in Fig. 17 (*d*), to the height of about the center of the flange *g*. In order to part the lower halves of the mold, a newspaper is used as shown at *n*. These lower halves are not built up

in front of the flange *g*, but are built close around it in such a way that the front can be closed with a large circular plate. Plates *r* and *s* are placed on top of the brickwork and fastened down with bolts to the plates *p* and *q*. The

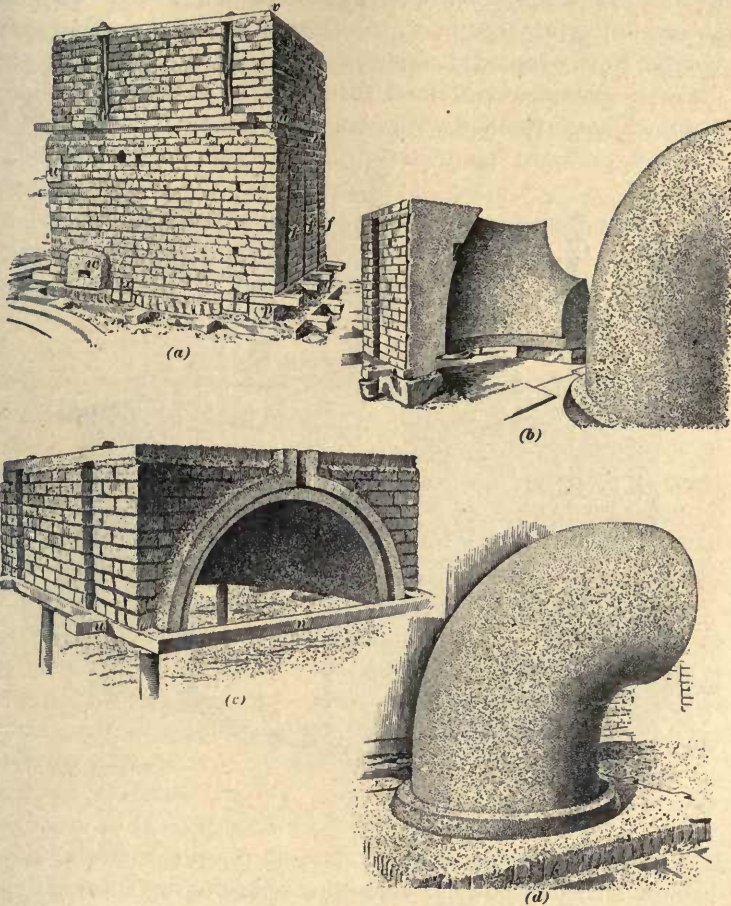

FIG. 18.

plate *u*, shown in Fig. 18 (*a*), is then put on around the pattern, brickwork is built up over the top of the pattern, and the plate *v* set on and bolted down as shown. The bar *n* on the plate *u*, Fig. 18 (*c*) is for the purpose of holding the

plate that closes this end of the mold in place. At the points marked *w, w* are the gates for the metal to enter the mold, and *x, x* are loam marks that indicate the position of the mold, so that it can be taken off and put back in exactly the same position. The mold is now separated, as shown in Fig. 18 (*b*) and (*c*), finished on the inside, and taken to the core oven and baked. The plates supporting the different parts are provided with lugs, to which the foundry crane can be attached with chain and hook.

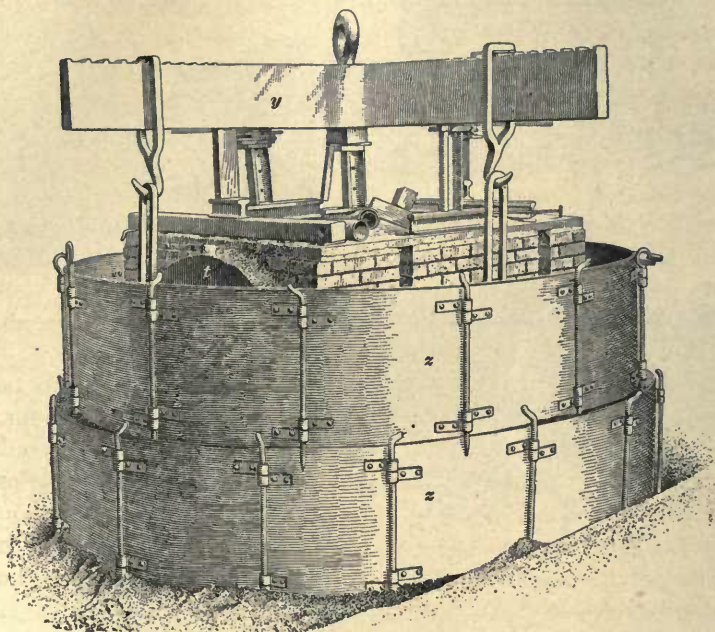

FIG. 19.

The pattern is made into a core by digging out the loam between the ribs of the skeleton, sweeping up these spaces with the inside sweep *j*, Fig. 17 (*a*) and removing the skeleton. It is only necessary to smooth up the core, finish off the outside, blacken it, and bake it in the core oven. The finished core is shown in Fig. 18 (*d*). The parts of the mold are placed around the core and drawn together as shown in

Fig. 19. The plate t is covered with loam, put in place, and wedged behind the bar n . The cross y with the hooks and links is drawn down on top until the whole mold including the core is held rigidly in place from the base plate b to the cross y . The jackets z, z are set on the base plate outside the mold and filled with sand in which the gates and pouring basins are made. These connect with the gates w, w , shown in Fig. 18 (a). One enters the mold at the bottom and the other at the height of the bottom of the vertical flange g . The clamping and weighting of the mold, together with the packing of sand around it inside the jackets, give the mold a greater strength to resist the outward pressure of the metal and gases that will be generated while pouring.

SWEEPING A CONICAL DRUM.

17. Making Mold and Core for a Hoisting Drum.

Figs. 20 and 21 show the mold and core of a large hoisting drum. The drum is to be 12 feet in length and have a diameter of 13 feet at the largest part. Fig. 20 shows the inside of the mold already swept up, with the sweep and spindle still in place. In preparing this mold, the first thing to be done is to dig a large conical hole in the foundry floor. The small end is down and is about 8 feet in diameter. Bricks are laid in loam over the bottom and around the sides of the hole. As the sides are built up, each course is laid out a little, so that the diameter increases regularly with each course of brick from the bottom to the top. The spindle a has a seat in the bottom very much as in Fig. 7, which is fastened rigidly, and the top of the spindle is also fastened so that it cannot move from its place. The thread or groove i in the spindle has the same pitch as that of the rope groove in the drum to be cast. The guide b is fastened to an arm at the bottom similar to the arm j to which it is fastened at the top. Both these arms have bearings k to which they are attached. The bearings k revolve around the spindle, but do not move along its axis, as they are held in place by collars.

The long sleeve *f* carries the slide arm *h* to which it is rigidly attached. In *f* there is an internal screw or nut *g*, which fits the thread *i* of the spindle and gives the sleeve and arm their upward movement as they revolve about the spindle. The arm *c* slides in a groove in the slide *h* and

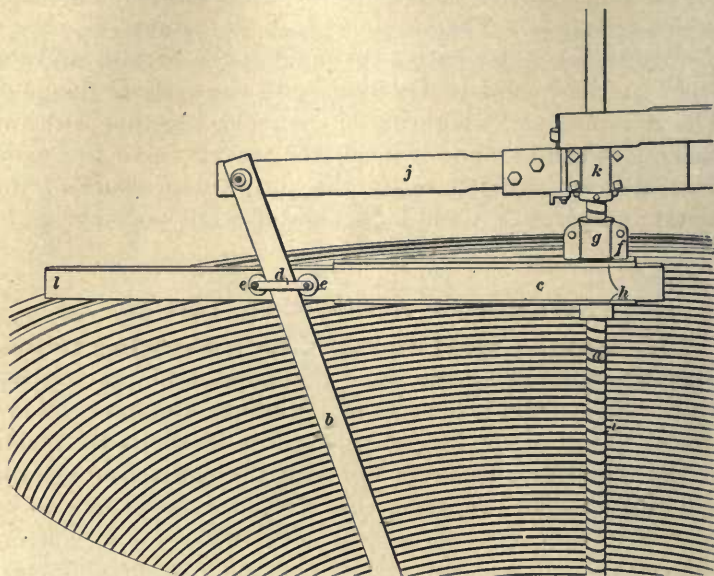

FIG. 20.

carries a strap *d* that connects the two rollers *e, e*, and with them moves out the arm *c* as it is carried around and up with the sleeve *f*. This gives the spiral motion necessary for the sweep to generate the form in the mold that will produce the rope groove in the casting. The groove for the rope is formed by placing a tool of the proper form on the end *l* of the bar *c*.

Fig. 21 shows the core for the inside of this same hoisting drum. The core is built up on the bottom plate *l* by first building up three or four courses, as at *m*, with a course of headers on top. On top of these brick the core is built up around the outside with brick laid in loam. Outside of this

brickwork loam is daubed on and swept up by a plain sweep, part patterns having been previously placed in the grooves as at *n*, *o*, and *p*. These part patterns are removed, leaving spaces to be filled with metal, forming ribs on the inside of

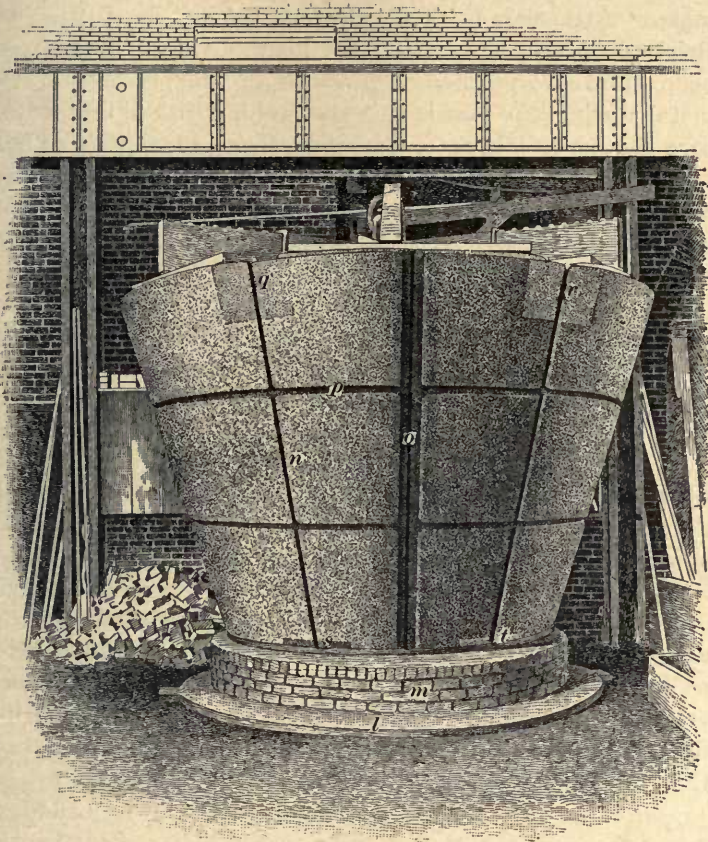

FIG. 21.

the casting to give it strength. At *q*, *r*, *s*, and *t* are cores in which are formed the T-shaped arms that connect with the hub of the drum. The core is finished and set in the mold by centering and leveling to the proper height. When properly set, the gates are built up on the inside ready for pouring.

DETAILS OF LOAM WORK.

18. Laying and Tying Courses of Brick.—Loam molding demands some skill in bricklaying, as a loam molder often has some very difficult constructions of brickwork to make. Attention is first called to the bricks *f*, Fig. 13. Bricks laid like this, having the longest side inwards, have been known to be pressed inwards by the pressure of the metal during the pouring of the mold. In building cores, care should be taken to use bricks that will match, so that when the pressure comes on them they will wedge together and give a greater resistance to the metal pressure. Bricks in the form of a circle resist pressure in a manner similar to the bricks in the arches of bridges.

After the bricks are laid, the joints *h*, Fig. 14, should be thoroughly daubed with a strong mud or good loam. When cores exceed 4 feet in diameter, whole bricks can be laid to form the circle. When cylinders exceed 4 feet in length and 30 inches in diameter, it is best to build an 8-inch wall for a foot or so at the bottom, and after this, a 4-inch wall should suffice for the balance of the length of the core as in the cores shown in Figs. 13 and 14. When cylinders exceed 6 feet in diameter, it is often necessary to strip an open space about 6 inches wide the length of the casting, after the mold is cast, to permit the core to contract without putting too great a strain on the casting. One plan to avoid this is to use strong loam bricks in the core, forming with them a vertical strip about 8 inches wide at one side of the core; then, when the casting commences to contract, it will crush the loam bricks, which crush easier than common red bricks.

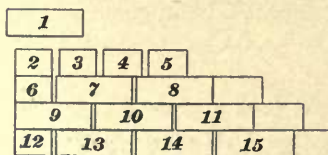

FIG. 22.

and 11, which in turn cover the joints between the bricks 12,

Attention is now called to Fig. 22, which presents the scheme involved in tying the joints of brickwork. Here it will be seen that the bricks 7 and 8 cover the joints or openings between the bricks 9, 10,

13, 14, and 15. Bricks 2, 3, 4, and 5 are laid across the other brick; such bricks are called **headers**. Fig. 23 is a top

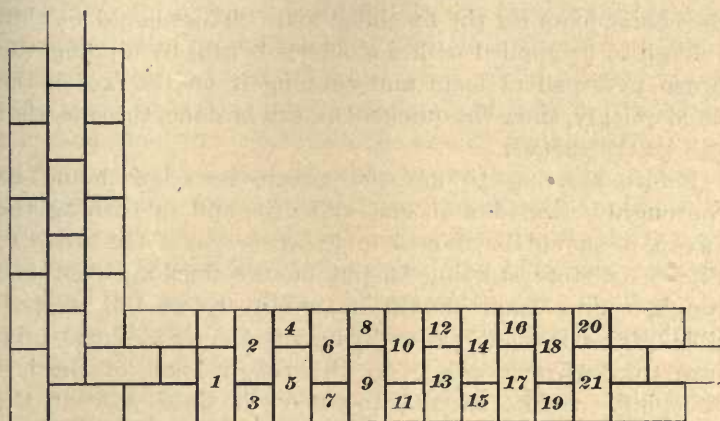

FIG. 23.

view of a 12-inch wall. Bricks 1 to 21 are headers laid on the top of the course below them, and have all their joints tied, as shown.

The bricks facing a mold should be dry, or nearly so, and of a soft character. Hard-burned bricks prevent the escape of the gases, are liable to cause scabs, and if they are not dry when laid, the loam stiffens slowly, making it difficult to obtain a good finish on the face of the mold. A dry, open, soft-burned brick should absorb about 1 pint of water.

19. Thickness of Loam for Daubing and Sweeping.—The face of the bricks should be kept from $\frac{3}{8}$ to $\frac{1}{2}$ inch away from the cutting edge of the sweep. Where the castings are thin, the thicker and more open the loam is on the face of the bricks, the better. The loam used should be of such a character as to adhere firmly to the bricks, and still not be so soft as to run or sag on the face of the mold. The loam should be rubbed on quickly with the hand, on account of the fact that if a large section can be kept soft until the cutting end of the sweep has passed over it, there will be

little tearing. The surface will be left smooth and firm, as it should be for the finishing loam. It may be necessary for the sweep to pass over the daubing four times to prepare the coarse loam for the finishing coat. This should be thin enough to be applied with a molder's brush, by dipping the brush in a pail of loam and rubbing it on the face of the mold quickly, since the quicker this can be done, the smoother will be the surface.

Before starting to use the sweep, its edge should be thoroughly cleaned of all grit and dirt, and in turning the sweep, it should be moved in the direction of the arrow *n*, Fig. 8. Before starting to put on the finishing coat, the rough, coarse loam should be swept up as full as possible. This is made easier by having the coarse-loam mixture thin when evening up the rough loam of the last sweeping. Before starting to put on the finishing coat, the coarse under coat should be allowed to dry until it is stiff and hard, so that it may absorb the moisture from the finishing coat in a fairly rapid manner. When putting on the finishing coat, it should be done so evenly that one revolution of the sweep will suffice. If more revolutions are made, the face will rarely be as smooth as if only one revolution were made.

20. Finishing and Blackening a Loam Mold.

The amount of finishing with the small tools that a mold requires depends on how smoothly it has been swept up and how smoothly the building up around the patterns has been done. A mold should be swept up so smooth as not to require any tool finishing; when this can be done, it will prevent blackening scabs. Sleeking the loam surface of a mold helps to close up the pores and thus prevent the escape of the gases.

It is generally necessary to do more or less finishing where patterns are used, as there may be seams at the brick joints that should be cleaned out and filled in with fresh loam. Then again, the oil that is used on the pattern to prevent the soft loam sticking to it will have to be washed off, so as

not to form a parting and cause the blackening to peel or scab off. In starting to finish parts of a mold that have peeled off, or those roughly swept, a wad of clean waste or fine "teased" hemp is saturated with water and rubbed over the face of the mold. Then thin finishing loam is taken in the hand and rubbed over the wet surface. A hard-wood smoothing block, made about 2 inches thick by 4 inches wide and 8 inches long, having rounded edges, so as not to tear the mold, is rubbed over this. The action of this smoothing block should leave the face of the mold in such a condition that a little sleeking with the finishing tools will make it ready for blackening. The blackening should be done before the surface becomes too dry; for if this is not done, the blackening dries so rapidly that it is difficult to do good smooth finishing. As a rule, loam molds cause the blackening to stiffen very rapidly. Where this takes place, it can be told by the dryness of the mold. Then only a small section at a time should be blackened in order that it may not stiffen too much before being finished with the sleeking tools. Loam molds are blackened both green and dry, as are dry-sand molds, and, like them, require a thickness of blackening according to the proportions of the casting. The character of the mixtures is practically the same for both branches, as is also the use of tools in finishing.

21. Joints in Loam Work.—To separate the loam at such joints as *b* in Fig. 10 (*b*), machine oil or other oil can be rubbed on the face of the finished loam, which is then covered with parting sand. Another method is to wet paper and lay it on the joint, or to fasten it on with nails. Another plan is to take pure charcoal dust and wet it with water to make a blackening, and then brush it smoothly on the joints. The loam, in drying, will absorb the water out of the blackening and leave a dust that separates the two bodies. Where the joint is very wet and lies flat, oil and parting sand are used. If the joint is vertical, the parts should be left until they are stiff before applying the separating material.

RAMMING UP LOAM MOLDS READY FOR CASTING.

22. Backing and Venting Loam Molds.—The mold shown in Fig. 5 having been dried and put together in the pit, as shown, the slings are attached to the handles *c* of the bottom plate. Blocking is wedged in between the bottom of the cross and the mold and the core plate. This is done in order to hold down the core, as well as the outside part of the mold, when casting.

The next thing is to back up the mold by ramming up around the mold with sand, that should be well mixed and shoveled in to a depth of 5 or 6 inches for each course of ramming. Where this work is all done by hand, there are generally four to eight men needed in ramming. The leader takes the peen end of the rammer to ram around close to the mold walls and goes roughly over the surface between the mold and sides of the pit, and he is followed by his men with butt rammers. The bottom course should be rammed very solidly, so as to prevent straining. The object of the backing is to support the brickwork of the mold during pouring.

As the ramming progresses, it is necessary to provide vents to carry off the gases. This is done by laying a course of cinders at every other ramming, leading them up the side of the pit and carrying their vents to the top by means of gates, sticks, or rods. It may be done, also, by placing $\frac{1}{2}$ -inch to $\frac{3}{4}$ -inch rods about 1 foot apart against the brick wall of the mold; at every third or fourth ramming these are pulled up the length that has been rammed, for if they were wholly rammed up before trying to pull them, there would be some difficulty in getting them out.

After the outside part of the mold has been rammed to the top of the pit, sand is rammed gently in the center of the core to a height of about 1 foot. Some molders do not follow this practice, and where the lower courses of bricks are carefully laid it may not be necessary. However, the ramming in of sand 1 foot high takes but little time and is a precaution that may prevent the casting being lost by the pressure of the metal finding a weak spot in the bottom of

the core, which would allow the metal to escape from the mold. The mold is now ready for making the pouring runners and gates.

It may be well to mention that the covering cores *e*, Fig. 5, were placed all around the top of the mold before starting to ram it up, in order to keep dirt from getting into the mold. These cores are removed after the mold is rammed up, and the mold is examined to see if all is right inside. Light for this purpose can be obtained by tying a piece of oily waste on a rod, or passing down a miner's lamp tied to a piece of wire. If the mold is found clean and unbroken, the covering cores *e* are replaced along with their gate sticks, which fill the holes *F*, *F*, Fig. 5. A little daubing made with dry blackening and oil is used to fill up the joints of the cores, after which good riddled sand is shoveled in and the top of the mold rammed up to the level of the loose rings, which project above the floor. The sand is now cut to form the pouring basin *G* and the runners.

23. Gating and Pouring Loam Molds.—In ramming up the mold shown in Fig. 5, round cores about 6 inches in diameter and 12 inches long, having a $1\frac{1}{2}$ -inch gate in the center, are connected with the inlet *H*, and lead up to the top of the mold. These cores are made in sections, and are placed one upon the other as the ramming progresses; they are used in place of gate sticks on account of the fact that the flowing iron may cut the gates if they are formed in green sand, and thus create dirt when the mold is being poured. In connection with the down gate, top gates made in the covering cores, as seen at *F*, are arranged about 10 inches apart around the circumference of the mold, except a space of about 1 foot wide that must be left for the feeding gate seen at *I* in the plan view of Fig. 5. These top gates should be small, so that while filling the mold, the pouring basin and runners can be kept full of metal. If the gates are much larger than $\frac{1}{2}$ inch by 1 inch, with the distance apart mentioned above, it will be difficult in large molds to keep the pouring basin full of metal while pouring.

In starting to pour a mold having bottom and top pouring gates, the metal should flow slowly from the ladle at the start, until the bottom of the mold has been covered to a depth of several inches. The pouring is then hastened to carry the metal to the top gates, with the view of filling rapidly all the runners, so that any dirt floating on top of the metal in the runners may be kept from passing into the mold. Should any dirt pass through the gates into the mold when the metal is started, the action of the metal dropping from the top gates on the raising metal in the mold chops it, as it were, into small particles. This keeps them agitated, so that they will float on the surface of the raising metal and be brought up into the dirt riser, which forms all that part of the casting seen above the line *n*.

If the casting were poured wholly from the bottom, through such gates as that at *H*, the greater part of the dirt carried into the mold or created in it by reason of scabs, etc. would lodge against the sides of the mold and make a dirty or bad casting. This would become apparent when the skin was removed in finishing its surfaces in the lathe or planer. This is because there is no force present to chop or break up into small pieces any dirt that might collect during the pouring. Furthermore, the fact that the metal becomes duller the higher it rises when poured entirely from the bottom of a mold has a still greater influence in making dirty castings. When the metal drops from the top, it will be practically as hot in the top portion of the mold as it is at the bottom. The metal is run in at the bottom merely for the purpose of covering the bottom of the mold with metal sufficiently deep to prevent the falling metal from cutting the bottom face of the mold, thus causing scabs and collecting dirt in the casting. Sometimes the loam can be mixed sufficiently strong to resist such dropping on the bottom of the mold, but wherever it is possible, a bottom inlet gate should be used in connection with top gates.

It is true that quite a number of cylindrical dry-sand and loam castings are poured successfully entirely from the bottom. Nevertheless, combined pouring is to be preferred

when practicable, as many castings that would have been lost had they been poured entirely from the bottom, turn out perfectly clean in finishing, because they have been poured with combined gates.

Reference has been made to pouring slowly at the start when filling the bottom of the mold through the inlet gate, before the metal commences to flow through the top gates. This is made possible by having the entrance of the bottom gate near the pouring basin and on a lower level than the top gates. Then, when starting to pour, the bottom gate will be the first to receive the metal, which can be prevented from running to the top gates by regulating the flow from the ladle.

24. Mud and Loam Mixtures.—There is a difference between mud and loam mixtures, but the important feature is to have a material that will give a plastic bearing between the joints of bricks. Mud is generally made out of old sand gathered from dry-sand heaps or the working floor of the molding room. Where more is wanted than these sources will supply, new molding sand or loam sand may be taken. Where the molds are tall, or of an intricate form, and require to be well bound, the mud may be strengthened by using a thick clay wash to wet the sand. As a rule, it is desirable to have the mud of an open texture when dried, so as to assist in carrying off the steam and gases. To make it open, sawdust, chopped straw, or hay is generally mixed with it in the proportion of 1 part of the sawdust or other material to from 6 to 12 parts of the sand. The sand forming the mud should be riddled through a $\frac{1}{4}$ -inch riddle, so that there will be no lumps to prevent the bricks from obtaining an even bearing.

The sand used for making loam mixtures should give a firm, hard, but open-grained body when dried. There are a few localities in the country where loams are found that are excellent for making a loam mixture without being mixed with other materials. Where such a natural loam cannot be obtained, it becomes necessary to combine different materials, some very loamy and others sharp-grained in their

texture. It may be necessary to mix binding or opening materials with some sands.

Coarse loams are made from coarse sand mixed with horse manure or chopped straw passed through a $\frac{1}{4}$ -inch riddle, whereas finishing loams are made of fine grades of sands passed through a No. 8 sieve, and generally without mixture. One objectionable feature of some finishing-loam mixtures lies in their closing up the pores of the under layer of coarse mixture and leaving the surface of the mold hard, dense, and liable to cause scabs.

In some localities, sand for making coarse-loam mixtures that will permit the use of fine, close, finishing mixture over them cannot be obtained. In such cases the latter is omitted entirely and the coarse mixtures are taken and thinned down sufficiently to pass through a sieve, using all that will run through it for a finishing loam. Again, some localities will have such weak loam that the molders must strengthen their finishing loam by wetting it with clay washes and molasses water. In making mixtures of loam, it is always advisable not to combine sands that are very different in grain, since the nearer in grain the different sands are, the closer they are to a natural loam. To give an idea of mixing loams and of combinations to use in different localities, the following receipts are presented.

25. Receipts for Loam Mixtures.—A mixture that can be made in the sections bordering on the Great Lakes is given in receipt No. 1. A finishing loam for this mixture can be obtained by screening the same mixture through a No. 8 sieve. This mixture is used for castings ranging from 1 to 4 inches in thickness. Receipt No. 2 is for making thin castings, such as pulleys, etc., and also for thin portions of large castings. Sometimes it is advisable to add sea coal to such mixtures, as it aids in giving a more open texture. Receipt No. 3 is for localities where good grades of regular loam sand are unobtainable. This mixture may be used for ordinary castings. Receipt No. 4 is one used in the East, and makes an excellent mixture for general castings.

26. *Receipt No. 1.*—Mix 1 part of chopped straw with 2 parts of lake sand and add 4 parts of a good grade of loam sand. Wet with medium-thick clay wash.

Receipt No. 2.—Mix 1 part of chopped straw with 1 part of old, burned loam and add 2 parts of lake sand and 2 parts of fair loam sand. Wet with very thin clay wash.

Receipt No. 3.—Mix 4 parts of molding sand with 5 parts of bank sand. For every 20 parts of this mixture add 1 part of dried and sifted fireclay; for every 6 parts of the mixture add 1 part of chopped straw, and for every 20 parts add 1 part of sea coal. Wet with fair clay wash.

Receipt No. 4.—Mix 1 part of white-pine sawdust with 1 part of dried, sifted fireclay, and 1 part of molding sand and 4 parts of fire-sand. Wet with thin clay wash.

The lake sands used in the above mixtures should be coarse and free from fine dust or foreign material. When none of these receipts are used for a finishing loam, because of a finer material being available, then the loam and molding sands will be taken separately, sifted finely, and wet with water, clay wash, or molasses water, according to the character of the sand and the condition of the coarse loam. In making mixtures, it is to be remembered that those made from open sand having a good body are better than those made from close-grained sand. In making these loam mixtures, the sand is generally mixed in a dry state on the floor. It is then removed to an iron bench to be wetted, and the mixture is threshed, the latter being done by a man using a $\frac{1}{2}$ -inch or $\frac{5}{8}$ -inch rod from 4 to 6 feet long. This is done by raising the rod a couple of feet above the bench and bringing it down with sufficient force to cut through the mixture and strike the bench with some force. This action separates a portion of the mixture at every stroke, and is generally repeated two or three times over the mass, which will be spread over the bench to a depth ranging from 2 to 3 inches. This beating action is necessary to give toughness and strength to the loam, especially where different grades of

sand are combined, as it brings them to a condition approaching natural loam. The horse manure or chopped straw is dried on plates or in ovens, then riddled through a $\frac{1}{4}$ -inch riddle before mixing with the sand. Much mixing of loam is done now with loam-grinding machines, which do the work cheaper, more quickly, and better than it can be done by hand.

MAKING CHILLED CASTINGS.

27. Difficulties Encountered in Making Chilled Castings.—A **chilled casting** is one that is cast in an iron mold; the object of the iron mold being to extract the heat rapidly and so harden the iron by causing the carbon to assume the combined form. In some cases only a portion of the mold is made of iron. The manufacture of chilled castings has cost founders more money, time, and labor to bring to a successful stage than any other branch of founding. The difficulties experienced were in preventing the chilled parts from checking or cracking, and also in obtaining the right character and depth of chill. The factors that affect the character and depth of chill are the nature of the iron used, the thickness of the iron mold, and the pouring temperature of the metal. The first factor will be described later in the part treating of the effect of different impurities on iron. The effect that variations in the pouring temperature has on the thickness of the chill is treated further on.

28. Construction of Chills.—In making **chills**, as the iron mold *a*, Fig. 24, is called, a quality of iron that possesses both strength and ductility to allow for alternate expansion and contraction should be used; if other grades are used, they will not last long, perhaps not more than one heat. Chills intended for rolls that are long in the body are often cast in sections joined as at *b*, Fig. 25. Flanges *c*, Fig. 25, are provided for the purpose of bolting the sections together. Great care must be exercised in turning up the

faces of such sections, as the joint must be air-tight. Any openings at these joints will cause chill cracks, spoiling the casting. When practicable, it is better to make the chill *a* in one piece, as in Figs. 24 and 26, instead of in sections, as

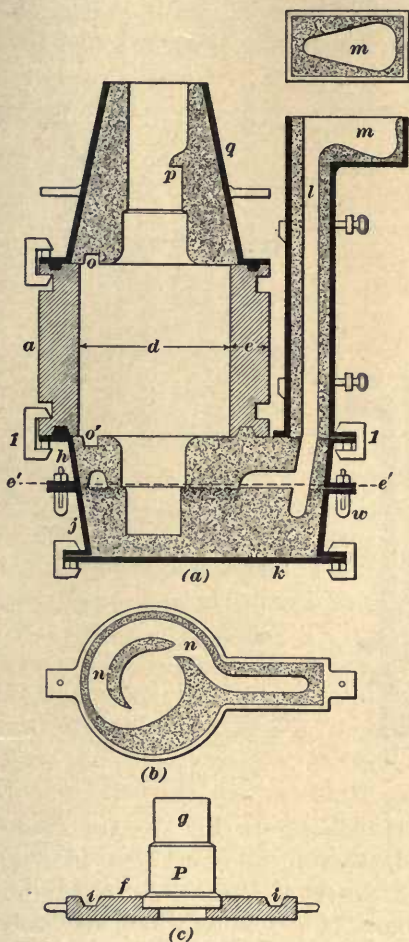

FIG. 24.

in Fig. 25. The inside surface of a chill must be finished as true and smooth as possible in the lathe, and care must be taken to prevent the finished surfaces from rusting through exposure to dampness. When chills are not in regular use, their surfaces should be coated with some good oil or grease, which must be rubbed off before using the chill again.

29. Thickness of Chills.—The thicker the body of a casting is, the greater must be the thickness of the chill; not so much for the purpose of resisting the head-pressure of the molten iron as to provide a body of metal that will rapidly extract heat from the molten iron and thus chill the surface of the casting, and also to prevent the chill itself from cracking when suddenly heated.

Table I gives the thickness of chills for rolls ranging from 4 inches to 30 inches in diameter, and varying in

length from 2 feet in their chilled section up to the size required for the common length of rolls. It will be noticed in the table that for rolls more than 9 inches in diameter, an increase of $\frac{3}{8}$ inch in the thickness of the chill is allowed for every inch increase in diameter of the roll. Thus, in Fig. 24, the diameter d is 18 inches; hence, the thickness e of the

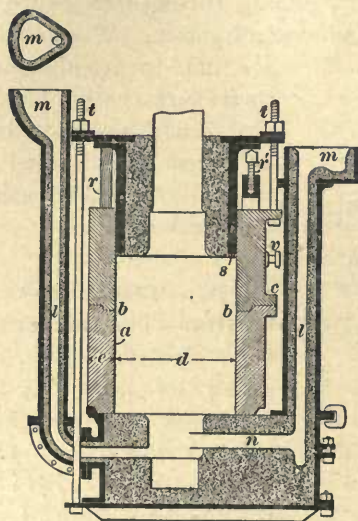

FIG. 25.

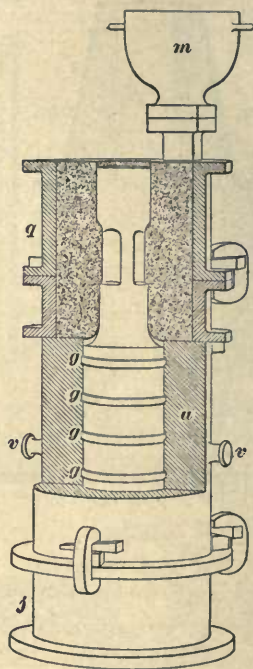

FIG. 26.

chill a is $3\frac{3}{8} + (9 \times \frac{3}{8}) = 6\frac{3}{4}$ inches. In Fig. 25, the diameter d is 14 inches, and, therefore, e is $3\frac{3}{8} + (5 \times \frac{3}{8}) = 5\frac{1}{4}$ inches. If the body of a chill were made too light, the chill would be in danger of cracking when suddenly heated.

30. Preparation of a Mold for a Chilled Roll.

Fig. 24 (a) shows a mold ready for casting; (b) gives a view taken on the line of joint $e' e'$ of view (a). In starting to

TABLE I.

THICKNESS OF CHILLS FOR ROLLS.

Diameter of Roll. Inches.	Thickness of Chill. Inches.	Diameter of Roll. Inches.	Thickness of Chill. Inches.	Diameter of Roll. Inches.	Thickness of Chill. Inches.
4	2	13	$4\frac{7}{8}$	22	$8\frac{1}{4}$
5	$2\frac{1}{2}$	14	$5\frac{1}{4}$	23	$8\frac{5}{8}$
6	3	15	$5\frac{5}{8}$	24	9
7	$3\frac{1}{8}$	16	6	25	$9\frac{3}{8}$
8	$3\frac{1}{4}$	17	$6\frac{3}{8}$	26	$9\frac{3}{4}$
9	$3\frac{3}{8}$	18	$6\frac{3}{4}$	27	$10\frac{1}{8}$
10	$3\frac{3}{4}$	19	$7\frac{1}{8}$	28	$10\frac{1}{2}$
11	$4\frac{1}{8}$	20	$7\frac{1}{2}$	29	$10\frac{7}{8}$
12	$4\frac{1}{2}$	21	$7\frac{7}{8}$	30	$11\frac{1}{4}$

mold such a roll as here shown, the mold board *f*, shown in Fig. 24 (*c*), is first set on solid ground, and the neck pattern *g* of the roll is then put in place as shown; this being done, the section *h* of the flask, view (*a*), is set on the mold board with its projection fitting into the grooves *i, i*, view (*c*), which serve to keep it central. The section *h* being rammed up and a joint having been made, the bottom part *j* of the flask is set on this section and rammed up. The bottom plate *k* being next set on and clamped, the whole arrangement is rolled over, the pattern drawn, the mold finished, the middle section *h* lifted off, and a whirl gate *nn* made as shown in view (*b*).

The molds for both chilled rolls and sand rolls are, as a rule, made in dry sand; the methods of ramming, venting, finishing, blackening, and drying are the same as with all dry-sand molds. The upper neck of the roll is rammed in the same manner as the lower neck.

31. The surface of the chill may with advantage be heated in an oven or by a fire inside the chill to a temperature of from

100° to 200° F. before closing the mold for casting. As a rule, it is advisable to coat the surface of the chill with a thin solution of black lead and molasses water, about $\frac{1}{4}$ pint of molasses to a pail of water, the amount depending, however, on the strength of the molasses. If the solution is too strong in molasses, the fact will be evident by the cracking or checking of the blackening when dried. Care must be taken in using this wash on the surface of chills, since the use of a material that will produce gas may have a worse effect than if nothing were used. Light oils are sometimes used instead of blackening for the surface of chills, but in such cases care must be exercised to have just as thin a coat of it on the chill as is practicable. A heavy coating of oil will create gas, and throw the metal back from the face of the chill as it rises in the mold, the result being rough and cold-shut spots on the surface of the casting, which would condemn it. It is best to have the chills at a warmer temperature than the atmosphere when about to cast.

32. In the molding of chilled rolls, it is always very important to attach whirl gates, such as are shown at *n, n*, Fig. 24 (*b*), so that when the metal enters the mold it will do so with a whirling motion, which will cause all the dirt to gather in a body in the center of the casting, and thus bring it up into the top feeding head and give the chill a face free from dirt. If it were not for such whirl gates, the dirt would be more or less apt to go to the outer body of the casting and form dirt holes or defects that would condemn them.

In making the runner *l* and pouring basin *m*, shown in Figs. 24 and 25, as much care is necessary as in the construction of the mold. They are made of dry sand and then black-washed in the same way as the mold. The projection *p*, Fig. 24, serves to reduce the size of the feeding head at its junction with the neck of the roll, and thus permit its being broken off with a sledge. To insure a more solid casting, the usual practice nowadays is to make the feeding head of the same diameter as the neck of the roll, it being cut off in the lathe when finishing the casting.

The completeness of detail of Fig. 24 will make clear the processes of closing, clamping, etc., in getting the molds ready for casting. The object of the little depressions at o and o' is merely to furnish pieces on the casting about 1 inch deep by $\frac{3}{4}$ inch thick, which may be knocked off to show the depth of chill in the roll before it is accepted or placed in the lathe. In order to free the runner l and basin m , the runner casing is made in sections. The contraction of the casting permits its easy removal from the chill after the cope g has been removed. Chilled castings are generally not removed from their mold until they have cooled down to a temperature below what would show a red heat in the dark; it is better, where possible, to leave them until they are nearly as cool as the atmosphere.

33. Vertical contraction of the body of the roll in cooling has often caused trouble by pulling off the upper neck or else causing invisible cracks that have caused it to break when put into use. Different methods of guarding against this trouble have been adopted. Fig. 25 illustrates the method originated by Mr. John E. Parker, of Beloit, Wisconsin. His plan is to make a cast-iron sleeve s about $\frac{3}{4}$ inch thick, which sleeve is turned on the outside so as to fit easily into the chill to a distance varying from 6 to 20 inches, according to the length of the roll desired. The upper neck of the roll is molded in this sleeve in the ordinary manner. In closing the mold, the height of the neck desired is regulated by placing in position three blocks r or three jack-screws r' . These blocks can be either of iron or wood, their length being made to suit the requirements. The neck mold or sleeve is held in place by bolts t, t . After the mold has been cast, the sustaining blocks r or r' are removed, after which the nuts on the bolts t, t are tightened occasionally so as to compel the sleeve s to follow the contraction that takes place. Of course, the screws are not tightened until solidification begins.

34. Another difficulty experienced in casting chilled rolls and work of similar character (car wheels, for instance)

is in obtaining an even depth of chill all around the outer surface of the casting. This is an item of considerable importance in some classes of work. In Fig. 26 is shown a method used by the Lewis Foundry and Machine Company, of Pittsburg, Pennsylvania, with a view to obtaining a uniformly chilled roll. The principle involved is that as the roll contracts lengthwise, the grooves *g* will compel the casting to remain central in its mold, so that the chill can have the same cooling effect all over the body of the casting. This is further accomplished by grooving or otherwise fixing the parts of flasks or chills that hold the bottom and top necks so that they cannot move from their connections with the chill. The sand is also of a solid, firm character, so as not to allow sufficient burning action to occur to permit the bottom or top necks of the rolls moving out of their position. Fig. 26 also gives a good idea of the formation of chills and of the methods of molding and casting chilled rolls. It also shows how rolls will settle down in contracting lengthwise.

35. Making Chilled Car Wheels.—In casting chilled car wheels, it is desirable to obtain an even depth of chill.

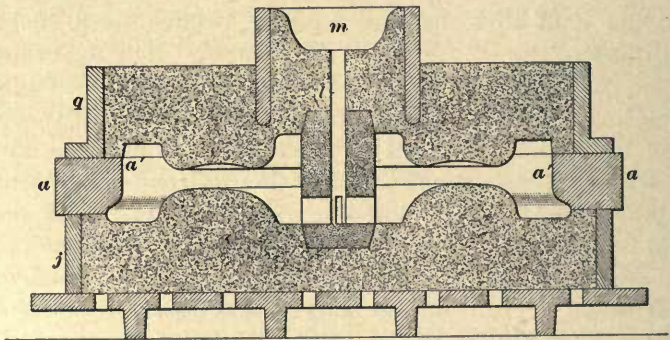

FIG. 27.

To insure this, some use what are called **contracting chills**, which are so constructed that as the wheel contracts, the chill closes in to keep in close contact with the casting;

such a chill has been patented by A. Whitney & Son, of Philadelphia, Pennsylvania. The general practice is to use solid chills, as *a* in Fig. 27, ranging in thickness from 4 to 5 inches. Trunnions are cast on these chills to handle them by; trunnions *v* are also cast on the chill shown in Fig. 26. The cope *q* and nowel *j* are guided centrally with the chill by means of dowel-pins and plates.

The wheels are molded in green sand in the usual way, and are then cast by having metal poured into a basin *m*, which flows into the mold through the gate *l*. In some cases the gates are made at the side of the core in place of through it. The depth of the chill on the tread *a'* of the wheel generally ranges from $\frac{1}{2}$ to $\frac{3}{4}$ inch; it should be very hard, to withstand the usage encountered in railroad service.

36. After the wheels have solidified, they are taken from the mold and put into annealing pits holding eight or more of them. The wheels are left in the annealing pits for 2 or 3 days, after which they are hoisted out and cleaned. This annealing is done for the purpose of relieving the wheel of internal strains and thus prevent its cracking when in use. After the wheels are cleaned, they are then inspected by experts; one wheel is taken out of every batch of fifty and is subjected to standard thermal and drop tests to prove its fitness for acceptance. If the one wheel of the batch stands the test, the whole batch is then accepted. If it does not, another is selected and tested, and if this second wheel also fails, the whole batch is condemned. The casting of car wheels, like that of chilled rolls, has been brought to its present standard of efficiency only after the expenditure of much time, money, and labor on the part of the founder.

CUPOLA PRACTICE.

APPLIANCES FOR MELTING IRON.

CUPOLAS.

INTRODUCTION.

1. Kinds of Furnaces for Melting Iron.—There are two distinct forms of furnaces used for melting iron. One, called a *cupola furnace*, is shown in Figs. 1, 2, 3, and 4; in this furnace the iron and fuel are charged together. The other form of furnace, called a *reverberatory*, or *air furnace*, is shown in Fig. 13 (a) and (b), and in it the iron and fuel are charged in separate chambers. The **cupola furnace**, or **cupola**, is the more convenient and economical one for melting, and is the furnace generally used. While this statement is true in general, there are conditions under which the cupola is less effective than the air furnace. These conditions exist where the strongest grades of cast iron are desired, or where large bodies of scrap iron, such as anvil blocks, pieces of large rolls, or cannon, are to be melted, or where it may be desirable to obtain large amounts of metal at one tapping.

2. Operating a Cupola.—There is much more experience, skill, and care required in melting iron in an air furnace than in a cupola; and failures to melt iron successfully, which are more frequent in air furnaces than in

cupolas, cause considerable extra expense. With cupolas the risks to be run are not so great. If the heat fails to be successful in a cupola, the damage is as a rule very small compared with what it may be in the air furnace. For this reason there is less risk to operate a cupola than an air furnace, and, in fact, with a study of the principles involved in the management of cupolas, any fairly intelligent person should after a little experience become proficient in operating them.

CONSTRUCTION OF CUPOLAS.

3. Form and Dimensions of Cupolas.—The style of cupola shown in perspective in Fig. 1 is constructed of sheet iron ranging from $\frac{3}{16}$ to $\frac{3}{8}$ inch in thickness. It has a wind belt *a*, with openings *b* in the outer casing opposite the tuyeres *c*. By uncovering the holes *b*, a bar may be introduced to clean the tuyeres *c*, or the condition of the inside of the cupola may be observed through small mica-covered openings in the covers of the holes. A drop bottom *d, d* is used for the purpose of emptying the cupola at the end of a heat. Cupolas are usually made from 22 to 100 inches inside diameter, and generally have stacks of the same diameter as the portion below the charging door *e*, as shown in Fig. 1. The top of the stack has a hood *f* that prevents the rain and snow from entering the cupola, and also to some extent prevents the sparks from passing out. Though the majority of cupolas are made from 22 to 100 inches inside diameter, there are a good many that are less than 22 inches; and in the United States there are a few cupolas that are over 100 inches in diameter. Small cupolas are used to melt iron for making tests; they are also used in foundries, such as those making iron bedsteads, where melted iron is required throughout the day, but in such small quantities that cupolas as large as 22 inches in diameter will melt it too fast for the work.

The larger a cupola is in diameter, the higher it can be made. The height of a cupola is generally considered to be the distance from the bottom plate *g*, Fig. 1, to the sill of

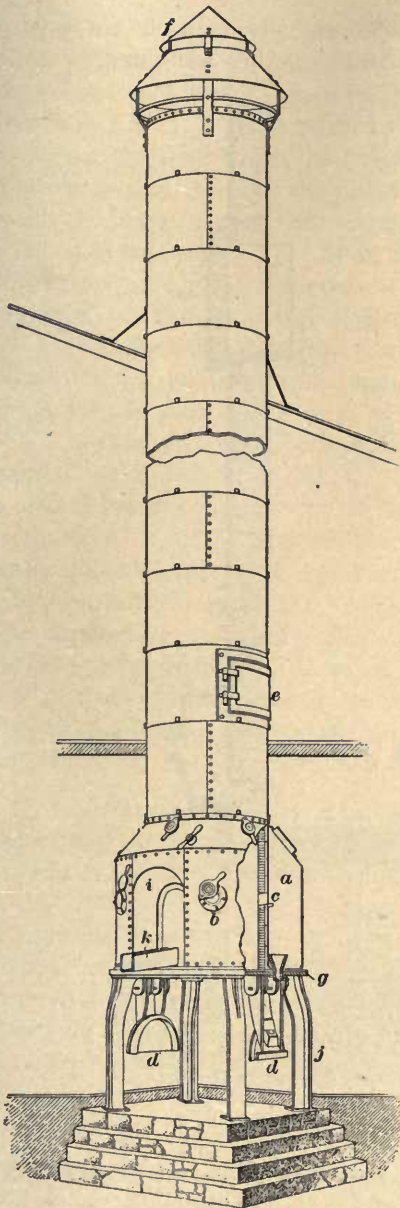

FIG. 1.

the charging door *e*, and, ordinarily, the height to the charging door should be $3\frac{1}{2}$ times the inside diameter for cupolas between 30 inches and 40 inches, and from this up to 60 inches, 3 times the diameter, and so on according to size. The most important part of a cupola is that part below the level of the charging door; that above it is merely for draft and to convey the sparks, gases, and smoke above the roof, so that they may be discharged clear of the building.

The modern tendency is to increase the distance between the tuyeres *c* and the charging door *e*; the advocates of this method claim greater fuel economy and more uniform melting than are secured in cupolas having the charging door located lower.

It is desirable that the interior of cupolas be provided with angle irons *b*, as shown in Fig. 2. These support the firebricks that are used to line the cupola.

in sections, any one of which may be torn out for repairs without disturbing or injuring the other sections.

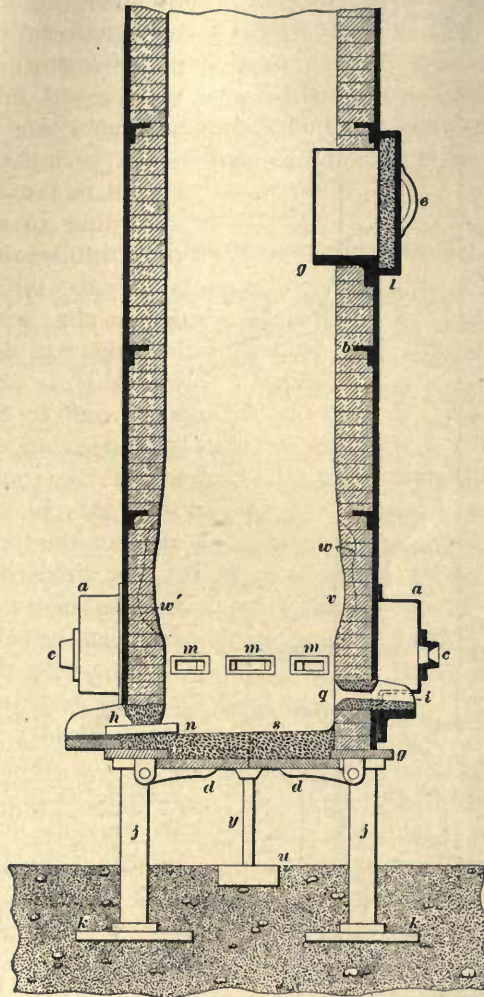

FIG. 2.

4. Wind Belt of a Cupola.—The wind belt of a cupola, shown at *a*, Figs. 1 and 2, should have its cross-section

at least equal in area to that of the tuyeres which are supplied with air through it. The wind belt has openings *b*, shown in Fig. 1, and *c*, shown in Fig. 2, opposite the tuyeres *c*, shown in Fig. 1. These permit the progress of the melting to be watched, and also the tuyeres to be opened by means of a bar passed through the openings, so that the blast may reach the incandescent fuel, should the metal become chilled or the tuyeres closed up. It is well, also, to have the wind belt arranged so that a portion of the side or bottom can be removed to take away any slag or iron that runs through the tuyeres into it. The iron for forming the wind belt may range from $\frac{1}{8}$ to $\frac{3}{16}$ inch in thickness. The wind belt may be cut off, as shown in Fig. 2, or made narrow at the front of the cupola, or it may be built with an opening around the spout *h*, as shown at *i*, Fig. 1. This form of construction is also necessary at the rear of the cupola, where slag holes are located. The foundation plate *g*, Figs. 1 and 2, is generally made of cast iron, and ranges in thickness from 1 to 3 inches, according to the size and weight of the cupola. The supporting columns *j*, Figs. 1 and 2, under the cupola should extend below the level of the floor from 1 to 2 feet and rest on a solid stone or brick foundation, as shown at Fig. 1, or on large and thick iron plates, as shown at *k*, *k*, Fig. 2.

5. Construction of the Charging Door.—The **charging door** of a cupola is sometimes made with a flange *l* projecting inwards about 2 inches around the edge, so that the interior of the door may be lined with firebrick or fireclay, as shown in Fig. 2. Charging doors are also made without any lining for fire protection, and one of the most serviceable charging doors is made of heavy iron-wire screen. Charging doors are hinged, or are arranged to slide vertically by means of chains and counterweights; very large charging doors are sometimes mounted on wheels that run on a track on the charging floor.

6. Tuyeres.—The **tuyeres** are the openings, shown at *c*, Fig. 1, and *m*, Fig. 2, that convey the blast from the

wind belt *a* to the interior of the cupola and are arranged in one or more rows around it. The rows of tuyeres may

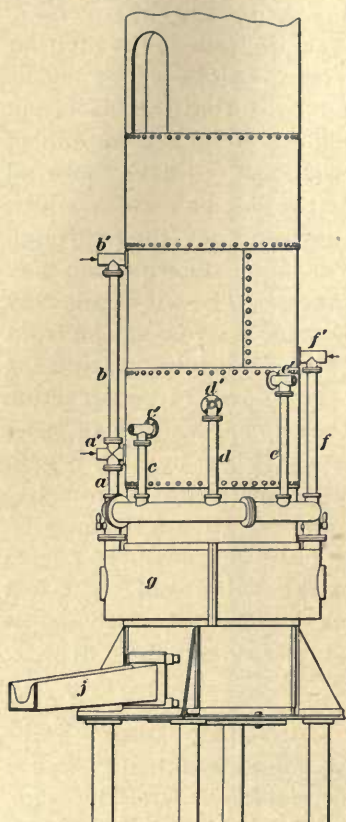

FIG. 3.

be horizontal, or the tuyeres may extend in one spiral row, as shown at *a'*, *c'*, etc., Fig. 3. Coke and coal are the two kinds of fuel generally used for melting iron in cupolas; a cupola designed to use coke for fuel should have a larger tuyere area than one designed to use coal. The larger area of tuyeres for coke melting is necessary because of its greater tendency to chill and also because it burns quicker than coal, and thus requires more air. When the fuel chills at the tuyeres, the slag and metal falling on it chill also, and enter the openings between the pieces of fuel and rapidly close the tuyeres and prevent the air entering the cupola.

Tuyeres have been constructed of nearly every conceivable form, but the rectangular and circular forms are the only ones now generally used. It is a good plan to have the tuyeres widen horizontally from the shell of the cupola to the face of the lining. The tuyeres are sometimes set so as to slope downwards into the cupola to prevent any melted iron from dropping into them. The combined area of all the tuyeres at their smallest section should not be larger than 25 per cent., nor smaller than 15 per cent., of the area of the cupola. This rule includes the upper as well as the lower tuyeres. The longer the cupola is intended to

be in blast at each heat, the larger tuyere area it should possess.

7. Height of Tuyeres.—The height of the tuyeres above the bottom of the cupola is dependent on two conditions; viz., the length of time a cupola is intended to be in blast at each heat, and the greatest amount of iron that may be required at any tapping. The majority of cupolas run from 1 to 3 hours per heat, and the iron is let out either as fast as it melts by having an open tap hole, or by tapping it at short intervals. In cupolas working under the conditions just mentioned, and using coke for fuel, the bottom of the tuyeres can be placed from 10 to 20 inches above the foundation plate, and from 8 to 10 inches when coal is used. Where cupolas are run over 3 hours, or larger bodies of metal are desired at one tapping than can be held in low-tuyere cupolas, then the tuyeres must be placed higher.

The reason that high tuyeres assist in running long heats is that they admit of a greater space below the level of the tuyeres to hold the slag and other refuse matter that comes from the fuel and iron. As an example, cupolas for melting iron at steel works that run day and night for a whole week must have high tuyeres. Sometimes upper tuyeres are used in connection with lower ones, to aid in obtaining long heats.

8. Height and Position of Slag Holes.—In cupolas made to run long heats, the bottom of the lower tuyeres is generally from 30 inches to 60 inches above the foundation plates. This height admits of placing the slag holes, which are for the purpose of drawing off the slag from the melted portion of the charge, 10 inches to 15 inches below the level of the bottom of the lower tuyeres.—This distance of the slag holes below the tuyeres prevents the slag from rising up to a point where the influence of a cold blast can have any effect in chilling it and thus retard its free discharge from the cupola during the process of melting. When the top of the slag holes is placed within 2 or 3 inches of the bottom of the tuyeres, the slag must rise up so close to

the cold blast before it can escape, that it will be chilled or thickened to such a degree that it cannot flow freely from the slag hole. This thickening of the slag at the level of the slag hole, caused by the cold blast chilling it and so preventing its free escape from the cupola, may cause it to rise rapidly to the level of the tuyeres, where it may then be so thoroughly chilled as to completely close the openings between the pieces of fuel about the tuyeres and so allow little or no blast to enter the cupola.

9. Long Heats in a Cupola.—The success of steel works and foundries in running **long heats** depends on the removal of the slag or refuse from the body of incandescent fuel before it reaches a level where the cold blast, as it enters the cupola, has any chilling effect on it. The objections to high tuyeres are that the cupola requires more fuel than one using low tuyeres, since the fuel below the level of the bottom tuyeres is of little value in increasing the heat above the bottom tuyeres, where the melting takes place, and also a cupola having very high tuyeres cannot produce as hot or fluid iron as one having lower tuyeres. Hence, unless high tuyeres are a necessity to give a good position to the slag holes, greater economy in the use of fuel when running small heats and hotter iron can be obtained by placing them as low as possible. In locating slag holes, they should be placed on the side of the cupola opposite to the spout and tap hole and between the tuyeres, so that, should the slag come up sufficiently near the level of the tuyeres to be affected by the blast, it cannot influence its free discharge, as will happen if the slag hole is placed under a tuyere. A slag hole is formed in a cupola by placing a 2-inch round gate stick in a 4-inch to 5-inch square or round hole made in the brick lining of the cupola, and packing damp clay around the stick to form a hole of the form shown at *g*, Fig. 2. A spout *i* is necessary to carry off the slag to a sand basin in the foundry floor, or into a car or ladle. One method to remove the slag is to collect it from the spout in a clay-lined iron box on a truck, a large eyebolt being set in the molten

slag. After the slag hardens, it is lifted from the box by means of a crane and deposited on a car and hauled to the dump.

10. Upper Tuyeres in Cupolas.—Upper tuyeres may be round or square, and are usually placed from 10 to 16 inches above the lower tuyeres; the lower the blast pressure, the nearer to the lower tuyeres should the upper ones be placed. The combined area of the upper tuyeres should be from two-tenths to three-tenths as much as that of the lower tuyeres.

11. Multiple Rows of Tuyeres.—Some cupolas have two or three rows of upper tuyeres, and others have them arranged in the spiral form shown in Fig. 3. Windpipes *a*, *b*, *c*, *d*, *e*, *f*, etc., Fig. 3, convey the air to the upper tuyeres *a'*, *b'*, *c'*, etc. The lower tuyeres receive the air directly from the wind belt *g*. It is best to have some arrangement of valves whereby the blast entering the upper tuyeres can be regulated or shut off entirely, as may be convenient; furthermore, it saves the lining of the cupola if the blast is shut off entirely from the upper tuyeres toward the close of a heat.

12. Advantages and Disadvantages of Upper Tuyeres.—While it is admitted that properly arranged upper tuyeres save fuel and also increase the speed of melting, as well as assist in extending the length of heats, a drawback to their use is found in the fact that they cause the lining of the cupola to burn out faster than when they are not used. Hence, some founders have closed the upper tuyeres of their cupolas in the belief that the tuyeres caused a greater loss of money for daubing clay and firebricks than they saved for fuel. Where daubing clays are expensive, and the linings are cut out badly by the use of upper tuyeres, this may be a good practice to follow. The success in cupola practice does not really depend on the shape of the tuyeres, but on furnishing the cupola with the proper volume of air evenly distributed. This has been done successfully in large cupolas, not by the spiral arrangement of the

tuyeres, but by making the lower tuyere continuous around the entire circumference of the cupola.

13. Center Tuyeres.—In Fig. 4 is shown a tuyere in the center of the cupola, which is a form sometimes used

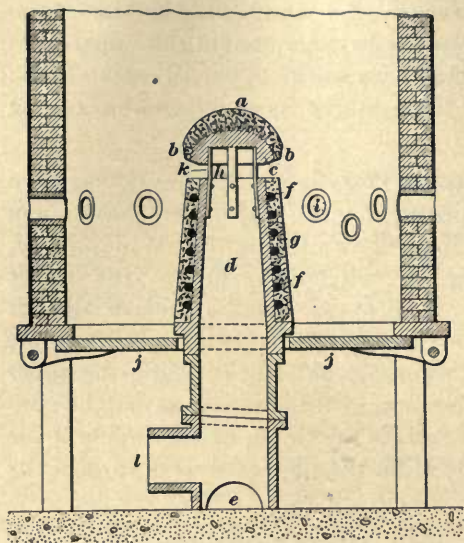

FIG. 4.

in cupolas above 66 inches inside diameter. A center-blast tuyere requires a cap *a*, as shown in Fig. 4, to prevent the iron and fuel from entering it. It is difficult, in using a center tuyere having a cap *a*, to prevent the points *b, b* from being broken by the friction of the charge in descending during the melting operation. To overcome this difficulty, it is necessary to have the iron cap *c* studded with fingers or prickers on its upper surface, which project outwards about $\frac{3}{4}$ inch, and, when daubing the cap with fireclay, to fill the spaces between the prickers full and even, as shown in Fig. 4. The clay, after having been daubed on, should be well dried either by having the cap and body *d* of the tuyere placed in an oven, or dried in the position shown in Fig. 4, by building a small fire at the bottom opening *e*. After the tuyere has been dried before being subjected to the action of great heat, it will require but little clay thereafter to patch and keep it in working order. The body *d* of a center tuyere, shown in section in Fig. 4, is made of cast iron with several rings *f* shrunk on the outside, which hold a coating of from 3 to 4 inches of fireclay *g* daubed on the tuyere to protect it from the heat when melting.

The opening at *h* for admitting the blast to the cupola should be from $2\frac{1}{2}$ to $3\frac{1}{2}$ inches high, and should be located about 4 inches above the tuyeres *i* in the side of the cupola. The opening of the center tuyere, being higher than the tuyeres *i* in the shell of the cupola, serves to promote perfect combustion to some extent like the upper tuyeres in the form of cupola shown in Fig. 3. The center tuyere shown in Fig. 4 is a permanent structure, the drop doors *j, j* being hinged so as to drop away from the tuyere. The cap *a* is supported by iron bars *k* that are fastened to the iron body *d*. The air enters the center of the tuyere through a pipe *l* at the bottom.

LINING CUPOLAS.

14. Laying the Bricks in a Cupola Lining.—In laying the bricks to line a cupola, the closer the joints are made, the better, since the bricks commence to cut or burn at the joints. If the joints are open, the flame and hot gases, under the influence of the blast, get between the bricks, causing a much greater destruction of the lining than if the joints were narrow and close. The bricks should be laid in the best quality of fireclay, which should be thoroughly mixed with water and made thin enough to pour readily from a dipper. Each layer of bricks should be bedded on the clay grouting quickly, before it has time to stiffen. As each brick is laid, it is a good plan to strike it lightly with a hammer, as this brings it to a solid bearing. Instead of using a dipper to spread the thin clay, the bottom and one end of each brick may be dipped into the clay grouting before being laid. Another method is to pour the clay by means of a dipper on the course of bricks that has been laid and then dip one end of each brick for the next course in the grouting and hammer it to a tight joint against the course under it and the end of the brick just preceding it in the same course.

In order to cheapen the grouting, sometimes about 1 part of silica, fire, or other clean sharp sand is mixed with 3 parts

of clay, but this ought not to be done unless the clay is very rich. A clearance of from $\frac{1}{2}$ to $\frac{3}{4}$ inch should be left between the bricks and the shell of the cupola. This space is then filled with grouting made of about equal parts of clay and sand, since the grouting for this purpose does not have to be as strong as that used between the joints of the bricks.

15. Single and Double Lining.—Cupolas are lined either with single or double courses of bricks. It is often better to line with double courses; then, when the inner one burns out, it can be replaced without disturbing the course next to the shell. Also, by having a double lining, the risk of burning through during the process of melting is avoided.

The outer course of bricks may be of a much cheaper or poorer quality than the inner one.

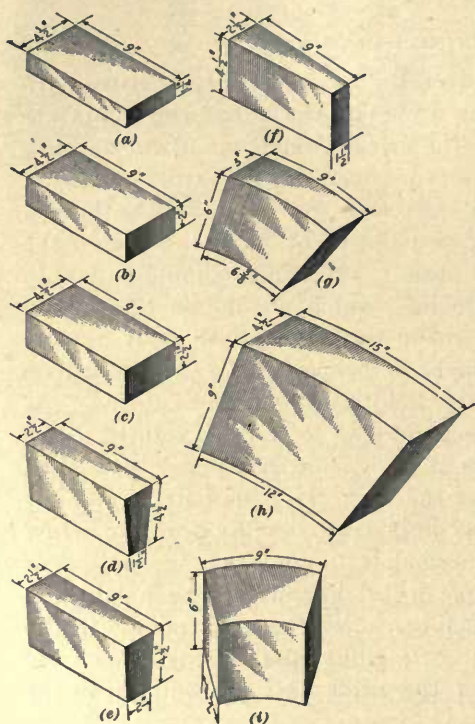

FIG. 5.

called *side-arch bricks*, while the one shown in Fig. 5 (f),

16. Forms of Bricks for Linings.—Fig. 5 shows the common forms of firebricks that are used for lining cupolas. The two bricks shown in Fig. 5 (a) and (b) are called *split bricks*, which are thinner than the regular 9-inch firebrick shown in Fig. 5 (c). The bricks illustrated in Fig. 5 (d) and (e), which taper from edge to edge, are

which tapers from end to end, is called a *wedge brick*. In Fig. 5 (*g*) and (*h*) are shown two sizes of *circle bricks*, and in (*i*) is shown a *block brick*.

When circle bricks or block bricks are used, they should have a radius exactly equal to that of the cupola. In general, the larger sizes of bricks give the best service for the reason that there are fewer joints to be attacked by the flame and heat during the process of melting.

The bricks for the lower portion of cupolas where the iron is melted should be of the best fireproof composition; these are generally softer in texture than the poorer quality of brick. Hard, close, dense bricks do not stand long usage in the melting portions of the cupola. The hard bricks are placed above the melting zone, as they will stand the abrasive action of the iron and fuel better than soft bricks. For the stack, cheap grades of firebrick are used; common red bricks are sometimes used for stacks and also for the outer course in laying the lining in the body.

17. Other Materials for Linings.—A number of attempts have been made to secure a lining that will resist heat better than bricks made of fireclay, and for this purpose silica, ganister, magnesia, asbestos, and carbon bricks are sometimes used. It is claimed that carbon bricks made of fine coke mixed with fireclay having tar for a binder have proved an excellent material to withstand high temperatures. Fireclay bricks are composed chiefly of silica and alumina. The more silica a fireclay contains, the better it will resist a high temperature. Some manufacturers claim that they make firebrick with the silica as high as 90 per cent. and having alumina for a binder. When bricks contain more than 70 per cent. of silica, they are generally very friable and disintegrate readily, and while they will work well in the melting portion of the cupola, they will not last long if placed near the charging door, where they have to withstand the abrasive action of the fuel and iron. Silica is an oxide of silicon, of which white sea sand is an example, and requires the addition of some plastic material as a binder when used

for bricks. Nearly all clays are composed chiefly of silicate of alumina, which, while having a lower melting point than silica, works well when mixed with it. There are other substances besides silicate of alumina in the clay, among which are iron oxides, magnesia, soda, and potash, most of which, to some degree, reduce the durability of firebricks. The silica in firebricks should be of pure quartz or anhydrous silica. The purchaser should have a chemical analysis of the bricks in addition to a knowledge of their physical qualities to assist him in forming an opinion of their durability.

18. Causes of Destruction of Linings.—When firebricks are used for the lining of a cupola, they are gradually destroyed by the action of the heat and flame from the fuel and by the sodium chloride and other alkaline substances in the coke. The bricks are also worn away by the abrasive action of the iron, fuel, and fluxes as they descend from the charging door. A third factor in the destruction of a cupola lining is the pressure of the blast used. A strong blast may prove very destructive to the lining when there is little iron in the cupola or when the charge is not sufficiently close to prevent the blast from passing up between the charge and the lining.

Relining a cupola is expensive work, and too much care cannot be exercised in the purchase and use of firebricks. The life of the firebricks is also greatly increased by proper picking out and daubing up the cupola, operations that are described later on in the text.

19. Drying the Lining.—After a cupola has been lined it should be dried, so as to drive the moisture out of the bricks and grouting as completely as possible before melting iron. If this is not done, the lining will be found burned out much more after the first heat than it otherwise would have been. Drying the lining prevents the great difference in the expansion of the inner and outer parts of the bricks, which would otherwise occur when the surface next to the fuel is suddenly highly heated. The drying process also drives out the greater part of the moisture and

prevents the rapid creation of steam, which, combined with unequal expansion, causes the outer surface of the bricks to spall or flake off when suddenly heated. This effect is greatest at the points of highest temperature and in hard dense bricks. Soft bricks allow the steam to be liberated easier and are also more yielding to differences in external and internal expansion.

20. Starting the Fire for Drying a Cupola Lining.

In starting a fire in a cupola to dry out a new lining, the drop doors *d, d*, shown in Fig. 2, are closed and covered with sand to a depth of from 2 to 3 inches, so as to prevent the heat from warping the doors. This having been done, shavings or other light combustibles are placed on the bottom sand *s*, and over this fine kindling wood is set in an open manner, so as to permit it being kindled easily, and on the top of this fine kindling, heavier combustibles are placed so as to form an open foundation for coke or coal, the charge of the latter fuels being from 12 to 18 inches in depth. The shavings are ignited by means of the red-hot end of an iron rod pushed through the breast of the cupola. After the fire is well under way and the coke burning, more fuel should be added to form a solid bed of ignited fuel about 2 feet deep. Finally, all the draft passages should be closed and the fire left to burn out before dropping the bottom to get the cupola ready for a heat.

21. Treatment of the Lining Before the First Heat.

—After the drying fire has burned out, and the bottom *d*, Fig. 2, is dropped and the cupola cooled off a little, it is a good plan to go over all the surface of the lining with a thin grouting of fireclay, using a handful of salt in the pail of water used to wet the clay. The grouting can be put on with a brush and should be rubbed well into all the joints of the lining. This treatment will help to put a glaze on the face of the lining, which is very beneficial in resisting the cutting out or burning effect of the first heat, which is always harder on the lining than any that will follow. It is also advisable in the case of a new lining to get the second

fire started as soon as practicable after the first, and also to let it burn as long as possible before starting the blast. The shorter the first heat can be made the better, and care should be taken to keep the blast as mild as practicable. By following these directions, the least amount of a new lining will be burned out during the first heat.

CLEANING THE CUPOLA.

22. First Operation in Cleaning a Cupola.—After a heat has been run off in a cupola, the dropping or dump has to be removed. This is either pulled out from under the cupola, at the time the bottom is dropped, or shoveled out by hand 6 to 12 hours afterwards, when it has cooled. The refuse sticking to the lining is next chipped or picked off by using two small hand picks of the form shown in Fig. 6; the first one should weigh about $2\frac{1}{2}$ pounds and the second one about $1\frac{1}{4}$ pounds. The heavier pick is to be used in the rough work, and the small pick for finishing up.

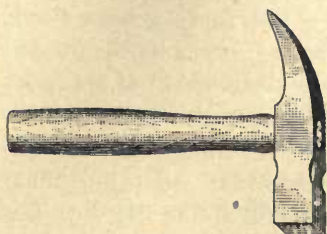

FIG. 6.

the form shown in Fig. 6; the first one should weigh about $2\frac{1}{2}$ pounds and the second one about $1\frac{1}{4}$ pounds. The heavier pick is to be used in the rough work, and the small pick for finishing up.

23. Necessary Precautions in Cleaning a Cupola.

In picking out the refuse, care should be taken not to remove the glaze or cinder coating of the lining. The glaze that a heat or two will create on the surface of the lining will generally protect it as well, if not better, than the daubing. In picking out a cupola, the surface of the melting zone should be kept in as good a form as possible. Any humps that may form above the tuyeres to distort the melting zone from the form shown at *v*, Fig. 2, are very injurious to the lining and to the speed in melting. All such humps, whether hard or soft in structure, should be carefully removed by using the heavy pick for the rough work and the light one to even up the surface.

24. Bunged Cupolas.—Sometimes a cupola, when operated beyond its capacity, or if not properly charged, or owing to some accident, **bungs up** so badly that one cannot enter it to repair the lining. In such a case a hole is made through the center of the bunged portion by means of heavy pointed bars introduced through the charging door. After a hole has been made with the bar, a heavy sledge may be used to knock down the refuse hanging to the lining, and the work may then be finished with the picks, which should be well tempered and sharpened so as to remove the refuse easily and without jarring the glazing of the lining.

MELTING ZONE OF A CUPOLA.

25. The conditions necessary to bring iron to the fusing point are definite and fix a certain place in the cupola as the **melting zone**, or point at which the charge melts. This zone starts from 5 to 8 inches above the top of the tuyeres and extends upwards 10 to 14 inches, according to the character of the fuel, the iron used, the pressure of the blast, and the internal diameter of the cupola, which is enlarged in the melting zone. To obtain the best results in melting, it is very essential to keep the melting zone in proper form. The area of the melting zone should enlarge gradually from the lower edge until it reaches the maximum size, and then contract gradually towards the upper edge of the zone, as shown at *v*, Fig. 2. It is a common occurrence for the melting zone to burn out and have the forms shown by the dotted lines at *w* and *w'*, Fig. 2. Either of these forms will cause bad melting, on account of the depressions being too great. The upper part *w*, being so much larger in diameter than the balance of the melting zone, does not give the descending stock a chance to expand outwardly and properly fill the abrupt depression. The abrupt depression, shown at the lower part of the dotted line at *w'*, often causes the iron to form a bridge over the tuyeres in such a manner that it prevents the charge from descending. The cavity formed at *w* permits the blast to escape up the sides of the

cupola, instead of being spread or forced outwards through the descending charges of fuel and iron, thus causing an escape of heat that should have been utilized in melting the iron. Not only does the escape of the blast in this manner at *w* retard the speed of melting, but it also causes the lining of the melting zone and portions above it to be burned out much more than will occur if the blast is forced through the body of the charge. Also, the more the blast cuts out the lining, the more dirt there is formed in the charge, and this decreases the speed of melting and causes the cupola to become bunged up. Hence, the blast escaping between the charge and the lining of the cupola prevents economy in the use of fuel, and also prevents the cupola from producing hot metal, doing fast melting, and making clean and successful heats.

It is very important, therefore, that the surface of the melting zone form a gradual slope in both directions from the longest diameter at the center, as shown at *v*, Fig. 2, towards the upper and lower edges of the zone, which are of the same diameter as the cupola lining. Not only should the slope be gradual in both directions, but care should be taken to prevent the melting zone becoming enlarged to any great degree; for if this occurs, although the slope may be gradual, the extension in area may be so great that the stock cannot adjust itself to the enlargement sufficiently to prevent too much of the blast escaping between the sides of the lining and the charge. Melters, as a rule, do not give sufficient attention to keeping the melting zone in correct form, forgetting that it is really one of the most important factors in controlling the results in melting.

26. Repairing the Melting Zone.—In repairing the melting zone, care should be taken not to make its diameter less than that of the cupola lining, for this is smaller than it should be and is a condition that may cause the lining to cut out very badly in a single heat. In all cases where the lining has been repaired, it is well to start the fire as long before putting on the blast as possible, so as to give the repaired

part a good chance to dry before the high temperature for melting the iron is reached. The lining above and below the melting zone, if of good bricks and well laid, should last from 9 to 12 months, or more, with a heat every day; and if the melting zone is kept repaired and in proper form, it will remain in good condition for melting iron as long as the rest of the lining.

DAUBING A CUPOLA.

27. General Method of Daubing a Cupola.—The cupola having been picked out to the proper form, the next operation is to fill up all the holes and daub the surface of the melting zone with clay, so as to prevent the lining from being excessively burned out during the process of melting. The material used for daubing should be as refractory as possible. The best materials for this purpose consist of a good grade of fireclay and sharp sand mixed together; the proportions depend on the character of the clay and the sharpness of the sand. The aim should be to obtain a daubing that will crack as little as possible in drying and when subjected to the high temperature when melting the iron. Nearly all kinds of clay will shrink and crack if used alone, but a mixture of sand and clay can be used for daubing that will crack very slightly when drying or when exposed to high temperatures.

28. Mixing the Materials for Daubing.—When the daubing for a cupola is made of clay and sand, they should be mixed together from 10 to 15 hours before using. Both the clay and sand should be dry, and the mixing should be done before the water is added. The mixing of sand with wet clay will not make a good homogeneous daubing, and the clay will crack in spots and some of the sand will be released when the mixture becomes heated, and either of these defects will reduce the value of the daubing.

Some clays are much more plastic than others, so that the amount of sand required to be mixed with them has to be found by trial. Some clays may be so plastic as to require

one-half sand, while others need only one-quarter; and some clays are so friable, possessing little or no plastic qualities, that they will not admit of any sand being mixed with them. A daubing should be so plastic that it will stick together well while being used. The clay should be as stiff as it can be handled, since the stiffer it is, the less moisture or steam there will be to expel during the process of drying. At the very best, the conditions are unfavorable to the escape of

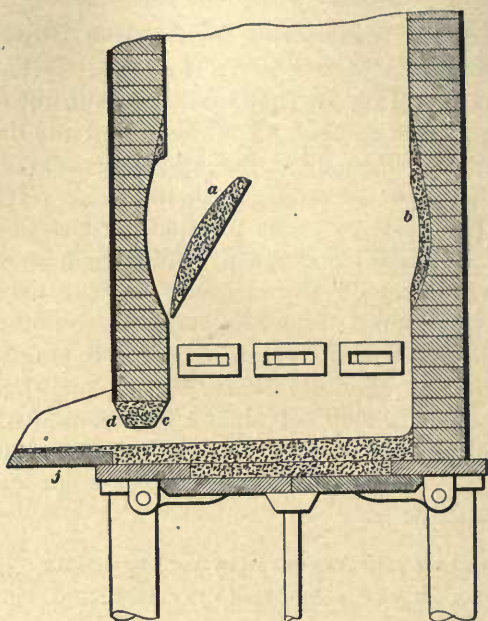

FIG. 7.

moisture or steam from the daubing, and where there is much formed, it will, in escaping, have a tendency to press the daubing outwards from the lining. The surface of the daubing exposed to the fire or blast forms a hard glazed crust through which the steam cannot pass; the steam will then tend to separate the daubing from the lining, often causing it to fall away at the commencement of the heat, as shown at *a*, Fig. 7.

29. Other Daubing Mixtures.—Instead of using fireclay mixed with sharp sand for daubing, some founders use common blue or yellow clay; some of these clays work fairly well when mixed with sharp sand. New molding sand, or loam, wetted with clay wash, or a loam without mixture with any other material, is sometimes used. Where good loam sand can be obtained, it may serve in the place of better material; but molding sand by itself is worse than nothing, as it only dries to a dust, which flakes off and mixes with the fuel and iron, thus clogging the cupola by making slag or dirty metal.

30. Cost of Materials for Daubing.—Fireclay is the best material for daubing, but many founders consider it too costly; but if one takes into consideration the extra amount of slag and the cost of relining the cupola every few months made necessary by the use of a cheap daubing, they will perceive that cheap daubings are the most expensive in the end. In putting on daubings, the smaller the amount used, as a rule, the better. The daubing should rarely be allowed to exceed 1 inch in thickness at any part, as shown at *b*, Fig. 7; this is far better than having the whole melting portion filled out to the level of the cupola lining at the edges of the zone. Many cupola tenders think it necessary to fill out the melting zone even with the rest of the lining. If it is considered that heavy bodies of thick clay cannot be dried thoroughly by a whole day's firing, and that only the surface of the daubing is dried before the blast is put on, it is evident that it is not proper to use thick daubings. In case the lining burns out badly in spots, pieces of firebrick embedded in clay may be used to fill it in, but a lump of wet clay should never be employed, as it is likely to come away from the lining as soon as the blast is started, or in a short time afterwards.

31. Badly Burned Melting Zones.—When the melting zone becomes burned out so badly as to enlarge it 4 inches or more beyond the general lining, thus permitting the blast to escape between the charge and the lining, it should be

repaired in a substantial manner, and its diameter reduced to a dimension not more than 5 inches greater than the diameter of the lining above the melting point. This can often be accomplished by taking split firebricks, about 2 inches thick, shown in Fig. 5 (*a*) and (*b*), which can be obtained of firebrick manufacturers, or may be made by splitting the whole bricks, and bedding them firmly in good clay against the solid lining, thus bringing the melting zone to approximately the form shown at *v*, Fig. 2.

CUPOLA BOTTOMS.

32. Bottom Props.—When the cupola has been daubed, the bottom doors *d, d*, shown in Fig. 2, are lifted up and a prop *y* is placed under them. The doors for cupolas having an inside diameter not greater than 40 inches can be held with one prop, but over this size it is best to have two props. These props are best made of wrought iron, and range in size from $1\frac{1}{2}$ to 3 inches in diameter. It is very important to have a solid foundation under the props, for if there is the least settling of the drop doors after the cupola commences to melt, the iron is apt to break out at the joint of the doors and probably injure the men and cause a loss of a heat and some iron.

33. Foundation for Props.—The foundations under the props may be made of solid iron blocks *u*, as shown in Fig. 2, ranging from 3 to 5 inches in thickness and from 12 to 24 inches square, according to the diameter and height of the cupola. Where the cupola is over 50 inches inside diameter, it is well to have a stone or brick foundation under the plate. In putting up the props, they should be so placed that the supporting columns of the cupola will not be in the way when it is necessary to knock the props down in order to drop the bottom at the close of the heat. After the doors are propped up, it is a good plan to close up all the joints on the inside with soft clay, rubbed in tightly, as this may prevent the bottom sand, when dried, from running out and leaving a hole through which the

metal may run. If there should be small holes in the bottom, caused by former leakage, they should be covered solidly with a piece of plate iron bedded into clay.

34. Quality of Material Used in Bottoms.—The bottom of a cupola is formed of sand, as shown in Figs. 2 and 7. The conditions require a sand that cannot bake so hard as not to drop readily when the doors are opened; the sand must also be of such a character that it cannot be washed away by the action of the blast and the molten metal flowing out of the tap hole. The sand generally used for this purpose is obtained from the gangways in light workshops and the dump-dirt piles of large workshops. This sand is mixed with what may be saved from the cupola bottom of the previous heat. Should this mixture be too weak, clay wash or new molding sand may be mixed with it. It is very important to have the bottom sand of the right strength and dampness, for if it is too strong or too damp, it may give trouble during the heat or when the doors are dropped, and if too weak or too dry, it is apt to be cut away by the flow of the metal or the force of the blast.

35. Preparing the Sand for Cupola Bottoms. The sand having been well mixed and made of the same consistency or temper as green sand for molding purposes, is then passed through a $\frac{1}{2}$ -inch riddle, after which it is shoveled on to the bottom either by passing it through the breast hole *c*, Fig. 7, or through the bottom by having but half of the bottom door in place, or by letting it down from the charging door. When the sand is all in, the cupola man goes inside and spreads it, giving it a proper slope; it is then rammed down firmly with the butt end of a rammer to a hardness similar to that necessary in ramming the nowel of a flat plate casting.

36. Density and Slope of a Sand Bottom.—If the sand is rammed too hard, it may cause the iron to boil when it commences to gather over the bottom, and if too soft, it may be cut by the wash of the metal or force of the blast. After the sand has been rammed, the hand or a

board is used to give it a gradual incline from the back to the front of the cupola, leaving the outer edges higher than the bottom. If the bed is not given an even slope, the hollows or depressions will retain metal, which may make dull iron and cause a waste of metal when the bottom is dropped. When the sand is weak, the bottom may be lightly sprinkled with water from a brush to cause a hard crust to form on the surface of the bed when heated; but care must be taken to use no more than will merely dampen the surface, since if the water goes any deeper it may cause the iron to boil and blow on the bottom, thus resulting in injury to the bottom. The slope given to the bed is very important, and varies, according to conditions, from $\frac{1}{2}$ to 1 inch per foot. When the cupola is a slow melter, or when irons are used that solidify quickly, it is advisable to adopt the steepest slope, for the reason that it causes the iron to collect quickly at the breast in a hotter state than if it had to dribble slowly over the bed before reaching it. While this is true, the slope should not be made any steeper than necessary, since the steeper the slope is made, the swifter the metal rushes out of the tap hole, making it difficult to stop up. In finishing up the bottom, it is a good plan to dig out a little sand back of the tap hole and replace the regular bottom sand with some good strong new loam sand or clay. This will serve as an aid to prevent the action of the tapping bar from cutting up the bottom immediately inside the tapping hole.

MAKING THE BREAST, TAP HOLE, AND SPOUT.

37. Dimensions of the Breast, Tap Hole, and Spout.—The hole for forming the breast or front, shown at *c*, Fig. 7, is generally about 6 inches wide by 8 inches high, and is left open to give draft to the cupola until the fire is well started. When all is ready to put in the front, the breast hole is brushed out clean on the bottom and is slightly wetted with clay water, after which a handful of wet clay is rubbed on the bottom and a $\frac{3}{4}$ -inch to $1\frac{1}{2}$ -inch

rod *n*, shown in Fig. 2, is bedded into the clay on the level of the bottom. Pieces of coke 3 or 4 inches long are coated with clay and placed about the stick *n* until the breast hole is completely and solidly filled, after which the stick *n* is withdrawn and the face of the breast and the tap hole dressed with clay. The coke expands when heated and forms a tight and durable breast. Sometimes the breast is made by fitting a piece of board in the breast hole flush with the inside of the cupola lining, and then ramming clay into the hole against the outside of the board and around a stick. After the breast has been filled, the front is cut away so as to reduce its thickness at the tap hole, as shown at *d*, Fig. 7. This is done to make the length of the tapping hole as short as possible, since a long tapping hole causes the metal to chill in it, which may cause trouble during the first tapping and often during the whole heat. In cutting out the breast to shorten the tapping hole, the slope from the face of the cupola to the tap hole should be gradual, as a very abrupt slope adds to the difficulty in tapping and stopping.

38. Materials Used in Making the Breast.—The material used in forming the breast should be of as refractory a character as possible, the best material being a mixture of fine clay and sharp sand, such as used in daubing the melting zone of the cupola; the next in order of value are good grades of blue or yellow clays. Some melters try to make the breast with molding sand wetted with clay, but this material is likely to give trouble, especially in long heats. In lining the cupola spout shown in

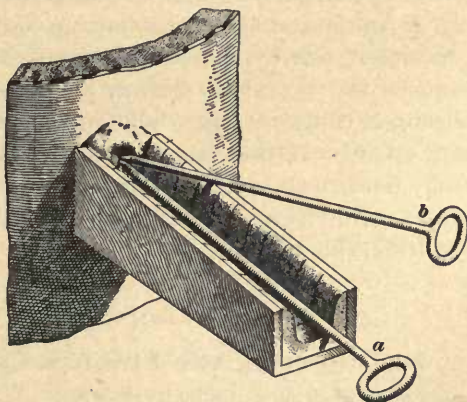

FIG. 8.

Fig. 8, the same material may be used as for making the breast. After the breast and spout are formed, the rod *n*, shown in Fig. 2, for forming the tap hole is pulled out, and some live coals are shoveled in the spout and against the breast to assist in drying them. This is continued up to the time the blast is put on, the heat of which is generally sufficient to leave the tapping hole in fair shape for its work; but where it can be done, it is best to let the iron run from 5 to 20 minutes before stopping up. This can be done best in large cupolas that have large ladles for taking away the metal.

39. Use of Clay Cores for Tap Holes.—Some founders place clay cores that have been dried in an oven, and have a tap hole formed in them, in the breast of the cupola. These are kept on hand, and when placed in the breast holes, clay is rammed around them. This plan works very well, since it insures a dry hole for the metal to run through. Where the metal runs steadily out of a tap hole, a smaller hole can be used than where it has to be let out at intervals. When it is necessary to stop it up every now and then, the hole should not be larger than is actually necessary, since the larger the hole, the more difficult it is to stop it up. In forming the spout, its bottom should be made small in diameter, not to exceed 4 inches; for when made wide, it causes the metal to spread, and then the metal not only becomes dull, but has a tendency to wash over the sides of the spout. If this latter accident should happen, the iron may be thrown by the moist sand in such a way as to injure the men in front of the cupola, or it may cause the loss of considerable metal.

CHARGING CUPOLAS.

40. Starting the Fire in a Cupola.—In building a fire in a cupola, some light combustible, such as dry shavings, oiled waste, charcoal, or straw, is passed through the charging door to the bottom of the cupola. On top of this, dry soft kindling wood is placed in such a manner as to catch

fire readily, and over this, heavier wood is placed. The amount of wood required will depend on its character and that of the coke or coal used. All that is necessary is to have sufficient wood to set the coke or coal burning rapidly, and any more than this only fills up the cupola with ashes and prevents the coke or coal settling down in such a manner as to give proper support to the iron when it is charged. Care is necessary in selecting the kindling wood to have it well dried and of as soft a quality as possible. The coke or coal should be of medium size, as too small a fuel will choke the fire and too large lumps will require too much kindling, besides taking too long to get the fire kindled.

41. Charging the Fuel in a Cupola.—In charging the fuel, about one-half the amount required for the bed is first put on before the fire is started. When this burns up brightly, one-half of the remaining portion of the fuel is shoveled in, and when this is fairly under way, the rest is charged. As soon as the fuel burns up evenly, it is ready for charging the iron; but before this is done, it should be remembered that the bed of fuel must be thoroughly afire all around the sides, as any neglect of this may cause the cupola to give poor results all through the heat. It is not uncommon to have ladles choked up, castings lost, or the bottom of the cupola dropped, before the heat is finished, simply because the bed of fuel was not thoroughly afire before starting to charge the iron. The time required to kindle the fire to get it in good condition for charging the iron generally ranges from 2 to 3 hours in large cupolas. Coal requires a longer time than coke, and wet fuel a longer time than dry. It is bad policy to let the bed burn longer than is necessary to get it well started, as this only results in a loss of fuel.

42. Use of Blast.—Some founders arrange to have the cupola charged and the blast on in from 1 to 2 hours after first starting the fire. This necessitates the use of a light blast on the fuel to hurry the fire. This should not be done if it can be avoided, as the bed ought to kindle gradually of

itself, with merely the draft that the open breast and tuyeres give it; these can be closed should the fire burn too rapidly. Letting the fire burn with natural draft and occupying 2 or 3 hours in burning up ready for charging affords time to bring the walls of the cupola to a temperature agreeing more nearly with that of the fire, and is a factor that is not only beneficial to the lining, but also aids in giving better results in taking off the heat. Those that have a uniform, well-kindled fire before charging the iron, combined with a good breast and tap hole, will have the least difficulty in running off a successful heat.

43. Amount of Charge.—The first considerations that present themselves in commencing to charge a cupola are: How much fuel should be used on the bed, how much between the charges of iron, and what weight of iron should be in the charges. The amount of fuel in the bed depends largely on the height of the lower tuyeres. With anthracite coal it will require a height of from 12 to 16 inches above the top of the lower tuyeres. With coke, a height of from 18 to 24 inches is required; which means in both cases a bed of solid fuel well ignited before commencing to charge the iron. In weight, it requires from 10 to 20 per cent. more of hard coal than good coke. The specific gravity of coke being less than coal, a given weight of it will stand higher above the tuyeres, but coal will sustain a heavier burden than coke, due to its being a more solid, dense fuel. Hardwood charcoal and gas-house coke have been used for melting iron; the ratios being about 1 of charcoal to 3 of iron, and 1 of gas-house coke to 4 of iron. Of recent years these fuels are little used.

44. Influence of Height of Tuyeres on Weight of Charge.—Owing to the great variation in the height of the tuyeres, it is impossible to lay down any fast rules that can be applied to determine the weight of the first charge of iron in reference to the weight of fuel in the bed. Again, the ratio of iron to fuel depends on the character of the iron used; thus, a greater weight of light pig or scrap can be

used than if heavier pieces of iron were charged. The following will give an idea of the weight of iron to charge: Starting with a 10-inch cupola, charge 300 pounds of iron on the bed; then, for every increase of 2 inches in the internal diameter of a cupola, add 300 pounds of iron on the bed. This will give a 30-inch cupola a first charge of iron weighing 1,800 pounds; a 40-inch cupola, 3,300 pounds; a 50-inch cupola, 4,800 pounds; a 60-inch cupola, 6,300 pounds; a 70-inch cupola, 7,800 pounds, and an 80-inch cupola, 9,300 pounds. These weights may often be increased from 10 to 30 per cent., but it is best to start with the figures given above and gradually increase the burden until the best weights are ascertained by actual test. As a rule, the weight of the iron charged on the bed is heavier than that in the succeeding charges, although, where a uniform mixture is used throughout the heat, some founders make all succeeding charges equal in weight to that of the first charge.

45. Amount of Fuel Between Charges of Iron.

The next consideration is how much fuel it is necessary to place between each of the succeeding charges of iron. As an approximation, it can be said that the amount of fuel between charges should average about 10 per cent. of the weight of the charges of iron, a little more coal being required than coke. The idea involved in placing fuel between the charges of iron is to keep the height of the bed by means of the descending fuel up to the thickness existing when the first iron commences to melt. In watching this point carefully, the melter may be able in some cases to do with less than 10 per cent. of fuel between the charges. In ascertaining the percentage of fuel used to melt the iron, all the fuel consumed in the bed, as well as that used between the charges of iron, must be considered.

46. Ratio of Fuel to Iron.—If 5 tons of fuel melt 50 tons of iron, the melting ratio is one of fuel to 10 of iron, which is about as small a ratio of fuel as can be used to get good hot iron; and to get this ratio, the best conditions must prevail. It is rarely wise to be sparing in the use of fuel, as

the least mishap, by uneven charging or from an unsteady blast, may result in giving dull iron, causing a loss in bunged-up ladles and bad castings at one heat that may more than balance the cost of fuel that could be saved during a month's melting.

The general average of cupola practice is to use ratios of from 1 to 6 up to 1 to 8 with good coke, and from 1 to 5 up to 1 to 7 with hard coal, the former being required to melt iron for light work, or that requiring hot iron, and the latter for heavy castings, or where the work does not require the hottest metal. In charging fuel and iron, they should be weighed, so that the amount of material being used may be known. Too many founders charge the fuel and iron by guesswork, but uniform results cannot be expected from this practice. Each pile of iron or scrap as it is brought to be charged should be weighed and a record kept of what goes into the cupola; and the same should be done with all the fuel and flux that may be used. The fuel is weighed either before coming on the staging to be charged into the cupola by a fork or shovel, or else it is measured in barrels or baskets and dumped from them into the cupola. Whatever way it is done, the exact quantity being used should be known definitely.

47. Effects From Too Much or Too Little Fuel.

If too little fuel is placed between the charges of iron, the bed as it is consumed will finally lower itself to the level of the lower tuyeres. The nearer the bed approaches this level, thus falling below the proper height, the more dull the iron becomes, and eventually it results in stopping the iron from melting. If too much fuel is placed between the charges, it will raise the bed above the proper height and the iron above the melting zone, which results in causing slow melting, and may finally stop the melting until the bed burns down to the proper height, but a high bed will produce hotter iron than a low bed. The best height at which to maintain the level of the bed varies with different cupolas, and is regulated by the area and form of the tuyeres and

their connections, as well as by the pressure of the blast. If the size, form, etc., of the tuyeres and their connections are fixed, the height of the bed may be varied by changing the pressure of the blast; the greater the pressure, the higher the point at which the melting takes place.

48. Indication of Correct Charging.—Whether a cupola is being handled to the best advantage or not is shown by the fluidity of the metal and the speed of melting. The fluidity of the metal and the speed of melting are regulated in accordance with the indications by varying the weight of the charges of iron. If the iron becomes duller near the latter end of the charge than it was at the first, it is evidence that the charge of iron is too heavy, and if such heavy charges of iron are continued, the result will be dull iron for the balance of the heat. If the iron comes down hot, with an increase of speed in melting at the end of each charge, it is evidence that the charges of iron are too light or the charges of fuel too great. It must be understood that these conditions hold even though the proper height of the bed of fuel is maintained in the melting zone by the descending charges of fuel. When the best weight of charge is known and used, the speed of melting, as well as the degree of fluidity of the metal, will be uniform. Where the cupolas are run continuously without tapping or stopping up, variations in the weight of the charge will produce the greatest changes in the fluidity of the metal.

49. Methods for Charging Heavy and Light Irons.—The charging of fuel and iron is generally done by hand. In throwing pig iron into a cupola, it is best to place the ends toward the lining as much as possible, though it is of much greater importance to have the charges level. For cupolas under 50 inches and over 30 inches inside diameter, it is necessary to have the pigs broken into two pieces, and for cupolas under 30 inches, the pigs should be broken into three pieces. When the pigs are long in proportion to the diameter of the cupola, they are very apt to wedge themselves in such a way as to hold up the charge, and, consequently,

do not permit the even and systematic charging necessary to economical use of the fuel and good melting. In charging iron, it should be dropped as gently as possible on the top of the bed, since throwing it in carelessly may cause it to injure the lining, thus creating slag; or it may embed itself in the fuel in such a manner that it disturbs the regularity of the charging. The iron should be charged as closely together as possible, in order to prevent the escape of heat up the stack.

The largest pieces of iron should be placed on the fuel and the smallest on top; the pieces will then melt simultaneously and so come down together and give a more uniform mixture. This is true in making mixtures of pig iron and scrap, as well as mixtures made with pig iron only. The heavier the iron used, whether pig iron or scrap, the more fuel will be required and the slower it will melt. When very large pieces of scrap are to be melted, they should be put in the second or third charge according to the size of the cupola, for if very heavy lumps are placed on the bed, they are liable to sink to the level of the lower tuyeres or even to the spout, before being melted; they may even clog up the cupola and stop the progress of the melting.

50. Charging Different Grades of Iron.—It often happens that foundrymen are called on to make castings of several different grades or brands of iron at one heat. Some of the castings may be made of very soft iron, while others will require hard iron. In such cases it is best to endeavor to place a charge of medium-grade iron between the charge having the soft iron and that having the hard iron. Then, if some of the medium-grade iron does melt down and mix with either of the extremes, it will not result in as much harm as if the extremes had melted together. If they show a tendency to mix, it is well to separate the charges farther apart by introducing a thick charge of fuel, so that the first one will all melt down before the second charge reaches the melting point. If there is doubt of this method not working successfully, the special grade

may be melted down by itself without any mixture, and when all this has come down, the blast may be shut off and the bed recharged with fuel to the original height; the next extreme of iron may then be charged and the melting proceeded with in the usual manner. Both of these methods will require much more fuel than is needed for a uniform grade of iron throughout the heat; but they are convenient for achieving special results. Whatever method may be employed in charging, the feature to be observed is to always exercise the greatest care to charge both fuel and iron in as even a manner as possible.

51. Irregular Charging.—When more fuel is placed on one side than on the other, or when the iron is not level at the end of the charge, very unsatisfactory results may be expected. Irregular charging may not only cause dull iron, but also result in clogging up the cupola to such an extent as to stop the process of melting entirely. After a cupola is once filled to the charging door, it should be kept full until all the iron for that heat is charged, for by keeping the cupola full it not only utilizes the heat better, but also keeps the gases and flame from affecting the men doing the charging.

SLAGGING A CUPOLA AND FLUXES USED.

52. Principle of Fluxes.—Where heats are of long duration, or where dirty or burned iron is used, it is necessary to use a *flux*, and to make special provisions for the slag by means of fluxes. The **fluxes** are materials that are lighter than iron, and that when melted in a cupola will float on the liquid iron and absorb and liquefy the non-metallic residue of the iron and the ash of the fuel, so that these may be discharged from the cupola through a slag hole *g*, shown in Fig. 2. When this refuse remains in the cupola, it soon becomes so great in bulk as to fill up much of the space required for the fuel. The longer the heats or the dirtier the iron, the more fluxing and slagging out are required.

53. Importance of Fluxes and Slagging.—A great many foundries have fine floor scrap, *shot iron* from tumbling barrels, and gates with the sand on, which, when charged with other iron into the cupola, create more or less residue that, if not carried off, will remain in the cupola and clog it up rapidly. Where such materials have to be charged with the regular grade of scrap and pig iron, the cupola will need to be slagged out more frequently. The capacity of a cupola is so greatly increased by fluxing and slagging that some cupolas, which could not otherwise be run for over three or four hours, can be kept in blast day and night for a whole week when properly slagged.

54. Kinds of Fluxes.—The substance used as a flux usually consists of a carbonate of lime, which is found in the form of limestone, oyster shells, clam shells, calcite, chalk, marble spalls, and dolomite; spar, fluorspar, feldspar, and magnesia are also used for fluxes. The weight of flux necessary is dependent on the character of the iron and fuel, also on the kind of the flux used. With limestone, the richer it is in lime, the less there will be required. The weight of limestone required to make a fluid slag may range from 50 to 80 pounds per ton of iron charged. Where the scrap is cleaned, and sandless pig iron and a good class of fuel are used, so as to leave a low percentage of residue, 30 to 50 pounds of good limestone per ton of metal may be sufficient to make a fluid slag. It is generally necessary to experiment with the flux in order to ascertain the best percentage to use.

Marble spalls are chippings from marble quarries, and are, as a rule, of purer limestone than the other forms. The amount required is nearly the same as that of limestone. Fluorspar is a most excellent flux and surpasses limestone, shells, or marble in producing a good slag, and also does not change the character of the iron. The objection to fluorspar is its cost, especially to those foundries situated at a distance from the mines. Fluorspar is sometimes mixed with other fluxes. Some foundrymen claim that fluorspar attacks the lining and hastens its destruction.

55. Composition of Limestone Fluxes.—The elements of the slag combine with the oxide of silica that comes from the oxidation of the silicon in the iron, and also combine with the oxide of manganese that comes from the manganese in the iron, and which, if very high in quantity in the iron, will carry off considerable sulphur from the fuel into the slag. In Table I is shown the composition of three samples of limestone fluxes. Those shown in columns 2 and 3 are the best, because of their freedom from sulphur. The limestone given in column 1 is very hard and of a dark color, and is a grade chiefly used for blast furnaces, although it also works well in cupolas. It is obtained at Newcastle, Pa.

TABLE I.

COMPOSITION OF LIMESTONES.

	I.	2.	3.
Silica.....	3.00	1.980	.54
Iron oxide.....	.92	.600	.12
Alumina.....	1.25	.900	.36
Phosphorus.....	.02	.037	
Sulphur.....	.02		
Carbonate of lime.....	92.10	82.850	98.78
Carbonate of magnesia	1.26	13.040	
Lime oxide.....	51.57	46.410	55.32
Magnesia oxide.....	1.63	17.230	

56. Charging the Flux.—The charging of limestone or any other flux is generally done by placing it on top of the iron, although it is often charged on top of the fuel or mixed with the iron and fuel; placing it on the iron is generally the best plan, since it then leaves the fuel more compact and in better form to sustain the iron. In using limestone, it should be broken into small pieces about the size of eggs, and should then be spread evenly over the charge;

oyster shells or clam shells are used without breaking, and the weight of shells required is about the same as that of limestone. When shells are first charged, they make a crackling noise and throw off flakes that cause some waste, but not sufficient to be excessive. The limestone given in column 2 is of a much softer quality than that in column 1, and is also more white and clear. It is known as Kelly Island limestone, and is mined at Kelly Island, Ohio. Column 3 gives the analysis of a grade that is softer and purer than either of the others, and has somewhat the appearance of marble. It is called calcite, and is obtained from the Benson mines, New York.

57. Quantity of Flux.—Whether the flux used is sufficient in quantity or not is generally shown by the fluidity of the slag, which should be as fluid as practicable. If it does not run freely, it is due to one of two causes: Either the cupola is running cold on account of poor combustion, or else there is not sufficient flux being used. A very great excess of limestone flux will also make a dull slag. When the slag is not sufficiently fluid, it runs out so sluggishly that it is very liable to pile up in the cupola to the level of the tuyeres. If this occurs, the cold blast will chill the slag, clogging the tuyeres, and the melting will be retarded or stopped entirely.

58. Necessity of a Free Slag.—It is very important to obtain a good free slag, i. e., one that is fluid, so as to prevent it piling up any higher than the slag hole. If the slag does pile up, the cupola would be far better off if no flux had been used, as its use only increases the amount of material that must be removed in order to successfully continue melting. In fact, if a cupola can be made to run free and clean to the end of the heat without using a flux, it is only a waste of money to use it, since, besides the cost of the flux itself, it also requires some fuel to melt it. Furthermore, it increases the loss of iron, as slag contains 3 to 6 per cent. of iron chemically combined with it, and also carries off small particles of iron that are

mechanically mixed with it. Besides, it costs considerable to haul away the slag from the cupola and the yard, for, as a rule, 20 to 70 pounds of slag are created per ton of iron melted when using a flux.

59. Methods of Slagging.—When cupolas require slagging out, the flux is not to be charged until the cupola is filled to the level of the charging door, or until it has been melting for about $\frac{1}{2}$ hour. In slagging out a cupola, some cupola tenders open the slag hole as soon as they think there is any accumulation of slag, and leave it open during the remainder of the heat, while others will close it after every tapping, leaving it closed until the melted iron brings the slag again up to the slag hole. The latter method is largely a matter of guesswork, and if the slag should rise above the slag hole to the level of the tuyeres, it may do much injury. It is a much safer plan to leave the slag hole open after it has been tapped. In either case, the slag hole will require watching; for, should any lump of fuel or chilled slag become fast in it, the slag might rise to the level of the tuyeres. If the slag is running thin and hot, the danger from it is less than if it were thick and sluggish.

FUEL COMBUSTION IN CUPOLAS.

60. The Blast.—In order to melt iron rapidly, it is necessary to force air into the cupola. This forced air is called the **blast**. It is claimed that 30,000 cubic feet of air, measured at atmospheric pressure and 62° F., is consumed in melting a ton of iron. This amount of air weighs 400 pounds more than the ton of iron that it assists to melt. Air consists chiefly of two gases, nitrogen and oxygen, which have the weight and volume given in Table II. The column headed Volume gives the percentage of each element in the air by volume, and the column headed Weight gives the percentage of each element by weight. One cubic foot of air at 32° F., and at the pressure of the air at the sea level, weighs .08 pound.

TABLE II.
COMPOSITION OF AIR.

	Volume.	Weight.
Nitrogen.....	79.19	76.99
Oxygen	20.81	23.01
Total	100.00	100.00

61. Combustion.—The oxygen of the air, when combined with the carbon of the fuel, creates **combustion**. The nitrogen does not aid combustion, but is an inert gas that dilutes the oxygen and carries off some of the heat. It requires 2 atoms of oxygen to produce the complete combustion of 1 atom of carbon. When the hot carbon combines with the oxygen of the blast entering the cupola, the result is perfect combustion, if the above proportion be steadily maintained; but this is not practicable in a cupola.

62. Heat from the Combustion of Carbon.—Since oxygen and carbon are the chief factors necessary to support combustion, it is important to note their influence in obtaining *perfect* combustion. One pound of carbon combined with the necessary oxygen to form carbonic-acid gas, which consists of 1 part of carbon, *C*, and 2 parts of oxygen, *O*₂, or *CO*₂, develops 14,500 units of heat. The specific heat of cast iron is about .13, and the average melting point may be taken as 2,200° F. If foundry coke containing 86.96 per cent. carbon, as shown in Table V, be used, then the theoretical amount necessary to heat 1 ton of cast iron (2,240 lb.) from 60° F. to 2,200° F., not allowing for any losses, is

$$\frac{(2,200 - 60) \times 2,240 \times .13}{14,500 \times .8696} = 49.5 \text{ pounds of coke.}$$

One pound of carbon burned to carbonic oxide, which consists of 1 atom of carbon, *C*, and 1 atom of oxygen, *O*, or *CO*, gives out only 4,400 heat units. The amount of

coke under these conditions necessary to melt 1 ton of iron is

$$\frac{(2,200 - 60) \times 2,240 \times .13}{4,400 \times .8696} = 162.9 \text{ pounds.}$$

As a matter of fact neither of these conditions prevails alone. The combination of the carbon with the oxygen of the blast produces carbonic-acid gas, CO_2 , at a point a little above the tuyeres, and this gas in passing up through the fuel heated to incandescence takes up more carbon and is converted into carbonic-oxide gas. This will again change to carbonic-acid gas if more air is admitted to it. The analysis of the escaping gases shows that about one-half of the carbon goes off as carbonic oxide and is incompletely burned. It must also be remembered that additional heat is necessary to melt the iron after it is raised to a temperature of $2,200^\circ$ F. and that neither of the above calculations takes into account the latent heat of fusion of iron. As the calculations are only intended to compare the two conditions of combustion, this will not make any difference. This extra heat does not increase the temperature of the iron, but its energy is used in changing it from a solid to a liquid state. Clement's experiments show that it requires over 500 heat units to raise the temperature of 1 pound of cast iron from 62° F. to the melting point and to continue the heat until the molten condition is reached. The amount of coke for complete melting in the theoretical furnace is $\frac{2,240 \times 500}{14,500 \times .8696} = 89$ pounds when the carbon is burned to carbonic-acid gas, and 294 pounds when burned only to carbonic oxide.

Allowances must be made for various losses. Generally they are as much as 10 per cent. for moisture in the coke, 10 per cent. for radiation of heat through the lining, and 20 per cent. for loss of heat from the top of the cupola, or fully 40 per cent. in all; so that in practice most foundrymen consider the melting of 1 ton of iron with 200 pounds of fuel, or a ratio of 1 to 10, as good work.

63. Pressure and Volume of Blast.—The best pressure and volume of blast for cupola work are largely

dependent on the character of the fuel used. Coal requires a pressure from one-fourth to one-third greater than coke, owing to its being a more dense fuel. The volume of air that each fuel consumes is about the same. The necessity of a greater pressure for coal than for coke results in a greater loss of heat when using coal. It is desirable that the blast be as strong and the volume of air blown into the cupola be as great as can be utilized to good advantage. However, too great a blast pressure only serves to cut out the lining of the cupola and reduces the fluidity of the metal.

TABLE III.

PRESSURES AND VOLUMES OF AIR FOR CUPOLAS.

Inside Diameter of Cupola. Inches.	Melting Capacity Per Hour. Pounds.	Cubic Feet of Air Per Minute.	Pressure in Ounces of Blast.
22	1,200	324	5
26	1,900	507	6
30	2,880	768	7
35	4,130	1,102	8
40	6,178	1,646	10
46	8,900	2,375	12
53	12,500	3,353	14
60	16,560	4,416	14
72	23,800	6,364	16
84	33,300	8,880	16

64. Blast Gauges.—Sometimes cupolas are equipped with **blast gauges** for the purpose of measuring the pressure of the blast. This is a very good plan for cupolas in which the tuyeres are kept open; but when this is not done, a blast gauge is not of much value in showing the amount of air that enters the cupola. This is due to the fact that if

the tuyeres become stopped up, it causes a greater pressure of the air in the outer pipes than exists in the interior of the cupola. By observing the speed of the blower, the rate of melting, and the force of the blast at the charging door, a knowledge of the volume and pressure of the air being utilized in the cupola can be obtained. The volumes and pressures of air for cupolas ranging from 22 to 84 inches in diameter, and their melting capacities per hour, are given in Table III, which is compiled from the results of numerous tests made by a prominent manufacturing company.

TAPPING OUT A CUPOLA.

65. Precautions Necessary in Tapping.—Tapping is, as a rule, the most hazardous part of cupola work, for if a cupola tender does not understand his business, or goes about the work carelessly, he is very liable to be burned. The tools used for tapping consist of round bars of iron or steel ranging from $\frac{5}{8}$ to 1 inch in diameter, and from 3 to 12 feet in length. The longer bars are generally used where the ladles are placed under the spout in such a manner as to prevent the cupola tender from standing near the tap hole. Where the conditions permit the tender to stand near the spout, bars 3 to 5 feet long are used. Tapping bars should be pointed at one end, so that they can easily pick out any obstruction in the tap hole.

66. Tools for Tapping.—It is well to have three or four tapping bars constantly on hand, for at any time the

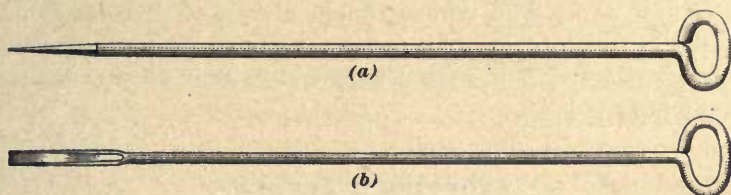

FIG. 9.

metal may come rushing out against the point of the bar, even before the hole is fully opened, and burn away the

point of the bar and greatly injure its utility. A pointed tapping bar is shown in Fig. 9 (*a*), and a chisel bar at (*b*). If the tender finds himself without bars to complete the tapping, the iron may run into the tuyeres and cause great damage before he can find a suitable bar. Some of the extra bars should be made of steel, having their points of a chisel shape and well tempered, as there are times when a tap hole may clog up so firmly that it will require good pointed bars and a sledge to open it.

67. Method of Tapping.—In tapping, the bar should never be driven straight into the center of the tap hole after the manner shown at *a*, Fig. 8. This only wedges the bar and makes the tapping more difficult, and often requires a sledge to drive the bar inwards; this method may do once or twice during the heat, but if repeated continually soon breaks up the breast so as to give trouble in stopping. The proper way to tap out is to dig out the old stopping plug, or *bod*, by picking around the outer edge of the tapping hole, applying the tapping bar in the manner shown at *b*, Fig. 8. By working the bar around the outer edge of the stopping bod, it is soon loosened, until the pressure of the metal is about to burst the bod outwards. When this is done, the points of the tapping bar can be easily inserted at one side of the hole to pry the daubing clear of any support and leave a clean hole for the free flow of the metal. As soon as the bar has started the metal freely, its point should be dipped in a pail of water to cool and reharden it. By such treatment as this, a bar is kept in good form ready for the next tap. The tender should always have a stand or place in which to keep his tapping tools and stopping tools, clay, and water pail, so that they will be at hand the instant they are needed.

STOPPING A CUPOLA.

68. Tools for Stopping.—The tools used for stopping up the tap hole when metal is running out of it consist of long bod sticks or rods as shown at (*a*) and (*b*), Fig. 10. The

iron stopper or bod stick, shown at Fig. 10 (a), may range from $\frac{5}{8}$ to 1 inch in diameter, and may be from 4 to 12 feet long. The wooden bod stick having an iron end *a*, as shown at (b), is most convenient where long bod sticks are necessary. Some tenders use an all-wood bod stick, ranging from $1\frac{1}{4}$ to 2 inches in diameter. These are objectionable, for when the stopping bod falls off, which is a common

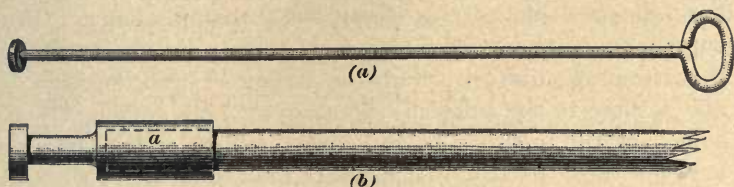

FIG. 10.

occurrence, without the cupola tender noticing it, the act of shoving the bare end of the wooden bod stick into the flowing metal will cause the iron to fly in all directions, and may result in badly burning any one standing near the cupola spout. Of the two forms of bod sticks, the iron one is preferable, but on account of its not being as convenient to handle as the wooden ones, it is not so generally used.

69. Stopping a Cupola Before and After Tapping.—When stopping up the tap hole against the stream of outflowing metal, it is better not to push the stopping rod directly against the flowing metal in an effort to strike the hole. Such a method causes the iron to be divided by the stopping stick and results in more or less of it being thrown out of the spout on the floor, where it will be spattered in all directions; it may also wash the stopping clay from the end of the bar. The proper way is to hold the stopping bod above the stream, and when near the stopping hole to push it down obliquely, which brings the bar at a sharp angle with the stream and permits the hole to be stopped in a firm manner without causing any spattering of the metal.

70. Materials for Stopping a Cupola.—The materials used for making stopping clays or bods, where the

cupola is tapped at short intervals, should be of as friable and dry a nature as practicable. In such a case there is little or no pressure in the cupola to shove out the bods, and all that is required is sufficient tenacity in the stopping clay to hold back the blast and a head-pressure of 1 or 2 inches of iron. Having the stopping bods friable and dry will make tapping easy and prevent that spattering and boiling of the iron at the tap hole that strong, close, wet bods may cause. For cupolas that are tapped at from 15 to 20 minute intervals, the stopping mixture should be stronger, in order that it may adhere to the sides of the tapping hole sufficiently to hold back the pressure of the metal. With a longer time between taps, the stopping mixture may be stronger without causing blowing, as there is more time to dry it. In making mixtures for short-interval tapping, new molding or loam sand mixed with about one-third of fireclay works very well; or the molding sand may be used by itself, having been wetted with thick clay wash. Bod mixtures for use where there are long intervals between taps generally require to be made almost entirely of clay, mixing from one-quarter to one-third of sea coal, blackening, or saw dust with the clay. In mixing the stopping clays, they should be made quite stiff, for if too soft, the mixture cannot be made to stay in place.

CAPACITY OF A CUPOLA.

71. Influence of Slagging on the Capacity of a Cupola.—The amount of iron that a cupola will melt cannot be given very readily. Some foundries can keep a cupola in blast and doing good, clean melting, by slagging out, for a whole week; whereas, if it were not slagged out, it would clog up in a few hours. The approximate amount of clean iron cupolas should melt with good fuel, and still have a clean drop when not slagged out, is given in Table IV. When foundries desire to complete their heats in from 1 to 2 hours, the latter being about the longest time a cupola should run without slagging, Table IV will aid them in selecting the proper size of cupola.

TABLE IV.

MELTING CAPACITY OF CUPOLAS.

Inside Diameter of Cupola. Inches.	Melting Capacity When Not Slag- ging Out. Tons.
20	2
25	3
30	5
35	7
40	10
45	12
50	15
55	20
60	25
65	30
70	35
75	40
80	50

72. Comparison of Sizes of Cupolas.—If, with one of the larger sizes of cupolas given in Table IV, the equipment of a shop or the force of employes is not sufficient to carry the iron away from the cupalo as fast as it melts, and the weights of the heats are in keeping with the capacity of the cupola as shown in the table, then a smaller cupalo should be used. To get the tonnage out of it, it is necessary to slag it out and to allow more time for pouring off. This can be carried to such extremes that a cupola over 30 inches in diameter can, by having upper tuyeres, be run for 10 hours or more, requiring but a few men to take care of the iron. There is really no economy in running very long heats. The cupola should be of such a capacity that it will melt iron as fast as it can be handled. Where small cupolas are used for long heats the molders stand around waiting for iron when they should be at work molding.

COKE AND COAL IN MELTING.**73. Comparison of Qualities of Coke and Coal.**

The value of coke as a fuel for melting iron was first successfully demonstrated in 1860 by the Clinton furnace, of Pittsburg, Pa. Since that time its use has so increased that now very few furnaces use coal entirely. The advantage of coke over anthracite coal is that it requires less blast and melts the iron more quickly than coal; and generally it is a much cheaper fuel and requires less time to kindle it, but often burns too fast. For this reason, coal excels coke for melting massive pieces of scrap and for prolonging heats beyond the time possible with coke, unless slagging out is practiced. Pieces of scrap weighing as much as 6,000 pounds have been melted by the use of coal in a 45-inch cupola.

In charging heavy pieces of iron, the bed of fuel must always be raised higher than is done for ordinary charging of medium pig and scrap. When a founder has difficulty in extending the length of his heat and does not care to slag out, he might in some cases use coal to advantage. Some founders make the bed of coal and use coke only for the charges, while others mix the coal and coke together all the way through the heat. It generally takes a less weight of coke than of coal to melt iron, but owing to coke being lighter than coal, a given weight of it will stand higher above the tuyeres or will be deeper between the charges. For this reason, the charges of iron are generally made heavier when using coal than coke; for, if the same weights of coal and iron are used that work well with coke and iron, there will not be sufficient coal in some cases to divide the charges of iron properly.

74. Manufacture of Coke.—Coke is made by driving the volatile matter out of certain kinds of bituminous coal. This operation is called coking, and is carried on in special kilns or in ovens. Coke differs from coal in structure, for the driving out of the volatile matter leaves the coke more porous than the coal from which it was made. Carbon and

ash are the two chief components of coke. The greater the amount of fixed carbon and the less ash the coke contains, the better are its melting qualities. Another component that may give trouble if it exceeds .85 per cent. is sulphur. This must be watched very carefully, as coke with much sulphur will harden the iron and do much harm when soft castings are desired. A coke possessing a silvery bright metallic luster and a solid body, with cells well connected and of a uniform structure, is generally a good fuel for melting iron.

TABLE V.

ANALYSES OF COKE.

Where Made.	Fixed Carbon.	Ash.	Sulphur.
Connellsville, Pa., average of 3 samples.....	86.96	9.74	.810
Chattanooga, Tenn., average of 4 samples.....	80.61	16.34	1.595
Birmingham, Ala., average of 4 samples.....	87.29	10.54	1.195
Pocahontas, Va., average of 3 samples.....	92.53	5.74	.597
New River, W. Va., average of 8 samples.....	92.38	7.21	.562
Big Stone Gap, Ky., average of 7 samples.....	93.23	5.69	.749

75. Analysis of Coke.—The kind of coke generally condemned by founders is small-sized coke mixed with coke dust, or coke that is dark in general appearance and soft in quality. Even when coke has all the other desirable qualities but is small in size, it is liable to produce bad results in melting. A coke may not possess the desired silvery bright

metallic luster, and may be of a dark color having black ends, and still be good, if it is only large and of a hard uniform character and possesses a good structure. In Table V is given the percentages of fixed carbon, ash, and sulphur in coke made in various sections of the United States.

ECONOMY OF FUEL IN MELTING IRON.

76. Ratio of Weights of Iron and Fuel.—Every now and then some one reports melting in the ratio of 1 to 10 or 12, and others dispute it, claiming that it is good practice to melt 5 to 7 pounds of iron with 1 pound of fuel. The man melting only in the ratio of 1 to 5 or 7 may be doing better work than the one melting in the ratio of 1 to 10 or 12. These ratios depend entirely on shop conditions, the character of the castings, fuel, and iron, and also the manner of managing the heats. For example, take two 40-inch cupolas, with the same height of tuyeres and with a capacity of 9 tons when not slagged. One shop may be called on to melt 4 to 5 tons in one of these cupolas, while another might be required to melt 30 tons, each having the same class of fuel and iron. There is little difference in the height of the bed, in the first place, for either of these extremes of tonnage, and to keep up the bed to its proper height, about the same weight of fuel will be required between the charges. Figuring up the ratio or percentage of fuel to iron each of these founders should use, it is found, taking 1,000 pounds for the bed and 200 pounds between the charges, that the one melting 4 tons of iron would use 1,600 pounds of fuel, a ratio of 1 to 5, while the one melting 30 tons of iron would use 5,800 pounds of fuel, a ratio of a little better than 1 to 10. This difference comes largely from the fact that if but 1 ton of iron were to be melted, it would require about as much fuel in the bed or above the top of the tuyeres as if 30 tons had to be melted. Furthermore, where the heats may be of the same weight, in the same sized cupolas and the same height of lower tuyeres, oneman may have the best of fuel and clean medium-sized iron

that is not required to be melted very hot for his work, while the other man may have conditions that are the reverse in every particular. When such a difference in conditions prevails, one might melt 4 tons with a ratio of 1 to 8, while the other could not do better than 1 to 4. It is not economy for any founder to cut down so closely on fuel as to get a dull iron when his work demands hot iron, and any one following this practice will find that the castings lost by dull iron and the expense of taking care of bunged ladles, cupolas, etc. will greatly exceed in cost that of the additional fuel that should have been used. On the other hand, there is no excuse for using large quantities of fuel, for often better melting can be done with less fuel.

MELTING IRON IN SMALL CUPOLAS.

77. Construction of Small Cupolas.—There are often cases where it is desired to melt iron on a small scale for commercial or experimental purposes. By reading the description of modern cupolas, many are led to think that these must be available in order to melt iron; this is not the case, however. Iron has actually been melted in an old flour barrel that was lined with clay and pieces of brick. Iron has been successfully melted in a 12-inch cupola having the blast furnished by a blacksmith's bellows. In this case the cupola was placed on a wagon and wheeled through the streets in an industrial exhibition of a large city's manufacturing establishments. It was not a special device, but one made from an old piece of a 16-inch sheet-iron pipe, 24 inches long, set on a flat plate, with $1\frac{1}{2}$ -inch holes on each side of the pipe about 3 inches from the bottom for tuyere holes, to admit the blast from the bellows. This little improvised cupola was kept in blast for about 1 hour and melted 200 pounds of small pieces of iron.

78. Cupolas for Experimental Work.—In Fig. 11 is shown a cupola made of a piece of an old cupola shell, lined

with 4-inch brick, that was placed alongside of a regular cupola and used for experimental purposes and for making small repair work when the large cupolas were not in blast. This cupola has melted 500 pounds of iron at one heat, and is illustrated here to show how readily and cheaply one can devise a cupola that will melt small quantities of iron. The

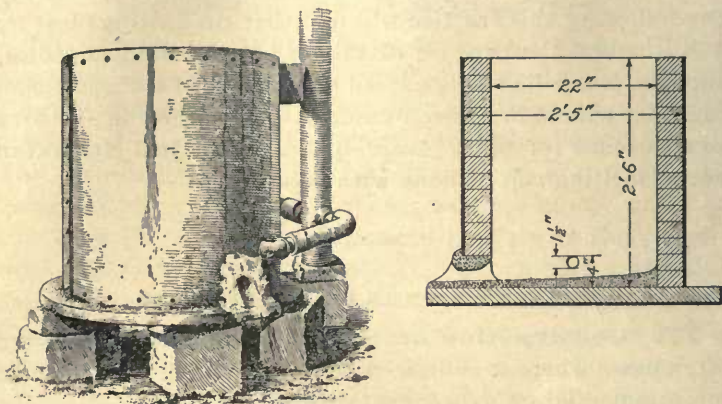

FIG. 11.

fuel and iron used for charging such cupolas must be small in size. The cupola shown in Fig. 11 is 22 inches inside diameter and 30 inches outside diameter; its height is 30 inches, and the two tuyeres, having a diameter of $1\frac{1}{2}$ inches, are placed 4 inches above the bottom plate at opposite sides of the shell.

79. Chinese Cupola.—A Chinese cupola is shown in Fig. 12, which is made in three sections placed on each other. The sections consist of riveted boiler-plate shells lined with fireclay, and have handles *a*, two on each side, for the purpose of lifting them apart by means of two bars. The upper section is open and enlarged at the top, and receives the charge of iron and fuel. The blast is supplied to the middle section through a single tuyere and a pipe *b* that carries the blast from the blower *c*. The blower is operated by hand and consists of a rectangular box *c* with

the interior arranged in compartments, each of which is fitted with a plunger operated by means of a rod *d* and handle *e*. As the tap hole *f* of the cupola is at the floor

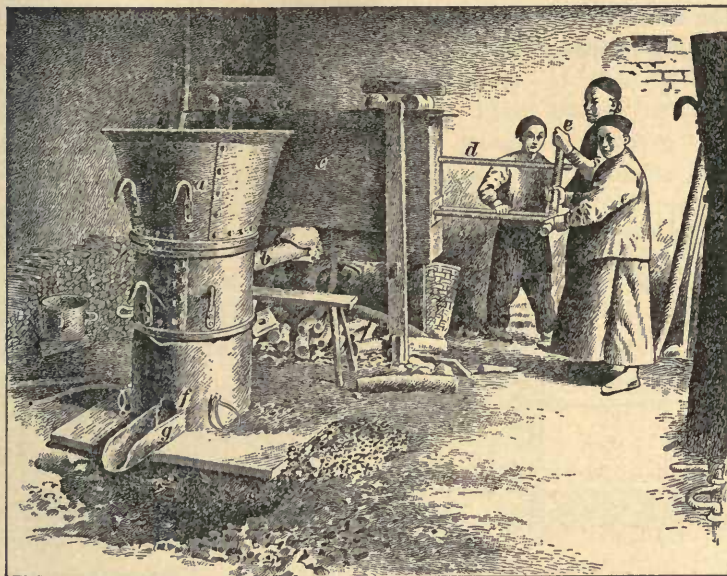

FIG. 12.

level it is necessary to place the receiving ladle in a pit in order to be under the spout *g*. The capacity of this cupola is about 80 Chinese plowshares per day.

AIR FURNACES.

GENERAL CONSTRUCTION OF AN AIR FURNACE.

80. Introduction.—One form of **reverberatory, or air, furnace** is shown in Fig. 13 (*a*) and (*b*), and receives the name because of its form and because the natural draft is generally used to operate it as distinguished from the blast or forced draft used in the cupola.

These furnaces are used for melting iron for heavy work when purity and great strength of metal are desired, such as for large bells, rolls, etc. Massive scrap iron can be most easily melted in a reverberatory furnace, as the charging can be done by the aid of a crane. The greatest strength of casting is obtained with a reverberatory furnace, because it

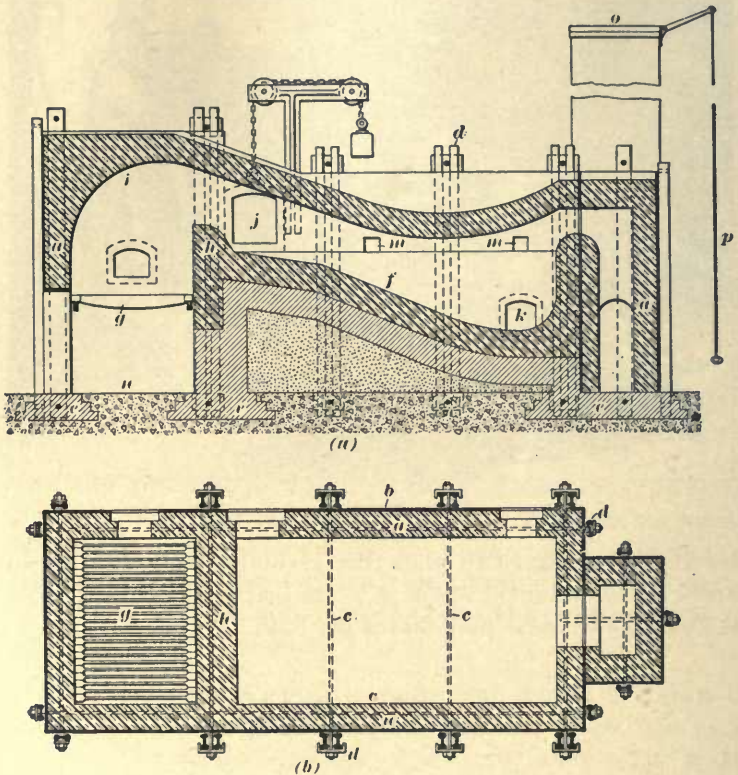

FIG. 13.

is possible to get a high percentage of combined carbon with a low percentage of sulphur. The character of the mixture can be observed in an air furnace and tested, and the necessary changes, if any, made with comparative ease before tapping. The metal is purer than that from the cupola, as

it is not in contact with the fuel during the melting, and a charge can be melted without changing to any appreciable degree the percentage of carbon originally contained.

On the other hand, there is a considerable loss by oxidation and scintillation, which may amount to as much as 12 per cent., and much greater skill is required to operate such furnaces as compared with cupolas. If the charge should chill, it is generally necessary to tear down the furnace to remove the cold metal; and being so massive, the further expensive operation of blasting with dynamite has sometimes to be resorted to in order to break it into pieces that can be handled.

81. Form and Dimensions.—The body of an air furnace consists of a box of rectangular form made of firebrick, as shown in vertical section in Fig. 13 (*a*), and in horizontal section in (*b*). The walls *a* are made extra thick and tight, so as to retain the heat and prevent any leakage of cold air into the furnace. The brickwork is incased in cast-iron or wrought-iron plates *b*, and the whole is securely bound together with anchor rods *c* running both crosswise and lengthwise through the furnace, but in such locations as not to be affected by the heat, and buck stays *d* on the sides and ends of the furnace.

82. Foundation.—As the furnace is massive and not a self-contained steel vessel like the cupola, the foundation must receive special attention in its construction. Heavy stresses are produced by the great heat and by the weight of the charge, and the furnace is liable to crack or settle, resulting in the loss of the molten metal. The footings *e* of the furnace walls rest on a bed of concrete that extends under the whole furnace.

83. The Hearth.—The bottom covering, or **hearth**, *f*, is made of sand and clay, and is supported by substantial brickwork. When melting an extra heavy piece of metal, firebrick piers, extending above the sand bottom, are sometimes used to support it free from the sand so the flame can play entirely around the piece.

84. Minor Parts.—The grate g is 3 or 4 feet long and the full width of the furnace. A bridge wall h from 10 to 15 inches high separates the grate from the hearth f . The crown i of the furnace is vaulted so as to deflect the flame on to the iron placed on the hearth, and the hearth, crown, and bridge wall must be so arranged as to secure the full effect of the heat where it is needed in melting. A charging opening j of liberal proportions is located either on the side or on the top of the furnace. It has a metal cover lined with firebrick. If located on the side, the door usually opens by sliding upwards and is operated by counterbalance weights and chains over pulleys or by levers, as shown in Fig. 13 (a). When the opening is on top, both the door and the charge may be lifted by means of a crane. An opening k is used for cleaning out the furnace and as an entrance for making repairs. Fireclay, daubing, and cementing are required in repairing the lining of air furnaces the same as is done in making repairs of cupola linings. The spout is located at the lowest part of the hearth and is made and attached the same as in a cupola. As it is important to keep the surface of the metal clean, holes m for skimming are located above the hearth. There is also an opening for introducing a hand ladle for samples to be tested. Peep holes are necessary to observe the melting process. The ash-pit n is made low, so as to give plenty of air space for the draft. Frequently the hearth of a reverberatory furnace is made more nearly level and the roof nearly parallel to the hearth. At times the roof is made in sections, so that it can be removed for charging. Such furnaces are illustrated and described in *Malleable Casting*.

85. The Chimney.—The chimney for an air furnace is constructed of firebrick, rectangular in section, and about equal in area to that of the air-space area of the grate. The height ranges from 30 to 80 feet, or whatever is necessary to secure a strong draft. It is fitted with a regulating damper o on top that is operated from the ground by means of a rod p . The chimney is preferably constructed on a separate

foundation from the body of the furnace, so as not to be injured by any movement of the furnace caused by the effects of the heat, and also to permit changes and repairs in the furnace.

86. Firing and Charging.—The furnace should be heated 5 or 6 hours before charging. The whole charge is then put in at once and all openings closed as tight as possible, permitting no air to enter except through the fire. The charge is stacked on the hearth in an open pile. If of pigs, the first layer is put lengthwise, with spaces between for the flame to enter; the next bars are laid crosswise, and so on until all the pigs are in. If the charge is a mixture of different sized pieces and kinds of iron, the smallest and easiest melted pieces are placed in the bottom, where they will receive the least heat.

As the charge is not placed in the fuel, as it is in the cupola, but in the flame, which has something of a blowpipe action, bituminous coal and gas are the fuels used, because they produce the most flame. Anthracite coal can be used by special draft arrangements, but it is objectionable on account of the ashes settling on the surface of the molten metal, necessitating skimming.

87. Boiling the Metal.—Boiling is a process which consists in inserting green-wood poles in the melted charge in an air furnace, causing a violent ebullition and a thorough mixing of the different grades of iron melted together. This process is also called **poling**. It is also necessary to stir the unmelted pieces in the basin, breaking them up with puddling bars.

OIL-BURNING FURNACES.

88. Construction of Oil-Burning Furnace.—In Fig. 14 is shown a furnace for melting metal by means of crude petroleum as fuel. The furnace consists of a cylinder *a* made of sheet steel, with cast-iron heads *b, b*, and lined with firebrick *c*. The door of the furnace consists of a circular hole *d* in the side of the shell. The shell is mounted

on trunnions *e, e* and can be revolved by means of a capstan handle *f* at one end.

The oil burner is located in one of the trunnions, which is hollow, and consists of a $\frac{1}{8}$ -inch oil tube *g* placed in a 3-inch air pipe *h*. The oil tube *g* is forked at the inner end, and the openings through which the oil passes in a spray consists

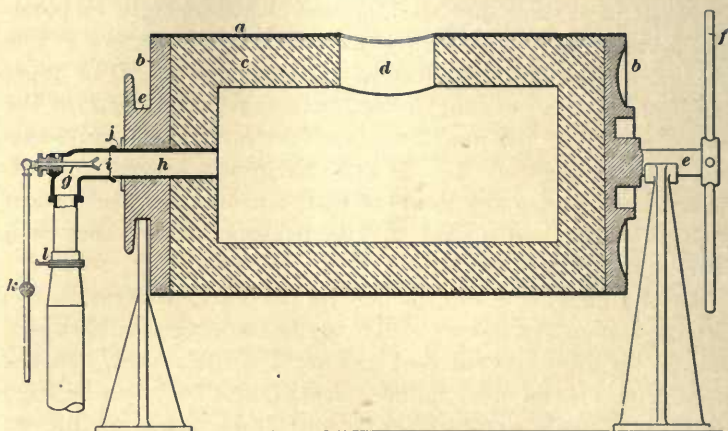

FIG. 14.

of a number of narrow slots in the flattened ends of the two prongs *i* of the tube. The axis of both these pipes is placed so as to coincide with that of the furnace *a*, and the air pipe *h* is connected to the shell by means of a sleeve joint *j*, so that the shell may be revolved without disturbing the burner. The oil pipe is fitted with a needle valve *k* for regulating the supply, and the air pipe has a gate valve *l*.

89. Operation of an Oil-Burning Furnace.—The operation of an oil-burning furnace is simple. The air blast under a pressure of from 8 to 10 ounces is first turned on, and a piece of flaming material, such as wood, paper, or waste, saturated with oil, introduced into the furnace. The oil at about 3 pounds pressure is then admitted. The first ignition causes a puff of heavy smoke due to the excess of oil in the material used to start the fire, but this immediately clears away and complete combustion ensues. The jet

of flame is blown against the opposite head of the cylinder, whence it reverberates, filling the entire space with flame. The temperature is such as to make the firebrick lining white hot in about 25 minutes with a consumption of about 6 gallons of oil. When this temperature is reached, metal in the required quantity is introduced directly into the cylinder, which is revolved so that the opening *d* is brought to any convenient position for this purpose. The furnace is then revolved and the opening brought to the top, and a crucible, having the bottom removed, is set into the opening like a hopper. This hopper is filled with pieces of the metal to be melted. The flame is now lengthened by adjusting the oil and air valves until it escapes through the crucible and gradually melts the contained metal, which drops into the heavier part of the charge in the cylinder. The crucible also serves to protect the edges of the hole in the shell from the flame.

From 20 to 25 minutes are required to melt a charge of brass in this manner; 25 minutes for copper; about 1 hour for cast iron, and a slightly longer time for steel. The consumption of oil is at the rate of about 12 gallons per hour in a furnace of 1,200 pounds capacity. When the charge is melted, the furnace is revolved on its trunnions and the molten metal poured into the ladles.

MIXING CAST IRON.

MAKING CAST IRON.

THE BLAST FURNACE.

INTRODUCTION.

1. Occurrence of Iron in Nature.—Iron is the most widely distributed of any of the metals; yet it is never found chemically pure in nature, except perhaps in some meteorites, where it is a mere curiosity of no practical value. There are many iron minerals, but only a few of them constitute useful ores of iron on account of the fact that many contain either too low a percentage of iron or elements that render them unfit for the manufacture of *cast iron* or *steel*. **Iron ore** may be defined as any iron-bearing mineral from which the metal can be extracted at a profit. This definition will bar out many minerals containing a large percentage of iron on account of the impurities that they contain; and on the other hand, it will admit many that carry a low percentage of iron, but no injurious elements. The ores of iron are oxides and carbonates. Formerly the harder magnetic ores and the hard hematites and carbonates were preferred, but with modern blast-furnace practice, the softer and more easily reduced ores are coming into more general use. In the United States very few furnaces are running on ore containing less than 50 per cent. iron. The

§ 47

For notice of copyright, see page immediately following the title page.

remainder of the ore is composed of oxygen, silicon, phosphorus, lime, sulphur, magnesia, aluminum, manganese, titanium, etc. Some ores also contain organic matter. Most of the impurities occur in very small amounts. The rich ores of iron contain from 60 to 68 per cent. metallic iron, while those low in iron, called lean ores, may contain only from 30 to 40 per cent.

2. Nature of Cast Iron.—Chemically pure iron is soft and ductile, and can be forged and welded, but its melting point is so high and its character is such that it cannot be used for making castings. The iron commonly known as **cast iron** contains some impurities that lower its fusing point and that change its characteristics materially. Wrought iron fuses above 3,000° F., while cast iron melts at about 2,200° F. Carbon is the element that makes the greatest change, though several other elements are active in producing changes; these with their effects will be taken up later. The fracture of cast iron varies from a coarse semi-crystalline gray to a fine, close-grained, white fracture. Formerly all iron was graded by its appearance when broken; now it is generally graded according to its chemical composition.

CONSTRUCTION OF BLAST FURNACE.

3. Form and Dimensions of Blast Furnaces. The iron is reduced from its ores by fusing them with lime in a **blast furnace**, the lime being obtained by the use of limestone, marble, shells, etc. A blast furnace consists of a tall shaft into which alternate layers of fuel, flux, and iron ore are introduced. The blast furnace is continuous in its operation; all the material charged into the top of the furnace is reduced to a liquid condition and tapped out at the bottom. Blast furnaces are much larger than *cupolas*, the height of the furnace depending somewhat on the fuel and ore used. A furnace capable of handling from 175 to 200 tons of ore in 24 hours is about 70 feet high and 14 feet

internal diameter at the largest part. Like a cupola furnace, a blast furnace is usually made of an iron shell lined with some refractory substance; but unlike most cupolas, the lower portion of the furnace that has to withstand the greatest heat is generally provided with water coolers built into the lining. These coolers usually consist of pipes arranged in sections, so that the water can be shut off from any one for repairs. Owing to the great weight of the furnace and its charge, very substantial foundations are necessary.

OPERATION OF BLAST FURNACE.

4. Fuels Used in a Blast Furnace.—The best and purest grades of cast iron are made in blast furnaces using charcoal for fuel. This is on account of the fact that the charcoal does not contain as much sulphur as coal or coke, and also because the ash is of such a nature that the impurities pass into the slag rather than into the iron. Owing to the soft, friable nature of charcoal, it will not sustain so great a burden as coke or coal; hence, it is impossible to use as high a blast furnace with this fuel as when coke or coal is used. Charcoal blast furnaces are rarely more than 30 or 40 feet in height, and are of comparatively small capacity. Charcoal iron is made only from the purest and richest ores and is used for special lines of manufacture. Coke and coal, especially anthracite coal, are the chief fuels used in blast furnaces. Owing to the strength of these fuels it is possible to carry a much higher burden in the furnace; hence, the furnaces using coal or coke for fuel range from 65 to 100 feet in height; they are also larger in diameter than those burning charcoal. All coke and coal contain more or less sulphur that will injure the iron to a greater or less extent, and these fuels also contain a large amount of ash that must be fluxed and removed with the slag.

According to the statistics of the American Iron and Steel Association, there were made in the United States during 1901, 13,782,386 tons of coke iron, 1,668,808 tons of

anthracite and coke iron mixed, 43,719 tons of anthracite iron, 360,146 tons of charcoal iron, and 23,294 tons of charcoal and coke iron mixed.

5. Temperature of the Blast Used in a Blast Furnace.—Formerly all blast furnaces used cold blast, as in cupola practice, but it has been found that this greatly reduces the temperature of the furnace at or near the melting zone, and consequently decreases its capacity, so that now the blast is usually heated to a greater or less extent in blast-furnace work. At present the cold blast is used only in a few charcoal furnaces. A warm blast ranging from 250° to 400° F., or a hot blast ranging from 700° to 1,100° F., is more commonly used in the average furnace, while some furnaces use a superheated blast having a temperature of from 1,100° to 1,600° F. There are two general methods used for heating the blast. In one, the escaping gases from the furnace are allowed to pass around iron pipes through which the blast is drawn. In the other, the escaping gases from the furnace are allowed to burn in a chamber filled with *brick checkerwork*, this being composed of bricks loosely piled up, as in a brick kiln. After the bricks are sufficiently heated the gases are turned into another chamber; the blast for the furnace is heated by being drawn through the chamber containing the heated bricks. The temperature of the blast used in coke or anthracite iron furnaces usually ranges from 1,000° to 1,300° F. The pressure of the blast in standard furnaces varies from 5 to 25 pounds per square inch, and the weight of the blast used in making iron is greater than that of all the fuel, iron, and limestone combined. The air for the blast is compressed to the desired pressure by blowing engines.

6. Charging a Blast Furnace.—The charge of iron, coke, and limestone is made up of the proper proportions of each by weight and hoisted to the platform at the top of the furnace and dumped into the hopper, which is closed at the bottom by a conical casting called the *bell*. After the proper

amount of charge has been distributed around the bell, it is lowered and the charge allowed to fall into the furnace, after which the bell is raised to its proper position, closing the top of the furnace and making it gas-tight.

7. Reactions in a Blast Furnace.—The blast is regulated so as not to burn completely the carbon of the fuel. Some of the carbon is burned to carbonic oxide, which is a gas composed of 1 atom of carbon and 1 atom of oxygen, or CO , and some of it to carbon dioxide, which is a gas composed of 1 atom of carbon and 2 atoms of oxygen, or CO_2 . The hot carbonic oxide passing through the charge reacts on the ore, taking oxygen from it, and becomes the gas called carbon dioxide. This extraction of oxygen from the ore reduces the iron oxide to metallic iron, and this in turn takes up more or less carbon and settles to the melting zone, which is from 2 to 4 feet above the tuyeres. At this point all the constituents of the charge are rendered fluid. From 10 to 30 per cent. of the ore and from 10 to 14 per cent. of the fuel charged into a blast furnace are composed of earthy matter and ash, which must be carried off as slag. A portion of this earthy matter is basic, and the remainder is acid. If the basic and the acid portions are equal, the ore will be self-fluxing and form a slag without the addition of any other material; but in most cases some acid element, such as silicon, predominates, and this necessitates the addition of limestone as a flux to carry off the excess of silicon. If either too much lime or too much silicon is present, the slag will be thick; if approximately the right amount of each is present, the slag will be very thin and fluid, so that it will separate thoroughly from the iron. As the charge descends in the furnace, the limestone is converted to quicklime by the heat that drives off the carbon dioxide. The moisture in the charge is also driven out by the heat. Owing to the fact that the slag is lighter than the iron, it floats on the surface of the latter and is tapped off through a separate and higher tap hole just previous to tapping for iron.

The proportions of fuel, limestone, and ore must be carefully calculated; for if the ore is not properly reduced, a portion of the iron will pass into the slag. In this case the iron obtained will be low in silicon and high in sulphur. This may also be due to an insufficient amount of heat, on account of which much partly reduced iron arrives at the melting point and the silicon is all utilized in carrying off the unreduced iron ore. When a furnace is working in this manner, it is said to be *working cold*. A larger percentage of fuel and an increase in the heat of the blast make the furnace *work hot* and cause the iron to absorb more silicon.

8. The carbon in pig iron is obtained from the fuel of the furnace, and the total amount of carbon that iron will absorb depends on the working conditions of the furnace and on the percentages of silicon, manganese, and sulphur in the iron. This characteristic of manganese is shown in the manufacture of spiegeleisen, which is rich in manganese, and for this reason may contain as much as 6 per cent. of carbon. In case the iron contains less than .75 per cent. of manganese, it cannot carry much, if any, more than 3.5 per cent. of carbon, though in rare cases it may contain over 4 per cent. It is claimed that if chromium is substituted for manganese, it will enable iron to absorb as much as 12 per cent. of carbon.

9. The sulphur in iron is obtained chiefly from the fuel, only a small portion of it coming from the ore and the fluxes. If limestone is used as a flux, and the slag is hot and fluid, it will usually absorb and carry off a large amount of the sulphur; while if the slag is allowed to get thick and sluggish, and the furnace is working cold, more of the sulphur will go into the iron. Low-sulphur or high-grade pig iron is generally obtained by having a hot furnace well, but not excessively, fluxed with lime. High-silicon iron and iron that is also high in sulphur may be obtained by having a hot furnace poorly fluxed with lime. When the furnace is

working hot with a thin slag, the silicon tends to go into the iron and the sulphur into the slag.

10. Tapping a Blast Furnace.—Owing to the fact that the slag is lighter than iron, it floats on the surface of the latter; it is tapped from a hole at the side of the furnace and is generally run into suitable cars and removed from the furnace, while the iron is tapped from a hole at the front of the furnace, and is either run directly into the pig bed or into a ladle, from which it is taken to a pig bed or a casting machine; or it may be taken to a converter or an open-hearth furnace and be made directly into steel without remelting.

CASTING PIG IRON.

11. Using Sand Molds for Casting Pig Iron.
The metal as it flows from a blast furnace is run either into sand or iron molds. If the former are used, the iron flows from the tap hole down a long runner having an incline of about 1 foot in 18 feet. From this it is led by branch runners on each side to the pig-bed molds. Each of these branch runners, as it fills up, is stopped off with an iron cutter driven into the main runner a few feet above the branch opening; another branch runner is then opened by pulling away the sand that divides the main runner from it. This operation is continued until the uppermost pig bed, which is nearest the furnace, is filled, at which time the furnace is generally freed of its metal for that tap. When the pigs have become solid enough not to bleed, that is, let molten iron flow out when broken, sand to a depth of about $\frac{1}{4}$ inch is thrown over them. One or two gangs of men wearing shoes having heavy wooden soles now start at the lower end to break the pigs away from the sows, or branch runners, by means of long pointed bars. After the pigs are separated, the sows are broken into small pieces by the use of bars and sledges.

A bed of 500 pigs and 18 sows can be broken in about 30 minutes by 3 men. After being broken, a large stream

of water is turned on to cool the metal, so that it can be loaded on cars or piled in the storage yard. The floor of the casting house is usually divided into two or more sections, so that the different operations can be carried on continuously.

12. Using Iron Molds for Casting Pig Iron.—In order to avoid the heavy sand scale that forms on pigs cast in sand molds, and also to avoid the labor of making up the pig bed, pig iron is cast in iron molds. In some cases the iron molds are placed in the pig bed itself. These molds are from 6 to 10 feet long and usually somewhat greater in cross-section than for the ordinary pig. Before the iron is allowed to flow into the molds, they are sprinkled with a wash of clay or lime water; the water evaporates and leaves a coating that prevents the iron sticking to the surface of the molds. The iron is conducted to the molds by means of the ordinary runners and branches. Owing to the great weight of these pigs, they have to be handled and broken by mechanical means. More or less trouble has been experienced in the cracking and breaking of the large molds, and occasionally from the difficulty of removing the iron from them, although, owing to the great length of the pigs, the contraction usually frees them without any difficulty.

13. Pig Casting Machines.—In order to make the casting process continuous, various forms of casting machines have been invented. Practically all of them produce small pigs that do not require much, if any, breaking before being charged into the cupola. There are two general styles of casting machines; in one style a series of molds moves around on an endless link belt or chain. The molds are given a coating of lime water as they run along the under side of the conveyer, the lime water being splashed into the molds by a suitable mechanism. Just after the molds come from the wheel at the head end of the conveyer, they receive the molten metal from the ladle. The pigs cool

as they are carried down the conveyer, and the contraction, together with the coating of lime on the molds, frees them from the molds. At the lower end of the conveyer there is usually arranged an automatic knocking device to insure the removal of the pigs from the molds. These casting machines are frequently arranged to load the pigs directly into cars.

In the other style of casting machines, the short molds are arranged radially around the periphery of a large wheel, and the iron is poured into the molds at one point and dumped out at the opposite side as the wheel slowly rotates on a vertical axis; the molds are coated with a suitable wash as they return to the ladle. In the operation of casting machines the iron is taken to them in ladles and frequently one machine or group of machines receive the iron from several furnaces. The fact that the metal is caught in a ladle before being poured into the molds gives a much more uniform product than is possible by the old method of casting pigs in beds. Also the iron being free from sand scale, there will be less dirt in the cupola and less fuel will be required for remelting the iron.

14. Segregation in Pig Iron.—Very frequently pigs taken from different parts of the same cast are found to vary greatly in composition. It is not uncommon for the metal to contain 1 per cent. more of silicon at one end of a tap than at the other, and to have a difference of over .05 per cent. in sulphur. The results from the analyses of the pigs from 6 beds are shown in Table I. The beds are numbered as they were cast, No. 1, being the farthest from the furnace, received the iron first, and No. 6 last. Table II shows the results from the same furnace under normal conditions. These tables show what unsatisfactory results a founder may expect when using furnace casts of iron that are so irregular in their silicon and sulphur contents. They also show the wisdom of thoroughly mixing furnace casts of iron before they are charged into a cupola, when uniform results are desired in castings.

TABLE I.

ANALYSES OF PIG BEDS IN A CHANGEABLE FURNACE.

Number of Bed.	1	2	3	4	5	6
Per Cent. Silicon	.600	.680	.700	1.00	1.250	2.200
Per Cent. Sulphur	.084	.071	.062	.05	.042	.027

TABLE II.

ANALYSES OF PIG BEDS WITH FURNACE IN NORMAL CONDITION.

Number of Bed.	1	2	3	4	5	6
Per Cent. Silicon	2.180	2.180	2.22	2.230	2.250	2.250
Per Cent. Sulphur	.021	0.021	.02	.019	.019	.019

Some furnacemen make an effort to mix their pig iron thoroughly, so as to give uniform results even from irregular casts of iron. This will be appreciated, as few founders have any opportunity for mixing the iron before being charged into the cupola. Silicon and sulphur are the elements most unevenly distributed in furnace casts of pig iron, as phosphorus and manganese rarely, if ever, vary sufficiently to change the grade of a brand of iron, at least not to such an extent as is done by silicon and sulphur.

15. Grading Pig Iron.—Previous to 1892 most furnacemen had their pig iron graded entirely by the appearance of the fracture. The iron having the most open grain was called No. 1, the next in order No. 2, and so on up to Nos. 5 or 7. The high numbers generally indicated a mottled or white grade of iron, giving hard iron in castings. Since

furnacemen commenced to make iron by analyzing the ores, fluxes, and fuels that go into the furnace, and the iron and slag that come out of it, they have learned that the appearance of the fracture of iron is generally deceptive and that the only safe guide to depend on is the analysis of the iron in defining its grade. This is due to the fact that the size and character of the grain in pig iron depend largely on the rate of cooling:

If two castings be made from the same pattern, poured from the same ladle and gates, one being formed in sand and the other in iron, so as to make a difference in the rate of cooling, it will be found that the one cast in the iron mold, and hence cooled first, will be much closer in grain than the one cast in sand, and cooled more slowly. The rate of cooling always affects the grain of cast iron. When it is considered that there are rarely two casts of pig iron that come out of the furnace alike in fluidity, that fill the pig molds in the same length of time, or that give the same size of pigs, it is evident that the grain of the iron, as exposed by fracture, will vary greatly. There are still some of the old-school founders who think that they can judge pig iron by fracture, and when they do not get the results from the cupola mixtures that they expected, they will excuse the bad work on the ground that the fuel was bad, or that there was a mistake in charging by getting the wrong iron, or that they had poor blast, or that the wind was blowing the wrong way, etc.

Many interesting experiments have been made to determine the relation between the grain of pig iron and its chemical composition, and it has been found that the grain does not depend on the chemical composition so much as on the rate of cooling, and that pig iron should be graded according to its analysis and not according to its grain.

16. For melting two different kinds of cast iron under exactly similar conditions, a twin cupola, as shown in Fig. 1, may be used. This is simply a small cupola having a tap hole *a* on each side and a brick dividing wall *b* in the center.

At the lower part of the furnace there is an arch *c* connecting the two sides, but the sand bed *d* is made high in the middle and the charging is done in such a manner that there is practically no chance for the iron charged on each side of the partition *b* to mix.

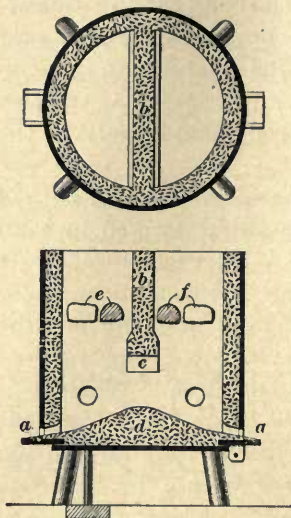

FIG. 1.

In an experiment with the double cupola shown in Fig. 1, two pieces of pig iron were melted in it. One of these possessed a very open grain, which, judging from the fracture, would make the softest kind of casting. Analysis, however, showed that it would produce a hard casting. The other pig was close grained and the surface full of blowholes, such as usually occur in the presence of a large amount of sulphur, so that judging from

its fracture it would produce a hard casting, though the analysis showed that a soft casting would be produced from it. The first contained 1.25 per cent. of silicon and .035 per cent. of sulphur, while the second had 2.86 per cent. of silicon and .04 per cent. of sulphur. The iron obtained by melting both pigs was cast in exactly similar molds, each mold being provided with one gate and arranged to produce a number of castings of various thicknesses, the end of all the castings being against a chill, so as to determine the chilling effect. The iron from the first specimen, which had appeared soft in the pig, gave very hard castings that in the case of the thinner castings could not be machined at all, while that from the second pig, which had appeared hard, gave very soft castings that could easily be machined. In the first casting, which appeared soft, the chilling of the ends of the specimens was marked, while the castings from the second pig, which appeared hard, showed practically no chilling whatever.

CALCULATING CAST-IRON MIXTURES.

COMPOSITION OF CAST IRON.

ELEMENTS CONTAINED IN PIG IRON.

17. Composition of Pig Iron.—The **pig iron** made by blast furnaces generally contains from 92 to 96 per cent. of metallic iron. The other 4 to 8 per cent. consists chiefly of impurities in the form of sulphur, phosphorus, carbon, manganese, and silicon. While it is true that the five elements mentioned are impurities in iron, they are really the elements that make cast iron of commercial value, as pure iron is worthless for making castings. The physical qualities required in pig iron for the construction of castings depend almost entirely on the percentages of the above elements present.

18. Elements That Are Fairly Constant in Pig Iron.—All the best blast furnaces are provided with pyrometers for measuring the temperature of the escaping gases and of the blast. This enables the manager to control the heat in the furnace very closely and thus, in a large measure, prevent irregularities arising from this source. The temperature and pressure of the blast are important factors affecting the regularity of furnace operation.

Ordinarily the phosphorus in the iron will remain fairly constant as long as the same fuels, ores, and fluxes are used, even though the furnace may be working quite irregularly.

Manganese can also be kept practically constant if the heat of the furnace can be closely controlled, and even when a furnace works quite irregularly, the percentage of manganese will not vary greatly with the same ores, fuel, and fluxes.

19. Elements That Vary in Pig Iron.—Even with the greatest care in the control of a blast furnace, it is impossible to keep the percentage of certain of the elements

in pig iron constant. Those having the greatest variation are silicon, sulphur, and carbon. The percentage of silicon depends very largely on whether the furnace is working hot or cold. A hot furnace with plenty of fuel will tend to put silicon into the iron, especially if it is well fluxed; if these conditions can be maintained, the percentage of silicon can be held fairly constant. But there are many irregularities that occur even with the greatest care in regulating the blast. The most common of these is called *scaffolding*. When this occurs, the charge becomes hung up in the furnace and then finally drops or slips down into the bosh, or into the crucible, thus suddenly bringing a large amount of comparatively cold material into the melting zone. When these conditions prevail, it is impossible to keep the silicon anywhere near constant.

The same cause that carries the silicon into the slag, i. e., low temperature, will reduce the power of the slag to carry off sulphur, and hence drives the sulphur into the iron.

The total percentage of carbon is not affected so much by the irregularities in the furnace, as by the fact that the higher the percentage of silicon, the less the power of the iron to absorb carbon; and as manganese remains fairly constant in any given furnace under stated conditions, the total percentage of carbon will generally decrease with an increase in the percentage of silicon.

KINDS OF PIG IRON.

20. Pig iron is now generally bought according to chemical analysis and not by fracture as formerly. Hence, the iron is graded with reference to the percentages of the metalloids contained. *Metalloids* are those non-metallic elements that resemble metal in some of their properties. The term is applied in founding to the several elements previously mentioned as impurities in the iron. There is an endless variety in the kinds of pig iron, but the following are the ones of most general use.

21. Bessemer iron is made with coke and anthracite fuels, and is used in the manufacture of steel ingots and their products, also ingot-mold castings. Regular Bessemer iron must not exceed .1 per cent. of phosphorus, 2.5 per cent. of silicon, and .05 per cent. of sulphur. The manganese can vary from .3 per cent. to 1 per cent. or over, according to the conditions required. Bessemer iron will not be accepted by steelmakers if over .1 per cent. in phosphorus, unless it is intended for making steel by the basic process, which is a method by which the greater part of the phosphorus can be removed from iron. If it goes over this limit, or is higher than .05 per cent. in sulphur, it is called "off Bessemer." Bessemer pig iron can be used only for castings that do not require much life or fluidity in the iron while liquid, as Bessemer iron, on account of its low phosphorus, loses its life or fluidity much quicker than iron possessing more phosphorus. As a rule, the combined carbon in Bessemer iron varies from .3 to 1.3 per cent., and the graphitic carbon from 3.45 to 1.8 per cent.

22. Foundry Iron.—There are several grades of **foundry iron**. They differ from Bessemer chiefly in the phosphorus, which may run up to 1 per cent. or over, and the silicon from 1 to 4 per cent. Sulphur must not exceed .05 per cent. The fracture of foundry iron cannot be told from that of Bessemer; neither is there much difference in their strength. Foundry iron flows better than Bessemer iron, and can be used for making more intricate castings.

23. Charcoal Iron.—As a rule, **charcoal iron** is stronger than either foundry or Bessemer iron, and differs from coke iron mainly in the carbon contents. It rarely contains more than 2 per cent. of silicon, and in most cases possesses less sulphur than is possible with any other brand of iron, while phosphorus and manganese occur about as in foundry iron and are quite constant. Usually charcoal iron can be distinguished from foundry or Bessemer iron by its

fracture, which is generally of a rich, dark, close, even texture. It is especially adapted to chill work, and by regulating the amount of silicon and carbon, it is possible to get any desired chill. Charcoal iron usually comes in smaller pigs than foundry or Bessemer iron. Its lower percentage of sulphur is due to its being made with charcoal fuel, which is practically free from sulphur; whereas coke or coal may contain 1 per cent. or more of sulphur, a great deal of which passes into the iron in the blast furnace. The total carbon will run from 2.5 to over 4.5 per cent.

24. Ferrosilicon contains from 6 to 16 per cent. of silicon, .01 up to .05 per cent. and over of sulphur, .5 to 1.5 per cent. of phosphorus, and often a high percentage of manganese, .2 to 3 per cent. or over, with the total carbon much lower than in foundry irons, .5 to 3 per cent., which is due to the fact that silicon reduces the power of iron to absorb carbon. The great variation that frequently occurs in the sulphur, phosphorus, and manganese should be watched carefully or else much injury may result from the use of ferrosilicon in foundry mixtures. This iron presents a silvery-white flaky fracture and possesses little strength. It is used chiefly in mixture with hard grades of pig iron or scrap to soften them. The high percentage of silicon in this iron is obtained by the use of highly silicious ores and an excess of fuel in the blast furnace. Ferrosilicon generally costs from \$4 to \$6 a ton more than foundry or Bessemer irons, the additional cost being largely due to the extra fuel required in its manufacture. In order to increase the silicon in foundry or Bessemer iron, the fuel in the blast furnace must be increased, thus adding to the cost of any iron high in silicon.

25. Gray forge iron is the cheapest iron made and rarely exceeds 1 per cent. of silicon. It is generally very high in sulphur, often exceeding .1 per cent. It may also be high in phosphorus and manganese. It is often derived from low grades of foundry iron and is chiefly used in the

manufacture of water pipe, etc., and as mill iron in puddling furnaces to produce wrought iron.

26. Basic iron contains less than 1 per cent. of silicon and not over .05 per cent. of sulphur. The phosphorus may vary from .3 up to over 1 per cent., but rarely exceeds .4 per cent. The manganese is usually less than 1 per cent. It is used mostly in the manufacture of open-hearth steel.

EFFECT OF IMPURITIES ON PIG IRON.

27. Rare Elements in Pig Iron.—The physical properties of different brands of iron frequently show marked differences even when the chemical composition seems to be the same, as far as the elements ordinarily determined are considered. At times these differences cannot be accounted for by variations in the rate of cooling or other similar causes. It is probable that many of them are due to the presence of other elements than silicon, sulphur, phosphorus, manganese, or carbon. Among the other elements that are known to exist in some brands of pig iron are titanium, copper, nickel, sodium, magnesia, cobalt, chromium, aluminum, and tungsten. While these elements are not present in appreciable quantities in much of the iron of commerce, it is nevertheless probably true that many irregularities in the working of iron would be cleared up if determinations were made for these and possibly other elements. Titanium was formerly comparatively common in certain brands of iron, but on account of the difficulties that it gave, ores carrying much titanium are now very generally avoided. It is probable that during the next few years much will be learned as to the effect of these elements, and the foundry manager will then be able to control his mixtures better than at present.

28. Problems in Casting.—In the production of any desired class of castings there are two problems to be solved. The first is the production of an iron having the proper physical characteristics, and the second, the production of

the iron at the lowest possible cost. To solve both of these problems it is usually necessary to mix different grades of pig iron and scrap together to obtain economical and practical mixtures. When the great number of classes of castings that must be produced is considered, some idea can be obtained as to the difficulty of adjusting all mixtures. Among the various classes may be mentioned chilled and sand rolls, car wheels, ore and rock crushers, brake shoes, dies for molding melted glass, cannon, shot and shell, engine and machinery castings, electrical-machinery castings, hydraulic-cylinder castings, ingot molds, annealing pots and kettles, flywheels, stove-plate castings, lock hardware, sash weights, etc. Among these will be found all kinds of difficult requirements. In the case of some of these castings considerable variation in the grade of iron will not seriously affect them, but in other cases a very small variation from the standard required will make them totally worthless.

29. Necessity for Chemical Analysis of Pig Iron.

The only way that some classes of castings can be produced is by analyzing all the materials and carefully making the proportions of the charges that go into the cupola. It will not do in all cases to depend on the analyses furnished by the maker, as they usually have to be recorded several times and pass through several hands, so that there is considerable liability of making mistakes, and a very small mistake in some of the elements will ruin some kinds of castings. Then, too, the analyses furnished may not give a fair average of the shipment owing to the fact that the different elements may segregate in different parts while casting pig iron. In order to insure a correct analysis, the founder should have determinations made of samples of the iron as received. As a rule, most founders can control their iron sufficiently close by having determinations made of the sulphur and silicon, as the phosphorus, manganese, and total carbon will generally run fairly uniform in a given brand of iron from any given furnace, and hence determinations for the last three elements will not have to be made for every lot of metal.

30. Taking Samples for Chemical Analysis of Pig Iron.—The sampling of a given lot of iron is often a difficult problem. For ordinary purposes it is usually accurate enough to take one pig from near each end of the car and three or four others from different parts of the car, some from near the bottom and some from near the top, the whole number being about equally distributed throughout the load. These pigs should be broken in two and drillings taken from the center, care being taken that no sand from the outside of the pig becomes mixed with the drillings. There are different methods of drilling. A single hole in the center of each face is the most common practice. Other methods, especially for carbon determinations, require from 3 to 10 holes so distributed as to get the average composition of the pig. The use of a flat drill is recommended, as it gives the least variation in the size of the borings. The more important the work in hand, the greater should be the care taken in procuring samples. The drillings from the various pigs in any one lot should be thoroughly mixed and sealed in an envelope and delivered to the chemist, the envelope being carefully marked with the number of the car and such other information as will serve to designate the particular lot of iron in question. It requires about a half teaspoonful of the drillings for the determination of each element; if it is required to make determinations for silicon and sulphur, one teaspoonful might be sufficient, but in most cases it is best to send from three to four times this amount, so that the chemist can repeat his work if necessary.

In case of dispute, one method of sampling prescribes ten pigs, the buyer and seller each to select five. These are broken and drillings taken from the faces of the fractures. Drillings from the ten pigs, after being well mixed, are divided into three samples, one to be analyzed by the furnace, one by the foundry, and one by a disinterested chemist mutually agreed on. The average of the two analyses nearest alike is accepted as the chemical composition of the iron.

31. Standardized Drillings.—Sometimes two chemists cannot obtain like results on the same sample of iron. This may be due to differences in the method for making the analysis, or to some impurity in the chemicals used. In case of such disputes a check can usually be made by using standardized drillings, such as those furnished by the American Foundrymen's Association.

32. Carbon.—Iron has a strong affinity for **carbon**, and always contains an amount ranging from a few hundredths of 1 per cent. to possibly 12 per cent., depending on the amount of the other metalloids present, temperature, etc. Iron may absorb carbon without being fluid, as in the case-hardening process; similarly, it may give up a large portion without being entirely fluid, as in the making of malleable cast iron. As pig iron gets its carbon by absorption in the blast furnace, a high percentage of carbon is obtained by raising the temperature and increasing the fuel in the blast furnace. When pig iron is remelted in the cupola, it may either gain or lose carbon, depending on the original composition and the conditions in melting. While passing down the cupola, part of its carbon is burned out. The molten iron then comes in contact with the incandescent coke and absorbs more carbon. The hotter the iron and the longer its contact with the fuel, the more carbon it will absorb. But if the blast is heavy and the charge of the fuel small, more carbon may be oxidized than is gained so that the net result in the iron is a loss. The following experiment was made with low-silicon irons in a cupola supplied with plenty of fuel and operated hot: In an iron containing .82 per cent. silicon and .78 per cent. manganese, the total carbon was raised from 3.94 to 4.75 per cent. by remelting five times; and in steel scrap containing .31 per cent. silicon and .34 per cent. manganese, the total carbon was raised from .6 to 3.5 per cent. by remelting three times.

33. Carbon exists in iron in two distinct forms: *combined carbon*, forming the chemical compound carbide of iron; and *uncombined*, or *graphitic carbon*, which is a

mechanical mixture with the iron. The physical properties of iron depend largely on the state of the carbon. The iron is soft or hard according to whether the carbon is free or combined, and this ratio can be modified in two ways: by varying the percentages of silicon, manganese, sulphur, and phosphorus in the iron, and by varying the rate of cooling and solidification. The thickness of the casting also influences the state of the carbon. When iron is liquid and hot, the carbon is probably chemically combined, but as it cools and solidifies some of the combined carbon changes to free or graphitic carbon. An excess of free carbon can sometimes be seen on top of the cooling metal and is known as *kish*, which in some cases rises in a cloud of black flakes from the ladle; the addition of manganese or low-carbon iron, or both, will prevent kish. Free carbon remains in the iron as flakes of graphite, more or less filling the spaces between the crystals. Manganese aids, and silicon hinders, the absorption of carbon. With much manganese present, the iron may contain as high as 6 per cent. of carbon. But with manganese under 1 per cent., the iron seldom contains more than 4.5 per cent., the general average being about 3.5 per cent. There is a wide range in the proportions of combined and free carbon that make up the total carbon. This may be effected either by the rate of cooling or by the other elements contained in the iron. A cast iron with a total carbon of 3.5 per cent. may by slow cooling be made to contain 3 per cent. of free or graphitic and .5 per cent. of combined carbon; while if chilled, these proportions may be reversed.

If two castings of equal width and length be made, one 1 inch and the other 4 inches thick, and poured from the same ladle at the same time, being left in the molds to cool naturally and completely, the thin one will have a close, dense grain, while the thick one will have a porous, open grain, due wholly to the rate in cooling. The thin casting will have a much greater percentage of combined carbon than the thick one, as indicated by the difference in grain.

34. A similar difference in structure can be produced by changes in silicon and sulphur. To make the 4-inch casting as dense as the 1-inch, use a mixture of iron having less silicon and more sulphur in the thick casting, allowing both castings the same length of time to cool, when the grain will be alike notwithstanding the difference in thickness. If liquid iron is poured into water or against an iron chill, the carbon will be less likely to take the graphitic form and the iron may have a hard, white, chilled body; whereas, were the same iron poured into a medium-thick casting and allowed to cool slowly, the iron would be gray and soft. The greater the percentage of total carbon, the more radically can the rate of cooling and the influence of the other elements affect it in taking a combined or graphitic form.

35. The combined carbon closes the grain of the iron, increases shrinkage, and increases the strength. Graphitic carbon weakens the iron and reduces shrinkage and chill, and makes a soft iron that is easily machined; but a smooth finish cannot be made if the percentage is very high.

36. Silicon.—On account of the fact that cast iron generally contains a larger percentage of **silicon** than any other of the elements, it is the safest and most convenient one to adopt as a base in regulating mixtures. Sulphur can neutralize from 10 to 15 parts of silicon, so that, if used as a base, the least error in its percentages will cause much more injury to the iron than slight errors made in silicon. The oxide of silicon is silica or pure sand. In passing through a cupola, iron always loses silicon, the amount depending on the quantity of blast and the percentage of silicon present. An increased blast brings more oxygen in contact with the iron in melting, and hence converts the silicon to silica. The higher the percentage of silicon, the greater the loss of silicon in the cupola. An iron running 4 per cent. in silicon may lose as much as 20 per cent. of the original amount, while the loss in very low silicon iron

may not be perceptible. As the percentage of silicon in iron decreases, the difficulty of oxidizing it increases.

37. It has been stated that low-carbon pig gained in carbon under certain conditions when melted in a cupola. If iron is low in carbon and low in silicon, it will gain in carbon when remelted. Pure iron will absorb 6.67 per cent. of carbon, or 23 per cent. of silicon; hence, a given amount of carbon will produce $3\frac{1}{2}$ times as much change on cast iron as the same amount of silicon. The percentage of silicon in cast iron varies with the amount of carbon it contains, and vice versa; the maximum amounts of each being impossible in any given iron at the same time. This ratio appears to exist in a remarkable degree. For every rise of .1 per cent. in carbon in pig iron made under the same conditions, there is a corresponding decrease of .35 per cent. in silicon, and vice versa. The same applies to cupola practice. When melting a pig of 3 per cent. carbon and 1 per cent. silicon, there may be a gain in carbon. With a small percentage of fuel, a high blast pressure, and a large percentage of carbon and silicon, there is a tendency toward a loss of carbon; while with a low blast pressure, a small percentage of carbon and silicon, and a large percentage of fuel, there is a tendency toward a gain in carbon during melting. Very high percentages of silicon decrease the fusibility of the iron.

38. Shrinkage depends more on the influence of silicon than any other metalloid. Every .2 per cent. increase of silicon decreases shrinkage about .01 inch per foot. Silicon not only reduces shrinkage but softens the iron by changing combined carbon into graphitic carbon, and also increases the length of time iron will remain in a molten state. As a rule, if more than 3 per cent. of silicon is contained in castings over $\frac{3}{8}$ inch thick, with sulphur not over .06 per cent., it will cause castings to be soft and rotten or brittle. Silicon can be used to overcome many difficulties in casting and to control the quality and cheapness of mixtures containing scrap iron, but it must be used with care.

39. Sulphur.—Under ordinary conditions, iron melted in a cupola takes up **sulphur** from the fuel. The greater the amount of manganese in the iron, the less sulphur will be absorbed; and it is possible in cases of very high manganese iron to reduce the percentage of sulphur during melting, it passing off as a manganese sulphide in the slag. The ratio between the total amount of sulphur in the fuel and the amount absorbed by the iron depends on three conditions: (1) the kind and quality of flux used; (2) the temperature of the iron; (3) the composition of the coke and iron. The proper quantity of flux in a hot-working cupola will take care of a considerable amount of sulphur. The sulphur present in the fuel as a sulphureted hydrocarbon has no appreciable effect in increasing the percentage of sulphur in melted iron. This accounts for the fact that many foundries melting with coal obtain castings with a lower percentage of sulphur in proportion to the amount of sulphur in the fuel than do foundries melting with coke. An increase in sulphur, with the other elements and rate of cooling remaining constant, will harden iron by increasing the combined carbon and will also cause greater shrinkage, contraction, and chill. Sulphur shortens the time that iron can be kept fluid in a ladle; when it commences to show loss of fluidity, it cools off rapidly, making the iron run sluggishly and so bung up the ladle. It requires less change in the amount of sulphur to alter the softness or hardness of iron than any other element.

40. Where the fuel does not contain over .8 per cent. of sulphur, and the iron about .5 per cent. of manganese, the sulphur will increase in ordinary gray iron about .025 per cent. in one melting; but where coke contains 1 per cent. or over of sulphur, it may add to the iron from .04 per cent. to .08 per cent. of sulphur. This means that sometimes a casting will show .06 per cent. to .08 per cent. in sulphur when made from an iron having .02 per cent. of sulphur before remelting. This demonstrates the evils of high-sulphur fuel and the wisdom of analyzing both the fuels and

the iron. An increase of .04 per cent. to .08 per cent. in sulphur in a casting can make intended soft castings so hard that they cannot be chipped or filed, this being especially true in the case of light work. One part of sulphur can neutralize the effect of 10 to 15 parts of silicon, the other elements and conditions remaining constant. Sulphur can be absorbed up to .3 per cent. in iron, increasing its fusibility, but decreasing the length of time that it will remain fluid. The presence of .2 per cent. of sulphur in any ordinary foundry mixture is sufficient to injure almost any class of castings, excepting sash weights, etc.

41. When a large percentage of sulphur is present in iron, it is very difficult to produce sound castings. The molten iron is usually sluggish and congeals quickly, thus enclosing escaping gases, dross, kish, etc., thereby producing blowholes and dirty castings. Such iron must be poured extra hot. The amount of sulphur in pig iron ranges from .01 per cent. to .08 per cent., and sometimes higher, but what is called a No. 1 iron, by analysis, generally contains from .01 per cent. to .03 per cent. of sulphur. No. 2 iron may have its sulphur run up to .06 per cent., but when it exceeds .08 per cent. it is usually classed as Nos. 4 to 6, which are often called mottled or white irons. Charcoal irons can be made more free from sulphur than any other class.

42. Manganese is a metal obtained from the ores. It has a white color, oxidizes readily, has a specific gravity of 8.01 (that of iron being 7.8), and requires from 200° to 500° higher temperature to melt than iron. Foundry, Bessemer, and charcoal irons contain from 2 per cent. to 3 per cent., and ferromanganese from 20 to 82 per cent. The general run of ordinary foundry pig irons contains from .5 per cent. to 2 per cent. of manganese. Manganese is not united with the iron as a chemical compound; it is rather alloyed with it, having practically no affinity for the iron.

Increasing manganese over .75 per cent., with the other elements remaining constant, creates greater contraction

and chill on account of the fact that it hardens the iron. These effects of manganese may be very pronounced in light castings. A peculiarity of manganese is found in the fact that it may allow pig iron or castings to be open-grained and have the appearance of softness even when they are quite hard. If powdered ferromanganese be added to molten iron in the proportion of about 1 pound of ferromanganese to 600 pounds of iron, and it is thoroughly diffused through the metal by stirring it with a rod, it will soften hard iron. In some grades of iron such treatment increases the transverse strength of the iron, but when castings that have been subjected to this treatment are remelted, the manganese disappears in the slag, leaving the iron hard.

Manganese has a great affinity for sulphur and can often eliminate it almost wholly from iron by carrying it into the slag. For this reason soft castings may often be made from iron high in manganese when it is charged with iron high in sulphur, on account of the fact that the sulphur is carried out of the iron by the manganese, both passing into the slag. The loss of manganese may be as much as .2 per cent. in a single melting.

Manganese gives life to molten iron, and when ferromanganese as a powder or in small pieces is thrown into iron, it may often act as a physic to purify it and drive out sulphur, a slight odor of sulphur fumes being observed, thus reducing the chance of blowholes existing in castings. Charging moderately high-manganese pig, 1 to 1.5 per cent., in the cupola gives better results, actually carrying the impurities off in the slag, and is more economical than using ferromanganese either in the cupola or the ladle.

43. Phosphorus is an element derived from the ores, the flux, and the fuel. When phosphorus is once absorbed by iron it cannot easily be eliminated. Its tendency is to increase in percentage every time iron is remelted. The amount of this increase will depend on the amount of phosphorus in the fuel, as very little of it escapes absorption by

the iron. In general, phosphorus weakens iron more than any other of the elements that commonly occur in cast iron. When over .7 per cent. of phosphorus occurs in castings, it has a tendency to make them cold-short, or brittle, when cold. It surpasses all other elements in increasing the fluidity of molten iron. High phosphorus with high silicon produces an extremely fluid iron, but it has very little strength. Necessity for extra fluidity or life in molten iron is about the only good reason that can be given for allowing phosphorus to exceed 1 per cent. in iron castings requiring any strength. Phosphorus increases the fusibility of iron, and hence for castings required to stand high temperatures, it is best to keep the percentage of phosphorus as low as practical. Malleable iron must be low in phosphorus.

44. Phosphorus greatly counteracts the tendency of sulphur to increase combined carbon, shrinkage, contraction, and chill. Where high sulphur is giving trouble by causing hard castings, if there is no other practical remedy at hand, the evil may often be overcome by increasing the phosphorus from .25 per cent. to .4 per cent. Each .1 per cent. increase of phosphorus in iron will, in many cases, give about the same results physically in counteracting the effect of sulphur that an increase of .25 per cent. of silicon will give, where all the other elements remain constant. By using phosphorus instead of silicon to counteract the effects of sulphur and soften the iron, the fluidity of the iron is much increased, all the gases and dross can easily come to the surface, and the castings are more free from blowholes and shrink holes than if silicon had been used. In a general way, where castings are not subjected to high temperatures, .2 per cent. to .7 per cent. of phosphorus in iron assists in the production of good castings by making the iron flow better.

45. Aluminum is rarely found in pig iron, and has to be alloyed with it, either in a pure form or alloyed with other metals. It is added to iron by placing it in the bottom of the ladle and allowing the iron to flow over it, or by

throwing it on the surface of the molten iron, the first being the better plan. In either case the mixture should be well stirred. The influences of aluminum are similar to those of silicon, the latter being cheaper. Where the combined carbon is high, aluminum will lower it so as to make the iron softer. Where the percentage of graphitic carbon is high, aluminum will close the grain, give the iron a leaden color, and generally decrease the strength, except in cases where the graphitic carbon exceeds the limit that affords iron the greatest strength. As a rule, aluminum will only increase the strength of very hard grades of iron, or those containing 1.4 to 1.8 per cent. combined carbon. The amount of aluminum used in iron varies from .25 per cent. to 1.25 per cent. It will increase the fluidity of hard grades of iron, but generally causes soft grades to be sluggish with an excessive amount of dross on the surface, in this latter respect being similar to silicon. When pouring castings from iron containing aluminum by means of two ladles, cold-shuts are liable to occur at the places where the flowing streams meet. On the whole, aluminum and iron make a very erratic alloy, which may work contrary to expectations.

46. Titanium is found in many brands of foundry and Bessemer iron, running from a trace up to .1 per cent. Owing to the fact that ores high in titanium are difficult to smelt and cause much trouble in the furnace, they are avoided as far as possible. It increases the strength of iron very materially, but its other qualities are not known. Ferrotitanium is now being made and gives promise of becoming useful in some mixtures.

47. Nickel.—Iron has a strong affinity for **nickel**. Of the 550 meteorites of which there is any record, in all that contain iron, nickel is invariably present, in a few cases being as high as 40 per cent. Nickel imparts wonderful properties to iron through its peculiar effect on the carbon contained. Steel having under .25 per cent. of carbon has its ductility and tensile strength greatly increased by the addition of from 3 to 6 per cent. of nickel.

48. Loss of Iron by Oxidation in Melting.—There is always more or less iron lost by oxidation in the cupola. The larger the amount of surface exposed to the action of the blast and the stronger its pressures, also the thicker the scale of rust or dirt on the iron, the greater will be the loss from this cause.

In a series of experiments on this subject, the following facts were developed: Sandless or chilled pig iron was the least affected, showing a loss of from 3 to 4 per cent. Sand pig iron, fairly cleaned from loose sand, showed a loss of from 4 to 5 per cent. Scrap-iron plate ranging from $1\frac{1}{2}$ to 3 inches thick showed a loss of from 5 to 7 per cent. Scrap plate ranging from $\frac{1}{2}$ to 1 inch thick showed a loss of from 6 to 8 per cent. With fairly clean stove plate the loss ran from 12 to 20 per cent. Burned iron and tin-sheet plate, called *tin scrap*, showed a loss ranging from 25 per cent. up to nothing but slag. A high bed and a strong blast will cause a greater loss than a low bed of fuel and a mild blast. There will be more *shot iron*, i. e., iron more or less globular in form, such as the drippings from the foundry ladle, etc., coming from a low bed of fuel than a high one, for the reason that the latter will melt the cleaner at the close of a heat and will leave less refuse sticking to the sides of the cupola to be carried down by the dump. If a low bed is used, the iron should be carefully picked from the cinder to avoid unnecessary loss. There is also a loss of iron in the slag, depending on the pressure of the blast and the size of the slag hole. By investigating the losses in the slag and from oxidation, and studying their causes, it will generally be possible to operate the cupola so as to reduce them.

MELTING POINT OF CAST IRON.

49. It is often necessary to melt several different mixtures in one heat, and to do this, it is necessary to know which class of iron will melt first. If two radically different grades of iron are charged together, and one melts sooner than the other and is drawn off first and poured, the result

will not be the mixture expected. When it is desired to charge a hard grade of iron, to be followed by a soft one, or vice versa, it is very important to know the different melting points of the various brands so as to keep the irons separate. In most cases it is not necessary to know at what temperature the different brands of iron melt, but simply to know which melts first.

50. Comparing Melting Points of Cast Iron.—In order to determine or compare the melting points of various brands of iron, a series of experiments were made by two foundry experts. The tests of one were made in an assaying furnace, converted for the time into a cupola, while the tests of the other were made in the twin-shaft cupola illustrated in Fig. 1. The results of both, although made under different conditions and independently, agreed in showing that it required a higher temperature to melt soft gray iron than hard, chilled, or white iron, and that the latter will melt faster than the former; also, that scrap steel requires a higher temperature than do soft grades of cast iron. The assaying furnace was arranged so that a Le Chatelier pyrometer could be used to record the temperatures. Table III shows the results of tests on six samples.

TABLE III.

MELTING POINTS OF DIFFERENT BRANDS OF IRON.

Combined Carbon. Percentage.	Graphitic Carbon. Percentage.	Character of Fracture.	Melting Point. Degrees F.	Remarks.
1.60	3.16	Gray	2,210	} Samples cast from same ladle.
4.67	.03	White	2,000	
1.57	2.90	Gray	2,250	} Samples cast from same ladle.
4.20	.20	White	1,990	
1.20	2.90	Gray	2,250	} Samples cast from same ladle.
3.90	.16	White	2,000	

These samples were obtained from the same ladle by pouring some of the metal into chills, shown in Fig. 2 (a), thus forming chilled castings about $2\frac{1}{4}$ inches in diameter by 6 inches long, as shown at (b), and some of the metal into sand molds, formed with a pattern of the same size as the chilled casting. In melting these samples, the chilled iron was placed on one side *e*, and the gray

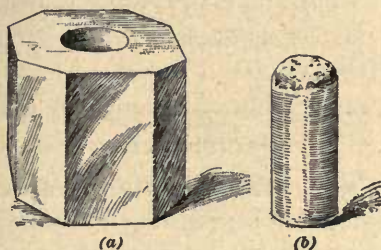

FIG. 2.

iron, or that unchilled, on the other side *f*, of the cupola shown in Fig. 1. As the conditions on the two sides of this cupola are practically alike, it is evident that the sample of iron that melts first must have the lower melting point and will come down first in a regular cupola.

51. Important Observations in Melting Cast Iron.—During the melting of 73 specimens, the following actions were observed: The white irons held their shape, the iron running from the sides and bottom freely, leaving smooth surfaces. The gray irons became soft and dropped in lumps, leaving a ragged surface. Ferromanganese became soft and mushy, exhibiting a consistency of putty before finally running down. Ferrotungsten behaved in the most marked way. As it melted, it acted like white iron, but instead of chilling quickly, it ran through the coke, coming down the spout in thin streams like quicksilver, and collected in a pool in the pan of sand. Both experimenters concluded that the higher the combined carbon, independent of the amount of graphitic carbon present, the lower the melting point.

The temperatures at which different brands of iron actually melt, however, have but little to do with the temperatures to which the metal must be raised before it can be poured into molds. While it is true that white iron will melt at a lower temperature than gray iron, the fact must

not be overlooked that white iron must have a higher temperature than gray iron to be poured into the same class of castings, on account of the fact that white iron chills in the ladle or gates of the mold much more quickly than gray iron.

SPECIFICATIONS FOR FOUNDRY PIG IRON.

52. General Requirements for Foundry Irons.

Founding establishments making their mixtures often purchase all materials according to specifications, based on their composition as shown by chemical analysis. Standards have been developed for each style of castings and for the methods of making the analyses. Aside from the percentages of metalloids, it is specified for all brands that they be of good, clean iron, free as possible from dross, kish, oxide, sand, etc., and that the percentage of sows must not vary to any great extent from the usual amount found in a strictly graded iron. The following specifications are taken from standard practice. Explanations regarding the action and influence of the various metalloids are given in detail elsewhere under their respective headings. The following chemical methods are used in making the analyses called for in these specifications, the standardized drillings furnished by the American Foundrymen's Association being used as standards to check the chemical work: for silicon, Drown's method; for sulphur, evolution and titration with iodine (volumetric) as a rapid method, and the oxidation method (gravimetric) in all cases of dispute; for phosphorus, Emmerton's method for rapid work, and the molybdate-magnesia method for accurate determinations; for manganese, Deshay's or the colorimetric method for rapid work, and the acetate process for extremely accurate work; carbons are worked by the colorimetric and combustion methods, and in cases of dispute, check analyses are made by gravimetric methods. A carload is taken as the unit for sampling pig iron. The analyses of the different grades of pig iron are given in Table IV.

TABLE IV.
SPECIFICATIONS FOR PIG IRON.

Class of Iron.	Silicon.			Sulphur			Phosphorus.			Manganese.			Total Carbon.		
	Per Cent. Preferred.	Not Less Than. Per Cent.	Not To Exceed. Per Cent.	Must Not Exceed. Per Cent.	Should Not Exceed. Per Cent.	Not Less Than. Per Cent.	Must Not Exceed. Per Cent.	Should Not Exceed. Per Cent.	Not Less Than. Per Cent.	Should Not Exceed. Per Cent.	Per Cent. Preferred.	Maximum. Per Cent.	Minimum. Per Cent.	Not Specified.	
No. 1 foundry..		2.50		.030	.60			.5			4.50	3.0		See Art. 52.	
No. 2 foundry.....		1.95		.040	.70			.7			4.20	2.9			
No. 3 foundry.....		1.35		.050	.80			.9			4.00	2.4			
Silicon pig.....		3.00	5.50	.040	.90				.3		3.00	2.5		See Art. 52.	
Ferrosilicon pig.....		7.00	12.00	.040	.70				.2		3.00	.5			
Manganese pig.....		2.50		.040					.9		3.75				
Malleable Bessemer, common		.70	2.10	.045	.15				.3					See Art. 52.	
Malleable Bessemer, straight.		1.00	1.50	.040	.10				.6						
Charcoal iron.....		.30	2.75	.025	.25				.7		4.50	2.5			
Phosphoric pig		1.50		.055		1			.3			3.0			

53. No. 1 Foundry Pig Iron.—The total carbon will usually be between 3 and 4.5 per cent. in **No. 1 foundry pig iron**. Any car of this iron that shows on analysis less than 2.4 per cent. silicon or more than .035 per cent. sulphur will be rejected.

54. No. 2 Foundry Pig Iron.—The total carbon in **No. 2 foundry pig iron** will generally range from 2.9 to 4.2 per cent. Any car of this iron that shows on analysis less than 1.85 per cent. silicon or more than .045 per cent. sulphur will be rejected.

55. No. 3 Foundry Pig Iron.—The total carbon in **No. 3 foundry pig iron** will usually be between 2.5 and 4 per cent. Any car of No. 3 foundry iron that shows on analysis less than 1.25 per cent. silicon or more than .055 per cent. sulphur will be rejected.

56. Silver-gray silicon pig iron is to be used as a softener and is expected to be medium high in silicon and not too low in graphitic carbon. Any car showing on analysis less than 3 per cent. of silicon or more than .055 per cent. of sulphur will be rejected.

57. Ferrosilicon Pig Iron.—The specification for **ferrosilicon pig iron** calls for a pig iron with about 8 per cent. silicon, the general range in this grade being from 6 to 12 per cent. As a rule, the graphitic carbon will be low, varying from .5 to 3 per cent. Cars will be rejected that show less than 6 per cent. of silicon or more than .045 per cent. of sulphur.

58. Manganese pig iron calls for an iron having from 1 to 2.5 per cent. manganese, the No. 1 pig iron running about 1.5 per cent. in manganese filling the required conditions. It is an ordinary iron made from ore containing somewhat more manganese than the regular foundry irons and carries from .8 to 3.5 per cent. As a rule, the higher the manganese, the greater the proportion of combined carbon, and this pig is added to the foundry pig mixture to raise the combined carbon and increase the strength. The

combined carbon may range from .3 to 3 per cent., and the graphitic carbon from .4 to 3.5 per cent. In a measure, the manganese pig neutralizes the effect of sulphur, removes excess of gas, and prevents blowholes. It must be used with caution, as low silicon and carbon with high manganese give hard iron and alter shrinkage.

59. Malleable Bessemer Pig Iron.—The specification is the same as for *common* Bessemer iron, as given in Art. 21. As a rule, the combined carbon will vary from .3 to 1.3 per cent., and the graphitic carbon from 3.45 to 1.8 per cent. When the preferred percentages are stated, an iron not varying more than .1 per cent. either way is expected. When no preferred figures are given, the silicon and manganese may be anywhere within the prescribed limits.

When the *straight* Bessemer is specified, the phosphorus is not to exceed .1 per cent., with from 1 to 1.5 per cent. silicon, about .6 per cent. manganese, and less than .04 per cent. sulphur. Iron for these grades will be rejected if the analysis shows more than .05 per cent. sulphur or more than .18 per cent. phosphorus.

60. Charcoal iron differs from coke iron mainly in regard to the carbon. The graphitic carbon appears to be in a finer state of division, and when changed into the combined form, it produces a closer grain and stronger metal than does a coke iron having the same total carbon. It is especially adapted to chill work, almost any desired chill being obtained by regulating the amount of silicon and carbon. The sulphur, phosphorus, and manganese are nearly constant in charcoal iron; silicon and carbon vary greatly and govern the various grades.

Graded according to fracture, there are usually seven grades, designated by letters and numbers, and as *soft*, *foundry*, *medium*, *high carbon*, *low carbon*, etc. Low carbon approximates 2.5 per cent.; medium, 3.5 per cent.; and high, 4.5 per cent., or over.

61. Phosphoric pig iron is used almost exclusively for small, thin castings where great fluidity is desired, it being essential in this work to fill all parts of the mold with a clear, solid casting. Any car showing on analysis more than .06 per cent. sulphur or less than .9 per cent. phosphorus will be rejected.

Table IV gives the metalloïd percentages required in the ten grades of pig iron just given.

62. Scrap Iron.—This term is used to designate that large product which has been remelted one or more times, and consists of castings that have been in service, and also the gates, defective castings, etc. in the shop, which must be utilized in new work. As outside scrap costs less than pig iron, the greatest possible amount is used in cupola mixtures. On the other hand, scrap is so variable that it is not proper to use it in special mixtures.

One great difference between scrap iron and pig iron lies in the fact that the former permits experienced persons to define its grade by the appearance of its fracture much better than is possible with pig iron. Generally, castings are allowed to cool under conditions that do not permit the great variations in the grain of the metal that occur in pig iron; also, the form of the casting in which the iron is found is some guide as to its grade.

With a little experience in grading scrap iron, one should be able to decide quite accurately how hard or soft the iron will become when remelted. As a rule, it is impracticable to make a chemical analysis of scrap iron, on account of the fact that it comes to the founder's yard in no regular order or system. A pile of scrap iron is more liable to come from a dozen different kinds of castings made in different parts of the country than from one heat or mixture, and it is next to impossible to get a fair sample for analysis. Almost any intelligent laborer should, with a little training, be able to select and pile up scrap according to its grade in a more economical and practical manner than can be done by attempting to analyze it.

63. Grading Scrap Iron.—A good plan in classifying scrap iron is to adopt a system of grades to be defined by numbers, as in grading pig iron. In order to obtain a standard of grades to compare scrap iron, one may adopt the texture and grain that will be obtained by the remelting of pig iron, containing, before being charged, 1, 2, and 3 per cent. of silicon, respectively, with sulphur supposed to be constant at .03 per cent., and the phosphorus and manganese as generally found in the character of pig iron being used. With such a system, one should soon learn to recognize the fracture of castings from such mixtures of pig iron when poured into castings ranging from the thickness of stove plate upwards to bodies 4 inches or 6 inches thick, and also to pick out the corresponding grades in the scrap iron. As an approximate guide to the sulphur and silicon contents of gray scrap, it can be said that iron ranging from stove plate up to 1 inch in thickness may be considered as an approximate equivalent of remelted pig iron in which the silicon ranged from 2 per cent. down to 1.5 per cent., and for bodies from 1 inch to 3 inches thick, from 1.75 per cent. down to 1 per cent. silicon, sulphur in all cases to be considered as constant at about .06 per cent. Above 3 inches in thickness, an open, gray fracture can range in silicon, with scrap iron, all the way from 2 per cent. down to .75 per cent. The grading of such heavy bodies generally requires more skill than is necessary with light and medium thicknesses of scrap iron, but practice should soon enable one to guess fairly close in judging the grade of heavy or thick bodies as well as light ones. In cases where scrap iron comes to the founder's yard in the form of complete castings that have to be broken, he can, by sizing up the general proportions of the whole casting, judge much closer the grade in the massive parts than if the scrap iron were received in a miscellaneous broken condition mixed with other irons. One of the most difficult classes of scrap to pass judgment on as to its grade is white iron. In castings ranging from the thickness of stove plate up to 2 inches, the silicon may range all the way from 1.5 per cent. down to .5 per cent.

In castings over 3 inches thick, it is generally safe to conclude, if the section is all white, that the silicon can range from .4 per cent. down to .1 per cent., with sulphur in any of these thicknesses ranging all the way from .05 per cent. to .2 per cent. As a rule, it can be taken for granted that the sulphur is very high and the silicon very low in all scrap iron having an entirely white fracture.

It is almost impossible to pass judgment on the analyses of burned iron, especially if badly burned. As a rule, such iron is unsuited for any work other than that of making castings similar to sash weights. When scrap iron exceeds one-half of the mixture, it is customary to allow the mixer a leeway of .1 to .15 per cent. on silicon and .005 to .01 per cent. on sulphur.

64. Method of Using Scrap Iron.—All founders have more or less fine scrap and shot iron collected from the shop's refuse and cupola dumps that should be remelted. Such refuse can be used, a few shovelfuls at a time, by evenly distributing it over the top of the regular charge in the cupola. Manufacturers of very light small-work castings find the most difficulty in utilizing their shop's refuse. In some cases the fine shot, etc., is held until the last of the heat and utilized for a few heavy castings, the rest being poured into pig beds.

Care should be taken to have all the scrap as free from scale or dirt as possible. Some founders go so far as to tumble all gates and sprues before charging them, so as to avoid dirt in the iron. Just as much care and judgment should be exercised in the selection of scrap as in selecting pig iron, if good results and success are desired.

65. Specifications for Machinery Scrap.—The specifications for scrap iron vary to some extent according to the class of castings to be made. For use in the manufacture of agricultural implements and light machinery, there is required a good clean scrap from similar castings, free from excess of rust. When a car of scrap is received, the inspector should superintend the unloading and discard

the following objectionable pieces: Wrought iron, steel, burned stove plate, grate bars, car wheels, brake shoes, large chilled work, burned malleables, and large pieces weighing more than 400 pounds.

66. Proportioning Iron Mixtures.—It is not always possible to obtain pig iron having the exact composition desired for the castings, and hence it is necessary to determine the percentages of the elements in the resulting product when two or more brands of iron are melted together or to select the proper amounts of different brands to make the desired composition. As a rule, the furnaceman only guarantees to keep the phosphorus and manganese within certain limits in the iron he furnishes, silicon and sulphur being allowed to vary to much wider limits. Iron undergoes other changes in a cupola besides being melted. There is a loss of from .2 to .3 per cent. in silicon and from .1 to .5 per cent. in manganese, and there may be variations in the other metalloids, so that allowance must be made for these after the theoretical percentages have been determined. The method of making these computations will be best understood from practical examples, taking silicon as the element under consideration. It is required to make a mixture containing 3 per cent. of silicon from two brands of pig iron containing 3.4 per cent. and 2.8 per cent. silicon, respectively. Every 100 pounds of mixture is to contain 3 pounds of silicon. Of the individual brands, 100 pounds of the first contains 3.4, and the second 2.8, pounds of silicon. Hence, one brand has .4 pound too much and the other .2 pound too little silicon. The problem then is to determine the amounts of each to use so that the excess of one will balance the deficiency of the other, and then to make a proper allowance for loss in the cupola. For a mixture running from 3 to 4 per cent., or over, in silicon, the loss may be as much as 20 per cent. By this is meant the ratio of the loss in silicon to the original amount; thus, if the contents were 5 per cent. and the loss 20 per cent., or one-fifth of this, the net amount in the casting would be 4 per cent.

Continuing with the example, and taking 100 pounds of mixture for a basis, if the pounds of high-silicon pig (H. S. P.) be multiplied by the percentage of silicon contained, the product will be the amount of silicon in pounds in it; likewise, if the low-silicon pig (L. S. P.) be multiplied by the percentage of silicon contained, the product will be the amount of silicon in pounds in it. Not allowing for losses, it is desired that the proportions of the two grades be such that the sum of these two products equals 3 pounds of silicon. This computation may be summarized as follows:

Pounds high-silicon pig $\times .034$ + pounds low-silicon pig $\times .028 = 100 \times .03 = 3$ pounds silicon. But as the iron mixture is to weigh 100 pounds, the pounds of low-silicon iron (L. S. I.) is equal to 100 pounds minus the pounds of high-silicon iron (H. S. I.), and the statement may be written thus:

Pounds H. S. I. $\times .034$ + (100 pounds - pounds H. S. I.) $\times .028 = 3$ pounds; or, $.034$ H. S. I. + $100 \times .028 - .028$ H. S. I. = 3; or, $.006$ H. S. I. + $2.8 = 3$; or, $.006$ H. S. I. = $3 - 2.8 = .2$; or, H. S. I. = $.2 \div .006 = 33\frac{1}{3}$ pounds; and the L. S. I. = $100 - 33\frac{1}{3} = 66\frac{2}{3}$ pounds. This shows that the mixture must be made up of one-third high-silicon iron and two-thirds low-silicon iron; and if the casting requires 1,500 pounds of metal, 500 pounds of H. S. I. and 1,000 pounds of L. S. I. must be charged into the cupola, no allowance being made in this example for losses.

67. Rule for Proportioning Iron Mixtures.—*From the number representing the greater percentage take the number representing the required percentage and multiply the remainder by 100, which gives the number of pounds of the brand of iron containing the smaller percentage that is to be used in the mixture. From the required percentage take the smaller percentage and multiply the remainder by 100; this will give the number of pounds of the brand of iron containing the greater percentage to be used in the mixture.*

EXAMPLE.—If a founder has two brands of iron, one of which contains .75 per cent. of silicon and the other 1.75 per cent. of silicon, and

he desires to make a mixture containing 1 per cent. of silicon, what proportion of each brand should be used in the mixture ?

SOLUTION.—Applying the rule just given, we get $(1.75 - 1.00) \times 100 = 75$ lb. of iron containing the smaller percentage of silicon, and $(1.00 - .75) \times 100 = 25$ lb. of iron containing the larger percentage of silicon, as the amounts to be used in the mixture. Since the amounts are in the proportion of 25 to 75, or 1 to 3, it follows that 3 parts of the iron containing the smaller percentage of silicon should be used for every part of the other iron.

68. Allowance for Loss of Silicon in Melting.

Suppose the loss in silicon in melting is 20 per cent. of the amount charged (A. C.), then the computations in the preceding example must be modified to conform to actual practice. If the charge contains 10 pounds of silicon, and 20 per cent. is lost, then the casting will contain 10 pounds minus 20 per cent. of 10 pounds, which may be stated as follows:

$$10 - (10 \times .20) = 10 - 2 = 8.$$

Now if 8 pounds are required, to find the amount to be charged, the process is reversed as follows: The pounds to be charged must equal 8 pounds plus 20 per cent. of the amount charged; hence, amount charged = $8 + \text{amount charged} \times .20$; or, A. C. - .20 A. C. = 8; or, .8 A. C. = 8; or, A. C. = $8 \div .8 = 10$.

Applying this principle to a mixture of 100 pounds and making the estimate to allow for 20 per cent. loss of the silicon, the statement may be written as follows, when it is desired to have 3 per cent. of silicon in the casting: A. C. - .2 A. C. = 3; or, .8 A. C. = 3; or, A. C. = $3 \div .8 = 3.75$ pounds of silicon required in the charge of 100 pounds of pig iron.

69. Rule for Loss of Silicon in Melting.—*To find the number of pounds of any metalloid to be charged into the cupola to allow for a definite loss, divide the amount to be in the casting by 1 less the loss per unit.*

The number of pounds to be used of each brand of iron in the mixture is next to be determined. As the required silicon is above the contents of the higher-silicon iron used in the example, Art. 67, it is necessary to use a still higher grade for this particular mixture. Suppose 6-per-cent.-silicon pig is available, then the computations for the proportions are as follows: $(6 - 3.75) \times 100 = 225$, and $(3.75 - 3.4) \times 100 = 35$. The sum of these numbers is 260, and the proportions are $\frac{225}{260}$ and $\frac{35}{260}$, or $\frac{45}{52}$ and $\frac{7}{52}$; that is, 45 pounds of the low-silicon pig must be used for each 7 pounds of the high-silicon pig. If, for example, the cupola charge requires 5,200 pounds of iron, then the number of pounds of low-silicon pig is equal to $\frac{5,200}{45 + 7} \times 45 = \frac{5,200}{52} \times 45 = 100 \times 45 = 4,500$; and the pounds of high-silicon iron is $5,200 - 4,500 = 700$.

The work may be proved as follows: $700 \times .06 = 42 =$ the number of pounds of silicon in the 6-per-cent. pig used; and $4,500 \times .034 = 153$ pounds of silicon in the 3.4-per-cent. pig, making a total of $42 + 153 = 195$ pounds of silicon in the charge. If 20 per cent. of this is lost, there remains 156 pounds, and this is equal to 3 per cent. of 5,200, as required in the casting.

The application of the rule is made in the same manner to get the proportions for any weight of mixture or for any element.

MIXTURES OF CAST IRON.

70. Examples of Iron Mixtures.—Those mixing iron by analysis usually have a preference for certain combinations, and naturally use mixtures giving the best results under existing conditions. For example, if the castings are to be cooled slowly or partly annealed, the silicon is generally made as low as possible, or to a point where extreme hardness does not interfere with machining.

The examples of mixtures for specific castings given in Tables V and VI are from current practice in foundry work. Table V gives a mixture for disappearing-gun mounts, which

TABLE V.

IRON FOR DISAPPEARING-GUN MOUNTS.

Class of Iron.	Percentage in Mixture.
No. 3 Muirkirk charcoal iron.....	5 to 15
No. 4½ Muirkirk charcoal iron.....	3½ to 15
No. 4 high Landon charcoal iron...	25 to 30
No. 4 low Landon charcoal iron....	30
Gun-iron scrap.....	20 to 25

was melted in the cupola at the Niles Tool Works, Hamilton, Ohio, and gave a tensile strength of about 33,000 pounds per square inch with an elongation of from .5 to .6 per cent. The percentages of metalloids in this mixture are given in Table VI; the table also gives the percentages in several mixtures used for specific purposes. The car-wheel iron of Table VI had stood hard service for from 8 to 11 years. It was made from both charcoal and coke irons, the percentage being from average analyses. The gray-iron mixture for hard, strong, close-grained iron for ammonia cylinders shows considerable variation in the elements. Where the castings are allowed to cool slowly, or are annealed, the silicon should not be over 1.6 per cent.; if not annealed, it may be from 1.6 to 1.9 per cent. The sulphur may run to .15 per cent. only where there is a high total carbon, though it is better to keep it lower on account of excessive shrinkage. Phosphorus should be kept below .7 per cent., and if greater strength is required, .4 per cent. or less is better. The manganese is made as high as .8 per cent. only in cases of high sulphur. In mixing the medium iron for engine cylinders and gears, 1.5 per cent. silicon gives the best results for gears and 1.6 per cent. for cylinders. If the castings have thin parts, or are not cooled slowly, add .10 to .20 per cent. of silicon. Sulphur is best kept below .085 per cent., but if the manganese is over .6 per cent., the sulphur may run up

to .1 per cent. The phosphorus should not exceed .7 per cent. The ideal soft mixture for pulleys and small castings has 2.4 per cent. silicon, with sulphur not above .085 per cent. Phosphorus may go to the limit of .95 per cent. in thin castings, but if strength is wanted, it is best to keep it below .7 per cent. Manganese gives the best results when between .4 and .6 per cent.

TABLE VI.

CHEMICAL ANALYSES OF IRON MIXTURES.

Class of Iron.	Silicon.	Sulphur.	Manganese.	Phosphorus.	Combined Carbon.	Graphitic Carbon.	Total Carbon.
Chill roll.....	.84	.071	.285	.547	.61	2.45	3.06
Gun metal.....	.73	.059	.408	.453	.76	2.47	3.23
Car wheel.....	.78	.132	.306	.364	1.07	2.36	3.43
General machinery.	1.30	.053	.224	.433	.58	3.31	3.89
Stove plate.....	2.47	.094	.265	.508	.19	4.00	4.19
Bessemer iron.....	1.52	.059	.326	.083	.49	3.73	4.22
Mixture of Table V.	1.00	.050	.600	.300	1.10	1.40	2.50
Car wheels in hard service 8 to 11 years.....	.58 to .68	.050 to .080	.150 to .270	.250 to .450	.63 to 1.01	2.56 to 3.10	3.19 to 4.11
Ammonia cylinders	1.20 to 1.90	.095 to .150	.800 to .600	.400 to .700			
Engine cylinders, gears, etc., me- dium iron.....	1.40 to 2.00	.085 to .100	.300 to .700	.700			
Pulleys, small cast- ings, etc., soft iron.....	2.2 to 2.8	.085 to .070	.300 to .700	.700 to .950			

71. Mixtures for Soft Castings.—The first thing to be done in making iron mixtures is to decide on the physical qualities that are desired in the castings. If only a common grade of castings is required, a mixture can be made by taking one-third of No. 1 foundry pig iron and two-thirds of scrap iron. The No. 1 pig should run from 2.75 per cent. to 3 per cent. in silicon; sulphur, from .01 per cent. to .03 per cent.; manganese, .3 per cent. to .6 per cent.; and phosphorus, .25 per cent. to .5 per cent. The scrap to go with the mixture should range in silicon 1.5 per cent. to 2.5 per cent., and sulphur, .05 per cent. to .08 per cent. Such a mixture should be soft enough to machine in castings over 1 inch thick.

If the castings are to be thinner than 1 inch, the percentage of scrap should be decreased. For castings about $\frac{1}{4}$ inch thick, a mixture of about three-fourths pig and one-fourth scrap will be required.

For light small castings and stove-plate work, a pig ranging from 3.5 per cent. to 3.75 per cent. in silicon, and not over .02 per cent. in sulphur, and manganese from .3 per cent. to .5 per cent., with phosphorus .7 per cent. to 1 per cent., should work well. The carbon in the foundry irons should not be less than 3.25 per cent., and higher if practicable up to 4 per cent.

Ferrosilicon containing 5 to 6 per cent. of silicon can often be mixed with 80-per-cent. scrap, running from 1.5 per cent. to 2 per cent. in silicon, and the castings finish fairly well when above 1 inch in thickness. When using ferrosilicon where it runs 4 per cent. or above in silicon, great care must be exercised to get just the amount necessary, for if too much is used, it may render the castings so brittle and weak that they will crack on the least jar.

It is always well to use iron from two or more furnaces in all mixtures, on account of the fact that this reduces the effect of any irregularities existing in one grade of iron that, if used by itself, could injure the mixture. In the manufacture of some specialties, as stove plate and light hardware, it is necessary to use all pig iron, no scrap being permitted

in the mixture, except that coming from gates, defective castings, etc.

72. Mixtures for Hard and Chilled Castings.

The silicon in pig iron for such work as chilled rolls, car wheels, and other classes of chilled castings generally ranges from .5 to 1.25 per cent., with the sulphur, manganese, and phosphorus varying according to the specialty being manufactured. The character of the chill often has more to do with the durability of chilled work than its depth. A chill promoted chiefly by manganese will be found better able to yield to stresses, and not so liable to crack on the surface of castings (which is done at the moment of solidification), or from *heat wear* in use (as in the case of rolling-mill rolls), than a chill that is chiefly promoted by sulphur, although manganese is best and often necessary to enable the wheels to stand the thermal test. For *friction wear*, as in the case of the tread of car wheels or brake shoes, a chill produced by sulphur gives more life than one produced by manganese. The temperature and fluidity of the metal with which a casting is poured, as well as the thickness of the casting, all have an influence on the depth of chilling. A casting poured with hot iron will chill deeper than one poured with dull iron, and a heavy casting will chill less than a light one in all cases where the thickness of the iron mold or chill used is about the same.

For making chilled castings, charcoal iron is generally used, although the use of coke and anthracite iron is increasing, especially since it has become the practice to select iron by analysis. In making mixtures for some kinds of chilled work, a fair percentage of scrap iron may be mixed with pig iron. The scrap generally used in mixtures for chilled work consists of chilled castings, such as chilled rolls, car wheels, brake shoes, and plow points. In judging the grade of chilled scrap, the gray body as well as the chilled portion of the iron should be considered. The pouring of the castings with a hot or a dull iron makes a difference in the depth of the chill that might deceive one in judging its grade, if no

note were taken of both the gray body and the chilled portions.

73. Remelting Chilled Iron.—Foundrymen were formerly in the habit of picking out the chilled portions of castings and using them only for extremely low-grade work, such as sash weights, etc., but a series of experiments with this kind of iron seems to prove that it is softened by remelting. In the experiment, the chilled parts of the scrap iron were separated from the gray parts and both melted separately, and the castings from the chilled scrap were softer than those from the gray scrap. When chilled iron contains the requisite amount of total carbon, remelting will often transform a sufficient amount of the carbon to the graphitic form to produce a very good soft gray iron. Owing to the fact that chilled castings are generally made from high-grade irons, it is evident that this chilled scrap can often be used in the very best foundry mixtures, especially in the case where the chilled scrap is composed of castings made from good charcoal iron low in sulphur. This is on account of the fact that the combined carbon in the chilled iron is freed by remelting, and if allowed to cool slowly, will take the free or graphitic form. The general character of the chilled iron can be judged more closely from the gray portion than from the white portion, when selecting scrap for ordinary foundry mixtures.

74. Mixing Steel and Wrought Iron With Cast Iron.—In making the strongest grades of cast iron, from 15 per cent. to 30 per cent. of scrap steel is sometimes mixed with the iron. Wrought iron is also used, but, as a rule, soft grades of steel give the best results. In charging the steel or wrought iron into a cupola, it is generally mixed with the cast iron the same as the other scrap, but more fuel is required on account of their higher melting points. The strongest steel and iron mixtures are obtained by melting in an air furnace. The metal obtained by this process is called semisteel, and may have a tensile strength of from 40,000 to 50,000 pounds per square inch.

TESTING CAST IRON.

EXPLANATION OF TERMS USED IN TESTING CAST IRON.

75. Density is the mass or quantity of matter in a substance per unit of its volume. The *unit of density* is that of water at 39.1° F. at sea level under the mean pressure of the atmosphere. By a *dense iron* is meant one having a fine, close grain, as distinguished from one having a coarse, open grain. The greater density of the former may cause it to weigh from 50 to 60 pounds more per cubic foot than a coarse-grained iron. A cubic foot of white iron weighs about 475 pounds, and a cubic foot of dark-gray iron 425 pounds.

76. Tenacity is that property by virtue of which a substance resists being pulled apart. The tensile strength of cast iron may vary from 7,000 to 40,000 pounds per square inch, depending on the mixture. Owing to its low ductility, cast iron breaks suddenly under maximum load.

77. Elasticity is that property of matter by virtue of which it tends to return to its normal form or volume when the stress is removed. When it does not so return upon a removal of the load, the material is said to have taken a *permanent set*. The *elastic limit* is the maximum load that can be applied without producing permanent set. In cast iron this is very near the breaking load. For stresses less than the elastic limit, bodies resume their original form upon removal of the load. Good gray cast iron will stretch about $\frac{1}{8}$ inch in every 58 feet per ton tension per square inch up to about one-half the breaking load.

78. Deflection is the divergence or bending from a normal position caused by a stress. The deflection is measured in making transverse tests, also in testing columns. A rough bar of sash-weight iron $\frac{1}{2}$ inch square and 12 inches between supports, when loaded at the middle, will deflect

about .06 inch before breaking, while a similar bar of machinery iron will deflect over three times as much.

79. Brittleness and Strength.—Cast iron is said to be **brittle** when it breaks easily. White iron and those high in silicon or phosphorus are usually brittle. Brittle iron should not be used where subjected to sudden loads or jars.

By the **strength** of cast iron is meant its ability to withstand stresses when applied in any of the several ways without yielding or breaking. Tests are usually applied to cast iron transversely and by impact. Cast iron is generally used to resist transverse and crushing stresses, also those from impact or blows. Tensile tests are sometimes used.

80. Chill.—The **chilled** portion of a casting is the hardened skin or shell, in which the greater part or all of the carbon is in the combined form. The term chill is also applied to the metal parts of the mold in contact with the molten iron, and that produce these hardened portions. The chilled structure is white and is produced by suddenly cooling the iron in the surface of the casting in the mold. The chill may be localized in castings by arranging metal parts in the mold, thus carrying off the heat rapidly from certain prescribed areas. Chill is promoted by varying the percentage of sulphur, silicon, manganese, phosphorus, etc. The strength and character of iron depend a great deal on the rate of cooling and thickness of the casting, the time in contact with the chill of the mold, hot iron, rate of contraction, etc.

81. Contraction is that quality of cast iron which causes it to decrease in volume as it cools after solidifying. Contraction depends largely on the form of the casting and its rate of cooling, and may vary greatly in different parts of the same casting, according as to whether the parts are thick or thin. Light bars contract more than heavy ones. The composition also regulates the contraction to a considerable extent. For certain classes of work it is desirable that the iron have as little contraction as possible. This is

especially true of those castings not well proportioned. The patternmaker's rule is to allow $\frac{1}{8}$ inch per foot for contraction. But this rule must be applied with care to patterns of different proportions. In heavy work the castings may be larger than the patterns. Slow cooling causes less contraction and promotes the formation of more graphitic carbon; hence the casting is more spongy and not so dense.

82. Shrinkage is the term applied to the decrease in volume of cast iron while cooling in a molten state. To overcome shrinkage requires feeding to keep the mold full. It is most noticeable in heavy castings. It also depends on the grade of iron. Cast iron expands at the moment of solidification, a valuable property by virtue of which it takes the exact impression of the mold; then contraction begins, the action being analogous to that of water in its physical changes. This expansion takes place between the actions of shrinkage and contraction. Shrink holes appear in castings near the top, or portions last to solidify, also where light and heavy parts join, the holes being in the latter, or those parts that solidify last. Blow, sand, and dirt holes are different from shrink holes, the former, being formed on both the interior and exterior of the castings, are generally smoother, and are caused by gases not carried away by the vents, or by dirt in the molten iron.

The distinction here made between contraction and shrinkage is one of convenience rather than fact, for the words are generally used as synonyms.

83. Hardness of Cast Iron.—**Hardness** is a relative term denoting that quality of cast iron the degree of which is determined by its power to scratch or to be scratched by other substances according to an arbitrary scale. Moh's scale of hardness is generally used, and includes ten minerals ranging from talc, the softest, to the diamond, which is the hardest substance known. Practically the hardness of cast iron exhibits itself in the wearing away of the tool used on it. It differs from tenacity in that the latter measures the force to do the cutting and not the wear on the tool.

84. By **stress** is meant the force that acts in the interior of a body and resists the external forces tending to change its form. **Strain** is the deformation or change in form caused by the stress. The stress is measured in pounds per square inch, and the strain in inches. Thus, if a bar of cast iron of 1 square inch section sustains a load of 40,000 pounds and is elongated .55 inch, the stress is 40,000 pounds and the strain is .55 inch.

PHYSICAL TESTS OF CAST IRON.

85. Importance of Physical Tests. — The great number of different brands of cast iron used in the different branches of founding presents very complex problems in mixing. The different grades have radically different characteristics, and these are due not only to differences in chemical composition, but also to the physical condition of the metal. The size and character of the grain in a casting depend largely on the rate of cooling, variations in chemical composition, and the form of the casting. **Physical tests** are those relating to the casting after it is made, and embrace the determination of those practical features most desired by the manufacturer and the consumer, viz., good strength with a close grain; material not too hard to machine; and a shrinkage to correspond with the pattern. In addition to this, the castings are expected to be free from blow and shrink holes, cold shuts, scabby spots, etc. Some of these defects may be eliminated by manipulating the constituents of the mixture, others must be corrected in the molding.

Chemical analysis alone is not a sufficient record of the character of castings. It is necessary to know the physical qualities also. It is necessary to test new brands of iron so as to compare their qualities with those previously used. By using a small cupola, metal for test bars can be easily and cheaply melted and the physical qualities of various mixtures determined. Some founders dispense with test bars and are guided by the analyses and the castings from the iron. This does very well in the manufacture of some forms of

TABLE VII.
TENSILE TESTS OF CAST IRON.

Rough Test Bars Cast in Green Sand.	Chemical Composition.								Dimensions of Cross- Section of Pattern. Inches.	Area of Bar. Square Inches.	Breaking Load. Pounds.	Load in Pounds Per Square Inch.
	Percentage of Silicon.	Percentage of Sulphur.	Percentage of Manganese.	Percentage of Phosphorus.	Percentage of Combined Carbon.	Percentage of Graphitic Carbon.	Percentage of Carbon.	Dimensions of Pattern. Inches.				
Soft Bessemer.....	1.67	.032	.29	.005	.43	3.44	3.87	5	0.22	3620	16750	
Soft Bessemer.....	1.67	.032	.29	.005	.43	3.44	3.87	1 x 1	1.00	15200	15040	
Soft Bessemer.....	1.67	.032	.29	.005	.43	3.44	3.87	1.5 x 1.5	2.33	29210	14330	
Soft Bessemer.....	1.67	.032	.29	.005	.43	3.44	3.87	2 x 2	4.04	44810	11110	
Soft Bessemer.....	1.67	.032	.29	.005	.43	3.44	3.87	.56 dia.	.20	4360	1090	
Soft Bessemer.....	1.67	.032	.29	.005	.43	3.44	3.87	1.13 dia.	1.00	13960	13060	
Soft Bessemer.....	1.67	.032	.29	.005	.43	3.44	3.87	1.69 dia.	2.30	30560	13200	
Soft Bessemer.....	1.67	.032	.29	.005	.43	3.44	3.87	2.15 dia.	4.10	47310	11540	
Dynamo frame iron.....	1.95	.042	.39	.005	.59	3.23	3.82	5 x 5	.29	4990	17600	
Dynamo frame iron.....	1.95	.042	.39	.005	.59	3.23	3.82	1 x 1	1.01	15900	15740	
Dynamo frame iron.....	1.95	.042	.39	.005	.59	3.23	3.82	1.5 x 1.5	2.24	29470	13150	
Dynamo frame iron.....	1.95	.042	.39	.005	.59	3.23	3.82	2 x 2	4.02	47920	11920	
Dynamo frame iron.....	1.95	.042	.39	.005	.59	3.23	3.82	.56 dia.	.25	4410	17640	
Dynamo frame iron.....	1.95	.042	.39	.005	.59	3.23	3.82	1.13 dia.	1.00	15870	15870	
Dynamo frame iron.....	1.95	.042	.39	.005	.59	3.23	3.82	1.69 dia.	2.26	20700	13140	
Dynamo frame iron.....	1.95	.042	.39	.005	.59	3.23	3.82	2.15 dia.	4.03	47040	11670	
Light machinery iron.....	2.04	.044	.39	.078	.32	3.52	3.84	5 x 5	.25	4740	18060	
Light machinery iron.....	2.04	.044	.39	.078	.32	3.52	3.84	1 x 1	1.03	16360	15880	
Light machinery iron.....	2.04	.044	.39	.078	.32	3.52	3.84	1.5 x 1.5	2.25	29200	13030	
Light machinery iron.....	2.04	.044	.39	.078	.32	3.52	3.84	2 x 2	4.01	45020	11230	
Light machinery iron.....	2.04	.044	.39	.078	.32	3.52	3.84	.56 dia.	.25	4660	12640	
Light machinery iron.....	2.04	.044	.39	.078	.32	3.52	3.84	1.13 dia.	1.00	16490	16420	
Light machinery iron.....	2.04	.044	.39	.078	.32	3.52	3.84	1.69 dia.	2.25	32470	14430	
Light machinery iron.....	2.04	.044	.39	.078	.32	3.52	3.84	2.15 dia.	4.06	49570	12420	

castings, for in some cases every casting serves the purpose of a test bar, on account of the fact that if the iron possesses any irregularities, they will be displayed in the casting itself much more quickly than in an ordinary test bar.

Under certain conditions the shrinkage of a test bar varies inversely as the percentage of silicon contained. Hence shrinkage tests are frequently useful. Shrinkage tests are cheaply and rapidly made, and their use is within the scope of small foundries. The strength of a casting is often more dependent on the grain of the iron than on its composition.

86. Actual and Comparative Tests. — Iron for heavy castings generally requires careful physical tests. Test bars do not give the actual strength, construction, and chill of the individual castings. Such information can only be obtained absolutely by making duplicate castings and using one for testing purposes. The test bar gives the relative physical properties of the iron, and from his general knowledge of the properties of this class of iron, the founder can tell quickly from the test bar the qualities of the iron in question. In Table VII is given a series of tensile tests on different forms and sizes of test bars. These tests show that while the three sizes of test bars gave very different values in the individual specimens, they hold about a constant ratio to the strength of the iron, so that a comparison of any one set of bars of the same size throughout the series will give a fair idea of the relative strength of the different brands of iron. Hence, the function of the test bar is to give relative qualities rather than absolute. Physical tests are especially necessary in foundries producing castings such as car wheels, chilled rolls, ingot molds, water pipe, etc.

Frequently test bars are referred to in the specifications by which duplicate castings are ordered. If the chemical composition and physical characteristics of a test bar poured from the same iron from which the original casting was poured are known, it should not be difficult for the founder to produce another casting having practically the same physical characteristics as the first.

87. Size and Form of Test Bars.—The size and form of bars for transverse tests vary greatly, and on this account it is nearly impossible to compare records obtained from different sets of experiments. Both round and square test bars have been used, the length varying from $13\frac{1}{2}$ to 50 inches, and the cross-section from $\frac{1}{2}$ to 5 or 6 square inches. Some of the points that should be observed in selecting the size of a test bar are the following: The test bar should be of such form and size that it will be as little affected by variations in the dampness of the molding sand as possible. In proportion as the molding sand contains moisture, the outside of the bar will receive a greater chilling effect, thus causing more of the carbon to take the combined form and the grain of the bar to be closer. The test bar should also be of such a form that its structure will be uniform throughout, and it should be cast in such a position as to maintain a uniform structure and rate of cooling. Some experimenters claim to have found the round bar very much better than the square one, the reasons for which are given in Art. 88. One point that should be kept in mind is that the test bar furnishes information that can be used only in the comparison of different mixtures and does not give the ultimate strength of the iron when cast into some other form. From a great many experiments one authority has found that it is not very good practice to use a bar having a sectional area of less than 1 square inch, on account of the fact that variations in the dampness in the sand will greatly affect a small bar. He claims that the small-diameter test bar, having a sectional area of about 1 square inch, is best adapted for soft or medium grades of iron, and that the larger sizes give the best results in the hard grades of iron. Any iron that takes a chill easily requires a large test bar, so that the surface of the bar may bear a smaller relation to the area of the cross-section. The important consideration is to keep the conditions the same in doing the work, so that comparisons can be made that will be useful.

88. Uniform Grain and Structure in Test Bars. Having decided on the dimensions of a test bar, the next

question is how to obtain a uniform structure in it. If the square bar is used, as shown in Fig. 3 (a), it has been found that it is surrounded by an outer shell of more dense metal, as indicated by the shaded portion in the illustration, and

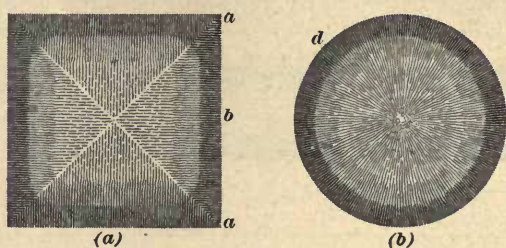

FIG. 3.

that this shell is thicker at the corners *a* than in the center of the flat surfaces *b*. It has also been found by careful analysis that the combined carbon is usually higher at the corners than at the center, one series of experiments showing that the combined carbon was .134 per cent. higher at the corners *a* than in the center of the flat surface *b*. It is evident from these facts that a uniform structure cannot be expected from a square bar, no matter in what position it is cast.

A round bar will also be surrounded by a shell of metal having a greater density than the central portion of the casting, as shown in Fig. 3 (b), but this outer shell will be uniform all around the bar, at least in the case of bars cast on end, and for this reason the round bar cast on end is to be preferred both for transverse and tension tests.

89. Structure of Test Bars.—In the case of test bars that are cast flat or on their side, when the load is applied on the surface that was uppermost in casting, also designated the *gate* side, a much greater strength is recorded than when the load is applied on the surface that was at the bottom during casting. A careful investigation as to the

structure of bars developed the facts illustrated in Fig. 4. The under surface *u* will have a thicker outer shell than the upper surface *v*, and the strength shown by the bar will depend largely on whether this thicker surface is up or down during the test. On this account the test bars should be cast on end. If for any reason it is found necessary to

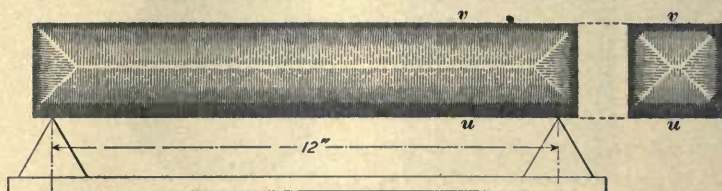

FIG. 4.

cast them horizontally, great care should be taken to see that they are all tested in the same relative position; that is, with the same side uppermost in the testing machine. When test bars are cast horizontally the word *top*, or some character to designate the upper surface of the bar, should be cast on the bar.

A square bar cast horizontally will have more defects, such as blowholes, dirt, etc., than a round bar cast vertically, and its transverse strength is from 200 to 300 pounds greater if broken with the gate side up. Tumbling the bars, either round or square, increases the strength from 100 to 300 pounds.

90. Testing Contraction in Cast Iron.—A knowledge of the contraction of iron will assist the molder greatly in proportioning the parts of a mold and determining whether or not a given brand of iron can safely be poured into the form of a given casting. In designing test bars for determining the contraction, it must be remembered that the contraction is affected more or less by the condition of the molding sand, and for this reason thin or small bars should be avoided. A difference in the moisture of the sand of two molds may make a difference of as much as $\frac{1}{32}$ inch in

12 inches in the contraction of the same brand of iron when using small bars.

One method of measuring the contraction of a test bar of cast iron is to cast the bar between the points *a* and *b* of a yoke *c*, as shown in Fig. 5 (*a*). The yoke *c* is placed in the mold, and a pattern placed between the points *a* and *b*. The yoke is left in the mold during casting, the iron contracting away from it. In the illustration, the casting *e* is shown in place in the same yoke in which it was cast, and

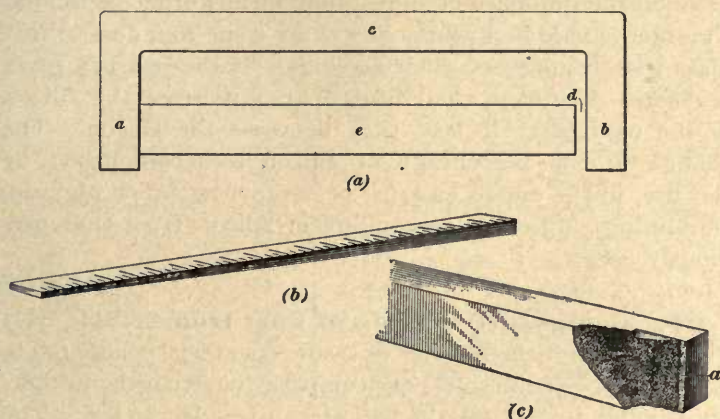

FIG. 5.

the space *d*, between the end of the bar *e* and the end *b* of the yoke *c*, is the contraction of the bar *e*, which may be measured by means of the wedge-shaped scale, shown in Fig. 5 (*b*), in thousandths of an inch per foot. The scale is placed vertically in the space *d*, and the reading made from the graduation on the scale at the top of the test bar.

A method adopted by some founding establishments is to use test bars 1 inch square, cast horizontally in a yoke, having the ends exactly 13.333 inches apart, and to determine both the contraction and the chill in the same mold. The contraction is measured by placing the bar in a laboratory yoke of the same dimensions as the one in which it

was cast and fitted with a micrometer; deducting one-tenth leaves the contraction per foot. For transverse tests the bars are laid on supports 12 inches apart, and the load applied in the middle.

The ends of the bar are cast against a metal chill. After measuring the contraction as just described, a piece is broken out of the side of the bar at the end and the depth of the chill *a* in the test bar, as shown in Fig. 5 (*c*), may be judged by the eye or measured.

It has been shown that the shrinkage of cast iron depends more on the influence of silicon than on any other metalloid. This fact is used in a practical way by some founders to regulate the shrinkage in their castings. If the test bar gives a greater shrinkage than desired, they increase the silicon in the next cast; if less, they decrease the silicon. The change in the percentage of silicon is accomplished by the use, in the cupola charge, of scrap iron or of pig iron containing a different percentage of silicon from that previously used.

91. Comparative Tests of Cast Iron.—Table VIII gives the results of a series of transverse tests conducted to determine two points: (1) the comparative strength of different grades of iron; (2) the best size of test bar to use. The classes of iron tested include those used in making chilled rolls, gun carriages, car wheels, heavy machinery, stove plate, and Bessemer-iron castings. The test bars used were round and of three sizes, the first being $1\frac{1}{8}$ inches, the second $1\frac{5}{8}$ inches, and the third $1\frac{7}{8}$ inches in diameter, giving areas approximately equal to 1 square inch, 2 square inches, and 3 square inches. The test bars were poured at the same time and under the same conditions. The bars were broken on bearings 12 inches apart, with the load applied at the middle. One fact brought out by these tests is that a bar having 1 square inch section is hardly large enough to give fair tests of the iron, but it may serve for comparing very soft grades of iron. Small bars are more affected than large ones by variations in dampness and other

irregularities in the molds. The test bars were supplied from foundries producing and using the grades of iron mentioned in the table. They all showed a perfectly solid structure at the point of fracture.

TABLE VIII.

COMPARATIVE TESTS OF VARIOUS GRADES OF CAST IRON.

Class of Iron.	Approximate Diameter of Bar. Inches.	Exact Diameter of Bar. Inches.	Area of Bar. Square Inches.	Transverse Breaking Load. Pounds.	Deflection. Inch.
Chilled roll	$1\frac{1}{8}$	1.140	1.021	3,250	.105
	$1\frac{1}{16}$	1.655	2.151	9,500	.090
	$1\frac{1}{8}$ sq.	1.968	3.042	15,250	.085
Gun carriage.....	$1\frac{1}{8}$	1.122	.988	2,780	.100
	$1\frac{1}{16}$	1.664	2.174	9,250	.110
	$1\frac{1}{8}$	1.859	2.714	11,820	.100
Car wheel.....	$1\frac{1}{8}$	1.174	1.082	2,200	.053
	$1\frac{1}{16}$	1.690	2.244	8,100	.070
	$1\frac{1}{8}$	2.008	3.167	13,500	.072
Heavy machinery..	$1\frac{1}{8}$	1.187	1.106	2,800	.092
	$1\frac{1}{16}$	1.705	2.282	7,100	.072
	$1\frac{1}{8}$	2.001	3.143	11,900	.079
Stove plate.....	$1\frac{1}{8}$	1.182	1.097	2,500	.117
	$1\frac{1}{16}$	1.745	2.391	6,050	.078
	$1\frac{1}{8}$	2.047	3.288	9,900	.081
Bessemer....	$1\frac{1}{8}$	1.175	1.084	2,150	.100
	$1\frac{1}{16}$	1.698	2.263	5,500	.100
	$1\frac{1}{8}$	1.991	3.112	8,900	.085
	1 in. sq.	.994	.988	1,757	.150

The majority of the committee appointed by the American Foundrymen's Association to make tests of different grades of iron decided, after making a large number of tests with different sizes of bars, that a $1\frac{1}{8}$ -inch round bar is the smallest size that should be used in soft irons,

and for hard grades they recommend a 2-inch or a 2½-inch round bar. They also recommend that all test bars be cast on end.

92. Testing the Chill of Cast Iron.—The chilling test is sometimes used as a guide in making up mixtures. If

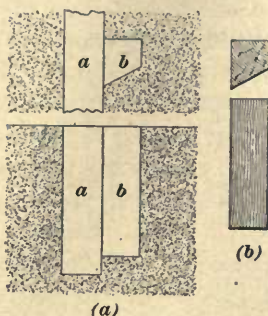

FIG. 6.

the test is always made in the same mold or against the same chill, and with iron at the same temperature and degree of fluidity, it is evident that the depth of chill will be affected mostly by the chemical composition of the iron, and can thus be relied on to give a pretty fair idea as to the silicon, sulphur, and manganese contents of the metal. Some experimental work is usually necessary to determine the best size and form of mold to

use, some metals requiring a larger and some a smaller specimen and chill. In all cases the specimen should be of such thickness that the entire body will not be chilled, some of the metal being left gray and soft. Chill tests may be made in the style of mold shown in Fig. 5, with various modifications, or the specimen may be cast against the flat chill shown in Fig. 6 (a). In this case a pattern similar to the one shown in Fig. 6 (b) is used. This is placed against the flat chill a, Fig. 6 (a), thus leaving the space b in the mold into which the metal can be poured. In chill tests, the chill should be so placed that the iron will not have a chance to flow over it in any large volume.

The white part denotes the chill, which can be measured, or, if small, judged by the eye. One precaution that must always be followed in chill tests is to see that the same mold or pattern and chill are always used in tests that are to be compared, on account of the fact that the body of metal in the chill will affect the rate of cooling and the physical conditions of the test piece.

93. Fluidity Test of Cast Iron.—In casting test bars it is often important to know the relative fluidity of the metal.

A method for making these determinations is to attach a wedge-shaped strip *b*, Fig. 7 (*a*), to the lower end of the pattern for the test bar that is cast vertically. The strip tapers from $\frac{1}{8}$ inch thick at the bar to a knife edge. Fig. 7 (*b*) shows two test bars cast at once, and so arranged that simultaneous tests may be made of the fluidity, contraction, and chill. The

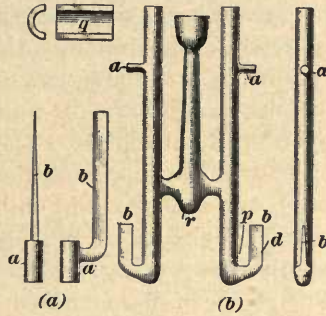

FIG. 7.

pieces *b* for testing the fluidity show that the iron was not sufficiently fluid to entirely fill the mold made by the tapered strips. Circular chills similar to that shown at *q* may be placed in the molds at the lower end of the test bars. In pouring castings in which there are to be local chills, the gates should be arranged so that no great amount of metal flows over the chills. The tips *a* and *p* are accurately cast 12 inches apart in the mold, and with chilled faces, so as to have a clean surface to measure from. By measuring the distance between *a* and *p* in the casting, the contraction is determined. Both bars were cast from one gate *r* and the gates cut in such a manner as to give the iron a spiral or whirling motion as it entered the molds, thus tending to float any dirt to the top. In molding test bars, the tempering of the sand and ramming of the mold should be very carefully attended to, as any variations are liable to cause uneven bars or irregularities in the combined carbon in the different parts of the bar. Care should also be taken in the use of the swab in molds for test bars, as the additional moisture introduced by the swab may affect the bar.

94. Tensile Tests of Cast Iron.—Table VII gives the tensile tests of three grades of cast iron for comparison. These bars were molded on end in green sand and broken

without any special cleaning or preparation except to brush them free from sand. It requires more skill than is generally supposed to cast perfect test bars on end. However, by arranging a suitable flask, to overcome the difficulties in getting the iron into the mold, so as to obtain uniform conditions and bars, very successful results were obtained. The length of bars for tensile tests is 8 inches between the grips of the machine. Thousands of tests have been made on bars of various dimensions. The bars were cast in green sand, dry sand, and in chills. Also, they were tested both in the rough and machined to some accurate area, and some rough bars were given treatment in the tumbling barrels. The strength of machined bars is less per square inch than rough bars of the same area; the variation in the strength of machined bars is as great as that of the rough ones; tumbling increases the strength of all rough bars.

95. Measuring Test Bars.—It is not safe to depend on the size of the pattern in determining the size of the bar, as differences in rapping the pattern, or in the condition of the molds, may cause a considerable variation in the size of the castings obtained from a given pattern. Hence, all test bars, whether round or square, should be carefully measured in order to determine their exact section. In case of bars that have been machined, this measuring is usually done before they are introduced into the testing machine, but as cast iron does not greatly reduce in cross-section at the point of fracture, it is good practice to measure the area of the bar after fracture. A micrometer is the best instrument for measuring the areas of test bars. As a cast-iron bar may not be a perfect circle, it is necessary to measure more than one diameter and get the average to use in calculating the area. Likewise, bars may not be perfectly square or rectangular, and measurements should be made across each edge.

The results obtained from any set of tests should be recorded in tabular form, as shown in Table VII. The areas of the bars should be determined, and, in tensile tests,

the breaking load per square inch computed. It is impossible to lay down any general rules for the strength of cast iron that will apply to any section, as its physical characteristics are radically different from those of wrought iron and steel. It is necessary to consider pieces of the same sections and lengths when comparing the strengths.

96. Testing Machines.—For breaking test bars or making deflection tests, a great variety of machines is used. Some shops are provided with elaborate testing machines, with capacities up to 100,000 pounds, driven by hand or by power; but for ordinary comparison work for transverse tests on bars not over $1\frac{1}{4}$ inches square or $1\frac{1}{4}$ inches in diameter, a machine of the style shown in Fig. 8 may be used. In this machine the bar *a* is placed on supports *b* and *c*, and is broken by forcing down the block *d* by means of the screw *e*. The pressure is weighed on the scale beam *n*, and the deflection recorded in thousandths of an inch by means of the pointer *i*. Unless an automatic poise is used, it is well to keep one hand in the position shown at *k*, so that any rise of the beam will be noticed and the sliding weight *l* adjusted immediately. If this precaution is not taken, the beam *n* may rise quickly and errors of as much as from 200 to 400 pounds be made in reading the breaking load.

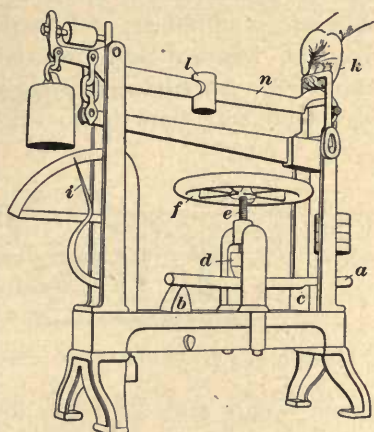

FIG. 8.

97. Autographic Testing Machine. — There are many foundries, for example those making agricultural castings, stove plate, etc., that require daily tests of the casts, or in some cases, one test per week. To get the average iron, the test bars should be poured from that taken about

the middle of the heat. While various sizes of test bars are used by sounders, for cheapness of bars and ease and rapidity in operating the testing machine, $\frac{1}{2}$ -inch square bars 12 inches long, molded with the grate underneath and with a chill at each end, are a favorite size for some founders. By making tests of strength, deflection, shrinkage, and chill each day, a record of the best mixture will be obtained, prompt notice is given of any tendency of the mixture to change, and an indication of what is needed to regain the proper standard is obtained; and frequently the cost of the mixture may be lessened and at the same time its quality be improved. An **autographic testing machine** for breaking small test bars is shown in Fig. 9. The test bar *a*,

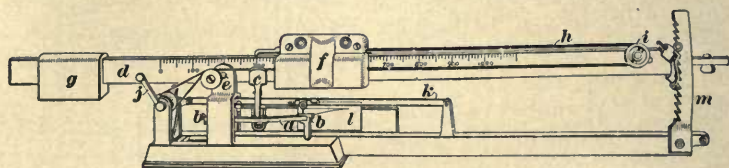

FIG. 9.

$\frac{1}{2}$ -inch square and 12 inches long, is fastened at the ends in flexible bearings *b, b*. The load is put on the middle of the bar by means of the arm *c* and the beam *d*, which is pivoted at *e* and carries a movable weight *f* and a counterpoise *g*. The weight *f* is propelled forwards or backwards by a steel cord *h* passing around a pulley *i* at the end of the beam and attached to the drum and crank *j* at the rear of the machine. The crank *j* also operates a cord *k* that moves a frame with a card *l* horizontally and in contact with a pencil point attached to the middle of the test bar. By turning the crank *j*, the weight *f* moves along the beam *d* and gradually applies the load to the test bar *a*. The rack *m* at the end of the machine catches the beam when the bar breaks and prevents any injury to the machine from the shock. As the weight *f* moves along the beam *d* and the test bar bends downwards in the middle, the card *l* moves horizontally and records the line *a b*, shown in Fig. 10, which is a full-size autographic

record of a test bar that broke at 390 pounds. The horizontal line ac is made by moving the card l in contact with the pencil before any load is applied to the bar. The perpendicular distance cd measured between the lines ab and ac at any point, as d , is the total deflection of the bar in inches for the load ac . The line af is the stress in the bar, which in this case is 390 pounds, and bf is the strain or

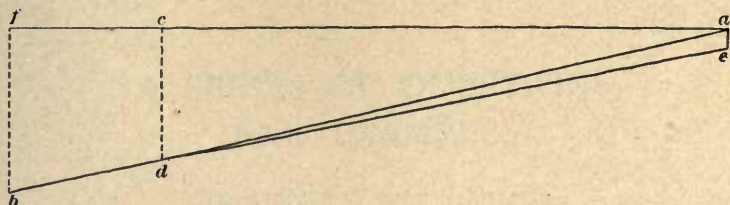

FIG. 10.

distortion in inches in the bar where it broke. When the stress reached 300 pounds and the strain cd was recorded, the weight f was brought back to the starting point and the card l recorded the line de . The distance ae is the amount in inches of permanent set in the bar. The stress was then applied and the line edb recorded, the bar breaking at 390 pounds, which is represented by the line af in the diagram.

A SERIES OF QUESTIONS AND EXAMPLES

RELATING TO THE SUBJECTS
TREATED OF IN THIS VOLUME

It will be noticed that the pages of the Examination Questions that follow have been given the same section numbers as the Instruction Papers to which they refer. No attempt should be made to answer any of the questions or to solve any of the examples until the Instruction Paper having the same section number has been carefully studied.]

WOOD WORKING.

(PART 1.)

EXAMINATION QUESTIONS.

- (1) What is a bench stop and for what is it used ?
- (2) Describe one form of vise for use in connection with a wood-worker's bench and state what advantages it possesses.
- (3) Describe the try square and explain how it differs from the framing square.
- (4) Describe the marking gauge and state its use.
- (5) What tool is used for drawing circles larger than can be made with the ordinary dividers ?
- (6) Describe the socket firmer chisel and state for what class of work it is used.
- (7) State how many planes a wood worker requires for ordinary work and explain the use of each.
- (8) What two classes of saws are there in regard to the direction in which they are to cut the wood ?
- (9) Describe the spur auger.
- (10) Describe the expansive bit and state its advantages.
- (11) Why should the sides of the point of a screwdriver be made parallel and not wedge-shaped ?
- (12) Why is a mallet better suited than a hammer for driving a wooden-handled chisel ?

- (13) What is sandpaper and for what is it used ?
- (14) Describe a miter-box and explain its use.
- (15) Describe fully the process of grinding a chisel, including the whetting of the edge.
- (16) What is meant by the term *set* in a saw ?
- (17) What method of setting is used in the case of hand cross-cut saws ?
- (18) What method of setting is sometimes used in the case of large ripping saws ?
- (19) What is meant by the term *jointing* a saw ?
- (20) Why is it better to keep a saw in repair by filing it frequently than to let it get very dull and then expend considerable time in sharpening it ?

WOOD WORKING.

(PART 2.)

EXAMINATION QUESTIONS.

- (1) What is a trimming machine and for what is it used ?
- (2) Describe briefly the universal circular-saw bench.
- (3) Why cannot all the work that can be done on a jig saw be done on a band saw ?
- (4) Describe briefly the process of setting and filing a circular ripping saw.
- (5) Describe briefly the rotary planer and state for what it is used.
- (6) Why is water used on a grindstone ?
- (7) At what speed should a grindstone be run for grinding wood-working tools ?
- (8) What are oilstones and for what are they used ?
- (9) Why is it better to surround a glue pot with a bath of hot water rather than to place it directly over the flame ?
- (10) Describe briefly the process of making a glued joint.
- (11) What is meant by the term laying out as used in connection with woodwork ?
- (12) What is meant by the term jointing ?
- (13) Name the tools most commonly used by the bench worker.
- (14) Describe the method of setting a bevel to an angle of 30° without the use of a protractor.

(15) What precautions should be observed in using the chisel along the grain of the wood when paring or finishing a surface ?

(16) Describe briefly the method of cutting a small mortise in a piece of wood.

(17) Describe briefly the process of reducing a rough-sawed board to a smooth-planed surface, stating what planes are used in different parts of the process and why.

(18) How should the hammer be held while in use ?

(19) Describe one style of corner joint commonly used and state what advantages it may possess and for what it is used.

(20) What is a mortise-and-tenon joint and for what is it used ?

WOOD TURNING.

EXAMINATION QUESTIONS.

(1) Describe the headstock of an ordinary wood-working lathe.

(2) What are the shears of a lathe ?

(3) Describe the tail-stock of an ordinary wood-working lathe.

(4) Describe the live and dead centers of a wood-working lathe, stating how they differ and giving the reason for the difference in form.

(5) When a piece of wood to be turned is of considerable length, and the grain lies in the direction of its length, how is it held during turning ?

(6) When it is desired to turn large flat pieces, where the turning is done across the grain, or plankwise, how is the work held ?

(7) (a) Describe the rest commonly used for guiding the tool when turning plain cylindrical work. (b) State at what height the rest should be set.

(8) (a) Describe the turner's gouge. (b) State for what class of work the gouge is used.

(9) (a) Describe the skew chisel. (b) State for what class of work the skew chisel is used.

(10) (a) Describe the round-nosed chisel. (b) Tell for what class of work the round-nosed chisel is used.

(11) When it is desired to turn a cylinder from a square block, how may the centers be laid off so as to guide the workman in placing the piece in the lathe?

(12) Describe the grinding of a skew chisel.

(13) At what speed should the work be run during a roughing cut?

(14) At what speed should the work be run during a finishing cut?

(15) Describe in detail the operation of roughing down a piece of square work with the gouge.

(16) Suppose that the driving belt of a lathe were running on the largest step of the cone pulley, at the headstock, and it is desired to move it to the next smaller step to drive the lathe at a higher speed; describe the operation of shifting the belt.

(17) What tools should be used for turning $\frac{1}{4}$ -inch beads on a piece of straight stock?

(18) When it is desired to turn a number of similar pieces, as balusters, for instance, how may the workman avoid the necessity of laying off each piece separately with the dividers and calipers?

(19) What tools are commonly used for inside turning?

(20) Describe one method of turning a ball.

PATTERNMAKING.

(PART 1.)

EXAMINATION QUESTIONS.

(1) Give the meaning of the term pattern as commonly employed in the founding and machinery business.

(2) What material is most commonly used for patterns?

(3) What are the advantages and disadvantages of metal patterns?

(4) What is a core box?

(5) What are core prints and for what purpose are they placed on patterns?

(6) (a) What is meant by the term seasoning as applied to wood? (b) Why is it necessary to season wood before using it in making patterns?

(7) In the case of symmetrical cores, how does the patternmaker avoid the making of a complete core box?

(8) Why are screws to be preferred to nails for fastening the portions of a pattern together?

(9) What is the advantage of using a parallel core-print piece that leaves a hole from the top of the core through the top of the mold?

(10) Why are patterns given a protective coating of varnish?

- (11) Why should sharp corners in patterns and castings be avoided ?
- (12) What are the advantages of leather fillets ?
- (13) What can you say concerning the use of metal fillets in patternmaking ?
- (14) What is the objection to wooden dowels in patternmaking ?
- (15) When metal dowels are employed, why are brass dowels better than iron ?
- (16) What is the purpose of rapping plates on a pattern ?
- (17) Why should all but small patterns be made from a block composed of several pieces of wood in place of being carved from a single large piece ?
- (18) Why is liquid glue not suited for patternmaking ?
- (19) Why should wood and grain alcohol never be used together in the making of shellac ?
- (20) How may metal letters be attached to patterns ?
- (21) Define the term draft.
- (22) What is the average amount of draft given to comparatively small patterns ?
- (23) In the case of patterns for iron castings, what allowance should be made for shrinkage ?
- (24) What conditions govern the allowance that must be made for finish on patterns ?
- (25) What are the causes of warping in castings and how may this evil be guarded against ?

PATTERNMAKING.

(PART 2.)

EXAMINATION QUESTIONS.

(1) Describe a simple device for rounding the edges of patterns.

(2) Describe one method of locating wooden dowel-pins in the two halves of a pattern in such a manner that they will come opposite each other.

(3) Describe one way in which the two parts of a pattern can be held together during turning.

(4) Fig. I illustrates a section of a required casting. Will a core box be necessary for this pattern?

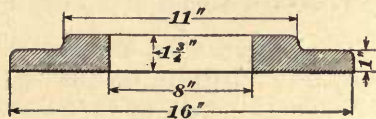

FIG. 1.

(5) What are the objections to making a solid turned pattern, such as a ball, as a single piece?

(6) When a large number of castings are required from a solid turned pattern, what special devices should be furnished to simplify the molding of the piece?

(7) Describe one method of building a large cylindrical pattern.

(8) In the case of small cylindrical cores, how are the core boxes usually made?

(9) Describe the core-box plane.

(10) How may a square be used to test a core box to see if the cross-section is a perfect semicircle?

(11) In the case of large cylindrical and symmetrical cores, how may the core boxes be made?

(12) Fig. II illustrates a special pipe casting. Sketch the necessary pattern and core boxes that the patternmaker

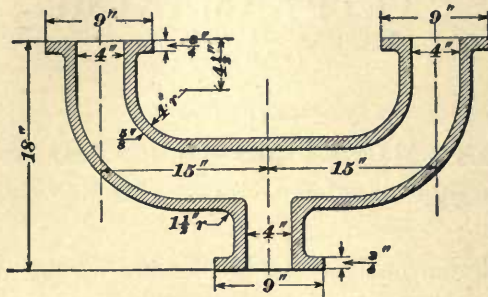

FIG. II.

should furnish the mold for making this casting, in case the pattern should be wanted for continuous service.

(13) State what modifications should be made in constructing a pattern for the casting shown in Fig. II, if only one casting is required.

(14) Fig. III illustrates a required casting. How would you make a pattern for this if only one piece were required and the pattern would probably never be used again?

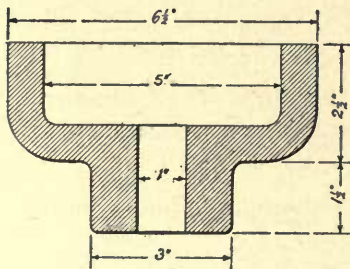

FIG. III.

and the pattern would probably never be used again?

(15) In case the pattern or the piece shown in Fig. III was wanted for practically continuous service, how should it be made?

(16) Describe the way in which the circular saw can be used to cut the curve on the inside of staves for large cylindrical patterns.

PATTERNMAKING.

(PART 3.)

EXAMINATION QUESTIONS.

(1) Describe the pattern and sweeps necessary for making an elbow in green sand.

(2) How do the pattern and sweeps necessary for molding an elbow in loam differ from those necessary for molding an elbow in green sand?

(3) What are auxiliary patterns?

(4) In making patterns for a six-armed pulley or gear in which the arms are to be quite thick, what kind of joints should be used at the hub?

(5) When the web for a small gear or pulley is composed of six or eight sections of one thickness each, how should the joint between the sections be strengthened?

(6) When a pattern consists of a thin web on which various pieces are to be glued, as, for instance, a crank-disk with counterbalance weight, hub, etc., how should the grain of the pieces run with reference to the grain of the stock in the web?

(7) Describe and illustrate by sketches the manner in which the pattern for the steam-chest cover for a plain slide-valve engine should be made.

(8) In what direction should the grain run in small bosses, as, for instance, those on patterns for the valve-gear details of Corliss engine work?

(9) Describe and illustrate by sketches one method of constructing a pattern for a medium-sized engine cylinder.

(10) How may small details that project from the body of a pattern at some distance from the parting line be arranged so that they will not interfere with the drawing of the pattern and will not necessitate an additional parting line, as, for instance, the bosses or other projections on the steam chest of an engine-cylinder pattern?

PATTERNMAKING.

(PART 4.)

EXAMINATION QUESTIONS.

- (1) Fig. I illustrates a special pipe fitting that is required, the straight fitting being for 6-inch and the flanges for 4-inch pipe. Show by sketch and description what devices should be furnished the molder for making this casting.

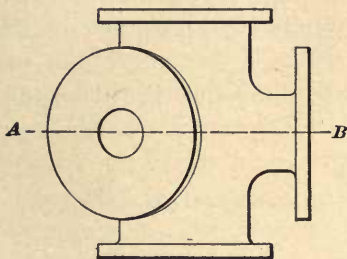

(2) When in building up a pattern from segments it becomes necessary to pass from a smaller to a larger diameter of courses, what is done to bring the larger course concentric with the smaller?

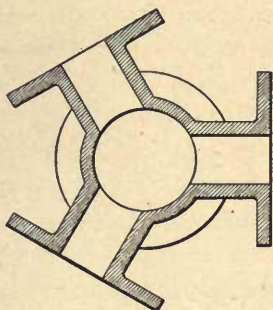

FIG. I.

(3) In the case of built-up patterns that have to be turned both on the inside and the outside, why is it best to do the outside turning last?

(4) (a) When it is desired to cast a number of pieces that shall link together as a chain, how may the work be done?
(b) What must the pattern-

maker furnish the molder for producing the castings?

(5) When wooden patterns are to be made from which metal patterns are to be cast, what allowance for shrinkage must be made in the wooden patterns?

(6) (a) Illustrate by sketches two methods of forming the fillets in patterns at the roots of gear and rack teeth.
(b) State the advantages of each and the conditions under which each should be used.

(7) Illustrate by sketch one method of fastening the gear-teeth to the body of a pattern and state the advantages that this method possesses.

(8) Describe a method for finishing the tooth surfaces of gear-patterns so that they will have the correct form.

(9) Show by sketch how the angle for the teeth of a worm-wheel, to run with a double-threaded worm about 6 inches in diameter, having a pitch of 1 inch, should be laid off.

(10) Describe one method of forming the thread on the pattern for a worm.

(11) What is an odontograph?

(12) What are some of the advantages of casting fly-wheels in sections?

PATTERNMAKING.

(PART 5.)

EXAMINATION QUESTIONS.

- (1) How may the proper form be given to the curved side of a propeller blade, especially when the propeller has a variable pitch, that is, when the pitch near the hub is not the same as the pitch near the circumference?
- (2) What is the object of making a model of the stove before completing the patterns for same?
- (3) Why is it necessary for a stove patternmaker to have more than one shrink rule?
- (4) Describe a device by the aid of which center lines can be drawn across the face of stove patterns that have irregular surfaces, such as surfaces that have been carved.
- (5) Why is it necessary that stove patterns be of the same thickness at all points?
- (6) How do the stove-patternmakers' thickness calipers differ from ordinary calipers?
- (7) (a) Describe a pair of stove-patternmakers' marking calipers. (b) State what the marking calipers are used for.
- (8) (a) Describe a chute board. (b) State what a chute board is used for.
- (9) Describe an attachment for an ordinary planer that may be used for planing thin stock intended for stove patterns.

§ 39

(10) What materials are commonly used for making stove patterns?

(11) Give the composition of a good white-metal alloy for use in making stove patterns.

(12) In the case of stove patternmaking, why is it necessary to make master patterns of metal from wooden patterns and then make the regular working patterns from these master patterns; that is, why cannot the wooden patterns be used as master patterns?

(13) Describe the process of making a metal stove pattern by the backing process, including all the work necessary up to the production of the finished metal pattern.

(14) Describe the making of a metal stove pattern by the blocking process, including all the work necessary up to the production of the finished metal pattern.

(15) (a) Will the blocking process produce uniform thickness of metal in curved parts? (b) If not, what is to be done to insure uniform thickness of the parts?

(16) In gluing up the stock for a stove leg, how may a center line be made in the wood that will always show, no matter how the surface of the material may be cut away?

(17) After a metal pattern is made, how is it finished?

(18) (a) Why is it necessary to make a wooden match board for a metal pattern? (b) How is the wooden match board made to fit the metal pattern accurately?

(19) Describe the wax process for making stove patterns.

(20) Why is it necessary to always use one brand of lead in making an alloy for stove patterns, if it is desired to maintain a constant shrinkage for the alloy?

GREEN-SAND MOLDING.

(PART 1.)

EXAMINATION QUESTIONS.

- (1) What is green-sand molding?
- (2) What is a flask?
- (3) Of what parts is a flask composed?
- (4) Define (a) molding board, (b) bottom board.
- (5) Define each of the following: (a) Gate, (b) sprue, (c) riser.
- (6) What is molding sand?
- (7) What is parting sand?
- (8) What is fireclay?
- (9) Define the terms sieve and riddle.
- (10) What is a vent?
- (11) What is a core?
- (12) Describe one method of tempering sand.
- (13) Why should the lower courses of a deep mold be rammed harder than the upper ones?
- (14) (a) Describe and illustrate by sketch one method of venting a deep mold. (b) Give the advantages and disadvantages of the method you describe.
- (15) (a) How are facing sands applied to a pattern? (b) What is the objection to allowing any of the heap sand coming in contact with the face of the pattern, especially in a deep mold?

(16) How long should a moderately light casting remain in the sand after it has been poured?

(17) (a) What is a swab? (b) For what is a swab used?

(18) When it is desired to direct water to a certain part of a mold, what device can be used?

(19) What is the objection to rapping on a draw-nail or draw-iron when the latter is screwed into a hole in the draw-plate?

(20) What allowance has to be made on a pattern intended for a deep mold to counteract the straining of the mold due to the great pressure of the iron in the lower portion?

(21) (a) What is meant by the term draft? (b) What relation does the allowance for draft bear to the allowance necessary on account of the straining of the mold by the pressure of the iron?

GREEN-SAND MOLDING.

(PART 2.)

EXAMINATION QUESTIONS.

(1) Why is it necessary to have a soft bed when casting flat plates without copes ?

(2) Describe the process of preparing a soft bed for casting open-sand work.

(3) If it is desired that several castings made in open sand shall be of approximately the same thickness, what precautions should be taken by the molder both in making the mold and in pouring the metal ?

(4) How should the bed intended for casting a prickered plate be vented ?

(5) When it is desired to mold a casting with projections on the bottom in open sand, describe one method by means of which the work may be carried out.

(6) Describe one method of facing the inside of projections when a pattern has been bedded in.

(7) How can beds with hard surfaces be properly vented ?

(8) Why is it necessary to know the condition of the ground under the bed of a mold ?

(9) How are bodies of sand intended to form cavities in the bottom of a casting vented ?

(10) How are bodies of sand that project at the bottom of a mold held in place ?

(11) (a) When a pattern has projections on the bottom that extend deep into the mold, should the inside or outside surface be given the most taper or draft? (b) Give your reasons for the statement in the first part of the question.

(12) Why is it necessary to clamp or weight molds?

(13) How much does a cubic inch of cast iron weigh?

(14) How is the weight necessary to hold down the cope of a mold computed?

(15) Why is it necessary to weight a cope more heavily than the amount which the calculation indicates would be required to hold down the cope?

(16) How is the buoyant effect exerted by iron influenced by its temperature, that is, by having the iron hot or dull?

(17) What is the objection to using a hammer in driving wedges under clamps on a mold?

(18) How should the clamps on a mold be tightened?

(19) Describe one method of arranging a foundry floor so that the copes of flasks may be bolted down, in order to avoid the use of weights.

GREEN-SAND MOLDING.

(PART 3.)

EXAMINATION QUESTIONS.

- (1) How are patterns that require two or more parting lines molded ?
- (2) Describe the process of making a three-part mold in a two-part flask.
- (3) Describe the making of a sand follow board or match.
- (4) What are gaggers ?
- (5) What precaution should be taken in setting gaggers ?
- (6) What are soldiers ?
- (7) What precaution should be taken in setting soldiers ?
- (8) How and why are cross-bars placed in copes ?
- (9) Describe one method of making cast-iron gaggers.
- (10) How may the sand about the joints or corners of a mold be strengthened ?
- (11) What is the proper method of applying the sand to a broken corner when patching a mold ?
- (12) How should sharp and patched bodies of sand be vented ?
- (13) If there is an excess of moisture in the mold, what effect will it have ?

(14) Name and describe the principal finishing tools that the molder uses.

(15) How is dry blacking applied to a mold ?

(16) What is a skin-dried mold ?

(17) How is a skin-dried mold finished ?

(18) What precautions should be taken in gating skin-dried molds ?

(19) (a) Describe a skimming gate. (b) What is the object of a skimming gate ?

(20) (a) What is a pouring basin ? (b) Why should the molder take especial pains in the preparation of a pouring basin ?

GREEN-SAND MOLDING.

(PART 4.)

EXAMINATION QUESTIONS.

- (1) What is a chaplet ?
- (2) Name and describe two different kinds of chaplets.
- (3) State two ways in which a chaplet may weaken a casting.
- (4) What is the effect of using a rusty chaplet or a chaplet covered with moisture ?
- (5) What precautions should be taken to prevent chaplets from rusting or from gathering moisture ?
- (6) What is meant by the expression " the drawing down of the cope " ?
- (7) What precaution should be taken to protect a cope from drawing down ?
- (8) In the case of large molds, why should the vents and risers be covered or closed during pouring ?
- (9) (a) What are blowholes ? (b) What are shrink holes ?
- (10) How can shrink holes in castings be avoided ?
- (11) Define each of the following and state the difference between them: (a) shrinkage; (b) contraction.

- (12) What sized rod should be used to feed a casting when the feeder head is 3 inches in diameter ?
- (13) (a) Should a cold rod ever be introduced into the feeding head ? (b) How may rods for feeding castings be heated before being placed in a feeding head ?
- (14) (a) What is bench molding ? (b) What are the advantages of bench molding ?
- (15) What is a snap flask ?
- (16) Describe the rammers used in bench molding.
- (17) After the snap flask is removed from a bench mold, what device is used for holding the sand in place during pouring ?
- (18) In bench molding where portable benches are used, how is the bench located in relation to the sand ?
- (19) What is the object of using a protective coating on the face of a mold ?
- (20) Name and describe two materials commonly used for blackening a mold.

CORE MAKING.

EXAMINATION QUESTIONS.

- (1) What is a core ?
- (2) What advantages have large green-sand cores over large dry-sand cores ?
- (3) What are core barrels ?
- (4) Why are pricklers better than ribs for holding sand on a core barrel ?
- (5) Why are ribs used in place of pricklers for holding the sand on core barrels of comparatively small diameter ?
- (6) Describe the process of sweeping a large cylindrical green-sand core.
- (7) Describe the process of making a large green-sand core in a box.
- (8) What is a core box ?
- (9) What is a dry-sand core ?
- (10) How should one proceed in making a small cylindrical core in a core box in order to be sure that the vent is central in the core ?
- (11) (a) What is the objection to ramming a core with a bar that is nearly as large in diameter as the core box ?
(b) What relation should the diameter of the rod used in ramming a core bear to the diameter of the core ?
- (12) What is the object of making cores in halves and then pasting them together ?

(13) When cylindrical cores that are so long that they cannot be placed on end when drying are not made in halves, what provision must be made for supporting them while drying?

(14) With what class of cores is it necessary to use a daubing mixture in the joints?

(15) What is the object of blackening cores?

(16) What is the purpose of putting rods in cores?

(17) What are some of the binding materials used in core making?

(18) What are the advantages of rosin as a binder in making cores?

(19) What are the advantages of linseed oil as a binder in making cores?

(20) What are the most common washes used for mixing blackening?

DRY-SAND AND LOAM WORK.

EXAMINATION QUESTIONS.

(1) Why is it that wooden flasks are not suited for dry-sand work ?

(2) How does the sand required for dry-sand work differ from that used in green-sand work ?

(3) (a) Do dry-sand molds require as much venting as green-sand molds ? (b) Give reasons.

(4) What is a fin in a casting ?

(5) Why do castings made in dry-sand molds generally have larger fins than those made in green-sand molds ?

(6) How does loam sand differ from ordinary molding sand ?

(7) What appliances are necessary to produce a loam mold for a cylindrical casting, such as that shown in Fig. I ?

(8) Describe in detail the making of a loam mold for producing a cylindrical casting such as that shown in Fig. I.

(9) Why are cinders often packed in the spaces between the bricks under loam castings so as to fill a large portion of the spaces, in place of filling the spaces entirely with loam ?

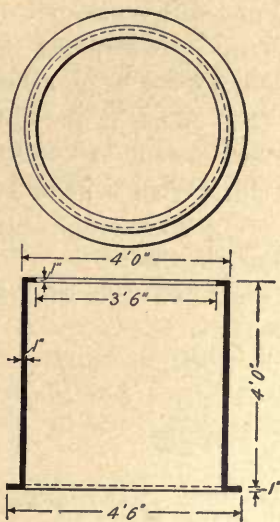

FIG. I.

(10) When it is desired to sweep up a loam mold for a cylinder that is to be made in halves, the halves being separated in the mold by cores, how can both halves of the cylinder be swept at once and at the same time provision made for the flat space necessary for introducing the parting cores?

(11) Describe briefly the making of a loam mold for a large pipe bend with the aid of a skeleton pattern.

(12) Describe one method by means of which a conical drum having a groove for the rope in its outer face can be swept.

(13) In laying up brick, what is meant by the term headers?

(14) What should be the thickness of the loam or daubing on the brickwork in a loam mold?

(15) (a) In a loam mold, should the surfaces produced by sweeps be sleeked with trowels, or should they be finished simply with a sweep? (b) Give reasons.

(16) Where joints occur in loam molds, how may the sand or loam be prevented from sticking together?

(17) What is the object of backing up a loam mold by ramming sand behind the brickwork?

(18) What is a chilled casting?

(19) What is the object of using a whirl gate when casting chilled rolls?

(20) Why are chilled car wheels annealed after being cast?

CUPOLA PRACTICE.

EXAMINATION QUESTIONS.

(1) What two styles of furnaces are used for melting iron?

(2) How does the charging of the fuel in the two styles of furnace used for melting iron differ?

(3) (a) What is the wind belt of a cupola? (b) How should the area of the wind belt of a cupola compare with that of the tuyeres?

(4) (a) What are the tuyeres of a cupola? (b) Which should have the greater tuyere area, a cupola intended for burning coal or one intended for burning coke? Give reasons.

(5) What relation should exist between the area of the tuyeres and the area of the cupola?

(6) On what two conditions does the height of the tuyeres in a cupola above the bottom generally depend?

(7) (a) What is the object of a slag hole in a cupola? (b) Where should the slag hole be located in the cupola, both as to its position in relation to the front of the cupola and as to its height in relation to the bottom of the cupola and the tuyeres?

(8) (a) In laying brick in a cupola lining, why is it essential that the brick should fit very closely and have as narrow joints as possible? (b) Describe the laying of bricks in a cupola lining, stating what material is used for holding them together.

(9) Describe fully the process of drying a new cupola lining and preparing it for the first heat.

(10) Describe the cleaning and repairing of a cupola lining after the heat, stating what tools are used and what precautions should be taken with the work.

(11) (a) What is meant by the melting zone of a cupola?
(b) Where is the melting zone of a cupola situated?

(12) What materials are used for daubing cupolas?

(13) (a) What material is used for making the bottom of a cupola? (b) Describe the process of making the bottom of a cupola ready for a heat.

(14) Describe one method of starting a fire in a cupola from the time of starting the fire until the cupola is charged up even with the charging door.

(15) (a) What is the effect of placing too much fuel between the charges of iron in a cupola? (b) What is the effect of placing too little fuel between the charges of iron in a cupola?

(16) Why is it that it takes more pounds of coke to melt a given number of pounds of iron in a very short heat than in a long heat?

(17) If it is necessary to melt two or more grades of iron in the same cupola at the same heat, how can they be prevented from mixing?

(18) (a) What is a flux? (b) What is the object of using fluxes in a cupola? (c) What are some of the fluxes commonly used in cupolas?

(19) Describe the tapping of a cupola, including a description of the tools necessary.

(20) Describe the stopping of the tapping hole of a cupola, including a description of the tools necessary.

MIXING CAST IRON.

EXAMINATION QUESTIONS.

- (1) How does iron occur in nature ?
- (2) (a) What is cast iron ? (b) How does cast iron differ from pure iron ?
- (3) Why can a blast furnace be built higher if anthracite coal or coke is used for fuel than if charcoal were to be used as fuel ?
- (4) Why can a better grade of cast iron be made with charcoal as fuel than with coal or coke as fuel ?
- (5) How does blast-furnace practice differ from cupola practice in regard to the pressure and temperature of the blast used ?
- (6) (a) From what source does cast iron derive its carbon ? (b) On what conditions does the amount of carbon absorbed by cast iron depend ?
- (7) (a) What two classes of molds are used for casting pig iron ? (b) State which class of molds is preferable, and why.
- (8) What elements vary most in pig iron during a single cast from a blast furnace ?
- (9) (a) On what do the size and character of the grain of pig iron depend ? (b) Is it safe to grade pig iron according to its grain, as exhibited by fracture ?
- (10) Describe one method of sampling a carload of pig iron and obtaining a sample for a chemist to analyze, stating how many pigs should be taken as the original sample and what amount of drillings is generally considered necessary for the chemist.

(11) (a) In controlling cupola mixtures by analysis, what elements require the closest attention? (b) Is it necessary to make determinations for all the elements when using a given brand of iron from the same furnace, and if not, what elements need not be determined?

(12) (a) In what two forms may carbon occur in cast iron? (b) What conditions in the mold may effect a change in the condition of the carbon?

(13) What element is usually considered best to adopt as a base for regulating foundry mixtures?

(14) (a) What effect has manganese on iron? (b) Why is it good practice to use a high-manganese iron when a high-sulphur fuel is to be used in the cupola?

(15) (a) From what source does cast iron derive its phosphorus? (b) What is the effect of phosphorus on cast iron?

(16) (a) Which has the higher melting point, white iron or gray iron? (b) Which must have the higher temperature at pouring?

(17) If a founder has two brands of iron, one of which contains .85 per cent. silicon and the other 1.65 per cent. silicon, and he desires to make a mixture containing 1.2 per cent. silicon, what proportions of each brand should be used in the mixture, provided no allowance is made for the loss of silicon during melting?

Ans. $\left\{ \begin{array}{l} 45 \text{ lb. first brand.} \\ 35 \text{ lb. second brand.} \end{array} \right.$

(18) If a man were running a foundry some distance from the pig-iron market, and hence was forced to rely largely on car-wheel scrap for iron, would it be necessary to separate the chilled faces of the wheels from the hubs when making a foundry mixture for soft castings, or should both the hubs and rims be used together, the car wheels being made of a good gray charcoal iron with chilled faces? Give reasons for your answer.

(19) Do physical tests made on test bars give actual figures concerning the same iron poured into castings?

(20) What is the advantage of casting test bars on end?

A KEY

TO ALL THE QUESTIONS AND EXAMPLES
INCLUDED IN THE EXAMINATION QUESTIONS.

It will be noticed that the Keys have been given the same section numbers as occur on the headlines of Examination Questions to which they refer. All article references refer to the Instruction Paper bearing the same section number as the Key in which it occurs, unless the title of some other Instruction Paper is given in connection with the article number.

To be of the greatest benefit, the Keys should be used sparingly. They should be used much in the same manner as a pupil would go to a teacher for instruction with regard to answering some example he was unable to solve. If used in this manner, the Keys will be of great help and assistance to the student, and will be a source of encouragement to him in studying the various papers composing the course.

ANSWERS TO QUESTIONS REQUIRING
NUMERICAL CALCULATIONS.

MIXING CAST IRON.

(17) Applying the rule given in Art. 67,

$$(1.65 - 1.2) \times 100 = 45 \text{ lb. of first brand.}$$

$$(1.2 - .85) \times 100 = 35 \text{ lb. of second brand. Ans}$$

§ 47

INDEX

NOTE.—All items in this index refer first to the section (see the Preface) and then to the page of the section. Thus, "Aluminum, §47, p27," means that aluminum will be found on page 27 of section 47.

A

Adhesive fastenings for patterns, §35, p17
Adjustable chaplet, §43, p3
Air, Composition of, §46, p38
furnaces, §46, p51
Allowance for draft, §35, p33
for finish, §35, p34
for shake, §35, p35
for shrinkage, §35, pp33, 34
for warp, §35, p36
in a pattern for distortion, §40, p35
Allowances necessary in patternmaking,
§35, p32
Alumina, §40, p7
Aluminum, §47, p27
Analysis for coke, §46, p47
of pig iron, Necessity for, §47, p18
of pig iron, Taking samples for, §47, p19
Standardized drillings for, §47, p20
Angles, Setting bevel to, §33, p19
Tools for laying out, §32, p10
Angular grooves, Turning of, §34, p24
Annular patterns, Built-up, §36, p43
Arkansas oilstone, §33, p14
Arms, Flywheels with hollow, §38, p36
for loam work, §45, p12
of wheels, Patterns for, §37, p24
Strengthening pattern, §38, p36
Auger bits, Sharpening, §32, p44
Double-twist spur, §32, p27
Spur, §32, p26
Autographic testing machine, §47, p63
Automatic boring tool, §32, p30
Auxiliary patterns, §37, p8
Awl, Scratch, §32, p13

B

Back saw, §32, p25
Backing process for making base panel,
§39, p30

Backing process for making stove-leg pat-
tern, §39, p30
sand, §45, p8
Ball turning, §34, p45
Baluster turning, §34, p33
Band saw, Setting and filing a, §33, p7
saws, §33 p5
Barring cores, §44, p17
Base panel by backing process, §39, p30
Basic iron, §47, p17
Basin, Runner, §40, p3
Basins, Pouring, §42, p44
Bead tool, §42, p29
Beads, §33, p34
Turning, §34, p29
Beading tool, §34, p12
Bearings for prints of pipe cores, §44, p8
Bed, Making a hard, §41, p8
Making a soft, §41, p3
Beds for coped molds, Hard, §41, p16
for prickered plates, Making, §41, p9
Ground beneath, §41, p21
Hard, for open-sand castings, §41, p11
Venting soft, §41, p7
Bedding in, §40, p5
in, Molding by, §41, p1
in, Objectionable method of, §41, p19
in, Use of straightedges in, §41 p1
Bell of a blast furnace, §47, p4
Pattern for small, §38, p11
Bench brush, §32, p6
Cabinetmaker's, §32, p3
for woodwork, §32, p1
hook, §32, p6
mold, Making a, §43, p26
molding, §43, p24
molding, Advantages of, §43, p24
Patternmakers', §32, p1
rammers, §43, p26
stop, §32, p3

- Bench trimmer, §33, p1
work, Laying out tools for, §33, p17
- Bessemer iron, §47, p15
- Bevel, §32, p9
board, §32, p39
gear, Laying out, §38, p25
gear patterns, §38, p24
Setting the, §33, p19
- Bevels, Stove, §39, p11
- Binder, Rosin as a, for cores, §44, p23
- Binders for cores, §44, p25
for cores, Mixing, §44, p24
used in core making, §44, p22
- Bit brace, §32, p27
Expansive, §32, p28
Foerstner, §32, p29
Nail, §32, p30
Spoon, §32, p30
- Bits, Sharpening of, §32, p44
- Black shellac varnish, §35, p18
- Blackening a loam mold, §45, p34
mixtures, §44, p29
of cores, §44, p15
or lead, §43, p36
scabs, §42, p28
Sleeking and printing dry, §42, p30
- Blackenings, Mixing, §44, p29
Washes for, §44, p29
- Blade of propeller, Laying out, §39, p3
- Blast furnace, §47, p1
furnace, Bell of, §47, p4
furnace, Charging a, §47, p4
furnace, Construction of, §47, p2
furnace, Fuels used in, §47, p3
furnace, Height of, §47, p2
furnace, Operation of, §47, p3
furnace, Reactions in, §47, p5
furnace, Tapping a, §47, p7
furnace, Temperature of blast for, §47, p4
gauges, §46, p40
Object of, §46, p37
Pressure and volume of, §46, p39
Temperature of, for blast furnace, §47, p4
Use of, in a cupola, §46, p27
- Block plane, §32, p16
- Blocking on top of chaplets, §43, p8
process applied to a stove leg, §39, p28
process for base panel, §39, p22
- Blowholes, Cause of, §43, p14
- Board, Bevel, §32, p39
Bottom, §40, p3
Chute, §36, p46; §39, p17
Follow, §40, p2
Molding, §40, p2
- Boards, Follow, §42, p7
- Bod sticks, §46, p42
- Bonnet, Core boxes for valve, §37, p15
Pattern for throttle-valve, §38, p5
Pattern for valve, §37, p15
- Boring tool, Automatic, §32, p30
tools, §32, p26
- Bottom board, §40, p3
Cupola, §46, p22
props for cupola, §46, p22
- Box, Core, §40, p6
Miter, §32, p37
- Boxes, Core, §35, p3
Core for bent pipes, §36, p24
for large cores, §36, p21
for small cores, §36, p15
for tapered cores, §36, p20
- Brace bit, §32, p27
- Branch pipes, Laying out, §36, p40
pipes, Patterns and core boxes for, §36, p36
- Brass letters, §35, p28
- Breast for a cupola, Making the, §46, p24
of a cupola, Materials used for, §46, p25
- Brick checkerwork for heating blast-furnace blast, §47, p4
Laying and tying courses of, §45, p32
Laying, in cupola linings, §46, p11
- Bricks, Forms of, for cupola linings, §46, p12
- Brittleness and strength, §47, p49
- Brush, Bench, §32, p6
- Brushes, Glue, §33, p16
Varnish, §35, p20
- Built-up patterns, §36, p9
- Bunged cupolas, §46, p17
- Buoyancy, §41, p27
- Burning irons, §35, p6
- Butt joint, §33, p33
of a rammer, §40, p4

C

- Cabinetmaker's bench, §32, p3
- Calculating iron mixtures, §47, p13
- Calipers, §34, p13
Marking, §39, p14
Thickness, §39, p14
- Cam-arrangement for sweeps, §45, p22
- Cans, Varnish, §35, p20
- Capacity of a cupola, §46, p44
- Carbon, §47, p20
Combined, §47, p20
Effect upon, in remelting iron, §47, p20
Graphitic, §47, p20
Heat from the combustion of, §46, p38
Origin of, in pig iron, §47, p6
- Carving and backing of stove patterns, §39, p20

- Carving and blocking stove patterns, §39, p21
tools, §39, p17
- Car wheels, Making of chilled, §45, p48
- Cast iron, Fluidity test of, §47, p61
iron, Hardness of, §47, p50
iron, Melting point of, §47, pp2, 29
iron, Mixing steel and wrought iron with, §47, p47
-iron mixtures, Calculation of, §47, p13
iron, Mixtures of, §47, p42
-iron mixtures, Proportioning, §47, p39
iron, Nature of, §47, p2
iron, Origin of carbon in, §47, p6
iron, Origin of sulphur in, §47, p6
iron, Physical tests of, §47, p51
iron, Specific gravity of, §41, p24
iron, Tensile tests of, §47, p61
iron, Testing chill in, §47, p60
iron, Testing, §47, p48
iron, Testing, contraction in, §47, p56
iron, Weight of, §41, p29
- Casting machines for pig iron, §47, p8
pig iron, §47, p7
Shaking out the, §40, p35
Shaking out of, §43, p34
- Castings, Classes of, §47, p18
Dirt in, §42, p43
Hard beds for open-sand, §41, p11
Making chilled, §45, p42
Mixtures for hard and chilled, §47, p46
Mixtures for soft, §47, p45
Necessity for round corners in, §35, p20
Patterns for hollow, §36, p2
Patterns for solid, §36, p1
Pouring open-sand, §41, p3
Skimming gates for light, §42, p40
Thickness of open-sand, §41, p7
- Center tuyeres, §46, p10
- Centers, Lathe, §34, p4
- Centering stock for turning, §34, p17
- Chains, Patterns and core box for casting, §38, p16
- Chaplet, Adjustable, §43, p3
and stand, §43, p1
- Chaplets, §43, p1
Blocking on top of, §43, p8
Double-headed, §43, p1
Effect of moisture on, §43, p5
Effect of rust on, §43, p4
in bottom of mold, Placing, §43, p8
Precautions in using, §43, p4
Setting and wedging, §43, p6
Single-headed, §43, p1
Spring, §43, p1
Types of, in general use, §43, p1
- Chaplets, Use of, with long cores, §44, p3
Wedges for setting, §43, p9
- Charcoal iron, §47, p15
iron, Specifications for, §47, p35
- Charge for cupola, Amount of, §46, p28
- Charging a blast furnace, §47, p4
a reverberatory furnace, §46, p55
bell for a blast furnace, §47, p4
cupolas, §46, p26
different grades of iron, §46, p32
door for a cupola, §46, p5
heavy and light iron in cupola, §46, p31
Indication of correct, §46, p31
the flux, §46, p35
the fuel in a cupola, §46, p27
- Checkerwork, Brick, for blast furnaces, §47, p4
- Cheeks or intermediate parts, §40, p2
- Chemical analysis of pig iron, Necessity for, §47, p18
analysis of pig iron, Taking samples for, §47, p19
properties of sand, §40, p7
- Chill, §47, p49
Testing, in cast iron, §47, pp58, 60
- Chills, Construction of, §45, p42
Contracting, §45, p48
for rolls, Thickness of, §45, p45
Thickness of, §45, p43
- Chilled car wheels, Making, §45, p49
castings, Difficulties encountered in making, §45, p42
castings, Making, §45, p42
castings, Mixtures for, §47, p46
iron, Remelting, §47, p47
rolls, Preparing the mold for, §45, p44
- Chimney for reverberatory furnace, §46, p54
- Chinese cupola, §46, p50
- Chisel, Corner, §32, p16
Framing, §32, p15
Paring, §32, p15
Round-nose, §34, p9
Sharpening of, §34, p12
Skew, §34, p9
Socket firmer, §32, p15
Use of, §33, p21
- Chisels for turning, §34, p8
Chuck, Turning, §34, p36
Chute board, §36, p46; §39, p17
Cinders for vent channels, §40, p27
Circles, Tools for drawing, §32, p12
Circular plane, Adjustable, §32, p20
saw, Setting and filing, §33, p7
saws, Set gauge for, §33, p9
- Clamps for flasks, §41, p35
for woodwork, §32, p36

- Clamps, Iron, §32, p37
 Strength of, §41, p37
 Tightening of, §41, p36
 Wooden parallel, §32, p36
- Clamping and weighing the mold, §41, p27
- Claw hammer, §32, p32
- Clay cores for tap holes, §46, p26
- Cleaning the cupola, §46, p16
- Coal and coke, Comparison of, for melting, §46, p46
 Sea, §43, p36
- Cock, Method of molding a three-way, §37, p21
 Patterns and core boxes for three-way, §37, p17
- Coke, Analysis of, §46, p47
 and coal, Comparison of, for melting, §46, p46
 Manufacture of, §46, p46
- Cold shuts, §43, p37
- Combined carbon, §47, p20
- Combustion in cupolas, Fuel, §46, p37
 Nature of, §46, p38
 of carbon, Heat from, §46, p38
- Conical drum, Sweeping a, §45, p29
- Contracting chills, §45, p48
- Contraction, §43, p19; §47, p49
 Testing of, in cast iron, §47, p56
- Copal varnish, §35, pp17, 18
- Cope, §40, p2
 Drawing down of the, §43, p10
 Extra weight required on, §41, p32
 Ramming of, §40, p31
 Weight of, §41, p29
- Copes, Driving stakes for holding, §42, p20
 Floors for holding down, §41, p38
 Weights for holding down, §41, p34
- Core, §40, p5
 arbors and square cores, Making, §44, p7
 barrels, Cast-iron, §44, p3
 box, §40, p6
 box for bonnet of throttle valve, §38, p5
 box for casting chain, §38, p16
 box for three-way cock, §37, p17
 -box machine, §36, p19
 -box plane, §36, p17
 box, Use of square for testing, §36, p18
 boxes, §35, p8; §36, p15
 boxes for bent pipes, §36, pp24, 34
 boxes for branch pipes, §36, p36
 boxes for cylinders, §37, p42
 boxes for dry-sand mold, §38, p7
 boxes for globe valve, §37, p12
 boxes for pipe elbows, §36, p31
 boxes for valve bonnet, §37, p15
 boxes, Forming, on circular saw, §36, p23
- Core boxes, Large, §36, p21
 boxes, Metal, §35, p4
 boxes, Partial, §35, p5
 boxes, Small, §36, p15
 boxes, Stop-pieces for, §36, p43
 boxes, Tapered, §36, p20
 Definition of, §44, p1
 for loam mold, Building, §45, p19
 making, Materials used in, §44, p22
 Meaning of the term, §35, p2
 ovens, §44, p13
 plate for skeleton pattern, §37, p3
 prints, §35, pp3, 6
 prints for large patterns, §36, p13
 prints, Special, §35, p10
 prints, Standard, §35, p7
 sand, §40, p10
 -sand mixtures, §44, pp22, 26
 sands, Liquids used in wetting, §44, p26
 Sweeping a, §44, p4
 Venting a crooked, §44, p20
- Cores, Advantages of different classes of, §44, p1
 and core boxes, §35, p2
 Bearings for the prints of pipe, §44, p8
 Blackening, §44, p15
 Comparison of dry-sand and green-sand, §44, p9
 Daubing joints of, §44, p15
 Dry-sand, §44, p9
 Drying crooked, §44, p21
 Finishing swept, §44, p5
 for pipe, Green-sand, §44, p2
 for tap holes, Use of, §46, p26
 for throttle valve, §38, p3
 Glue water as a binder for, §44, p25
 Green-sand, §44, p2
 Linseed oil as a binder for, §44, p25
 Making crooked, §44, p20
 Making green-sand, in boxes, §44, p5
 Making square, §44, p7
 Making small, in formers, §44, p13
 Mixing binders for, §44, p24
 Molds with bottom projecting, §41, p22
 partially submerged, §41, p30
 Pasting, §44, p14
 Prints for straight, §35, p8
 Ramming, §44, pp8, 11
 Rodding or barring, §44, p17
 Rodless round, §44, p12
 Rosin as a binder for, §44, p23
 Setting, §44, p6
 Small round, §44, p10
 Submerged, §41, p29
 Sweeping green-sand, §44, p2
 Use of chaplets with long, §44, p3

- Cores, Venting, §44, p19
 with central vents, §44, p10
 Core making, Binders used in, §44, p22
 Corliss engine valve-gear details, Patterns
 for, §37, p36
 Corner chisel, §32, p16
 joint, §33, p34
 Corners of molds, Swabbing the broken,
 §42, p24
 Coupling, Pattern for shaft, §37, p27
 Countershaft for lathe, §34, p6
 Cracking of wood, §35, p13
 Crank, disk, Pattern for, §37, p32
 Cross-bars for flasks, §42, p18
 -cutting saw, §32, p25
 Crush in a mold, §42, p34
 Cupola, Amount of charge for, §46, p28
 bottoms, §46, p22
 bottoms, Preparing the sand for, §46, p23
 breast, Materials used in making the,
 §46, p25
 Capacity of, §46, p44
 charge, Influence of height of tuyeres on
 weight of, §46, p28
 Charging different grades of iron in,
 §46, p32
 Charging door for, §46, p5
 Charging flux in, §46, p35
 Charging heavy and light iron in the,
 §46, p31
 Charging the fuel in a, §46, p27
 Chinese, §46, p50
 Cleaning the, §46, p16
 Comparison of coal and coke for melting
 in, §46, p46
 Daubing a, §46, p19
 Effect of irregular charging of, §46, p33
 Indication of correct charging of, §46, p31
 lining, Drying the, §46, p14
 lining, Laying brick in, §46, p11
 lining, Treatment of, §46, p15
 linings, Causes of destruction of, §46, p14
 linings, Forms of bricks for, §46, p12
 linings, Special materials for, §46, p13
 Making the breast, tap hole, and spout
 for, §46, p24
 Materials for daubing, §46, p19
 Materials for stopping a, §46, p43
 Melting zone of a, §46, p17
 Object of blast for, §46, p37
 Operating a, §46, p1
 Quantity of flux for, §46, p36
 Repairing the melting zone of, §46, p18
 Slagging a, §46, p33
 Stopping a, §46, p42
 Tapping out a, §46, p41

 Cupola, Tuyeres for, §46, p5
 Twin, for comparing pig iron, §47, p11
 Use of blast in, §46, p27
 Wind belt for, §46, p4
 Cupolas, §46, p1
 Bunged, §46, p17
 Charging, §46, p26
 Comparison of sizes of, §46, p45
 Construction of, §46, p2
 Construction of small, §46, p49
 for experimental work, §46, p49
 Fuel combustion in, §46, p37
 Linings for, §46, p11
 Long heats in, §46, p8
 Melting iron in small, §46, p49
 Single and double linings for, §46, p12
 Starting the fire in a, §46, p26
 Upper tuyeres in, §46, p9
 Curve for propeller blades, Development
 of, §39, p1
 Curves, Stove-patternmakers', §39, p13
 Turning compound, §34, p31
 Curved grooves, Turning, §34, p26
 Cut, Roughing, in wood turning, §34, p19
 with skew chisel, §34, p23
 Cutting action of planes, §32, p18
 in tool, §34, p12
 speed, Changing of, §34, p15
 speed in turning wood, §34, p14
 Cylinder head, Pattern for, §37, p29
 Pattern for slide-valve engine, §37, p38
 Cylinders, Core boxes for engine, §37, p42
 Cylindrical patterns, Large, §36, p9
 turning, §34, p14
 work, Finishing, §34, p21

D

 Daniels planer, §33, p10
 Daubing a cupola, §46, p19
 joints, §44, p15
 materials for cupola, §46, p19
 Deep molds, §40, p22
 molding, Example of, §40, p28
 Deflection, §47, p48
 Density of iron, §47, p48
 Details of loam work, §45, p32
 Dirt, Gates for catching, §42, p38
 in castings, §42, p43
 Disk crank, Pattern for, §37, p32
 Distortion, Allowance in a pattern for,
 §40, p35
 Dividers, §32, p12; §34, p13
 Dogs and driving plates, §35, p31
 Door, Charging, for a cupola, §46, p5
 panels, §33, p40
 Double-headed chaplets, §43, p1

- Dovetail, Drawer, §33, p35
 joint, §33, p34
- Dowels, Metal, §35, p23
 Wooden, §35, p23
- Doweling together of patterns, §36, p7
- Draft, §35, p33; §40, p4
- Drag, §40, p2
 Making of, for deep mold, §40, p28
- Draw-hook, §40, p3
 knife, §32, p32
 nail, §35, p27; §40, p3
 plates, §40, p41
 screw, §40, p3
- Draw-spike, §40, p3
- Drawer dovetail, §33, p35
- Drawing deep patterns, §41, p26
 down of the cope, §43, p10
 plates, §40, p3
 plates for patterns, §35, p25
 rod for patterns, §35, p25
- Drawings, Stove, §39, p9
- Drill, Twist, §32, p29
- Drillings, Standardized, §47, p20
- Driving plates and dogs, §35, p31
- Drum, Sweeping a conical, §45, p29
- Dry-sand cores, §44, p9
 -sand cores, Comparison of, with green sand, §44, p9
 -sand mold for a three-way stop-cock, §38, p7
 -sand molds, Finishing of, §45, p6
 -sand molds, Sand for, §45, p1
 -sand molds, Venting, §45, p2
 -sand molding, §45, p1
 -sand work, Facing mixtures for, §45, p8
 -sand work, Flasks for, §45, p3
 -sand work, Method of molding used in, §45, p3
- Drying a skin-dried mold, §42, p35
 crooked cores, §44, p21
- Dull iron, Effect of, on buoyancy, §41, p33
 sand, §40, p6
- E**
- Elasticity, §47, p48
- Elbows, Patterns and core boxes for, §36, p31
- Elements that are fairly constant in pig iron, §47, p13
 that vary in pig iron, §47, p13
- Emery cone for grinding gouges, §32, p43
- Engine cylinders, Core boxes for, §37, p42
 valve-gear details, Patterns for Corliss, §37, p36
- Exhaust arm, Pattern for, §37, p36
- Expansive bit, §32, p28
- F**
- Face of pattern, §35, p33
 plate for lathe, §34, p7
 plate, Lathe, §34, p7
 plates, Preparation of wooden, §36, p45
- Facing, §40, p4
 inside of projections, §41, p15
 material, Necessity of thorough mixing, §43, p39
 mixtures for dry-sand work, §45, p8
 sand, §40, p18; §45, p8
 sand, Preparing the, §43, p37
- Fastenings for patterns, Adhesive, §35, p17
 Pattern, §35, p16
- Feather or fillet, §33, p34
- Feed-head, §40, p4
- Feeders, Use of large, §43, p23
- Feeding heads, §43, p20
 heads and risers, Covering of, §43, p13
 Hot iron for, §43, p23
 rods, Use of, §43, p21
 the mold, §43, p20
- Ferrosilicon, §47, p16
 Specifications for, §47, p34
- Figures, Pattern, §35, p27
- Filing circular and band saws, §33, p7
 of saw, §32, p48
- Fillet or feather, §33, p34
 plane, §35, p22
- Fillets, §35, p20
 Leather, §35, p22
 Metal, §35, p23
 Wax, §35, p22
 Wooden, §35, p21
- Fin, Definition of, §45, p7
- Finish, Allowance for, §35, p34
- Finishing a mold, §40, p34
 a skin-dried mold, §42, p34
 dry-sand molds, §45, p6
 loam molds, §45, p34
 swept cores, §44, p5
 the mold, §42, p21
 tools, §42, p28
 Using the trowel in, §42, p27
- Fire for drying the cupola lining, §46, p15
 in a cupola, Starting the, §46, p26
 sand, §40, p9
- Fireclay, §40, p4
- Firing reverberatory furnace, §46, p55
- Firmer chisel, Socket, §32, p15
- Flange and lifter tools, §42, p29
- Flanges for patterns, Preparing, §36, p12
 Securing, on patterns, §36, p39
- Flask, §40, p2
- Flasks, §40, p17
 Clamps for, §41, p35

- Flasks, Cross-bars for, §42, p18
 for dry-sand work, §45, p3
 Snap, §43, p25
 Special hinges for, §42, p6
 Three-part molds in three-part, §42, p3
 Three-part molds in two-part, §42, p5
- Floor rammer, §40, p4
- Floors for holding down copes, §41, p38
- Fluidity test of cast iron, §47, p61
- Flute tool, §42, p29
- Flux, Charging the, §46, p35
 Quantity of, §46, p36
- Fluxes, Composition of limestone, §46, p35
 Kinds of, §46, p34
 Principle of, §46, p33
- Flywheel patterns, §38, p36
- Flywheels with hollow arms, §38, p36
- Foerstner bit, §32, p29
- Follow board, §40, p2
 board, Making a sand, §42, p7
 boards, §42, p7
 boards, Composition of sand, §42, p9
 boards, Plaster-of-Paris, §42, p10
 boards, Sand, §42, p7
 boards, Sand-and-composition, §42, p7
 boards, Wooden, §42, p7
- Fore plane, §32, p16
- Formers, Making small cores in, §44, p13
- Foundation for loam molds, Making a, §45, p14
 for reverberatory furnace, §46, p53
- Founding, Definition of, §40, p1
- Foundry iron, §47, p15
- Framing chisel, §32, p15
 square, §32, p7
- Fuel, Amount of, between charges of iron, §46, p29
 Charging, in a cupola, §46, p27
 combustion in cupolas, §46, p37
 Economy of, in melting iron, §46, p48
 Effects of too much or too little, in a cupola, §46, p30
 Ratio of, to iron in cupola practice, §46, p29
 ratios in melting iron, §46, p48
- Fuels used in blast furnace, §47, p3
- Furnace, Blast, §47, p1
 Charging a blast, §47, p4
 Construction of a blast, §47, p2
 Fuels used in the blast, §47, p3
 Operation of blast, §47, p3
 Reactions in a blast, §47, p5
 Tapping a blast, §47, p7
- Furnaces, Air, §46, p51
 for melting iron, §46, p1
 Oil-burning, §46, p55
- Fusing point of cast iron, §47, p2
 point of wrought iron, §47, p2
- G**
- Gagger mold, §42, p16
- Gaggers and soldiers, §42, p14
 Making of, §42, p15
- Gas burner for drying the mold, §42, p36
- Gases, Pressure of, in mold, §43, p12
- Gate, §40, p3
 cutter, §40, p43
 cutters, §40, p5
 Horn, §40, p36
- Gates, Cuting of, §40, p42
 for catching dirt, §42, p38
 for molds, §42, p38
 Skimming, §42, p38
 Skimming, for light castings, §42, p40
 Top-pouring skimming, §42, p42
 Whirl, §45, p46
- Gating a skin-dried mold, §42, p37
 and pouring of loam molds, §45, p37
 molds, §44, p8
- Gauge, Scratch, §32, p11
 set for circular saws, §33, p9
 Marking, §32, p11
- Gauges, Blast, §46, p40
- Gear, Laying out of bevel, §38, p25
 Laying out teeth for worm-, §38, p34
 patterns, Fastening teeth on, §38, pp20, 27
 patterns, Forming of teeth on, §38, p27
 patterns, Miter and bevel, §38, p24
 patterns, Spur, §38, p18
- Gears, Patterns for, §37, p24
- Globe-valve patterns, §37, p9
 valves, Core boxes for, §37, p12
- Glue, §33, p15; §35, p17
 brushes, §33, p16
 pot, §33, p16
 water as a binder for cores, §44, p25
- Gluing, Precautions in, §33, p17
- Gouge, §32, p16
 Inside-ground, §32, p16
 Outside-ground, §32, p16
 Use of, §33, p24
- Gouges for turning, §34, p8
 Grinding, on emery cone, §32, p43
 Sharpening of, §34, p12
- Grading pig iron, §47, p10
- Graphite or plumbago, §43, p36
- Graphitic carbon, §47, p20
- Gray forge iron, §47, p16
- Green-sand cores, §44, p2
 -sand cores, Comparison of, with dry-sand, §44, p9
 -sand cores for pipe, §44, p2

- Green-sand cores in boxes, Making of, §44, p5
 -sand cores, Sweeping of, §44, p2
 -sand molding, §40, p1
 sand, Skeleton patterns for making pipe bends in, §37, p4
 Grinding chisels and gouges, §32, p40
 gouges with emery cone, §32, p43
 Grindstone, Action of water on, §33, p11
 mountings, §33, p12
 Speed of, §33, p13
 truing device, §33, p12
 Truing of, by hand, §33, p12
 Grindstones, Artificial, §33, p13
 Composition of, §33, p11
 Tool rests for, §33, p11
 Grooves, angular, Turning of, §34, p24
 Turning of curved, §34, p26
 Turning square, §34, p25
 Ground beneath prepared beds and molds, §41, p21
 Gullet teeth for saws, §32, p24
- H**
- Half-round corner tool, §42, p29
 Hammer, Claw, §32, p32
 Use of, §33, p31
 Hand rammer, §40, p4
 wheel for throttle valve, Pattern for, §38, p6
 Hard beds for coped molds, §41, p16
 beds for open-sand castings, §41, p11
 Hardness of cast iron, §47, p50
 Hatchet, §32, p34
 Head-pressure, Computing the, for mold, §41, p34
 Sinking, §43, p18
 Heads, Feeding, §43, p20
 Headers in brickwork, §45, p33
 Headstock, Lathe, §34, p3
 Heart wood, §35, p11
 Hearth of reverberatory furnace, §46, p53
 Heat from combustion of carbon, §46, p38
 Heats in cupola, Long, §46, p8
 Hexagonal parts, Tool for laying out of, §37, p8
 Hoisting drum, Making mold for, §45, p29
 Holes, Cause of shrink, §43, p16
 Hook, Bench, §32, p6
 lever, Pattern for, §37, p37
 Horn gate, §40, p36
 Horses, Wooden, §32, p39
 Hubs, Standard, §35, p7
- I**
- India oilstones, §33, p15
 Inside turning, §34, p38
 Intermediate parts or cheeks, §40, p2
 Iron, Amount of fuel between charges of, §46, p29
 Basic, §47, p17
 Bessemer, §47, p15
 Casting of pig, §47, p7
 Charcoal, §47, p15
 Charging different grades of, §46, p32
 Chill of, §47, p49
 clamps, §32, p37
 Composition of pig, §47, p13
 Contraction of, §47, p49
 Density of, §47, p48
 Economy of fuel in melting, §46, p48
 Effect of dull, on buoyancy, §41, p33
 Effect of impurities on pig, §47, p17
 Effect of remelting on, §47, p31
 Effect of remelting, upon carbon contents, §47, p20
 Elements that are fairly constant in pig, §47, p13
 Elements that vary in pig, §47, p13
 Ferrosilicon, §47, p16
 flasks, §45, p3
 Fluidity test of cast, §47, p61
 for feeding, Hot, §43, p23
 Foundry, §47, p15
 Furnaces for melting, §46, p1
 Grading of pig, §47, p10
 Grading of scrap, §47, p37
 Gray forge, §47, p16
 Hardness of cast, §47, p50
 Influence of casting position on, test bars, §47, p56
 Kinds of pig, §47, p14
 Loss of, by oxidation in melting, §47, p29
 match plates, §42, p13
 Measuring of, test bars, §47, p62
 Melting of, in small cupolas, §46, p49
 Melting point of cast, §47, pp2, 29
 Melting point of wrought, §47, p2
 Method of using scrap, §47, p38
 Mixing steel and wrought iron with cast, §47, p47
 mixtures, Calculation of cast-, §47, p13
 Mixtures of cast, §47, p42
 mixtures, Proportioning of, §47, p39
 molds for casting pig iron, §47, p8
 Nature of cast, §47, p2
 Necessity for analysis of pig, §47, p18
 Occurrence of, in nature, §47, p1
 ore, §47, p1
 Origin of carbon in cast, §47, p6
 Origin of sulphur in cast, §47, p6
 Physical tests of cast, §47, p51
 Rare elements in pig, §47, p17

- Iron, Ratio of fuel to, in cupola practice, §46, p29
 Remelting chilled, §47, p47
 Scrap, §47, p36
 Segregation of pig, §47, p9
 Shrinkage of, §47, p50
 Specifications for charcoal, §47, p35
 Specifications for ferrosilicon, §47, p34
 Specifications for foundry pig, §47, p32
 Specifications for machinery scrap, §47, p38
 Specifications for malleable Bessemer pig, §47, p35
 Specifications for manganese pig, §47, p34
 Specifications for phosphoric pig, §47, p36
 Specifications for silver-gray silicon pig, §47, p34
 Specific gravity of cast, §41, p24
 Taking samples of pig, for analysis, §47, p19
 Tenacity of, §47, p48
 Tensile tests of cast, §47, p61
 Testing chill in cast, §47, p60
 Testing contraction in cast, §47, p56
 Testing of cast, §47, p48
 Testing of chill in, §47, p58
 Uniform structure in, test bars, §47, p54
 Weight of cast, §41, p29
- Irons, Burning, §35, p6
- J**
- Jack-plane, §32, p16
 Jig saw, §33, p6
 Joint, Butt, §33, p33
 Corner, §33, p34
 Dovetail, §33, p34
 Drawer dovetail, §33, p35
 Miter, §33, p35
 Mortise-and-tenon, §33, p36
 of mold, Starting in lifting, §42, p6
 Starting the, of a mold, §42, p20
 Tongued, §33, p33
- Joints, Daubing of, §44, p15
 Door panel, §33, p40
 for arms of wheel patterns, §37, p24
 for circular forms, §42, p1
 for irregular forms, §42, p2
 Forming of, by follow boards, §42, p7
 Framing, §33, p40
 in loam work, §45, p35
 in woodwork, §33, p31
 of molds, §42, p1
- Jointed roller pattern, §36, p6
 Jointing of saws, §32, p47
 of work, §33, p18
 Plain-edge, §33, p32
- K**
- Keyhole saw, §32, p26
 Knife, Draw, §32, p32
- L**
- Lathe centers, §34, p4
 countershaft, §34, p6
 Description of woodworkers', §34, p2
 face plate, §34, p7
 headstock, §34, p3
 Placing work in, §34, p17
 rest, §34, p5
 rest, Adjusting of, §34, p18
 shears, §34, p2
 tail-stock, §34, p4
 Woodworkers', §34, p1
- Lathes, Supports for work in, §34, p6
 Laying out of branch pipes, §36, p40
 Lead or blackening, §43, p36
 Silver, §43, p37
- Leather fillets, §35, p22
 Letters, Brass, §35, p28
 made from soft alloys, §35, p27
 Pattern, §35, p27
- Leveling straightedges for beds, §41, p1
 Lifting pressure of molten metal, §41, p27
 Lime, §40, p8
 Limestone fluxes, Composition of, §46, p35
 Lining, Drying the cupola, §46, p14
 Linings, Causes of destruction of cupola, §46, p14
 for cupolas, §46, p11
 Forms of brick, for cupola, §46, p12
 Single and double, for cupola, §46, p12
 Special materials for cupola, §46, p13
 Treatment of cupola, §46, p15
- Linseed oil as binder for cores, §44, p25
 Loam for daubing, Thickness of, §45, p33
 mixtures, §45, p39
 mixtures, Receipts for, §45, p40
 mold, Blackening, §45, p34
 mold, Building core for, §45, p19
 mold, Building outside of, §45, p17
 mold for cylinder, §45, p10
 mold, Making the foundation and prints for, §45, p14
 molds, Backing of, for casting, §45, p36
 molds, Finishing of, §45, p34
 molds, Gating and pouring of, §45, p37
 molds, Skeleton-pattern, §45, p24
 molds, Venting of, §45, p36
 molding, §40, p1
 Skeleton patterns for making pipe bends in, §37, p4
 Sweeping conical drum mold in, §45, p29
 work, §45, p10

- Loam work, Details of, §45, p32
 work, Joints in, §45, p35
 work, Laying brick in, §45, p32
 work spindles, Sweeps and arms for, §45, p12
- M**
- Machine, Core-box, §36, p19
 Machines and tools used for pattern work, §35, p32
 for casting pig iron, §47, p8
 Sawing, §33, p3
 Surfacing, §33, p9
 Testing, §47, p63
 Trimming, §33, p1
 Making a bench mold, §43, p26
 a hard bed, §41, p8
 a soft bed, §41, p3
 chilled car wheels, §45, p48
 gaggers, §42, p15
 green-sand cores in boxes, §44, p5
 soldiers, §42, p17
 Malleable Bessemer pig iron, Specifications for, §47, p35
 Mallet, §32, p33
 Mallets, §34, p13
 Manganese, §47, p25
 pig iron, Specifications for, §47, p34
 Marking and recording patterns, §35, p37
 calipers, §39, p14
 gauge, §32, p11
 Master patterns, §39, p10
 Match board, §42, p7
 board for stove pattern, §39, p36
 boards, Making iron, §42, p13
 Composition of oil sand for, §36, p6
 Making sand, §42, p7
 or odd side, §36, p5
 plate, §42, p7
 plates, Making iron, §42, p13
 Matches, §42, p7
 Plaster-of-Paris, §42, p10
 Materials for stopping the cupola, §46, p43
 used for stove patterns, §39, p19
 used in core making, §44, p22
 used in pattern making, §35, p10
 Measuring test bars, §47, p62
 Medullary rays in wood, §35, p11
 Melting, Comparison of coke and coal for, §46, p46
 iron, Economy of fuel in, §46, p48
 iron in small cupolas, §46, p49
 point of cast iron, §47, pp2, 29
 point of wrought iron, §47, p2
 zone of a cupola, §46, p17
 zone, Repairing of, §46, p18
 Metal core boxes, §35, p4
 dowels, §35, p23
 fastenings for patterns, §35, p16
 fillets, §35, p23
 Lifting pressure of molten, §41, p27
 patterns, §35, p15
 Metalloids, §47, p14
 Microscopic section of wood, §35, p12
 Miter-box, §32, p37
 -gear patterns, §38, p24
 joint, §33, p35
 square, §32, p10
 Mixtures, Mud and loam, §45, p39
 of cast iron, §47, p42
 Mixing binders for cores, §44, p24
 blackenings, §44, p29
 cast iron, §47, p39
 Models, Stove, §39, p7
 Moisture in molds, §42, p24
 on chaplets, Effect of, §43, p5
 Mold, Blackening loam, §45, p34
 Building core for loam, §45, p19
 Building outside of loam, §45, p17
 Clamping and weighting the, §41, p27
 Computing the static or head pressure for, §41, p34
 Construction of a cylindrical, in loam, §45, p10
 Crush in, §42, p34
 Drying a skin-dried, §42, p35
 Finishing, §40, p34; §42, p21
 Finishing a skin-dried, §42, p34
 for chilled roll, Preparing, §45, p44
 for gaggers, §42, p16
 Gas burner for drying, §42, p36
 Gating a skin-dried, §42, p37
 Hard beds for coped, §41, p16
 Making bench, §43, p26
 Making drag for deep, §40, p28
 Making foundation and print for loam, §45, p14
 Patching the, §42, p22
 Placing chaplets in bottom of, §43, p8
 Pouring, §40, pp34, 44
 Preparation of, by rolling over, §40, p17
 Protection of, against fusing, §43, p35
 Ramming flat surface in, §40, p36
 Ramming of, §40, p17
 Starting the joint of, §42, p20
 Starting the joint of, in lifting, §42, p6
 Tucking up, §41, p14
 Molds, Backing, loam, for casting, §45, p36
 Deep, §40, p22
 Finishing of dry-sand, §45, p6
 Finishing of loam, §45, p34
 Finishing tools for, §42, p28

- Molds, Gates for, §42, p38
 Gating and pouring of loam, §45, p37
 Gating of, §44, p8
 Ground beneath, §41, p21
 Hardness required in, §40, p20
 Iron, for casting pig iron, §47, p8
 Joints of, §42, p1
 Methods of computing weights for
 §41, p31
 Moisture in, §42, p24
 Momentum lift in, §41, p33
 Nails and rods at joints and corners of
 §42, p22
 Pouring off, §43, p34
 Pressure of gases in, §43, p12
 Sand, for casting pig iron, §47, p7
 Sand for dry-sand, §45, p1
 Sand required for deep, §40, p22
 Shallow, §40, p36
 Skeleton-pattern loam, §45, p24
 Skin-dried, §42, p31
 Swabbing broken corners of, §42, p24
 Three-part, in three-part flasks, §42, p3
 Three-part, in two-part flasks, §42, p5
 Venting deep, §40, p22
 Venting of dry-sand, §45, p2
 Venting of loam, §45, p36
 Venting shallow, §40, p26
 with bottom projecting cores, §41, p22
 Feeding the, §43, p20
- Molding a propeller without pattern, §39, p7
 Bench, §43, p24
 board, §40, p2
 by bedding in, §41, p1
 Difference between dry-sand and green-
 sand, §45, p1
 Dry-sand, §40, p1; §45, p1
 Examples of deep, §40, p28
 Green-sand, §40, p1
 Loam, §40, p1
 Method of, for three-way cock, §37, p21
 planes, §32, p19
 plates with projections in open sand,
 §41, p12
 sand, §40, pp4, 6
 sand, where found, §40, p10
 Momentum lift in molds, §41, p33
 Mortise-and-tenon joint, §33, p36
 Making of, §33, p23
 Mud and loam mixtures, §45, p39
- N
- Nail bit, §32, p30
 Draw, §35, p27; §40, p3
 set, §32, p33
 Nails, §35, p16
- Nails and rods at joints and corners,
 §42, p22
 Nickel, §47, p28
 Nowel, §40, p2
- O
- Odd side, §36, p5
 sides, §42, p7
 Odontograph, Use of, §38, p35
 Oil-burning furnaces, §46, p55
 Oilstone, Washita, §33, p14
 Oilstones, Arkansas, §33, p14
 Artificial, §33, p14
 Composition of, §33, p14
 Indian, §33, p15
 Kinds of, §33, p14
 Qualities of, §33, p14
 Open-sand casting, Hard beds for, §41, p11
 -sand castings, §41, p3
 -sand castings, Thickness of, §41, p7
 sand, Molding plates with projections in,
 §41, p12
 Ore, Iron, §47, p1
 Organic matter in sand, §40, p8
 Ovens for drying small cores, §44, p13
- P
- *Panels, Door, §33, p40
 Parallel clamps, Wooden, §32, p36
 Paring chisel, §32, p15
 Parting, Cam arrangement for making, in
 loam molds, §45, p22
 sand, §40, p4
 sand, Use of, §40, p30
 tool, §34, p10
 Pasting cores, §44, p14
 Patching the mold, §42, p22
 Pattern, Allowance for distortion in a,
 §40, p35
 arms, Strengthening of, §38, p36
 Building a propeller, §39, p4
 Definition of, §35, p2; §40, p3
 Drawing of, §40, p34
 Face of, §35, p33
 fastenings, §35, p16
 figures, §35, p27
 for crank-disk, §37, p32
 for cylinder head, §37, p29
 for cylinder-head cover, §37, p29
 for deep mold, §40, p28
 for exhaust arm, §37, p36
 for hook lever, §37, p37
 for pipe bend, Skeleton, §37, p2
 for range shelf, §39, p40
 for shaft coupling, §37, p27
 for slide-valve engine cylinder, §37, p38
 for small bell, §38, p11

- Pattern for solid roller, §36, p5
 for special three-way stop-cock, §38, p7
 for steam-chest cover, §37, p34
 for the bottom of a range, §39, p39
 for three-way cock, §37, p17
 for throttle valve, §38, p1
 for throttle valve hand wheel, §38, p6
 for top of range, §39, p37
 for valve bonnet, §37, p15
 Jointed roller, §36, p6
 letters, §35, p27
 Making, for front jamb of range, §39, p33
 Molding propeller without, §39, p7
 Reversing stove, §39, p24
 turning, §36, p4
 varnish, §35, p17
 Wax, for stove door, §39, p41
 Patterns and core box for casting chain, §38, p16
 and core boxes for bent pipes, §36, p24
 Building up of ring, §36, p46
 Built-up, §36, p9
 Built-up annular, §36, p43
 Carving and blocking process for stove, §39, p20
 Carving and blocking stove, §39, p21
 Character of stove, §39, p19
 Core prints for large, §36, p13
 Doweling together of, §36, p7
 Drawing deep, §41, p26
 Drawing plates for, §35, p25
 Drawing rods for, §35, p25
 Fitting staves for, §36, p10
 Flywheel, §38, p36
 for bent pipes, §36, p34
 for branch pipes, §36, p36
 for Corliss engine valve-gear details, §37, p36
 for hollow castings, §36, p2
 for large pipe bends, Skeleton, §37, p4
 for pipe elbows, §36, p31
 for racks, §38, p18
 for screw propellers, §39, p1
 for solid castings, §36, p1
 for spur gears, §38, p18
 for valve details, §37, p16
 for wheels and gears, §37, p24
 for worm-gear, §38, p32
 Globe-valve, §37, p9
 having thin webs, §37, p32
 Holding parts of, while turning, §36, p8
 involving auxiliary patterns, §37, p8
 Joining parts of, §36, p38
 Large cylindrical, §36, p9
 Marking and recording, §35, p37
 Patterns, Master, §39, p10
 Materials used for, §35, p1
 Materials used for stove, §39, p19
 Metal and other materials for, §35, p15
 Miter and bevel gear, §38, p24
 Preparation of flanges for, §36, p12
 Processes of making stove, §39, p20
 Protective coatings for, §35, p17
 Provision for rapping and drawing of, §35, p25
 Rapping plates for, §35, p25
 Rounding corners of, §36, p3
 Rubber, §35, p15
 Securing flanges on, §36, p39
 Selection of stock for, §37, p1
 Skeleton, §37, p2
 Skeleton, for loam molds, §45, p24
 Small rectangular, §36, p1
 Special tool for turning large, §36, p14
 Taper on, §41, p26
 Turning large cylindrical, §36, p12
 Two-part, §36, p6
 Varnishing of, §37, p11
 Wax process for stove, §39, p21
 Worm, §38, p29
 Patternmakers' bench, §32, p1
 curves, Stove, §39, p13
 tools, §35, p29
 universal circular-saw bench, §33, p3
 Patternmaking, §35, p1
 Allowances necessary in, §35, p32
 Examples of stove, §39, p22
 materials, §35, p10
 Special tools for stove, §39, p10
 Stove, §39, p7
 Peen of a rammer, §40, p4
 Phosphoric pig iron, Specifications for, §47, p36
 Phosphorus, §47, p26
 Physical properties of sand, §40, p7
 tests of cast iron, §47, p51
 Picks for cleaning the cupola, §46, p16
 Pig-casting machines, §47, p8
 Pig iron, Casting of, §47, p7
 iron, Composition of, §47, p13
 iron, Effect of impurities on, §47, p17
 iron, Elements that are fairly constant in, §47, p13
 iron, Elements that vary in, §47, p13
 iron, Grading of, §47, p10
 iron, Iron molds for, §47, p8
 iron, Kinds of, §47, p14
 iron, Necessity for analysis of, §47, p18
 iron, Rare elements in, §47, p17
 iron, Sand molds for, §47, p7
 iron, Segregation of, §47, p9

- Pig iron, Specifications for foundry, §47, p32
 iron, Specifications for malleable Bessemer, §47, p35
 iron, Specifications for manganese, §47, p34
 iron, Specifications for phosphoric, §47, p36
 iron, Specifications for silver-gray silicon, §47, p34
 iron, Taking samples of, for analysis, §47, p19
 Pin, Sprue, §40, p3
 Pipe bend, Skeleton pattern for, §37, p2
 bends, Skeleton patterns for making, in green sand, §37, p4
 bends, Skeleton patterns for making, in loam, §37, p4
 cores, Bearings for prints of, §44, p8
 elbows, Core boxes for, §36, p31
 elbows, Patterns for, §36, p31
 Green-sand cores for, §44, p2
 slick, §42, p29
 Pipes, Core boxes for bent, §36, pp24, 34
 Laying out of branch, §36, p40
 Patterns and core boxes for the branch, §36, p36
 Patterns for bent, §36, pp24, 34
 Plain-edge jointing, §33, p32
 Plane, Adjustable circular, §32, p20
 Block, §32, p16
 Core-box, §36, p17
 Fore, §32, p16
 iron, §32, p16
 iron, Sharpening of, §32, p43
 Jack, §32, p16
 Rabbet, §32, p21
 Routing, §32, p22
 Scrub, §32, p18
 Smooth, §32, p16
 Throat of, §32, p17
 Universal, §32, p21
 Use of, §33, p27
 Planes, Cutting action of, §32, p18
 Molding, §32, p19
 Tongue and groove, §33, p33
 Types of, §32, p16
 Planer attachment for making thin stock, §39, p18
 Daniels, §33, p10
 Rotary, §33, p9
 Plaster-of-Paris matches, §42, p10
 Plates, Drawing, §40, p3
 Making beds for prickered, §41, p9
 Preparation of wooden face, §36, p45
 Rapping, §40, p3
 Plates, Rapping and draw, §40, p41
 with projections, Molding of, in open sand, §41, p12
 Plow, §32, p21
 Plumb, Vertical, §39, p13
 Plumbago or graphite, §43, p36
 Poling metal, §46, p55
 Pouring a mold, §40, p44
 basins, §42, p44
 gates for catching dirt, §42, p38
 loam molds, §45, p37
 off, §43, p34
 Pressure, Computing the static or head, for mold, §41, p34
 gauges for blast, §46, p40
 of blast, §46, p39
 of gases in molds, §43, p12
 of molten metal, Lifting, §41, p27
 Prickered plates, Making beds for, §41, p9
 Print for a loam mold, Making of, §45, p14
 Prints, Core, §35, pp3, 6
 for straight cores, §35, p8
 Special core, §35, p10
 Standard core, §35, p7
 Printing dry blackening, §42, p30
 Projections, Rodding of, §41, p24
 Propeller blade, Development of curve for, §39, p1
 blade, Laying out of, §39, p3
 Molding of, without a pattern, §39, p7
 Propellers, Patterns for screw, §39, p1
 Props, Bottom for cupola, §46, p22
 Protective coatings for patterns, §35, p17
 Protractor, §32, p11
 Combination square and bevel, §32, p10

Q
 Quarter sawing, §35, p13

R
 Rabbet plane, §32, p21
 Rack patterns, §38, p18
 Rammer, §40, p4
 Floor, §40, p4
 Hand, §40, p4
 Use of, §40, p17
 Rammers, Bench, §43, p26
 Ramming a flat surface, §40, p36
 Care and skill in, §42, p21
 cores, §44, pp8, 11
 up loam molds for casting, §45, p36
 with the feet, §40, p37
 Range, Making pattern for front jamb of, §39, p33
 Pattern for bottom of, §39, p39
 Pattern for top of, §39, p37
 shelf, Pattern for, §39, p40

- Rapping plates, §40, pp3, 41
plates for patterns, §35, p25
- Ratio of fuel to iron in cupola practice, §46, p29
- Rays, Silver, in wood, §35, p11
- Reactions in a blast furnace, §47, p5
- Receipts for core-sand mixtures, §44, p27
for loam mixtures, §45, p40
- Recording patterns, §35, p37
- Red shellac varnish, §35, p18
- Remelting chilled iron, §47, p47
- Rest, Adjusting lathe, §34, p18
Lathe, §34, p5
- Reverberatory furnace, §46, p51
furnace, Chimney for, §46, p54
furnace, Firing and charging of, §46, p55
furnace, Foundation for, §46, p53
furnace, Hearth of, §46, p53
- Riddle, §40, p5
- Riddles, §40, p15
- Riddling, §40, p16
- Ring patterns, Building up of, §36, p46
- Rings, Turning hollow, §34, p42
- Ripping saw, §32, p24
- Riser, §40, p4
Cutting of, §40, p42
Risers, Covering of, §43, p13
- Rods at joints of molds, §42, p22
Use of feeding, §43, p21
- Rodding or barring cores, §44, p17
projections, §41, p24
- Rolls, Preparing mold for chilled, §45, p44
Thickness of chills for, §45, p45
- Rolling over, §40, p5
- Rope, Use of, in venting crooked cores, §44, p21
- Rosette, Turning a, §34, p36
- Rosin as a binder for cores, §44, p23
- Rotary planer, §33, p9
- Roughing in turning, §34, p17
- Round cores, Small, §44, p10
nose chisel, §34, p9
- Routing plane, §32, p22
- Rubber patterns, §35, p15
- Rule, §33, p18
Folding, §32, p7
Four-fold, §32, p7
Two-fold, §32, p7
- Rules, Shrink, §39, p10
- Runner basin, §40, p3
Vertical, §40, p3
- Rust on chaplets, Effect of, §43, p4
- S
- Samples for chemical analysis, §47, p19
- Sand, Adhesive qualities of molding, §40, p6
- Sand and protective materials, Composition of, §43, p35
- Backing, §45, p8
- Chemical and physical properties, §40, p7
- Combined water in, §40, p8
- Constituents of, §40, p7
- Dull, §40, p6
- Facing, §40, p18; §45, p8
- Fineness of, §40, p8
- follow board, Making a, §42, p7
- follow boards, §42, p7
- follow boards, Composition of, §42, p9
- for cupola bottoms, Preparing, §46, p23
- for dry-sand molds, §45, p1
- Grades of, §40, p6
- mixtures, Core-, §44, p26
- molds for casting pig iron, §47, p7
- Molding, §40, p4
- Molding, where found, §40, p10
- Organic matter in, §40, p8
- Parting, §40, p4
- Preparing the facing, §43, p37
- Quality of, §40, p9
- required for deep mold, §40, p22
- Sharp, §40, p6
- Silica or fire, §40, p9
- Strong, §40, p6
- Tempering of, §40, p11
- Tempering the, §43, p34
- Use of, §40, p30
- used in making cores, §44, p22
- Venting patched bodies of, §42, p26
- Weak, §40, p6
- Wetting down of, §40, p13
- Sands, Liquids used in wetting the core, §44, p26
- Sandpaper, §32, p35; §35, p16
Use of, §33, p30
- Sap wood, §35, p11
- Saw, Back, §32, p25
- Saw, bench, Universal circular, §33, p3
blade, §32, p22
clamp, §32, p45
Cross-cutting, §32, p25
Filing of, §32, p48
Forming of core boxes on, §36, p23
Jig, §33, p6
Keyhole, §32, p26
Ripping, §32, p24
set, §32, p45
Set of, §32, p44
setting and sharpening, §32, p44
Setting the, §32, p46
teeth, §32, p23
teeth, Gullet, §32, p24

- Saw, Use of, §33, p24
 Sawing machines, §33, p3
 Quarter, §35, p13
 Saws, §32, p22
 Band, §33, p5
 Jointing of, §32, p47
 Set gauge for circular, §33, p9
 Size of, §32, p23
 Swedge setting of, §32, p47
 Scabs, Blackening, §42, p28
 Scrap iron, §47, p36
 iron, Grading of, §47, p37
 iron, Method of using, §47, p38
 Specifications for machinery, §47, p38
 Scraper, §32, p34
 Use of, §33, p30
 Scratch awl, §32, p13
 gauge, §32, p11
 Screw, Draw, §40, p3
 propellers, Patterns for, §39, p1
 Screwdriver, §32, p31
 Screws, §35, p16
 Scriber, §32, p13
 Scrub plane, §32, p18
 Sea coal, §43, p36
 coal, Percentage of, in facing sand,
 §43, p37
 Seasoning wood, §35, p12
 Segregation of pig iron, §47, p9
 Set for a saw, §32, p45
 gauge for circular saws, §33, p9
 of a saw, §32, p44
 Setting and filing circular and band saws,
 §33, p7
 and wedging chaplets, §43, p6
 cores, §44, p6
 saws with a swage, §32, p47
 the saw, §32, p46
 Shaft coupling, Pattern for, §37, p27
 Shake, §40, p4
 Allowance for, §35, p35
 Shaking out castings, §43, p34
 Shallow molds, §40, p36
 Sharp sand, §40, p6
 Sharpening auger bits, §32, p44
 chisels, §34, p12
 gouges, §34, p12
 plane iron, §32, p43
 spoke shave, §32, p44
 Shears, Lathe, §34, p2
 Shellac varnish, Black, §35, p18
 varnish, Red, §35, p18
 varnish, Yellow, §35, p17
 Shovels, §40, p13
 Shrink holes, Cause of, §43, p16
 rules, §39, p10
 Shrinkage, §35, p33; §40, p4; §43, p19;
 §47, p50
 Allowance for, §35, p34
 Sieve, §40, p5
 Sieves and riddles, §40, p15
 Silica, §40, p7
 or fire-sand, §40, p9
 Silicon, §47, p22
 Allowance for loss of, in melting, §47, p41
 Silver lead, §43, p37
 rays in wood, §35, p11
 Sinking head, §43, p18
 Sizing tool, §34, p10
 Skeleton pattern, Core for, §37, p3
 pattern for pipe bend, §37, p2
 pattern loam molds, §45, p24
 patterns, §37, p2
 Skew chisel, §34, p9
 chisel, Cut with, §34, p23
 chisel, Holding, §34, p21
 Skimming gates, §42, p38
 gates for medium and light castings,
 §42, p40
 gates, Top-pouring, §42, p42
 Skin-dried mold, Drying a, §42, p35
 -dried mold, Finishing a, §42, p34
 -dried molds, §42, p31
 Slag holes, Height and position of, §46, p7
 Necessity of a free, §46, p36
 Slagging a cupola, §46, p33
 Importance of, §46, p34
 Influence of, on capacity of a cupola,
 §46, p44
 Methods of, §46, p37
 Slickers, §40, p5
 Sleeking and printing dry blackening,
 §42, p30
 tools, Using the, §42, p28
 Slide-valve engine cylinder, Pattern for,
 §37, p38
 Smooth plane, §32, p16
 Snap flasks, §43, p25
 Soldiers, Making of, §42, p17
 Use of, §42, p14
 Specific gravity of cast iron, §41, p24
 Specifications for foundry pig iron, §47, p32
 for machinery scrap, §47, p38
 Speed, Cutting, in wood turning, §34, p14
 Spike, Draw, §40, p3
 Spindles for loam work, §45, p12
 Spoke shave, §32, p32
 shave, Sharpening of, §32, p44
 Spoon bit, §32, p30
 Spout for a cupola, Making the, §46, p24
 Spring chaplets, §43, p1
 Spruce, §40, p3

- Sprue pin, §40, p3
 Spur auger, §32, p26
 -gear patterns, §38, p18
 Square, §33, p19
 and bevel protractor, Combination, §32, p10
 corner tool, §42, p29
 Framing, §32, p7
 grooves, Turning of, §34, p25
 Miter, §32, p10
 Try, §32, p9
 Use of, for testing core box, §36, p18
 Wooden-head, §32, p9
 Stakes, Driving of, for holding copes, §42, p20
 Standard core prints and hubs, §35, p7
 Standardized drillings for chemical analysis, §47, p20
 Static or head pressure for mold, Computing of, §41, p34
 Staves for patterns, Fitting of, §36, p10
 Steam-chest cover, Pattern for, §37, p34
 Steel, Mixing of, with cast iron, §47, p47
 Stock for patterns, Selection of, §37 p1
 Preparation of, for turning, §34, p17
 Stop-cock, Patterns for special three-way, §38, p7
 pieces for core boxes, §36, p43
 Stopping materials for cupola, §46, p43
 the cupola, §46, p42
 Stove-base panel by the blocking process, §39, p22
 bevels, §39, p11
 door pattern by the wax process, §39, p41
 drawings, §39, p9
 leg by backing process, §39, p30
 leg by blocking process, §39, p28
 leg, Sawing out of pattern for, §39, p28
 Making pattern for the front jamb of, §39, p33
 models, §39, p7
 pattern, Match board for, §39, p36
 pattern, Reversing a, §39, p24
 patternmakers' curves, §39, p13
 patternmaking, §39, p7
 patternmaking, Examples of, §39, p22
 patternmaking, Special tools for, §39, p10
 patterns, Carving and backing, §39, p20
 patterns, Carving and blocking, §39, p21
 patterns, Character of, §39, p19
 patterns, Materials used for, §39, p19
 patterns, Processes of making, §39, p20
 patterns, Wax process for, §39, p21
 Straightedges, Use of, in bedding in, §41, p1
 Strain, Definition of, §47, p51
 Strength of iron, §47, p49
 Stress, Definition of, §47, p51
 Strickle, §37, p3
 Strikes, §37, p3
 Strong sand, §40, p6
 Submerged cores, §41, p29
 Sulphur, §47, p24
 Origin of, in cast iron, §47, p6
 Surface venting, §41, p17
 Surfacing machines, §33, p9
 Swabbing broken corners of molds, §42, p24
 Swabs and swabbing, §40, p40
 Swedge sets for saws, §32, p47
 Sweeping a conical drum mold in loam, §45, p29
 a core, §44, p4
 green-sand cores, §44, p2
 Thickness of loam for, §45, p33
 Sweeps, Cam-arrangement for, §45, p22
 for loam work, §45, p12
- T**
- Tail-stock, Lathe, §34, p4
 Tap hole, Clay cores for, §46, p26
 hole for a cupola, Making the, §46, p24
 Taper on patterns, §41, p26
 Tapered core boxes, §36, p20
 Tapping a blast furnace, §47, p7
 Method of, §46, p42
 out of cupola, §46, p41
 Tools for, §46, p41
 Teeth, Fastening, on gear-pattern, §38, p27
 Fastening, on worm-gear, §38, p33
 Fastening, on gear-patterns, §38, p20
 Finishing of, on gear-patterns, §38, p22
 for worm-gear, Laying out, §38, p34
 Forming, on gear-patterns, §38, p27
 Saw, gullet, §32, p24
 Size of saw, §32, p23
 Temperature of blast for blast furnace, §47, p4
 Tempering sand, §40, p11
 the sand, §43, p34
 Templet for work being turned, §34, p33
 Templets for the gear-teeth on patterns, §38, p22
 Tenacity of iron, §47, p48
 Tensile tests of cast iron, §47, p61
 Test bars, Influence of casting position on, §47, p56
 bars, Measuring, §47, p62
 bars, Uniform structure in, §47, p54
 Testing cast iron, §47, p48
 machines, §47, p63
 Tests of cast iron, §47, p51
 of cast iron, Fluidity, §47, p61
 of cast iron, Tensile, §47, p61

- Thickness calipers, §39, p14
 of open-sand castings, §41, p7
 Thread, Forming of, for worm, §38, p31
 Laying out, for worm, §38, p30
 Three-part molds in the three-part flasks, §42, p3
 part molds in two-part flasks, §42, p5
 -way cock, Core boxes for, §37, p17
 -way cock, Method of molding, §37, p21
 -way cock, Patterns for, §37, p17
 Throttle valve, Bonnet pattern for, §38, p5
 valve, Core for, §38, p3
 valve, Pattern for, §38, p4
 Titanium, §47, p28
 Tongued joint, §33, p33
 Tool, Automatic boring, §32, p30
 Beading, §34, p12
 Cutting in, §34, p12
 for laying out hexagonal parts, §37, p8
 for rounding corners of patterns, §36, p3
 for turning of large patterns, Special, §36, p14
 Parting, §34, p10
 Sizing, §34, p10
 Tool, Sizing, §34, p10
 Tools and machines for pattern work,
 Variety and size of, §35, p32
 Boring, §32, p26
 Care of, §35, p30
 Carving, §39, p17
 Finishing, §42, p28
 for stopping the cupola, §46, p42
 for tapping, §46, p41
 Holding turning, §34, p21
 Patternmakers', §35, p29
 Requirements of wood-cutting, §32, p13
 Special, used for stove patternmaking, §39, p10
 Speed of stone in grinding, §33, p13
 Sharpening appliances for, §34, p14
 Sharpening bench, §32, p40
 Sharpening, on whetstone, §32, p41
 Turning, §34, p8
 Using the sleeking, §42, p28
 Wire edge of, §32, p41
 Wood-working, §35, p30
 Tool rests for grindstones, §33, p11
 Top-pouring skimming gates, §42, p42
 Trammels, §32, p13
 Trimming machines, §33, p1
 Trowel, §40, p5
 Using the, §42, p27
 Truing grindstone by hand, §33, p12
 Trunnions for flasks, §45, p5
 Try square, §32, p9
 Tucking up a mold, §41, p14
 Turning, §34, p1
 a rosette, §34, p36
 across the grain, §34, p34
 angular grooves, §34, p24
 balls, §34, p45
 balusters, §34, p33
 beads, §34, p29
 built-up work, §34, p43
 chisels and gouges, §34, p8
 chuck, §34, p36
 compound beads and grooves, §34, p31
 curved grooves, §34, p26
 Cylindrical, §34, p14
 hollow rings, §34, p42
 Inside, §34, p38
 large cylindrical patterns, §36, p12
 large patterns, Special tool for, §36, p14
 operations, §34, p14
 patterns, §36, p4
 patterns, Holding parts during, §36, p8
 plankwise, §34, p34
 Rough, §34, p16
 Roughing out in, §34, p19
 square grooves, §34, p25
 tools, §34, p8
 tools, Holding, §34, p21
 wood, Cutting speed in, §34, p14
 work, Templet for, §34, p33
 Tuyeres, Center, §46, p10
 for a cupola, §46, p5
 Height of, §46, p7
 Influence of height of, on weight of charge, §46, p28
 Multiple rows of, §46, p9
 Upper, in cupolas, §46, p9
 Twist drill, §32, p29
 U
 Universal plane, §32, p21
 Upper tuyeres, Advantages and disadvantages of, §46, p9
 V
 Valve bonnet, Core box for, §37, p15
 bonnet, Pattern for, §37, p15
 Core for throttle, §38, p3
 details, Patterns for, §37, p16
 gear details, Patterns for Corliss, §37, p36
 Pattern for throttle, §38, p1
 Valves, Core boxes for globe, §37, p12
 Patterns for globe, §37, p9
 Varnish, Application of, §35, p19
 Black shellac, §35, p18
 brushes, §35, p20
 cans, §35, p20
 Copal, §35, pp17, 18
 Pattern, §35, p17

- Varnish, Red shellac, §35, p17
 Yellow shellac, §35, p17
 Varnishing patterns, §37, p11
 Vent, §40, p5
 channel, Cinders for, §40, p27
 wire, §40, p5
 wire, Precautions in using, §40, p27
 Venting a crooked core, §44, p20
 beds for prickered plates, §41, p10
 cores, §44, p19
 deep molds, §40, p22
 Difficulties in, §40, p25
 dry-sand molds, §45, p2
 hard beds, §41, p12
 loam molds, §45, p36
 Objectionable methods of, §41, p17
 of patched and sharp bodies of sand, §42, p26
 shallow molds, §40, p26
 soft beds, §41, p7
 surface, §41, p17
 the cope of a shallow mold, §40, p39
 the drag of a deep mold, §40, p33
 the drag of a shallow mold, §40, p39
 Vents in cores, §44, p10
 Use of rope in, in crooked cores, §44, p21
 Vertical plumb, §39, p13
 runner, §40, p3
 Vise, Woodworkers', §32, p4
- W**
- Warp, Allowance for, §35, p36
 Warping of wood, §35, p13
 Washes for blackenings, §44, p29
 Washita oilstone, §33, p14
 Water, Action of, on a grindstone, §33, p11
 combined in sand, §40, p8
 Wax fillets, §35, p22
 process for making stove-door patterns, §39, p41
 process of making stove patterns, §39, p21
 Weak sand, §40, p6
 Wedges for setting chaplets, §43, p9
 Weight of copes, §41, p29
 required on cope, Extra, §41, p32
 Weighting the mold, §41, p27
 Weights for holding down copes, §41, p34
 for molds, Methods of computing, §41, p31
- Wheel, Pattern for throttle-valve hand, §38, p6
 Wheels, Making of chilled car, §45, p48
 Patterns for, §37, p24
 Whetstone, §32, p41
 Whirl gates, §45, p46
 Wind belt for cupola, §46, p4
 Wood, Characteristics of, §35, p11
 Cracking of, §35, p13
 for patterns, Selection of, §37, p1
 Gluing, to overcome changes of shape, §35, p14
 Heart, §35, p11
 Medullary rays in, §35, p11
 Microscopic section of, §35, p12
 Sap, §35, p11
 Seasoning, §35, p12
 Silver rays in, §35, p11
 Warping of, §35, p13
 Wooden dowels, §35, p23
 face plates, Preparation of, §36, p45
 fillets, §35, p21
 horses, §32, p39
 Woodwork, Bench for, §32, p1
 Joints in, §33, p31
 Woodworkers' lathe, §34, p1
 vise, §32, p4
 Woodworking tools, §35, p30
 tools, Sharpening, §32, p40
 Work, Centering, §34, p17
 Finishing cylindrical, §34, p21
 Jointing of, §33, p18
 Preparation of, for turning, §34, p17
 Supports for, in lathe, §34, p6
 Templet for turning, §34, p33
 Turning built-up, §34, p43
 Worm, Forming thread for, §38, p31
 -gear, Fastening teeth on, §38, p33
 -gear, Laying out teeth for, §38, p34
 -gear patterns, §38, p32
 Laying out thread for, §38, p30
 patterns, §38, p29
 Wrought iron, Melting point of, §47, p2
 iron, Mixing, with cast iron, §47, p47
- Y**
- Yankee, §40, p43; §42, p29
 Yellow shellac varnish, §35, p17

