





SPONS'
MECHANICS' OWN BOOK:

A MANUAL
FOR
HANDICRAFTSMEN AND AMATEURS.

SECOND EDITION.

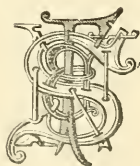

E. & F. N. SPON, 125, STRAND, LONDON.

NEW YORK: 35, MURRAY STREET.

1886.

J
57
52
127

LONDON :
PRINTED BY WILLIAM CLOWES AND SONS, LIMITED,
STAMFORD STREET AND CHAPING CROSS.

INTRODUCTION.



THE title of this work almost suffices to indicate the character of the contents, without the aid of any prefatory explanation. The authors have no new theories to advance, nor discoveries to relate: their aim has been rather to discuss from an everyday practical view the various mechanical trades that deal with the conversion of wood, metals, and stone into useful objects.

The method of treatment of each branch is scientific, yet simple. First in order comes the raw material worked upon, its characters, variations, and suitability. Then the tools used in working up the material are examined as to the principles on which their shape and manipulation are based, including the means adopted for keeping them in order, by grinding, tempering, filing, setting, handling, and cleaning. A third section, where necessary, is devoted to explaining and illustrating typical examples of the work to be executed in the particular material under notice. Thus the book forms a complete guide to all the ordinary mechanical operations; and whilst professional workmen will find in it many suggestions as to the direction in which improvements should be aimed at, amateur readers will be glad to avail themselves of the simple directions and ingenious devices by which they can in a great degree overcome the disadvantage of a lack of manipulative skill.

To render the book still more useful to the emigrant and colonist, who often has only his own wits to depend on in building and repairing his home, several further chapters have been added, dealing with the enclosure, approaches, water supply, drainage, warming, lighting, and ventilation of a dwelling.

In conclusion, hearty thanks are tendered to the many specialists whose writings have combined to give unusual value to the book. It is hoped that the following list is complete:—

Sir J. Savile Lumley on bronze casting; J. Richards, T. D. West, W. H. Cooper, and Leander Clarke on iron founding and casting; Joshua Rose on chisels, and hammering iron plates; Cameron Knight on blacksmithing generally; E. Kirk on soldering and burning; Dr. Anderson on

woods; Rev. A. Rigg and A. Cabe on carpenters' tools; Grimshaw and Hodgson on saws; Henry Adams on joints in woodwork; R. J. Palmer and J. Cowan on dovetailing and dowelling; A. Yorke, E. Luckhurst, and A. Watkins, on rustic constructions; D. B. Adamson on veneering; T. J. Barnes on wood carving; J. Dalton on French polishing; J. Woodley on brickwork; J. Slater on roofing; P. J. Davies on lead glazing; W. F. Smith on metal-working machine tools; E. Lockwood on electric bells and telephones; R. W. Edis on paperhangings; Field on lighting; Eldridge on gas-fitting; A. Walmisley on ventilation; Dr. Pridgin Teale on warming; Rev. J. A. Rivington on fresco painting; W. R. Corson on stairs; and R. Gambier Bousfield on house construction in Canada. Mention may also be made of T. J. Syer, 1, Finsbury Street, Chiswell Street, at whose workshops amateurs can receive lessons in the manipulation of tools. Lastly, some acknowledgment is due to the following technical journals, whose interesting columns always repay perusal, viz. American Artizan, American Machinist, Builder, Building News, Cabinet-maker, Deutsche Industrie Zeitung, English Mechanic, Industrial World, Iron Age, Plumber and Decorator, Sanitary Record, Scientific American.

THE EDITORS.

CONTENTS.

Mechanical Drawing : buying and keeping instruments ; drawing boards ; scales ; squares ; paper ; mounting ; mounting on linen ; pencilling ; erasing errors ; inking ; testing straight-edge ; using parallel rules ; using compasses ; tints, dimensions, and centre lines ; title ; nature of drawings ; finishing a drawing ; colours ; shading ; colouring tracings ; removing drawings from the board ; mounting engravings ; fixing pencil drawings ; tracing-cloth ; tracing-paper ; transfer-paper ; copying drawings .. pages 1-13

Casting and Founding : general outline of the operations. *Brass and Bronze Casting :* characters of the various alloys employed, reactions of the metals on each other, mixing the metals, effects of tempering ; furnaces, their construction, means of producing draught, fuel, the ordinary cupola, the ordinary melting furnace, the circular melting furnace, the reverberatory furnace ; crucibles ; moulding ; facing the moulds, filling the moulds, moulding in wax, *forma perduta* method, castings of natural objects ; casting, pouring the metal, temperature for pouring, escape of gases from the mould, ornaments in relief ; cores ; making bronze figures ; using plaster patterns, finishing the casting, bronzing its surface, Japanese bronzes, inlaying on bronzes ; casting *en cre perdue*, the model, reproduction in wax, formation of the core, constructing the lanthorn, retouching the wax bust, preparing the bust before making the cope, formation of the cope, firing the block, the final casting in bronze. *Iron Founding :* pattern-making, cores, shrinkage, taper ; tools, crucibles, pots, moulding flasks, packing the flasks, clamping them ; casting in sand, with and without cores ; casting in loam ; forms of castings ; examining castings as to quality and soundness ; shrinkage of iron castings ; chilling iron castings .. 13-44

Forging and Finishing : definition of the terms ; explanation of the technical phrases, to make up a stock, fireirons, rod, bar, plate, to take a heat, to finish at one heat, to draw down, to draw away, to upset, scarfing, butt-weld, tongue-joint, to punch, to drift out, the hammerman, the tuyère or tweer ; forges or hearths ; anvils ; vices and tongs ; hammers ; cutting tools, principles and practices in making chisels ; drilling and boring, construction of drills ; swaging tools ; surfacing tools, filing up, cleaning clogged files, polishing ; screw-cutting tools ; forging ; welding, wrought iron, steel, steel to wrought iron ; tempering, hardening, softening, annealing, the colour scale, case-hardening ; examples of smiths' work,—making keys, bolts, nuts, tongs, hammers, chisels, files, scrapers, drifts, punches, spanners, wrenches ; adjusting surfaces by hammering ; red-lead joints ; rust joints ; riveting 44-90

Soldering : solders, composition and characters of these alloys ; colouring solders to match metals. *Burning or Autogenous soldering :* adaptations of the process, application to pewter, brass castings, iron castings, stove plates ; burning seams in lead ; the burning machine, air-vessels, bellows, tubes, jets, wind guards. *Cold soldering :* the flux, the solder, application. *Hard soldering* various metals and objects. *Soft soldering :* the solders, fluxes, irons, and bits employed, and precautions needed. *Generalities,*—including blowpipes, lamps, mechanical blowers, supports, tools, braziers' hearth, means of heating the iron ; hints on fluxes, spelter, commercial grades of solder, cleaning impure solder, soldering zinc and galvanized iron, soldering without an iron, soldering brass to platinum.

soldering brass wire, soldering brass to steel, mending cracked bell, soldering iron and steel, soldering silver, soldering glass to metal, soldering platinum and gold, mending tin saucepans, soldering brass, soldering pewters and compo pipes, laying sheet lead, mending leaden pipe, gas for blowpipe work, blowpipe brazing 90-116

Sheet-metal working: useful characters of sheet metals. *Striking out the patterns*,—relations of circles, cones, cylindrical tubes. *Tools*,—mallet, cutting tools, flattening tools, folding tools, forming tools. *Working the metals*,—seamless goods, bending, spinning; seamed goods, pipes, cups, square boxes, riveting 116-126

Carpentry:—*Woods*: acacia, ake, alder, alerce, aierse, apple, ash, assegai, beeches, birches, blackwood, boxes, broadleaf, bunya-bunya, cedars, cedar boom, cherry, chestnut, cypress, cypress pine, dark yellow-wood, deal, deodar, dogwoods, doorn boom, ebony, elms, eucalyptus, fir, greenheart, gums, hickories, hinau, hinoki, hornbeam, horoeka, horopito, ironbark, ironwood, jacks, jaral, jarrah, kaiwhiria, kamahi, kanyin, kanri, kohe-kohe, kohutnhutu, kohwai, larches, lignum-vitæ, locust-tree, mahoganies, maire, maire-taw-hake, mako, mango, manuka, maple, mingi-mingi, miro, monoa, mora, muskwood, mutti, nageswar, nanmu, naugiia, neem, neinei, oaks, pai-ch'ha, pear, persimmon, pines, plane, pohutukawa, poon, poplar, pukatea, puriri, pymma, pynkado, rata, rewa-rewa, rohun, rosewood, sabicu, sal, satinwood, sawara, she-pine, sissu, sneezewood, spruces, stopperwood, stringy-bark, sycamore, tamanu, tanekaha, Tasmanian myrtle, tawa, tawhai, teak, titoki, toon, totara, towai, tulip, walnuts, willow, yellow-wood, yew; British Guiana woods; Cape, Natal, and Transvaal woods; Ceylon woods; English woods; Indian woods; New Zealand woods; Queensland woods; Straits Settlements woods; Tasmanian woods; West Indian woods; growth of wood; felling; squaring; features; defects; selecting; classification; market forms; seasoning; decay; preserving; fireproofing; conversion; shrinkage; composition; suitability; strength; measuring; prices. *Tools*: Guiding tools,—chalk line, rule, straight-edge, squares, spirit level, plumb level, gauges, bevels, mitre-box, compasses, callipers, trammel, shooting-board, bell-centre punch, combinations; Holding tools,—pincers, vices, clamps; Rasping tools,—saws (principles, qualities, selecting, using, filing, setting, sharpening, gumming; examples of teeth for cross-cuts, back-saws, fleam tooth, buck-saws, web-saws, rip-saws, circular saws, hand-saws; jig-saws, table for jig and circular saws, home-made fret-saw); files (principles, forms, using, sharpening); Edge-tools,—chisels and gouges (principles, forms, using), spokeshaves, planes (principles, forms, adjusting, using), sharpening methods (grindstones, oilstones), miscellaneous forms (circular plane, rounder, box scraper, veneer scraper, mitre-plane, combination filisters, adjustable dado); Boring tools,—awls, gimlets, augers, bits and braces, drills, miscellaneous (angular bit stock, countersink, expansion bit, boring machine); Striking tools,—hammers, mallets; Chopping tools,—axes and hatchets (principles, using, form of handle, form of cutting edge), adzes (curvature); Accessories,—bench, bench-stops, holdfasts, sawing rest, bench-vices; nails, nail-punch, nail-pullers; screws, screw-driver. *Care of Tools*: wooden parts, iron parts, rust preventives, rust removers. *Construction*: joints, definition of carpentry and joinery, principles of joints, equal bearing, close jointing, strains, classification of joints, classification of fastenings, lengthening joints, strengthening joints, bearing joints, post and beam joints, strut joints, miscellaneous joints, fastenings, keying, corner-piecing, mortising and tenoning, half-lap joint, dovetailing, blind dovetails, mechanical aids in dovetailing, dowelling, joining thin woods, glueing, hinging. *Examples of Construction*: workshop appliances,—tool-chest, carpenters' bench, grindstone mount; rough furniture,—steps, ladders, casks, tables, seats (box stool, 3-legged stool, chairs), washstand, bedstead, chest of drawers, dresser; garden and yard accessories,—wheelbarrow, poultry and pigeon house, hives, forcing frames, greenhouses, summer-houses, fences, gates; house building,—floors, roofs, doors, windows 126-350

Cabinet-making:—*Woods*: Amboyna, apple, ash, beech, beefwood, birch, box, camphor, canary, cedar, cherry, ebony, holly, kingwood, lime, locust-wood, mahogany, maple, oak, partridge-wood, pear, pine, plane, rose, sandal, satin, teak, tulip, walnut, zebra. *Tools*:

tool-chest, bench, planes, dowel plate, smoothing implements, sawing rest, moulding board, mitring and shooting board, vice. *Veneering*: cutting veneers, fixing the veneer by the hammering and cauling processes, presses and hammers employed; inlaying, imitation inlaying. *Examples*: couch, chairs, folding bookcase, chest of drawers, wardrobe, side-board 350-386

Carving and Fretwork:—*Carving*: woods,—camphor, ebony, lime, mahogany, oak, pear, sandal, sycamore, walnut, wild cherry, yew; qualities of wood, staining, adaptability; tools, their selection, qualities, use, sharpening; operations. *Fretwork*: woods; tools; operations 386-399

Upholstery: tools; materials; leather work,—small chair buttoned and welted, plain seats, easy chairs, settees and couches; hair cloth; fancy coverings,—plain seats, buttoned seats, spring edges, French easy chairs, needlework chairs; mattresses,—spring, tufted top, folding, stuffed, French pallets; beds and pillows 399-405

Painting, Graining, and Marbling:—*Painting*: definition of paints; basic pigments,—white-lead, red-lead, zinc oxide, iron oxide; colouring pigments,—blacks, blues, browns, greens, lakes, oranges, reds, yellows; vehicles or mediums,—linseed-oil; driers; grinding; storing; applying; priming; drying; filling; coats; brushes; surface; removing old paint; cleaning paint; knotting; water-colours; removing smell; discoloration; miscellaneous paints,—cement paint for carton-pierre, coloured paints, copper paint, floor painting, gold paint, iron paint, iron painting, lead paints, lime paints, silicated paint, steatite paint, tin-roofing paint, transparent paint, tungsten paints, window paint, zinc painting; composition of paints; measuring painters' work; painters' cream; wall painting, frescoes, spirit fresco, preparing the ground, the pigments admissible for colouring, preparation of the colours, production of delicate tints, the fixing medium and its application, unalterable durability of the finished work. *Graining*: object of the process, outline of the operations, colours, tools; styles of graining—ash, chestnut, mahogany, maple, oak (light and dark), rosewood, satinwood, walnut; hints. *Marbling*: the production of painted surfaces in imitation of black and gold, black Bardilla, Derbyshire spar, dove, Egyptian green, granites, Italian jasper, royal red, St. Ann's, sienna, and verd antique marbles 405-433

Staining: the staining of wood considered as a substitute for painting, objects to be attained, essential features to be observed; recipes for compounding and applying black stains, black-board washes, blue stains, brown stains, ebonizing, floor staining, green stains, grey stains, imitating and darkening mahogany, oak stains, purple stains, red stains, imitating satinwood, violet stains, imitating and darkening walnut, and yellow stains 433-446

Gilding: what the process consists in; leaf metals; composition and characters of the sizes used for attaching the leaf; tools and apparatus. The operation of *Dead gilding*,—preparing the surface to receive the leaf, transferring the leaf to the surface, when to lay it, making good the blank spaces, completing the adhesion, sizing the surface; modifications for dead gilding on plain wood, polished wood, cards, textiles, painted and japanned surfaces, metals, masonry, ivory, and plaster of Paris. *Bright Gilding*—on transparent material, such as glass; securing adhesion of the leaf, making fancy patterns; on opaque material 446-449

Polishing: principles. *Marble* polishing: producing a plane surface, taking off the rough, polishing up, rendering brilliant, filling flaws; polishing imitation marbles. *Metal* polishing: the broad principles of polishing metallic surfaces by hand, best means of conducting the operation, mistaken notions to be avoided, running work in the lathe, relative merits of oils and water; Belgian burnishing powder; brass-polishes; burnishing, kinds of burnishers, precautions in using the burnisher, variations in the tools and methods adapted for plated goods, gold and silver leaf on wood, gold leaf on metal; leather

gilding; engravers' burnishers; clockmakers' burnishers; burnishing book edges, cutlery, pewter, and silver; making crocus; emery paper, emery paper pulp, emery wheels; friction polish; german silver polish; glaze wheels for finishing steel; polishing gold and silver lace; an artificial grindstone; polishing and burnishing iron and steel; plate powders; prepared chalk; putty powder; razor pastes; rottenstone or tripoli; rouges. *Wood* polishing: object of the process, what it consists in, the preliminary filling in, modes of performing it and materials employed, smoothing the surface, rubbing in linseed-oil, the foundation coat of polish, its importance and the precautions to be observed in applying it, the bodying-in process, allowing to harden, putting on the final polish, original recipe for making the finishing polish, unfavourable characters of the ingredients, attempts to improve by bleaching the lac, a new evil thus introduced, action of solvents on the lac, meteorological conditions to be observed when polishing, most favourable range of temperature, state of the weather, reasons for its influence; general method of wood polishing adopted in America; the processes carried on in first-class piano factories; collection of recipes for furniture creams, French polishes, reviving fluids, compounds for darkening furniture, wood-fillers, and mixtures for black woodwork, carvings, antique furniture, fancy woods, black and gold work, white and gold work, &c.; polishing woods in the lathe, modifications to suit hard and soft woods; the Japanese lacquer shiunkei as a substitute for French polishing 449-472

Varnishing: nature of varnishes, points governing their qualities, objects in view in using varnishes; ingredients of varnishes; the principal resins and gums, their varnish-making qualifications; solvents and their suitability; driers and the objections to them; kinds of varnish and their essential differences; mixing varnishes, white oil varnishes or spirit and turpentine varnishes; rules regulating the application of varnishes; recipes for compounding oil varnishes (copal, amber, Coburg, wainscot, &c.), spirit varnishes (cheap oak, copal, hard spirit, French polish, hardwood lacquer, brass lacquer, &c.), turpentine varnishes, Brunswick black, and varnish for ironwork 472-475

Mechanical Movements: simple, compound, and perpetual motion; pulleys, blocks and tackle, White's pulleys, Spanish bartons, mangle-wheel and pinion, fusee-chain and spring-box, frictional clutch-box, other kinds of clutch-box, throwing in and out of gear the speed motion in lathes, tilt-hammer motion, ore-stamper motion, reciprocating rotary motion, continuous rotary motion converted into intermittent rotary motion, self-reversing motion, eccentrics, crank motions, cams, irregular vibrating motion, feed-motion of drilling machine, quick return crank motion of shaping machines, rectilinear motion of horizontal bar, screw bolt and nut, uniform reciprocating rectilinear motion, rectilinear motion of slide, screw stamping press, screw-cutting and slide-lathe motion, spooling-frame motion, micrometer screw, Persian drill, rack and pinion, cam between friction rollers in a yoke, double rack, substitute for crank, doubling length of stroke of piston-rod, feed-motion of planing machines, fiddle drill, substitute for crank, bell-crank lever, motion used in air-pumps, Chinese windlass, shears for cutting metal plates, lazy tongs, toothed sectors, drum, triangular eccentric, cam and rod, cam-wheel, expansion eccentric, rack and frame, band-saw, toggle-joint for punching machine, silk spooling motion, crank and fly-wheel, yoke-bar, steam-engine governor, valve motion, bell-crank, ellipsograph, elbow-lever, pawl and elbow-lever, crank-pin and bell-crank, treadle and disc, centrifugal governor for steam-engines, water-wheel governor, knee-lever; cam, bar, and rod; spiral grooved drum; disc, crank-pin, and slotted connecting-rod; slotted crank, engine governor, valve motion and reversing gear, obtaining egg-shaped elliptical motion, silk spooling motion, carpenters' bench clamp, uncoupling engines, varying speed of slide in shaping machines, reversing gear for single engine, diagonal catch and hand-gear, disengaging eccentric-rod, driving feed-rolls, link-motion valve-gear, screw clamp, mangle-wheel and pinions, mangle-rack, rolling contact, wheel and pinion, ratchet-wheel, worm-wheels, pin-wheel and slotted pinion, Geneva stop, stops for watches, cog-wheels, roller motion in wool-combing machines, ratchet and pawl, drag-link motion, expanding

pulley, chain and chain pulley, lantern-wheel stops, transmitted circular motion, intermittent circular motion, tappet-arm and ratchet-wheel, spur-gear stops, pawl and crown-ratchet, ratchet-wheel stops, brake for cranes, dynamometer, pantograph, union coupling, anti-friction bearing, releasing sounding-weight, releasing hook in pile-driving, centrifugal check-hooks, sprocket-wheel, differential movement, combination movement, series of changes of velocity and direction, variable motion, circular into reciprocating motion, Colt's revolver movement, Otis's safety stop, Clayton's sliding journal box, Pickering's governor, windlass, rack and pinion for small air-pumps, feeding sawing machine, movable head of turning lathe, toe and lifter, conical pendulum, mercurial compensation pendulum, compound bar compensation pendulum, watch regulator, compensation balance, maintaining power in going barrel, Harrison's going barrel, parallel rulers, Cartwright's parallel motion, piston-rods, Chinese windlass, gyroscope, Spohnberger's machine, gyroscope governor, drilling apparatus, sea-saws, helicograph, spiral line on cylinder, cycloidal surfaces, polishing mirrors, White's dynamometer, edge-runners, Robert's friction proof, portable cramp drills, Bowery's clamp, tread-wheels, pendulum saws, adjustable stand for mirrors, cloth-dressing machine, feed-motion of Woodworth's planing machine, Russian door-shutting contrivance, folding ladder, self-adjusting step-ladder, lifting jack, jig-saw, polishing lenses, converting oscillating into rotary motion, reciprocating into rotary motion, Parsons's plan for same, four-way cock, continuous circular into intermittent rectilinear reciprocating motion, repairing chains, continuous circular into intermittent circular, Wilson's 4-motion feed for sewing-machines, Brownell's crank motion, describing parabolas, cyclographs, describing pointed arches, centrolinead, Dickson's device for converting oscillating into intermittent circular motion, proportional compasses, Buchanan and Righter's slide-valve motion, trunk-engine, oscillating piston engine, Root's double quadrant engine, rotary engines, bisecting gauge, self-recording level, assisting crank of treadle motion over dead centres, continuous circular into rectilinear reciprocating motion, continuous circular into rocking motion, Root's double reciprocating engine, Lilly's rotary engine, Jonval turbine, reciprocating motion from continuous fall of water, water-wheels, Fourneyron turbine, Warren's turbine, volute wheel, Barker mill, tumbler, Persian wheel, water-raising machines, Montgolfier's hydraulic ram, D'Ectol's oscillating column, swing boat, lift-pump, force-pump, double-acting pump, double lantern-bellows pump, rotary pumps, Hiero's fountain, diaphragm forcing pump, counter-balance bucket, pulley and bucket, reciprocating lift, Fairbairn's bailing scoop, Lansdell's steam siphon pump, swinging gutters, chain pumps, weir and scouring sluice, balance pumps, steam hammer, Hotchkiss's atmospheric hammer, rotary motion from different temperatures in two bodies of water, flexible water main, air-pump, aeolipile or Hero's steam toy, Brear's bilge ejector, gasometer, Hoard and Wiggin's steam trap, Ray's steam trap, wet gas-meter, Powers's gas regulator, dry gas-meter, converting wind or water motion into rotary motion, common windmill, vertical windmill, paddle-wheel, screw propeller, vertical bucket paddle-wheel, Brown and Level's boat-detaching hook, steering apparatus, capstan, lewis, tongs for lifting stones, drawing and twisting in textile spinning, fan blower, siphon pressure gauge, mercurial barometer, epicyclic trains, Ferguson's mechanical paradox, aneroid or Bourdon gauge, Magdeburg gauge; gearings, spur-gears, multiple gearing, brush wheels, disc wheel and spur-gear, worm and worm-wheel, friction wheels, elliptical spur-gears, internally-toothed spur-gear and pinion, uniform into variable rotary motion, uniform and varied rotary motion, sun-and-planet motion, frictional grooved gearing, bevel gears and ratchet-wheels, bevel gears and double clutch, mangle or star wheel, jumping rotary motion, registering revolutions, scroll gears, mangle-rack, doubling speed by gears, wheel-work in base of capstan, Howlett's adjustable frictional gearing, scroll gear and sliding pinion, Entwisle's gearing 475-531

Turning: the operation. Lathes, mandrels, chucks, poppet-heads, rests, supports, boring collars, true frames, self-acting slide-rest, poppet-heads for self-acting lathes, complete double-gear foot-lathe, single-gear foot-lathe, compound slide-rests; hints on lathe mani-

pulation, form of tools, shape of cutting edges, angle of holding, number of tools required, screw cutting, skilfulness with hand tools. *Tools*: their selection. Metal-turning tools: their temper, grinding, cutting angles, typical examples; iron-turning tools: common roughing tool, round nose, parting tool, knife tool for finishing edges and faces, boring tools for hollow cylinders, square nose, scraping tool, spring tool, finishing tools for rounded work; brass-turning tools; use of water in turning; adapting tools; making a grindstone; whetting tools; making milling tools for screw-heads; making centre punches and drills; scribing block. Tool-holders: the swivel tool-holder and its adaptation to various needs—e.g. planing under horizontal surface of a lathe-bed, planing in a limited space, clearing a projecting boss, cutting a vertical slot, undercutting slots and clearance corners, cutting square threads; relation of the cutting and clearance angles to the work done; grinding the cutting edges, and means suitable therefor; angle-gauges for maintaining correct forms; system in running an engineering works; rehardening cutters; forged tools superseded; general remarks on the relative merits of the swivel holders; broad finishing and its limits. Drilling and boring tools: early forms of the twist drill; necessity for absolutely identical clearance angles; equal lips cannot be attained by hand grinding; experiments on the cutting angle; why common drills run; fixing standard shape and clearance for lips of twist drills; the grinding line; grinding machines for twist drills; results of tests and experiments with twist drills. Milling: range of milling machines; milling cutters; faults of the old system; modern milling cutters—how they are made and set; various forms,—disc, cylindrical, circular saw-like, conical, annular, and complex forms; precautions in making large cutters; cutting speed and power required. Wood-turning tools: plain gouges and chisels; turning straight stuff; feeling the work; holding the tool; flaws in tools; selection of gouges and chisels, their thickness, angle of cutting edge, and shape of edge; various forms of round-nosed tool, and how to make them from worn-out files; fixing the tools in handles; restoring the edges of wood-turning tools 531-561

Masonry: *Stonework*: durability of natural stones, conditions which affect it, chemical composition must be considered, physical structure and its influence, average life of various building stones; working; hardness; strength; weight; appearance; position in quarry seasoning; natural beds; destructive agents,—chemical, mechanical, lichens, molluscs; examination,—Brard's test, acid test, Smith's test; quarrying; classification; granite; serpentine; sandstones; limestones,—marble, compact limestones, shelly limestones, magnesian limestones; preserving,—painting, silicatising, other processes; stonemasons' tools,—saws, mallets, chisels; laying stonework,—rough rubble, coursed rubble, combined rubbles, ashlar work; joining stones; stone walls. *Brickwork*: bricks,—classification, cutters, rubbers, ordinary building, underburnt; names and prices of various kinds of brick, with minute descriptions; qualities of a good building brick; size; testing. Terracotta blocks, joining them, their advantages and disadvantages; errors in using terracotta; faults in making it. Limes: rich or fat limes, poor limes, hydraulic limes, artificial hydraulic limes. Sand: argillaceous, siliceous, and calcareous, its characters and impurities; washing, substitutes. Mortar: its quality governed by that of its constituents; danger of using fat limes; superiority of hydraulic lime and cement; objects of using sand, and conditions to be observed; choice of water; proportions of sand desirable; measuring the ingredients of mortar; mixing the mortar; selenitic mortar; lime and cement mixtures; grout; moisture essential to the setting of mortars. Bricklayers' tools. Laying bricks: sizes, breaking joint, bond; headers, stretchers, and closers; English and Flemish bond; raking courses in thick walls: keeping the work level and plumb; ensuring adhesion between the brick and the mortar; pointing and finishing brickwork,—striking, tuck pointing, weather joint, bastard tuck, bastard-tuck pointing, evils and uselessness of the common methods and description of how it should be done; examples of first and second courses of walls in various styles of bond; hollow walls; fireplaces. *Concrete*: the materials composing it, their choice and proportions; mixing; laying moulds for constructing walls; the cementing material; bulk

produced; selenitic concrete; expansion of concrete. Saltpetreing of walls—causes and cure. Damp walls and their prevention. Scaffolding for bricklayers 561-604

Plastering and Whitewashing: *Plastering:* materials,—basis of plasters, Portland cement, Parian or Keating's cement, composition of the several coats; lime, water, and hair used; coarse stuff, fine stuff, plasterers' putty, gauged stuff; selenitic plaster; rough cast; stucco; scagliola; Marezzo marble; mouldings and ornaments in plaster and papier maché; tools; lathing; laying and pricking-up. *Whitewashing, Calcimining or Distemper Painting:* common whitewash or lime whitening; common colouring, making whitening; white and coloured distemper; indoor operations on good ceilings; a simple lime-wash; a good stone-colour wash; a waterproof calcimine that bears washing; re-whiting an old dirty ceiling; further hints and recipes for milk distempers and whitewashes .. 604-613

Roofing: pitches of roofs, what decides them, and what are generally adopted; thatching; shingles or shides; felt; dachpappe; Willesden paper; slates; tiles; metallic roofing .. 613-627

Glazing: Glass of various kinds; putty, soft putty, to soften putty; tools; lead glazing; special methods of glazing, not dependent on putty 627-634

Bell-hanging: the ordinary domestic bell system, tubes, wires, cranks, gimlet, bells, and general directions; electric bells,—the battery, wires, circuit-closer, bells, arrangement of series; systems with 1 bell and 1 press button, 1 bell and 2 buttons, 2 bells and 1 button, annunciator system, double system, bell and telephone; making electric bell,—backboard and cover, electro-magnet, bobbins or coils, filling the bobbins with wire, putting the bell together 634-640

Gas-fitting: fixing brackets and pendants, making joints, using the tongs .. 640-642

Paper-hanging: classification of wall papers, their characters and uses; how sold; colours to avoid; papers for damp walls; varnishing, sizing, painting and washing wall papers; wall papers considered as ornament, and rules as to colour, pattern, dado, and frieze; pasting, cutting, and hanging the paper, and precautions to be observed .. 642-646

Lighting: natural lighting, window area; artificial lighting by candles, oils, gas, and electricity. Oil lamps, their principles, and the objects aimed at in the various forms of wick, burner, and regulator. Gas, how supplied, computing the number of burners necessary, advantage of a ventilator, how to turn off gas at night; construction of burners and conditions that govern it; distribution of jets; selection of glass globes; how to utilize fully the luminosity of the gas. Electric lighting,—rules and regulations for minimizing risk, joining the wires 646-654

Ventilating: window ventilators, Butler's system, Arnott's system, Morse's system, American plan in large buildings, method at St. Thomas's Hospital, method at Guy's Hospital, Harding's ventilators, system adopted by the Sanitary Engineering and Ventilating Co., Boyle's air-pump ventilators, Kershaw's chimney cowl 654-658

Warming: conserving heat, double windows; radiant heat and hot air, their relative position as regards health; open grates; open stoves, economizing fuel with ordinary grates; close stoves; hot-air furnaces; hot-water heating; steam heating .. 658-667

Foundations: points to be considered; foundations on rock, gravel, sand, clay, firm ground overlying soft ground, soft ground of indefinite thickness; concrete; fascines; piling; footings; damp course 667-670

Roads and Bridges: *Roads:* the original foot track, temporary roads in unmapped country, one made across the Chenab; plank roads and turnouts; pavements,—flagging, asphalt, cement floors. *Bridges,*—simple timber bridge, paved causeway, boat bridges, travelling cradles, rope bridges, weighted beams 670-676

Banks, Hedges, Ditches, and Drains	676-677
Water Supply and Sanitation: river water, cleansing; spring water, filtering; wells, sinking in various strata, steining, simple plan used in India; pumps and various other methods of raising water; ponds, cavern tanks, artificial rain ponds. Drains and traps	677-680
House Construction: Log huts, building the fireplace. Frame houses. Earth walls. Stairs. Colonial houses,—peculiar conditions of building in Canada, Ceylon, and India, to suit the climatic requirements	680-688

SPONS'

MECHANICS' OWN BOOK.

MECHANICAL DRAWING.—A knowledge of the method of making working drawings, and a capability of interpreting them correctly and with facility, are essential qualifications in a mechanic, as almost all work, unless that of a very simple character, is first drawn to scale, and then carried out in detail according to the drawing. The following observations on the subject are mainly condensed from Richards' 'Workshop Manipulation,' and the first and second series of Binns' 'Orthographic Projection.'

The implements required by the draughtsman include drawing-boards, scales, squares, compasses, ruling pens, pencils, Indian ink, paper, indiarubber, and water-colours.

Buying and Keeping Instruments.—Persons with limited means will find it better to procure good instruments separately of any respectable maker, W. Stanley of Holborn for instance, as they may be able to afford them, than to purchase a complete set of inferior instruments in a case. Instruments may be carefully preserved by merely rolling them up in a piece of wash-leather, leaving space between them that they may not rub each other; or, what is better, having some loops sewn on the leather to slip each instrument separately under.

Drawing-boards.—You may procure 2 drawing-boards, 42 in. long and 30 in. wide, to receive "double elephant" paper. Have the boards plain, without cleets, or ingenious devices for fastening the paper; they should be made from thoroughly seasoned wood, at least $1\frac{1}{2}$ in. thick, as if thinner they will not be heavy enough to resist the thrust of the T-squares. The qualities a good drawing-board should possess are, an equal surface, which should be slightly rounded from the edges to the centre, in order that the drawing-paper when stretched upon it may present a solid surface; and that the edges should be perfectly straight, and at right angles to each other. With 2 boards, one may be used for sketching and drawing details, which, if done on the same sheet with elevations, dirties the paper, and is apt to lower the standard of the finished drawing by what may be called bad association. Details and sketches, when made on a separate sheet, should be to a larger scale than elevations. By changing from one scale to another, the mind is schooled in proportion, and the conception of sizes and dimensions is more apt to follow the finished work to which the drawings relate.

Scales.—In working to regular scales, such as $\frac{1}{2}$, $\frac{1}{8}$, or $\frac{1}{16}$ size, a good plan is to use a common rule, instead of a graduated scale. There is nothing more convenient for a mechanical draughtsman than to be able to readily resolve dimensions into various scales, and the use of a common rule for fractional scales trains the mind, so that computations come naturally, and after a time almost without effort.

Squares.—A plain T-square, with a parallel blade fastened on the side of the head, but not imbedded into it, is the best; in this way set squares can be passed over the

head of a T-square in working at the edges of the drawing. It is strange that a drawing square should ever have been made in any other manner than this, and still more strange, that people will use squares that do not allow the set squares to pass over the heads and come near to the edge of the board. A bevel square is often convenient, but should be an independent one; a T-square that has a movable blade is not suitable for general use. Combinations in drawing instruments, no matter what their character, should be avoided. For set squares, or triangles, as they are sometimes called, no material is so good as ebonite; such squares are hard, smooth, impervious to moisture, and contrast with the paper in colour; besides, they wear longer than those made of wood. For instruments, it is best to avoid everything of an elaborate or fancy kind. Procure only such instruments at first as are really required, of the best quality, and then add others as necessity may demand; in this way, experience will often suggest modifications of size or arrangement that will add to the convenience of a set.

Paper.—The following table contains the dimensions of every description of English drawing-paper.

	in.	in.		in.	in.
Demy	20	by 15	Columbier	34	by 23
Medium	22	„ 17	Atlas	33	„ 26
Royal	24	„ 19	Double Elephant	40	„ 26
Imperial	31	„ 21	Antiquarian	52	„ 29
Elephant	27	„ 23	Emperor	68	„ 48

For making detail drawings an inferior paper is used, termed Cartridge; this answers for line drawings, but it will not take colours or tints perfectly. Continuous cartridge paper is also much used for full-sized mechanical details, and some other purposes. It is made uniformly 53 in. wide, and may be had of any length by the yard, up to 300 yd. For plans of considerable size, mounted paper is used, or the drawings are afterwards occasionally mounted on canvas or linen.

Mounting.—In mounting sheets that are likely to be removed and replaced, for the purpose of modification, as working drawings generally are, they can be fastened very well by small copper tacks driven in along the edges at intervals of 2 in. or less. The paper can be very slightly dampened before fastening in this manner, and if the operation is carefully performed the paper will be quite as smooth and convenient to work upon as though it were pasted down; the tacks can be driven down so as to be flush with, or below the surface of, the paper, and will offer no obstruction to squares. If a drawing is to be elaborate, or to remain long upon a board, the paper should be pasted down. To do this, first prepare thick mucilage, or what is better, glue, and have it ready at hand, with some slips of absorbent paper 1 in. or so wide. Dampen the sheet on both sides with a sponge, and then apply the mucilage along the edge, for a width of $\frac{1}{4}$ – $\frac{3}{8}$ in. It is a matter of some difficulty to place a sheet upon a board; but if the board is set on its edge, the paper can be applied without assistance. Then, by putting the strips of paper along the edge, and rubbing over them with some smooth hard instrument, the edges of the sheet can be pasted firmly to the board, the paper slips taking up a part of the moisture from the edges, which are longest in drying. If left in this condition, the centre will dry first, and the paper be pulled loose at the edges by contraction before the paste has time to dry. It is therefore necessary to pass over the centre of the sheet with a wet sponge at intervals to keep the paper slightly damp until the edges adhere firmly, when it can be left to dry, and will be tight and smooth. One of the most common difficulties in mounting sheets is in not having the gum or glue thick enough; when thin, it will be absorbed by the wood or the paper, or is too long in drying. It should be as thick as it can be applied with a brush, and made from clean Arabic gum, tragacanth, or fine glue. Thumb-tacks are of but little use in mechanical drawing except for the most temporary purposes, and may very well be dispensed with

altogether; they injure the drawing-boards, obstruct the squares, and disfigure the sheets.

Mounting on Linen.—The linen or calico is first stretched by tacking it tightly on a frame or board. It is then thoroughly coated with strong size, and left until nearly dry. The sheet of paper to be mounted requires to be well covered with paste; this will be best if done twice, leaving the first coat about 10 minutes to soak into the paper. After applying the second coat, place the paper on the linen, and dab it all over with a clean cloth. Cut off when thoroughly dry.

Pencilling.—This is the first and the most important operation in drawing; more skill is required to produce neat pencil-work than to ink in the lines after the pencilling is done. A beginner, unless he exercises great care in the pencil-work of a drawing, will have the disappointment to find the paper soon becoming dirty, and the pencil lines crossing each other everywhere, so as to give the whole a slovenly appearance. He will also, unless he understands the nature of the operations in which he is engaged, make the mistake of regarding the pencil-work as an unimportant part, instead of constituting, as it does, the main drawing, and thereby neglect that accuracy which alone can make either a good-looking or a valuable one. Pencil-work is indeed the main operation, the inking being merely to give distinctness and permanency to the lines. The main thing in pencilling is accuracy of dimensions and stopping the lines where they should terminate without crossing others. The best pencils only are suitable for drawing; if the plumbago (graphite) is not of the best quality, the points require to be continually sharpened, and the pencil is worn away at a rate that more than makes up the difference in cost between the finer and cheaper grades of pencils, to say nothing of the effect upon a drawing. It is common to use a flat point for drawing pencils, but a round one will often be found quite as good if the pencils are fine, and some convenience is gained by a round point for freehand use in making rounds and fillets. A Faber pencil, that has detachable points which can be set out as they are worn away, is convenient. For compasses, the lead points should be cylindrical, and fit into a metal sheath without paper packing or other contrivance to hold them; and if a draughtsman has instruments not arranged in this manner, he should have them changed at once, both for convenience and economy. If the point is intended for sketching, it is cut equally from all sides, to produce a perfectly acute cone. If this be used for line drawing, the tip will be easily broken, or otherwise it soon wears thick; thus, it is much better for line drawing to have a thin flat point. The general manner of proceeding is, first, to cut the pencil, from 2 sides only, with a long slope, so as to produce a kind of chisel-end, and afterwards to cut the other sides away only sufficient to be able to round the first edge a little. A point cut in the manner described may be kept in good order for some time by pointing the lead upon a small piece of fine sandstone or fine glass-paper; this will be less trouble than the continual application of the knife, which is always liable to break the extreme edge.

Erasing Errors.—To erase Cumberland-lead pencil marks, native or bottle india-rubber answers perfectly. This, however, will not entirely erase any kind of German or other manufactured pencil marks. What is found best for this purpose is fine vulcanised india-rubber; this, besides being a more powerful eraser, has also the quality of keeping clean, as it frets away with the friction of rubbing, and presents a continually renewed surface to the drawing; the worn-off particles produce a kind of dust, easily swept away. Vulcanised rubber is also extremely useful for cleaning off drawings, as it will remove any ordinary stain.

For erasing ink lines, the point of a penknife or erasing knife is commonly used. A much better means is to employ a piece of fine glass-paper, folded several times, until it presents a round edge; this leaves the surface of the paper in much better order to draw upon than it is left from knife erasures. Fine size applied with a brush will be found convenient to prevent colour running.

To produce finished drawings, it is necessary that no portion should be erased, otherwise the colour applied will be unequal in tone; thus, when highly finished mechanical drawings are required, it is usual to draw an original and to copy it, as mistakes are almost certain to occur in delineating any new machine. Where sufficient time cannot be given to draw and copy, a very good way is to take the surface off the paper with fine glass-paper before commencing the drawing; if this be done, the colour will flow equally over any erasure it may be necessary to make afterwards.

Where ink lines are a little over the intended mark, and it is difficult to erase them without disfiguring other portions of the drawing, a little Chinese white or flake-white mixed rather dry, may be applied with a fine sable-brush; this will render a small defect much less perceptible than by erasure.

Whenever the surface of the paper is roughened by using the erasing knife, it should be rubbed down with some hard and perfectly clean rounded instrument.

Inking.—Ink used in drawing should always be the best that can be procured; without good ink a draughtsman is continually annoyed by an imperfect working of pens, and the washing of the lines if there is shading to be done. The quality of ink can only be determined by experiment; the perfume that it contains, or tin-foil wrappers and Chinese labels, are no indication of quality; not even the price, unless it be with some first-class house. It is better to waste a little time in preparing ink slowly than to be at a continual trouble with pens, which will occur if the ink is ground too rapidly or on a rough surface. To test ink, a few lines can be drawn on the margin of a sheet, noting the shade, how the ink flows from the pen, and whether the lines are sharp. After the lines have dried, cross them with a wet brush: if they wash readily, the ink is too soft; if they resist the water for a time and then wash tardily, the ink is good. It cannot be expected that inks soluble in water can permanently resist its action after drying; in fact, it is not desirable that drawing inks should do so, for in shading, outlines should be blended into the tints where the latter are deep, and this can only be effected by washing. Pens will generally fill by capillary attraction; if not, they should be made wet by being dipped into water. They should not be put into the mouth to wet them, as there is danger of poison from some kinds of ink, and the habit is not a neat one. In using ruling pens, they should be held nearly vertical, leaning just enough to prevent them from catching on the paper. Beginners have a tendency to hold pens at a low angle, and drag them on their side, but this will not produce clean sharp lines, nor allow the lines to be made near enough to the edges of square blades or set squares. The pen should be held between the thumb and first and second fingers, the knuckles being bent, so that it may be at right angles with the length of the hand. The ink should be rubbed up fresh every day upon a clean palette. Liquid ink and other similar preparations are generally failures. The ink should be moderately thick, so that the pen when slightly shaken will retain it $\frac{1}{2}$ in. up the nibs. The pen is supplied by breathing between the nibs before immersion in the ink, or by means of a small camel-hair brush; the nibs will afterwards require to be wiped, to prevent the ink going upon the edge of the instrument to be drawn against. The edge used to direct the pen should in no instance be less than $\frac{1}{16}$ in. in thickness: $\frac{1}{17}$ in. is perhaps the best. If the edge be very thin, it is almost impossible to prevent the ink escaping upon it, with the great risk of its getting on to the drawing. Before putting the pen away, it should be carefully wiped between the nibs by drawing a piece of folded paper through them until they are dry and clean.

With all forms of dotting pen a little knack is required in using. If straight lines are to be produced, it is advisable to lay a piece of writing paper right up to the place where the line is intended to commence. By this means it is readily discovered if the pen is working well. It also avoids a starting-point on the drawing, which very commonly leaves a few dots running into each other. For drawing circles with the dotting

pen, fixed in the compass, the same precaution is necessary. The paper may be pushed aside as soon as it comes in the way of completing the circle. Another necessary precaution with dotting pens is not to stop during the production of a line. In all dotting pens the rowels have to be made rather loose to run freely, and by this cause are liable to wobble; to avoid this, the pen should be held slightly oblique to the direction of the line, so as to run the rowel against one nib only.

Testing Straight-edge.—Lay the straight-edge upon a stretched sheet of paper, placing weights upon it to hold it firmly; then draw a line against the edge with a needle in a holder, or a very fine hard pencil, held constantly vertical, or at one angle to the paper, being careful to use as light pressure as possible. If the straight-edge be then turned over to the reverse side of the line, and a second line be produced in a similar manner to the first, at about $\frac{1}{10}$ in. distance from it, any inequalities in the edge will appear by the differences of the distances in various parts of the lines, which may be measured by spring dividers. Another method will be found to answer well if 3 straight-edges are at hand; this method is used in making the straight-edge. Two straight-edges are laid together upon a flat surface, and the meeting edges examined to see if they touch in all parts, reversing them in every possible way. If these appear perfect, a third straight-edge is applied to each of the edges already tested, and if that touch it in all parts the edges are all perfect. It may be observed that the first two examined, although they touch perfectly, may be regular curves; but if so, the third edge applied will detect the curvature.

Using Parallel Rule.—One of the rules is pressed down firmly with the fingers, while the other is moved by the centre stud to the distances at which parallel lines are required. Should the bars not extend a sufficient distance for a required parallel line, one rule is held firmly, and the other shifted, alternately, until the distance is reached.

Using Compasses.—It is considered best to place the forefinger upon the head, and to move the legs within the second finger and thumb. In dividing distances into equal parts, it is best to hold the dividers as much as possible by the head joint, after they are set to the required dimensions; as by touching the legs they are liable to change, if the joint moves softly, as it should. In dividing a line, it is better to move the dividers alternately above and below the line from each point of division, than to roll them over continually in one direction, as it saves the shifting of the fingers on the head of the dividers. In taking off distances with dividers, it is always better, first to open them a little too wide, and afterwards close them to the point required, than set them by opening.

Tints, Dimensions, and Centre Lines.—A drawing being inked in, the next things are tints, dimensions, and centre lines. The centre line should be in red ink, and pass through all points of the drawing that have an axial centre, or where the work is similar and balanced on each side of the line. This rule is a little obscure, but will be best understood if studied in connection with the drawing.

Dimension lines should be in blue, but may be in red. Where to put them is a great point in drawing. To know where dimensions are required involves a knowledge acquired by practice. The lines should be fine and clear, leaving a space in their centre for figures when there is room. The distribution of centre lines and dimensions over a drawing must be carefully studied, for the double purpose of giving it a good appearance and to avoid confusion. Figures should be made like printed numerals; they are much better understood by the workman, look more artistic, and when once learned require but little if any more time than written figures. If the scale employed is feet and inches, dimensions to 3 ft. should be in inches, and above this in feet and inches; this corresponds to shop custom, and is more comprehensible to the workman, however wrong it may be according to other standards.

In shading drawings, be careful not to use too deep tints, and to put the shades in the right place. Many will contend, and not without good reasons, that working

drawings require no shading; yet it will do no harm to learn how and where they can be shaded: it is better to omit the shading from choice than from necessity. Sections must, of course, be shaded—with lines is the old custom, yet it is certainly a tedious and useless one; sections with light ink shading of different colours, to indicate the kind of material, are easier to make, and look much better. By the judicious arrangement of a drawing, a large share of it may be in sections, which in almost every case are the best views to work by. The proper colouring of sections gives a good appearance to a drawing, and makes it “stand out from the paper.” In shading sections, leave a margin of white between the tints and the lines on the upper and left-hand sides of the section: this breaks the connection or sameness, and the effect is striking; it separates the parts, and adds greatly to the clearness and general appearance of a drawing.

Cylindrical parts in the plane of sections, such as shafts and bolts, should be drawn full, and have a “round shade,” which relieves the flat appearance—a point to be avoided as much as possible in sectional views.

Title.—The title of a drawing is a feature that has much to do with its appearance, and the impression conveyed to the mind of an observer. While it can add nothing to the real value of a drawing, it is so easy to make plain letters, that the apprentice is urged to learn this as soon as he begins to draw; not to make fancy letters, nor indeed, any kind except plain block letters, which can be rapidly laid out and finished, and consequently employed to a greater extent. By drawing 6 parallel lines, and making 5 spaces, and then crossing them with equidistant lines, the points and angles in block letters are determined; after a little practice, it becomes the work of but a few minutes to put down a title or other matter on a drawing so that it can be seen and read at a glance in searching for sheets or details. In the manufacture of machines, there are usually so many sizes and modifications, that drawings should assist and determine in a large degree the completeness of classification and record. For simplicity sake it is well to assume symbols for machines of different classes, consisting generally of the letters of the alphabet, qualified by a single number as an exponent to designate capacity or different modifications. Assuming, in the case of engine lathes, A to be the symbol for lathes of all sizes, then those of different capacity and modification can be represented in the drawings and records as A^1 , A^2 , and so on, requiring but 2 characters to indicate a lathe of any kind. These symbols should be marked in large plain letters on the left-hand lower corner of sheets, so that any one can see at a glance what the drawings relate to. When the dimensions and symbols are added to a drawing, the next thing is pattern or catalogue numbers. These should be marked in prominent, plain figures on each piece, either in red or other colour that will contrast with the general face of the drawing.

Nature of Drawings.—Isometrical perspective is often useful in drawing, especially in wood structures, when the material is of rectangular section, and disposed at right angles, as in machine frames. One isometrical view, which can be made nearly as quickly as a true elevation, will show all the parts, and may be figured for dimensions the same as plane views. True perspective, although rarely necessary in mechanical drawing, may be studied with advantage in connection with geometry; it will often lead to the explanation of problems in isometric drawing, and will also assist in free-hand lines that have sometimes to be made to show parts of machinery oblique to the regular planes.

Geometrical drawings consist of plans, elevations, and sections; plans being views on the top of the object in a horizontal plane; elevations, views on the sides of the object in vertical planes; and sections, views taken on bisecting planes, at any angle through an object.

Drawings in true elevation or in section are based upon flat planes, and given dimensions parallel to the planes in which the views are taken.

Two elevations taken at right angles to each other fix all points, and give all

dimensions of parts that have their axis parallel to the planes on which the views are taken; but when a machine is complex, or when several parts lie in the same plane, 3 and sometimes 4 views are required to display all the parts in a comprehensive manner.

Mechanical drawings should be made with reference to all the processes that are required in the construction of the work, and the drawings should be responsible, not only for dimensions, but for unnecessary expense in fitting, forging, pattern-making, moulding, and so on.

Every part laid down has something to govern it that may be termed a "base"—some condition of function or position which, if understood, will suggest size, shape, and relation to other parts. By searching after a base for each and every part and detail, the draughtsman proceeds upon a regular system, continually maintaining a test of what is done.

Finishing a Drawing.—While to finish a drawing without any error or defect should be the draughtsman's object, he should never be in haste to reject a damaged drawing, but should exercise his ingenuity to see how far injuries done to it may be remedied. Never lose a drawing once begun; and since prevention is easier and better than cure, always work calmly, inspect all instruments, hands, and sleeves, that may touch a drawing, before commencing an operation; let the paper, instruments, and person be kept clean, and when considerable time is to be spent upon a portion of the paper, let the remainder be covered with waste paper, pasted to one edge of the board. For the final cleaning of the drawing, stale bread, or the old-fashioned black indiarubber, if not sticky, is good; but, aside from the carelessness of ever allowing a drawing to get very dirty, any fine drawing will be injured, more or less, by any means of removing a considerable quantity of dirt from it. Another excellent means of preventing injuries, which should be adopted when the drawing is worked upon only at intervals, is to enclose the board, when not in use, in a bag of enamelled cloth or other fine material.

Colours.—For colouring drawings, the most soluble, brilliant, and transparent water-colours are used; this particularly applies to plans and sections. The colour is not so much intended to represent that of the material to be used in the construction, as to clearly distinguish one material from another employed on the same work. The following table shows the colours most employed by the profession:—

Carmine or Crimson Lake	For brickwork in plan or section to be executed.
Prussian Blue	{ Flintwork, lead, or parts of brickwork to be removed by alterations.
Venetian Red	Brickwork in elevation.
Violet Carmine	Granite.
Raw Sienna	English timber (not oak).
Burnt Sienna	Oak, teak.
Indian Yellow	Fir timber.
Indian Red	Mahogany.
Sepia	Concrete works, stone.
Burnt Umber	Clay, earth.
Payne's Grey	Cast iron, rough wrought iron.
Dark Cadmium	Gun metal.
Gamboge	Brass.
Indigo	Wrought iron (bright).
Indigo, with a little Lake	Steel (bright).
Hooker's Green	Meadow land.
Cobalt Blue	Sky effects.

And some few others occasionally for special purposes.

In colouring plans of estates, the colours that appear natural are mostly adopted, which may be produced by combining the above. Elevations and perspective drawings

are also represented in natural colours, the primitive colours being mixed and varied by the judgment of the draughtsman, who, to produce the best effects, must be in some degree an artist.

Care should be taken in making an elaborate drawing, which is to receive colour, that the hand at no time rest upon the surface of the paper, as it is found to leave a greasiness difficult to remove. A piece of paper placed under the hand, and if the square is not very clean, under that also, will prevent this. Should the colours from any cause, work greasily, a little prepared ox-gall may be dissolved in the water with which the colours are mixed, and will cause them to work freely.

Shading.—For shading, camel- or sable-hair brushes, called softeners, are generally used: these have a brush at each end of the handle, one being much larger than the other. The manner of using the softener for shading is, to fill the smaller brush with colour, and to thoroughly moisten the larger one with water; the colour is then laid upon the drawing with the smaller brush, to represent the dark portion of the shade, and immediately after, while the colour is quite moist, the brush that is moistened with water is drawn down the edge intended to be shaded off; this brush is then wiped upon a cloth and drawn down the outer moist edge to remove the surplus water, which will leave the shade perfectly soft. If very dark shades are required, this has to be repeated when the first is quite dry.

To tint large surfaces, a large camel-hair brush is used, termed a wash-brush. The manner of proceeding is, first, to tilt the drawing, if practicable, and commence by putting the colour on from the upper left-hand corner of the surface, taking short strokes the width of the brush along the top edge of the space to be coloured, immediately following with another line of similar strokes into the moist edge of the first line, and so on as far as required, removing the last surplus colour with a nearly dry brush. The theory of the above is, that you may perfectly unite wet colour to a moist edge, although you cannot to a dry edge without showing the juncture. For tinting surfaces, it is well always to mix more than sufficient colour at first.

Colouring Tracings.—It is always best to colour tracings on the back, as the ink lines are liable to be obliterated when the colour is applied. Mix the colours very dark, so that they may appear of proper depth on the other side. If ink or colour does not run freely on tracing cloth, mix both with a little ox-gall.

Removing Drawings from the Board.—Make a pencil line round the paper with the T-square at a sufficient distance to clear the glued edge, and to cut the paper with a penknife, guided by a stout ruler. In no instance should the edge of the T-square be used to cut by. A piece of hard wood $\frac{1}{2}$ in. thick by 2 in. wide, and about the length of the paper, forms a useful rule for the purpose, and may be had at small cost. The instrument used for cutting off, in any important draughtsman's office, is what is termed a stationers' rule, which is a piece of hard wood of similar dimensions to that just described, but with the edges covered with brass. It is necessary to have the edge thick, to prevent the point of the knife slipping over. Either of the above rules will also answer to turn the edge of the paper up against when glueing it to the board.

Mounting Engravings.—Strain thin calico on a frame, and then carefully paste on the engraving so as to be free from creases; afterwards, when dry, give 2 coats of thin size (a piece the size of a small nut in a small cupful of hot water will be strong enough); finally, when dry, varnish with white hard varnish.

Pencil Drawings, to fix.—Prepare water-starch, in the manner of the laundress, of such a strength as to form a jelly when cold, and then apply with a broad camel-hair brush, as in varnishing. The same may be done with thin, cold isinglass water or size, or rice water.

Tracing-cloth.—Varnish the cloth with Canada balsam dissolved in turpentine, to which may be added a few drops of castor-oil, but do not add too much, or it will not dry. Try a little piece first with a small quantity of varnish. The kind of cloth to use

is fine linen; do not let the varnish be too thick. Sometimes difficulties are encountered in tracing upon cloth or calico, especially in making it take the ink. In the first place, the tracing should be made in a warm room, or the cloth will expand and become flabby. The excess of glaze may be removed by rubbing the surface with a chamois leather, on which a little powdered chalk has been strewn; but this practice possesses the disadvantage of thickening the ink, besides, it might be added, of making scratches which detract from the effect of the tracing. The use of ox-gall, which makes the ink "take," has also the disadvantage of frequently making it "run," while it also changes the tint of the colours. The following is the process recommended: Ox-gall is filtered through a filter paper arranged over a funnel, boiled, and strained through fine linen, which arrests the scum and other impurities. It is then placed again on the fire, and powdered chalk is added. When the effervescence ceases, the mixture is again filtered, affording a bright colourless liquid, if the operation has been carefully performed. A drop or two may be mixed with the Indian ink. It also has the property of effacing lead-pencil marks. When the cloth tracings have to be heliographed, raw sienna is also added to the ink, as this colour unites with it most intimately, besides intercepting the greatest amount of light.

Tracing-paper.—(1) A German invention has for its object the rendering more or less transparent of paper used for writing or drawing, either with ink, pencil, or crayon, and also to give the paper such a surface that such writing or drawing may be completely removed by washing, without in any way injuring the paper. The object of making the paper translucent is that when used in schools the scholars can trace the copy, and thus become proficient in the formation of letters without the explanations usually necessary; and it may also be used in any place where tracings may be required, as by laying the paper over the object to be copied it can be plainly seen. Writing-paper is used by preference, its preparation consisting in first saturating it with benzine, and then immediately coating the paper with a suitable rapidly-drying varnish before the benzine can evaporate. The application of varnish is by preference made by plunging the paper into a bath of it, but it may be applied with a brush or sponge. The varnish is prepared of the following ingredients:—Boiled bleached linseed-oil, 20 lb.; lead shavings, 1 lb.; zinc oxide, 5 lb.; Venetian turpentine, $\frac{1}{2}$ lb. Mix, and boil 8 hours. After cooling, strain, and add 5 lb. white copal and $\frac{1}{2}$ lb. sandarach. (2) The following is a capital method of preparing tracing-paper for architectural or engineering tracings:—Take common tissue- or cap-paper, any size of sheet; lay each sheet on a flat surface, and sponge over (one side) with the following, taking care not to miss any part of the surface:—Canada balsam, 2 pints; spirits of turpentine, 3 pints; to which add a few drops of old nut-oil; a sponge is the best instrument for applying the mixture, which should be used warm. As each sheet is prepared, it should be hung up to dry over 2 cords stretched tightly and parallel, about 8 in. apart, to prevent the lower edges of the paper from coming in contact. As soon as dry, the sheets should be carefully rolled on straight and smooth wooden rollers covered with paper, about 2 in. in diameter. The sheets will be dry when no stickiness can be felt. A little practice will enable any one to make good tracing-paper in this way at a moderate rate. The composition gives substance to the tissue-paper. (3) You may make paper sufficiently transparent for tracing by saturating it with spirits of turpentine or benzoline. As long as the paper continues to be moistened with either of these, you can carry on your tracing; when the spirit has evaporated, the paper will be opaque. Ink or water-colours may be used on the surface without running. (4) A convenient method for rendering ordinary drawing-paper transparent for the purpose of making tracings, and of removing its transparency, so as to restore its former appearance when the drawing is completed, has been invented by Puseher. It consists in dissolving a given quantity of castor-oil in 1, 2, or 3 volumes of absolute alcohol, according to the thickness of the paper, and applying it by means of a sponge. The alcohol evaporates in a few

minutes, and the tracing-paper is dry and ready for immediate use. The drawing or tracing can be made either with lead-pencil or Indian ink, and the oil removed from the paper by immersing it in absolute alcohol, thus restoring its original opacity. The alcohol employed in removing the oil is, of course, preserved for diluting the oil used in preparing the next sheet. (5) Put $\frac{1}{4}$ oz. gum-mastic into a bottle holding 6 oz. best spirits of turpentine, shaking it up day by day; when thoroughly dissolved, it is ready for use. It can be made thinner at any time by adding more turps. Then take some sheets of the best quality tissue-paper, open them, and apply the mixture with a small brush. Hang up to dry. (6) Saturate ordinary writing-paper with petroleum, and wipe the surface dry. (7) Lay a sheet of fine white wove tissue-paper on a clean board, brush it softly on both sides with a solution of beeswax in spirits of turpentine (say about $\frac{1}{2}$ oz. in $\frac{1}{2}$ pint), and hang to dry for a few days out of the dust.

Transfer-paper.—(1) Rub the surface of thin post or tissue-paper with graphite (blacklead), vermilion, red chalk, or other pigment, and carefully remove the excess of colouring matter by rubbing with a clean rag. (2) Rub into thin white paper a mixture of 6 parts lard and 1 of beeswax, with sufficient fine lampblack to give it a good colour; apply the mixture warm, and not in excess. (3) Under exactly the same conditions use a compound consisting of 2 oz. tallow, $\frac{1}{2}$ oz. powdered blacklead (graphite), $\frac{1}{4}$ pint linsced oil, and enough lampblack to produce a creamy consistence.

Copying Drawings.—Apart from the mechanical operation of tracing, there are several methods by which facsimile copies of drawings can be produced with a very slight expenditure of labour and at small cost. These will now be described. (1) Cyanotype, or ferro-prussiate paper. This is prepared by covering one side of the sheet with a mixture of red prussiate of potash (potassium ferrocyanide) and iron peroxide; under the influence of light, i. e. under the white portions of the drawing to be copied, the ferric compound is reduced to the state of a ferrous salt, which gives with the red prussiate of potash an intense blue coloration, analogous to Prussian blue. This coloration is not produced in the portions of the sensitive paper protected from the light by the black lines of the drawing to be copied, and on washing the print the design appears in white lines on a blue ground. The formula for preparing the sensitive paper is as follows:—Dissolve 10 dr. red prussiate of potash (ferrocyanide) in 4 oz. water; dissolve separately 15 dr. ammonio-citrate of iron in 4 oz. water; filter the 2 solutions through ordinary filtering-paper, and mix. Filter again into a large flat dish, and float each sheet of paper to be sensitised for 2 minutes on the surface of the liquid, without allowing any of this to run over the back of the paper. Hang up the sheets in a dark place to dry, and keep from light and dampness until used. They will retain sensitiveness for a long time. The paper being ready, the copy is easily made. Procure either a heavy sheet of plate glass, or a photographer's printing frame, and lay the drawing to be copied with the face against the glass; on the back of the drawing, lay the prepared side of the sensitive paper, place upon it a piece of thick felt, and replace the cover of the printing frame, or in some other way press the felt and papers firmly against the glass. Expose, glass side up, to sunshine or diffused daylight, for a time, varying, with the intensity of the light and the thickness of the paper bearing the original drawing, from minutes to hours. It is better to give too much than too little exposure, as the colour of a dark impression can be reduced by long washing, while a feeble print is irremediably spoiled. By leaving a bit of the sensitive paper projecting from under the glass, the progress of the coloration can be observed. When the exposure has continued long enough, the frame is opened and the sensitive sheet is withdrawn and thrown into a pan of water, to be replaced immediately by another, if several copies are desired, so that the exposure of the second may be in progress while the first is being washed and fixed. The water dissolves out the excess of the reagents used in the preparation of the paper, and after several washings with fresh water the print loses its sensitiveness and becomes permanent. It is advantageous, after several washings

with water, to pass over the wet surface a weak solution of chlorine or of hydrochloric acid, 3 or 4 parts acid to 100 of water, which gives brilliancy and solidity to the blue tint, and prevents it from being washed out by long soaking. This should be followed by 2 or 3 rinsings with fresh water, and the print may then be hung up to dry, or placed between sheets of blotting-paper. This mode of reproduction, whose simplicity has led to its adoption in many offices, has the inconvenience of giving a copy in white lines on blue ground, which fatigues the eye in some cases, while the application of other colours is impracticable. By repeating and reversing the process, copying the white line print first obtained on another sensitive sheet, a positive picture, representing the black lines of the original by blue lines on white ground, can be obtained; or the same result may be reached by a different mode of treating the sensitive paper. This latter may also be made by brushing it over with a solution of ferric oxalate (10 gr. to the oz.); the ferric oxalate is prepared by saturating a hot aqueous solution of oxalic acid with ferric oxide. A better sensitising solution may be made by mixing 437 gr. ammonium oxalate, 386 gr. oxalic acid, and 6 oz. water, heating to boiling-point, and stirring in as much hydrated iron peroxide as it will dissolve.

(2) Several varieties of paper called "cyanoferric," or "gommoferric," are sold, which have the property of giving a positive image. The mode of preparation is nearly the same for all: 3 solutions, 1 of 60 oz. gum arabic in 300 of water; 1 of 40 oz. ammoniacal citrate of iron in 80 of water; 1 of 25 oz. iron perchloride in 50 of water, are allowed to settle until clear, then decanted, mixed, and poured into a shallow dish, the sheets being floated on the surface as before, and hung up to dry. The solution soon becomes turbid, and must be used immediately; but the paper once dry is not subject to change, unless exposed to light or moisture. The reactions involved in the printing process are more complex than in the first process, but present no particular difficulty. Under the influence of light and of the organic acid (citric), the iron perchloride is reduced to protochloride, and, on being subjected to the action of potassium ferrocyanide, the portions not reduced by the action of the light, that is, the lines corresponding to the black lines of the original drawing, alone exhibit the blue coloration. The gum plays also an important part in the process by becoming less soluble in the parts exposed to light, so as to repel in those portions the ferrocyanide solution. The mode of printing is exactly the same as before, but the paper is more sensitive, and the exposure varies from a few seconds in sunshine to 15 or 20 minutes in the shade. The exact period must be tested by exposing at the same time a slip of the sensitive paper under a piece of paper similar to that on which the original drawing is executed, and ruled with fine lines, so that bits can be torn off at intervals, and tested in the developing bath of potassium ferrocyanide. If the exposure is incomplete, the paper will become blue all over in the ferrocyanide bath; if it has been too prolonged, no blue whatever will make its appearance, but the paper will remain white; if it is just long enough, the lines alone will be developed in blue on a white ground. During the tests of the trial bits, the printing frame should be covered with an opaque screen to prevent the exposure from proceeding further. After the exact point is reached, the print is removed from the frame and floated for a few moments on a bath of saturated solution of potassium ferrocyanide, about 1 oz. of the solid crystals to 4 of water. On raising it, the design will be seen in dark-blue lines on white ground. It is necessary to prevent the liquid from flowing over the back of the paper, which it would cover with a blue stain, and to prevent this the edges of the print are turned up all round. On lifting a corner, the progress of the development may be watched. As soon as the lines are sufficiently dark, or blue specks begin to show themselves in the white parts, the process must be immediately arrested by placing the sheet on a bath of pure water. If, as often happens, a blue tint then begins to spread all over the paper, it may be immersed in a mixture of 3 parts sulphuric or 8 of hydrochloric acid, to 100 of water. After leaving it in this acidulated liquid for 10 or 15 minutes, the design will seem to clear, and the sheet may

then be rinsed in a large basin of water, or under a faucet furnished with a sprinkling nozzle, and a soft brush used to clear away any remaining clouds of blue; and finally, the paper hung up to dry. The ferrocyanide bath is not subject to change, and may be used to the last. If it begins to crystallise by evaporation, a few drops of water may be added. The specks of blue which are formed in this bath, if not removed by the subsequent washings, may be taken out at any time by touching them with a weak solution of soda or potash carbonate. The prints may be coloured in the usual way.

(3) Blue figures on a white ground are changed into black by dipping the proof in a solution of 4 oz. common potash in 100 oz. water, when the blue colour gives place to a sort of rusty colour, produced by iron oxide. The proof is then dipped in a solution of 5 oz. tannin in 100 oz. water. The iron oxide takes up the tannin, changing to a deep black colour; this is fixed by washing in pure water.

(4) Joltrain's. Black lines on white ground. The paper is immersed in the following solution:—25 oz. gum, 3 oz. sodium chloride, 10 oz. iron perchloride (45° B.), 5 oz. iron sulphate, 4 oz. tartaric acid, 47 oz. water. The developing bath is a solution of red or yellow prussiate of potash, neutral, alkaline, or acid. After being exposed, the positive is dipped in this bath, and the parts which did not receive the light take a dark-green colour; the other parts do not change. It is then washed with water in order to remove the excess of prussiate, and dipped in a bath containing acetic, hydrochloric, or sulphuric acid, when all the substances which could affect the whiteness of the paper are removed. The lines have now an indigo-black colour. Wash in water, and dry.

(5) Copies of drawings or designs in black and white may be produced upon paper and linen by giving the surface of the latter 2 coatings of: 217 gr. gum arabic, 70 gr. citric acid, 135 gr. iron chloride, $\frac{1}{4}$ pint water. The prepared material is printed under the drawing, and then immersed in a bath of yellow prussiate of potash, or of silver nitrate, the picture thus developed being afterwards put in water slightly acidified with sulphuric or hydrochloric acid.

(6) Benneden states that paper, prepared as follows, costs but $\frac{1}{3}$ as much as the ordinary silver chloride paper, is as well adapted to the multiplication of drawings, and is simpler in its manipulation. A solution of potash bichromate and albumen or gum, to which carbon, or some pigment of any desired shade, has been added, is brushed, as uniformly as possible, upon well-sized paper by lamplight, and the paper is dried in the dark. The drawing, executed on fine transparent paper (or an engraving, or woodcut, &c.), is then placed beneath a flat glass upon the prepared paper, and exposed to the light for a length of time dependent upon the intensity of the light. The drawing is removed from the paper by lamplight, and after washing the latter with water, a negative of the drawing remains, since the portions of the coating acted on by the light become insoluble in water. From such a negative, any number of positives can be taken in the same way.

(7) Dieterich's copying-paper. The manufacture may be divided into 2 parts, viz. the production of the colour and its application to the paper. For blue paper, he uses Paris blue, as covering better than any other mineral colours. 10 lb. of this colour are coarsely powdered, and mixed with 20 lb. ordinary olive oil; $\frac{1}{4}$ lb. glycerine is then added. This mixture is, for a week, exposed in a drying-room to a temperature of 104°–122° F. (40°–50° C.) and then ground as fine as possible in a paint-mill. The glycerine softens the hard paint, and tends to make it more easily diffusible. Melt $\frac{1}{2}$ lb. yellow wax with 18 $\frac{3}{4}$ lb. ligroine, and add to this 7 $\frac{1}{2}$ lb. of the blue mixture, mixing slowly at a temperature of 86°–104° F. (30°–40° C.). The mass is now of the consistence of honey. It is applied to the paper with a coarse brush, and afterward evenly divided and polished with a badgers' hair brush. The sheets are then dried on a table heated by steam. This is done in a few minutes, and the paper is then ready for the market. The quantities mentioned will be sufficient for about 1000 sheets of 36 in. by 20, being a day's work for 2 girls. For black paper, aniline black is used in the same

proportion. The operation must be carried on in well-ventilated rooms protected from fire, on account of the combustibility of the material and the narcotic effects of the ligroine. The paper is used between 2 sheets of paper, the upper receiving the original, the lower the copy.

(8) By means of gelatine sensitive paper any ordinary thick cardboard drawing can be copied in a few seconds, either by diffused daylight or gas- or lamplight. The copy will be an exact reproduction of the original, showing the letters or figures non-reversed. If it is desired to make a copy in the daytime, any dark closet will answer, where all white light is excluded. The tools required are an ordinary photograph printing frame and a red lantern or lamp. The sensitive gelatine paper is cut to the size required, laid with the sensitive side upward upon the face of the drawing, and pressed thereon in the usual manner, by springs at the back of the frame, which is then carried to the window and exposed with the glass side outward for 2 to 5 seconds to the light, the exposure varying according to the thickness of the drawing. If gas- or lamplight is used at night, 20 to 30 minutes' exposure is sufficient. The frame is returned to the dark closet, the exposed sheet is removed to a dark box, and other duplicates of the drawing can be made in the same way. It is thus possible to make 10 to 20 copies of one thick drawing in the same time that it usually takes to obtain one copy of a transparent tracing by the ordinary blue process. The treatment of the exposed sheets is quite simple; all that is necessary is to provide 3 or 4 large pans or a large sink divided into partitions. The development of the exposed sheets can be carried on at night or at any convenient time, but a red light only must be used. The paper is first passed through a dish or pan of water, and then immersed in a solution, face upwards, composed of 8 parts of a saturated solution of potash oxalate to 1 of a saturated solution of iron sulphate, enough to cover the face of the paper. The latent image soon appears, and a beautiful copy of the drawing is obtained, black where the original was white, with clear white lines to represent the black lines of the drawing. With one solution, 6 to 8 copies can be developed right after the other. After development, the print is dipped in a dish of clear water for a minute, and finally immersed for 3 minutes in the fixing solution, composed of 1 part of soda hyposulphite dissolved in 6 of water. It is then removed to a last dish of water face downward, soaked for a few minutes, and hung up to dry; when dry it is ready for use.

Some very useful suggestions will be found in a little volume by Tuxford Hallatt, entitled 'Hints on Architectural Draughtsmanship.'

CASTING AND FOUNDING.—The following remarks by W. H. Cooper in the *School of Mines Quarterly*, New York, give a very clear outline of the operations of casting and founding:—

We are indebted to the fusibility of the metals for the power of giving to them, with great facility and perfection, any required form, by pouring them, whilst in a fluid state, into moulds of various kinds, of which, in general, the castings become exact counterparts. Some few objects are cast in open moulds, the upper surface of the metal becoming flat under the influence of gravity, as in the casting of ingots, flat plates, and other similar objects; but in general, the metals are cast in close moulds, so that it becomes necessary to provide one or more apertures or ingates for pouring in the metal, and for allowing the escape of air. Moulds made of metal must be sufficiently hot to avoid chilling or solidifying the fluid metal before it has time to adapt itself throughout to every part of the mould. And when made of earthy materials, although moisture is essential to their construction, little or none should remain at the time they are filled. Earthen moulds must also be so pervious to air that any vapour or gases formed either at the moment of casting or during the solidification of the metal may easily escape. Otherwise, if the gases are rapidly formed, there is danger that the metal will be blown from the mould with a violent explosion, or, when more slowly formed and unable to escape, the bubbles of gas will displace the fluid metal and render it spongy or porous.

The casting is then said to be "blown." It not infrequently occurs that castings which appear good and sound externally are filled with hidden defects, because, the surface being first cooled, the bubbles of air will attempt to break their way through the central and still soft parts of the metal.

The perfection of castings depends much on the skill of the pattern-maker, who should thoroughly understand the practice of the moulder, or he is liable to make the patterns in such a manner as to render them useless. Straight-grained deal, pine, and mahogany are the best woods for making patterns, as they remain serviceable longest. Screws should be used in preference to nails, as alterations may be more easily made, and for the same reason dovetails, tenons, and dowels are also good. Foundry patterns should always be made a little tapering in the parts which enter most deeply into the sand, whenever it will not materially injure the castings, in order that they may be more easily removed after moulding. This taper amounts to $\frac{1}{16}$ or $\frac{1}{8}$ in. per ft., and sometimes much more. When foundry patterns are exactly parallel, the friction of the sand against their sides is so great that considerable force is required to remove them, and the sand is torn down unless the patterns are knocked about a good deal in the mould to enlarge the space around them. This rough usage frequently injures the patterns, and causes the castings to become irregularly larger than intended, and defective in shape, from the mischief sustained by the moulds and patterns.

Sharp internal angles should be avoided as much as possible, as they leave sharp edges or arrises in the sand, which are liable to be broken down on the removal of the pattern, or washed down by the entry of the metal into the mould. Either the angle of the mould should be filled with wood, wax, or putty, or the sharp edges of the sand should be chamfered off with a knife or trowel. Sharp internal angles are also very injudicious in respect to the strength of castings, as they seem to denote where they will be likely to break. Before the patterns reach the founder's hands, all the glue remaining on their surfaces should be carefully scraped off, or it will adhere to and break down the sand. The best way is to paint or varnish wooden patterns, to prevent their absorbing moisture and the warping of the surface and sticking of the sand. Whether painted or not, they deliver better from the mould when they are well brushed with blacklead.

Foundry patterns are also made in metal. These are excellent, as they are permanent, and when very small are less liable to be blown away by the bellows used for removing the loose sand and dust from the moulds. To prevent iron patterns from rusting and to make them deliver more easily, they should be allowed to become slightly rusty, and then warmed and beeswax rubbed over them, the excess removed, and the remainder polished after cooling, with a hard brush. Wax is also used by the founder for stopping up any little holes in the wooden patterns. Whiting is also used for this purpose, but is not as good. Very rough patterns are scared with a hot iron. The good workman, however, leaves no necessity for these corrections, and the perfection of the pattern is well repaid by the superior character of the castings. Metallic patterns frequently have holes tapped in them for receiving handles, which screw in, to facilitate their removal from the sand. Large wooden patterns should also have iron plates let into them, into which handles can be screwed. Otherwise, the founder is obliged to drive pointed wires into them, and thereby injure the patterns.

The tools used in making the moulds are few and simple—a sieve, shovel, rammer, strike, mallet, a knife, and 2 or 3 loosening wires and little trowels, which it is unnecessary to describe.

The principal materials for making foundry moulds are very fine sand and loam. They are found mixed in various proportions, so that the proportion proper for different uses cannot be well defined; but it is always best to employ the least quantity of loam that will suffice. These materials are seldom used in the raw state for brass casting, although more so for iron, and the moulds made from fresh sand are always dried. The

ordinary moulds are made of the old damp sand, and they are generally poured immediately, or while they are green. Sometimes they are more or less dried upon the face. The old working sand is considerably less adhesive than the new, and of a dark-brown colour. This arises from the brick-dust, flour, and charcoal-dust used in the moulding becoming mixed with the general stock. Additions of fresh sand must therefore be occasionally made, so that when slightly moist and pressed firmly in the hand it may form a moderately hard, compact lump.

Red brick-dust is generally used to make the parting of the mould, or to prevent the damp sand in the separate parts of the flask from adhering together. The face of the mould which receives the metal is generally dusted with meal, or waste flour. But in large works, powdered chalk, or wood- or tan-ashes are used, because cheaper. The moulds for the finest brass castings are faced either with charcoal, loamstone, rottenstone, or mixtures of them. The moulds are frequently inverted and dried over a dull fire of cork shavings, or when dried are smoked over pitch or black rosin in an iron ladle.

The cores or loose internal parts of the moulds, for forming holes and recesses, are made of various proportions of new sand, loam, and horse-dung. They all require to be thoroughly dried, and those containing horse-dung must be well burned at a red heat. This consumes the straw, and makes them porous and of a brick-red colour.

In making the various moulds, it becomes necessary to pursue a medium course between the conditions best suited to the formation of the moulds and those most suitable for the filling of them with the molten metal without danger of accident. Thus, within certain limits, the more loam and moisture the sand contains, and the more closely it is rammed, the better will be the impression of the model; but the moist and impervious condition of the mould incurs greater risk of accident both from the moisture present and the non-escape of the air. The mould should, therefore, be made of sand which is as dry as practicable, to render the mould as porous as possible. Where much loam it used, the moulds must be thoroughly dried by heat before casting the metal.

As castings contract considerably in cooling, the moulds for large and slight castings must not be too strongly rammed or too thoroughly dried, or their strength may exceed that of the red-hot metal whilst in the act of shrinking, and the casting be broken in consequence. If the mould is the weaker of the two, its sides will simply be broken down without injury to the casting.

The method of preparing a mould is as follows: The sand having been prepared, the moulder frees the patterns from all glue and adhering foreign particles. He then selects the most appropriate "flasks," which are frames, or boxes without top or bottom, made of wood, for containing and holding the sand. The models are then examined to ascertain the most appropriate way of inserting them into the sand. The bottom flask is then placed upon a board, face downwards. A small portion of strong facing-sand is rubbed through a sieve, the remainder shovelled in and driven moderately hard into the flask. The surface is then struck off level with a straight metal bar or scraper, a little loose sand sprinkled on the surface, upon which another board is placed and rubbed down close. The 2 boards and the flask between them are then turned over together; the top board is removed, and fine brick-dust is dusted over the clean surface of moist sand from a linen bag. The excess of brick-dust is removed with a pair of hand-bellows, and the bottom half of the mould is then ready for receiving the patterns. The models are next arranged upon the face of the sand, so as to leave space enough between them to prevent the parts breaking into each other, and for the passages by which the metal is to be introduced and the air allowed to escape. Those patterns which are cylindrical, or thick, are partly sunk into the sand by scraping out hollow recesses, and driving the models in with a mallet, and the general surface of the sand repaired with a knife, trowel, or piece of sheet-steel. The level of the sand should coincide with that of the greatest diameter or section of the model.

After the sand is made good to the edges of the patterns, brick-dust is again shaken over it, the patterns also receiving a portion. The upper part of the flask is then fitted to the lower by pins of iron fitting in metal eyes; and a little strong sand is sifted in. It is then filled up with the ordinary sand, which is rammed down and struck off flush with the edge of the flask. The dry powder serves to keep the 2 halves from sticking together.

In order to open the mould for the extraction of the patterns, a board is placed on the top of the flask and struck smartly at different places with a mallet. The upper part of the flask is then gently lifted perpendicularly and inverted on its board. Should it happen that any considerable portion of the mould is broken down in one piece, the cavity is moistened and the mould is again carefully closed and lightly struck. On the second lifting, the defect will usually be remedied. All breaks in the sand are carefully repaired before the extraction of the patterns.

To remove the models, they are driven slightly sidewise with taps of a mallet, so as to loosen them by enlarging the space around them. The patterns are then lifted out, and any sand which may have been torn down must be carefully replaced, or fresh sand is used for the repairing. Should the flask only contain one or two objects, the ingate or runner is now scooped out of the sand, so as to lead from the pouring-hole to the object. Where several objects are in the same flask, a large central channel, with branches, is made. The entrance of the pouring-hole is smoothed and compressed, and all the loose sand blown out of the mould with hand-bellows.

The faces of both halves of the mould are next dusted with meal-dust or waste flour, put together, and the boards replaced—one just flush with the side of the flask in which the pouring-hole is situated, and the other (on the side from which the metal is to be poured) is put about 2 in. below, and secured by hand-screws. The mould is then held mouth downwards, that any sand loosened in the screwing down may fall out. It is now ready to be filled.

Where the bottom half of the flask requires to be much cut away for imbedding the patterns, it is usual, when the second half is completed, to destroy the first or "false" side, which has been hastily made, and to repeat it by inverting the upper flask and proceeding as before.

When many copies of the same patterns are required, an "odd side" is prepared—that is, a flask is chosen which has one upper and two lower portions. One of the latter is carefully arranged, with all the patterns barely half-way imbedded in the sand, so that when the top is filled, and both are turned over, all of the patterns are left in the new side. A second lower portion is then made for receiving the metal while the first one is kept for rearranging the patterns. By this plan, the trouble of arranging the patterns for every separate mould is avoided, as the patterns are simply replaced in the odd side and the routine of forming the two working-sides is repeated. (W. H. Cooper.)

Brass and Bronze Founding.—A vast number of articles, chiefly small in size and of a more or less artistic character, are cast in brass, bronze, or one of the many modifications of these well-known alloys.

Pure copper is moulded with difficulty, because it is often filled with flaws and air-bubbles, which spoil the casting; but by alloying it with a certain quantity of zinc, a metal is obtained free from this objection, harder and more easily worked in the lathe. Zinc renders the colour of copper more pale; and when it exists in certain proportions in the alloy, it communicates to it a yellow hue, resembling that of gold; but when present in large quantity the colour is a bright yellow; and, lastly, when the zinc predominates, the alloy becomes of a greyish white. Various names are given to these different alloys. The one most used in the arts is brass, or yellow copper, composed of about $\frac{2}{3}$ of copper and $\frac{1}{3}$ of zinc. Other alloys are also known in commerce, by the names of tombac, similar or Mannheim gold, pinchbeck or prince's metal (chrysoeale), &c.; they contain in addition greater or less quantities of tin. Tombac, used for ornamental objects which

are intended to be gilded, contains 10-14 per cent. of zinc; the composition of Dutch gold, which can be hammered into very thin sheets, being nearly the same. Similar, or Mannheim gold, contains 10-12 per cent. of zinc and 6-8 of tin; and pinchbeck contains 6-8 per cent. of zinc and 6 of tin. If brass be heated in a brasqued crucible in a forge-fire, the zinc is nearly wholly driven off. Brass is made by melting directly copper and zinc; rosette copper being used, fused in a crucible, and run into water to granulate it. The zinc is broken into small pieces. The fusion is effected in earthen crucibles which can contain 30-40 lb. of alloy, the metals being introduced in the proportion of $\frac{2}{3}$ of copper and $\frac{1}{3}$ of zinc, to which scraps of brass are added. Small quantities of lead and tin are frequently added to brass to make the alloy harder and more easily worked; brass which contains no lead soon chokes a file, which defect is remedied by the addition of 1 or 2 hundredths of lead.

Copper and tin mix in various proportions, and form alloys which differ vastly in appearance and physical properties, as tin imparts a great degree of hardness to copper. Before the ancients became acquainted with iron and steel, they made their arms and cutting instruments of bronze, composed of copper and tin. Copper and tin, however, combine with difficulty, and their union is never very perfect. By heating their alloys gradually and slowly to the fusing point, a large portion of the tin will separate by eliquation, which effect also occurs when the melted alloys solidify slowly, causing circumstances of serious embarrassment in casting large pieces. Different names are given to the alloys of copper and tin, according to their composition and uses: they are called bronze or brass, cannon-metal, bell-metal, telescope-speculum metal, &c. All these alloys have one remarkable property: they become hard and frequently brittle, when slowly cooled, while they are, on the contrary, malleable when they are plunged into cold water, after having been heated to redness. Tempering produces, therefore, in these alloys an effect precisely opposite to that produced on steel. When alloys of copper and tin are melted in the air, the tin oxidizes more rapidly than the copper, and pure copper may be separated by continuing the roasting for a sufficient length of time.

Furnaces.—Furnaces for melting brass or bronze may be built of common brick and lined with fire-brick; but the best are made with a boiler-plate caisson, 20-30 in. diam. and 30-40 in. high, usually set down in a pit, with the top only 10 or 12 in. above the floor of the foundry. The ash-pit, or opening around the furnace, is covered by a loose wooden grating, that admits of the ashes being removed. The iron caisson is lined with fire-brick, the same as a cupola, the lining being usually 6 in. or more thick. The inside diameter of the furnace should not exceed the outside diameter of the crucible by more than 4 or 5 in., as greater space will require greater expenditure of fuel. These furnaces are liable to burn hollow around where the crucible rests; to avoid waste of fuel, they should be kept straightened up with fire-clay and sand. Sometimes these furnaces are built square inside, but they are inferior to the circular form and consume more fuel; 3 or 4 such furnaces are commonly arranged in sets giving a graduated scale of sizes, to suit the needs of large or smaller castings. When the quantity of metal used is large, a blast is generally employed. The common brass furnace usually depends on a natural draught and connects by a flue with a chimney stack at the back; 3 or 4 commonly share a single stack, each having a separate flue and damper. When the chimney does not give sufficient draught, the ash-pit may be tightly closed, and a mild blast turned into the pit, to find its way up through the grates. The fuel may be hard coal or coke, broken into lumps about the size of hens' eggs; coke is preferable as heating more rapidly, and thus lessening the oxidation of metal, but gas-coke from cannon coal is not admissible.

The ordinary cupola furnace is shown in Fig. 1. It consists of a circular chamber *a* built of fire-brick, rising in the form of a dome, in the top of which is a circular opening, carrying a cast-iron ring *b*, through which the pots and fuel are introduced. At the bottom is a bed-plate *c*, which is a circular plate of cast-iron having one large hole *d* in the centre (for the withdrawal of ashes and clinkers), and 12 smaller ones *e* arranged

symmetrically around it. Below the bed-plate is the ash-pit *f* leading to an arched air passage *g*, which supplies air to the ash-pit. Tapering cast-iron nozzles, 6 in. high, 3 in. diameter at the bottom, 1½ in. at the top, and about ⅜ in. thick, are placed over the 12 small holes *e*. The space between the top of the bed-plate and the top of the nozzles is built up with fire-brick and fire-clay until it forms a surface perfectly level with the top of the small nozzles, leaving the central hole free. These nozzles do the duty

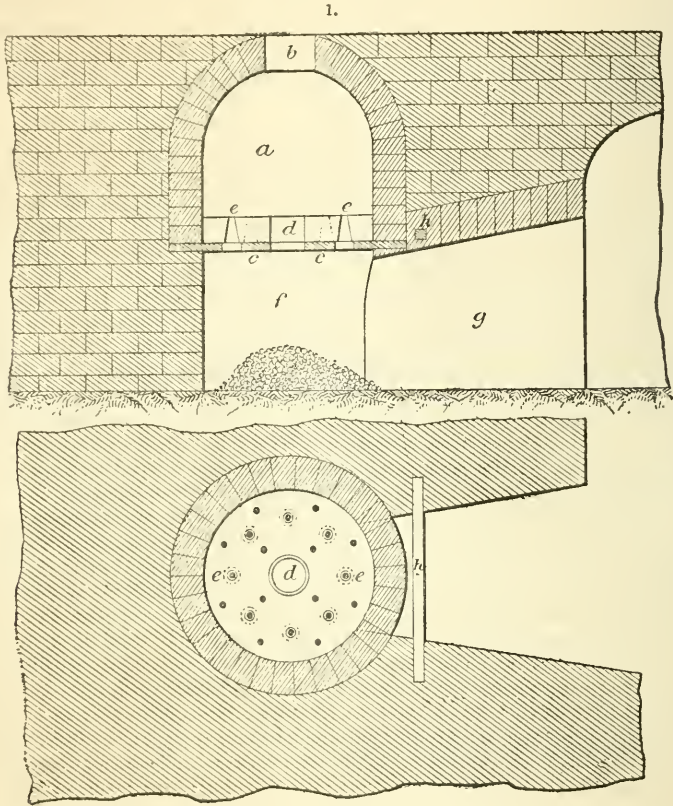

of a fire-grate, by admitting the air that supports combustion. The whole construction is enclosed in a solid mass of brickwork, and an iron bar *h* is built in over the air-way in front of the bed-plate, and resting on the walls forming the sides of the air-way, to give support. The dimensions of the furnace shown are 3 ft. 6 in. diameter, and 3 ft. 6 in. height from furnace bed to crown of arch.

The ordinary melting furnace is shown in Fig. 2. The fire-place *a* is lined throughout with fire-brick, as well as the opening *d* into the flue and a portion of the flue *e* itself; *b* is the ash-pit; *c*, register-door of ash-pit, by which the draught is partially regulated; *f*, fire-brick cover for the furnace; *g*, fire-bars. It is built all round with common brick; and as many as 6 may use the same stack.

Fig. 3 illustrates the circular melting furnace, consisting of an iron plate *a* pierced, in the centre by a circular hole of the size of the interior of the furnace, and crossed by,

the fire-bars; *b* is a sheet-iron drum riveted together, forming the shell of the furnace, and resting on the bed-plate; it is first lined on the inside with $4\frac{1}{2}$ in. of ordinary brick, and next with 9 in. of fire-brick; *c*, fire-place; *d*, flue leading to stack; *e*, iron grating

2.

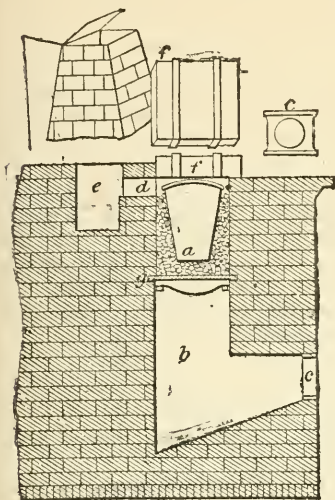

3.

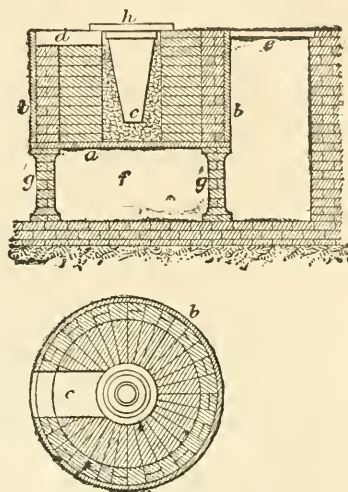

for admitting air beneath the furnace; *f*, ash-pit; *g*, 4 small brickwork pillars, about 18 in. high, supporting the bed-plate; *h*, fire-brick cover to furnace. The draught is regulated by a damper in the flue or on the stack. The latter is an iron plate large enough to entirely cover the top of the stack, hinged at one edge, and open or closed by a lever.

A reverberatory furnace is illustrated in Fig. 4: *a*, fire-place; *b*, ash-pit; *c*, bridge; *d*, melting furnace; *e*, fire-door; *f*, flue leading out metal; *g*, door for feeding in and lading out metal. The draught is regulated by the fire-door and the damper on the top of the stack.

Crucibles.—All the metals and alloys, with the exception of iron and the very fusible metals, are melted in crucibles, of which there are several different kinds. The principal ones in use are the Hessian pots, the English brown or clay pots, the Cornish and the Wedgwood crucibles—all extensively used for melting alloys of brass, bell-metal, gun-metal, &c.; but they are very brittle, and seldom stand more than one heat, yet are generally sold cheap, and some foundrymen prefer to use a crucible only once, for crucibles often crack or burn through on the second heat.

The best crucibles for all kinds of alloys are made of graphite (miscalled plumbago and blacklead). These are sold higher than any of the clay crucibles, but they are more refractory, and may be used for 3 or more successive heats without any danger

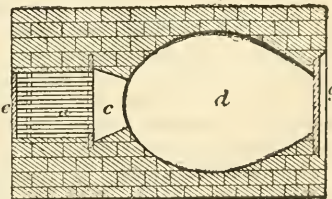
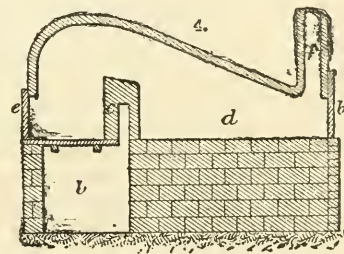

of cracking or burning through. They are not so open and porous as the clay crucibles, and do not absorb so much of the metal, and for this reason they are to be preferred for melting valuable metals. When about to use a crucible, it should be heated gradually by putting it in the furnace when the fire is started, or by setting it on the top of the tyle or covering of the furnace, with the mouth down; it should be heated in this way until it is almost too hot to hold in the hands. Some foundrymen stand a fire-brick on end in the bottom of the furnace to set the crucible on. This prevents the crucible from settling with the fuel as it is burnt away. This way of supporting the crucible is a good idea when the furnace has a poor draught and the metal is melted slowly and it is necessary to replenish the fuel before the metal can be melted; but in furnaces where the metal is melted quickly, and it is not necessary to replenish the fuel in the middle of the heat, the crucible should be allowed to settle with the fuel, as the heat will then be more concentrated upon it. After the metal has been poured from the crucible into the mould or ingot, the crucible should always be returned to the furnace, and allowed to cool off with the furnace to prevent it from cracking. In forming alloys of brass, &c., a lid for the crucible is seldom used, but a covering of charcoal or some kind of flux is generally laid on the metal. The metal to be melted in the crucible is generally packed in before the crucible is put into the furnace; and when it is desirable to add to the metal after some has been fused, it is put in with the tongs, if in large pieces; but when the metal to be added is in small pieces, it is put into the crucible through a long funnel-shaped pipe. The small end of this pipe is used for putting metals into the crucible, and the large end is used for covering the crucible to prevent the small pieces of fuel from falling in.

Moulding.—Brass moulding is carried on by means of earthen or sand moulds. The formation of sand moulds is by no means so simple an affair as it would first appear, for it requires long practical experience to overcome the disadvantages attendant upon the material used. The moulds must be sufficiently strong to withstand the action of the fluid metal perfectly, and, at the same time, must be so far pervious to the air as to permit of the egress of the gases formed by the action of the metal on the sand. If the material were perfectly air-tight, then damage would ensue from the pressure arising out of the rapid generation of gases, which would spoil the effect of the casting, and probably do serious injury to the operator. If the gases are locked up within the mould, the general result is what moulders term a "blown" casting; that is, its surface becomes filled with bubbles, rendering its texture porous and weak, besides injuring its appearance.

For a number of the more fusible metals, plaster of Paris is used. This material, however, will not answer for the more refractory ones, as the heat causes it to crumble away and lose its shape. Sand, mixed with clay or loam, possesses advantages not to be found in gypsum, and is consequently used in place of it for brass and other alloys. In the formation of brass moulds, old damp sand is principally used in preference to the fresh material, being much less adhesive, and allowing the patterns to leave the moulds easier and cleaner. Meal-dust or flour is used for facing the moulds of small articles, but for larger works, powdered chalk, wood ashes, and so on are used, as being more economical. If particularly fine work is required, a facing of charcoal or rottenstone is applied. Another plan for giving a fine surface is to dry the moulds over a slow fire of cork shavings, or other carbonaceous substance, which deposits a fine thin coating of carbon. This is done when good fine facing-sand is not to be obtained. As regards the proportions of sand and loam used in the formation of the moulds, it is to be remarked that the greater the quantity of the former material, the more easily will the gases escape, and the less likelihood is there of a failure of the casting; on the other hand, if the latter substance predominates, the impression of the pattern will be better, but a far greater liability of injury to the casting will be incurred from the impermeable nature of the moulding material. This, however, may be got over without the slightest risk, by

well drying the mould prior to casting, as would have to be done were the mould entirely of loam.

Where easily fusible metal is used, metallic moulds are sometimes adopted. Thus, where great quantities of one particular species of casting are required, the metallic mould is cheaper, easier of management, and possesses the advantage of producing any number of exactly similar copies. The simplest example is the casting of bullets. These are cast in moulds constructed like seissors, or pliers, the jaws or nipping portions being hollowed out hemispherically, so that when closed a complete hollow sphere is formed, having a small aperture leading into the centre of the division line, by which the molten lead is poured in. Pewter pots, inkstands, printing types, and various other articles, composed of the easily fusible metals, or their compounds, are moulded on the same principle. The pewterer generally uses brass moulds: they are heated previous to pouring in the metal. In order to cause the casting to leave the mould easier, as well as to give a finer face to the article, the mould is brushed thinly over with red ochre and white of an egg; in some cases a thin film of oil is used instead. Many of the moulds for this purpose are extremely complex, and, being made in several pieces, they require great care in fitting.

A few observations on the method of filling the moulds. The experienced find that the proper time for pouring the metal is indicated by the wasting of the zinc, which gives off a lambent flame from the surface of the melted metal. The moment this is observed, the crucible is removed from the fire, in order to avoid incurring a great waste of this volatile substance. The metal is then immediately poured. The best temperature for pouring is that at which it will take the sharpest impression and yet cool quickly. If the metal is very hot, and remains long in contact with the mould, what is called "sand-burning" takes place, and the face of the casting is injured. The founder, then, must rely on his own judgment as to what is the lowest heat at which good, sharp impressions will be produced. As a rule, the smallest and thinnest castings must be cast the first in a pouring, as the metal cools quickest in such cases, while the reverse holds good with regard to larger ones.

Complex objects, when inflammable, are occasionally moulded in brass, and some other of the fusible metals, by an extremely ingenious process; rendering what otherwise would be a difficult problem a comparatively easy matter. The mould, which it must be understood is to be composed of some inflammable material, is to be placed in the sand-flask, and the moulding sand is put in gradually until the box is filled up. When dry, the whole is placed in an oven sufficiently hot to reduce the mould to ashes, which are easily removed from their hollow, when the metal may be poured in. In this way small animals, birds, or vegetables may be cast with the greatest facility. The animal is to be placed in the empty moulding box, being held in the exact position required by suitable wires or strings, which may be burnt or removed previous to pouring in the metal.

Another mode, which appears to be founded on the same principle, answers perfectly well when the original model is moulded in wax. The model is placed in the moulding box in the manner detailed in the last process, having an additional piece of wax to represent the runner for the metal. The composition here used for moulding is similar to that employed by statue founders in forming the cores for statues, busts, and so on, namely, 2 parts brickdust to 1 of plaster of Paris. This is mixed with water, and poured in so as to surround the model well. The whole is then slowly dried, and when the mould is sufficiently hardened to withstand the effects of the molten wax, it is warmed, in order to liquefy and pour it out. When clear of the wax, the mould is dried and buried in sand, in order to sustain it against the action of the fluid metal.

Large bells are usually cast in loam moulds, being "swept" up, according to the founder's phraseology, by means of wooden or metal patterns whose contour is an exact representation of the inner and outer surfaces of the intended bell. Sometimes, indeed,

the whole exterior of the bell is moulded in wax, which serves as a model to form the impression in the sand, the wax being melted out previous to pouring in the metal. This plan is rarely pursued, and is only feasible when the casting is small. The inscriptions, ornaments, scrolls, and so on, usually found on bells, are put on the clay mould separately, being moulded in wax or clay, and stuck on while soft. The same plan is pursued with regard to the ears, or supporting lugs, by which the bell is hung.

Moulds faced with common flour turn out castings beautifully smooth and bright; the sand parts easily from the surfaces, and, as a rule, can be readily removed by the application of a hard brush. For large brass castings, quicklime is successfully used in some places; it is simply dusted on the face of the mould and smoothed down in the usual way.

Sometimes, even when the brass mixtures are good, there will be much trouble with blowing, both in dry and green moulds. This may be due to want of porosity in the sand or to insufficient heat of metal. A first-class sand is that from the Mansfield quarries, near Nottingham. It is a good plan to stir the metal with a hazel rod just before pouring.

The ordinary method of casting in sand moulds applied in successive pieces, as in plaster of Paris casting, is not so much in use in Italy as what is called the "forma perduta" mode; meaning that the object is destroyed or "lost" every time. Casting from metallic or other incombustible objects is therefore impossible by this method. The object must be of wax, or something that will melt or burn out, the mould having been dried and baked. By this way very little chasing is required, but the artist has to finish his wax object (cast in a plaster mould) each time. The advantage of this method is that you get the artist's finishing of his own work instead of the chaser's, who, though he ought to be, is by no means always an artist. He can copy mechanically, but the work always loses terribly in expression and finish.

The following process is recommended by Abbass for producing metallic castings of flowers, leaves, insects, &c. The object—a dead beetle, for example—is first arranged in a natural position, and the feet are connected with an oval rim of wax. It is then fixed in the centre of a paper or wooden box by means of pieces of fine wire, so that it is perfectly free, and thicker wires are run from the sides of the box to the object, which subsequently serve to form air-channels in the mould by their removal. A wooden stick, tapering towards the bottom, is placed upon the back of the insect to produce a runner for casting. The box is then filled up with a paste of $\frac{3}{4}$ plaster of Paris and $\frac{1}{4}$ brickdust, made up with a solution of alum and sal-ammoniac. It is also well first to brush the object with this paste to prevent the formation of air-bubbles. After the mould thus formed has set, the object is removed from the interior by first reducing it to ashes. It is therefore dried slowly, and finally heated gradually to a red heat, and then allowed to cool slowly to prevent the formation of flaws or cracks. The ashes are removed by pouring mercury into the cold mould and shaking it thoroughly before pouring it out, repeating this operation several times. The thicker wires are then drawn out, and the mould needs simply to be thoroughly heated before it is filled with metal, in order that the latter may flow into all portions of it. After it has become cold, it is softened and carefully broken away from the casting.

Casting.—When brass is ready to be poured, the zinc on the surface begins to waste with a lambent flame. When this condition is observed, the large cokes are first removed from the mouth of the pot, and a long pair of crucible tongs are thrust down beside the same to embrace it securely, after which a coupler is dropped upon the handles of the tongs; the pot is now lifted out with both hands and carried to the skimming place, where the loose dross is skimmed off with an iron rod, and the pot is rested upon the spill-trough, against or upon which the flasks are arranged.

The temperature at which the metal is poured must be proportioned to the magnitude of the work; thus, large, straggling, and thin castings require the metal to

be very hot, otherwise it will be chilled from coming in contact with the extended surface of sand before having entirely filled the mould; thick massive castings, if filled with such hot metal, would be sandburnt, as the long continuance of the heat would destroy the face of the mould before the metal would be solidified. The line of policy seems therefore to be, to pour the metals at that period when they shall be sufficiently fluid to fill the moulds perfectly, and produce distinct and sharp impressions, but that the metal shall become externally congealed as soon as possible afterwards.

For slight moulds, the carbonaceous facings, whether meal-dust, charcoal, or soot, are good, as these substances are bad conductors of heat, and rather aid than otherwise by their ignition; it is also proper to air these moulds for thin works, or slightly warm them before a grate containing a coke fire. But in massive works these precautions are less required; and the facing of common brickdust, which is incombustible and more binding, succeeds better.

The founder therefore fills the moulds having the slightest works first, and gradually proceeds to the heaviest; if needful, he will wait a little to cool the metal, or will effect the same purpose by stirring it with one of the ridges or waste runners, which thereby becomes partially melted. He judges of the temperature of the melted brass principally by the eye, as, when out of the furnace, and the very hot surface emits a brilliant bluish-white flame, and gives off clouds of white oxide of zinc, a considerable portion of which floats in the air like snow, the light decreases with the temperature, and but little zinc is then fumed away.

Gun-metal and pot-metal do not flare away in the manner of brass, the tin and lead being far less volatile than zinc; neither should they be poured so hot or fluid as yellow brass, or they will become sandburnt in a greater degree, or, rather, the tin and lead will strike to the surface. Gun-metal and the much-used alloys of copper, tin, and zinc are sometimes mixed at the time of pouring; the alloy of lead and copper is never so treated, but always contains old metal, and copper is seldom cast alone, but a trifling portion of zinc is added to it, otherwise the work becomes nearly full of little air-bubbles throughout its surface.

When the founder is in doubt as to the quality of the metal, from its containing old metal of unknown character, or if he desires to be very exact, he will either pour a sample from the pot into an ingot-mould, or extract a little with a long rod terminating in a spoon heated to redness. The lump is cooled, and tried with a file, saw, hammer, or drill, to learn its quality. The engraved cylinders for calico-printing are required to be of pure copper, and their unsoundness, when cast in the usual way, was found to be so serious an evil that it gave rise to casting the metal under pressure.

Some persons judge of the heat proper for pouring by applying the skimmer to the surface of the metal, which, when very hot, has a motion like that of boiling water; this dies away and becomes more languid as the metal cools. Many works are spoiled from being poured too hot, and the management of the heat is much more difficult when the quantity of metal is small. In pouring the metal, care should be taken to keep back the dross from the lip of the melting-pot. A crucible containing the general quantity of 40 lb. or 50 lb. of metal can be very conveniently managed by one individual, but for larger quantities, sometimes amounting to 1 cwt., an assistant aids in supporting the crucible by catching hold of the shoulder of the tongs with a grunter, an iron rod bent like a hook.

Whilst the mould is being filled, there is a rushing or hissing sound from the flow of metal and escape of air; the effect is less violent where there are 2 or more passages, as in heavy pieces, and then the jet can be kept entirely full, which is desirable. Immediately after the mould is filled, there are generally small but harmless explosions of the gases, which escape through the seams of the mould; they ignite from the runners, and burn quietly; but when the metal blows, from the after-escape of any confined air, it makes a gurgling, bubbling noise, like the boiling of water, but much

louder, and it will sometimes throw the fluid metal out of the runner in 3 or 4 separate spurts; this effect, which mostly spoils the castings, is much the more likely to occur with cored works, and with such as are rammed in less judiciously hard, without being, like the moulds for fine castings, subsequently well dried. The moulds are generally opened before the castings are cold, and the founder's duty is ended when he has sawn off the ingates or ridges, and filed away the ragged edges where the metal has entered the seams of the mould; small works are additionally cleaned in a rumble, or revolving cask, where they soon scrub each other clean. Nearly all small brass works are poured vertically, and the runners must be proportioned to the size of the castings, that they may serve to fill the mould quickly, and supply at the top a mass of still fluid metal, to serve as a head or pressure for compressing that which is beneath, to increase the density and soundness of the casting. Most large works in brass, and the greater part of those in iron, are moulded and poured horizontally.

The casting of figures is the most complex and difficult branch of the founder's art. An example of this is found in the moulding of their ornaments in relief. The ornament, whatever it may be—a monumental bas-relief, for instance—is first modelled in relief, in clay or wax, upon a flat surface. A sand-flask is then placed upon the board over the model, and well rammed with sand, which thus takes the impress of the model on its lower surface. A second flask is now laid on the sunken impression, and also filled with sand, in order to take the relief impression from it. This is generally termed the cope or back mould. The thickness of the intended cast is then determined by placing an edging of clay around the lower flask, upon which edging the upper one rests, thus keeping the two surfaces at the precise distance from each other that it is intended the thickness of the casting shall be. In this process, the metal is economized to the greatest possible extent, as the interior surface, or back of the casting, is an exact representation of the relief of the subject, and the whole is thus made as thin in every part as the strength of the metal permits. Several modifications of the process just described are also made use of, to suit the particular circumstances of the case. What has been said, however, is a detail of the principle pursued in all matters of a similar nature.

Cores.—Following are instructions for a composition for cores that may be required for difficult jobs, where it would be extremely expensive to make a core-box for the same: Make a pattern (of any material that will stand moulding from) like the core required. Take a mould from the same in the sand, in the ordinary way, place strengthening wires from point to point, centrally; gate and close your flask. Then make a composition of 2 parts brickdust and 1 of plaster of Paris; mix with water, and cast. Take it out when set, dry it, and place it in your mould warm, so that there may be no cold air in it.

Making Bronze Figures.—It is a singular fact that melted gold, silver, copper, and iron, if poured hot into a mould, will take an impression of all the details of the pattern from which the mould was made, only if the mould is made of sand. Zinc can be moulded in copper moulds, and that is the principal cause of the low price of spelter or zinc statuettes, known in the trade as imitation or French bronze. The real bronze is an alloy of copper, zinc, and tin, the 2 latter metals forming a very small part of the combination, the object of which is the production of a metal harder than the pure copper would be, and consequently more capable of standing the action of time, and also less brittle and soft than zinc alone would be. Let us follow a statuette through the different processes under which it has to pass from the time it leaves the hands of the artist who has modelled it to that when it reaches the shop where it is to be sold.

The original statuette is generally finished in plaster. The manufacturer's first operation is to have it cut in such pieces as will best suit the moulder, the mounter, and the chaser, for very few statuettes are cast all in one piece. Arms and legs are

generally put on after the body is finished. The next operation is to reproduce the different parts of the figure in metal. For this the moulder takes it in hand to prepare the mould. He begins by selecting a rectangular iron frame, technically termed a flask, large enough for the figure to lie in easily. To this frame, which is 2 to 6 in. deep, another similar frame can be fastened by bolts and eyes arranged on the outside of it, so that several of these frames superposed form a sort of box. The workman places the plaster statuette, which is now his "pattern," on a bed of soft moulding-sand inside the first iron frame. The sand used for mould making is of a peculiar nature, its principal quality being due to the presence of magnesia. One locality is celebrated for affording the best sand—that is Fontenay-aux-Roses, a few miles from Paris, in France. This sand, when slightly damp, sticks together very easily, and is well fitted to take the impression of the pattern.

Once the pattern is embedded in the sand, the workman takes a small lump of sand, which he presses against the sides of the figure, covering a certain portion of it. Next to this piece he presses another, using a small wooden mallet to ensure the perfect adhesion of the sand to the pattern. Each one of these pieces of sand is trimmed off, and a light layer of potato-flour is dusted both over the pattern and the different parts of the mould, to prevent them from adhering together. In course of time, the entire part of the pattern left above the first bed of sand, on which it has been placed, will be covered with these pieces of sand, which are beaten hard enough to keep together. Loose sand is now thrown over this elementary brickwork of sand, if it may be so called, and a second iron frame is bolted to the first one to hold the sand together, which, when beaten down, will form a case holding the elementary sand pieces of the mould in place. The workman now turns his mould over, removes the loose sand which formed the original bed of the pattern, and replaces it by beaten pieces, just as he had done on the upper side.

It can now easily be conceived that if the mould is opened the plaster pattern can be removed, and that if all the pieces of sand are replaced as they were, there will be a hollow space inside the mould, which will be exactly the space previously occupied by the pattern. If we pour melted metal into this space, it will fill it exactly, and consequently, when solidified by cooling, reproduce exactly the plaster pattern. For small pieces, this will answer very well; but large pieces must be hollow. If they were cast solid, the metal in cooling, would contract, and the surface would present cracks and holes difficult to fill. To make a casting hollow it is necessary to suspend inside the mould an inner mould or "core," leaving between it and the inner surface of the first mould a regular space, which is that which will be filled by the metal when it is poured in. This core is made of sand, and suspended in the mould by cross wires or iron rods, according to the importance of the piece. A method often used in preparing a mould, named by the French *cire perdue*, will help to illustrate this. The artist first takes a rough clay image of the figure he wants to produce. This will be the core of the mould; he covers it with a coating of modelling-wax of equal thickness, and on this wax he finishes the modelling of his figure. The moulder now makes his sand mould over the wax, and, when it is completed by baking the mould in a suitable furnace, the wax runs out, leaving exactly the space to be filled up by the metal. The celebrated statue of Perseus, by Benvenuto Cellini, was cast in this way, and the method is very frequently employed by the Japanese and Chinese. Sometimes flowers, animals, or baskets are embedded in the mould, and, after the baking, the ashes to which they have been reduced are either washed or blown out to make room for the metal. This can easily be done through the jets or passages left for the metal to enter the mould, and through the vent-holes provided for the escape of air and gases.

When the mould has cooled, it is broken to remove the casting it contains; and here is the reason why real bronze is so much more expensive than the spelter imitation. For each bronze a new sand mould must be made, while the zinc or spelter

can be poured in metallic moulds, which will last for ever. In this way the pieces are produced with but little more labour than that required to manufacture leaden bullets. These pieces, of course, do not receive the same expensive finish as the real bronze. When the casting is taken out of the mould, it goes to the moulder, who trims it off, files the base "true," prepares the sockets which are to receive the arms or other pieces to be mounted, and hands the piece to the chaser. The work of this artisan consists in removing from the surface of the metal such inequalities as the sand mould may have left, and in finishing the surface of the metal as best suits the piece. The amount of work a skilful chaser can lay out on a piece is unlimited. In some cases the very texture of the skin is reproduced on the surface of the metal. This mode of chasing, called in French *chaîré*, and in English "skin-finish," is, of course, only found on work of the best class. Sometimes pieces are finished with slight cross-touches, similar to the cross-hatching of engraving. This style of finish, which is much esteemed by connoisseurs, is named "cross-rifled," or *ribouté*. After the chaser has finished his work, the piece returns to the moulder, who definitively secures the elements of the piece in their places.

The next process is that of bronzing. The colour known as "bronze" is that which a piece of that metal would take through the natural process of atmospheric oxidation, if it were exposed to a dry atmosphere at an even temperature. But the manufacturer, not being able to wait for the slow action of nature, calls chemistry to his aid, and by different processes produces on the surface of the piece a metallic oxide of copper, which, according to taste or fashion, varies from black to red, which are the 2 extreme colours of copper oxide. The discovery of old bronzes, buried for centuries in damp earth, and covered with verdigris, suggested the colour known as *vert antique*, which is easily produced on new metal by the action of acetic or sulphuric acid. In the 15th century, the Florentine artisans produced a beautiful colour on their bronzes by smoking them over a fire of greasy rags and straw. This colour, which is very like that of mahogany, is still known as Florentine or smoked bronze. Bronze can also be plated with gold and silver, nickel and platinum, like every other metal.

On this subject, Gornaud says that the manufacturer of art bronzes begins by giving the style and general proportions to the artist, who is his first and most important assistant. The artist takes the clay, the model, the style, and arranges it into its varied forms; soon the architecture is designed, the figures become detached, the ornaments harmonize, and the idea embodied in the outline becomes clear. The manufacturer, before giving his model to the founder, should indicate with a pencil the parts which ought to be thickest, lest some be found too light, without, however, altering the form; he should also mark the parts to be cut in the mould to facilitate putting together. Care must be taken to rub with hard modelling wax all the projecting parts which serve to join the pieces, so that the turner may not want matter. He must carefully verify all the pieces separately, and cover with wax the angles and ends of the leaves—in a word the weak parts. Generally the model is cast in half-red bronze, in the following proportions (the body of it is harder, and less easy to work):—

Copper	91·60	per cent.
Zinc	5·33	"
Tin	1·70	"
Lead	1·37	"

Objects destined to be gilded require a little more zinc than those of plain bronze. The models just described serve to make the moulds in moulding sand, the moulds being afterwards baked in a stove heated to 572° F. (300° C.). They are fastened horizontally with binding screws, in order to run in the bronze; the temperature, when cast, varies from 2732° to 3272° F. (1500° to 1800° C.).

The Japanese word corresponding to the English "bronze" is *karakane*, which means

“Chinese metal” ; whereas the brass alloys are called *shin-chu*. The spelter used for the latter is imported. The industry of bronze-casting is of very ancient origin; at first foreign metal, imported either from China or Corea, must have been used, as Japanese copper has only been produced since the beginning of the 8th century; by that time, however, the industry of bronze-casting had already reached a certain state of perfection. This is shown by the fact that the priest Giyoki, who lived about this time, proposed the erection of a monster bronze statue of Buddha, which was carried into effect. There were formerly 3 of these statues in Japan, each about 50 ft. in height. Other specimens of large bronze-castings are the famous bells of Nara, Kiyoto, Nikko, Shiba in Tokio, and others, which have an average height of 15 ft. and are more than 10 ft. in diameter. Statues of all sizes, bells, vases, water-basins, candlesticks, incense-burners, lanterns, &c., have been manufactured in large quantities for temples and their approaches. Portrait-statues, like the monuments erected in foreign countries to honour the memory of celebrated men, have never been made in Japan. As articles for household uses, may be mentioned fire-pots, water-pots, flower-vases and basins in which miniature gardens are made, perfume-burners, pencil-cases, small water-pots of fanciful shapes for writing-boxes, paper-weights, and small figures representing divinities. These bronze-castings are either made in the simple and severe style of the old celebrated Chinese bronzes, or else are specimens of the peculiar character of Japanese art, which chooses its subjects from natural life, either combining them with lively scenes showing a great deal of humour, together with the most minute copying of nature, or else using them to produce some artistical effect. The bronze is cast in clay moulds formed upon models made of a mixture of wax and resin, which is melted out from the finished mould previous to pouring the metal in. The artist who makes the model generally does the casting himself, and in most cases the workshops consist only of the master's family and 2 or 3 assistants. The melting furnaces are of exceedingly small dimensions, and generally made of an iron kettle lined with clay. After casting, the pattern is carefully corrected and worked out by chiselling, but the best bronze-casters prepare the model, the mould, and the alloy in such a way as to produce castings which need no further correcting or finishing. In some cases also the whole pattern is produced merely with the chisel working upon a smooth surface; this, for instance, is frequently done in the provinces of Kaga and Yechiu, which are very important centres of the bronze industry. The bronzing of the pieces is done in many different ways, each manufacturer having his own particular process, which he modifies according to the composition of the alloy and the colour he wishes to produce. The chemicals used for this purpose are very few in number, and limited to vinegar, copper sulphate, and verdigris as the principal substances; other materials, used less frequently, consist of iron sulphate, red oxide of iron, and lacquer. It may be added, as a peculiarity, that an infusion of *Eryanthus tinctorius* is also made use of in the bronzing process.

The ornamentation of bronze castings is not only produced by relief patterns moulded or chiselled, but also by inlaying the objects with gold, silver, or with a different alloy. This kind of workmanship is called *zogan*, and is principally carried on in the provinces of Kaga and Yechiu. The process by which the inlaid work is effected differs according to the nature of the material on which it is produced. Sometimes the design is hollowed out to a certain depth with a graver or chisel, and the ornamenting metal, silver, gold, &c., generally in the shape of threads, is laid into the hollow spaces and hammered over, should the alloy be soft enough; the edges of these grooves are first slightly driven up, so that when the silver or gold has been laid in, they can be easily hammered down again, so as to prevent the inlaid metal from getting loose. Or else the surface is merely covered in the required places with a narrow network of lines by means of filing, and the thin gold or silver leaf fastened on to this rough surface by hammering. This last process is the one used mostly for inlaid iron-work. It is also

said that the design is often produced by a process very similar to that of the so-called *niello*; only instead of the black sulphuretted silver and copper, a more easily fusible alloy is used. Inlaid work of the above kind is principally made in Kaga and Yechiu, at Kanasawa and Takaoko, where the alloy used for the bronze-casting is mostly composed of copper, tin, zinc, and lead. In addition to the castings, the repoussé work should be mentioned, by which mostly small metallic ornaments for swords, tobacco-pouches, &c., and also larger pieces, such as tea-pots, scent-burners, vases, &c., are produced; the inlaying of this kind of ware is sometimes of extraordinary delicacy and beauty. The dark-blue colour shown by a great number of smaller pieces is that of the *shakudo*, composed of copper, and 3 and 4 per cent. of gold. Finally, attention should be called to the so-called *moku-me*, a word which might be rendered by "veins of the wood." The metal-work designated by this name presents a sort of damask pattern composed of variously-coloured metals, chiefly white silver, red copper, and a dark-blue alloy. Pieces of this very difficult sort of workmanship are produced by overlaying and soldering together a certain number of plates of the said metals or alloys, by hammering, kneading, resoldering, filling up the hollow spaces with new metal, and repeating these operations many times; finally, when stretched out into a thin sheet, this composition shows the aforesaid pattern all composed of veins of the different metals that have been made use of.

Casting en cire perdue.—A very interesting report on bronze-casting in Belgium, by Sir J. Savile Lumley, has recently been issued, from which the following remarks are abstracted.

The bronze castings made under the First Empire were from moulds made on plaster models by an ingenious method known by the name of "moulage à la Française," which is now employed in all French bronze foundries; it has the advantage of being economical, especially for large works, and is generally used in all the foundries of the north of Europe; it resembles in some respects the system practised in iron foundries, and is now employed even in Italy in preference to the wax process.

It must also be remarked that casting "en cire perdue" is not suitable for every style of sculpture; works, for instance, requiring a smooth surface can, and indeed ought to be, cast by the ordinary French system, which produces metal of a closer grain and more polished surface, requiring, however, the use of the chasing tool over the whole surface to efface the marks left by the joints of the piece-mould, and the entire removal of what is called "la peau de la fonte," the casting skin or "epidermis" of the bronze as it comes from the mould, and which, in the wax process, constitutes its peculiar charm, reproducing as it does a perfect *facsimile* of the original work as it left the artist's hands.

The ordinary method of casting is more suitable to the bronze articles of commerce which require reproduction, as well as for bronzes intended to be gilt or silvered and burnished. The wax process, on the contrary, is adapted to unique artistic works not intended for reproduction; the casting skin, however, so dear to the sculptor, diminishes to a certain extent the beauty of the artificial "patina," or bronzing, which is always more brilliant on bronzes that have been worked over with the file and the graving tool. The objection manifested by modern bronze founders to adopting the wax process has hitherto been that in case of failure in the casting, the model is completely lost; but by a method adopted by the Brussels Bronze Co., failure in casting confines the loss to the casting itself, and leaves the original model intact and available for a second attempt. Following is a technical description of the operations carried out by them for bronze-casting *en cire perdue*.

Supposing the work to be reproduced to be the portrait bust of a man with curly locks and a long flowing beard, such a head would not be easy to cast by the ordinary process, owing to the difficulty of conveying the liquid bronze into the cavities of the curls and the interstices of the beard, but this is easily overcome when the bust is cast by the wax process. The different operations to be carried out are as follows: (1) The production of

the model in plaster or terra-cotta by the artist sculptor. (2) Its reproduction in wax by the founder. (3) The repairing and retouching of the wax bust by the artist sculptor. (4) The preparation for casting the bust before forming the mould and cope. (5) The formation of the mould. (6) Firing. (7) Casting. (8) Finishing and decorating the bronze bust. Fig. 5 illustrates the arrangement of the runners, vents, and drains: *a* are the 6 runners by which the molten bronze is conveyed into the mould; *b*, vents for

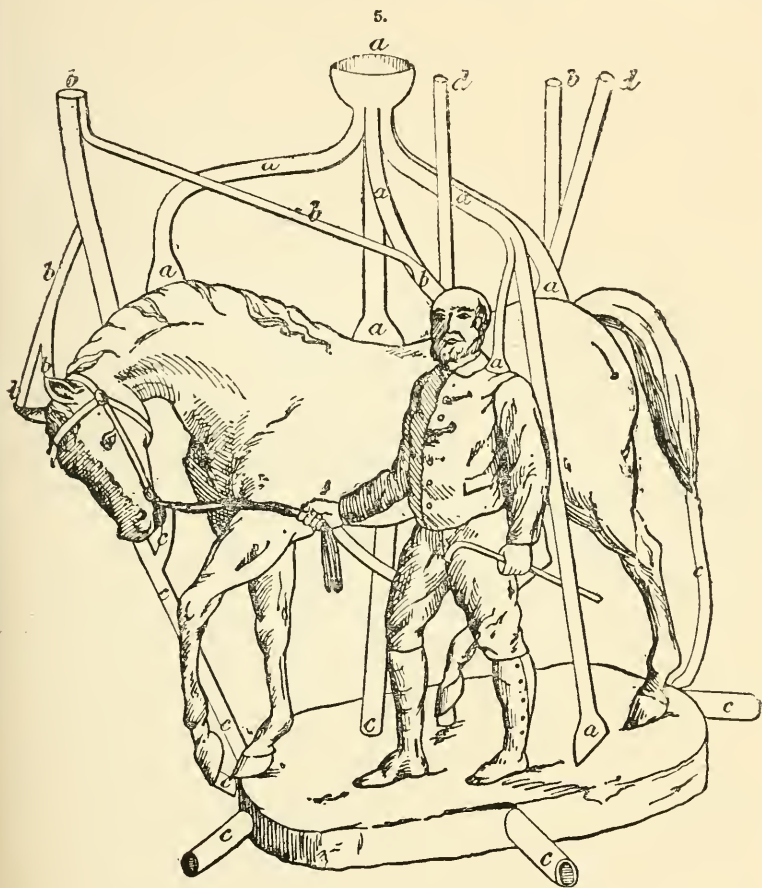

the escape of air and gases; *c*, drains for carrying off the melted wax; *d*, vents for the escape of air from the cores within the bodies of the horse and man. All except *d* are originally of wax like the group itself; but when the mould is fired, the wax disappears, and the hollows left by the melted wax are converted into bronze and have to be sawn off.

The model.—The bust produced by the sculptor, which may be in terra-cotta or plaster, finished as far as the artist thinks advisable, is handed over to the founder.

Reproduction in wax. This requires 3 distinct operations: A. The formation of a piece-mould. B. The reproduction of the bust in wax. C. Running the core.

A. Formation of a piece-mould.—After having examined the bust so as to be

thoroughly acquainted with its difficulties, the workman proceeds to cut off with a twisted wire the projecting portions of the beard, and the hair, which, from the cavities of the locks and curls, would present difficulties for casting. The parts thus removed are afterwards easily replaced. The bust is now reduced to a very simple instead of the complicated form it at first presented. The plaster mould is then made in the ordinary way: the bust being laid on a table, face upwards, is fixed in that position by lumps of modelling clay so that one-half of the thickness of the bust is completely covered, the remaining half presenting the appearance of a figure floating on its back in water. The workman then begins to make the pieces of the mould: taking the liquid plaster, which is of the consistency of thick cream, he forms a cube 2 in. high, and the same length and width, which he squares as soon as the plaster begins to harden; with this cube of plaster he covers a first portion of the surface of the bust; close to this first cube a second is formed, and so on until the whole bust is covered with an irregular mosaic of plaster cubes, care being taken to prevent them from adhering to each other or to the bust by the application of a strong solution of soap. The surface of these cubes, after being well wetted with this solution, is covered over with a very thick coating of plaster, which is called the cope, the place of each cube having been previously marked; the first half of the piece-mould is now complete. The moulder then turns the bust with the face down on to the table, fixing it as before, and proceeds to cover the back in the same way with cubes of plaster, so that when this second half is also covered with a thick plaster cope, a complete mould is formed in 2 halves. The great art of the moulder is to make the piece-moulds at the same time simple and solid, and fitting so closely together as to leave the least possible trace of the joints on the plaster cast produced from it; care must also be taken that in handling the mould none of the small pieces should detach themselves from it. The mould being completed, it is opened, that is to say, the 2 plaster copes are separated, the bust which is intact is taken out, leaving a complete mould in which other busts can be cast just as bullets are cast in a bullet-mould. The next operation is the reproduction of a bust in wax, precisely like the original in plaster.

B. Reproduction in wax.—One-half of the piece-mould is placed on the table, that is to say, one of the copes, with all its pieces, and the mould is wetted with water in order to prevent the wax from adhering to it; the workman then, with his thumb, presses wax into all the hollows of the mould: this is an operation of considerable delicacy. The wax, which must be very pure and malleable, is affected by the weather, working more easily in summer than in winter; the most suitable quality for average temperature is composed of 1 lb. of yellow wax, 6·2 lb. of mutton fat, 0·1 lb. of white pitch, melted together and coloured a deep red with alkanet. The wax pressed into the mould should be $\frac{1}{12}$ in. thick. When all the hollows of the first cope have had wax of the requisite thickness pressed into them, the same process is applied to the second cope; the two copes, on being united, form a complete mould; they are then tied together with strong cords, and the joints of the copes are smeared with clay so that the mould should be watertight. In the meantime another description of wax of harder consistency, composed of 1 lb. of yellow wax, 1 lb. of resin, and $\frac{1}{4}$ lb. of Venetian turpentine, has been melted in a cauldron and allowed to stand on the fire until the froth has subsided. The wax, being ready, is left to cool to 140° or 158° F. (60° or 70° C.), when it is poured into the mould, which it fills, and is allowed to remain there for 40 seconds; the liquid wax is then poured out of the mould into a bucket prepared to receive it. On examining the interior it will be found that the soft wax which was pressed into the mould has received throughout a coating of strong wax $\frac{1}{8}$ to $\frac{1}{10}$ in. in thickness, making an entire thickness of about $\frac{1}{4}$ in., which will be the thickness of the bronze when cast.

C. Formation of the core.—The core is the substance with which is filled the hollow left in the mould after the liquid wax is poured out of it; if the bust were cast in bronze without a core, it would come out solid and weighing 10 or 15 times heavier than is

necessary, and the casting itself would be faulty, owing to the great shrinkage produced by such a mass of molten metal, which would also have the effect of vitrifying the earths forming the mould. The core is, in fact, indispensable in the reproduction of artistic bronzes. The core in use at the Brussels Compagnie des Bronzes is formed of a mixture consisting of 2 parts of fine plaster of Paris, and 3 parts of a pulverized earth composed of quartz sand, thin argillaceous clay with traces of iron oxide, carbonate of lime, magnesia, and potash, mixed together with pure water, forming a liquid paste which is called "potin," and which, like plaster of Paris, hardens very rapidly.

Having calculated the capacity of the hollow left by the wax, a quantity of "potin," sufficient to fill it, is prepared and poured into the hollow, leaving enough of the mixture to form a pedestal projecting about 4 in. from the bottom of the bust. The core, having been thus poured into the hollow, is left to harden.

Before proceeding further it is necessary to describe the means by which an escape is provided for the air or gases of the core, which, if not set free, might destroy twist, or otherwise injure the bronze.

This is effected by what is called, in the language of the foundry, a "lanthorn" or chimney, by which the core of every work in bronze must communicate with the external air. The core being composed of porous matter, it is easy to understand that when the molten metal enters the channel prepared for it, the core being completely isolated and superheated, the gas within it is violently dilated, and would force a passage through the fused metal if a vent were not prepared for it. If, owing to an accident or faulty arrangement, the lanthorn should not act, the bronze figure containing the core would be inevitably bulged and distorted, and would have other defects which would considerably diminish the value of the work.

In the case of the bust already described, when the piece-mould is emptied of the liquid wax that has been poured into it, and just as the "potin" which is to form the core is about to be poured in, a round stick, about $\frac{5}{8}$ in. in diameter, having a pin or iron point at the end, after being well oiled, must be fixed into the centre of the hollow of the bust, so that the pin should project through the wax of the top of the head. The stick must be held in this position while the "potin" is poured in round the stick, and when the "potin" begins to harden, which it will do in a few minutes, the stick is twisted out, leaving, of course, a hollow the size of the stick traversing the bust from the base to the head. After the artist-sculptor has retouched the wax bust, the mark left by the point of the stick is sought, and sufficient wax is removed round it to permit of a small iron tube of the same diameter as the hole left by the stick being forced 2 or 3 in. deep into the head, leaving, however, a portion projecting from the head and beyond the block-mould when it is formed over the wax bust.

Any crack that may appear between the tube and the hole is carefully closed, and the wax is retouched where the tube projects from the head. If the tube were not forced sufficiently into the head, or if the joint were not properly closed, the molten bronze would find a passage and fill up the chimney left for the escape of air from the core—an accident which would give rise to effects like those above referred to. In complicated pieces the proper formation of the lanthorn is of the greatest importance; it is often difficult to arrange, and requires considerable experience to make and place it properly. The precise proportions of the earths of which the "potin" is composed is the only part of the process concerning which any reserve is shown.

The mould is then placed on the table, the cords are unfastened, the clay closing the joints of the 2 copes is removed, and by inserting a wedge between the 2 copes the upper cope is carefully lifted off. The workman then removes one by one all the little pieces forming the mould, exposing the corresponding parts of the bust in wax. When all the pieces are removed from the front, the bust is placed upright on its base of "potin" and the cope covering the back is then removed in the same way, together with the pieces forming the mould. These pieces are then carefully returned to the cope each in its

place, and the mould when put together again is ready to be used for another wax bust when required.

The bust now appears in wax reproducing exactly the original bust in clay, with the exception of the seams from the joints of the mould, which are then removed by the artist-sculptor himself. Although wax is neither as easy nor as pleasant a material to work in as modelling-clay, a very short time suffices to enable the sculptor to manipulate it with facility, and an opportunity is afforded him of giving the finishing touches to his work with still greater delicacy than in clay.

It is at this period that the beard and curls of the hair which were removed before making the mould, and which have been separately reproduced in wax by the same process, are fixed in their respective positions by iron points which are driven through the wax into the solid core and hold the pieces firmly in their places; the artist then going over the joints with a modelling tool renders them invisible.

Retouching the wax bust.—The great advantage of reproducing the bust in wax is that it enables the artist to work upon it so that the wax bust is not only equal to the original in plaster or terra-cotta, but may become even superior to it, for the artist on seeing his work in a material of another colour, and after a certain time, may discover certain faults which he can correct in the wax, or if he thinks it necessary he can make such alterations as he may consider advisable.

Preparing the bust before making the casting mould or cope.—The bust in wax, having been looked over and corrected by the artist, is now placed in the hands of the founder, who begins by building a layer of fire-bricks of the size required for the object that is to be cast; this layer, for a bust, may be 3 ft. by 2 ft. 4 in. and 9 in. in height above the floor of the atelier. When ready the wax bust is placed upon it on its pedestal of "potin," and firmly fixed to the brick layer or base. The next operation is one of considerable delicacy, namely, the placing of the runners or channels to enable the liquid bronze to flow through and fill up the vacant space left by the melted wax, and the vents, which are other channels for the escape of the air and gas driven out of the hollow by the force of the liquid metal.

For a bust the placing of these channels is not difficult, but when a complicated work—a group or a large bas-relief—has to be prepared for casting, the proper position of these channels requires considerable study, for if one of them should be badly placed it would compromise the success of the casting.

In order to make a runner for the bust in question, a stick of wax is used 2 ft. long with a diameter of $1\frac{3}{4}$ in., one end of which is cut or flattened into the shape of the mouthpiece of a whistle; the other end is considerably thickened by the addition of wax until it has the form of a funnel; it is then bent into the form of a double siphon with the 2 parallel branches considerably lengthened. Having thus prepared the runner, in order to fix it, 3 or 4 thin iron pins are driven, in a straight line, at a distance from each other of $\frac{1}{2}$ in., into one shoulder of the bust, from which they are allowed to project about 1 or $1\frac{1}{2}$ in.; upon these is pressed the flattened end of the runner, and the joint where it touches the shoulder is then closed with wax, which is melted with a heated tool, thus increasing the solidity of the joints. The vent, which is fastened in the same way on the other shoulder, is a simple straight stick of wax, thinner than that of the runner, also with the flattened end touching the shoulder.

If from any cause the runner and the vent are not firm in their positions, another iron pin is driven into the top of the head of the bust, and the runner and vent are fastened to it with packthread.

The founder has now before him the bust, surmounted by the runner and the vent rising from the shoulders to the summit of the head, like little chimneys, to the height of 6-8 in.; he then proceeds to drive a number of iron pins all over the surface of the bust, through the wax, into the core, the object of which is to maintain the core in its place; these pins must project one-half their length from the surface of the bust.

Formation of the casting mould or cope.—The bust thus prepared is placed on the brick layer in the place in which it is to be fired; it is then surrounded by a wooden case, having the form of a 4-sided truncated pyramid. This case, which must be sufficiently large to leave a space of 6-8 in. between it and the greatest projection of the bust, is made of frames placed one upon the other, 9 in. in height, the whole, when placed together, having the form of a pyramid; the first frame, namely that which rests on the brick layer, being naturally the largest. The case being ready, the cube measure of its capacity is calculated, and the upper frames are removed, leaving only the lower one resting on the brick layer. The mould is made of precisely the same material as that forming the core of the wax bust; the requisite quantity is prepared as well as the proper number of measures of water required for mixing the "potin." As the operation of filling the frames must proceed rapidly, and, once begun, cannot be stopped, care must be taken to have a sufficient supply of the material at hand. For the formation of the cope of a large-sized bust, 3 men are required for mixing the "potin," 2 for pouring it into the frames, and 2 for throwing the mixture on to the bust, which is done with painters' brushes, and in such a way as to thoroughly fill up all the cavities of the sculpture.

The 3 mixers have each before them a vat or bucket containing one measure of water, into which they pour rapidly the dry "potin," which is in the form of fine sand or powder, and this not all at once, but gradually, by allowing it to fall through their fingers; when the "potin" is all in the water, the men work it into a paste with their hands. As soon as it is ready, the other men pour one after the other the contents of the 3 vats or buckets into the lower frame of the wooden case; in the meantime the mixers are preparing fresh vats of "potin." As soon as the first frame is nearly filled, the second frame is placed above it, the joints being closed with "potin" that has become almost hard, and it is filled in the same way; at the same time the other 2 men, armed with brushes, have been sprinkling the bust with the mixture so as to fill up completely all the cavities of the wax bust; if this is not done with great care and exactitude, any cavity that is not filled with "potin" will retain a certain quantity of air, and when cast the cavity will be entirely filled up with a solid mass of bronze which would require to be removed by the chaser at a considerable expense, or it may happen that the fault is one impossible to remedy. When all the frames have been placed one upon the other and filled with "potin," the operation is completed, care having been taken to fill the upper frame only to the level of the top of the runner and the vent, so as not to cover them.

A third channel, required for draining off the melted wax, is formed in the same way as the other two, a stick of wax $1\frac{1}{4}$ in. in diameter being placed at the base of the bust on the slant, so as to facilitate the issue of the liquid wax, the stick of wax being fastened by one end to the wax of the bust, while the other end touches the wood which forms the case. The "potin" having been allowed to harden, which it does very rapidly, the wooden frames are removed, and the cope appears in the form of a block of stone, on the upper surface of which is seen, on the right the wax of the runner, and on the left that of the vent, and at the base that of the drain.

Firing.—The block is now ready for firing. A furnace of fire-bricks is built round it, 2 chimneys being placed on the runner, and the vent communicating with the outer air, and round this furnace a second is built, in which a coke fire is lighted. The fire should be moderate at first, gradually increasing until the mass is baked throughout, so that it is completely red-hot to the very centre. After baking for 6 hours, the block is sufficiently heated to cause the wax to melt; this then escapes through the drain, which is in connection with an iron tube passing through the 2 furnaces, and communicating with a vat into which the wax flows. When the wax has ceased to flow, the opening from the drain must be carefully closed, in order to prevent any air from reaching the interior, which would be injurious to the process.

After 36 hours' firing, puffs of blue smoke are seen issuing from the chimneys. This shows that the heat is sufficiently intense to cause the evaporation of any wax that may have remained in the block. After 60 or 70 hours the smoke changes from blue to a reddish hue; this shows that the wax is completely destroyed. The smoke is succeeded by a slight watery vapour, and the fire is increased until all moisture has disappeared. This is ascertained by placing a cold steel plate over the orifice, upon which the slightest vapour shows itself in the form of a veil or dewlike drops. If at this moment it were possible to look into the centre of the block, it would be found to be of a deep red. When all symptoms of moisture have disappeared, the fire is covered up, no further fuel is added, and the fire goes out gradually.

The external furnace is pulled down as soon as the bricks have cooled sufficiently to enable the workmen to do so without burning themselves; and in order to hasten the cooling of the block some of the bricks forming the cover of the interior furnace are also removed. Later this is also demolished, and the moulding block is allowed to cool. In a word, it is necessary to proceed gradually for the purpose of cooling as well as for that of firing, sudden changes of temperature being fatal, and the success of the operation depending in great part on the regularity of the process.

The firing being now finished, the block has the same appearance as before, only in removing the chimneys the runner and the vent are found to be replaced by holes or channels, while another hole will be found at the base in the place of the wax drain. The wax in melting has formed these channels, and has left a hollow space throughout the block between the core and the mould. Reference has been made above to the use of iron pins pressed into the wax bust. As long as the core, the wax, and the mould had not been submitted to the action of the fire they formed a solid mass, but with the melting of the wax the core has become isolated, and, as it is formed of exceedingly friable earth, the least motion might throw it down and break it; this inconvenience is avoided by the employment of the pins above referred to, which, penetrating through the wax, on the one hand into the core and on the other into the mould, render the core immovable even after the disappearance of the wax.

The casting in bronze.—This is the last operation. The block having become sufficiently cool, it is surrounded with iron frames placed one above the other; the space between the block and the frames is filled by pressing into it ordinary moulding earth. This operation requires the greatest care; its object is to prevent the block from bursting when the liquid bronze is poured into it by the pressure of the gas and the expansion of the air while the fused metal is flowing through the mould, a comparatively small quantity of metal in fusion being capable of producing effects of incredible force which it is difficult to account for.

The block being perfectly iron-bound, a basin of iron covered with baked clay and pierced with a conical funnel is placed over the runner and closed with an iron stopper, from which projects a long stem. The hole of the basin communicates directly with that of the runner; the opening of the vent is left free, but in front of it a small basin is hollowed out of the block. Everything is now ready for the casting.

If the bust is calculated to weigh 50 lb., 80 lb. of bronze are put into the melting-pot in order to be certain of having enough metal, and it is necessary to allow for the runner, the vent, and the drain. The bronze which has hitherto given the best results is composed as follows:—70 lb. red copper, 28 lb. zinc, 2 lb. tin.

The bronze being sufficiently melted, the crucibles are lifted out of the furnace and are emptied into the basin above referred to; a workman at the word of command takes out the iron stopper, the molten bronze flows into the runner, penetrates into the mould, fills up all the hollows, and returns to its level, the surplus metal flowing out at the vent into the basin that has been hollowed out of the block to receive it, preceded by the air and gas driven out by the entry of the metal.

If the operation has been made without producing noise, the casting may be con-

sidered to have been successful, but notwithstanding all the care taken to attain success, some fault may have occurred. The natural curiosity to learn the result may soon be satisfied, for in $\frac{1}{4}$ hour the metal will have cooled sufficiently to allow the block to be broken up.

The workmen begin by lifting off the iron frames, and then, removing the earth that was pressed round it, commence to break up the block with iron picks, proceeding with precaution, and as soon as any portion of the bronze shows itself the picks are laid aside for smaller and lighter tools, with which the "potin" that surrounds and conceals the work is at length removed, the bust gradually appears, and it is possible to judge whether the casting has been successful; the bust itself, however, is covered with a white crust from the "potin" still adhering to it, and which only partially detaches itself. To get rid of this crust entirely is a work of some time.

The runner, the vent, and the drain, which have been transformed by the casting into solid bronze, are now sawn off, the core inside the bust is broken up, and the bust is emptied; it is then placed for several hours in a bath of water and sulphuric acid, and when taken out is vigorously scrubbed with hard brushes, rinsed in clean water, and allowed to dry. The bust is now handed over to the chasers, who efface the traces left by the runners and vents, remove any portions of metal that may fill up the cavities into which the "potin" has not penetrated, stop up with bronze the little holes left by the iron pins, and in fact place the work in a perfect state, leaving, however, untouched the epidermis of the bronze, for in this consists the merit and value of the "cire perdue" process, which renders so completely every touch of the artist that it seems as if he had kneaded and worked the bronze with his fingers.

The bust, now completed, is placed in the hands of the bronze decorators, who give it a "patina" in imitation of that produced by oxidation; the colour generally preferred for portrait busts is the brown tone of the Florentine bronzes. This artificial "patina" can be produced in a great variety of tones, light or dark, but in every case it is preferable that a well-modelled work should have a dead unpolished surface. The decoration of a bronze work is a question of taste or fashion for which there is no rule, though no doubt for many the success of a work depends very often on its decoration.

Iron Founding.—The following observations, while bearing more or less on casting generally, refer more particularly to the art of the ironfounder.

The first consideration is the pattern from which the moulding is to be made, the planning of which necessitates a knowledge of shrinkage and cooling strains in heated metal. Founding operations are divided into 2 classes, known technically as green sand moulding and loam or dry sand moulding: the first, when patterns or duplicates are used to form the moulds; the second, when the moulds are built by hand without the aid of complete patterns. Founding involves a knowledge of mixing and melting metals such as are used in machine construction, the preparing and setting of cores for the internal displacement of the metal, cooling and shrinking strains, chills, and many other things that are more or less special, and can only be learned and understood from actual observation and practice.

Patterns.—The subjoined remarks on the conditions to be considered in pattern-making are condensed from Richards' valuable manual on 'Workshop Manipulation,' which is more than once referred to as an indispensable companion for the intelligent worker in metals. He enumerates the following points:—

(1) Durability, choice of plan and cost. Consider the amount of use that the patterns are likely to serve, whether they are for standard or special machines, and the quality of the castings so far as affected by the patterns. A first-class pattern, framed to withstand moisture and rapping, may cost twice as much as another that has the same outline, yet the cheaper pattern may answer almost as well to form a few moulds.

(2) Manner of moulding, and expense, so far as determined by the patterns. These last may be parted so as to be "rammed up" on fallow boards or a level floor, or the

patterns may be solid, and have to be bedded, as it is termed; pieces on the top may be made loose, or fastened on so as to "cope off;" patterns may be well finished so as to draw clean, or rough so that a mould may require a great deal of time to dress up after a pattern is removed.

(3) The soundness of such parts as are to be planed, bored, and turned in finishing. Determined mainly by how the patterns are arranged, by which is the top and which the bottom or drag side, the manner of drawing, and provisions for avoiding dirt and slag.

(4) Cores, where used, how vented, how supported in the mould, and how made. Cores of irregular form are often more expensive than external moulds, including the patterns; the expense of patterns is often greatly reduced, but is sometimes increased, by the use of cores, which may be employed to cheapen patterns, add to their durability, or ensure sound castings.

(5) Shrinkage. This is the allowance that has to be made for the contraction of castings in cooling, i. e. the difference between the sizes of the pattern and the casting—a simple matter apparently, which may be provided for in allowing a certain amount of shrinkage in all directions; but when the inequalities of shrinkage both as to time and degree are taken into account, the allowance to be made becomes a problem of no little complication.

(6) Inherent, or cooling strains. They may either spring and warp castings, or weaken them by maintained tension in certain parts—a condition that often requires a disposition of the metal quite different from what working strains demand.

(7) Draught. The bevel or inclination on the sides of patterns, to allow them to be withdrawn from the moulds without dragging or breaking the sand.

For most ordinary purposes, patterns are made of wood; but in very heavy parts of machinery, such as pulleys and gear wheels, iron patterns are preferable. As there must be always a proportion of loose sand and "scruff" in a casting, it is important to arrange the pattern so that this part shall come in the least disadvantageous position. Thus the top of a mould or "cope" contains the dirt, while the bottom or "drag side" is generally clean and sound: the rule is to arrange patterns so that the surfaces to be finished will come on the drag side. Expedients to avoid dirt in such castings as are to be finished all over, or on 2 sides, are various. Careful moulding and washing, to remove loose sand, is the first requisite; sinking heads, that rise above the moulds, are commonly employed when castings are of a form which allows the dirt to collect at one point. The quality of castings is governed by many other conditions, such as the manner of "gating" or flowing the metal into the moulds, the temperature and quality of the iron, the temperature and character of the mould.

Cores are employed mainly for the displacement of metal in moulds; they may be of green sand, and made to surround the exterior of a piece, as well as to make perforations or to form recesses within it. The term "core," in its technical sense, means dried moulds, as distinguished from green sand: thus, wheels or other castings are said to be "cast in cores" when the moulds are made in pieces and dried. Supporting and venting cores, and their expansion, are conditions to which especial attention is needed. When a core is surrounded with hot metal, it gives off, because of moisture and the burning of the "wash," a large amount of gas which must have free means of escape. In the arrangement of cores, therefore, attention must be had to some means of venting, which is generally attained by allowing them to project through the sides of the mould and communicate with the air outside. The venting of moulds is even more important than venting cores, because core vents only carry off gas generated within the core itself, while the gas from its exterior surface, and from the whole mould, has to find means of escaping rapidly from the flasks when the hot metal enters. If it were not for the porous nature of sand moulds, they would be blown to pieces as soon as the hot metal entered them; both because of the mechanical expansion of the gas, and often from explosion by combustion. But for securing vent for gas, moulds could be made

from plastic material, so as to produce fine castings, with clear sharp outlines. The means of supporting cores consist of "prints" and "anchors." Prints are extensions of the cores, which project through the casting and into the sides of the mould, to be held by the sand or flask. They have duplicates on the patterns, called "core prints," which should be of a different colour from the patterns. The amount of surface required to support cores is dependent upon their cubic contents, because the main force required is to hold them down, and not to bear their weight: the floating force of a core is as the difference between its weight and that of a solid mass of metal of the same size. When it is impossible, from the nature of castings, to have prints large enough to support the cores, this is effected by anchors,—pieces of iron that stand like braces between the cores and the flasks or pieces of iron imbedded in the sand to receive the strain of the anchors. Cores expand when heated, and require an allowance in their dimensions the reverse from patterns, especially when the cores are made upon iron frames. For cylindrical cores less than 6 in. diam., or less than 2 ft. long, expansion need not be taken into account by pattern-makers, but for large cores careful calculation is required.

Shrinkage, or the contraction of castings in cooling, is provided for by adding $\frac{1}{10}$ in. to $\frac{1}{2}$ in. to each foot in the dimensions of patterns. This is accomplished by employing a shrink rule in laying down pattern-drawings from the figured dimensions of the finished work. Inherent or cooling strains is a much more intricate subject. They may weaken castings, or cause them to break while cooling, or sometimes even after they are finished; and must be carefully guarded against, both in the preparation of designs and the arrangements of patterns, especially for wheels and pulleys with spokes, and for struts or braces with both ends fixed. The main difficulty resulting is that of castings being warped and sprung by the action of unequal strains, caused by one part cooling or "setting" sooner than another. This may be the result of unequal conducting power in different parts of a mould or cores, or it may arise from the varying dimensions of the castings, which contain and give off heat in the same ratio as their thickness. As a rule, the drag or bottom side of a casting cools first, especially if a mould rests on the ground, and there is not much sand between the casting and the earth; this is a common cause of unequal cooling, especially in large flat pieces. Air being a bad conductor of heat, and the sand usually thin on the cope or top side, the result is that the top of mould remains quite hot, while at the bottom the earth, being a good conductor, carries off the heat and cools that side first, so that the iron "sets" first on the bottom, afterwards cooling and contracting on the top.

The draught, or the taper required to allow patterns to be drawn readily, is another indefinite condition in pattern-making: may be $\frac{1}{16}$ in. to each foot of depth, or 1 in., or there may be no draught whatever. Patterns that are deep, and for castings that require to be parallel or square when finished, are made with the least possible amount of draught; a pattern in a plain form, that affords facilities for lifting or drawing, may be drawn without taper if its sides are smooth and well finished; pieces that are shallow and moulded often should, as a matter of convenience, have as much taper as possible; and as the quantity of draught can be as the depth of a pattern, we frequently see them made with a taper that exceeds 1 in. to the foot of depth.

Tools.—These include crucibles or furnaces for melting the metal; pots for carrying it to the moulds; moulding flasks and implements for packing them; clamps for holding the moulds.

Crucibles vary in size, shape, and composition, according to their destined uses. The so-called "plumbago" crucibles, made of graphite, are dearest but most durable. The cheaper kinds are made of pipeclay. They are charged with the metal to be melted, and placed in a sufficiently strong fire, such as that obtainable on a smith's forge. For considerable quantities of metal, the crucible is dispensed with, and the melting is conducted in a blast furnace.

The ironfounders' pot is illustrated in Fig. 6, and consists of an iron pot supported by a handle which is single at one end and double at the other. In very small operations this may be replaced by an iron ladle.

Very small articles can be cast in moulds made of stone, brick, or iron, the interior surfaces being first coated with a "facing" of soot, by holding over a smoky flame, to prevent adhesion of the metal when poured in. But for general casting operations, recourse is had to sand packed into "flasks" or "boxes" surrounding the pattern. The flask resembles a box, without top or bottom, and made in 2 sections, so that the top half may be lifted away from the bottom half, or joined to it by bolts to form the whole. Fig. 7 illustrates the upper "side" of a flask, in which *a* is a handle, *b* are the holes by which the metal is poured in, and *c* are lugs carrying pins which pass through corresponding holes in similar lugs on the bottom side. The pattern being placed in a flask of suitable size, the space intervening on all sides between the pattern and the

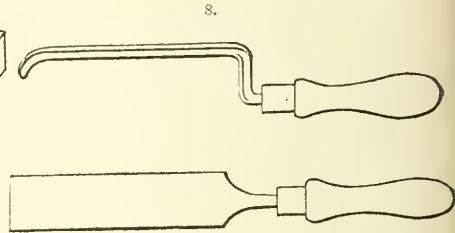
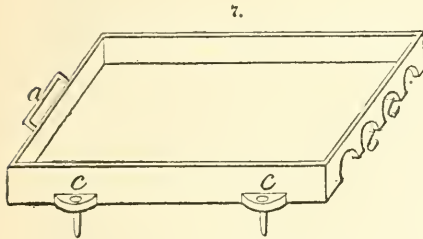
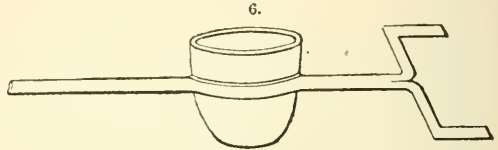

flask is packed in with sand, which, to be of suitable quality, must retain a ball shape on being squeezed in the hand, and exhibit an impression of the lines and inequalities of the skin surface that pressed it. The finest quality of sand is placed next the pattern, and the surface of the latter is dusted with dry "parting sand," to prevent adhesion. The packing of the sand is performed by the aid of a moulding-trowel (Fig. 8), which

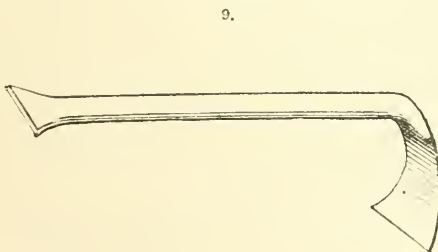

consists of a thin steel blade in a wooden handle; a moulding-wire (Fig. 9), useful for smoothing corners and removing dirt from the mould; and a stamper (Fig. 10), or pestle of hard wood or iron. Runner sticks of smooth tapering form are inserted in the holes *b* of the flask, to make feeding ways for the metal. When the impress of the

pattern has been properly taken in the mould, the pattern is removed, and the top and bottom sides of the flask are joined, enclosed on the open sides by thick boards, and transferred to a clamp (2 boards joined by adjustable screws) to prevent its giving way under the sudden and considerable pressure produced by the weight of metal poured in, and expansive tendency of the gases generated.

Casting in Sand.—The foregoing preparations having been completed, the metal may be poured in. But first, to prevent the metal being chilled by contact with the sand, the inside of the mould is painted over with a blacking made of charred oak, which evolves gases under the action of the hot iron, and prevents too close a contact between the metal and sand. The sand is also pierced with holes to allow of the escape of the air, and of gases evolved when the metal is poured in. If these are allowed to force their way through the metal, they will cause it to be unsound and full of flaws. The passages through which the molten iron is poured into the mould should be so arranged that the metal runs together from different parts at the same time. If one portion gets partially cool before the adjacent metal flows against it, there will be a clear division when they meet; the iron will not be run into one mass, but will form what is called a *cold shut*. The above is the simplest form of the process. When a casting is to be hollow, a pattern of its inner surface, called a “core,” is formed in sand, or other material, so that the metal may flow round it. This leads to arrangements in the pattern which are somewhat complicated. The core for a pipe consists of a hollow metal tube, having its surface full of holes. This is wound round with straw bands, and the whole is covered with loam turned and smoothed to the form of the inside of the pipe. The strength of a casting is increased if it be run with a “head” or superincumbent column of metal, which by its weight compresses the metal below, making it more compact, and free from bubbles, scoriæ, &c. These rise into the head, which is afterwards cut off. For the same reason, pipes and columns are generally cast vertically, that is when the mould is standing on end. This position has another advantage, which is that the metal is more likely to be of uniform density and thickness all round than if the pipe or column is run in a horizontal position. In the latter case, the core is very apt to be a little out of the centre, so as to cause the tube to be of unequal thickness. In casting a large number of pipes of the same size, iron patterns are used, as they are more durable than wooden ones, and draw cleaner from the sand. Socket pipes should be cast with their sockets downwards, the spigot end being made longer than required for the finished pipe, so that the scoriæ, bubbles, &c., rising into it may be cut off. Pipes of very small diameters are generally cast in an inclined position.

Casting in Loam.—Large pipes and cylinders are cast in a somewhat different way. A hollow vertical core of somewhat less diameter than the interior of the proposed cylinder is formed either in metal or brickwork. The outer surface of this is plastered with a thick coating of loam (which we may call A), smoothed and scraped to the exact internal diameter of the cylinder (by means of a rotating vertical template of wood), and covered with “parting mixture.” Over this is spread a layer of loam (B) thicker than the proposed casting; the outer surface of B is struck with the template to the form of the exterior of the proposed casting, and dusted with parting mixture. This surface is covered with a third thick covering of loam (C), backed up with brickwork, forming a “cope” built upon a ring resting on the floor, so that it can be removed. The outer brick cope is then temporarily lifted away upon the ring. The coating (B) is cleared out, and the cope is replaced so that the distance between its inner surface and the outer surface of A is equal to the thickness of the casting. The metal is then run in between C and A. When cool, C and A can be broken up, and the casting extracted. The core, &c., have to be well dried in ovens before the metal is run. B is often dispensed with, and the inner surface of C struck with the template.

Form of Castings.—The shape given to castings should be very carefully considered. All changes of form should be gradual. Sharp corners or angles are a source of weakness

This is attributed to the manner in which the crystals composing the iron arrange themselves in cooling. They place themselves at right angles to the surfaces forming the corner, so that between the two sets of crystals there is a diagonal line of weakness. All angles, therefore, both external and internal, should be rounded off. There should be no great or abrupt differences in the bulk of the adjacent parts of the same casting, or the smaller portions will cool and contract more quickly than the larger parts. When the different parts of the casting cool at different times, each acts upon the other. The parts which cool first resist the contraction of the others, while those which contract last compress the portions already cool. Thus the casting is under stress before it is called upon to bear any load. The amount of this stress cannot be calculated, and it is therefore a source of danger in using the casting. In some cases it is so great as to fracture the casting before it is loaded at all. The internal stress, produced by unequal cooling in the different parts of a casting, sometimes causes it to break up spontaneously several days after it has been run. Castings should be covered up and allowed to cool as slowly as possible; they should remain in the sand until cool. If they are removed from the mould in a red-hot state, the metal is liable to injury from too rapid and irregular cooling. The unequal cooling and consequent injury, caused by great and sudden differences in the thickness of parts of a casting, are sometimes avoided by uncovering the thick parts so that they may cool more quickly, or by cooling them with water. It is generally thought that molten cast-iron expands slightly just at the moment when it becomes solid, which causes it to force itself tightly into all the corners of the mould, and take a sharp impression. This, however, has been disputed. Superior castings should never be run direct from the furnace. The iron should be remelted in a cupola. This is called "second melting;" it greatly improves the iron, and gives an opportunity for mixing different descriptions which improve one another. Castings required to be turned or bored, and found to be too hard, are softened by being heated for several hours in sand, or in a mixture of coal-dust and bone-ash, and then allowed to cool slowly.

Examination of Castings.—In examining castings, with a view to ascertaining their quality and soundness, several points should be attended to. The edges should be struck with a light hammer. If the blow make a slight impression, the iron is probably of good quality, provided it be uniform throughout. If fragments fly off and no sensible indentation be made, the iron is hard and brittle. Air bubbles are a common and dangerous source of weakness. They should be searched for by tapping the surface of the casting all over with the hammer. Bubbles, or flaws, filled in with sand from the mould, or purposely stopped with loam, cause a dulness in the sound which leads to their detection. The metal of a casting should be free from scoriae, bubbles, core nails, or flaws of any kind. The exterior surface should be smooth and clear. The edges of the casting should be sharp and perfect. An uneven or wavy surface indicates unequal shrinkage, caused by want of uniformity in the texture of the iron. The surface of a fracture examined before it has become rusty should present a fine-grained texture, of an uniform bluish-grey colour and high metallic lustre. Cast-iron pipes should be straight, true in section, square on the ends and in the sockets, the metal of equal thickness throughout. They should be proved under a hydraulic pressure of 4 or 5 times the working head. The sockets of small pipes should be especially examined, to see if they are free from honeycomb. The core nails are sometimes left in and hammered up. They are, however, objectionable, as they render the pipe liable to break at the points where they occur.

As there is an endless variety of patterns from which moulds are made, it will be necessary to divide them into light and heavy work. Stove castings are very light. In the moulding of such work, much depends upon the quality of sand used; the moulders' heap should be composed of no more than $\frac{1}{2}$ loam, the other $\frac{1}{2}$ being a very open sand. This makes a good strong mixture, which will not allow the sharp corners and fine ornamental work to be washed away when the molten iron is poured into the mould. In

ramming such work, the moulder should be careful that the sand on top and bottom of his pattern is not rammed hard; but the sides or edges should be well rammed, in order that the casting may not strain from having a soft parting. Great care should be taken to see that the bottom board is well bedded on the flask, after which it should be removed and the vent wire used freely. The venting of the work is often but partially done, on account of the point of the vent wire coming into contact with the pattern; and when the iron enters the mould, it finds its way into said vents, fills them up, and thus, in a measure, prevents the escape of the gas that arises from the iron coming in contact with the charcoal, graphite, or soapstone with which the mould has been dusted to prevent the sand from adhering to the casting. The bottom board should then be carefully replaced on the flask, and dogged down so that in the act of turning it over it cannot move, which would cover the vents over with sand. The top part of the flask (or cope, as it is termed) needs the same care in ramming over the pattern as the bottom, and should be well vented. If the mould has any high projections in the cope, they should be well vented; for it is at these elevated points that a large portion of the gas accumulates and needs a quick exit, in order to make sharp corners on the casting and prevent blowing. The strainings of castings in this branch of the trade is greatly due to an insufficient amount of weight being placed on the flask, or the parts not being properly dogged together, as well as to the rapidity with which the iron is poured into the mould, together with the height of the runner. Cutting short the supply of iron as soon as the runner is full, and a careful watching of the work to be poured, will in most cases remedy the trouble of the casting being thicker than the pattern.

As to the warping of the plates, much depends upon the quality of iron used and the judgment of the pattern-maker. It can often be prevented, in a measure, by the moulder, in making the runner from the round sprue no thicker than the piece to be cast; and as soon as the metal is poured, by digging away in front of the sprue and breaking it loose from the casting. Where a flat sprue is used, this breaking off should invariably be done as soon as the runner is cool enough. Being wedge-shaped, with the small end of the wedge downwards, it lifts a portion of the casting in shrinking, and thus causes it to be out of shape.

In heavy work, care and judgment are needed, and it requires a man's lifetime to become proficient. In ramming work that is to be poured on its end, having a height of 3 or 4 ft., there is no risk in well packing the sand, for $\frac{2}{3}$ its height, around the pattern; and as you near the top, ram it as you would a pattern no more than 1 ft. in thickness. The sand in all such work should be very open or porous, in order to prevent scabbing. As there is so large a quantity of iron used, much steam and gas are generated in the mould; and as there is no other way of escape for them but through the vents, there should be no fault in this particular part of the mould. In the pouring of such work, it is best to run it from the bottom. If a runner is used, do not raise the risers to correspond in height with the runner, as by so doing you increase the amount of strain on the mould; but form a little basin around the risers by ramming out the sprue holes with the finger, and on the side nearest the outer edge of the flask form a lip for the surplus iron in the runner to run over on to the floor. When heavy work is bedded in the floor, too much care cannot be taken in preventing the dampness of the ground beneath from striking through into the mould. The sand that is thrown out of the pit, if it has been of long standing, should not be used for the moulding of that piece; for it is too cold and damp and should be thrown on one side, and allowed to stand, that it may dry and warm up. The 2 or 3 ladlefals of iron that remain in the furnace after the work on the floor has been poured, can be run into pigs in this sand, which will greatly help to fit it for immediate use. In the venting of heavy work, the small vents should terminate in a number of large ones, which should have an opening on both sides of the mould: then a draught would be formed to carry off the gas which is continually growing as the workman is in the act of pouring the iron into the mould.

All men connected with this branch of the trade have heard that sharp report which immediately follows the pouring of a large piece, and which is caused by the confined gas in the lower end of a large vent, there being no draught to drive it out. Where facing is used, much more care is needed in venting. In the making of large pulleys and gear-wheels, too much care cannot be taken in this particular. Not so much depends upon the ramming of such work as upon the venting for the proper exit of the gas from the sand in the immediate vicinity of the mould; for if the mould has been rammed harder than there was any necessity for, and the venting has been properly looked after, there is not much danger of the casting being a poor one. Such work should invariably be run from the hub or centre, with sufficient risers, arranged as above described. This branch of the trade is called green-sand work, and it involves a large part of the art of ramming.

Shrinkage of Iron Castings.—The chief trouble with iron castings is their liability to have internal strains put upon them in cooling, in consequence of their shrinking. The amount of this shrinkage varies with the quality of the metal, and with the size of the casting and its comparative thickness. Thus locomotive cylinders shrink only about $\frac{1}{16}$ in. per ft. (1-192 = .0052), while heavy pipe castings and girders shrink $\frac{1}{10}$ in. per ft. (1-120 = .0083), or even $\frac{1}{8}$ in. per ft. (1-96 = .0104). While small wheels shrink only $\frac{1}{32}$ in. per ft. (1-300 = .0033), large and heavy ones contract $\frac{1}{10}$ in. per ft. (1-120 = .0083). The "shrink-rule" is employed by pattern-makers to relieve them of the labour of calculating these excesses, the scales being graduated to inches, &c., which are .0052, .0083, &c., too long. Now, if thick metal proportionately shrinks more than thin, we must expect any casting not absolutely symmetrical in every direction to change its form or proportion. A cubic or spheric mould yields a cube or a sphere as a casting; but a mould, say of the proportions of $100 \times 5 \times 1$, shrinking differently according to dimensions, gives a casting not only less in size but in somewhat different proportion. In many cases we still find them strained and twisted. Those parts which cool first get their final proportions, and the later cooling portions strain the earlier, the resistance of which to deformation puts strains on those cooling. This initial strain may of itself break the casting, and, if not, will weaken it. Castings of excessive or varying thickness, and of complicated form, are most in danger from internal strain. This strain is gradually lessened in time by the molecules "giving." In a casting such as *a* (Fig. 11), say a thick press cylinder, the outer layers solidify and shrink first, and as the inner layers contract after the outer ones have "set," there is compression of the outer layers and tension of the inner. Such a cylinder will, if subjected to internal pressure, be weak, because there is already in the inner layers a force tending to expand them. The cylinder

11.

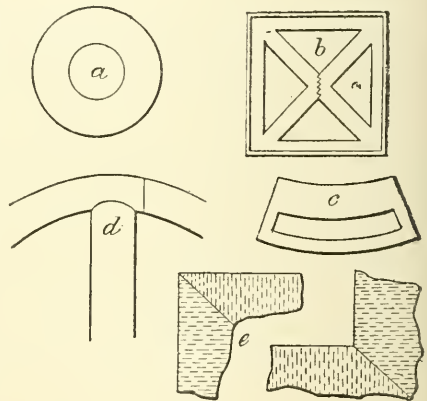

would be stronger if these layers were braced to resist extension, or, in other words, were already in compression. If we cool the interior first, by artificial means, while delaying the cooling of the exterior layers, we have these layers braced to receive gradual or sudden pressure, and this is especially desirable in cannon. In a panel like *b*, with a thin but rigid flange, the diagonals shrink more slowly than the rim, and a crack is likely to appear. A casting like that in *c* would solidify on the thin

side first, and when the thick side shrank, it would curve the bar and compress the thick part, and put the thin in tension. Wheel and pulley castings are especially troublesome. The latter have a thin rigid rim, which cools before the arms, and when the latter cool they are very apt to break by tension. If the arms set first, they are apt to break the rim, as they make a rigid abutment which resists the rim-contraction, bending the rim and breaking it from within outwards. In the cooling of castings, the particles range themselves in crystals perpendicular to the cooling surface; hence we may expect to find weak points at sharp corners, as in *e*. The remedy for this is to round off all angles.

Chilling Iron Castings.—The service part of a casting that is wanted to retain a certain shape, size, and smoothness, and to withstand constant wear and tear, can in most cases be chilled, when cast, by forming the shape of iron instead of sand. The iron mould or chill, when made of cast-iron, should be of the best strong iron, having very little contraction, as the sudden heating of the surfaces by the melted iron is liable to crack it, so that in a short time the face will be full of small cracks or raised blisters. When melted grey iron is poured around or against the surface of solid iron, it is chilled $\frac{1}{8}$ in. to 1 in. in depth, depending on the hardness and closeness of the iron the mould is poured with. In order to chill this iron as deep as $1\frac{1}{2}$ in. and upward, there must be some cast steel melted in the cupola. The proportion will depend on the quality of the iron and steel used. Steel borings can be put into the ladles, and the hot iron let mix with them; but the best plan is to have some old steel castings or pieces of steel rails, and melt them in the cupola, and when the iron is in the ladle, mix or stir the metal with a large rod. With strong, close iron, about 1 part steel to 5 of iron will cause a chill of $1\frac{1}{2}$ in. Iron for making chilled castings should be strong, as chilling iron impairs its strength. An iron that contracts very little in cooling is of the greatest importance in keeping chilled castings from checking or cracking.

The following may explain the cause of chilled casting being bad.

Melted iron, when poured inside a chill, similar to a roll or car-wheel chill, cools and forms a shell in a very short time, the thickness of which will depend on the hardness and temperature of the iron. It is during the course of the first 2 or 3 minutes that the checking or cracking takes place; for as soon as melted iron commences to cool or freeze, it starts to contract more or less, and as the shell thus formed becomes cool, or half-molten, it contracts and leaves the surface of the chill, so that the contracting shell stands, or holds in the pressure of the liquid iron inside. Should the mould not be dead level, the inside liquid metal will have the most pressure at the lowest point of the shell, and will cause this part to burst open. A check or crack never starts at the top part of a mould, but always at the bottom, and if you look closely at one of these cracks you will see it is the largest at the bottom, and running up to nothing. In some cases you can see where the inside liquid iron has flowed out, and partly filled up the crack.

So far as mixing the iron is concerned, it will stand a deal of variation, and it is a poor excuse for a moulder to put the blame on the melter for 3 or 4 bad wheels out of a heat of 16. If he would make a straight edge that would reach across the top and come down on to the turned level face of the chill, and then level his flasks instead of dumping them in any shape, the melter would not get blamed so much as he does for cracked wheels.

In making chilled rolls, the temperature of the iron is as important a point as it is in the manufacture of car-wheels. The iron should be poured as dull as possible, for the duller the iron the quicker and thicker is the outside shell formed, thereby offering a stronger resistance to the pressure of the inside liquid iron. Of course, the moulder must use his judgment in cooling off the iron, for if too dull, the face of the chilled part will be cold shut, and look dirty. The rolls should be poured quickly at the neck, and the gates cut, so as to whirl the iron and keep all dirt in the centre and away from the face of the chill. When the mould is full, do not put in the feeding-rod until the

neck is about to freeze up. When you do put it in, do not ram it down suddenly so as to cause a pressure on the contracting shell, which would be liable to crack it. When feeding, work the rod slowly. It is better to make the chills as hot as possible by heating them in the oven, as the iron will lie closer and make a smoother casting against a hot chill than when poured against a cold one. By having the mould dead level, the pressure will be equal all around. Whenever there is a check or crack, you may depend that it is caused by unequal pressure of the confined liquid metal against the contracting shell.

FORGING AND FINISHING.—These terms are defined by Richards, in his ‘Workshop Manipulation,’ in the following words: “Forging relates to shaping metal by compression or blows when it is in a heated or softened condition; as a process it is an intermediate one between casting and what may be called the cold processes. Forging also relates to welding or joining pieces together by sudden heating that melts the surface only, and then by forcing the pieces together while in this softened or semi-fused state. Forging includes, in ordinary practice, the preparation of cutting tools, and tempering them to various degrees of hardness as the nature of the work for which they are intended may require; also the construction of furnaces for heating the material, and mechanical devices for handling it when hot, with the various operations for shaping. Finishing and fitting relate to giving true and accurate dimensions to the parts of machinery that come in contact with each other and are joined together or move upon each other, and consist in cutting away the surplus material which has to be left in founding and forging because of the heated and expanded condition in which the material is treated in these last processes. In finishing, material is operated upon at its normal temperature, in which condition it can be handled, gauged, or measured, and will retain its shape after it is fitted. Finishing comprehends all operations of cutting and abrading, such as turning, boring, planing, and grinding, also the handling of material; it is considered the leading department in shop manipulation, because it is the one where the work constructed is organized and brought together. The fitting shop is also that department to which drawings especially apply, and other preparatory operations are usually made subservient to the fitting processes. A peculiarity of forging is that it is a kind of hand process, where the judgment must continually direct the operations, one blow determining the next, and while pieces forged may be duplicates, there is a lack of uniformity in the manner of producing them. Pieces may be shaped at a white welding heat or at a low red heat, by one or two strong blows or by a dozen lighter blows, the whole being governed by the circumstances of the work as it progresses. A smith may not throughout a whole day repeat an operation precisely in the same manner, nor can he, at the beginning of an operation, tell the length of time required to execute it, nor even the precise manner in which he will perform it. Such conditions are peculiar, and apply to forging alone.”

The technical phrases employed in forging are thus explained by Cameron Knight:—

To “make up a stock.”—The “stock” is that mass of coal or coke which is situated between the fire and the cast-iron plate, through the opening in which the wind or blast is forced. The size and shape of this stock depend upon the dimensions and shape of the work to be produced. To make up a stock is to place the coal in proper position around the taper-ended rod, which is named a “plug.” The taper end of the plug is pushed into the opening from which comes the blast; the other end of the plug is then laid across the hearth or fireplace, after which the wet small coal is thoroughly battered over the plug while it remains in the opening, and the coal piled up till the required height and width of the stock is reached; after which the plug is taken out and the fire made, the blast in the meantime freely traversing the opening made in the stock by the plug.

Fire-irons.—These consist of a poker with small hook at one end, a slice, and rake. The poker with small hook is used for clearing away the clinker from the blast-hole, also for holding small pieces of work in the fire. The slice is a small flat shovel or spade, and is used for battering the coal while making up a stock. The slice is also used for adding coal to the fire when only a small quantity is required at one time. The rake consists of a rod of iron or steel with a handle at one end, and at the other a right-angle bend of flat iron, and is used to adjust the coal or coke into proper position while the piece to be forged is in the fire.

Rod.—This term is usually applied to a long slender piece of iron, whose section is circular.

Bar.—Bar signifies a rod or length of iron whose section is square, or otherwise angular, instead of circular.

Plate.—This term is applied to any piece of iron whose length and breadth very much exceed its thickness. Thin plates of iron are termed “sheets.”

To “take a heat.”—This signifies to allow the iron to remain in the fire until the required heat is obtained. To “take a welding heat” is to allow the iron to remain in the fire till hot enough to melt or partially melt.

To “finish at one heat” is to do all the required forging to the piece of work in hand by heating once only.

To “draw down.”—Drawing down signifies reducing a thick bar or rod of iron to any required diameter. There are several methods of drawing down: by a single hammer in the hand of one man; by a pair of hammers in the hands of 2 men; 5 or 6 hammers may be also used by 5 or 6 men. Drawing down is also effected by steam-hammers, air-hammers, and rolling-mills.

To “draw away.”—This term signifies the same as to draw down.

To “upset.”—This operation is the reverse of drawing down, and consists in making a thin bar or rod into a thick one; or it may consist in thickening a portion only, such as the middle or end, or both ends. The operation is performed by heating the iron to a yellow heat, or what is named a white heat, and placing one end upon the anvil, or upon the ground, and striking the other end with 3 or 4 hammers, as required. Iron may be also upset, while in the horizontal position, by pendulum hammers and by the steam-striker, which will deliver blows at any angle from horizontal to vertical.

Scarfing.—This operation includes 2 processes—upsetting and bevelling. Scarfing is resorted to for the purpose of properly welding or joining 2 pieces of iron together. When the pieces are rods or bars, it is necessary to upset the 2 ends to be welded, so that the hammering which unites the pieces shall not reduce the iron below the required dimensions. After being upset, the 2 ends are bevelled by a fuller or by the hammer.

Butt-weld.—When a rod or bar is welded to another bar or plate, so that the joint shall be at right angles to the bar, it is termed a butt-weld.

Tongue-joint.—This joint is made by cutting open the end of a bar to be welded to another, whose end is tapered to fit the opening, and then welding the 2 bars together.

To “punch” is to make a hole, either square or round, in a piece of iron by means of square or round taper tools, named punches, which are driven through the iron by hand-hammers or by steam-hammers.

To “drift out” is to enlarge a hole by means of a taper round or square tool, named a drift.

The hammerman is the assistant to the smith, and uses the heavy hammer, named the sledge, when heavy blows are required.

The Tuyere or Tweer.—This is a pipe through which the blast of air proceeds to the stock, and thence to the fire. The nozzle of the tweer is the extreme end or portion of the tweer which is inserted into the opening of the plate against which the stock is built. (‘Mechanician and Constructor.’)

Forges or Hearths.—These are made in a great variety of form and size, some obtaining the necessary blast by means of bellows, others by rotary fans or blowers; some with a single and others with a double blast; some with, others without hoods; according to the work they are destined for. Fig. 12 illustrates a “cyclops” circular forge, with a pan 20 in. across, weighing altogether 106 lb., and costing 90s.; this size is only suited for riveting. The blast is produced by a small rotary blower. The square form of pan, 34 in. by 26 in., will heat 2-in. round iron, weighs 2 cwt., and costs 140s. Fig. 13 is a portable forge, the pan consisting of a box made with thin iron plates, 19 in. square and 9 in. high when closed, as shown at B, and capable of containing all the tools accompanying the forge, as well as the bellows and legs. This forge is made by Schaller, of Vienna, and is much used in the Austrian army. In large forges the tuyere pipe feeding the blast to the fire is rendered more durable by the constant application of a stream of cold water.

Anvils.—An anvil is an iron block, usually with a steel face, upon which metal is hammered and shaped. The ordinary smith’s anvil, Figs. 14 and 15, is one solid mass of metal,—iron in different states; C is the core or body; B, 4 corners for enlarging the base; D, Fig. 14, the projecting end; it contains one or two holes for the reception of set chisels in cutting

12.

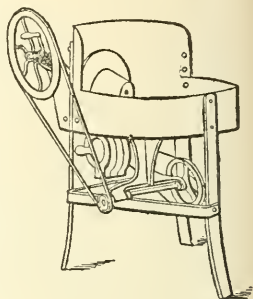

13.

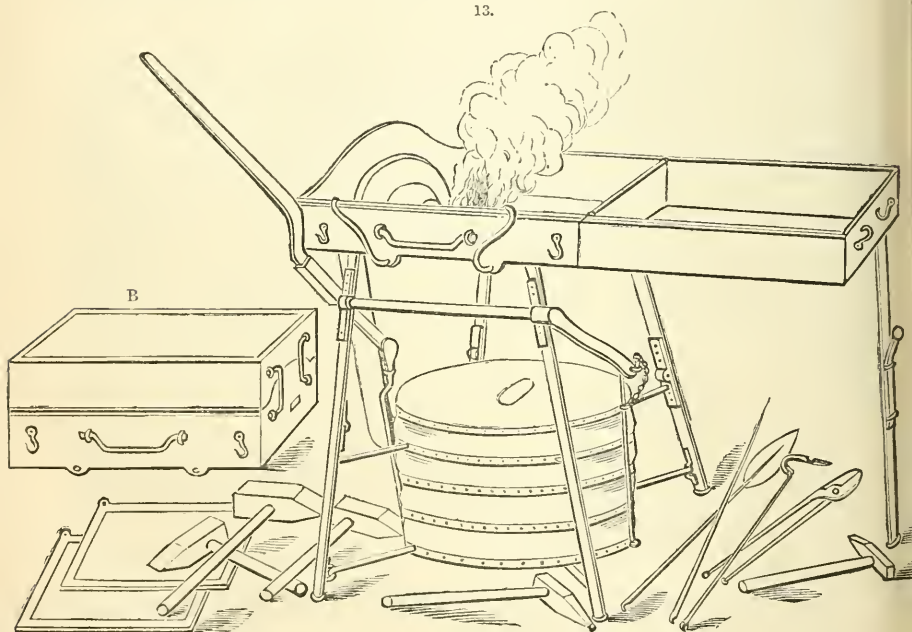

pieces of iron, or for the reception of a shaper, as shown at E, Fig. 15. In punching flat pieces of metal, in forming the heads of nails or bolts, and in numerous other cases, these holes *a* of ordinary anvils are not only useful but indispensable. The beak-

horn A is used for turning pieces of iron into a circular or curved form, welding hoops, and for other similar operations. In the smithery, the anvil is generally seated on the root end of a beech or oak tree; the anvil and wooden block must be firmly connected, to render the blows of the hammer effective; and if the block be

14.

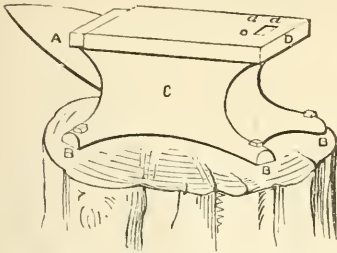

15.

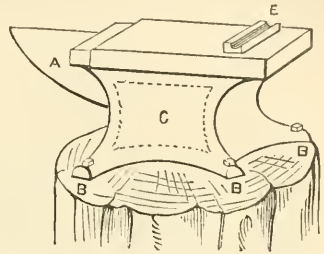

not firmly connected to the earth, the blows of the hammer will not tell. The best anvils, anvil-stakes, and planishing hammers are faced with double shear-steel. The steel-facings are shaped and laid on a core at a welding heat, and the anvil is completed by being reheated and hammered.

When the steel-facing is first applied, it is less heated than the core. But the proper hardening of the face of the anvil requires great skill; the face must be raised to a full red-heat, and placed under a descending column of water, so that the surface of the face may continue in contact with the successive supply of the quenching fluid, which at the face retains the same temperature, as it is rapidly supplied. The

16.

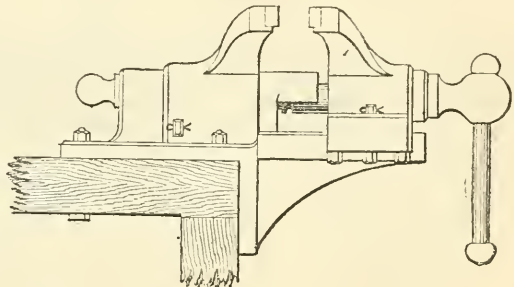

rapidity of the flow of water may be increased by giving a sufficient height to its descending column; it is important that the cooling stream should fall perpendicularly to the face which is being hardened. Heat may escape parallel to the face, but not in the direction of the falling water.

The operator, during this hardening process, is protected from spray and smoke by a suitable cover, and by confining the falling water to a tube which must contain the required volume. When an anvil is to be used for planishing metals, it is polished with emery and crocus powders. It is better to be too heavy than too light, and may range from 2 to 5 cwt., according to the work to be done on it. On being tapped with a hammer, it should give out a clear ringing note. It is generally used with the tail (square) end towards the right hand, and the horn (beak iron) towards the left.

17.

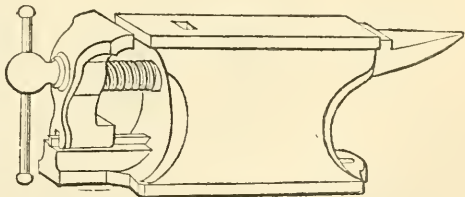

On being tapped with a hammer, it should give out a clear ringing note. It is generally used with the tail (square) end towards the right hand, and the horn (beak iron) towards the left.

Vices and Tongs.—Of vices there is a great variety; Fig. 16 is a typical example

of a malleable iron parallel vice. Fig. 17 is a useful little combined anvil and vice, face 10 in. by 4, 4-in. jaw, weight 40 lb., costing 22s. 6d. Tongs are usually home-made, and will be described further on.

Hammers.—Upon the principles underlying the shapes, sizes, and uses of hammers, much will be found under the heading of Carpentry. A few representative forms of hammer head are shown in Figs. 18, 19: *a* to *d* are used by engineers and mechanics,

18

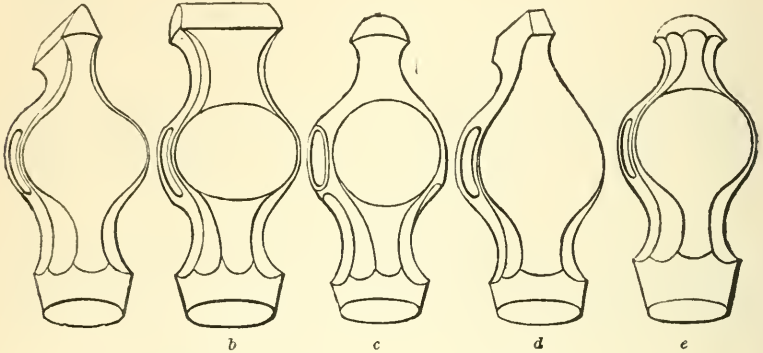

e to *k* by boiler-makers, while *l* is a sledge hammer. All but *l* are hand-hammers. They differ mainly in the form of the pane, the head remaining pretty much the same; *a* is a cross pane, *b* a straight pane, *c* a ball pane, and so on. Hand-hammers mostly range between 1 and 4 lb. in weight; chipping hammers, $\frac{1}{2}$ – $1\frac{1}{2}$ lb.; riveting hammers, $\frac{1}{2}$ –2 lb.;

19.

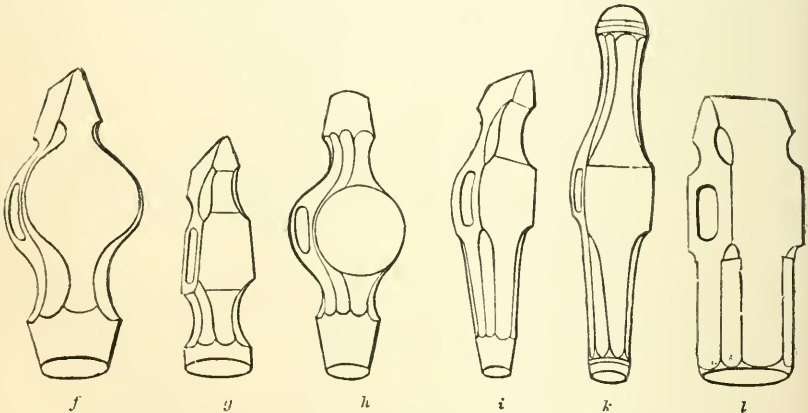

sledge hammers not exceeding 8 lb. in weight are “uphanded,” i. e. only raised to a little above the shoulder, while the heavier ones (8–16 lb.) are “swung” in a complete circle. The machinists’ hammer is made heavier at the face than at the pane end, so that the hammer will naturally assume a position in the hand with the face downwards, thus relieving the workman from the necessity of specially forcing it into that position. In using a hammer it is essential to study the difference between a sharp blow with a

light hammer and a slow blow with a heavy one: the former penetrates farthest and gives least lateral pressure; while the latter penetrates less and spreads more sideways.

Cutting Tools.—The following remarks are in the main condensed from a lecture on Chisels and Chisel-shaped Tools, delivered by Joshua Rose before the Franklin Institute, Philadelphia.

In Figs. 20 and 21 are shown the shapes in which flat chisels are made. The difference between the two is that, as the cutting edge should be parallel with the flats on the chisel, and as Fig. 20 has the widest flat, it is easier to tell with it when the cutting edge and the flat are parallel; therefore the broad flat is the best guide in holding the chisel level with the surface to be chipped. Either of these chisels is of a proper width for wrought-iron or steel, because chisels used on these metals take all the power to drive that can be given with a hammer of the usual proportions for heavy clipping, which is—weight of hammer, 1 $\frac{3}{4}$ lb.; length of hammer handle, 13 in.; the handle to be held at its end and swinging back about vertically over the shoulder.

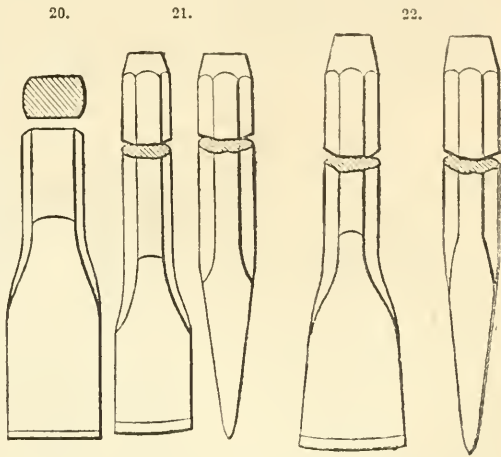

If so narrow a chisel be used on cast-iron or brass, with full-force hammer blows, it will break out the metal instead of cutting it, and the break may come below the depth wanted to chip, and leave ugly cavities. So for these metals the chisel must be made broader, as in Fig. 22, so that the force of the blow will be spread over a greater length of chisel edge, and the edge will not move forward so much at each blow, therefore it will not break the metal out.

Another advantage is that the broader the chisel the easier it is to hold its edge fair with the work surface and make smooth chipping. The chisel point must be made

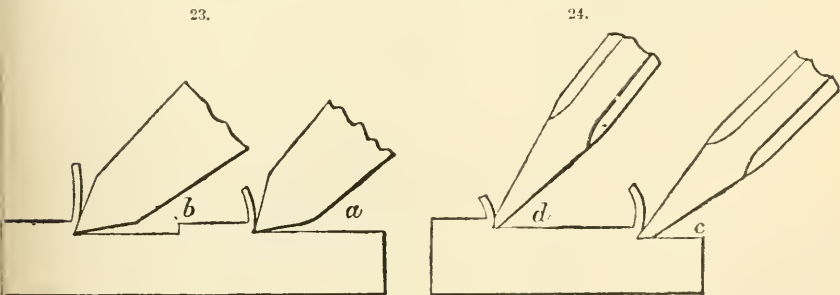

as thin as possible, the thickness shown in the sketches being suitable for new chisels. In grinding the 2 facets to form the chisel, be careful to avoid grinding them rounded, as shown in *a* in the magnified chisel ends in Fig. 23; the proper way is to grind them flat, as at *b* in the sketch. Make the angle of these 2 facets as acute as you can, because the chisel will then cut easier.

The holding angle at *c*, in Fig. 24, is about right for brass, and that at *d* is about right for steel. The difference is that with hard metal the more acute angle dulls too quickly.

Considering the length of the cutting, it may for heavy chipping be made straight, as in Fig. 20, or curved, as in Fig. 22, which is the best, because the corners are relieved of duty and are therefore less liable to break. The advantage of the curve is greatest in fine chipping, because, as seen in Fig. 25, a thin chip can be taken without cutting with the corners, and these corners are exposed to the eye in keeping the chisel edge level with the work surface.

In any case you must not grind the chisel hollow in its length, as in Fig. 26, or as shown exaggerated in Fig. 27, because in that case the corners will dig in and cause the

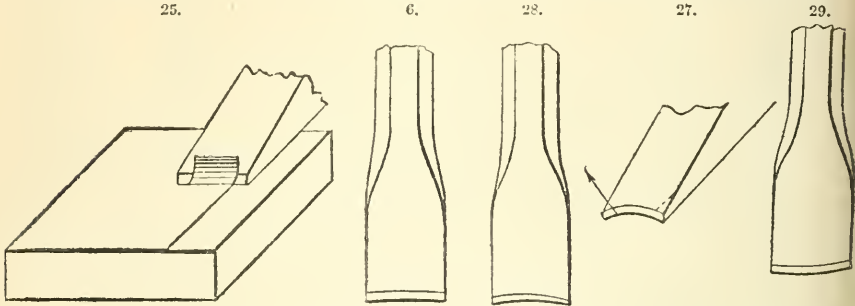

chisel to be beyond control; besides that, there will be a force that, acting on the wedge principle and in the direction of the arrows, will operate to spread the corners and break them off.

Do not grind the facets wider on one side than on the other of the chisel, as in Fig. 28, because in that case the flat of the chisel will form no guide to let you know when

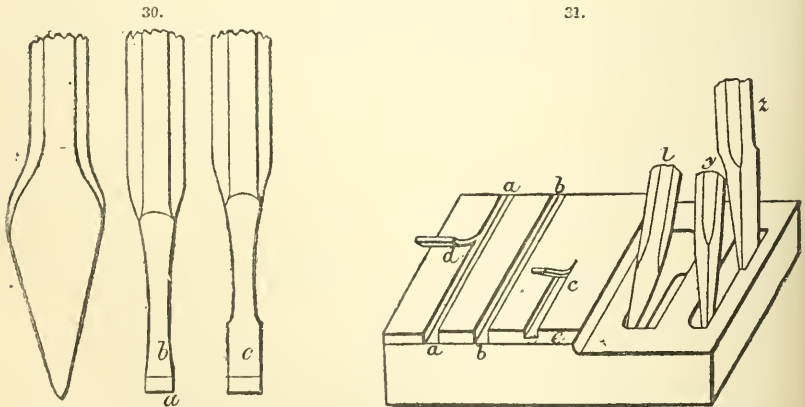

the cutting edge is level with the work surface. Nor must you grind it out of square with the chisel body, as in Fig. 29, because in that case the chisel will be apt to jump sideways at each hammer blow.

A quantity of metal can be removed quicker by using the cape chisel in Fig. 30, to

first cut out grooves, as at *a*, *b*, and *c* in Fig. 31, spacing these grooves a little narrower apart than the width of the flat chisel, and thus relieving its corners. It is necessary to shape the end of this chisel as at *a* and *b*, and not as at *c*, as in Fig. 30, so as to be able to move it sideways to guide it in a straight line, and the parallel part at *c* will interfere with this, so that if the chisel is started a very little out of line it will go still farther out of line, and cannot be moved sideways to correct this.

The round-nosed chisel, Fig. 32, must not be made straight on its convex edge: it may be straight from *h* to *g*, but from *g* to the point it must be bevelled so that by altering the height of the chisel head it is possible to alter the depth of the cut.

The cow-mouthed chisel, Fig. 33, must be bevelled in the same way, so that when

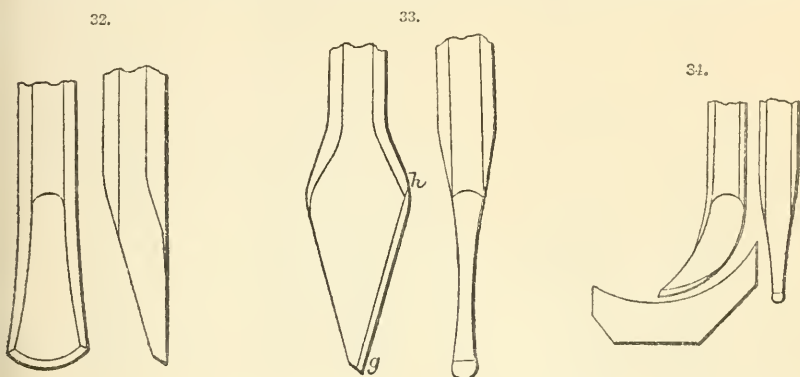

used to cut out a round corner, as at *l* in Fig. 31, you can move the head to the right or to the left, and thus govern the depth of its cut.

The oil groove chisel in Fig. 34 must be made narrower at *a* than it is across the curve, as it will wedge in the groove it cuts.

The diamond-point chisel in Figs. 35 and 36 must be shaped to suit the work, because if it is not to be used to cut out the corners of very deep holes, you can bevel it at *m* and thus bring its point *x* central to the body of the steel, as shown by the dotted line *q*, rendering the corner *x* less liable to break, which is the great trouble with this chisel. But as the bevel at *m* necessitates the chisel being leaned over as at *y* in Fig. 31, it could in deep holes not be kept to its cut; so you must omit the bevel at *m*, and make that edge straight as at *r* in Fig. 36.

The side chisel obeys just the same rule, so you may give it bevel at *w* in Fig. 37 for shallow holes, and lean it over as at *z* in Fig. 31, or make the side *vw* straight along its whole length, for deep ones; but in all chisels for slots or mortices it is desirable to have, if the circumstances will permit, some bevel on the side that meets the work, so that the depth of the cut can be regulated by moving the chisel head.

In all these chisels, the chip on the work steadies the cutting end, and it is clear that the nearer you hold the chisel at its head the steadier you can hold it, and the less the liability to hit your fingers, while the chipped surface will be smoother.

To take a chip off a piece of wrought iron, if it is a heavy chip, stand well away from the vice, as an old hand would do, instead of close to it, as would be natural in an un instructed beginner. In the one case the body is lithe and supple, having a slight motion in unison with the hammer; while in the other it is constrained, and not only feels but looks awkward. If, now, you wish to take a light chip, you must stand nearer to the work, so that you can watch the chisel's action and keep its depth of cut level. In both cases you push the chisel forward to its cut and hold it as steadily as you can. It

is a mistake to move it at each blow, as many do, because it cannot be so accurately maintained at the proper height. Light and quick blows are always necessary for the finishing cuts, whatever the kind of metal may be.

With the side chisel there must be a bevel made at the end in order to enable the depth of cut to be adjusted and governed, for if you happened to get the straight chisel too deeply into its cut, you cannot alter it, and unless you begin a new cut it will

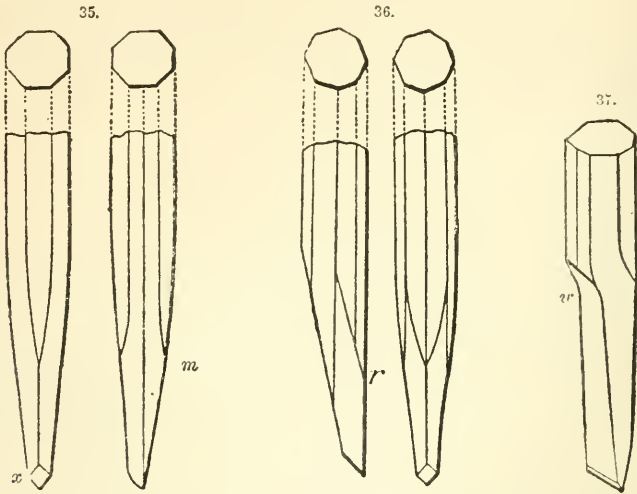

get embedded deeper, and will finally break. But with this side chisel (Fig. 37) that is slightly bevelled, you can regulate the depth of cut, making it less if it gets too deep, or deeper if it gets too shallow.

The chisel that is driven by hammer blows may be said to be to some extent a connecting link between the hammer and the cutting tool, the main difference being that the chisel moves to the work while the work generally moves to the cutting tool. In many stone-dressing tools the chisel and hammer are combined, inasmuch as that the end of the hammer is chisel shaped, an example of this kind of tool being given in the pick that flour millers use to dress their grinding stones. On the other hand, we may show the connection between the chisel and the cutting tool by the fact that the wood-worker uses the chisel by driving it with a mallet, and also by using it for a cutting tool for work driven in the lathe. Indeed, we may take one of these carpenters' chisels, and fasten it to the revolving shaft of a wood-planing machine, and it becomes a planing-knife; or we may put it into a carpenters' hand plane, and by putting to the work it becomes a plane blade. In each case it is simply a wedge whose end is made more or less acute so as to make it as sharp as possible, while still retaining strength enough to sever the material it is to operate upon.

In whatever form we may apply this wedge, there are certain well-defined mechanical principles that govern its use. Thus, when we employ it as a hand tool its direction of motion under hammer blows is governed by the inclination of that of its faces which meets the strongest side of the work, while it is the weakest side of the material that moves the most to admit the wedge, and, therefore, becomes the chip, cutting, or shaving. In Fig. 38, for example, we have the carpenters' chisel operating at *a* and *b* to cut out a recess or mortice, and it is seen that so long as the face of the chisel that is next to the work is placed level with the straight surface of the work, the

depth of cut will be equal, or, in other words, the line of motion of the chisel is that of the chisel face that lies against the work. At *c* and *d* is a chisel with, in the one instance, the straight, and in the other the bevelled face toward the work surface. In both cases the cut would gradually deepen because the lower surface of the chisel is not parallel to the face of the work.

If now we consider the extreme cutting edge of the chisel or wedge-shaped tools, it will readily occur that but for the metal behind this fine edge the shaving or cutting would come off in a straight ribbon, and that the bend or curl that the cutting assumes increases with the angle of the face of the wedge that meets the cutting, shaving, or chip. For example, if you take a piece of lead, and with a penknife held as at *a*, Fig. 39, cut off a curl, it will be bent to a large curve; but if the same knife is held as at *b*, it will cause the shaving to curl up more. It has taken some power to effect this extra bending or curling, and it is therefore desirable to avoid it as far as possible. For

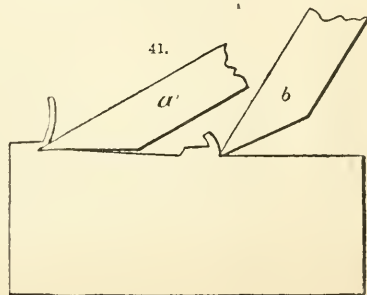
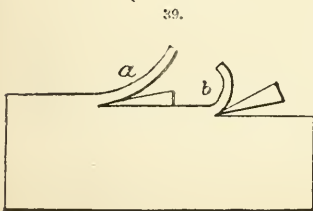
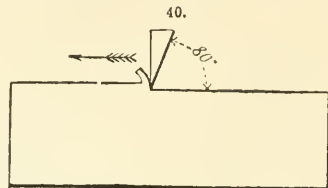
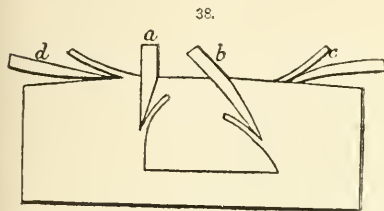

the purpose of distinction, the face of the chisel which meets the shaving may be called the top face, and that which lies next the main body of the work the bottom face. Then at whatever angle these 2 faces of the chisel may be to each other, and in whatever way the chisel is presented to the work, the strength of the cutting edge depends upon the angle of the bottom face to the line of motion of the chisel; and this is a rule that applies to all tools embodying the wedge principle, whether they are moved by hand or machine. Thus in Fig. 40 the bottom face is placed at an angle of 80° to the line of tool motion, which is denoted by the arrow, and its weakness is obvious. If the angle of the top face to the line of tool motion is determined upon, we may therefore obtain the strongest cutting edge in a hand-moved tool by causing the bottom angle to lie flat upon the work surface. But in tools driven by machine power, and therefore accurately guided in their line of motion, it is preferable to let the bottom face clear the work surface, save at the extreme cutting edge. The front face of the tool is that which mainly determines its keenness, as may be seen from Fig. 41, in which the tool is differently placed with relation to the work, that at *a* being obviously the keenest and least liable to break from the strain of the cutting process.

Drilling and Boring.—The term “drilling” is applied to the operation of perforating

or sinking holes in solid material, while "boring" is confined to turning out annular holes to true dimensions. These allied processes are thus succinctly explained by Richards in his excellent manual on 'Workshop Manipulation.' In boring, tools are guided by axial support independent of the bearing of their edges on the material; while in drilling, the cutting edges are guided and supported mainly from their contact with and bearing on the material drilled. Owing to this difference in the manner of guiding and supporting the cutting edges, and the advantages of an axial support for tools in boring, it becomes an operation by which the most accurate dimensions are attainable, while drilling is a comparatively imperfect operation; yet the ordinary conditions of machine fitting are such that nearly all small holes can be drilled with sufficient accuracy.

Boring may be called internal turning, differing from external turning, because of the tools performing the cutting movement, and in the cut being made on concave instead of convex surfaces; otherwise there is a close analogy between the operations of turning and boring. Boring is to some extent performed on lathes, either with boring bars or by what is termed chuck-boring; in the latter, the material is revolved and the tools are stationary. Boring may be divided into three operations as follows: chuck-boring on lathes; bar-boring when a boring bar runs on points or centres, and is supported at the ends only; and bar-boring when a bar is supported in and fed through fixed bearings. The principles are different in these operations, each being applicable to certain kinds of work. A workman who can distinguish between these plans of boring, can always determine from the nature of a certain work which is the best to adopt, has acquired considerable knowledge of fitting operations. Chuck-boring is employed in three cases: for holes of shallow depth, taper holes, and holes that are screw-threaded. As pieces are overhung in lathe-boring, there is not sufficient rigidity, either of the lathe spindle or of the tools, to admit of deep boring. The tools being guided in a straight line, and capable of acting at any angle to the axis of rotation, the facilities for making tapered holes are complete; and as the holes are stationary, and may be instantly adjusted, the same conditions answer for cutting internal screw-threads; an operation corresponding to cutting external screws, except that the cross motions of the tool slide are reversed. The second plan of boring by means of a bar mounted on points or centres is one by which the greatest accuracy is attainable; it is, like chuck-boring, a lathe operation, and one for which no better machine than a lathe has been devised, at least for the smaller kinds of work. It is a problem whether in ordinary machine fitting there is not a gain by performing all boring in this manner, whenever the rigidity of boring bars is sufficient without auxiliary supports, and when the bars can pass through the work. Machines arranged for this kind of boring can be employed in turning or boring as occasion may require. When a tool is guided by turning on points, the movement is perfect, and the straightness or parallelism of holes bored in this manner is dependent only on the truth of the carriage movement. This plan of boring is employed for small steam cylinders, cylindrical valve seats, and in cases where accuracy is essential. The third plan of boring with bars resting in bearings is more extensively practised, and has the largest range of adaptation. A feature of this plan of boring is that the form of the boring bar, or any imperfection in its bearings, is communicated to the work; a want of straightness in the bar makes tapering holes. This, of course, applies to cases where a bar is fed through fixed bearings placed at one or both ends of a hole to be bored. If a boring bar is bent, or out of truth between its bearings, the diameter of the hole (being governed by the extreme sweep of the cutters) is untrue to the same extent, because as the cutters move along and come nearer to the bearings, the bar runs with more truth, forming a tapering hole diminishing toward the rests or bearings. The same rule applies to some extent in chuck-boring, the form of the lathe spindle being communicated to holes bored; but lathe spindles are presumed to be quite perfect compared with boring bars.

The prevailing custom of casting machine frames in one piece, or in as few pieces as possible, leads to a great deal of bar-boring, most of which can be performed accurately enough by boring bars supported in and fed through bearings. By setting up temporary bearings to support boring bars, and improvising means of driving and feeding, most of the boring on machine frames can be performed on floors or sole plates and independent of boring machines and lathes. There are but few cases in which the importance of studying the principles of tool action is more clearly demonstrated than in this matter of boring; even long practical experience seldom leads to a thorough understanding of the various problems which it involves.

Drilling differs in principle from almost every other operation in metal cutting. The tools, instead of being held and directed by guides or spindles, are supported mainly by the bearing of the cutting edges against the material. A common angular-pointed drill is capable of withstanding a greater amount of strain upon its edges and rougher use than any other cutting implement employed in machine fitting. The rigid support which the edges receive, and the tendency to press them to the centre, instead of to tear them away as with other tools, allows drills to be used when they are imperfectly shaped, improperly tempered, and even when the cutting edges are of unequal length. Most of the difficulties which formerly pertained to drilling are now removed by machine-made drills, which are manufactured and sold as an article of trade. Such drills do not require dressing and tempering, or fitting to size after they are in use, make true holes, are more rigid than common solid shank drills, and will drill to a considerable depth without clogging. A drilling machine, adapted to the usual requirements of a machine fitting establishment, consists essentially of a spindle arranged to be driven at various speeds, with a movement for feeding the drills; a firm table set at right angles to the spindle, and arranged with a vertical adjustment to or from the spindle; and a compound adjustment in a horizontal plane. The simplicity of the mechanism required to operate drilling tools is such that it has permitted various modifications, such as column drills, radial drills, suspended drills, horizontal drills, bracket drills, multiple drills, and others. Drilling, more than any other operation in metal cutting, requires the sense of feeling, and is farther from such conditions as admit of power feeding. The speed at which a drill may cut without heating or breaking is dependent upon the manner in which it is ground, and the nature of the material drilled; the working conditions may change at any moment as the drilling progresses, so that hand feed is most suitable. Drilling

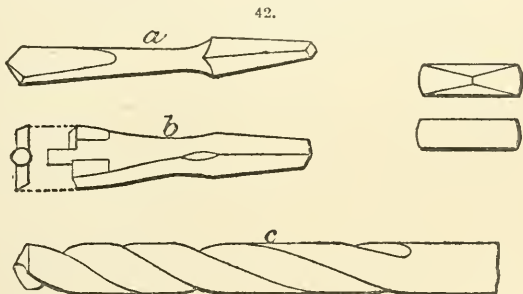

machines arranged with power feed for boring should have some means of permanently disengaging the feeding mechanism to prevent its use in ordinary drilling.

Drills present considerable variety in size and shape, but representative examples are shown in Fig. 42: *a* is the simplest and most general form; *b* is a pin drill, which does rapid work when a hole for the reception of the pin has been first made with a smaller drill; *c* is an American production, the Morse twist drill, which far surpasses

all others in working capacity. In grinding an ordinary drill (*a*) ready for use, it is essential to see that the cutting edges are at right angles to each other, the outside faces of the blade slightly rounded, and the point as small and fine as the work will allow. If these conditions are neglected, the point will not maintain a central position, and there will not be convenient space for the escape of the chips. In pin drills it is absolutely necessary to have the first hole for the pin quite straight, and fitting so well that the pin cannot shake, or the work will be irregular; these drills are not easy to sharpen when worn. The Morse twist drills can be obtained in sets of standard sizes.

All forms of drill are applied by the aid of a rotary motion, which may be communicated by the ratchet brace, of which several forms are shown: Fig. 43 is a universal

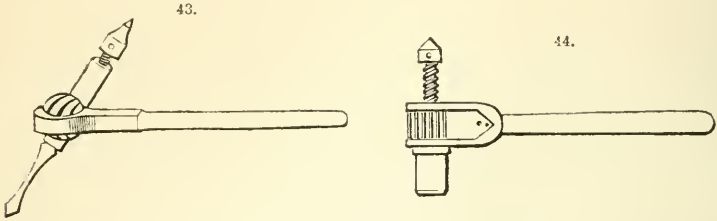

ball; Fig. 44, a self-feeding; Fig. 45, a treble-motion; and Fig. 46, Calvert's ratchet brace. Figs. 47 to 49 are drill stocks of various kinds, differing mainly in the means by which suitable pressure is secured.

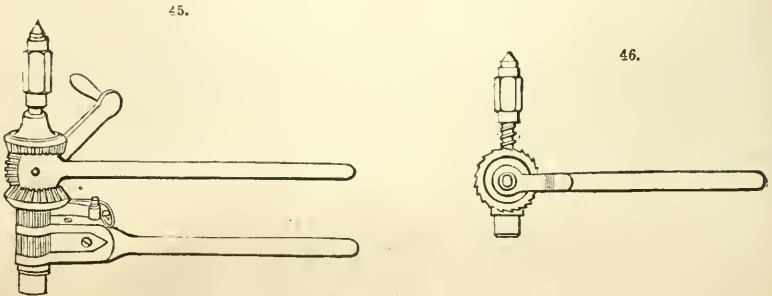

Swaging Tools.—Figs. 50, 51, illustrate a couple of forms of swaging block, which are often useful for shaping a piece of hot metal quickly and truly.

Surfacing Tools.—By far the most important tool used in perfecting the surface of fused or cast work is the file. It is sometimes replaced by emery, either in the form of wheels or as powder attached to cloth; and is often supplemented in fine work by one of the various kinds of polishing powder, e. g. chalk, crocus, putty powder, tripoli, sand, &c.

It has been remarked that the most important point to be decided before commencing filing is the fixing the vice to the correct height and perfectly square, so that when the work to be operated on is placed in the vice it will lie level. As to what is really the correct height some slight difference of opinion exists, but the height which is generally thought right is such that the "chops" or jaws of the vice come just below the elbow of the workman when he is at his place in front of the vice. Having the vice fixed properly, the correct position to assume when filing is the next consideration. The left foot should be about 6 in. to left and 6 in. to "front" of the vice leg; the right foot being about 30 in. to front, that is to say, 30 in. away from the board in a straight line with the vice

post. This position gives command over the tool, and is at once characteristic of a good workman.

The file must be grasped firmly in the right hand by the handle, and it is as well here to make a few parenthetical remarks on handles; they should always be propor-

47.

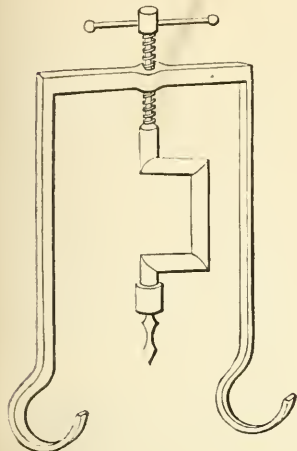

48.

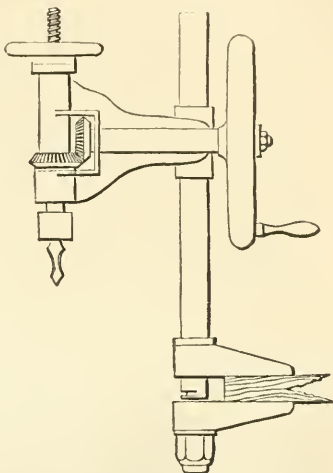

tionate to the files to which they are fitted, and the hole in the handle should be properly squared out to fit the "tang" by means of a small "float" made from a small bar of steel, similar to those used by plane-makers and cabinet-makers. The handles should always have good strong ferrules on them, and the files should be driven home

49.

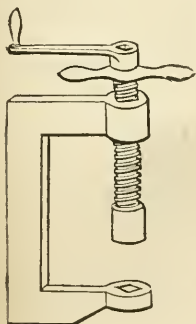

50.

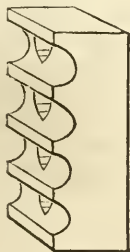

51.

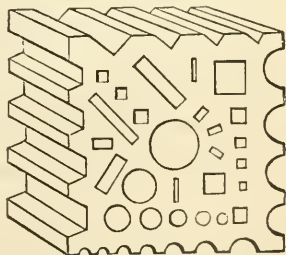

quite straight and firm, so that there is no chance of the tool coming out. Each tool should have its handle permanently fixed; it is very false economy, considering the price of handles is about 9d. per dozen, to be continually changing. The left hand must just hold the point of the file lightly, so as to guide it; and in taking the forward cut a fairly heavy pressure must be applied, proportionate to the size of the tool in use and the work being done. Amateurs who have never received any practical instruction

in the use of files generally have a bad habit of pressing heavily on the tool continuously during both forward and backward stroke, and at the same time work far too quickly. These habits combined will almost invariably spoil whatever is operated on, producing surfaces more or less rounding, but never flat.

The art of filing a flat surface is not to be learned without considerable practice, and long and attentive practice is necessary ere the novice will be able to creditably accomplish one of the most difficult operations which fall to every-day engineering work, and one which even the most professionally taught workman does not always succeed in. The file must be used with long, slow, and steady strokes, taken right from point to tang, moderate pressure being brought to bear during the forward stroke; but the file must be relieved of all pressure during the return stroke, otherwise the teeth will be liable to be broken off, just in the same manner that the point of a turning tool would be broken if the lathe were turned the wrong way. It is not necessary to lift the file altogether off the work, but it should only have its bare weight pressing during the back stroke. One of the chief difficulties in filing flat is that the arms have a tendency to move in arcs from the joints, but this will be conquered by practice.

A piece of work which has been filed up properly will present a flat, even surface, with the file marks running in straight parallel lines from side to side. Each stroke of the file will have been made to obtain a like end, whereas work which has been turned out by a careless or inexperienced workman will often bear evidence that each stroke of the file was made with utter disregard to all others, and the surface will be made up of an unlimited number of facets, varying in size, shape, and position.

There is considerable skill required to "get up" surfaces of large area by means of files alone, more especially when these surfaces are required to be accurately flat. The method of preparing surface plates, as detailed by Sir Joseph Whitworth, is most valuable information to any one desirous of excelling in this particular branch of practical handicraft, and those interested should get Whitworth's pamphlet entitled 'Plane Metallic Surfaces, and the Proper Mode of Preparing Them.' In large engineering works, filing is superseded by the planing and shaping machines for almost all work of any size. The speed and accuracy of the planing machine cannot be approached by the file when there is any quantity of material to be removed, and files are only used for the purpose of "fitting" and to smooth up those parts which are inaccessible to the planing tool. However, a planing machine is one of those expensive and heavy pieces of machinery usually beyond the reach of amateurs and "small masters"; it therefore becomes necessary to learn how to dispense with its valuable aid.

Cast iron usually forms the bulk of the material used by engineers. The hard outside skin on cast iron, and the sand adhering to its surface, make it somewhat formidable to attack. If a new file is used for the purpose it will be assuredly spoiled and with no gain; for one which has been very nearly worn out will be almost as effective, and will not be much deteriorated by the use to which it is put. There are several ways of removing the "bark"—e. g. the castings may be "pickled"—that is, immersed in a bath of sulphuric acid and water for a couple of days; this will dissolve the outer crust of the casting, and liberate the sand adhering to the surface; another plan is to remove a stratum of the casting from that part which has to be filed, by means of a chipping chisel, and this is a very good plan where much material has to be removed from any particular part of a large, unwieldy piece of machinery, though some practice will be required with the hammer and chisel before they can be used satisfactorily.

The best plan to follow is probably this:—First brush the casting thoroughly—scrub it—with a hard brush; this will rub off the loose sand; then take an old file, and file away steadily at the skin till you come to a surface of pure metal. Having by this time removed those parts which spoil files, the "old file," with which but slow progress is made, can be changed for a better one, and the best, as well as the most economical,

will be one which has been used for filing brass till it has become too much worn for that material; such a file is in first-class condition for working on cast iron (when cleaned of its sandy skin), and when worn out on that it will serve admirably for steel.

When it is necessary to file up a small surface—say 2 in. or 3 in. square—the file must be applied in continually changing directions, not always at right angles to the chops of the vice, as, though the work might be made perfectly straight in that direction, yet there would not be any means of assuring a like result on that part lying parallel to the jaws. When the surface is fairly flat, the file should be applied diagonally both ways; thus any hollow or high places otherwise unobservable will be at once seen, without the aid of straight-edges, &c. This method of crossing the file cuts from corner to corner is recommended in all cases, and the file should invariably travel right across the work, using the whole length of the file, not just an inch or so at some particular part, as is too often the case. When in use, the file must be held quite firmly, yet not so rigid that the operator cannot *feel* the work as it progresses; the sense of touch is brought into use to a far greater extent than would be imagined by the inexperienced, and a firm grasp of the tool, at the same time preserving a light touch to feel the work, is an essential attribute of a good filer.

In filing out mouldings and grooves which have sections resembling, more or less, parts of a circle, a special mode of handling the file becomes requisite. The files used are generally rats'-tails or half-rounds, and these are not used with the straightforward stroke so necessary in welding the ordinary hand-files, but a partial rotary motion—a sort of twist axially—is given to the file at each stroke, and this screw-like tendency, given alternately from right to left, and *vice versâ*, serves to cross the file cuts and regulate the truth of the hollow.

With regard to cleaning tools which have become clogged up with minute particles of metal, dirt, and grease, files which are in that state are not fit to use, and the following directions will enable any one to keep them in proper order. The most generally used tool for cleaning files is the scratch brush; but this is not very efficient in removing those little pieces which get firmly embedded and play havoc with the work. File cards are also used; they are made by fixing a quantity of cards—such as a pack of playing cards—together by riveting, or screwing to a piece of wood. These file cards are used in the same way as the scratch brushes, i. e. transversely across the file in the direction of its “cuts,” and though neither tool produces much effect yet they are both often used. When files have become clogged up with oil and grease, the best plan is to boil them for a few minutes in some strong soda water; this will dissolve the grease and, as a rule, set most of the dirt and filings free; a little scrubbing with an old tooth brush will be beneficial before rinsing the files in boiling water and drying them before the fire. These methods will prove effective in removing the ordinary accumulation of dirt, &c., in files, but those “pins” which are so much to be dreaded when finishing work can only be removed by being picked out with a scriber point, or, what is better, a piece of thin, very hard, sheet brass, by means of which they can be pushed out very easily. These “pins” may be to a certain extent avoided by using chalk on the file, if it is used dry, or a drop or two of oil will sometimes help matters.

With regard to finishing filed work, such as has to be made particularly presentable to the eye, there are many ways of polishing, burnishing, &c., but, properly speaking, that is not filing. There is much beauty in well-finished work, perfectly square and smooth, as left by the file, untouched by any polishing materials; in such work the filing must be got gradually smoother by using progressively files of finer cut, and, when the work is deemed sufficiently finely finished for the purpose, the lines should be carefully equalized by “draw-filing,” that is, the file is held in both hands, in a manner similar to a spoke-shave, and drawn over the work in the same way, producing a series of fine parallel lines.

Screw-cutting Tools.—These are intended for cutting screw threads in circular work,

such as on the outside of pipes or rods, and in the holes cut in solid work, for the purpose of making screwed joints. Figs. 52-63 show a double-handed screw stock with 4 pairs of dies, and 4 each of taper and plug taps; Fig. 64 is a clock screw plate; Fig. 65, a double-handed screw plate with taps; Fig. 66, Whitworth's screw stock.

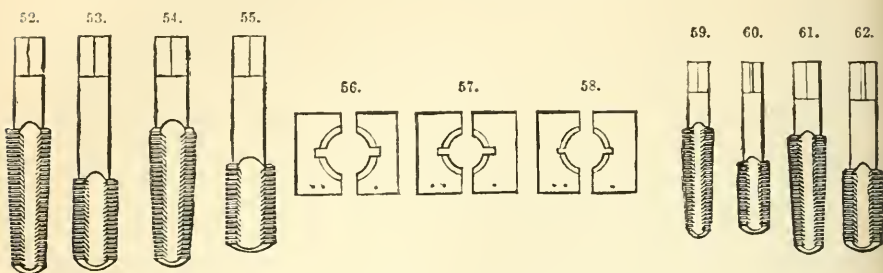
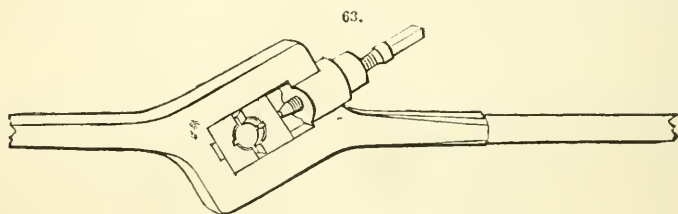
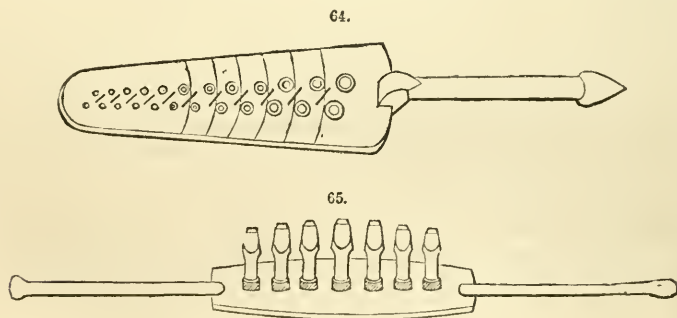

Fig. 67 illustrates the centre gauge for grinding and setting screw tools, and the various ways of using it. At *a* is shown the manner of gauging the angle to which a lathe centre should be turned; at *b* the angle to which a screw thread cutting tool



should be ground; at *c* the correctness of the angle of a screw thread already cut. At *d*, the shaft with a screw thread is supposed to be held in the centres of a lathe, and by applying the gauge, as at *d* or *e*, the thread tool can be set at right angles to the shaft



and then fastened in place by the screw in tool post, thereby avoiding imperfect or leaning threads. At *fg* the manner of setting the tool for cutting inside threads is illustrated. The angle used in this gauge is 55° . The 4 divisions upon the gauge of

14, 20, 24, and 32 parts to the inch are very useful in measuring the number of threads to the inch of taps and screws. The cost of the gauge is only 2s. 3d.

For extensive operations a number of small machines are made for cutting threads in bolts and in nuts.

66.

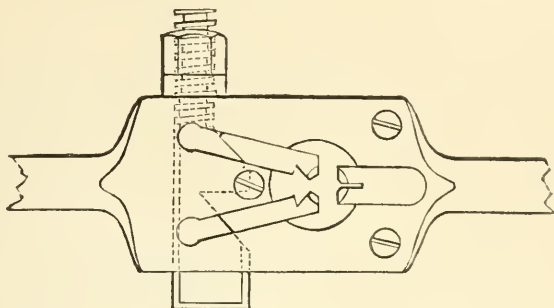

67.

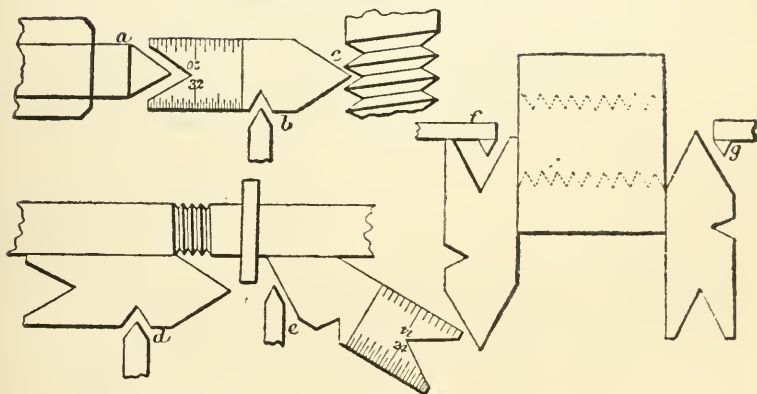
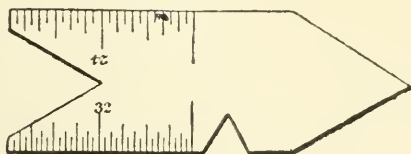

Forging.—Forging metal consists in raising it to a high temperature and hammering it into any form that may be required. Good wrought iron may be seriously injured by want of care or skill in forging it to different shapes. Repeated heating and reworking increases the strength of the iron up to a certain point; but overheating may ruin it; the iron should therefore be brought to the required shape as quickly as possible. The form given to forgings is also important; there should be no sudden change in the dimensions—angles should be avoided—the larger and thicker parts of a forging should gradually merge by curves into the smaller parts. Experiments have shown that the continuity of the fibres near the surface should be as little interrupted as possible; in

other words, that the fibres near the surface should lie in layers parallel to the surface. If wrought iron be "burnt," i. e. raised to too high a temperature, its tensile strength and ductility are both seriously reduced. These qualities may, however, be to a great extent restored by carefully reheating and rerolling the iron. Forging steel requires still more care in order to avoid overheating. Each variety of steel differs as to the heat to which it can safely be raised. Shear steel will stand a white heat; blister steel a moderate heat; cast steel a bright red heat.

Welding.—This is the process by which 2 pieces of metal are joined together with the aid of heat. There are several forms of "weld." The principles upon which the welding of metals depends are here given. In welding generally, the surfaces of the pieces to be joined, having been shaped as required for the particular form of weld, are raised to a high temperature, and covered with a flux to prevent oxidation. They are then brought into intimate contact and well hammered, by which they are reduced to their original dimensions, the scale and flux are driven out, and the strength of the iron is improved.

Wrought iron.—The property of welding possessed by wrought iron is due to its continuing soft and more or less pasty through a considerable range of temperature below its melting point. When at a white heat, it is so pasty that if 2 pieces be firmly pressed together and freed from oxide or other impurity they unite intimately and firmly. The flux used to remove the oxide is generally sand, sometimes salt.

Steel.—The facility with which steel may be welded to steel diminishes as the metal approximates to cast iron with respect to the proportion of carbon; or, what amounts to the same thing, it increases as the metal approximates to wrought iron with respect to absence of carbon. Hence in welding together 2 pieces of steel—*cæteris paribus*—the more nearly their melting points coincide—and these are determined by the amount of carbon they contain—the less should be the difficulty. (Percy.) Puddled steel welds very indifferently, and so does cast steel containing a large percentage of carbon. The mild cast steels, also shear and blister steel, can be welded with ease. In welding cast steel, borax or sal-ammoniac, or mixtures of them, are used as fluxes. Another used for mining drills in America is a mixture of 6 qt. powdered limestone and 1 qt. sulphur; heat very carefully with frequent turnings, take from the fire and brush with a short besom, dip into the mixture, and return to the fire, 4 or 5 times, before the heat is on. (See also WORKSHOP RECEIPTS, Third Series, pp. 293-303.)

Steel to Wrought Iron.—If the melting points of 2 metals sensibly differ, then the welding point of the one may be near the melting point of the other, and the difference in the degree of plasticity, so to speak, between the 2 pieces may be so considerable that when they are brought under the hammer at the welding point of the least fusible, the blow will produce a greater effect upon the latter, and create an inequality of fibre. This constitutes the difficulty in welding steel to wrought iron. A difference at the rate of expansion of the 2 pieces to be welded produces unequal contraction, which is a manifest disadvantage. (Percy.) Hard cast steel and wrought iron differ so much in their melting points that they can hardly be welded together. Blister and shear steel, or any of the milder steels, can, however, be welded to wrought iron with ease, care being taken to raise the iron to a higher temperature than the steel, as the welding point of the latter is lower is consequence of its greater fusibility.

Tempering.—According to Richards, an excellent authority on the subject, no one has been able to explain clearly why a sudden change of temperature hardens steel, nor why it assumes various shades of colour at different degrees of hardness; we only know the fact. Every one who uses tools should understand how to temper them, whether they be for iron or wood. Experimenting with tempered tools is the only means of determining the proper degree of hardness, and as smiths, except with their own tools, have to rely upon the explanations of others as to proper hardening, it follows that tempering is generally a source of complaint. Tempering, as a term, is used to com-

prehend both hardening and drawing; as a process, it depends mainly upon judgment instead of skill, and has no such connection with forging as to be performed by smiths only. Tempering requires a different fire from those employed in forging, and also more care and precision than blacksmiths can exercise, unless there are furnaces and baths especially arranged for tempering tools. A difficulty which arises in hardening tools is because of the contraction of the steel which takes place in proportion to the change of temperature; and as the time of cooling is in proportion to the thickness or size of a piece, it follows, of course, that there is a great strain and a tendency to break the thinner parts before the thicker parts have time to cool; this strain may take place from cooling one side first, or more rapidly than another.

The following propositions in regard to tempering comprehend the main points to be observed:—(1) The permanent contraction of steel in tempering is as the degree of hardness imparted to it by the bath. (2) The time in which the contraction takes place is as the temperature of the bath and the cross section of the piece; in other words, the heat passes off gradually from the surface to the centre. (3) Thin sections of steel tools, being projections from the mass which support the edges, are cooled first, and if provision is not made to allow for contraction they are torn asunder.

The main point in hardening, and the most that can be done to avoid irregular contraction, is to apply the bath so that it will act first and strongest on the thickest parts. If a piece is tapering or in the form of a wedge, the thick end should enter the bath first; a cold chisel, for instance, that is wide enough to endanger cracking should be put into the bath with the head downward. The upflow of currents of warmed water is a common cause of irregular cooling and springing of steel tools in hardening; the water that is heated rises vertically, and the least inclination of a piece from a perpendicular position allows a warm current to flow up one side. The most effectual means of securing a uniform effect from a tempering bath is by violent agitation, either of the bath or the piece; this also adds to the rapidity of cooling. The effect of tempering baths is as their conducting power; chemicals, except as they may contribute to the conducting properties of a bath, may safely be disregarded. For baths, cold or ice water loaded with salt for extreme hardness, and warm oil for tools that are thin and do not require to be very hard, are the two extremes outside of which nothing is required in ordinary practice. In the case of tools composed partly of iron and partly of steel, steel laid as it is called, the tendency to crack in hardening may be avoided in most cases by hammering the steel edge at a low temperature until it is so expanded that when cooled in hardening it will only contract to a state of rest and correspond to the iron part; the same result may be produced by curving a piece, giving convexity to the steel side before hardening.

Tools should never be tempered by immersing their edges or cutting parts in the bath, and then allowing the heat to "run down" to attain a proper temper at the edge. Tools so hardened have a gradually diminishing temper from their point or edge, so that no part is properly tempered, and they require continual rehardening, which spoils the steel; besides, the extreme edge, the only part which is tempered to a proper shade, is usually spoiled by heating, and must be ground away to begin with. No latheman who has once had a set of tools tempered throughout by slow drawing, either in an oven, or on a hot plate, will ever consent to point hardening afterwards. A plate of iron 2-2½ in. thick, placed over the top of a tool-dressing fire, makes a convenient arrangement for tempering tools, besides adding greatly to the convenience of slow heating, which is almost as important as slow drawing. Richards has by actual experiment determined that the amount of tool dressing and tempering, to say nothing of time wasted in grinding tools, may in ordinary machine fittings be reduced one-third by "oven tempering."

As to the shades that appear in drawing temper, or tempering it is sometimes called, it is quite useless to repeat any of the old rules about "straw colour, violet, orange, blue,"

and so on ; the learner knows as much after such instruction as before. The shades of temper must be seen to be learned, and as no one is likely to have use for such knowledge before having opportunities to see tempering performed, the following plan is suggested for learning the different shades. Procure 8 pieces of cast steel about 2 in. long by 1 in. wide and $\frac{3}{8}$ in. thick, heat them to a high red heat and drop them into a salt bath ; preserve one without tempering to show the white shade of extreme hardness, and polish one side of each of the remaining 7 pieces ; then give them to an experienced workman to be drawn to 7 varying shades of temper ranging from the white piece to the dark-blue colour of soft steel. On the backs of these pieces labels can be pasted describing the technical names of the shades and the general uses to which tools of corresponding hardness are adapted. This will form an interesting collection of specimens and accustom the eye to the various tints, which after some experience will be instantly recognized when seen separately.

It may be remarked as a general rule that the hardness of cutting tools is "inverse as the hardness of the material to be cut," which seems anomalous, and no doubt is so, if nothing but the cutting properties of edges is considered ; but all cutting edges are subjected to transverse strain, and the amount of this strain is generally as the hardness of the material acted upon ; hence the degree of temper has of necessity to be such as to guard against breaking the edges. Tools for cutting wood, for example, are harder than those usually employed for cutting iron ; for if iron tools were always as carefully formed and as carefully used as those employed in cutting wood, they could be equally hard. ('Workshop Manipulation.')

Steel plunged into cold water when it is itself at a red heat becomes excessively hard. The more suddenly the heat is extracted the harder it will be. This process of "hardening," however, makes the steel very brittle, and in order to make it tough enough for most purposes it has to be "tempered." The process of tempering depends upon another characteristic of steel, which is that if (after hardening) the steel be reheated, as the heat increases, the hardness diminishes. In order then to produce steel of a certain degree of toughness (without the extreme hardness which causes brittleness), it is gradually reheated, and then cooled when it arrives at that temperature which experience has shown will produce the limited degree of hardness required. Heated steel becomes covered with a thin film of oxidation, which grows thicker and changes in colour as the temperature rises. The colour of this film is therefore an indication of the temperature of the steel upon which it appears. Advantage is taken of this change of colour in the process of tempering, which for ordinary masons' tools is conducted as follows :—The workman places the point or cutting-end of the tool in the fire till it is of a bright-red heat, then hardens it by dipping the end of the tool suddenly into cold water. He then immediately withdraws the tool and cleans off the scale from the point by rubbing it on the stone hearth. He watches it while the heat in the body of the tool returns, by conduction, to the point. The point thus becomes gradually reheated, and at last he sees that colour appear which he knows by experience to be an indication that the steel has arrived at the temperature at which it should again be dipped. He then plunges the tool suddenly and entirely into cold water, and moves it about till the heat has all been extracted by the water. It is important that considerable motion should be given to the surface of the water while the tool is plunged in, after tempering, otherwise there will be a sharp straight line of demarcation between the hardened part and the remainder of the tool, and the metal will be liable to snap at this point.

In very small tools there is not sufficient bulk to retain the heat necessary for conduction to the point after it has been dipped. Such tools, therefore, are heated, quenched, rubbed bright, and laid upon a hot plate to bring them to the required temperature and colour before being finally quenched. In some cases, the articles so heated are allowed to cool slowly in the air, or still more gradually in sand, ashes, or powdered charcoal. The effect of cooling slowly is to produce a softer degree of temper.

The following table shows the temperature at which the steel should be suddenly cooled in order to produce the hardness required for different descriptions of tools. It also shows the colours which indicate that the required temperature has been reached :—

Colour of Film.	Temp. Fahr.	Nature of Tool.
Very pale straw yellow ..	430°	Lancets and tools for metal.
A shade of darker yellow ..	440°	Razors and do.
Darker straw colour ..	470°	Penknives.
Still darker straw yellow ..	490°	Cold chisels for cutting iron, tools for wood.
Brownish yellow ..	500°	} Hatchets, plane irons, pocket knives, chipping chisels, saws, &c.
Yellow tinged with purple ..	520°	
Light purple	530°	} Swords, watch-springs, tools for cutting sand- stone.
Dark purple	550°	
Dark blue	570°	Small saws.
Pale blue	600°	Large saws, pit and hand saws.
Paler blue with tinge of green	630°	Too soft for steel instruments.

The tempering colour is sometimes allowed to remain, as in watch springs, but is generally removed by the subsequent processes of grinding and polishing. A blue colour is sometimes produced on the surface of steel articles by exposing them to the air on hot sand. By this operation, a thin film of iron oxide is formed over the surface, which gives the colour required. Steel articles are often varnished in such a way as to give them an appearance of having retained the tempering colours. The exact tempering heat required to produce the same degree of hardness varies with different kinds of steel, and is arrived at by experience.

There are several ways of heating steel articles both for hardening and tempering. They may be heated in a hollow or in an open fire, exposed upon a hot plate, or in a dish with charcoal in an oven, or upon a gas stove. Small articles may be heated by being placed within a nick in a red-hot bar. If there is a large number of articles, and a uniform heat of high degree is required, they may be plunged into molten metal alloys, or oil raised to the temperature required.

In hardening steel, care must be taken not to overheat the metal before dipping. In case of doubt, it is better to heat it at too low than too high a temperature. The best kinds require only a low red heat. If cast steel be overheated, it becomes brittle, and can never be restored to its original quality. If, however, the steel has not been thoroughly hardened, it cannot be tempered. The hardness of the steel can be tested with a file. The process of hardening often causes the steel to crack. The expansion of the inner particles by the heat is suddenly arrested by the crust formed in consequence of the cooling of the outer particles, and there is a tendency to burst the outer skin thus formed.

When the whole bulk of any article has to be tempered, it may either be dipped or allowed to cool in the air. It does not matter which way they become cold, provided the heat has not been too suddenly applied; for when the articles are removed from the heat, they cannot become more heated, consequently the temper cannot become more reduced. But those tools in which a portion only is tempered, and in which the heat for tempering is supplied by conduction from other parts of the tool, must be cooled in the water directly the cutting part attains the desired colour, otherwise the body of the tool will continue to supply heat and the cutting part will become too soft.

When toughness and elasticity are required rather than extreme hardness, oil is used instead of water both for hardening and tempering, and the latter process is sometimes called "toughening." The steel plunged into the oil does not cool nearly so rapidly as it would in water. The oil takes up the heat less rapidly. The heated particles of oil

cling more to the steel, and there is not so much decrease of temperature caused by vapourisation as there is in using water. Sometimes the oil for tempering is raised to the heat suited to the degree of hardness required. When a large number of articles have to be raised to the same temperature, they are treated in this way.

Saws are hardened in oil, or in a mixture of oil with suet, wax, &c. They are then heated over a fire till the grease inflames. This is called being "blazed." After blazing the saw is flattened while warm, and then ground. Springs are treated in somewhat the same manner, and small tools after being hardened in water are cooled with tallow, heated till the tallow begins to smoke, and then quenched in cold tallow.

Annealing or softening steel is effected by raising hardened steel to a red heat and allowing it to cool gradually, the result of which is that it regains its original softness.

Case-hardening is a process by which the surface of wrought iron is turned into steel, so that a hard exterior, to resist wear, is combined with the toughness of the iron in the interior. This is effected by placing the article to be case-hardened in an iron box full of bone-dust or some other animal matter, and subjecting it to a red heat for a period varying from $\frac{1}{2}$ hour to 8 hours, according to the depth of steel required. The iron at the surface combines with a proportion of carbon, and is turned into steel to the depth of $\frac{1}{10}$ to $\frac{3}{8}$ in. If the surface of the article is to be hardened all over, it is quenched in cold water upon removal from the furnace. If parts are to remain malleable, it is allowed to cool down, the steeled surface of those parts is removed, and the whole is then reheated and quenched, by which the portions on which the steel remains are hardened. Gun-locks, keys, and other articles which require a hard surface, combined with toughness, are generally case-hardened. A more rapid method of case-hardening is conducted as follows:—The article to be case-hardened is polished, raised to a red heat, sprinkled with finely powdered prussiate of potash. When this has become decomposed and has disappeared, the metal is plunged into cold water and quenched. The case-hardening in this way may be made local by a partial application of the prussiate. Malleable castings are sometimes case-hardened in order that they may take a polish.

Many further details on hardening, tempering, softening, and annealing steel will be found in *WORKSHOP RECEIPTS*, Third Series, pp. 256–295.

Examples of Smiths' Work.—It will be instructive to conclude this section with detailed descriptions of the operations entailed in a few of the more common kinds of work performed by smiths.

Keys.—For forging small round short rods, or keys, no tools are required except the ordinary fire irons and the hand-hammer, tongs, and anvil chisel, in the anvil, shown by Figs. 68 to 70. The pin should be forged to the proper diameter, and also the ragged piece cut off the small end by means of the anvil chisel, shown by Fig. 70, while the work is still attached to the rod of steel from which it is made. After having cut and rounded the small end, it is proper to cut the key from the rod of steel, allowing a short piece to be drawn down to make the holder, by which to hold it in the lathe. This holder is drawn down by the fuller, and afterwards by the hammer. The fuller is first applied to the spot that marks the required length of key; the fuller is then driven in by the hammerman to the required diameter of the holder, the bottom fuller being in the square hole of the anvil during the hammering process, and the work between the top and bottom fullers. During the hammering, the forger rotates the key, in order to make the gap of equal or uniform depth; the lump which remains is then drawn down by the hammers, or by the hand hammer only, if a small pin is being made. If the pin is very small, it is more convenient to draw down the small lump by means of the set hammer and the hammerman. The set hammer is shown in Fig. 74; and the top and bottom fullers by Fig. 75. The double or alternate hammering by forger and hammerman should at first be gently done, to avoid danger to the arm through not holding the work level on the anvil. The hammerman should first begin, and strike at the rate of one blow a second; after a few blows the smith begins, and both hammer the work at

times, and other times the anvil. Figs. 71, 72, show the top and bottom rounding tools, for rounding large keys. Large keys may be made without rounding tools by rounding the work with a hand hammer, and cutting off the pin by the anvil chisel, instead of the rod chisel, Fig. 73. The rod chisel is so named because the handle by

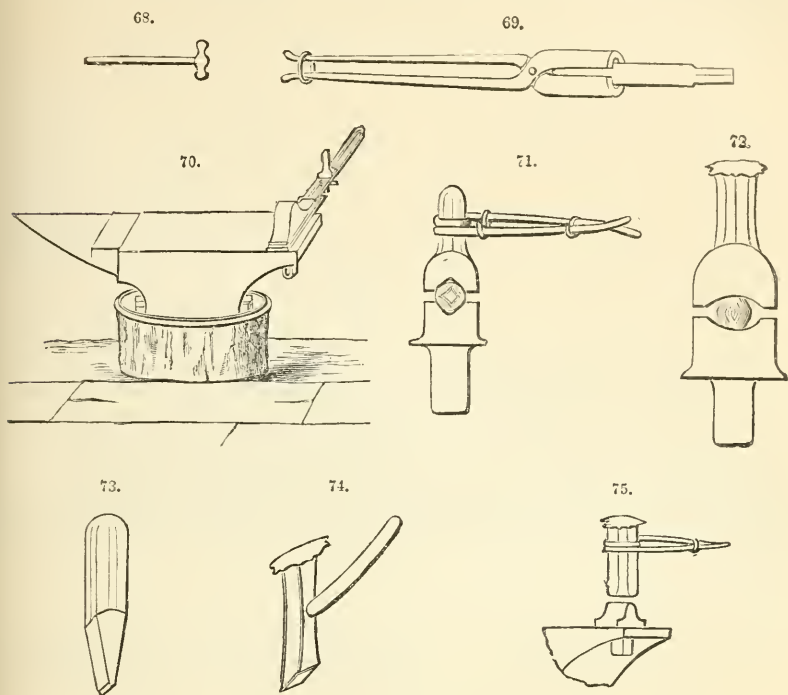

which the chisel is held is an ash rod or stick, see Fig. 71. A rod chisel is thin for cutting hot iron, and thick for cutting cold iron. Fig. 70 represents the anvil chisel in the square hole of the anvil. By placing the steel while at a yellow heat upon the edge of the chisel, a small key can be easily cut off by a few blows of a hammer upon the top of the work.

To forge a key with a head involves more labour than making a straight one. There are 3 principal modes of proceeding, which include drawing down with the fuller and hammer; upsetting one end of the iron or steel; and doubling one end of a bar to form the head. For proceeding by drawing down, a rod or bar of steel is required, whose diameter is equal to the thickness of the head required; consequently, large keys should not be made by drawing down unless steam hammers can be used. Small keys should be drawn to size while attached to the bar from which they are made; the drawing is commenced by the fuller and set hammer. Instead of placing the work upon the bottom fuller in the anvil, as shown for forging a key without a head, the steel is placed upon the face of the anvil, and the top fuller only is used, if the key required is large enough to need much hammering; but a very small key can be drawn down by dispensing with the top fuller and placing the bottom fuller in the hole, and placing the work upon the top, and then striking on one side only, instead of rotating the bar or rod by the hand. By holding the bar or rod in one position, the head is formed upon the

under-side of the bar; and by turning the work upside down, and drawing down the lump, the stem is produced. The upsetting of iron generally should be done at the welding heat; the upsetting of steel at the yellow heat, except in some kinds of good steel, that will allow the welding heat. And both iron and steel require cooling at the extremity, to prevent the hammer spreading the end without upsetting the portion next to it. If the head of the key is to be large, several heats and coolings must take place, which render the process only applicable to small work. A small bar can be easily upset by heating to a white heat or welding heat, and cooling a quarter of an inch of the end; then immediately put the bar to the ground with the hot portion upwards, the bar leaning against the anvil, and held by the tongs (Fig. 76). The end is then upset, and the extremity cooled again after being heated for another upsetting, and so on until the required diameter is attained. When a number of bars are to be upset in this manner, it is necessary to provide an iron box, into which to place the ends of the bars, instead of upon the soft ground or wood flooring, injury to the floor being thereby prevented. When the key-head is sufficiently upset, the fuller and set hammer are necessary to make a proper shoulder; the stem is then drawn four-sided and rounded by the ∇ top and bottom tools. If the bar from which the key is being made is not large enough to allow being made four-sided, eight sides should be formed, which will tend to close the grain and make a good key.

The third method of making keys with heads is the quickest of the three, particularly for making keys by the steam hammer. By its powerful aid we are able to use a bar of iron an inch larger than the required stem, because it is necessary to have sufficient metal in order to allow hammering enough to make it close and hard, and also welding, if seamy. If the bar from which it is to be made is too large to be easily handled without the crane, the piece is cut from the bar at the first heat. But if the bar is small, it can be held up at any required height by the prop, shown in Fig. 77.

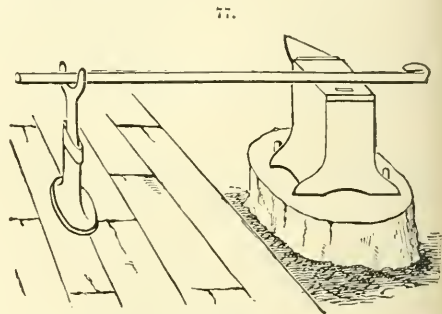
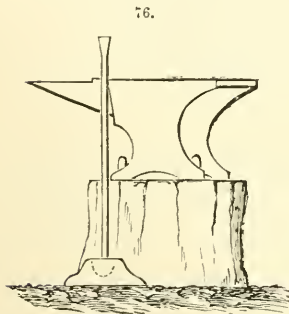

While thus supported, the piece to be doubled to make the head is cut three-quarters of the distance through the iron, at a proper space from the extremity. The piece is then bent in the direction tending to break it off: the uncut portion being of sufficient thickness to prevent it breaking, will allow the two to be placed together and welded in that relation. A hole may also be punched through the two, while at a welding heat, as shown by Fig. 78. The hole admits a pin or rivet of iron, which is driven into the opening, and the three welded together. This plan is resorted to for producing a strong head to the key without much welding; but for ordinary purposes it is much safer to weld the iron when doubled, without any rivet, if a sufficient number of heavy blows can be administered. At the time the head is welded, the shoulder should be tolerably squared by the set hammer; and the part next to the shoulder is then fullered to about

three-quarters of the distance to the diameter of stem required. In large work the fuller used for this purpose should be broad, as in Fig. 79. After the head is welded, and the portion next to it drawn down by the fuller, the piece of work is cut from the bar or rod, and the head is fixed in a pair of tongs similar to Fig. 80. Such tongs are useful for very small work, and are made of large size for heavy work. Tongs of this character

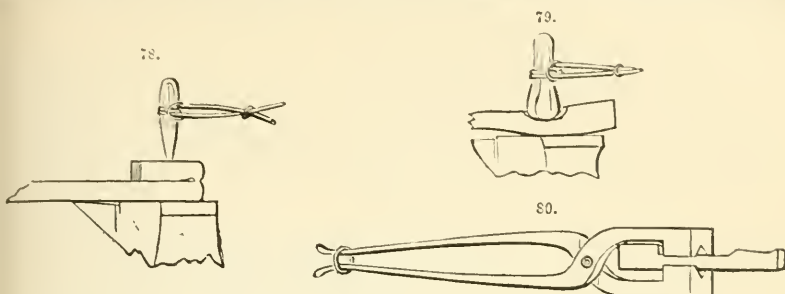

are suited to both angular and circular work. They will grip either the head or the stem, as shown in the figure. While held by the tongs the thick lump of the stem that remains is welded, if necessary. Next draw the stem to its proper shape, and trim the head to whatever shape is required.

Bolts.—Bolts are made in such immense numbers, that a variety of machinery exists for producing small bolts by compression of the iron while hot into dies. But the machinery is not yet adapted to forge good bolts of large size, such as are daily required for general engine-making. Good bolts of large diameters can now be made by steam hammers at a quick rate; and small bolts of good quality are made in an economical and expeditious manner by means of instruments named bolt headers. There is a variety of these tools in use, and some are valuable to small manufacturers because of being easily made, and incurring but little expense. The use of a bolt header consists in upsetting a portion of a straight piece of iron to form the bolt head, instead of drawing down or reducing a larger piece to form the bolt stem, which is a much longer process; consequently, the bolt header is valuable in proportion to its capability of upsetting bolt heads of various sizes for bolts of different diameters and lengths. The simplest kind of heading tool is held upon the anvil by the left hand of the smith, while the piece to be formed into a head is hammered into a recess in the tool, the shape of the intended head. Three or four recesses may be drilled into the same tool, to admit three or four sizes of bolt heads. Such a tool is represented by Fig. 81, and is made either entirely of steel, or with a steel face, in which are bored the recesses of different shapes and sizes.

The pieces of iron to be formed into bolts are named bolt pieces. When these pieces are of small diameter or thickness, they are cut to a proper length while cold by means of a concave anvil chisel and stop, or by a large shearing machine. One end of each piece is then slightly tapered while cold by the hand-hammer, Fig. 68, or a top tool. This short bevel or taper portion allows the bolt to be driven in and out of the heading tool several times without making sufficient ragged edge to stop the bolt in the hole while being driven out. Those ends that are not bevelled are then heated to about welding heat, and upset upon the anvil or upon a cast-iron block, on, or level with, the ground. This upsetting is continued until the smaller parts or stems will remain at a proper distance through the tool; after which, each head is shaped by being hammered into the recess. During the shaping process, the stem of the bolt protrudes through the square hole in the anvil, as indicated by Fig. 81.

But when a large number of small bolts are required in a short time, a larger kind of heading tool is made use of, which is named bolt header. One of these, Fig. 82, is a jointed bolt header. The actual height of these headers depends upon the lengths of bolts to be made, because the pieces of which the bolts are formed are cut of a suitable length to make the bolts the proper length after the heads are upset; consequently, bolt headers are made 2 or 3 ft. in height, that they may be generally useful. The header represented by Fig. 82 contains a movable block B, upon which rests one end of a bolt piece to be upset; it is therefore necessary to raise or lower the block to suit various lengths of bolts.

All bolts, large and small, that are to be turned in a lathe require the two extremities to be at right angles to the length of the bolt, to avoid waste of time in centring previous to the turning process; and connecting-rod bolts and main-shaft bolts require softening, which makes them less liable to break in a sudden manner; and it is important to remember that hammering a bolt while cold will make it brittle and unsafe, although the bolt may contain more iron than would be sufficient if the bolt were soft. Great solidity in a bolt is only necessary in that portion of it which is to be formed into a screw. The bolt is less liable to break if all the other parts are fibrous, and the lengths of the fibres are parallel to the bolt's length. But in the screw, more solidity is necessary, to prevent breaking off while the bolt is being screwed, or while in use. However good the iron may be, the bolt is useless if the screw is unsound; and it is well to apply a pair of angular-gap tools, Fig. 88, to the bolt end while at welding heat. Bolts of all kinds, large and small, are injured by the iron being overheated, which makes it rotten and hard, and renders it necessary to cut off the burnt portion, if the bolt is large enough; if not, a new one should be made in place of the burnt one.

Long bolts that require the lathe process are carefully straightened. This is conveniently effected by means of a strong lathe, which is placed in the smithy for the purpose. Long bolts are also straightened in the smithy by means of a long straight-edge, which is applied to the bolt stem to indicate the hollow or concave side of the stem. This concave side is that which is placed next to the anvil top, and the upper side of the bolt is then driven down by applying a curved top tool and striking with a sledge hammer. This mode is only available with bolts not exceeding 2 or 3 in. diameter and of length convenient for the anvil, because in some cases bolts require straightening or rectifying in two or more places along the stems. If a bolt 6 ft. in length is bent 1 ft. from one end, the bent portion is placed upon an anvil, while the longer portion is supported by a crane, and a top tool is applied to the convex part. The raising of the bolt end to any required height is effected by rotating a screw which raises a pulley, upon which is an endless chain; the work being supported by the chain, both chain and work are raised at one time. It is necessary to adjust the work to the proper height while being straightened; if not, the hammering will produce but little effect. The amount of straightening necessary depends upon the diameters to which the bolts are forged, and also upon their near approach to parallelism. A small bolt not exceeding $1\frac{1}{2}$ in. in diameter need not be forged more than a tenth of an inch larger than the finished diameter; a bolt about 2 in. diameter, only an eighth larger; and for bolts 4 or 5 in. in diameter and 4 or 5 ft. in length, a quarter of an inch for turning is sufficient, if the bolts are properly straightened and in tolerable shape. This straightening and shaping of an ordinary bolt is easily accomplished while hot, by the method just mentioned; other straightening processes, for work of more complicated character, will be given as we proceed. After the bolts are made sufficiently straight by a top tool, the softening is effected by a treatment similar to that adopted for softening steel, which consists in

81.

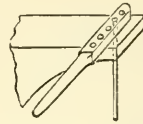

82.

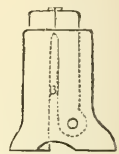

heating the bolts to redness and burying them in coke or cinders till cold. A little care is necessary while heating the bolts to prevent them being bent by the blast. To avoid this result, the blast is gently administered and the bolt frequently rotated and moved about in the fire.

Nuts.—The simplest method of making small nuts is by punching with a small punch that is held in the left hand; this punch is driven through a bar near one end of it, which is placed upon a bolster on the anvil, while the other end of the bar is supported by a screw-prop. This mode is adapted to a small maker whose means may be very limited. By supporting the bar or nuts in this manner, it is possible for a smith to work without a hammerman. A bar of soft iron is provided, and the quantity of iron that is required for each nut is marked along the bar by means of a pencil, and a chisel is driven into the bar at the pencil marks while the bar is cold. A punch is next driven through while the iron is at a white heat. Each nut is then cut from the bar by an anvil chisel, and afterwards finished separately while on a nut mandrel. The bar on the bolster is shown by Fig. 86.

A more economical method is by punching with a rod punch, which is driven through by a sledge hammer. By this means several nuts are punched at one heating of the bar, and also cut from the bar at the same heat. A good durable nut is that in which the hole is made at right angles to the layers or plates of which the nut is composed. Some kinds of good nut iron are condemned because of these plates, which separate when a punch is driven between them instead of through them. By punching through the plates at right angles to the faces of the intended nuts, the iron is not opened or separated, and scarfing is avoided. Nuts that have a scarf end in the hole require boring, that the hole may be rendered fit for screwing; but nuts that are properly punched may be finished on a nut mandrel to a suitable diameter for the screw required. Nuts for bolts not exceeding $2\frac{1}{2}$ or 3 in. diameter can be forged with the openings or holes of proper diameter for screwing by a tap. The precise diameter is necessary in such cases, and is attained by the smith finishing each nut upon a nut mandrel of steel, which is carefully turned to its shape and diameter by a lathe. The mandrel is tapered and curved at the end, to allow the nut to fall easily from the mandrel while being driven off. Such nut mandrels become smaller by use, and it is well to keep a standard gauge of some kind by which to measure the nuts after being forged. The best kind of nut mandrel is made of one piece of steel, instead of welding a collar of steel to a bar of iron, which is sometimes done.

One punch and one nut mandrel are sufficient for nuts of small dimensions, but large ones require drifting after being punched and previous to being placed upon a nut mandrel. The drifting is continued until the hole is of the same diameter as the mandrel upon which the nut is to be finished. The nut is then placed on, and the hole is adjusted to the mandrel without driving the mandrel into the nut, which would involve a small amount of wear and tear that may be avoided. A good steel nut mandrel, with careful usage, will continue serviceable, without repair, for several thousands of nuts. The holes of all nuts require to be at right angles to the two sides named faces; one of these faces is brought into contact and bears upon the work while the nut is being fixed; consequently, it is necessary to devote considerable attention to the forging, that the turning and shaping processes may be as much as possible facilitated. If the two faces of the nut are tolerably near to a right angle with the hole, and the other sides of the nut parallel to the hole, the nut may be forged much nearer to the finished dimensions than if it were roughly made or malformed.

To rectify a nut whose faces are not perpendicular to the opening, the two prominent corners or angles are placed upon an anvil to receive the hammer, as indicated in Fig. 87. By placing a nut while at a yellow heat in this position, the two corners are changed to two flats, and the faces become at the same time perpendicular to the

opening; the nut is then reduced to the dimensions desired. If the nut is too long, and the sides of it are parallel to the opening, the better plan is to cut prominences from the two faces by means of a trimming chisel, Fig. 91, instead of rectifying the nut by hammering. Cutting off scrap pieces while hot with a properly shaped chisel of this kind is a much quicker process than cutting off in a lathe.

Small connecting bolts, not more than 2 or 3 inches in diameter, are made in an economical manner by drawing down the stems by a steam hammer. Those who have not a steam hammer will find it convenient to make a collar to be welded on a stem, in order to form a head, as shown by Fig. 83. After being welded the head

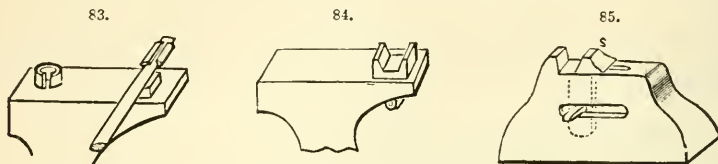

may be made circular or hexagonal, as required. The tool for shaping hexagonal heads is indicated by Fig. 85. Such an apparatus may be adapted to a number of different sizes by fixing the sliding part of the tool at any required place along the top of the block, in order to shape heads of several different diameters. The movable or sliding block is denoted in the figure by S.

Tongs.—Fig. 88 shows a curved-gap tongs, Fig. 89 a bar tongs, and Fig. 90 a side-grip tongs. Other forms are illustrated in Figs. 92 to 99. To forge and put together a pair of flat bitted tongs (Fig. 93), of the most usual pattern, select a bar of good 1 in.

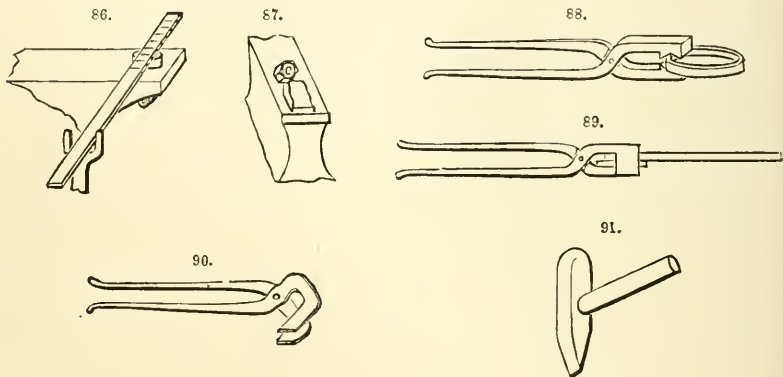

square iron; lay about 3 in. on the inside edge of the anvil (Fig. 100) and "take down" the thickness to $\frac{1}{2}$ in., at the same time "drawing" it edgewise to maintain the width at 1 in.; this is done rapidly, so as to have heat enough in the bar to proceed with the next step, which consists in turning it at right angles, and hanging the "bit," or part just taken down, over the front edge of the anvil (Fig. 101) and flattening the bar just behind it. The third step is performed by placing the work about 3 in. farther forward on the anvil, and again turning at right angles (Fig. 102), slightly raising the back end, and striking the iron fairly over the front edge of the anvil, alternating the blows by turning and returning the bar. Cut off the "bit" 3 or 4 in. behind

the part last treated (Fig. 103). Prepare a second bit in exactly the same manner, and scarf down one end of each. For the handles or "reins," choose a piece of $\frac{1}{2}$ -in.

92.



93.



94.

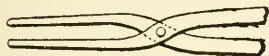

95.

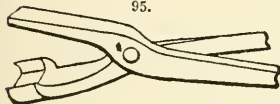

96.



97.



98.

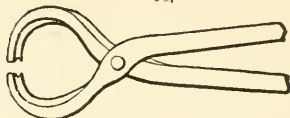

99.

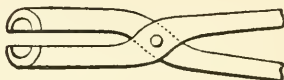

rod, upset one end, scarf it, and weld it to one of the bits. Serve the other bit the same. Punch a $\frac{3}{8}$ -in. hole through each, and connect them by riveting. Reheat the finished tongs and dress them parallel; then cool by immersion and constant motion in cold water. The other forms are made in a similar manner, dressing the bits in each case around pieces of metal of suitable shape and size.

100.



101.



102.



103.



Hammers.—All hammers for hand use, whether chipping hammers or sledge hammers, should be made entirely of steel. The practice of welding steel faces to iron eye portions in order to avoid using a larger quantity of steel, is more expensive than making the entire tool of one piece of steel, and an unsound inferior tool is made instead of a good one. The steel selected for hammers is a tough cast steel, and may be termed a soft fibrous steel that will bear hardening. Cast steel which has been well wrought with rolling and hammering is suitable for hammers, and but little forging is necessary if the metal selected is of proper size. The small chipping hammers and other hammers for vice work are easily made of round steel, but the larger sizes, termed sledge hammers, require to be made of square bar steel. When several are to be made, a long piece is selected, that each hammer may be forged at one of the bar's ends, thus avoiding a great portion of the handling with tongs. While the work is attached to the bar, it is punched and drifted to shape the hole, and also thinned with top and bottom fullers at both sides of the hole. The greater part of the forging is thus effected previous to cutting the hammer from the bar, and when cut off, all rugged portions at the extremities are carefully trimmed off with a sharp rod chisel, that the faces of the work may be solid.

A good hammer is that which has a long hole to provide a good bearing for the

handle, and which has the metal around the hole curved with punching and drifting, the hole being oval, as in Fig. 104, and tapered at both ends or entrances of the hole. The entrances of the hole are principally tapered at the two sides which are nearest to the hammer's faces, the other two sides being nearly parallel. Steel taper drifts of proper shape are therefore driven into both ends of the hole, to produce the required form, and all filing of that part is thus avoided.

The making of small sledge hammers is conducted by forging each one at the end of a bar, similar to the mode for chipping hammers, but a sledge hammer, about 20 lb. in weight, is made either singly, or of a piece of steel which is only large enough to be made into two; the handling of a heavy bar is thus avoided. By referring to Fig. 105, it may be seen that the handle hole or shaft hole of a sledge hammer is comparatively smaller than that of a chipping hammer; this is to provide a solid tool that will not quiver or vibrate when in use, and is therefore not liable to break.

Very little filing is sufficient to smooth a hammer, if properly forged, the shaping being easily effected with fullers and rounding tools; and after being filed, each of the two ends is hardened, but not afterwards tempered. After hardening, the two ends are finished with grinding on a grindstone. Polishing the faces of engineers' hammers is not necessary.

Through the handle hole of a hammer being tapered at both ends, the shaft end is made to resemble a rivet which is thickest at the two ends, one part of the shaft being made to fit one mouth of the hole with filing or with a paring chisel for wood, and the outer end of the shaft being made to fit the other mouth of the hole by spreading the wood with a wedge. The wood for the shaft is ash, and is fitted while dry, so that the handle requires hammering to force its end into the hole, and when the hammering has made the taper shoulder of the shaft end bear tight against the taper mouth of the hole, the driving ceases, and the superfluous wood extending beyond the wedge end of the hole is cut off, and the wedge hammered into its place. This wedge is of iron, and has an angle of about 5° or 6° ; consequently, the mouth of the hole should have the same angle, to cause the wood to fill the hole when a wedge is driven in. The principal taper of the wedge is in its thickness, its width being nearly parallel, to make it hold tight to the wood. When it is to be put in, it is placed so that its width shall be parallel with the parallel sides of the hole, the taper part will then spread the wood in the proper direction. An additional means of tightening the wedge consists in making a few barbs upon the edges, and also cleaning and chalking it when it is to be hammered into the wood.

In order to produce a large number of hammers of the same shape and dimensions, each one should be shaped while between a couple of top and bottom springy shapers. This shaping is effected near the conclusion of the forging, and the hammer being shaped, is held with a long handle drift, whose point extends a few inches through the hammer, and also beyond the shapers, the length of the hammer being at right angles to the length of the drift. After such shaping, the mouths of the hole may be tapered with a drift or with filing; to avoid filing, a short taper drift is used for tapering the mouths of the hole, and the long handle drift for holding the hammer in the shapers is provided with a taper shoulder, to fit the taper mouths of the hole; and when a hammer is to be put between the shapers, this drift is hammered tight into the hole until the taper shoulder of the drift bears on the taper mouth of the hammer.

Chisels.—Chipping chisels for engineers seldom remain in use, through the continual hammering and consequent vibration to which they are subjected for cutting metals, and because they are made of a granular tool steel which is too solid for chisels, and always breaks unless the cutting part of the chisel is too thick to possess good cutting properties. Every sort of steel which has been cast, but not afterwards made

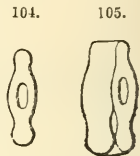

fibrous with hammering, should be rejected, and pure iron bars, that were carbonized with charcoal without being afterwards cast, should be selected, the precise quality of any one piece in all cases depending on the quality of the iron at the time of carbonization.

It is not possible for the tool maker to know how or of what materials his steel was made, but he is able to ascertain the quality of any piece by testing it, which should always be done previous to making a large number of one bar, or of one sort of steel. It is also necessary to test each bar, and sometimes both ends of one bar, because one end may be much harder than the other end, and the operator be deceived thereby.

The bar steel which is made for hand chisels is in the shape of four-sided bars, each having two flat sides and two curved convex ones; such a shape is produced with rolling, and is convenient for handling. A piece of such a bar, or a few inches at one end of it, is to be first tested by heating it to a bright red, and cooling it in clean cold water until the steel is quite cold; it is then filed with a saw file, or some other smooth file known to be hard, and if the steel cannot be cut, its hardening property is manifested. The next test consists in hardening it and allowing it to remain in the water till nearly cold, then taking it out and allowing the heat in the interior to expand the hard exterior; this will break it, if not fibrous enough to withstand the trial. A third test consists in making a grooving chisel of the steel, and hardening it ready for use. This is the proper test for all chisels, because it is easily and quickly performed; and it is advisable to make the cutting end rather thinner than for ordinary chipping, so that if it does not break nor bend while thin, it is reasonable to expect it would not break if thicker.

The forging of a chisel, whether a broad smoother or a narrow groover, consists in tapering one end, and next cutting off the cracked extremity which is produced whenever steel is forged thin and tapered. During the final reducing, the taper part is thinned with a flatter, and the flattening is continued till the end is below red heat. Hardening is next performed while the work is yet warm; this consists in gripping the chisel in tongs, and heating 5 or 6 in. of the steel to redness, then placing about 2 in. of the taper part slantways into water and moving it quickly to and fro till cold; it is then taken out and tempered, which is effected with the heat in the thick portion that was not put into the water; this heat moves along to the hard end and softens it while the operator rubs off the thin scale with a piece of grindstone, which allows the colour to appear; and as soon as a purple is seen at the cutting part, the entire taper portion is cooled in water. This mode of tempering allows only about half an inch of the taper part to remain hard, all the remainder being soft; if not, the vibration caused while hammering would break the tool in the midst of the taper portion. Some sorts of steel require hardening at a very dull red, and tempering until a quarter of an inch at the end is blue.

Sharpening chisels ready for use is effected on ordinary grindstones. The cutting edge should be made convex, to obtain two results, one of which is rendering the tool less liable to break, and the other result is the greater ease of cutting while holding the tool to its work. Those chisels that are to cut brass or gun-metal have their long taper portions, and also their cutting parts, thinner than the taper portions of chisels for iron and steel, those for steel being thickest of all; but the angles of the taper parts are about the same for all chisels. When, however, a small difference is made in such angles, the smaller angle is given to those for cutting brass and gun-metal. The angle of a hand chisel's long taper portion is only about 6° , but that of the cutting end is about 60° . In Fig. 106 a narrow side of a chisel is shown, and a couple of lines are made that extend from the cutting end; two other lines are also shown, which extend from the long taper part, the difference between the two angles being indicated by such lines.

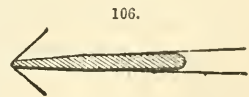

It is only during the mending of a chisel that the proper management can be exactly

effected. After they have been in use, the workman can decide whether the metal he is cutting requires the chisels to be harder or softer than they were when first hardened, so that he instructs the tool maker to make them harder, if necessary, or to make them thicker at the cutting part, if steel or hard iron is being chipped. By using a chisel it is also discovered whether it were left too hard at its tempering, and needs different treatment.

To prevent the head of a chisel burring around the edges with hammering, and causing pieces to fly off, the head should be frequently curved with grinding, at the time the cutting part is sharpened; and when a head is mended at a forge, the end may be tapered, but none of the burr is to be hammered; all these should be cut off with a small trimmer, or ground off with a grindstone, previous to tapering on the anvil.

Files.—The processes to which files are subjected, after receiving them from the file maker, include hardening, bending, cranking the tangs, and shaping the tangs to prevent their handles falling off.

Rough files are oftener made of inferior steel than smooth ones, and if the metal is not capable of properly hardening in ordinary water, salt water is used; and if an extraordinary hardness is requisite, the file may be hardened in mercury. Rough files are often softer than they should be, to prevent their teeth breaking off during use; this should be remedied by forming the teeth so that they shall be inclined at a proper angle to the file's broad sides, and by properly polishing the sides previous to forming the teeth; smooth teeth are more durable than rugged ones, and teeth having smooth extremities cannot be produced if the blank sides are not smooth. The cutting sides of a file must be convex, and to obtain this form the middle of the file is made thickest. The convexity of one side of a flat file is destroyed if the tool bends much in hardening, and if found to be thus bent, it is heated to dull red and hammered with a wood hammer while lying across a wood block having a concave face; this hammering is equally administered along the entire length to avoid forming crinkles, after which it is heated to redness and hardened. Half-round files are always preferable if the half-round sides are convex and the point very much tapered. A rough file which is made of soft steel that cannot be properly hardened, is improved by heating it to a bright red and rolling it in a long narrow box containing powdered prussiate of potash; the file is then held in the fire a few seconds until the powder attached is melted, when the work is cooled in water. The tangs of files are not hardened, or, if hardened, are always made quite soft afterwards, to prevent them breaking while in use.

In order to crank the tang of a file without softening its teeth, it is necessary to bind a couple of thick pieces of iron to that portion which adjoins the tang, and to heat the tang as quickly as possible by putting it through the hole of a thick iron ring which is at near welding heat; this ring is narrow enough to allow the greater part of the tang's length to extend beyond the hole, by which means the thick portion in the hole is heated to redness while the thin end remains black. When the proper heat is thus obtained, the first bend to commence the cranking is made by bending the work while in the hole, if the hole is small enough; if not, the bending is performed on the anvil edge. The situation of the first bend is near the file's teeth, and the second bend nearer the tang's point is afterwards easily made, because it is not necessary to heat the tang in its thick part.

File handles frequently slip off through the tangs being too taper: this is remedied by grinding and filing the tang at its thickest end, without heating it and thinning it on an anvil, especially if the file is a good one. Handles also slip off through their holes being of a wrong shape, resulting from using one handle for several files. The proper mode of fitting a handle to a tang consists in making a small round hole which is nearly as deep as the length of the tang, and next shaping the hole to the desired form by burning out the wood with the tang; for this purpose it is heated to a bright red at the

point, and a dull red at the thick part; it is then pushed into the handle, and allowed to remain in a few seconds, when it is pulled out and the dust shaken from the hole; the tang is then again heated and put the same way into the hole, to obtain the proper shape. One heating of the tang is sufficient, except it happens that the round hole were too small or too shallow, when two or three burnings may be necessary. In order to avoid the danger of softening a good file, it is proper to use the tang of an old file, observing that its shape is similar to that of the tang to be fitted.

Scrapers.—A scraper having a flat extremity is easily made of a small flat file, the thin taper portion of the file being first broken off, and a straight smooth extremity produced with grinding on a grindstone. The two broad sides are ground near the intended cutting edges, to destroy all convexity in that part, and to produce a slight concavity, for giving a cutting property to the edges, these two concave sides being afterwards polished with flour-emery cloth. The flat extremity requires to be slightly curved and convex, and is ground until about a sixteenth of an inch prominent in the middle. After such a scraper has been properly made, the several grindings for sharpening are entirely performed upon the flat extremity, so named, the broad sides not being ground, but merely rubbed on an oilstone. An oilstone is also required to smoothly polish the cutting part every time the tool is sharpened.

Three-cornered scrapers are much used, and are made of triangular files of various sizes; the points of these are ground on a grindstone until the three intended cutting edges are regularly curved and convex; and the tool is finally polished on an oilstone. Scrapers having broad thin ends for scraping sides of holes, concave surfaces, brasses, shells of steam-cocks, and similar work, require a concave side, that may be termed the bottom. This side or surface is that which bears on the surface being scraped, and, through being concave, the tool has a superior cutting property, and is also easily moved to and fro by the operator without being liable to rock or cant while on the work.

A mode of making a scraper very light, to promote an easy handling, consists in thinning the intermediate portion, thus making it much thinner than the cutting part. If a scraper thus lightened is not thick enough to permit its being firmly held by the workman, the thin portion is covered with a few layers of cloth, flannel, worsted, felt, or similar substance, to enlarge the mid-part of the tool to a convenient thickness. Such a covering is also useful for all scrapers, whether thick or thin, rectangular or triangular, if they are small, to avoid cramping the fingers.

Scrapers that are made of files by grinding need no hardening; but if one has been forged by thinning and spreading one end of a piece of round steel, the process of hardening is performed after the tool is roughly filed to its shape. For scrapers, no tempering is necessary.

Drifts.—Cutting drifts having teeth on their sides, similar to large file teeth, are shaped by two methods; small ones not more than 1 in. thick being grooved by filing, and large ones that may be 3 or 4 in. thick being grooved with a planing machine or shaping machine.

The steel suitable for drifts is a tough, well-hammered metal that has not been cast, and the smaller the intended tool the greater is the need to select an elastic fibrous metal which will bend after being hardened, and not be liable to crack in hardening through being too solid. Small thin drifts may be made of a hard Swedish iron, and afterwards partly carbonized to steel the exterior. A drift thus made will sustain a severe bending while in a crooked hole, without being so liable to break as if the entire tool were of steel. The short drifts do not bend while being hammered through a piece of work; they may therefore be made of steel; but all long ones that are comparatively thin are more pliable if made of iron. The hammering of any drift, whether long or short, shakes and tends to break it, and it is advisable to make each one as short as its intended work will permit. Those for drifting small holes often require long handles,

similar to that shown in Fig. 107; such a handle is thinner than the portion for cutting, that all its teeth may be driven through the work.

Iron drifts are steeled by being packed in charcoal in boxes; the lids are put on, all the crevices are filled with loam, and a thick layer of loam is put on the ledge, which extends all round the mouth for the convenience of supporting the loam. After all the crevices are thus filled, to keep out the air, the affair is put into a large clear fire, that plenty of room may exist around, and gradually heat all sides of the box at one time. A plate furnace fire will afford a convenient heat, a substitute being a large forge fire; if this is used, the blast is very gently administered until the work is red hot, when the blast is stopped, and the work is allowed to remain at the same heat for 2 hours, during which time the drifts have absorbed the carbon from the charcoal, and the surfaces are steeled. This being done, each one is taken carefully from the charcoal without bruising the edges, and allowed to cool separately, if they are required immediately; if not, the box is taken from the fire, the lid is raised, and the work is allowed to slowly cool while among the charcoal. When the drifts are cold, they are put into order for hardening. This may be done at any future time, and consists in sharpening the teeth and polishing the surfaces, to make them as they appeared previous to being heated, and when they are to be hardened they are again heated and cooled in water. This second heating is seldom necessary for drifts if they are properly finished previous to steeling, and they may be hardened while hot at the time they are first carbonized. Drifts thus steeled may be softened at any future time when the teeth require sharpening, and again hardened by merely heating and dipping into water, because heating the tool does not liberate the carbon.

107.

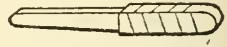

This method of carbonizing is also adopted for changing the surfaces of iron screw-taps into steel; taps thus treated are useful for several classes of work, if properly managed.

Punches.—A punch with a circular extremity, for making round holes into cold sheet iron and other metals, is about 6 in. long, and made of an old round file, to avoid forging. The file is first thoroughly softened along its entire length, and one end is reduced until of a proper diameter to make the holes desired; this reducing is often done with a grindstone, while the file is soft, when forging cannot be effected, and the intended cutting extremity is ground until flat. When properly shaped, the tool is hardened by heating to redness about 3 in. of its length, and placing about 1 in. into water, moving it to and fro as for hardening other tools; as soon as the tool's extremity is cold, it is taken from the water and cleaned, during which time the heat slowly softens the end, and when a blue colour appears at $\frac{1}{4}$ or $\frac{1}{2}$ in. from the extremity, the hard part of the punch is cooled, but the remainder is allowed to cool as slowly as possible, that it may be quite soft.

Square punches and other angular punches for hand use are of the same length as round ones, and are made of properly softened round and square files. Punches are not merely required to make holes; they are useful for smoothing and polishing the boundaries of various recesses that cannot be filed, scraped, or ground. A punch for such work is held in one hand, and applied to the work while the head of the punch is hammered until the surface in contact is shaped. Tools of this class have shaping extremities of various forms, some being curved and convex, others are concave, some are provided with ridges, knobs, teeth, and other protuberances, the extremities of others are rectangular, triangular, and oval, having recesses of several forms. All such punches require a careful polishing, both previous to hardening and afterwards, and the better the polish given to the punch, the smoother will be the surface to be punched. The ends of such tools are specially tempered after hardening, to suit their respective shapes, those extremities which are broad, and consequently strong, being tempered to a

brown, unless the steel happens to be a brittle cast steel, for which metal the temper denoted by blue is necessary.

Spanners.—The proper metal for spanners generally, is a soft fibrous Bessemer steel; such metal is produced by rolling and hammering the Bessemer product after being cast, that the fibrous character may be produced. If such steel is soft enough, it will weld, and spanners of all shapes may be made of it.

To make a gap spanner quickly for immediate use, one end of an iron or steel bar is heated to a bright yellow heat, and bent until a hook is formed; the work is next heated at the curved part, and lengthened or shortened until the gap is of a proper width. A gap spanner of this character is shown by Fig. 108. Another simple class of gap spanners are those made of thin bar or plate steel. A spanner of this sort needs no thinning to produce the handle, because the gap portion is no thicker than the handle; it is therefore made by cutting out with chisels while the plate is at bright red heat. Small spanners only should be made by this mode, because of their wide gap portions, and are represented by Figs. 109 and 110.

Small gap spanners, of only 1 or 2 lb. each in weight, are easily made of steel, and should have cylindrical handles, usually termed round handles, to promote an easy handling. Large spanners may have broad thin handles, that they may be light, and the two edges or narrow sides are curved. A gap spanner with only one gap end is made by providing a bar which is thick enough to be made into the spanner's gap portion without upsetting, and thinning the end of the bar until it is of the desired length and shape for the spanner's handle. The gap in the thick portion is next made by first punching a hole at the place for the bottom of the intended gap, a round punch being used if the bottom is to be curved, and a 6-sided punch or drift, if the bottom is to be angular. When the hole is made, two slits are formed from the hole to the extremities, and the superfluous gap-piece is cut out, at which time the work is roughly prepared for an after trimming. Another spanner is next partly made by the same means of the same bar, if necessary, and any greater number that may be required. A spanner in process of being made of such a piece is indicated by Fig. 111.

The forging of a spanner which is to have a gap at each end is effected by making two gap-pieces, each one having a gap of proper size, and an end or stem of about half the entire length of the intended spanner. These two stems are scarfed, or a tongue-joint is made, for the purpose of welding them together, which produces the desired spanner having a gap at each end. After being shaped at the gap parts, the spanner is bent, whether it has one gap or two, the bending being necessary that the spanner may be applied to the 6 sides of a nut by moving the handle to and fro in the shortest possible space. This bending consists in heating the junction of the gap part with its stem, and bending it until the handle or stem is at an angle of 15° with the gap-sides.

The final shaping of a gap-spanner consists in trimming the edges with a trimming chisel and curving the outer surfaces. Half-round top and bottom tools are employed

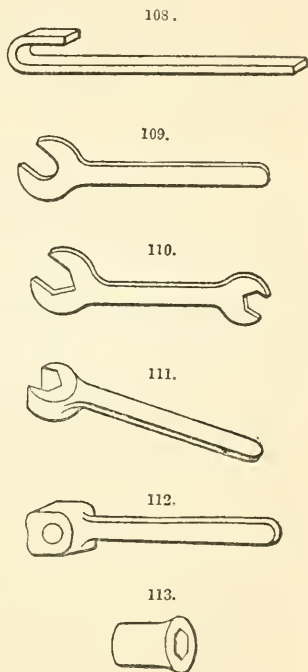

for this curving, and the edges of the gap portions are shaped while between such tools, and also while a filler is in the spanner's gap. This filler is of steel, and is long enough to be supported on a couple of blocks, or across an opening of some sort, while the spanner's gap-part is held on the filler and shaped with the top and bottom tools. One narrow side of the filler is angular, similar to the bottom of the gap, and the thickness is the forged width of the gap; consequently, while the outer surfaces are being shaped at the time the filler is in the gap, both the gap and the outer edges of the gap portion are shaped at one hammering.

In order to provide good bearings in the gap surfaces, and to prevent the entire gap portion being too broad, and thereby occupying too much room, the thickness of a gap portion belonging to a small spanner should be about equal to the height of the nut which is to be rotated, and the total breadth across the gap part only about 3 times the diameter of the hole in the nut. Large spanners for nuts 3 or 4 in. height, may have gap parts which are two-thirds of the nuts' heights. The proper shape for the bottom of a spanner's gap is angular, that it may fit any two contiguous sides of a 6-sided nut or bolt head. Gaps of such a form will suit hexagonal nuts and square ones. A gap with a curved bottom bruises the nuts' corners, and it must be made very deep to prevent the spanner slipping off while in use. By Fig. 112 a spanner is represented whose gap part is of proper shape.

Gap spanners are often forged of ordinary fibrous wrought iron, and after they are properly finished and the gap surfaces smoothly filed to suit the nuts, the entire gap portion of each spanner is hardened; this is performed by heating it to a bright red, rolling it in powdered prussiate of potash, and then cooling it in clean water. Small iron spanners, that are only 6 or 8 in. long, are put into a box with bones or hoofs, and their entire surfaces are steeled, similar to the mode for steeling other small tools.

Cast-iron spanners are those that are made by pouring the metal into sand moulds that are shaped with wood or iron patterns resembling the spanners to be cast. After casting, the spanners are softened by a long gradual cooling, which makes the metal soft, and prevents the tool breaking while in use, although the metal is not made fibrous. Cast steel thus used is a preferable metal to cast iron.

The stems and handles of socket spanners are made of round iron or steel, and separate from the socket portions. The socket portion of the spanner consists of a tubular piece which is attached to the stem by welding its end in the socket hole. This socket piece may be an end of a thick tube, if such a piece can be obtained with a hole of proper diameter. The socket may be made also by punching a hole through a solid piece, and drifting the hole to a proper shape and size; this produces a good socket if the metal is solid. The convenient mode of making a socket of an iron or soft steel bar consists in curving to a circular form one end of a bar which is about as thick as the intended socket, and welding the two ends together by means of a sort of scarf joint termed a lap joint. Such a joint is made by tapering both the ends that are to be welded together, and curving the socket piece until its hole is about three-quarters of its finished diameter, which allows the socket to be stretched with welding to its proper diameter. After a socket is made by either of these means, its hole is shaped with a steel 6-sided drift which is of the same shape and thickness as the required socket hole. One end of the socket is next heated and upset, to make it thicker and larger in diameter than the remainder, at which time it appears as in Fig. 113, being then ready for welding to the stem.

The preparation of the stem consists in thickening one end by upsetting, and shaping it to a 6-sided form to fit the socket-hole. A stem thus shaped is denoted by Fig. 114; and the thick part is made to fit tight in the hole, that it may be easily handled and welded in that situation. The length of the part which is in immediate contact with the enlarged end of the hole is about half of the socket's length, and while the two are together a welding heat is given them, and they are welded with a couple of

angular-gap tools while the socket is between. During this welding, the tools are in contact with only that part which contains the end of the stem, in order that the hole may not be made much smaller by the hammering. This welding reduces the thick part of the socket to the same diameter as the thinner part, and also lengthens the bearing of the stem in the hole.

The final shaping of the socket, after it is properly attached to the stem, is accomplished by trimming off superfluous metal to make the socket to a proper length, and smoothly finishing the hole with a 6-sided filler. This filler is parallel, and is carefully made so that it shall be the precise thickness and shape of the finished hole, being tapered a short distance at the point, that it may enter easily into the hole when necessary. The extremity of the part which is in the hole is smoothly shaped and curved, for smoothing the bottom of the socket hole. This smoothing is effected by beating that part of the socket and hammering the end of the stem while the filler is in the hole and touches its bottom. To conveniently hammer the stem, the filler is put into the hole, and the outer end of the filler is then put to the floor with the socket-stem extending upwards, the filler resting on a soft iron block or lead block, whose top is level with the floor; while thus arranged, the upper end of the stem is hammered and the bottom of the hole is shaped. A filler of this class, in the hole of a socket, is represented by Fig. 115. Through such a filler being nearly or quite parallel along a great part of its length, it cannot be released from any socket after being once hammered in, without beating it and enlarging the hole enough to let out the filler with pulling in a vice, or similar means.

The handle end of the stem for socket spanner is provided with a hole, if to be used with a separate lever, or provided with a T handle, to be rotated by such means; and the spanner has a bent stem, constituting a handle which is at right angles to the length of the socket, the stem is heated to make the end in the right place, after all the joint-making is completed.

If a socket spanner is not to be the-turned, it is necessary to carefully reduce the work to a proper shape and dimensions while on the

anvil; but if to be turned, a proper amount of metal is allowed, that the socket may not be too thin. A socket spanner is turned while its handle end is supported on the endrel pivot of a lathe, and its socket part is supported on a broad conical pivot, which is large enough to bear on the edges of the hole's mouth. By this method, the socket is accurately turned so that one side shall be just as thick as the opposite side, and if the entire length of the socket were forged parallel to the drift while in the hole, the tire outer surface of the socket when turned would be also parallel with the hole.

A spanner which has a boss at one end containing a square, 6-sided, or round hole, is forged at one end of a bar which is nearly as thick as the length of the boss which is to have the hole. At the end of the bar a portion is reduced until small enough for the handle, and the thick portion adjoining is punched with a taper, square, or round punch, and also drifted while at welding heat with taper drifts of proper shapes. In Fig. 116 a spanner being made at one end of a bar is shown, and may be partly drifted while

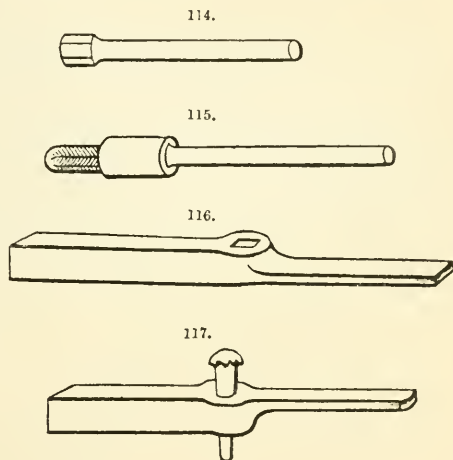

attached to the bar, and also afterwards, while separate, as denoted by Fig. 117. When it is cut from the bar, the shaping of the boss is completed by hammering the outside while at welding heat, and by fullers applied to the junction of the boss with the handle; during both these processes a drift is in the hole; a drift is also in the hole of a boss, which is circular, and being rounded with half-round top and bottom tools.

The drifts for enlarging the holes are very taper, similar to the one shown in Fig. 117, and those for adjusting holes to proper diameters are so nearly parallel that they appear parallel to ordinary observation. A parallel drift is indicated in Fig. 118 and is tapered at each end, to prevent its being stopped by the burs made with hammering while being driven into or out of a hole.

Several drifts of various sizes and shapes are always kept ready by the smith, and by a proper use of the parallel ones a spanner with a circular hole can be enlarged until the desired amount of metal remains for boring the boss to the stated dimensions; and if the spanner being finished has a square or 6-sided hole, it can be drifted until it fits the nuts, bolt heads, spindle end, plug end, or other works for which the spanner is made, thus avoiding much filing, drifting with cutting drifts, and other lengthy processes.

Wrenches.—Wrenches for rotating taps, branches, and similar tools are made of three portions for each wrench, one piece being the boss which is to contain the hole or holes, and the other pieces being round straight pieces for the handles, the three being separately made, and the holes in the boss-part finished, previous to welding the pieces together. The length of the boss-part depends on the number of holes to be in it, and after the length is ascertained, a piece of soft steel is selected which is large enough for the boss, and long enough to allow a stem to be thinned at each end of the boss; this component piece is first properly marked while cold, to denote the commencement of each stem, and next fullered with top and bottom fullers to commence the thinning, which reduces the stems to a proper diameter. A boss-piece of this class is shown by Fig. 119, which is to have only one square hole. Another boss-piece, made by the same means, but having 3 holes, is represented by Fig. 120; in this figure a mouth for a tongue joint is shown at the end of each stem, such a joint being adopted when making large tap spanners. A tap spanner to be welded by means of scarf joints is indicated by Fig. 121, in which the ends are thickened and bevelled ready for welding. When the handles are welded with tongue joints, the joints are made very strong, through the extremities being made to extend several inches along the handles, as denoted in Fig. 122.

A small wrench that is only about 1 ft. long is made of only one piece of steel, and it is not necessary to select soft steel for welding, the stems which are produced from the boss being made long enough by thinning to become the handles, without welding them to separate pieces. Large tap spanners, also, are occasionally made in this way if the operators have access to steam hammers for the reducing. For economy, small wrenches are often made of old files, and if the steel is not too brittle to be properly thinned for the handles, strong, hard, durable spanners are produced.

All the holes in wrenches are square, and are made by punching and drifting, having proper care to enlarge the holes with smooth drifts, so that only a very little filing shall be necessary. The handles of tap wrenches are lathe-turned, and the junctions of the stems with the bosses are nicely curved with springy corner tools.

To make a capstan spanner having 4 handles extending from the boss, one thick piece for the boss is necessary, and 4 straight pieces for the handles; these are welded to the boss part by means of stems that are produced from the boss by thinning.

The outer shape of the boss should be square, not circular; and to produce a boss which is to be 4 in. long and about 4 in. square, a piece of soft steel bar should be selected which is about $4\frac{1}{2}$ in. square, which will allow a trimming to shape the boss after it is spread with punching and drifting, the length of the piece being about

9 in., that there may be ample metal for the 4 stems, in addition to the boss. This piece is first fullered at each side of the intended boss, and thinned, to form a lump in the middle, and which shall extend from only one side, as shown in Fig. 123; the two thinner portions are next punched with a round punch to make 2 holes near the boss, similar to those in Fig. 124; a slip is next made from each hole, to make the 2 stems or arms into 4; these are separated, and the junctions fullered to make a rough 4-arm

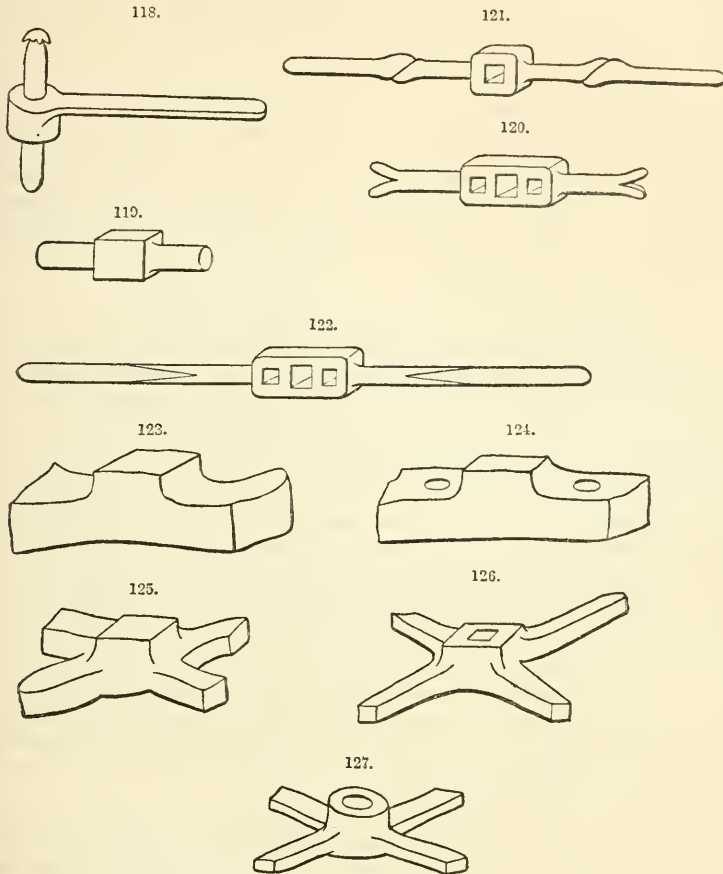

boss denoted by Fig. 125. The square hole is next punched in the boss, by commencing with a very taper square punch, which is driven from both ends of the hole, the punch being placed to make each corner of the hole opposite one of the 4 arms. After punching, square drifts are used to enlarge the hole, and a hammering is given to the boss while a drift is in the hole, and the boss at welding heat, which makes it rather more fibrous than before. The junctions of the arms are next shaped with a fuller and set hammer, and the arms lengthened to a convenient length, that the boss may not be too near the anvil while welding the handles to the stems of the boss. The final shaping of the boss consists in cutting off superfluous metal with a flat chisel and a gouge chisel,

and smoothing it with a set hammer or flatter, also with a fuller at the junctions, while a drift of the finished size of the hole remains in it. A boss of this class requires a careful trimming to shape it at the conclusion of forging, to avoid a lengthy shaping while cold, especially because it cannot be turned in a lathe. The boss, having its arms at right angles to each other, and reduced to a proper thickness, is represented by Fig. 126.

The circular boss, shown by Fig. 127, has an elegant appearance, and can be lathered to partly shape it; but such a boss requires more metal around a square hole than is necessary for a square boss of the same strength. When bosses having 4 arms, or 3 arms, are being made in considerable numbers, each one can be easily shaped in a shaping mould, which is fitted to a steam-hammer anvil.

Adjusting surfaces by hammering.—One of the most interesting uses of the hammer is for stretching plates of metal. Blows applied upon the surface of a straight piece of metal will cause the side struck to rise up and become convex, and render the other side concave. This process is termed “paning” or “peening,” from the pane or pene of the hammer being generally used to perform it; it is resorted to for straightening plates, correcting the tension of circular saws, &c., and has recently been made the subject of a most instructive lecture before the Franklin Institute, by Joshua Rose, from which the following abstract is taken.

Supposing you have a $\frac{1}{8}$ -in. plate with a dent in the middle, on laying one end on an anvil, holding up the other in your left hand, and springing the plate up and down with your right hand, if you watch the plate, you will see that as you spring it the middle moves most, and the part that moves is a “loose” place. The metal round about it is too short and is under too much tension. Now, if you hammer this loose place you will stretch it and make it wide, so hammer the places round about it that move the least, stretching them so that they will pull the loose place out. With a very little practice you can take out a loose place quite well; but when it comes to a thick plate, the case is more difficult, because you cannot bend the plate to find the tight and loose places, so you stand it on edge, and between you and the window the lights and shades show the high and low patches. Fig. 128 represents what is called the “long cross-face” hammer used for the first part of the process, which is termed the “smithing.” The face that is parallel to the handle is the long one, and the other is the cross-face. These faces are at right angles one to the other, so that without changing his position the operator may strike blows that will be lengthways in one direction, as at *a*, in Fig. 129, and by turning the other face towards the work he may strike a second series standing as at *b*. Now, suppose we had a straight plate and delivered these two series of blows upon it, and it is bent to the shape shown in Fig. 130, there being a straight wave at *a*, and a seam all across the plate at *b*, but rounded at its length, so that the plate will be highest in the middle, or at *c*, if we turn the plate over and repeat the blows against the same places, it will become flat again.

To go a little deeper into the requirements of the shape of this hammer, for straightening saws both faces are made alike, being rounded across the width and slightly rounded in the length, the amount of this rounding in either direction being important, because if the hammer leaves indentations, or what are technically called “chops,” they will appear after the saw has been ground up, even though the marks themselves are ground out; because in the grinding the hard skin of the plate is removed, and it goes back to a certain, but minute, extent towards its original shape. This it will do more in the spaces between the hammer blows than it will where the blows actually fell, giving the surface a slightly waved appearance.

The amount of roundness across the face regulates the widths, and the amount of roundness in the face length regulates the length of the hammer marks under any given force of blow. As the thicker the plate the more forcible the blow, therefore the larger the dimensions of the hammer mark. This long cross-face is used again after the saws

have been ground up, but the faces are made more nearly flat, so that the marks will not sink so deeply, it being borne in mind, however, that in no case must they form distinct indentations or "chops."

Fig. 131 is a "twist" hammer, used for precisely the same straightening purposes as the long cross-face, but on long and heavy plates, and for the following reasons.

When the operator is straightening a short saw, he can stand close to the spot he is hammering, and the arm using the hammer may be well bent at the elbow, which enables him to see the work plainly, and does not interfere with the use of the

128.

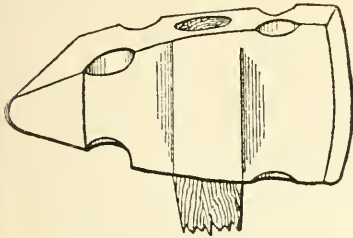

129.

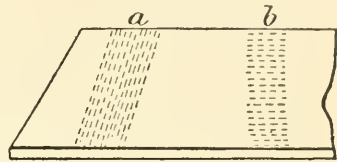

130.

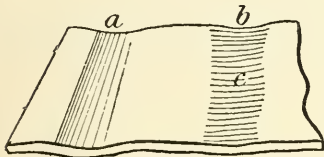

131.

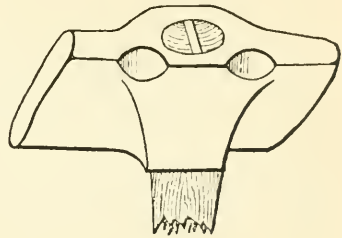

hammer, while the shape of the smithing hammer enables him to bend his elbow and still deliver the blows lengthways, in the required direction. But when a long and heavy plate is to be straightened, the end not on the anvil must be supported with the left hand, and it stands so far away from the anvil that he could not bend his elbow and still reach the anvil. With the twist hammer, however, he can reach his arm out straight forward to the anvil, to reach the work there, while still holding up the other end, which he could not do if his elbow were bent. By turning the twist hammer over he can vary the direction of the blow the same as with the long cross-face.

Both these hammers are used only to straighten the plates, and not to regulate their tension, for a plate may be flat and still have in it unequal strains; that is to say, there may exist in different locations internal strains that are not strong enough to bend the plate out of truth as it is, but which will tend to do so if the slightest influence is exerted in their favour, as will be the case when the saw is put to work. When a plate is in this condition, it is said to have unequal tension, and it is essential to its proper use that this be remedied.

The existence of unequal tension is discovered by bending the plate with the hands, as has been already mentioned, and it is remedied by the use of the dog-head hammer, shown in Fig. 132, whose face is rounded so that the effects of its blow will extend equally all round the spot struck. It will be readily understood that the effects of the blow delivered by the smithing, or by the twist hammer, will be distributed as in Fig. 133, at *a*, *b*, while those of the dog-head will be distributed as at Fig. 133, *c*, gradually diminishing as they pass outwards from the spot struck; hence the dog-head exerts the most equalized effect.

Now, while the dog-head is used entirely for regulating the tension, it may also be

used for the same purposes as either the long cross-faced or the twist hammer, because the smith operates to equalize the tension at the same time that he is taking down the lumps; hence he changes from one hammer to the other in an instant, and if, after regulating the tension with the dog-head, he should happen to require to do some smithing, before regulating the tension in another, he would go right on with the dog-head and do the intermediate smithing without changing to the smithing hammer. Or, in some cases, he may use the long cross-face to produce a similar effect to that of the dog-head, by letting the blows cross each other, thus distributing the hammer's effects more equally than if the blows all lay in one direction.

In circular saws, which usually run at high velocity, there is generated a centrifugal force that is sufficient to actually stretch the saw and make it of larger diameter. As the outer edge of the saw runs at greater velocity than the eye, it stretches most, and therefore the equality of tension throughout the saw is destroyed, the outer surface becoming loose and causing the saw to wobble as it revolves, or to run to one side if one side of the timber happens to be harder than the other, as in the case of meeting the edge of a knot.

The amount of looseness obviously depends upon the amount the saw expands from the centrifugal force, and this clearly depends upon the speed the saw is to run at, so the saw straightener requires to know at what speed the saw is to run, and, knowing this, he gives it more tension at the outside than at the eye; or, in other words, while the eye is the loosest, the tension gradually increases towards the circumference, the amount of increase being such that when the saw is running the centrifugal force and consequent stretching of the saw will equalize the tension and cause the saw to run steadily.

In circular saws the combinations of tight and loose places may be so numerous that as the smith proceeds in testing with the straight-edge he marks them, drawing a circular mark, as at *g*, in Fig. 134, to denote loose, and the zig-zag marks to indicate tight places.

To cite some practical examples of the principles here laid down, suppose we have in Figs. 135 and 136 a plate with a knick or bend in the edge, and as this would stiffen the plate there, it would be called a tight place. To take this out, the hammer marks could be delivered on one side radiating from the top of the convexity as in Fig. 135, and on the other as shown radiating from the other end of the concavity as in Fig. 136, the smithing hammer being used. This would induce a tight place at *a*, Fig. 135, which could be removed by dog-head blows delivered on both sides of the plate. Suppose we had a plate with a loose place, as at *g* in Fig. 137, we may take it out by long cross-face blows, as at *a* and *b*, delivered on both sides of the plate, or we might run the dog-head on both sides of the plate, both at *a* and at *b*, the effect being in either case to stretch out the metal on both sides of the loose place *g*, and pull it out. In doing this, however, we shall have caused tight places at *e* and *f*, which we remove with dog-head blows, as shown. If a plate had a simple bend in it, as in Fig. 138, hammer blows would first be delivered on one side, as at *a*, and on the other side, as at *b*. A much more complicated case would be a loose place at *g*, in Fig. 139, with tight places at *h*, *i*, *k*, *l*, for which the hammer blows would be delivered as marked, and on both sides of the plate. Another complicated case is given in Fig. 140, *g* being two loose places, with tight places between them and on each side. In this case, the hammering with the long cross-

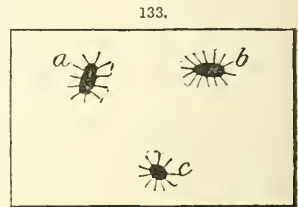
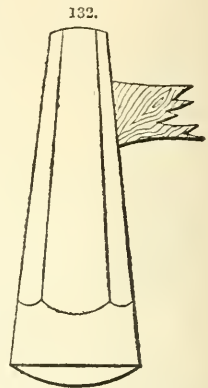

face would induce tight places at *d* and *e*, requiring hammer blows as denoted by the marks.

Rose had some examples to illustrate how plainly bending a plate will show its tight and loose places. With a rectangular piece of plate that is loose in the middle,

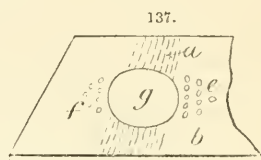
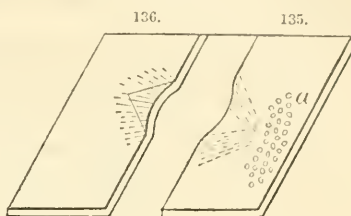
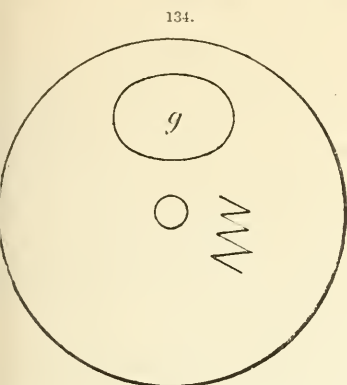

the straight-edge lies flat on it; but if you try to bend the middle of the plate downwards with your hands, you will see that it goes down instantly, the straight-edge showing a large hollow in the middle, as in Fig. 141, the same thing occurring with the straight-

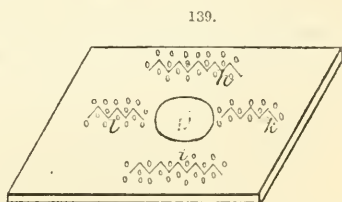
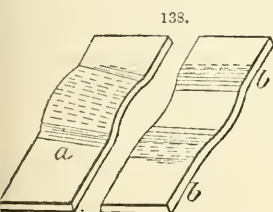

edge tried on both sides of the plate. Another piece is tight in the middle, and when you try to bend its middle downwards in precisely the same way, it comes upwards, and the straight-edge shows it to be round as in Fig. 142. In the first case the middle

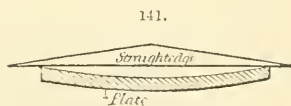
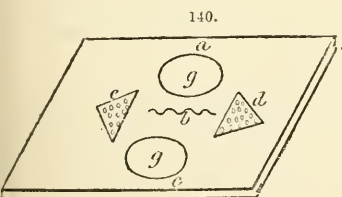

actually moves, because it is loose; in the second place the edges move, because they are loose.

With two circular saws, one tight and one loose at the centre, the same thing occurs;

for if you bend the loose one down, it goes down, leaving a wide space between the eye of the saw and the straight-edge; while if you try to bend the middle of the tight one down it refuses to go there, but goes at the outside, leaving the straight-edge resting on the middle. Here, again, then, the part that is loose moves the most. These examples are simple cases, but they impart a general knowledge of the principles involved in the skilful use of the hammer.

Red-lead Joints.—In every case in which steam is used at a pressure exceeding that of the atmosphere, either as a motive power or a heating agent, it is necessary to make the machinery or piping connected therewith in many pieces, for obvious reasons, the chief of which is convenience in manufacture, and wherever these are joined together to hold or convey steam it is necessary to make the joints steamtight. For this purpose there are almost innumerable methods, but we only intend giving briefly a few notes on those in which red lead is used, which are most familiar to those connected with the trade of an engineer; but notwithstanding this familiarity, nineteen out of twenty mechanics have very erroneous ideas on the subject, and consequently many joints are the cause of much delay, trouble, and expense, which could easily have been avoided if the general principles were understood. The fundamental principle of all joint-making is, that the thinner the joint the stronger and more durable it is.

(a) Flat-faced joints, as pipe flanges, cylinder covers, &c.—Each face must have all the old lead removed, and then be wiped over with a piece of oily waste (boiled linseed oil). The lead must be thoroughly worked, either by machine or by hand, to make it soft and pliable, and also to remove all grit and lumps. It should then be rolled in the hands into thin ropes, about $\frac{1}{4}$ in. diameter, and laid on once round inside the bolt holes. The 2 faces must now be brought together carefully, and tightened up equally all round, by screwing up opposite bolts, so as to avoid getting one side closer than another. Tarred twine, hemp, string, wire gauze, &c., should be studiously avoided wherever possible, as it prevents the faces from being brought into close contact. There are certain rough jobs where it may be permitted, but a joint so made is never so durable, and very clumsy. When joints are accurately faced, by scraping or otherwise, as in locomotive practice, nothing but liquid red lead is used, made of white lead mixed with boiled oil to the consistency of paint; they are of exceptional durability.

(b) Joints between male and female threads, such as screwed pipes and sockets, bolts or studs screwed into boiler plates, &c.—In these cases liquid red lead is used, and should be put on the female thread for inside pressure, on the male for outside pressure, as then the steam in each case forces any surplus lead into the thread, and forms a more reliable joint, or rather assists it; whereas, when it is applied in the reverse way, as generally done, the threads are left quite bare and clear, leaving nothing to assist the joint.

These methods, broadly speaking, apply just the same to the various compositions sold as substitutes for lead, the chief advantages claimed for them being cheapness and durability; but they can never surpass, or even equal it, if it be only used as explained, especially if a little common sense be applied in special cases.

Rust Joints.—“Rust” cement, known also as cast iron cement, and by other names, is used for caulking the joints of cast iron tanks, pipes, &c. It is composed of cast iron turnings, pounded so that they will pass through a sieve of 8 meshes to the in.; to these are added powdered sal-ammoniac, and sometimes flowers of sulphur. The ingredients having been mixed are damped, and soon begin to heat. They are then again well mixed and covered with water. The exact proportions of the ingredients vary. A simple form is 1 oz. sal-ammoniac to 1 cwt. iron turnings. The following are recommended by Molesworth:—

Quick-setting Cement.—1 sal-ammoniac by weight; 2 flowers of sulphur; 80 iron borings.

Slow-setting Cement.—2 sal-ammoniac; 1 flowers of sulphur; 200 iron borings.

The latter cement being the best if the joint is not required for immediate use. In the absence of sal-ammoniac the urine of an animal may be substituted. The cement will keep for a long time under water. Its efficacy depends upon the expansion of the iron in combining with the sal-ammoniac. The joints may be undone by heating the part to redness and jarring by hammer blows; paraffin or benzoline applied to the joint will sometimes assist.

Rivets.—The dimensions of rivets and of the plates at the joint may be calculated by the same rules as for single bolts. If it is a joint subject to tension, as in Fig. 143, the effective strength of the joint

and of the plate is the resistance of the cross-sections ab and cd to tension, and of the cross-sections be and cf to shearing. If it is a joint subject to compression, as in Fig. 144, the effective strength is the resistance of the section ghi to compression. Hence, in a tensile lap joint the size of the rivets should be as small as possible, and the sections of the parts $abcd$ as large as possible; and in a compressible lap joint the size of the rivets should be as large as possible.

Lap joint is the name given to a riveted joint when the plates overlap each other. In a single rivet lap joint, as in Fig. 145, the whole tensile or compressible strain being divided amongst the spaces between the rivets determines the interval of them. And the whole shearing strain being divided amongst the sections a, b, c, d , &c., determines

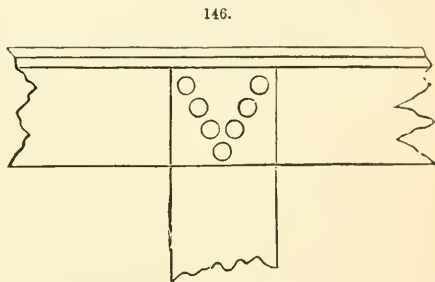
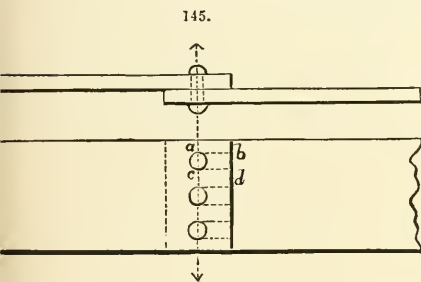
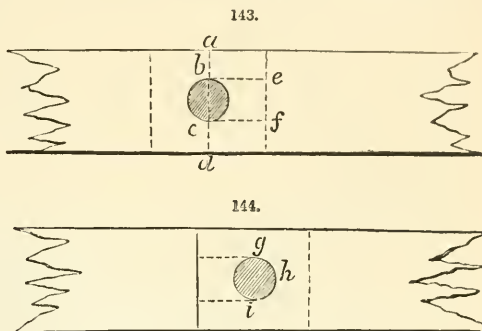

the amount of overlap. Fairbairn considers that the strength of such a joint under tension is only 0.56 of that of the solid plate of the same general cross-sections.

In a double rivet lap joint the amount of overlap and the intervals between the rows of rivets both ways, and the size of the rivets, are all determined by the above considerations, and by the rules for bolts. Fig. 146 shows the joint recommended by Humber for tensile strains.

Fig. 147 shows the joint he recommends for compressive strains.

In practice the diameter of the rivets is generally made a little more than the thickness of the plate, and the interval is from 2 to 4 times the diameter, according to the closeness of the joint required.

The practice in H.M. Dockyard at Chatham, in the construction of iron ships, is to

use rivets rather larger in diameter than the thickness of the plate, and at intervals from 2 to 4 times the diameter. Thornton states that a watertight joint can be formed with single riveting at intervals of 4 diameters; double riveting is commonly used, the first row being placed at a distance of at least one diameter (of rivet) from the edge of the plate, and the second row at about 3 diameters from the first. These rules determine the length of what is called the butt-plate, or fishing-piece. The rivets in the second row are placed directly opposite those in the first row, and not diagonally opposite the spaces. In all exterior plates the outer rivet-holes are countersunk and the rivets hammered flush.

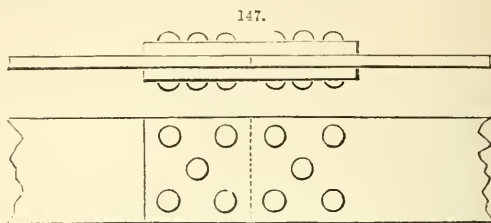

SOLDERING.—Soldering is the art of forming joints between metallic surfaces by the application of molten alloys.

Solders.—Alloys employed for joining metals together are termed “solders,” and they are commonly divided into two classes: hard and soft solders. The former fuse only at a red heat, but soft solders fuse at comparatively low temperatures.

One of the most easily fusible metals is an alloy of 2 parts bismuth, 1 tin, and 1 lead; tin is the most fusible of these three metals, melting at 455° F. (235° C.), but this alloy melts at 199½° F. (93° C.), or a little below the boiling-point of water. By diminishing the quantity of bismuth in the alloy, the point of fusion may be made to vary between 212° F. (100° C.), and 329° F. (200° C.), and thus it is an easy matter to form a solder which shall fuse at any required temperature between these limits, for electrical purposes, steam-boiler plugs, &c. The following are the best recipes for the common solders:—For *aluminium-bronze*: (a) 88·88 gold, 4·68 silver, 6·44 copper; (b) 54·4 gold, 27 silver, 18·6 copper. (c) Melt 20 parts of aluminium in a suitable crucible, and when in fusion add 80 of zinc. When the mixture is melted, cover the surface with some tallow, and maintain in quiet fusion for some time, stirring occasionally with an iron rod. Then pour into moulds. (d) 15 parts aluminium and 85 of zinc; (e) 12 aluminium and 88 zinc; (f) 8 aluminium and 92 zinc; all of these alloys are prepared as (c). The flux recommended consists of 3 parts copaiba balsam, 1 of Venetian turpentine, and a few drops of lemon-juice. The soldering-iron is dipped into this mixture.

For *brasswork*: (a) equal parts of copper and zinc; (b) for the finer kinds of work, 1 part silver, 8 copper, 8 zinc.

For *copper*: (a) 3 parts copper, 1 zinc; (b) 7 copper, 3 zinc, 2 tin.

Hard solder: 86·5 copper, 9·5 zinc, 4 tin.

Hard solder for gold: 18 parts 18-carat gold, 10 silver, 10 pure copper.

Hard silver solder: (a) 4 parts silver, 1 copper; (b) 2 silver, 1 brass wire; these are employed for fine work; the latter is the more readily fusible; (c) equal parts copper and coin silver; requires higher temperature than b, but will not “burn,” is as fluid as water, and makes a far sounder joint.

Hard spelter solder: 2 parts copper; 1 zinc; this solder is used for ironwork, gun-metal, &c.

For *jewellers*: (a) 19 parts fine silver, 10 brass, 1 copper; (b) for joining gold, 24 parts gold, 2 silver, 1 copper.

Middling hard solder: 4 parts scraps of metal to be soldered, 1 zinc.

For *pewterers*: (a) 2 parts bismuth, 4 lead, 3 tin; (b) 1 bismuth, 1 lead, 2 tin; the latter is best applied to the rougher kinds of works.

For *sealing iron in stone*: 2 lead, 1 zinc.

For *sealing tops of canned goods*: 1½ lb. lead, 2 lb. tin, 2 oz. bismuth; the lead is melted first, the tin added next, and finally the bismuth stirred in well just before pouring. This makes a soft solder, and the cans do not take much heat to open them.

Soft solder: 1 lead, 2 tin.

Soft solder for joining electrotype plates: 67 parts lead, 33 tin.

For *steel*: 19 parts silver, 3 copper, 1 zinc.

For *tinned iron*: 7 lead, 1 tin.

The following table exhibits the composition and characters of a number of solders:—

No.	Name.	Composition.	Flux.	Fluxing point.
1	Plumbers' coarse solder	Tin 1, Lead 3	R	800 F. (427 C.)
2	" sealed "	" 1 " 2	R	441 F. (227 C.)
3	" fine "	" 1 " 1	R	370 F. (188 C.)
4	Tinners' solder	" 1½ " 1	R or Z	334 F. (168 C.)
5	" fine solder	" 2 " 1	R or Z	340 F. (171 C.)
6	Hard solder for copper, brass, iron	Copper 2, zinc 1	B	
7	" " " " " "	Good tough brass 5, zinc 1	B	
8	{ " " " " " " } more fusible than 6 or 7	Copper 1, zinc 1	B	
9	Hard solder for copper, brass, iron	Good tough plate brass ..	B	
10	Silver solder for jewellers	Silver 19, copper 1, brass 1	B	
11	" " " plating	" 2, brass 1	B	
12	" " " silver, brass, iron	" 1 " 1	B	
13	" " " steel joints	" 19, copper 1, brass 1	B	
14	" " " more fusible	" 5, brass 5, zinc 5 ..	B	
15	Gold solder	Gold 12, silver 2, copper 4	B	
16	Bismuth solder	Lead 4, tin 4, bismuth 1	R or Z	320 F. (160 C.)
17	" " " " " "	" 3 " 3	1 R or Z	310 F. (154 C.)
18	" " " " " "	" 2 " 2	1 R or Z	292 F. (144 C.)
19	" " " " " "	" 2 " 1	2 R or Z	236 F. (113 C.)
20	" " " " " "	" 3 " 5	3 R or Z	202 F. (94 C.)
21	Pewterers' solder	" 4 " 3	2 R or Z	

Abbreviations: R, Rosin; B, Borax; Z, Zinc Chloride.

Advantage may be taken of the different degrees of fusibility of the solders in the table to make several joints in the same piece of work. Thus, if the first joint has been made with fine tinners' solder, there would be no danger of melting it in making a joint near it with bismuth solder No. 16, and the melting-point of both is far enough removed from No. 19 to be in no danger of fusion during the use of that solder. Soft solders do not make malleable joints. To join brass, copper, or iron, so as to have the joint very strong and malleable, hard solder must be used. For this purpose, No. 12 will be found excellent; though for iron, copper, or very infusible brass, nothing is better than silver coin, rolled out thin, which may be done by any silversmith or dentist. This makes decidedly the toughest of all joints, and, as a little silver goes a long way, it is not very expensive. To obtain hard solders of uniform composition, they are generally granulated by pouring them into water through a wet broom. Sometimes they are cast in solid masses, and reduced to powder by filing. Nos. 10, 11, 12, 13, 14, and 15 are generally rolled into thin plates, and sometimes the soft solders, especially No. 21, are rolled into sheets, and cut into narrow strips, which are very convenient for small work that is to be heated by lamp. Hard solders, Nos. 6, 7, 8, and 9, are usually reduced to powder, either by granulation or filing, and then

spread along the joints after being mixed with borax which has been fused and powdered. It is not necessary that the grains of solder should be placed between the pieces to be joined, as with the aid of the borax they will sweat into the joint as soon as fusion takes place. The best solder for platinum is fine gold. The joint is not only very infusible, but is not easily acted upon by common agents. For German silver joints, No. 14 is excellent.

When brass is soldered with soft solder, the difference in colour is so marked as to direct attention to the spot mended. The following method of colouring soft solder is given by the *Metallarbeiter*: First prepare a saturated solution of copper sulphate (bluestone) in water, and apply some of this on the end of a stick to the solder. On touching it with a steel or iron wire it becomes coppered, and by repeating the experiment the deposit of copper may be made thicker and darker. To give the solder a yellow colour, mix 1 part of a saturated solution of zinc sulphate with 2 of copper sulphate, apply this to the coppered spot, and rub it with a zinc rod. The colour can be still further improved by applying gilt powder and polishing. On gold jewelry or coloured gold, the solder is first coppered as above, then a thin coat of gum or isinglass solution is applied, and bronze powder is dusted over it, which can be polished after the gum is dry, and made very smooth and brilliant; or the article may be electroplated with gold, and then it will all have the same colour. On silverware, the coppered spots of solder are rubbed with silvering powder, or polished with the brush and then carefully scratched with the scratch-brush, then finally polished.

Burning, or Autogenous Soldering.—The process of uniting two or more pieces of metal by partial fusion is called "burning." This operation differs from the ordinary soldering, in the fact that the uniting or intermediate metal is the same as those to be joined, and generally no flux is used, but the metals are simply brought almost to the fusing-point and united. The process of burning is, in many cases, of great importance; when the operation is successfully performed, the work is stronger than when soldered, for all parts of it are alike, and will expand and contract evenly when heated, while solders often expand and contract more or less than the metals which they unite, and this uneven contraction and expansion of the metal and solder often tears the joint apart; another objection to soldering is that the solders oxidize either more or less freely than the metals, and weaken the joints, as is the case if leaden vessels or chambers for sulphuric acid are soldered with tin, the tin, being so much more freely dissolved by the acid than the lead, soon weakens or opens the joints.

Fine work in pewter is generally burned together at the corners or sharp angles, where it cannot be soldered from the inside; this is done that there may be no difference of colour in the external surface of the work. In this operation, a piece or strip of the same pewter is laid on the parts to be united, and the whole is melted together with a large soldering-iron or copper bit, heated almost to redness; the superfluous metal is then dressed off, and leaves the surfaces thoroughly united, without any visible joint. In burning together pewter or any of the very fusible metals, great care is required to avoid melting and spoiling the work.

Castings of brass are often united by burning. In this operation, the ends of the 2 pieces to be united are filed or scraped, so as to remove the outside surface or scale; they are then embedded in a sand mould in their proper position, and a shallow or open space is left around the joint or ends of the castings; 30 or 40 lb. of melted brass are then poured on to the joint, and the surplus metal is allowed to escape through a flow-gate. In this way 2 castings may be united so that they are as solid as if they had been cast in one piece. This process is resorted to by all brassfounders in making large and light castings, such as wheels, large circular rims, &c.; when too large to be run in one piece, they are usually cast in segments and united by burning together.

Cast iron is often united by burning together, or, more properly, burning on, for in this case one of the metals added or united is in the fluid state. When about to burn

on to a piece of casting, the part to be united to is scraped or filed perfectly clean, and is then embedded in sand, and a mould of the desired shape is formed around the casting; the metal is then poured into the mould, and allowed to escape through a flow-gate until the surface of the casting is melted, and the metals unite, the same as in burning together brass castings. In this way, small pieces that have broken off large castings are burned on, and cylinders that have had part of the flanges torn off by blowing out the heads are repaired by burning on a new flange or the part that has been torn off. In burning on to cast iron there are several very important points that must be observed in order to make it a success. The ingate, as well as the flow-gate, should be made of a good size, so that the molten metal may be flowed through them rapidly if necessary. The molten iron used should be the hottest that can be procured, and in pouring it into the gate it should be let in rapidly at first, and allowed to run out freely at the flow-gate, so as to prevent its being chilled upon the surface of the casting. After the casting has been heated in this way, the metal should be poured and flowed through the gates slowly, so as to give the solid metal a chance to melt and unite with the fluid metal. After the surface of the metal has been melted, the pouring should be urged, so as to unite the metals more thoroughly; the operation should be continued for some time, so that the casting may be more thoroughly heated, and not be so liable to crack from uneven expansion and shrinkage.

The process of burning together or mending is often resorted to by stove-plate moulders for stopping small holes in the plates; this is done by laying the plate on the sand, with the sand firmly tucked under the part to be mended; a little sand is also put on top of the plate, around the part to be mended, so as to prevent the iron spreading over the plate; the molten iron is poured on the part to be mended, until the edges are fused, and the surplus metal is then scraped off with the trowel or a clamp iron while in the molten state.

The simplest method of burning is that adopted in the manufacture of leaden tubs, tanks, and other vessels, the success of the operation depending more upon the quantity and state of the materials than upon the skill of the workman. Thus if a round or square tank is required, a piece of the sheet lead sufficient in size to form the sides and ends of the tank, or the hoop, if a round one, is bent into shape, the overlapping ends being secured by a few touches of solder or a few nails, driven from the inside, so as to keep the overlapping edges perfectly close. On the outside of the joint a piece of stout brown paper is pasted, so as to cover the whole of the joint. The hoop, or parts to be joined, are then turned downwards on to the casting floor, and moulding sand of good quality is packed over the joint to about 5 or 6 in. in depth, a piece of wood about $\frac{3}{4}$ in. thick being placed over the junction of the edges, while the sand is being rammed together. This wood is to form the runner or channel for the molten metal, and must be slightly longer than the joint to be made, so that it can be drawn out lengthways. The sand being tolerably firm, cut down to the wood, with a trowel, forming a sort of V-shaped groove along nearly the whole length of the intended joint, leaving a few inches of the wood buried at one end, which is also to be completely stopped. When the wood is drawn out, which is the next operation, the other end of the "runner" is to be stopped up to a greater or lesser height, according to the thickness of the metal; about 1 in. is usually sufficient. It will be understood that we have here, as it were, a broad-mouthed ditch in the sand, stopped at one end, and with a "bar" 1 in. deep at the other; and at the bottom are the overlapping edges of the lead that is to be joined. A quantity of lead is then melted in a furnace, and brought to a heat sufficient to melt the 2 edges in the metal to be joined. Everything being in readiness, a small quantity of rosin is dusted along the intended joint at the bottom of the runner, and a bay is formed to catch the overflow of metal. The latter is then poured in steadily but quickly, giving it as much fall as possible, and keeping up the supply till by means of a trying stick it is known that the cold metal of the edges has

been melted. The overflow end is then stopped up, and more metal is poured in, the molten lead being kept ready to fill up as shrinkage shows itself. When set, the sand is removed, and the "runner," or the remains of the metal poured on the joint, is cut off with a chisel and mallet; the surface is finished off with a scratch-brush or wire-card. The paper that was pasted over the outside will have fallen off, and will be seen to have left a smooth surface, in which no trace of a joint is visible. The secret of success lies in having a good bed of sand, plenty of hot metal, and careful attention to the shrinkage. The bottom of the tub or tank is put in by a similar process. The hoop or sides, when the tank is not too deep, being completely sunk in a hole in the casting-shop, is filled up with sand inside and out. The sand is then removed from the inside to a depth equal to the thickness required in the bottom of the tank, and smoothed over well with the trowel. The sand outside the tank must be rammed hard, and a bay left all round to take the overflow. As before, rosin is sprinkled over the edge of the metal, and the melting-furnace is brought close to the work. When the metal is as hot as possible, 2 or more men take a ladleful and pour along the edge, and when the latter is melted, the molten metal is poured in until it is up to and running over the level of the outside sand all round. The dross is then skimmed off and the metal is left to cool, as it shrinks equally all over and requires no further attention. It is obvious that instead of making the bottom by pouring on molten metal, a piece of the required size can be cut out of thinner sheet lead, and placed on the top of the inside sand; but the majority of experienced workmen prefer the first-mentioned method of burning in a bottom. If the article is of considerable size, however, it is necessary to have more than one workman, as the metal must be poured on as quickly as possible.

This method of lead-burning is considerably troublesome, and is rarely used, except when the lead is too thick to be melted conveniently by means of the blowpipe, or the oxyhydrogen flame. The latter is, however, always used when possible by those who can accomplish the operation, which requires a much greater degree of skill than the process described above.

Similar processes are applicable in the case of the other metals. Thus brass may be burned together by placing the parts to be joined in a sand mould, and pouring a quantity of molten brass on them, afterwards reducing the parts by means of the file, &c., to proper dimensions. The *sine quâ non* is plenty of molten metal, made a trifle hotter than usual. Pewter is generally "burned" by the blowpipe or a very hot copper-bit. In angles, where bent over sharp corners, and in seams, one edge is allowed to stand over the surface of the other, and a strip of the same metal is then laid along the intended junction. This joint is burned, as mentioned, by melting the surfaces and edges by means of a blowpipe or the hot soldering-iron, and the superfluous metal is filed off, leaving the joint, if at an angle, looking as if it had been made out of the solid. The principle of the process is the same whatever be the mode in which it is performed; and when hot metal is used as the sole agent of heat, it is necessary to have plenty of it, and to see that the parts to be joined are clean. It is scarcely necessary to say that the autogenous method is the only proper method of remedying the defects in castings, and notwithstanding the trouble attached to it, should always be attempted with all metals for which it is applicable, and all articles in which it is possible. It is not to be supposed that trifling defects in iron castings will be remedied by this means, though there is no very great difficulty in accomplishing it, as flanges are often burned on to pipes and wheels, but with the more costly or easily worked metals, the practice of this process would be attended with advantage.

Dr. Hoffman suggests endeavours being made to employ the oxyhydrogen flame for effecting autogenous joints in all metals. The operation is already conducted with complete success in the case of 2 essentially different metals, lead and platinum, and offers the advantages of being cleaner, stronger, and more economical of time and materials.

For all leaden vessels and chambers to be used in contact with acid vapours or liquids, autogenous soldering is the only admissible way of making a joint. The apparatus employed consists of a hydrogen gas generator, or "burning machine," as it is commonly called, an "air vessel" or portable bellows, some indiarubber tubing, and a set of gas-cocks and jets. The hydrogen generator is shown in Fig. 148: *a* is an airtight leaden cistern, having a perforated shelf *b*, and an opening *c* in the top; *d* is another leaden cistern with a perforated shelf *e*. A pipe *f* connects the cisterns *a* *d*, passing through *a*

148.

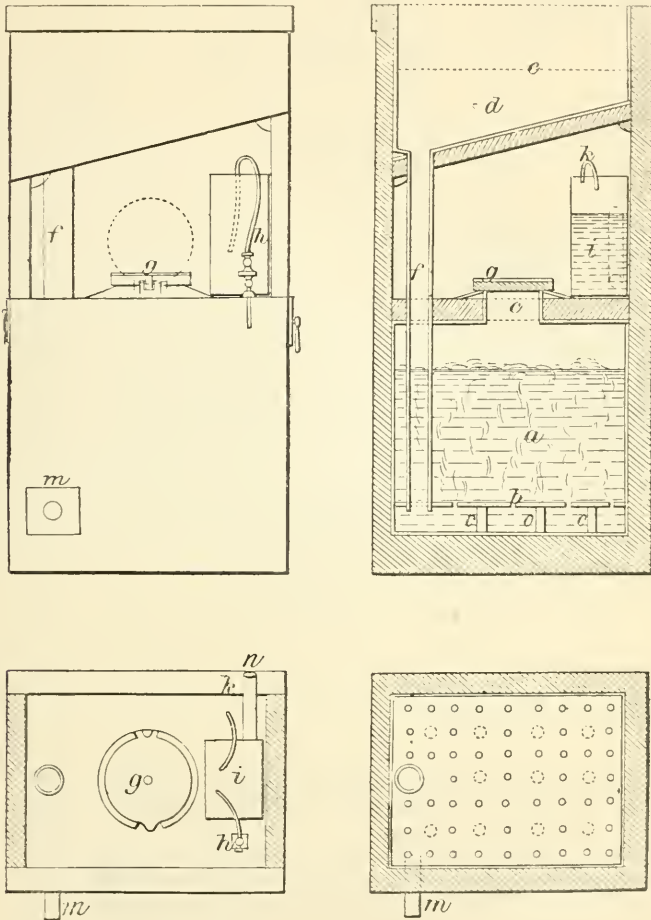

as far as the shelf *b*, which it just perforates. The hinged cover *g* being turned back, the cistern *a* is filled with sheet zinc cuttings, and the cover is closed. Diluted oil of vitriol, say 1 qt. of the acid to 1 gal. water, is poured into the cistern *d*, and finds its way through the pipe *f* into the bottom of the cistern *a*, rising through the strainer *b*, and surrounding the zinc. The acid acts upon the zinc, forming zinc sulphate, with

consequent liberation of hydrogen. As the hydrogen gas is set free, it passes through the cock and pipe *h* into the leaden vessel *i*, partially filled with water, and, passing through the water, it becomes purified, and escapes at the pipe *k*; *m* is the pipe through which the generator is emptied of acid when the gas is no longer required. The vessel *i* may be removed from its place by unscrewing the nut close to the cock on the pipe *h*, and

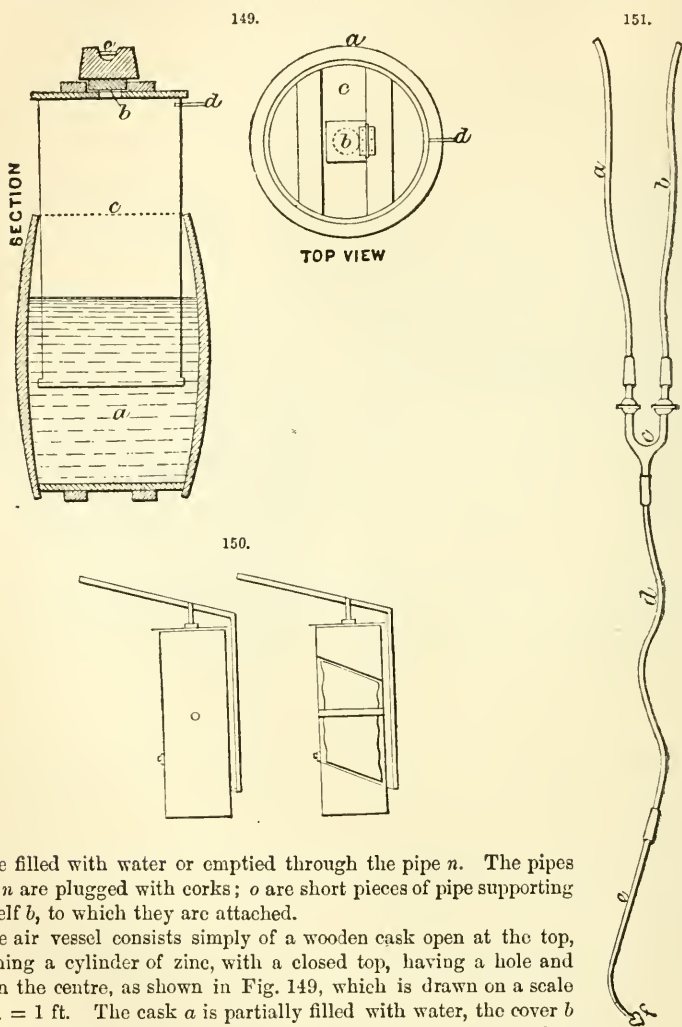

may be filled with water or emptied through the pipe *n*. The pipes *m* and *n* are plugged with corks; *o* are short pieces of pipe supporting the shelf *b*, to which they are attached.

The air vessel consists simply of a wooden cask open at the top, containing a cylinder of zinc, with a closed top, having a hole and cover in the centre, as shown in Fig. 149, which is drawn on a scale of $\frac{1}{2}$ in. = 1 ft. The cask *a* is partially filled with water, the cover *b* (which is coated underneath with sheet indiarubber to make it shut close) is opened, the cylinder *c* is raised, and the cover is closed again, preventing the escape of air from the cylinder except through the small pipe *d*. A weight *e* is placed on the top of the cylinder, to keep the cover *b* firmly closed, and give force to the current of air issuing from *d*, the weight being conveniently represented by a $\frac{1}{4}$ -, $\frac{1}{2}$ -, or 1-cwt., according to the pressure of air required.

A small bellows, Fig. 150, is sometimes used by plumbers for obtaining a supply of air. It is more portable than the air vessel, but cannot be used without an assistant to work it.

Indiarubber tubes *a b* (Fig. 151) connect the gas generator and air vessel or bellows with a pair of brass cocks and breeches-pipe *c*. The gas and air, being admitted through these cocks, unite in the tube *d*, and, passing through the brass pipe *e* and jet *f*, may be ignited, and produce an intensely hot flame, by which leaden sheets may be joined without the aid of any flux.

The lead to be burned must first be scraped bright, and where a strong seam is required, as for instance in the bottoms of chambers, strips of clean lead are run on in the manner of solder. But it is essential to success that all the surfaces to be subjected to the flame be bright and dry, and that no moisture be sufficiently near the seam to be drawn into it by the heat. Several jets are in use, with holes of various sizes, for procuring a large or small flame, according to the special requirements of the work in hand; and the intensity of the heat is also regulated by the proportions and quantities of gas and air admitted through the cocks. As it is imperative that the flame should not be subject to sudden variation, little brass tubes are fitted to the nozzle to guard the flame from air currents, when working out of doors or in draughty places. (Lock's 'Sulphuric Acid.')

Cold Soldering.—Various nostrums have been proposed from time to time which profess to be reliable methods of soldering without heat; but when tried, they have generally proved useless. The following recipe, which is due to Fletcher, of Warrington, will be found to be more trustworthy. It must be borne in mind that, though the first preparation is tedious, a large quantity of the materials can be made at once, and the actual soldering process is as simple and quick as it well can be.

Flux: 1 part metallic sodium to 50 or 60 of mercury. These combine on being well shaken in a bottle. If this is too much trouble, the sodium amalgam can be bought, ready made, from any chemist or dealer in reagents. This sodium amalgam must be kept in a stoppered bottle closed from the air. It has the property of amalgamating (equivalent to tinning by heat) any metallic surface, cast iron included.

Solder: Make a weak solution of copper sulphate, about 1 oz. to 1 qt. of water. Precipitate the copper by rods of zinc; wash the precipitate 2 or 3 times with hot water; drain the water off, and add, for every 3 oz. of precipitate, 6 oz. or 7 oz. mercury; add also a little sulphuric acid to assist the combination of the 2 metals. When combined, they form a paste which sets intensely hard in a few hours, and this paste should be made, whilst soft, into small pellets.

When wanted for use, heat one or more of the pellets until the mercury oozes out from the surface in small beads; shake or wipe them off, and rub the pellet into a soft paste with a small mortar and pestle, or by any other convenient means, until it is as smooth and soft as painters' white-lead. This, when put on a surface previously amalgamated by the sodium and mercury, adheres firmly, and sets perfectly hard in about 3 hours. The joint can be parted, if necessary, either by a hammer and cold chisel, or by a heat about sufficient to melt plumbers' solder.

Hard Soldering.—Hard soldering is the art of soldering or uniting 2 metals or 2 pieces of the same metal together by means of solder that is almost as hard and infusible as the metals to be united. In some cases, the metals to be united are heated to a high degree, and their surfaces simply united without solder by means of fluxing them. This process is then termed brazing, and some of the hard soldering processes are also often termed brazing; both brazing and hard soldering are usually done in the open fire on the braziers' hearth. When soldering work of copper, iron, brass, &c., the solder generally used is a fusible brass, and the work to be soldered is prepared by filing or scraping perfectly clean the edges or parts to be united. The joints are then put in proper position, and bound securely together with binding wire or clamps; the granulated solder and powdered borax are mixed in a cup with a very little water, and spread

along the joint to be united with a strip of sheet metal or a small spoon. The work is then placed upon a clear fire, and heated gradually to evaporate the water used in uniting the solder and borax, and also to drive off the water contained in the crystallized borax, which causes the borax to boil up with an appearance of froth. If the work is heated hastily, the boiling of the borax may displace the solder, and for this reason it is better to roast or boil the borax before mixing with the solder. When the borax ceases to boil, the heat is increased; and when the metal becomes a faint red, the borax fuses quietly, like glass, and shortly after, as the heat of the metal is increased to a bright red, the solder also fuses, which is indicated by a small blue flame from the burning of the zinc. Just at this time the work should be jarred slightly by being tapped lightly with the poker or hammer, to put the solder in vibration and cause it to run into the joint. For some work it is not necessary to tap it with the poker, for the solder is absorbed into the joint and nearly disappears without tapping. In order to do good work, it is necessary to apply the heat as uniformly as possible, so as to have the solder melt uniformly. This is done by moving the work about in the fire. As soon as the work has been properly heated, and the solder has flushed, the work should be removed from the fire, and, after the solder has set, it may be cooled in cold water without injury.

Tubes to be soldered are generally secured by binding wire twisted together around the tube with the pliers. All tubes that are soldered upon the open fire are soldered from within, for if they were soldered from the outside the heat would have to be transmitted across the tube with greater risk of melting the lower part of the tube, the air in the tube being a bad conductor of heat; and it is necessary that both ends of the tube should be open, so as to watch for the melting of the solder. In soldering long tubes, the work rests upon the flat plate of the braziers' hearth, and portions equal to the length of the fire are soldered in succession. The common tubes or gas-pipes are soldered or welded from the outside. This is done by heating the tube in a long air furnace, completely surrounded by hot air, by which means the tube is heated more uniformly than in the open fire. After the tubes have been heated to the welding heat, they are taken out of the furnace, and drawn through clamps or tongs to unite the edges, and are then run through grooved rollers 2 or 3 times, and the process is complete. The soldering or welding of iron tubes requires much less precaution in point of the heat than some of the other metals or alloys, for there is little or no risk of fusing it.

In soldering light ironwork, such as locks, hinges, &c., the work is usually covered with a thin coating of loam to prevent the iron from being scaled off by the heat. Sheet iron may be soldered at a cherry-red heat by using iron filings and pulverized borax as a solder and flux. The solder and flux are laid between the irons to be soldered, and the whole is bound together with binding wire, heated to redness, taken from the fire, and laid upon the anvil; the 2 irons are united by a stroke upon the set hammer. Steel or heavy iron may be united in the same way at a very low heat. For soldering iron, steel, and other light-coloured metals, as well as brasswork that requires to be very neatly done, the silver solder is generally used on account of its superior fusibility and combining so well with most metals, without gnawing or eating away the sharp edges of the joints. Silver solder is used a great deal in the arts, and from the sparing or careful way in which it is used, most work requires little or no finish after soldering, so that the silver solder, although expensive, is in reality the cheapest solder in the long run. For silver soldering, the solder is rolled into thin sheets and then cut into narrow strips with the shears. The joints or edges to be united are first coated with pulverized borax, which has been previously heated or boiled to drive off the water of crystallization. The small strips of solder are then placed with forceps upon the edges or joints to be united, and the work is heated upon the braziers' hearth. The process of silver soldering upon the larger scale is essentially the same as the operation of brazing.

For hard soldering small work, such as drawing instruments, jewellery, buttons, &c., the blowpipe is almost exclusively used, and the solder employed is of the finest or best quality, such as gold or silver solder, which is always drawn into thin sheets of very fine wire, and it is sometimes pulverized or granulated by filing; but if solder is pulverized very fine, a greater degree of heat is required to fuse a minute particle of metal than to fuse a large piece.

In soldering jewellery, the jeweller usually applies the borax or other flux in solution, with a very small camel-hair brush. The solder is rolled into very thin sheets and then clipped into minute particles of any desired shape or size, which are so delicately applied to the work that it is not necessary to file or scrape off any portion of them, none being in excess. The borax or other flux used in the operation is removed by rubbing the work with a rag that has been moistened with water or dilute acids.

Soft Soldering.—Soft soldering is the art of soldering or uniting 2 of the fusible metals or 2 pieces of the same metal. The solder used is a more soft and fusible alloy than the metals united, and the mode of applying the heat is consequently different from that employed in hard soldering. The soft solders are prepared in different forms to suit the different classes of work for which they are intended. Thus for tin soldering, the solder is cast into bars of 10 or 12 in. long by 1 in. wide, and by some it is cast into cakes 10 or 12 in. long by 3 or 4 in. wide. Plumbers' solder is generally cast into small ingots or cakes, 2 in. square or more, according to the work for which they are intended, and size of pot they are to be melted in. Some of the very fusible solders that are destined for very light work are trailed from the ladle upon an iron plate, so as to draw the solder into thin or large bars, so that the size of the solder may always suit the work that it is used upon.

In soft soldering, it is very essential that the parts to be united should be perfectly clean and free from metallic oxides, and for this reason they are generally wet with a little zinc chloride before applying the solder; and when the metal is old or very dirty, it must be scraped on the edges intended to be united before applying the solder. When soldering leaden pipe, sheet lead, &c., the plumber first smears a mixture of size and lampblack around the intended joint to prevent the melted solder adhering to the metal at the point where it is not wanted. The parts to be united are then scraped quite clean with the shave-hook, and the clean metal is rubbed over with tallow. The wiped joints are usually made without using the soldering-iron. The solder is heated in the plumbers' pot rather beyond its melting-point, and poured plentifully upon the joint to heat it. The solder is then moulded into the proper shape, and smoothed with cloth or several folds of thick bed-ticking, which is well greased to prevent burning, and the surplus solder is removed by the cloth. In forming the striped joint, the soldering-iron and cloth are both used at the commencement in moulding the solder and heating the joint. Less solder is poured on when forming this joint than when forming the wiped joint, and a smaller quantity remains upon the work. Striped joints are not so neat in appearance as wiped joints, but they are often claimed to be sounder, from the solder having been left undisturbed when in the act of cooling; but in wiped joints, the body of solder is heavier, and the shrinkage of it around the pipe is sufficient to unite with the pipe. In forming joints in leaden pipe, the cloth is always used to support the fluid solder when poured on the pipe.

Light leadwork that requires more neatness than the ordinary plumbing is usually soldered with the common tinner's soldering-iron. This is made of a square piece of copper weighing 3 or 4 oz. to 3 or 4 lb., according to the size of the work it is intended for. This piece of copper is drawn down to a long square point, or to a flat wedge, and is riveted into an iron shank fitted to a wooden handle. The copper bit or soldering-iron is then heated in the tinner's firepot with charcoal to dull redness, and is then screwed in the vice and hastily filed to a clean metallic surface. It is next rubbed with a piece of sal-ammoniac, or on some powdered rosin, and then upon a few drops of solder in the

bottom of the soldering-pan. In this way the soldering-iron is thoroughly coated with tin, and is then ready for use. In soldering tin-plate work, the edges are slightly lapped over each other, and the joint or seam is strewed with powdered rosin, which is usually contained in a small box set in the soldering-pan. The soldering-iron, which has been heated in the firepot, is then drawn over the cake of solder; a few drops are melted and adhere to the soldering-iron, and are distributed by it along the joint or seam. In large work, the seams are first tacked together, or united by drops of solder so as to hold the seams in proper position while being soldered; but this is seldom done in small work, which can be easily held together with the hands. Two soldering tools are generally employed, so that while one is being used for soldering, the other is being reheated in the firepot, thus avoiding the delay of waiting for the tool to heat. The temperature of the tool is very important: if it is not hot enough to melt the solder, it must be returned to the fire; and if it gets too hot, the tinning will be burnt off, the solder will not hang to it, and the tool must be retinned before it can be used. In soldering tinware, the tool is usually passed only once over the work, being guided by the contact with the fold or ledge of the seam; but when the operator is not an expert, he usually runs the tool backward and forward over the work 2 or 3 times. This makes slow work.

Sheet copper, in common work, is soldered with the soldering-iron in the same manner as sheet tin; but the finer or more important work is brazed or hard soldered. In soft soldering copper, as well as sheet iron, the flux generally used is powdered sal-ammoniac, or a solution of sal-ammoniac and water. A piece of cane, the end of which is split into filaments to make a stubby brush, is used for laying the solution on the work, and powdered rosin is subsequently applied. Some workmen mix the powdered sal-ammoniac and rosin together before applying it to the work. This they claim is better than putting them on separately; but so long as the metals are well defended from oxidation, either of the modes is equally good, for the general principle is the same in both. Zinc is the most difficult metal to solder, and the joints or seams are seldom so neatly formed as in tin or copper. Zinc will remove the coating of tin from the soldering tool in a very short time. This arises from the superior affinity of copper for zinc than for tin, and the surface of the tool is freed from tin, and is coated with zinc. Sal-ammoniac is sometimes used for a flux in soldering zinc, but the most common flux employed for zinc is zinc chloride, which is made by dissolving fragments of zinc in hydrochloric acid diluted with about an equal amount of water. This solution is put in a wide-mouthed bottle, and small strips of zinc are dropped into it until they cease to be dissolved. The solution is then ready for use; it is likewise resorted to for almost all the other metals, as it can be employed without such strict necessity for clean surfaces as when some of the other fluxes are availed of.

In soft soldering, the soldering-iron is only used for thin sheet metals, because, in order to unite 2 metals by soldering, their temperature must be raised to the melting-point of the solder, and a heavy body of metal cannot be sufficiently heated with the soldering-iron without making the latter too hot, which is apt to burn off the coating of tin, or to cause it to be absorbed by the copper, as in superficial alloying, and the solder will not adhere to the tool, and cannot be spread along the joint by it. In soft soldering heavy work, the work is first filed or scraped perfectly clean at the points to be soldered, and is dipped into a bath of liquid solder, which is covered with a little melted sal-ammoniac to prevent oxidation, and also to act as a flux for uniting the metals. In dipping the work into the bath, it first comes into contact with the flux, and is coated by it before it is subjected to the heat; when dipped into the solder, the tin readily adheres to it; and after heavy pieces of metal have been tinned in this way, or by the process of dry-tinning with mercury, they may be soldered with the soldering-iron. When tinning thin pieces of brass or copper alloys for soldering, it is usually done by rubbing a few drops of solder over the part to be tinned with the soldering-iron; and if tinned by

dipping into a bath, it must be quickly dipped, or there is a risk of the thin sheet being melted by the solder. When tinning iron or steel, the work must be allowed to remain in the bath, for some time, so as to be thoroughly heated by the bath, or the tin will not be completely united to the iron or steel, and may peel off when cold. Large pieces of iron or steel that are inconvenient to dip into a bath are tinned by heating in an open fire, and rubbing the solder on with the soldering-iron, using either sal-ammoniac or rosin as a flux. When tinning in this way, the lowest heat that will fuse the solder should be used.

Hard solder differs from soft solder in that the "hard" is an alloy of silver and brass, while the "soft" is of bismuth, lead, &c.; the mode of working differs also. With hard solder, an intense and glowing heat is absolutely necessary to cause fusion of the metals, but with soft solder a comparatively low heat will suffice. It must be evident that by the former mode, where fusion takes place, there is a more complete union made than by the latter, where there is little more than cohesion. The latter mode of repairing has, however, these advantages, that as many articles are built up, so to speak, of pieces, and in such ways that only experienced workmen can handle them satisfactorily, the amateur may attempt repairing them with greater confidence and assurance of success, and he has no need to provide himself with a variety of chemicals, for the purpose of restoring the colour to the article that has been rendered unsightly by the heat. Apart from these advantages there are others, as soft soldering may be accomplished by the blowpipe, the soldering "bit," or actual contact with the flame. Preference is given to one method by one worker, to another by another; no absolute rule can be laid down; all three modes can be used as the necessities of the work in hand may require. Rosin, sal-ammoniac, solution of hydrochloric acid and zinc, and in some cases fats, are used as a flux. Generally speaking, hydrochloric acid (spirits of salts) killed by zinc will answer all purposes: to make the solution, procure a pennyworth of spirits of salts, and place it in an open glass or glazed earthenware vessel; and having a number of small pieces of zinc, throw in a few. As they become consumed, throw in more until all chemical action has ceased. So soon as the zinc is put in, a violent action commences, and it is well to set the vessel down, as it becomes intensely hot, and emits a pungent vapour which it is wise not to inhale. When all turbulence has ceased, strain off the clear liquid and add twice its quantity of clear water, decanting all into a stoppered or well-corked bottle. A piece or two of zinc may be dropped in to kill any remaining salts. A soldering bit may be made by taking a piece of stout brass wire, say, rather thinner than a common wood penholder, and about 6 in. long, and hammering one end into the form of an abrupt spear-point; inserting the other into a wooden handle. Solder of a pure and easy-flowing kind should be procured; preference being given to that sold by dealers in jewellers' requisites. A pair of tweezers or long slender pliers should also be got. Armed with these, no fear of burnt fingers need be entertained.

As an example to illustrate the operation, we may take the movable top of a silver-plated candlestick. It often happens that a too-low burning candle melts the solder away from the connections. To repair this, carefully remove all dirt and grease from the parts in contact, and scrape them bright with a knife or other tool. Then take the "bit" and file the end clean; dip it in the zinc solution, and, holding the afterpart in the gas flame, run a little solder all over the tip to "tin" it. Next, run a bead of solder on the end; then, taking either part of the broken top in the tweezers, apply, by means of a peg or piece of brass wire, a little of the solution to the part where the solder is required. Proceed to warm the metal top in the edge of the flame, at the same time holding the "bit" obliquely in the gas and in contact with the top. The solder will quickly melt, and attach to it, and whilst in a molten state must be thinly distributed all round on that part only which has to be connected with the socket. This has to be "tinned" in the same way. This done, lay aside the "bit" and take the

blowpipe. Holding the top inverted, place the socket in its position, and after putting a little more solution to the parts, direct a small flame all round the joint, turning the article about to do this. If the top has an ornamental filled edge to it, keep the heat as much as possible away from that part, or the filling, which is only lead or solder, will run out. A sufficient heat having been got, the solder, at the points of contact, will melt and run together. When it has run all round, press the socket gently down, and hold until the solder is seen to "set," and the union is then completed. Cool, and swill in water. If there is an excess of solder, and it has run out into a bead, a sharp knife-edge will detach it, and an oiled leather buff will remove the stain. A little cleaning with rouge will finish the work. Experience only in these matters teaches one how much or how little solder is required: use too little rather than too much at first. Do not let the solution spatter upon, or come in contact with, or vaporize near to steel tools, or they will soon have a coating of rust upon them.

Generalities.—(a) *Apparatus.* Blowpipes and Lamps.—The blowpipe and an alcohol lamp are largely used in hard soldering, tempering small tools, and by chemists and mineralogists as an important means of analysis, &c., and for these uses the blowpipe has received very great attention, both from mechanics and distinguished philosophers. Most of the small blowpipes are supplied with air from the lungs of the operator, and the larger ones, or where they are brought into general use, are supplied with air from a bellows moved with the foot, or from a vessel in which the air has been condensed by a syringe, or from a small rotary fan. The ordinary blowpipe is a light brass or tin tube about 10 or 12 in. long, and $\frac{1}{2}$ to $\frac{3}{4}$ in. in diameter at the end for the mouth and $\frac{1}{16}$ in. or less at the jet end. The small end is slightly curved, so that the flame may be thrown immediately under the observation of the operator. There are several other kinds of blowpipe for the mouth, which are fitted with various contrivances, such as a series of apertures of different diameters, joints for portability and for placing the jet at different angles, and with a ball for collecting the condensed vapour from the lungs; but none of these is in common use. The blowpipe may be supplied with air from the lungs with much more effect than might be expected, and, with a little practice, a constant stream can be maintained for several minutes if the cheeks of the operator are kept fully distended with wind, so that their elasticity alone will serve to impel a part of the air, while the ordinary breathing is carried on through the nostrils for a fresh supply.

The heat created by the blowpipe is so intense that fragments of almost all the metals may be melted when they are supported upon charcoal, with the heat from a common tallow or wax candle. The most intense heat from the blowpipe is the pointed flame, and the hottest part of the flame is the extreme point of the inner or blue flame. Large particles of ore or metals that require less heat are held somewhat nearer to the candle or lamp, so as to receive a greater portion of the flame, and, when a very mild degree of heat is wanted on a small piece of metal it is held farther away. By thus increasing or decreasing the distance between the candle or lamp and the object to be melted, any desirable degree of heat may be obtained. When only a minute portion of metal is to be heated, the pointed flame is used with a mild blast; but when it is desirable to heat a large surface of metal, as in soldering and brazing, a much larger flame is used. This is produced by using a lamp with a large wick, plentifully supplied with oil, which produces a large flame. The blowpipe used has a larger opening than the one employed for the pointed flame, and is held at a little distance from the flame and blown vigorously, so as to spread it out over a large surface of the work. This is called the bush or sheet flame. The work to be brazed or soldered by this flame is generally supported upon charcoal.

When melting metals with the blowpipe, the metal to be melted is laid upon a flat piece of charcoal, which has previously been scooped out slightly hollow in the centre to prevent the metal from running off when melted. If it is desirable to run the metal into

a mould when melted, a small groove or lip is cut in the charcoal, and when the metal is sufficiently heated it is poured into the mould. In this way, jewellers melt most of their gold, silver, &c., when making rings and other jewellery. The cupel is also used for melting metals in with the blowpipe, but it is not so good as the charcoal, for it is liable to break from being heated unevenly, and spill the metals. Several different kinds of stationary or bench blowpipes are used by jewellers, braziers, &c.

Two examples of the mouth blowpipe are shown in Fig. 152, the form *a* having a movable nozzle which may be serewed on and off, thus admitting of the use of a jet with the

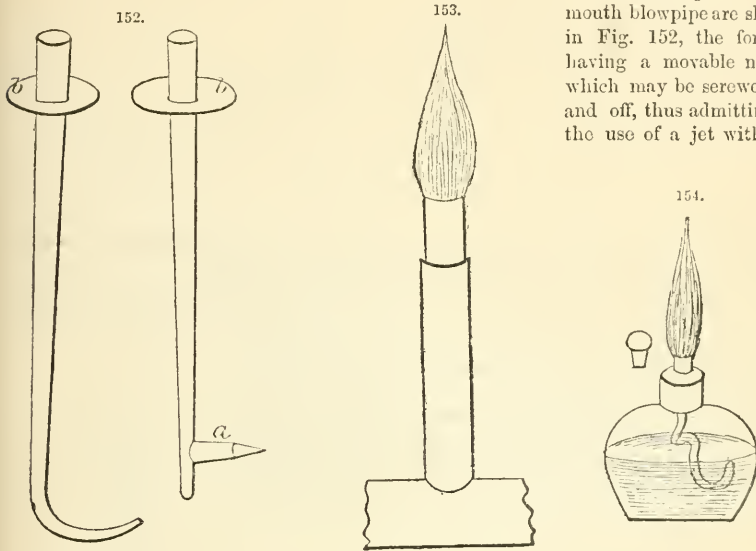

most suitable sized orifice. The flange *b* is convenient for holding the blowpipe in the mouth.

Lamps or their equivalents show a variety of forms. The most primitive yet efficient method of obtaining a flame is to tie a bundle of reeds, coated with tallow

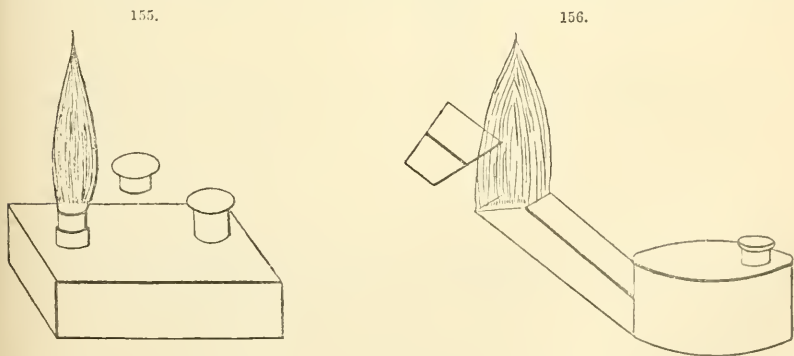

by immersion in melted suet, in a paper wrapper, and stick it in a hole in a piece of wood, as in Fig. 153. Spirit lamps differ according to the material burned in them and the degree of heat required from them. A handy little lamp for delicate objects is

shown in Fig. 154. One made by Griffin for burning a mixture of wood spirit and turpentine (4 volumes to 1) is illustrated in Fig. 155. Fletcher's lamp (Fig. 156) for the same mixture has the spout made large enough to accommodate 5 or 6 folds of 1-in. soft cotton wick. All these lamps should be capped when not in use. Figs. 157 and 158

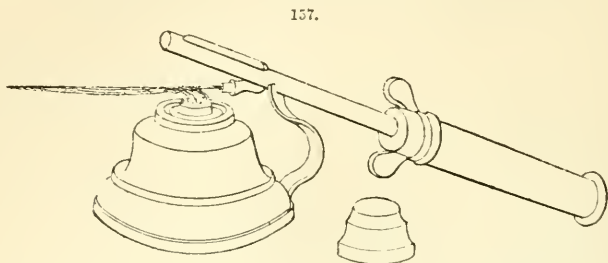

represent respectively the fixed and adjustable forms of the patent self-acting soldering lamps with blowpipes attached. Fig. 159 is a Bunsen gas-burner.

Blowers.—When the work exceeds the capacity of the mouth blowpipe, or when it is too continuous to be done with the mouth alone, a mechanical blower must be used, and the selection of this to suit the work required is a matter of considerable importance. The temperature of a given flame, the fuel combustion being equal, is greater in inverse proportion to its size. The smaller a flame becomes when the air blast is applied, the hotter it is, and the more work it will do, provided the air is not supplied in excessive quantity. Other things being equal, a high-pressure blast gives the most powerful

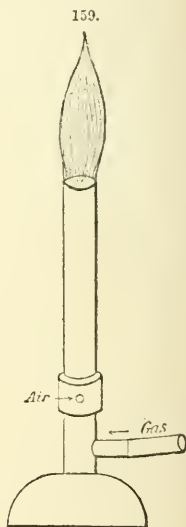
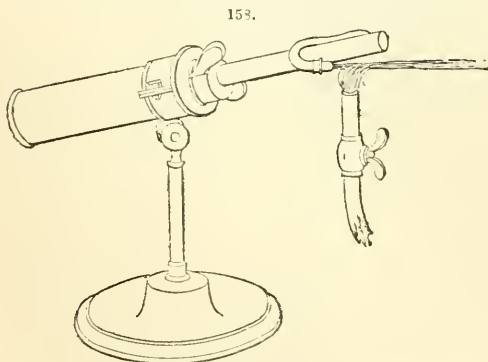

flame, and the pressure of the air supplied is therefore a matter of serious importance. An average adult can, with an effort, give an air pressure in a blowpipe equal to about 36 in. of water pressure, or $1\frac{1}{2}$ lb. on the sq. in. The average pressure is, however, about half this, or rather less, the maximum being only obtained by a severe strain, which cannot be continued. A fan worked by the foot will give an air pressure equal to about $\frac{1}{2}$ to 1 in. of water. A fan worked by power will give air at 1 to 5 in. of water pressure, depending on its speed and construction. An average smiths' bellows about 5 in. pressure. Small heavily-weighted circular bellows about 8 to 10 in. pressure. Root's blower driven by power, 24 in. pressure. Fletcher's foot blower No. 2, 15 in.

pressure. Fletcher's foot blower Nos. 3 and 5, 30 in. pressure. Fletcher's foot blower No. 4, 45 in. pressure. Cotton and Johnson's foot blower (variable), 5 to 20 in. pressure.

The temperature of a blowpipe flame may be estimated from the above, being in close proportion to the pressure of air supplied, and it may be taken as a rough rule in brazing or hard soldering with gas, that, given an air pressure equal to 15 in. of water, a blowpipe, having an air jet of $\frac{1}{8}$ -in. bore, will braze work up to $\frac{1}{2}$ lb. total weight. One with an air jet of $\frac{1}{4}$ -in. bore will braze up to about 2 lb. total weight, i. e. 2 brass weights, each 1 lb., could be securely brazed together with a blowpipe with $\frac{1}{4}$ -in. bore air jet, and supplied with air at a pressure equal to 15 in. of water, or 10 oz. on the sq. in. It will, of course, be remembered that the areas given are those of the air jet or point at which the blast leaves the blowpipe, and the area of the gas supply is that of the space between the air tube and the gas tube outside it. The area of taps and pipes to supply these must, of course, be larger, to prevent friction as much as possible. When anything like a high power is required, it is of the first necessity that any elastic or flexible tube used shall be perfectly smooth inside. A length of 6 or 8 ft. of india-rubber tube, with wire inside, will reduce a gas supply or a pressure of blast to about one half. Practically this amounts to requiring apparatus double the size for the same work, and it therefore does not pay to use rough tubing. Applying the rule to other shapes of work, it may be taken that a blowpipe which will braze a block of 2 lb. total weight, when the work is supported on a good non-conductor, will braze brass plate up to $\frac{1}{8}$ in. or $\frac{3}{16}$ in. thick. Its capability of brazing iron is not so great, as iron does not take up the heat of the blowpipe so readily as brass does. When the blowpipe is supplemented by either a bed of burning coke or by a non-conducting jacket round the work, the power of any blowpipe may be extended almost without limit, as little of the actual work of heating the body of metal is done by the direct blowpipe flame.

In the construction of blowpipes for gas they should be so proportioned as to give the maximum effect for the minimum of fuel and blast. To do this the air pressure available must be an important factor. Speaking roughly, but still sufficiently near to make a correct rule to work by, a blowpipe requires 1 of gas to 8 of air. If the gas is supplied at a pressure equal to 1 in. of water, and the air at 8 times that pressure, the area of the gas and air pipes should be equal, to get the best effect. If the air supply is equal to 16 in. of water pressure, the gas pipe must be double the area of the air, and so on in proportion. Of course the air and gas supplies can be adjusted by taps easily, but in the first construction of a blowpipe for large work, this rule must be adhered to. Any departure from it reduces the power of the blowpipe, and ignorance of this simple rule has frequently caused failures which the makers of blowpipes have been unable to explain.

It is often an advantage to build up a blowpipe quickly for some special work, and the method and rules for construction are here given, bearing in mind always that a high-pressure blast gives the most compact and highest temperature flame, without having any actually greater quantity of heat in the flame produced.

At day, pressure = 10-10ths on the gas supply, a $\frac{1}{2}$ -in. pipe with a $\frac{1}{2}$ -in. bore tap will supply about $1\frac{1}{4}$ cub. ft. per minute, or 75 cub. ft. per hour. A 1-in. bore pipe and tap will supply about 5 cub. ft. per minute. About 25 cub. ft. of gas equals 1 lb. of coal in fuel value, and, therefore, a $\frac{1}{2}$ -in. gas pipe will supply at the rate of 1 lb. of coal, in a gaseous form, in 20 minutes. To burn this in a blowpipe, an air supply of 10 cub. ft. per minute is required, and given the available blast pressure the area of the air jet necessary is easily found.

For the construction of large blowpipes for special work, the stock fittings can generally be utilized, and an efficient blowpipe built up in a few minutes, as shown in Fig. 160. Nothing more is necessary than 3 short bits of tube, a T coupling and diminishing socket, or straight union. No taps are necessary on the blowpipe, if not at hand, as if an elastic tube is used the flame can be perfectly controlled by squeezing the

tubes between the fingers, holding them in the same way as the reins are held in driving a horse. If a diminishing socket is not at hand, the end of the T-piece can be plugged up and the air tube fastened into this plug, and it will be a convenience if an elbow is put on the gas inlet close to the T, so as to turn the gas pipe in the same direction as the air pipe. In this form it makes a handy and convenient blowpipe.

For any except very small work, some mechanical blower is absolutely necessary. Those who do not care to go to the expense of any of the apparatus usually sold, can produce a good make-shift with one or two pairs of common house bellows. If an upholsterers' or sofa spring is placed between the handles so as to render the opening of the bellows automatic, the pressure of the foot on the top board will give a strong blast of air. This, although intermittent, acts very well for a large proportion of work, and a full-sized pair of house bellows will supply a blowpipe with an air jet of full $\frac{1}{8}$ or $\frac{3}{16}$ in. bore. A continuous blast, at all events for soldering and brazing, is not at all necessary, unless the maximum possible power is required. To obtain a continuous blast from this arrangement several ways may be adopted. It is of course necessary to have a reservoir, which is always under pressure, and some means must be adopted to prevent the air in the reservoir blowing back into the bellows, whilst they are being lifted between the strokes.

If a square tin or zinc vessel is made, with a sloping partition, shown at *b* (Fig. 161),

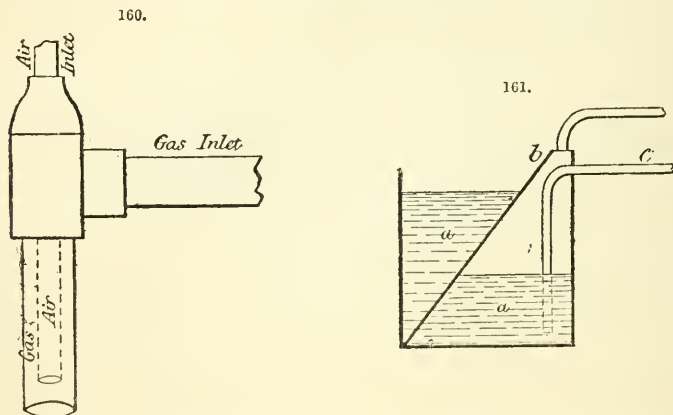

the partition slightly open at the bottom, and the vessel half filled with water, the air when blown by the bellows through the pipe *c*, bubbles up through the water, which makes the bottom of the pipe *c* tight against the return of the air. As the air accumulates in the close part, it presses the water *a* under the partition to the other side, causing a difference in level, which exerts a continued pressure on the air pipe on the top. The deeper this vessel the heavier the air pressure which can be obtained, as this is ruled by the difference in level between the two water surfaces. This is the only means of getting a continuous pressure without a valve. The next easiest way is to get a second pair of bellows, plug up the hole underneath the inlet valve at the bottom, and in this plug insert a pipe leading from the first pair of bellows. The second pair then forms the reservoir, the air being taken from the nozzle to supply the blowpipe, and the necessary pressure must be obtained by weights on the top board or by a strong spiral spring resting on the top board. The rule with house bellows is that they are made in a wholesale rough way, and very few are anything like air-tight. They should be carefully selected for the purpose by opening fully, stopping the nozzle with the finger, and pressing the handles heavily together. Many will be found to close almost as quickly with the nozzle stopped as with it open, and, of course, these are quite useless for the purpose.

Supports.—Work to be brazed needs to be supported on a bed of some refractory material. Often a fire-brick or piece of fire-lump is used for heavy work, or powdered pumice or charcoal for lighter work. A fire-brick forms a convenient basis, and may be hollowed out to receive a dough-like compound of 1 part fine fire-clay and 2 parts charcoal dust combined by adding a little stiff rice-flour paste, as Edwinson suggests. Or pumice may replace the fire-clay. In this dough the article is embedded, and all is dried gently before the brazing begins. Freeman has introduced a new and improved heat deflector, for use with the blowpipe, as a support for the work whilst it is being brazed or soldered. This article is made of a very light porous clay, specially prepared, and is corrugated, so as to allow the heat to pass entirely underneath the article to be soldered. It is superior as a support to that of an ordinary fire-brick, it does not burn like composition supports, it does not crackle or spit like charcoal, nor crumble away like pumice. The article has been tested by many of the leading electroplate and jewellery manufacturers of Birmingham, who speak highly in their testimonials of its efficiency. Blocks of the material may be had in disc form 14 in. in diameter, or in lumps 12½ in. square at 3s. each.

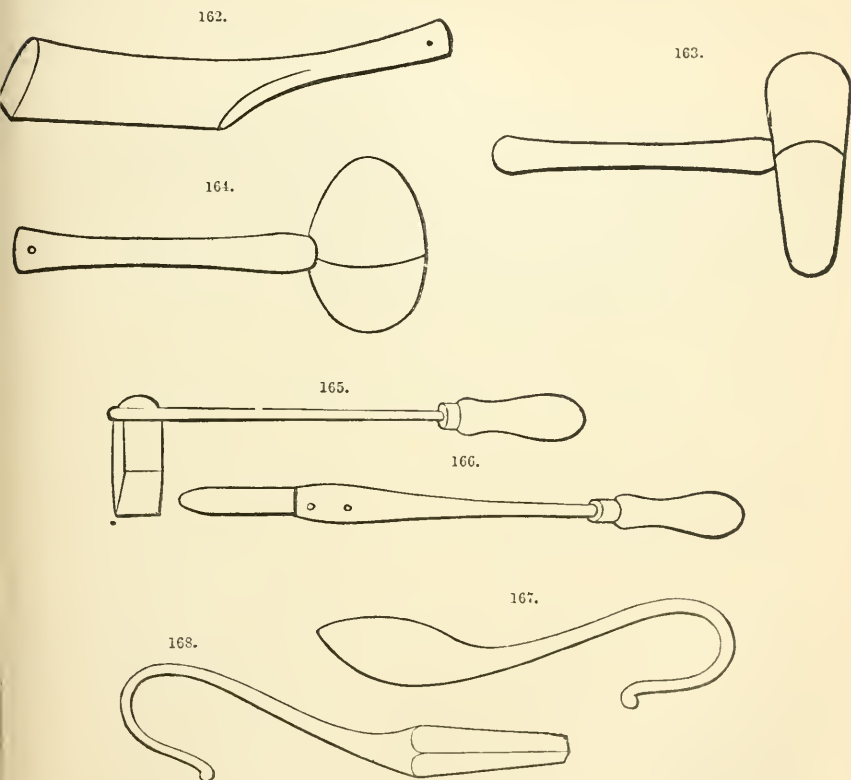

Tools.—Some of the tools incidental to soldering are illustrated above. Fig. 162 is a hornbeam dresser for flattening metal; Figs. 163, 164, bossing mallets; Figs. 165

166, copper bits; Figs. 167 to 170, soldering and bossing irons; Fig. 171, a ladle; Fig. 172, a shave-hook; Fig. 173, a boxwood chase wedge; Fig. 174, a boxwood turnpin.

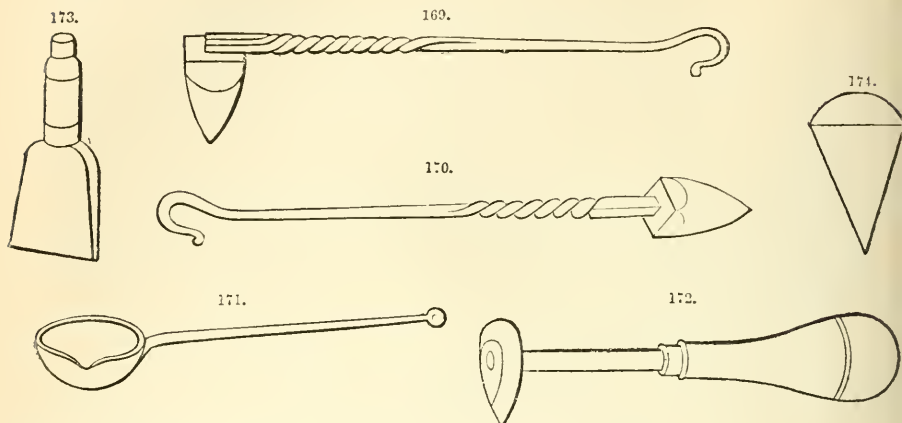

Braziers' Hearth.—In soldering or brazing large work of copper, silver, &c., an open fire is used, called the braziers' hearth. For large and long work, this hearth is made with a flat iron plate about 4 ft. by 3, which is supported by 4 legs, and stands on the floor at a sufficient distance out from the wall, so that the operator can get all around it. In the centre of this plate is a depression about 6 in. deep and 2 ft. long by 1 wide, for containing the fuel and fire. The fire is depressed in this way so that the surface of the plate may serve for the support of large work, such as long tubes, large plates, &c. The rotary fan is commonly used for the blast. The twyer iron is similar to those for the common blacksmiths' forge, but with a larger opening for admitting the blast to the fire. The nose or top of this twyer iron is fitted loosely into grooves, so as to admit of easy renewal, as they are burned out in a very short time, and must be replaced to do good work. The fire is sometimes used the full length of the hearth, in which case a long or continuous twyer is employed. Occasionally 2 separate fires are made on the same hearth. In this case, they are separated by a loose iron plate. The hood or mouth of the stack is suspended from the ceiling over the hearth with counterpoise weights, so that it may be raised or lowered, according to the magnitude of the work. The common blacksmiths' forge fire is frequently used for brazing. It is temporarily converted into a braziers' hearth by being built hollow around the fire, and the fire removed from the wall or flue, out into the centre of the hearth. But the brazing operation injures the fuel so that it cannot be again used for ordinary forging of iron or steel. For want of either the braziers' hearth or the blacksmiths' forge, the ordinary grate made be used, or it is better to employ a brazier or chafing dish containing charcoal, and urge the fire with a hand-bellows, which should be blown by an assistant, so that the operator may have both hands at liberty to manage the work and fuel. The best fuel for brazing is charcoal, but coke and cinders are generally used. Fresh coals are highly injurious to the work, on account of the sulphur they contain, and soft or bituminous coal cannot be used at all until it is well charred or converted into cinders. Lead is equally as injurious in the fire for brazing as for welding iron and steel, or in forging gold, silver, or copper, for the lead is oxidized and attaches itself to the metals that are being brazed or welded, and prevents the union of the metals, and in all cases it renders the metal brittle and unserviceable. There are many kinds of work which require the application of heat

having the intensity of the forge fire or the furnace, but in a number of these cases it is only desirable to heat a small portion of the work, and avoid soiling the surface of the remainder, and also to have the work under the observation and guidance of the operator, as in brazing or soldering small articles of jewellery, silver plate, &c. In these cases, the blowpipe with pointed flame is generally used, and in many cases the work is supported upon charcoal so as to concentrate the heat upon it.

Heating the Iron.—Fig. 175 shows a simple form of lamp for heating the soldering-iron: *a* is the casing; *b*, lamp and uptake; *c*, flame; *d*, baffle-plate; *e*, top of stove; *f*, tilt; *g*, wires; *h*, place for the bit. Make the tilt just high enough for the proper heating of the bit, and let it rise 1 in. higher at the back. Adjust the lamp, &c., that the article is not covered with a deposit of carbon (soot).

The following is a simple and useful adjunct to the "solderer," in order to do away with the nuisance caused by the smoke from an ordinary gas-burner. Take a piece of sheet tin—say 7 in. by 7 in.; turn it round into a cylinder, and rivet. (The small brass nails, to be had at any iron-monger's, are handy; make holes with a bradawl, and snip off the tack to the desired length, and rivet; 4 will be plenty in cylinder.) Vandyke one end all round, turn down a flange at the other end, make a circular cover for this end, and fill full of holes by means of a fine sprig bit; rivet this, then, on to flange with 4 tacks; make a hole to receive an ordinary gas-burner—say, 2 in. from the bottom or vandyked end, and solder the burner (the new brass ones are the handiest). Now procure a piece of vulcanized rubber pipe of $\frac{1}{4}$ in. bore, draw over the burner, and also over an adjacent burner in the shop, and turning on the gas you have a beautiful blue and smokeless flame, with great heat.

Fletcher, of Warrington, sells very useful little implements for heating the soldering-iron by a suitably arranged gas-jet.

(*b*) *Hints*.—(1) The soldering of 2 metallic surfaces together implies something more than mere mechanical union, and probably depends in some measure upon the formation of an alloy between the solder and the metals joined by it: hence the necessity for clean contact, and therefore perfectly bright inoxidized surfaces. To ensure this condition, various solutions are used just at the moment of soldering. The most common is hydrochloric acid "killed" with zinc (i. e. in which zinc is dissolved until the acid takes up no more), forming zinc chloride, which runs over the surface exposed to it, removing any existing oxide, and preventing its further formation by the action of the air. Sal-ammoniac (ammonium chloride) sometimes replaces the zinc chloride, or is used in conjunction with it. Powdered rosin applied to the heated metallic surface forms a protective varnish which excludes the air and prevents oxidation. With the same object, borax (sodium biborate) is mingled with granulated hard solder just before use, either by crushing the borax and mixing dry, or by dissolving the borax in water and making a paste of the solution and the powdered solder.

(2) "Hard" or "strong" solder is commonly known as "spelter," a term properly applied to commercial zinc ingots. For some kinds of work, commercial spelter is not so well suited as other brasses; for ordinarily it consists of equal weights of zinc and copper, and in certain cases it is advisable to use a harder solder than is obtained by these proportions. The admixture of copper and zinc produces a series of alloys differing considerably in their qualities, and when tin is introduced, the increase or

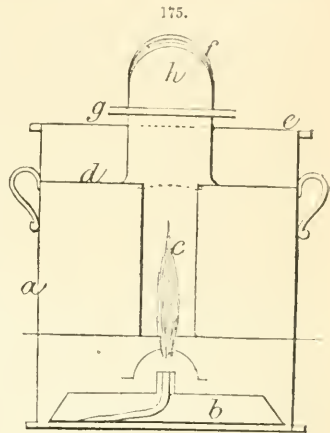

decrease of the zinc and tin produces a compound metal, the properties of which are widely different according to the relative quantities of the ingredients used in its production. Spelter when home-made is best prepared by melting the copper and zinc in separate crucibles, the copper being in a crucible large enough to hold the zinc as well. When both metals are thoroughly melted, the zinc is poured into the copper crucible, the two being stirred well, so as to ensure thorough admixture, when the alloy is poured out on to a bundle of birch twigs or pieces of coarse basket-work, supported over a tub of water, the object being to obtain the solder in the form of fine grains with an irregular crystallization. If, when taken from the water, the spelter is not sufficiently uniform in size of grain, it is passed through a sieve, and the large particles are crushed in a cast-iron mortar or any suitable appliance, and again passed through the sieve, for fineness and uniformity of size are essential to the accomplishment of some examples of brazing in a thoroughly satisfactory manner. Manufacturers of hard solder, however, usually cast it into ingots, delaying the cooling in order to develop as much as possible the crystallization, which is found to facilitate the subsequent crushing and sifting of the spelter. The term "brazing" is often applied to the operation of "hard soldering," from the fact that the solder used is really a brass.

(3) The solder found in commerce generally is known as "coarse," "common," and "fine"; and the respective proportions of the metals are supposed to be—for coarse, 2 parts lead to 1 of tin; for common, equal parts; and, for fine, 2 parts tin to 1 of lead. These proportions can generally be detected in the manufactured article, for coarse solder exhibits on its surface small circular spots, caused by a partial separation of the metals on cooling; but these are wanting when the tin exceeds the lead, as in fine solder. In the ordinary solder of commerce, it is very rare that the tin exceeds the lead, and No. 1, or hard solder, of the shops, will, as a rule, be found to vary between $1\frac{1}{2}$ and 2 of lead, to 1 of tin. The commoner stuff—that which plumbers use for making wiped joints in leaden pipes—contains $2\frac{1}{2}$ to 3 parts lead and 1 of tin.

(4) Solder will sometimes get contaminated with zinc, burnt tin, lead, iron, &c., which causes it to "work short," "set," or crystallize, contrary to the general rule. This is known by the solder quickly curdling or setting and working rough, with the tin separating, and looking like so much sawdust, except in colour, which, if disturbed when cooling, is a kind of grey-black. This is often caused by overheating the metal, viz. by making it red hot or by dipping brasswork into the pot for tinning, and also when soldering brasswork to lead, when, if brasswork be dipped into the pot too hot, the zinc leaves the copper and the tin takes it up, because tin and zinc readily mix. A small portion of zinc will also cause the lead and tin to crystallize or separate. If you have any idea that there is zinc in your solder (the least trace is quite sufficient), heat it to about 800° F. (427° C.), or nearly red hot, only just visible in the dark (if visible, or red hot, in the day time, it will be at least 1100° F.: red-hot irons do not improve solder). Throw in a lump of brimstone (sulphur), which melts at 226° F. (108° C.), but at a greater heat, between this and 430° F. (221° C.)—just below the melting-point of plumbers' solder, it thickens, and from 480° to 600° F. (249° to 315° C.) remelts, and again becomes thinner. At 773° F. (412° C.) the zinc melts, and being lighter than lead or tin, has a chance to float, especially with the aid of sulphur. The sp. gr. of lead is 11·45; tin, 7·3; zinc, 6·8 to 7 (just enough to rise); and sulphur, 1·98. The last named readily mixes with the zinc, &c., and carries the lot of foreign matter to the surface. It also brings up all the oxidized lead and tin in the form of a whitish powder called "putty powder," which may be in the pot, or makes it fly to the iron. Skim the solder well, and after the heat is brought down to about 400° F. (204° C.), or just below working-point, stir the lot well up in plenty of tallow, which will free the sulphur, and your solder will be clean. A good lump of rosin will improve it; and add a little tin. If you have very much zinc present, the best way will be to granulate the solder as follows:—Just at setting point, turn it out of the pot and break it

up with the dresser, like so much mould or sand. Put it into an earthenware basin or jar, or back into the pot, and cover it with hydrochloric acid; let it soak for a day or so, then well wash the lot, and serve it as above. This will effectually take the zinc out. Afterwards add a little more tin to compensate for that destroyed by the excessive heat, and the acid. A little arsenic very readily carries zinc through the solder.

Overheating solder renders it "burnt," i. e. much of the various metals present is oxidized, producing a cloggy dull mass; this is remedied by the process just described, which eliminates the injurious oxides. When there is only a small quantity of bad solder, it is best to make it up into fine solder, or use it for repairing zinc roofs. Do not put bought fine solder into plumbers' solder, as it may contain all sorts of metal. (P. J. Davies.)

(5) Soldering zinc and galvanized iron.—Zinc may be soldered as readily as tin by using dilute hydrochloric acid ($\frac{1}{3}$ its bulk of rain-water added) as a flux instead of rosin, and by taking care to keep the soldering-iron well heated.

(6) For soldering without the use of an iron, the parts to be joined are made to fit accurately, either by filing or on a lathe. The surfaces are moistened with soldering fluid, a smooth piece of tinfoil is laid on, and the pieces are pressed together and tightly wired. The article is then heated over the fire by means of a lamp until the tinfoil melts. In this way 2 pieces of brass can be soldered together so nicely that the joint can scarcely be found.

(7) For soldering brass to platinum, put a piece of thick brass wire in a handle, and flatten and file the end like the point of a soldering bit; dip this end in soldering fluid, and, holding it in the flame of gas or lamp, run a little solder on it; now, having put some fluid on the platinum, which will require to be supported with a fine pair of tongs, place it near the flame, but not in it, at the same time heating the brass wire in the flame with the other hand, and as soon as the solder melts it will run on to the platinum; you must put very little on, and take care the solder does not run to the other side. Having applied soldering fluid or rosin to the brass, hold the two together in any convenient manner, and warm them in the flame till the solder runs. It is best to use rosin for electrical work, unless the work can be separated and thoroughly cleaned.

(8) Soldering brass wire.—For making a chain, procure a piece of hard wood or metal, the cross section of which will be the same shape as the intended links. The wire must be wound on this—then, with a fine saw, cut through each link and form the chain (or a part thereof). Have a large piece of pumice or charcoal (preferably the latter), with a nice flat surface, and arrange the chain on it ready for soldering, the points of each link being turned the same way; the solder must be hammered thin, and cut into very small pieces. Get a piece of borax, and grind it on a slate with water; now, with a small camel-hair pencil, touch each joint with the moist borax, and with the point of the pencil pick up a piece of solder and place it over the joint. When every link has been so treated, heat them with the blowpipe till the solder runs; do not attempt to heat them all at once, but direct the flame (and your attention) to one link after another, till all are soldered—then boil them in water, to which is added a little sulphuric acid. For this purpose you should use a copper or porcelain "pickle pan"; for solder, take a mixture of 1 part brass and 2 of silver, melted together and rolled or hammered very thin. In order to make neat joints, the solder must be cut very small, and only put the borax just where you wish the solder to run. The charcoal or pumice-block you can grind flat on the hearthstone, or use an old file for the purpose; an ordinary blowpipe, which you can buy for 4*d.*, will answer every purpose. You can also buy the silver solder ready for use. Spelter solder can be used for this purpose, but is not so convenient.

(9) Soldering brass to steel.—(a) Clean the surface of the steel, and with a fine brush coat the steel with a solution of copper sulphate. The iron reduces the copper to the metallic condition, in which condition it firmly adheres to the steel; then solder in the usual way. (b) Take a suitable-sized piece of tinfoil, and wet in a strong solution of

commercial sal-ammoniac; place this between the surfaces to be soldered, and apply a hot iron or gas-flame. The surfaces do not require trimming.

(10) Mending cracked bell.—The crack is first soldered with tin, and the bell is heated to dull redness or nearly so for a little time. The tin has the property, when heated above its melting-point to nearly redness, of rapidly dissolving copper, an alloy being thereby formed in the crack of nearly the same composition as the bell itself, and which, being in absolute metallic union with it, is quite as brittle and as sonorous as the other portions of the bell.

(11) Soldering iron and steel.—For large and heavy pieces of iron and steel, copper or brass is used. The surfaces to be united are first filed off, in order that they may be clean. Then they are bound together with steel, and upon the joint a thin strip of sheet copper or brass is laid, or, if necessary, fastened to it with a wire. The part to be soldered is covered with a paste of clay, free from sand, to the thickness of 1 in., the coating being applied to the width of a hand on each side of the piece. It is then laid near a fire, so that the clay may dry slowly. The part to be soldered is held before the blast, and heated to whiteness, whereby the clay vitrifies. If iron is soldered to iron, the piece must be cooled off in water. In soldering steel to steel, however, the piece is allowed to cool slowly. The semi-vitrified clay is then knocked off, and the surface is cleaned in a proper manner. By following the hints given, it will be found that a durable and clean soldering is obtained. If brass, instead of copper, is used, it is not necessary to heat so strongly; the former recommends itself, therefore, for steel. Articles of iron and steel of medium size are best united with hard or soft brass solder. In both cases the seams are cleanly filed and spread over with solder and borax, when the soldering seam is heated. Hard brass solder is prepared by melting in a crucible 8 parts brass, and adding 1 of previously heated zinc. The crucible is covered and exposed to a glowing heat for a few minutes, then emptied into a pail with cold water, the water being strongly agitated with a broom. Thus the metal is obtained in small grains or granules. Soft brass solder is obtained by melting together 6 parts brass, 1 of zinc and 1 of tin. The granulation is carried out as indicated above. Small articles are best soldered with hard silver solder or soft solder. The former is obtained by alloying equal parts of fine silver and soft brass. In fusing, the mass is covered with borax, and when cold, the metal is beaten out to a thin sheet, of which a sufficiently large and previously annealed piece is placed with borax upon the seams to be united and heated. Soft silver solder differs from hard silver solder only in that the former contains $\frac{1}{10}$ of tin, which is added to it during fusion. Very fine articles of iron and steel are soldered with gold, viz. either with pure gold or hard gold solder. The latter can be obtained by fusion of 1 part gold, 2 of silver, and 3 of copper. Fine steel wire can also be soldered with tin, but the work is not very durable. Hard and soft brass solders are used for uniting copper and brass to iron and steel, silver solder for silver, hard gold solder for gold.

(12) Soldering silver.—The best solder for general purposes, to be employed in soldering silver, consists of 19 parts (by weight) silver, 10 of brass, and 1 of copper, carefully melted together, and well incorporated. To use this for fine work, it should be reduced to powder by filing; the borax should be rubbed up on a slate with water, to the consistency of a cream. This cream should then be applied with a fine brush to the surfaces intended to be joined, between which the powdered solder (or wire) is placed, and the whole is supported on a small block of charcoal to concentrate the heat. In the hands of a skilful workman, the work can be done with such accuracy, as to require no scraping or filing, it being only needful to remove the borax when the soldering is complete, by immersion in "pickle."

Silver soldering as applied to silversmiths' work, is an art which requires great care and practice to perform it neatly and properly. The solder should in every way be well suited to the particular metal to which it is to be applied, and should possess a powerful chemical affinity to it; if this is not the case, strong, clean, and invisible connections

cannot be effected, and that is partly the cause of roughness in goods, and not, as may more frequently be supposed, from the want of skill on the part of the workman. The best connections are made when the metal and solder agree as nearly as possible in uniformity as regards fusibility, hardness, and malleability. Soldering is more perfect and more tenacious as the point of fusion of the solder rises. Thus tin, which greatly increases the fusibility of its alloys, should not be used excepting when a very easy running solder is wanted, as in soldering silver which has been alloyed with zinc. Solders made with tin are not so malleable and tenacious as those prepared without it. Solders made from silver and copper only are, as a rule, too infusible to be applied to the general run of silver goods. Solders are manufactured of all degrees of hardness, the hardest being an alloy of silver and copper; the next silver, copper, and zinc; the most fusible, silver, copper, and tin, or silver, brass, and tin. Arsenic is sometimes used to promote fusion, but its poisonous vapours render its use inadmissible. In applying solder, of whatever composition, it is of the utmost importance that the edges, or parts to be united, should be chemically clean; and for the purpose of protecting these parts from the action of the air and oxidation during the soldering process they are covered with a flux, always borax, which not only effects the objects just pointed out, but greatly facilitates the flow of the solder to the required places. Silver may be soldered with silver of a lower quality, but easy running solder may be made of 13 dwt. fine silver, 6 dwt. brass; the composition of brass being so uncertain, it is best to fuse zinc and copper with the silver, and the following proportions make a very easy running solder: 12 dwt. fine silver, 6 dwt. pure copper, 1 dwt. zinc. Brass sometimes contains lead, which burns away in soldering and must be carefully guarded against. Solder for filigree-work is prepared by reducing easy flowing solder filings and mixing it with burnt borax powdered fine. In this state it is sprinkled over the work to be soldered, or the parts to be soldered are painted with wet borax, and the solder filings are sifted on and adhere to the borax. The flux which adheres to the work after soldering is removed by boiling the article in a pickle of sulphuric acid and water, 1 part to 30.

(13) Soldering glass to metal.—This may be effected by first coating the glass with lead, as is sometimes done to give a bright reflecting surface. Small flat pieces of glass are painted over on one side with chalk or colcothar and water, and then left to dry. They are placed with the coated side downwards on the bottom of a flat cast-iron tray about 1 ft. square, surrounded by a vertical border of 1 to 1½ in., and are gradually heated in a large muffle to a temperature somewhat above the melting-point of lead. The tray is withdrawn, and melted lead is immediately poured into it sufficient to cover the glass, which is held down by pieces of wire. A slightly oscillating movement is given to the tray, so as to cause the molten lead to flow gently backwards and forwards. After a short time, a plug is taken out of the corner of the tray, which is tilted to let the lead run off as completely as possible. The pieces of glass will now be covered with a firmly-adherent film of lead. The lead employed should be of good quality; and in order to prevent it from becoming mixed with any oxide which may have formed on its surface, the tray is provided with a gutter-like arrangement, leaving only a slit for the passage of the lead. The tray is suspended at one end by a chain, and held by tongs at the other. Glass buttons thus backed with a lead coating have their shanks soldered on (Dr. Percy). Solder may also be made to adhere to glass by first coating the glass surface with amalgam.

(14) Soldering platinum and gold.—To make platinum adhere firmly to gold by soldering, it is necessary that a small quantity of fine or 18-carat gold shall be sweated into the surface of the platinum at nearly a white heat, so that the gold shall soak into the face of the platinum; ordinary solder will then adhere firmly to the face obtained in this manner. Hard solder acts by partially fusing and combining with the surfaces to be joined, and platinum alone will not fuse or combine with any solder at a temperature anything like the fusing point of ordinary gold solder.

(15) Mending tin saucepan.—The article is first scoured out with strong soda water,

and the hole is scraped quite clean. If small enough, it is covered with a drop of solder, applied after the spot has been moistened with "killed spirits." If this plan will not suffice, a larger space must be cleansed and a small patch of tin laid on. When the bottom is seriously impaired, the quickest and best method is to cut it off and replace it by a new one.

(16) Soldering brass.—All kinds of brass may be soldered with Bath metal solder (79 copper, 21 zinc) or soft spelter, using borax as a flux. A good plan is to spread on a little paste of borax and water and lay a bit of tinfoil on this, then heating till the tin melts and runs, and thus coats the surface. Work previously tinned in this way, can be joined neatly and easily.

(17) Soldering pewters and compo pipes.—These require powdered rosin as a flux, with very thin strips of the more fusible solders, care being taken that the soldering-iron is not too hot.

(18) Laying sheet lead.—In laying sheet lead for a flat roof, the joints between the sheets are made either by "rolls," "overlaps," or soldering. In joining by rolls, a long strip of wood 2 in. square, flat at the base and rounding above, is placed at each seam; the edge of one sheet is folded round the rod and beaten down close, and then the corresponding edge of the next sheet is folded over the other. In overlapping, the adjacent edges of the 2 sheets are turned up side by side, folded over each other, and closely beaten down. Soldering is not adopted when the other plans can be carried out.

(19) Mending leaden pipe.—When a water pipe is burst by frost, the damaged portion must be cut out and replaced by a length of new pipe, in the following manner. The ends to be joined are sawn off square, then the open end of the lower section is enlarged by inserting a boxwood turnpin and driving it down by light blows till the opening is large enough to admit the lower end of the new length, which is rasped thinner all round to facilitate this operation. The top end of the new length and the open end of the upper section are then served the same way. The surfaces to be joined are scraped quite bright, either by a shave-hook or by a pocket-knife, and then fitted together, thus forming a couple of circular ditches, as it were. Into these is sprinkled a little powdered rosin to keep the surfaces bright, and then molten solder is poured in from a ladle till the ditches are quite full. Adhesion between the solder and the pipes is then brought about by passing the point of a hot soldering-iron round the ditches, the heat of the iron being sufficient to liquefy the solder and just fuse the surface of the lead, but it must not be so hot as to melt the lead.

(20) Gas for blowpipe work.—Fletcher, of Warrington, the well-known inventor of so many improved appliances for the employment of gas in the workshop, has published some interesting remarks on the use of the blowpipe. Where available, there is no fuel to equal gas for general blowpipe work, and in using the blowpipe with gas, it is usual to cut a notch or groove in the upper side of the open end of a $\frac{3}{8}$ -in. brass tube, so as to allow the top of the blowpipe to rest in it, pointing in the same direction as the opening in the gas pipe. The blowpipe tip should then be placed in the notch, and a wire bound round both in such a manner that the blowpipe is held firmly in position, and still can be easily drawn out backwards. This arrangement forms a carrier for the blowpipe, which leaves the hands at liberty, and enables the whole attention to be directed to the work. A short length of tube made like this could be carried in the tool-bag, and connected to any available gas supply.

For hard soldering, where the solder used melts at a heat approaching redness, and sometimes at a still higher temperature, the same form of blowpipe and the same source of heat are commonly used, except that as the work is usually done in fixed workshops, the sources of heat do not require to be portable, and are therefore usually confined to gas, or, where this is not available, to a lamp, having fixed on the upper side of the wick tube, in a convenient position, a support of wire, or other material, to carry the front of the blowpipe. Sometimes the blowpipe is made as a simple straight tube, sliding in a loose collar, the blowpipe in this case being about 3 or 4 in. long. At the opposite end

of the jet is fixed about 14 or 16 in. of small indiarubber tubing (feeding-bottle tube), which is used for blowing. The sliding motion of the blowpipe is necessary, so that the jet can either be drawn back, giving a large rough flare for general heating, or it can be pushed into the flame, so as to take up part only and give a finely pointed jet on any part where the solder requires to be fused. When gas is used, the sliding motion of the blowpipe is not necessary, as the flame can be altered equally well by the gas tap, and it is therefore usual to make gas blowpipes with fixed jets.

Another form has the blowpipe coiled as a spiral round the gas tube, both gas and air being heated before burning by a Bunsen burner underneath. This gives a very much greater power for small work, but possesses no advantage whatever for large flames. On the contrary, when the maximum bulk of work is to be heated with a mouth blowpipe, a better result is obtained with a cold blast of air, and the advantage of the hot blast is only perceived when a small pointed flame is used. When this blowpipe is used for soldering, the bulk of the work should be heated up first with the cold blast, and the lower Bunsen turned on a few seconds before the small pointed flame is required for finishing the soldering. The hot blast has one advantage peculiar to itself in addition to the high temperature of the small flame; it requires no chamber for condensed moisture. The moisture of the breath, instead of appearing as occasional splashes of wet on the work, at critical times, is converted into steam, and goes to assist the blast from the lungs.

(21) Blowpipe brazing.—For brazing, where powdered or grain spelter (a very fusible brass) is used, the borax is mixed as a powder with a spelter, usually with a little water, but sometimes the work to be brazed is made hot and dipped into the dry powder mixture, which partially fuses and adheres. In either case, care is requisite not to burn or oxidize the grains of the spelter with the blowpipe flame, or it will not run or adhere to the surface to be brazed; and for such small work as can be done with the mouth blowpipe, it is better to discard spelter entirely, and use either common silver solder (an alloy of 1 silver and 2 tinned-brass pins), or what is still better an alloy of 13 parts copper and 11 fine silver. If fine silver is not easily to be got, the same alloy can be made by equal weights of copper and coin silver. The solder should be rolled into thin sheets, cut into small bits of the shapes and sizes required, and put into a small saucer, containing a rather thin pasty mixture of powdered borax and water. The surfaces of the joint to be soldered should be brushed with this mixture, using a small camel-hair brush, the bit of solder being put in its position either with the brush or a fine pair of tweezers. The heat of the blowpipe must then be applied very slowly. The borax dries up and swells enormously, frequently lifting the solder along with it. The borax then sinks down again and begins to fuse. There is now no risk of blowing the solder away, and the full blast can be at once applied, directing the flame principally round the solder so as to heat the body of the work. When hot enough, the solder begins to fuse and adhere to the work, and the flame must now be instantly reduced to a small point, and directed on the solder only, which usually fuses suddenly. The instant the solder runs, the blast must be stopped by the tip of the tongue, or in delicate work mischief may be done which may take hours to make good.

One great difficulty with beginners is in soldering two or more parts in exact positions relatively to each other, these parts being of such a form that they cannot be held in position. The way to overcome the difficulty is this: With a stick of beeswax, the end of which has been melted in a small flame, stick the parts together as required. The wax is sufficiently soft when cold to admit of the most exact adjustment of parts, and it must surround the parts only which are to be soldered. Make a mixture of about equal parts of plaster-of-paris and clean sand, and stir this up in a cup or basin with sufficient water to make a paste, turn it out on to a sheet of paper, and bed the work to be soldered into it, taking care that the part covered with wax shall be freely exposed. When this is set hard, say in about 10 minutes, slowly warm it over a Bunsen flame, or near a fire (if suddenly heated it will break up); wipe the melted wax off with a small ball of wool;

apply the borax and solder as before mentioned, and continue the slow heating up until the whole mass is hot enough to complete the soldering with the blowpipe. If a light bit has only to be carried or held in position after fixing with wax, as before mentioned, a bridge or arm may be made between the pieces with a very stiff paste made of common whiting and water, or a mixture of clay, whiting, and water. This, being only small in bulk, dries much more quickly than the plaster and sand, but it requires also very slow heating at first, so as to drive the moisture out gradually, otherwise it explodes as steam is formed inside, and the whole work has to be recommenced. The Indian jewellers in making filagree work use clay alone for holding the parts together, but it is very slow in drying, and requires much more care in use than either of the forms given.

When soldering, the work has to be supported in such a manner that it can be turned about and its positions altered quickly, more especially when a fixed blowpipe is used, and for this purpose it is common to use either a lump of pumice or a small sheet-iron pan with a handle, and filled with broken pumice, broken charcoal, and plaster-of-paris, or other non-conductor. The best material is willow charcoal, and the best result can be obtained by its use, as, burning with the heat of the blowpipe, it gives off heat and assists the workman, giving a greater power than when any other support is used. Oak charcoal is not admissible, as it crackles and disturbs the work. For a permanent support, which does not burn away to any practical extent, the best is a mixture of finely-powdered willow charcoal and a little china clay, made into a stiff paste with a rice-flour starch, and rammed into a mould. These are to be bought in many shapes, and are the most convenient for all purposes.

Speaking generally of the mouth blowpipe, the most practised users, as a maximum feat, might, with gas, soft solder a 3-in. lead pipe, or, with a lamp, do the same with a 1½-in. pipe. In hard soldering (with silver solder or spelter), it is usually as much as can be done to solder properly any work weighing over 3 oz., if gas is used; or about half this weight with a lamp; although in exceptional cases, using a charcoal support, these weights may be exceeded, and more especially if the bulk of the work is heated up by a fire or other means so as to admit of an extra strain being put on the lungs for a short time for finishing only. It is a common practice for heavy or awkwardly-shaped work—where the heat is liable to be conducted away quickly—to support the work on a bed of burning coke or charcoal, using the blowpipe only for running the solder whilst the body of metal is heated by the burning coke. By this assistance the capacity of any blowpipe is doubled, or more than doubled, and when the work to be done is beyond the capacity of the blowpipes available, this remedy is a valuable one.

SHEET-METAL WORKING.—By the term “sheet metals” is meant those metals and alloys which are used in thin plates or sheets, such as brass, copper, lead, tin, zinc, tinned iron (tin plate), and thin sheet iron. The arts of making gold, platinum, and tin foils, and platinum vessels for chemical operations, are obviously embraced in the term, but these trades are too special to warrant description here.

The combined strength, durability, lightness, and clean smooth surface of sheet metal, render it particularly useful in a vast number of articles where these qualities are desirable. Another most important property possessed by the majority, especially copper and tin, is that of assuming various shapes without fracture by simple hammering.

Striking out the Patterns.—As the metal is procurable only in flat sheets of various dimensions and thicknesses, some knowledge of geometry is required to determine how the flat piece is to be marked and cut in order to produce the shape decided on for the finished article.

There is scarcely any end to the variety and intricacy of pattern which may be introduced into sheet-metal goods; but when the surface is very irregular it becomes necessary to employ machines for stamping out the design, or rolls for impressing it on the metal. Apparatus designed for these purposes will be described further on; but many simple articles can be constructed without such aid. In measuring the metal in

sheet to make an article of any desired dimensions, allowance must be made for the amount of metal used up in forming the joint, when that is to be of the lapped kind. Where the edges only abut against each other, no such allowance is needed. It is generally between $\frac{1}{8}$ and $\frac{1}{4}$ in. per joint, according to the thickness of the metal used and the strength required in the joint. Before cutting out the piece of sheet metal corresponding to the dimensions aimed at, it is well to make a pattern in stout brown paper, and fold it up so as to make a counterpart of the article in view. Unforeseen errors can then easily be rectified, and the metal cut exactly to the corrected pattern, without risk of waste. The following diagrams and examples illustrate the manner of striking out the metal for many objects of general application.

Relations of Circles.—The diameter of a circle is 0.31831 times the circumference; the circumference is 3.1416 times the diameter; the area (external surface) is the diameter multiplied by itself (squared) and by 0.7854; the diameter multiplied by 0.8862 equals the side of a square of the same area; the side of a square multiplied by 1.128 equals the diameter of a circle of the same area; the diameter multiplied by the circumference equals the surface of a globe.

Cones.—The solidity of a cone equals $\frac{1}{3}$ the product of the area of the base multiplied by the perpendicular height; the convex surface equals half the product of the circumference of the base (diameter $\times 3.1416$) multiplied by the slant height; the slant surface of a truncated (the top cut off) cone equals half the product of the sum of the circumferences of the 2 ends multiplied by the slant height.

To strike out a sheet to cover a whole cone, describe an arc equal in length to the desired circumference, and at

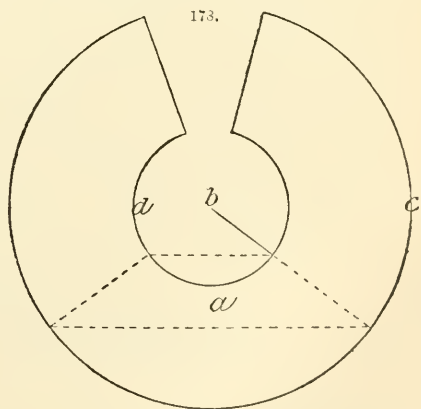
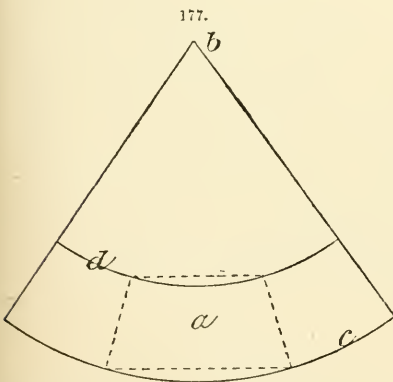
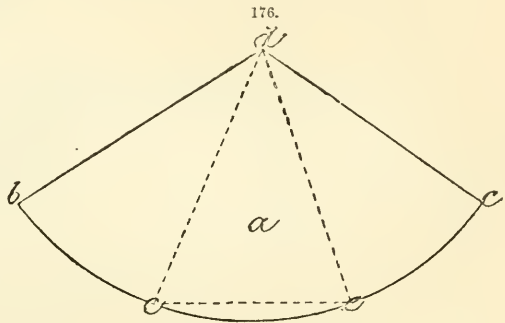

the radius of the required height. In Fig. 176, *a* is the desired cone, having a circumference at the base *e* of 15 in., and a height *d e* of 8 in.; then the length between *b c* must be 15 in., and the length between *d e* 8 in.

When only a frustum of a cone is required, as for instance a funnel fitted over a pipe end, or the shoulder top of a can, the same law holds good; but in this case a second arc must be described equal in length to the smaller circumference. Thus, in Fig. 177, supposing the ring *a* to have a larger circumference of 12 in. at the base, and a smaller circumference of 10 in. at the top, with a height of 7 in.; then 2 arcs have to be described at radii 7 in. apart, from the centre *b* (which is the point where the sides of *a* would cut each other if prolonged), the larger arc *c* measuring 12 in. long, and the smaller *d* 10 in. Fig. 178 is another example where the shoulder has a much shallower slope, and when consequently the inner arc *d* is much smaller than the outer *c*.

Cylindrical Tubes.—The width of sheet required to form a cylinder is ascertained by multiplying the desired diameter of the cylinder by 3.1416; the diameter of a cylinder made from a sheet of known width will be the product of that width multiplied by 0.31831.

Among the most frequent operations in sheet-metal working is the adjustment of cylindrical pipes to each other at various angles, and in various positions.

If it be desired to join 2 pipes of equal diameter at right angles to each other, proceed as in Figs. 179, 180. The T-piece *a* will fit the outline of the main pipe *b*, as

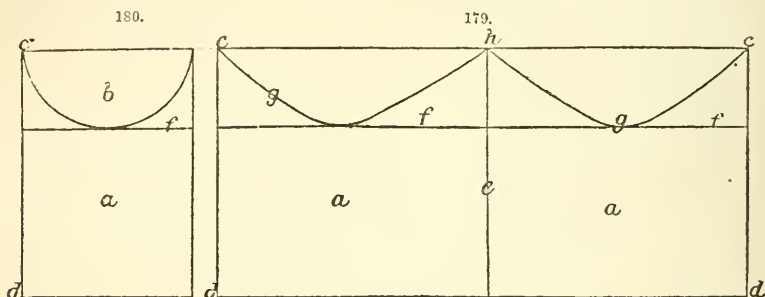

shown. To strike out this T-piece, take a sheet having the same width as the distance between *c d*, and the same length as the circumference of the T-piece. Divide the circumference into halves by the line *e*; then draw the line *f* at the level of the contact line of the main pipe *b*; finally describe 2 curves *g* commencing at the point *h* on the line *e*, touching the line *f*, and terminating at the points *c*. These curves *g* must be sketched in, as they do not form correct arcs of a circle, but are somewhat deeper. The seam joining the edges *c d* will be on one of the long sides of the T-piece. The exact delineation of the curve *g* may be attained by dividing the half-circumference into a number of equidistant spaces by vertical lines, which are numbered or lettered; equivalent lines then drawn at the same distances and of the same lengths on the sheet, indicate the sweep of the curve.

Tools.—For small operations, the tools required may be said to consist simply of a mallet, shears, and a few shapes for moulding on; but many useful little machines

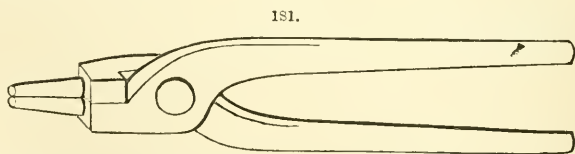

have been introduced into the trade, and effect considerable saving in labour. The ordinary boxwood tinmen's mallet should have the paul rounding at one end and flat at the other. Tinmen's pliers are shown in Fig. 181.

Cutting Tools.—Shears are made in several patterns, according to the stoutness and toughness of the material to be cut. Fig. 182 represents the common form termed platers' hand shears; Figs. 183, 184, are respectively called stock and block shears, and both are intended for use in a fixed position on a bench. Fig. 185 is a guillotine shears. Fig. 186 is a machine for cutting edges true. Fig. 187 is a machine for cutting out circles. Fig. 188 is a pair of follies for punching holes. Fig. 189 represents a contrivance for cutting

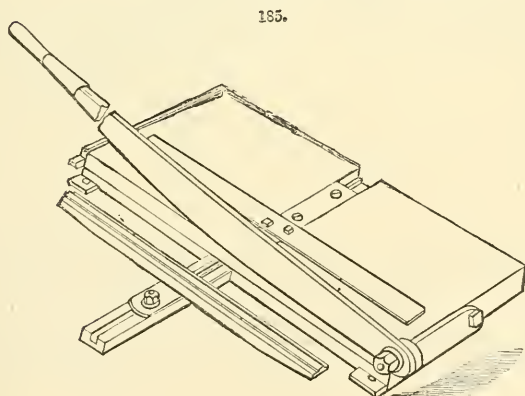
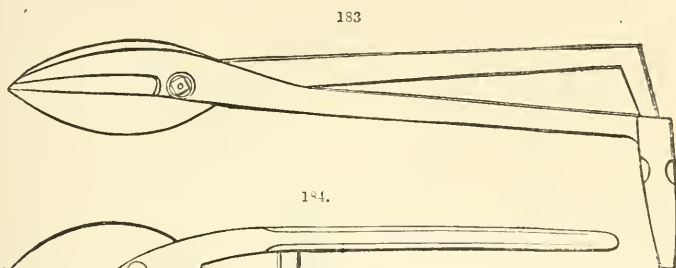
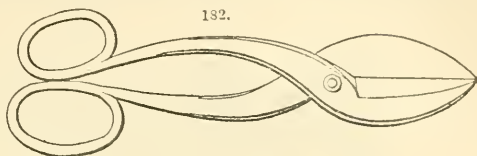

circular holes of considerable size, by the aid of an ordinary carpenters' brace; *a* is a thumb-screw; *b*, a bar of $\frac{3}{8}$ -in. square steel; *c*, cutting edge, which may be modified to suit the material under treatment; *d*, pivot.

Flattening Tools.—Fig. 190 is a flattening mill for sheet metal; and Fig. 191 is a pair of tinmen's rolls.

Folding Tools.—Fig. 192 is a folding or hatchet stake, which may be replaced by a strip of iron with a sharp edge, over which the margins of sheets are bent. Fig. 193 is

186.

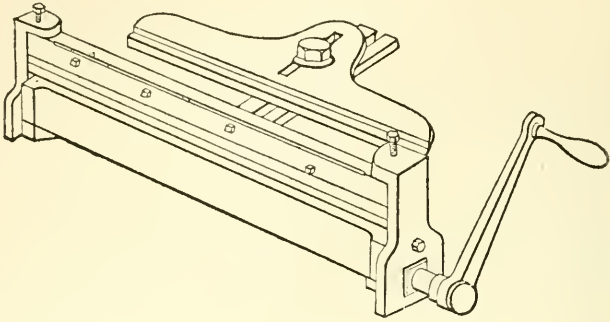

187.

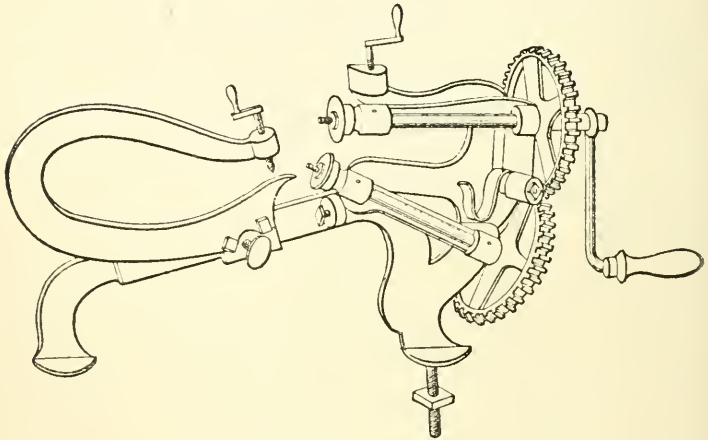

188.

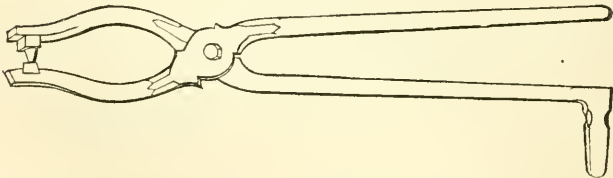

a taper stake used for folding tubes of tapering form; a parallel stake is also required for cylinders. Fig. 194 is a pair of folding rollers. Fig. 195 is a machine for turning over edges and running a wire through the rim formed to give it strength. Fig. 196 is

a machine for closing the bottoms of vessels. Fig. 197 is a burring machine. Fig. 198 is a tea-kettle bottom stake; Fig. 199, a funnel stake; Fig. 200, a side stake; Fig. 201, a tinmen's and braziers' horse; Fig. 202, a saucepan belly stake.

189.

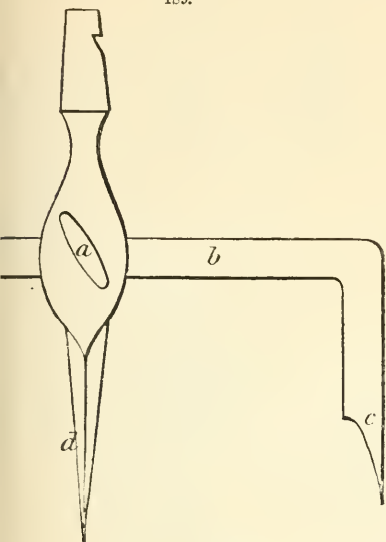

190.

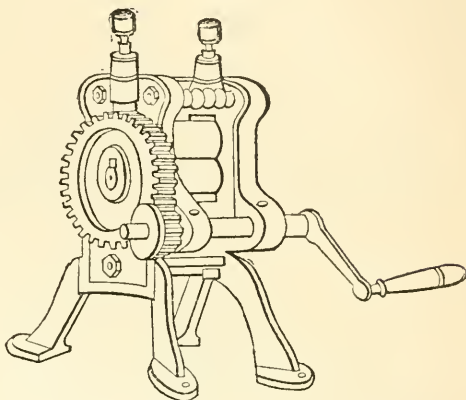

191.

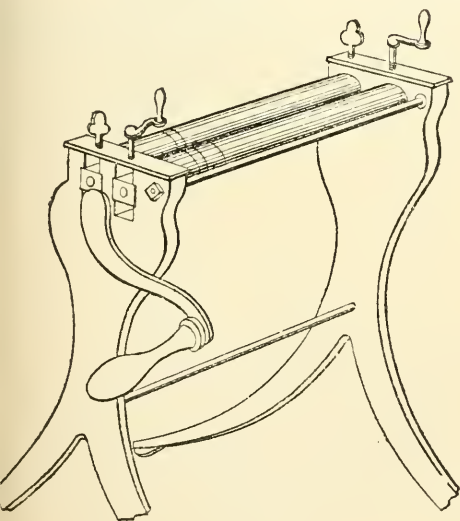

192.

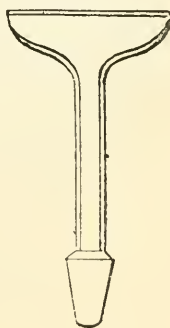

193.

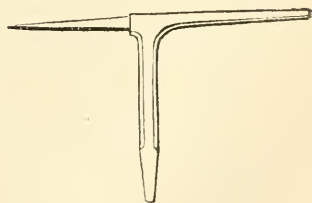

Forming Tools.—Fig. 203 is an iron or boxwood block recessed in the centre, by which cups or dishes of copper and tin may be shaped in one piece. Fig. 204 is a fluting block, which is used on the same principle to make corrugated patterns. When extensive

194.

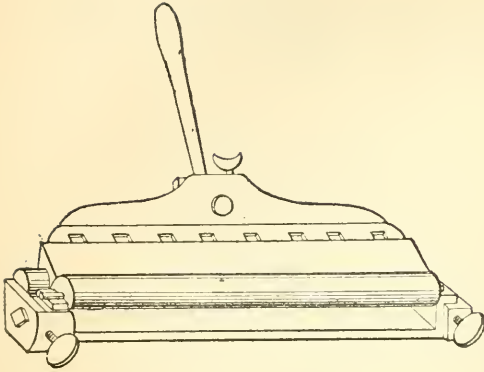

195.

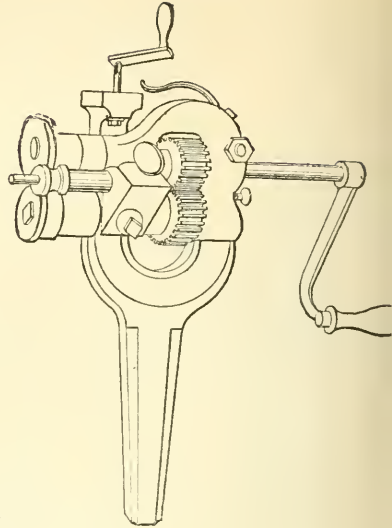

196.

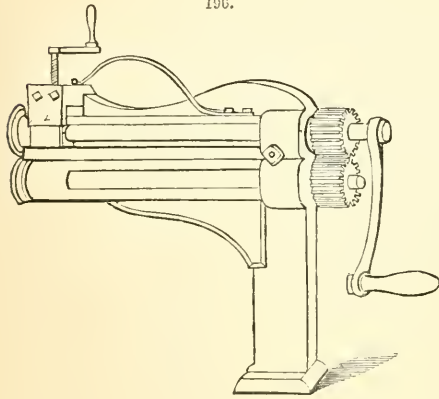

197.

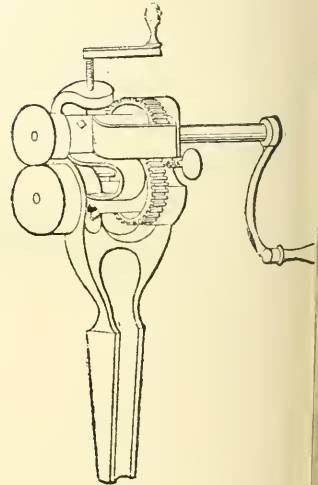

199.

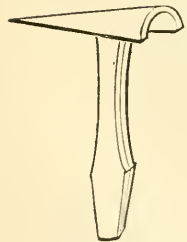

200.

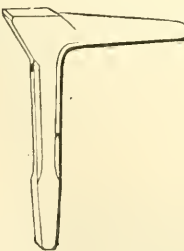

201.

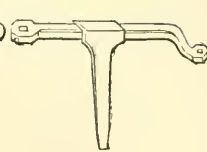

193.

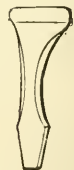

203.

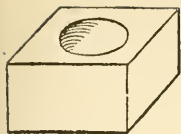

202.

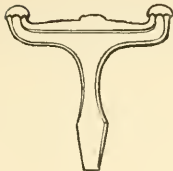

204.

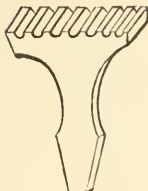

203.

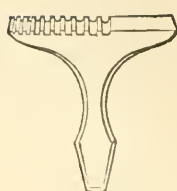

205.

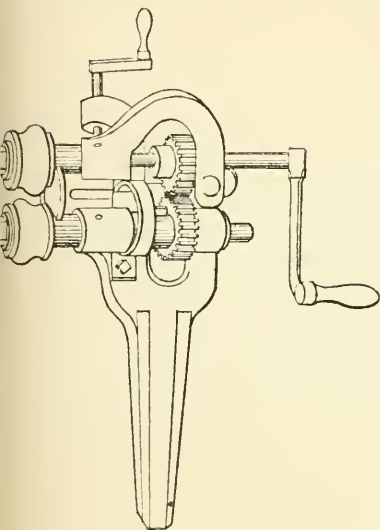

206.

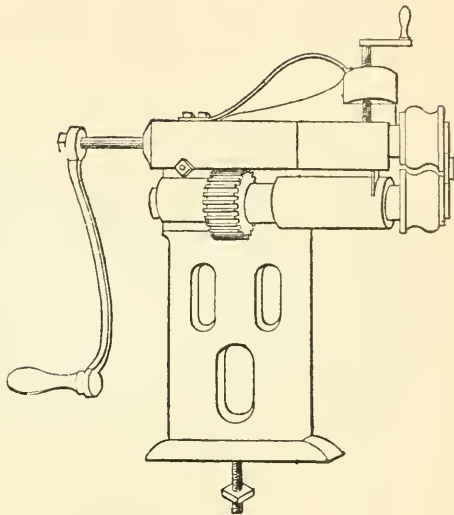

207.

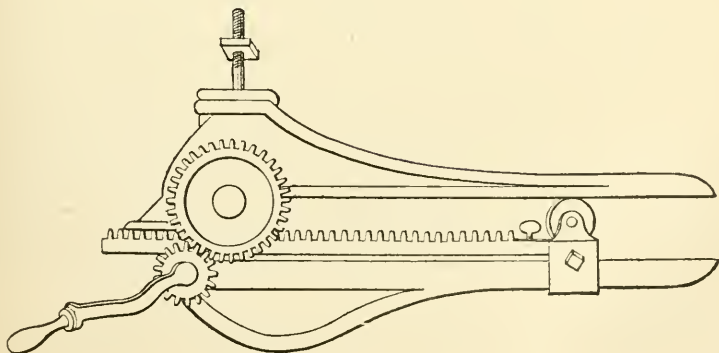

operations are carried on, machines replace these simple contrivances. Fig. 205 is a small and Fig. 206 a large swaging machine; Fig. 207 is a grooving machine. Fig. 208 is a creasing iron; Fig. 209, a block hammer; Fig. 210, a concave hammer; Fig. 211, a rivet set; Fig. 212, a groove punch; Fig. 213, a hollow punch; Fig. 214, a teapot neck tool; Fig. 215, a kettle lid swage.

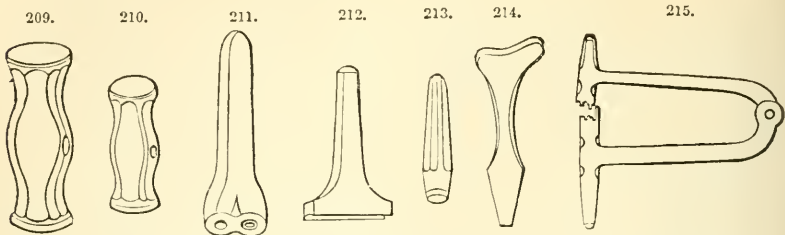

Working the Metals.—There are 3 distinct ways of working sheet metal into objects of use or ornament, characterized by the manner of securing continuity of surface and absence of holes: these may be termed seamless, soldered, and riveted goods.

Seamless Goods.—Some metals, especially copper and block tin, lend themselves so well to hammering processes, and manifest such a tendency to assume various bent forms without either creasing or cracking, under the influence of repeated blows judiciously delivered, that this is the general way of working with them. The piece of sheet metal of the required size is placed on the mould whose form it is to acquire, and very carefully, gradually, and equally hammered till it assumes the desired shape. The metal appears to have the power of redistributing its constituent molecules, so that the portion expanded by the blows draws upon the unhammered parts and maintains a uniform thickness. A hemispherical bowl may be made in this way from a flat sheet by gradually beating it into the recess in Fig. 203 by means of the round end of the mallet. A dish with fluted sides may be formed from another sheet by hammering a margin of the same width as the desired sides in the hollows of Fig. 204, the bottom of the dish being subsequently flattened down by hammering a hard block on it. Obviously the process must be gradual and the blows equally distributed in order to secure symmetry in the finished article. Highly ornamental work may be done with suitable moulds and dies; but in the case of copper, if the impressions are deep, the metal will require frequent annealing by heating it, as the blows or stamps rapidly render it brittle and liable to crack.

There is another kind of seamless work produced by a spinning process. The metal or rather alloy best adapted to it seems to be Britannia metal or pewter. A sheet of this metal is mounted in a lathe, either by drilling a hole through and screwing it, or by pinching it between wooden blocks. When fixed so that it can rotate freely, pressure is applied to the side of the plate by means of an oiled or greased burnishing tool with a smooth blunt surface, the curve in the sheet increasing as the pressure is augmented. In this way a circular cup is gradually produced without the least sign of a crease or inequality in the surface. By using sectional moulds capable of being taken to pieces, most complicated patterns, such as teapots, feet of candlesticks, &c., can be made, by gradually pressing the rotating metal till it tightly embraces the mould, which is then removed. More elastic metals may be used if duly annealed, provided they possess sufficient malleability.

Seamed Goods.—Seamed goods, whether to be soldered or riveted, may be described under one head, as they differ only in the manner of securing the seam.

Pipes.—These are among the simplest articles constructed out of sheet metal. The

strip must be cut according to the directions already given for cylinders, allowing sufficient margin for the joint, whatever kind may be chosen. The strip is then bent throughout its length into a tubular form by encircling it around a stout circular pole of suitable dimensions, and the seam made in one of the methods illustrated in Fig. 216.

It should be stated, however, that in the case of the bent joints, the edges must be turned before bending the sheet into a cylinder; this is effected by hammering the edge over the hatchet stake with a mallet. In Fig. 216, *a* is a simple lapped joint adapted for

216.

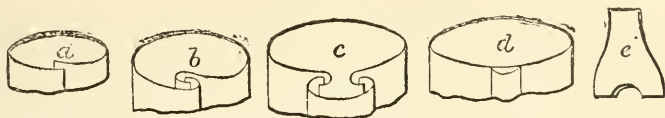

articles demanding no great strength, and secured by soldering down the edge; in *b*, the 2 edges are hooked into each other, as it were, then hammered down and soldered; in *c*, an extra strip is hooked into the 2 edges, hammered down to assume the form shown in *d* by means of the punch *e*, and secured by thin soldering inside. These joints all refer to tinned iron (tin plate); in the case of copper and brass the edges would only abut instead of overlapping. Sheet zinc may be bent to any desired shape, but will not retain the acquired form unless it is heated to a temperature not exceeding that of boiling water, say 200° to 212° F. (93° to 100° C.). Sheet brass may be cut and worked like zinc and tin. The same may be said of lead, which, however, has too little rigidity for many purposes; pewter often replaces it as being less soft and capable of taking a polish.

Cups.—Cups differ from cylinders in the addition of a bottom and the necessity for strengthening the upper edge or rim. The sheet is set out as already described to form the upright or sloping sides, with allowance for a lapped joint, and a disc is cut out for the bottom about $\frac{1}{8}$ in. too large all round. Before converting the sheet into a cylinder or frustrum of a cone, the margins must be prepared. The upper margin is provided with a rim by turning down about $\frac{1}{8}$ in. of the edge, by the aid of a mallet and hatchet stake, in such a manner that the actual edge of the metal shall lie quite close against the outside surface of the article, while the rim retains a fullness and rotundity. If the article is of a size to require this rim to possess considerable strength or rigidity, this feature is gained by enclosing a piece of wire, of suitable gauge, within the rim. Care is needed to make the turnover of the same width exactly all round, otherwise the rim will present an uneven surface. Wiring facilitates the operation of making a rim, but has sometimes to be dispensed with, as, for instance, when a cover is to fit tightly over—in canisters for storing goods, for example. The next step is to prepare the lower margin for receiving the bottom, which may be done either before or after the sheet (with its rim formed and wired) is bent to a cylindrical form. In the former case, the margin is held on the hatchet stake, and about $\frac{1}{8}$ in. is hammered out at right angles all round, so as to form a flange or foot to the cylinder; in the latter case, the perfected cylinder is slipped over a round bar held in a vice, and supported with the lower margin resting on the bar, so that blows with a hammer on the outside will turn the margin slightly outwards, when, the bend being thus commenced, the cylinder is stood on end, and the hammering gradually proceeded with till a right angle is attained. The foot of the cylinder may either be turned over the disc forming the bottom, or it may have the disc turned over it instead, the latter being the easier method. To make a folded seam, with the bottom turned up over the foot, stand the cylinder centrally on the disc, and mark the margin extending beyond it. Then remove the cylinder and proceed to turn up a flange on the disc by holding it on a flat circular surface as near the right size

as possible, and gradually hammering it down. When many articles of the same size are to be made, a hard cylindrical block of the correct dimensions is very useful. After the disc has had its margin turned up saucer-wise, the cylinder is replaced in it, and the margin of the disc is closely hammered down upon the foot of the cylinder; solder run along the seam completes the joint. This folded joint is unsurpassed for strength, but it demands more metal and more time for its production, and hence is generally replaced by the following modification. The completed cylinder, without any foot or flange at the bottom margin, is stood on the disc, which has already been converted into a saucer, and the edge of this saucer is soldered to the upright wall of the cylinder all round.

Square boxes.—The sheets to form boxes and trays of rectangular shape may be cut in different ways, according to where it is admissible to have a soldered seam. Thus the bottom may be made separately from the sides, having a little flange turned on the margin to be attached by a horizontal seam to the sides, which latter may consist of one long strip, bent to suit the corners and with only one vertical seam to join the 2 ends; or the bottom and sides may be all in one piece, with triangular slips cut out at the corners to allow of the turning up, when there will be a vertical seam at each corner, and no horizontal seam.

Riveting.—This simple operation consists in punching holes in the overlapping sheet metal, inserting rivets of corresponding composition, and hammering out the ends to form second heads. A riveted joint can seldom be made watertight; but in some cases it is very useful on the score of its strength, and inside soldering can be added to fill interstices and complete the joint.

CARPENTRY.—The term “carpentry” is here employed in its widest sense, embracing what is more properly known as “joinery.” The former is strictly applied to the use of wood in architectural structures, as for instance the joists, flooring, and rafters of a house, while the latter refers to the conversion of wood into articles of utility which are not remarkable for beauty of design or delicacy of finish. It is eminently convenient to discuss the united arts of carpentry and joinery under a single head, as they are really so closely connected as to present no real difference.

The art of the carpenter may be divided into 3 distinct heads—(1) a consideration of the kinds, qualities, and properties of the woods to be worked upon; (2) a description of the tools employed, and how to use them and keep them in order; and (3) the rudimentary principles of constructing fabrics in wood, with examples showing their application in various ways. The subject will be dealt with in this order.

Woods.—It will be well to begin with an enumeration of the woods used in carpentry—(other woods will be found described under the arts in which they are used, e. g. Carving)—leaving such matters as relate to all woods in general till afterwards. They will be arranged in alphabetical order. The terms used in describing the characters of the various woods may be explained once for all. The “cohesive force” is the weight required to pull asunder a bar of the wood in the direction of its length; the figures denoting the strength, toughness, and stiffness, are in comparison with oak, which is taken as the standard, and placed at 100 in each case; the “crushing force” is the resistance to compression; the “breaking-weight” is the weight required to break a bar 1 in. sq. supported at two points 1 ft. apart, with the weight suspended in the middle.

Acacia or American Locust-tree (*Robinia pseudo-acacia*).—This beautiful tree, of considerable size and very rapid growth, inhabits the mountains of America, from Canada to Carolina, its trunk attaining the mean size of 32 ft. long and 23 in. diam. The seasoned wood is much valued for its durability, surpassing oak. It is admirable for building, posts, stakes, palings, treenails for ships, and other purposes. Its weight is 49–56 lb. a cub. ft.; cohesive force, 10,000–13,000 lb.; and the strength, stiffness, and toughness of young unseasoned wood are respectively 95, 98, and 92. The wood is

greenish-yellow, with reddish-brown veins. Its structure is alternately nearly compact and very porous, distinctly marking the annual rings; it has no large medullary rays.

Ake (*Dodonea viscosa*).—A small tree, 6–12 ft. high. Wood very hard, variegated black and white; used for native clubs; abundant in dry woods and forests in New Zealand.

Alder (*Alnus glutinosa*).—This small tree inhabits wet grounds and river-banks in Europe and Asia, seldom exceeding 40 ft. high and 2½ in. diam. The wood is extremely durable in water and wherever it is constantly wet; but it soon rots on exposure to the weather or to damp, and is much attacked by worms when dry. It is soft, works easily, and carves well; but it is most esteemed for piles, sluices, and pumps, and has been much cultivated in Holland and Flanders for such purposes. Its weight is 34–50 lb. a cub. ft.; cohesive force, 5000–13,900 lb.; strength, 80; stiffness, 63; toughness, 101. The wood is white when first cut, then becomes deep-red on the surface, and eventually fades to reddish-yellow of different shades. The roots and knots are beautifully veined. It is wanting in tenacity, and shrinks considerably. The roots and heart are used for cabinet-work.

Alerce-wood (*Callitris quadrivalvis*).—This is the celebrated citrus-wood of the ancient Romans, the timber of the gum sandarach tree. The wood is esteemed above all others for roofing temples and for tables, and is employed in the cathedral of Cordova. Among the luxurious Romans, the great merit of the tables was to have the veins arranged in waving lines or spirals, the former called “tiger” tables and the latter “panther.” Others were marked like the eyes on a peacock’s tail, and others again appeared as if covered with dense masses of grain. Some of these tables were 4–4½ ft. diam. The specimens of the tree now existing in S. Morocco resemble small cypresses, and are apparently shoots from the stumps of trees that have been cut or burnt, though possibly their stunted habit may be due to sterility of soil. The largest seen by Hooker and Ball in 1878 were in the Ourika valley, and were about 30 ft. high. The stems of the trees swell out at the very base into roundish masses, half buried in soil, rarely attaining a diameter of 4 ft. It is this basal swelling, whether of natural or artificial origin, which affords the valuable wood, exported in these days from Algiers to Paris, where it is used in the richest and most expensive cabinet-work. The unique beauty of the wood will always command for it a ready market, if it be allowed to attain sufficient size.

Alerce (*Libocedrus tetragona*).—This is a Chilian tree, affording a timber which is largely used on the S. Pacific coast of America, and an important article of commerce. It gives spars 80–90 ft. long, and 800–1500 boards. Its grain is so straight and even that shingles split from it appear to have been planed.

Apple [Australian] (*Angophora subvelutina*).—The so-called apple-tree of Queensland yields planks 20–30 in. in diameter, the wood being very strong and durable, and much used by wheelwrights and for ships’ timbers.

Ash (*Fraxinus excelsior*).—The common ash is indigenous to Europe and N. Asia, and found throughout Great Britain. The young wood is more valuable than the old; it is durable in the dry, but soon rots by exposure to damp or alternate wetting, and is very subject to worm when felled in full sap. It is difficult to work and too flexible for building, but valuable in machinery, wheel-carriages, blocks, and handles of tools. The weight is 34–52 lb. a cub. ft.; cohesive force, 6300–17,000 lb.; strength, 119; stiffness, 89; toughness, 160. The colour of the wood is brownish-white, with longitudinal yellow streaks; the annual layers are separated by a ring full of pores. The most striking characteristic possessed by ash is that it has apparently no sapwood at all—that is to say, no difference between the rings can be detected until the tree is very old, when the heart becomes black. The wood is remarkably tough, elastic, flexible, and easily worked. It is economical to convert, in consequence of the absence of sap. Very great advantage is found in reducing ash logs soon after they are felled into plank

or board for seasoning, since, if left for only a short time in the round state, deep shakes open from the surface, which involve a very heavy loss when brought on later for conversion. Canadian and American ash, of a reddish-white colour, is imported to this country chiefly for making oars. These varieties have the same characteristics as English ash, but are darker in colour. The Canadian variety is the better of the two.

Assegai-wood or Cape Lancewood (*Curtisia faginea*).—This tree, the *oomhlebe* of the African natives, gives a very tough wood, used for wheel-spokes, shafts, waggon-rails, spears, and turnery, weighing 56 lb. a cub. ft.

Beech (*Fagus sylvatica*).—The common beech inhabits most temperate parts of Europe, from Norway to the Mediterranean, and is plentiful in S. Russia. It is most abundant in the S. and Midland counties of England, growing on chalky soils to 100 ft. high and 4-6 ft. diam. Wood grown in damp valleys becomes brittle on drying; it is very liable to destruction by worms, decays in damp situations, less in a dry state, but least of all when constantly under water. It is thus most useful for piles, and for knees and planking of ships. Its uniform texture and hardness make it very valuable for tools and common furniture. It is also used for carriage-panels and wooden tramways. Its weight is 43-53 lb. a cub. ft.; cohesive force, 6070-17,000 lb.; strength, 103; stiffness, 77; toughness, 138.

Beech [American].—Two species of *Fagus* are common in N. America,—the white (*F. sylvestris*), and the red (*F. ferruginea*). The perfect wood of the former is frequently only 3 in. in a trunk 18 in. diam., and it is of little use except for fuel. The wood of the latter, which is almost exclusively confined to the N.-E. States, Canada, New Brunswick, and Nova Scotia, is stronger, tougher, and more compact, but so liable to insect attacks as to be little used in furniture; yet it is very durable when constantly immersed in water.

Beech [Australian] (*Gmelina Leichhardtii*) attains a height of 80 to 120 ft. and yields planks 24 to 42 in. wide; its wood is valuable for decks of vessels, &c., as it is said neither to expand nor contract, and is exceedingly durable. It is worth 100s. to 120s. per 1000 ft. super.

Birch (*Betula spp.*).—The common birch (*B. alba*) is less important as a source of wood than as affording an empyreumatic oil. Its wood is neither strong nor durable, but is easily worked, moderately hard, and of straight and even grain, rendering it useful for chair-making, cabinet-making, and light turnery. The American red birch (*B. rubra*) has similar uses. The black or cherry birch (*B. lenta [nigra]*) of N. America is superior to all others, and imported in logs 6-20 ft. long and 12-30 in. diam. for furniture and turnery. Quebec birch is worth 3l. 5s.-4l. 15s. a load. There is a so-called "yellow birch" in Newfoundland, known also as "witch-hazel."

Birch [White or Black-heart] (*Fagus solandri*).—A lofty, beautiful evergreen tree 100 ft. high, trunk 4-5 ft. diameter. The heart timber is darker than that of *Fagus fusca* and is very durable. This wood is well adapted for fencing and bridge piles. The tree occurs only in the southern part of the North Island of New Zealand, but is abundant in the South Island up to 5000 ft.

Blackwood (*Acacia melanoxylon*) is one of the most valuable Australian woods. It is extensively used in the construction of railway carriages, and is well adapted for light and heavy framing purposes, gun-stocks, coopers' staves, and turners' work, and in this respect contrasts favourably with most of the English woods; and, from the facility with which it is bent into the most difficult curves, it is highly prized for buggy and gig shafts, &c. Within the last few years it has been introduced extensively into the manufacture of the finer description of furniture, such as drawing-room suites, and is found far superior to walnut, owing to its strength and toughness. Blackwood resembles in figure different woods, such as walnut, mahogany, rosewood, zebrawood, &c. Formerly mahogany was extensively imported for the purpose of manufacturing billiard tables; but at the present time blackwood has taken the place of mahogany in the

above-named manufacture. It is pronounced to be far superior to the best Spanish mahogany for this purpose; owing to its density and resisting qualities, it is acted on very slightly by the changes of weather, and is capable of taking a fine polish. It is named from the dark-brown colour of the mature wood, which becomes black when washed with lime-water. In moist shaded localities, the tree grows more rapidly, and the wood is of a much lighter colour; hence this variety is called "Lightwood" in Hobart Town, to distinguish it from the other. Diameter, $1\frac{1}{2}$ to 4 ft.; average, about $2\frac{1}{4}$ ft.; height, 60 to 130 ft.; sp. grav., about 0.855. Found throughout Tasmania, but not abundantly in any one locality. Price, about 12s. to 14s. per 100 ft. super., in the log.

Box (*Buxus sempervirens*).—The common evergreen box is a native of Europe as far as 52° N. lat., and is abundant in S. and E. France, Spain, Italy, the Black Sea coast, Persia, N. India, China, and Japan. For some years past the supply of this important wood has diminished in quantity and risen in price. It is mainly derived from the forests of the Caucasus, Armenia, and the Caspian shores. The wood of the best quality comes from the Black Sea forests, and is principally shipped from the port of Poti. The produce of the Caspian forests known in the trade as "Persian," used also to be exported through the Black Sea from Taganrog. This found its way, after the commencement of the Russo-Turkish war, via the Volga canal, to St. Petersburg. The produce of the Caspian forests is softer and inferior in quality to that of the Black Sea. It is a large article of trade with Russia, reaching Astrakhan and Nijni-Novgorod in the spring, and being sold during the fair. It recently amounted to 130,000 *poods* (of 36 lb.). True Caucasian boxwood may be said to be commercially non-existent, almost every marketable tree having been exported. The value of the yet unworked Abkhasian forests has been much exaggerated, many of the trees being either knotted or hollow from old age, and most of the good wood having been felled by the Abkhasians previous to Russian occupation. The boxwood at present exported from Rostov, and supposed to be Caucasian, comes from the Persian provinces of Mazanderan and Ghilan, on the Caspian. Boxwood is characterized by excessive hardness, great weight, evenness and closeness of grain, light colour, and capacity for taking a fine polish. Hence it is very valuable for wood-engraving, turning, and instrument-making. The Minorca box (*B. balearica*), found in several of the Mediterranean islands, and in Asia Minor, yields a similar but coarser wood, which probably finds its way into commerce. The approximate value of Turkey box is 6–20l. a ton.

Box [Australian] (*Tristania conferta*) grows in Queensland to 10 ft. in height, and 35–50 in. in diameter; the wood is invaluable for ship-building, ribs of vessels made from it having been known to last unimpaired upwards of 30 years.

Box [Spurious] (*Eucalyptus leucozyllon*) is a valuable Victorian timber, of a light-grey colour and greasy nature, remarkable for the hardness and closeness of its grain, great strength, tenacity, and durability both in the water and when placed on the ground. It is largely used by coachmakers and wheelwrights for the naves of wheels and for heavy framing, and by millwrights for the cogs of their wheels. In ship-building it has numerous and important applications, and forms one of the best materials for treenails, and for working into large screws in this and other mechanical arts.

The Grey Box [*E. dealbata*] is another species, used for similar purposes to the preceding.

Broadleaf (*Griselinia littoralis*).—An erect and thickly branched bush tree, 50–60 ft. high; trunk 3–10 ft. diam. Wood splits freely, and is valuable for fencing and in ship-building; some portions make handsome veneers. Grows chiefly in the South Island of New Zealand and near the coasts.

Broadleaf or Almond (*Terminalia latifolia*).—This is a Jamaica tree, growing 60 ft high to the main branches, and $3\frac{1}{2}$ –5 ft. diam. It is used for timbers, boards, shingles, and staves. Its weight is 48 lb. a cub. ft.; crushing-force, 7500 lb.; breaking-weight, 750 lb.

Bullet-tree (*Mimusops Balata*).—This tree is found in the W. Indies and Central America. Its wood is very hard and durable, and fitted for most outside work; it is used principally for posts, sills, and rafters. It warps much in seasoning, splits easily, becomes slippery if used as flooring, and is very liable to attacks of sea-worms. Its weight is $65\frac{1}{2}$ lb. a cub. ft.; crushing-force, 14,330 lb.

Bunya-bunya (*Araucaria Bidwillii*) grows to the height of 100–200 ft., and attains a diameter of 30–48 in. This noble tree inhabits the scrubs in the district between the Brisbane and the Burnett rivers, Queensland, and in the 27th parallel it extends over a tract of country about 30 miles in length and 12 in breadth. The timber is strong and good, and full of beautiful veins, works with facility, and takes a high polish.

Cedar [Australian Red] (*Cedrela australis*).—This tree is a native of Australia, where it has been almost exterminated, the timber being found so useful in house-building (for joinery, doors, and sashes) and boat-building. Its weight is 35 lb. a cub. ft.; breaking-weight, 471 lb.

Cedar [Bermuda] (*Juniperus bermudiana*).—This species is a native of the Bermudas and Bahamas. Its wood much resembles that of Virginian Cedar, and is used for similar purposes, as well as for ship-building. It is extremely durable when ventilated and freed from sapwood. It lasts 150–200 years in houses, and 40 years as outside ship-planking. It is difficult to get above 8 in. sq. Its weight is 46–47 lb. a cub. ft.

Cedar [Lebanon] (*Abies Cedrus* [*Cedrus Libani*]).—This evergreen tree is a native of Syria, and probably Candia and Algeria. The trunk reaches 50 ft. high and 34–39 in. diam. The wood is said to be very durable, and to have been formerly extensively used in the construction of temples. It is straight-grained, easily worked, readily splits, and is not liable to worm. Its weight is 30–38 lb. a cub. ft.; cohesive force, 7400 lb. a sq. in.; strength, 62; stiffness, 28; toughness, 106.

Cedar [New Zealand] (*Libocedrus Doniana* and *L. Bidwillii*).—Of the species, the former, the *kawaka* of the natives, is a fine timber tree 60–100 ft. high, yielding heavy fine-grained wood, useful in fencing, house-blocks, piles, and sleepers. It weighs 30 lb. a cub. ft.; breaking-weight, 400 lb. The wood runs 3 to 5 ft. in diameter, and is reddish in colour; it is used by the Maoris for carving, and is said to be excellent for planks and spars. The second species, called *pahantea* by the natives, reaches 60 to 80 ft. high and 2 to 3 ft. in diameter. In Otago it produces a dark-red free-working timber, rather brittle, chiefly adapted for inside work. The timber has been used for sleepers on the Otago railways of late years, and is largely employed for fencing purposes, being frequently mistaken for Totara.

Cedar [Virginian Red] (*Juniperus virginiana*).—This small tree (45 to 50 ft. high and 8 to 18 in. in diameter) inhabits dry rocky hillsides in Canada, the United States, and W. Indies, and flourishes in Britain. The wood is much used in America for wardrobes, drawers, boxes, and furniture, being avoided by all insects on account of its strong odour and flavour. It is light, brittle, and nearly uniform in texture. It is very extensively employed for covering graphite pencils, being imported in logs 6–10 in. sq. It weighs $40\frac{1}{2}$ lb. a cub. ft. The heartwood is reddish-brown, the sapwood is white, straight-grained, and porous. It possesses about $\frac{2}{3}$ the strength of red pine, is easily worked, shrinks little, and is very durable when well ventilated. A resinous exudation makes freshly-cut timber hard to work.

Cedar [W. Indian or Havanna] (*Cedrela odorata*).—This tree is a native chiefly of Honduras, Jamaica, and Cuba, having a stem 70 to 80 ft. high and 3 to 5 ft. diam., and exported in logs up to 3–4 ft. sq. Its wood is soft, porous, and brittle, and used chiefly for cigar-boxes and the inside of furniture. It makes durable planks and shingles. Its weight is 36 lb. a cub. ft.; crushing-weight, 6600 lb.; breaking-weight, 400 lb. The approximate London market values are $4-5\frac{1}{2}d.$ a ft. for Cuba cedar, and $4-6\frac{1}{4}d.$ for Honduras, &c.

Ceda Boom (*Widdringtonia juniperoides*).—This tree is found in N. and W. Cape

Colony, and its wood is used for floors, roofs, and other building purposes, but will not stand the weather.

Cherry [Australian] (*Exocarpus cupressiformis*) is a soft, fine-grained timber, and forms the best Australian wood for carving. It reaches a height of 20-30 ft., and a diameter of 9-15 in.; its sp. gr. is about 0.785. It is used for tool-handles, spokes, gun-stocks, &c.

Chestnut (*Castanea vesca*).—This, the sweet or Spanish chestnut, is said to be a native of Greece and W. Asia, but grows wild also in Italy, France, Spain, N. Africa, and N. America. It lives to 1000 years, but reaches its prime at about 50, when the stem may be 40-60 ft. long and 3-6 ft. diam. The wood is hard and compact: when young, it is tough and flexible, and as durable as oak; when old, it is brittle and shaky. It does not shrink or swell so much as other woods, and is easier to work than oak; but soon rots when built into walls. It is valued for hop-poles, palings, gate-posts, stakes, and similar purposes. Its weight is 43-54 lb. a cub. ft.; cohesive force, \$100 lb.; strength, 68; stiffness, 54; toughness, 85. The wood much resembles oak in appearance, but can be distinguished by having no distinct large medullary rays. The annual rings are very distinct; the wood has a dark-brown colour; the timber is slow of growth, and there is no sapwood.

Cypress (*Cupressus sempervirens*).—This tree is abundant in Persia and the Levant, and cultivated in all countries bordering the Mediterranean, thriving best in warm sandy or gravelly soil, and reaching 70-90 ft. high. Its wood is said to be the most durable of all. For furniture, it is stronger than mahogany, and equally repulsive to insects. In Malta and Candia, it is much used for building. It weighs about 40-41 lb. a cub. ft.

Cypress pine (*Callitris columellaris*) is a plentiful tree in Queensland, attaining a diameter of 40 in. It is in great demand for piles and boat-sheathing, as it resists the attacks of cobra and white ants. The wood is worth 120s. per 1000 ft. super. The roots give good veneers.

Dark yellow wood (*Rhus rhodanthema*) grows in Queensland to a moderate size, affording planks up to 24 in. wide; the wood is soft, fine-grained, and beautifully marked, and is highly esteemed for cabinet work, being worth 100 to 120s. per 1000 ft. super.

Deal [White], White Fir, or Norway Spruce (*Abies excelsa*).—This tree inhabits the mountainous districts of Europe, and extends into N. Asia, being especially prevalent in Norway. It rises to 80-100 ft. high, and about 2-3 ft. max. diam. The tree requires 70-80 years to reach perfection, but is equally durable at all ages. It is much imported in spars and deals, the latter about 12 ft. long, 3 in. thick, and 9 in. wide. The wood glues well, and is very durable while dry, but much more knotty than Northern Pine. It is fine-grained and does well for gilding on, also for internal joinery, lining furniture, and packing-cases. A principal use is for scaffolds, ladders, and masts, for which purpose it is largely imported from Norway in entire trunks, 30-60 ft. long, and 6-8 in. max. diam. It is shipped from Christiania, Friedrichstadt, Drontheim, Gottenburg, Riga, Narva, St. Petersburg, &c. Christiania deals and battens are reckoned best for panelling and upper floors; Friedrichstadt have small black knots; lowland Norway split and warp in drying; Gottenburg are stringy and mostly used for packing-cases; Narva are next in quality to Norway, then Riga; St. Petersburg shrink and swell even after painting. The wood is generally light, elastic, tough, easily worked, and extremely durable when properly seasoned. It weighs 28-34 lb. a cub. ft.; cohesive force, 8000-12,000 lb. a sq. in.; strength, 104; stiffness, 104; toughness, 104. The wood is yellowish-white or brownish-red, becoming bluish by exposure. The annual rings are clearly defined, the surface has a silky lustre, and the timber contains many hard glossy knots. It is soft, warps much unless restrained while seasoning, and lacks durability; it is weaker than red and yellow pine, less easily worked, and apt to snap under a sudden load. It is a nice wood for dresser-tops, shelves, and common tables, but should not be

less than 1 in. thick, on account of warping. The knots are liable to turn the plane-iron.

Deodar (*Cedrus Deodara*).—This tree is found in the Himalayas at 5000–12,000 ft., and on the higher mountains from Nepal to Kashmir, measuring 150–200 ft. high, and over 30 ft. circ. Its wood is extremely valuable for all carpentry, and most generally used in the Punjab for building. Its weight is 37 lb. a cub. ft.; breaking-weight, 520 lb.

Dogwood.—The American dogwood (*Cornus florida*) is a tree 30 ft. high, common in the woods of many parts of N. America. Its wood is hard, heavy, and close-grained, and largely used locally for tool-handles; it has been imported into England with some success as a substitute for box in making shuttles for textile machinery. The black dogwood or alder buckthorn (*Rhamnus Frangula*) is abundant in Asia Minor, and affords one of the best wood charcoals for gunpowder-making. The principal uses made of Bahama dogwood (*Piscidia Erythrina*) are for fellies for wheels and for ship timber. From its toughness and other properties, it is better adapted to the former purpose than any other of the Bahamian woods. The tree does not attain any considerable size, and is generally crooked; a rather soft, open-grained, but very tough wood.

Doorn or Kameel Boom (*Acacia horrida*).—This tree is a native of S. Africa, and affords small timber used for fencing, spars, fuel, and charcoal.

Ebony (*Diospyros spp.*).—The best and most costly kind of ebony, having the blackest and finest grain, is the wood of *D. reticulata*, of Mauritius. The E. Indian species, *D. Melanoxylon* and *D. Ebenaster*, also contribute commercial supplies, and another kind is obtained from *D. Ebenum*, of Ceylon. The heartwood of the trunk of these trees is very hard and dense, and is largely used for fancy cabinet-making, mosaic work, turnery, and small articles. The approximate London market values are 5–20l. a ton for Ceylon, and 3–12l. for Zanzibar, &c.

Elm (*Ulmus spp.*).—Five species of elm are now grown in Britain:—The common rough-leaved (*U. campestris*) is frequent in scattered woods and hedges in S. England, and in France and Spain, attaining 70–80 ft. high, and 4 ft. diam. Its wood is harder and more durable than the other kinds, and is preferred for coffins, resisting moisture well. The corked-barked (*U. suberosa*) is common in Sussex, but the wood is inferior. The broad-leaved wych-elm or wych-hazel (*U. montana*) is most cultivated in Scotland and Ireland, reaching 70–80 ft. high and 3–4½ ft. diam. The smooth-leaved wych-elm (*U. glabra*) is abundant in Essex, Hertford, the N. and N.-E. counties of England, and in Scotland, growing to a large size. The wood is tough and flexible, and preferred for wheel-naves. The Dutch elm (*U. major*), the smallest of the five, is indigenous to Holland; its wood is very inferior. Elm-trunks average 44 ft. long and 32 in. diam. The wood is very durable when perfectly dry or constantly wet. It is not useful for general building, but makes excellent piles, and is used in wet foundations, waterworks, and pumps; also for wheel-naves, blocks, keels, and gunwales. It twists and warps in drying, shrinks considerably, and is difficult to work; but is not liable to split, and bears the driving of bolts and nails very well. Its weight is 34–50 lb. a cub. ft.; cohesive force, 6070–13,200 lb.; strength, 82; stiffness, 78; toughness, 86. The colour of the heartwood is a reddish-brown. The sapwood is yellowish- or brownish-white, with pores inclined to red. The medullary rays are not visible. The wood is porous and very twisted in grain; is very strong across the grain; bears driving nails very well; is very fibrous, dense, and tough, and offers a great resistance to crushing. It has a peculiar odour, and is very durable if kept constantly under water or constantly dry, but will not bear alternations of wet and dry. Is subject to attacks of worms. None but fresh-cut logs should be used, for after exposure, they become covered with yellow doaty spots, and decay will be found to have set in. The wood warps very much on account of the irregularity of its fibre. For this reason it should be used in large scantling, or smaller pieces should be cut just before they are required; for the same reason it is difficult to

work. The sapwood withstands decay as well as the heart. Elm timber should be stored under water to prevent decay. Three species of elm are indigenous to N. America, and have similar uses to the European kinds:—The common American (*U. americana*) grows in low woods from New England to Canada, reaching 80–100 ft. high; its wood is inferior to English. The Canada rock or mountain (*U. racemosa*) is common to Canada and the N. States; the wood is used in boat-building, but is very liable to shrink, and gets shaky by exposure to sun and wind; its weight is 47–55 lb. a cub. ft. The slippery (*U. fulva*) gives an inferior wood, though much used for various purposes. Quebec elm is valued at 4–5l. a load.

Eucalyptus.—Besides the chief species which are described separately under their common names, almost all have considerable value as timber trees for building, fencing, and general purposes throughout Australia.

Fir [Silver] (*Picea pectinata*).—This large tree (100 ft. high, and 3–5 ft. diam.) is indigenous to Europe, Asia, and N. America, growing in British plantations. It is said to attain its greatest perfection in this country at 80 years. The wood is of good quality, and much used on the Continent for carpentry and ship-building. Floors of it remain permanently level. It is liable to attacks of the worm, and lasts longer in air than in water. It weighs about 25½ lb. a cub. ft.

Greenheart or Bibiri (*Nectandra Rodiwi* [*leucantha*]).—This celebrated ship-building wood is a native of British Guiana, and has been largely exported from Demerara to English dockyards. It gives balks 50–60 ft. long without a knot, and 18–24 in. sq., of hard, fine-grained, strong, and durable wood. It is reputed proof against sea-worms, and placed in the first class at Lloyd's; it is very difficult to work, on account of its splitting with great force. Its weight is 58–65 lb. a cub. ft.; crushing-weight, 12,000 lb.; breaking-weight, 1424 lb. The section is of fine grain, and very full of fine pores. The annual rings are rarely distinct. The heartwood is dark-green or chestnut-coloured, the centre portion being deep brownish-purple or almost black; the sapwood is green, and often not recognizable from the heart. An essential oil causes it to burn freely. It comes into the market roughly hewn, much bark being left on the angles, and the ends of the butts are not cut off square.

Gum [Blue] (*Eucalyptus Globulus*).—This Australian and Tasmanian tree is of rapid growth, and often reaches 150–300 ft. high and 10–20 ft. diam. Its wood is hard, compact, difficult to work, and liable to split, warp, and shrink in seasoning. It is used for general carpentry and wheel-spokes. Its weight is 60 lb. a cub. ft.; crushing-force, 6700 lb.; breaking-weight, 550–900 lb. It is employed in the erection of buildings, for beams, joists, &c., and for railway sleepers, piers, and bridges. It is also well adapted for ship-building purposes; from the great length in which it can always be procured, it is especially suitable for outside planking, and has been used for masts of vessels, but, owing to its great weight, for the latter purpose has given place to Kaurie; it is also bent and used for street cab shafts, &c.

Gum [Red] (*Eucalyptus rostrata*), of Australia, is a very hard compact wood, possessing a very handsome curly figure; it is of light-red colour, and suitable for veneering purposes for furniture; it is largely used for posts, resembling jarrah in durability. Properly selected and seasoned, it is well adapted for ship-building, culverts, bridges, wharves, railway sleepers, engine buffers, &c.

Gum [White or Swamp] (*Eucalyptus viminalis*).—This tree is found chiefly in Tasmania, and a variety called the Tuart occurs in W. Australia. The wood is valued for its great strength, and is sometimes used in ship-building, but more in house-building, and for purposes where weight is not an objection. It is sound and durable, shrinks little, but has a twisted grain, which makes it difficult to work. Its weight is about 70 lb. a cub. ft.; crushing-force, 10,000 lb.; breaking-weight, 730 lb.

Hickory or White Walnut (*Carya* [*Juglans*] *alba*).—There are about a dozen species of hickory, natives of N. America, forming large forest trees. Their timber is coarse-

grained, and very strong, tough, and heavy; but is unsuited for building, as it does not bear exposure to the weather, and is much attacked by insects. It is extensively used where toughness and elasticity are required, such as for barrel-hoops, presses, handles, shafts and poles of wheel carriages, fishing-rods, and even light furniture. The most important is the shell-bark, scaly-bark, or shag-bark (*C. alba*), common throughout the Alleghanies from Carolina to New Hampshire, growing 80-90 ft. high and 2-3 ft. diam.

Hickory [Australian] (*Acacia supporosa*) is a valuable wood for many purposes. It is exceedingly tough and elastic, and would make good gig shafts, handles for tools, gun-stocks, &c. Tall straight spars, fit for masts, can be obtained 50 to 100 ft. long and 18 in. in diam.

Hinau (*Elaeocarpus dentatus*).—A small tree, about 50 ft. high, and 18 in. thick in stem. Wood, a yellowish-brown colour and close grained, very durable for fencing and piles. Common throughout New Zealand. Makes a very handsome furniture wood.

Hinoki (*Retinospora obtusa*) enjoys the highest repute in Japan for building purposes. The tree grows with amazing rapidity and vigour, and its wood is used almost exclusively for the structure and furniture of the temples, generally unvarnished. It gives a beautifully white even grain under the plane, and withstands damp so well that thin strips are used for roofing and last a hundred years. The wood is soft enough to take the impression of the finger nail.

Hornbeam (*Carpinus Betulus*).—Notwithstanding that the wood is remarkable for its close grain, even texture, and consequent strength, it is seldom used for structural purposes. To a certain extent this is attributable to the tree not usually growing to a very large size, and also to the fact that when it does it is liable to become shaky. Hornbeam has of late been much more largely used in this country than formerly, it having been found to be peculiarly adapted for making lasts used by bootmakers. This wood being sent to this country in considerable quantities from France, led to the discovery that it was being used almost exclusively for the above purpose, and that it was imported in sacks, each containing a number of small blocks, in shape of the rough outline of a last. The advantage over other woods, and even over beech, which has hitherto been considered the best wood for last-making, is that, after the withdrawal of nails, the holes so made close up, which is not the case with most other woods. The wood is white and close, with the medullary rays well marked, and no sapwood. Under vertical pressure, the fibres double up instead of breaking. It stands exposure well.

Horoeka, or Ivy Tree (*Panax crassifolium*).—An ornamental, slender, and sparingly branched tree. The wood is close-grained and tough. Common in forests throughout New Zealand.

Horopito, Pepper Tree, or Winter's Bark (*Drimys azillaris*).—A small, slender, ever-green tree, very handsome. Wood very ornamental in cabinet-work, making handsome veneers. Grows abundantly in forests throughout New Zealand.

Ironbark (*Eucalyptus resinifera*).—This rugged tree is found in most parts of the Australian continent, frequently reaching 100-150 ft. high and 3-6 ft. diam., the usual market logs being 20-40 ft. long and 12-18 in. sq. Its wood is straight-grained, very dense, heavy, strong, and durable, but very difficult to work. It is liable to be shaky, and can only be employed with advantage in stout planks or large scantlings. Its weight is 64½ lb. a cub. ft.; crushing-force, 9921 lb.; breaking-weight, 1000 lb. It forms one of the hardest and heaviest of the Australian woods, and is highly prized by the coachmaker and wheelwright for the poles and shafts of carriages and the spokes of wheels. Its greasy nature also renders it serviceable for the cogs of heavy wheels, and it is valued for many purposes in ship-building.

Ironwood [Cape] (*Olea undulata*).—This S. African wood, the *tambooti* or *hooshe* of the natives, is very heavy, fine-grained, and durable, and is used for wagon-axles, wheel-cogs, spokes, telegraph-poles, railway-sleepers, and piles. This is the "black" ironwood. The "white" (*Vepris lanceolata*) is used for similar purposes.

Jack, or Ceylon Mahogany (*Artocarpus integrifolia*).—This useful tree is a native of the E. Archipelago, and is widely cultivated in Ceylon, S. India, and all the warm parts of Asia, mainly as a shade-tree for coffee and other crops. Its wood is in very general use locally for making furniture; it is durable, and can be got in logs 21 ft. long and 17 in. diam. Its weight is 42 lb. a cub. ft.; breaking-weight, 600 lb.

Jack [Jungle], or Anjilli (*Artocarpus hirsuta*).—This species is remarkable for size of stem, and is found in Bengal, Malabar, and Burma. Its wood is strong and close-grained, and considered next in value to teak for ship-building. Its weight is 38–49 lb. a cub. ft.; cohesive force, 13,000–15,000 lb.; breaking-weight, 740 lb.

Jaral (*Lagerstræmia reginæ*) is a valuable timber tree of Assam, giving a light salmon-coloured wood, with coarse uneven grain, very hard and durable, and not liable to rot under water. It is used chiefly in boat-building and for house-posts. Full-sized trees run 35 ft. high and 7–8 ft. in girth, fetching 6*l.*–8*l.* each.

Jarrah, Australian Mahogany, or Flooded or Red Gum (*Eucalyptus marginata*).—This tree attains greatest perfection in W. Australia, reaching 200 ft. high. Its wood is hard, heavy, close-grained, and very durable in salt and fresh water, if cut before the rising of the sap. It is best grown on the hills. It resists sea-worms and white ants, rendering it specially valuable for ships, jetties, railway-sleepers and telegraph-posts, but shrinks and warps considerably, so that it is unfit for floors or joinery. Logs may be got 20–40 ft. long and 11–24 in. sq. Its weight is 62½ lb. a cub. ft.; crushing-force, 7000 lb.; breaking-weight, 500 lb. The chief objection raised against it is that it is liable to “shakes,” the trees being frequently unsound at heart. For piles it should be used whole and unhewn; there is very little sapwood, and the outer portion of the heartwood is by far the harder, hence the desirability of keeping the annular rings intact.

Kaiwhiria (*Hedycarya dentata*).—A small evergreen tree 20–30 ft. high; the wood is finely marked and suitable for veneering. Grows in the North and South Island of New Zealand, as far south as Akaroa.

Kamahi (*Weinmannia racemosa*).—A large tree; trunk 2–4 ft. diam., and 50 ft. high. Wood close-grained and heavy, but rather brittle; might be used for plane-making and other joiners' tools, block-cutting for paper and calico printing, besides various kinds of turnery and wood-engraving. Grows in the middle and southern parts of the Northern Island and throughout the Southern Island of New Zealand. It is chiefly employed for making the staves of barrels.

Kanyin (*Dipterocarpus alatus*).—This magnificent tree is found chiefly in Pegu and the Straits, reaching 250 ft. high. Its wood is hard and close-grained, excellent for all house-building purposes, but not durable in wet. Its weight is 45 lb. a cub. ft.; breaking-weight, 750 lb. Another species (*D. turbinatus*), found in Assam, Burma, and the Andamans, is similar, and much used by the natives in house-building.

Kauri, Cowrie, or Pitch-tree (*Dammara australis*).—This gigantic conifer is a native of New Zealand, growing 80–140 ft. high, with a straight clean stem 4–8 ft. diam. The wood is close, even, fine-grained, and free from knots. It is chiefly used and well adapted for masts and spars; also for joinery, as it stands and glues well, and shrinks less than pine or fir. But it buckles and expands very much when cut into narrow strips for inside mouldings. Its weight is 35–40 lb. a cub. ft.; cohesive force, 9600–10,900 lb. a sq. in. The timber is in high repute for deck and other planking of ships. It possesses great durability, logs which had been buried for many years being found in sound condition, and used as railway sleepers. In the Thames goldfield it supplies the mine props, struts, and cap pieces. It is the chief timber exported from New Zealand. Some of the largest and soundest sticks have richly mottled shading, which appears to be an abnormal growth, due to the bark being entangled in the ligneous portion, causing shaded parts, broad and narrow, according as the timber is cut relative to their planes; such examples form a valuable furniture wood. The heartwood is yellowish-white fine and straight in grain, with a silky lustre on the surface.

Kohe-kohe (*Dysoxylum spectabile*).—A large forest tree, 40-50 ft. high. Wood tough, but splits freely, and is considered durable as piles under sea-water. Grows in the North Island of New Zealand.

Kohutuhutu (*Fuchsia excorticata*).—A small and ornamental tree, 10-30 ft. high; trunk sometimes 3 ft. in diameter. It appears to furnish a durable timber. House blocks of this, which have been in use in Dunedin for more than 20 years, are still sound and good. Grows throughout New Zealand.

Kohwai (*Sophora tetraptera*).—A small or middling-sized tree. Wood red; valuable for fencing, being highly durable; it is also adapted for cabinet-work. It is used for piles in bridges, wharves, &c. Abundant throughout New Zealand.

Larch [American Black], Tamarak, or Hackmatack (*Larix pendula*).—This tree ranges from Newfoundland to Virginia, reaching 80-100 ft. high, and 2-3 ft. diam. The wood is said to be nearly equal that of the European species.

Larch [Common or European] (*Larix europæa*).—This species is a native of the Swiss and Italian Alps, Germany, and Siberia, but not of the Pyrenees nor of Spain. The Italian is most esteemed, and has been considerably planted in England. The tree grows straight and rapidly to 100 ft. high. The wood is extremely durable in all situations, such as posts, sleepers, &c., and is preferable to pine, pinaster, or fir for wooden bridges. But it is less buoyant and elastic than Northern Pine, and boards of it are more apt to warp. It burns with difficulty, and makes excellent ship-timber, masts, boats, posts, rails, and furniture. It is peculiarly adapted for staireases, doors, and shutters. It is more difficult to work than Northern Pine, but makes a good surface, and takes oil or varnish better than oak. The liability to warp is said to be obviated by barking the trees while growing in spring, and cutting in the following autumn, or next year; this is also said to prevent dry-rot. The wood weighs 34-36 lb. a cub. ft.; cohesive force, 6000-13,000 lb.; strength, 103; stiffness, 79; toughness, 134. The wood is honey-yellow or brownish-white in colour, the hard part of each ring being of a redder tinge, silky lustre. There are two kinds in this country, one yellowish-white, cross-grained, and knotty; the other (grown generally on a poor soil or in elevated positions) reddish-brown, harder, and of a straighter grain. It is the toughest and most lasting of all the coniferous tribe, very strong and durable, shrinks very much, straight and even in grain, free from large knots, very liable to warp, stands well if thoroughly dry, is harder to work than Baltic fir, but the surface is smoother, when worked. Bears nails driven into it better than any of the pines. Used chiefly for posts and palings exposed to weather, railway sleepers, flooring, stairs, and other positions where it will have to withstand wear.

Lignum-vitæ (*Guaiacum officinale*).—This tree grows chiefly on the south side of Jamaica, and affords one of the hardest and heaviest woods, extremely useful for the sheaves and blocks of pulleys, for which purpose it should be cut with a band of sapwood all round, to prevent splitting. Its weight is 73 lb. a cub. ft.; crushing-weight, 9900 lb. The approximate London market value is 4-10*l.* a ton. Lignum-vitæ grows on several of the Bahama islands, and is generally exported to Europe and America. The principal use made of it in the Bahamas is for hinges and fastenings for houses situated by the sea shore or in the vicinity of salt ponds on the islands, where, from the quick corrosion of iron hinges, &c., metal is seldom used.

Locust-tree (*Hymenæa Courbaril*).—This tree is a native of S. America, and is found also in Jamaica. Its wood is hard and tough, and useful for house-building. Its weight is 42 lb. a cub. ft.; crushing-force, 7500 lb.; breaking-weight, 750 lb.

Mahogany (*Swietenia Mahoganii*).—This tree is indigenous to the W. Indies and Central America. It is of comparatively rapid growth, reaching maturity in about 200 years, and the trunk exceeding 40-50 ft. long and 6-12 ft. diam. The wood is very durable in the dry, and not liable to worms. Its costliness restricts its use chiefly to furniture; it has been extensively employed in machinery for cotton-mills. It shrinks very little, warps and twists less than any other wood, and glues exceedingly well. It

is imported in logs: those from Cuba, Jamaica, San Domingo, known as "Spanish," are about 20-26 in. sq. and 10 ft. long; those from Honduras, 2-4 ft. sq. and 12-14 ft. long. The weight is 35-53 lb. a cub. ft.; the cohesive force is 7560 lb. in Spanish, and 11,475 lb. in Honduras; the strength, stiffness, and toughness are respectively 67, 73, and 61 in Spanish, and 96, 93, and 99 in Honduras. The tree attains its greatest development and grows most abundantly between 10° N. lat. and the Tropic of Cancer, flourishing best on the higher crests of the hills, and preferring the lighter soils. It is found in abundance along the banks of the Usumacinta, and other large rivers flowing into the Gulf of Mexico, as well as in the larger islands of the W. Indies. British settlements for cutting and shipping the timber were established so long ago as 1638-40, and the right to the territory has been maintained by Great Britain, chiefly on account of the importance of this branch of industry. The cutting season usually commences about August. It is performed by gangs of men, numbering 20-50, under direction of a "captain" and accompanied by a "huntsman," the duty of the latter being to search out suitable trees, and guide the cutters to them. The felled trees of a season are scattered over a very wide area. All the larger ones are "squared" before being brought away on wheeled trucks along the forest roads made for the purpose. By March-April, felling and trimming are completed; the dry season by that time permits the trucks to be wheeled to the river-banks. A gang of 40 men work 6 trucks, each requiring 7 pair of oxen and 2 drivers. Arrived at the river, the logs, duly initialed, are thrown into the stream; the rainy season follows in May-June, and the rising current carries them seawards, guided by men following in canoes. A boom at the river-mouth stops the timber, and enables each owner to identify his property. They are then made up into rafts, and taken to the wharves for a final trimming before shipment. The cutters often continue their operations far into the interior, and over the borders into Guatemala and Yucatan. Bahama mahogany grows abundantly on Andros Island and others of the Bahama group. It is not exceeded in durability by any of the Bahama woods. It grows to a large size, but is generally cut of small dimensions, owing to the want of proper roads and other means of conveyance. It is principally used for bedsteads, &c., and the crooked trees and branches for ship timber. It is a fine, hard, close-grained, moderately heavy wood, of a fine, rich colour, equal to that of Spanish mahogany, although probably too hard to be well adapted for the purposes to which the latter is usually applied. Honduras is best for strength and stiffness, while Spanish is most valued for ornamental purposes. The Honduras wood is of a golden or red-brown colour, of various shades and degrees of brightness, often very much veined and mottled. The grain is coarser than that of Spanish, and the inferior qualities often contain many grey specks. This timber is very durable when kept dry, but does not stand the weather well. It is seldom attacked by dry-rot, contains a resinous oil which prevents the attacks of insects, and is untouched by worms. It is strong, tough, and flexible when fresh, but becomes brittle when dry. It contains a very small proportion of sap, and is very free from shakes and other defects. The wood requires great care in seasoning, does not shrink or warp much, but if the seasoning process is carried on too rapidly it is liable to split into deep shakes externally. It holds glue very well, has a soft silky grain, contains no acids injurious to metal fastenings, and is less combustible than most timbers. It is generally of a plain straight grain and uniform colour, but is sometimes of wavy grain or figured. Its market forms are logs 2-4 ft. sq. and 12-14 ft. in length. Sometimes planks have been obtained 6-7 ft. wide. Mahogany is known in the market as "plain," "veiny," "watered," "velvet-cowl," "bird's-eye," and "festooned," according to the appearance of the vein-formations. Cuba or Spanish mahogany is distinguished from Honduras by a white, chalk-like substance which fills its pores. The wood is very sound, free from shakes, with a beautiful wavy grain or figure, and capable of receiving a high polish. It is used chiefly for furniture and ornamental purposes, and for ship-building. Mexican shows the characteristics of Honduras.

Some varieties of it are figured. It may be obtained in very large sizes, but the wood is spongy in the centre, and very liable to starshakes. It is imported in balks 15-36 in. sq., and 18-30 ft. in length. St. Domingo and Nassau are hard, heavy varieties, of deep-red colour, generally well veined or figured, and used for cabinet-works. They are imported in very small logs, 3-10 ft. long and 6-12 in. sq.

Mahogany [African] (*Swietenia senegalensis*).—This hard and durable wood is brought from Sierra Leone, and is much used for purposes requiring strength, hardness, and durability. But it is very liable to premature decay, if the heart is exposed in felling or trimming.

Mahogany [E. Indian].—Two species of *Swietenia* are indigenous to the E. Indies:—*S. febrifuga* is a very large tree of the mountains of Central Hindostan; the wood is less beautiful than true mahogany, but much harder, heavier, and more durable, being considered the most lasting timber in India. *S. chloroxylon* is found chiefly in the Circar mountains, and attains smaller dimensions; the wood more resembles box.

Maire (*Santalum Cunninghamii*).—A small tree 10-15 ft. high, 6-8 in. diam.; wood hard, close-grained, heavy. Used by the natives of New Zealand in the manufacture of war implements. Has been used as a substitute for box by wood-engravers.

Maire [Black] (*Olea Cunninghamii*).—Grows 40-50 ft. high, 3-4 ft. diam.; timber close-grained, heavy, and very durable. Much of this very valuable timber is at present destroyed in clearing the land.

Maire-taw-hake (*Eugenia maire*).—A small tree about 40 ft. high; trunk 1-2 ft. in diam.; timber compact, heavy, and durable. Used for mooring-posts and jetty-piles on the Waikato, where it has stood well for 7 years. It is highly valued for fencing. Common in swampy land in the North Island of New Zealand.

Mako (*Aristolotelia racemosa*).—A small handsome tree 6-20 ft. high, quick growing. Wood very light, and white in colour, and might be applied to the same purposes as the lime tree in Britain; it makes good veneers.

Mango (*Mangifera indica*).—This tree grows abundantly in India, where numerous varieties are cultivated, as also in Mauritius, Brazil, and in other tropical climates. Its wood is generally coarse and open-grained, but is excellent for common doors and door-posts when well seasoned; it is light and strong, but liable to snap; it is durable in the dry, but decays rapidly when exposed to weather or water, and is much attacked by worms and ants. Its weight is 41 lb. a cub. ft.; cohesive force, 7700 lb.; breaking-weight, 560 lb.

Manuka (*Leptospermum ericoides*).—A small tree 10-80 ft. high, highly ornamental, more especially when less than 20 years old. The timber can be had 28-30 ft. long, and 14 in. diam. at the butt, and 10 in. at the small end. The wood is hard and dark coloured, largely used at present for fuel and fencing, axe-handles and sheaves of blocks, and formerly by the natives for spears and paddles. The old timber, from its dark-coloured markings, might be used with advantage in cabinet-work, and its great durability might recommend it for many other purposes. Highly valued in Otago for jetty and wharf piles, as it resists the marine worm better than any other timber found in the province. It is extensively used for house piles. The lightest coloured wood, called "white manuka," is considered the toughest, and forms an excellent substitute for hornbeam in the cogs of large spur wheels. It is abundant in New Zealand as a scrub, and is found usually on the poorer soils, but is rare as a tree in large tracts to the exclusion of other trees.

Maple (*Acer saccharinum*).—The sugar-maple is liable to a peculiarity of growth, which gives the wood a knotted structure, whence it is called "bird's-eye maple." The cause of this structure has never been satisfactorily explained. The handsome appearance thus given to the wood is the reason of its value in furniture and cabinet making.

Mingi-Mingi or Yellowwood (*Olearia avicunifolia*).—An ornamental shrub tree,

trunk 2 ft. diam. Wood close-grained, with yellow markings, which render it desirable for cabinet-work; good for veneers. Occurs in South Island of New Zealand.

Miro (*Podocarpus ferruginea*).—This is a New Zealand tree, giving brownish wood 20–30 ft. long and 15–30 in. sq., useful for internal carpentry and joinery, and weighing 46 lb. a cub. ft. It is known as the “bastard black pine” in Otago, the wood being less durable than that of the matai or “true black pine”; it is reddish, close-grained and brittle, the cross section showing the heartwood star-shaped and irregular. The wood is generally thought to be unfitted for piles and marine works, except where only partially exposed to the influence of sea-water, when it is reported durable.

Monoao or Yellow Pine (*Dacrydium Colensoi*) is a very ornamental tree, 20–80 ft. high, giving a light and yellow wood, which is one of the strongest and most durable in New Zealand. Posts of this wood have stood several hundred years’ use among the Maoris, and it is greatly valued for furniture.

Mora (*Mora excelsa*).—This tree is a native of British Guiana and Trinidad, growing luxuriantly on sand-reefs and barren clays of the coast regions, reaching 130–150 ft. high, and squaring 18–20 in. Its wood is extremely tough, close, and cross-grained, being one of the most difficult to split. It is one of the eight first-class woods at Lloyd’s, making admirable keels, timbers, beams, and knees, and in most respects superior to oak. Its weight is 57 lb. a cub. ft.; crushing-force, 10,000 lb.; breaking-weight, 1212 lb. The wood is of a chestnut-brown colour, sometimes beautifully figured. It is free from dry-rot, but subject to starshake. Its market form is logs 18–35 ft. long and 18–20 in. sq.

Muskwood (*Eurybia argophylla*) grows in densely scrubby places among the mountain ranges of Tasmania, which makes it difficult to get out. This timber never grows very high; it has a pleasant fragrance, is of a beautiful mottled colour, and well adapted for veneering, fancy articles of furniture, pianofortes, &c. Diam. 6–15 in., the butt enlarging towards the ground to 1½, and even 2½ ft.; height, 15–30 ft.; sp. grav., about 0·685. Abundant throughout the island.

Mutti (*Terminalia coriacea*).—This is a common tree of Central and S. India. Its wood is hard, heavy, tough, fibrous, close-grained, rather difficult to work, unaffected by white ants, and considered extremely durable. It is used for beams and telegraph posts. Its weight is 60 lb. a cub. ft.; breaking-weight, 860 lb.

Nageswar (*Mesua ferrea*) is a valuable Assam timber, harder and more durable than Jaral, but not so suitable for boat-building, as it is much heavier, and difficult to work. Grows till 80 years old, when it reaches a height of 45 ft. and a diam. of 6 ft., such trees being worth 3*l.*

Nan-mu (*Persea Nanmu*).—That portion of the Chinese province of Yunnan which lies between 25° and 26° N. lat. produces the famous *nan-mu* tree, which is highly esteemed by the Chinese for building and coffins, on account of its durability and pleasant odour. It is imported into Shanghai in planks measuring 8 ft. long and 13–14 in. wide, for which the highest price is 200 *dol.* (of 4*s.* 2*d.*) a plank.

Naugia.—This tree is generally found in the Pacific Islands on desert shores, or on the brinks of lagoons, where its roots are bathed by the tide. Its wood has great weight, intense hardness, and closeness of grain. It is considered a valuable substitute for box for wood-engraving. Blocks 18 in. diam. are common.

Neem (*Melia Azadirachta*).—This is a common, hardy, and quick-growing Indian tree, reaching 40–50 ft. high, and 20–24 in. diam. The trunk and branches are cut into short, thick planks, much used for lintels of doors and windows. The wood is hard and durable, but attacked by insects. Its fragrant odour makes it in request by natives for doors and door-frames. It is difficult to work, takes a fine polish, and is good for joinery where strength is not demanded; but becomes brittle and liable to snap when dry. Its weight is 51 lb. a cub. ft.; cohesive force 6940 lb.; breaking-weight, 600 lb.

Nei-nei (*Dacrophyllum longifolium*).—Wood is white, marked with satin-like specks,

and is adapted for cabinet-work. Grows in South Island of New Zealand, and in Lord Auckland's group and Campbell's Island. The tree in the vicinity of Dunedin attains a diam. of 10-12 in.

Oak (*Quercus spp.*).—The most common British oak is *Q. pedunculata*, found throughout Europe from Sweden to the Mediterranean, and in N. Africa and Asia. Its wood is tolerably straight and fine in the grain, and generally free from knots. It splits freely, makes good laths for plasterers and slaters, and is esteemed the best kind for joists, rafters, and other purposes where a stiff, straight wood is desirable. The "durmast" oak (*Q. pubescens*) has the same range as the preceding, but predominates in the German forests. Its wood is heavier, harder and more elastic, liable to warp, and difficult to split. Both are equally valuable in ship-building. Quantities of Oak timber are shipped from Norway, Holland, and the Baltic ports, but are inferior to English-grown for ship-building, though useful for other purposes. A third kind is the cluster-fruited or "bay" oak (*Q. sessiliflora*). Of American oaks, the most important are as follows: The chestnut-leaved (*Q. prinus*) gives a coarse-grained wood, very serviceable for wheel-carriages. The red (*Q. rubra*), in Canada and the Alleghanies, affords a light, spongy wood, useful for staves. The wood of the white oak (*Q. alba*), ranging from Canada to Carolina, is tough, pliable, and durable, being the best of the American kinds, but less durable than British. It is exported from Canada to Europe as "American oak." The iron or post oak (*Q. obtusiloba*), found in the forests of Maryland and Virginia, is frequently called the "box white oak," and chiefly used for posts and fencing. The live oak (*Q. virens*) is the best American ship-building kind, inhabiting the Virginian coast. Oak warps, twists, and shrinks much in drying. Its weight is 37-68 lb. a cub. ft., according to the kind; cohesive force, 7850-17,892 lb. It is valuable for all situations where it is exposed to the weather, and where its warping and flexibility are not objectionable. Quebec oak is worth about 4*l.* 10*s.*-7*l.* a load; Dantzie and Memel, 3*l.* 10*s.*-5*l.* It is generally considered that the timber from the stalk-fruited oak is superior to that from the bay oak. The respective characteristics of the two varieties are:—The wood of the stalk-fruited oak is lighter in colour than the other. It has a straight grain, is generally free from knots, has numerous and distinct medullary rays, and good silver grain; it is easy to work and less liable to warp, and is better suited for ornamental work, joists, rafters, and wherever stiffness and accuracy of form are required; it splits well and makes good laths. The timber of the cluster-fruited oak is darker in colour, more flexible, tougher, heavier, and harder; it has but few large medullary rays, so that in old buildings it has been mistaken for chestnut; it is liable to warp, difficult to split, not suited for laths or ornamental purposes, but is better where flexibility or resistance to shocks is required. On the whole they so much resemble each other that few are able to speak positively as to their identity; but the Durmast oak is decidedly of inferior quality. Oak is sometimes felled in the spring for the sake of the bark (instead of being stripped in the spring and felled in the winter); the tree being then full of sap, the timber is not durable. American oak has a pale reddish-brown colour, with a straighter and coarser grain than English. The timber is sound, hard, and tough, very elastic, shrinks very slightly, and is capable of being bent to any form when steamed. It is not so strong or durable as English oak, but is superior to any other foreign oak in those respects. It may be used for ship-building, and for many parts of buildings. It is imported in very large-sized logs varying from 25 to 40 ft. in length, and from 12 to 28 in. in thickness; also in 2-4 in. planks, and in thick stuff of 4½-10 in. Dantzie oak is grown chiefly in Poland, and shipped also at Memel and Stettin. It is of dark-brown colour, with a close, straight, and compact grain, bright medullary rays, free from knots, very elastic, easily bent when steamed, and moderately durable. It is used for planking, ship-building, &c. It is classified as "crown" and "crown brack" qualities, marked respectively W and WW. It is imported in logs 18-30 ft.

long, 10-16 in. sq., and in planks averaging 32 ft. long, 9-15 in. wide, and 2-8 in. thick. French oak closely resembles British in colour, quality, texture, and general characteristics. Riga oak is grown in Russia, and is like that shipped from Dantzic, but with more numerous and distinct medullary rays. It is valued for its silver grain, and is imported in logs of nearly semicircular section. Italian (Sardinian) oak is from several varieties of the tree. It is of a brown colour, hard, tough, strong, subject to splits and shakes in seasoning, difficult to work, but free from defects, and extensively used for ship-building in her Majesty's dockyards. "Wainscot" is a species of oak, soft and easily worked, not liable to warp or split, and highly figured; it is obtained by converting the timber so as to show the silver grain, which makes the wood very valuable for veneers, and other ornamental work. It is imported chiefly from Holland and Riga, in semicircular logs. "Clap Boarding" is a description of oak imported from Norway, inferior to wainscot, and distinguished from it by being full of white-coloured streaks.

Oak [African], African Teak, or Turtosa (*Oldfieldia africana*).—This important W. African timber has lately been largely imported from Sierra Leone as a substitute for oak and teak. Though stronger than these, its great weight precludes its general use; but it is valuable for certain parts of ships, as beams, keelsons, waterways, and it will stand much heat in the wake of steamer fires, decaying rapidly, however, in confined situations. It warps in planks, swells with wet, and splits in drying again; it is not proof against insects. Its weight is 58-61 lb. a cub. ft.; cohesive force, 17,000-21,000 lb.

Oak [Australian].—Two hard-wooded trees of Australia are the forest-oak (*Casuarina torulosa*) and the forest swamp-oak (*C. paludosa*). They reach 40-60 ft. high and 12-30 in. diam., and are used in house-building, mainly for shingles, as they split almost as neatly as slate. They weigh 50 lb. a cub. ft.; crushing-force, 5500 lb.; breaking-weight, 700 lb. The she-oak (*C. quadrivalvis*) and he-oak (*C. suberosa*) of Tasmania are used mostly for ornamental purposes. *C. leptoclada* and *C. cristata* are other species well adapted for furniture purposes from the singular beauty of their grain. They are used for certain applications in boat-building, but rarely found to exceed 2-3 ft. in diameter. The wood is excellent for turnery purposes and the manufacture of ornamental work.

Pai-ch'ha (*Euonymus sp.*).—The wood of this tree has been proposed as a substitute for boxwood, being extensively produced in China, and largely used at Ningpo and other places for wood-carving. It is very white, of fine grain, cuts easily, and is well suited for carved frames, cabinets, &c.; but it is not at all likely to supersede box-wood, though well fitted for coarser work.

Pear (*Pyrus communis*).—Pear-tree wood is one of the heaviest and hardest of the timbers indigenous to Britain. It has a compact, fine grain, and takes a high polish; it is in great request by millwrights in France for making cog-wheels, rollers, cylinders, blocks, &c., and is preferred before all others for the screws of wine-presses. It ranks second to box for wood-engraving and turnery.

Persimmon (*Diospyros virginiana*).—The Virginian date-palm or persimmon is a native of the United States, growing 50-60 ft. high and 1½ ft. diam. Its heartwood is brown, hard, and elastic, but liable to split; it has been with some success introduced into England as a substitute for boxwood in shuttle-making and wood-engraving.

Pine [Black], or Matai (*Polocarpus spicata*).—This New Zealand timber is much more durable than Miro, and is used for all purposes where strength and solidity are required. Its weight is 40 lb. a cub. ft.; breaking-weight, 420-800 lb. It is a large tree, 80 ft. high and with a trunk 2-4 ft. in diameter. The wood is yellowish, close-grained, and durable; among the various purposes to which it is applied may be mentioned piles for bridges, wharves and jetties, bed-plates for machinery, millwrights' work, flooring, house blocks, railway sleepers, fencing, and bridges. It has been known to resist exposure for over 200 years in a damp situation.

Pine [Cluster], or Pinaster (*Pinus Pinaster*).—This pine inhabits the rocky mountains of Europe, and is cultivated in English plantations; it reaches 50–60 and even 70 ft. in height. It likes deep dry sand, or sandy loam in a dry bottom; but avoids all calcareous soils. The wood is said to be more durable in water than in air. It is much used in France for shipping-packages, piles and props in ship-building, common carpentry and fuel. It weighs 25½ lb. a cub. ft.

Pine [Huon] (*Daerydium Franklinii*).—This tree is said to be abundant in portions of S.W. Tasmania, growing 50–100 ft. high and 3–8 ft. diam. The wood is clean and fine-grained, being closer and more durable than American White Pine, and can be had in logs 12–20 ft. long and 2 ft. sq. Its weight is 40 lb. a cub. ft. It is considered one of the handsomest and most suitable woods for bedroom furniture, bearing a strong resemblance to satinwood. From its lasting qualities, it is much prized for ship-building.

Pine [Moreton Bay] (*Araucaria Cunninghamii*).—This abundant Queensland tree grows over 150 ft. high and 5 ft. diam., giving spars 80–100 ft. long. Its wood is straight-grained, tough, and excellent for joinery; but is not so durable as Yellow Pine, and is liable to attacks of sea-worms and white ants. It is used for flooring and general carpentry, and for shingles; it holds nails and screws well. Its weight is 45 lb. a cub. ft. It is strong and lasting either when dry or actually under water, but will not bear alternations of dryness and damp. When grown on the mountains of the interior, the wood is fine-grained and takes a polish which is described as superior to that of satinwood or bird's-eye maple. Its average value is 55s.–70s. per 1000 ft. super.

Pine [Norfolk Island] (*Araucaria excelsa*).—This tree inhabits Norfolk Island and Australia, growing 200–250 ft. high and 10–12 ft. diam. Its wood is tough, close-grained, and very durable for indoor work.

Pine [Northern], or Red, Yellow, Scotch, Memel, Riga, or Dantzic Fir (*Pinus sylvestris*).—This tree forms with the spruce fir the great forests of Scandinavia and Russia, and attains considerable size in the highlands of Scotland. The logs shipped from Stettin reach 18–20 in. sq.; those from Dantzic, 14–16 in. and even 21 in. sq. and up to 40–60 ft. long; from Memel, up to 13 in. sq. and 35 ft. long; from Riga, 12 in. sq. and 40 ft. long, and spars 18–25 in. diam. and 70–80 ft. long; Swedish and Norwegian, up to 12 in. sq. It comes also in planks (11 in. wide), deals (9 in.), and battens (7 in.). The best are Christiania yellow deals, but contain much sap; Stockholm and Gefle are more disposed to warp; Gottenburg are strong, but bad for joinery; Archangel and Onega are good for joinery, but not durable in damp; Wiborg are the best Russian, but inclined to sap; Petersburg and Narva yellow are inferior to Archangel. Well-seasoned pine is almost as durable as oak. Its lightness and stiffness render it the best timber for beams, girders, joists, rafters, and framing; it is much used for masts, and for joinery is superior to oak on all scores. The hardest comes from the coldest districts. The cohesive force is 7000–14,000 lb. per sq. in.; weight, 29–40 lb. per cub. ft.; strength, 80; stiffness, 114; toughness, 56. The colour of the wood of different varieties is not uniform; it is generally reddish-yellow or honey-yellow of unequal depths of brightness. The section shows alternate hard and soft circles, one part of each annual ring being soft and light-coloured, the other harder and darker. It has a strong resinous odour and flavour, and works easily when not too highly resinous. Foreign wood shrinks about $\frac{1}{10}$ in width in seasoning from the log. In the best timber the annual rings do not exceed $\frac{1}{10}$ in. in thickness, and the dark parts of the rings are bright, reddish, hard, and dry, neither leaving a woolly surface after the saw nor choking the teeth with rosin. Inferior kinds have thick rings, and their dark portion is either more yellow, heavier, and more resinous, or is spongy, less resinous, and leaves a woolly surface after sawing; such is neither strong nor durable. Shavings from good timber will bear curling 2 or 3 times round the finger, those from bad will break off. The best balks come from Dantzic, Memel, and Riga. Dantzic is strong,

tough, elastic, easily worked, and durable when seasoned. It contains (especially in small trees) much sapwood, and large and dead knots, while the heart is often loose and cuppy. The balks run 18-45 ft. long and 14-16 in. sq.; deals, 18-50 ft. long and 2-5 in. thick. Memel is similar to Dantzic, but hardly so strong, and only 13-14 in. sq. Riga is somewhat weaker than Dantzic, but remarkable for straightness, paucity of sapwood, and absence of knots; being often rather shaky at the centre, it is not so good for turning into deals. Norway is small, tough, and durable, but generally contains much sapwood. The balks are only 8-9 in. sq. Swedish resembles Prussian, but the balks are generally tapering, small, of yellowish-white colour, soft, clean, straight in grain, with small knots and very little sap, but generally shaky at heart, and unfit for conversion into deals. It is cheap, suitable for the coarser purposes of carpentry, and used chiefly for scaffolding. Balks are generally 20-35 ft. long, and 10-12 in. sq. Planks, deals, and battens from the Baltic, cut from northern pine, are known as "yellow" or "red" deal; when cut from spruce, they are called "white" deals. Taking deals, battens, &c., in a general way, the order of quality would stand first or best with Prussia; then with Russia, Sweden, and Finland; and lastly with Norway. Prussian (Memel, Dantzic, Stettin) deals are very durable and adapted for external work, but are chiefly used for ship-building, being 2-4 in. thick. The timber from the southern ports, being coarse and wide in the grain, cannot compete in the converted form as deals, &c., with the closer-grained and cleaner exports from the more northern ports. Russian (Petersburg, Onga, Archangel, Narva) are the best deals imported for building purposes. They are very free from sap, knots, shakes, or other imperfections; of a clean grain, and hard, well-wearing surface, which makes them well adapted for flooring, joinery, &c. The lower qualities are of course subject to defects. Petersburg deals are apt to be shaky, having a great many centres in the planks and deals, but the best qualities are very clean and free from knots. They are very subject to dry rot. All Russian deals are unfit for work exposed to damp. In those from Archangel and Onga the knots are often surrounded by dead bark, and drop out when the timber is worked. Wyborg deals are sometimes of very good quality, but often full of sap. Finland and Nyland deals are 14 ft. long, very durable, but fit only for the carpenter. Norwegian (Christiania, Dram) yellow deals and battens used to bear a high character, being clean and carefully converted, but are now very scarce. Much of the Norwegian timber is imported in the shape of prepared flooring and matched boarding. Dram battens often suffer from dry rot, especially when badly stacked. Of Swedish (Gefle, Stockholm, Holmsund, Soderham, Gottenburg, Hernosand, Sundswall) the greater portion is coarse and bad, but some of the very best Baltic deal, both yellow and white, comes from Gefle and Soderham. The best Swedish run more sound and even in quality than Russian, from the different way in which the timber is converted. A balk of Russian timber is all cut into deals of one quality, hence the numerous hearts or centres seen amongst them, which are so liable to shake and split; whereas in Swedish timber the inner and the outer wood are converted into different qualities of deals. Hence the value of first-class Swedish goods. 4-in. deals should never be used for cutting into boards, as they are cut from the centres of the logs. 3-in. deals, the general thickness of Russian goods, are open to the same objection. Swedish 2½- and 2-in. of good quality are to be preferred to 3-in., since they are all cut from the sound outer wood. Swedish deals are fit for ordinary carcase work, but, from their liability to warp, cannot be depended upon for joiners' work. They are commonly used for all purposes connected with building, especially for floors.

Pine [Pitch] (*Pinus rigida* [*resinosa*]).—This species is found throughout Canada and the United States, most abundantly along the Atlantic coast. The wood is heavy, close-grained, elastic, and durable, but very brittle when old or dry, and difficult to plane. The heartwood is good against alternate damp and dryness, but inferior to White Pine underground. Its weight is 41 lb. per cub. ft.; cohesive force, 9796 lb. per

sq. in.; stiffness, 73; strength, 82; toughness, 92. The best comes from the S. States of N. America, chiefly from the ports of Savannah, Darien, and Pensacola. The colour is reddish-white or brown; the annual rings are wide, strongly marked, and form beautiful figures after working and varnishing. The timber is very resinous, making it sticky and troublesome to plane, but very durable; it is hard, heavy, very strong, free from knots, but contains much sapwood, is subject to heart and cup shake, and soon rots in damp; it is brittle when dry, and often rendered inferior by the trees having been tapped for turpentine. Its resinous nature prevents its taking paint well. It is used in the heaviest timber structures, for deep planks in ships, and makes very durable flooring. Market forms are logs 11-18 (aver. 16) in. sq., 20-45 ft. long; planks 20-45 ft. long, 10-15 in. wide, 3-5 in. thick.

Pine [Red, Norway, or Yellow] (*Pinus rubra [resinosa]*).—This tree grows on dry, stony soils in Canada, Nova Scotia, and the N. United States, reaching 60-70 ft. high, and 15-25 ft. diam. at 5 ft. above ground. The wood weighs 37 lb. per cub. ft.; it is much esteemed in Canada for strength and durability, and, though inferior in these respects to Northern Pine, is preferred by English shipwrights for planks and spars, being soft, pliant, and easily worked. This timber has a reddish-white appearance, with clean, fine grain, much like Memel, but with larger knots. It is small, very solid in the centre, with little sap or pith, tough, elastic, not warping nor splitting, moderately strong, very durable where well ventilated, glues well, and suffers little loss in conversion. Cabinet-makers use it for veneering, and sometimes it is employed for internal house-fittings. Market forms are logs 16-50 ft. long, 10-18 in. sq., 40 cub. ft. in contents, sized as "large," "mixed," and "building."

Pine [Red] or Rimu (*Dacrydium cupressinum*).—This New Zealand wood runs 45 ft. long, and up to 30 in. sq., and is much used in house-framing and carpentry, but is not so well adapted to joinery, as it shrinks irregularly. It weighs 40 lb. a cub. ft. It is an ornamental and useful wood, of red colour, clear-grained, and solid; it is much used for joisting, planking, and general building purposes from Wellington southwards. Its chief drawback is liability to decay under the influence of wet. It is largely employed in the manufacture of furniture, the old wood being handsomely marked like rosewood, but of a lighter brown hue. The best quality comes from the South Island.

Pine [Weymouth or White] (*Pinus strobus*).—This tree inhabits the American continent between 43° and 47° N. lat., occupying almost all soils. The timber is exported in logs over 3 ft. sq. and 30 ft. long; it makes excellent masts; is light, soft, free from knots, easily worked, glues well, and is very durable in dry climates; but is unfit for large timbers, liable to dry-rot, and not durable in damp places, nor does it hold nails well. It is largely employed for wooden houses and timber bridges in America. Its weight is 28½ lb. per cub. ft.; cohesive force, 11,835 lb.; stiffness, 95; strength, 99; toughness, 103. The wood, when freshly cut, is of a white or pale straw colour, but becomes brownish-yellow when seasoned; the annual rings are not very distinct; the grain is clean and straight; the wood is very light and soft, when planed has a silky surface, and is easily recognized by the short detached dark thin streaks, like short hair-lines, always running in the direction of the grain. The timber is as a rule clean, free from knots, and easily worked, though the top ends of logs are sometimes coarse and knotty; it is also subject to cup and heart shakes, and the older trees to sponginess in the centre. It is much used in America for carpenters' work of all kinds; also for the same purpose in Scotland, and in some English towns, but considered inferior in strength to Baltic timber. The great length of the logs and their freedom from defects causes them to be extensively used for masts and yards whose dimensions cannot be procured from Baltic timber. For joinery this wood is invaluable, being wrought easily and smoothly into mouldings and ornamental work of every description. It is particularly adapted for panels, on account of the great width in which it may be procured; it is also much used for making patterns for castings. Of market forms the best are inch

masts roughly hewn to an octagonal form. Next come logs hewn square, 18-60 ft. long, averaging 16 in. sq., and containing 65 cub. ft. in each log. A few pieces are only 14 in. sq.; short logs may be had exceeding even 26 in. sq. Some 3-in. deals vary in width from 9 to 24 and even 32 in. The best are shipped at Quebec. Goods from southern ports, such as Richibucto, Miramichi, Shediac, are inferior. American yellow deals are divided into 3 principal classes—Brights, Dry floated, Floated. Each of these is divided into 3 qualities, according to freedom from sap, knots, &c.; the first quality should be free from defects. First quality brights head the classification, then first quality dry floated, next first quality floated; then come second quality brights, second quality dry floated, and so on. Brights consist of deals sawn from picked logs and shipped straight from the sawmills. Floated deals are floated in rafts down the rivers from the felling grounds to the shipping ports. Dry floated deals are those which, after floating down, have been stacked and dried before shipment. Floating deals damages them considerably, besides discolouring them. The soft and absorbent nature of the wood causes them to warp and shake very much in drying, so that floated deals should never be used for fine work.

Pine [White] or Kahikatea (*Podocarpus dactyloides*).—This New Zealand timber tree gives wood 40 ft. long and 24-40 in. sq., straight-grained, soft, flexible, warping and shrinking little, and well adapted for flooring and general joinery, though decaying rapidly in damp. Its weight is 30 lb. a cub. ft.; breaking-weight, 620 lb. When grown on dry soil, it is good for the planks of small boats; but when from swamps, it is almost useless. A variety called "yellow pine" is largely sawn in Nelson, and considered to be a durable building timber.

Pine [Yellow, Spruce, or Short-leaved] (*Pinus variabilis* and *P. mitis*).—The former species is found from New England to Georgia, the wood being much used for all carpentry, and esteemed for large masts and yards; it is shipped to England from Quebec. The latter is abundant in the Middle States and throughout N. America, reaching 50-60 ft. high and 18 in. diam. It is much used locally for framework: the heartwood is strong and durable; the sapwood is very inferior.

Plane (*Platanus orientalis* and *P. occidentalis*).—The first species inhabits the Levant and adjoining countries, growing 60-80 ft. high and up to 8 ft. diam. The wood is more figured than beech, and is used in England for furniture; in Persia it is applied to carpentry in general. The second species, sometimes called "water-beech," "button-wood," and "sycamore," is one of the largest N. American trees, reaching 12 ft. diam. on the Ohio and Mississippi, but generally 3-4 ft. The wood is harder than the oriental kind, handsome when cut, works easily, and stands fairly well, but is short-grained and easily broken. It is very durable in water, and preferred in America for quays. Its weight is 40-46 lb. a cub. ft.; cohesive force, 11,000 lb.; strength, 92; stiffness, 78; toughness, 108.

Pohutukawa (*Metrosideros tomentosa*).—This tree has numerous massive arms; its height is 30-60 ft.; trunk 2-4 ft. in diam. The timber is specially adapted for the purposes of the ship-builder, and has usually formed the framework of the numerous vessels built in the northern provinces of New Zealand. Grows on rocky coasts, and is almost confined to the province of Auckland.

Poon (*Calophyllum Burmanni*).—This tree is abundant in Burma, S. India, and the E. Archipelago. It is tall and straight, and about 6 ft. circ. It is used for the decks, masts, and yards of ships, being strong and light. Its texture is coarse and porous, but uniform: it is easy to saw and work up, holds nails well, but is not durable in damp. Its weight is 40-55 lb. a cub. ft.; cohesive force, 8000-11,700 lb. Another species (*C. angustifolium*) from the Malabar Hills is said to furnish spars.

Poplar (*Populus spp.*).—Five species of poplar are common in England: the white (*P. alba*), the black (*P. nigra*), the grey (*P. canescens*), the aspen or trembling poplar (*P. tremula*), and the Lombardy (*P. dilatata*); and two in America: the Ontario

(*P. macrophylla*) and the black Italian (*P. aeladesca*). They grow rapidly, and their wood is generally soft and light, proving durable in the dry, and not liable to swell or shrink. It makes good flooring for places subject to little wear, and is slow to burn. It is much used for butchers' trays and other purposes where weight is objectionable. The Lombardy is the lightest and least esteemed, but is proof against mice and insects. The weight is 21-33 lb. a cub. ft.; cohesive force, 4596-6641 lb.; strength, 50-86; stiffness, 44-66; toughness, 57-112. Poplar is one of the best woods for paper-making. The colour of the wood is yellowish- or brownish-white. The annual rings are a little darker on one side than the other, and therefore distinct. They are of uniform texture, and without large medullary rays. The wood is light and soft, easily worked and carved, only indented, not splintered, by a blow. It should be well seasoned for 2 years before use. When kept dry, it is tolerably durable, and not liable to swell or shrink.

Pukatea (*Laurelia Novæ-Zelandiæ*).—Height, 150 ft., with buttressed trunk 3-7 ft. in diam.; the buttresses 15 ft. thick at the base; wood soft and yellowish, used for small boat planks. A variety of this tree has dark-coloured wood that is very lasting in water, and greatly prized by the natives in making canoes. Grows in the North Island and northern parts of the Middle Island of New Zealand.

Puriri or Ironwood (*Vitex littoralis*).—A large tree, 50-60 ft. high, trunk 20 ft. in girth. Wood hard, dark olive brown, much used; said to be indestructible under all conditions. Grows in the northern parts of the North Island of New Zealand only. It is largely used in the construction of railway waggons, and is said to make excellent furniture, though but little employed in that direction. It splits freely and works easily, and is used wherever durability is essential, as in cart work, bridges, teeth of wheels, and fencing-posts.

Pymma (*Lagerstræmia reginæ*).—The wood of this abundant Indian tree, particularly in S. India, Burma, and Assam, is used more than any except teak, especially in boat-building, and posts, beams and planks in house-building. Its weight is 40 lb. a cub. ft.; cohesive force, 13,000-15,000 lb.; breaking-weight, 640 lb.

Pynkado or Ironwood (*Inga xylocarpa*).—This valuable timber tree is found throughout S. India and Burma. Its wood is hard, close-grained, and durable; but it is heavy, not easily worked, and hard to drive nails into. It is much used in bridge-building, posts, piles, and sleepers. Its weight is 58 lb. a cub. ft.; cohesive force, 16,000 lb.; breaking-weight, 800 lb. Called also erool.

Rata (*Metrosideros lucida*).—This tree is indigenous to New Zealand, giving a hard timber 20-25 ft. long and 12-30 in. sq., very dense and solid, weighing 65 lb. a cub. ft. A valuable cabinet wood; it is of a dark-red colour; splits freely. It has been much used for knees and timbers in ship-building, and would probably answer well for cogs of spur wheels. Grows rarely in the North Island, but is abundant in the South Island, especially on the west coast. In Taranaki it is principally used by mill- and wheelwrights. *M. robusta* grows 50-60 ft. high, diameter of trunk 4 ft., but the descending roots often form a hollow stem 12 ft. in diam. Timber closely resembles the last-named species, and is equally dense and durable, while it can be obtained of much larger dimensions. It is used for ship-building, but for this purpose is inferior to the pohutukawa. On the tramways of the Thames it has been used for sleepers, which are perfectly sound after 5 years' use. Grows in the North Island; usually found in hilly situations from Cape Colville southwards.

Rewarewa (*Knightia excelsa*).—A lofty, slender tree 100 ft. high. Wood handsome, mottled red and brown, used for furniture and shingles, and for fencing, as it splits easily. It is a most valuable veneering wood. Common in the forests of the Northern Island of New Zealand, growing upon the hills in both rich and poor soils.

Rohun (*Soyimida febrifuga*).—This large forest tree of Central and S. India affords a close-grained, strong and durable wood, which stands well when underground or buried in masonry, but not so well when exposed to weather. It is useful for palisades, sleepers,

and house-work, and is not very difficult to work. Its weight is 66 lb. a cub. ft.; cohesive force, 15,000 lb.; breaking-weight, 1000 lb.

Rosewood.—The term "rosewood" is applied to the timber of a number of trees, but the most important is the Brazilian. This is derived mainly, it would seem, from *Dalbergia nigra*, though it appears equally probable that several species of *Triptolema* and *Machærium* contribute to the inferior grades imported thence. The wood is valued for cabinet-making purposes. The approximate London market values are 12-25*l.* a ton for Rio, and 10-22*l.* for Bahia.

Sabieu (*Lysiloma Sabieu*).—This tree is indigenous to Cuba, and found growing in the Bahamas, where it has probably been introduced. Its wood is exceedingly hard and durable, and has been much valued for ship-building. It has been imported from the Bahamas in uncertain quantities for the manufacture of shuttles and bobbins for cotton-mills. It resembles mahogany in appearance, but is darker, and generally well figured. The wood is very heavy, weathers admirably, and is very free from sap and shakes. The fibres are often broken during the early stages of the tree's existence, and the defect is not discovered until the timber is converted, so that it is seldom used for weight-carrying beams.

Sal or Saul (*Shorea robusta*).—This noble tree is found chiefly along the foot of the Himalayas, and on the Vindhyan Hills near Gaya, the best being obtained from Morung. Its wood is strong, durable, and coarse-grained, with particularly straight and even fibre; it dries very slowly, continuing to shrink years after other woods are dry. It is used chiefly for floor-beams, planks, and roof-trusses, and can be had in lengths of 30-40 ft., and 12-24 in. sq. Its weight is 55-61 lb. a cub. ft.; cohesive force, 11,500 lb.; crushing-force, 8500 lb.; breaking-weight, 881 lb.

Satinwood.—The satinwood of the Bahamas is supposed to be the timber of *Maba guianensis*, an almost unknown tree. The Indian kind is derived from *Chloroxylon Swietenia*, a native of Ceylon, the Coromandel coast, and other parts of India. The former comes in square logs or planks 9-20 in. wide; the latter, in circular logs 9-30 in. diam. The chief use of satinwood is for making the backs of hair- and clothes-brushes, turnery, and veneering. The approximate value of San Domingan is 6-18*l.* a ft. Bahama satinwood, also called yellow-wood, grows abundantly on Andros Island and others of the Bahamian group, and to a large size. It is a fine, hard, close-grained wood, showing on its polished surface a beautifully rippled pattern.

Sawara (*Retinospora pissifera*) is used in Japan for the same purposes as hinoki, when that is unprocurable.

She-pine (*Podocarpus elata*) is very common in Queensland, attaining 80 ft. in height and 36 in. in diam.; the timber is free from knots, soft, close-grained, and easily worked. It is used for joinery and spars, and worth 65*s.*-70*s.* per 1000 ft. super.

Sissu or Seesum (*Dalbergia Sissu*).—This tree is met with in many parts of India, being said to attain its greatest size at Chanda. Its wood resembles the finest teak, but is tougher and more elastic. Being usually crooked, it is unsuited for beams, though much used by Bengal ship-builders, and in India generally for joinery and furniture. Its weight is 46½ lb. a cub. ft.; cohesive force, 12,000 lb.; breaking-weight, 700 lb.

Sneeze-wood or Nies Hout (*Pteroxylon utile*).—This most durable S. African timber, the *oomtata* of the natives, is invaluable for railway-sleepers and piles, being almost imperishable.

Spruce [American White], Epinette, or Sapinette blanche (*Abies alba*).—This white-barked fir is a native of high mountainous tracts in the colder parts of N. America, where it grows 40-50 ft. high. The wood is tougher, lighter, less durable, and more liable to twist in drying than white deal, but is occasionally imported in planks and deals. It weighs 29 lb. a cub. ft.; cohesive force, 8000-10,000 lb.; strength, 86; stiffness, 72; toughness, 102.

Spruce [American Black] (*Abies nigra*).—This tree inhabits Canada and the N.

States, being most abundant in cold-bottomed lands in Lower Canada. It reaches 60-70 and even 100 ft. high, but seldom exceeds 24 in. diam. The wood is much used in America for ships' knees, when oak and larch are not obtainable.

Spruce [Red], or Newfoundland Red Pine (*Abies rubra*).—This species grows in Nova Scotia, and about Hudson's Bay, reaching 70-80 ft. high. It is universally preferred in America for ships' yards, and imported into England for the same purpose. It unites in a higher degree all the good qualities of the Black Spruce.

Stopperwood is principally used for piles and for wheel spokes. It is a very strong and durable wood, and grows from 12 to 16 ft. long and from 6 to 8 in. in diam. It is found on all the Bahamian islands, and is an exceedingly hard, fine, close-grained, and very heavy wood.

Stringy-bark (*Eucalyptus gigantea*).—This tree affords one of the best building woods of Australia, being cleaner and straighter-grained than most of the other species of *Eucalyptus*. It is hard, heavy, strong, close-grained, and works up well for planking, beams, joists, and flooring, but becomes more difficult to work after it dries, and shrinks considerably in drying. The outer wood is better than the heart. Its weight is 56 lb. a cub. ft.; crushing-force, 6700 lb.; breaking-weight, under 500 lb. It is liable to warp or twist, and is susceptible to dry-rot. It splits with facility, forming posts, rails and paling for fences, and shingles for roofing.

Sycamore or Great Maple (*Acer pseudo-platanus*).—This tree, mis-called "plane" in N. England, is indigenous to mountainous Germany, and very common in England. It thrives well near the sea, is of quick growth, and has a trunk averaging 32 ft. long and 29 in. diam. The wood is durable in the dry, but liable to worms; it is chiefly used for furniture, wooden screws, and ornaments. Its weight is 34-42 lb. a cub. ft.; cohesive force, 5000-10,000 lb.; strength, 81; stiffness, 59; toughness, 111. The wood is white when young, but becomes yellow as the tree grows older, and sometimes brown near the heart; the texture is uniform, and the annual rings are not very distinct; it has no large medullary rays, but the smaller rays are distinct.

Tamanu (*Calophyllum sp.*).—This valuable tree of the S. Sea Islands is becoming scarce. It sometimes reaches 200 ft. high and 20 ft. diam. Its timber is very useful for ship-building and ornamental purposes, and is like the best Spanish mahogany.

Tanekaha or Celery-leaved Pine (*Phyllocladus trichomanoides*) is a slender, handsome tree, 60 ft. high, but rarely exceeding 3 ft. in diam., affording a pale, close-grained wood, excellent for planks and spars, and resisting decay in moist positions in a remarkable manner. It grows in the hilly districts of the North Island of New Zealand, and in Tasmania.

Tasmanian Myrtle (*Fagus Cunninghamii*) exists in great abundance throughout the western half of the island, growing in forests to a great size in humid situations. It reaches a height of 60-180 ft., a diam. of 2-9 ft., averaging about 3½ ft., and has a sp. gr. of 0.795. Its price is about 16s. per 100 ft. super. in the log. It is found in considerable quantities in some of the mountainous parts in South Victoria. It is a reddish-coloured wood, and much employed by cabinet-makers for various articles of furniture. Occasionally planks of it are obtained of a beautiful grain and figure, and when polished its highly ornamental character is sure to attract attention. It is also used for the cogs of wheels by millwrights.

Tawa (*Nesodaphne tawa*).—A lofty forest tree, 60-70 ft. high, with slender branches. The wood is light and soft, and is much used for making butter-kegs. Grows in the northern parts of the South Island, and also on the North Island of New Zealand, chiefly on low alluvial grounds; is commonly found forming large forests in river flats. The wood makes fairly durable flooring, but does not last out of doors.

Tawai or Tawai-raie-nui (*Fagus fusca*).—Black birch of Auckland and Otago (from colour of bark). Red birch of Wellington and Nelson (from colour of timber). This is a noble tree, 60-90 ft. high, the trunk 5-8 ft. in diam. The timber is excessively

tough and hard to cut. It is highly valued in Nelson and Wellington as being both strong and durable in all situations. It is found from Kaitaia in the North Island to Otago in the South Island of New Zealand, but often locally absent from extensive districts, and grows at all heights up to 3000 ft.

Teak (*Tectona grandis*).—This tall, straight, rapidly-growing tree inhabits the dry elevated districts of the Malabar and Coromandel coasts of India, as well as Burma, Pegu, Java, and Ceylon. Its wood is light, easily worked, strong, and durable; it is the best for carpentry where strength and durability are required, and is considered foremost for ship-building. The Moulmein product is much superior to the Malabar, being lighter, more flexible, and freer from knots. The Vindhyan excels that of Pegu in strength, and in beauty for cabinet-making. The Johore is the heaviest and strongest, and is well suited for sleepers, beams, and piles. It is unrivalled for resisting worms and ants. Its weight is 45–62 lb. a cub. ft.; cohesive force, 13,000–15,000 lb.; strength, 109; stiffness, 126; toughness, 94. It contains a resinous aromatic substance, which has a preservative effect on iron. It is subject to heartshake, and is often damaged. The resinous secretion tends to collect and harden in the shakes, and will then destroy the edge of any tool. When the resinous matter is extracted during life by girdling the tree, the timber is much impaired in elasticity and durability. Teak is sorted in the markets according to size, not quality. The logs are 23–40 ft. long, and their width on the larger sides varies according to the class, as follows:—Class A, 15 in. and upwards; B, 12 and under 15 in.; C, under 12 in.; D, damaged logs.

Titoki (*Alcetryon excelsum*).—A beautiful tree with trunk 15–20 ft. high and 12–20 in. diam. Wood has similar properties to ash, and is used for similar purposes. Its toughness makes it valuable for wheels, coach-building, &c. Grows in the North and Middle Islands of New Zealand, not uncommon in forests.

Toon, Chittagong-wood, or Red Cedar (*Cedrela Toona*).—This tree is a native of Bengal and other parts of India, where it is highly esteemed for joinery and furniture, measuring sometimes 4 ft. diam., and somewhat resembling mahogany. Its weight is 35 lb. a cub. ft.; cohesive force, 4992 lb.; breaking-weight, 560 lb. It is found in abundance in Queensland, on the coast and inland, reaching 100–150 ft. in height, and 24–76 in. in diam. The wood is light and durable; it is largely employed in furniture and joinery-work, and beautiful veneers are obtained from the junctions of the branches with the stem. Its value runs from 150s. to 170s. per 1000 ft. super. In Assam this timber is reckoned one of the most important, and is employed for making canoes and furniture. It is highly spoken of for making tea-chests in India and Ceylon, being light, strong, clean, non-resinous, not attacked by insects, and giving no unpleasant odour or flavour to the tea. It grows to an immense size; one tree alone has been known to yield 80,000 ft. of fine timber. It stands the test of climate well, and does not require the same amount of seasoning as blackwood; it is of a much softer nature, but takes a very fine polish, and is suitable for dining-room furniture, &c.

Totara (*Podocarpus Totara*).—This tree is fairly abundant in the North and South Islands of New Zealand, reaching 80 ft. high and 2½–3½ ft. diam. Its wood is easily worked, straight and even-grained, warps little, and splits very clean and free; but it is brittle, apt to shrink if not well seasoned, and subject to decay in the heart. It is used generally for joinery and house-building. Its weight is 40 lb.; breaking-weight, 570 lb. The timber is reddish-coloured, and much employed for telegraph poles; it is extensively used in Wellington for house-building, piles for marine wharves, bridges, railway sleepers, &c. When felled during the growing season, the wood resists for a longer time the attacks of *teredo* worms. It is durable as fencing and shingles, post and rail fences made of it being expected to last 40–50 years. The Maoris made their largest canoes from this tree, and the palisading of their paha was constructed almost entirely of it. Timber from trees growing on hills is found to be the more durable.

Towai or Red Birch (*Fagus Menziesii*) is a handsome tree, 80–100 ft. high, trunk

2-3 ft. diam. The timber is chiefly used in the lake district of the South Island of New Zealand. Durable and adapted for mast-making and oars, and for cabinet and cooper's work. Grows in the North Island on the mountain-tops, but abundant in the South Island at all altitudes to 3000 ft.

Tulip (*Harpullia pendula*) grows in Queensland to a height of 50-60 ft., and yields planks 14-24 in. wide, of close-grained and beautifully marked wood, highly esteemed for cabinet-work.

Walnut (*Juglans regia*).—The walnut-tree is a native of Greece, Asia Minor, Persia, along the Hindu Kush to the Himalayas, Kashnir, Kumaon, Nepal, and China, and is cultivated in Europe up to 55° N. lat., thriving best in dry, deep, strong loam. It reaches 60 ft. high and 30-40 in. diam. The young wood is inferior; it is in best condition at about 50-60 years. Its scarcity excludes it from building application, but its beauty, durability, toughness, and other good qualities render it esteemed for cabinet-making and gun-stocks. Its weight is 40-48 lb. a cub. ft.; cohesive force, 5360-8130 lb.; strength, 74; stiffness, 49; toughness, 111—all taken on a green sample. Of the walnut-burrs (or *loupes*), for which the Caucasus was once famous, 90 per cent. now come from Persia. The walnut forests along the Black Sea, which give excellent material for gun-stocks, do not produce burrs, which only occur in the drier climates of Georgia, Daghestan, and Persia. Italian walnut is worth 4-5½d. a ft.

Walnut [Black Virginia] (*Juglans nigra*).—This is a large tree ranging from Pennsylvania to Florida; the wood is heavier, stronger, and more durable than European walnut, and is well adapted for naval purposes, being free from worm attacks in warm latitudes. It is extensively used in America for various purposes, especially cabinet-making.

Willow (*Salix spp.*).—The wood of the willow is soft, smooth, and light, and adapted to many purposes. It is extensively used for the blades of cricket-bats, for building fast-sailing sloops, and in hat-making, and its charcoal is used in gunpowder-making.

Yellow-wood or Geel hout (*Taxus elongatus*).—This is one of the largest trees of the Cape Colony, reaching 6 ft. diam. Its wood is extensively used in building, though it warps much in seasoning, and will not bear exposure.

Yew (*Taxus baccata*).—This long-lived shrubby tree inhabits Europe, N. America, and Japan, being found in most parts of Europe at 1000-4000 ft., and frequently on the Apennines, Alps, and Pyrenees, and in Greece, Spain, and Great Britain. The stem is short, but reaches a great diameter (up to 20 ft.). The wood is exceedingly durable in flood-gates, and beautiful for cabinet-making. Its weight is 41-42 lb. a cub. ft.; cohesive force, 8000 lb.

As this volume is intended as much for colonial as for home readers, it will be useful to give a brief summary of the woods native to various localities:—

British Guiana Woods.—The only wood from this colony which is known as it deserves is the greenheart, already described at p. 133. Yet there are several other woods equally worthy of being studied and utilized; among them the following were mentioned recently by Dr. Prior at the Linnean Society. "Ducalibolly" is a rare red wood used in the colony for furniture. "Hyawa-bolly" (*Omphalobium Lambertii*) is a rare tree 20 ft. high, known commercially as zebrawood. Lancewood is variously referred to *Duguetia quitarensis*, *Guatteria virgata*, *Oxyandra virgata*, *Xylopia sp.*, and *Rollinia Sieberi*; there seem to be 2 kinds, a "black" called *carisiri*, growing 50 ft. high and 4-8 in. diam., only slightly taper and affording by far the better timber, and a "yellow" called "yari-yari" (*Jijécou* in French Guiana), 15-20 ft. high and 4-6 in. diam.; the Indians make their arrow points of this wood, and the spars go to America for carriage building. Letter-wood (*Brosimum auletii*) is useful for inlaying and for making very choice walking-sticks.

Cape, Natal, and Transvaal Woods.—The timber trees of Cape Colony and Natal are chiefly evergreens. Their wood is dry and tough, and worked with more or less

difficulty. Owing to the dryness of the soil and climate, it is very liable to warp and twist in seasoning. Some descriptions shrink longitudinally as well as transversely, and with few exceptions the timber is not procurable in logs of more than 12-15 in. diameter. The Cape woods principally used for waggon-making, mill machinery, fences, posts, &c., are assegai wood, essen wood or Cape ash, cedarwood, red and white ironwood (excellent for spokes); and melk wood, red and white, for felloes of wheels. These are principally brought to the market in convenient scantlings for the purposes for which they are required, and are all rather tough than hard to work. They have considerable specific gravity, and at first an English carpenter finds it difficult to do a satisfactory day's work with them. No European wood can stand the heat and dryness of the Cape climate as these woods do.

Assegai-wood, Cape lancewood, or Oomhlebe: weight, 56 lb. per cub. ft.; cost of working 1.5 times as much as fir; colour, light-red; grain, like lancewood; very tough and elastic; used for wheel-spokes, shafts, waggon-rails, assegai-shafts, turnery.

Cedar boom: weight, 41 lb.; cost of working, 1.25; used for floors, roofs, and other building purposes; grain not unlike Havannah cedar, but of a lighter colour; will not stand exposure to the weather.

Doorn boom, Kameel doorn, Makohala or Motootla: weight 40 lb.; cost of working, 1.25; several varieties afford small timber available for fencing, spars, &c., and are also much used for fuel, chareoal, &c.

Els (white) or Alder; weight, 38 lb.; cost of working, 1.25; used for palings, posts, and ordinary carpentry.

Els (red): weight, 47 lb.; cost of working 1.6; grain, colour of red birch; used for waggon-building and farm purposes.

Els (rock): a harder and smaller variety of the last.

Essen hout, Cape ash, or Oomnyamati: weight, 48 lb.; cost of working, 1.30; used for common floors, palings, &c.; is a tough and valuable timber, somewhat resembling elm; can be procured up to 18 in. sq.

Flat crownwood: cost of working, 1.30; grows in Natal to 2 ft. diameter; the wood is similar to elm, but of a bright yellow colour, with a fine and even grain; used for the naves of wheels.

Ironwood (black), Tambooti, or Hooshe: weight, 64 lb.: cost of working, 2.0; the grain fine, like pear tree; used for waggon axles, cogs of machine wheels, spokes, telegraph poles, railway sleepers, piles, &c.; is very durable, and can be obtained in logs up to 18 in. sq.

Ironwood (white), or Oomzimbiti: used for same purposes as black.

Kafir boom, Oomsinsi, or Limsootsi: weight, 38 lb.; wood, soft and light; the grain open and porous; splits easily; and is used principally for roof shingles, owing to its not being liable to take fire.

Mangrove (red): used in Natal for posts and fencing generally.

Melk hout, Milkwood, or Oomtombi: weight, 52 lb.; cost of working, 1.75; colour, white; used in the construction of waggons (wheelwork); there is also a darker variety.

Oliven hout, Wild olive, or Kouka; weight, 60 lb.; cost of working, 2.0; wood of small size, and generally decayed at the heart; used for fancy turnery, furniture, &c.

Pear hout or Kwa: weight, 46 lb.; resembles European pear, but closer in the grain.

Saffraan hout: weight, 54 lb.; wood strong and tough; used for farm purposes.

Sneezewood, Nies hout, or Oomtata: weight, 68 lb.; cost of working, 3.0; most durable and useful timber, resembling satinwood; very full of gum or resin resembling guaiacum; burns like candlewood; invaluable for railway sleepers, piles, &c., as it is almost imperishable, and is very useful for door and sash sills or similar work; difficult to be procured of large scantling.

Stinkwood, Cape mahogany, or Cape walnut: weight, 53 lb.; cost of working, 1·6; resembles dark walnut in grain; is used for furniture, gun-stocks, &c.; while working, it emits a peculiar odour; stands well when seasoned; usually to be obtained in planks 10-16 in. wide and 4 in. thick; there are one or two varieties which are inferior; for furniture, it should be previously seasoned by immersing the scantlings, sawn as small as possible, in a sand bath heated to about 100° F. (38° C.).

Yellow-wood, Geel hout, or Oomkoba: weight, 40 lb.; cost of working, 1·35; one of the largest trees that grows in the Cape, and often found upwards of 6 ft. in diameter; the wood is extensively used for common building purposes; it warps much in seasoning, and will not stand exposure to the weather; the colour is a light-yellow, which, with the grain, resembles lancewood; it shrinks in length about $\frac{1}{10}$ part; it has rather a splintery fracture, which makes it very unsafe for positions where heavy cross strains may be expected; for flooring, it does well, but should be well seasoned and laid in narrow widths; planks up to 24 in. wide can be got, but 12-in. ones are more general; it suffers much loss in conversion, owing to twisting; when very dry, it is apt to split in nailing; and is subject to dry-rot if not freely ventilated.

Willow or Wilge boom: weight, 38 lb.; this wood, which grows along the banks of rivers, is of little value, as it is soon destroyed by worms; but is used where other timber is scarce; makes good charcoal.

Ceylon woods.—In the following list of Ceylon woods, the breaking-weight and the deflection before breaking are taken on a bar 24 in. long and 1 in. square; the absorptive power is calculated on a block measuring 12 in. by 4 in. by 4 in.; and the weight represents 1 cub. ft.

Alubo: weight, 49 lb.; durability, 20 years; use, common house-building.

Aludel: breaking weight, 356 lb.; deflection, 1 in.; absorption, 15 oz.; weight, 51 lb.; durability, 35-70 years; logs average 22½ ft. by 16 in.; uses, fishing boats and house buildings.

Aramana: breaking weight, 297 lb.; deflection, 1½ in.; absorption, 13 oz.; weight, 57 lb.; durability, 50 years; logs average 15 ft. by 13 in.; uses, furniture and house buildings.

Beriya: weight, 57 lb.; durability, 10-30 years: uses, anchors and house-building.

Buruta or Satinwood: breaking-weight, 521 lb.; deflection, 1 in.; absorption, 14 oz.; weight, 55 lb.; durability, 10-80 years; logs average 19 ft. by 20½ in.; uses, oil-presses, waggon-wheels, bullock-carts, bridges, cog-wheels, buildings, and furniture.

Calamander: weight, 57 lb.; durability, 80 years; a scarce and beautiful wood; the most valuable for ornamental purposes in Ceylon.

Daminna: weight, 44 lb.; durability, 40 years; uses, gun-stocks and common house buildings.

Dangaha: weight, 23 lb.; buoys for fishing nets, models for dhonies.

Dawata: weight, 43 lb.; durability, 25 years; uses, roofs of common buildings.

Del: breaking-weight, 264 lb.; deflection, $\frac{7}{8}$ in.; absorption, 17 oz.; weight, 40 lb.; durability, 20-50 years.; logs average 22½ ft. by 16 in.; uses, boats and buildings.

Dun: weight, 29 lb.; durability, 50 years; uses, house buildings.

Ebony: breaking-weight, 360 lb.; deflection, 1¾ in.; absorption, 11 oz.; weight, 71 lb.; durability, 80 years; logs average 12½ ft. by 13 in.; a fine black wood, used largely for buildings and furniture.

Gal Mendora: breaking-weight, 370 lb.; deflection, 1¼ in.; absorption, 14 oz.; weight, 57 lb.; durability, 15-60 years; logs average 22½ ft. by 13 in.; uses, bridges and buildings; is the best wood for underground purposes; also used for reepers (battens) for tiling.

Gal Mora: weight, 65 lb.; durability, 30 years; uses, house buildings, and gives best firewood for brick- and lime-kilns.

Godapara: weight, 51 lb.; durability, 60 years; use, roofs for houses.

Gorukina: weight, 44 lb.; durability, 25 years; uses, poles for bullock-carts, and house buildings.

Hal: weight, 26 lb.; durability, 10 years; uses, packing cases, ceilings, coffins.

Hal Mendora: weight, 56 lb.; durability, 8-20 years; uses, bridges and house buildings, lasts longer than the preceding for underground purposes.

Hal Milila: breaking-weight, 422 lb.; deflection, $2\frac{1}{4}$ in.; absorption, 6 oz.; weight, 48 lb.; durability, 10-80 years; logs average 20½ ft. by 14¾ in.; uses, casks, tubs, carts, waggons, and buildings; is the best wood for oil-casks in the island.

Hirikadol: weight, 49 lb.; durability, 15 years; use, common house buildings.

Hora: weight, 45 lb.; durability, 15 years; use, roofs of common buildings.

Ironwood: breaking-weight, 497 lb.; deflection, 1 in.; absorption 7 oz.; weight, 72 lb.; durability, 10-60 years; logs average 22½ ft. by 14½ in.; uses, bridges and buildings.

Jack: breaking-weight, 306 lb.; deflection, $\frac{7}{8}$ in.; absorption, 17 oz.; weight, 42 lb.; durability, 25-80 years; logs average 21 ft. by 17 in.; in general use for buildings, boats, and all kinds of furniture.

Kadol: weight, 65 lb.; durability, 40 years; use, common house-building.

Kadubberiya or Bastard ebony; weight, 45 lb.; durability, 40 years; use, furniture; the heart of this wood is occasionally of great beauty.

Kaha Milila: breaking-weight, 385 lb.; deflection, 1 in.; absorption, 8 oz.; weight, 56 lb.; durability, 15-80 years; logs average 16 ft. by 18½ in.; uses, water-casks, padé-boats, waggon-wheels, bullock-carts, bridges, and buildings.

Kahata: weight, 38 lb.; durability, 10-20 years; uses, axles for bullock bandies, and buildings.

Kalukela: weight, 38 lb.; durability, 30 years; uses, common house buildings; when variegated, it is a beautiful wood, and is used for furniture and cabinet-work.

Kiripella: weight, 30 lb.; durability, 20-30 years; uses, common furniture and house buildings.

Kiriwala: weight, 35 lb.; durability, 30 years; uses, principally for inlaying ornamental furniture and cabinet-work.

Kitul: weight, 71 lb.; durability, 30-90 years; uses, reepers (roof battens) and window-bars.

Kokatiya: weight, 56 lb.; durability, 80 years; use, house buildings.

Kon: weight, 49 lb.; durability, 5-10 years; uses, native oil presses and wooden anchors.

Kottamba: weight, 38 lb.; durability, 30 years; use, common house buildings.

Mal Buruta: breaking-weight, 252 lb.; weight, 57 lb.; durability, 80 years; logs average 19 ft. by 20½ in.; use, furniture, being the most valuable Ceylon wood next to Calamander.

Mi: breaking-weight, 362 lb.; deflection, 1 in.; absorption, 15 oz.; weight, 61 lb.; durability, 25-80 years; logs average 25 ft. by 16 in.; uses, keels for dhonies, bridges, and buildings.

Mian Milila: breaking-weight, 394 lb.; deflection, 1 in.; absorption, 8 oz.; weight, 56 lb.; durability, 20-90 years; logs average 16 ft. by 18½ in.; uses, bridges, padé-boats, cart and waggon-wheels, water-tubs, house buildings.

Muruba; weight, 42 lb.; durability, 30-40 years; uses, water and arrack casks, buildings, and underground purposes.

Nedun: breaking-weight, 437 lb.; deflection, 1 in.; absorption, 12 oz.; weight, 56 lb.; durability, 60-80 years; logs average 15 ft. by 16 in.; uses, buildings and furniture.

Nelli: weight, 49 lb.; durability, 30 years; uses, wheels and wells.

Pol or Coconut: weight, 70 lb.; durability, 20-50 years; uses, buildings, fancy boxes, and furniture.

Sapu: weight, 42 lb.; durability, 20-50 years; uses, carriages, palankins, &c.; in buildings it is a very good wood for window-sashes.

Sapu Milila: weight, 49 lb.; durability, 10–40 years; uses, water-casks, cart and waggon wheels, padé-boats, bridges, and house buildings.

Suriya: breaking-weight, 354 lb.; deflection, $1\frac{1}{8}$ in.; absorption, 16 oz.; weight, 49 lb.; durability, 20–40 years; logs average 12 ft. by 16 in.; uses, admirable for carriages, hackeries, gun-stocks, and in buildings.

Tal: breaking-weight, 407 lb.; deflection, $\frac{3}{4}$ in.; absorption, 13 oz.; weight, 65 lb.; durability, 80 years; uses, rafters and reepers (battens for roofs).

Teak: breaking-weight, 336 lb.; deflection, $\frac{2}{5}$ in.; absorption, 13 oz.; weight, 44 lb.; durability, 15–90 years; logs average 23 ft. by $17\frac{1}{2}$ in.; uses, carts, waggons, bridges, buildings, and arrack casks, imparting fine colour and flavour to the liquor.

Ubbariya: breaking-weight, 232 lb.; weight, 51 lb.; durability, 80 years; uses, rafters and reepers.

Velanga: weight, 36 lb.; uses, poles of bullock-carts, betel trays, and gun-stocks.

Walbambu: weight, 36 lb.; durability, 15 years; use, common house buildings.

Waldomba: weight, 39 lb.; durability, 20 years; use, common house buildings.

Walukina: weight, 39 lb.; durability, 10 years; use, masts of dhonies.

Welipenna: weight, 35 lb.; durability, 40 years; use, common house buildings.

Wewarana: weight, 62 lb.; durability, 60 years; uses, house buildings and pestles.

English woods.—The spruce fir of Oxfordshire is used for scaffold-poles, common carpentry, &c.; the maple of the same county is valuable for ornamental work when knotted, it makes the best charcoal and turns well. The Wandsworth sycamore is used in dry carpentry, turns well and takes a fine polish. The Wandsworth horse-chestnut is used for inlaying toys, turnery, and dry carpentry. The Oxfordshire alder for common turnery work, &c., and lasts long under water or buried in the ground. The Killarney arbatus is hard, close-grained, and occasionally used by turners; the Killarney barberry is chiefly used for dyeing. The common birch of Epping is inferior in quality, but much used in the North of England for herring barrels. The Epping hornbeam is very tough, makes excellent cogs for wheels, and is much valued for fuel. Cornwall chestnut is valuable in ship-building, and is much in repute for posts and rails, hop-poles, &c. Cedar of Lebanon makes good furniture, and is sometimes employed for ornamental joinery work. The common cherry is excellent for common furniture, and much in repute; it works easily, and takes a fine polish. The young wood of the common nut is used for fishing rods, walking sticks, &c. The Epping white thorn is hard, firm, and susceptible of a fine polish; that of Mortlake is fine-grained and fragrant, and very durable. Oxfordshire common laburnum is hard and durable, and much used by turners and joiners. Lancewood is hard and fine-grained, and makes excellent skewers. Oxfordshire common beech is much used for common furniture, for handles of tools, wooden vessels, &c., and when kept dry is durable. Oxfordshire common ash is very tough and elastic. It is much used by the coachmaker and wheelwright, and for the making of oars. Holly is the best whitewood for Tunbridge ware, turns well, and takes a very fine polish. The common walnut of Sussex is used for ornamental furniture, is much in repute for gun-stocks, and works easily. Oxfordshire larch is excellent for house carpentry and ship-building; it is durable, strong, and tough. Mortlake common mulberry is sometimes worked up into furniture, and is useful to turners, but is of little durability. Silver fir is used for house carpentry, masts of small vessels, &c. Oxfordshire pine makes good rafters and girders, and supplies wood for house carpentry. The Wandsworth plane is an inferior wood, but is much used in the Levant for furniture. The damson of that part is hard and fine-grained, but not very durable, and is suitable for turning. The laurel is hard and compact, taking a good polish. The Yorkshire mountain ash is fine-grained, hard, and takes a good polish, and is of great value for turnery, and for musical instruments. Yorkshire crab is hard, close-grained, and strong. Epping service-tree, hard, fine-grained, and compact, and much in repute by millwrights for cogs, friction rollers, &c. Wandsworth evergreen oak is very shaky when aged, is

strong and durable, and makes an excellent charcoal. Sussex oak is much esteemed for ship-building, and is the strongest and most durable of British woods. Welsh oak is a good wood for ship-building, but is said to be inferior to the common oak. Epping common acacia is much used for treenails in ship-building, and in the United States is much in repute for posts and rails. Surrey white willow is good for toys, and used by the millwright; it is tough, elastic, and durable. Oxfordshire palm willow is tough and elastic, is much used for handles to tools, and makes good hurdles. Oxfordshire crack willow is light, pliant, and tough, and is said to be very durable. The yew is used for making bows, chairs, handles, &c.; the wood is exceedingly durable, very tough, elastic, and fine-grained. Wandsworth common lime is used for cutting blocks, carving, sounding boards, and toys. English elm is used in ship-building, for under-water planking, and a variety of other purposes, being very durable when kept wet, or buried in the earth; and Oxfordshire wych elm is considered better than common elm, and is used in carpentry, ship-building, &c. Specimens of the above were shown at the Great Exhibition of 1862. Of course, the list is far from being exhausted, still sufficient has been said to give an idea of the various uses to which our home-grown wood can be put.

Indian woods.—In the following descriptions of Indian woods, the “weight” denotes that of 1 cub. ft. of seasoned timber, “elasticity” is the coefficient of elasticity, “cohesion” is the constant of direct cohesion in lb. per sq. in., “strength” is the constant of strength in lb. for cross strains.

Abies Smithiana: furnishes a white wood, easily split into planks, but not esteemed as either strong or durable; used as “shingle” for roof coverings.

Acacia arabica: weight 54 lb.; elasticity, 4186; cohesion, 16,815 lb.; strength, 884 lb.; seldom attains a height of 40 ft., or 4 ft. in girth: its wood is close-grained and tough; of a pale-red colour inclining to brown; can never be had of large size, and is generally crooked; used for spokes, naves, and felloes of wheels, ploughshares, tent pegs.

Acacia Catechu: weight, 56–60 lb.; a heavy, close-grained, and brownish-red wood, of great strength and durability; employed for posts and uprights of houses, spear and sword handles, ploughs, pins and treenails of cart-wheels; but rarely available for timber.

Acacia elata: weight, 39 lb.; elasticity, 2926; cohesion, 9518 lb.; strength, 695 lb.; furnishing logs 20–30 ft. long, and 5–6 ft. in girth; wood red, hard, strong, and very durable; used in posts for buildings, and in cabinet-work.

Acacia leucophloea: weight, 55 lb.; elasticity, 4086; cohesion, 16,288 lb.; strength, 861 lb.; resembles *A. arabica* and has similar uses.

Acacia modesta: very hard and tough timber, suitable for making mills, &c.

Acacia speciosa: weight, 55 lb.; elasticity, 3502; strength, 600 lb.; grows to 40–50 ft. in height and 5–6 ft. in girth: the wood is said by some writers to be hard, strong, and durable, never warping or cracking, and to be used by the natives of South India for naves of wheels, pestles and mortars, and for many other purposes; but in Northern India it is held to be brittle, and fit only for such purposes as box planks and firewood.

Acacia stipulata: weight, 50 lb.; elasticity, 4474; cohesion, 21,416 lb.; strength, 823 lb.; furnishes large, strong, compact, stiff, fibrous, coarse-grained, reddish-brown timber, well suited for wheel naves, furniture, and house-building.

Adenantha pavonina: weight, 55 lb.; elasticity, 3103 lb.; cohesion, 17,846 lb.; strength, 863–1060 lb.; timber does not enter the market in large quantities; is strong, but not stiff; hard and durable, tolerably close and even-grained, and stands a good polish; when fresh cut, it is of beautiful red coral colour, with a fragrance somewhat resembling sandalwood; after exposure it becomes purple, like rosewood; used sometimes as sandalwood, and adapted for cabinet-making purposes.

Ailanthus excelsa: wood is white, light, and not durable; used for scabbards, &c.

Albizzia elata: weight, 42-55 lb.; used by the Burmese for bridges and house-posts; it has a large proportion of sapwood, but the heartwood is hard and durable; may eventually become a valuable article of trade.

Albizzia stipulata: weight, 66 lb.; has a beautifully streaked brown heartwood, which is much prized for cart-wheels and bells for cattle.

Albizzia sp. (Kokoh): weight, 46 lb.; elasticity, 4123; cohesion, 19,263 lb.; strength, 855 lb.; much valued by the Burmese for cart-wheels, oil-presses, and canoes.

Artocarpus hirsuta (Anjilli): weight, 40 lb.; elasticity, 3905; cohesion, 15,070 lb.; strength, 744 lb.; especially esteemed as a timber bearing submersion in water; durable, and much sought after for dockyards as second only to teak for ship-building; also used for house-building, canoes, &c.

Artocarpus integrifolia (Jack): weight, 44 lb.; elasticity, 4030; cohesion 16,420 lb.; strength, 788 lb.; wood when dry is brittle, and has a coarse and crooked grain; is, however, suitable for some kinds of house carpentry and joinery; tables, musical instruments, cabinet and marquetry work, &c.; wood when first cut is yellow, afterwards changing to various shades of brown.

Artocarpus Lacoocha (Monkey Jack): weight, 40 lb.; wood used in Burma for canoes.

Artocarpus mollis: weight, 30 lb.; used for canoes and cart-wheels.

Azadirachta indica (Neem): weight, 50 lb.; elasticity, 2672-3183; cohesion, 17,450 lb.; strength, 720-752 lb.; wood is hard, fibrous, and durable, except from attacks of insects; it is of a reddish-brown colour, and is used by the natives for agricultural and building purposes; is difficult to work, but is worthy of attention for ornamental woodwork; long beams are seldom obtainable; but the short thick planks are in much request for doors and door-frames for native houses, on account of the fragrant odour of the wood.

Barringtonia acutangula: weight, 56 lb.; elasticity, 4006; cohesion, 19,500 lb.; strength, 863 lb.; wood of a beautifully red colour, tough and strong, with a fine grain, and susceptible of good polish; used in making carts, and is in great request by cabinet-makers.

Barringtonia racemosa: weight, 56 lb.; elasticity, 3845; cohesion, 17,705 lb.; strength, 819 lb.; wood is lighter coloured, and close-grained, but of less strength than that of the last-named species; used for house-building and cart-framing, and has been employed for railway-sleepers.

Bassia latifolia: weight, 66 lb.; elasticity, 3420; cohesion, 20,070 lb.; strength, 760 lb.; wood is sometimes used for doors, windows, and furniture; but it is said to be eagerly devoured by white ants.

Bassia longifolia: weight, 60 lb.; elasticity, 3174; cohesion, 15,070 lb.; strength, 730 lb.; is used for spars in Malabar, and considered nearly equal to teak, though smaller.

Bauhinia variegata: centre wood is hard and dark like ebony, but seldom large enough for building purposes.

Berrya ammonilla (Trincomallie): weight, 50 lb.; elasticity, 3836; cohesion, 26,704 lb.; strength, 784 lb.; most valuable wood in Ceylon for naval purposes, and furnishes the material of the Madras Masoola boats; considered the best wood for capstan bars, crosstrees, and fishes for masts; is light, strong, and flexible, and takes the place of ash in Southern India for shafts, helms, &c.

Bignonia chelonoides: weight, 48 lb.; elasticity, 2804; cohesion, 16,657 lb.; strength, 642 lb.; wood is highly coloured orange-yellow, hard, and durable; a good fancy wood, and suitable for building.

Bignonia stipulata: weight, 64 lb.; elasticity, 5033; cohesion, 28,998 lb.; strength, 1386 lb.; furnishes logs 18 ft. in length and 4 ft. in girth, with strong, fibrous, elastic

timber, resembling teak; used in house-building, and for bows and spear-handles; one of the strongest, densest, and most valuable of the Burman woods.

Bombax heptaphyllum: elasticity, 2225; cohesion, 6951 lb.; strength, 678 lb.; light loose-grained wood, valueless as timber, but extensively used for packing cases, tea-chests, and camel trunks; and as it does not rot in water, it is useful for stakes in canal banks, &c.; long planks 3 ft. in width can be obtained from old trees.

Borassus flabelliformis: weight, 65 lb.; elasticity, 4904; cohesion, 11,898 lb.; strength, 944 lb.; timber is very durable and of great strength to sustain cross strain; used for rafters, joists, and battens; trees have, however, to attain a considerable age before they are fit for timber.

Bridelia spinosa: weight, 60 lb.; elasticity, 4132; cohesion, 14,801 lb.; strength, 892 lb.; strong, tough, durable, close-grained wood, of a copper colour, which, however, is not easily worked; employed by the natives for cart-building and house-beams, and is also used for railway-sleepers; lasts under water, and is consequently used for well-curbs.

Butea frondosa: wood is generally small or gnarled, and used only for firewood; in Guzerat, however, it is extensively used for house purposes, and deemed durable and strong.

Buxus nepalensis: a very valuable wood for engraving, but inferior to the Black Sea kind of box in closeness of grain and in hardness.

Byttneria sp.: weight, 63 lb.; elasticity, 4284; cohesion, 26,571 lb.; strength, 1012 lb.; wood of great elasticity and strength, invaluable for gun-carriages; used by Burmese for axles, cart-poles, and spear-handles.

Caesalpinia Sappan: weight, 60 lb.; elasticity, 4790; cohesion, 22,578 lb.; strength, 1540 lb.; admirably adapted for ornamental work, being of a beautiful "flame" colour, with a smooth glassy surface, easily worked, and neither warping nor cracking.

Calophyllum angustifolium: weight, 45 lb.; elasticity, 2944; cohesion, 15,864 lb.; strength, 612 lb.; see Poon, p. 145.

Calophyllum longifolium: weight, 45 lb.; elasticity, 3491; cohesion, 16,388 lb.; strength, 546 lb.; a red wood, excellent for masts, helms, &c., and also (when well cleaned and polished) for furniture; but it does not appear to be abundant.

Careya arborea: weight, 50–56 lb.; elasticity, 3255; cohesion, 14,803 lb.; strength, 675–870 lb.; furnishes a tenacious and durable wood, which admits of a fine polish; does not, however, appear to be much used as timber, except in Pegu, where it grows to a very large size, and is the chief material of which the carts of the country are made, and the red wood is esteemed equivalent to mahogany.

Casuarina muricata: weight, 55 lb.; elasticity, 4474; cohesion, 20,887 lb.; strength, 920 lb.; yields a strong, fibrous, stiff timber, of reddish colour.

Cathartocarpus Fistula: weight, 41 lb.; elasticity, 3153; cohesion, 17,705 lb.; strength, 846 lb.; generally a small tree, whose close-grained, mottled, dark-brown wood is suited for furniture; in Malabar, however, it grows large enough to be used for spars of native boats.

Cedrela Toona: weight, 31 lb.; elasticity, 2684–3568; cohesion, 9000 lb.; strength, 560 lb.; see Toon, p. 149.

Cedrus Deodara: elasticity, 3205–3925; strength, 456–625 lb.; see Deodar, p. 132.

Chickrassia tabularis: weight, 42 lb.; elasticity, 2876; cohesion, 9943 lb.; strength, 614 lb.; stronger and tougher than Toon (p. 149), but very liable to warp; used as mahogany by cabinet-makers.

Chloroxylon Swietenia: weight, 60 lb.; elasticity, 4163; cohesion, 11,369 lb.; strength, 870 lb.; see Satinwood, p. 147.

Cocos nucifera: weight, 70 lb.; elasticity, 3605; cohesion, 9150 lb.; strength, 608 lb.; gives a hard and durable wood, fitted for ridge-poles, rafters, battens, posts, pipes, boats, &c.

Connarus speciosa: heavy, strong, white timber, adapted to every purpose of house-building.

Conocarpus acuminatus: weight, 59 lb.; elasticity, 4352; cohesion, 20,623 lb.; strength, 880 lb.; heartwood is reddish brown, hard, and durable; used for house and cart building; exposed to water, it soon decays.

Conocarpus latifolius: weight, 65 lb.; elasticity, 5033; cohesion, 21,155 lb.; strength, 1220 lb.; furnishes a hard, durable, chocolate-coloured wood, very strong in sustaining cross strain; in Nagpore 20,000 axletrees are annually made from this wood; it is well suited for carriage shafts.

Dalbergia latifolia; weight, 50 lb.; elasticity, 4053; cohesion, 20,283 lb.; strength, 912 lb.; perhaps the most valuable tree of the Madras Presidency, furnishing the well-known Malabar blackwood; the trunk sometimes measures 15 ft. in girth, and planks 4 ft. broad are often procurable, after the outside white wood has been removed; used for all sorts of furniture, and is especially valued in gun-carriage manufacture.

Dalbergia oojeinensis: centre timber is dark, of great strength and toughness, especially adapted for cart-wheels and ploughs.

Dalbergia Sissu: weight, 50 lb.; elasticity, 3516-4022; cohesion, 12,072-21,257 lb.; strength, 706-807 lb.; see *Sissu*, p. 147.

Dillenia pentagyna; weight, 70 lb.; elasticity, 3650; cohesion, 17,053 lb.; strength, 907 lb.; furnishing some of the Poon spars of commerce; wood used in house and ship building, being close-grained, tough, durable (even under ground), of a reddish-brown colour, not easily worked, and subject to warp and crack.

Dillenia speciosa: weight, 45 lb.; elasticity, 3355; cohesion, 12,691 lb.; strength, 721 lb.; light, strong, light-brown wood, of the same general characteristics with the preceding tree; used in house-building and for gun-stocks.

Diospyros Ebenum: see *Ebony*, p. 132.

Diospyros hirsuta: weight, 60 lb.; elasticity, 4296; cohesion, 19,830 lb.; strength, 757 lb.; see *Calamander wood*, p. 152.

Diospyros melanoxylon: weight, 81 lb.; elasticity, 5058; cohesion, 15,873 lb.; strength, 1180 lb.; furnishing a valuable wood for inlaying and ornamental turnery; the sapwood white, the heartwood even-grained, heavy, close, and black, standing a high polish.

Diospyros tomentosa: furnishing a hard and heavy black wood; young trees are extensively felled by the natives as cart-axles, for which they are well suited from their toughness and strength.

Dipterocarpus alatus: weight, 45 lb.; elasticity, 3247; cohesion, 18,781 lb.; strength, 750 lb.; timber is excellent for every purpose of house-building, but if exposed to moisture is not durable; it is hard and coarse-grained, with a powerful odour, and of light-brown colour.

Dipterocarpus turbinatus: weight, 45-49 lb.; elasticity, 3355; cohesion, 15,070 lb.; strength, 762-807 lb.; a coarse-grained timber of a light-brown colour, not easily worked, and not durable; used by the natives for house-building, in sawn planks, which will not stand exposure and moisture.

Emblica officinalis: weight, 46 lb.; elasticity, 2270; cohesion, 16,964 lb.; strength, 562 lb.; furnishing a hard and durable wood, used for gun-stocks, furniture, boxes, and veneering and turning; is suitable for well-curbs, as it does not decay under water.

Erythrina indica: furnishes a soft, white, easily worked wood, being light, but of no strength, and eagerly attacked by white ants; used for scabbards, toys, light boxes and trays, &c.; grows very quickly from cuttings.

Feronia elephantum: weight, 50 lb.; elasticity, 3248; cohesion, 13,909 lb.; strength, 645 lb.; a yellow-coloured, hard, and compact wood, used by the natives in house- and cart-building, and in some places employed as railway sleepers.

Ficus glomerata (*Gooler*): weight, 40 lb.; elasticity, 2096-2113; cohesion, 12,691 lb.;

strength, 588 lb.; wood is light, tough, coarse-grained, and brittle; used for door-panels, and, being very durable under water, for well-curbs.

Ficus indica (Banyan): weight, 36 lb.; elasticity, 2876; cohesion, 9157 lb.; strength, 600 lb.; wood is brown-coloured, light, brittle, and coarse-grained, neither strong nor durable (except under water, for which cause it is used for well-curbs); the wood, however, of its pendant aerial roots is strong and tough, and used for yokes, tent-poles, &c.

Ficus religiosa: weight, 34 lb.; elasticity, 2371–2454; cohesion, 7535 lb.; strength, 458–584 lb.; similar in appearance, characteristics, and uses to banyan.

Gmelina arborea: weight, 35 lb.; elasticity, 2132; has a pale-yellow wood, light, easily worked, not shrinking or warping, strong and durable, especially under water; it is, [however, readily attacked by white ants; used for furniture, carriage panels, palkees, &c.; in Burma, for posts and house-building generally.

Grewia clastica: weight, 34 lb.; elasticity, 2876; cohesion, 17,450 lb.; strength, 565 lb.; wood generally is procured in small scantlings, suitable for spear-shafts, carriage- and dooly-poles, bows, and tool-handles, for which it is admirably adapted, being light, soft, flexible, and fibrous, resembling lanecwood or hickory.

Guatteria longifolia: weight, 37 lb.; elasticity, 2860; cohesion, 14,720 lb.; strength, 547 lb.; wood is very light and flexible, but only used for drum cylinders.

Hardwickia binata: weight, 85 lb.; elasticity, 4579; cohesion, 12,016 lb.; strength, 942 lb.; furnishing a red- or dark-coloured, very hard, very strong and heavy wood, useful for posts, pillars, and piles; excellent also for ornamental turnery.

Heritiera minor: weight, 64 lb.; elasticity, 3775–4677; cohesion, 29,112 lb.; strength, 816–1312 lb.; the toughest wood that has been tested in India, and stands without a rival in strength; is used for piles, naves, felloes, spokes, carriage shafts and poles; is, however, a perishable wood, and shrinks much in seasoning.

Hopea odorata: weight, 45–58 lb.; elasticity, 3660; cohesion, 22,209 lb.; strength, 706–800 lb.; one of the finest timber trees of British Burma, sometimes reaching 80 ft. in height to the first branch, and 12 ft. in girth—a large boat of 8 ft. beam, and carrying 4 tons, being sometimes made of a single scooped-out trunk; wood is close, even-grained, of a light-brown colour.

Inga lucida: heartwood is black, and called “ironwood” in Burma.

Inga xylocarpa: weight, 58 lb.; elasticity, 4283; cohesion, 16,657 lb.; strength, 836 lb.; furnishing a wood of very superior quality, heavy, hard, close-grained, and durable, and of a very dark-red colour; it is, however, not easily worked up, and resists nails; is extensively used for bridge-building, posts, piles, &c., and is a good wood for sleepers, lasting (when judiciously selected and thoroughly seasoned) for 6 years.

Juglans regia (walnut): its beautiful wood is used for all sorts of furniture and cabinet work in the bazaars of the Hill stations.

Lagerstræmia reginæ: weight, 40 lb.; elasticity, 3665; cohesion, 15,388 lb.; strength, 637–642 lb.; the wood is used more extensively than any other, except teak, for boat-, cart-, and house-building, and in the Madras Gun-carriage Manufactory for felloes, naves, framings of waggons, &c.

Mangifera indica (mango): weight, 42 lb.; elasticity, 3120–3710; cohesion, 7702–9518 lb.; strength, 560–632 lb.; wood is of inferior quality, coarse, and open-grained, of a deep-grey colour, decaying if exposed to wet, and greedily eaten by white ants; is, however, largely used, being plentiful and cheap, for common doors and door-posts, boards and furniture; also for firewood; should never be used for beams, as it is liable to snap off short.

Melanorrhœa usitatissima: weight, 61 lb.; elasticity, 3016; strength, 514 lb.; furnishes a dark-red, hard, heavy, close and even-grained and durable (but brittle) timber; used for helves, sheave-blocks, machinery, railway sleepers, &c.

Melia Azadirach; weight, 30 lb.; elasticity, 2516; cohesion, 14,277 lb.; strength,

596 lb.; soft, red-coloured, loose-textured wood (resembling in appearance cedar), is used only for light furniture.

Michelia Champaca: weight, 42 lb.; in Mysore, trees measuring 50 ft. in girth 3 ft. above ground-level are found, and slabs 6 ft. in breadth can be obtained; as the wood takes a beautiful polish it makes handsome tables; it is of a rich brown colour.

Millingtonia hortensis: wood is white, fine and close-grained, but of little use.

Mimusops elengi: weight, 61 lb.; elasticity, 3653; cohesion, 11,369 lb.; strength, 632 lb.; wood is heavy, close and even-grained, of a pink colour, standing a good polish and is used for cabinet-making purposes, and ordinary house-building.

Mimusops hexandra: weight, 70 lb.; elasticity, 3948; cohesion, 19,036 lb.; strength, 944 lb.; furnishes wood very similar to the last named; used for similar purposes, and for instruments, rulers, and other articles of turnery.

Mimusops indica: weight, 48 lb.; elasticity, 4296; cohesion, 23,824 lb.; strength, 845 lb.; a coarse-grained, but strong, fibrous, durable wood, of a reddish-brown colour; used for house-building and for gun-stocks.

Morus indica (mulberry): wood is yellow, close-grained, very tough, and well suited for turning.

Nauclera Cadumba: a hard, deep-yellow, loose-grained wood, used for furniture; in the Gwalior bazaars it is the commonest building timber, and is much used for rafters on account of cheapness and lightness; but it is obtained there only in small scantlings.

Nauclera cordifolia: weight, 42 lb.; elasticity, 3052-3467; cohesion, 10,431 lb.; strength, 506-664 lb.; a soft, close, even-grained wood, resembling in appearance box, but light and more easily worked, and very susceptible to alternations of temperature; is esteemed as an ornamental wood for cabinet purposes.

Nauclera parviflora: weight, 42 lb.; strength, 400 lb.; a wood of fine grain, easily worked, used for flooring-planks, packing-boxes, and cabinet purposes; much used by the wood-carvers of Saharmpore.

Phoenix sylvestris: weight, 39 lb.; elasticity, 3313; cohesion, 8356 lb.; strength, 512 lb.

Picea webbiana: weight, 88 lb.; wood is white, soft, easily split, and used as shingle for roofing, but is not generally valued as timber.

Pinus excelsa (Silver Fir): furnishing a resinous wood much used for flambeaux; durable and close-grained; much used for burning charcoal in the hills, and also for building.

Pinus longifolia: elasticity, 3672-4668; strength, 582-735 lb.; being common and light, is largely used in house-building; requires, however, to be protected from the weather, and is suitable for only interior work in houses.

Pongamia glabra: weight, 40 lb.; elasticity, 3481; cohesion, 11,104 lb.; strength, 686 lb.; wood is light, tough, and fibrous, but not easily worked, yellowish brown in colour, not taking a smooth surface; solid wheels are made from this wood; it is, however, chiefly used as firewood, and its boughs and leaves as manure.

Prosopis spicigera: a strong, hard, tough wood, easily worked.

Psidium pomiferum (Guava): weight, 47 lb.; elasticity, 2676; cohesion, 13,116 lb.; strength, 618 lb.; furnishes a grey, hard, tough, light, very flexible, but not strong wood, which is very close and fine-grained, and easily and smoothly worked, so that it is fitted for wood-engraving, and for handles of scientific and other instruments.

Pterocarpus dalbergioides: weight, 49-56 lb.; elasticity, 4180; cohesion, 19,036 lb.; strength, 864-934 lb.; furnishes a red, mahogany-like timber, prized by the natives above all others for cart-wheels, and extensively used by Government in the construction of ordnance carriages.

Pterocarpus Marsupium: weight, 56 lb.; elasticity, 4132; cohesion, 19,943 lb.; strength, 868 lb.; wood is light-brown, strong, and very durable, close-grained, but not

easily worked; it is extensively used for cart-framing and house-building, but should be protected from wet; also well fitted for railway sleepers. ;

Pterocarpus Santalinus (Red Sandal): weight, 70 lb.; elasticity, 4582; cohesion, 19,036 lb.; strength, 975 lb.; heavy, extremely hard, with a fine grain, and is suitable for turnery, being of a dark-red colour, and taking a good polish.

Pterospermum acerifolium: a dark-brown wood of great value, and as strong as teak; but its durability has not yet been tested.

Putranjaya Roxburghii: wood is white, close-grained, very hard, durable, and suited for turning.

Quercus spp. (Oak): woods are heavy, and do not float for two years after felling, hence they are not sent down the rivers into the plains.

Rhus acuminata: furnishes a wood much valued by cabinet-makers for ornamental furniture: planks 8 x 2½ ft. can be obtained from some trees.

Santalum album (Sandal): weight, 58 lb.; elasticity, 3481; cohesion, 19,461 lb.; strength, 874 lb.; valued for making work-boxes, and small articles of ornament; and for wardrobe-boxes, &c., where its agreeable odour is a preventive against insects.

Sapindus emarginatus: weight, 64 lb.; elasticity, 3965; cohesion, 15,495 lb.; strength, 682 lb.; furnishing a hard wood, which is not durable or easily worked, and is liable to crack if exposed; but is used by natives for posts and door-frames, also for fuel.

Schleichera trijuga: a red, strong, hard, and heavy wood, used for oil-presses, sugar-crushers, and axles; a large and common tree in Burma, where excellent solid cart-wheels are formed from it.

Shorea obtusa: weight, 58 lb.; elasticity, 3500; cohesion, 20,254 lb.; strength, 730 lb.; a heavy and compact wood, closer and darker coloured than ordinary sál, used for making carts, and oil- and rice-mills.

Shorea robusta (Sál): weight, 55 lb.; elasticity, 4209-4963; cohesion, 11,521-18,243 lb.; strength, 769-880 lb.; furnishes the best and most extensively used timber in Northern India, and is unquestionably the most useful known Indian timber for engineering purposes; is used for roofs and bridges, ship-building and house-building, sleepers, &c.; timber is straight, strong, and durable, but seasons very slowly, and is for many years liable to warp and shrink.

Sonneratia apetala: yields a strong, hard, red wood of coarse grain, used in Calcutta for packing-cases for beer and wine, and is also adapted for rough house-building purposes.

Soymida febrifuga: weight, 66 lb.; elasticity, 3986; cohesion, 15,070 lb.; strength, 1024 lb.; furnishing a bright-red close-grained wood, of great strength and durability, preferred above all wood by the Southern India Hindus for the woodwork of their houses; though not standing exposure to sun and weather, it never rots under ground or in masonry, and is very well suited for palisades and railway sleepers.

Sterculia foetida: weight, 28 lb.; elasticity, 3349; cohesion, 10,736 lb.; strength, 464 lb.; in Ceylon it is used for house-building, and in Mysore for a variety of purposes, taking the place of the true Poon; wood is light, tough, open-grained, easily worked, not splitting nor warping, in colour yellowish-white.

Syzygium jambolanum: weight, 48 lb.; elasticity, 2746; cohesion, 8840 lb.; strength, 600 lb.; brown wood is not very strong or durable, but is used for door and window-frames of native houses, though more generally as fuel; is, however, suitable for well and canal works, being almost indestructible under water.

Tamarindus indica (Tamarind): weight, 79 lb.; elasticity, 2803-3145; cohesion, 20,623 lb.; strength, 816-864 lb.; heartwood is very hard, close-grained, dark-red, very hard to be worked; used for turnery, also for oil-presses and sugar-crushers, mallets, and plane-handles; is a very good brick-burning fuel.

Tectona grandis (Teak): weight, 42-45 lb.; elasticity, 3978; cohesion, 14,498-15,467 lb.; strength, 683-814 lb.; wood is brown, and when fresh cut is fragrant; very

hard, yet light, easily worked, and though porous, strong and durable; soon seasoned, and shrinks little; used for every description of house-building, bridges, gun-carriages, ship-building, &c.

Terminalia Arjuna: weight, 54 lb.; elasticity, 4094; cohesion, 16,288 lb.; strength, 820 lb.; furnishes a dark-brown, heavy, very strong wood, suitable for masts and spars, beams and rafters.

Terminalia Belerica: wood is white, soft, and not used in carpentry.

Terminalia Chebula: weight, 32 lb.; elasticity, 3108; cohesion, 7563 lb.; strength, 470 lb.; wood is used in Southern India for common house-building, but it is light and coarse-grained, possessing little strength, and liable to warp. In Burma it is used for yokes and canoes.

Terminalia coriacea: weight, 60 lb.; elasticity, 4043; cohesion, 22,351 lb.; strength, 860 lb.; the heartwood is one of the most durable woods known: reddish-brown, heavy, tough, and durable, very fibrous and elastic, close and even-grained; used for beams and posts, wheels, and cart-building generally, and telegraph-posts; is durable under water, and is not touched by white ants.

Terminalia glabra: weight 55 lb.; elasticity, 3905; cohesion, 20,085 lb.; strength, 840 lb.; furnishing a very hard, durable, strong, close and even-grained wood, of a dark-brown colour, obtainable in large scantling, and available for all purposes of house-building, cart-framing, and furniture.

Terminalia tomentosa: supplies a heavy, strong, durable, and elastic wood; is, however, a difficult timber to work up, and splits freely in exposed situations; good wood for joists, beams, tie-rods, &c., and for railway purposes, and is often sold in the market under the name of sāl, but it is not equal to that wood.

Thespesia populnea: weight, 49 lb.; elasticity, 3294; cohesion, 18,143 lb.; strength, 716 lb.; grows most rapidly from cuttings, but the trees so raised are hollow-centred, and only useful for firewood; seedling trees furnish a pale-red, strong, straight, and even-grained wood, easily worked; used for gun-stocks and furniture.

Trewia nudiflora: a white, soft, but close-grained wood.

Ulmus integrifolia (Elm): a strong wood, employed for carts, door-frames, &c.

Zizyphus Jujuba: weight, 58 lb.; elasticity, 3584; cohesion, 18,421 lb.; strength, 672 lb.; red dark-brown wood is hard, durable, close and even-grained, and well adapted for cabinet and oriental work.

New Zealand Woods.—The dimensions of the specimens described in the following table were 12 in. long, and 1 in. sq.

Name.	Specific Gravity.	Weight of 1 Cub. Ft.	Greatest Weight Carried with Unimpaired Elasticity.	Transverse Strength.
		lb.	lb.	lb.
Hinau (<i>Elæocarpus dentatus</i>)	·562	33·03	94·0	125·0
Kahika, supposed white pine	·502	31·28	57·3	77·5
Kahikatea, white pine (<i>Podocarpus dactyloides</i>),	·488	30·43	57·9	106·0
Kauri (<i>Dammara australis</i>)	·623	38·96	97·0	165·5
Kawaka (<i>Libocedrus Doniana</i>)	·637	39·69	75·0	120·0
Kohokohe (<i>Dysoxylum spectabile</i>) ..	·678	42·25	92·0	117·4
Kowhai (<i>Sophora tetraptera</i>)	·884	55·11	98·0	207·5
Maire, black (<i>Olea Cunninghamii</i>) ..	1·159	72·29	193·0	314·2
Maire (<i>Eugenia maire</i>)	·790	49·24	106·0	179·7
Mako (<i>Aristolelia racemosa</i>)	·593	33·62	62·0	122·0
Manoao (<i>Dacrydium colensoi</i>)	·788	49·1	200·0	230·0
Mangi, or mangeo (<i>Tetranthera calioaris</i>)	·621	38·70	109·0	137·8

Name.	Specific Gravity.	Weight of 1 Cub. Ft.	Greatest Weight Carried with Unimpaired Elasticity.	Transverse Strength.
		lb.	lb.	lb.
Manuka (<i>Leptospermum ericoides</i>) ..	·943	59·00	115·0	239·0
Mapau, red (<i>Myrsine urvillei</i>)	·991	61·82	92·0	192·4
Matapo, black mapau (<i>Pittospermum tenuifolium</i>)	·955	60·14	125·0	243·0
Matai (<i>Podocarpus spicata</i>)	·787	49·07	133·0	197·2
Miro (<i>Podocarpus ferruginea</i>)	·658	40·79	103·0	190·0
Puriri (<i>Vitex littoralis</i>)	·959	59·5	175·0	223·0
Rata, or ironwood (<i>Metrosideros lucida</i>)	1·045	65·13	93·0	196·0
Rewarewa (<i>Knightsia exzelsa</i>)	·785	48·92	93·0	161·0
Rimu, red pine (<i>Dacrydium cupressinum</i>)	·563	36·94	92·8	140·2
Taraire (<i>Nesodaphne taraire</i>)	·888	55·34	99·6	112·3
Tawa (<i>Nesodaphne tawa</i>)	·761	47·45	142·4	205·5
Tawiri-kohu-kohu, or white mapau (<i>Carpodetus serratus</i>)	·822	51·24	80·0	177·6
Titoki (<i>Alectryon excelsum</i>)	·916	57·10	116·0	248·0
Totara (<i>Podocarpus totara</i>)	·559	35·17	77·0	133·6
Towai, red birch (<i>Fagus menziesii</i>) ..	·626	38·99	73·6	158·2
Towai, black birch (<i>Fagus fusca</i>) ..	·780	48·62	108·8	202·5

Queensland Woods.—Among the principal are the following:—

Acacia pendula (Weeping Myall): 6-12 in. diam.; 20-30 ft. high; wood is hard, possessing a close texture, and a rich dark colour.

Barklya syringifolia: 12-15 in. diam.; 40-50 ft. high; wood hard and close-grained.

Bauhinia Hookeri: 10-20 in. diam.; 30-40 ft. high; wood is heavy, and of a dark reddish hue.

Bursaria spinosa: 6-9 in. diam.; 20-30 ft. high; timber is hard, of a close texture, and admits of a good polish.

Cargillia Australis: 18-24 in. diam.; 60-80 ft. high; grain is close, very tough and fine, of little beauty, but likely to be useful for many purposes.

Cupania anacardioides: 18-24 in. diam.; 30-50 ft. high; the wood is not appreciated.

Cupania nervosa: 12-20 in. diam.; 30-45 ft. high; wood is nicely grained.

Eremophila Mitchellii (Sandalwood): 9-12 in. diam.; 20-30 ft. high; wood is very hard, beautifully grained, and very fragrant; will turn out handsome veneers for the cabinet-maker.

Erythrina vespertilio (Cork-tree): 12-25 in. diam.; 30-40 ft. high; wood soft, and used by the aborigines for making war-shields.

Excœcaria Agallocha (Poison Tree): 12-14 in. diam.; 40-50 ft. high; wood is hard, and fine-grained.

Excœrcarpus latifolia (Broad-leaved Cherry): 6-9 in. diam.; 10-16 ft. high; wood very hard and fragrant; excellent for cabinet-work.

Flindersia Schottiana: stem 12-16 in. diam.; 60-70 ft. high; wood is soft, and soon perishes when exposed.

Harpullia pendula (Tulipwood): 14-24 in. diam.; 50-80 ft. high; wood has a firm fine texture, and is curiously veined in colouring; much esteemed for cabinet-work.

Maba obovata: 10-15 in. diam.; 30-50 ft. high; timber is hard, fine-grained, and likely to be useful for cabinet-work.

Melia Azadirach (White Cedar): 24-30 in. diam.; 40-60 ft. high; wood is soft, and not considered of any value.

Owenia venosa (Sour Plum): 8-12 in. diam.; 20-30 ft. high; wood is hard, of a reddish colour, and its great strength renders it fit for wheelwright work.

Podocarpus elata: 24-36 in. diam.; 50-80 ft. high; wood is hard, fine-grained, flexible, and elastic.

Sarcocephalus cordatus (Leichhardt's Tree): 24-36 in. diam.; 60-80 ft. high; wood is soft, but close-grained, of a light colour, and easily worked.

Spondias pleiogyne (Sweet Plum): 20-45 in. diam.; 70-100 ft. high; the wood is hard and heavy, dark-red, finely marked, and susceptible of a high polish.

Stenocarpus sinuosus (Tulip Tree): 18-24 in. diam.; 40-60 ft. high; wood is very nicely marked, and would admit of a good polish.

Straits Settlements Woods.—The specimens experimented on measured 3 ft. by 1½ ft. by 1½ ft.

Name of Wood.	Average weight per cub. ft.	Deflection in in.	Weight producing deflection in lb.	Breaking weight in lb.	Remarks.
Billian Chingy ..	60	$\frac{5}{10}$	408	913	Hard, close-grained, fine-fibred, but very much inferior to Billian Wangy; of a brownish grey colour; readily attacked by insects and dry rot; used for flooring joists.
Billian Wangy ..	72	$\frac{5}{10}$	473	1038	Very hard, durable, heavy, close-grained, fibre long, is not liable to be attacked by worms or white ants; beams of 50 ft. long and 18 in. square can be obtained. Very suitable for roofing timber, girders, joists, and timber bridges.
Darroo	61	$\frac{7}{10}$	840	1300	Much used for beams of houses and door frames; durable, if kept either wet or dry, but rots soon if exposed to sun and rain; colour white, close-grained, fracture long; has an agreeable smell.
Johore Cedar ..	40½	$\frac{5}{10}$	410	616	Well adapted for house-building purposes, as in the manufacture of doors, windows, and flooring planks. Fracture short, timber open-grained, and is not liable to be worm-eaten.
Johore Rosewood, } or Kayu Merah. }	38	$\frac{5}{10}$	583	952	Resembles rosewood in appearance, and used largely in cabinet-work and household furniture.
Johore Teak, or } Ballow. }	73	$\frac{5}{10}$	737	1210	Well adapted for permanent sleepers, beams, piles, ship-building, engineering, and general purposes where strength and durability are required. Piles which have been in the ground for 100 years have been found in a good state of preservation. One of the few woods which will really stand the climate of India. Colour dull grey.
Jolotong	29	$\frac{5}{10}$	280	732	Well adapted for patterns and mouldings, excellent for carving purposes; grain very close, scarcely any knots, colour whitish yellow, fracture short, but not very durable.

Name of Wood.	Average Weight per cub. ft.	Deflection in in.	Weight Producing Deflection in lb.	Breaking Weight in lb.	Remarks.
Krängee	77	$\frac{5}{10}$	980	1339	Very hard, close-grained, well adapted for beams of every description. White ants or other insects do not touch it. Well adapted for piles for bridges in fresh or salt water; also used for junks' masts; stands well when sawn, ranks with Tampénis for durability. Fracture long, fibres tough, colour dark red.
Kruen	50	$\frac{5}{10}$	472	625 $\frac{1}{3}$	Close-grained, tough fibres, and resembling yellow pine. Used for native boats, planks, &c. Contains a kind of dammar-like oleo-resin.
Kulim, or Johore Ironwood. }	73	$\frac{5}{10}$	766	1141	Somewhat similar to Ballow. Used for planking cargo boats; fracture short; makes superior beams and telegraph-posts, as it lasts well in the ground.
Marbow, Murboo, or Marraboo. }	61	$\frac{5}{10}$ to $\frac{5}{10}$	399 to 578	894 to 987	Durable, principally used for furniture, readily worked, and takes polish well; also used for flooring beams, timber bridges, carriage bodies, and framing of vessels; trees 4 ft. diam. are sometimes obtained; not readily attacked by white ants, but is by worms. Colour almost like English oak.
Panaga	72	$\frac{5}{10}$	688	1310	Bright red, very hard and durable, well adapted for roofing timbers, joists, and timber work of bridges; very cross-grained and difficult to work; can be obtained in any quantity to 9 in. square. Fracture short.
Samaran	42	$\frac{5}{10}$	326	532	Well adapted for doors, windows, moulding, and other house-building purposes; close and even grained, dull-red colour, short fracture, but liable to attacks of white ants.
Serian	47	$\frac{5}{10}$	438	737 $\frac{1}{3}$	Of a dull-red colour, close-grained, and largely used in house-building, for boxes, boards, &c.
Tampénis	67	$\frac{5}{10} +$	802	1599+	Very hard, close-grained, red-coloured, long-fibred, and tough. Well adapted for beams of every description; white ants and other insects do not touch it. Used largely for bridge piles in fresh or salt water; considered one of the most lasting timbers; warps if cut in plauks.
Tumboosoo ..	67	$\frac{5}{10}$	306	548	Capital for piles, or for any wood-work which is exposed to the action of fresh or salt water; not attacked by worms or white ants. Fracture short.

Tasmanian woods.—Ironwood, Tasmanian (*Notelœa ligustrina*): exceedingly hard, close-grained wood, used for mallets, sheaves of blocks, turnery, &c.; diam., 9-18 in.; height, 20-35 ft.; sp. grav., about .965. Not uncommon.

Native Box (*Bursaria spinosa*): diam., 8-12 in.; height, 15-25 ft.; sp. grav., about .825. Used for turnery.

Native Pear (*Hakea lissosperma*): diam., 8-12 in.; height, 29-30 ft.; sp. grav., about .675. Fit for turnery.

Pinkwood (*Beyeria viscosa*): diam., 6-10 in.; height, 15-25 ft.; sp. grav., about .815. Used for sheaves of blocks, and for turnery.

Swamp Tea-tree (*Melaleuca ericæfolia*): diam., 9-20 in.; height, 20-60 ft.; sp. grav., about .824. Used for turnery chiefly.

White-wood (*Pittosporum bicolor*): diam., 8-13 in.; height, 20-35 ft.; sp. grav., about .875. Used in turnery; probably fit for wood-engraving.

West Indian woods.—Crabwood is mostly used for picturo-frames and small ornamented cabinet-work, &c. It seldom grows larger than 3-4 in. in diam., and is a rather hard, fine, cross-grained, moderately heavy wood. The heartwood is of a beautifully veined Vandyke brown, its external edge bright black, and the alburnum of a pure white. In Trinidad, the balata is a timber extensively used for general purposes, and much esteemed. Its diameter is 2-6 ft. The mastie is also held in high estimation, and varies from 2 to 4 ft. in diam. The gru-gru, which is a palm, yields beautiful veneer, as also does the gri-gri. For some of these trees it will be observed there is no vernacular name, consequently the choice lies between the native and the botanical name. The heartwood of the butterwood only is used. The beauty of the wood is well known, but it never attains a large size. Its recent layers are of a uniform yellowish-white colour. The carapa bears a considerable resemblance to cedar, and is extensively used and much esteemed. It is 2-3 ft. in diam. The West Indian cedar of Trinidad is a most useful timber, and is well deserving the attention of consumers, as is also the copai, a beautiful and durable wood. The sepe is a light wood, resembling English elm, impregnated with a bitter principle, which preserves it from the attacks of insects. It is tough, strong, and is used for general purposes. In diameter it ranges from 1 to 2 ft. L'Angleme is a strong, hardy wood, exclusively used for the naves of wheels, &c. Courbaril is a valuable and abundant timber of 2-6 ft. in diam., and may be otherwise described under the name of West India locust. Yorke saran is a very hard and useful wood, and also pearl heart, which has the advantage of being very abundant, and runs from 2 to 4 ft. in diam. Aquatapana is a very durable and curious wood, susceptible of high polish, and 18-36 in. in diam. The green, grey, and black poni furnish the favourite timbers of the colony, and produce the hardest and most durable of wood. Their timber takes a fine polish, has a peculiar odour, and is very abundant. The trees are 3-4 ft. in diam., and proportionately lofty.

Growth of wood.—This may be sufficiently explained in a few words. A cross section of an exogenous ("outward growing") tree, which class includes all timbers used in construction, shows it to be made up of several concentric rings, called "annual," from their being generally deposited at the rate of 1 a year; at or near the centre is a column of pith, whence radiate thin lines called "medullary rays," which, in some woods, when suitably cut, afford a handsome figure termed "silver grain." As the tree increases in age, the inner layers are filled up and hardened, becoming what is called duramen or "heartwood"; the remainder, called alburnum or "sapwood," is softer and lighter in colour, and can generally be easily distinguished. The heartwood is stronger and more lasting than the sapwood, and should alone be used in good work. The annual rings are generally thicker on the side of the tree that has had most sun and air, and the heart is therefore seldom in the centre.

Felling.—While the tree is growing, the heartwood is the strongest; but after the growth has stopped, the heart is the first part to decay. It is important, therefore, that

the tree should be felled at the right age. This varies with different trees, and even in the same tree under different circumstances. The induration of the sapwood should have reached its extreme limits before the tree is felled, but the period required for this depends on the soil and climate. Trees cut too soon are full of sapwood, and the heartwood is not fully hardened. The ages at which the undermentioned trees should be felled are as follows:—Oak, 60-200 years, 100 years the best; Ash, Larch, Elm, 50-100 years; Spruce, Scotch Fir, 70-100 years. Oak bark is sometimes stripped in the spring, when loosened by the rising sap. The tree is felled in winter, at which time the sapwood is hardened like the heart. This practice improves the timber. A healthy tree for felling is one with an abundance of young shoots, and whose topmost branches look strong, pointed, and vigorous. The best season for felling is midsummer or midwinter in temperate, or the dry season in tropical climates, when the sap is at rest.

Squaring.—Directly the tree is felled it should be squared, or cut into scantling, in order that air may have free access to the interior.

Features.—These depend greatly upon the treatment of the tree, the time of felling it, and the nature of the soil in which it has grown. Good timber should be from the heart of a sound tree, the sapwood being entirely removed, the wood uniform in substance, straight in fibre, free from large or dead knots, flaws, shakes, or blemishes of any kind. If freshly cut, it should smell sweet; the surface should not be woolly, nor clog the teeth of the saw, but firm and bright, with a silky lustre when planed; a disagreeable smell betokens decay, and a dull chalky appearance is a sign of bad timber. The annual rings should be regular in form; sudden swells are caused by rind-galls; closeness and narrowness of the rings indicate slowness of growth, and are generally signs of strength. When the rings are porous and open, the wood is weak, and often decayed. The colour should be uniform throughout; when blotchy, or varying much from the heart outwards, or becoming pale suddenly towards the limit of the sapwood, the wood is probably diseased. Among coloured timbers, darkness of colour is in general a sign of strength and durability. Good timber is sonorous when struck; a dull, heavy sound betokens decay within. Among specimens of the same timber, the heavier are generally the stronger. Timber for important work should be free from defects. The knots should not be large or numerous, and on no account loose. The worst position for large knots is near the centre of the balk required, more especially if forming a ring round the balk at one or more points. Though the sapwood should be entirely removed, the heart of trees having most sapwood is generally strongest and best. The strongest part of the tree is usually that containing the last-formed rings of heartwood, so that the strongest scantlings are got by removing no more rings than those including the sapwood. Timber that is thoroughly dry weighs less than green; it is also harder and more difficult to work.

Defects.—The principal natural defects in timber, caused by vicissitudes of climate, soil, &c., are:—“Heartshakes”: splits or clefts in the centre of the tree; common in nearly every kind of timber; in some cases hardly visible, in others extending almost across the tree, dividing it into segments; one cleft right across the tree does not occasion much waste, as it divides the squared trunk into 2 substantial balks; 2 clefts crossing one another at right angles, as in Fig. 217, make it impossible to obtain scantlings larger than $\frac{1}{4}$ the area of the tree; the worst form of heartshake is when the splits twist in the length of the tree, thus preventing its conversion into small scantlings or planks. “Starshakes”: in which several splits radiate from the centre of the timber, as in Fig. 218. “Cupshakes”: curved splits separating the whole or part of one annual ring from another (Fig. 219); when they occupy only a small portion of a ring they do no great harm. “Rind-galls”: peculiar curved swellings, caused generally by the growth of layers over the wound remaining after a branch has been imperfectly lopped off. “Upsets”: portions of the timber in which the fibres have been injured by crushing. “Foxiness”: a yellow or red tinge caused by incipient decay. “Doatiness”: a speckled

stain found in beech, American oak, and others. Twisted fibres are caused by the action of a prevalent wind, turning the tree constantly in one direction; timber thus injured is not fit for squaring, as many of the fibres would be cut through.

The large trees of New South Wales, when at full maturity, are rarely sound at heart, and even when they are so, the immediate heartwood is of no value, on account of its extreme brittleness. In sawing up logs into scantlings or boards, the heart is always rejected. The direction in which the larger species split most freely is never from the bark to the heart (technically speaking, the "bursting way"), but in concen-

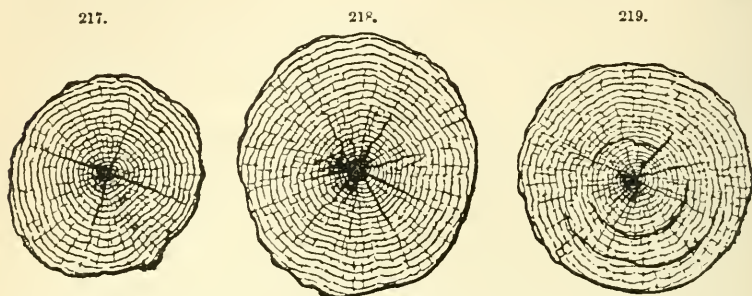

tric circles round the latter. Some few of the smaller species of forest trees are exceptions to this rule; such as the different species of *Casuarina*, *Banksia*, and others belonging to the natural order *Proteaceæ*. They split most freely the "bursting way," as do the oaks, &c., of Europe and America. A very serious defect prevails amongst a portion of the trees of this class, to such an extent as to demand especial notice here. It is termed "gum-vein," and consists simply in the extravasation, in greater or less quantity, of the gum-resin of the tree, in particular spots, amongst the fibres of woody tissue, and probably where some injury has been sustained; or, which is a much greater evil, in concentric circles between successive layers of the wood. The former is often merely a blemish, affecting the appearance rather than the utility of the timber; but the latter, when occurring frequently in the same section of the trunk, renders it comparatively worthless, excepting for fuel. In the latter case, as the wood dries, the layers with gum veins interposing separate from each other; and it is consequently impracticable to take from trees so affected a sound piece of timber, excepting of very small dimensions. The whole of the species of *Angophora*, or apple-tree, and many of the *Eucalypti*, or gums, are subject to be thus affected; and it is the more to be regretted, because it appears to be the only reason why many of the trees so blemished should not be classed amongst the most useful of the hard woods of the colony.

In selecting balks and deals, it should be remembered that most defects show better when the timber is wet. Balk timber is generally specified to be free from sap, shakes, large or dead knots and other defects, and to be die-square. The best American yellow pine and crown timber from the Baltic have no visible imperfections of any kind. In the lower qualities is either a considerable amount of sap, or the knots are numerous, sometimes very large, or dead. The timber may also be shaken at heart or upon the surface. The wood may be waterlogged, softened, or discoloured by being floated. Wanes also are likely to be found, which spoil the sharp angles of the timber, and reduce its value for many purposes. The interior of the timber may be soft, spongy, or decayed, the surface destroyed by worm holes, or bruised. The heart may be "wandering"—that is, at one part on one side of the balk, at another part on the other side. This interrupts the continuity of the fibre, and detracts from the strength of the balk. Again, the heart may be twisted throughout the length of the tree. In this case, the

annual rings which run parallel to 2 sides of the balk at one end run diagonally across the section at the other end. This is a great defect, as the wood is nearly sure to twist in seasoning. Some defects appear to a certain degree in all except the very best quality of timber. The more numerous or aggravated they are, the lower is the quality of the timber. Deals, planks, and battens should be carefully examined for freedom (more or less according to their quality) from sap, large or dead knots, and other defects, also to see that they have been carefully converted, of proper and even thickness, square at the angles, &c. As a rule, well-converted deals are from good timber, for it does not pay to put much labour upon inferior material. The method in which deals have been cut should be noticed, those from the centre of a log, containing the pith, should be avoided, as they are likely to decay.

Classification.—Timber is generally divided into 2 classes, called “pine” woods and “hard” woods. The chief practical bearings of this classification are as follows:—Pine wood (coniferous timber) in most cases contains turpentine; is distinguished by straightness of fibre and regularity in the figure of the trees, qualities favourable to its use in carpentry, especially where long pieces are required to bear either a direct pull or a transverse load, or for purposes of planking; the lateral adhesion of the fibres is small, so that it is much more easily shorn and split along the grain than hard wood, and is therefore less fitted to resist thrust or shearing stress, or any kind of stress that does not act along the fibres. In hard wood (non-coniferous timber) is no turpentine; the degree of distinctness with which the structure is seen depends upon the difference of texture of several parts of the wood, such difference tending to produce unequal shrinking in drying; consequently those kinds of timber in which the medullary rays and the annual rings are distinctly marked are more liable to warp than those in which the texture is more uniform; but the former kinds are, on the whole, more flexible, and in many cases very tough and strong, which qualities make them suitable for structures that have to bear shocks. For many practical purposes timber may be divided into two classes:—(a) soft wood, including firs, pines, spruce, larch, and all cone-bearing trees; (b) hard wood, including oak, beech, ash, elm, mahogany, &c. Carpenters generally give the name “fir” to all red and yellow timber from the Baltic, “pine” to similar timber from America, and “spruce” to all white wood from either place.

Market Forms.—The chief forms into which timber is converted for the market are as follows:—A “log” is the trunk of a tree with the branches lopped off; a “balk” is obtained by roughly squaring the log. Fir timber is imported in the subjoined forms: “Hand masts” are the longest, soundest, and straightest trees after being topped and barked; applied to those of a circumference between 24 and 72 in., measured by the hand of 4 in., there being also a fixed proportion between the number of hands in the length of the mast and those contained in the circumference taken at $\frac{1}{3}$ the length from the butt end; “spars” or “poles” have a circumference of less than 24 in. at the base; “inch masts” have a circumference of more than 72 in., and are generally dressed to a square or octagonal form; “balk timber” consists of the trunk, hewn square, generally with the axe (sometimes with the saw), and is also known as “square timber”; “planks” are parallel-sided pieces 2–6 in. thick, 11 in. broad, and 8–21 ft. long; “deals” are similar pieces 9 in. broad and not exceeding 4 in. thick; “whole deals” is the name sometimes given to deals 2 in. or more thick; “cut deals” are less than 2 in. thick; “battens” are similar to deals, but only 7 in. broad; “ends” are pieces of plank, deal, or batten less than 8 ft. long; “scaffold” and “ladder poles” are from young trees of larch or spruce, averaging 33 ft. in length, and classed according to the diameter of their butts; “rickers” are about 22 ft. long, and under 2½ in. diameter at the top end; smaller sizes are called “spars.” Oak is supplied as follows: “rough timber” consists of the trunk and main branches roughly hewn to octagonal section; “sided timber,” the trunk split down and roughly formed to a polygonal section; “thick stuff,” not less than 24 ft. and averaging at least 28 ft. long, 11–18 in. wide between the sap in the middle

of its length, and $4\frac{1}{2}$ - $8\frac{1}{2}$ in. thick; "planks," length not less than 20 ft. and averaging at least 28 ft., thickness 2-4 in., and width (clear of sap) at the middle of the length varying according to the thickness, i. e. between 9 and 15 in. for 3-, $3\frac{1}{2}$ -, and 4-in. planks, between 8 and 15 in. for 2- and $2\frac{1}{2}$ -in. planks. "Waney" timber is a term used for logs which are not perfectly square; the balk cut being too large for the size of the tree, the square corners are replaced by flattened or rounded angles, often showing the bark, and called "wanes." "Compass" timber consists of bent pieces, the height of the bend from a straight line joining the ends being at least 5 in. in a length of 12 ft.

The following is an approximate classification of timber according to size, as known to workmen:—

Balk	12 in. × 12 in. to 18 in. × 18 in.
Whole timber	9 " 9 " 15 " 15 "
Half timber	9 " $4\frac{1}{2}$ " 18 " 9 "
Scantling	6 " 4 " 12 " 12 "
Quartering	2 " 2 " 6 " 6 "
Planks	11 in. to 18 in. × 3 in. to 6 "
Deals	9 in. × 2 " $4\frac{1}{2}$ "
Battens	$4\frac{1}{2}$ in. to 7 in. × $\frac{3}{4}$ " 3 "
Strips and laths	2 " $4\frac{1}{2}$ " × $\frac{1}{2}$ " $1\frac{1}{2}$ "

Pieces larger than "planks" are generally called "timber," but, when sawn all round, are called "scantling," and, when sawn to equal dimensions each way, "die-square." The dimensions (width and thickness) of parts in a framing are sometimes called the "scantlings" of the pieces. The term "deal" is also used to distinguish wood in the state ready for the joiner, from "timber," which is wood prepared for the carpenter. A "stick" is a rough whole timber unsawn.

Seasoning.—The object of seasoning timber is to expel or dry up the sap remaining in it, which otherwise putrefies and causes decay. One effect is to reduce the weight. Tredgold calls timber "seasoned" when it has lost $\frac{1}{3}$, and considers it then fit for carpenters' work and common purposes; and "dry," fit for joiners' work and framing, when it has lost $\frac{1}{3}$. The exact loss of weight depends, however, upon the nature of the timber and its state before seasoning. Timber should be well seasoned before being cut into scantlings; the scantlings should then be further seasoned, and, after conversion, left as long as possible to complete the process of seasoning before being painted or varnished. Logs season better and more quickly if a hole is bored through their centre; this also prevents splitting.

Natural seasoning is carried out by stacking the timber in such a way that the air can circulate freely round each piece, at the same time protecting it by a roof from the sun, rain, draughts, and high winds, and keeping it clear of the ground by bearers. The great object is to ensure regular drying; irregular drying causes the timber to split. Timber should be stacked in a yard, paved if possible, or covered with ashes, and free from vegetation. The bearers should be damp-proof, and keep the timber at least 12 in. off the ground; they should be laid perfectly level and out of winding, otherwise the timber will get a permanent twist. The timber should be turned frequently, so as to ensure equal drying all round the balks. When a permanent shed is not available, temporary roofs should be made over the timber stacks. Logs are stacked with the butts outwards, the inner ends being slightly raised so that the logs may be easily got out; packing pieces are inserted between the tiers of logs, so that by removing them any particular log may be withdrawn. That timber seasons better when stacked on end, seems doubtful, and the plan is practically difficult to carry out. Boards may be laid flat and separated by pieces of dry wood 1 in. or so in thickness and 3-4 in. wide; any that are inclined to warp should be weighted or fixed down to prevent them from twisting; they are, however, frequently stacked vertically, or inclined at a high angle.

Laslett recommends that they should be seasoned in a dry cool shed, fitted with horizontal beams and vertical iron bars, to prevent the boards, which are placed on edge, from tilting over. The time required for natural seasoning differs with the size of the pieces, the nature of the timber, and its condition before seasoning. Laslett gives the following table of the approximate time required for seasoning timber under cover and protected from wind and weather:—

				<i>Oak.</i>	<i>Fyr.</i>
				Months.	Months.
Pieces 24 in. and upward square require about..	26	13
„ Under 24 in. to 20	„	22	11
„ „ 20 „ 16	„	18	9
„ „ 16 „ 12	„	14	7
„ „ 12 „ 8	„	10	5
„ „ 8 „ 4	„	6	3

Planks $\frac{1}{2}$ — $\frac{3}{4}$ the above time, according to thickness. If the timber is kept longer than the periods above named, the fine shakes which show upon the surface in seasoning open deeper and wider, until they possibly render the logs unfit for conversion. The time required under cover is only $\frac{2}{3}$ of that required in the open.

Water seasoning consists in totally immersing the timber, chaining it down under water, as soon as it is cut, for about a fortnight, by which a great part of the sap is washed out; it is then carefully dried, with free access of air, and turned daily. Timber thus seasoned is less liable to warp and crack, but is rendered brittle and unfit for purposes where strength and elasticity are required. Care must be taken that it is entirely submerged; partial immersion, such as is usual in timber ponds, injures the log along the water line. Timber that has been saturated should be thoroughly dried before use; when taken from a pond, cut up and used wet, dry-rot soon sets in. Salt water makes the wood harder, heavier, and more durable, but should not be applied to timber for use in ordinary buildings, because it gives a permanent tendency to attract moisture.

Boiling water quickens the operation of seasoning, and causes the timber to shrink less, but it is expensive to use, and reduces the strength and elasticity. The time required varies with the size and density of the timber, and according to circumstances; one rule is to allow 1 hour for every inch in thickness.

Steaming has much the same effect as boiling; but the timber is said to dry sooner, and it is by some considered that steaming prevents dry-rot. No doubt boiling and steaming partly remove the ferment spores.

Hot-air seasoning, or desiccation, is effected by exposing the timber in an oven to a current of hot air, which dries up the sap. This process takes only a few weeks, more or less, according to the size of the timber. When the wood is green, the heat should be applied gradually. Great care must be taken to prevent splitting; the heat must not be too high, and the ends should be clamped. Desiccation is useful only for small scantling; the expense of applying it to larger timber is very great; moreover, as wood is one of the worst conductors of heat, if this plan be applied to large logs, the interior fibres still retain their original bulk, while those near the surface have a tendency to shrink, the consequence of which would be cracks and splits of more or less depth. Desiccated wood should not be exposed to damp before use. During this process ordinary woods lose their strength, and coloured woods become pale and wanting in lustre.

McNeile's process consists in exposing the wood to a moderate heat in a moist atmosphere charged with various gases produced by the combustion of fuel. The wood is placed in a brick chamber, in which is a large surface of water to produce vapour. The timber is stacked in the usual way, with free air-space round every piece; about $\frac{1}{3}$ of the whole content of the chamber should be air-space. Under the chamber is a fireplace. The fire having been lighted, the products of combustion (among which is carbonic acid gas) circulate freely in a moist state around the pieces of timber to be seasoned. The time required

varies with the nature of the wood. Oak, ash, mahogany, and other hard wood planks 3 in. thick, take about 8 weeks; oak wainscot planks 2 in. thick take 5-6 weeks; deals 3 in. thick, something less than a month; flooring-boards and panelling, about 10 days or a fortnight. The greener the wood when first put into the stove the better. As a rule, if too great heat be not applied, not a piece of sound wood is split, warped, or opened in any way. The wood is rendered harder, denser, and tougher, and dry-rot is entirely prevented. The wood will not absorb by subsequent exposure to the atmosphere nearly so much moisture as does wood dried by exposure in the ordinary way. The process seems to have no injurious effects upon the appearance or strength of the timber.

Gardner's process is said to season timber more rapidly than any other, to preserve it from decay and from the attacks of all kinds of worms and insects, to strengthen the timber, and render it unflammable; and by it the timber may be permanently coloured to a variety of shades. The process takes 4-14 days, according to the bulk and density of the timber. It consists in dissolving the sap (by chemicals in open tanks), driving out the remaining moisture, leaving the fibre only. A further injection of chemical substances adds to the durability, or will make the timber unflammable. The process has been satisfactorily tested in mine props, railway sleepers, logs of mahogany for cabinet-work, and in smaller scantlings of fir and pine. Experiments showed that the sap was removed, the resistance of the timber to crushing augmented 40-90 per cent., and its density considerably increased.

René, a pianoforte manufacturer, of Stettin, Germany, has devised a plan by which he utilizes the property of ozonized oxygen, to artificially season timber used for sounding-boards of musical instruments. It is a well-known fact that wood, which has been seasoned for years, is much more suitable for the manufacture of musical instruments than if used soon after it is thoroughly dried only. René claims that instruments made of wood which has been treated by his oxygen process possess a remarkably fine tone, which not only does not decrease with age, but as far as experience teaches, improves with age as does the tone of some famous old violins by Italian masters. Sounding-boards made of wood prepared in this manner have the quality of retaining the sound longer and more powerfully. While other methods of impregnating woods with chemicals generally have a deteriorating influence on the fibre, timber prepared by this method, which is really an artificial ageing, becomes harder and stronger. The process is regularly carried on at René's works, and the apparatus consists of a hermetically closed boiler or tank, in which the wood to be treated is placed on iron gratings; in a retort, by the side of the boiler and connected to it by a pipe with stop-valve, oxygen is developed and admitted into the boiler through the valve. Provision is made in the boiler to ozonize the oxygen by means of an electric current, and the boiler is then gently fired and kept hot for 48-50 hours, after which time the process is complete.

Woods, of Cambridge, Mass., has introduced a method which is spoken of as leaving no room for improvement. The wood is placed in a tight chamber heated by steam, and having one side made into a condenser by means of coils of pipes with cold water continually circulating through them. The surface of these pipes is thus kept so much below the temperature of the chamber that the moisture drawn from the wood is condensed on them, and runs thence into a gutter for carrying it off. In the words of the United States Report on the Vienna Exhibition, "if the temperature of these condensing pipes can be kept at say 40° F., and that of the atmosphere be raised to 90° F., it will not require a long time to reach a degree of 20 per cent. of saturation, when the work of drying is thoroughly completed."

Smoke-drying.—It is said that if timber be smoke-dried over a bonfire of furze, straw, or shavings, it will be rendered harder, more durable, and proof against attacks of worms; to prevent it from splitting, and to ensure the moisture drying out from the interior, the heat should be applied gradually.

Second seasoning.—Many woods require a second seasoning after they have been

worked. Floor boards should, if possible, be laid and merely tacked down for several months before they are cramped up and regularly nailed. Doors, sashes, and other articles of joinery should be left as long as possible after being made, before they are wedged up and finished. Very often a board that seems thoroughly seasoned will commence to warp again if merely a shaving is planed off the surface.

Decay.—To preserve wood from decay it should be kept constantly dry and well ventilated; clear of the influence of damp earth or damp walls, and free from contact with mortar, which hastens decomposition. Wood kept constantly submerged is often weakened and rendered brittle, but some timbers are very durable in this state. Wood that is constantly dry is very durable, but also becomes brittle in time, though not for a great number of years. When timber is exposed to alternate moisture and dryness it soonest decays. The general causes of decay are (1) presence of sap, (2) exposure to alternate wet and dryness, or (3) to moisture accompanied by heat and want of ventilation.

“Rot” in timber is decomposition or putrefaction, generally occasioned by damp, and which proceeds by the emission of gases, chiefly carbonic acid and hydrogen; 2 kinds of rot are distinguished—“dry” and “wet.” Their chief difference seems to be that wet-rot occurs where the gases evolved can escape; by it, the tissues of the wood, especially the sappy portions, are decomposed. Dry-rot, on the contrary, occurs in confined places, where the gases cannot get away, but enter into new combinations, forming fungi which feed upon and destroy the timber. Wet-rot may take place while the tree is standing; dry-rot occurs only when the wood is dead.

“Dry-rot” is generally caused by want of ventilation; confined air, without much moisture, encourages the growth of the fungus, which eats into the timber, renders it brittle, and so reduces the cohesion of the fibres that they are reduced to powder. It generally commences in the sapwood. Excess of moisture prevents the growth of the fungus, but moderate warmth, combined with damp and want of air, accelerates it. In the first stage of rottenness, the timber swells and changes colour, is often covered with fungus or mouldiness, and emits a musty smell. The principal parts of buildings in which it is found are—warm cellars, under unventilated wooden floors, or in basements particularly in kitchens or rooms where there are constant fires. All kinds of stoves increase the disease if moisture be present. The ends of timbers built into walls are nearly sure to be affected by dry-rot, unless they are protected by iron shoes, lead, or zinc. The same result is produced by fixing joinery and other woodwork to walls before they are dry. Oilcloth, kamptulicon, and other impervious floorecloths, by preventing access of air and retaining dampness, cause decay in the boards they cover. Carpets do the same to a certain extent. Painting or tarring cut or unseasoned timber has a like effect.

Sometimes the roots of large trees near a house penetrate below the floors and cause dry-rot. It is said that if two kinds of wood—as, for example, oak and fir—are placed so as to touch end to end, the harder will decay at the point of junction. There is this particular danger about dry-rot, that the germs of the fungi producing it are carried easily, and in all directions, in a building where it once displays itself, without necessity for actual contact between the affected and the sound wood.

“Wet-rot” occurs in the growing tree, and in other positions where the timber may become saturated with rain. If the wood can be thoroughly dried by seasoning, and the access of further moisture can be prevented by painting or sheltering, wet-rot can be prevented. The communication of the disease only takes place by actual contact. To detect dry-rot, in the absence of any outward fungus, or other sign, the best way is to bore into the timber with a gimlet or auger. A log apparently sound, as far as external appearances go, may be full of dry-rot inside, which can be detected by the appearance of the dust extracted by the gimlet, or more especially by its smell. If a piece of sound timber be lightly struck with a key or scratched at one end, the sound

can be distinctly heard by a person placing his ear against the other end, even if the balk be 50 ft. long; but if the timber be decayed, the sound will be very faint, or altogether prevented from passing along. Imported timber, especially fir, is often found to be suffering from incipient dry-rot upon arrival. This may have originated in the wood of the ship itself, or from the timber having been improperly stacked, or shipped in a wet state, or subjected to stagnant, moist, warm air during the voyage. Sometimes the rot appears only in the form of reddish spots, which, upon being scratched, show that the fibres have been reduced to powder. After a long voyage, however, the timber will often be covered with white fibres of fungus. Canadian yellow pine is very often found in this state. The best way of checking the evil is to sweep the fungus off, and restack the timber in such a way that the air can circulate freely round each piece.

Preserving.—The best means for preserving timber from decay are to have it thoroughly seasoned and well ventilated. Painting preserves it if the wood is thoroughly seasoned before the paint is applied; otherwise, filling up the outer pores only confines the moisture and causes rot. The same may be said of tarring. Sometimes before the paint is dry it is sprinkled with sand, which is said to make it more durable. For timber that is not exposed to the weather, the utility of paint is somewhat doubtful. Wood used in outdoor work should have those parts painted only where moisture is likely to find a lodgment, and all shakes, cracks, and joints should be filled up with white-lead ground in oil, or oil putty, previous to being painted over. The lower ends of posts put into the ground are generally charred with a view of preventing dry-rot and the attacks of worms. Care should be taken that the timber is thoroughly seasoned, otherwise, by confining the moisture, it will induce decay and do more harm than good. Posts should be put in upside down, with regard to the position in which they originally grew; the sap valves open upwards from the root, and when thus reversed they prevent the ascent of moisture in the wood. Britton recommends charring the embedded portions of beams and joists, joists of stables, wash-houses, &c., wainscoting of ground-floors, flooring beneath parquet work, joints of tongues and rebates, and railway sleepers. Lapparent applied the method on a large scale by the use of a gas jet passed all over the surface of the timber, but Laslett would only advise its use as a possible means of preventing the generation of moisture or fungus where two unseasoned pieces of wood are placed in juxtaposition.

There are some preserving processes of a special character, not available for application by the carpenter. These are described at length in the Second Series of 'Workshop Receipts,' under the head of Preserving Wood, pp. 456-468. A few simpler methods may be mentioned here. The following will be found a good method of preserving wooden posts, say verandah posts, from decay, and also from the white ant, which is the greatest enemy to carpenters' work in Ceylon. Bore with a 1¼-in. auger from the butt-end of the post to a distance that will be 6 in. above the ground-line when the post is set. Then char over a good fire for 15 minutes. This will drive all moisture out of the heart of the butt through the hole bored. Next fill with boiling hot coal-tar, and drive in a well-fitted plug, which will act as a ram, and force the tar into the pores of the wood; the latter thus becomes thoroughly creosoted, and will last for many years. A post 4 in. × 4 in. may have one hole in its centre; a post 6 in. × 6 in., 2 holes side by side; a post 8 in. × 8 in., 3 holes; and one 12 in. × 12 in., 4 holes. Creosoting timber for sleepers and underground purposes answers very well; also coal-tar is a great means of preserving timber underground from the effects of the white ant, as they will not touch it as long as there is a smell of tar from it. A method used by the natives to protect timber from white ants is—To every gallon of water add 3 oz. croton tiglium seeds, 3 oz. margosa bark, 3 oz. sulphur, 2 oz. blue vitriol; immerse the timber until it ceases to absorb the water, and afterwards take out, and dry in an airy situation.

The following table shows the amount of creosote that will be taken up by some of the harder Indian woods:—

	Lb. of Creosote per cub. ft.		Lb. of Creosote per cub. ft.
Sissú	3 $\frac{3}{4}$	Sál	1
Sundri	2 $\frac{1}{4}$	Ironwood	1
Teak	1 $\frac{3}{4}$	Mahogany	$\frac{3}{4}$
Swan River wood (Australia)	1 $\frac{3}{4}$	Jaman	$\frac{3}{4}$

It was thought that the forests of Southern India would furnish numerous timbers suitable for sleepers; but these hopes have not been fulfilled, no timber used having been found capable of resisting the combined effects of the heat and moisture of Southern India, and only on the woods of 3 trees is any great reliance now placed, viz. the Erool (*Iuga xylocarpa*), Karra marda (*Terminalia glabra*), and Vengay (*Pterocarpus Marsupium*). Taking an average of the various native woods used on the Madras railway, the duration of its sleepers has been about 3 $\frac{1}{2}$ years. Creosoted sleepers of Baltic fir have been found to last nearly 6 $\frac{1}{2}$ years.

Fireproofing.—The accepted methods for rendering wood incombustible or reducing its inflammability are described in the Second Series of ‘Workshop Receipts,’ under the head of Fireproofing Timber, pp. 298-9.

Conversion; Shrinkage.—By the term “conversion” is understood the cutting up of the log or balk timber to dimensions suitable for use, allowance being made for alterations in form due to atmospheric influence, even on well-seasoned wood. While wood is in the living state, a constant passage of sap keeps the whole interior moist and the fibres distended, more especially towards the outside. When the tree is felled and exposed to the air, the internal moisture evaporates gradually, causing a shrinkage and collapse of the fibres according to certain laws, being always greatest in a direction parallel with the medullary rays. In straight-grained woods the changes of length caused by atmospheric effects are slight, but those in width and depth are great, especially in new timber. Ordinary alternations of weather produce expansion and contraction in width in wood of average dryness to the following extent:—fir: $\frac{1}{300}$ to $\frac{1}{75}$, mean $\frac{1}{150}$; oak: $\frac{1}{150}$ to $\frac{1}{50}$, mean $\frac{1}{100}$. A practical allowance for shrinkage in 9-in. deals is $\frac{1}{4}$ in. for northeru pine and $\frac{1}{8}$ in. for white.

The subject of shrinkage in timber has been well dealt with by Dr. Anderson, in a Cantor Lecture at the Society of Arts. His observations may be summarized as follows. If Fig. 220 be taken as representing the section of a newly-felled tree, it will be seen that the wood is solid throughout, and on comparing Fig. 221 with this the result of the seasoning will be apparent. The action is exaggerated in the diagrams in order to render it more conspicuous. As the moisture evaporates, the bundles of woody fibres shrink and draw closer together; but this contraction cannot take place radially, without crushing or tearing the hard plates forming the medullary rays, which are unaffected in size by the seasoning. These plates are generally sufficiently strong to resist the crushing action, and the contraction is therefore compelled to take place in the opposite direction, i.e. circumferentially; the strain finding relief by splitting the timber in radial lines, allowing the medullary rays in each partially severed portion to approach each other in the same direction as the ribs of a lady’s fan when closing. The illustration of a closing fan affords the best example of the principle of shrinking during seasoning, every portion of the wood practically retaining its original distance from the centre. If the tree were sawn down the middle, the cut surfaces, although flat at first, would in time become rounded, as in Fig. 222; the outer portion shrinking more than that nearer the heart on account of the greater mass of woody fibre it contains, and the larger amount of moisture. If cut into quarters, each portion would present a similar

result, as shown in Fig. 223. Figs. 224-228 show the same principle applied to sawn timber of various forms, the peculiarities of which are perhaps indicated more clearly in Fig. 230. If we assume the tree to be cut into planks, as shown in Fig. 229, it will be found, after allowing due time for seasoning, that the planks have altered their shape, as in Fig. 230. Taking the centre plank first, it will be observed that the thickness at



the middle remains unaltered, at the edge it is reduced, and both sides are rounded, while the width remains unchanged. The planks on each side of this are rounded on the heart side, hollow on the other, retain their middle thickness, but are reduced in width in proportion to their distance from the centre of the tree; or, in other words,

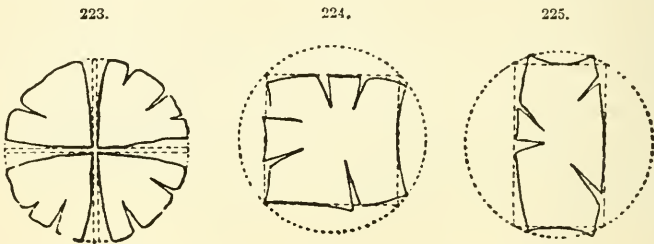

the more nearly the annual rings are parallel to the sides of the planks the greater will be the reduction in width. The most striking result of the shrinkage is shown in Figs. 231-233. Fig. 231 shows a piece of quartering freshly cut from unseasoned timber; in Fig. 232 the part coloured black shows the portion lost by shrinkage, and Fig. 233

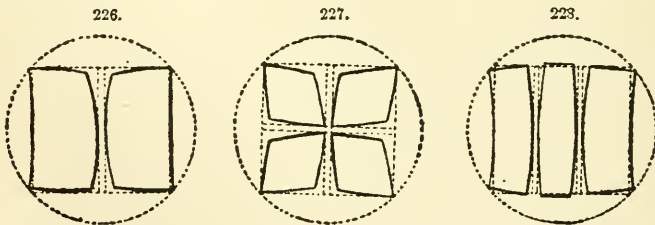

shows the final result. These remarks apply more especially to oak, beech, and the stronger home firs. In the softer woods the medullary rays are more yielding, and this slightly modifies the result; but the same principles must be borne in mind if we wish to avoid the evils of shrinking which may occur from negligence in this respect.

The peculiar direction which "shakes" or natural fractures sometimes take is due to the unequal adhesion of the woody fibres, the weakest part yielding first. In a "cup-shake," which is the separation of a portion of 2 annual rings, the medullary rays are deficient in cohesion. The fault sometimes occurs in Dantzic fir, and has been attributed to the action of lightning and of severe frosts. So far we have considered the shrinking only as regards the cross section of various pieces. Turning now to the effect produced when we look at the timber in the other direction, Fig. 234 represents a piece of timber with the end cut off square; as this shrinks, the end remains square, the width alone being affected. If, however, the end be bevelled as in Fig. 235, we shall find that in

229.

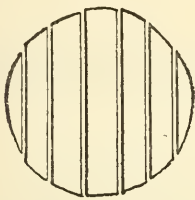

230.

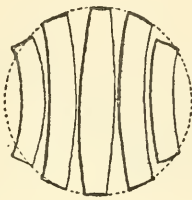

231.

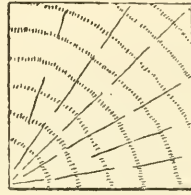

shrinking it assumes a more acute angle, and this should be remembered in framing roofs, arranging the joints for struts, &c., especially by the carpenters who have to do the actual work of fitting the parts. If the angle be an internal one or bird's-mouth, it will in the same way become more acute in seasoning. The transverse shrinkage is here considered to the exclusion of any slight longitudinal alteration which might occur, and which would never be sufficient to affect the angle of the bevel. When seasoned timber is used in positions subject to damp, the wood will swell in exactly the

232.

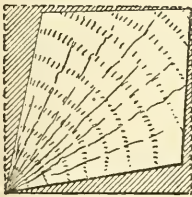

233.

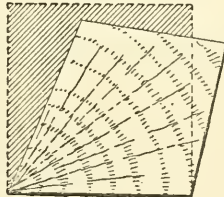

234.

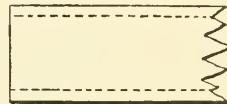

235.

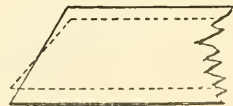

reverse direction to the shrinkage, and induce similar difficulties unless this point has also received due attention. Of course it will be seen from a study of the cross sections illustrated in the diagrams that the pieces might be selected in such a way that the shrinkage and expansion would take place chiefly in the thickness instead of the width, and thus leave the bevel unaltered. In this consists the chief art of selecting pieces for framing; but in many instances motives of economy unfortunately favour the use of pieces on stock, without reference to their suitability for the purpose required.

It has been proved that beams having the annual rings parallel with their depth are stronger than those having them parallel with their breadth. Thus in the log shown in

Fig. 236, the beam cut from A will be stronger than that from B. In preparing floor-boards, care should be taken that the heart does not appear on the surface of the finished board, or it will soon become loose and kick up, as in Fig. 237, forming a rough and unpleasant floor. When planks which have curved in shrinking are needed to form a flat surface, they are sometimes sawn down the middle, and the pieces are alternately reversed and glued together, as in Fig. 238, each piece tending to check the curvature of the others.

In converting fir timber in Sweden and Norway, each log is inspected before sawing, to see how many of the most marketable sizes it will cut, and then it is marked out accordingly. The most general arrangement is that shown in Fig. 239, the thicker deals

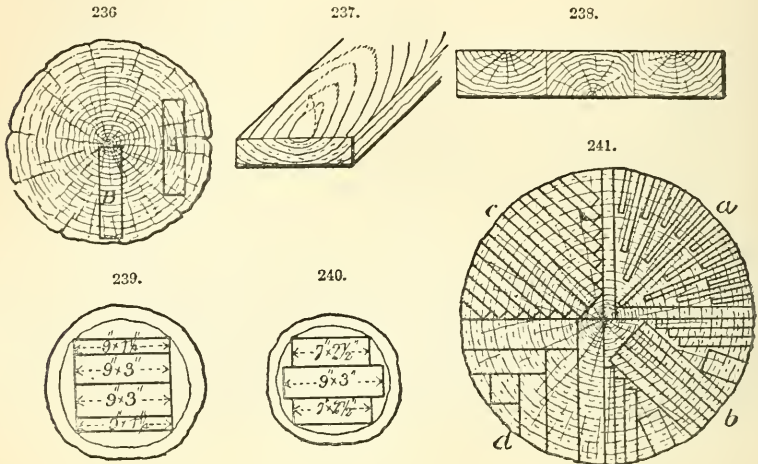

being for the English and the thinner for the French market. Another plan, shown in Fig. 240, has the disadvantage that the central deal embraces all the pith, and is thus rendered more liable to dry-rot.

In converting oak, the log is first cut into 4 quarters, each of which may then be dealt with as shown in Fig. 241. The best method is represented at *a*; it gives no waste, as the triangular portions form feather-edged laths for tiling, &c.; it also shows the silver grain of the wood to the best advantage. *b* is the next in order of merit; *c* is inferior; *d* is most economical for thick stuff.

Composition.—The composition of wood is shown in the following table:—

	Carbon.	Hydrogen.	Oxygen.	Nitrogen.	Ash.
	per cent.	per cent.	per cent.	per cent.	per cent.
Beech	49·36	6·01	42·69	0·91	1·00
Oak	49·64	5·92	41·16	1·29	1·97
Birch	50·20	6·20	41·62	1·15	0·81
Poplar	49·37	6·21	41·60	0·96	1·86
Willow	49·96	5·96	39·56	0·96	3·37
Average	49·70	6·06	41·30	1·05	1·80
Practically .. .	50	6	41	1	2

Wood, in its raw state, contains a large amount of water, which holds more or less soluble minerals, and is called sap. By drying wood a great part, but not all, of this water is evaporated. If wood is dried in a closed vessel, and then exposed to the atmosphere, it quickly absorbs moisture; but the moisture thus absorbed is much less than the wood originally contained. The amount of water varies in different kinds of wood, and according to the season. Wood cut in April contains 10-20 per cent. more water than that cut in January. The following table shows the percentage of water in woods, dried as far as possible in the air:—

Beech	18·6	Pine, white	37·0
Poplar	26·0	Chestnut	38·2
Sugar and common maple	27·0	Pine, red	39·7
Ash	28·0	Pine, white	45·5
Birch	30·0	Linden	47·1
Oak, red	34·7	Poplar, Italian	48·2
Oak, white	35·5	Poplar, black	51·8

Wood cut during December and January is not only more solid, but will dry faster than at any other period of the year, because the sap by that time has incorporated a great part of soluble matter with the woody fibre; what remains is merely water. When the sap, during February, March, and April, rises, it partly dissolves the woody fibre, and the drying of the wood is not only retarded, but the wood is weakened in consequence of the matter thus held in solution.

Suitability.—The properties which render a wood most suitable for one class of purposes may preclude its use in another class. It is therefore useful to have a general idea of the relative order of merit of woods according to the application for which they are destined. The subjoined catalogue is framed after the opinions of the best authorities:—

- Elasticity—ash, hickory, hazel, lancewood, chestnut (small), yew, snakewood.
- Elasticity and Toughness—oak, beech, elm, lignum-vitæ, walnut, hornbeam.
- Even grain (for Carving or Engraving)—pear, pine, box, lime tree.
- Durability (in Dry Works)—cedar, oak, yellow pine, chestnut.
- Building (Ship-building)—cedar, pine (deal), fir, larch, elm, oak, locust, teak.
- Wet construction (as piles, foundations, flumes, &c.)—elm, alder, beech, oak, white-wood, chestnut, ash, spruce, sycamore.
- Machinery and millwork (Frames)—ash, beech, birch, pine, elm, oak.
- Rollers, &c.—box, lignum-vitæ, mahogany.
- Teeth of wheels—crab tree, hornbeam, locust.
- Foundry patterns—alder, pine, mahogany.
- Furniture (Common)—beech, birch, cedar, cherry, pine, whitewood.
- Best furniture—amboyna, black ebony, mahogany, cherry, maple, walnut, oak, rosewood, satinwood, sandalwood, chestnut, cedar, tulip-wood, zebra-wood, ebony.
- Piles—oak, beech, elm. Posts—chestnut, acacia, larch. Great Strength in Construction—teak, oak, greenheart, Dantzic fir, pitch pine. Durable in Wet Positions—oak, beech, elm, teak, alder, plane, acacia, greenheart. Large Timbers in Carpentry—Memel, Dantzic, and Riga fir; oak, chestnut, Bay mahogany, pitch pine, or teak, may be used if easily obtainable. Floors—Christiania, St. Petersburg, Onega, Archangel, make the best; Gelfe and spruce inferior kinds; Dram battens wear well; pitch pine, oak, or teak, where readily procurable, for floors to withstand great wear. Panelling—American yellow pine for the best; Christiania white deals are also used. Interior Joinery—American red and yellow pine; oak, pitch pine, and mahogany for superior or ornamental work. Window Sills, Sleepers—oak; mahogany where cheaply procurable. Treads of Stairs—oak, teak. Handles—ash, beech. Patterns—American yellow pine, alder, mahogany.

Strength.—The following table shows the results of many experiments :—

Wood seasoned.	Weight of 1 cub. ft. (dry.)	Tenacity per sq. in., length- ways of the grain.	Modulus of Rupture.	Modulus of Elasticity.	Resistance to Crush- ing in direction of fibres.	Comparative Stiffness and Strength, Oak being 100.	
		From. To.	1000 lb.	1000 lb.	Tons per sq. in.	Stiff- ness.	Strength.
Acacia	48	5.0 8.1	..	1152-1687	Moderately dry. Thoroughly dry.	98	95
Alder	50	4.5 6.3	..	1086		63	80
Ash, English ..	43-53	1.8 7.6	12-14	1525-2290	3.8 4.2	89	119
" Canadian ..	30	2.45	10	1380	2.5	77	79
Beech	43-53	2.1 6.6	9-12	1350	3.4 4.2	77	103
Birch	45-49	6.7	11	1645	1.5 2.8		
Cedar	35-47	1.3 5.1	7-8	486	2.5 2.6	28	62
Chestnut	35-41	4.5 5.8	10	1140	..	67	89
Elm, English ..	34-37	2.4 6.3	6-9	700-1340	2.6 4.6	78	82
" Canadian ..	47	4.1	14	2470	4.1	139	114
Fir, Spruce ..	29-32	1.3 4.5	9-12	1400-1800	2.9 3.0	72	86
" Dantzic ..	36	1.4 4.5	13	2300	3.1	130	108
" American red pine ..	34	1.2 6.0	7-10	1460-2350	2.1	132	81
" American yel- low pine ..	32	0.9	8	1600-2480	1.8	139	66
" Memel	34	4.2 4.9	..	1536-1957	6	114	80
" Kaurie	34	2.0	11	2880	2.6	162	89
" Pitch pine ..	41-58	2.1 4.4	14	1252-3000	3.0	73	82
" Riga	34-47	1.8 5.5	9	870-3000	2.1	62	83
Greenheart ..	58-72	3.9 4.1	16-27	1700	5.8 6.8	98	165
Hornbeam	47.5	9.1	3.7	..	108
Jarrah	63	1.3	10	1187	3.2	67	85
Larch	32-38	1.9 5.3	5-10	1360	2.6	79	103
Mahogany, Spanish	53	1.7 7.3	7	1255-3000	3.2	73	67
" Honduras	35	1.3 8.4	11-12	1596-1970	2.7	93	96
Mora	57-68	4.1	21-22	1860	..	105	164
Oak, English ..	49-58	3.4 8.8	10-13	1200-1750	2.9 4.5	100	100
" American ..	61	3.0 4.6	12	2100	3.1	114	86
Plane	40	5.4	..	1343	..	78	92
Poplar	23-26	2.68	..	763	1.4 2.3	44	50
Sycamore	36-43	4.3 5.8	9	1040	3.1	82	111
Teak	41-52	1.47 6.7	12-19	2167-2414	2.3 5.4	126	109
Willow	24-35	6.25	6	..	1.3 2.7		

Timber when wet has not half the strength of the same when dry. The resistance of wood to a crushing force exerted across the fibres is much less than in the direction of their length. Memel fir is indented with a pressure of 1000 lb. per sq. in., and oak with 1400 lb. The resistance to shearing is nearly twice as great across the fibres as with them.

Measuring.—Following are useful rules for the measurement of timber:—

Standing timber.—In measuring standing timber, the length is taken as high as the tree will measure 24 in. in circumference. At half this height the measurement for the mean girth of the timber in the stem of the tree is taken. One-fourth this girth is assumed to be the side of the equivalent square area. The buyer has generally the option of choosing any spot between the butt-end and the half height of the stem as the

girding place. All branches, as far as they measure 2½ in. in girth, are measured in with the tree as timber.

Unquared timber.—In order to ascertain the contents, multiply the square of the quarter girth, or of $\frac{1}{4}$ of the mean circumference, by the length. When the buyer is not allowed his choice of girth in taper trees, he may take the mean dimensions, either by girding it in the middle for the mean girth, or by girding it at the two ends, and taking half of their sum. If not, girth the tree in so many places as is thought necessary, then the sum of the several girths divided by their number, will give a mean circumference, the fourth part of which being squared, and multiplied by the length, will give the solid contents.

The superficial ft. in a board or plank are known by multiplying the length by the breadth. If the board be tapering, add the breadth of the two ends together, and take half their sum for the mean breadth, and multiply the length by this mean breadth.

The solid contents of squared timber are found by measuring the mean breadth by the mean thickness, and the product again by the length. Or multiply the square of what is called the quarter girth, in inches by the length in feet, and divide by 144, and you have the contents in feet.

Boughs, the quarter girth of which is less than 6 in., and parts of the trunk less than 2 ft. in circumference, are not reckoned as timber.

1½ in. in every foot of quarter girth, or $\frac{1}{8}$ of the girth, is allowed for bark, except of elm. 1 in. in the circumference of the tree, or whole girth, or $\frac{1}{12}$ of the quarter girth is the general fair average allowance.

The quarter girth is half the sum of the breadth and depth in the middle.

The nearest approach to truth in the measuring of timber is to multiply the square of $\frac{1}{2}$ of the girth, or circumference, by double the length, and the product will be the contents.

100 superficial feet of planking equals 1 square.

120 deals „ „ 1 hundred.

50 cub. ft. of squared timber „ „ 1 load.

40 ft. of unhewn timber „ „ 1 load.

600 superficial ft. of 1-in. planking „ „ 1 load.

A fir pole is the trunk of a fir tree, 10–16 ft. long.

Battens, deals, and planks, as imported into this country, are each similar in their various lengths, but differing in their widths and thicknesses, and hence their principal distinction; thus, a batten is 7 in. by 2½ in.

a deal „ 9 „ 3 „

a plank „ 11 „ 3 „

these being what are termed the standard dimensions, by which they are bought and sold, the length of each being taken at 12 ft.; therefore, in estimating for the proper value of any quantity, nothing more is required than their lineal dimensions by which to ascertain the number of times 12 ft. there are in the given whole. Thus—if purchasing deals—

7 of 6 ft.	6 × 7 = 42 ft.
5 „ 14 „	14 × 5 = 70 „
11 „ 19 „	19 × 11 = 209 „
and 6 „ 21 „	21 × 6 = 126 „

12)447(37·25 standard deals.

Prices.—In London, a different system of charging sawing of deals is adopted to that in the provinces, viz. cuts are charged so much per dozen, the price varying with the length; ripping being called flat-cuts in the same way. In the country method, all cuts

in the deal or log are charged for at per 100 ft. super, and all rips or flat-cuts under 6 in. are charged at per 100 ft. lineal; herewith are the usual prices for this work, viz. :—

	Per 100 ft. super.	Ripping per 100 ft. run.	× Cuts.
	s. d.	s. d.	d.
Oak	4 0	1 6	each 4
Mahogany	5 6	1 6	„ 4
Memel	2 6	1 0	„ 2½
Swede and Yellow Pine.. .. .	2 3	0 10	„ 2½
Pitch Pine	3 9	1 6	„ 3
Deals.. .. .	1 9	0 9	„ 0¾
Planing Deals	1 6		
Chipping do.	1 0		
Matching, Rebating, or Grooving for Hoop Iron, 3d. per 100 ft. super.			

Tools.—Carpenters' tools may conveniently be divided into 7 classes, as follows :— (1) Guiding tools—rules, lines, squares; (2) Holding tools—pincers, vice; (3) Rasping tools—saws, files; (4) Edge tools—chisels, planes; (5) Boring tools—awls, gimlets, bits; (6) Striking tools—hammers, mallets; (7) Chopping tools—axes, adzes. In an eighth category may be put such important accessories as the carpenter's bench, nails, screws, and various hints and recipes.

GUIDING TOOLS.—These comprise the chalk line, rule, straight-edge, square, spirit level, A-level, plumb level, gauges, bevel, mitre-box, callipers and compasses, trammel, and a few modern contrivances combining two or more of these tools in one.

Chalk line.—The chalk line is used as shown in Fig. 242 for the purpose of marking where cuts have to be made in wood. It consists of several yards of cord wound on a

242.

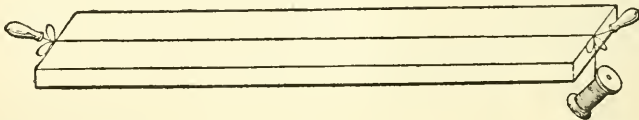

wooden reel, and well rubbed with a piece of chalk (or charcoal when a white line would be invisible) just before use. In applying it, first mark with the carpenter's pencil the exact spots between which the line is to run, then pass a bradawl through a loop near the end of the cord and fix it firmly in the wood at the first point marked, next apply the chalk or charcoal to the cord, or as much of it as will suffice for the length of line to be marked, this done, stretch the cord tightly to the second point marked, and either fasten it by looping it round a second bradawl, or hold it very tightly in the finger and thumb of one hand, whilst with the finger and thumb of the other hand you raise it in the middle as much as it will stretch; on suddenly releasing it, it springs back smartly and leaves a well-defined line between the two points. The novice may find it helpful to mark both sides of his work, which is best done by removing the cord without disturbing the bradawls.

Rule.—The foot rule consists of a thin narrow strip of metal, hard wood, or ivory, generally 2 ft. long, graduated on both sides into inches and fractions of an inch (halves, 4ths, 8ths, 12ths, 16ths, 32ndths), and hinged so as to fold into a shorter compass for convenience in carrying. Superior kinds are fitted with a sliding brass rule adding another foot to the length, and graduated in minute subdivisions which facilitate calculations of dimensions. In the form shown in Fig. 243, known as "Stanley's No. 32," this brass slide is furnished with an elbow at the end, so that it constitutes a combined

rule and calliper (see p. 189). Ordinary prices are 1s. to 5s., according to quality and finish.

Straight-edge.—The nature of this tool is expressed in its name. It consists of a long (5 or 6 ft.) strip of well-seasoned wood or of bright hardened steel (nickel-plated if preferred), several inches wide, having at least one edge perfectly level and true throughout. Its use is for ascertaining whether a surface is uniformly even, which is readily done by simply laying the straight-edge on the surface, when irregularities of the surface become apparent by spaces between the two planes in contact. Steel straight-edges are made with one bevelled edge and with English or French scales graduated on them.

243.

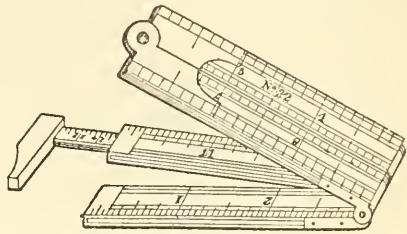

Squares.—The use of these instruments is for marking out work at right angles.

The most usual forms are illustrated below. Fig. 244 is a common brass-mounted square ; Fig. 245 a mitre square. It consists generally of a wooden stock or back with a steel blade fitted into it at right angles, and secured by 3 screws or rivets; the sizes vary from 3 to 30 in., and the prices from 1s. to 10s. They are also made of plain or nickel-plated steel, with scales engraved on the edges. In use, the stock portion of the square is placed tight against the edge which forms the base of the line to be marked, so

244.

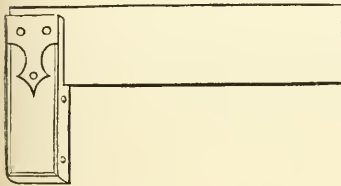

245.

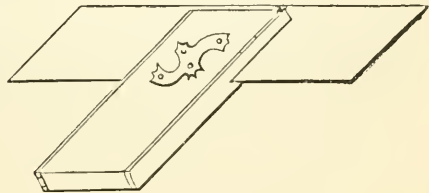

that the blade indicates where the new line is to be drawn. The making and application of squares have been well described by Lewis F. Lyne in the *American Machinist*. He remarks that the 2 sides of a square should form an angle of 90° , or the $\frac{1}{4}$ of a circle; but hundreds of tools resembling squares in appearance, and so named, when the test is applied to them, are found entirely inaccurate: the angle is in some instances more, and in others less, than a right angle. The way these tools are generally made is by taking a piece of steel for the stock, planing it up to the right size, and squaring up the ends, after which a slot is cut in one end to receive the blade. The blade is neatly fitted and held securely by 2 or 3 rivets passing through the end of the stock and blade. It is a very difficult undertaking, with ordinary appliances, to cut this slot precisely at right angles to the sides and ends of the stock; and, when the blade is finally secured, it will be found that it leans to one side or the other, as shown in Fig. 246, where *a* represents the stock, and *b* the blade; *c* is an end view, the dotted lines showing the position of blade, as described.

The best way to produce a square without special tools is to make a complete flat square of the size desired out of thin sheet steel, the thickness depending upon the size of square desired. In almost every instance where squares are made by amateurs at tool-making, the blades are left too thick. After the square has been trued up

and finished upon the sides, 2 pieces of flat steel should be made exactly alike as to size, to be riveted upon the sides of the short arm of the square to form the stock. To properly locate these pieces, the square should be placed upon a surface plate, and the parts clamped in position, care being taken to get them all to bear equally upon the surface plate, after which, holes may be drilled and countersunk, and the rivets inserted. The angle formed by the cutting edges of the drills for countersinking the holes should be about 60° , so that when the rivets are driven, and the sides of the back finished, there will be no trace left of the rivets, which should always be of steel.

Close examination may reveal the fact that the blade is winding, or is slightly inclined to one side. If inclined, as shown at *e*, in Fig. 246, the end of the blade only will touch a square piece of work when the tool is held in a proper position, as shown in Fig. 247, where *i* represents the piece of work, and *f* the square. It is a custom among machinists to tip the stock, as shown at *k* and *l*, to enable the workman to see light under the blade. This only aggravates any imperfection in the squareness of the blade, for when the stock is tipped, as shown at *k*, it will touch

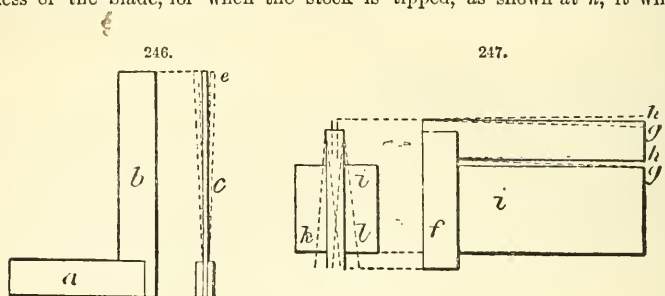

the work at *g*, occupying the position indicated by the dotted lines *g, g*; whereas, if the stock be tipped, as shown at *l*, the blade will assume the position indicated by the dotted lines *h, h*. These conditions will exist when the blade of the square is inclined, as shown at *e*, in Fig. 246. If the blade is inclined to the left, a precisely similar condition will exist, except in the reverse order. It is next to an impossibility to perform accurate work, or test the same with a square having a thick edge, because of the reason already stated that the light cannot be seen between the edge of the blade and the work.

The most ingenious tool for overcoming the foregoing difficulties is a sort of self-proving square, made by a machinist in New York. This is shown in Fig. 248, and consists of a steel beam *j*, shown in bottom view at *k*. In the end of this beam is a hole for the reception of a screw, with a common bevelled head. A square piece of steel, *l, m*, forms the blade of this square, *n* representing the end of the blade. The blade is first planed, then tapped and hardened, after which it is ground to bring the sides exactly parallel and of equal size, which makes the bar perfectly square. The stock is of a rectangular section, and, with this exception, is hardened and ground in the same manner as the blade. The end of the screw is then carefully ground at right angles to the sides, after which the parts are put together and the screw is tightened. If the blade is not precisely at right angles to the stock, it will occupy a position indicated by the dotted line *o*; then, if the screw be loosened and the blade turned half a revolution, the edge will stand as shown by the dotted line at *p*.

The end must be so ground that the blade will occupy precisely the same relation to the beam when turned in all positions. When this is accomplished, the square is a very close approximation to perfection. The accuracy of work is tested with one of the corners; when it becomes worn, another may be turned into position; and when all are

worn, the blade is removed and trued up by grinding, as at first. In testing the accuracy of the ordinary square, it is usually placed upon a flat surface having a straight edge, as shown in Fig. 249, where *s* represents the surface with the square upon it. The stock is pressed firmly against the edge of the surface, and with a scriber

248.

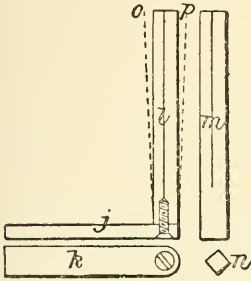

249.

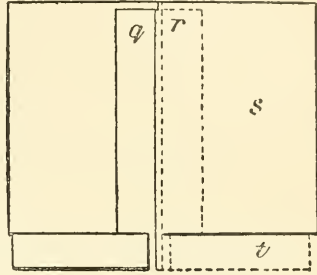

a fine line is drawn along the edge of the blade. The square is then turned to the position *t*, indicated by the dotted lines, and a second line is drawn along the edge of the blade. If the tool is less than a right angle, the line with the square in the former position will incline towards *q*, while in the latter position it will appear as shown at *r*; whereas, if the square be correct, the two lines will exactly coincide with each other. This is not a reliable test for the accuracy of a square, but it answers very well in case of emergency.

It is difficult to draw the lines to exactly represent the edge of the blade, owing to the fact that the slightest inclination of the hand holding the scriber to either side will make a crooked line. The form of square shown in Fig. 248 always presents a fine edge to work to, and may always be relied upon for accuracy when properly fitted up. This square would seem to be quite as easily made as the common one, but the construction of an accurate square with ordinary appliances is a job that tests the skill of a good workman.

Spirit level.—The spirit level consists of a glass tube partially filled with spirit, encased in a framework made of hard wood and protected by metallic facing on the most important sides. The quantity of spirit placed in the glass tube is just insufficient to

250.

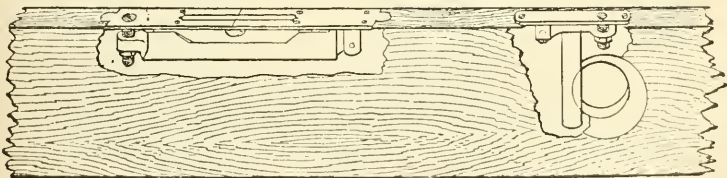

fill it, so that a "bubble" of air perhaps $\frac{1}{2}$ in. long always appears at the surface, being rendered visible by means of a sight-hole in the metallic plate which encloses and secures the glass tube in the wooden block. The ends of the glass tube are hermetically sealed when the proper quantity of spirit has been introduced. The wooden case or block must be perfectly level and true, and of a material that will not change its form by climatic or other influences. Average sizes are 8-14 in. in length and cost 2-10s.

Some are made with the sight-hole at the side instead of the top. Others have both top and side openings. Such is shown in Fig. 250, which represents Stanley's improved adjustable combined spirit and plumb level, by which it is possible to adjust a surface to a position both truly horizontal and truly perpendicular. The principle of action of the spirit level is that the air bubble contained in the glass tube will always travel towards the highest point; when it rests immediately in the centre of the sight-hole, a true level is obtained. It is necessary to remember, however, that it is only a guide to the level of that length of surface on which it lies; and in levelling longer surfaces the spirit level should be placed on a straight-edge instead of directly on the surface to be tested.

Plumb level.—This consists of a straight-edge to which is attached a cord having a weight suspended from the end, as shown in Fig. 251. The top end *a* of the straight-edge has 3 saw-cuts made in it, one being exactly in the centre. From this centre cut a line is drawn perfectly straight to the other end *b*. On this line at *e* a pear-shaped hole is cut out of the straight-edge. A piece of supple cord is next weighted by attaching a pear-shaped lump of lead, and then fastened to the top *a* of the straight-edge by passing it first through the central saw-cut, and then through the others to make it fast, just so that the leaden weight is free to swing in and out of the hole. The law of gravity forces the cord to hang (when free) in a truly upright (perpendicular) position; on

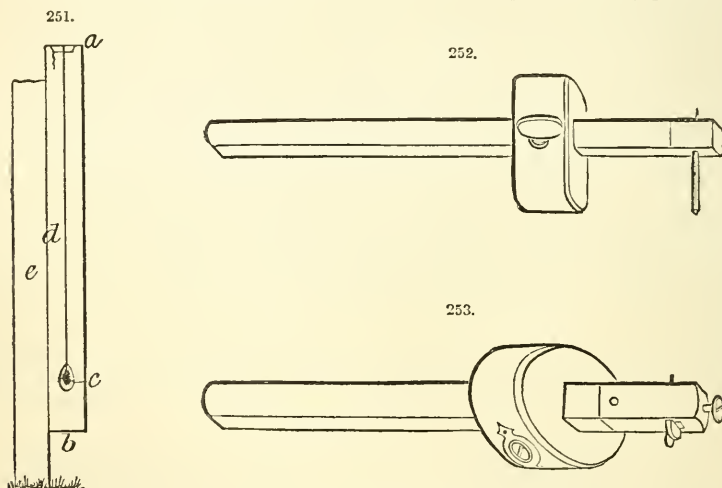

placing the side *d* of the straight-edge against a surface *e*, whose perpendicularity is to be tested, if there is any disagreement between the cord and the line marked on the straight-edge, then the surface is not upright, and it must be altered until the cord exactly corresponds to and covers the line marked down the centre of the straight-edge.

Gauges.—There are 3 kinds of gauge used in carpentry, known respectively as the "marking," the "cutting," and the "mortice" gauge. They are outlined in the annexed illustrations. Fig. 252 is a cutting gauge having the head faced with brass; Fig. 253 is an improved form of cutting gauge; Fig. 254 is a thumb or turn-screw screw-slide mortice gauge; Fig. 255 is an improved mortice gauge with improved stem. The marking gauge has a shank about 9 in. long with a head or block to slide along it; a spike is inserted near the end of the shank, and the movable head is fixed at any required distance from the spike by a screw or wedge; its use is to make a mark on the wood parallel to a

previously straightened edge, along which edge the gauge is guided; for dressing up several pieces of wood to exactly the same breadth this gauge is eminently useful. The cutting gauge is similarly composed of a shank and a head, but the spike is replaced by a thin steel plate, passing through the shank and secured by a screw, and sharpened on one edge so as to be capable of making a cut either with or across the grain; its main applications are for gauging dovetailed work and cutting veneers to breadth. The

254.

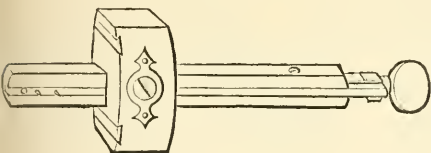

255.

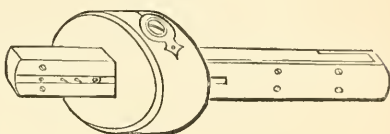

mortice gauge resembles the others in having a shank (about 6 in. long) and a movable brass-shod head, but it has 2 spikes, one fixed and the other arranged to be adjusted by means of a screw at varying distances from the first; it is used for gauging mortice and tenon work. Gauges are generally made of beech, and the shank is often termed the "strig"; compound gauges are now made, consisting of marking and cutting, or marking and mortice appliances combined in one tool. Prices vary from 3*d.* to 10*s.*, according to finish. In using the gauge, the marking point is first adjusted to the correct distance, then secured by turning the screw, and the mark is made when required by holding the head of the gauge firmly against the edge which forms the basis of the new lines, with the marker resting on the surface to be marked, and passing the instrument to and fro.

Bevels.—These differ from squares, in that they are destined for marking lines at angles to the first side of the work, but not at right angles. Examples are shown in the

256.

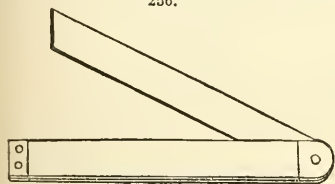

257.

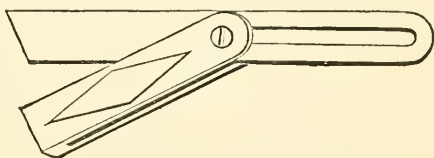

annexed illustrations. Fig. 256 is an ordinary angle bevel; Fig. 257 is an improved metallic frame sliding bevel; and Fig. 258 is a boat-builder's bevel with 2 brass blades. The bevel is used in precisely the same manner as the try square. A

258.

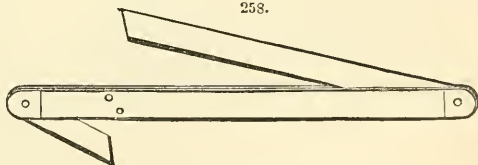

very useful bevel protractor, with a sliding arm and half circle divided into degrees, is sold by Churchills.

Mitre-box.—The mitre-box is an arrangement for guiding a saw-cut at an angle of 45° exactly, or half the dimensions of a right angle. It is mostly required for cutting mouldings, where the end of one piece of wood meeting the end of another has to form with it a true corner of 90° (a right angle). The best illustration of a mitre is to be seen in either of the 4 corners of a picture frame. In its simplest form the mitre-box

may be made out of any piece of good sound plank $1\frac{1}{2}$ ft. long and say 6 in. by 3 in. A rebate is cut lengthwise in this, i.e. half its width and half its thickness is cut away, leaving the slab in the form of 2 steps, thus constituting a rest for any work to be operated upon. Next 2 saw-cuts, one facing each way, are carried down through the top step and about $\frac{1}{4}$ in. into the lower step, these saw-cuts being exactly at an angle of 45° with the front edge of the "box." When a mitre has to be cut, the wood to be operated on is laid on the lower step and held firmly into the angle, while a saw is passed down in the old cuts in the box and so through the wood to be mitred.

For cutting other angles than 45° , other saw-cuts might be made in the same box; but the most convenient instrument for cutting a wide series of angles is the Langdon mitre-box, sold by Churchills, and illustrated in Fig. 259. Whilst ordinary mitre-boxes range only from right angles (90°) to 45° , this cuts from right angles to 73° on $2\frac{1}{2}$ -in. wood, and is the only form adjustable for mitreing circular work in patterns and segments of various kinds. Prices range between 24s. and 70s. without the saw, according to depth and width of cut.

The ordinary mitre-box may also be made in the form of a wide shallow trough, the saw-cuts at an angle of 45° being carried down through the sides to the floor, while the sides and floor combined form the rest for the work in hand.

All the forms of mitre-box described above are intended for use with a saw, the edges of the mitre being left rough from the saw in order to take glue better.

259.

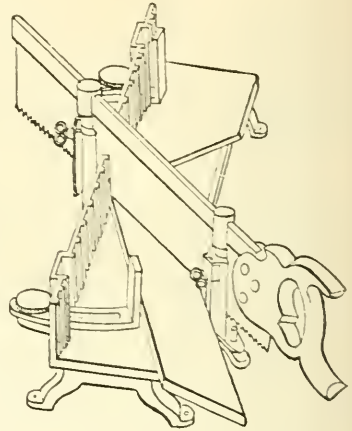

260.

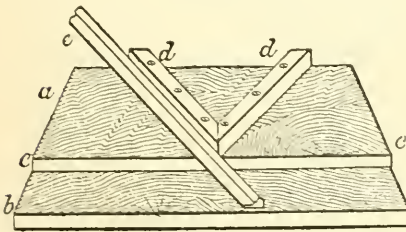

261.

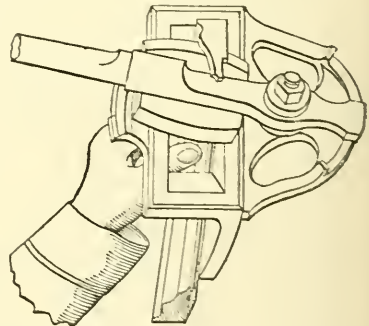

Another form, admitting of the sawed work being planed up, is called a "shooting-board," and is shown in Fig. 260. It consists of 2 slabs, *ab*, of good sound mahogany, about 30 in. long, 18 in. wide, and 1 in. thick, screwed together so as to form a step *c*; on the topmost are screwed 2 strips *d* of hard wood $1\frac{1}{2}$ –2 in. wide, at right angles. The piece of moulding *e* to be mitred is laid against one guide bar, and sawn off on the line *c*, or laid on the other side against the second guide bar, and similarly cut off. It will be necessary to use both sides in this way, because, although the piece cut off has

also an angle of 45° , it would need to be turned over and applied to the other, which could not be done without reversing the moulding. In a plain unmoulded strip, this would not signify. The strip lying close to the step or rebate of the board, can be trimmed by the plane by laying it on its side, but care must be taken not to plane the edge of the step itself. The plane must be set very fine, and must cut keenly. To saw off

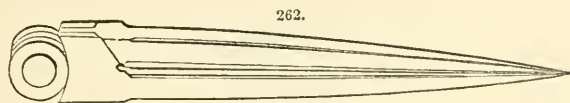

262.

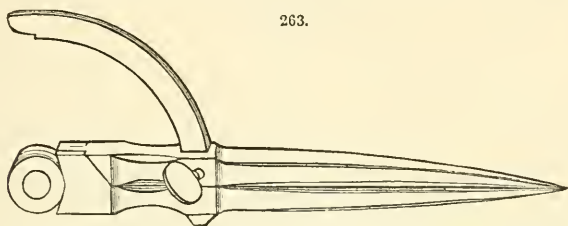

263.

a piece at right angles, and not with a mitre, lay it against the bar, and saw it off in a line with the other, when it cannot fail to be cut correctly, *dd* forming 2 sides of a square.

A handy mitreing tool sold by Melhuish is shown in Fig. 261. It cuts a clean

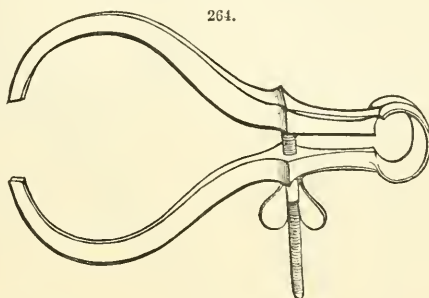

264.

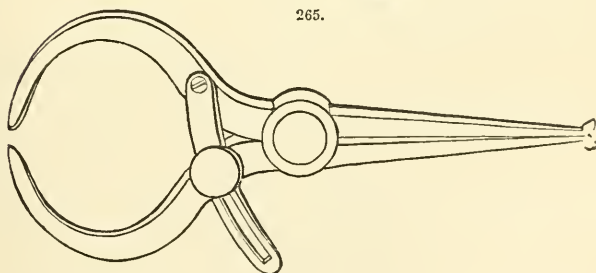

265.

mitre at one thrust of the handle. Its price is 15s. to cut 2-in. mouldings, and 30s. for 4-in.

Compasses and Callipers.—These implements are used for taking inside and outside dimensions where a rule cannot be employed, and for striking out circular figures. Ordinary forms are shown in the annexed diagrams. Fig. 262 is a pair of ordinary plain

compasses; Fig. 263, wing compasses; Fig. 264, spring callipers; Fig. 265, inside and outside callipers; Fig. 266, improved inside and outside callipers. The method of using

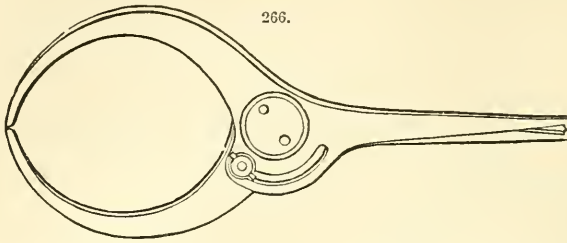

these instruments is sufficiently obvious from their shape. Ordinary useful sizes vary in price from 1 to 5s.

Trammel.—This is employed for drawing elliptic or oval curves, and is represented in Fig. 267. It can be purchased with varying degrees of finish, or may be home made in the following manner:—Two strips of dry hard wood *a*, 18 in. long, $1\frac{1}{2}$ in. wide, and $\frac{3}{4}$ in. thick, are ploughed down the centre to a depth of $\frac{3}{8}$ in. and a width of $\frac{3}{4}$ in.; one is let into the other at right angles so that the bottoms of the grooves or channels are exactly flush, and the structure is strengthened by having a piece of thin sheet brass cut to the shape and screwed down to its upper surface. Next 2 hard-wood blocks $1\frac{1}{2}$ in. long are cut to slide easily but firmly in these grooves, their surfaces coming barely flush with the face of the instrument. A hole is drilled nearly through the centre of each block and about $\frac{1}{10}$ in. diam., to admit the pins *b*; and thin strips of brass are then screwed on to the surface of the instrument in such a manner as to secure the blocks from

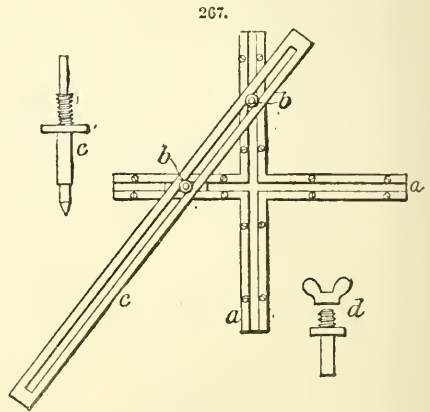

coming out of the grooves while not interfering with the free passage of the pins and blocks along the grooves. To this is added the beam compass *c*, which consists of a straight mahogany ruler with a narrow slit down the middle permitting it to be adjusted on the pins. These last may be of brass or steel wire with a shoulder and nut, as at *d*; they are fixed at the required points on the ruler *c*, and then inserted in the holes in the blocks, where they are free to revolve. A hollow brass socket *e* fitted with a pencil is also made to screw on to the beam, and forms the delineator.

Shooting-board.—This implement, Fig. 268, is for the purpose of securing a true surface and straight edge on wood when planing. It is generally made by fastening one board on another in such a way as to form a step between them; shooting-boards made by gluing 2 pieces of board together, are very apt to twist and cast through the action of the air, and once out of square, are very hard to set right, generally requiring to be pulled apart, and made again. The following plan renders this unnecessary:—Take 2 boards (of the length you require the board, allowing at least 1 ft. extra for the plane to run;

thus, to plane up 5-ft. stuff, make the board at least 6 ft.) of thoroughly dry pine, 1 in. thick and 11 in. wide, and plane them perfectly true; cut 4 in. off one the whole length of the board; these 2 pieces are for the bottom board, and across these glue about

268.

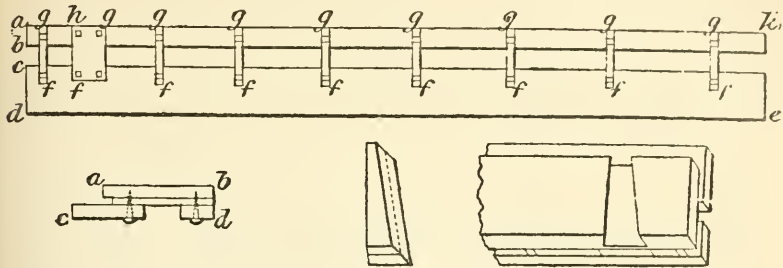

8 pieces of $\frac{1}{2}$ -in. pine $1\frac{1}{2}$ in. wide by 10 in. in length and one piece 5 in. in width by 10 in. in length to build up or strengthen the upper board where the groove will come, leaving a gap 4 in. wide between the 2 bottom boards, thus making it 15 in. wide; now glue on the upper board, allowing it to lap 1 in. over the cross-pieces (as in cross section), and screw together with 2 1-in. screws from the bottom. This will allow the top to be planed if it should cast, as the screws do not come through, and the edge being raised and lapping over the cross-pieces, allows the edge to be squared, without parting the boards, while the air having free play all round the boards they are not so likely to cast, and, in shooting an edge, the shavings and dust work away under the top board, so as not to throw the plane out of square. The blocks are generally screwed across the board, but it is better to cut a groove across, wedge-shape, 6 in. from the end, and cut wedges of various thicknesses for planing wood of any substance, so that the plane may run over the block, as in section. The measurements are *a-b*, 4 in.; *b-c*, 4 in.; *c-d*, 7 in.; *d-e*, 6 ft.; *f-g*, 10 in.; *g-h*, 5 in.; *h-k*, 4 in.; and in the section of the boards, *a-b*, 11 in.; *c-d*, 15 in.

269.

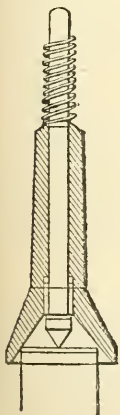

Bell centre punch.—This handy little device enables any mechanic instantaneously to centre any round, square, oval, triangular, hexagonal, or octagonal article for the purpose of drilling or turning. In use the punch is held upright (as shown in Fig. 269) over the article to be centred, and the punch centre tapped, when the true centre of any geometrically-shaped article will be found. It will centre any size from $\frac{1}{4}$ to 1 in. diam., and costs from 3s. upwards.

270.

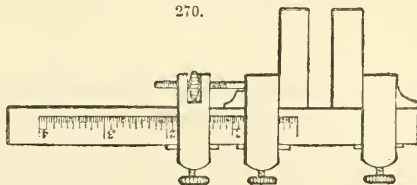

Combinations.—Combination tools are essentially American novelties, and those described here may all be obtained of Churchills, Finsbury.

Starrett's calliper-square is shown in Fig. 270; the jaws are hardened, and, being

made independent and accurately ground, can be reversed for an inside calliper of larger scope, or used for depth gauge, &c. The beam is graduated to 64ths in. on one, and 100ths on the other. The 4-in. size costs 18s. with adjusting screw, or 14s. without.

The steel calliper-rule is shown in Fig. 271; when closed it is 3 in. long, and the

271.

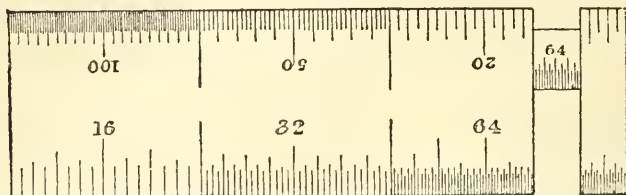

calliper can be drawn out to measure $2\frac{1}{2}$ in. They are accurately graded, and durable; cost, 15s. 9d.

Starrett's combined try-square, level, plumb, rule, and mitre, is shown in Fig. 272; the various parts are: *a*, centre head forming centre square both inside and outside, one scale fitting both heads; *b*, square; *c*, mitre; *d*, rule; *e*, plumb level. As a try-square, it is a substitute for every size of the common kind, and more compact; as a centre square, it gives both inside and outside grades; as a mitre, it affords both long

272.

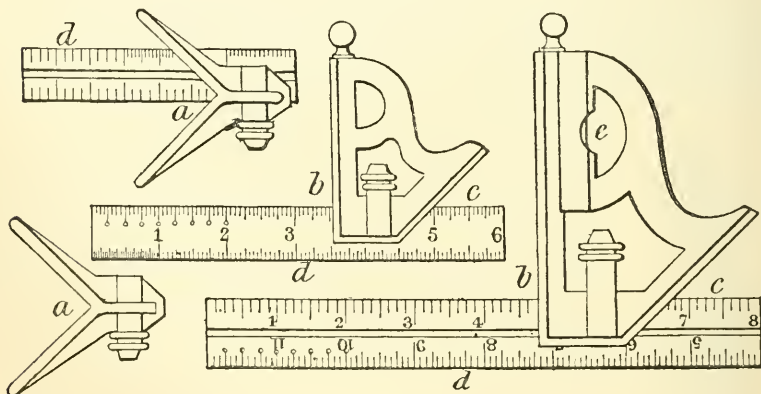

and short tongues; and it can be used as a marking gauge, mortice gauge, or T-square. The 4-in. size without centre head or level costs 4s. 6d., and the complete tool may be had for 11s. 3d. for the 6-in. size to 15s. 9d. for the 12-in.

Ames's universal or centre square is shown in Fig. 273. For finding the centre of a circle, as in A, the instrument is placed with its arms *b a e* resting against the circumference, in which position one edge of the vertical rule *a d* will cross the centre. If a line be drawn here, and the instrument be similarly applied to another section of the circumference, and another line be drawn crossing the first, the point of crossing will be the centre of the circle. B illustrates its use as a try-square at *n*, and as an outside

square at *l*. In C it is applied as a mitre, in D as a rule and T-square, in E as an outside square, and in F as a T-square for machinists. The prices range from 11s. 3d. for the 4-in. size to 31s. 6d. for the 12-in.

HOLDING-TOOLS.—These are chiefly represented by pincers, vices, and clamps.

Pincers.—This well-known tool is shown in Fig. 274. It is made in various sizes and qualities, the most generally useful being the 5-in. and 8-in. sizes, costing about 3d. per in.

Vices.—The old-fashioned form of hand-vice is shown in Fig. 275; in size and price it ranges from 3-in. and 2s. to 6-in. and 6s. Steer's patent hand-vice, as sold by Melhuish, Fetter Lane, is represented in Fig. 276; cost 5s. The improved American hand-vice, as sold by Churchills (Fig. 277), is of metal throughout, the jaws being of forged steel, and the handle of case-hardened malleable iron; price 6s. 6d. The 2 last forms have a hole through the handle, and screw for holding wire. An ordinary wrought-iron parallel vice is shown in Fig. 278.

Great improvements have been made of late years in vices, more especially in the American forms sold by Churchills. The one shown in Fig. 279 has a 3-in. jaw, with swivel base; and beckhorn and swivel-jaw attachment, allowing it to take hold in any position that may be found convenient; its price is 20s. Fig. 280 illustrates Parker's saw-filer's vice, made with a ball-and-socket joint, by which the jaws may be turned to any position; price 7s. for 9-in. jaws. Hall's patent sudden-grip vice is shown in Fig. 281. To open the jaws, lift the handle to a horizontal position, or as high as it

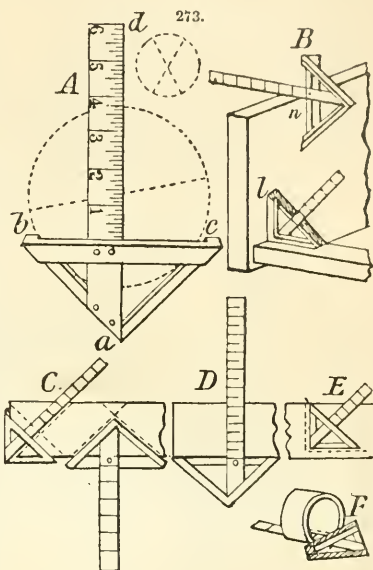

274.

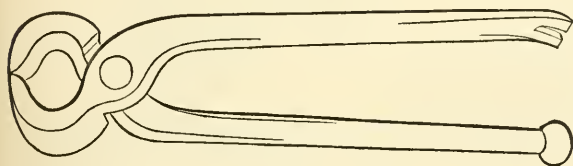

275.

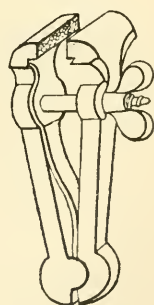

276.

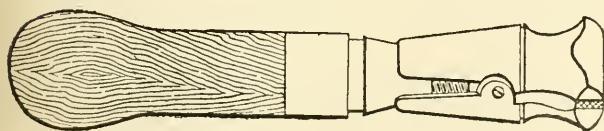

will go, and draw it towards you. In this way the sliding jaw can be moved to any position, and the vice swivelled if desired. In order to grasp the work, push in the sliding jaw till it presses against the work, then depress the handle, which causes the

jaws to securely grasp the work and at the same time lock the swivel. If the handle should not go low enough for convenience, it can be made to go lower by depressing it just before it touches the work to be held. If the vice swivels too easily, drive in the key W in the bottom plate; but if it does not turn easily enough, drive out the key a little. If the handle fails to remain in a horizontal position, the screw S can be tightened to hold it. Care should be taken that the screw N is down, so as to keep the rack H from lifting

277.

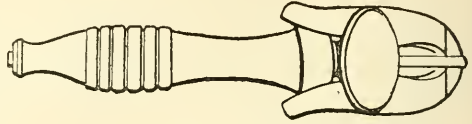

278.

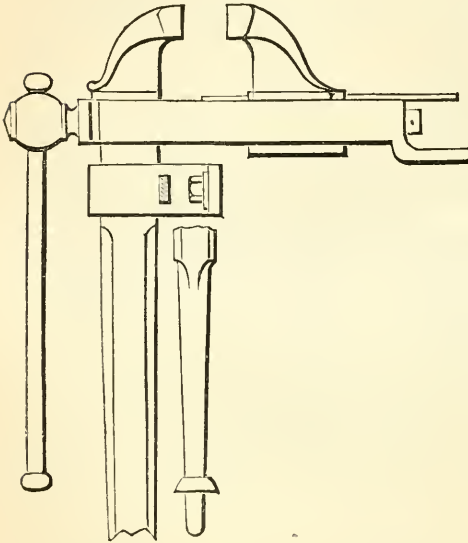

279

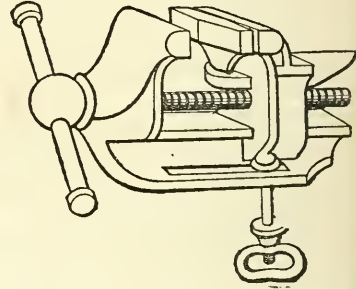

280.

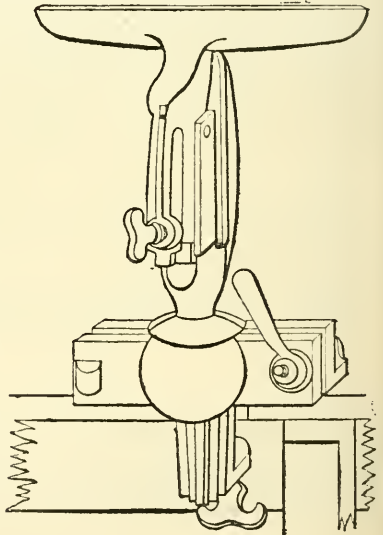

with the clutch G. The sliding jaw can be removed by taking out the pin at the end of the slide, keeping the handle horizontal. If grease or dirt gets on the rack H, the slide should be withdrawn, and the rack and clutch thoroughly cleaned. Sizes and prices vary from 2-in. jaw, opening 2 in., weighing 6 lb., cost 22s. 6d., to 5-in. jaw, opening 6 in., cost 95s.

A very handy little "instantaneous grip" vice, sold by Melhuish, Fetter Lane, is shown in Fig. 282; the size with 9-in. jaws opening 12 in. costs 16s.

The picture-frame vice illustrated in Fig. 283 is a useful novelty, sold by Churchills. It is operated by means of a cam lever attached to a treadle, thus allowing entire freedom to both hands of the workman. It is easily and quickly adjusted of mouldings

of any width and frames of all sizes; and holds both pieces, whether twisted or straight, so firmly that perfect joints are made without re-adjusting; price, 22s. 6d.

Stephens' parallel vice, as sold by Churchills, is shown in Fig. 284. The working parts consist simply of a toggle G and toothed bar T, held together by a spring S, and

281.

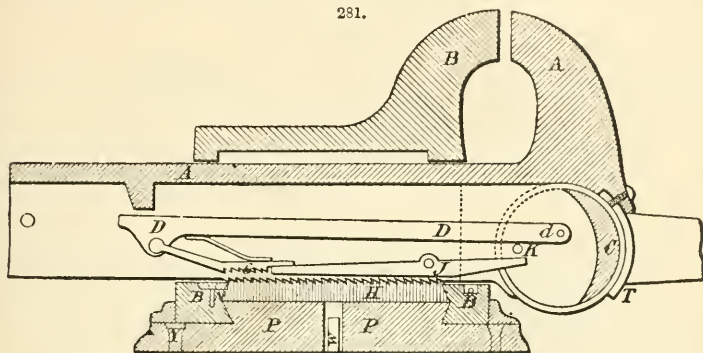

worked by a cam C, and hook M, on the handle H. Pressing the handle hard back, the tooth M is brought to bear under the tooth m, on the left joint of the toggle, thus disengaging the racks by raising the tooth bar t away from the rack T. The movable

282.

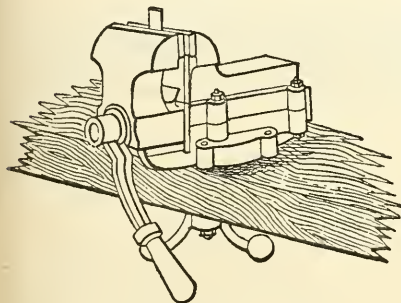

283.

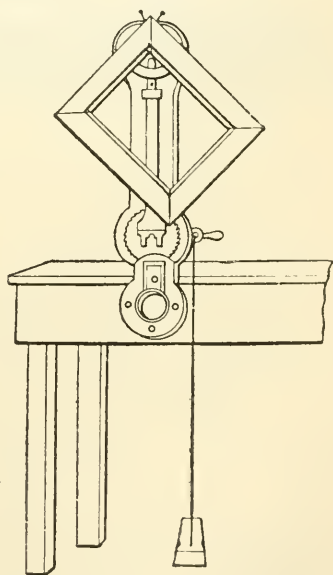

jaw B can now be slid in and out, to its extreme limits, with perfect ease, and an article of any size be held at any point between these limits, simply by placing it between the jaws of the vice, then pressing the movable jaw B against it and pulling the handle out. At the first start of the handle outward, the tooth M slips from under the tooth m, and the spring S draws down and firmly holds the tooth bar t against the rack T; as the handle is pulled farther outward, the cam C is brought to bear against the ridge n, thus straightening the toggle and forcing the movable jaw B against the article to be held. The parts are interchangeable. The racks and all parts where pressure comes are made of steel. There is no wear to the

racks, for they merely engage without rubbing. Great solidity and strength are added to the movable jaw by a projection from the stock strengthened by two upright flanges. Occasionally put a drop of oil on the cam C and tooth M.

234.

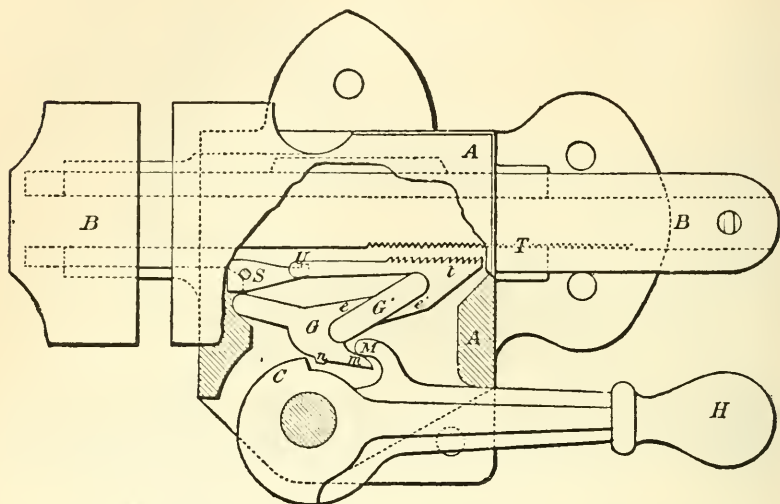
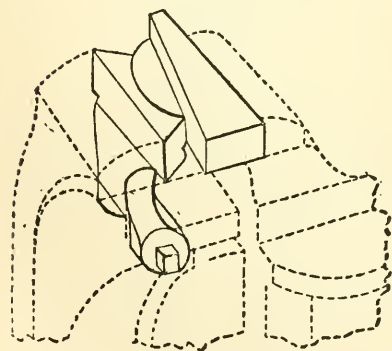
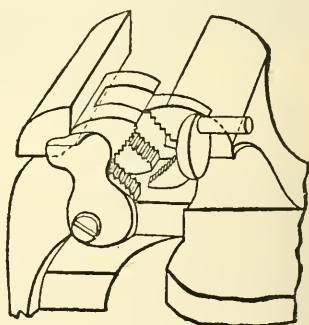

Fig. 285 represents Stephens' adjusting taper attachment, for holding all kinds of taper or irregular work; and Fig. 286 illustrates the pipe attachment for holding gas-pipes or round rods. The width of jaw varies from 2 to 6½ in.; opening, 2¼-11 in.;

' 285.



286.



price 14-150s. with plain base, or 18-176s. with swivel base; taper attachment costs 6-32s., and pipe attachment, 12s. 6d.-36s.

Vices also form an essential part of the carpenter's bench, and will be further noticed under that section (p. 261).

Clamps.—The ordinary carpenter's clamp (or cramp), shown in Fig. 287, is employed for tightening up the joints of boards, whether for the purpose of nailing or to allow

time for glue to harden. It is composed of a long iron bar *a* provided with holes *b* at intervals for receiving iron bolts which hold the sliding bracket *c*; the length of slide of the second bracket *d* is limited by the screw *e* which actuates it. The length of opening varies from 3 to 6 ft., cost 25–38s.

Murphy's bench clamp, as sold by Churchills for 14s. 6d. is shown in Fig. 288. It is

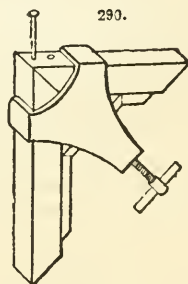
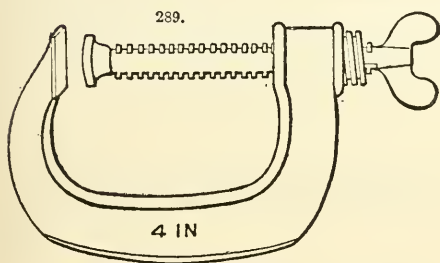
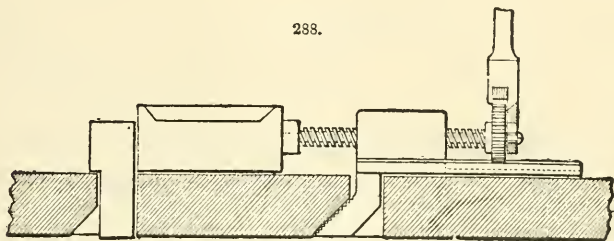
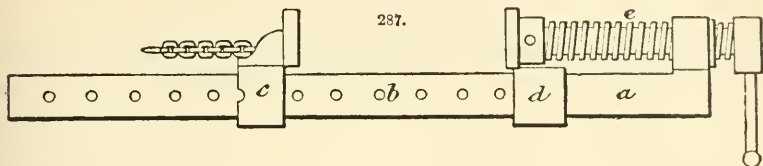

reliable, does not injure the work, is adapted to any thickness of bench top, can be changed to any position, and laid aside when not in use.

Hammer's adjustable clamp, Fig. 289, is a strong tool made of malleable iron; prices range from 22s. 6d. a doz. for the 3-in. size, to 55s. for the 8-in.

For simple rough work a suitable clamp can be made by driving wedges in to tighten up the work laid between stops on a plank.

A very useful corner clamp for securely gripping 2 sides of a picture frame during nailing or gluing together, is shown in Fig. 290. The two pieces being accurately mitred are placed in close contact and so held while the clamp is being tightened. These clamps are sold by Melhuish at 2s. a pair for taking 1½-in. moldings, up to 5s. for 4-in.

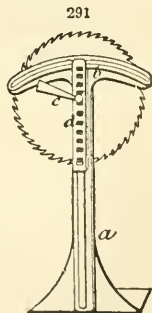

Fig. 291 shows a clamp designed for holding a circular-saw while being filed: *a* has 2 jaws, one of which is seen at *b*; they are of metal lined with wood, and are closed or

unclosed by turning the handle *c*. The temporary mandrel of the saw may be placed in either of the holes of the clamp standards at *d*, so as to bring the saw to the right height in the jaws.

Bench clamps and holdfasts will be described under another section (p. 259).

RASPING TOOLS.—These comprise the various forms of saw as well as files and rasps.

Saws.—The saw is a tool for cutting and dividing substances, chiefly wood, and consisting of a thin plate or blade of steel with a series of sharp teeth on one edge, which remove successive portions of the material by cutting or tearing. Some representative examples of handsaws are illustrated below: Fig. 292 is a panel and ripping-

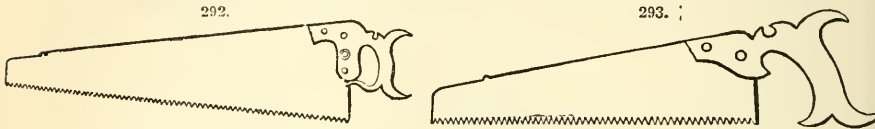

saw; Fig. 293, a gaffer saw; Fig. 294, a tenon saw; Fig. 295, a dovetail saw; Fig. 296, an iron bow saw; Fig. 297, a frame turning saw.

Principles.—The saw is essentially a tool for use across or at right angles to the fibres of the wood, although custom and convenience have arranged it for use along the fibres, still not when those fibres are straight and parallel. If in the growth of timber there was not any discontinuity in the straight lines of the fibres, then all longitudinal separation would be accomplished by axes or chisels. It is because this rectilinear continuity is interrupted by branches and other incidents of growth that the saw is used for ripping purposes. Were not some tool substituted for the wedge-like action of the axe, timber could not as a general rule be obtained from the log with flat surfaces. Hence the ripping saw, a tool which is intermediate between an axe and a saw proper. To study the saw as a tool fulfilling its own proper and undisturbed duties, it must be

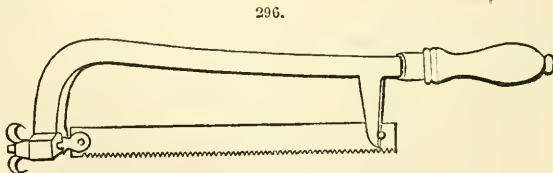
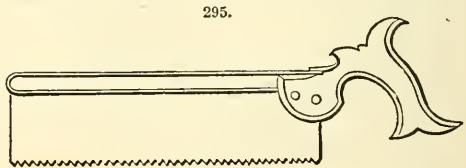
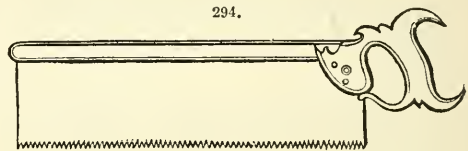

regarded in the character of a cross-cut saw. In this character it is called upon to meet the two opposing elements—cohesion and elasticity of fibre.

To deal with the treatment of fibrous wood at right angles to the length of the

fibre is then clearly an operation in which considerations must enter, differing in many respects from those that decide action in direction of the grain. The object now is, as it were, to divide with the least expenditure of power a string which connects two ends of a tensioned bow. If a blow be given in the middle of a bow-string, the elasticity imparted by the bow to the string renders the blow inoperative. The amount of this elasticity is very apparent when one notes the distance it can project an arrow. Indeed, any one who has struck a tensioned cord or a spring is well aware that the recoil throws back the instrument, and by so much abstracts from the intensity of the blow. To separate the string in this experiment even the pressure of a knife blade is insufficient; for a heavy pressure, as manifested by the bending of the string, is borne before separation takes place. It may be taken for granted that in thus severing the string, the power expended has been employed in two ways; first in bending the string; second in separating it. If the string be supported and prevented from bending, and the same cutting edge be applied, and the power be measured by weights or a spring balance, it will be seen how much of the former was expended in the useless act of bending the string, and therefore quite lost in the separating of it.

297.

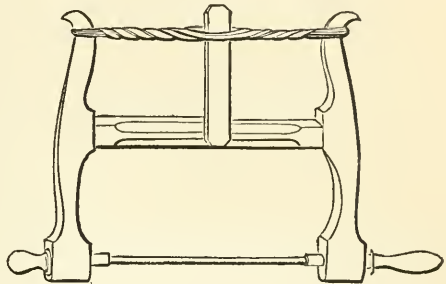

If the cutting instrument were a short narrow edge, or almost a sharpened point, and drawn forward, each fibre would be partially cut. A repetition of this action in the same line would still further deepen the cut. But a cutting edge requires support from a back, i.e. from the thickening of the metal, otherwise it would yield. Further, a cutting edge held at right angles to the surface of the fibres may not be the most effective position. Let any one draw the point of a knife across the grain of a smooth pine plank, holding the blade first at right angles to the surface, and, secondly, inclining forward, he will observe that by the first operation the fibres are roughly scratched; by the second they are smoothly divided.

Hence, even where the edge has deepened, this back support or metal strengthening must follow. It cannot do so upon this knife contrivance, because the sharp edge has not prepared a broad way for the thick back, which being of a wedge-like character should be acted upon by impact and not by such tension or thrust as in this case is only available. Therefore simple cutting is insufficient for the purpose of separating the fibres, but it has been suggestive.

If now something must enter the cut thicker than the edge, then it is clear that the edge alone is insufficient for the required purpose, and an edge, as a cutting edge alone, cannot be used for the separation of the fibres cross-wise. Longitudinally it may be, and is used, but in reality what appears to be thus used is a wedge, and not a cutting edge, for in a true cut the draw principle must enter. The axe and chisel do not work upon the cutting "edge," but upon the driven "wedge" principle. They are driven by impact, and not drawn by tension or thrust by pressure.

The consideration now suggested is not simply how to cross-cut the fibres, but, further, how to permit the material on which the edge is formed to follow without involving an inadmissible wedge action. It may be done as in a class of saws called metal saws, viz. making the "edge" the thickest part of the metal of the saw. This however, ignores the true principle of the saw, and introduces the file. It may, in

passing, be well to remark that in marble cutting, where the apparent saw is only a blade of metal without teeth, this want of metal teeth is supplied by sharp sand, each grain of which becomes in turn a tooth, all acting in the manner of a file, and not a saw proper. A former method of cutting diamonds was similar to this. Two thin iron wires were twisted, and formed the string of a bow. These were used as a saw, the movable teeth being formed of diamond dust. A similar remark applies to a butcher's saw; its metal teeth really act as files.

For the purpose of separating a bundle of fibres, the "edge" cannot be the edge with which we are familiar in axes and chisels. Such an edge drawn across will cut fibres on a surface only; this is insufficient, for a saw is required to cut fibres below a surface.

The tearing also of upper fibres from lower ones is not consistent with true work. To actually cut or separate these is the question to be considered, and the simple answer is another question. Can a narrow chisel be introduced which shall remove the piece of fibre whose continuity has been destroyed by cutting edges previously alluded to? If so, then an opening or way will have been found along which the back or strengthening part of the cutting edge can be moved. If, however, we look at the work of a single cutting edge, we notice that, although the continuity of the fibre is destroyed, yet the separated ends are still interlaced amongst the other fibres. To obtain a piece removable as by a small narrow chisel, it will be requisite to make a second cut parallel to the first. This being done, there is the short piece, retained in position by adhesion only, which must by some contrivance be removed, for it is in the way, and the room it occupies is that in which the back of the cutting edge must move. To slide, as it were, a narrow chisel along and cut it out is more simple in suggestion than in execution.

There is another defect upon the application of what at first seems sufficient in principle, but only wanting in physical strength—it is the absence of any guide. To draw a pointed cutting edge along the same deepening line needs a very steady hand and eye. This consideration of the problem requires that some guide principle must enter.

To increase the number of cutting edges, and form as it were a linear sequence of them, may give a partial guidance, and if the introduction of our chisel suggestion be impracticable, then another device must be sought. Instead of the 2 parallel cutters, it will be possible to make these externally parallel but internally oblique to the line of cut, in other words to sharpen them as an adze is sharpened and not as an axe, and in doing so one obstacle will be removed, it is true, but a blemish which was non-existent will appear. The combining obliquity of the dividing edges will so press upon the intervening piece of fibre as to press it downwards into and upon the lower fibres, thus solidifying, and, in so far as this is done, increasing the difficulty of progressing through the timber.

Note the mode of operating, as shown by Fig. 298. The portions of wood abd and ecd have been removed by the gradual penetration of the oblique arms—not only have they been cut, but they have been carried forward and backward and removed, leaving a clear space behind them of the width ae . But how with regard to the portion within the oblique arms? That part would either be left as an impeding hillock, or it would have to be removed by the introduction of such a plan as making rough the insides of these oblique arms. If we consider the nature of the material left, it will be admitted to consist of particles of woody fibre adhering to each other only by the glutinous or gummy matter of the timber, and not cohering. If the breadth ae is not too large, the whole of the heap would be rubbed away by the power exerted by the workman. There will therefore be not only economy in power, but economy also in material in narrowing ae . If attention be given to the form of the pieces



bent from the plane of the metal of which this cutting instrument is made, it will be observed that the active portion has 3 edges, of which the lower or horizontal one only is operative, for the tool rides upon the fibres, divides them, and when the dividing has been accomplished, the sloping parts will remove the hillock. To act thus, the lower edges would require to be sharpened at *a* and *e* so as to clear a gate for the metal to follow. The action of the tool as described would require a downward pressure, in order to cause the cutting segments to penetrate vertically. The resistance to this downward entrance is the breadth of the "tooth," for it rides upon a number of fibres and divides them by sliding over; the complete action requires not only downward pressure for the cut, but also horizontal pressure for the motion, the latter both in the advance and withdrawal of the tool. These 2 pressures being at right angles do not aid each other, and will employ both hands of the workman. It is very obvious that the compounding of these will give freedom to at least one hand.

For the present, assume that the 2 pressures to be compounded are equal, then the simple operation is to employ one pressure making (say) an angle of 45° with the horizontal line of thrust. Although this be done, yet if the saws be any length, clearly the angle will vary, and therefore the effect of the sawyer's labour will be counteracted, either as a consequence of excessive thrust or of excessive pressure at the beginning or ending of the stroke. In fact, not only the position in which the handle is fixed on the saw, but the very handling itself will require those adaptations which experience alone can give.

The effect of this will be to cause the forward points to penetrate, and cross-cut the fibres obliquely. The return action will be altogether lost unless the instrument is arranged accordingly, and sloped in the other direction.

If the tool becomes a single-handed one, and relies for its operation upon thrust or tension in one direction only (say thrust), then cutting edges on the back portions of the teeth are useless, and had better be removed.

The experiment worthy of trial is, can the whole power, or nearly the whole power, be converted into a tension or thrust for cutting purposes. To do this the cutting edge must be so formed as to be almost self-penetrating; then the cutting edge is no longer a horizontal edge, but it becomes oblique, on the advancing face, and formed thus there is no reason why it should not also be oblique on the back face, and so cut equally in both directions. The inclination of these faces to the path of the saw must be determined by the power—whether it is capable of separating as many fibres as the teeth ride between, and if these are formed to cut each way (as a single-handed tool) whether it could be done; because it necessitates a construction to which tension and thrust may be alternately applied. The nature of the wood, the power and skill of the workman, and the strength of the metal, must answer this suggestion.

The depth, or rather length, of the cutting face may be decreased, and the number of teeth increased, for the fibres to be cut cannot be more vertically than can be contained between 2 teeth. The operative length of the tool must also be taken into account, for the combined resistance of all the fibres resting within the teeth must be less than the power of the workman. It may be well to remark that this difficulty is generally met in practice by the workman so raising certain teeth out of cut as to leave only so many in operation as the circumstances enable him to work. One advantage results by so doing—the guide principle of a longer blade is gained than could be done had the length been limited by that of the operating teeth, or had there been a prolongation of metal without any teeth upon it. To avoid complicating an attempt to deal progressively with the action of the saw, this, and perhaps other considerations may for a while pass from notice. Considered as hitherto the teeth and tool are planned for operation in both tension and thrust. Now these are of so opposite a nature that a tool perfect under the one is likely to be imperfect under the other. When the necessary thinness of the material and the tenacity of it are taken into account, tension seems the most suitable;

but although the ancients and the workmen in Asia are of this way of thinking, yet in England the opposite practice is adopted. It may be well to give a few minutes to this branch of the subject.

The form of a saw must in one dimension at least be very thin, and that without any opportunity for strengthening any part by means of ribs. When a strengthening bar is introduced at the back as in dovetail saws, the depth of cut is limited. In order, then, to permit the guide principle to operate efficiently, this thin material must be so prolonged as under all circumstances to guide the cutting edge in a straight line. Of course we are dealing with saws to be used by hand, and not with ribbon or machine-driven saws.

If a light saw blade be hooked on an object, or placed against one, then tension causes this straight blade to be more and more straightened. On the contrary, if pressed forward by thrust, the weakness of the blade is evidenced by the bending. Now, formed as saw teeth are, either to cut in both directions, or in the forward direction only, then there is always one direction in which the work to be done is accomplished by a thrust upon this thin metal. Clearly the metal will bend. If, however, the teeth are such as to cut in one direction only, and that when the tension is on the metal, the work tends to preserve that straightness of blade upon which an important quality and use of the tool depends. That this tension system can be efficient with a very narrow blade is clear from the extensive use of ribbon saws. There is, however, a property in the breadth of the blade which applies equally to the tension and thrust systems—it is the guide principle. The breadth of the blade operates by touching the sides of the gateway opened by the teeth. When it is desired to dispense with a straight guide for sawing purposes, it is done by narrowing the blade as in lock saws, tension frame saws, &c.

There is obviously a limit to the required breadth even for the most effectual guidance and movement: this guidance should be uniform through the entire cut; hence upon the guide principle alone, there is required a breadth of saw beyond what is requisite for the teeth. The reasoning hitherto has landed us upon a parallel blade of some (as yet) undecided breadth. When one of our ordinary hand cross-cutting saws is examined, it is observed to be taper and not parallel, the tapering being at the edge or back, where the teeth are not. This has been done to meet our practice of using the saw as an instrument for thrust instead of tension. When the teeth near the end farthest from the handle are to operate, and there is no steadiness obtained from the guidance of the sides of the already separated timber, then the whole of the thrust must be transmitted through the necessarily thin blade. An attempt to compensate for this thinness by increasing the breadth is the only course open. It is one not defensible upon any true principles of constructive mechanism, for it is not in the increased breadth or extension of surface that resistance to bending is wanted, but it is in the thickness, and that is impracticable.

In thrust saws, the hand and the arm of the workman occupy a definite position, and the line of pressure on the saw is thus very much determined by the inclination of the handle (that part grasped in the hand) to the line of teeth prolonged backwards. If the handle be placed at such an angle that a large part of the resolved thrust be perpendicular to the line of teeth, then the "bite" may be greater than the other resolved portion of the power can overcome. At another angle the "bite" may be very little, and although the saw thus constructed would move easily, it would work "sweetly," but slowly. The construction is suitable for saws with fine teeth and for clear cuttings. It will be seen from these considerations that there should be preserved a very carefully considered relationship between the size and angle of the teeth and the position in which the handle is fixed, or rather the varying adaptability of the workman's thrust. Indeed, upon fully developed and accurate principles, the timber to be cut should first be examined, its fibrous texture determined physically, and a saw deduced from these data,

having teeth and handle so related as to do the required work with a minimum of power. This multiplicity of saws is not available; and as in music the multiplicity of notes which only the violin can produce are rejected in other instruments, so here the multiplicity of theoretical saws is rejected, and a kind of rough and ready compromise is effected between the position of the handle and the angle and depths of the teeth. It would, however, well repay those whose works are usually of the same character and of the same class of timber, to consider these points, with a view to the selection of saws and position of handle suitably constructed to do the work with the least expenditure of power.

A few words upon the handles of single-handed saws. Whatever may be the other conditions required in handles, the large majority of saw-handles have the curved hooked projections *a* and *b*, Fig. 299; these are connected with the pressure of the sawyer on the teeth. If, in sawing, the hand bears upon the upper hook *a*, then an increased pressure is given to the forward teeth; if upon the hook *b*, the pressure on the forward teeth is released, and consequent ease in sawing results, also a pressure may be given to the back teeth. The angle at which direct thrust ought to act upon the line of teeth in the saws is obviously very different. Each material may be said to have its own proper angle. Provision may be made by 2 set screws above *a* and *b* for varying the intersection of the line of thrust with the line of teeth. It will be further noticed that in the handle of the "one-man saw," Fig. 301, the upper hook is wanting, and this because under any circumstances the weight of the saw is more than sufficient, and therefore it is not requisite that any resolved portion of the workman's energy should be compounded with this. Not so with the other hook; that is retained in order that thus the weight of the saw may be taken from the work. For these reasons the line of direct thrust is nearly parallel with that of the teeth. We seem to be guilty of much inconsistency in the placing as well as in the formation of saw handles.

299.

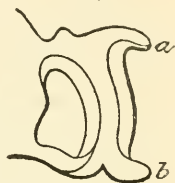

A brief recapitulation of what has been said may suitably close this far from exhausted branch of the subject.

There have been considered:—

The effect of impact transverse to fibre.

The effect of thrust transverse to fibre.

The passing of a cutting edge transverse to fibre.

The reduction of length of cutting edge transverse to fibre.

The introduction of combined vertical with horizontal cut.

The rounding off the back of cutting edge.

The pressures required in sawing.

Tension compared with thrust.

The angular position of handle.

The resolution of forces operating.

Now may be considered the circumstances which influence the form and position both of the teeth and the edges to be put upon them, in the case of hand-saws operating either by thrust alone, or by thrust and tension combined (as in the 2-handed cross-cutting saws used by 2 men, or in the whip and frame saw used in saw pits). Unless specially mentioned the thrust hand-saw for cross-cutting will be the only one considered.

It may be well at the outset to explain that the coarseness and fineness of saws are estimated by the number of teeth points in an inch. The sawmaker uses the term "pitch," but not in the sense as employed in wheels and screws. By pitch he "means the inclination of the face of the teeth up which the shaving ascends." Clearly if the saw is to cut when drawn in both directions, the slope of the teeth from the points

must be the same on both sides; indeed, this may be considered the primitive form of saw teeth, and derived as the saw is said to have been from the backbone of a fish, it is the form that would be suggested. To use a saw with such teeth in the most perfect manner would require that the action at each end should be the same; hence, these are the forms of teeth generally met in the ordinary 2-handled saw used for the cross-cutting of timber. The teeth of these saws are generally wide spaced, and the angle included in their point is from 40° to 60° . The forms, however, of teeth, to cut in both directions, are sometimes more varied, especially when the material is not of uniform non-fibrous character. When this equality of tension in both directions cannot be had, and the workman is required to cross-cut the timber by a one-handled saw, it is clear that he must consider the action as that of tension or thrust alone—one of these only. The sole reason why both are not adopted seems to be that were it so, very different muscular motions and postures of the body would be introduced, and probably experience has shown that these are more fatiguing than the alternate pressure and relaxation which takes place in the ordinary process of hand-sawing. Now, if the cut is in the thrust only, then the form of the back of the tooth must be the very reverse of that of the front, for it ought to slide past the wood, because not required to separate the fibres. In this case the back of the tooth may be sloped away, or it may be shaped otherwise. The faces of the teeth are no longer bound to be formed in reference to an equality at the back. Indeed, with the liberty thus accorded, there has arisen an amount of fancy in the forms of teeth, which fancy has developed into prejudice and fashion. Names dependent either upon uses or forms are given to these, and they are distinguished by such names in the trade. Peg tooth, M tooth, half-moon tooth, gullet tooth, briar tooth; also "upright pitch," "flat pitch," "slight pitch." Of these varieties, custom has selected for most general use in England the one in which the face of the tooth is at right angles to the line of the teeth. The backs of the teeth are, therefore, sloped according to the distance between the teeth and the coarseness or fineness of the saw. This is called ordinary, or hand-saw pitch.

A consideration of the action of the saw in cross-cutting timber settles the cutting edge, and so suggests the mode of sharpening. Taking our ordinary cross-cutting single-handed saw as the type, the forward thrust is intended to separate the fibres, and this not in the way of driving a wedge, but in the actual removal of a small piece by two parallel cuts. For example, if $\bigcirc \bigcirc$, Fig. 300, be a fibre, then the action of the saw must be to cut clean out the piece a, b , so making a space a, b , wider than the steel of which the saw is made. The cleaner the cuts a, d, b, c are the better.

Now this clean cut is to be made by the teeth advancing toward the fibre. If they come on in axe fashion, then the separation is accomplished by the direct thrust of a sharp edge, in fact, by a direct wedge-like action.

Now a wedge-like action may be the best for separating fibre adhering to fibre, but it is an action quite out of place in the cross-cutting of a single fibre, in which cohesion has to be destroyed. There is needed a cutting action, i.e. a drawing of an edge, however sharp, across the mark for separation; this drawing action is very important. Admit for the present that such action is essential, then the saw tooth as constructed does not supply it. Clearly the sharp edge must somehow or other be drawn and pressed as drawn across the fibre. Two ways of accomplishing this present themselves. The effect on the action of the workman is very different in these cases. In the first we must press the saw upon the fibre, and at the same time thrust it lengthwise. Now in soft timber, and with a saw having teeth only moderately sharp, this pressure will tend rather to force the fibres into closer contact, to squeeze them amongst each other, to solidify the timber, and increase the difficulty in cutting. Two actions are here, pressure and thrust. In the second case the pressure must be very light indeed; if otherwise, the point of the tooth will gather

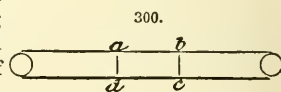

up more fibres than the strength of the workman can separate; indeed, as a rule, in the cross-cutting of broad timber, with all the saw teeth in action, pressure is not required, the average weight of the saw-blade sufficing for the picking up of the fibres. It is probably from the delicate and skilful handling which a tooth thus constructed requires, that hand-saws are not more generally constructed with teeth of this form. In addition to these there is the penetrating tooth, as the points of the peg tooth and others. Whatever may be the form of the teeth, the small piece *a b, c d*, Fig. 300, has to be removed so as to leave the ends from which it is taken as smooth and clean cut as possible, therefore the cutting edge must be on the outside of the tooth. This being so, it follows that the act of severing a fibre will be attended with compression whose effect is to shorten it. Thus condensed it is forced up into the space between the teeth. If now this space is not so formed as to allow the condensed piece to drop freely away so soon as the tooth passes from the timber, then the saw will become choked, and its proper action will necessarily cease. In large saws this is provided for in the shape of the "gums" in which the teeth may be said to be set. What in America are called "gums" are frequently in England called "throats." Saws cannot work easily unless as much care is bestowed upon the "throats" or "gums" as is given to the teeth.

Any exhaustive attempt to deal with the considerations which present themselves to one who enters upon the question, what under all the varying conditions of the problems should be the form and set of a saw-tooth, would require more experimental knowledge and patient research than the subject seems to have received. There are more than 100 different forms of teeth. Sheffield and London do not agree upon the shape of the handle. The Eastern hemisphere and the Western do not agree whether sawing should be an act of tension or one of thrust.

The quantity of timber cut down in America must have led to investigations with respect to saws such as the requirements of this country were not likely to call forth. Hence we have very much to learn from the Americans on this point.

As it seems most judicious to investigate the principles by considering a large and heavy tool, perhaps it may be well to examine the largest handicraft saw. This (Fig. 301)

301.

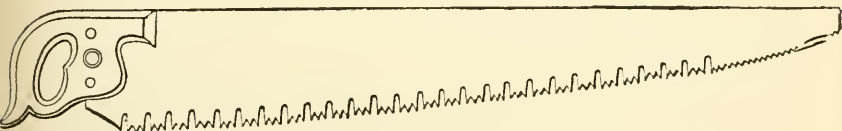

is a "one-man saw" 4 ft. long, by Disston, Philadelphia. Long as the blade is, it is not too long. The travel is near, but still, within the limit of a man's arm. To enter the wood, the teeth at the extreme end are used. These are strong, but of the form generally met with in the largest of our own cross-cut saws. The acting teeth are of an M shape, with a gullet or space between them. The angle at which the teeth are sharpened is very acute; the consequence of this and of their form is, that they cut smoothly as a sharp knife would do; indeed, much as a surgeon's lancet would. Some teeth are formed on the principle of the surgeon's lancet, and these are called "flea" teeth. The spaces between the M's in the "one-man saw" are "gums" for the reception and removal of the pieces cut out of the separated fibre. In the particular case before us, the M is $\frac{3}{4}$ in. broad and $\frac{3}{4}$ in. deep; the upright legs of the M are sharpened from within, the V of the M is sharpened on both sides. The legs are "set" to one side and the V to the other side. Thus arranged, the saw cuts equally in tension and in thrust, and the debris is brought out freely at each end. The M tooth for this

double-cutting results from an observation on two carefully-toothed short cross-cut elementary saws, where it will be noticed that the form of tooth to cut both ways, resulting from the combination, is M. The set of this large "one-man saw" is worthy of notice. An inspection of the cutting points will show that each point is diverted from the plane of the saw blades not more than about $\frac{1}{32}$ in. When the object of "set" is considered, it will be allowed that so little is sufficient.

The annexed diagrams (Fig. 302) of teeth of certain cross-cut saws used in America may illustrate the present subject. A single tooth will in some instances be observed between the M teeth: this is a "clearance" tooth, and is generally shorter than the cutting tooth. Sometimes it is hooked, as may be seen in c; in such case it is shorter by $\frac{1}{32}$ in. than the cutting teeth, and acts the part of a plane iron by cutting out the pieces of fibre separated by the other or cutting teeth, which cutting teeth under these circumstances are lancet-like sharpened to very thin edges.

That the "set" of the teeth should be uniform in the length of the saw follows from a moment's reflection upon the object of this set. If one tooth projects beyond the line of the others, that tooth will clearly scratch the wood, and therefore leave a roughness on the plank. As more than its share of work is then allotted to it, the keenness of edge soon leaves it, and thus increases the labour of the sawyer. The American contrivance for securing a uniformity in the set of the teeth is the "side-file." The three set screws determine the elevation of the file above the face, and the travel of the short length of fine cut file reduces all excessive "sets" to a uniform "set" through the entire length of the saw.

The "crotch punch" is also an American contrivance for obtaining a clearance set out of a spreading of the thick steel of the saw by an ingeniously formed angular punch.

It is occasionally required to saw certain cuts to the same depth, as, for instance, in the making of tenons. The saw to which the term "tenon" is applied is more suited for cabinet than for carpenters' work. However, an ordinary saw may be provided with a gauge, which can be adjusted so as to secure a uniform depth in any number of cuts, and in this respect it is even superior to a tenon-saw, and may be suggestive to some whose labours might be facilitated by the adoption of such a contrivance.

The rip-saw considered as a cutting tool, may be likened to a compound chisel, and the form of teeth which would operate with the least application of power would be the same as that of a mortising chisel; but knots and hard wood are conditions which call for rigid teeth, rendering the chisel form impracticable, except for sawing clear lumber, and with a high degree of skill in filing and setting. The limit of endurance of such steel as must be employed for saws, will not admit of pointed teeth; these will break in cutting through knots and hard wood, and no form of saw-teeth which permits their points to crumble and break should be adopted. In actual practice, with the skilled filer, there is a tendency to create pointed saw-teeth, and when there is a want of skill in the filer the tendency is the other way, and teeth unnecessarily blunt are common. "The action of a saw when ripping or cutting with the fibres of the wood is entirely different

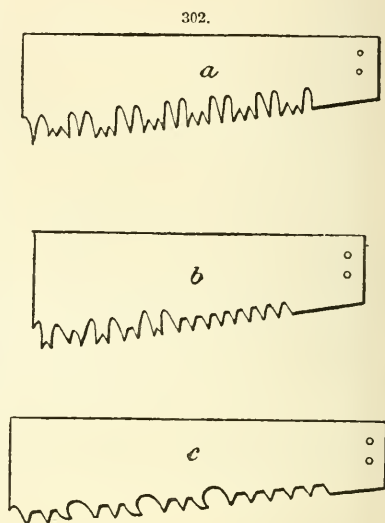

from that when cross-cutting or severing the fibres of the wood transversely; the shape of the teeth and the method of sharpening should therefore differ. In the case of a rip-saw, the action of the saw is chiefly splitting, the teeth acting like a series of small wedges driven into and separating the longitudinal fibres of the wood; whilst with cross-cutting saws, the fibre of the wood has to be severed across the grain: it is comparatively unyielding, the teeth of the saw meet with much more resistance, and it is found necessary to make the teeth more upright and more acute or lancet-shaped than for cutting with the grain. The faces of the teeth should be sharpened to a keen edge, and for hard wood filed well back, so that in work they may have a direct cutting action, similar to a number of knives. Care should also be taken that the teeth are made of sufficient depth to afford a free clearance for the sawdust. This is an important point too with rip-saws. The teeth should also be equal in length; if not, the longest teeth get the most work, and the cutting power of the saw is much lessened. The length of the teeth should depend on the nature of the wood being sawn: for sawing sappy or fibrous woods, long, sharp, teeth are necessary, arranged with ample throat space for sawdust clearance; care must be taken, however, that the teeth are not too long, or they will be found to spring and buckle in work. In sawing resinous woods, such as pitch pine, the teeth of the saw should have a considerably coarser set and space than for hard woods. It will also be found advisable—especially with circular saws—to lubricate the blades well, as the resinous matter is thus more easily got rid of. In sawing hard woods, either with reciprocating or circular saws, the feed should be not more than one-half as fast as for soft wood, the saw should contain more teeth, which should be made considerably shorter than those used for soft wood, roughly speaking, about $\frac{1}{4}$; it is impossible, however, to make a fixed rule, owing to the great variety of woods and their different hardnesses; the length of teeth which may be found to suit one wood well may in another case require to be increased or decreased. In cutting woods which are much given to hang and clog the saw-teeth, increment teeth may be used with advantage; these are arranged with fine teeth at the point of the saw, which gradually get coarser till the heel of the saw is reached; thus the fine teeth commence the cut and the coarser ones finish it, obviating in a great degree the splintering and tearing of the wood caused by coarse teeth striking the wood at the commencement of the cut. As regards the angles of the teeth best adapted for cutting soft or hard woods no absolute rule can be laid down. The following may be modified according to circumstances. If a line be drawn through the points of the teeth, the angle formed by the face of the tooth with this line should be: For cutting soft woods, about 65° – 70° ; for cutting hard wood, about 80° – 85° . The angle formed by the face and top of the tooth should be about 45° – 50° for soft wood, and 65° – 70° for hard. The angle of the tooth found best for cutting soft woods is much more acute than for hard. Terms used in describing the parts of a saw are:—"Space": the distance from tooth to tooth measured at the points. "Pitch" or "rate": the angle of the face of the tooth up which the shaving ascends, and not the interval between the teeth, as with the threads of a screw. "Gullet" or "throat": the depth of the tooth from the point to the root. "Gauge": the thickness of the saw, generally measured by the wire gauge. "Set": the amount of inclination given to the saw-teeth in either direction to effect a clearance of the sawdust. "Points": small teeth are reckoned by the number of teeth points to the inch. The chief facts to be borne in mind in selecting a saw with the teeth best suited to the work in hand are the nature and condition of the wood to be operated on. No fixed rule can, however, be laid down, and the user must be guided by circumstances. All saws should be ground thinner towards the back, as less set is thus necessary, the friction on the blade is reduced, and the clearance for sawdust is improved. Care should also be taken that they are perfectly true and uniform in toothing and temper. The angle of the point of a tooth can be found by subtracting its back angle from its front, and to do the best and cleanest work this angle should be uniform in all the teeth of the saw." (M. Powis Bale, M.I.M.E., A.M.I.C.E.)

The following table includes saws generally used by mechanics who work wood by hand:—

Names.	Length in Inches.	Breadth in Inches.		Thickness in Inches.	Teeth to the Inch.
		At Handle.	At End.		
<i>Without Backs.</i>					
Rip-saw	28-30	7-9	3-4	0·05	3½
Fine rip-saw	26-28	6-8	3-3½	0·042	4
Hand-saw	22-24	5-7½	2½-3	0·042	5
Cut-off saw	22-24	5-7½	2½-3	0·042	6
Panel-saw	20-24	4½-7½	2-2½	0·042	7
Fine panel-saw	20-24	4-6	2-2½	0·035	8
Siding-saw	10-20	2½-3½	1½-2	0·032	6-12
Table-saw	18-26	1¾-2¼	1-1½	..	7-8
Compass or lock-saw	8-18	1-1½	½-¾	..	8-9
Keyhole or pad-saw	6-12	½-¾	⅓-¼	..	9-10
<i>With Backs.</i>					
Tenon-saw	16-20		3¼-4¼	0·032	10
Sash-saw	14-16		2½-3½	0·028	11
Carcass-saw	10-14		2-3	0·025	12
Dovetail-saw	6-10		1½-2	0·022	14-18

(Holtzapfel.)

Qualities.—Hodgson made a number of experiments on saws to test their qualities and capabilities; and after using them in various ways, fairly and unfairly, he arrived at the following conclusions:—

(1) That a saw with a thick blade is, 9 cases out of 10, of a very inferior quality, and is more apt to break than a thin-bladed saw; it requires more “set,” will not stand an edge nearly so long as a thin one, is more difficult to file, and being heavier and cutting a wider kerf, is more tiresome to use.

(2) Saws hung in plain beech handles, with the rivets flush or countersunk, are lighter, easier to handle, less liable to receive injury, occupy less space in the tool chest, and can be placed with other saws without dulling the teeth of the latter by abrasion on the rivets.

(3) Blades that are dark in colour, and that have a clear bell-like ring when struck with the ball of the finger, appear to be made of better stuff than those having a light iron-grey colour; and he noticed, in proof of this, that the thinner the blades were, the darker the colour was, and that saws of this description were less liable to “buckle” or “twist.”

(4) American-made saws, as a rule, are better “hung” than English ones. And, where beech is used for handles, and the rivets are flush or countersunk, all other things being equal, the American make is the most desirable.

(5) Polished blades, although mechanics have a strong prejudice against them, cut freer and much easier than blades left in the rough, and they are less liable to rust.

(6) Saws that ring clear and without tremor, when held by the handle in one hand and struck on the point with the other hand and held over at a curve, will be found to be well and securely handled; but saws that tremble or jar in the handle, when struck on the point of the blade, will never give satisfaction.

Selecting.—The following valuable suggestions on the purchasing of saws are given by Disston, the well-known saw-maker of Philadelphia. The first point to be observed in the selection of a hand-saw is to see that it “hangs” right. Grasp it by the handle and hold it in position for working. Then try if the handle fits the hand properly.

These are points of great importance. A handle ought to be symmetrical, and as handsome as a beautiful picture. Many handles are made out of green wood; they soon shrink and become loose, the screws standing above the wood. An unseasoned handle is liable to warp and throw the saw out of truth. The next thing in order is to try the blade by springing it. Then see that it bends regular and even from point to butt in proportion as the width of the saw varies. If the blade be too heavy in comparison to the teeth the saw will never give satisfaction, because it will require twice the labour to use it. The thinner you can get a stiff saw the better. It makes less kerf, and takes less muscle to drive it. A narrow true saw is better than a wide true saw; there is less danger of dragging or creating friction. You will get a smaller portion of saw-blade, but you will save 100 dollars' worth of muscle and manual labour before the saw is worn out. Always try a saw before you buy it. See that it is well set and sharpened, and has a good crowning breast; place it at a distance from you, and get a proper light to strike on it, and you can see if there be any imperfections in grinding or hammering. We set our saws on a stake or small anvil with one blow of a hammer. This is a severe test, and no tooth ought to break afterwards in setting, nor will it, if the mechanic adopts the proper method. The saw that is easily filed and set is easily made dull. We have frequent complaints about hard saws, but they are not as hard as we would make them if we dared; but we shall never be able to introduce a harder saw until the mechanic is educated to a more correct method of setting his saw. The principal point is that he tries to get part of the set out of the body of the plate when the whole of the set must be got out of the tooth. As soon as he gets below the root of the tooth to get his set, he distorts and strains the saw-plate. This will cause a full-tempered cast-steel blade to crack, and the saw will eventually break at this spot.

Grimshaw says that a hand-saw must be springy and elastic, with almost a "Toledo blade" temper. There is no economy in buying a soft saw; it costs more in a year for files and filing than a hard one does, dulls sooner, drives harder, and does not last so long. A good hand-saw should spring regularly in proportion to its width and gauge; that is, the point should spring more than the heel, and hence the curve should not be a perfect arc of a circle. If the blade is too thick for the size of the teeth, the saw will work stiffly. If the blade is not well, evenly, and smoothly ground, it will drive hard and tend to spring. The thinner the gauge and narrower the blade, the more need for perfectly uniform and smooth grinding; the smoother and more uniform the grinding, the thinner and narrower a saw you can use. The cutting edge is very often made on a convex curve, or with a "crown" or "breast," to adapt it to the natural rocking motion of the hand and arm. By holding the blade in a good light, and tapping it, you can see if there are imperfections in grinding or hammering. Before buying a saw, test it on about the same grade of work as it is intended to be put to. It is a mistake to suppose that a saw which is easily set and filed is the best for use. Quite the reverse is the case. A saw that will take a few more minutes and a little harder work to sharpen will keep its edge and set longer than one which can be put in order quickly, and it will work better in knots and hard wood.

Using.—The first thing to be considered is the position of the stuff while being operated upon. Board or plank should be laid on one or more saw-horses *a* in either a sloping or flat position, the saw being held more or less nearly vertical, while the workman rests his right knee firmly on the work to secure it. If the stuff is more than 3 in. thick it should be lined on both sides, and repeatedly turned so that the sawing proceeds from opposite sides alternately; this helps to ensure straight and regular cutting. The saw is held firmly in the right hand with the forefinger extended against the right side of the handle. The workman's eyes should look down on both sides of the saw. As the work progresses, a wooden wedge should be driven into the slit or "saw kerf" *b*, to allow a free passage for the saw. Care is needed not to draw the tool too far out of the cut, or the end will be "crippled" by sticking it into the wood when returning it to the

cut. Grease should be applied freely to lubricate the teeth. Sometimes the saw-horse is dispensed with and the work is laid on the bench and held down by the hand or by mechanical contrivances, either with the end of the stuff hanging over the end of the bench, or with the edge hanging over the side. The operator can then stand erect at his work and can use one or both hands. Continental workmen often use the rip-saw with the back of the saw towards them; they place the work on saw-horses and commence in the usual way, then turn round and sit on the work and drive the saw before them, using both hands.

For cutting wide tenons, the stuff is first gauged with a mortice gauge (p. 186), and then secured in a bench vice in a more or less vertical position. The saw is first applied in an almost horizontal position, the workman taking care to adhere to the line so that the tenon may have the proper size when done. As soon as the saw has entered the line it is inclined in such a way as to cut down to the bottom of the mark on the side farthest from the operator. When that has been reached, the stuff is reversed, and the saw is worked in an inclined position till the opposite shoulder has been reached. This gives the limit of the cut at each edge, leaving a triangular piece uncut in the middle of the slit, which is finally removed by setting the work and using the saw in an exactly horizontal position. This facilitates working with truth and accuracy to the square. Large work is best done with a rip-saw; small, with a hand- or panel-saw. The left hand seizes the wood to steady the work and the workman. The workman makes a cut with the grain of the wood, which should always be the first half to be performed. When the longitudinal cuts have been made, the cross-cuts or shoulders are made by laying the wood flat on the bench against a stop.

For cross-cutting timber, the hand-saw is commonly used; the teeth are finer than in the rip-saw, and are set a little more to give greater clearance in the kerf, as the tool is more liable to gain when cutting across the fibres of the wood. The saw is held in the right hand, the left hand and left knee being placed on the work to steady it on the saw-horses. The workman must proceed very cautiously towards the end of the cut, and provide some support (generally his left hand) for the piece which is about to be detached, or it will finally break off and perhaps produce long splinters that will render the work useless for its intended purpose. When cross-cutting on the bench, the work rests firmly and flat on the bench, the end to be removed hanging over the side so that it can be held by the left hand. Unless the piece is very heavy, some means must be provided for holding it still during the sawing, or a slight movement may twist and damage the saw.

For sawing work that is slightly curved, a narrow rip-saw must be used, and the kerf must be kept well open by inserting a wedge. In ripping planks or tenons, both hands may be used to advantage in guiding the saw. In all sawing, the tool should be grasped in the right hand, while the left may rest on the material, or may be used to assist in working the saw. In the first few strokes, the length and vigour of the stroke of the saw should be gradually increased, until the blade has made a cut of 2-4 in. in depth, after which the entire force of the arm is employed: the saw is used from point to heel, and in extreme cases the whole force of both arms is used to urge it forward. In most instances, little or no pressure is directed downwards, or on the teeth; when excessive effort is thus applied, the saw sticks so forcibly into the wood that it refuses to yield to the thrust otherwise than by assuming a curved form, which is apt permanently to distort it. The fingers should never extend beyond the handle, or they may be pinched between it and the work. To acquire a habit of sawing well, the work should, as often as practicable, be placed either exactly horizontal or vertical; the positions of the tool and the movements of the person will then be constant. The top of saw-benches should be level. The edge of the saw should be exactly perpendicular, when seen edgeways, and nearly so when seen sideways; the eye must narrowly watch the path of the saw, to check its first disposition to depart from the line set out for it: look

only so far on the right and left of the blade alternately as to be just able to see the line. To correct a small deviation at the commencement, twist the blade as far as the saw kerf will allow; the back being somewhat thinner than the edge, the true line may be thus returned to. Make it a habit to watch the blade so closely as scarcely to require any correction. The saw, if most "set" (having the teeth standing higher) on one side, cuts more freely on that side, and has a tendency to run towards it.

The "table" or "ship-carpenters" saw has a long narrow blade intended for cutting sweeps of long radius; it is handled similarly to the rip-saw. The "compass" saw with its long (12 in.) and narrow (tapering from $\frac{1}{2}$ in. to $1\frac{1}{4}$ in.) blade generally resembles the hand-saw; in use it is apt to buckle and snap in short curves, unless it is filed so as to cut by a pulling motion instead of with a thrust. The "pad" or "socket" saw is a more diminutive form of the preceding, made to slide into a hollow handle, where it is held by screws, only so much of the blade being drawn out as is required; it should be filed for the pulling stroke. The "web" or "bow" saw is a narrow ribbon-saw fastened in a frame; it has very fine teeth, adapted for cutting both with and across the grain; the chief use is for fretwork, the blades being made to twist round to suit the work. "Back" saws are of several kinds, all characterised by deep thin blades: the "dovetail" is the thinnest, and simple filing usually gives it sufficient set; great care is necessary with it to prevent buckling and kinking, a twist of the hand sufficing to ruin it. "Tenon" and "sash" saws being somewhat thicker require a little set. All back-saws need to be kept well oiled and polished, and are best used in a mitre-box (p. 187) or other guide rest; they should be held firmly when in use, but with the least possible force exerted in controlling their direction; the cut should be commenced by placing the heel (handle end of the blade) of the saw on the farthest edge of the work and drawing it towards the body of the operator (Hodgson).

This tool, it must be remembered, in forming its saw kerf, removes, in the shape of sawdust, a solid bit of the material, which is thereby channelled as much as if the kerf had been formed by a very narrow iron fitted in a grooving plane. This is practically ignored by many amateurs, who carefully saw to line, and remove that line in doing so, and then find that the piece is cut too small. Of course, the wider the saw is set, the broader is the piece removed. A great many apparently unaccountable misfits are due to this error, which accounts also for the absence of squareness in framed work—for all the marked lines are seldom thus effaced. Casting the eye along a saw of which the teeth are turned upwards, this tool will be seen to contain an angular groove caused by the alternate bending outwards of its teeth. These, if properly filed, present also, taken together, 2 knife-like edges *de* (Fig. 303), which are very keen, and form the outside limits of the saw kerf: one of these edges, therefore, right or left, as the case may be, must just touch the ruled line upon the work, but must not encroach upon it. The result will be a clean true cut if the saw be in good order; but one tooth having too much set (projecting beyond the general line) will spoil it. Thus, in Fig. 303, *bc* are the limits of the intended kerf, of which the darker line *b* is the guide line to be left on the work; but the tooth which stands out too far reaches to the line *a* and quite effaces *b*.

Filing and Setting.—These subjects have been so ably discussed in such works as Grimshaw on 'Saw Filing'; Holly on the 'Art of Saw Filing'; and Hodgson on 'Hand Saws,' that it is difficult to attack them without in some measure traversing the same ground.

A saw tooth consists of 4 parts—face, point, back, and gullet or throat. Teeth vary in spacing, length, angle, rake, set, fleam, and form of gullet. A saw blade may contain several kinds of teeth in succession; but all teeth of a kind must be either quite uniform or arranged in a regular order of change.

The ordinary spacing of saw teeth is as follows: Hand-saws, 5-12 points in an inch; rip, 3-5 at the heel and 6-8 at the point; panel, 8-12; tenon, 11-15; mitre, 10-11; band-

saw teeth should have a tooth space equal to $\frac{1}{2}$ the width of the blade for soft wood, and $\frac{1}{3}$ for hard, while the depth of the tooth in each case should be $\frac{1}{5}$ the width of the blade.

The length of tooth is governed by the hardness of the wood, the longest teeth being best adapted for wet, fibrous, and soft woods, as giving greater clearance; but more care is needed in having a moderate and regular set.

The angle of saw teeth may vary between about 60° and 40° . The fundamental angle is 60° . This may be in the form of an equilateral triangle for hard and knotty wood, but for soft wood it is better that all the pitch should be on the cutting face,—an upright edge with sloping back. For varied work the usual angle is 40° , the pitch being equally divided. Teeth of any angle but 60° are not so readily filed with an ordinary file.

The degree of rake may increase in proportion to the softness of the wood; in hard woods it causes a tendency to spring in. It may also be greater in a circular saw on account of its greater speed. Fig. 304 (from Grimshaw) shows various degrees of rake, the arrows indicating the direction of the strain.

The set of a tooth may be either "spring" (bent) or "swaged" (spread). The former cut only on one side, have more tendency to spring in, and are more subject to side strains; the latter cut on both sides, unless they are sheared, and they are less liable to spring in and suffer from side strains. The more gummy the wood, the greater set is needed. Circular saws require more set than straight ones.

The fleam or side angle of the teeth varies from 80° or 90° horizontally for hard

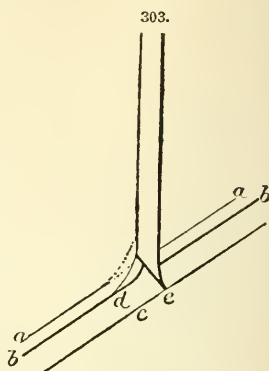

304.

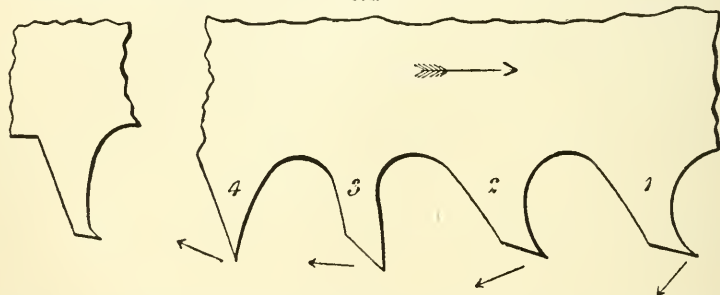

woods, to 60° or 70° horizontally and 30° or 35° vertically for soft. It is most effective in the case of soft woods free from knots; and should not accompany a bent set, as both tend to aggravate the tendency to spring in.

The gullet or throat should always be rounding and never square, as the latter condition gives a tendency to crack. Fig. 305 (modified from Grimshaw) shows when the gullet requires deepening, by a process known as "gumming." The tooth *a* is in perfect order; *b* is still capable of doing good work; but *c* demands gumming. The higher the speed and the faster the feed, the greater the necessity for rounding the gullet, especially in band-saws. Spaulding's rule for finding the amount of gullet in sq. in. per tooth for circular saws is to double the number of cub. in. of wood removed at one revolution, and divide by the number of teeth. Insufficient gullet causes choking, heating, and uneven running.

The depth, fleam, hook, and rake of teeth may increase in direct proportion to the

softness of the wood; the spacing and depth of gullet should be augmented for fibrous and porous wood; thin blade and slight set are desirable for costly wood; a thick blade is demanded for hard wood.

The operations entailed in keeping a saw in working order are threefold—filing, setting, and gumming. These will be described in succession.

First of filing. It is a great deal easier to keep a saw sharp by frequent light file-touches, than to let it get so dull as to need a long-continued filing down, after it gets so

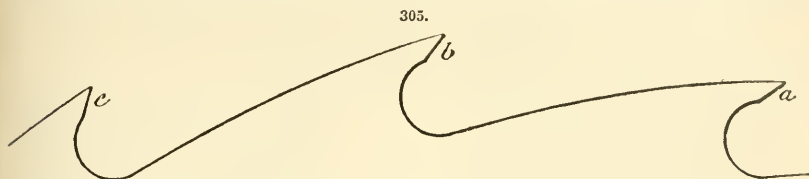

dulled as to refuse to work. The saving in power, by using a sharp saw, is very great. Thinner blades may be used than where the teeth are dull; because the duller the saw, the more power required to drive it through the wood, and the more strain on each tooth separately, and on the blade as a whole. For the same reason, longer teeth may be used where they are sharp, than where they are dull. The advantage of using sharp teeth is greatest in those saws in which the strain of cutting tends to deform the blade—as in all “push-cut” straight saws and in circulars. (Grimshaw.)

The saw, secured in a proper clamp, should be placed where a strong light will fall on the teeth, so that the filer can have the full advantage of all the light he requires. Should there be a deficiency of light, the filer should provide a good lamp, and place a dark shade between the light and his eyes, so that he can see at a glance when every tooth is filed to a complete point. One careless thrust of the file, when a tooth is filed enough, will do a saw more harm than can be repaired by $\frac{1}{2}$ hour's filing. A beginner should always take a try-square and the sharp point of a small file, and make a hair-mark from the point of every tooth at a right angle with the teeth on the sides of the blade. This should be done when the points of the teeth are all at a uniform distance apart. Such marks will enable the filer to keep the face of every tooth dressed at the most desirable angle. These directions, however, are only applicable to saws intended for cross-cutting. Beginners must always exercise unusual care when filing the back of each tooth that has been finished. After the teeth are filed to complete points, it is an excellent practice to go over them carefully with a half worn-out file, for the purpose of bringing the points to a more perfect cutting edge. (Hodgson.)

Both hand filing and machine filing have their advocates. The former is generally more convenient, and may be rendered sufficiently regular by means of guides. The latter gives greater speed and regularity at less cost.

For hand filing, reference has already (p. 193) been made to a clamp for holding the saw. A very old and convenient form is shown in Fig. 306, and consists merely of 2 strips of wood (which may be pine, but hard wood is better), about 3 in. wide and $\frac{7}{8}$ – $1\frac{1}{4}$ in. thick, joined laterally by a wooden screw passing through both at one end, and having their upper outside edges chamfered off. The toothed edge of the saw stands sufficiently high above the clamp to allow the saw to be used in a slanting direction without coming into contact with the clamp. Another form consists of an A-shaped horse, whose standards are hinged together along the top, where the saw is placed and held fast by putting the foot down firmly on the cross bars supporting the legs of the horse. Other forms have been already described under Holding tools. Much of the noise produced in saw filing may be remedied by having a layer of leather,

rubber, or a few folds of paper between the saw blade and the jaws of the clamp. There must be no shake or jar in the saw while under operation, or the teeth of the file will be damaged.

To put a saw in order, the first thing to be done is to joint the tops of the teeth, or render them uniform in length. This is termed "top-jointing" in straight saws and "rounding" in circular saws. To carry it out, Hodgson recommends the following cheap and expeditious plan. Procure a block of wood, say 6 in. long, 3 in. wide, 1 in. thick, dressed straight and true, then nail a similar piece on one edge, thus forming a corner in which to place a file. The file can then be held with the fingers, or be secured in various ways. Place the file flatly on the teeth, and press the larger block against the side of the saw blade, then file off the points of the longest teeth until the file just touches the extremities of the short teeth.

It is important that the file be held in such a position that it will take off the points exactly at right angles with the blade, otherwise the teeth will be longer on one side than the other, which will cause the saw to deviate or "run" more or less. Grimshaw remarks that the operation is generally performed with a flat or "mill" file, although it may be done with a plane emery rubber or a whetstone. "Side-jointing" is the term applied to a process for correcting irregularity in the set, or preventing undue side projection of any tooth; each tooth is thus made to do only its fair share of the work, and scratching or ridging of the sawn surface is avoided. It is most effective on swaged teeth, and is performed by a side file set in an adjustable clamp as shown in Fig. 307.

Very useful adjuncts to inexperienced workmen are the so-called filing guides, which determine the angle of contact and degree of force with which the file is applied. Fig. 308 shows a simple form, easily worked, and adapted to both straight and circular

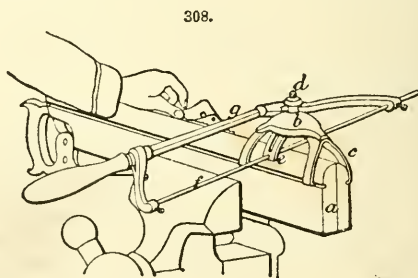
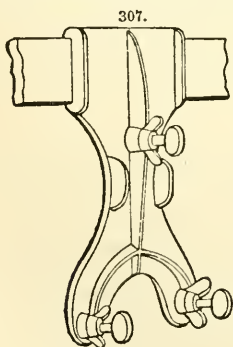
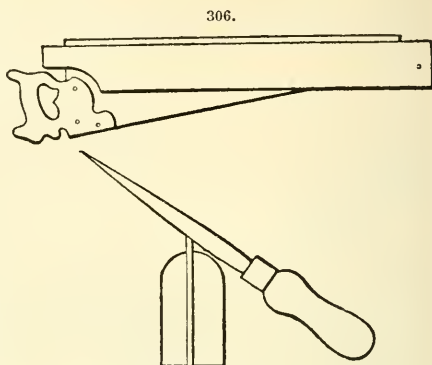

saws. The saw is held in the clamp *a*. On the guide is a circular plate *b* graduated to a scale for setting the file to a bevel for either side or square across the saw. Legs *c* extend from the plate over the clamp into grooves in the sides of the clamp. On the nether side of the plate *b* are a number of grooves corresponding to the scale on the edge, and into which a raised rib on the arched piece *e* meshes, and is held in place by

the thumb-screw *d* on the top of the plate. Through the ends of the arched piece *e* slides a rod *f*, to which are secured by screws the arms that carry the file *g*. By loosening the thumb-screw *d*, the file is readily changed to any desired bevel, and the handle of the tool may be lowered. When the file is set to the required bevel it is secured by tightening the thumb-screw *d*, and its pitch is regulated by a set-screw in the socket of the arm at the handle. During the operation of filing, the rod *f* governs the pitch and bevel, so that every tooth is equally filed. The machine is adapted for full, hollow, straight-edged, or circular saws. A table is issued with the machine, giving the correct bevells and pitches for the various kinds of saw to be filed.

Fig. 309 shows the Amesbury band-saw filing machine, fastened to an ordinary bench.

The file is in 2 sections, one stationary, the other movable in the direction of the axis; the stationary section carries the feeders and a thin segmental file, which files only the gullets and faces of the teeth; the movable section carries a thick bevelled file with varying grades of teeth, rotating in a higher plane, and destined to file the backs and take the burr from the points. The thumb-screw *a* varies the height of this section to suit the grade of teeth and to change the pressure. The thin face and throat file is cut only on its face and corner. The filing head runs in an oblong bearing, so that it can move to allow for high teeth. An adjustable pressure spring *b* holds it to the work, and another spring under the head keeps it to the tooth-face, thus giving the high teeth the most pressure, and bringing them down to the general bevel. The saw is held in a clamping-jaw, with the back resting against the gauge *c*,

which is adjustable to any saw width by the screw *d*, and can be set at any angle. The clamping-jaw is operated by a cam on the hub of the gear, and opens and closes as the machine is feeding or filing. This jaw acts like a vice upon the saw when the files are in contact with the teeth, and releases it when in contact with the feeder. The filer will work on saws from $\frac{1}{16}$ in. to 2 in. in width, and having 2-20 teeth to the inch.

Elkin's patent saw sharpener, Fig. 310, enables any person to accurately and quickly sharpen any straight saw, including rip, cross-cut, buck, band, jig, &c. It is a combination of clamps and adjustable guides, by means of which the saw can be firmly clamped and correctly sharpened. The adjustable guides can be so marked as to give the tooth the same bevel, pitch, and elevation. The machine is simple, strong, and durable in construction, being made from the best iron and steel. It only occupies a space in inches of 16 x 3 x 3. For use, secure it to a bench with 2 screws, place the saw in the clamp, with the teeth just above the face or upper part of the jaws—the handle to the right. The rod, upon which the travelling plate slides as each tooth is filed, can be secured at any desired elevation by means of the thumb-nuts at the ends. Having obtained the elevation, the file is brought across the saw at an angle corresponding with the bevel of the tooth, and there made fast by turning the thumb-screw beneath the travelling plate

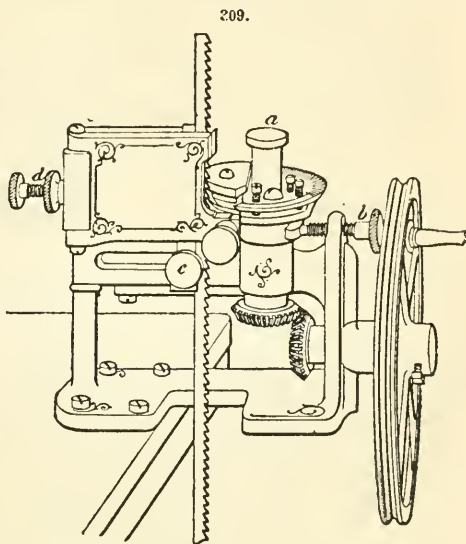

In order to get the correct pitch of the tooth, the loose bushing, through which the file carrier passes, must be perfectly free, and by pressing the file down between the teeth, you have the pitch. This bushing is held in its proper position by a set screw. Always file from the handle toward the point of the saw, and never press down upon the file when it is being drawn back. Having filed one side of the saw, it should then be reversed with the handle at the left. Then swing the handle of the file to the left,

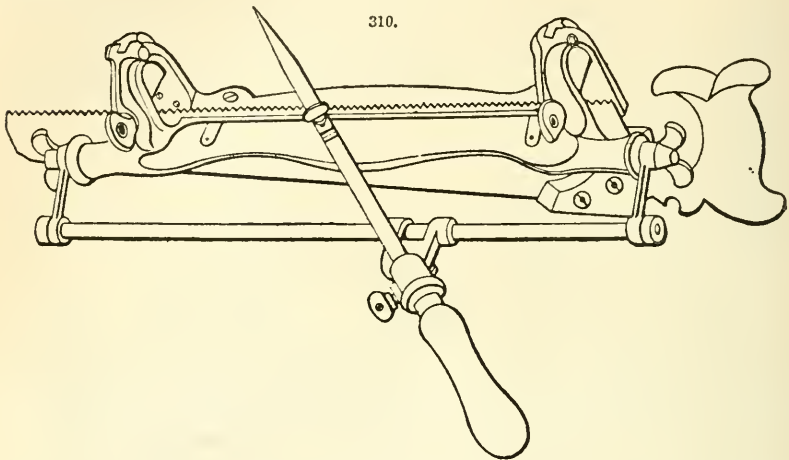

bringing the file across the saw to the correct bevel. The pitch of the tooth is again to be obtained as before. The price, including 1 file, is 20s. It is sold by Churchills.

The files employed for sharpening saws include flat ("mill"), triangular, round (for gulleting), and special shapes, varying of course in size and in grade of cut. The width of the file should always be double the width of the surface to be filed. Preference is given to files in which the grade of the cut (distance between the teeth) increases progressively from point to heel; with this exception, hand-cut files are esteemed superior to machine-cut. For small teeth set at 60° it is convenient to use a file which will sharpen the back of one tooth and face of the next at the same time. "Float" or single-cut files are the best. Double-tapered triangular files are not to be recommended; when used, they should have a button at the point end. Files for hand-saws are made with rounded angles to suit the gullets of the teeth. Order and regularity in filing are essential. Common rules for filing are: (1) File the faces before the backs; (2) if the teeth are to be square, file in regular succession—I, 2, 3, 4; (3) if they are to have fleam, file 1, 3, 5, 7 to right, and 2, 4, 6, 8 to left; (4) file the fronts of all teeth set from you, and the backs of those set towards you. (Grimshaw.)

In sharpening saws by means of emery wheels, the speed of the wheel has great influence on the cutting action. The coarseness or fineness of the grit composing the wheel must be suited to the nature of the work. The average speed of periphery adapted for most purposes is 4500-6000 ft. per minute, the slower speed being for wheels of 12 in. diam. and less. These wheels are only employed satisfactorily on large circular saws.

Setting, whether of the bent or spread kind, is performed both by simple hand-tools, and by more modern and complicated appliances.

(a) In bent setting by blows, the saw is laid nearly flat with its teeth along the ridge of a round-edged anvil held in a vice, of varying curve to produce an angle suited to the character of the saw, or the saw blade is gripped in a horizontal vice close to the

ends of the teeth. Alternate teeth are then struck in a most careful and uniform manner with a peculiar hammer, the object of the blow being to bend every tooth in exactly the same degree sideways. When half the teeth have been so treated, the saw is reversed, and the second half are similarly served, only in the opposite direction. There is a risk of giving either too short or too long set: the former results in bending the tooth too sharply near the point, while the latter requires greater expenditure of force. Over-setting may be corrected by slight blows in the opposite direction. A very simple apparatus for bent setting may be made as shown in Fig. 311. It consists of a wooden framework *a*, carrying at the base a movable steel anvil *b*, each of whose 8 edges may be chamfered to a different bevel. The framework also supports a steel punch *c* free to slide up and down; the end of the punch is bevelled, the angle corresponding (there are 8 punches) to the angle of the side of the anvil to be used, which varies with the kind of saw required to be set. To set the saw, it is laid on the anvil with the teeth overhanging the bevel desired and under the line of fall of the punch, which latter is applied to alternate teeth in succession by striking it with a hammer. The advantage of the apparatus is that the amount of set given to each tooth must agree with the bevel of the punch and anvil.

(*b*) Bent setting is perhaps more commonly effected by leverage. The simplest form is a notch cut in the end of a file, which is applied to each tooth in order, and the requisite set is given by a turn of the wrist. Fig. 312 shows a handsaw-set with 6 different gauges to suit the thickness of the saw blade; and Fig. 313 is an improved set

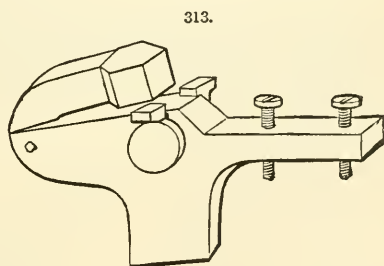
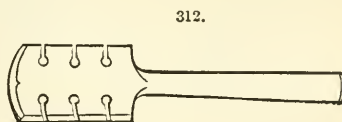
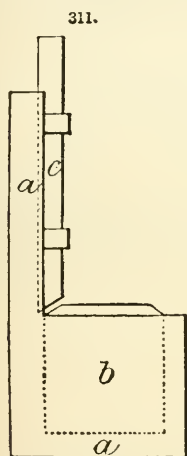

for fastening to a bench. In using these tools, the saw must first be securely clamped. For bent-setting band and circular saws by leverage, special machines are necessary, of which there are several forms in the market. Goodell and Waters, Philadelphia, make a band-saw set suited to saws $\frac{1}{8}$ in. to 2 in. wide, holding the saw in a rigid position and setting the teeth without straining the blade. It works by an easy, uniform crank motion, and when the tooth to be set is fed into position, the blade is firmly locked between the steel jaws of a vice, and remains immovable while the tooth is set to any degree required. As the crank goes forward, the blade is released, when the next tooth is fed up to the dies, the blade again locked in vice, and this tooth set in the opposite direction. All these movements are automatic, and can be carried on at a speed of 300 teeth per minute. The feeder picks up only the tooth that is to be set, consequently each tooth is fed to its proper position, regardless of their irregularity. The band-saw

is simply hung up over the machine on a wooden bracket, and the lower part left pendent near the floor.

(c) Spread setting is generally performed by "crotch punches" or "upset dies" having suitable outline and faces, applied to the tooth-point by sharp blows from a hammer. There should be 2 notches, one for spreading the tooth-point and the other for regulating the side play and making the cutting edge concave when necessary. Care should be taken to always leave sufficient metal behind the corners of the saw teeth, or they will break off. The accompanying illustrations, reduced from Grimshaw, represent the edges of teeth when "swaged" or "upset." In Fig. 314, *a* is the best attainable in practice; *b* has extremely weak corners. In forming the swage, the tool should be held so as to deliver the blow in a straight line with the face of the tooth, otherwise cracks may be started in the gullet, especially in frosty weather.

Many appliances for bending and spreading teeth are described in Grimshaw's large work on 'Saws.' The crotch-punch of ordinary form is shown in Fig. 315. It is made of steel and case-hardened in the fork, where it comes into contact with the points of the saw

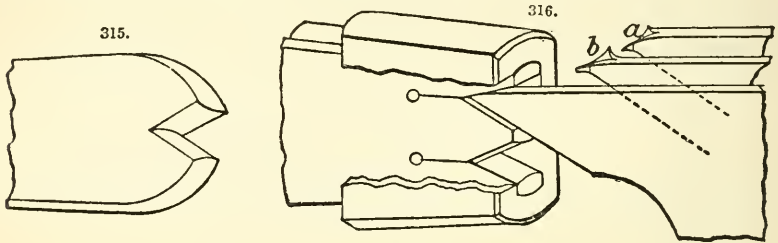
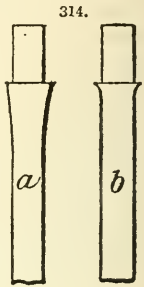

teeth. There is much difficulty in making crotch-punches of a satisfactory character, as the tempering has to be extremely hard just for the jaws, while if it runs back too far they have a tendency to split. They should be fitted with a side guard to prevent the operator's hand being injured by the punch slipping off a tooth. This guide may be made to serve also as a means of keeping the punch central or of giving it an inclination to either side. Crotch-punches have been introduced which are claimed to act on the teeth behind the cutting edge as well as at the edge, spreading the teeth without reducing their length and consequently the diameter of the saw (circular). Fig. 316 is a diagram of the end of the punch with part of the covering sleeve removed to show the form. If a

tooth is struck with the convex-sided lower angle, the resulting tooth is as shown at *a*; a second blow with the upper angle produces the flattened and double set tooth *b*.

Disston's revolving saw set is shown in Fig. 317. Its price is 1s. 6d. or 2s., according

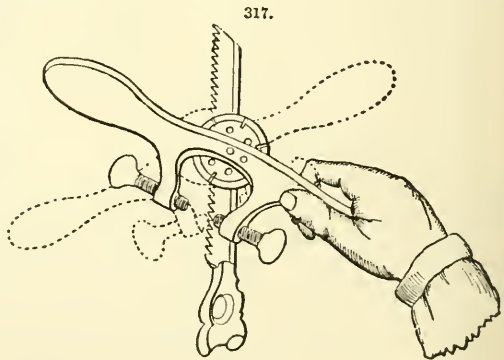

to size. Among the advantages claimed for this useful little tool are the following:— it is portable, simple, effectual, and cheap; it can be readily adjusted to any size tooth, from a 14-point back-saw to a 4-point rip-saw. The tooth in front of the one being set forms a guide for the tool, and the operator can readily and with certainty slide the set from tooth to tooth. The different bevels on the disc are in accord with the different slots for the various-sized teeth. The screws on each side determine the amount of set. The implement is sold by Churchills.

Trickett's lever saw set, sold by Melhuish, at 3s. 6d., is represented in Fig. 318.

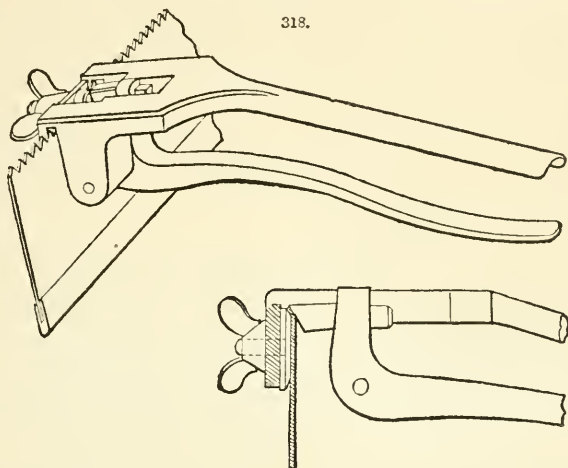

For use, place the set on the saw as indicated, holding it in the right hand; place the punch in line to tooth requiring to be set, then grasp the lever and handle together; the punch in lever forces the saw tooth over on the bevelled head of the bolt, and the tooth is set.

Morrill's saw sets for hand, band, scroll, cross-cut, circular, and mill saws, are sold by

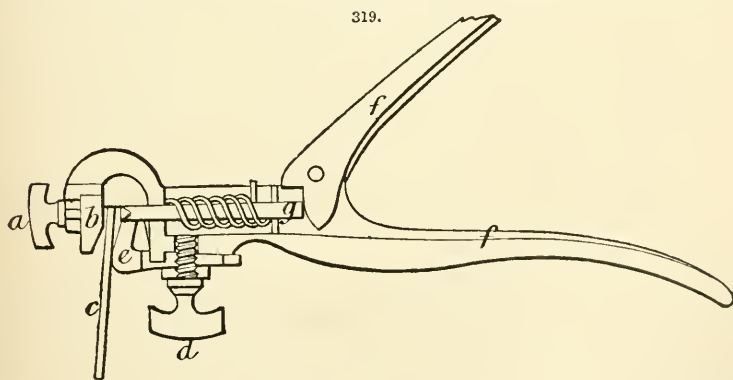

Churchills at prices ranging from 3s. 8d. to 16s. Fig. 319 illustrates the application of the implement. Hold the saw on any level place, teeth upwards. Place the set on the saw as shown. The anvil *b* is movable up and down, and must be regulated to suit

the distance that the operator desires to set his saw teeth down from their points. Care must be taken not to have the angle or the point where the bend is made below the base of the tooth. The nut or screw *a* fastens the anvil in any desired position. The guard *e*, when moved forward, increases the amount of set to be given; when moved back, decreases it. The guard is made fast by the screw *d*. The set is operated by compressing the handles *f*, which carries the plunger *g* forward, and takes effect on the tooth of the saw *c*, as shown. Great care should be taken against setting saws too wide, as, with too much latitude, they will chatter and tear rather than cut, at a great cost of power and waste of lumber. All saws should be set or pressed into line 3 times to 1 filing, as by constant use the teeth wear off on the outside at their points, causing them to heat and spring out of true, thus spoiling the saws, burning the wood, consuming power, and retarding the work, besides rendering it dangerous to the operator.

A spring set with a slightly shearing tooth performs its cutting in the easiest manner, but as only the corners of the teeth operate, twice as many teeth are required to do the same amount of work in a spring set saw as in a fully swaged one; the latter is generally preferred as being more easily kept in order. In bent setting, care must be taken that it is only the tooth and not the plate of the saw that is operated upon, or there is a risk of distorting or cracking the blade.

Gumming consists in deepening the throat or gullet of a saw, and is effected by means of punches, or preferably by rotating steel cutters or emery wheels. Too often the gumming is neglected, more of the face of the tooth being filed away instead, thus reducing the diameter of the saws and causing waste. Grinshaw illustrates several efficient machines for gumming.

According to Duncan Paret, the simplest method by which solid emery wheels can be applied for saw gumming is by placing them on the spindle of the circular saw. The saw to be gummed can then be laid on the saw table, or supported in any convenient way. A simple way is to pass the end of a rope with a small cross stick on it through the eye of the saw, and thus suspend the saw so that it swings evenly balanced just in front of the emery wheel. The weight being thus carried, the operator only has to use his hands to guide the saw against the wheel. Where expensive machinery is scanty, and where people are slow to introduce the latest improvements, there is a steady demand for saw-gumming wheels 14-24 in. in diameter. Where the latest improvements are quickly added, regardless of price, nearly all the emery wheels used for saw gumming are 12-8 in., none of the machines specially designed for saw gumming being intended to carry anything above a 12-in. wheel. Emery wheels are unfavourably contrasted with grindstones as causing a heating of the saw, but this can be obviated by using the wheel under a small constant stream of water. One advantage of a rotating steel-cutter gummer over an emery wheel is that, whereas an inexperienced hand can ruin a saw by case-hardening with an emery wheel, this cannot be done with a steel cutter or "burr gummer." Most of the emery gummers for circulars require that the saw shall be taken off its arbor to be gummed; all burr gummers work with the saw in position. (Grinshaw.)

The order followed in renovating the cutting edge of a saw should be (1) gumming, (2) setting, (3) filing; but as the last named is often the only kind of attention the saw receives, it has been described first.

Having discussed the general principles on which the renovation of saw teeth is based, and detailed the manner in which the operation is conducted, a few illustrated examples may be given of the teeth of the chief kinds of saw in use (see Fig. 320).

(1) Cross-cut saws (hand) vary from 12 to 32 in. in length. Their tooth edge should be straight or a trifle bulged in the middle. The teeth should be fully set and well-jointed. *a* (Fig. 320) shows the best tooth for soft wood; *b* is better adapted for wood of medium hardness and for mitreing soft wood; *c*, for harder wood, has the back of the teeth filed square. For cutting timber, the teeth are made much larger, but resemble

those in *b*, the set being increased with the wetness of the wood. The long cross-cut for 2 men is toothed as at *i* (Fig. 320), the cutting edge of the saw being appreciably highest in the middle and gradually tapering towards each end; the bevel shown is adapted to soft or wet wood, and must be lessened for harder or drier material. *k* represents an American hook tooth, which is based on the principle that the while the fleam teeth or knives cut into the wood, the hook teeth remove the "dust." These saws work easily and cut rapidly. The rake of a cross-cut saw is at the side. It takes less

320.

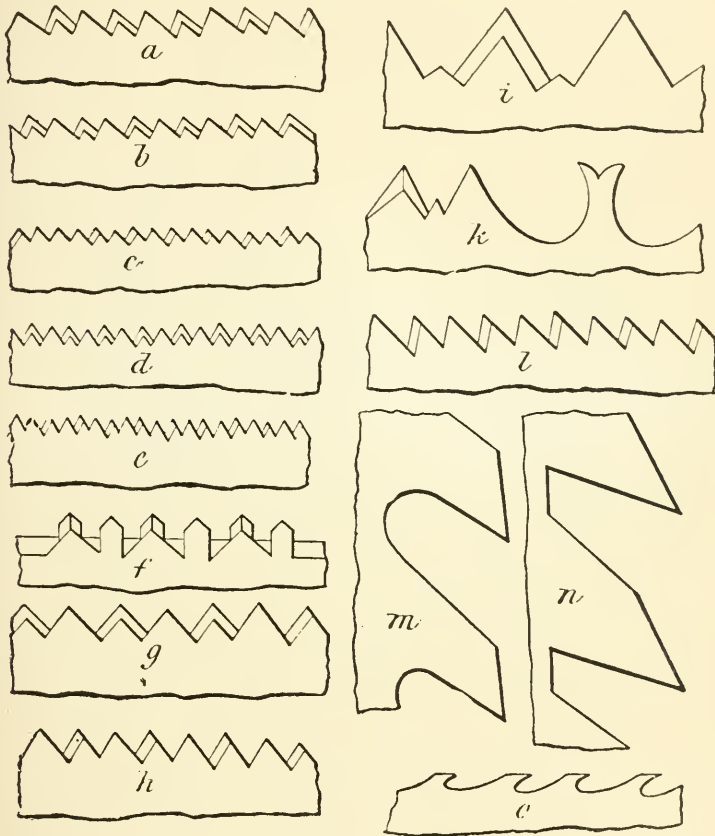

inclination than the cross-cut. The cross-cut requires finer and more particular filing than the rip or web saw, and cannot be considered well filed unless a needle will travel down the angular groove which is formed by the line of alternating points of teeth seen in all well-filed saws. When the teeth are so regularly formed that a needle will travel from end to end in the angular groove, and the points are sharp and keen, the saw will cut a kerf in the wood that will have a flat bottom. The last teeth of cross-cuts may be rounded at the points, to prevent tearing the wood when entering and leaving the cut.

(2) Back-saws are shown at *d* and *e* (Fig. 320); the former suits soft wood, while

the latter is for harder wood and for mitreing. The thinness of the blade of the back-saw is compensated for by the extra back, which must be kept tightly in place.

(3) The fleam tooth is illustrated at *f* (Fig. 320). It is only adapted for very clean soft wood, which it cuts rapidly and smoothly. It has no set, and is filed while lying quite flat.

(4) Buck-saws are represented at *g* and *h* (Fig. 320), the former being for wet or soft wood, and the latter for dry or hard.

(5) Web, scroll, and compass saws are best provided with teeth as shown at *l* (Fig. 320), for whilst they have to perform both ripping and cross-cutting, a tooth adapted for the latter will perform the former operation, though more slowly, but the converse rule does not hold good. Finer teeth will be necessary for hard wood. The backs of all saws of this class are made very thin, to avoid the necessity for giving a set to the teeth.

(6) The rip-saw, for cutting wood longitudinally, requires an essentially different tooth from the cross-cut. For a vertical mill-saw, the best form of tooth is that shown at *m* (Fig. 320), the edge of each tooth being spread out by means of the crotch-punch. An inferior-shaped tooth is seen at *n*, the setting being on one side of the tooth only, taking opposite sides in succession. *o* illustrates the best form of tooth for a hand rip-saw, the action being precisely like that of a mortice chisel. The rake of a rip-saw is in front. It takes more inclination than a cross-cut. The points of the teeth should be trued with a straight-edge, as, in general experience, a rip-saw does more work, with greater ease, straight, than when either rounding or hollow on the cutting edge; some good workmen, however, prefer rip-saws slightly hollow, not more than $\frac{1}{4}$ in. in the length of the blade. The hand rip-saw is usually a few inches longer than the cross-cut, but has far fewer teeth. Rip-saws are often given too little rake and gullet. The first 6 or 8 in. at the point of a hand rip-saw may have cross-cut pitch, to allow of cutting through knots without having to change the saw for a cross-cut.

(7) Circular-saw teeth generally have greater space, angle, and set than the teeth of straight saws. They should be filed on the under side; widely spaced, very hooking, and with plenty of gullet to let out the chips. Teeth of circular saws can be gauged to exact shape by having a piece of sheet steel cut out to fit. Absolute likeness in all respects can be controlled by having a piece of sheet metal cut to the required outline and attached to an arm forming a radius of a circle from the shaft carrying the saw. Three light filings are preferable to one heavy. The shape of under-cut teeth is apt to be altered in filing. The flaring sides of *M* teeth require special files. When a tooth is broken so as to be only slightly short, it can often be brought out to line by using the crotch-swage as a lever while hammering upon it. The saw should always be allowed to run free for a few minutes before removing it from the shaft. Circular saws should always be either hung up in a free perpendicular position, or laid quite flat. Fig. 321 shows a series of circular-saw teeth of varying shape and rake. The softer the wood, the greater rake admissible. In some cases (*b, c*) the back rake tends to reduce the acuteness. *e* is recommended for ripping hard wood in winter; *c*, for hard wood in summer; *g*, for all kinds of wood in summer; *b, c*, for harder woods than when no back rake is given; *f*, with a rounded gullet, 2 in. long for soft wood, $1\frac{3}{4}$ in. for hard; *h, i, j, k, n*, are forms of ripping teeth little used in soft wood; *l* is popular in Europe; *m* is a cross-cutting tooth, very liable to break on a knot in frosty weather. The question of few or many teeth in a circular rip-saw depends almost entirely upon the character of timber being ripped; and the feed per revolution should be made dependent upon the strength of the teeth to resist breaking, and the capacity of the gullet to hold the cuttings. In a cross-cut, the conditions are different. To straighten a circular saw, get a hard-wood block 12 in. by 12 in.; bed it on end on the ground (not floor); round the top off with $\frac{1}{2}$ in. rise; nail up a joist at the back of the block, for the saw to rest on; let its face be an inch below the top of the block. Use a 3 or 4 lb. blacksmiths' hammer for saws over 50 in.; a lighter one for smaller and thinner blades. For large saws, the

straight edge should be about $\frac{1}{16}$ in. thick, 20 in. long, $3\frac{1}{2}$ in. wide in centre, 1 in. at end; the edge of the straight side chamfered or rounded off. Balance the saw on a mandrel, and apply the straight-edge; mark the high places with chalk; have a helper to hold the saw on the block, and hammer on the humps, testing frequently. (Grimshaw.)

When a saw is not round, the defect may be corrected by adopting the following directions: Take a piece of grindstone or a cobblesone and hold it against the points of the teeth while the saw is revolving, and thus reduce or wear down the most prominent

321.

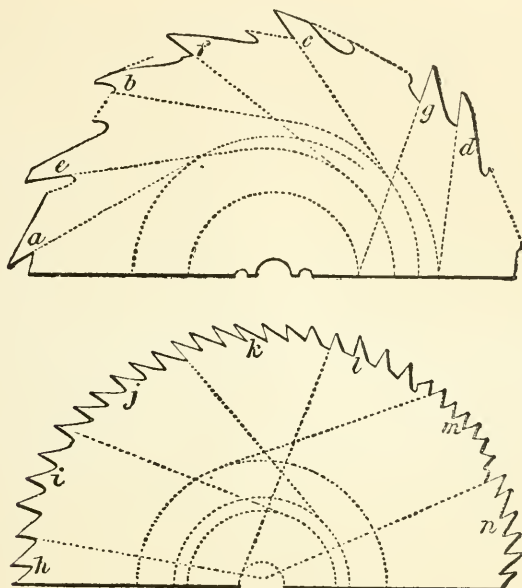

teeth; or a piece of red chalk may be held against the points, which will mark them in proportion as they are long or short, when the long teeth are reduced by filing. Circular saws sometimes burst from what appear as unknown causes. There can be no doubt when a saw does fly in pieces that a thorough investigation would trace the occurrence to one of the following causes: (1) Square corners at bottom of tooth; (2) Out of round, with the backs higher than the points, so that instead of cutting, they scrape the dust off with the back; (3) Undue strain put upon the saw by the plate rubbing against the timber, causing it to heat, which takes the life out of a saw. In a recent report of the French Society for Preventing Accidents from Machines, a recommendation is made for the avoidance of the use of circular saws in workshops where practicable. The following are the reasons for this recommendation: (1) Circular saws are dangerous to workmen; (2) they require more power than other saws; (3) they cut a broader line, and are consequently more wasteful. The speed of circular saws varies with the size, approximately as follows:—8 in. diam., 4500 rev. per minute; 12 in., 3000; 16 in., 2200; 20 in., 1800. The speed for cross-cutting can be increased with advantage 1000 ft. beyond those used for ripping, say to 10,000 ft. per minute. Never cut stuff that measures more than $\frac{1}{3}$ the diameter of the saw. The manner in which a circular saw is hammered has much to do with the speed at which it can be run, and often when a saw becomes

limber and “runs,” it is the fault of the hammering instead of the speed. When slack on the periphery, it will not stand speed, and becomes weaker and bends more readily when in motion than when it is still; on the contrary, if it is properly hammered, a little tight, as it is termed, on the periphery, it becomes more rigid when in motion up to a certain limit. The theory of this is that the steel is elastic, and is stretched by the centrifugal strain in proportion to the speed, which is greatest on the line of teeth, and diminishes to the centre. If saws evince a tendency to spring and a want of rigidity, have them rehammered at once, before changing the speed in an endeavour to remedy the defect.

(8) The band-saw is never used for cross-cutting, except when cutting scroll-work, and may generally be treated as a rip-saw. It requires special regularity in shape and set of teeth to prevent it from breaking and from running into the work. In order to set it up, or join the 2 ends together, the 2 tongues are introduced simultaneously into the 2 corresponding openings, and the ends of the saw are pressed together laterally in such a manner as to cause the snugs on the tongues to engage with or hook on to the bevelled edges in the openings, and the thin ends of the tongues then lie in the inclined recesses in the sides of the saw. When the parts are in this position, the 2 extremities of the saw cannot be separated either by a considerable strain in the direction of its length or by a diminution of the tension. To disconnect the ends of the saw, separate the hooked and bevelled edges by applying lateral pressure, and at the same time draw the ends apart in opposite directions. The junction of the 2 extremities is effected by means of a hook or interlocking joint. A portion of the saw near each extremity is reduced in thickness in such a manner that, when the ends are laid together, the two combined do not exceed the thickness of the remaining part of the saw. Portions of the back and front of the extreme ends are also cut away, so as to leave narrow tongues at each extremity of the saw, and these tongues are provided on opposite sides relatively to each other with snugs or hooks. In the thin portions at the extremities of the saw there are formed, at equal distances from the tongues, 2 longitudinal slits or openings, presenting bevelled or inclined surfaces at the edges nearest the ends of the saw, corresponding exactly to the snugs on the tongues. The opposite edge of each opening is also bevelled or inclined, but at a much more acute angle, so as to form a recess in the side of the saw for the reception of the extreme end of the corresponding tongue, which is suitably reduced in thickness towards the extremity, in order to enable it to be well within the said recess. Where gas is used for lighting purposes, it is often employed for brazing band-saws, and nearly in every case where this is done, the blade of the saw operated upon deteriorates, and breakages gradually increase. As these breakages do not occur exactly at the joint, no blame is attached to the use of gas, and the cause of continual failures is rarely discovered. A gas flame not only scales steel deeply, but also destroys its nature by burning the carbon out, and this occurs especially at the edge of the flame. Band-saws brazed by gas almost invariably break again at a point some little distance from the previous fracture, at the point where the outer edge of the flame has damaged the metal. The only really satisfactory way of repairing is to make a thick, heavy pair of tongs bright red-hot, and clamp the joint with them. The heat melts the spelter instantly, and makes a good joint without scaling or damaging the steel.

For a joint which has to stand constant heavy strains and bending, it is better to use an alloy of equal parts of coin-silver and copper, melted together and rolled out thin. This alloy never burns, cannot be overheated, and makes first-rate joints, which will stand hammering and bending to almost any extent. The working action of a band-saw is, generally speaking, similar to the working action of a circular saw,—continuous. “Owing chiefly to the thinness of the gauge, the small area of the blade which operates on the wood at one time, and the constant cooling action which is going on, as the saw passes through the air, a comparatively small amount of heat is engendered ;

the saw therefore can be run at a considerable speed without detriment. On machines in which the saw-wheels are of small diameter, say below 36 in., and where the arc of contact of the saw on the wheels is necessarily more acute, the speed of the saw-blade should not much exceed 4500 ft. per minute for all ordinary kinds of sawing. With saw-wheels above 36 in. diameter, this speed may safely be increased up to 6000 ft. per minute; this is, however, on the supposition that the top wheel is of the lightest construction, and is mounted elastically, i.e. has a spring or other adjustment to allow for the expansion and contraction of the saw-blade. There is no advantage in running band-saws beyond 6000 ft. per minute, as the risk of breakage is increased without affording any corresponding gain. In sawing hard woods, the speed should be reduced. The band-saw may be said to have a blade of superior thinness, capable of tension in varying degrees, moving in right lines through the material at a speed that is almost unlimited and can exceed that of circular saws, operating by machinery consisting only of rotating parts and of the most simple construction, the sawdust all carried down through the timber and offering no obstruction in following lines and peculiar adaptation to curved lines.

“The speed of sawing, or the cost of sawing, which is much the same thing as the movement of the teeth, is with the band-saw almost unlimited. Its performance, contrasted with jig-saws for cutting plain sweeps or scroll-work, shows a gain of time or cost of 3 to 1, with the important advantage of being easier to operate, and much more popular with workmen. The greatest objection to a band-saw is that it cannot be used for cutting inside work. Some workmen saw clean through the stuff to get at the inside, when the nature of the work will admit of such treatment without weakening or injuring the design. Strips of the same kind of wood as the design are firmly glued into the saw-kerfs when the work is completed. Of course, this method of reaching inside cutting can only be adopted where the design is not intended to bear any strain. Many devices have been suggested for separating and joining band-saws, but most of them are unavailable or impracticable. One, however, enables the operator to separate the saw, pass it through a hole bored in the wood and join it again, in less time than it takes to disconnect the blade of a jig-saw, pass it through the wood and connect it again to the machinery. This arrangement gives the band-saw an important advantage over the jig-saw in its own special province, as it renders it possible for much thicker material to be sawn than could be done with the jig-saw, and the work will be better done in less time.” (M. Powis Bale, M.I.M.E., A.M.I.C.E.)

(9) “The jig-saw or reciprocating saw is a blade arranged to work upright by means of a crank in a table. One is shown in Fig. 322, p. 226. In setting up a jig-saw, choose the most solid part in the building, over a post, pier, or timber; if on a ground floor, it should be set on solid masonry or piles. If obliged to put the saw on an upper floor, use a counter-balance equal to three-fourths the weight of the movable parts; this will throw the vibration on a horizontal plane. When a jig-saw is set on solid masonry, no counter-balance is required, as it is better to let the vibration fall vertically on the masonry. It is not wise to drive jig-saws at too high a speed, as the wear and tear of the machinery will more than balance the gain in speed of sawing: 300 strokes per minute is about the correct pace. The speed of the feed may be varied according to the nature of the wood being sawn. For very hard wood, a feed of 6 in. per minute is suitable, whilst for very soft wood as much as 30 in. may be cut in the same time; it is a great mistake, however, to force the feed, as the sawdust has not time to escape, and the saws become choked and buckled, and run out of line.” (M. Powis Bale, M.I.M.E., A.M.I.C.E.)

(10) A sawing table for using either a jig-saw or a circular saw may conclude this section. An example is shown in Fig. 322. The table consists of $1\frac{1}{2}$ -in. planed plank *a*, about 3 ft. by 2 ft., of beech or good deal, supported on 4 legs *b*, 2 or 3 in. square, tied by a framing *c* to which the plank is screwed. From the centre of the back of the table rises a wooden pillar *d*, $2\frac{1}{2}$ ft. high and measuring 3 in. by 2, mortised into the table

and further held and strengthened by screw-bolts and a T-iron brace, or carried to the floor, or to a longitudinal brace (not shown) joining the 2 back legs near the ground. A strong rubber door-spring *f* attached to a screwed eye in the arm *e* pulls the saw *g* up at each stroke. The lower end of the saw *g* may be attached directly to the crank of the treadle *h*, giving only 1 stroke of the saw for each revolution of the fly-wheel *i*; or, to obtain several strokes for each revolution, the saw is attached by a hook and band to a smaller crank and axle worked by a strap from the fly-wheel, and the saw is at the

322.

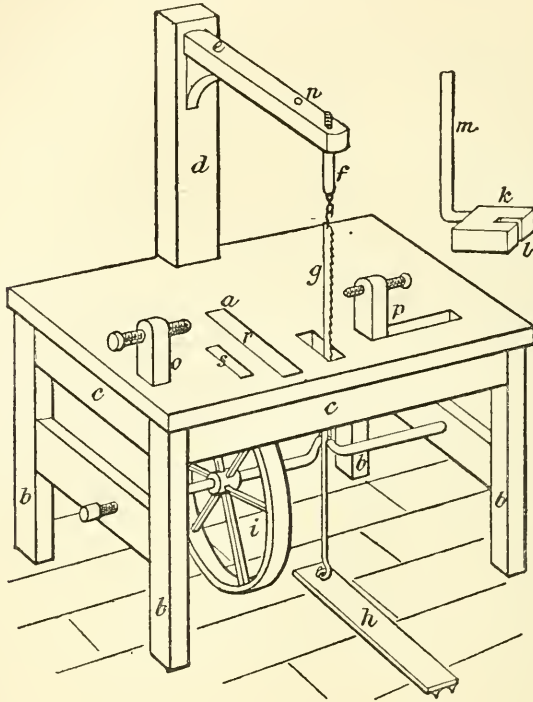

same time made to work vertically by passing the band over a pulley under the table exactly in line with the upper end of the saw, before taking it to the crank. For holding down the work whilst sawing, and simultaneously acting as a bearer to keep the saw engaged in its work, a convenient arrangement is to have a block of hard wood *k* with a slit in the front edge *l* carried by an iron rod *m* fitting into the hole *n* in the arm *e*, and adjustable by screw-nuts. The fly-wheel may be 18 in. diam. with a heavy rim, and the main crank $1\frac{1}{2}$ -2 in., giving a 3-in. stroke. For working a small circular saw, the wooden poppets *o p* are used, *o* being tenoned into a square hole in the table, while *p* is free to slide in a groove. The circular saw and its pulley work in the holes *r s* respectively in the table.

Fig. 323 shows a home-made fret-saw, having a capacity ranging from $\frac{1}{8}$ -in. to 6-in. stuff. The 2 uprights *a* are of spruce, and measure 7 ft. high and 4 in. sq.; they are mortised at foot into stout planks *b* screwed down to the workshop floor, and at top into a beam *c*, 6 ft. long, 4 in. wide, and 3 in. thick. The space between the uprights is 5 ft. 6 in. in the clear. The inner frame *d* is of pine, 3 in. wide and 2 in. thick, the

transverse pieces being composed of 2 lengths of 1-in. stuff, glued and screwed together with the grain reversed. The spring *e* at the top of the frame is made of 3 pieces of ash, $\frac{3}{8}$ in. thick, planed down to $\frac{1}{8}$ in. at each extremity; a bolt and nut attaches the spring to the frame, and short lengths of chain or rope connect it with the saw-frame *d*. The treadle *f* is hinged to the floor at the lower end, and suspended by straps *g* from the frame at the upper end. The table *h* for carrying the work, and through which the

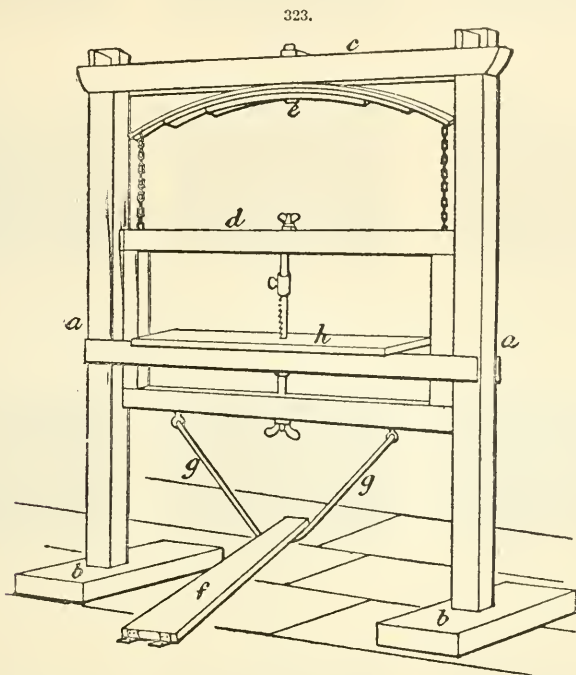

saw passes, is supported by 2 strips of batten screwed to the outer frame, and measures 2 ft. long and 18 in. wide. The saw is set up in the usual manner. Obviously the dimensions may be altered to suit any particular need.

Files. Principles.—A file is a steel instrument having the surface covered with sharp-edged furrows or teeth, used for abrading or smoothing substances, chiefly wood and metals. A file proper differs from a rasp, in having the furrows made by straight cuts (produced by a chisel or a sand blast), either single or crossed, while the rasp has coarse single teeth raised by the pyramidal end of a triangular punch. The effective power of the file resembles that of the saw, represented by a wedge not encumbered by the friction of one of the faces. The angle of the faces of the wedge is formed by the direction of the applied power and a tangent to the teeth. The diagonal position of the furrows of the file gives an additional shearing wedge power.

Forms.—Examples of the cutting faces of files and rasps 12 in. long are shown in the annexed illustrations; the cuts of longer and shorter sizes vary in proportion. Figs. 330–335 are float cut; Figs. 324–329, double cut; and Figs. 336–341, rasp cut. Fig. 324 is rough; 325, middle; 326, bastard; 327, second cut; 328, smooth; 329, dead smooth; 330, rough; 331, middle; 332, bastard; 333, smooth; 334, dead smooth; 335,

324.

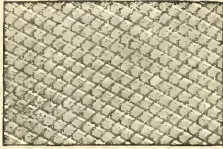

Rough.

325.

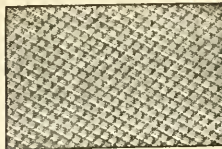

Middle.

326.

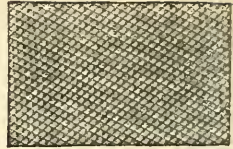

Bastard.

327.

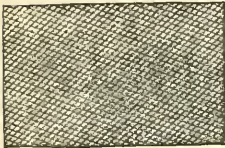

Second Cut.

328.

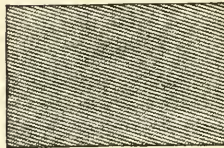

Smooth.

329.

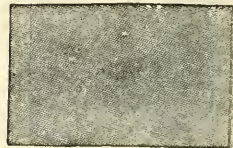

Dead Smooth.

330.

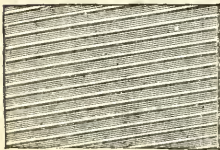

Rough.

331.

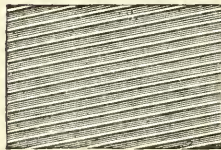

New Cut.

332.



Middle.

333.



Second Cut.

334.

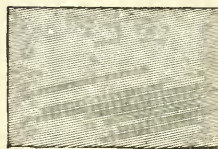

Smooth.

335.

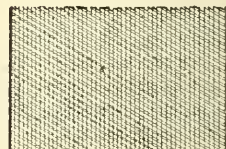

Bastard.

336.



Horse.

337.



Rough.

338.



Middle.

new cut; 336, horse; 337, rough; 338, middle; 339, bastard; 340, second cut; 341, smooth.

Using.—In using a file care should be taken that it is applied evenly to the work, or there is a danger of wearing it away rapidly in one spot. When a file loses its cutting power it may be resharpened.

Sharpening.—Until recently this was done by recutting the grooves in machines devoted to that class of work, but lately the sand blast has been most successfully

339.



Bastard.

340.



Second Cut.

341.



Smooth.

applied to the purpose. The operator holds the files which have to be sharpened, one at a time, in a long gas-pipe handle, into the end of which has been driven a plug of wood; the file is not held still, but is moved to and fro, resting upon a slip of gun metal, the file being also occasionally turned over. The slip not only forms a rest, but as the operator moves the file backward and forward upon it he learns when the file has reached a good cutting state. As far as the sharpening is concerned, this is the whole operation. It will be easily understood that a little practice is necessary to enable a man to make the best job of a file. In Fig. 342, *a b* are sections of file teeth.

a shows the form of the teeth as they come from the file cutter or machine. From this it will be seen that the upper part of the tooth is turned backward somewhat, and the top is rather weak. The effect of the sand blast is to remove this bent-over or rounded top, and to take off the tops of the extra high teeth. The form then is as shown at *b*. It might be expected that the sand would cut the point or fine edge of the teeth, but this is not the case, for smooth files are improved as much as those of the coarser descriptions. The sand used is exceedingly fine, and is the waste material resulting from the grinding of plate glass. It is so fine as to be like smooth, clean mud, and it seems remarkable that this will do the work. In the ordinary way, cleaning files after the hardening and tempering processes is a dirty, laborious operation. They have to be scoured with brushes and sand by hand, then put into lime-water, and dried. By one workman, only about 3 doz. per hour can be cleaned. It is an accident of the sand-blast process that it cleans the files as well as sharpens them. As they pass from the sand-blast hand they go to a boy, who passes them under a jet of hot water, which cleans out sand sludge, and, the file being then hot, it dries of itself. Before the use of the hot-water jet, one man used to be employed in brushing the dried sand mud out of the files at the cost of one man for each machine and 6s. per week for brushes. Now a lad does all. With one machine, 14-in. files may be sharpened at the rate of—flat bastard, 5-8 doz. per hour; second cut, 10-12 doz.; smooth, 12-15 doz.; half round bastard, 4-6 doz.; ditto second cut, 8-9 doz., and so on. The apparatus is now being used a good deal to sharpen worn files, which it does at a very low cost. There is another method

342.

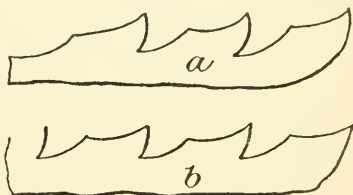

spoken of as being employed in French dockyards, consisting in pickling the files in an acid bath (dilute sulphuric and nitric acids, 1 part of each in 7 of water) for 45 minutes, after a washing with hot alkaline water; but it is not explained how the action of the acid is prevented from exerting the chief degree of erosion upon the exposed angles of the file face, instead of in the hollows where it is wanted to act.

EDGE-TOOLS.—This section comprises chisels and gouges, planes, and miscellaneous smoothing tools (e. g. spokeshaves), as well as the means adopted for keeping up a keen cutting edge (grindstones, oilstones).

Chisels and Gouges. Principles.—The chisel in its simplest form constitutes a slice of an axe, but as the impact is not from the motion of the chisel, but from that of a swung mallet or hammer, the eye of the axe is replaced by a contrivance for receiving the blow. When the element of thrust enters, then the chisel is passing into the “plane iron.” For applying the chisel, 2 contrivances are in general use. One is to put a tang on the metal of the chisel, and to let this be driven into a handle so shaped at the extremity as to receive the blow of a mallet. A very few blows would soon drive the handle forward, and so the tang end would then project through the handle and receive the blows. To avert this a shoulder is forged, where the tang is supposed to end, and the chisel proper to begin. When the blows have been repeated, so that the handle rests upon the tang shoulder, then the handle is “home,” and the tool completed. In turners’ chisels where mallets are not used, the shouldered tang is not required. A suitable handle being selected, a ferule is loosely put on it, and a hole is bored down the handle a little shallower than the length of the tang, and widened at the mouth so as to show a square, the sides of which are just shorter than those of the tang under the ferule—now, enter the chisel-tang, and let it be pressed in by the hand until it is so retained by friction, that by pointing the chisel edge downwards, the metal does not fall out. The operation of fixing the handle may now be said to commence. The line of the handle and blade is then inclined at about an angle of 45° to the horizon. A blow with a mallet is struck at the end of the handle; the inclination remaining the same, the tool is turned round on its longitudinal axis, say, $\frac{1}{4}$ rotation. another blow given; the operation of turning and striking being continued until the feruled end of the handle and tang meet. As to the effects of a blow upon the end of a handle, there being no apparent resistance, this takes place: The velocity of impact is communicated to the handle and chisel. Now the greatest effort is required to cause the first motion, so here a high velocity in the mallet has to be divided between a supported tool and itself. What is sometimes called “inertia” has to be overcome in the act of this transference of velocity through the length of the handle and chisel; that portion which offers the least resistance will be the first to move. No velocity can be communicated to a body at rest without what is usually called resistance. The friction between the tang and the handle is so adjusted by the preliminary formation of the hole, that the resistance from friction is less than the resistance from inertia; hence the gradual approach of the ferule and the flange. Now as to the turning in the hand about the axial line. The wooden handle is held in the left hand, therefore the effect of gravity upon it is neutralized. Not so with the chisel; gravity produces its full effect upon this. Consequently some part or other of the hole becomes a fulcrum, the cutting end of the chisel is drawn downwards by gravity, and therefore the tang end is pointed upwards. Continued impact in this position would place the chisel oblique to the axis of the handle; the turning is to avert this. Again, it was said that the depth of the hole should be less than the length of the tang. The reason is this: the end of the hole is of greater diameter than the end of the tang; if, therefore, the tang does not enter and fix itself in the wood, there may be unsteadiness in the chisel. Assuming the instrument to be under the operation of repeated blows, the effect of these will be first expended upon the end of the wooden handle, and then transmitted to the cutting edge. Unless provision be made, the destruction of the end of the wooden handle will be

assured. To diminish as much as possible liabilities to such a result, the end of the handle is formed as a portion of a sphere. Further, the impact blow is modified in the mallet, which is of wood, with a curvilinear face; thus these 2 wooden surfaces act and re-act upon each other. The yielding elasticity of the wood also gives to the blow and so transmits to the work a different effect to that which would take place if the handle and chisel were of iron. Another way of fixing the tool in the handle is to have a long tubular top to the tool, into which a wooden handle is driven. This is preferable for heavy work, as the repeated blows only tend to condense the fibre of the wooden handle and increase its firmness in the shank; but as it adds much to the weight of the complete tool, it is not adapted for ordinary cases. (Rigg.) Much annoyance is caused by the tendency of the butt end of the chisel handle to split under the effects of repeated blows from the mallet. A remedy suggested for this is to saw off the round end, leaving it quite flat, and on this to nail 2 round discs of sole-leather to form a pad for receiving the blows. When the leather has expanded inconveniently it can be trimmed round with a knife.

Forms.—Forms of chisels and gouges are shown in the annexed illustrations. The

343.

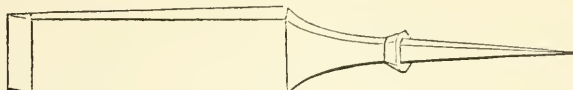

344.

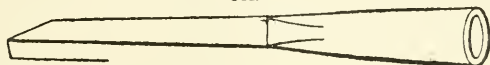

345.

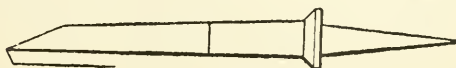

346.

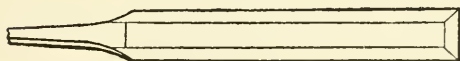

347.

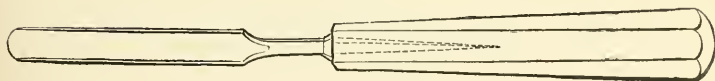

348.

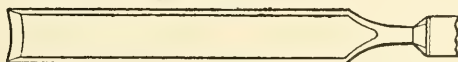

difference between a chisel and a gouge is that the former has a straight cutting edge while the latter is more or less curved. Fig. 343 is a common paring chisel; Fig. 344, a socket mortice chisel; Fig. 345, a common mortice chisel; Fig. 346, a thin paring chisel with bevelled edges; Fig. 347, a common gouge in its handle; Fig. 348,

a long thin paring gouge, cannelled inside. Mortice chisels range in width from $\frac{1}{8}$ in. to 1 in., the sizes increasing $\frac{1}{16}$ in. at a time; paring chisels advance $\frac{1}{8}$ in. at a time, from $\frac{3}{8}$ in. to 2 in. wide; gouges have a similar range, in addition to which they are made with 8 different degrees of curve, as shown in Fig. 349, and known respectively as A or very flat, B or flat, C, D or middle, E, F or scribing, G or half fluting, H or fluting. In the figure, all are 1-in. size.

Using.—The chisel cannot be used satisfactorily over a surface wider than itself, and though the gouge was devised to excel it in this respect, there is still a tendency for this tool to follow the leadings of the fibres of the wood rather than cut through them at a very slight obliquity. The only guidance the tool receives is from the hand of the workman, hence everything depends upon the degree of his skill. The impossibility of ensuring the amount and direction of the cut given by the chisel was the main incentive to introducing its modified forms the spokeshave and the plane, which will be discussed presently. In paring, the chisel is held in the right hand and applied with a thrusting motion without the aid of a mallet, the left hand being employed to hold the wood, and always kept well in rear of the tool to avoid accidents in case of the tool slipping. The wood to be operated upon should be held securely and in such a manner that if the tool goes beyond it or misses a cut it will neither damage its own edge nor meet with anything that will be injured by it, such as the surface of the bench. In paring horizontally or lengthwise with the fibres of the wood, the forefinger should be extended along the tang of the tool; but in paring vertically across the grain, all the fingers should firmly grasp the handle. When cutting mortices and tenons, the chisel is tightly held in the left hand while the right wields the mallet for giving effect to the cutting tool. To make a close joint, it is very necessary that the edges cut by the chisel (as well as those cut by the saw) shall be perfectly square and flat. This can only be attained by observing the correct way of applying the chisel-edge to the work. If the flat side of the chisel be held against the shoulder that is to be cut away, the chisel will "draw in"; if the bevelled side is against the shoulder, the contrary effect will be obtained. This is illustrated in Fig. 350. If the chisel is held as at *b* or *d*, just (and barely) allowed to cut, it will act as a paring tool; but its tendency will be found to follow the dotted line *b c*, so that, if not checked, it will "undercut" the shoulder. When held as at *a*, its tendency is in the opposite direction, when the sloping end can be rectified without spoiling the work. The same care is needed in cutting a mortice (Fig. 351). Let the mortice be carefully marked on both sides, but cut right through from one side only; the chances are that it will be found to have been cut too long on the farther side of the stuff from the drawing in of the chisel. The section will be as at *a*, Fig. 351. Of course, therefore, the safe plan when a mortice *must* be cut only from one side is to cut it more like *b*, and to pare it back carefully at the finish. Whenever possible, however, a mortice should be cut from both sides—half through from each; but the same tendency of course prevails, the result being shown in *c*, and here the faulty work will not be visible in the least when the tenon is in its place. The joint will appear quite close-fitting and neat, but it is evident that it will have little strength, as the component parts are only in contact just at the 2 surfaces, the rest being quite hollow. The best way to begin a

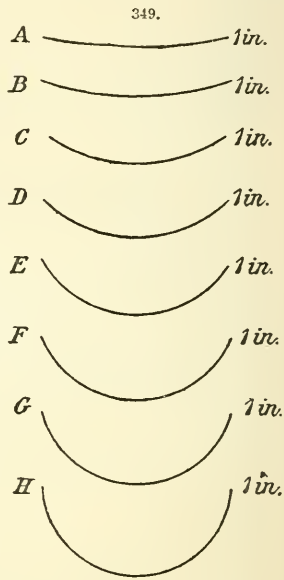

mortice is shown at *d*. It should be commenced by cutting out wedge-shaped chips from the middle, cutting each side by turns, and it will be found in many cases easier to take out the main part of the chips with the bevel of the chisel downwards. Each chip is thus heaved by pressing on the bevel as the fulcrum, and the mortice is gradually lengthened each way. After the main part of the wood has been removed, the back of the chisel is used next the shoulders, as already stated, care being taken, as the work approaches completion, that the hole is not undercut, but that the mortice

350.

351.

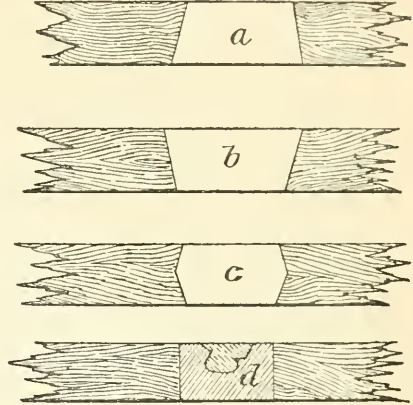
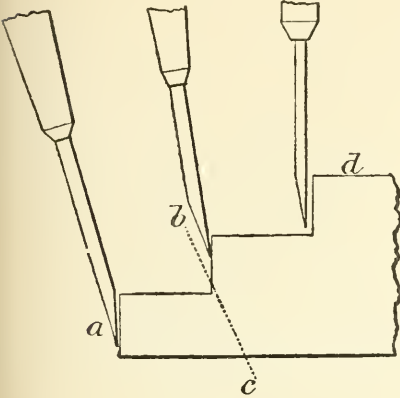

when finished shall have 4 perfectly flat walls, the sides as free as possible from loose fibre.

Another cause of failure in making a clean tight joint is the bruising of the fibres on the surface of the board at the end of the mortice by using a blunt chisel. It is mainly avoided by commencing in the middle, as just explained, and using a keen chisel to finish with. Certainly the work may be passed over again after the mortice is cut, but this is not always allowed for in squaring up the piece originally. In soft wood, especially when the fibres are loosely compacted, they will bruise and start up considerably if struck with a blunt tool, and often come completely away, leaving a depression that cannot be effaced without deeply planing the surface. Stray tacks, chips, and inequalities in the surface of the bench will also produce bad results.

The gouge is used and held in the same way as a paring chisel. When driven by a mallet it should always have a perpendicular position.

Spokeshaves.—The drawing-knife, Fig. 352, is practically a 2-handed chisel, which can only be used by drawing it towards the operator. Beyond its greater effective surface it is no improvement upon the chisel. A desire to govern the depth of

352.

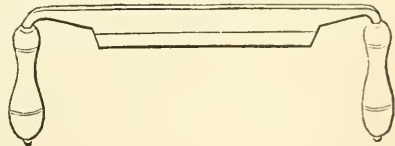

cut performed by the chisel led to the adoption of a tool called a spokeshave, in which the long blade of the drawing knife is retained, the depth of the cut being determined by the nearness of the edge to a parallel wooden handle. This tool may be used in both directions, towards and from the workman. But owing to the position of the application of the power, viz. the hands, and the tendency of resistance by the work to turn the

whole tool in the hand, it is not of general utility. When, however, the curvature of surface varies, the parings to be removed are light, and the operator has convenient access, the tool is capable of doing good work, and possesses some advantages over the plane. (Rigg.) Besides the original simple long-bladed spokeshave, this tool is now made with cutters of varying forms, for chamfering, rabbeting, and other purposes, being then often termed a "router," especially by the American makers who have introduced the novelties.

Planes.—Principles.—The plane, in its simplest form, consists of a chisel inserted at an angle into a box, generally of wood, and with the cutting edge projecting through the bottom of the box. If the actions of a workman be noted as he is smoothing wood with a chisel alone, it will be seen that he holds the bevel edge on the wood, and so elevates or lowers the handle as to secure a proper and efficient cut. Then he advances the tool in a line at right angles to its cross section. If now, instead of thus continuing to hold the tool, the chisel was so fixed in a movable piece of wood as to be at the same angle as the workman required, then if the mouth were broad enough, and the instrument were propelled along the wood, a shaving would be removed very nearly the same as that obtained from the chisel alone. In the arrangement thus sketched, the workman would be relieved from the care needed to keep the tool at a constant angle with the surface of the timber. There is, however, a fixity of tool here, and consequently an optional or needful adjustment called for by any varying condition of the problem cannot be had. When operated upon by hand alone, if an obstacle to the progress of the tool is presented, as, for instance, a twist or curl in the fibre or grain of the plank—the presence of a knot—then the workman by hand can adjust the handle, and so vary the inclination of the cutting edge as the circumstances of the case require. Not so if the tool is securely fixed in a box as described. Whilst therefore one gain has been had, one loss has been encountered. Observe the defects of the primitive plane, as hitherto described, and note what hopeful elements it contains.

The front of the sole of the box will clearly prevent the penetration of the encased chisel into the wood, because it cannot now be drawn to follow the fibre should it lead inwards. Suppose, however, that in the progress of the work such a place has been reached as would have so drawn the chisel inwards: either the strength of the indrawing fibre will be so great that the workman will be unable to propel the tool, or, if not thus impeded, he must by extra effort separate the fibre and so release the tool. This separation, however, may not be by the process of cutting, but by that of tearing, and shavings so torn off will have left their marks in the roughnesses which attend the tearing asunder of fibrous woods. Thus the tool will defeat the very purpose for which it was designed. To obviate the difficulty described has exercised much ingenuity, and led to more than one contrivance in planes as generally used.

The causes which so forcibly draw, or tend to draw, the tool downwards below the surface of the timber are the hand of the workman and the tenacity of the fibre. If the tenacity is greater than the power, the workman must stop. That the tool cannot follow the direction of the fibre is clear, because the front part of the wooden sole forbids the penetration, but that it may be brought to a standstill, or must tear off the fibre, is also very clear. The mechanic has therefore to consider how to defeat these tendencies which, as now sketched, result from a collision between the indrawing strength of the fibre and the power of the man to cross-cut the fibre by the tool, or else to tear it asunder and leave the surface rough. Since the tool, as now contrived, cannot efficiently cross-cut the resisting fibre, and since that fibre has to be removed, the object must be either to prevent such an accumulation of fibres as will stop the progress of the tool, or to destroy the fibre piecemeal as it is operative for hindrance. Both plans have been adopted. A consideration of the former may prove introductory to the latter, which appears in almost all attempts to perfect this tool and its appended contrivances.

As the tool progresses, and the fibres become more and more impeding, it will be clear that a portion of this impediment results from a condensation of the fibre in the mouth of the wooden box. The more numerous the fibres admitted here, the greater will be the condensation. This state of affairs can be partially obviated by a narrowing of the mouth of the plane; such an act of course requires that the introduced chisel should enter less deeply into the timber being operated upon. Although thus abated, the cause is not removed, and even if so far abated as to prove no real impediment to the workman, yet the quantity of material removed on each occasion will be so small that the tool becomes one for finishing work only, and not for those various operations to which its present powers enable artisans to apply it. To be the useful tool it is, the mouth must not be so narrowed, nor the inserted chisel so withdrawn, that the shaving is thus the thinnest possible. This led to a contrivance now almost universal, that of breaking the fibre so soon as it is separated from the piece of timber. The designer seems to have considered that as soon as a short length of shaving had been removed, it would be well to destroy the continuity of the fibre, and so prevent an accumulative resistance from this cause. Hence, instead of allowing the cut-off fibres to slide up the inserted chisel, he bent them forward, in fact, cracked them, and so broke the cumulative indrawing force of them. This he accomplished by the use of what is now called the "back iron," and from henceforth the boxed-in chisel loses its identity, and must be regarded as part of an independent tool.

The tool thus built up is called a plane. Three forms are in general use in English workshops, called the "jack," the "trying," and the "smoothing" plane. These are on the bench of all workers in smooth straight surface wood. Although externally alike except in size, they are yet used for different purposes, and each has a specialty in its construction. These specialties may now be considered.

Forms.—After the wood has passed from the sawyer into the hands of the carpenter, the surface undergoes those operations which render it true and smooth. These 3 planes do this work. The "jack," usually about 15 in. long, and the "trying" plane, ranging from 18 to 24 in. long, but, in exceptional cases, far exceeding these dimensions, are to external appearances alike; indeed, some regard the different handles as the only dis-

353.

354.

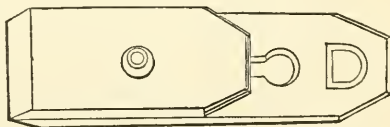
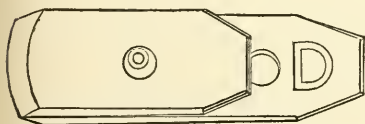

tinction between them, and that these handles show which must be used for rough work and which for smooth (see Fig. 355 as an example of the handle of a "jack-plane," and Fig. 356 as an example of "trying-plane" handle). This is an error. There are other differences, but the main and leading one is the different form given to the edge of the cutting iron.

If the iron of the "jack" plane be looked at from the front end of the plane, the form of the edge will be curved, as in Fig. 353; but the iron of the "trying" plane is straight, as in Fig. 354. Upon the curvature of the edge depends the efficient action of the "jack."

Sufficient has been said of the tendency of the fibre to draw the tool downwards; but it must not be forgotten that the same adhesion of fibre to fibre takes place between the surface fibres as amongst those below the surface. For the purpose of separating the surface connected fibres, the jack iron is convex. Note its action. The convex sharp edge is pushed along a horizontal plank, penetrating to a depth determined by the projection of each vertical section below the sole of the plane. The

ends of this convex edge are actually within the box of the plane, consequently (side-ways) all the fibres are separated by cutting, and are therefore smooth and not torn. The effect of this upon the entire surface is to change the surface from the original section to a section irregularly corrugated. The surface after using the "jack" is ploughed, as it were, with a series of valleys and separating hillocks, the valleys being

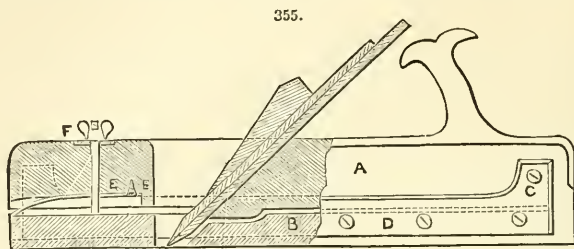

arcs from the convexity of the tool and the separating hillocks being the intersection of these arcs. All traces of the tearing action of the saw have been removed, and from a roughened but level surface a change has been made to a smooth but in cross-section an undulating one.

The mechanic's next object is to remove these lines of separation between the valleys. For this the trying-plane is required. The trying-plane is longer than the

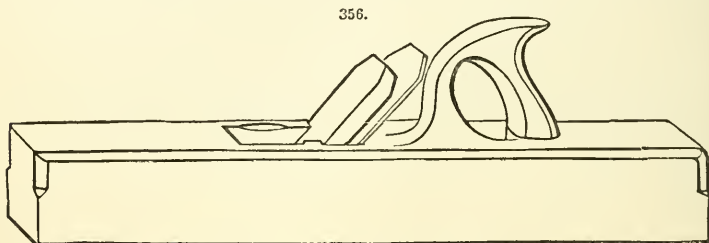

jack, because the sole of the plane which is level is, so far as its size goes, the counterpart of that which the surface of the wood is to be; further, the trying-plane should be broader than the jack, because its object is to remove the hillocks and not to interfere with the wood below the bottoms of the valleys. If its action passes below the bottoms of the furrows, then occasion arises for cutting the side connection of the fibres, and however a workman may sharpen the edge of his trying-plane for this purpose, he in one respect has destroyed one object of the plane, because, so soon as the iron penetrates below the surface, then does the effect of the jack action begin to reappear, and the cutting edge should pass from the shape shown in Fig. 354 to the shape in Fig. 353. The result of the trying-plane following the jack is to remove all the elevations of wood above the valleys the jack left; and, secondly, to compensate by its great length for any want of lineal truth consequent upon the depth of bite of the jack. Again, the mouth of the trying-plane is much narrower than that of the jack; hence the shavings removed are finer, therefore the slope of the iron, or its inclination to the wood may be less than is the iron of the "jack"—hence the line of cut is more nearly accordant with that of the fibre, and by so much the surface is left more smooth from the trying-plane than from the jack, as there is more cutting and less tearing action than in the jack. The reasoning hitherto pursued in reference to the purpose of this sequence of a jack and

trying-plane might and does legitimately produce the conclusion that, after the trying-plane has done its duty, the work is as perfectly finished as it can be. Custom, and perhaps other considerations, have established that after the long trying-plane must follow the short and almost single-handed smoothing-plane (Fig. 357). So far as the form of the iron of the smoothing-plane is concerned, there is no difference between it and the one used in the trying-plane; each (as across the plane) is straight, the corners being very slightly curved, but only so much as to ensure that they do not project

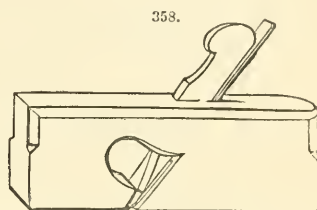
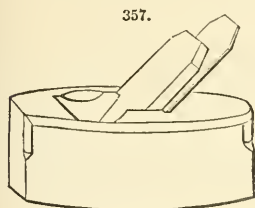

below the line of the cutting edge. It would seem that, whilst the trying-plane levelled down all the elevations left by the jack, and brought the surface of the wood as a counterpart to that of the plane, there might be in the fibre, or grain of the wood, twists, curls, and other irregularities which, whilst levelled, were yet left rough in consequence of the direction in which the cutting edge came upon them. Indeed, this cutting edge, in a long plane, which must advance in the direction of its length, must at times come across a large number of surfaces where the fibre is in opposite directions. The consequence is that there will be various degrees of smoothness; for good work these must be brought to uniformity. This is effected by passing a short-soled plane over the respective parts of the surface in such directions as observation may indicate. Hence the smoothing-plane is of use chiefly to compensate for such changes in the direction of the fibres of the wood as the greater length of the trying-plane could not conveniently deal with.

The plane shown in Fig. 355 is claimed to possess some advantages over the ordinary jack-plane, in that it gives a control over the thickness of the shaving and depth of the cut by the pressure of the hand, and prevents the drag of the bit on the board when the plane is drawn back. The stock of the plane is made in two parts, the upper portion A, which holds the bit, being pivoted to the lower part B at the rear end by a screw C passing through metallic guide plates D on each side the plane. The front end of the upper portion is raised from the lower portion by means of a spring E, which, when the pressure of the hand on the front of the plane is withdrawn, lifts the upper portion together with the bit or plane iron. The amount of this movement is governed by the thumb-screw F.

The "rabbet" or "rebate" plane, Fig. 358, differs from the preceding examples in that the cutter reaches to the edge of the wooden block, so as to enable the smoothing operation to be carried right into the corner of work. It is employed in making window frames and similar articles in which a recess (termed a "rebate" or "rabbet") has to be cut for the insertion of some other material, as, for instance, a pane of glass. The cutter has not of necessity a square edge, but may be shaped like the examples shown in Figs. 359, 360, which are termed "skew," "round," and "hollow" rabbet-irons respectively.

Another form of simple plane is the "plough," intended for cutting a deep groove along the edge of a board for the purpose of inserting in it a corresponding "tongue" along the edge of another board to be joined to it. The tongue may be formed by using the rabbet-plane along each side of the board edge; but it is more convenient to employ

“match” planes, which are made in pairs, one cutting the plough and the other the tongue. Their cutters are shown in Fig. 361.

The stop-chamfer plane, sold by Booth, Dublin, for 4s., is a very useful tool for cutting any chamfer from $\frac{1}{8}$ in. to $1\frac{1}{2}$ in. with a constant angle and size. It is shown in

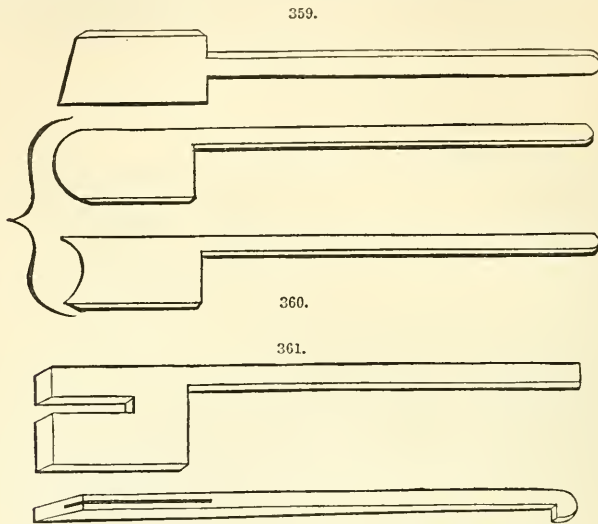
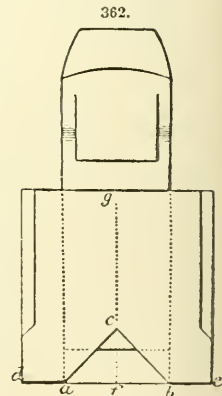
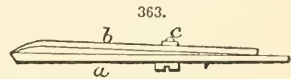

Fig. 362. The box of the plane is made in much the same way as that of ordinary planes, and the iron is inserted and held in place in the same manner. The point of difference is that a Λ -shaped channel is cut along the sole of the plane, the sides of the channel being at right angles to one another, and at an angle of 45° with the sole of the plane; meeting in a point in a line drawn perpendicular to the sole, and exactly up the centre of the end of the plane. Thus the sides ac bc of the groove are at right angles to each other, and at an angle of 45° to de , the sole of the plane, and they meet in c , a point in fg , which is perpendicular to de , and drawn exactly up the centre of the end of the plane, as shown. The depth of the iron, which is indicated by the shaded part of the figure, is regulated to suit the width of the chamfer that it is proposed to make.

The preceding include all the kinds of plane in most general use; but it is obvious that the same principle may be applied to almost any form of cutter. Hence a great variety of tools, known as “moulding” and “filletsterning” or “filister” planes, have been introduced, whose cutters consist of combinations of chisel and gouge edges. These are employed for cutting mouldings and beads of numerous designs, which are familiar to every one who has observed the edge of skirting boards in rooms, the panels of doors, or the sash-frames of windows. The great bulk of this class of work, however, is now performed by rotating cutters worked by steam power, and such beads and mouldings, of any desired pattern, can be procured better at the manufactory than they can be made by hand.



Adjusting.—Reference has already been made (p. 235) to the second iron introduced into the plane for the purpose of curling up and breaking off the shaving produced by the cutter. The arrangement of the 2 irons is shown in Fig. 363, *a* being the cutter, and *b* the back or break-iron, the two being united by a screw-nut and bolt *c*. The united irons are fastened in a hole in the stock of the plane by means of a wooden wedge, and so adjusted that they traverse the stock and project very slightly through a narrow slit in the sole provided for that purpose. The angle ordinarily formed between the sole and the irons is one of 45° , but this is reduced to 35° by the head of the cutter. In adjusting the plane to its work, 2 considerations have to be borne in mind: (1) the degree to which the cutter projects beyond the sole, and (2) the distance between the edges of the cutter *a* and breaker *b*. In regulating the position of the double iron, in relation to the sole, it will seldom be necessary to apply a blow of the hammer to either the top or sides of the wedge or irons; by taking the plane in the left hand so that the palm of the hand covers the hole where the shavings come out, a gentle tap with a hammer or mallet can be administered to either end of the stock of the plane: this will effect the purpose. A blow given in this way even suffices to loosen the double iron enough to permit its complete withdrawal, when it is necessary to sharpen its cutting edge. An occasional side tap may be needed to make the iron set square with the sole. The relations of the edges of the cutter and breaker can be altered by unscrewing the nut *c* that unites the 2 plates, a long slot being provided in *b* with that object. The distance between the edges of the 2 irons varies from about $\frac{1}{8}$ in. for the coarsest roughing-down work to $\frac{1}{16}$ in. for smoothing, the breaker being placed of course that much above the cutter. The higher the breaker, the easier the plane works; the lower it is, the cleaner the cut. It is necessary to caution the operator against wedging up his planes too tightly, as such a procedure will cause the cutting iron to assume a curved form and prevent smooth work being done. Care must be also taken that the projection of the cutting edge beyond the sole of the plane be perfectly square with the sole, and level in itself; in fact it is better that the corners be rounded off, to prevent the possibility of their catching. Many of the planes of modern pattern are made either self-adjusting or so that their adjustment is very easily and accurately performed.



Using.—Wood to be planed.—should be laid quite flat on the bench, and tight against a “stop” to prevent its moving. The planing must always follow the direction of the grain of the wood, and never meet it or cross it. If a piece of wood should exhibit the grain running in different directions in different portions of its surface, the piece must be turned about accordingly so that the plane may always go with the grain. The sole of the plane is necessarily subjected to a considerable degree of wear, which ultimately renders it useless for all but the roughest work. This effect can be much reduced in the case of a wholly wooden stock, by occasionally oiling the surface. A more enduring but more costly method is to shoe the sole with metal, or to have a metallic stock, as most of the new American planes have. As the sole (wooden) wears, it must be periodically planed up true again.

The method of applying the jack-plane is as follows. The right hand grasps the handle or “toat,” the forefinger being extended along the wedge; the left hand partially encircles the front part of the plane with the thumb turned inwards. The trying-plane is also held similarly for “facing up,” but in applying the force of the arms there is this difference, that while with the jack-plane the pressure of the hands should be uniform throughout the stroke, with the trying-plane the chief pressure should come from the left hand for the first half of the stroke and from the right for the last half. For “shooting” work, the trying-plane is held differently, the fingers beneath the sole serving as a sort of gauge for keeping the plane on the narrow edge of the board

being worked. The smoothing-plane is held by the right hand clutching it behind the knife (there is no handle) and the left grasping its front end with the left thumb on top and pressing it down. The rabbeting plane is also called a filister or filletster. It is provided with a "screw stop" and a "fence" for the purpose of limiting the range of its cut in both width and depth. The small grooving iron in front of the plane proper should extend a little beyond it, with the object of detaching the wood sideways before the plane has to remove a shaving downwards; thus the angle is cut out perfectly clean. The plough, in many respects closely resembles the filister. Indeed the latter may easily be extemporised out of a plough by adopting the following suggestion put forward by Ellis Davidson. Supposing *a* (Fig. 364) to represent the plane looking at the fore end, and *b* a board in the edge of which it is required to cut a rebate $\frac{1}{2}$ in. wide and $\frac{1}{4}$ in. deep; a strip of these dimensions has literally to be planed away, and the plane must therefore not travel horizontally farther on the surface of the board than $\frac{1}{2}$ in., nor vertically sink deeper than $\frac{1}{4}$ in. The plane with which the work is to be done is $1\frac{1}{2}$ in. wide. Plane up a strip of wood *c* to the width of 1 in. (the thickness will not be any consideration), and screw it at right angles to another piece *d*, thus forming the letter L. This forms a case which will, when planed and fastened to the side of the plane by a couple of screws, shut off 1 in. of the width of the sole, allowing it to encroach upon the surface of the board to the extent of $\frac{1}{2}$ in. only; a mere strip *e* screwed on the other side at $\frac{1}{4}$ in. from the sole, will prevent the plane sinking deeper than is required. On no account should the guide be screwed to the sole of the plane, which should always be kept perfectly smooth, the surface uninjured by screw holes. Nor is it necessary to damage the sides of the plane by more than 2 small screw holes, for the same side-piece *d* may be permanently used, the width of the strip *e* being altered according to circumstances; and the width of *e* can also be regulated, either by planing a portion off below the screws if the rebate is to be deeper, or moving the screws lower down in the strip if it is to be shallower, taking care that the holes correspond with those in the side of the plane, and that the strips do not cover the apertures through which the shavings should escape.

Sharpening.—The sharpening of the cutting edges of planes and chisels is performed primarily on a grindstone or its equivalent an emery grinder, and secondarily on an oil-stone.

Grindstones.—The implement known as a grindstone consists of a wheel of sandstone mounted on a revolving axle in a trough capable of containing water, its ordinary form being sufficiently familiar to dispense with illustration. There is probably no instrument in the machine shop or factory which pays better for the care bestowed upon it than the grindstone; and considering that nearly every tool, and all edge tools, require it, before they can be used to advantage, or in fact at all, it is somewhat surprising that more attention has not been bestowed on the proper selection of the grit for the purposes for which it is intended. As grindstones are almost constantly in use, their first cost is of little consequence if the quality is calculated to do the work in the shortest time and in the most perfect manner, as more time can be lost on a poor grindstone, badly hung, and out of order, than will pay for a good one every 3 months. This state of things should not continue, as with the great improvements made in the manner of hanging them, and the endless variety of grits to select from, every mechanic should have a grindstone which will not only do its work perfectly, but in the shortest time. This can be accomplished by sending a small sample of the grit wanted to the dealer to select by. Grindstones are frequently injured through the carelessness of those having them in charge. The grindstone, from being exposed to the sun's rays, becomes so hard as to be worthless, and the frame goes to pieces from the same cause; it will have a soft place in

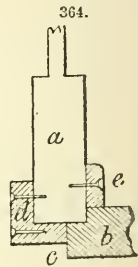

it, caused by a part of it being allowed to stand in water overnight, and the difficulty arising from this cause increases with every revolution of the stone; but as this homely implement is in charge of all the men in the shop in general, and no one in particular, and as the workmen are all too busy to raze it down, double the time is consumed in imperfectly grinding a tool than would be required to do it perfectly if the stone were kept in order by some one, whose business it would be to attend to keeping all the grindstones of the establishment in order. The wages of a man for this duty would be saved in the time and perfection with which the numerous tools could be kept in order for work.

Most commonly grindstones are made to turn by hand, and necessitate the services of an assistant. It is much better to have one that may be driven by the foot of the operator, with a handle to attach for a second workman to turn it when necessary. When the needs of the workshop will admit of it, the best plan is to have a large grindstone (say 2 ft. diam. or more) for heavy work, and a smaller one (say 9 in. diam.) capable of being fixed to the end of the carpenters' bench and driven by foot power for lighter work. The stone should never be used dry, and with this object a trough is provided for containing water; but the stone must not under any circumstances be allowed to remain immersed in the water when not in use, consequently the water must be drawn off through a bung-hole, or a hinge attached to the trough for lowering it away from the stone, or a prop introduced for supporting the stone out of reach of the water. A sponge held against the revolving stone by a small rack is useful for preventing the water travelling round with the stone and wetting the handle of the tool and the hands and clothes of the operator. An absolutely essential quality in a grindstone is a true level face. This may be partially secured by distributing the work over the whole breadth of its surface, so as to wear it away equally all over; but every care in this respect will not suffice to keep it even enough for some tools, and then it must be refaced by means of a steel tool wider than itself. Fig. 365 illustrates an

365.

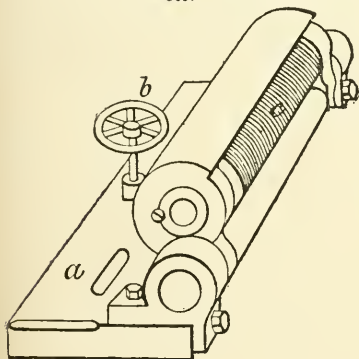

366.

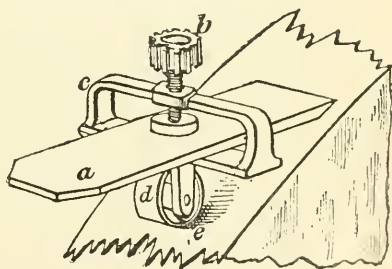

American device (sold by Churehills, Finsbury) for keeping the face of the grindstone constantly true while at work, without interfering with the use of the stone or raising any dust. The main stand or bottom piece *a* is securely clamped upon the trough close to the face of the stone; then by turning the handwheel *b*, the threaded roll *c* is brought into contact with the face of the stone, and allowed to remain so long as it is necessary to produce the desired result. The water is left in the trough as usual. When the thread of the rod *c* is worn it can be recut. The price of one of these implements suited to a 12-in. stone is 4*l.* 10*s.* The tool to be ground should be held against the stone in

such a way that the bevel or slope of the cutting edge lies flat on the stone, while the handle maintains a horizontal position. The stone should revolve towards the operator, i. e. against the edge. Usually the trough of the grindstone has high ends or similar means of supporting the tool during the grinding. Such means may take the form of a bevelled block to support the blade, or a notched rest to hold the handle, in either case securing that the grinding is done at the correct angle. Fig. 366 shows a contrivance for resting the tool, and ensuring its being ground at the desired angle. The plane iron *a* is held by a clamp screw *b* in the frame *c*, while the wheel *d* revolves on the stone *e*, and steadies the whole. This rest is sold by Churchills, Finsbury, for 2s. The amount of angle or bevel given to the edge varies with different tools and with the fancies of different workmen. In the case of a plane iron it must always be more acute than the angle formed by the sole of the plane and its mouth. The bevel produced on the grindstone should not be quite flat nor rounding (bulging) but rather hollowed out, a result naturally following from the circular form of the grinding surface of the stone, and varying of course with the size of the stone. Many workmen object to the use of any form of rest for the tool during grinding, as tending to produce a hollow edge—the very thing desired by another class. Gouges are best held across the stone, as otherwise they are apt to score the surface of the stone. In grinding the jack-plane iron, the cutting edge should be somewhat round, so that the shaving taken off is thicker in the centre than at the edges. The trying iron is also slightly round, but so slight that it is hardly noticeable. The smoothing iron should be a straight line on the cutting edge, with the corners very slightly rounded, but on no account should the edge be curved, though ever so little. These irons are all ground on the back only—that is, the bevel side; the bevel or ground part is about $\frac{1}{2}$ in. across. If too long, the iron when working is apt to jump.

Oilstones.—These are of several kinds, the best known being the Charnley Forest, Turkey, Arkansas, and Washita brands. They are sold in pieces of convenient size at about 1s. 6d. to 2s. a lb., and smaller slips for gouges at 4s. a lb. They can be procured ready cased, but if bought without a case, they should not long remain so, as they are then easily broken and exposed to dust and other evils. The casing may be accomplished in the following manner. Supposing the stone to be 9 in. long, 2 in. broad, and 1 in. thick, get 2 pieces of clean, straight, hard wood, 1 in. longer and wider than the stone, and $\frac{3}{8}$ in. thick. Plane one side of each piece flat, so that they will lie closely together. On one of the pieces, place the stone, keeping uppermost the side of it which you mean to use. Draw a line all round the wood close to the stone, when you will have a margin outside the line of $\frac{1}{2}$ in. With the brace and centre bit ($\frac{5}{8}$ in. or $\frac{3}{4}$ in.) bore all over the portion within the line $\frac{1}{2}$ in. deep, then with a sharp chisel ($\frac{3}{4}$ in. or 1 in.) cut down to the draw-point line all round, clearing out all within to $\frac{1}{2}$ in. deep, and making the bottom of this hollow box level throughout. If it is pared square down at the edges, the stone will slip into it; take care to put it in the same way as when you previously drew it. When the stone is bottomed, $\frac{1}{2}$ in. will project above the wood, and this part is to receive the top or cover. The stone is placed upon the second piece of wood, which is to make the cover, and drawn in the same way; and this piece has to be bored and cleared out in the same way to fully $\frac{1}{2}$ in. deep. It must have a smoother finish inside than the under piece; and must be pared a little without the draw-point line, so that the cover will slip on to the stone easily, but without shaking. The stone being within, the case is planed on the edges and ends, by catching it in the bench vice. The 4 corners may be rounded as well as the edge of the cover, and a $\frac{1}{8}$ -in. bead may be run round the cover where it joins the under part. (Cabe.) The oilstone will always wear most in the middle, becoming hollow in both length and breadth. This may not matter much for sharpening jack-plane irons, as the roundness thereby communicated to the corners of the cutting edge is rather an advantage. But when the hollow is of such a degree that it is inconvenient, the surface must be levelled. This may be effected by

rubbing it on a flat sandstone or grindstone, or by an emery slab, prepared by scattering emery powder on slips of wood previously well glued to hold it, and leaving for 24 hours to dry. The very best oil for use on the stone is either sperm or neat's foot, but this is often replaced by olive (salad) oil or by petroleum. In applying the tool, its bevel edge is rubbed to and fro on the stone, great care being necessary to ensure that the tool is held at exactly the same angle throughout the whole length of its travel backwards and forwards. That is to say, the natural tendency of the tool to lie flatter as it advances farther away from the operator's body must be compensated for by raising the hand slightly as it goes forward and lowering it as it returns. Square the elbows, let hand and arms have freedom, grasp the tool above with the right hand so as to bring the fingers underneath it, and let the fingers of the left lie together, and straight upon the upper side, their ends tolerably near the edge of the tool, the thumb being underneath. The tool will be thus held firmly, and also under control. Holtzappel gives a way the reverse of this. He says the first finger only of the right hand should be held above, and the thumb and rest of the fingers below, the left hand grasping the right, with the finger above the tool and the thumb below. It is probably in a great measure a question of habit. Apply the ground side of the iron to the stone, and rub backwards and forwards nearly the whole length of the stone. Hold the iron slightly more upright than at the grindstone, so that the extreme cutting edge only may come in contact with the oilstone. After 5 or 6 rubs on the bevel, turn the iron over and give it 1 or 2 light rubs when lying quite flat on the stone. This double operation is repeated till a keenly sharp edge is obtained. If the irons are newly ground, very little setting is needed, but as they are dulled or blunted when working, a fresh edge has to be brought up on the oilstone; this sharpening may go on for 20 or 30 times before the irons require re-grinding. A blunt iron, looked at on the bevel side, presents a whitish rounded or worn appearance, and the sharpening has to be continued until this white worn edge disappears, which is also ascertained by touching the edge lightly with the thumb. When an iron is sharpened or set, a very fine "wire edge" remains along the edge; this is removed by a dexterous slapping backwards and forwards on the palm of the hand, and is the same in effect as finishing the setting of a razor by stropping on a piece of leather. Gouges and bead-planes are generally set with a stone slip, several being necessary for the various bead and other moulding planes.

The slips are usually about 6 in. long, 2 in. broad, and $\frac{1}{8}$ in. to $\frac{1}{2}$ in. thick, with the edges rounded to fit the irons to be set. The cutting part of a bead-plane iron is a little smaller than the corresponding curve in the stock of the plane, the difference being the thickness of the shaving taken off. When the iron has been set a number of times with the slip, the curve has a tendency to get wider, and consequently is soon as wide as the curve in the stock. The iron will not then take off a shaving of equal thickness throughout the whole curve, but thickest in the middle, so the iron must be reground and set anew by the plane-maker, who has very thin round-edged grindstones for the purpose. The same thing occurs with most other moulding planes. In setting with the slip, the hollow part is continually getting wider, and the round part which is set on the ordinary oilstone is getting smaller. From these causes, the moulding gets out of proportion, and the iron does not fit the stock with a cutting edge even throughout its whole breadth, and will not turn a good shaving as before. The tool-maker must re-grind the iron when in this condition. (Cabe.)

Miscellaneous Forms. Circular plane.—All the forms of plane hitherto considered have been provided with a guide principle which shall repeat a straight level surface. The guide may, however, be the counterpart of any required surface. The American adjustable circular plane shown in Fig. 367 has an elastic steel sole, which, by means of adjusting screws, enables the workman readily to convert a straight-faced sole into one either concave or convex. It also possesses an advantage in the mode of fixing the iron,

viz. by a cam action. Often in ordinary planes the wood splits when the holding wedge binds on the box.

Rounder.—Wheeler's rounder is shown in Fig. 368. It is a very useful tool for producing a smooth and even surface on a cylindrical-shaped article, such as a broom handle; *a* is the cutting edge, and *b* the handles by which it is made to revolve round the wood.

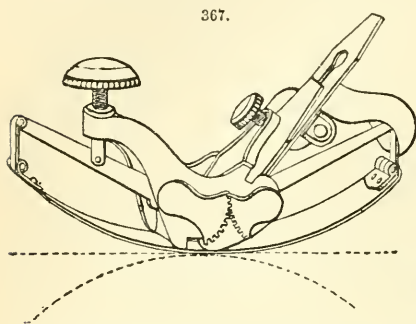

367.

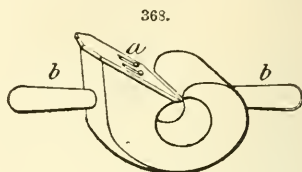

368.

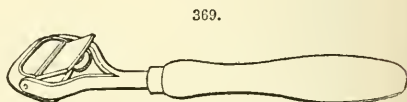

369.

Box scraper.—Fig. 369 illustrates an adjustable box scraper, made of malleable iron, with 2-in. steel cutters, and costing 2s. 6d.

Veneer scraper.—An adjustable veneer scraper is represented in Fig. 370. Its price with a 3-in. cutter is 15s., extra cutters costing 1s. 3d. each. The two latter tools may be obtained of Churchills, Finsbury, or Melhuish, Fetter Lane.

Mitre-plane.—The Rogers mitre-plane, Fig. 371, is made entirely of iron, and is arranged for planing any desired angle on straight or curved work. The main bed-piece is semicircular in form, with a way or frame at its rear on which the plane runs. The upper or movable bed-plate is in quadrant form, having, at right angles, sides which act as guides for the material to be planed, and revolving on a pivot *a* at the end, enabling the user to form the desired angle for straight work, and place it in its proper position against the face of the plane. When the quadrant or movable bed-plate is in the centre of the main bed-piece, its side elevations form an exact mitre, so that no change is required in planing the ends of parts for frames of 4 sides. In the sides of the quadrant are 2 adjustable guides or rests kept in position by set-screws *d*. The special object of these rests is to enable one to finish the ends or angles on curved work with exactness. In preparing pieces for circular or oval work, frames, pulleys, emery wheels, circular patterns, &c., it is necessary to plane the ends of the various segments at varying angles. In planing these, the point of the quadrant near the plane and the adjustable guides form the rests required for accurate work. The quadrant is kept in position at any angle desired by pressing the catch *c* down into the notches prepared for it, or by the thumb-screw *b*, and can be used in connection with the arms or guides as desired. It is sold by Churchills, Finsbury, at prices varying from 90s. for the 2-in. size, to 135s. for the 4-in.

370.

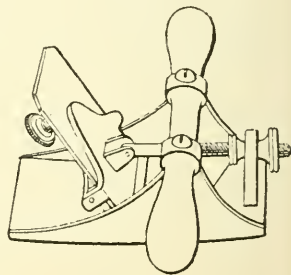

Combination Filisters.—Miller's combination, Fig. 372, embraces the common carpenters' plough, an adjustable filletster, and a perfect matching-plane. The entire assortment can be kept in smaller space, or made more portable, than an ordinary car-

penters' plough. With each plough, 8 bits ($\frac{1}{8}$, $\frac{3}{16}$, $\frac{1}{4}$, $\frac{5}{16}$, $\frac{3}{8}$, $\frac{7}{16}$, $\frac{1}{2}$, and $\frac{5}{8}$ in.) are furnished; also a tonguing tool ($\frac{1}{4}$ -in.), and by the use of the latter, together with a $\frac{1}{4}$ -in. plough bit for grooving, a perfect matching-plane is made. A metallic bed-piece, with $1\frac{1}{2}$ -in. cutter in it, can be attached to the stock of the tool by means of 2 screws passing through the slots in the base-piece of the stock. Over this bed-piece the gauge, or

371.

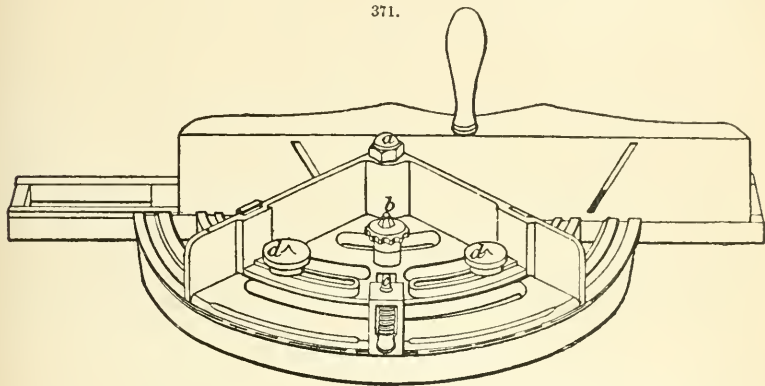

fence, will move backward or forward, and when secured to the bars by the thumb-screw, will constitute an adjustable filletster of any width required. The upright gauge on the back of the stock is adjusted by a thumbscrew likewise, and regulates the depth for the use of the filletster, as for all the other tools embraced in the combination. Churchills sell it at 36s.

Trant's adjustable dado, &c., sold by the same firm at 32s., is shown in Fig. 373.

372.

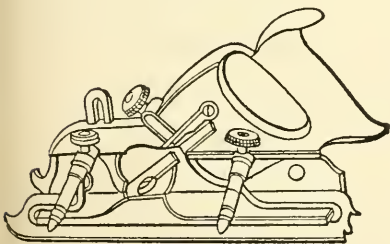

373.

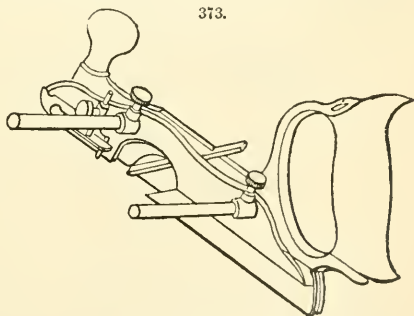

It consists of 2 sections—a main stock with 2 bars or arms; and a sliding section, having its bottom, or face, level with that of the main stock. It can be used as a dado of any required width, by inserting the bit into the main stock, and bringing the sliding section up to the edge of the bit. The 2 spurs, one on each section of the plane, will thus be brought exactly in front of the edges of the bit. The gauge on the sliding section will regulate the depth to which the tool will cut. By attaching the guard-plate to the sliding section, the tool may be readily converted into a plough, a filletster, or a matching-plane—as explained in the printed instructions which go in every box.

The tool is accompanied by 8 plough bits ($\frac{3}{16}$, $\frac{1}{4}$, $\frac{5}{16}$, $\frac{3}{8}$, $\frac{1}{2}$, $\frac{5}{8}$, $\frac{7}{8}$, and $1\frac{1}{4}$ in.), a filletster cutter, and a tonguing tool. All these bits are secured in the main stock on a skew.

Lunt, Hackney Road, sells a circular rabbeting and filister router for 3s. 6d.; it cuts any rebate up to $\frac{7}{8}$ in. wide, but the filister is not adjustable.

BORING TOOLS.—These comprise awls, gimlets, augers, bits and braces, and drills.

Awls.—The simplest form of boring tool is the awl or bradawl as it is more generally called, Fig. 374. It consists of a piece of small steel rod, with one end fastened in a wooden handle, and the other doubly bevelled to a sharp edge, which serves the purpose of compressing and displacing the fibres of the wood so as to form a hole without producing any chips or dust from the wood operated on. Its greatest drawback is the readiness with which the awl proper may be pulled out of its handle in withdrawing the tool from the hole it has made, especially in the case of hard woods. Superior awls are, however, made to overcome this fault, the handle being hollow and containing a selection of awls of different sizes, each fastening into the handle by means of a screw-nut. The use of the awl is to prepare holes for the admission of nails and screws.

Gimlets.—The gimlet is an offspring of the awl, and of more recent origin. The gimlet of the Greeks had the cross-head or handle of the style now prevalent. It also had possibly a hollow pod, as the earliest specimens found are of that type, but no screw-point, and it demanded a large expenditure of muscle, especially in boring hard

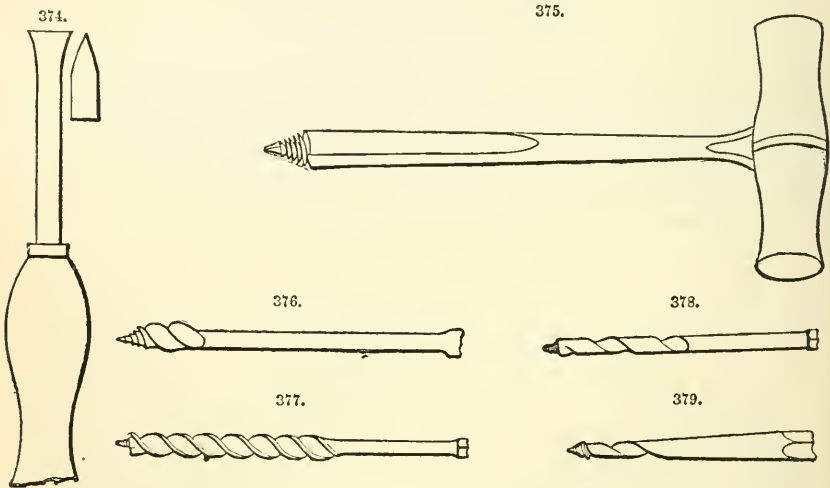

woods, where it was not very effective. Later, a gimlet of square section, having sharp corners and tapering to a sharp point, was introduced, and gave the hint for a form of auger now in use. In course of time, the screw point was added, and the hollow-pod gimlet, with a point of this kind, was the only sort in use for many centuries. In England, this was called a "wimble." This form is still in use to some extent, and is effective where very shallow holes only are to be bored, but as it has to be removed whenever the pod becomes full of chips from boring, it causes a waste of time when deeper holes are desired. The twisted or spiral form of gimlet, which is self-discharging, is an American invention, and only of very recent date. It has, however, superseded all other forms, and is now in common use. The field of the gimlet is becoming greatly narrowed, giving ground to the more rapid and convenient brace and bit. (*Industrial World.*) Some gimlets are made with twisted shanks, which allow the dust and little

chips to escape more easily, and some have only a gouge-shaped channel with a pointed screw below. These tools cut away the material as they go, the screw point only serving to give a hold at first, and gradually to draw the tool deeper into the work. The shell or gouge-shaped are generally preferred by carpenters, as being stronger and more suited for rough work in various woods; but they are more likely to split the work, especially if the latter be at all thin or slight. In such case, it is best to use very little pressure, and to give a quick movement to the handle. Fig. 375 shows the commonest form of gimlet, termed a "spike." Fig. 376 is a "treble twist"; Fig. 377, an auger gimlet; Fig. 378, a patent twist; and Fig. 379, a brewers' twist. The prices of awls and gimlets range from 1*d.* to 6*d.* each, according to size. An assortment is needed.

Augers.—These are only magnified gimlets for use with both hands. They are represented in Fig. 380, *a* being the "twisted," and *b* the "shell" form. A wooden bar is thrust through the eye *c*, and the hands exchange ends of this bar at each half revolution given to the tool. Their sizes advance $\frac{1}{8}$ in. at a time from $\frac{3}{8}$ in. to 2 in. in diameter, and prices range from 8*d.* to 6*s.* 6*d.*

Bits and Braces.—The faults inherent in all forms of awl, gimlet, and auger are that the rotation is necessarily interrupted to enable the position of the hand or hands to be changed, and that the pressure exercised on the tool is in most cases limited. These drawbacks are overcome by the brace and its accompanying bits. The ordinary form of brace is shown in Fig. 381. It consists simply of a crank, one end *a* being provided with a round head for receiving pressure from the breast of the workman, the other end *b* recessed for the introduction of the bit, and the centre *c* rendered smooth for the application of the hand that turns the whole. It will be obvious that much greater working efficiency can be got out of the boring tool by the continuous rapid rotation and heavy pressure secured by this implement than by the simpler forms previously described. The tools

adapted for use with the brace (Figs. 382-394) are made fast in the end *b* by means of a thumb-screw catching in the notch seen near the end of their stems. This constitutes the weak point in the ordinary form of this compound tool. In the first

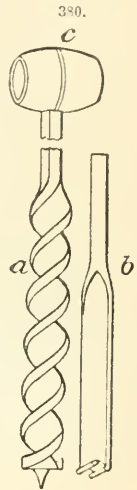

381.

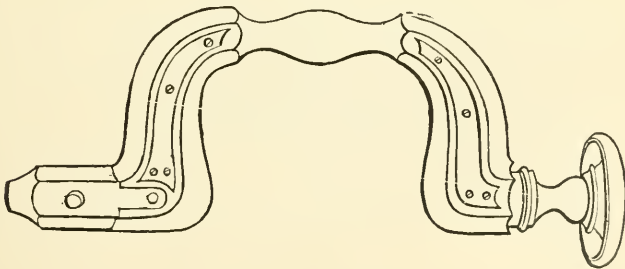

place, the use to which the implement is subjected has a direct tendency to wear the thumb-screw in such a degree as to soon render it loose and incapable of holding the boring tool firmly; and in the second place, the square hole in the end *b* is of fixed size, and will only admit tools which fit it accurately. These defects are remedied in Barber's patent brace, which is provided with an expanding chuck that adapts itself

to all shapes and sizes of stems, and holds them tight and true. It is made in several sizes and styles, the most useful being the 9-in., costing 3s. 6d.; the common socket iron brace of the same size may be had for about 1s. 6d. Of the tools employed in the brace, Fig. 382 is a centre-bit, useful for boring large and deep holes; Figs. 383, 384, 385, countersinks for enlarging the entrances of holes when it is desirable to let the screw or other occupant of the hole lie completely beneath the surface of the wood—they are termed respectively “snail-horn,” “rose-head,” and “flat-head,” from their shapes; Fig. 386, a screw-driver; Fig. 395, a bobbin bit; Fig. 387, a taper bit, for boring funnel-shaped holes; Fig. 388, a sash bit; Fig. 389, a shell bit; Fig. 390, a nose bit; Fig. 391, a spoon bit; Fig. 392, a square rinder; Fig. 393, a half-round rinder; Fig. 394, a gimlet bit; Fig. 396, a dowling bit. Many other forms might be mentioned, including those employed in metal working, for which the implement is equally well adapted.

Drills.—This is another method of securing more rapid and continuous rotation of the tool. A quick-speed hand-drill sold by Churchills, Finsbury, for 7s. 6d. is shown

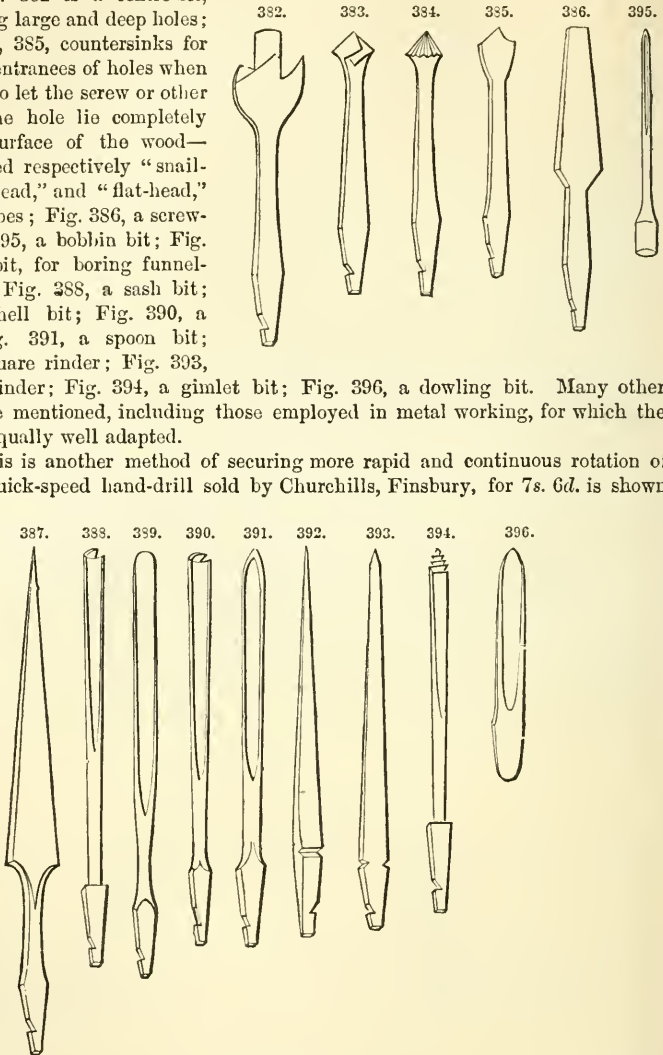

in Fig. 397. It has a continuous revolving movement in one direction at a speed of 500-1000 turns per minute. It is operated by holding the handle in the left hand, and quickly drawing out the cord with the right hand; on relieving the tension, the cord is re-wound on the spindle by a spring concealed in the spool. The momentum given to the fly-wheel is sufficient to maintain the speed while the cord is re-wound and the

operation repeated. It may be worked in any position. It carries an adjustable self-centring chuck for holding the drill-points; 6 of these, from $\frac{1}{32}$ to $\frac{1}{8}$ in., are sent with each drill. It will be found a rapid working tool for light work in wood or metal.

Fig. 398 shows the Miller's Falls breast-drill mounted in a steel frame. Most work can better be done with the drill mounted in the frame. When used against the breast,

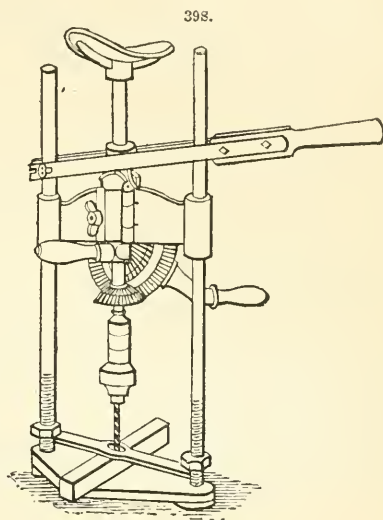
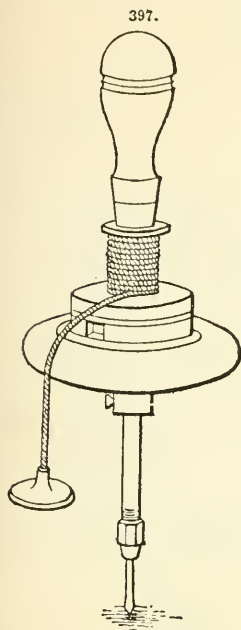

it often requires a heavy pressure, which is very fatiguing to the workman. In this arrangement, there is a leverage of 5 to 1, which makes the feeding an easy matter. When work is required, which cannot be done in the frame, the drill can be taken out and used in the ordinary way. The upright rods of the frame are $\frac{5}{8}$ -in. round steel, 16 in. high, and 8 in. apart. As seen in the cut, the drill is held true by the frame, and the work held firmly in place by the clamp. The lever feed is operated by hand, or a weight may be used. The drillstock is of $\frac{5}{8}$ -in. round steel, heavily nickel-plated. The gears are cut, and are changeable from even to a speed of 3 to 1, as may be desired. The handles are rosewood. The jaws of the chuck are forged steel, and will hold any size or shape shank—round, square, or flat. An extra set of steel jaws is supplied for small round drills only. The drillstock can be put in or out of the frame by the half-turn of a thumb-nut. The machine weighs only 15 lb., and costs 30s. It is sold by Churchills.

Miscellaneous.—Several improved tools of recent introduction scarcely fall under any of the foregoing classes. They are as follows:—

Angular Bit Stock.—This very useful adjunct to the brace and bits is shown in Fig. 399. Its object is to alter the direction of the pressure in boring (so as to permit boring in a corner), for which purpose it is placed between the brace and bit, forming their connecting link. The angle at which the hole is to be bored is decided beforehand, and the stock is properly set, the ball joint enabling the tool to turn without hindrance. It is sold by Churchills for 8s. 6d.

Wheeler's Countersink.—The bit of this countersink, Fig. 400, is in the shape of a

hollow eccentric cone, thus securing a cutting edge of uniform draft from the point to the base of the tool, and obviating the tendency of such a tool to lead off into the wood at its cutting edge, and to leave an angular line where it ceases to cut. It works equally well for every variety of screw, the pitch of the cone being the same as the taper given to the heads of all sizes of screws, thereby rendering only a single tool necessary for every variety of work. It cuts rapidly, and is easily sharpened by drawing a thin file lengthways inside of the cutter. By fastening the gauge at a given point, any number of screws may be driven so as to leave the heads flush with the surface, or at a uniform depth below it. The gauge can be easily moved or detached entirely, by means of the set-screw.

Expansion Bit.—Clark's expansion bit, Fig. 401, is designed to cut holes of varying size by means of a shifting cutter. It is made in 2 sizes, one ranging from $\frac{1}{2}$ in. to $1\frac{1}{2}$ in., and costing 7s. 6d.,

and the other embracing all diameters between $\frac{7}{8}$ in. and 3 in., and costing 11s. One of these tools not only replaces a complete set of the ordinary kind, but enables holes to be

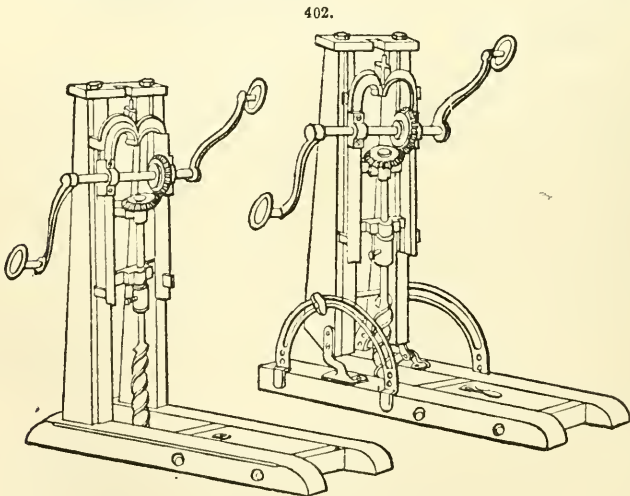
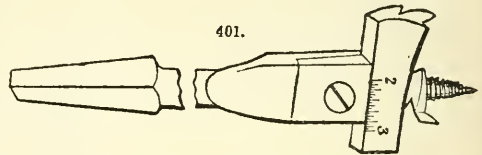
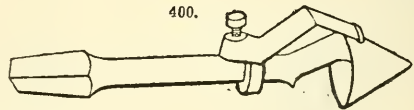
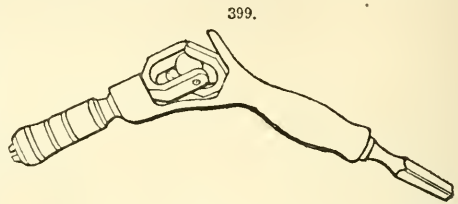

bored of all intermediate sizes. These, however, are seldom required in the general way.

Boring Machine.—Fig. 402 represents a plain and an angular boring machine, adapted for heavy work, costing respectively 22s. and 30s. without augers; a set of augers to

match, $\frac{1}{2}$ in., $\frac{5}{8}$ in., $\frac{3}{4}$ in., $\frac{7}{8}$ in., 1 in., $1\frac{1}{4}$ in., $1\frac{1}{2}$ in., $1\frac{3}{4}$ in., and 2 in., costs 42s. 6d. The diagrams will explain themselves.

STRIKING TOOLS.—The only members of this group are the familiar hammer and mallet.

Hammers.—Hammers, with and without handles, are in use; hammers of various weights from $\frac{1}{2}$ oz. to 10 lb., and from 15 lb. to 56 lb., are now employed as hand-hammers. The angles of attachment of handles to heads are various; the position of the centre of gravity of the head in reference to the line of penetration of the handle is various; the faces have various convexities; the panes have all ranges and forms, from the hemispherical end of the engineer's hammer, and the sharpened end of the pick and tomahawk, to the curved sharpened end of the adze, or the straight convex edge of the hatchet and axe; the panes make all angles with the plane in which the hammer moves. Various as are the uses to which hammers may be directed, yet like many other handicraft tools certain contrivances are requisite in order either to direct or give full effect to the tool itself. Art has given to the hammer head only the handle as its contribution. Nature supplies other and more essential contrivances. These contrivances are mainly the muscles of the arm, although under certain circumstances other muscles of the body, especially those about the loins, are called into action. The weight of the hammer head, and the balance of the head in the handle, are the most important considerations governing the suitability of the hammer to the nature of the work as well as to the capacity of the workman. The ordinary ("Exeter") carpenter's hammer is shown in Fig. 403, consisting of a wooden handle fastened in an eye in the steel head by means of a wedge. Fig. 404

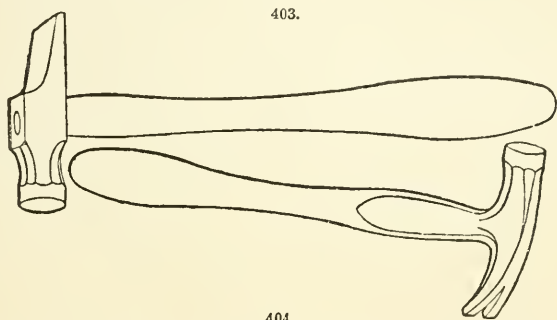

is the next common form, termed a "claw" hammer, and secured head to haft by means of side flanges. This is an inferior plan, as the elasticity of the blow is not only interfered with, but the head is liable to be loosened by using the claw for drawing nails. It

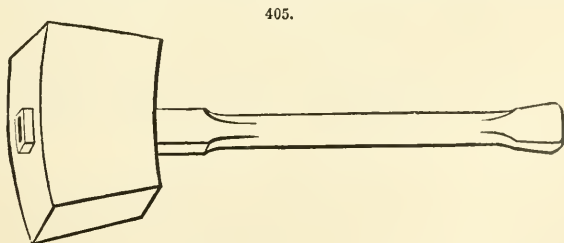

is well to have 2 or 3 sizes for various work, costing 1s. to 3s. each. No hammer should ever be used to strike a wooden surface, especially an article lighter than the hammer itself, as it will certainly do mischief.

Mallets.—In these tools the steel head is replaced by a wooden one. Fig. 405 shows the usual square form; there is also a round form. The former ranges from 6 in. long and $2\frac{1}{2}$ in. by $3\frac{1}{2}$ in. wide, costing $9d.$, to 7 in. by 3 in. by 4 in., costing $13\frac{1}{2}d.$; the latter, from 5 in. long and 3 in. diam., costing $7d.$, to 6 in. by 4 in., costing $11\frac{1}{2}d.$ These have hickory heads; similar tools made of lignum vitæ cost nearly double. The chief use of the mallet is in conjunction with the chisel.

CHOPPING TOOLS.—These comprise axes, hatchets, and adzes. They consist of a combination of a striking tool with a cutting tool, the cutting edge being of stronger form than those described in a previous section (p. 230), in order to support the strain resulting from their being applied with greater force. The construction of these tools necessitates the addition of a handle or "helve," whose shape, length, and method of attachment to the blade have no small influence on the effectiveness of the tool.

Axes and Hatchets.—Principles. Axes are tools to be used with both hands; they have long handles, and may be swung as sledge hammers. Hatchets are to be used with one hand, have short handles, are much lighter and thinner than axes, and are employed more in the trimming than in the hewing of timber. Both narrow and broad axes are employed in forestry, the woodman's choice being affected by the size of the timber and the character of the fibre. A hatchet is handled with the centre of gravity nearer the cutting edge than the line of the handle; an axe, with the centre of gravity in the line of handle produced. When we pass from the tool and its contrived handle to the mode of using, and the purpose for which it has been constructed, we find, as a rule, a cutting edge formed by 2 inclined surfaces meeting at an angle, the bisecting line of which passes through the middle of the metal. It is very apparent that the more acute this angle is, the greater, under the same impact, will be the penetrative power of the axe into the material against which it is driven. This supposition needs to be qualified, for suppose the material offers a great resistance to the entrance of this edge, then the effect of the blow, upon the principle that action and reaction are equal, will react upon the edge, and the weakest, either edge of axe or object struck, must yield. Here experience would be obliged to qualify the simple tool in which the edge was keen and acute, and would naturally sacrifice the keenness and acuteness to strength. When early uses of the axe are considered, it will be noticed that even in fashioning with an axe or adze the same piece of wood, different conditions of edge are requisite. If the blow be given in the direction of the fibre, resistance to entrance of the edge is much less than in the blow across that fibre. So great, indeed, may this difference become, that whilst the axe seems in all respects a suitable tool, yet as the attention of the workman passes to directions inclined to the fibre at an angle of more than 45° , he will be induced to lay it aside in favour of the saw. These remarks apply only to tools used in dividing materials, and not to tools used in preparing surfaces of materials. This preliminary consideration prepares us for the different circumstances under which these 2 classes of tools may be respectively used. And as the contrast of the effect of the same tool under different circumstances in the same substance is considerable, great also is likely to be the contrast between the edges of the tools and the manner of using them, e. g. the axe, which is the proper tool in the direction of the fibre, is operated upon by impact, whilst a saw, which is the proper tool across the fibre, is operated upon by tension or thrust, but never by impact.

Using.—The mode in which the axe is used will explain why it is unsuited for work across the fibre. The axe is simply a wedge, and therefore arranged to cleave, rather than to cut, the wood. Now a calculation of the pressure necessary to thrust forward a wedge, and the impact necessary to cause the same wedge to enter the same depth, would explain why (regarded as a wedge only) the handle proves an important adjunct to the arm of the workman.

The motions of the hands on the handle of an axe are similar to those of a work-

man on that of the sledge hammer. The handle of a properly handled axe is curved, that of a sledge hammer is straight. For present consideration this curvature may be overlooked, although it plays an important part in the using of an axe with success and ease. If the almost unconscious motions of a workman skilled in the use of an axe be observed, it will be noticed that whilst the hand farthest from the axe head grasps the handle at the same or nearly the same part, the other hand, or the one nearest to the head, frequently moves. Let us follow these motions and consider the effect of them. The axe has just been brought down with a blow and entered between the fibres of the wood. In this position it may be regarded as wedged in the wood, held in fact by the pressure of the fibres against the sides of the axe; from this fixity it must be released, and this is usually done by action on or near the head. For this purpose the workman slides his hand along the handle, and availing himself (if need be) of the oval form of the handle after it has passed through the eye of the metal, he releases the head. The instrument has now to be raised to an elevation; for this purpose his hand remains near to the head, so causing the length of the path of his hand and that of the axe head to be nearly the same. The effect of this is to require but a minimum of power to be exerted by the muscles in raising the axe; whereas if the hand had remained near the end of the handle most distant from the head, then the raising of the axe head would have been done at what is called a mechanical disadvantage. Indeed, if a workman will notice the position of the hand (which does not slide along the handle) before and after the blow has been given, he will find that its travel has been very small indeed. Reverse the problem. Take the axe head as raised to such an elevation as to cause the handle to be vertical (we are dealing with ordinary axes, the handles being in the plane of the axe blade). Now the left hand is at the extremity of the handle, the right hand is very near to the axe head—the blow is about to be given. The requirement in this case is that there should be concentrated at the axe head all the force or power possible; hence to ease the descent would be as injudicious as to intensify the weight of the lift. Consequently whilst with the hand nearest to the head (as it is when the axe reaches its highest elevation) the workman momentarily forces forward the axe, availing himself of the leverage now formed by regarding the left hand as the fulcrum of motion, he gives an impulse, and this impelling force is continued until an involuntary consciousness assures him that the descending speed of the axe is in excess of any velocity that muscular efforts can maintain. To permit gravity to have free play, the workman withdraws the hand nearest to the head, and sliding it along the handle, brings it close to the left hand, which is at the extremity of the handle; thus the head comes down upon the work with all the energy which a combination of muscular action and gravity can effect. The process is repeated by the right hand sliding along the handle, and releasing as well as raising the head.

Form of handle.—The form of the axe handle deserves notice, differing as it does from that of the sledge hammer. In the latter, it is round or nearly so; in the axe, it is oval, the narrow end of the oval being on the side towards the edge of the axe, and, more than this, the longer axis of the oval increases as the handle approaches the head, till at its entrance into the head it may be double what it is at the other extremity. It often has also a projection at the extremity of the handle. The increasing thickness near the head not only gives strength where needed, as the axe is being driven in, but it also supplies that for which our ancestors employed thongs, viz. assistance to the strain necessary to release the blade from the cut. There is, too, this further difference—in a sledge hammer more or less recoil has to be provided for, and the handle does this; in the axe no recoil ought to take place. The entrance of the axe edge is, or ought to be, sufficient to retain it, and the whole of the energy resulting from muscular action and gravity should be utilized. The curvature, too, of the handle is in marked contrast with the straight line of the sledge hammer handle. The object of this curvature is worthy of note. In the American forester's axe, the handle is very long and curved. If laying the

axe handle across the finger where the head and handle balance, the blade of the axe is placed horizontal, the edge does not turn downwards: in fact, the centre of gravity of the axe head is in the horizontal straight line prolongation of the handle through the place where the finger is. Now in sleight hammer work the face is to be brought down

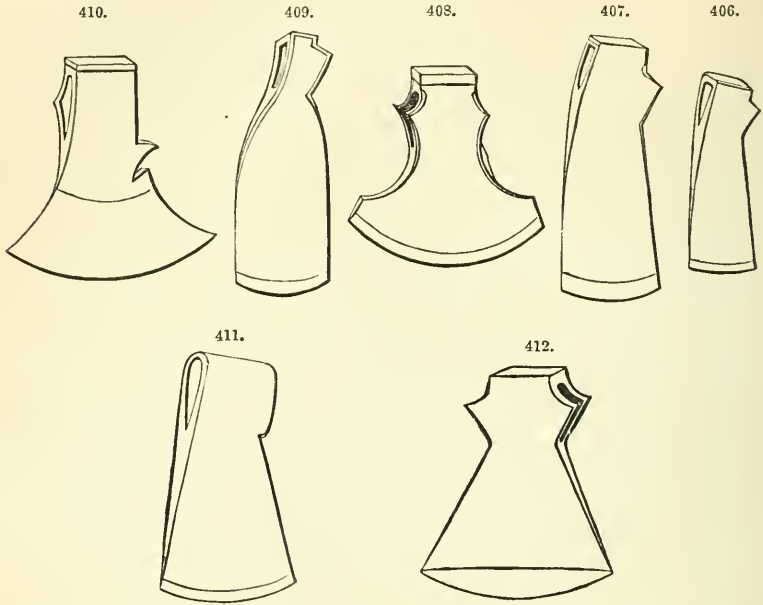

flat, i.e. as a rule, in a horizontal plane. With the foresters' axe, it has to be brought down at varying obliquities. If the hewer's hand had to be counteracting the influence of gravity, there would be added to him very needless labour, hence the care of a skilled forester in the balance of the axe-head and the curvature of the handle.

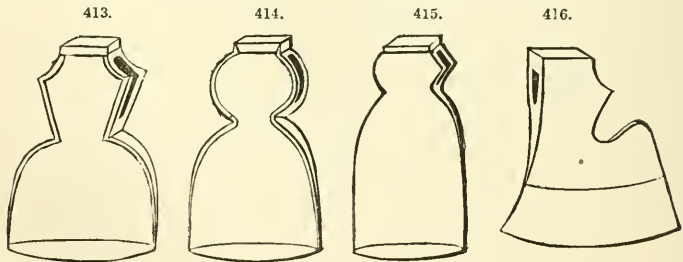

Form of cutting edge.—The form of the cutting edge as seen in the side of the axe is often convex. The line across the face in Fig. 417 indicates the extent of the steel, and the corresponding line in Fig. 407 the bevel of the cleaving edge. It will be noticed that the cutting edge in each case is curved. The object of this is to prevent not only the jar and damage which might be done by the too sudden stoppage

of the rapid motion of the heavy head in separating a group of fibres, but also to facilitate that separation by attacking these fibres in succession. For, assuming the axe falls square on its work in the direction of the fibres, a convex edge will first separate 2 fibres, and in so doing will have released a portion of the bond which held adjoining fibres. An edge thus convex, progressing at each side of the convexity which first

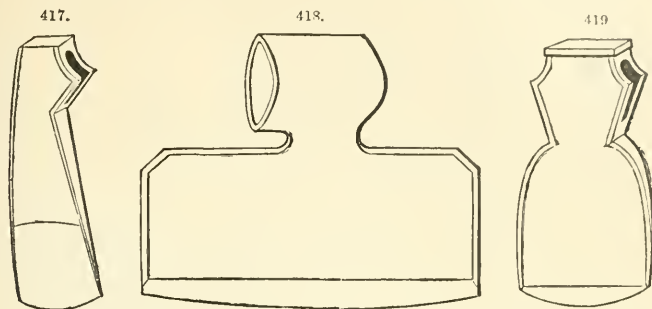

strikes the wood, facilitates the entrance of successive portions from the middle outwards. If the edge had been straight and fallen parallel to itself upon the end of the wood, none of this preliminary preparation would have taken place; on the contrary, in all probability there would have been in some parts a progressive condensation of fibres, and to that extent an increase in the difficulty of the work.

The equally inclined sides of the wedge-form of edge hitherto alone described as belonging to axes, and the equal pressure this form necessarily exerts upon each side if a blow is given in the plane of the axe, suggest what will be the action of an axe if the angle of the wedge is not bisected by the middle line of the metal. Assume that one face only is inclined, and that the plane of the other is continuous to the edge, then let the blow be struck as before. It will be obvious that the plane in the line of the fibres cannot cause any separation of these fibres, but the slope entering the wood will separate the fibres on its own side. Supposing a hatchet sharpened as previously described, and one as now described, are to be applied to the same work, viz. the cutting from a solid block the outside irregularities—say to chop the projecting edges from a square log and to prepare it for the lathe. It may be briefly stated that the hatchet described in the

420.



421.

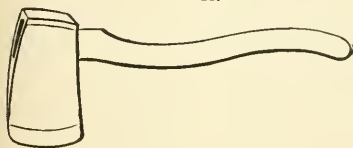

422.

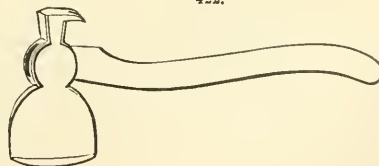

second case would do the work with greater ease to the workman, and with a higher finish than the ordinary equally inclined sides of the edge of the common hatchet. Coach-makers have much of this class of hatchet-paring work to do, and the tool they use is shaped as in Fig. 416. The edge is bevelled on one side only, and under where the handle

enters the eye, may be noticed a piece rising towards the handle; on this the finger of the workman rests in order to steady the blade in its entrance into the timber in the plane of the straight part of the blade, and to counteract the tendency of the wedge side pressing the hatchet out of its true plane.

The principal forms of axe and hatchet, illustrated below, are as follows:—Fig. 406, colonial felling axe; Fig. 407, Australian felling axe; Fig. 408, wheelers' axe; Fig. 409, north country ship axe; Fig. 410, Dutch side axe; Fig. 411, Brazil axe; Fig. 412, broad axe; Fig. 413, Kent axe; Fig. 414, Scotch axe; Fig. 415, blocking axe; Fig. 416, coach-makers' axe; Fig. 417, coopers' axe; Fig. 418, long felling axe; Fig. 419, common ship axe; Fig. 420, Kentucky wedge axe; Fig. 421, Canada hatchet; Fig. 422, American shingling hatchet, with claw; Fig. 423, shingling hatchet, with hammer head.

Adzes.—Those whose business requires the forming of lengths of wood into curved shapes, and who rely upon the adze for the preliminary operation, use an Indian form of adze. In India it is held so near the metal that the workman's hand touches the metal. He accomplishes blows chiefly by acting from the elbow. This very general mode of holding gives a pretty uniform length to the radius of the swing, hence the form of the adze in the plane of the swing is nearly that of the circle described. The angle of the handle and the adze is very much the same as that of the handle of the file-makers' hammer and the head. The handling of the adze, as used by English wheelwrights or shipwrights, briefly described, is the following: The workman stands with one foot upon the wood, this foot being in the line of the fibre. He thus assists in steadying (say) the felloe of a wheel. From this felloe much of the wood on which the sole of his shoe rests has to be removed. The long handle of the adze is curved; the object of this is to permit an efficient blow to be given, and the instrument brought to a stop before the handle strikes any part of the workman's body—in fact, caused to stop by the exhaustion of its impact energy in and amongst the fibres of wood to be separated. The edge is often so keen as to cut through a horse hair held at one end and pressed against it. This instrument is raised by both hands until nearly in a horizontal position, and then not simply allowed to fall, but steadily driven downwards until the curved metal, with its broad and sharp edge, enters near to, if not below the sole of the workman's shoe, separating a large flake of wood from the mass; the handle is rapidly raised, and the blows repeated. This is done with frequency, the workman gradually receding his foot until the end flakes of wood are separated. It is fearful to contemplate an error of judgment or an unsteady blow. So skilled do men become in thus using the adze, that some will undertake, with any pre-determined stroke in a series, to split their shoe sole in two.

Curvature.—Clearly the adze must be sharpened from the inside; and when the action of it is considered, it is also clear that the curvature of the adze iron must be circular, or nearly so. The true curvature of the metal may be approximately deduced from considering the radius of the circle described by the workman's arms and the handle of the adze. The edge of the adze is convex (Fig. 425), the projection in the middle being so formed for the same reasons as influenced the curvature of the edge of the axe already alluded to. The curvature in the blade also serves (though partially) as a fulcrum, for, by slightly thrusting the handle from him, the workman may release such flakes of timber as are over the adze, and yet so slightly adherent as not to require another blow. Thus the adze when applied lever-fashion discharges its duty as the curvature in the claw of a hammer does. Fig. 428 is a gouge formed adze; a modification of this is used in making wooden spouts and similar hollow work.

423.

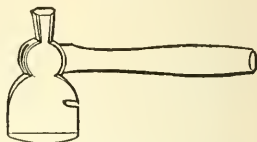

The principal forms of adze are illustrated below. Fig. 424 is an ordinary carpenters' adze; Fig. 425, ship carpenters' adze; Fig. 426, coopers' adze; Fig. 427, improved wheelers' adze; Fig. 428, spout adze; Fig. 429, coopers' adze with sexagon eye; Fig. 430, coopers' nail adze.

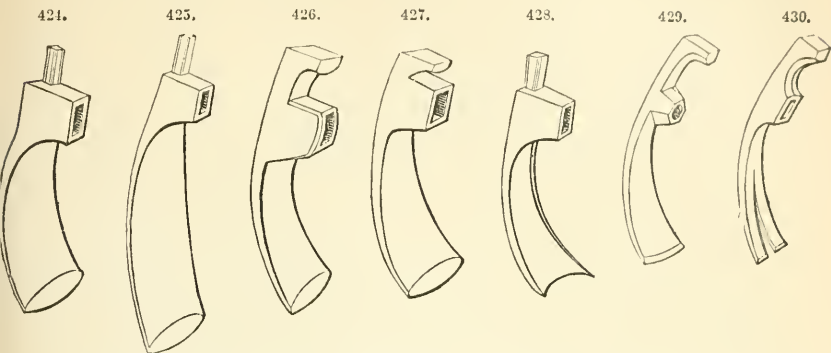

ACCESSORIES.—The principal accessories to a carpenters' workshop are a bench, nails and screws, and a few trifles which could not be conveniently placed in the preceding categories.

Bench.—The essential qualities of a carpenters' bench are that it shall be very strong and firm to resist the sawing, planing, and other operations performed on it; also that the surface shall be level and even. The wood must be good and sound, but not of an

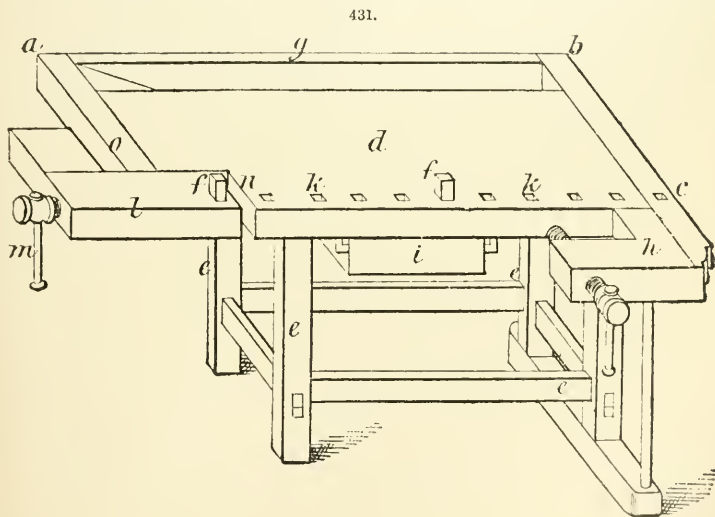

expensive kind (beech is a favourite), nor need it be planed. Excellent benches may be purchased of tool dealers; on the other hand a home-made article may be quite as good and will cost much less. An example will be given on a future page.

Fig. 431 shows a solid bench of the so-called German pattern, sold by Melhuish

Fetter Lane, in 4 different sizes: carpenters', price 80s., length 68 in., breadth 24 in., height, 33 in.; trade, price 45s., length 48 in., breadth $16\frac{1}{2}$ in., height 31 in.; amateurs', price 42s., length 40 in., breadth $16\frac{1}{2}$ in., height 31 in.; boys', price 37s. 6d., length 40 in., breadth $16\frac{1}{2}$ in., height 29 in. The length is measured from *a* to *b*, and the width from *b* to *c*, thus excluding the projections. A description of the "carpenters'" size will do for all. The top *d* is movable, and can be taken off the stand *e*, which also takes to pieces, so that it can be packed. Two pegs in the upper rails of the stand fit into holes made for their reception in the under part of the bench top, and by this simple arrangement, combined with the weight of the top itself, the parts are sufficiently connected and rendered firm. The mortices which receive the tenons of the lower rails, in front and at the back and sides, go through the legs, and the top part of the front and back rail at either end passes over the side rails, so that the mortice is deeper on the inside than on the outside; a tapering wedge is driven into the mortice at each end of both front and back rail, which has the effect of forcing these rails down on the ends of the side rails, and locking the whole together. When the bench is put up for work the ends of the wedges may be sawn off. The massive legs to the right are tenoned into a thick piece of timber, which is further utilized as a support for the end in which the bench-screw works. The top of the bench presents many points in which it differs from the ordinary form in common use. The central part is a solid piece of beech, 4 in. thick, $60\frac{1}{2}$ in. long, and $16\frac{1}{2}$ in. wide. To this portion all the surrounding parts are added. It is lengthened by 2 pieces *a b* clamped on one at each end, also 4 in. thick, and $3\frac{3}{4}$ in. wide, thus bringing up the length of the bench to 68 in. The 3 parts are bolted together by an iron bar, at the left end of which is a nut whereby they are screwed up as closely as possible. The piece *a* is $18\frac{3}{4}$ in. and *b* 33 in. long. They project beyond the central piece at the back to the distance of $7\frac{1}{2}$ in., and by inserting a board *g* $1\frac{1}{2}$ in. thick, and another at the bottom, a trough 6 in. wide and extending the whole length of the bench forms a useful receptacle for tools not in actual use. The shoulder *h* is formed of a solid piece, 4 in. thick, 8 in. wide at its widest part, and $2\frac{3}{4}$ in. wide at the narrowest part in which the bench-screw works, leaving an opening of $5\frac{1}{4}$ in. between the edge of the front of the bench and the inner surface of the narrow part of the shoulder. To plane the edge of a board, the screw is turned out sufficient to admit the board and a check piece supplied with the bench, which is intended to receive the pressure of the end of the screw, and prevent injury to the wood to be planed. To the bottom of the bench is appended a drawer *i* 18 in. sq., which works by means of cleats in grooved L-shaped timbers, screwed to the under surface of the bench; this drawer pulled out a little acts as a support for timber being planed. Along the front edge of the bench runs a row of 10 holes *k*, $1\frac{1}{2}$ in. long by $\frac{1}{8}$ in. wide, serving as receptacles for bench-stops *j*. These are used in conjunction with another in the movable vice jaw *l*, and when planing a board, all that is necessary to fix it is to insert a bench-stop to the left, at a suitable distance from the bench-stop in the movable piece *l*, lay the board between the 2 stops, and grip it by turning the screw *m*. The bench-stops can be adjusted to any height likely to be required. The movable bench-vice *l* has a projecting fillet on its inner face, which works in a groove of corresponding size cut in the central part of the bench. This vice, which is 22 in. long in its longest, and $6\frac{3}{4}$ in. wide in its narrowest part, presents intervals of different widths between the ends of its 2 parts and the end of the bench at *n o*. These openings afford the means of gripping pieces of wood in the most convenient manner for cutting tenons, dovetails, &c.

Another excellent bench is that furnished by Syer, Finsbury Street, and termed a portable cabinet bench. It is shown in Fig. 432, and is formed of an iron stand *a*, made in separate pieces bolted together, with a wooden top *b* of sound white deal, traversed by 3 iron bolts *c* to prevent warping, and measuring 6 ft. by 1 ft. 10 in. All the parts are joined by screw-bolts, and therefore quite rigid but easily taken apart. The ordinary bench-screw is replaced by an instantaneous grip vice *d*, and the usual bench-

stops are superseded by a screw rising stop *e*. The whole costs 72s., or a smaller size (4½ ft. by 1½ ft.) may be had for 63s. The upright piece of wood *f* is perforated with holes to take a peg wherever it may be necessary to support a piece of board, one end of which is held in the grip vice *d*. The space between this and the standard to the left can be partly filled with a nest of 5 drawers—one large at the bottom, and 2 tiers each containing 2 smaller drawers above. These chests are 22 in. long, 18 in. high, and 16 in. deep,

432.

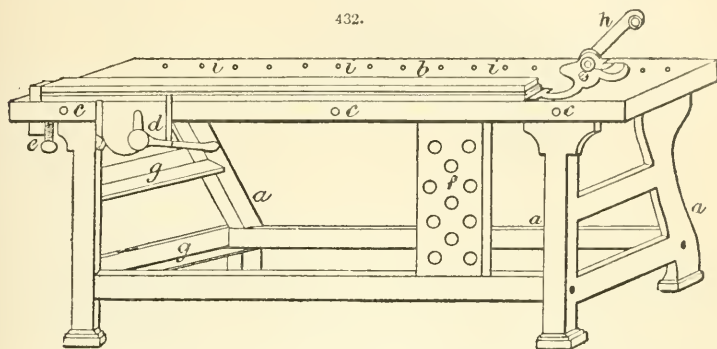

and are supplied with the bench at a cost of 35s. extra. If not required, the ledges *y* within the standards can be utilized as supports for boards on which large tools can be laid when not in use. Another useful adjunct to the bench is the bench-knife *h*, supplied at 3s. 6d., and consisting of a small bed-plate, having 2 pins on the under side to drop into holes made in the top of the bench to receive them, and an arm or knife for holding the work firmly between itself and the bench-stop, the arm being pushed and held against the work by the action of a small lever handle and cam attached to the upper surface of the bed-plate. This plate is only 9 in. by 3½ in., and the weight of the entire appliance is only 2 lb. The knife works smoothly and easily on the surface of the bench-top, and never injures it by cutting into it as is frequently the case with the ordinary bench-knife. The row of holes *i* near the inner edge of the bench-top shows how provision is made for using the bench-knife with various lengths of wood. The perforated piece *f* slides backwards and forwards between the bench-top and the lower rail of the frame at pleasure. The bench-stop *e* is a rectangular block of wood, cut and fitted to the top of the bench in such a manner that the side nearest any piece of wood that is brought against it slopes a little so as to bring a slightly projecting edge against the wood at the top. The screw has a plate at the upper end, which is let into and held with screws to the lower end of the bench-stop. It works in an internal screw, cut in a projection at the back of a small iron bow, each end of which is screwed to a block of wood attached to the under side of the bench-stop. The price of the iron fitting for bench-stop is 1s. 2d. A bench-top made of beech instead of white deal adds 12s.—15s. to the cost of the bench.

In choosing a position for the bench, attention must be paid to the light, the floor, the wall, and the space. The light should fall immediately upon it, hence it is best placed against the wall and under the window. The floor must be level and firm, and is best made of boards. The wall next the bench should also be covered with match boarding. If sufficient firmness cannot otherwise be secured, the bench should be fastened to the floor and wall by strong angle irons.

Bench-stops.—These necessary adjuncts to the bench consist of an arrangement capable of projecting above the surface of the bench to hold pieces of wood against during the operation of planing. One of the simplest contrivances is to have 2 or more

stout screws standing up in the table of the bench itself, and easily raised or lowered to suit the thickness of the wood being operated upon; but this of course tends to spoil the surface of the bench. A better plan is shown in Fig. 433; it is easily manipulated, being adjusted from the top of the bench, and a very slight tap loosens or tightens it at any height desired. All blows are struck on the top, and no damage results to the bench from

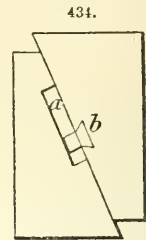
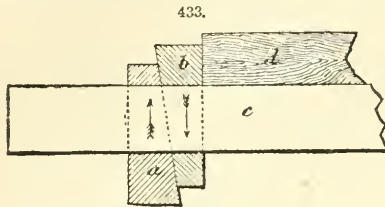

its use. It consists simply of 2 wedges *a b* tightening against each other in a mortice cut for their reception in the bench-top *c*, while *d* is the piece of wood to be planed. An improvement designed to prevent the wedges falling out when loosened is shown in Fig. 434. It consists of a slip of wood *b* let into one wedge and a slot *a* cut in the other, both slot and slip running the whole width of the stop. Fig. 435 is an improved iron stop, which is let into the top of the bench so as to lie flush; the stop proper *a* can be raised or lowered to the work by turning the screw *b*.

Holdfasts.—These are intended for holding wood down firmly on the top of the bench. For securing wood edgewise on the table an excellent contrivance is shown in Fig. 436. The strips *a b* are of any hard wood, $1\frac{1}{2}$ -2 in. thick, 6-9 in. long, and chamfered underneath. These are screwed firmly to the plank *c* by 3 ordinary wood screws, with their ends converging somewhat; 2 hard wood wedges *d*, chamfered, slide in the groove formed by the 2 fixed pieces. Their sides opposite the chamfered part are planed up true and square to the flat sides; between these the strip to be planed is placed on edge, and the wedges are tapped until they grip the work between them. The

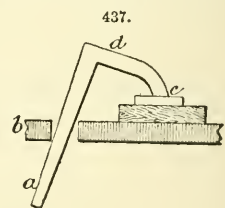
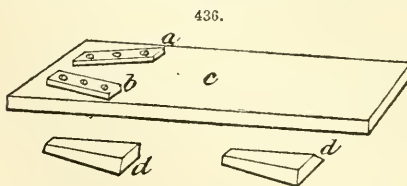
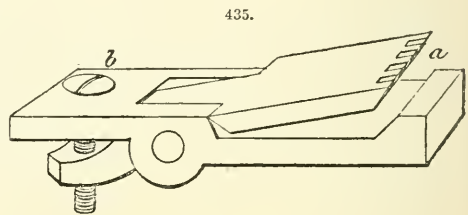

pressure of the plane at each stroke has the effect of still further tightening the grip of the wedges. The work is held at any part of its length, so that the plane can pass over its whole surface. By a slight pull in the contrary direction, the work is loosened, and can be shifted and refixed.

For holding work in a flat position, use is generally made of the implement illustrated in Fig. 437, and termed a "valet." It is formed of a bar of 1 in. diameter iron, drawn

down square, and bent into form. The lower end *a* is inserted in a circular hole through any convenient part of the bench *b*. When it is required to hold work down firmly with it, the work is placed under the end *c*. A sharp blow is then struck with a mallet at *d*, which causes *a* to jamb slightly crosswise in the hole, and so the work is held firmly until by a slight blow at the back of *d* the valet is loosened. Its help is invaluable, as it gives free use of both hands for mortising, carving, or the like; and it is equally an assistant in sawing. To prevent the end *c* leaving ugly marks or dents in soft wood, a small piece of softer wood is placed between it and the work. It is also well to thicken the top of the bench at this spot by screwing a piece of board on beneath. But still it is apt to damage the bench, from the nature of the grip of the stem in the hole. A better form is shown in Fig. 438, wherein the necessary pressure on the work under *a* is obtained by means of the screw *b*, which meets the elbow of the rod *c* and transfers the pressure to *a* through the medium of the pivot *d*.

Sawing-rest.—Fig. 439 represents a handy article for holding a piece of wood on the bench while using the tenon-saw. It consists of a strip of hard wood about 9 in. long,

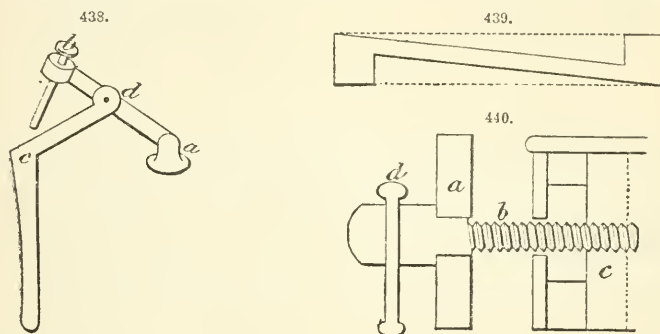

4 in. wide, and 1 in. thick, cut with blocks at the ends as shown. In use, one end hangs over the edge of the bench, and against the other end the work in hand is thrust.

Bench-vice.—Various forms of independent vice have already been described (p. 193). Those now to be mentioned differ in that they are either attached to, or form part of, the bench, and are for the most part of wood. The object of the bench-vice is to hold boards while planing their edges, and pieces of timber while cutting tenons, &c. The simplest substitute for a vice to hold boards for planing is a 1½-in. sq. strip of wood screwed to the front of the bench about 4 in. below the top, and having 2 or 3 thumbscrews or buttons distributed along its length, with wedges to fit between the thumbscrews and the wood to hold it quite tight. The ordinary wooden screw bench-vice, Fig. 440, is a cumbersome arrangement, not particularly effective, and wastes much time in adjusting. It consists of a solid wooden cheek *a* and a wooden screw *b*, the latter working in a female screw cut in a block attached to one leg *c* of the bench in a secure manner. The head of the screw *b* is perforated for the admission of a wooden handle *d* by which it is rotated. The manner of using the vice is sufficiently obvious to need no description. One great fault in the ordinary wooden bench-vice is that there is no means of maintaining parallelism between the cheek of the vice and the leg of the bench against which it grips, so that the screw is sure to be strained sooner or later by the uneven hold it gets of the material placed in the vice. Several plans have been devised to overcome this drawback. That shown in Fig. 441 consists in having a supplementary screw *a* beneath the first; this screw *a* being fixed to the cheek *b*, and working freely through a hole in the leg of the bench *c*, on both sides of which are screw-nuts *d e* that regulate the amount of insertion or withdrawal of the cheek *b*.

The evils of this plan are the trouble and time consumed in the manipulation, and the weakening of the bench-leg *c*, not only by the hole which penetrates, but also by a recess cut in it to receive the screw-nut *e*, in order to permit the jaws of the vice to be completely closed when necessary. A simpler arrangement, which somewhat modifies the undesirable features just noted, is shown in Fig. 442, and consists in replacing the

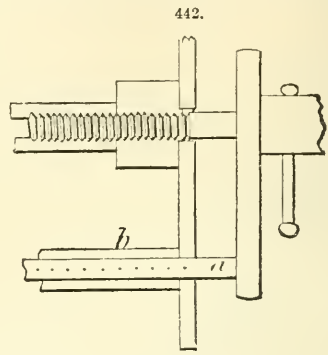
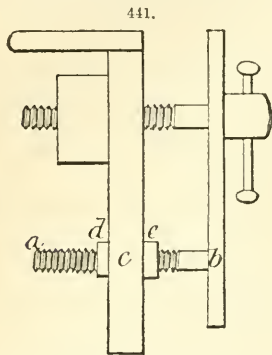

second screw by a sliding bar *a* working in a box *b* fitted to the frame of the bench, and perforated at intervals with holes for the reception of an iron pin to keep it in position. Perhaps the least objectionable plan is the so-called "St. Peter's cross," shown in Fig. 443, consisting of two bars of flat iron placed crosswise, joined by a pin in the centre, and also pinned at the top, one to the cheek and the other to the bench-leg; their lower ends are free to work up and down in the recesses cut for them, and thus maintain the cheek in a perpendicular position, whatever may be its distance from the bench-leg.

A great improvement upon all these forms of vice is the instantaneous grip-vice, represented in Fig. 444. The manner of manipulating it is as follows: Raise the

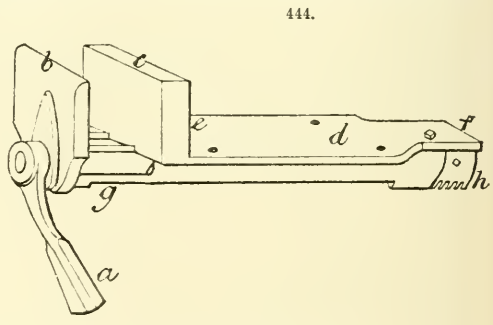
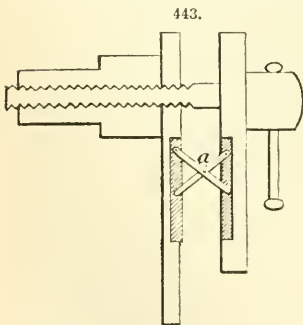

handle *a* to a perpendicular position with the left hand, and draw out or close, as may be necessary, the front jaw *b* the required distance. Place the piece of wood to be operated upon between the jaws *b c*, and press the front jaw *b* nearly close to the wood; then press down the lever, when the wood will be held firm in the vice. To remove the piece of wood, raise the lever. The grip is caused in the following manner: On the under side of the plate *d*, and in the straight line that lies between the letters *e f*, is a plate indented with a row of V-shaped depressions inclined at a slight angle to its sides, in other words, a longitudinal strip cut out of a female screw. At the end *h* of the bar *g h*, which is held in position, and travels in and out between 2 curved flanges

projecting from the under side of the plate, is a short cylinder which is grooved along part of its surface with screw-threads, the remainder being left plain, and carrying a stop or stud, which prevents the progress of the screw beyond a certain point, so as not to cause injury to any substance placed within the bite of the jaws. When the piece of wood has been placed within the jaws, and the front jaw pushed nearly close to it, the downward turn of the lever or handle brings the threads of the male screw within the threads of the female screw, and draws the front jaw against the wood tightly, and with

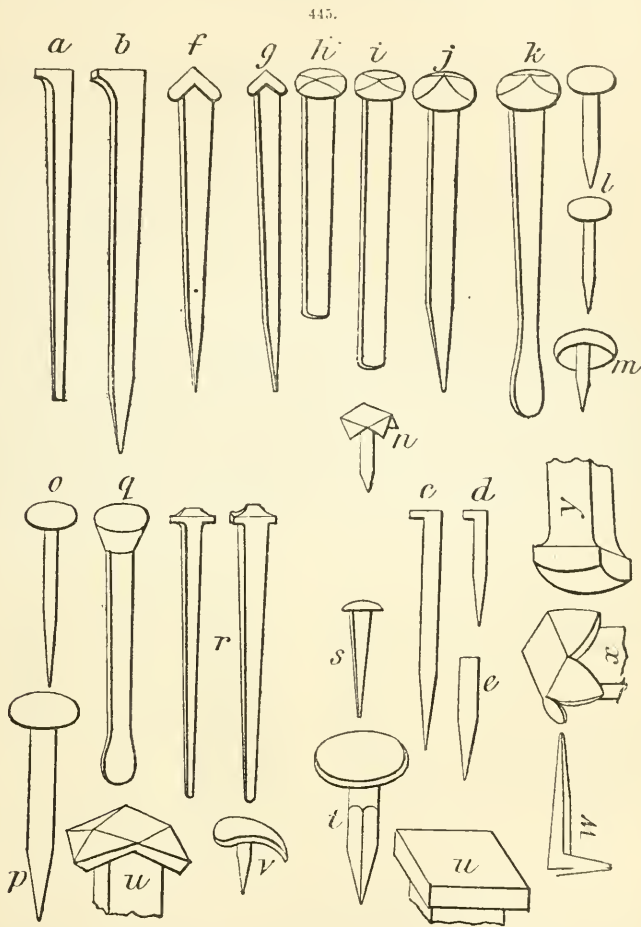

a firm grip, so that it is impossible to remove the material without injuring it, until the lever is raised and the pressure relaxed. The drawing action of the screw causes the pressure of the jaws to be brought gradually, though swiftly, to the point that is required to hold the material immovable within their grasp. The principal advantages of this bench-vice are : (1) it grips and relaxes its hold instantly in any distance up to 13½ in. ; (2) the action and working are so complete that a piece of ordinary writing-

paper can be secured and held as firmly as a piece of timber; (3) it effects a saving of about 75 per cent. of the time employed in working the ordinary bench-vice; (4) if wood facings are fitted to the faces of the iron jaws, all possibility of the indentation of the article placed in it is removed; (5) it can be fitted to any description of bench, new or old. The price of the vice is 18s., or if supplied with wood facings fitted to the jaws, 20s. As the jaws are of iron, the vice will serve the purpose of an iron bench-vice for holding pieces of metal, as well as that of an ordinary bench-vice for holding wood; and by placing within the jaws 2 pieces of wood of sufficient length to hold a saw, it may be further utilized as a saw-vice.

Nails.—These are of various shapes and sizes, and are made of wrought, cast, and malleable iron. Fig. 445 illustrates many kinds in general use: *a*, joiners' cut "brad," varying in size from $\frac{1}{4}$ in. to 2 in. long; *b*, flooring brad, of larger sizes, running 10 lb., 14 lb., 16 lb., and 20 lb. to the 1000, and costing 3s.-5s. per 1000; *c d*, fine cabinet brad, $\frac{3}{8}$ -2 in.; *e*, sash glaziers' brad; "brads" must be driven so that the head does not cross the grain of the wood, or they will be likely to split it. *f g*, strong and fine "clasp," the former running 7-36 lb. to the 1000, and the latter, 2-6 lb., useful in soft woods; *r*, another form; *h i*, fine and strong "rose," with flat points, the former ranging from 1 to $3\frac{1}{2}$ in. long, and $2\frac{1}{2}$ to 13 lb. per 1000, the latter 5-26 lb., also called "patent wrought"; *j*, "rose" or "gate," with sharp points, 2-3 lb. per 1000, much used in coarse work; *k*, flat point rose, driven across the grain they do not split the wood. *l*, Flemish "tacks"; *m*, round "hob"; *n*, clasp "hob." *o*, fine "clout," $1\frac{3}{4}$ -7 lb. per 1000; *p*, strong "clout"; *q*, countersunk "clout"; *r s*, clog or brush nail; *t*, scupper; *u*, die deck and clasp deck "spikes"; *v*, clinker "tack"; *w*, tenter hook; *x*, diamond deck-spike; *y*, composition spike. Holes should always be prepared for nails by means of a bradawl one size smaller than the nail to be used. Driven across the grain they hold twice as firmly as with it. Wetting the nail before driving causes it to rust slightly and therefore to hold all the more securely.

Nail-punch.—This is simply a piece of tapering steel, used with a hammer for driving the heads of nails below the surface of the wood they are in. Some 3 or 4

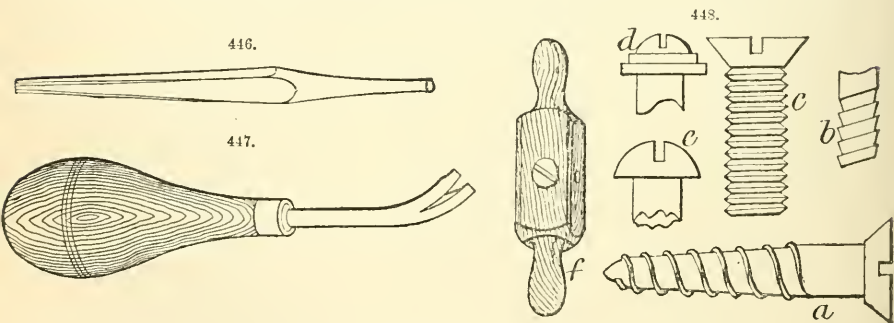

sizes are needed to suit the various nails. The punch is held in the left hand, with the thumb and forefinger grasping the top, and the little finger encircling it below, while the middle and third fingers are placed inside it. Holes in the wood left by the punch must be filled with putty before painting is done. The punch is shown in Fig. 446.

Nail-pullers.—Fig. 447 shows a handy little tack-wrench for drawing small nails out of wood. A more complicated implement is the "Victor" nail-puller, which is said to remove nails without injuring either them or the wood, and which costs 10s.

Screws.—These are made in many sizes and degrees of stoutness, and of both brass

and iron. In Fig. 448, *a* is the ordinary "gimlet pointed" wood screw; *b* is the Nettlefold, with a stronger kind of thread; *c*, a stove screw; *d*, head of brass lock screw; *e*, head of japanned lock screw. *f* is a screw box for cutting wooden screws, costing 5s.—15s. Screws are made of the following lengths: $\frac{1}{2}$, $\frac{5}{8}$, $\frac{3}{4}$, $\frac{7}{8}$, 1, $1\frac{1}{4}$, $1\frac{1}{2}$, $1\frac{3}{4}$, 2, $2\frac{1}{4}$, $2\frac{1}{2}$, 3, $3\frac{1}{2}$, 4, 5, and 6 in.; and in each length there are 12–30 different thicknesses, called "numbers."

Screw-driver.—Screws are driven into wood (in holes previously made by a bradawl or gimlet one size smaller) by means of a screw-driver or turn-screw, shown in Fig. 449. This tool consists of a steel blade tapering to a blunt edge at the working end, and fixed by a tang in a wooden handle at the other. The shape and size of both blade and handle depend on the sizes of the screws and the positions in which they are placed, cabinet screw-drivers for

449.

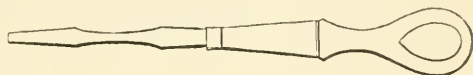

instance being long and light to reach into deep work. Screws hold three times as firmly as nails without risk of splitting the wood, and may be withdrawn without suffering or causing any injury. They are sunk below the surface when necessary by means of a tool called a countersink, described on p. 248. The screw-driver blade fitted to the brace and bits (p. 247) is the quickest way of using the tool.

Hints on the Care of Tools.—The following hints on the best means of keeping tools in good condition cannot fail to be useful:—

Wooden Parts.—The wooden parts of tools, such as the stocks of planes and handles of chisels, are often made to have a nice appearance by French polishing; but this adds nothing to their durability. A much better plan is to let them soak in linseed oil for a week, and rub them with a cloth for a few minutes every day for a week or two. This produces a beautiful surface, and at the same time exerts a solidifying and preservative action on the wood.

Iron Parts. Rust preventives.—The following recipes are recommended for preventing rust on iron and steel surfaces:—

(1) Caoutchouc-oil is said to have proved efficient in preventing rust, and to have been adopted by the German army. It only requires to be spread with a piece of flannel in a very thin layer over the metallic surface, and allowed to dry up. Such a coating will afford security against all atmospheric influences, and will not show any cracks under the microscope after a year's standing. To remove it, the article has simply to be treated with caoutchouc-oil again, and washed after 12 to 24 hours.

(2) A solution of indiarubber in benzine has been used for years as a coating for steel, iron, and lead, and has been found a simple means of keeping them from oxidizing. It can be easily applied with a brush, and is as easily rubbed off. It should be made about the consistency of cream.

(3) All steel articles can be perfectly preserved from rust by putting a lump of freshly-burnt lime in the drawer or case in which they are kept. If the things are to be moved (as a gun in its case, for instance), put the lime in a muslin bag. This is especially valuable for specimens of iron when fractured, for in a moderately dry place the lime will not want renewing for many years, as it is capable of absorbing a large quantity of moisture. Articles in use should be placed in a box nearly filled with thoroughly pulverized slaked lime. Before using them, rub well with a woollen cloth.

(4) The following mixture forms an excellent brown coating for protecting iron and steel from rust: Dissolve 2 parts crystallized iron chloride, 2 antimony chloride, and 1 tannin, in 4 water, and apply with a sponge or rag, and let dry. Then another coat of the paint is applied, and again another, if necessary, until the colour becomes as dark as desired. When dry, it is washed with water, allowed to dry again, and the surface polished with boiled linseed-oil. The antimony chloride must be as nearly neutral as possible.

(5) To keep tools from rusting, take $\frac{1}{2}$ oz. camphor, dissolve in 1 lb. melted lard; take off the scum and mix in as much fine blacklead (graphite) as will give it an iron colour. Clean the tools, and smear with this mixture. After 24 hours, rub clean with a soft linen cloth. The tools will keep clean for months, under ordinary circumstances.

(6) Put about 1 qt. fresh slaked lime, $\frac{1}{2}$ lb. washing soda, $\frac{1}{2}$ lb. soft soap in a bucket; add sufficient water to cover the articles; put in the tools as soon as possible after use, and wipe them up next morning, or let them remain until wanted.

(7) Soft soap, with about half its weight of pearlash; 1 oz. of the mixture in about 1 gal. boiling water. This is in every-day use in most engineers' shops in the drip-cans used for turning long articles bright in wrought-iron and steel. The work, though constantly moist, does not rust, and bright nuts are immersed in it for days till wanted and retain their polish.

(8) Melt slowly together 6 or 8 oz. lard to 1 oz. rosin, stirring till cool; when it is semi-fluid, it is ready for use. If too thick, it may be further let down by coal-oil or benzine. Rubbed on bright surfaces ever so thinly, it preserves the polish effectually, and may be readily rubbed off.

(9) To protect metals from oxidation—polished iron or steel, for instance—the requisite is to exclude air and moisture from the actual metallic surface; wherefore, polished tools are usually kept in wrappings of oiled cloth and brown paper; and, thus protected, they will preserve a spotless face for an unlimited time. When these metals come to be of necessity exposed, in being converted to use, it is necessary to protect them by means of some permanent dressing; and boiled linseed-oil, which forms a lasting film of covering as it dries on, is one of the best preservatives, if not the best. But in order to give it body, it should be thickened by the addition of some pigment, and the very best—because the most congenial—of pigments is the ground oxide of the same metal—or, in plain words, rusted iron reduced to an impalpable powder, for the dressing of iron or steel—which thus forms the pigment of red oxide paint.

(10) Slake a piece of quick-lime with just water enough to cause it to crumble, in a covered pot, and while hot add tallow to it and work into a paste, and use this to cover over bright work; it can be easily wiped off.

(11) Olmstead's varnish is made by melting 2 oz. rosin in 1 lb. fresh sweet lard, melting the rosin first and then adding the lard and mixing thoroughly. This is applied to the metal, which should be warm if possible, and perfectly cleaned; it is afterwards rubbed off. This has been well proved and tested for many years, and is particularly well suited for planished and Russian iron surfaces, which a slight rust is apt to injure very seriously.

Rust Removers.—(1) Cover the metal with sweet oil well rubbed in, and allow to stand for 48 hours; smear with oil applied freely with a feather or piece of cotton wool, after rubbing the steel. Then rub with unslaked lime reduced to as fine a powder as possible. (2) Immerse the article to be cleaned for a few minutes until all dirt and rust is taken off in a strong solution of potassium cyanide, say about $\frac{1}{2}$ oz. in a wine-glassful of water; take out and clean it with a tooth-brush with some paste composed of potassium cyanide, Castile soap, whiting, and water, mixed into a paste of about the consistence of thick cream.

Construction.—This section of the art of carpentry may be conveniently dealt with in 2 divisions, the first containing a description of the multifarious forms of joint which underlie all kinds of construction in wood, and the second being devoted to some examples illustrating the manner of making various articles of every-day use.

JOINTS.—The following remarks are principally drawn from an excellent paper on "Joints in Woodwork," read before the Civil and Mechanical Engineers' Society by Henry Adams, and embracing nearly all that need be said when the preceding sections on woods and tools have been duly studied.

Definition of Carpentry and Joinery.—The use of wood may be discussed under the 2 heads of carpentry and joinery: the former consists principally in using large timbers, rough, adzed, or sawn; the latter employs smaller pieces, always sawn, and with the exposed surfaces planed. Carpenters' work is chiefly outdoor, and embraces such objects as building timber bridges and gantries, framing roofs and floors, constructing centreing, and other heavy or rough work. Joiners' work is mostly indoor, and includes laying flooring, making and fixing doors, window sashes, frames, linings, partitions, and internal fittings generally.

Principles of Joints.—In all cases the proper connection of the parts is an essential element, and in designing or executing joints and fastenings in woodwork, the following principles, laid down by Professor Rankine, should be adhered to, viz. :—

(1) To cut the joints and arrange the fastenings so as to weaken the pieces of timber that they connect as little as possible.

(2) To place each abutting surface in a joint as nearly as possible perpendicular to the pressure which it has to transmit.

(3) To proportion the area of each surface to the pressure which it has to bear, so that the timber may be safe against injury under the heaviest load which occurs in practice, and to form and fit every pair of such surfaces accurately in order to distribute the stress uniformly.

(4) To proportion the fastenings so that they may be of equal strength with the pieces which they connect.

(5) To place the fastenings in each piece of timber so that there shall be sufficient resistance to the giving way of the joint by the fastenings shearing or crushing their way through the timber.

(6) To these may be added a 6th principle not less important than the foregoing; viz. to select the simplest forms of joints, and to obtain the smallest possible number of abutments. The reason for this is that the more complicated the joint, or the greater the number of bearing surfaces, the less probability there will be of getting a sound and cheaply-made connection.

Equal Bearing.—To ensure a fair and equal bearing in a joint which is not quite true, it is usual, after the pieces are put together, to run a saw-cut between each bearing surface or abutment; the kerf or width of cut being equal in each case, the bearing is then rendered true. This is often done, for instance, with the shoulders of a tenon or the butting ends of a scarf, when careless workmanship has rendered it necessary.

Close Jointing.—When the visible junction of 2 pieces is required to be as close as possible and no great strain has to be met at the joint, it is usual to slightly undercut the parts, and give clearance on the inside, as in Fig. 450, which shows an enlarged view of a tongued and rebated heading joint in flooring. In pattern-making, the fillets which are placed at the internal angle of 2 meeting surfaces are made obtuse angled on the back, in order that when bradded into place the sharp edges may lie close, as shown in

Fig. 451. The prints used by pattern-makers for indicating the position of round-core holes are also undercut by being turned slightly hollow on the bottom, as shown in Fig. 452. This principle is adopted in nearly all cases where a close joint is a desideratum. Clearance must also be left in joints of framing when a settlement is likely to take

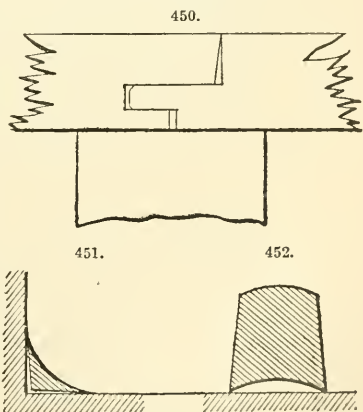

place, in order that, after the settlement, the abutting surfaces may take a fair bearing to resist the strain.

Strains.—The various strains that can come upon any member of a structure are—(1) Tension: stretching or pulling; (2) Compression: crushing or pushing; (3) Transverse strain: cross strain or bending; (4) Torsion: twisting or wrenching; (5) Shearing: cutting. But in woodwork, when the last-named force acts along the grain, it is generally called “detrusion,” the term shearing being limited to the action across the grain. The first 3 varieties are the strains which usually come upon ties, struts, and beams respectively. The transverse strain, it must be observed, is resolvable into tension and compression, the former occurring on the convex side of a loaded beam, and the latter on the concave side, the 2 being separated by the neutral axis or line of no strain. The shearing strain occurs principally in beams, and is greatest at the point of support, the tendency being to cut the timber through at right angles to the grain; but in nearly all cases, if the timber is strong enough to resist the transverse strain, it is amply strong for any possible shearing strain which can occur. Keys and other fastenings are especially subject to shearing strain, and it will be shown in that portion of the subject that there are certain precautions to be adopted to obtain the best results.

Classification of Joints.—(1) Joints for lengthening ties, struts, and beams; lapping, fishing, scarfing, tabling, building-up; (2) Bearing-joints for beams: halving, notching, coggling, dovetailing, tusk-tenoning, housing, chase-mortising; (3) Joints for posts and beams: tenon, joggle, bridle, housing; (4) Joints for struts with ties and posts: oblique tenon, bridle, toe-joint; (5) Miscellaneous: butting, mitreing, rebating.

Classification of Fastenings.—(1) wedges; (2) keys; (3) pins: wood pins, nails, spikes, treenails, screws, bolts; (4) straps; (5) sockets; (6) glue.

Lengthening Joints.—One of the first requirements in the use of timber for constructive purposes is the connection of 2 or more beams to obtain a greater length. Fig. 453 shows the method of lengthening a beam by lapping another to it, the 2 being held

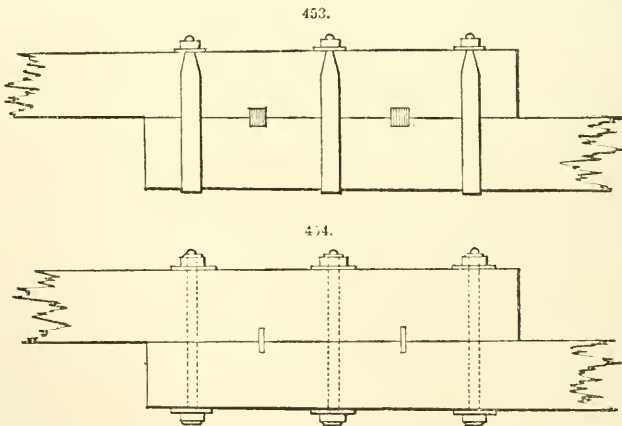

together by straps and prevented from sliding by the insertion of keys. Fig. 454 shows a similar joint, through-bolts being used instead of straps, and wrought-iron plates instead of oak keys. This makes a neater joint than the former, but they are both unsightly, and whenever adopted the beams should be arranged in 3 or 5 pieces, in order that the supports at each end may be level, and the beams horizontal. This joint is more suitable for a cross strain than for tension and compression. Fig. 455

shows the common form of a fished beam adapted for compression. If required to resist tensile strain, keys should be inserted in the top and bottom joints between the bolts. Fig. 456 shows a fished joint adapted for a cross strain, the whole sectional area of the original beam taking the compressive portion of the cross strain, and the fishing-piece

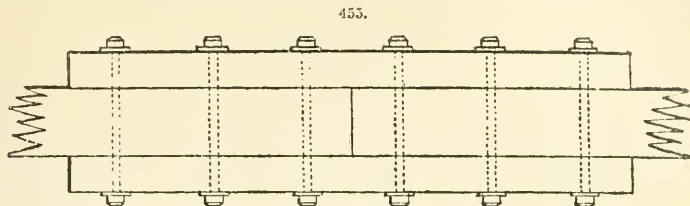

455.

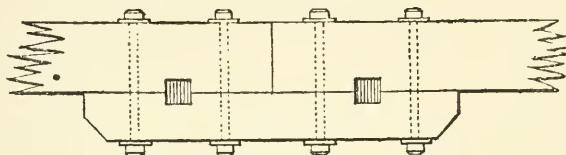

taking the tensile portion. Fig. 457 shows a fished beam for the same purpose, in which a wrought-iron plate turned up at the ends takes the tensile strain. Tabling consists of bedding portions of one beam into the other longitudinally. Occasionally the fishing-pieces are tabled at the ends into the beams to resist the tendency to slip

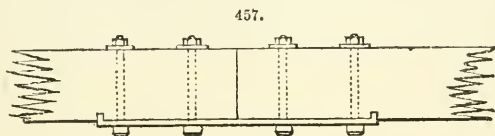

457.

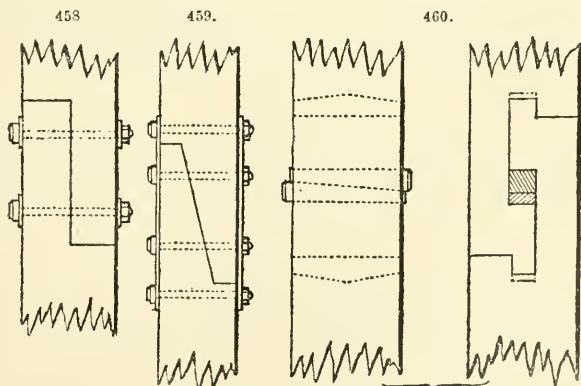

458

459.

460.

under strain, but this office is better performed by keys, and in practice tabling is not much used. The distinction between fished beams and scarfed beams is that in the former the original length is not reduced, the pieces being butted against each other,

while in the latter the beams themselves are cut in a special manner and lapped partly over each other; in both cases, additional pieces of wood or iron are attached to strengthen the joint. Fig. 458 shows a form of scarf adapted to short posts. Here the scarf is cut square and parallel to the sides, so that the full sectional area is utilized for resisting the compressive strain. When the post is longer and liable to a bending strain, the scarf should be inclined, as in Fig. 459, to allow of greater thickness being retained at the shoulder of each piece, the shoulder being kept square. In this joint a considerable strain may be thrown on the bolts from the sliding tendency of the scarf, if the shoulders should happen to be badly fitted, as any slipping would virtually increase the thickness of the timber where the bolts pass through. The width of each shoulder should be not less than $\frac{1}{4}$ the total thickness. Joints in posts are mostly required when it is desired to lengthen piles already driven, to support a superstructure in the manner of columns. Another form of scarf for a post put together without bolts is shown in Fig. 460, the parts being tabled and tongued, and held together by wedges. This is not a satisfactory joint, and is, moreover, expensive, because of its requiring extra care in fitting; but it may be a suitable joint in some special cases, in which all the sides are required to be flush. Fig. 461 shows the common form of scarf in a tie-beam. The

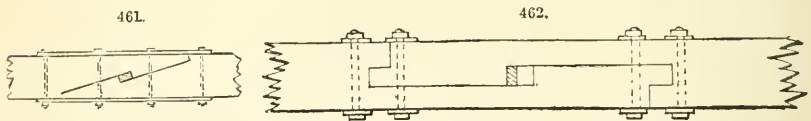

ends of the scarf are birds'-mouthed, and the joint is tightened up by wedges driven from opposite sides. It is further secured by the wrought-iron plates on the top and bottom, which are attached to the timber by bolts and nuts. In all these joints the friction between the surfaces, due to the bolts being tightly screwed up, plays an important part in the strength of the joint; and as all timber is liable to shrink, it is necessary to examine the bolts occasionally, and to keep them well tightened up. Figs. 462 and 463 show

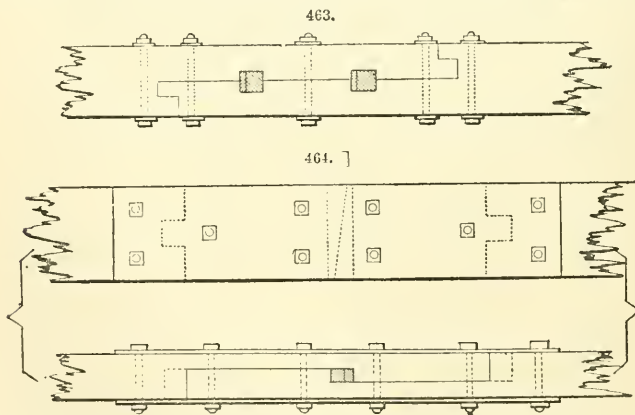

good forms of scarfs, which are stronger but not so common as the preceding. Sometimes the scarf is made vertically instead of horizontally; when this is done, a slight modification is made in the position of the projecting tongue, as will be seen from Fig. 464, which shows the joint in elevation and plan. The only other scarfs to which

attention need be called are those shown in Figs. 465 and 466, in which the compression side is made with a square abutment. These are very strong forms, and at the same time easily made. Many other forms have been designed, and old books on carpentry teem with scarfs of every conceivable pattern; but in this, as in many other cases, the simplest thing is the best, as the whole value depends upon the accuracy of the workmanship, and this is rendered excessively difficult with a multiplicity of parts or abutments.

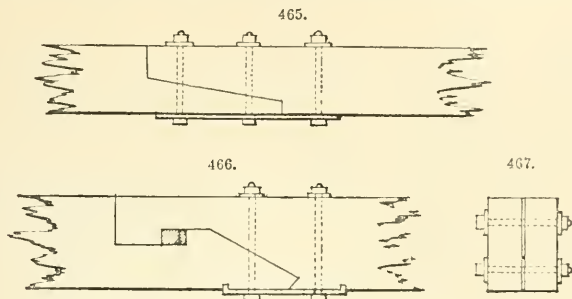

Strengthening.—In building-up beams to obtain increased strength, the most usual method is to lay 2 beams together sideways for short spans, as in the lintels over doors and windows; or to cut one down the middle, and reverse the halves, inserting a wrought-iron plate between, as shown in the fitch girder, Fig. 467. The reversal of the halves gives no additional strength, as many workmen suppose, but it enables one to see if the timber is sound throughout at the heart, and also allows the pieces to season better. A beam uncut may be decayed in the centre, and hence the advantage of cutting and reversing, even if no fitch-plate is to be inserted, defective pieces being then discarded. When very long and strong beams are required, a simple method is to bolt several together so as to break joint with each other, as shown in Fig. 468, taking care that on

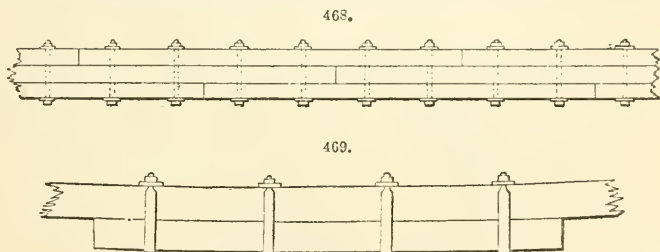

the tension side the middle of one piece comes in the centre of the span with the 2 nearest joints equidistant. It is not necessary in a built beam to carry the full depth as far as the supports; the strain is, of course, greatest in the centre, and provided there is sufficient depth given at that point, the beam may be reduced towards the ends, allowance being made for the loss of strength at the joints on tension side. A single piece of timber secured to the under side of a beam at the centre, as in Fig. 469, is a simple and effective mode of increasing its strength. It will be observed that the straps are bedded into the sides of the beams; they thus form keys to prevent the pieces from slipping on each other. This weakens the timber much less than cutting out the top or bottom, as the strength of a beam varies only in direct proportion to the

breadth but as the square of the depth. The addition of a second piece of timber in the middle is a method frequently adopted for strengthening shear legs and derrick poles temporarily for lifting heavy weights.

Bearing Joints.—In a consideration of bearing joints for beams, the term “beam” is taken to include all pieces which carry or receive a load across the grain. The simplest of these is the halving joint, shown at Fig. 470, where 2 pieces of cross bracing are

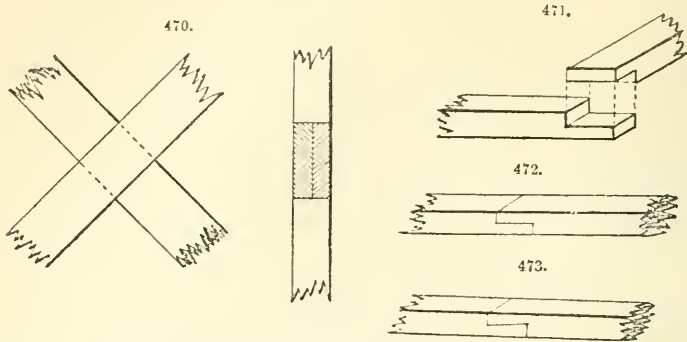

halved together. This joint is also shown at Fig. 471, where the ends of 2 wall plates meet each other. When a joint occurs in the length of a beam, as at Fig. 472, it is generally called a scarf. In each of these examples it will be seen that half the thickness of each piece is cut away so as to make the joint flush top and bottom. Sometimes the outer end of the upper piece is made thicker, forming a bevelled joint and acting as a dovetail when loaded on top. This is shown at Figs. 473 and 474. When a beam crosses another at right angles, and is cut on the lower side to fit upon it, the joint is known as single-notching, shown in Fig. 475. When both are cut, as in Fig. 476, it is known as double-notching. These forms occur in bridging and ceiling joists. When a

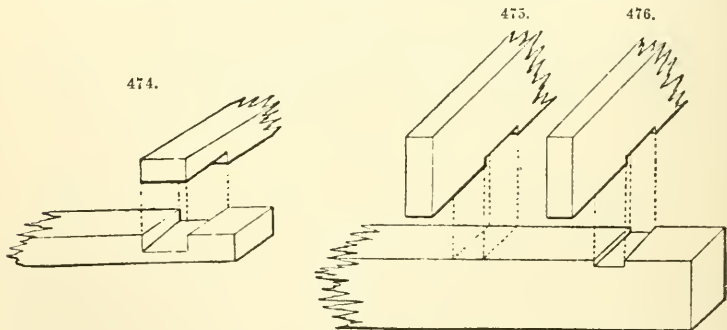

cog or solid projecting portion is cut in the lower piece at the middle of the joint it is known as cogging or caulking, and is shown in Fig. 477. Figs. 478 and 479 show two forms of the joint occurring between a tie-beam and wall plate in roofing. Dovetailing is not much used in carpentry or house joinery, owing to the shrinkage of the wood loosening the joint: 2 wall plates are shown dovetailed together at Figs. 480 and 481; in the latter, a wedge is sometimes inserted on the straight side to enable the joint to be tightened up as the wood shrinks. Tredgold proposed the form shown in Fig. 482, which

is known as the "Tredgold notch;" but this is never seen in practice. Tusk-tenoning is the method adopted for obtaining a bearing for a beam meeting another at right angles at the same level. Fig. 483 shows a trimmer supported on a trimming joist in this manner; this occurs round fireplaces, hoistways, and other openings through floors. Fig. 484 shows the same joint between a wool girder and binding joist; it is also used in double-framed flooring. The advantage of this form is that a good bearing is obtained without weakening the beam to any very great extent, as the principal portion

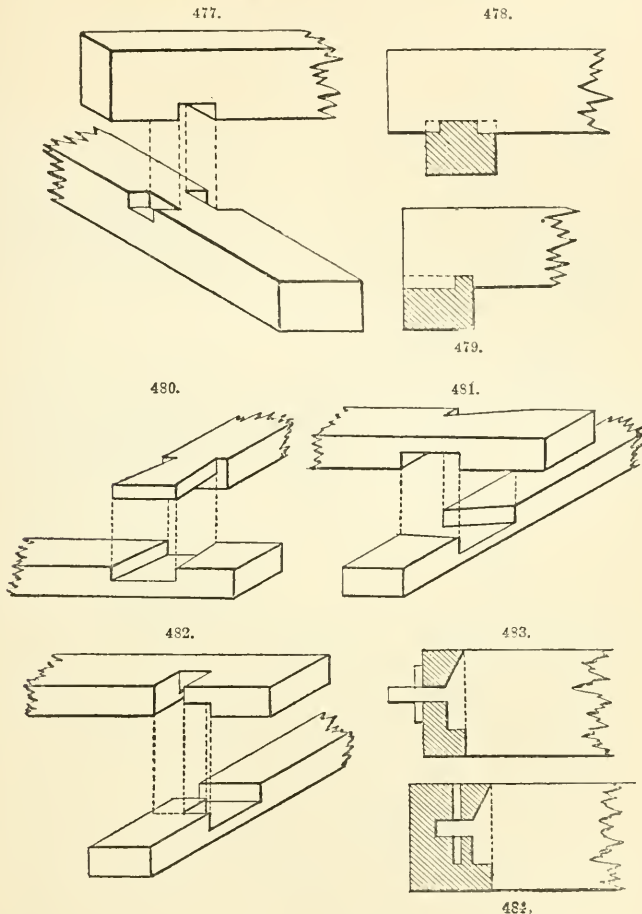

of the material removed is taken from the neutral axis, leaving the remainder disposed somewhat after the form of a flanged girder. When a cross-piece of timber has to be framed in between 2 beams already fixed, a tenon and chase-mortice (Fig. 485) is one of the methods adopted. If the space is very confined, the same kind of mortice is made in both beams, but in opposite directions; the cross-piece is then held obliquely and slid into place. Occasionally it is necessary to make the chase-mortice vertical; but this is not to be recommended, as the beam is much weakened by so doing—it is shown in

Fig. 486. In some cases of ceiling joists a square fillet is nailed on the tenon and chase-mortice, to take the weight of the joists without cutting into the beam. While speaking of floors, the process of firing-up may be mentioned; this consists of laying thin pieces, or strips, of wood on the top of joists, or any surfaces, to bring them up to a level. Firing-pieces are also sometimes nailed underneath the large beams in framed floors, so that the under side may be level with the bottom of the ceiling joists, to give a bearing for the laths, and at the same time allow sufficient space for the plaster to form a key.

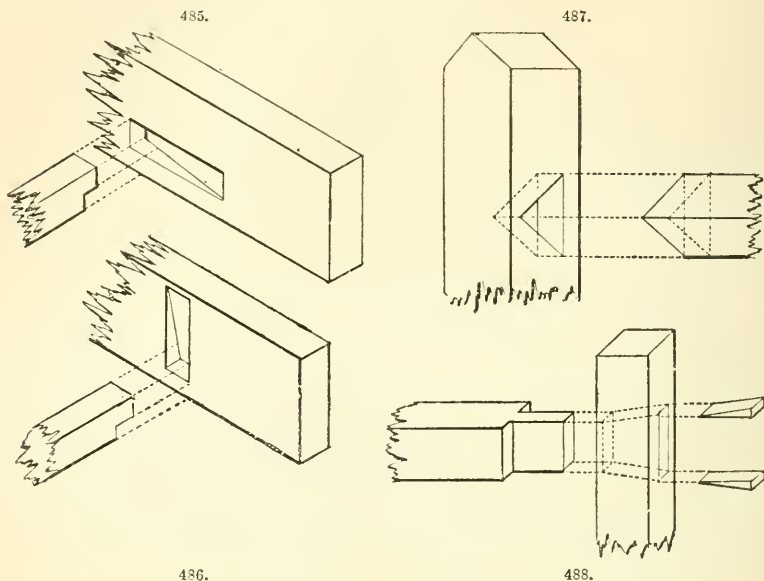

Branding is formed by strips about 1 in. square, nailed to the under side of the ceiling joists at right angles to them; these strips help to stiffen the ceiling, and, being narrower than the ceiling joists, do not interrupt the key of the plastering so much. Housing consists of letting a piece of wood bodily into another for a short distance, or, as it were, a tenon the full size of the stuff; this is used in staircases, housed into the strings, and held by wedges. Housing is likewise adopted for fixing rails to posts, as in Fig. 487, where an arris rail is shown housed into an oak post for fencing.

Post and Beam Joints.—The most common joint between posts and beams is the tenon and mortice joint, either wedged or fixed by a pin; the former arrangement is shown in Fig. 488, and the latter in Fig. 489. The friction of the wedges, when tightly driven, aided by the adhesion of the glue or white-lead with which they are coated, forms, in effect, a solid dovetail, and the fibres, being compressed, do not yield further by the shrinking of the wood. A framed door is an example of the application of this joint. When it is desired to tenon a beam into a post, without allowing the tenon to show through, or where a mortice has to be made in an existing post fixed against a wall, the dovetail tenon, shown in Fig. 490, is sometimes adopted, a wedge being driven in on the straight side to draw the tenon home and keep it in place. In joining small pieces, the foxtail tenon, shown in Fig. 491, has the same advantage as the dovetail tenon of not showing through, but it is more difficult to fix. The outer wedges are made the longest, and in driving the tenon home, these come into action first, splitting away the sides, and filling up the dovetailed mortice, at the same time compressing the fibres of the

tenon. This joint requires no glue, as it cannot draw out; should it work loose at any time, the only way to tighten it up would be to insert a very thin wedge in one end of the mortice. Short tenons, assisted by strap bolts, as shown in Fig. 492, are commonly adopted in connecting large timbers. The post is cut to form a shoulder so that the beam

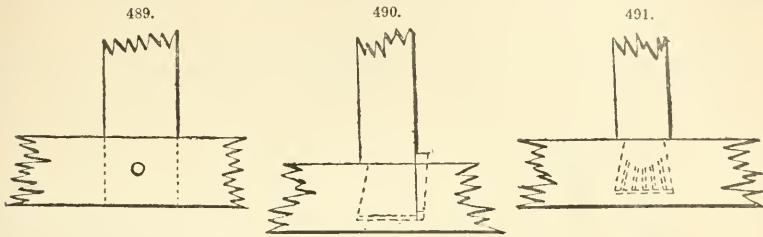

takes a bearing for its full width, the tenon preventing any side movement. When a post rests on a beam or sill piece, its movement is prevented by a "joggle," or stub-tenon, as shown in Fig. 493; but too much reliance should not be placed on this tenon, owing to the impossibility of seeing, after the pieces are fixed, whether it has been properly

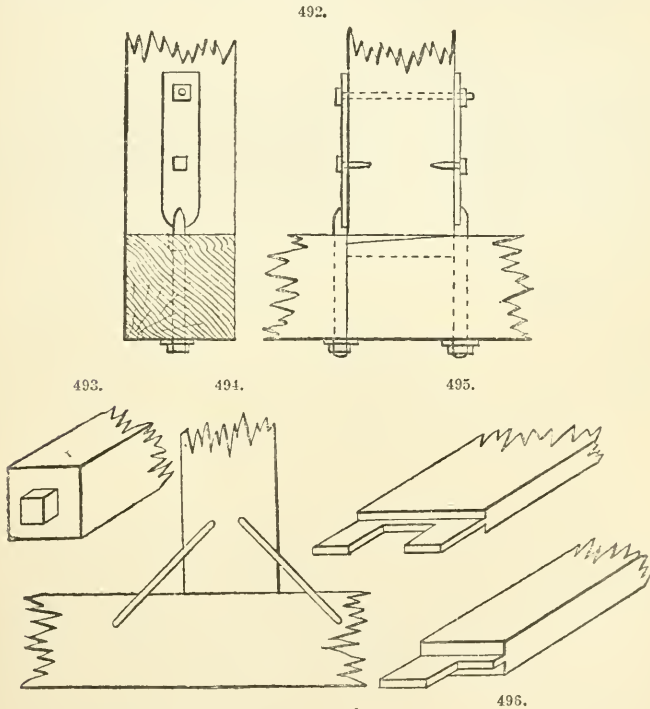

fitted, and it is particularly liable to decay from moisture settling in the joint. For temporary purposes, posts are commonly secured to heads and sills by dog-irons or "dogs," Fig. 494; the pieces in this case simply butt against each other, the object being to avoid cutting the timber, and so depreciating its value, and also for economy of labour

Other forms of tenons are shown in Figs. 495 and 496. The double tenon is used in framing wide pieces, and the haunched tenon when the edge of the piece on which the tenon is formed is required to be flush with the end of the piece containing the mortice. In Figs. 497 and 498 are shown 2 forms of bridge joint between a post and beam.

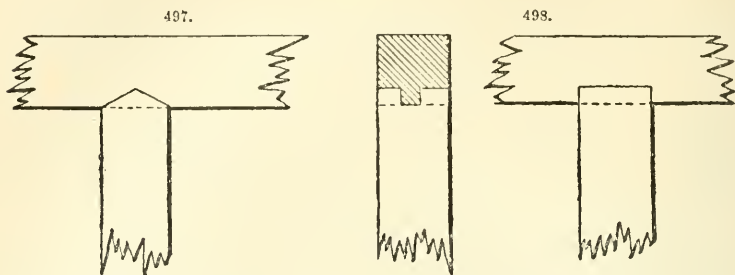

Tredgold recommended a bridge joint with a circular abutment, but this is not a correct form, as the post is then equivalent to a column with rounded ends, which it is well known is unable in that form to bear so great a load before it commences to yield.

Strut Joints.—A strut meeting a tie, as in the case of the foot of a principal rafter in a roof truss, is generally tenoned into the tie by an oblique tenon, as shown in Fig. 499; and the joint is further strengthened by a toe on the rafter bearing against a shoulder in the tie. Tredgold strongly advised this joint being made with a bridge instead of a tenon, as shown in Fig. 500, on account of the abutting surfaces being fully open to view. A strut meeting a post as in Fig. 501, or a strut meeting the principal rafter of a roof truss (Fig. 502), is usually connected by a simple toe-joint. The shoulder

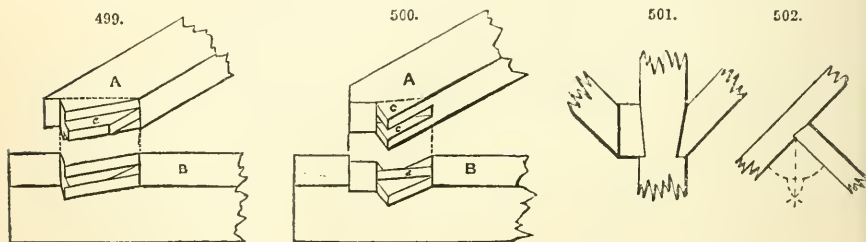

should be cut square with the piece containing it, or it should bisect the angle formed between the two pieces. It is sometimes made square with the strut, but this is incorrect, as there would in some cases be a possibility of the piece slipping out. In ledged and braced doors or gates this joint is used, the pieces being so arranged as to form triangles, and so prevent the liability to sag or drop, which is difficult to guard against in square-framed work without struts or braces. When a structure is triangulated, its shape remains constant so long as the fastenings are not torn away, because, with a given length of sides, a triangle can assume only one position; but this is not the case with four-sided framing, as the sides, while remaining constant in length, may vary in position. A mansard roof contains various examples of a toe-joint; it shows also the principle of framing king-post and queen-post roof trusses, each portion being triangulated to ensure the utmost stability.

Miscellaneous Joints.—Among the miscellaneous joints in carpentry not previously

mentioned, the most common are the butt-joint, Fig. 503, where the pieces meet each other with square ends or sides; the mitre-joint, Fig. 504, where the pieces abut against each other with bevelled ends, bisecting the angle between them, as in the case of struts mitred to a corbel piece supporting the beam of a gantry; and the rabbeted or "rebated" joint, Fig. 505, which is a kind of narrow halving, either transverse or longitudinal. To these must be added in joinery the grooved and tongued joint, Fig. 506; the matched and beaded joint, Fig. 507; the dowelled joint, Fig. 508; the dovetailed joint, Fig. 509; and other modifications of these to suit special purposes. To one of

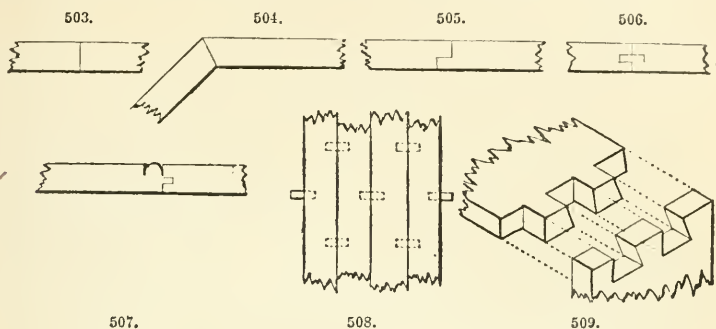

these it may be desirable to call particular attention, viz. the flooring laid folding. This is a method of obtaining close joints without the use of a cramp. It consists of nailing down 2 boards, and leaving a space between them rather less than the width of, say 5 boards; these 5 boards are then put in place, and the two projecting edges are forced down by laying a plank across them, and standing on it. This may generally be detected in old floors by observing that several heading joints come in one line, instead of breaking joint with each other. It is worthy of notice that the tongue, or slip feather, shown in Fig. 506, which in good work is formed generally of hard wood, is made up of short pieces cut diagonally across the grain of the plank, in order that any movement of the joints may not split the tongue, which would inevitably occur if it were cut longitudinally from the plank.

Fastenings.—With regard to fastenings, the figures already given show several applications. Wedges should be split or torn from the log, so that the grain may be continuous; or if sawn out, a straight-grained piece should be selected. Sufficient taper should be put on to give enough compression to the joint, but too much taper would allow the possibility of the wedge working loose. For outside work, wedges should be painted over with white-lead before being driven, this not being affected by moisture, as glue would be. In scarf joints the chief use of wedges is to draw the parts together before the bolt holes are bored. Keys are nearly parallel strips of hard wood or metal; they are usually made with a slight draft, to enable them to fit tightly. If the key is cut lengthways of the grain, a piece with curled or twisted grain should be selected, but if this cannot be done, the key should be cut crossways of the log from which it is taken, and inserted in the joint with the grain at right angles to the direction of the strain, so that the shearing stress to which the key is subject may act upon it across the fibres. In timber bridges and other large structures, cast-iron keys are frequently used, as there is with them an absence of all difficulty from shrinkage. Wooden pins should be selected in the same way as wedges, from straight-grained, hard wood. Square pins are more efficient than round, but are not often used, on account of the difficulty of forming square holes for their reception. Tenons are frequently secured in mortices, as in Fig. 489, by pins, the pins being driven in such a manner as to draw the tenon tightly into the

mortice up to its shoulders, and afterwards to hold it there. This is done by boring the hole first through the cheeks of the mortice, then inserting the tenon, marking off the position of the hole, removing the tenon, and boring the pin-hole in it rather nearer the shoulders than the mark, so that when the pin is driven it will draw the tenon as above described. The dowelled floor shown in Fig. 508 gives another example of the use of pins.

Nails, and their uses, are too well known to need description; it may, however, be well to call attention to the two kinds of cut and wrought nails, the former being sheared or stamped out of plates, and the latter forged out of rods. The cut nails are cheaper, but are rather brittle; they are useful in many kinds of work, as they may be driven without previously boring holes to receive them, being rather blunt-pointed and having 2 parallel sides, which are placed in the direction of the grain of the wood. The wrought nails do not easily break, and are used where it is desired to clench them on the back to draw and hold the wood together. Spikes are nearly of the same form as nails, but much larger, and are mostly used for heavy timber work. Treenails are hard wooden pins used in the same way as nails. In particular work, with some woods, such as oak, they are used to prevent the staining of the wood, which would occur if nails were used and any moisture afterwards reached them. Compressed treenails are largely used for fixing railway chairs to sleepers, as they swell on exposure to moisture, and then hold more firmly. Screws are used in situations where the parts may afterwards require to be disconnected. They are more useful than nails, as they not only connect the parts, but draw them closer together, and are more secure. For joiners' work the screws usually have countersunk heads; where it is desired to conceal them, they are let well into the wood, and the holes plugged with dowels of the same kind of wood, with the grain in the same direction. For carpenters' work the screws are larger and have often square heads; these are known as coach screws. The bolts, nuts, and washers used in carpentry may be of the proportions given in the following table;—

Thickness of nut	= 1 diam. of bolt.	
" head	= $\frac{3}{4}$	
Diameter of head or nut over sides	= $1\frac{3}{4}$	"
Side of square washer for fir	= $3\frac{1}{2}$	"
" " oak	= $2\frac{1}{2}$	"
Thickness of washer	= $\frac{1}{3}$	"

The square nuts used by carpenters are generally much too thin; unless they are equal in thickness to the diameter of the bolt, the full advantage of that diameter cannot be obtained, the strength of any connection being measured by its weakest part. The best proportion for nuts is that of a Whitworth standard hexagon nut. A large square washer is generally put under the nut to prevent it from sinking into the wood and tearing the fibres while being screwed up; but it is also necessary to put a similar washer under the head to prevent it sinking into the wood. This is, however, often improperly omitted. Straps are bands of wrought iron placed over a joint to strengthen it and tie the parts together. When the strap is carried round a piece, and both ends are secured to a piece joining it at right angles, as in a king-post and tie-beam, it is known as a stirrup, and is tightened by means of a cotter and gib keys, as shown in Fig. 510. When straps connect more than two pieces of timber together, they are made with a branch leading in the direction of each piece; but they are usually not strong enough at the point of junction, and might often be made shorter than they are without impairing their

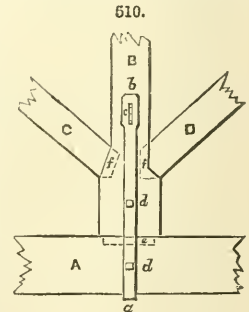

efficiency. Sockets are generally of cast iron, and may be described as hollow boxes formed to receive the ends of timber framing.

With regard to the use of glue for securing joints, it has been found that the tensile strength of solid glue is about 4000 lb. per sq. in., while that of a glued joint in damp weather is 350-360 lb. per sq. in., and in dry weather about 715 lb. The lateral cohesion of fir wood is about 562 lb. per sq. in., and therefore in a good glue joint the solid material will give way before the junction yields.

Keying.—This is a useful joint for uniting pieces of wood at right angles, as in the sides of a box, where much strength is not needed. Each end is mitred off and the bevels are then joined by glue. When the glued joint is quite firm, a few saw cuts are made in the angle, so as to cross both pieces forming the joint, and into the kerfs are driven small slips of wood previously well glued. After all has dried, the projecting ends of the keys are cut off. The direction of the saw cuts should not be horizontal: some may incline upwards and some downwards.

Corner-piecing.—This is another weak joint, only admissible in the lightest work. The bevelled ends of the side pieces (of a box, for instance) are glued together as for keying, and then a triangular piece is glued inside the corner.

Mortising and Tenoning.—This joint is so important and so constantly employed in one modification or another in almost all branches of carpentry and joinery that it deserves special description at some length. The gauge used for marking out the mortice has been spoken of on p. 186; and the use of the chisel in cutting it out has been explained on p. 232. In cutting the tenon, a very sharp and accurately set saw should be used, so that the edges left will need no paring or trimming of any kind. The simple mortice and tenon have been shown on p. 233. In sawing the shoulders of a tenon, there should be just a tendency to undercutting them, as a safeguard against rounding them. A few words may be said about wedging and pinning. Suppose that a tenon nicely fitted is to be wedged and glued. Taking it out of the mortice, the latter has a wedge-like portion cut out on each side to be filled in by a pair of wooden wedges of similar form. If these are made short and blunt, they will not be able to be driven home, but will jump back, and have no effect in tightening up the joint by drawing the parts together. The wedges should be long in proportion to their thickness. The object is to convert a straight tenon into a dovetailed shape, which cannot be drawn back out of its mortice. The whole tenon and the wedges are carefully glued with hot glue, about as thick as cream, the wood having also been well warmed. The joint is driven up, wedged, and left to dry. In pinning a tenon and mortice through (which is always the method used in heavy carpentry), having cut and fitted the parts accurately, bore through the mortice carefully at right angles, having just removed the tenon. Use for this a shell or nose bit in a brace. Now insert the tenon, put the nose bit in again, and just begin to bore the tenon sufficiently to mark it. Take it out and bore the hole about $\frac{3}{16}$ in. nearer the shoulder of the tenon than you would have done if it had been left in its mortice and bored while therein. Then make a nice oak pin, and not too tapering, but a tight fit; as it enters the hole in the tenon, it will draw it in close in the endeavour to bring its hole true with those of the mortice. It must not be so bored that it cannot draw in, and so will be in danger of tearing and splitting: but must almost tally at the outset with the other holes. This forms a perfect joint that can (if need be) be at any time separated by knocking out the pin, which is sometimes left long that it may be more readily driven back.

As an example of more difficult fitting, it sometimes happens that the mortice is cut in a piece of hexagonal form, or rather section of that nature, and that a rail has to be fitted in which the shoulders of the tenon must be so made as to embrace the parts about the mortice. Fig. 511, *a* and *b*, represents such. The shoulders *c*, *d*, are specially difficult to pare, owing to the angular direction of the grain, as the natural way of cutting such a surface smoothly would be to work from *x* to *y* of *e*, and this cannot be

done in this case. It may be pared with a chisel more readily when laid down on its side, as at *f*, the chisel cutting perpendicularly; but the angles frequently prohibit the chisel from cutting into them closely. Still, there is no help for it, and there is no job which requires a sharper tool deftly managed. When the work is small, the finest saw, used carefully, may suffice without any subsequent paring, and is the safer tool to use. When, however, the parts are to be constructed of wood of more than usually curled grain, it may suffice to cut a recess into the standard, to receive the hexagonal rail itself beyond its tenon, Fig. 512, *a*, *b*, and *c*, where the mortice is shown quite black, and the recess is

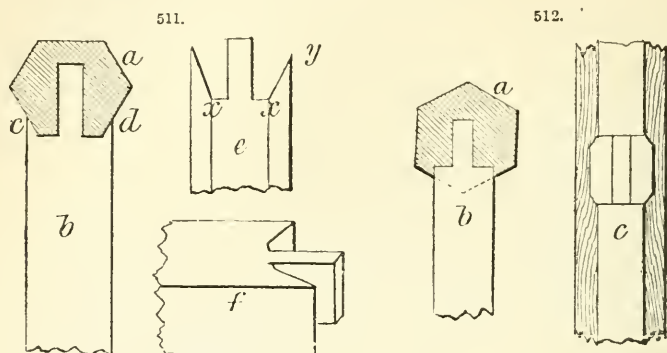

shaded. Neatly done, the effect is the same as when the shoulders are cut, as in the previous case; but allowance must be made in the length of the rail, or it will, of course, be too short when fitted into its place. The first plan, even if well done, is not so strong as the second, and, in an outdoor job, where exposed, the latter would be far less liable to admit rain to injure the tenon; but there are many cases in which the same kind of fitting is needed where a plan similar to that first described is essential. It should be borne in mind that a mortice and tenon ought to just slide stiffly into place, without requiring a lot of knocking with the mallet.

A curious form of mortice and tenon is shown in Fig. 513, and is made in the following manner:—Get 2 pieces of clean, straight-grained yellow pine, recently cut from the log that is not seasoned, 9 in. long, $1\frac{1}{4}$ in. broad, and $\frac{3}{8}$ in. thick. In the middle of one of these make a $\frac{1}{4}$ -in. mortice $1\frac{1}{4}$ in. long, as at *a*; and on the other piece, after it has been dressed to $\frac{3}{8}$ in. thick at 3 in. from one end, make a tenon $\frac{1}{4}$ in. thick and $1\frac{1}{4}$ in. long, as at *b*, and taper the other end as shown, so as to make it easy to introduce into the mortice. Then get both pieces steamed, and while they are heating prepare something to support the sides of *a*, so as to prevent it from splitting when *b* is being driven through, and a strong clamp or vice to compress *b*. When the wood is thoroughly steamed, place *b* in the vice or clamp, with a piece of hard wood on each side, so as to press its whole surface from the tenon to the tapered end equally, and screw up as hard as possible. Withdraw *a* from the steam, and place it in its prepared position; try the screw again on *b*; then take it out, enter its tapered end into the mortice, and drive through until the shoulders that have not been pressed rest on *a*; put them into warm water for several hours, then take them out and dry; afterwards cut all the arms to an equal length, and clean off. It will allow of examination better if the tenon on *b* is made 2 in. long, so as to enable *a* to be moved along, as when all is firmly together it will be at

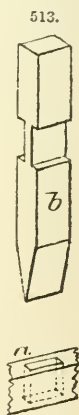

once asserted that the cross is made of 3 pieces. Obviously no practical carpenter would use such a joint, as the wood must suffer much in the unequal compression and expansion of its fibres, besides giving no particular strength. It is a sort of puzzle in joinery.

Half-lap Joint.—This is an every-day joint, and apparently one of the simplest, yet it is very often badly made. Each of the pieces has 3 surfaces in contact, viz. the broad face *a* of Fig. 514, the side *d*, the front *b*, corresponding to similar ones on *h*, to which it is supposed to be necessary to attach it at right angles. As a joint it has no strength however well made; but it is of very frequent use in stuff of all sizes, and is used not only to join a piece at right angles (or at some intermediate angle) to another, but also to join them lengthwise. The line of the end *b* must be accurately scribed with the help of a square, and, with the same appliance, the line answering to *c e* of *h* must be marked round 3 sides of each piece. Then with a marking gauge, *e f* and its counterpart, which, together, determine the plane of *a*, are set off, and this line is carried along the end *g*. On white wood, a finely-pointed (or finely-edged) pencil will make a better line. It is here that amateurs are apt to be lazy. They mark perhaps *b*, saw down a shoulder, with no further guide line, and holding a broad chisel at the end, hit it with a mallet, and off goes the whole cheek piece, leaving possibly a fairly true face, and more generally a very untrue one—so untrue frequently that no subsequent paring will correct it. But as it will be much concealed from view, it is allowed to pass muster, and a nice botched job it makes. Supposing this intended, as it often is, to be a glued joint, the great object to be aimed at is to make each face as level and true as possible, so as to provide plenty of surface contact. We may, in this way, even make the half-lap joint strong enough. Hence it is essentially necessary to scribe all lines with accuracy, and then to cut precisely up to them. The cutting across the grain will, of course, be done by the tenon saw, which be will carried down to the line gauged to show the line *e f* marking the position of the half-thickness of the stuff. Then the work should be stood end up in the vice, and the cheek piece carefully removed, leaving the surface, if possible, so flat and true as not to need subsequent dressing with the chisel. A small hand saw will do this best, its teeth set out only just so far as to prevent the blade from binding in the cut. A saw known as a panel saw will do nicely; a large hand saw with much set is far more difficult to use.

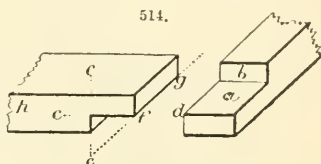

Dovetailing.—This forms a secure and strong joint, but needs great care in marking out and cutting the work. The dovetails should not have too sharp angles, or they will be liable to be broken off. The fit may be tight, but not so tight as to require considerable force to effect a juncture, or the top and bottom dovetails may be split off. When a dovetail joint is used at a corner that is to be rounded externally, the joint should be made in the usual way first, and the rounding done afterwards.

Blind Dovetails.—These are so named when the pins or dovetails, or both, are hidden from view in the finished article. One plan, in which the joint is seen at the side only, is shown in Fig. 515. The wood *a* forming the side should be rather thinner than *b* on the front. The pins *c* are cut first, and their outline is marked out on *b*, in which the sockets are then cut for their reception, noting that these sockets do not extend farther in length than the dotted line *d*, nor farther in width than the dotted line *e*.

The plan illustrated in Fig. 516 allows only a line to be seen in the side piece. In this case, each piece has a distance marked off on it equalling the thickness of the piece to be joined to it; at about half this thickness another line is marked to indicate the

depth (in the thickness of the wood) to which the pins and dovetails are to be cut. As the pins in *a* have to overlap and hide the ends of the dovetails, half their (the pins') length is cut off after their full dimension has been used in marking out the dovetails. All the cutting must be carefully done with a chisel. When the joint is complete

515.

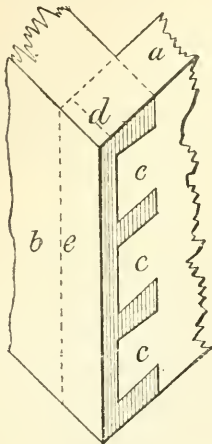

516.

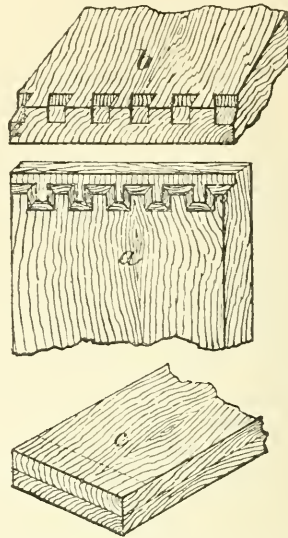

and dry, the edge of the lap on *a* can be rounded. Or again, by making a lap on each piece and cutting the edges of the laps to the same bevel, they will meet so as to exhibit only a single line at the corner.

Mechanical aids in dovetailing.—To an amateur, dovetailing is no easy matter, when beauty and strength of joint are aimed at. The pins are less difficult to make than the dovetails, but they must be truly vertical. The real trouble is with the dovetails, as they are on arbitrary lines. Much assistance may be got from the employment of a fret sawing machine. This should either have a wooden table, or its iron table must be covered with a wooden one $\frac{3}{4}$ in. thick. On this are scribed, $\frac{1}{2}$ in. apart, parallel lines at right angles to the saw front; about $\frac{1}{3}$ in. in front of it is grooved out $\frac{1}{2}$ in. deep between the lines. Fitted to slide in this groove, 2 pieces of hard wood are prepared: one carries, at right angles, a sloping block as a guide for cutting the pins, and the other a similar guide for the dovetails. Screws can be used to hold the guides in place. A slot is cut through the table (or false table, as the case may be) to let the saw work. The guides just described are used to regulate and govern the direction of the saw so that it shall not deviate from the lines marked out.

Dowelling.—The "dowels," which are tapering cylindrical pegs of tough wood, prepared beforehand, and kept dry, should be placed 3-12 in. apart in holes prepared for them by the centre-bit, all of uniform depth (secured by a gauge on the bit), and countersunk. The dowels are cut $\frac{1}{8}$ in. shorter than the united depths of the holes, and rounded at the ends. The dowels are warmed for an hour to shrink them, then the joint is warmed, and thin hot glue is quickly applied to joint, dowels, and dowel-holes. This joint is largely used by chairmakers, and known as "framing." When the work comes shoulder to shoulder, the dowel-hole must be bored square to the shoulder.

Joining thin woods.—For making joints in $\frac{1}{4}$ -in. to $\frac{1}{2}$ -in. stuff, the material is cut to size, trimmed clean, and arranged in sets, with the joints numbered. The edges are planed off with a sharp trying-plane on a shooting-board. To make tongued joints, the joints are shot, then grooved and tongued with a pair of piecing-planes, to match the thickness of the stuff, always keeping the fence of the plane to the face of the work. For gluing, the tongue must be slack to allow for swelling when the hot glue is put in. (J. Cowan.) The lighter and smaller the work, the greater is the difficulty of securing accurate joints, because defects in squaring-up are not obvious on very thin wood. In the case of a small box with a deep cover, it is easiest to make box and cover all in one piece, and afterwards saw them apart. A neat and strong joint, allowing the corners to be rounded, is shown in plan in Fig. 517: the end pieces of the box are rebated like *a*, and the front and back pieces are grooved like *b*.

517.

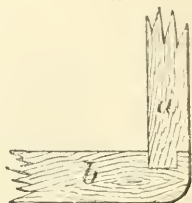

Gluing.—For an account of glue, its qualities, characters, &c., the reader is referred to 'Workshop Receipts,' second series, pp. 78-84, in which full details are given for soaking, boiling, and otherwise preparing the adhesive solution. Glued surfaces need to be forced into the closest possible contact, so that there shall intervene the slightest possible film of the adhesive substance; and there is no point upon which amateurs make greater mistakes. A thick wad of glue does not stick 2 pieces of wood together, but keeps them apart. If we could plane 2 boards perfectly true, so as to exclude even a film of air, they would adhere without glue. But this is not possible. Nevertheless, we make some approach to such condition when, having planed both approximately level, we insert the thinnest possible layer of some adhesive substance—in this case glue—and press them into the very closest contact that we can. The bulk of the glue is squeezed out, and is to be wiped off; but after all is squeezed out that is possible, a sufficient film will remain to give the necessary adhesion; and supposing the glue of good quality and properly applied, the closest union of the parts will be found to take place. The glue should be applied quite hot; and in cold weather it is well to warm the joint before applying the glue, if the character of the work will allow it. With very thin stuff this warming is not advisable, as the fire will warp the wood. A convenient "glue-brush," according to Cowan, may be made from a piece of rattan cane, having the outside crust pared off, and the end dipped in boiling water and hammered out till the fibre is well separated. It is described as the best, cheapest, most durable, and most effective means of applying glue.

Hinging.—Hinging is the art of connecting two pieces of metal, wood, or other material together, such as a door to its frame; the connecting ligaments that allow one or other of the attached substances to revolve are termed hinges. There are many sorts of hinges, among which may be mentioned, butts, chest hinges, coach hinges, rising hinges, case-ment hinges, garnets, scuttle hinges, desk hinges, screw hinges, back-fold hinges, centre-point hinges, and so on. To form the hinge of a highly-finished snuff-box requires great mechanical skill; but few of the best jewellers can place a faultless hinge in a snuff-box.

There are many varieties of hinges, and hence there are many modes of applying them, and much dexterity and delicacy are frequently required. In some cases the hinge is visible, in others it is necessary that it should be concealed. Some hinges require not only that the one hinged part should revolve on the other, but that the movable part shall be thrown back to a greater or lesser distance. Figs. 518 to 564 exhibit a great variety of methods of hinging.

Fig. 518 shows the hinging of a door to open to a right angle, as in Fig. 519. Figs. 520, 521, and Figs. 522, 523, show modes of hinging doors to open to an angle of 90° . Figs. 524, 525, show a manner of hinging a door to open at right angles, and to have

the hinge concealed. The segments are described from the centre of the hinge A, and light portion requires to be cut out to permit the passage of the leaf of the hinge A B.

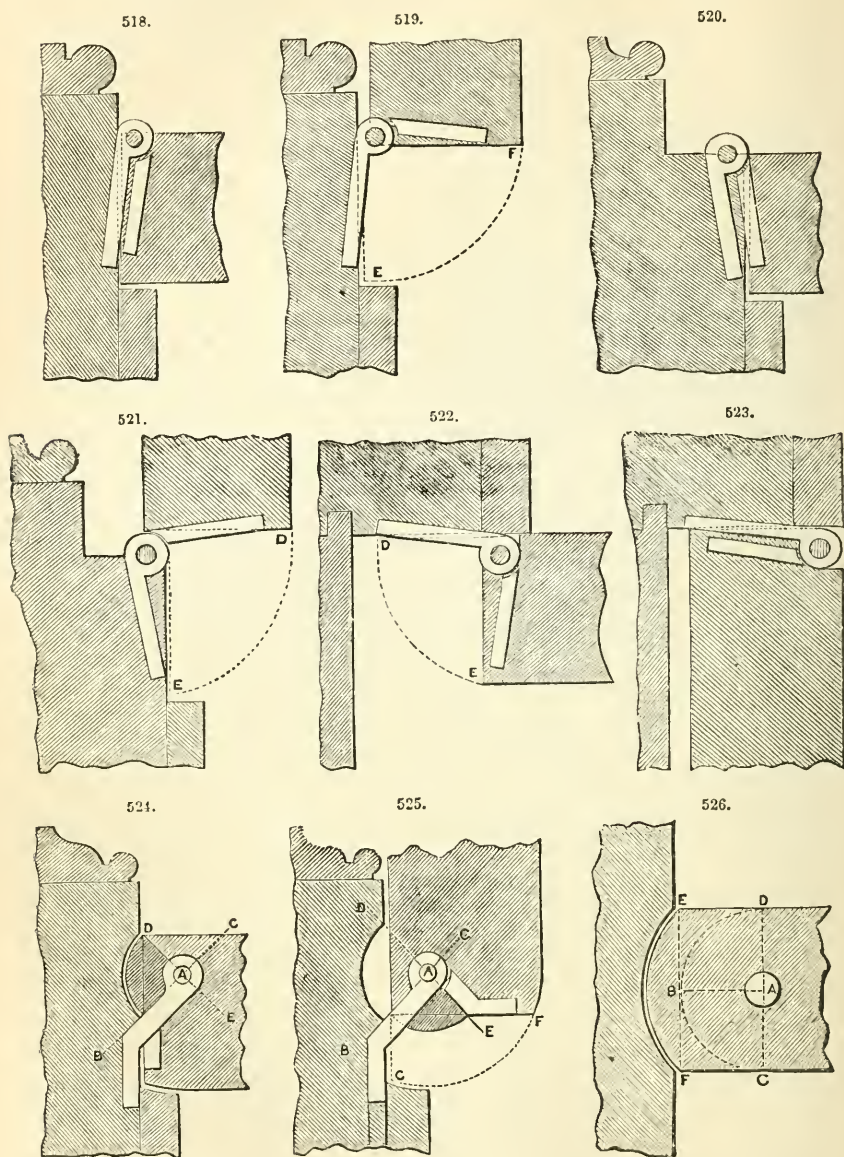

Figs. 526, 527, illustrate an example of a centre-pin hinge, the door opening either way, and folding back against the wall in either direction. Draw E F at right angles to the

door, and just clearing the line of the wall, which represents the plane in which the, inner face of the door will lie when folded back against the wall in either direction. Bisect $E F$ in B ; draw $A B$ perpendicular to $E F$, which make equal to $E B$ or $B F$ then A is the position of the centre of the hinge.

To find the centre of the hinge, Figs. 528, 529; draw $A D$, making an angle of 45° with the inner edge of the door, and $A B$ parallel to the jamb, meeting $D A$ in A the centre of the hinge; the door, in this case, will move through a quadrant $D C$.

Figs. 532, 533, are of another variety of centre-pin hinging, opening through a

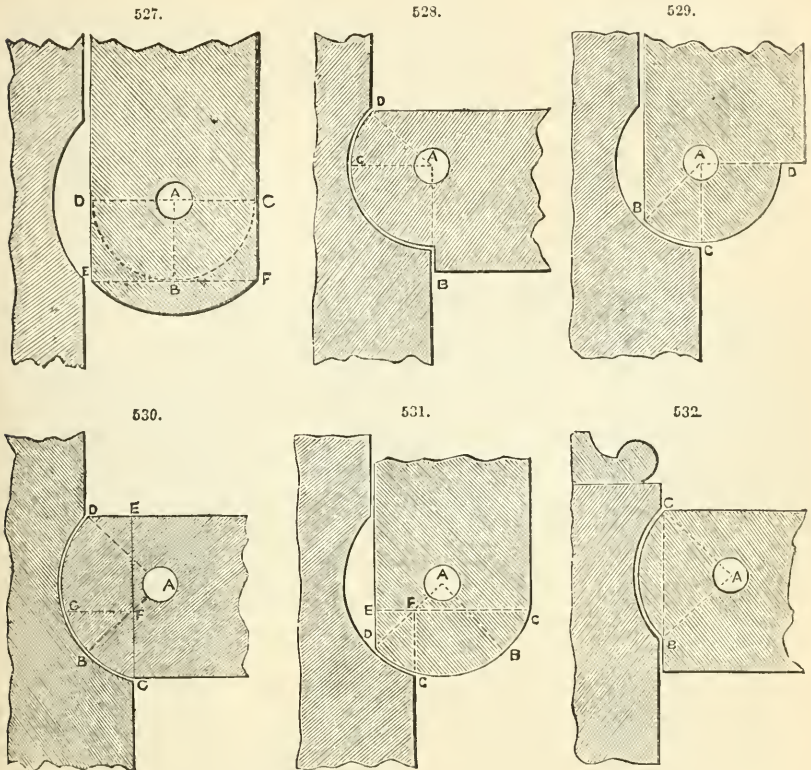

quadrant. The distance of A from $B C$ is equal to half $B C$. In this, as in a previous case, there is a space between the door and the wall when the door is folded back. In Figs. 528, 529, as well as in Figs. 532, 533, there is no space left between the door and the wall.

Fig. 530; bisect the angle at D by the line $D A$; draw $E C$ and make $C F = \frac{3}{2} D E$; draw $F G$ at right angles to $C E$, and bisect the angle $G F C$ by the line $B F$, meeting $D A$ in A ; then A is the centre of the hinge. Fig. 531 shows, when the door, Fig. 530, is folded back, that the point C falls on the continuation of the line $G F$.

Figs. 534, 535; Figs. 536, 537; Figs. 538, 539; and Figs. 540, 541, are examples of centre-pin joints, and require no particular or detailed describing.

Figs. 542 to 544 are of a hinge, the flap of which has a bead B closing into a corresponding hollow, so that the joint cannot be seen through.

Figs. 545 to 547 show a hinge *b a* let equally into the styles, the knuckles of which

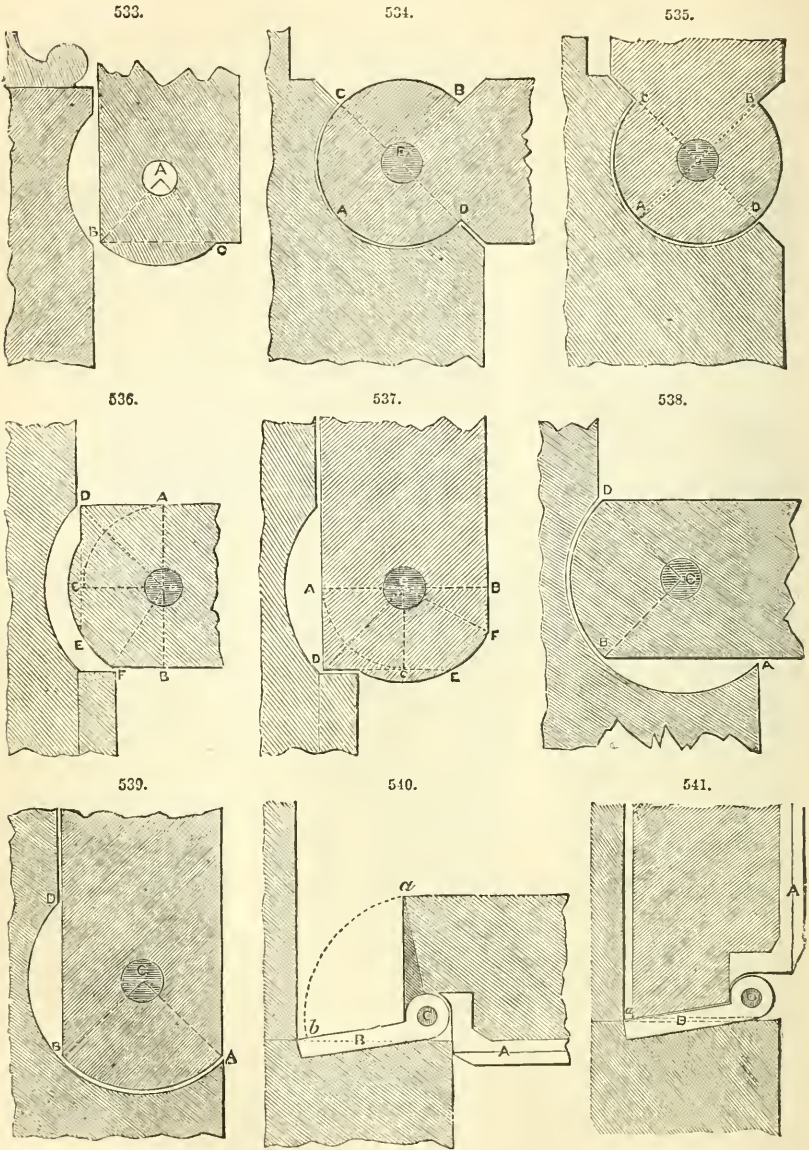

form a part of the bead on the edge of the style B. In this case the beads on each side are equal and opposite to each other, with the joint-pin in the centre.

In the example, Figs. 548 to 550, the knuckle of the hinge forms a portion of the bead on the style C, and is equal and opposite to the bead of the style D. In Figs. 551 to 553, the beads are not directly opposite to one another.

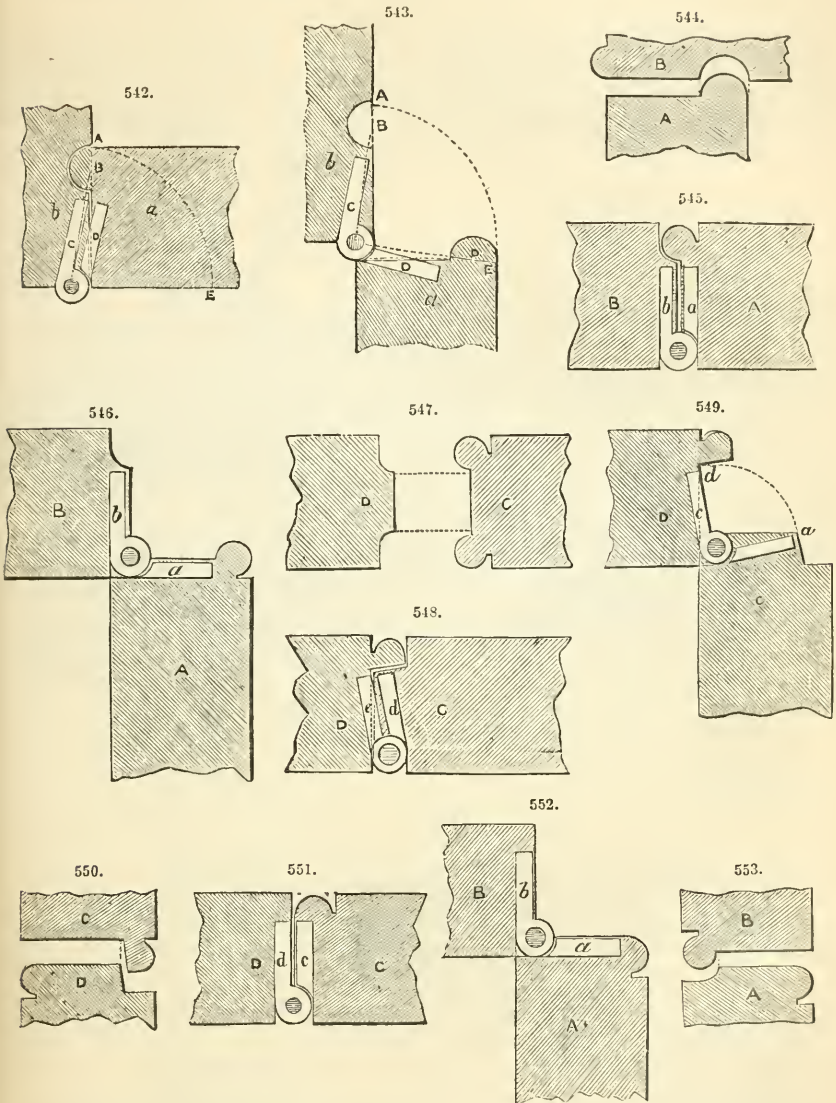

Fig. 554 exhibits the hinging of a back flap when the centre of the hinge is in the middle of the joint.

Figs. 555, 556, relate to the manner of hinging a back flap when it is necessary to throw the flap back from the joint. An example of a rule-joint is given, Figs. 557, 558.

Figs. 559, 560, point out or define the ordinary mode of hinging shutters to sash-frames.

Figs. 561, 562, illustrate a method of hinging employed when the flap on being

554.

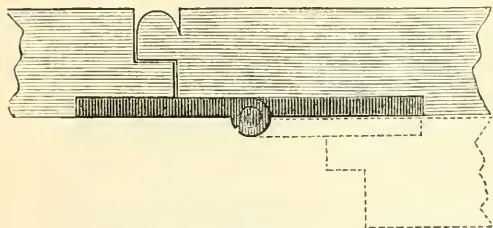

556.

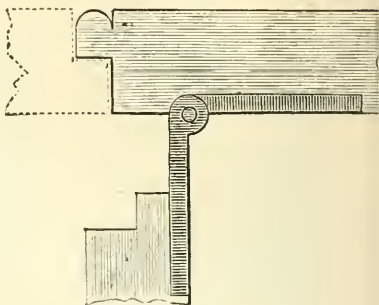

555.

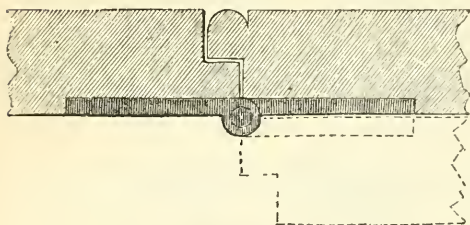

557.

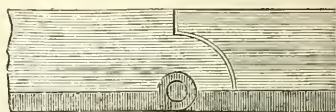

55R

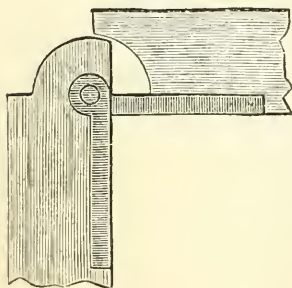

559.

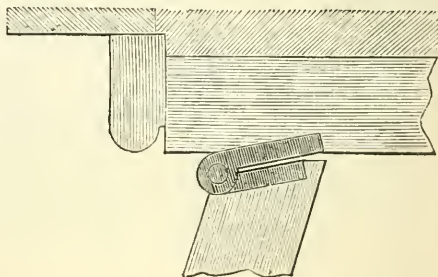

560.

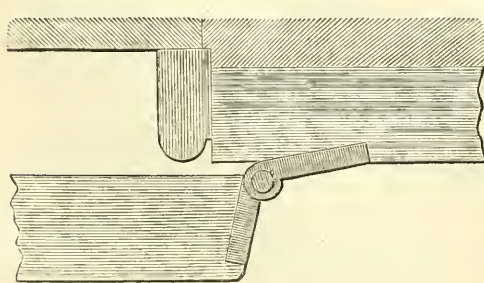

561.

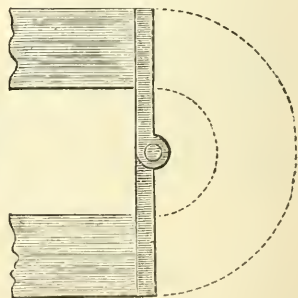

opened has to be at a distance from the style. This method of hinging is used on the doors of pews, to throw the opening flap or door clear of the mouldings.

Figs. 563, 564, show the manner of finding the rebate when the hinge is placed on the contrary side. Let h be the centre of the hinge, ye the line of joint on the same side, ac the line of joint on the opposite side, and ec the total depth of the rebate. Bisect ec in d , and join dh ; on dh describe a semicircle cutting ye in f , and through f and d draw fb , cutting ac in b , and join ab , bf , and fy , to complete the joint.

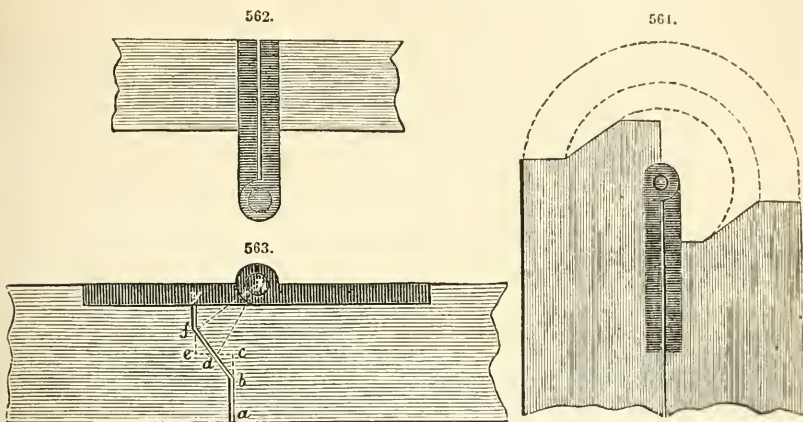

Examples of Construction.—In giving a selection of examples illustrative of the construction of articles in which wood forms the chief if not only material employed, it will be convenient to adopt some sort of classification. The following will be found to have practical advantages:—(1) Workshop Appliances, (2) Rough Furniture, (3) Garden and Yard Erections, (4) House Building.

WORKSHOP APPLIANCES.—The principal workshop appliances which can be made by the mechanic or amateur for his own use are the tool-chest, carpenters' bench, and grindstone mount.

Tool-chest.—The most common way of arranging a tool-chest is in the form of a box, i. e. with the cover opening at top. This has one great disadvantage as compared with what may be called the cupboard arrangement, in that some of the tools must necessarily be below the others and in the dark, giving double trouble to get them out or replace them, and tending not a little to their injury. The chest or cupboard shown in Fig. 565 is based on one described in *Amateur Work* by the designer. It measures 4 ft. high, 3 ft. wide, and 11 in. deep from back to front, the shell being made of $\frac{3}{4}$ -in. boards 11 in. wide. These are carefully sawn to size, planed up, and dovetailed at the joints. The shelves are of $\frac{5}{8}$ -in. boards planed down to about $\frac{1}{2}$ in. The back is formed of $\frac{1}{2}$ -in. lining boards, which may be bought ready ploughed for putting together. The interior is divided into compartments: a measures about 3 ft. high, and 8 in. wide, and is adapted for hanging saws in, hooks being screwed into h for that purpose; b is 2 ft. 2 in. wide, and 14 in. deep, so as to admit full-sized bottles containing turpentine, &c., as well as a paint-pot and glue-pot; c is about 9 in. high and the same width as b ; d , e , f , g equally divide the remaining height of the cupboard, the 2 former being only 2 ft. 2 in. wide, while the 2 latter have the full width of the cupboard. All the boards forming the partitions of the interior are of $\frac{5}{8}$ -in. stuff planed down to about $\frac{1}{2}$ in. The ends of the shelves which abut on the sides of the cupboard are rabbeted into grooves $\frac{3}{8}$ in. deep, and those ends which abut on the partition i are supported on triangular strips screwed to i . The shelves may be free to slide to and fro if desired, except h , which receives the upper end of the partition i . The front side of the cupboard is made in the following ingenious manner. A frame of wood 3 in.

broad, and $1\frac{1}{8}$ in. thick, is made to go right round, with an upright bar in the centre, the whole being fixed together with mortice and tenon. Tenons cut on the ends of the centre bar are let into mortices in the end pieces, and tenons on the ends of the end pieces into mortices in the side-pieces. A $\frac{1}{4}$ -in. bead-plane is run along the inside edges of the frame before the tenons are cut or the mortices made. If neatly done, this will leave a complete bead round each door. This frame is nailed to the front of the case; and if it has been made slightly large, there will be a little border to clean off with the plane. The doors may be of any desired style. A good appearance, with little cost or trouble, is gained by the following plan. The frame is $1\frac{1}{8}$ in. thick; and the apertures to be closed are about 14 in. wide: take two pieces of board of the necessary length and width, and, when planed, $\frac{5}{8}$ in. thick; fit these into the apertures of the frame as doors; next take some slips of $\frac{3}{8}$ -in. wood, $2\frac{1}{2}$ in. broad, dressed and squared; upon one side make a moulding, $\frac{3}{8}$ in. broad, with an O-G moulding-plane, and with the slips thus prepared plant the outside of the doors, of course keeping the square edges along the edges of the doors, and the moulding inwards. There is a little caution needed if the deception is to be complete, as

viewed from the outside. Consider that you require to keep the pieces appearing as styles full width from top to bottom of door, but cutting the mouldings at an angle where they meet on the inner edges. For the middle and lower rails, these slips should be considerably broader than the styles and top-rail, but proportionate to the size of the door. While the inside of the doors is plain board, the outside has all the appearance of a proper framed door. Secure the case with a lock on each door, as being most handy and neat. Obviously one or more of the spaces *e*, *f*, *g* may be fitted with a nest of drawers for holding assorted nails, screws, and small tools. These drawers will resemble small shallow boxes, but differing from ordinary boxes, inasmuch as the front side is of thicker stuff than the remainder, because it has to take a blind dovetail (Fig. 515, p. 282). The sides, back, and front of the drawers are dovetailed together, and the bottom rests in a rebate or groove. The dovetails need be only 2 or 3 in number, and shallow, as the sides are thin, say, $\frac{1}{4}$ -in. stuff. The depth (height) of the drawer should not in general exceed 3 in. The bottom is secured by a few small brads in the rebate or groove cut for it; being supported in this way, it leaves a small portion of the sides of the drawer projecting below it. These form the runners on which the drawer slides in and out, and which may be lubricated by rubbing with a little soap or domestic blacklead (graphite). The drawers, when more than one in depth (height) or width, are separated by a narrow framework running back about $\frac{2}{3}$ of the total distance from front to rear.

Carpenters' bench.—Several forms of bench which can be purchased ready made have been already described (pp. 257-9); but a home-made bench is much less expensive and affords good practice in joinery, accurate work being necessary, while the materials are not too delicate. Good sound deal is a suitable wood to use, and the dimensions must depend on circumstances. Figs. 566, 567, 568 represent a bench described by a contributor to *Amateur Work*; the dimensions refer to the rough unplanned wood, which must all be planed up with the least possible waste. The legs *a* are $4\frac{1}{2}$ in. by $2\frac{1}{2}$ in.; the side ties *b*, 1 in. thick, are let into the legs $\frac{3}{4}$ in., and the legs are let into the ties

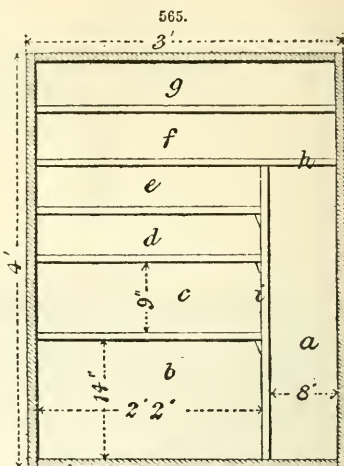

$\frac{1}{4}$ in., and both are screwed together by stout 2-in. screws placed so as not to interfere with each other. The top *e* is at least $1\frac{1}{2}$ -2 in. thick, and made up of two pieces, which are caused to lie close by the following means. When the frame (legs and ties) has been made quite firm and even, the two 11-in. boards to form the top are planed smooth and

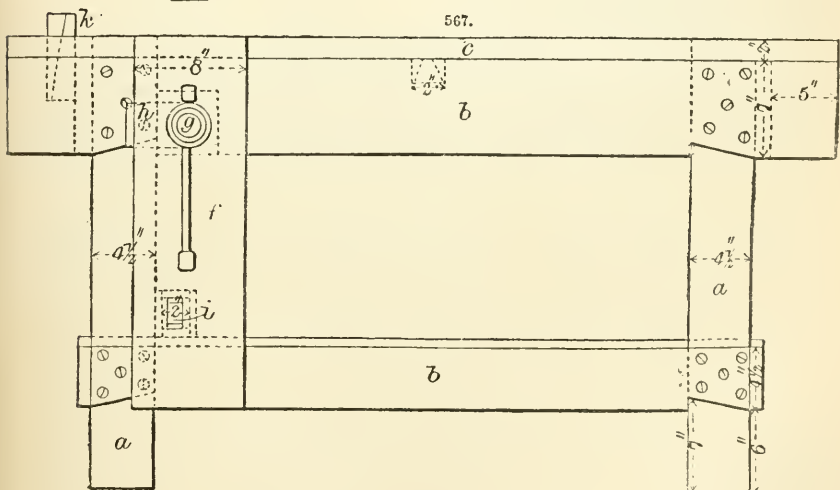
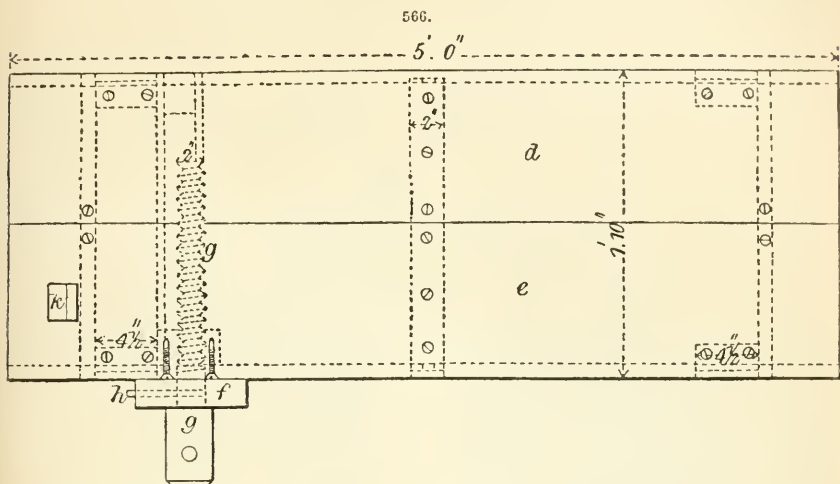

true along the edges that are to meet; the outer edge of the board *d* is screwed securely to the frame, and wedges are put under its inner edge to force it up about $\frac{1}{2}$ in. from the frame; while in this position the other board *e* is thrust as tightly as possible against *d* and has its outer edge screwed down in a similar manner while its inner edge is raised $\frac{1}{2}$ in. The 2 boards thus form a table with a ridge along the centre, whilst an angular trough separates the inner edges of the boards. In this trough hot glue is

applied, the wedges are withdrawn, and the boards are gently pressed down quite flat and secured by screws and heavy weights, the latter being removed when the glue has set. This plan avoids the necessity for a powerful clamp. The chop *f* of the old-fashioned wooden bench-vice is made of beech or oak, 2 in. thick and 8 in. wide, and reaches to the lower edge of the bottom side tie. The screw *g* passes through the chop *f* and the top side tie, at the back of which the nut should be screwed. In the neck of the screw is a groove for the reception of a thin slip of hard wood *h*, to be mortised through the side of the chop, and cut into shape to fit half round the neck of the screw and into the groove, serving to pull the chop outwards. The chop is also furnished with a guide bar *i*, about 2 in. sq., mortised into it, and sliding in a guide box or channel provided for it; the angles of the guide bar may be planed off to ease its movements. The stop *k* consists of a couple of wedges let right through the bed of the bench. The bottom ties may support a table of $\frac{1}{2}$ -in. boards, convenient for holding tools temporarily. The cost of the complete bench is estimated not to exceed 20s.; say wood 15s., bench-screw 2s., screws, glue, stop, &c., 3s.

Obviously the various etceteras of more perfect benches can be added if desired; and there is scarcely any limit to the uses which may be made of the open spaces under the bed of the bench, as situations for drawers, cupboards, tool-racks, or even for a treadle to work a small bench grindstone, circular or band saw, lathe, or other contrivance finding a suitable foundation on the firm frame of the bench.

Grindstone mount.—As already stated (p. 240), grindstones may be bought ready mounted; but while the stone and its iron handle, friction rollers, and other metallic accessories had best be obtained in a complete form from some reputable firm (e. g. Booth Bros., Dublin), the wooden frame can be easily and most cheaply put together (Fig. 569) by the workman himself. A good durable wood for the purpose is pitch pine; of this will be wanted the following pieces:—2 (*a*) 3 ft. by 4 in. by 3 in., 1 (*b*) 4 ft. by $4\frac{1}{2}$ in. by 1 in., 1 (*c*) 2 ft. by 4 in. by 2 in., 1 (*d*) 3 ft. by 2 in. by 1 in., 4 (*e*) 3 ft. by 3 in. by 2 in., the lot costing about 3s. Plane them all true and square. Take the 2 pieces *a*, forming the long sides of the top, and prepare them to receive, at 4 in. from each end, the ends of the cross-pieces formed by cutting *c* in half, the joints being made by dovetailing $1\frac{1}{2}$ in. deep. This should make the inside measurement of the top 20 in. by 7 in. The four pieces *e* for the legs are mortised into the frame sides *a* at an angle of about 85° , the mortices and tenons being cut on the bevel to suit; the legs should be $11\frac{3}{8}$ in. apart at the top and 14 in. at the bottom, to give stability to the structure. This is further increased by cutting the piece *d* into two halves, and letting it into the legs across the ends at 14 in. above the ground. The dovetailed joints of the frame and the tenons of the legs should be put in with white-lead; in addition, a stout 3-in. screw is driven into each dovetail, and the tenon joints are tightened by wedges. The next step is to fix the friction rollers exactly in the centre of each side of the top frame, and accurately parallel; this done, the axle has to be fitted into the stone so that it traverses it

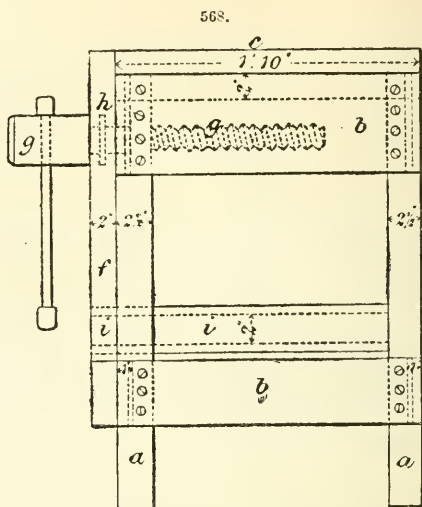

precisely at right angles. This has to be done gradually by putting the axle loosely in and plugging it round with red deal wedges just inserted with slight pressure. Then put the stone on the frame with the ends of the axle resting on the friction rollers. Keep the stone slowly turning, holding a rule against the stone, and drive in wedges from both sides of the stone at the 4 sides of the axle, and also at the 4 corners. The stone has to be true 2 ways, so try it on the side as well as the front. When you have it as true as

569.

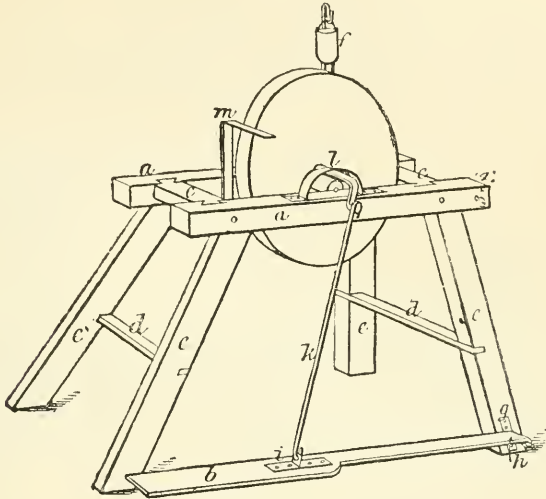

the stone will allow, cut off the wedges, put on the handle, and get some one to turn. Get an old plane iron or a well-tempered piece of steel, and, resting it on the stand, hold it close to the face of the stone. Keep the stone dry, and set it going. Work more on the edges than the centre, so as not to hollow out the stone. Keep at it till you have the stone perfectly true and smooth. Do not put on a trough unless you contrive a plan for raising and lowering it. A can *f* overhead is better: a meat-tin, with a fine hole drilled in the bottom, will do. A blacksmith can make a set of fittings which will cost about 3s. *g* is a plate of $\frac{1}{4}$ -in. iron, 7 in. by $1\frac{3}{4}$ in., with 4 screw holes in it, and with a spud 3 in. long riveted in the centre, at the end of which a small pin-hole has been drilled. *h* is a plate of $\frac{1}{4}$ -in. iron, 7 in. by $1\frac{3}{4}$ in., with 3 screw holes in it, bent round to an eye, to fit the spud very tightly. *i* is a plate of $\frac{1}{4}$ -in. iron, 5 in. by 1 in., with 4 screw holes and a plate, with an eye in it, riveted in the centre. *k* is the connecting rod for the treadle, made out of $\frac{3}{8}$ -in. round iron, about 36 in. long, bent to a hook at one end, and to an eye (to which *i* has to be attached) at the other. *l* is a guard (in duplicate) of $\frac{1}{4}$ -in. iron, 17 in. by 1 in., with 4 screw holes, bent as shown, which passes over axle and rollers, and screws to the stand. This must be made carefully, just to shave the axle but well clear of the rollers. *m* is a rest, made out of $\frac{1}{4}$ -in. iron, 15 in. by $1\frac{3}{4}$ in., bent as shown, at 9 in. from the end, with 2 screw holes. Take the piece of wood *b*, and cut it as shown, half of it the full width, and the other half $2\frac{1}{2}$ in. wide. About $\frac{1}{2}$ in. from the bottom of one of the right side legs, screw *g*. Underneath the treadle, at the narrow end, screw *h*. Hang the connecting rod *k* on to the axle. Fix the treadle on the spud, and raise it about 1 in. from the ground; bring the rod and eye forward till it meets the treadle, mark it and screw it on. The length of the rod, of course, is an essential point

and will depend on the height of the top of the stand from the ground; it must be determined by bending a piece of wire to the necessary length. Screw on the guards *l* over the rollers. The hook supplied with the rollers may, if desired, be hung over the axle, on the handle side, and screwed to the wood, and the guards dispensed with, but the guards are preferable. Screw the support for the can *f* into the stand, on the handle side, between the rollers and the stone. Screw on the rest *m*, so that the short arm just shaves the stone. A water guard made out of back board may, if wished for, be tacked on under the rest at one end, and one to match it at the other, but they are not essential unless you have a trough. (W. J. Stanford in *Amateur Work*.)

ROUGH FURNITURE.—Perhaps the term “furniture” is hardly appropriate here in its commonly accepted sense. Furniture proper will come under Cabinet-making and Upholstery; but there are some few articles that admit of being made in a rough and ready style, simply of wood, and these will come under immediate consideration.

Steps.—These are shown in Fig. 570. The sides (2) *a* may be 2½–6 ft. long (high), 5 in. wide, and 1 in. thick; their top and bottom ends are bevelled, so that the finished article shall stand in a slanting attitude. The

4 steps *b* are 6 in. wide, 1 in. thick, and increase about 1 or 1½ in. in length as they descend, i. e. supposing the topmost of the 4 to be 12 in. long internally, the lowermost might be 16½ in.; this gives solidity by spreading the sides. Each of these 4 steps *b* is let about ¼ in. to ⅜ in. into grooves cut in the 2 side pieces *a*, and secured by a few nails or screws. As the side pieces *a* are only 5 in. wide while the steps *b* are 6 in., there remains 1 in. of step projecting beyond the sides; this projection comes in front, where the step is allowed to have the full width so as to come flush with the outside of the side pieces. The top step *c* differs from all the others: it is long enough to have about 1 in. at each end over-

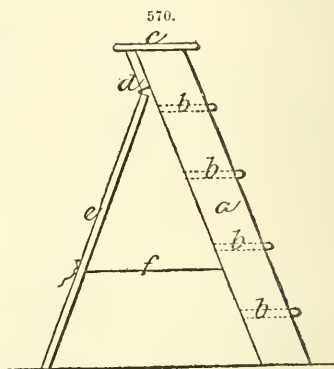

hanging the sides; it is about 2 in. wider than the other steps; and into it the upper ends of the side pieces *a* are mortised, or let into a groove and screwed. When this half of the steps is complete, a piece of board *d*, about 6 in. wide, 1 in. thick, and of a shape to fit flush with the outside of the side pieces *a*, is firmly screwed to the back of the side pieces. To this board *d* is attached, by a couple of stout flap hinges, a light frame *e*, formed by mortising and glueing together 2 upright strips 2½ in. wide by 1 in. thick and 2 cross pieces 3 or 4 in. wide and 1 in. thick, in such a manner that each upright falls at the back of one of the side pieces, while the upper cross piece comes immediately below *d* and receives the lower halves of the 2 hinges, and the bottom cross piece is at the level represented by the cord *f*, which is attached to it at one end and to one of the side pieces *a* at the other. The length of the frame *e* should correspond exactly to that of the side pieces *a*. The front top edges of the steps are rounded off. The distance between the steps is usually 7–9 in.

Ladders.—The simplest form of ladder, and suited only to lengths of 12 ft. and under, consists of 2 pieces of good red deal, about 2 in. by 3 in., placed side by side some 14 in. apart, and joined by cross pieces 2 in. by 1 in., at intervals of 8 in., the cross pieces being generally let into notches about ⅜ in. deep in the side pieces, and securely nailed or screwed. For ladders of greater length recourse is had to a sound fir pole of the requisite length, which is planed smooth all over, and bored through at 9-in. intervals with a series of ⅜- or 7⁄8-in. holes. The pole is then sawn in half down the centre, forming 2 pieces flat on the inside, but rounding on the outside. Spokes cut for the purpose,

of ash or oak, are next inserted by one end into all the holes in one side piece, and their free ends are afterwards similarly introduced into the holes of the other side piece. This done, the projecting ends of the "rounds" or spokes are sawn off flush with the outside of the side pieces, a chisel cut is made in each of them (the rounds) in the direction of their length, and these chisel cuts are filled by little wooden wedges driven tight. Extra strength is given in long ladders by inserting an iron rod across under the steps near the top and bottom, and putting a washer and nut on each end to tighten up.

Cask-cradle.—This is simply a stout frame on 4 legs 9–12 in. high, made of quartering which may vary from 2 in. sq. for small casks to 3 in. sq. for larger ones. The proportions given in the annexed illustration (Fig. 571) are suited to a 9-gal. cask. This should be 22 in. long, 15 in. wide, 9 in. high, and made of $2\frac{1}{2}$ -in. stuff, of which it

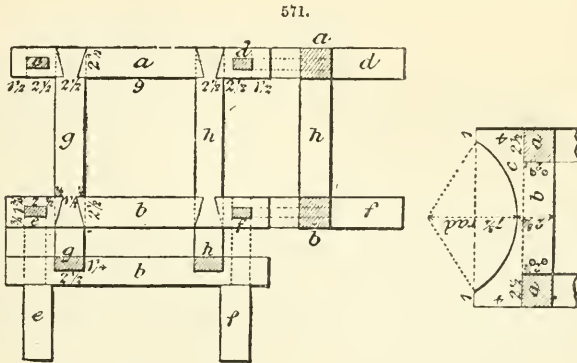

will consume about $9\frac{1}{2}$ ft. run. It will be seen that the sides *a, b* are joined to the legs *e, d, e, f* by mortice and tenon joints, while the ends *g, h* are dovetailed into the sides *a, b*. The joints are secured by pins of oak or red deal driven into holes bored by a gimlet. The stand thus made is only adapted to carry casks stood on end. For holding them steadily on their side, and at the same time giving them a tilt forward to allow all the clear contents lying above the sediment to be drawn out without disturbing the barrel, use is made of 2 pieces of board hollowed out to receive the barrel. For the sized cask mentioned (9-gal.), 15 in. will suffice in length and 1 in. in thickness for each piece. Both are prepared for letting down into the frame by cutting out a piece $2\frac{1}{2}$ in. sq. from each of the 2 bottom corners as at *a*, and can then be screwed to the cross piece *b* of the frame. Previously the cradle is formed by describing on the piece of wood an arc of a circle corresponding to the size of the cask at the point where it is to be supported. Supposing the diameter of the cask to be $15\frac{1}{2}$ in., the radius of the circle to be described will be $7\frac{3}{4}$ in., as shown. This gives the correct arc, but as the cask will lie sloping and not flat, the foremost edge of the arc must be shaved away till the cask will rest on the entire breadth of the edges of the cradle *c*. For the front cradle the board may be $6\frac{1}{2}$ in. wide, and for the back $8\frac{1}{2}$ in.

Tables.—To begin with a simple example and one where but little finish is necessary, recourse may be had to a kitchen table described by Cabe in *Amateur Mechanics*. The table and its parts are shown in Figs. 572–584; the top measures 3 ft. 6 in. long by 1 ft. 10 in. wide. For the 4 legs get a piece of clean yellow pine, 30 in. long, 8 in. broad, and 2 in. thick; line it out so that each piece has a taper (Fig. 574); this is called cutting one out of the other. The proper method to line out the wood is:—Draw a line down the middle, which will give 2 halves, each 4 in. broad; from the outer edge of each half, mark $2\frac{1}{4}$ in.

at *b*, and $1\frac{3}{4}$ in. at *c*; draw lines to these marks 2 in. thick, and saw up; you thus have 4 pieces each tapering from $2\frac{1}{2}$ in. to $1\frac{3}{4}$ in. Plane up the 2 best adjacent faces of each piece, and square them; when planed, mark their faces with pencil. Set marking gauge to bare 2 in., and gauge from the dressed faces for about 6 in. in length, at the broad end or top of each piece. This is the part of the leg that comes opposite the rails, and has no

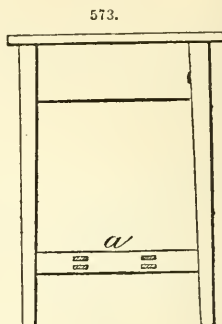
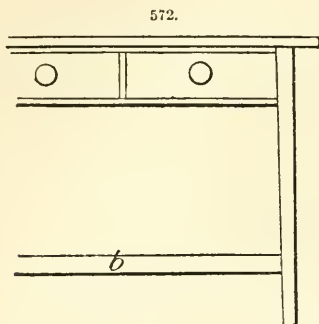

taper. Plane and square the 4 pieces to their gauge marks, and place them together on the bench, even at the bottom. Mark from the bottom 24 in., which will be 6 in. from the top, and square across, continuing the line round the remaining sides; this is the line the tapering commences from. Set the making gauge to $1\frac{1}{2}$ in., and gauge the bottom end of each piece from the dressed side. Taper from the lines mentioned above, stopping at the gauge marks on the end. The legs will be 2 in. square for 6 in. of their length, and the remainder tapered to $1\frac{1}{2}$ in. square at the bottom.

Plane and square the back rail 35 in. long, 5 in. broad, and 1 in. thick; 2 end rails 19 in. long, 5 in. broad, and 1 in. thick; front rail over the drawer, 35 in. by 2 in. by $\frac{3}{4}$ in.; 1 under the drawer, 35 in. by 2 in. by 1 in.; 2 end stretchers, *a*, Fig. 573, 19 in. by 2 in. by 1 in.; and 2 long ones, 35 in. by 2 in. by 1 in. These pieces prepared, draw in the legs for mortising. Place them on the bench in 2 pairs, each pair having a taper side up, and the remaining taper sides opposite each other, as in Fig. 575, the parallel portions of all 4 lying close, and the bottoms of each pair about 1 in. apart. 2 mortices are made in each leg to receive the 5-in. rail. First draw a line across all 4 at the beginning of the taper *a*, set a pair of compasses to $1\frac{1}{2}$ in., and mark from *a* to *b*; mark 1 in. from *b* to *c*, then $1\frac{1}{2}$ in. with the compasses to *d*. During this operation the legs should be clipped by their ends in a hand screw, to prevent shifting. Draw in the mortises for stretchers, by making the line *e* 6 in. from the bottom, and *f* $1\frac{1}{2}$ in. higher up. Set the mortice gauge to $\frac{3}{8}$ in. mortice line, and set the head $\frac{3}{8}$ in. from the inner spike. Gauge with this all the mortices both for rails and stretchers, from the marked faces of the legs. Square over 1 pair of the legs for the 5-in. long or back rail, which will be on the remaining taper side, as in Fig. 576, and the other pair square across for a rail beneath the drawer, 1 in. thick, the mortice

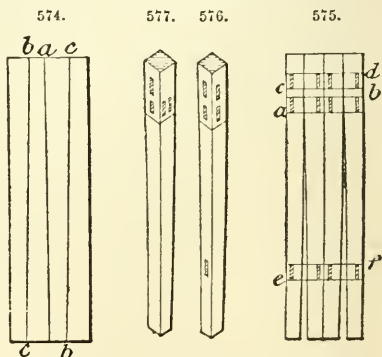

being $\frac{1}{16}$ in. less than the thickness of rail (see Fig. 577). Gauge for mortices as before, from the marked faces, as in the case of Fig. 577 from both faces, as there are 2 mortices in the breadth.

Place the legs for mortising on the bench as in Fig. 575. Mortise for the rails $1\frac{1}{2}$ in. deep, and for the stretchers $1\frac{1}{4}$ in. deep. When mortised clean out, blaze with a $\frac{5}{16}$ -in. chisel, taking care not to bruise the edge of the mortices, which should be smoothed a little on the sides with a chisel, but not pared wider, or they will be too wide for tenons.

Draw in the rails and stretchers—first of all for the 2 ends, as they are cramped together first. Draw in the two end rails 16 in. long between the shoulders; this will give 2 tenons $1\frac{1}{2}$ in. long. Draw in the back rail and the 2 front rails over and under the drawers, 32 in. long. This “drawing-in” means marking them across with square and cutting knife for shouldering. Place the 2 end rails edge up on the bench, mark off 16 in., and square both across. Then from these lines square and mark both sides of each rail. The cutting knife is best for this marking, making a good deep cut, which serves as a channel or guide for the dovetail saw.

Though the shoulders of the 5-in. rails are square across, it will be evident that the shoulders of the stretchers *a*, Fig. 573, are bevelled, arising from the taper on the feet or legs, and the stretcher is also somewhat longer than the rail. Now to find this length, and this bevel, proceed as follows:—To find the length, place a pair of the legs together with a hand screw at top, mortices together; at the stretcher mortice they will be apart about $\frac{3}{4}$ in., and this is the extra length over the rails. To find the bevel, square across any part of the taper of a leg from the outer face with bench-square and pencil, and with a bevel square or bevel stock set the blade to this line. The stock being on the inner or taper side of leg, the bevel thus found is that for stretcher shoulders, the bevel stock being worked from upper edge of stretcher. The shoulders being marked, shift the head of mortice gauge $\frac{1}{8}$ in. nearer the spikes, and gauge rails and stretchers from the outer face. Thus they will be $\frac{1}{8}$ in. within the surface of the legs when cramped together.

The rail under the drawer is flush with the legs, and must be gauged same as the mortices, then shifted to fit the second or inner mortice; see Fig. 577. For this reason the rails and legs should be gauged together, as it saves time and shifting of the gauge. The shoulders are cut in with dovetail saw, and the tenons are ripped with a tenon saw. Then the rails have a piece cut out for the bridge in the mortices, and a rebate of 1 in. at the upper edge, which will leave 2 tenons a little over $1\frac{1}{2}$ in. broad. They should be a little less in length than the depth of mortices. The tenoning being finished, the 2 stretchers *a*, Fig. 573, are mortised for long stretchers *b*, Fig. 572. These mortices are shown at *a*, Fig. 573, where the tenons come through and are wedged. The long stretchers are 6 in. apart, and the mortising is exactly as that for the rail below drawers where let into legs, and also at the division between the drawers. This being done, the insides of the legs are hand-planed and sandpapered, as also the faces of 5-in. rails and stretchers all round.

Now the ends are ready to cramp together. Cut a little off the corner of each tenon, and see that they enter their respective mortices before gluing. The glue should be thin, and while one heats the tenons at a fire another puts glue in the mortices with a bit of lath. A very little glue will do on the tenons. The object of heating is to prevent the glue getting chilled. In cramping up, protect the work with bits of wood under the jaws of the cramps. When cramped, see that it is square by gauging with a rod from corner to corner, diagonally between stretcher and rail; also see that it is out of twist. If the work is well done, the cramp may come off at once, as the shoulders will stay close. If ill performed, no amount of cramping will ever make it a good job. Another important thing in cramping these table ends, and in all kinds of mortised framing, is to see that the legs are not pressed out of the plane of the rails. If the jaws of the cramp are kept too high, then the legs are slanted inwards. If, on the other hand, the cramp be too low, the legs are turned outwards, so that the point of pressure should be opposite

the centre of the thickness of the rails. When cramping, place a straight-edge across the 2 legs; the straight-edge should touch the legs on the whole of their breadth—then they will not be winding.

The 2 ends being framed together, the next operation is to fill them in for drawer guides. These consist of pieces of wood 2 in. broad, and thick enough to flush the table legs, fitted in between the legs, and glued to the rails, being kept flush with the bottom edge of rail. They should be fixed down with hand screws, and laid aside for an hour or so, after which they are planed straight and flush with the legs. The tops of the 2 front legs are cut off flush with the edge of the rails, and planed; then the $\frac{3}{4}$ -in. rail over the drawers is drawn in same length as that under, and a dovetail made on each end about $1\frac{1}{2}$ in. long. These dovetails are drawn on the tops of the legs, and then cut out to the depth required—namely, $\frac{3}{4}$ in. The space from this to the 2 mortices under the drawer is the length to make the short upright division, or fore-edge between the drawers. This has a double tenon each end, same as for the stretchers, the 2 rails being mortised to receive it; see Fig. 578, which is the frame without drawers or top. The rail below the drawers is mortised to receive the cross rail *a* (Fig. 578), which is a rest for both drawers. It is 3 in. broad, and same thickness as front rail; one end is tenoned to enter the front rail, while the opposite or back end has a dovetail, and is let in flush into the under edge of the back rail; its position is from front to back, and in the centre of the frame. The mortice and tenon being prepared, the proper length of this rail will be found when the frame is cramped up, and stood on its legs.

To find the length of the long stretchers, place the 2 ends together, with the mortices towards each other; catch them in a hand screw at top, when you can measure the gap between the end stretchers: this is the length that the long stretchers are to be in excess of the rails at back and front. Tenon the long stretchers to fit the mortices in cross ones; all mortising and tenoning being done, hand plane all the parts that cannot afterwards be reached, before glueing up. Being now ready to glue the frame up, set a cramp to about 3 ft. 2 in., which will allow of 2 pieces of wood to protect the job. The back rail, front rail below drawer, and 2 long stretchers all receive glue, and are fitted in their places at once. Insert them all into one end, first with the hands, then turn them over, and insert them in the other end; now rap them nearly home with a piece of wood and a hammer; then apply the cramp. It is almost necessary for 2 persons to be at this part of the job, one heating tenons, and afterwards assisting with the cramp. Cramp all the shoulders close, wedging the long stretchers with the cramp in the centre between them.

Glue and insert the short upright rail between the drawers, then above this the rail with 2 dovetails; press the short upright home with a small cramp or a hand screw on either side of the projecting tenons, and drive in wedges as explained in glueing the long stretchers. Rap home the dovetailed ends, and drive a 2-in. nail through them into each leg. You will now find the correct length of the rail across the centre, which fit by dovetailing into back rail. Make 2 bearing fillets, 1 in. sq., and nail them inside of each end and level with the front rail, when they will be on the same level with the centre bearing rail, and support the drawers properly on both sides. The 2 drawers are made with fronts $\frac{7}{8}$ in. thick, and are fitted closely into the apertures to receive them. Mark the front on the outside thus, Δ , when you will always know the end to be kept uppermost. Plane the bottom edge first, then make one end square, assuming that the aperture is rectangular. Place the front against the aperture, with the squared end in its place, and draw the other on the inside with drawpoint. Saw off and square this end with the plane on the shooting-board. Having got the ends to the exact length, place the front against the aperture again, letting the lower edge enter a little way. Draw again along the upper edge inside, and plane down to this mark. These fronts should fit tight, and at present it is sufficient if they just enter. Cut out 4 sides of $\frac{5}{8}$ -in. wood, dress and square the ends on the shooting-board, $\frac{1}{2}$ in. shorter than the width from

face of rail to inside of back rail. These 4 sides may be at present a little broader than the finished side. Groove the sides and front with a drawer-bottom plane, and make 2 backs exactly same length as fronts, and 1 in. narrower; these are also $\frac{5}{8}$ in. thick, and have no grooves like the sides have. Being ready to dovetail, set the cutting gauge to a shaving less than the thickness of sides; gauge all the pieces with this—the fronts on the inner face and also on the end wood, gauging from the inside; then the backs and sides on both sides. Mark on the fronts 4 pins, as in Fig. 579, and on the backs 3 pins,

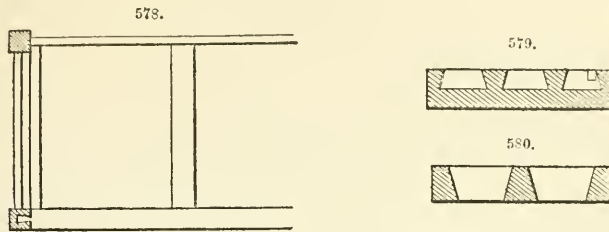

as in Fig. 580, cutting down to the gauge lines. The backs are cut from both sides, as is all "through" dovetailing, while the fronts are only cut to a depth of $\frac{5}{8}$ in.

To draw the sides for dovetailing: Place a pair of sides in position, groove to groove (Fig. 581), and, taking a front, stand on the end of the side flush with gauge line, and flush on grooved edge. Draw close to each pin with the drawpoint, reverse the front, and draw on other side same way. Turn the sides end for end and draw the backs in the same way, having each back marked so that you make no mistake when fitting the drawers together. Observe by Fig. 582 that in drawing the back pins, the back is placed

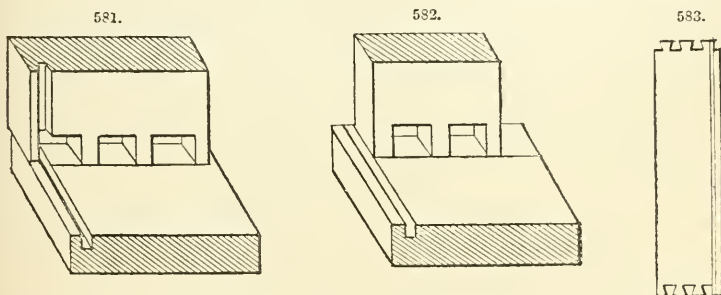

even with the groove in the side, as the bottom slips in under it—in other words, the groove in the sides is clear of the back to receive the bottom. The pieces to be taken out of the sides are ripped with a dovetail saw, and cut out with a $\frac{3}{8}$ -in. chisel; these pieces are 3 at the back end, and 2 at the front, with the 2 corners cut out as in Fig. 583. In dovetailing, it must be observed that the thickness taken by the cut of the saw must come off the piece to be cut out—in other words, the piece cut out is exactly the portion within the drawpoint lines, so that the pins from which they were drawn will fit exactly in the openings thus made. In "through" dovetailing, which is cut from both sides, the chisel is inclined very slightly to cut inwards, which allows the sharp edges to come closely and neatly against the adjoining part when glued up; this is called making it "lean" in the centre. The same remark applies in dovetails not through, as on the drawer fronts, which are slightly "lean" at the bottom both ways—that is, both from

face to end. The dovetails are cleaned neatly out with narrow chisels, and the corners of the sides pared, after sawing off, to the gauge lines.

The drawer stuff, all dovetailed, has to be planed on the inside and sandpapered; then try if the fronts and backs enter their respective sides; after which glue them as follows, and this rule will hold good in all work of a similar kind:—Take a drawer front and the corresponding side, put some glue with a small brush into the recesses in end of front, taking care to allow none to get on to the inner face; put a little on the end wood of the side and on the 2 cut-out corners; stand the front on the bench, glued end up, enter the side, and rap it home with hammer and a bit of wood; turn it over on the bench, the side standing vertically; see that the junction inside is perfectly close; apply a large square inside and press the side to agree with the square. This done, take the back belonging to this drawer, put glue on the pins to enter this same side, enter it and rap home as with the front. Glue the remaining end of front and back, and rap on the remaining side. See that the inside junctions are all close. Lay the drawer flat down on the bench, and square it with a foot rule, applied from corner to corner.

When both drawers are glued, lay them aside, and prepare the bottoms. These are of $\frac{3}{8}$ -in. wood, and if not broad enough may be jointed with $\frac{3}{8}$ -in. match-ploughs. To do this jointing, mark the best side of each piece, place in the bench-vice lug with marked side next you, plane straight with half-long. It is usual to work the "feather" in the narrower piece, if there is a broad and a narrow; it is also usual to work the feather first. The groove and feather made, rap the joint up dry to see it is close. If it is a perfect joint, use thin glue made by dipping the brush into the boiler of the glue-pot. Apply the glue directly with one stroke of brush, and rap the pieces together very smartly with a mallet; they should need no cramping. When glueing of the bottoms is set, plane up both sides with half-long, one edge and one end squared to each other; hand plane inside of each bottom. Take the drawer bottom—plane, and make a gauge by running a groove in a piece of wood 4 in. or 5 in. long. Lay the bottoms face down on the bench, and bevel the edges now uppermost for about $1\frac{1}{2}$ in. inwards, bringing the thickness down to the size of groove in gauge (Fig. 584), in which g is the gauge and b the bottom. This done on front edge and one end, find the length to cut the bottom, by placing one corner in the groove at back of the drawer; mark at the bottom of opposite groove. From this mark cut the bottom to the square, and bevel the back to fit gauge as before, sandpaper the bottoms inside, and before driving them into their places, try that they enter both grooves by inserting the bottom, both back and front edges, because, if wider at the back, they will burst or split the sides. All being correct, drive them down gently with mallet, and see that they enter the groove in the front to the full depth; see also that the sides are perfectly straight and not bulged in the middle.

584.

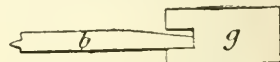

To block the bottoms, glue on fillets $\frac{3}{4}$ in. broad, and $\frac{1}{2}$ in. thick. These are fitted to the drawers along the bottom and side, and must be bevelled to the required angle. They are well glued, and rubbed in with a motion lengthway, when they will take hold. If they do not lie close along their length, cut them into 2 or more pieces before glueing; 2 or 3 short blockings of this kind are also glued on behind the front; these may be 3 in. or 4 in. apart; whereas those on the sides are continuous, being subject to wear in after use. These blockings should harden for 6 or 7 hours, after which drive 3 nails about $1\frac{1}{4}$ in. long through the bottom into the back.

Fit the drawers to the table frame by planing with jack and half-long. First reduce the breadth of the sides to enter easily, then place a piece of board across the bench, catch the drawer in the bench lug, and let the side rest upon this board. Plane both sides and try into frame: when they push in with an easy motion, but not loose enough to shake, they may be hand planed, the back dressed off, and the front planed to stand even with the face of the frame. They must be stopped at the back by glueing small

pieces of wood to the back rail. Push the drawer in $\frac{3}{8}$ in. beyond the face of the frame, and fit the bits of wood in the space left at the back. A guiding fillet is also fitted between the 2 drawers and running from the short upright to the back; this should not be too tight. The drawers should pull out and in easily, and without sticking or shaking.

The table frame is cleaned off with the hand plane in all parts, the tops of the back legs are cut off, and the upper edges of rails planed, to receive the top. The frame is 3 ft. long by 1 ft. 8 in. broad, and the top 3 ft. 6 in. by 1 ft. 10 in. It is planed both sides with half-long, and squared, then nailed down to frame at back and ends; the front is fastened by 4 screws passing upwards through the rail over the drawers. The top is planed flat to agree with a straight-edge, hand planed, and sandpapered; each corner is rounded off and sandpapered. The nail holes in the top are stopped with white putty. The bottoms of the legs are cut all to the same length. Turn the table feet up, take 2 straight-edges, and place one across each pair of feet; the eye will at once detect whether the legs are all one length or not. Cut a little off the foot that carries the straight-edge too high. Bore a $\frac{5}{8}$ -in. hole in the centre of each drawer front for a $2\frac{1}{4}$ -in. patent zebra knob.

A modified form of kitchen table is shown in Fig. 585. The slab *a* is $1\frac{1}{2}$ in. thick;

the legs *b* are 2 ft. $2\frac{1}{2}$ in. high from floor to slab, 3 in. square, and are slightly bevelled inside; the rails *c* are $4\frac{1}{2}$ in. deep, and are attached at each end *d* by means of a double tenon, let into mortices in the legs to the depth indicated by *e*, the inner half of the tenon shown by the line *f* on *d* entering the leg only so far as the line *g* on *e*. The mortice and tenon joints are glued and pinned with wooden pegs. The top is fastened down to the frame by one of the following methods:—(1) It may be screwed to the rail *c* as at *h*, by making a small recess in *c* and driving the screw somewhat diagonally, assuming *c* to be stout enough for the purpose; (2) it may be nailed

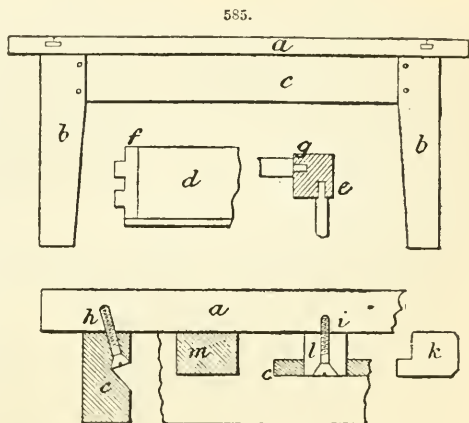

or screwed down from above, the holes in the slab being afterwards stopped with putty; (3) it may be secured by a number of wooden buttons placed about 1 ft. apart all round it, and each revolving on a screw as at *i*, the flange on the button *k* fitting into a groove *l* cut in the rail *c*, this plan presenting the advantage that the top may be removed and refixed at will. The rail *c* is generally "blocked," or strengthened by a series of rectangular wooden blocks *m* glued into the angle between the top *a* and rail *c*.

The construction of a gipsy table is a very simple matter. This form of table consists of a top, usually round, supported on 3 legs, which converge from near the margin of the top to a wooden ball about midway in height from the top to the floor; from this ball start 3 other legs diverging so as to constitute a tripod stand. The top of the table is built up of boards pinned together, and is usually provided with a fringed cover. Underneath the top is attached a second thickness of wood to receive the upper ends of the 3 top legs. The lower ends of the top legs and the upper ends of the bottom legs fit into holes in the ball, and are secured by glueing.

One more example of the arrangements adopted for supporting table tops must

suffice. This consists in having crossed legs (χ -shaped) at each end of an oblong top, see Fig. 586, *a*. The top is formed in the usual manner of $\frac{3}{4}$ -in. boards joined up by tonguing and grooving and by glueing, with 2 or 3 cross ledges *b* screwed on beneath to give additional strength. These cross pieces should come so near the ends of the top *a* (say within 6 in.) as to afford space for the legs *c* (top ends) to abut against them, and be flanked in turn by a rail *d* without the rail coming within say 2 in. of the edge of

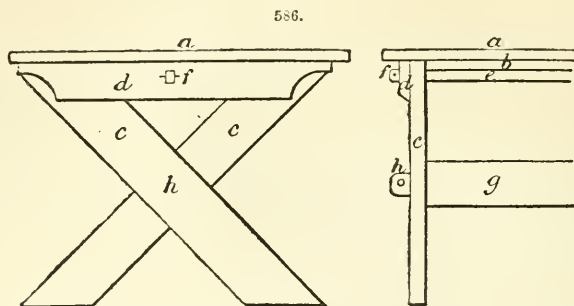

the top. The legs *c* are of red deal, about 3 ft. long, 6 in. wide, and $1\frac{1}{2}$ in. thick, and are halved into one another where they cross. They are held in position by the rail *d* and the bar *e* at top, the latter being run the full length of the table and pinned outside at each end *f*; and by a second stouter rail *g* passing through the legs at the point where they are halved into each other, and held by a pin at *h*. It is obvious that any desired ornamentation by carving, &c., can be given to the legs and rails.

Seats.—Seats are of miscellaneous kinds, ranging from rustic garden chairs to iron benches and the most elegant specimens of artistic furniture. Here attention will be confined to simple forms.

Box stool.—The box stool or ottoman consists of a box without a bottom and with a stuffed lid, supported on knob feet. One is shown in Fig. 587. The box *a* is formed of 4 pieces of wood, 12–15 in. long, and 3 in. wide, dovetailed together. The top *b* is nailed on so as to cover the whole and overlap $\frac{1}{2}$ in. all round; this supports the stuffing *c* covered by a piece of carpet or woolwork. The interior of the box is left empty. There is no complete bottom, but a wide strip of wood *d* is nailed all round the bottom edge of the sides, and into this are screwed the 4 knob feet *e*. A bead *f* may be run round in the angle between the strip *d* and the sides of the box. The stuffed top *c* may be made separately and afterwards attached by screws from the inside.

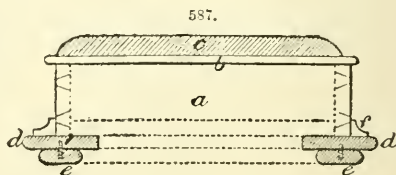

3-legged stool.—This is simplicity itself. The top or seat proper consists of a circular slab of wood $1\frac{1}{2}$ in. thick having 3 1-in. holes bored through it at equidistant intervals about $1\frac{1}{2}$ in. from the edge. Into these holes are driven the stout rods forming the legs, the holes having been bored somewhat sloping so that the legs may diverge outwards to give solidity. When the legs are driven in quite tight, the portion which projects above the seat is sawn off, and a wooden wedge is driven firmly into a slit cut in the top of each leg by means of a chisel. If the legs are less than 1 ft. high, no rails will be needed; but if more, they should be strengthened by joining them together with $\frac{1}{2}$ -in. wooden rods let into holes bored in the legs at about $\frac{1}{3}$ the height of the seat from the ground, and secured by glue.

Chairs.—A short description may be given here of the general principles underlying the construction of chairs, with some illustrated examples of the commoner and rougher kinds, showing how they are made and repaired. Briefly, a chair consists of a more or less flat “seat” or slab supported at a convenient sitting height above the floor on a wooden framework formed of 4 legs joined by cross rails; on one side, these legs are prolonged upwards to constitute the “back,” and, on each of the sides adjoining the back, they may be similarly heightened to produce “arms.” The framework may be plain or ornamented, and the materials of the seat may be wood, cane, rushes, or a “stuffing” (horsehair, flock, &c.), enclosed in a textile or leather covering.

A very cheap and simple kind of chair known as the “cane-bottomed,” is shown in Fig. 588. *a* is the back, cut out of 2 pieces of wood to the required shape, and strengthened by 2 flat rails *b* completing the back of the seat, and by a round rail *c*

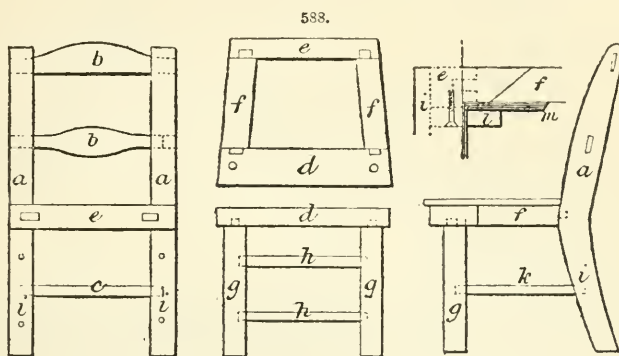

completing the back of the legs. The seat consists of a front rail *d*, back rail *e*, and 2 side rails *f*. The front legs *g* are similarly joined by round rails *h*, and let into the front rail *d* of the seat. The front legs *g* are connected with the back legs *i* by means of round rails *k*. The joints are all made by mortices and tenons, and are well glued, and clamped. There is a tendency in light chairs of this description to suffer injury in the frame, generally in one of the pieces *f* near where they join the back rail *e*. One good plan for repairing such an injury is to introduce a strip of wood *l* from beneath, just long enough to fit tightly between the 2 legs *i*, and to fasten it by screws into the back frame *e* and both sides *f*. Another efficient method is to screw a small angle-iron *m* to the injured frame and to the leg nearest it. As implied by its name, the seat of this chair is formed by stretching strips of rattan cane across it in the manner of a network, attaching them to holes bored for the purpose in the frame of the seat, and securing them by little wooden pegs driven into the holes. It may be mentioned that the front part of the frame of the seat should be wider than the back, and made rounding in shape; the front legs may be perpendicular, but the back legs should diverge gradually towards the feet.

The Windsor, kitchen, or wooden seated-chair is even simpler than the last, the seat consisting simply of a somewhat dished-out slab of wood, attached to the front legs by having them inserted in holes bored into it, and to the back by mortising. The seat should be of elm and the back and legs of beech. These chairs, though strong, are liable to injury from being used for improper purposes, such as carrying clothes while drying, which causes warping and shrinkage, and consequent looseness of joints. Such evils may be remedied by reglueing and clamping tightly till fixed. A broken rail may be replaced by a new one, but a broken leg is generally beyond anything

approaching neat repair. Frequently one corner of the seat will split away at the line where the leg is inserted. This may be put right by temporarily removing the leg, and boring (with a centre-bit) 3 or 4 holes laterally in the wood, from the edge towards the centre of the seat, filling them with wooden pegs dipped in good hot glue, and clamping till quite dry and firm, when the leg may be reintroduced into its place.

Washstand.—A rough handy washstand of simple design is shown in Fig. 589. The legs *a*, of 2-in. or 2½-in. wood, are shown square, but may of course be rounded at the corners by a plane, or completely turned in a lathe, in the intervals between the joints, this being done before the mortices are cut. These latter will be 2 in each inner face of each leg—an upper to take the tenons on the bearers *b* that carry the top *c*, and a lower to receive the supports *d e* of the drawer *f*. The mortices should be cut deeply but not quite through the legs. The bearers *b d* are 3 in. wide and ½-¾ in. thick, placed edge upwards; *e* are only 1½ in. wide and laid flat. All are best situated about the centre of the width of the legs, and therefore flush with neither the back nor the front. The

2 side bearers *d* have little strips glued and tacked inside on a level with the top edge of the lower bearer *e*, on which the drawer *f* is supported and can slide to and fro. The drawer *f* is made with half-lap dovetails, as the tool chest, Fig. 565, p. 290. The top should be made complete before it is fixed to the stand. Its table *c* will require to be cut out of 2 pieces to gain sufficient width. These must be pinned and glued securely together, and further strengthened by strips attached beneath while cutting out the circular hole *g*. This latter operation is effected by means of a fret-saw or key-hole saw worked with the face of the table towards the operator. When the table of the top is so far complete, the back *h* and sides *i* are attached, being first dovetailed together at the corners, and then bradded or screwed to the table from the other side. It will be seen that the table *c* is large enough to project about 2 in. beyond the frame on each side and 1 in. in front. It is fixed to the frame by first glueing some triangular blocks on to the sides *b*, inside the frame, and flush with the top of it, one in the centre of each side *b*, in such a way as to offer a flat surface at top, which may take some of the bearing of the table *c*. When these blocks are quite firm, their upper surface, as well as that of the whole frame, receives a coat of glue, and the complete top is laid in place. It may be further secured by driving a screw through it and into the top of the leg at each corner, allowing the heads of the screws to be countersunk and hiding them by putty before painting. The washstand is completed by fastening a board *k*, cut out at the corners so as to fit between the legs, over the drawer *f*, and reaching a little beyond the bearers *d*.

Bedstead.—A simple yet comfortable trestle bedstead is shown in Fig. 590, which is an end view looking at the head. The frame consists in the main of 2 lengths of deal *a*, about 3 in. by 2½ in., planed off to the sectional shape indicated in the figure, into which are mortised 3 sets of cross legs *b*, formed of hard wood 2 in. sq., with the feet cut sloping as at *c*, and joined at the centre by a bolt and nut *d*. To allow for the legs crossing each other, it is obvious that the mortices in the rails *a* for receiving the ends of the legs *b* must not be opposite each other, but exactly the width of the

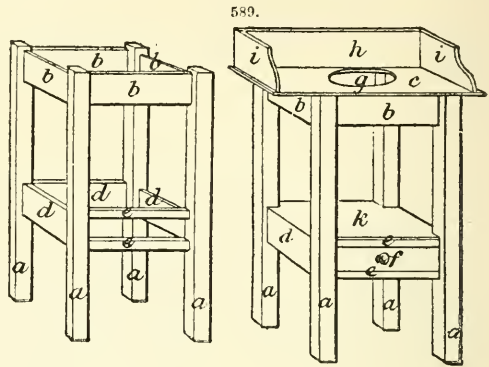

leg apart. The pairs of legs are situated one at each end and one in the middle. Throughout the whole length of the bedstead, coarse sacking *e* is strained tightly across from one rail to the other, and brought round the corner, where it is securely nailed. This sacking prevents the legs opening too wide, and forms the support of the bed and its occupant. An additional solidity and finish is given by attaching a head-board *f*, on

590.

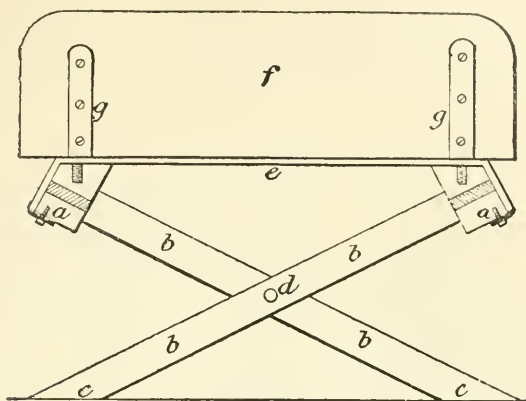

which are screwed 2 strips of iron *g* brought to a pin form at their free ends, and dropping into holes bored for them in the rails *a*. By removing the head-board *f*, the bedstead may be shut up so as to occupy very little space. A foot-board may be added in the same way, and will further strengthen the structure.

Equally simple in constructive detail, only requiring more wood, is the ordinary 4-post bedstead. As to material, almost any wood but deal is suitable, e. g. beech, birch, ash, mahogany. The joints are all simple mortices and tenons, with the addition of a special feature in the shape of a bed-screw. Dimensions vary with requirements; 6 ft. long by 5 ft. wide to $5\frac{1}{2}$ ft. by $4\frac{1}{2}$ ft. forms a "double" size; $5\frac{1}{2}$ to 6 ft. by $3\frac{1}{2}$ ft. is a "single" size; and cots are made smaller for children. The section of the frame timber may run from $4\frac{1}{2}$ in. by $2\frac{1}{2}$ in. to $3\frac{1}{2}$ in. by 2 in., according to the size of the bedstead. These measurements refer to the rough timber, and are reduced considerably by the planing down and perhaps turning. The legs may be $3\frac{1}{2}$ in. sq. in the rough. Their length will depend upon whether there is to be a foot-board, head-board, tester, or other addition to the frame. The height of the frame above the floor varies from 12 to 18 in., and the posts should in any case stand up some 12 or 18 in. above the frame, both to enclose the bedding and to afford sufficient material for the mortices which have to support the frame. When the legs are of minimum length they need only be planed smooth and square, and covered with a piece of chintz or other material, corresponding with that which is hung around the sides and ends to fill up the space between the frame and the floor; but when the legs are prolonged upwards to support head-board and foot-board, it is almost imperative to turn those portions which intervene between the mortices, or the appearance is very mean. The plan of the bedstead having been decided on, the 4 pieces for the legs and the other 4 pieces for the frame are planed up smooth and square. On the sides of the legs are marked where the mortices have to be cut for the reception of the ends of the frame, remembering that in each case there will be 2 contiguous sides of the leg to be mortised. Before proceeding to cut the mortices, which need only be $\frac{3}{4}$ in. deep, it is essential to mark the spot where a hole is to be bored for the insertion of the bed-screw.

Now, each post contains 2 mortices, as at *a*, Fig. 591, and a screw has to be inserted through the back (not side) of the mortice and into the end (not side) of the tenon; consequently the hole for the screw must be exactly in the centre of the post so far as its width is concerned, and this is ascertained by drawing diagonal lines, the centre being their point of junction, as at *b*. But as there are to be 2 screws inserted in the post, one *b* for the mortice which is hidden in the cut, and another for the mortice *a*, these holes must not be on the same level, or they would cross each other in the middle of the post—one must be at least 1 in. higher than the other. To ensure these holes being bored quite straight, it is well to mark opposite sides of the post, and bore half-way from each side. The size of the holes should be

591.

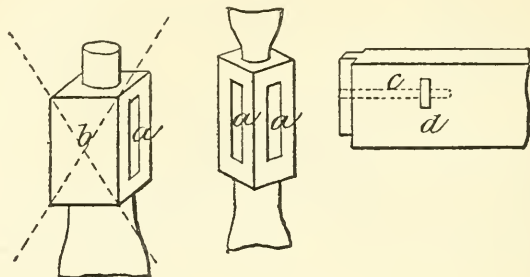

such as just to admit with ease the bed-screws available for the job, several sizes being made. At the outer surface of the hole a recess is cut to allow the head of the bed-screw to drop in out of the way. When the holes are completed, the mortices may be cut; and after this the legs may be turned according to any desired pattern, so long as the portions carrying the mortices are not interfered with. Next the tenons are cut out the ends of the frame-pieces and fitted into their respective mortices. Whilst in this position, each hole which has been bored in the posts is continued into the end of the frame-piece corresponding to it, as seen by the dotted line *c*, the hole being carried a little deeper than the full length of the bed-screw when its head is recessed. The holes will be alternately a little above and a little below the centre of the tenon, to admit of the screws crossing each other, and not in the exact centre. When a hole is finished, a notch is cut into the side of the frame-piece, as at *d*, with a sharp chisel, just large enough to receive comfortably the nut of the bed-screw, which must lie so that it is central with regard to the hole for admitting the bed-screw. The nut is made quite tight, so that it shall not revolve when the screw turns in it, by wedging in a little slip of wood, previously glued. When all these preparations have been completed, the bedstead is put together by inserting the tenons on the frame-pieces into the mortices in the legs, and screwing all up tight and firm by the bed-screws. If there is to be a foot-board, it is recessed a little into the legs, and a rail is then generally added above it to connect the tops of the legs. The head legs may also be of a height (5 or 6 ft.) to carry a canopy, the frame of which is mortised into the legs and further supported by angle irons. The recessed ends of the bed-screws are covered by little turned wooden cups made for the purpose.

Chest of Drawers.—This article of furniture may be divided into 3 parts—the case or frame, the cross pieces or partitions, and the drawers. A rough form is illustrated in Fig. 592. The sides *a* and bottom *b* of the case are of 1-in. pine about 18 in. wide. The bottom is let into a v-shaped groove in the sides, and further supported by blocks glued on to the sides all round underneath it. The cross pieces *c d* are dovetailed into the

top edges of the sides, and serve to hold the sides from spreading out. The cross pieces *e f g* are mortised into the sides of the case, but not so that the tenons come through to the outside of the case. The side ledges *h* running back from the cross pieces on each side of the case are glued and screwed to the sides. A board *i*, 3 in. wide and 1 in. thick, is notched into the cross piece *e* and the bottom *b* and supports by a mortice

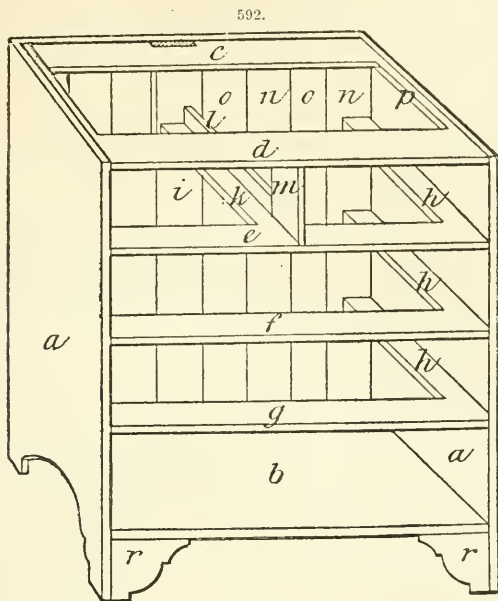

the bearer *k*, whose other end is mortised into the cross piece *e*; this bearer *k* carries the sides of the 2 small top drawers. A strip *l* placed edgewise on it is screwed from beneath on to the bearer *k*, and is replaced in front by a vertical partition *m* mortised into the cross pieces *d e*. The back, which is next put on, consists of alternate pieces of $\frac{1}{2}$ -in. and $\frac{3}{4}$ -in. stuff, the outer ones, as *n*, being $\frac{3}{4}$ -in.; these pieces are nailed to the cross piece *c* at top and to the bottom *b*, and the sides *a* are nailed to them. The thicker pieces *n* have their edges rebated so as to cover those of the thinner ones *o*, and thus the surface of the back is flush inside but irregular outside. The top is made of 1-in. pine, screwed on to the cross pieces *c d* and to 2 strips *p* from below, and lying flush with the back but projecting 1 in. over the sides and front. The strips *p* are fastened to the sides *a* by screws. The sides *a* are made in one piece, and are cut out at the bottom; angular pieces *r* glued into the front below the bottom drawer then give the appearance of dwarf legs. The drawers are made of 1-in. wood in the fronts, $\frac{5}{8}$ -in. in the sides and back, and $\frac{1}{2}$ -in. or $\frac{7}{16}$ -in. in the bottom. Their construction resembles that described on p. 290. The completed article may be painted, stained, or polished.

The preceding is not a very workmanlike plan. A superior way is as follows:—The case is made like a box turned up on end, all the corners having dovetail joints. The edges of the boards which come at the back of the chest are rebated about $\frac{1}{3}$ of their thickness to admit of letting the back in so as to lie flush with the sides, top, and bottom. The partitions for separating the drawers are made so as to completely cover the drawer immediately beneath, and are not merely strips for giving support; they are let into grooves previously cut for them about $\frac{3}{8}$ in. deep into the sides of the chest, and

instead of being formed of single boards, which are liable to warp, are built up of frames and panels, after the manner of a door, the joints being made by tongues and grooves, with mortices and tenons at the angles, and wooden pins driven through. The top is formed of an extra slab laid on the top of the case, projecting at the sides and front, secured by screws from below, and having a bead or moulding run round under it. The back is constructed of thin panelling, glued and bradded into the rebate in the sides. The bottom is added in the same way as the top, and may project rather more. A moulding is also run round it. The legs should be turned, and are fastened to the chest by a beech pin screwed into them and into stout beech blocks under the bottom corners of the case.

Dresser.—A useful form of kitchen dresser, removable at pleasure, is shown in Fig. 593. It is constructed out of best clean yellow pine, French polished. The ends are formed by 2 gables *a*, 5 ft. 2 in. high, 20 in. wide in the full body, 10 in. wide at the top drawers *b*, and 1 in. thick. They rest on strips *c*, 2 in. sq., and projecting $2\frac{1}{2}$ in. in front, to which they are mortised. The 3 large drawers *d* are surmounted by a slab *e*, 4 ft. long, $1\frac{1}{4}$ in. thick, projecting $\frac{3}{4}$ in. beyond the front of the drawers, and at a height of 3 ft. 2 in. above the floor. Being of the same width as the gables (20 in.), this slab does not reach the back of the dresser by $\frac{3}{4}$ in., thus leaving a space for the back lining. Boards *f*, 4 ft. long, $9\frac{1}{4}$ in. wide, and $\frac{3}{4}$ in. thick, are placed above and below the 5 small drawers *b*, which latter are separated by partitions 7 in. long, $3\frac{1}{2}$ in. wide, and $\frac{3}{4}$ in. thick. The fronts of the large drawers *d* are 6 in. wide, and of the small ones *b* $2\frac{3}{4}$ in. There is a clear space *h* 10 in. high between the 2 rows of drawers. As indicated in the drawing, the joints in the frame are made by mortices and tenons, the latter being of full depth and diagonally wedged. A shelf *i*, 4 ft. long, 18 in. wide, and 1 in. thick, divides the cupboard *k* into an upper and a lower compartment. A fore edge *l* and a back edge *m*, each 3 in. wide, 1 in. thick, and 4 ft. long, are mortised as shown, to support the weight of the large drawers *d*. The curves on the gables are cut as follows. The first one *n* is a quarter circle of 4 in. radius, the next *o* is a reversed quarter circle of $5\frac{1}{2}$ in. radius, the 2 being joined by a straight line; the top curve *p* is a quarter circle of 4 in. radius. The base rail *r* is 4 ft. long, $2\frac{1}{2}$ in. wide, and $1\frac{1}{4}$ in. thick, and mortised into the 2 gables *a* with its under side resting on the strips *c*. From the centre of the base rail, and mortised into it, rises the moulder *s*, also $2\frac{1}{2}$ in. by $1\frac{1}{4}$ in., 30 in. long, and mortised into the fore edge *l* at top. The case for the 5 small drawers is made by mortice and tenon joints, carefully fitted, planed, glued, and wedged. The wedging is done in the following way. Diagonal saw-cuts are made in the ends of the tenons before putting together, and for these are prepared little wooden wedges $\frac{3}{4}$ in. wide, $\frac{1}{2}$ n. long, and $\frac{1}{10}$ in. thick, tapering to a fine edge. When one wedge has been

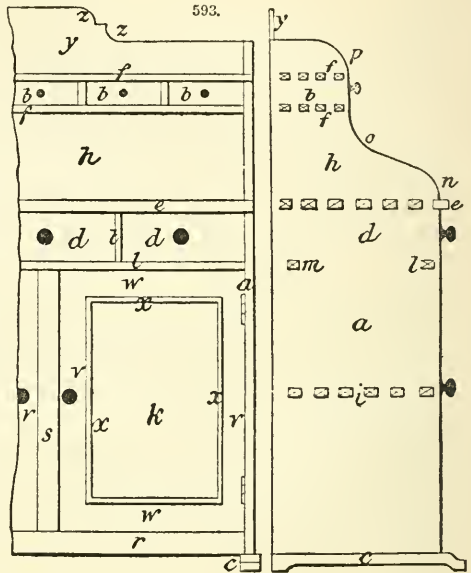

driven into one slit, a second is cut in halves and driven into the other slit at right angles to the first. The frame for the 3 large drawers *d* consists of the fore and back edges *l m*, into which 2 cross rails, 3 in. wide, are mortised exactly under the divisions *t* between the drawers. These divisions are 6 in. wide, and have tenons at top and bottom, fitting into mortices in the cross rails *t* and the shelf *e*. The cross rails may be thinner than *l* and *m*, but their upper surfaces must all be made flush. The frame, thus far completed, is glued, wedged, and cramped up till quite firm. The bottom is next fitted in so as to lie close up to the gable at each end, to the base rail *r* in front, and to the back behind, its ends resting upon the strips *c*, which project $\frac{1}{2}$ in. inwards for that purpose. The method of fastening the bottom to the base-rail *r* and strips *c* by screws presents some peculiarities, and is illustrated at *u*. At intervals of about 9 in. on the under side of the bottom, recesses are gouged out in triangular form, shallowest at the apex, and deepening to $\frac{1}{2}$ in. at the base, which latter is about $\frac{3}{4}$ in. within the margin. From the edge of the bottom $\frac{1}{4}$ -in. holes are bored through into these recesses, for the reception of $1\frac{1}{2}$ -in. screws, which are driven from the recess, as shown. The 3 large drawers are made of $\frac{7}{8}$ -in. wood for the fronts, $\frac{5}{8}$ -in. for the backs and sides, and $\frac{3}{8}$ -in. for the bottoms; the 5 small ones take $\frac{3}{4}$ -in., $\frac{1}{2}$ -in., and $\frac{1}{4}$ -in. respectively. The backs of the drawers may be $\frac{1}{4}$ in. lower than the sides, to prevent catching; and the drawers themselves may be $\frac{1}{16}$ in. shorter than their niches in the case, to ensure their shutting in flush with the front. The corners of the drawers are made with dovetail joints, and glued. The bottoms are let into grooves previously cut with a plough, and are further supported by narrow fillets glued beneath along the sides, and two or three blocks of hard wood along the front, the latter making contact with stops in the frame to regulate the degree to which the drawer is pushed in. For the 2 doors *k*, make 4 stiles *v* or upright pieces of framing, 3 in. wide, $1\frac{1}{4}$ in. thick, and 2 in. longer than the height of the aperture to be covered; also 4 rails *w* or horizontal pieces of framing, of the same width and thickness. Draw in the stiles for mortising and rails for tenoning. Find the height and width of the apertures in the dresser front, place the stiles on edge on the bench, and draw at each end with pencil, the breadth of a rail at the outer lines being a little farther apart than the height of the opening. Then mark off $\frac{1}{2}$ in. from the inner lines towards the ends. From this line mark off $1\frac{3}{4}$ in. towards the ends. Between these last 2 lines is the portion to be mortised, leaving $\frac{3}{4}$ in. at the extreme end to give strength to the frame. When drawing in the rails, deduct the breadth of the 2 stiles from the width of opening, allowing $\frac{1}{8}$ in. for fitting; draw in the shoulders at this with cutting knife. Gauge for $\frac{3}{8}$ in. mortice-iron in the centre of the stuff. Mortise about 2 in. deep, taking care to have all mortices in the centre of the stuff for their whole depth, otherwise the framing will be twisted. When the rails are tenoned the thickness way, gauge the inner edge of tenons $\frac{1}{2}$ in. to be ripped off, and $\frac{3}{4}$ in. bare to rip off the outer edge; then the tenon should fill the mortice. Cut it to within $\frac{1}{8}$ in. of the depth of the mortice. All these pieces, being mortised and tenoned, are grooved for the panels. This is done in the centre of the stuff with a flit plough and $\frac{1}{4}$ -in. iron, the groove being $\frac{1}{2}$ in. deep; all the grooving is done with the outer face of each piece towards the operator. The panels *k* are of $\frac{1}{2}$ -in. wood, and "fielded" on the front side, i. e. a ribbon about 2 in. wide is sliced off all round, so as to bevel the front face gradually to a thickness of about half at the edge. This fielded edge is let about $\frac{1}{2}$ in. deep into a groove cut for it in the inner edges of the pieces *v w*. When the frame and panel have been fitted and glued up, a small moulding *x* is run round in the angle. When the door is thus completed and has been duly cramped and dried, it may be fitted to the aperture it has to close, and its edges planed away smooth till the adjustment is perfect. The doors are not hung till the back *y* of the dresser has been put in. The back consists of $\frac{5}{8}$ -in. boards arranged to run up and down, or across, or partly both, according as the wood available best suits. The boards are united by groove and feather joints, and any exposed ends are contrived to come where they will not be seen. The curves at *z* in the top of the back are of

2 in. radius. The boards are secured by $1\frac{1}{4}$ -in. screws, and a bead is run round the edge. The stops for the small drawers may be glued on the back boards, and of such a thickness as to allow the drawer fronts to come $\frac{1}{16}$ in. within the face of the frame. The stops for the large drawers are 2 in. sq. and $\frac{1}{4}$ in. thick, and are screwed on to the frame under the drawers $\frac{1}{16}$ in. farther in than the point reached by the blocks on the drawers when their fronts are flush with the outside of the frame. The doors are hung on 3-in. brass butt hinges, and great accuracy must be observed in fixing the hinges, so that the doors hang perfectly square and free. Finally the whole work is sandpapered quite smooth, and polished, varnished, or painted.

GARDEN AND YARD ACCESSORIES.—This section is intended to include such articles of every-day use as wheelbarrows, coops, hutches, kennels, hives, flower-stands, and garden frames, as well as such elementary examples of rough building as greenhouses, summer-houses, fences and gates.

Wheelbarrow.—For ordinary work, good sound deal board $\frac{3}{4}$ in. thick is quite durable enough for the body of the barrow; elm lasts much longer under rough wear, but is much more costly and difficult to work. The dimensions will vary with the size of the person using the barrow, but on the average they may be as follows: Total length, including wheel and handles, 4 ft.; maximum length of body, 2 ft.; width of body, $1\frac{1}{4}$ ft.; depth of body, 10 in. While the body is 2 ft. long at top, it should slope back to 18 in. at the bottom, to allow for the wheel. The first step is to make a frame of $1\frac{1}{2}$ -in. or 2-in. stuff, measuring 18 in. long and 15 in. wide, but with the long sides of the frame projecting about 1 ft. forwards to carry the wheel, and about 15 in. backwards to form the handles. This frame should be dovetailed together at the corners. The body of the barrow is made with the sides perpendicular, while the tail-board may slope a little outwards, and the head-board (next the wheel) much more so. This body is formed with mortice and tenon joints. It is fitted to the frame either by tenons let into mortices in the frame, or by rebating the frame about $\frac{1}{2}$ in. all round on the inside. The legs are attached outside the body, and help to strengthen the whole. They should be cut with a shoulder at such a height as to support the barrow, when at rest, at a convenient distance above the ground. If let in about $\frac{3}{8}$ in. into the frame, so much the better; a $\frac{1}{4}$ -in. iron rod may be carried through the legs and frame from side and side, and 2 or 3 screws secure it to the body. A good wheel can be made by cutting a 10- or 12-in. circle out of a piece of 1-in. elm; a 2-in. sq. hole is chiselled out in the centre, to receive an axle formed of a piece of oak or ash, having a diameter of 2 in. sq. in the centre, but tapered off to about $1\frac{1}{4}$ or $1\frac{1}{2}$ in. at the ends. The wheel is strengthened by having a rim of stout hoop-iron "shrunk on," that is to say, the rim is made quite close-fitting, and is then heated ready for putting on; the heating stretches it and facilitates its being put on, when a plunge into cold water causes it to contract and hold firmly. The axle must fit very tightly in the wheel, and this is best secured by making the hole rather large and using wooden wedges for tightening up, driving them from opposite sides alternately. The ends of the axle are each shod with a ferrule, to prevent the wood splitting on driving in the iron pins on which the wheel is to revolve. These pins are square where they enter the wood, and round in the projecting part, which latter passes on each side of the wheel to the front shafts of the frame of the barrow. About the easiest effective way of connecting these pins to the shafts is to drive a staple into the under side of each shaft, of a size large enough to hold the pins without preventing their free revolution. In this way the wheel can be added last of all, and can be removed and repaired, if necessary, without injuring the frame.

Poultry and Pigeon Houses.—A useful size for a hencoop (Fig. 594) to place against a wall is about 4 ft. long, 2 ft. wide, $2\frac{1}{2}$ ft. high in front, and $3\frac{1}{4}$ ft. at the back. The framework will consist of 6 uprights *a*, a bottom plate *b*, top plates *c d*, and rafters *e*. All the wood but that for the rafters may be $1\frac{1}{2}$ in. sq.; the rafters are $1\frac{1}{2}$ in. wide, 1 in. deep, and $2\frac{1}{2}$ ft. long. The bottom plate is fitted to the uprights, at about 2 in.

above the floor, by halving each into the other. The top plates are fitted on in the same manner, and nailed up. This done, the rafters are cut out to a depth of about half their thickness, and fitted into the top plates. The roof may be formed of 7-in. feather-edge boards, long enough to overhang about 3 in. at each end, fastened by nailing them to the rafters, commencing at the bottom edge and lapping about 1 in. as they proceed; or it may be flat boarded, covered with felt, and thoroughly tarred. The right end is occupied by a door, the left end is boarded up like the roof, and the 3 front spaces are closed by galvanized iron wire netting. The door frame is made of wood $1\frac{1}{2}$ in. wide and 1 in. thick, and both it and the triangular space above it are filled in with netting. The floor is of $\frac{3}{4}$ -in. deal boards laid the short way. Perches must be fastened across inside. The wall forms

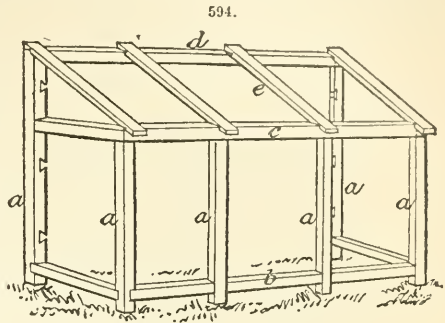

the back of the coop; therefore the coop should be tied to it by means of iron stays driven into the wall and nailed or screwed to the frame of the coop. A strip of sheet zinc having one edge driven into a course in the wall, and the other edge nailed down on the roof, will prevent wet finding its way down into the coop.

Fig. 595 is a plan of a fowl-house of more ambitious dimensions, arranged at the end of garden or yard, so that the back *a* and sides *b c* are formed by the walls of the enclosure, thus saving expense. Commencing at one end, the compartment *d* is a

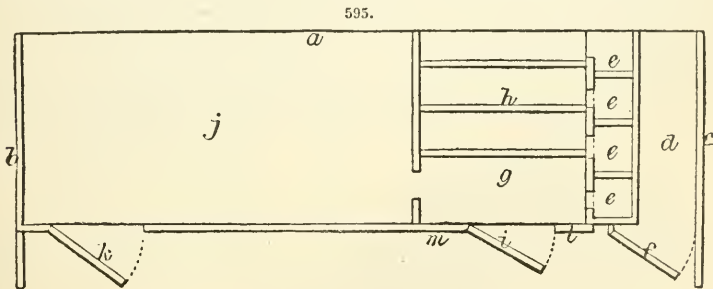

passage giving access to the nests *e*, and closed by a door *f*; *g* is the roosting-place, fitted with perches *h*, reached by a door *i* in front, and leading into the run *j*, also approached through the door *k*. In arranging the construction, it is best to pursue the following order. First make the front framing, which will consist of a bottom rail 3 in. sq. reaching from *b* to *c* at about 6 ft. from the wall *a*. Into this will be mortised at intervals a series of uprights, about 3 in. by 2 in. and 6 ft. high, these being nowhere more than 3 ft. apart, and in some places less to suit the positions of the doors. A top rail will next be fitted over the tenoned tops of all the uprights. At about 8 ft. from the ground a wall plate 3 in. by 2 in. is nailed to the wall *a*, and then the rafters are fitted to the wall plate and the front rail. Before proceeding to roof over and close in the framing, it is well to complete the internal fittings. These are better shown in Figs. 596, 597. The 3 perches *h* are rough poles with the bark on; they are arranged in descending order, and are sufficiently secured at each end by dropping them loosely into

wooden blocks nailed to the partitions. The nests *e* are raised a little above the ground, and closed in on all sides, including the top, a small hole being cut in front just admitting the hen. The fowls enter the nests *e* from the house *g*; the nests are provided with doors along the back, opening into *d*, both for the removal of the eggs and for the occasional cleansing of the nests. The front of the house, as far as the partition separating the run *j* from the roosting-house *g*, may be covered with galvanized iron wire

596.

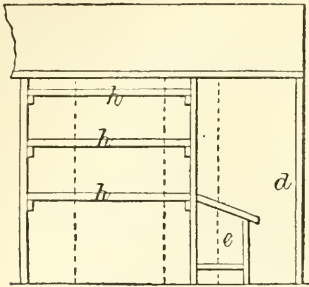

597.

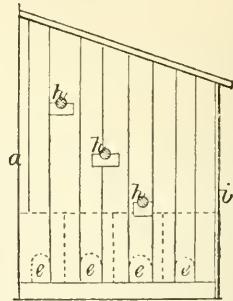

netting, the remainder is boarded. The doors *f i* may be of simple construction, such as 3 or 4 boards placed side by side and fastened together by cross pieces nailed to them. The portions *l m* of the front, coming between the doors, may be "weather boarded," i. e. covered with feather-edged boards overlapping each other and running horizontally. The roof is best boarded flat with $\frac{5}{8}$ -in. boards, then covered with felt and well tarred. A zinc gutter along the front adds to the comfort, and a piece of 3-in. zinc pipe inserted in the roof over the middle of the house *g* forms an efficient ventilator, when surmounted by an overhanging cap to keep out rain. The doors *f i*, being heavy, will need T-hinges, while butts will answer for *k*.

A rough pigeon-coop, only suitable for placing under the shelter of a roof, may be made as shown in Fig. 598, say 3 ft. long, 2 ft. wide, 20 in. high in the sides and 29 in.

598.

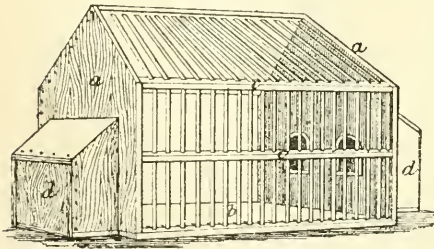

599.

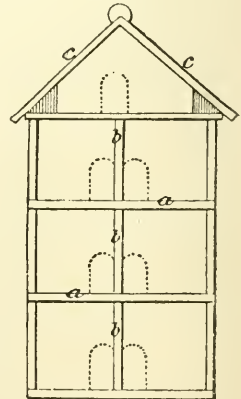

to the top of the roof. For the ends *a*, 3 strips of 8-in. by 1-in. deal board may be nailed to 2 cross pieces 2 in. by 1 in. The floor *b* is of $\frac{3}{4}$ -in. deal board laid the short way. The back and half the roof may be boarded in, while in the front are fixed 2 strips *c* 1 in. sq., joining the ends, and perforated at intervals of $1\frac{1}{4}$ in. by galvanized iron wires. At each end is attached a nest box *d* 18 in. long, 9 in. wide, and 16 in. high, with sloping top; it is made of $\frac{1}{2}$ -in. stuff nailed together. The nest box is entered by the

holes in the ends *a*. One or more of the front wires may be made movable for the egress and ingress of the birds.

A house for 7 couples of pigeons, adapted for hanging against a wall having a warm aspect, is shown in Fig. 599. The principal part of the house consists of a box of 1-in. deal, measuring 3 ft. long, 2 ft. wide, and 15 in. deep. Lengthwise it is divided into 3 compartments by 2 partitions *a* of $\frac{1}{2}$ -in. wood, and these are supported by 3 upright partitions *b* of $\frac{3}{4}$ -in. wood. The bottom of the box forms the back of the house. The front of the house is set back 3 in., so that the sides and floors of all the compartments project that distance beyond their entrances. The object of this is to secure greater privacy for each pair of birds. As the top of the box must be rendered sloping in order to throw off the rain, by the addition of 2 boards *c*, the triangular space thus enclosed forms a convenient compartment for a 7th pair of birds. The 2 boards *c* are best dovetailed together at the top, and protected by a zinc cap; they are secured to the top of the box by the intervention of 2 triangular strips which afford a solid bearing. The entrance holes indicated by the dotted lines measure about 6 in. high and 3 or $\frac{1}{2}$ in. wide, and are cut in the positions shown by means of a keyhole saw.

The following description of a combined poultry and pigeon house is condensed from an interesting communication made to *Amateur Work*. The ground at disposal measures 22 ft. by 8 ft., with walls on 3 sides; it is divided into 3 portions—a central covered-in house 6 ft. sq., and on each side a run 8 ft. sq. The house is divided into 2 unequal parts, one 6 ft. by 4 ft. for a covered shady run during hot or wet weather, and another 6 ft. by 2 ft. for a breeding house. The floor is sloped throughout from front to back, and trodden quite hard. The framework (Fig. 600) of the whole rests

600.

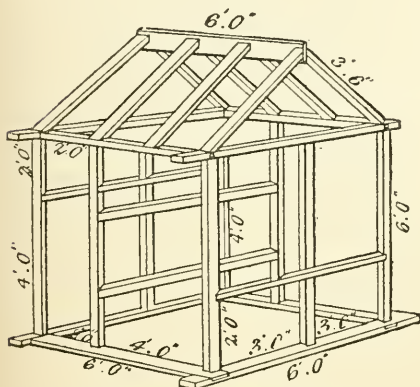

601.

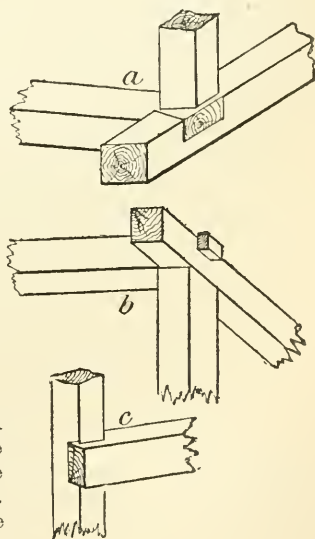

on a course of bricks, protecting it from damp and rendering it portable. The dimensions of the quartering for the construction of the house will be 4 8-ft. lengths of 3-in. by 3-in. for the 6-ft. sq. ground frame, and the upright joists and rafters are $2\frac{1}{2}$ in. sq. The joints employed are illustrated in Fig. 601, *a* being that of a corner of the bottom frame, *b* that of the upper frame with the upright, and *c* that of the cross pieces. In the larger division of the house, the cross pieces are placed 2 ft. from the ground as joists for the loose floor of the compartment reserved for fowls and egg-boxes, this floor forming at the same time a roof to the dry shed beneath. In the smaller division

of the house, the joists are 4 ft. from the ground; the lower part is set aside for nesting places, and the upper serves as a pigeon-loft extending to the roof. The object in putting the nests (for sitting) upon the ground is to give the eggs, during incubation, the benefit of the moisture of the earth. Hence the dry run underneath the larger compartment goes no farther than the wooden partition which intervenes. The upright which bisects the front of the house is intended for a stop for 2 large doors, hanging from the outer supports. The 8 rafters, each $3\frac{1}{2}$ ft. long, for the roof are simply nailed in position, the plank placed at the apex acting as a sort of keyboard, and the weight of the roofing material afterwards added being sufficient to make all secure. So far the framework may be made in the workshop, and taken to its place for putting together, temporarily strengthening it by nailing a few diagonal stays to it.

For roofing the building, sheet zinc is perhaps the most suitable material. Felt harbours vermin, requires early renewal, and necessitates a wooden roofing underneath it. Corrugated iron is expensive, and is very hot in the sun and very cold in time of frost; moreover, it wears badly, and soon begins to leak where nails are driven through. Zinc is one-third less expensive, looks as neat, is twice as durable, and can be fixed without trouble. For the roof, 63 sq. ft. of No. 10 zinc will be needed. The weight should be 17 lb. to the sheet, measuring 6 ft. 8 in. wide; 3 such sheets will be sufficient, and if one of them be cut in two, they may be overlapped an inch or so, and, with a few nails, all soldering will be avoided. Out of the same quantity, 3 pieces 12 in. wide and 3 ft. long may be cut. With these, a semicircular ridge, to bend over the key-board of the roof, can be formed; and if care has been taken not to carry the sheets of zinc quite up to the top, a species of ventilator will be the result, the air having free access to the channel running the whole length of the building, whilst direct draught is obviated, and no rain-water can enter. The roof will have eaves extending 4 in. from the sides of the house. In addition to the ventilation provided by the channel on the crown of the roof, it will be found that the zinc plates, resting on the rafters, will not fit closely to the 2 sides of the house, but an aperture will be left underneath the eaves. This aperture should not be wholly closed in as a well-ventilated but not a draughty roosting-house is a necessity. A wooden strip $2\frac{1}{2}$ in. wide should, however, be nailed horizontally under the eaves.

For boarding in the 4 sides, the cheapest, warmest, and most weather-tight material is 6-in. match-lining (it is practically $5\frac{1}{2}$ in. in width). No planing will be wanted, except that which it has received at the mills. The tongue-and-groove method of joining each strip to its fellow, ensures the air-tightness of the interior, and prevents the possibility of the boards themselves warping; in addition, the superadded beading lends an ornamental appearance to the exterior. This match-lining is bought by the "square" of 16 ft., and 3 such squares, at 11s. 6d. each, will give ample material.

The principal distinguishing feature of this poultry-house is the facility with which every part of the interior can be reached without requiring to go inside. Wherever a place is inconvenient to reach the chances are cleansing will be neglected and dirt accumulate, a state of things fatal to success. Therefore, in the whole arrangement of the compartments, every corner is easily accessible; hence the structure consists almost entirely of doors. But the match-lining throughout being used horizontally, the number of doors is not obtrusive, as many of them are hardly noticeable.

Figs. 602 to 605 represent the 4 sides of the house. The rear (Fig. 602) is boarded up from top to bottom with the exception of 2 widths of match-lining 4 ft. from the ground, which are battened together to form a flap *a*, and are hinged as shown. This flap *a* is to allow the loose flooring of the pigeon-loft, situated in the uppermost part of the building, to be withdrawn whenever necessary, that the boards may be cleansed. The left side (Fig. 603) of the poultry-house faces north. The small door *b* is hinged to the outer upright, and does not extend quite to the top. By it the pigeon-lockers are gained. Underneath it is door *c*, hinged to the same upright, and allowing good height

(4 ft.) to permit of entrance to the breeding-house for fowls, the nests in which, it will be remembered, are placed on the ground. *d* is simply a larger flap than *a*, consisting of match-lining battened together to the width of 2 ft., and hinged from the plank above it. When down, this flap shuts in the dry shed running under the roosting compartment; when open at an angle it enlarges that shed, admitting at the same time fresh air.

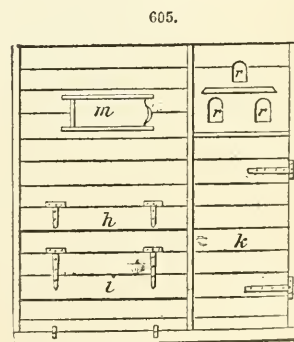
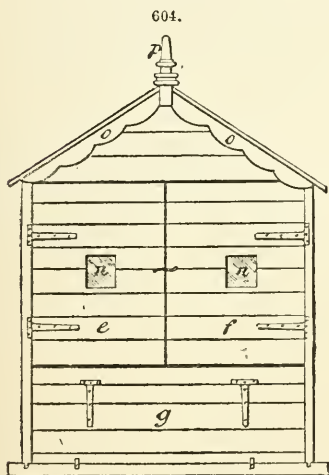
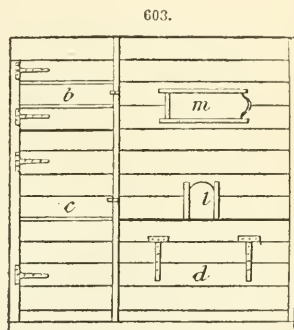
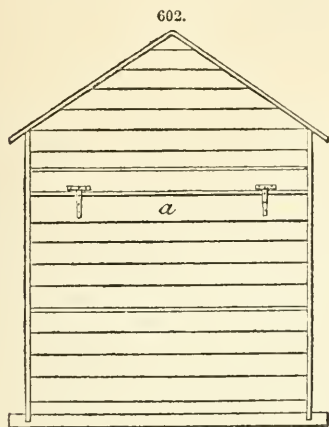

Passing to the front of the house (Fig. 604) doors *e f*, each 4 ft. high by 3 ft. wide, open up the entire roosting compartment. It is important that this pair should be made to fit well. Below is *g*, a flap similar to *d*, but 2 ft. longer. It is intended to allow of the earth of the dry run being removed from the front without the inconvenience of entering the closed yards. The material forming the floor should be changed as often as it becomes polluted. On the right side (Fig. 605) of the house facing south are 2 flaps, viz. a small one *h*, 10 in. deep, which opens on to the egg-boxes, and a larger one *i*, identical in every respect with *d*, on the opposite side. When it is wished that the door run should be at the disposal of one yard exclusively, it will be necessary to keep door *f*

closed, but when there are no chickens and pullets to occupy the other yard, and the whole of the available space is to be given to the adult birds, by lifting flaps *d* and *i* at the same time, the dry shed accommodation will be much increased. The last entrance *k* is 4 ft. high, and leads into the breeding-house. The open space above it is the dormer part of the pigeon-house.

There are 4 windows to be added: one *m* on either side, the glass of which slips backwards and forwards in a rabbet; and 2 *n* in the front which are for lighting purposes only, the glass remaining fixed, with strips of wood at the back and a beading in front.

Preliminary to fitting the doors, lengths of 2-in. pine beading are nailed to the uprights as a stop. All the doors are made in the same way, consisting of match-lining nailed to 2 battens formed of the same material, sawn in half. Flat-headed wrought-iron $1\frac{1}{2}$ -in. nails should be used, as they drive cleanly into the wood. Some time will be spent in this part of the work, and open-air labour will be saved by nailing together the doors full-large in the workshop, and afterwards fitting each by sawing it to its exact dimensions and planing down the edges when ready. Cross-garnet or T hinges are the best suited to bearing the weight of the doors. For the two largest (*e* and *f*), the 16-in. size will be required, as the strain is great from the side. All the other flaps and doors have the 10-in. size. The hinges should be so placed that the $\frac{3}{4}$ -in. screws fixing them may be in the centre of the plank. The doors which form integral parts of the divisions of the house, necessary to be weather-tight and warm, should be nicely constructed, and some trouble taken in fitting will be amply repaid. The flaps to the dry shed are not so essential, and less care may be expended upon them. Should the doors warp in the fixing, no great anxiety need be felt, for when they have been hung a short time they will be sure to regain their right shape. They should all be secured with wooden buttons. The window and other apertures should be cut when the match-lining is fixed, a key-saw being first used. They will not lessen the strength of the walls if cut in the centre of the planks.

The exterior of the fowl-house should now receive its first coat of paint, 3 coats being the rule. Priming of the ordinary description may be used for the first. If prepared priming be used, it is the more necessary to paint swiftly, as it dries in almost immediately. About 12 lb. of paint will be needed for the first coat. The main thing to be observed is that the beading shall be properly covered, and therefore the better plan is to paint this first carefully, and afterwards go over the planks, filling in all white places wherever they may be noticed. If beading and planking were treated simultaneously, it would be difficult to discover whether the former had been properly done. For the second coat about the same proportion of lead colour should be laid thinly on, and these 2 coats should suffice to preserve the wood effectually. The third coat may be according to fancy.

On reference to Fig. 603, showing the left side of the house, it will be seen that there is a small opening *l*, 9 in. high by 6 in. wide, with a circular top. This is the entrance for the fowls, and it is closed with a sliding panel. When desirous of keeping this panel raised, a loop of wire attached to a screw in it may be slipped over a second screw placed a few inches above it on the side of the house. To prevent the sliding glasses of the windows from being withdrawn too far, a screw should be driven in almost flush some few inches beyond the aperture on the side to which each pane is slipped.

To complete the front of the house, 2 planks *o*, cut to an ornamental pattern, are nailed under the eaves, but not close up to the match-lining, the intention being to allow a current of air to ascend under them, finding its way to the channel on the ridge of the roof. These boards may be mortised into a spike *p*, which gives a finish to the whole, and nailed at their further extremities to the projecting strip of wood running under the zinc plates at each side of the house. On the right side of the building, 3 pigeon-holes *r* are provided. These should be cut in a permanent partition, their measurement being

6 in. by 4 in. The partition should be nailed to the inner side of the uprights and 2 shelves, one under each opening, added to serve as an alighting board, which ought not to measure less than 6 in. in width.

The interior remains to be dealt with. As a preliminary, any spare mortar, sand, and lime may be thrown into the dry run, where it will tread down and form an excellent floor. As a means of protection against the burrowing of rats, whilst retaining the advantages of the moisture of the natural soil, a length of 18-in. galvanized wire-work, 1 in. mesh, should be placed on the floor of the breeding compartment. A little mortar will be sufficient to keep it in position.

In the whole interior is but one permanent partition—that is, there is a single part only which is nailed, all the other portions being removable at pleasure. The exception is the boarding which divides the breeding compartment and pigeon-loft above it, from the dry shed and roosting-house. If the first pair of rafters from the back have been placed to correspond with the uprights 2 ft. from the rear, as shown in Fig. 600, the match-lining, nailed vertically, may be secured to them at the top, and to the uppermost joist at the bottom, taking care to nail the planks on the side to allow the top of the joist to remain free to support the flooring of the pigeon-loft. No difficulty will be met with if the match-lining be sawn into 2 lengths, the shorter to reach from the roof to the first pair of joists in the smaller part of the house on the one side, and the longer planks to be nailed to the same pair of joists on the opposite side, and to extend to the ground, in which a piece of quartering 3 in. by 3 in. should be sunk as a stop. If the measurements are a little out, a fillet of wood nailed to the joists will make everything easy. As regards the flooring, all that requires to be done is that broad planks be sawn to the exact length, and fitted to extend from back to front. The boarding need not be of more than $\frac{3}{4}$ -in. stuff, but the broader the planks the better, for they will be easier to remove when it is desired to cleanse them, or for any other purpose, and the quicker to replace when that purpose is accomplished. If the flooring be of a slight nature, however, a plank strong enough to bear a man's weight should be made fast in the centre of the fowl-house, for it will be found convenient to stand upon it, and so obtain command over every corner of the roof. The flooring in the pigeon-loft is best made of planed wood, as it is the most easy to clean. The advantage of having it loose is obvious, for by lifting one or two of the planks the whole of the loft may be easily reached by a person entering the breeding-place underneath.

In the roosting-house, there remain to be fitted the nests and the perches. The former consist of a strip of wood, 4 ft. in length and 4 in. high, which forms the front to a set of 4 egg-boxes, each 12 in. wide, and without bottom, which are simply made by nailing at every foot an upright piece of board 11 in. wide and 18 in. high. Stability may be given to them by a thin length of wood, nailed along the top. As a back to this row of nests, a piece of wood 4 in. high should be dropped into grooves attached to the uprights of the building on the right and left of flap *h*, against which the skeleton boxes should be set so that a person by lifting the flap may take the eggs out of the boxes without entering the house. The reason why the back of the nests should be movable, is that they may be cleaned without inconvenience. The arrangement of the nests and perches is shown by Fig. 606. *a* is the skirting nailed to the front of the boxes; *b*, the movable back running in grooves at each end; *c*, the hinged flap on the outside of the building; *d*, a wide shelf resting upon, but not attached to, brackets, and serving a double purpose: first as a roof to the egg-boxes beneath, giving them that privacy in which laying hens delight; and, second, as a tray to catch the droppings of the fowls roosting upon the perch *e*, which is slipped into sockets 4 in. above it. This plan is

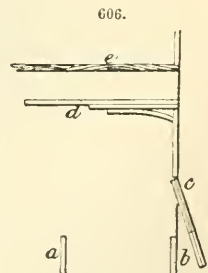

highly desirable, conducing as it does to the rapid and effectual cleansing of the house daily. The shelf will also serve to prevent the fowls from an upward draught, which may arise from deficiencies in fitting the floor-boards.

The fittings of the pigeon-loft consist of a shelf placed 12 in. above the flooring, on which is an oblong box, without top or bottom, and divided in the centre so as to form a pair of nests, which are reached by an alighting board. A similar contrivance is on the floor below it, and other lockers may be put elsewhere if required. A house of the dimensions stated should accommodate with comfort 6 fancy pigeons and 8 or 9 adult fowls, besides chickens. In regard to the latter, when a hen becomes broody her proper place is in the compartment reached by door *c*, where a nest may be made up for her with 3 bricks and some moist earth. So soon as the chicks are hatched, they may be allowed the run of the compartment, and as they grow older may be given the use of one yard, from which the grown fowls are excluded by closing flap *i*. Should great pressure be felt in respect to accommodation for young chickens, an excellent run sheltered from the weather is furnished by the dry shed under the roosting house, the adult fowls being temporarily deprived of it by dropping flaps *d* and *i*. Sunshine and air, combined with perfect safety from cats and vermin, may be afforded by wiring in, with 1-in. mesh netting, the front side of the run; and if a piece of small quartering be secured to the bottom of the wirework, whilst the top depends from staples driven into the joist above it, the protecting barrier may be readily raised when food and water are to be given.

The fowls enter the house from the yards by the side doorway already described, which they reach by means of a ladder made of a plank, with half a dozen steps of beading 4 or 5 in. apart. If a staple be driven through the plank and the flap *d*, a peg will suffice to keep both in position; by withdrawing the peg, the flap falls and the dry shed is closed in, whilst the ladder remains in its proper place. With regard to the yards, the uprights are of 2½-in. by 1½-in. quartering, mortised into a bed of 3-in. by 3-in. stuff. The rafters are 2 in. by 1½ in. The wire below is 1-in. mesh nailed to a plank 1 ft. high. For the remaining portion of the runs, 1½-in. mesh netting is used. A door is at each extremity. Following is a statement of the actual cost of materials required for the combined pigeon and poultry house, exclusive of the yards:—

	£	s.	d.
Quartering	0	18	0
Odd planking	0	2	6
Bricks and Lime	0	3	6
Wood (beading)	0	2	0
Hinges	0	6	2
Zinc for Roofing	0	14	0
Match-lining	1	14	6
Glass	0	1	9
Paint	0	14	0
Nails and Screws	0	3	7
	<hr/>		
	£5	0	0

The same writer in *Amateur Work* suggests a useful adjunct to the preceding arrangement, for the breeding season, to supply the following demands: (1) secluded spots for sitting hens, the nests placed on the ground, so that the eggs may benefit by the natural moisture of the earth; (2) dry runs for young chickens, in which they may be housed with the mother hen during wet or windy weather; (3) dust bath and ash box for the growing broods, chickens being particularly plagued by insects; (4) coops for fattening cockerels for killing. For pigeons, the most pressing demands are: (1) pairing

pens; (2) hospital quarters for lame birds; (3) cages for prize pigeons, or valuable specimens. To supply these requisitions, if the articles be purchased separately from makers, must entail considerable outlay; while for the home construction of a suitable contrivance, the cost for material should not exceed 15s.

Fig. 607 is a sketch of the completed house. Tier *a* is a portion allotted to pigeons, and as the flooring does not extend for more than $\frac{2}{3}$ of the length the birds can readily obtain access to it from below, where on tier *b* they are provided with a run, partly roofed, and a compartment in which to nest, reached by holes, and placed within command of the owner by means of a door on the outside. The remaining lower half of the house is apportioned to chickens. On tier *c* are two boxes—one containing lime and loam, the other cinder-ashes and calcined bones. These boxes are easily lifted, and as they serve to roof over the run underneath, means of reaching the innermost recesses of that part are at once at hand. The sketch represents this lower run shut in by 2 flaps *d e*. Behind the front and larger flap *d* galvanized wirework is permanently fastened. In the case of the smaller flap *e*, this wirework is stretched on a frame swinging from above, and so arranged that, fastened back at an ascertained angle, the chickens find room for free ingress and egress under it, whilst the hen is not permitted to have her liberty, the aperture not allowing of her escape. In fine weather, both the outer flaps are opened, thus allowing the light to enter the run, and in themselves providing platforms, of which the chickens avail themselves when basking in the sunlight. Closed, the flaps effectually exclude wind and wet, and render the quarters warm and secure; and again, when both are fastened down, there is ample room for 2 broody hens, which do not appreciate too much light, and require to sit on the soil. The same space may be converted into fattening pens for cockerels whenever occasion arises.

In the construction of the house, the measurements were decided with special reference to the economical use of wood as purchased in small quantities at a timber yard. The framework is formed of quartering $1\frac{1}{2}$ in. sq. obtainable retail in lengths of 12 ft., at 5d. per length. Fig. 608 gives an idea of the skeleton of the whole, and Fig. 609 depicts a frame, of which it is necessary to make 2—one for each end of the house, which is 6 ft. in height and 2 ft. in depth, the length and breadth of the frame. The frames, stood up on end, 4 ft. apart, are braced together on either side by widths of

607.

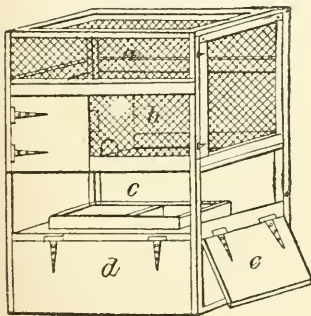

608.

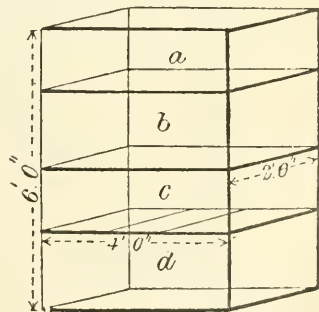

quartering, put 18 in. from top and bottom. As to how the frames are made, Fig. 610 represents the bottom corner, *a* being the detached pieces of wood before they are screwed together. Fig. 611 in the same way shows the cross-bar mortice. Fig. 612 gives a portion of the left-hand corner of the entire skeleton, *a* being the cross braces, 4 ft. in length, and *b* the bar bisecting the frame shown in the smaller sketch in Fig. 608. All the joints are of the simplest mortice; they are quite good enough for the purpose in

view, for every board hereafter added to the structure increases its stability. Order 5 lengths of quartering, and these can be cut to the required measurements with a minimum of waste.

In Figs. 607 and 608 on tier *e* in the skeleton sketch, 4 short cross pieces connecting the lower pair of braces are shown. These can be of $\frac{3}{4}$ -in. wood 2 in. wide, and 2 similar pieces can be nailed on the top of the frames from corner to corner, as an additional stay; 2 lengths will afford sufficient stuff. With the framework thus erected, the braces on tier *a* will form joists for the flooring, which is to go $\frac{2}{3}$ only, or length of the compartment. This flooring consists of pieces of $\frac{3}{4}$ -in. match-lining, 6 in. wide. The rabbet and groove arrangement locks the several boards into one safe whole, which answers the double purpose—that of a roof to the nests below, and of a platform upon which the pigeons parade in the sunshine. To maintain a rapid disposal of rain-water, give this platform an incline from left to right, which may be done by nailing a tapering fillet of wood upon one end of the joists. The same plan serves for the flooring below, which, in its turn, protects the ash-box and dust-bath beneath; in this case, the floor boards run lengthways instead of across, and the fillet without, being tapered, must be attached to the cross bar of the left-hand frame.

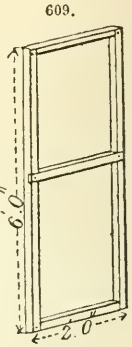

For the sake of economy, it is best to employ match-lining on the other parts of the house, using say 3 lengths of 16 ft. each at 1*d.* per ft. run. Match-lining should be nailed round 3 sides of tier *a*, as shown in Fig. 608. A door 15 in. wide is made by battening the wood together, with the planed surface outwards; it can be hung to the upright by means of 6-in. garnet hinges, at 3*d.* per pair. To divide the breeding place from the run, a few pieces of board nailed together, having

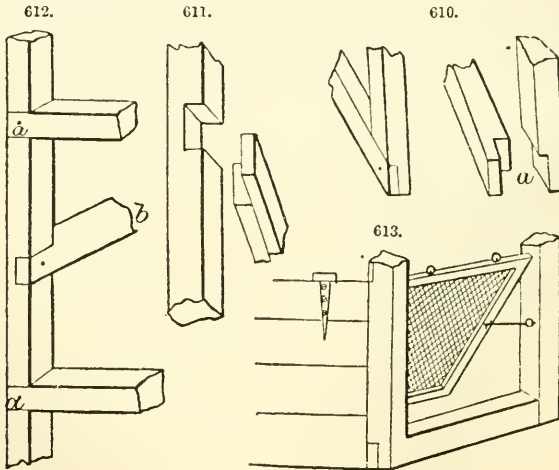

pigeon-holes cut therein, may be kept in position by means of a slide at top and bottom; it will also be necessary to board in that portion of tier *b* at the side and back. Tiers *a b* are under control by the addition of the door at one end; measuring 3 ft. in height and 2 ft. in breadth, it answers for closing in the ends of both tiers, one large door being more convenient and practicable than 2 small ones. This door is a light frame,

constructed on the same model as that which is given for the frame in Fig. 609; but the quartering used is only 1 in. sq., the price being 2½*d.* per length of 12 ft.—of which one will be just enough. It may be attached either by hinges or with latches; the latter permit of the door being unhooked and carried out of the way. To complete the pigeon part of the house, wirework is wanted to enclose the vacant spaces. A mesh of 1½ in. will do, taking 2 yd., 2 ft. wide, and 4 yd., 1 ft. wide.

On tier *c*, all that needs attention is the fitting of a skirting to cover in that portion not already roofed, by the 2 boxes shown. Such boxes (old brandy cases) which are thoroughly well made, and measure 20 by 18 in. may be bought of a grocer for say 4*d.* a piece. The skirting consists of the match-lining already obtained.

Tier *d* is all the better if made draught free, and for the sake of warmth, match-lining may give place to stouter planks, unplanned, with which board in on 2 sides, one end, and the back permanently. The flap, or front is of like material, one board in width, and hung by garnet or T-hinges to the brace, or joist above. The structure is skirted with planks, screwed to the 4 uprights. At one extremity, the smaller flap *e*, drawn partly open in Fig. 608, is hung in a similar manner, but as it is now and then required to be thrown right up, it is made of match-lining, as less weighty. It has already been explained that under the flaps wirework (1-in. mesh) is stretched in the front as a permanency, and at the end in the form of a swing door. Fig. 613 indicates a mode which answers to confine hen and chickens, or hen alone, at will, according to the angle at which the door is raised and suspended by a stay-hook.

Below is a detailed account of expenditure for materials; by working with screws instead of nails throughout, every part may be rendered easily detachable and capable of being packed away in small compass, either for removal when changing residence, or storage during the winter months.

<i>Cost of Materials.</i>				<i>s.</i>	<i>d.</i>
5	12-ft. lengths	quartering, 1½ in. square, at 5 <i>d.</i>	2	1
2	" "	¾-in. stuff, by 2 in., at 5 <i>d.</i>	∴ ..	0	10
3	16-ft. "	¾-in. match-lining, 6 in. wide, at 1 <i>d.</i> per ft. run	4	0	0
1	12-ft. "	1-in. quartering, at 2½ <i>d.</i>	0	3
1	" "	1-in. planking, 11 in., at 1 <i>s.</i>	1	0
2	old brandy cases, 20 by 18 in., at 4 <i>d.</i>	0	8
3	pair 6-in. garnet hinges, at 3 <i>d.</i>	0	9
	Nails and screws, catches, say	1	5
2	yd. wirework, 1½-in. mesh, 2 ft. wide, at 4 <i>d.</i>	0	8
4	" "	" " 1 ft. wide, at 2 <i>d.</i>	0	8
2	" "	1-in. mesh, 1 ft. wide, at 4 <i>d.</i>	0	8
	Paint (3 coats)	1	0
				<hr/>	
				14	0

Hive.—The construction of a good bar-frame hive at a low cost out of an old tea-chest is thus described by A. Watkins.

Materials.—A full-sized or Indian tea-chest, another packing-case, at least 6 in. longer than the tea-chest, containing some sound ½-in. boards. Have the lids with the boxes. The 2 will cost at the grocer's 1*s.* to 1*s.* 3*d.* The tea-chest is left whole to make the body of the hive; the other box is knocked down for the boards in it. In the frames, a piece of best pine is necessary 2 ft. by 11 in.; have it sawn by the circular into 2 equal boards: they will be ¾ in. thick. If at the same time you could get these boards sawn into strips 7⁄8 in. wide, it will save a deal of trouble. You will also want a bit of ¼-in. board for cutting up into strips for the bottom of the super case; 17 in. by

6 in. will do. 1 lb. of $1\frac{1}{4}$ -in. wire nails, and a few of the deepest round flat-headed shoe-nails, to be had from the currier's, will also be wanted.

Frames.—These are to be made first. If your pine board is not already cut up into $\frac{7}{8}$ -in. strips, you must do so by means of a cutting gauge (not a marking-gauge). Set the cutting knife $\frac{7}{8}$ in. from the movable block, the knife projecting a full $\frac{1}{8}$ in. Make a cut along one edge of the board, keeping the block tightly pressed against it. Do the same on the other side, and a strip of wood $\frac{7}{8}$ in. wide will easily break off. The whole of the boards must be cut up into strips, and it will be well to plane the edges. Cut the strips to exact length. You will want 11 for top bars $15\frac{1}{2}$ in. (bare) long, 10 for bottom bars, 14 in. long, 20 for side bars $7\frac{3}{4}$ in. long. Cut them off exactly square. The frames (as shown in Fig. 614) must now be nailed together in the frame block.

They are of the Association size, but with a shorter top bar ($15\frac{1}{2}$ in. instead of 17 in.). This makes the hive and super case simpler to make than with a long top bar. The top, sides, and bottom of frame are made of the same thickness of wood for the sake of simplicity; but if the hive-maker possesses a circular saw, he may follow the Association dimensions exactly. The frame under consideration has the same outside dimensions as the Association, and will fit into any Association hive.

Frame Block.—A piece of board, thickness not important, is cut off 17 in. long, and $8\frac{1}{2}$ in. deep; 2 strips (*a*, Fig. 615), 1 in. square, and $8\frac{1}{2}$ in. long, are nailed across the ends exactly square, and with a space of 14 in. between.

The ends of the strips are level with one edge of the board. Another 1-in. strip *b* is pivoted in the centre by a screw, the ends are rounded off, and the sides are held firmly while being nailed. Two nails are driven half-way in $15\frac{1}{2}$ in. apart, and serve to keep the top bar in its place while being nailed.

Division Board.—This hangs in the hive in the same manner as the frames *d*, Fig. 616. A piece of $\frac{1}{2}$ -in. board is cut $14\frac{1}{2}$ in. long, and $8\frac{1}{2}$ in. wide; a top bar $15\frac{1}{2}$ in. long nailed to the top edge, and 2 1-in. strips across the ends to keep it from warping.

Distance Guides for Frames.—Advanced bee-keepers often dispense with these, but they are useful to a beginner. The flat-headed shoennails are driven into each side of the top bar ($\frac{1}{4}$ to each frame), $1\frac{1}{2}$ in. from each end; the distance between the heads of the nails should be $1\frac{1}{8}$ in., so that the frames will be that distance apart from centre to centre, when hung in the hive; they are indicated in Fig. 614 by small circles on the line above *e*.

Body of Hive.—The stand and flight board *a b*, Fig. 616, should be made first; they are fixtures to the hive; 2 pieces of board, 4 in. wide and as thick as convenient (not less than 1 in.), are cut with one end slanting, the shorter side the same length as the outside width of the chest, the longer 6 in. more. They are nailed on edge underneath the bottom of the chest, and the flight board *b*, $7\frac{1}{2}$ in. by $\frac{1}{2}$ in. and the same length as the

614.

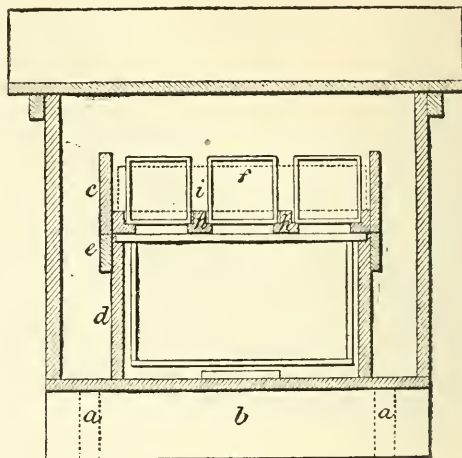

615.

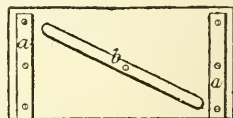

chest, is nailed on the sloping ends. The entrance slit, 4 in. long and $\frac{3}{8}$ in. high, can now be cut; it is shown by dotted lines in Fig. 614. In order to fit up the interior of the hive to receive the frames, 2 pieces of $\frac{1}{2}$ -in. board $8\frac{1}{2}$ in. wide, and the same length as the interior width of the chest (from back to front), are prepared. One edge of each is bevelled for the frames to rest on, and a strip of $\frac{1}{8}$ -in. wood *e*, Fig. 614, about 2 in. wide and the same length as the board, is nailed to the bevelled side, and $\frac{5}{8}$ in. above the top edges; then a stout strip is nailed across the ends of the boards on the same side as the top strip. The 2 boards thus prepared have now to be nailed across the chest exactly $14\frac{1}{2}$ in. apart; but before doing so, it will be well to clearly understand their use. They form the support for the frames, the projecting ends of which hang on the thin upper edges. It will be seen that the frames do not touch in any other part, but that there is "bee space" between them and the sides and bottom. This space is important, therefore the outside size of the frames and the inside size of that part of the hive which contains them should always be exact. In nailing the 2 boards across the inside of the chest (as shown in *d*, Fig. 614) the division board will form a good guide to keep them the requisite $14\frac{1}{2}$ in. apart, and as it is difficult to nail from the outside into the ends, it will be best to nail from the inside, through the strips at the ends of the boards.

Super Case.—Sectional supers are used by most advanced bee-keepers; they can be bought much cheaper and better than they can be made, and as the most used (and probably the best) size is $4\frac{1}{2}$ in. sq. holding when filled 1 lb. of honey, a case will be described to take that size. A bottomless box (*c*, Fig. 614) is made of $\frac{1}{2}$ -in. board, $4\frac{1}{2}$ in. (full) deep, and $16\frac{1}{2}$ in. by $15\frac{1}{2}$ in. outside measurement. Four strips (*h*, Fig. 614), each $15\frac{1}{2}$ in. by $1\frac{1}{4}$ in. by $\frac{1}{4}$ in., are nailed across the bottom of the box, being let in flush; 2 of them are at the outside, the other 2 at equal distances, forming 3 equal spaces between; 4 strips (*i*, Fig. 614) $14\frac{1}{2}$ in. by $\frac{1}{2}$ in. by $\frac{1}{2}$ in. are nailed on the top of the wide strips, the 2 outer ones against the sides of the box, the others on the centre of the strips. There must be a space of a little more than $4\frac{1}{4}$ in. between these strips, as they serve to keep the sections the right distance apart. 21 sections, 7 in each row, are placed in the case: they do not quite fill it; but a thin board $15\frac{1}{2}$ in. by $4\frac{1}{4}$ in., with notches cut out of the lower edge to fit over the strips, serves to wedge them up together. "Separators" made of tin, or exceedingly thin wood, not thicker than cardboard, each $15\frac{1}{2}$ in. by $3\frac{1}{4}$ in., are placed between the sections, as shown by dotted lines in Fig. 614. They are necessary to keep the combs from bulging into each other: if they are not used, the sections, when filled, can only be packed in the order in which they come out of the hive. The section case is shown in its place in Fig. 614, but omitted in Fig. 616.

Roof.—This is the most unsatisfactory part of a large hive like this to make. The chief fault is that it is heavy and cumbersome to lift off. A good carpenter, with new boards to work on, would do better to make the roof of a gable shape instead of flat, and it would be worth while to try the waterproof paper roofing, which is not expensive,

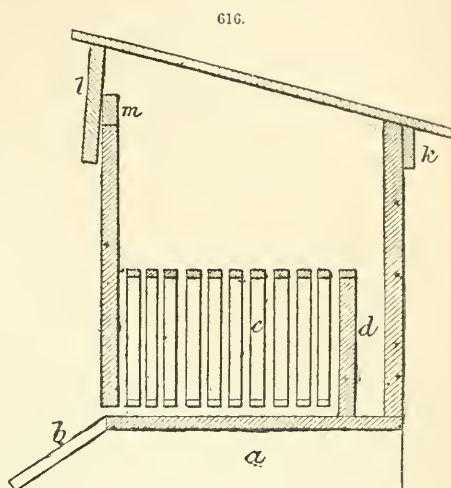

and very light. To describe the one illustrated: its sides are made sloping like a desk or garden frame, and large enough to slip easily over the hive top like the lid of a box. The front of the roof (*k*, Fig. 616) may be 7 in. deep, and the back 2 in., so that they may both be cut out of one length, and the two sloping sides out of another length of 9-in. board. The flat top is nailed on the top of this frame, projecting $1\frac{1}{2}$ in. to 2 in. all round; the joints, which must run from back to front, should be as close as possible, and thin strips of board 1 in. wide should be nailed over them. If the boards are smooth, the roof may be well painted; if not, treated to a thick coating of pitch, melted in a pot and applied hot (mind it does not boil over). If the boards which make the roof are very rough and uneven, it may be well to cover them with common roofing felt (cost 1d. per sq. ft.). In this case the strips on joints should be omitted. A block of wood (*m*, Fig. 616) must be nailed inside the front, 2 in. from the bottom edge, to keep the roof from slipping down the hive, and a 1-in. ventilation hole, covered with perforated zinc, bored in the back and front. The hive is now complete; but, before putting a swarm in, the frames must be fitted with wax guides. Most bee-keepers now use full sheets of comb foundation; but if this is not done, a thin line of melted wax must be run along the centre of the under side of top bar. A quilt must be laid on the frames; a single thickness of China matting (from the outside of tea chests) is best for the first layer, as the bees cannot bite it, and above it 2 or 3 thicknesses of old carpet. The hive is not a mere makeshift one, but can be used to advantage on any system, as there is plenty of room at the rear to add more than the 10 frames, if extracted honey be the object; or frames of supers can be hung behind the brood frames. It can also be packed with chaff or other warm material during winter if thought necessary. Of course a couple of coats of paint will be an improvement. Frames placed across the entrance are much better than if running from back to front: the first comb acts as a screen, and brood is found in the combs clear down to the bottom bar.

Forcing-frames.—The construction of the wooden portion of forcing-frames is illustrated in Fig. 617, and described below; the fixing of the glass portion will be found under Glazing. A convenient length for the frame is 6 ft., and the width may be

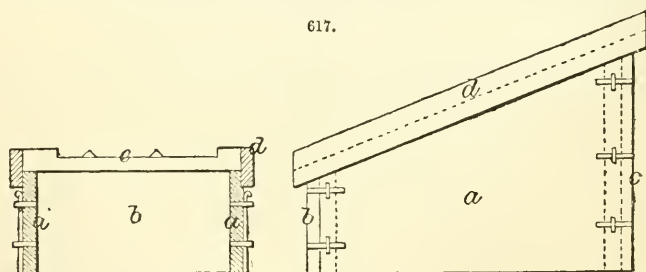

either 4 ft. for single or 8 ft. for double size. It is an advantage to have a frame that will take to pieces, and the one shown is designed with that object. The sides *a*, foot *b*, and head *c* are of $1\frac{1}{4}$ -in. deal. The top edge of the sides *a* is cut with a slope so as to allow the glass lid to be at an angle of about $22^{\circ} 30'$; therefore if the foot *b* is 1 ft. high, the head *c* on a frame 6 ft. long will be over 3 ft. high. The ends of the foot and head boards *b c* are halved into the ends of the sides *b*, so as to make a good joint. Into the ends of *b c*, staples are driven, and notches are cut out of *a* to admit them; small bars or wedges are thrust into the projecting loops of these staples in order to secure the sides and ends together in place. Halved into the top edge of the sides *a* are 2 strips *d*, measuring about 2 in. by 1 in. These are firmly screwed to the sides and constitute guards for the sliding sash *e*, to prevent it slipping sideways off the frame. In a double

frame there must be a central bar, 3 in. by 2 in., run from the head to the foot of the frame to carry the inner edges of the sashes, and this should have a strip $\frac{3}{4}$ in. wide placed edgewise down the middle to separate the 2 sashes. On the top edges of the sides *a*, and similarly in the upper surface of the central bar, little channels should be grooved out to carry away any water that may find its way under the edge of the sashes. The sashes themselves are made of 2-in. by 1-in. quartering, dovetailed at the corners, with small bars for carrying the glass, as described on p. 318.

Greenhouses.—Fig. 618 illustrates the construction of a greenhouse with a span roof 20 ft. wide, as recommended by E. Luckhurst in the *Journal of Horticulture*. Following are the details:—

The Roof.—This is only 5 ft. high at the eaves, and 10 ft. at the apex. It consists simply of fixed rafters mortised into a ridge-board at top, and an eave-board at bottom.

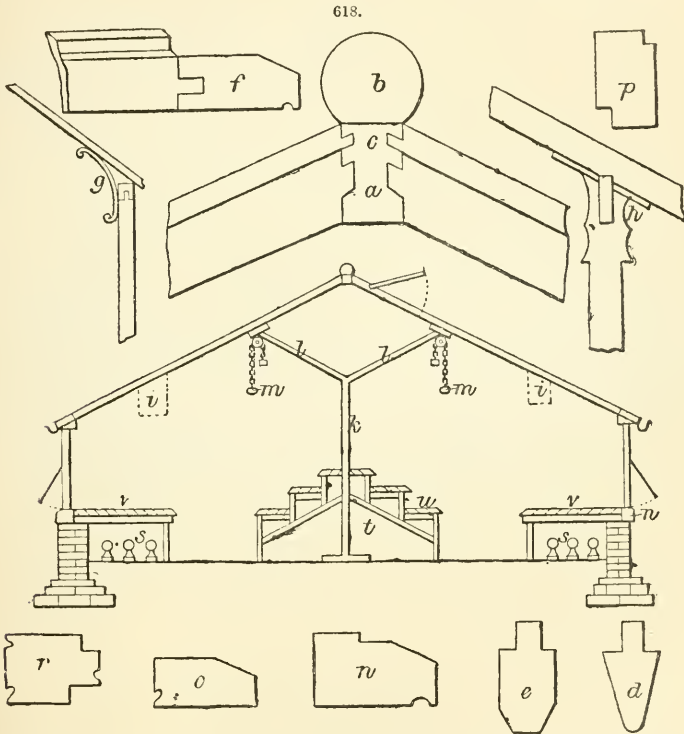

The width of the ridge-board *a* depends upon that of the sashbars; 2 in. will be thick enough for the house treated of. *b* represents the beading fastened by screws or nails to the top of the ridge-board, to preserve it from the action of the weather, as well as to impart finish to building. *a* also shows how the sashbars are mortised into the ridge-board, and how a groove *c* for the glass is ploughed in the ridge-board above each tenon. In glazing, especial care must be taken to thrust the glass to the top of these grooves, so as to make the ridge weather-proof. The size of the sashbars is determined by their length, and whether it is intended to strengthen the roof with stays, or pillars with supports, as shown in *d*. A bar of the form shown by *d*, $2\frac{1}{2}$ in. by $\frac{1}{2}$ in. at its

widest part, answers very well, with every fifth bar like the section *e*, in size $3\frac{3}{4}$ in. by 2 in. When interior supports are not used, the bars should be 3 in. by $1\frac{1}{4}$ in. with every eighth bar $3\frac{1}{2}$ in. by 3 in. The eave-board *f* should be 4 in. by 2 in., bevelled as shown, and with a small semi-circular groove to prevent any moisture creeping into the house, under the eaves, as will happen without the groove. In exposed windy situations, additional strength may readily be imparted by bolting a few iron braces to the angles of the building at any convenient point, as shown by *g*. Pieces of bar iron bent to the required angle, flattened, and holes pierced at the ends by a blacksmith, answer admirably, and are neat enough in appearance when painted. To those who prefer the usual plan of side pillars, *h* will be useful, as showing a longitudinal sectional portion of such a pillar, with a slot cast in the top to admit a flat iron bar on edge, running along under the roof from end to end, and forming a capital support, so light as to make no appreciable shade, and yet very strong; in size it is 3 in. by $\frac{1}{2}$ in. The brackets for hanging shelves *i* are objectionable, as spoiling the appearance of the interior; but such shelves are so useful that they are shown where to be placed, for the guidance of those who are compelled to use them. The roof support shown is considered by Luckhurst preferable to the ordinary style. It consists of central pillars *k*, with arms *l*, the pillars being placed about 9 ft. apart. The hanging baskets *m* are suspended by chains with counterpoise weights, which enables them to be lowered at will for watering and inspection.

The Sides.—Here the sashbars are similar to those in the roof, the only difference being in the large size, which, as they help to support the roof, are 3 in. by 3. They are mortised into the wall-plate *n*, which is about 6 in. by $2\frac{1}{2}$ in. or 3, as may prove most suitable, and into an eave-plate *o* 4 in. by $2\frac{1}{4}$. The angle pieces *p* for the corners of the building are $4\frac{1}{4}$ in. by 3, and have rebates for glazing and for ventilators to shut into. When side ventilators are introduced, they consist simply of a frame $2\frac{1}{2}$ in. by $1\frac{1}{2}$, grooved for the glass, with sashbars mortised into the frame, and are suspended by hinges to a fixed bar, $2\frac{1}{2}$ in. by $1\frac{1}{2}$, into the upper side of which the top side fixed sashbars are mortised. Although mention is made of side ventilators, it is by no means intended to imply that they are an indispensable necessity, for if the roof ventilation be put through, side ventilation is not wanted, and fixed sides point of course to a considerable saving. Let, therefore, the roof ventilators run from end to end of the roof and consist of a clear space of quite 2 ft. in width, so as to admit so large a volume of air as to ensure a brisk and thorough circulation. Avoid a cheap opening apparatus; let it be strong and yet so easy that a touch may set it in motion. The best principle is that of a spiral shaft and stout-jointed levers by which the ventilators may be regulated to a nicety. The brickwork of the sides and ends consists of 5 courses above ground and 6 courses below, inclusive of the footings. The walls are 9 in. thick, and the footings are respectively $13\frac{1}{2}$, 18, and $22\frac{1}{2}$ in., so that 1 yd. in length of wall and footings will require 112 bricks; and to make enough mortar for 500 bricks it requires 3 bush. new grey lime and 18 bush. sand.

The doors should be $1\frac{1}{2}$ in. in thickness, and the doorsteps 4 in. by 3, with rebates and beading as shown by *t*; one for door, the other for glass. The central stage has upright supports 2 in. by 2, and the braces are 3 in. by 2. The strips *u* forming the shelves are 2 in. by 1, with $\frac{1}{2}$ -in. spaces between every 2 strips. The woodwork of the side stages *v* is of the same size.

The glass for the roof is 21-oz. seconds; size of squares, 20 in. by 12; for the sides and ends 16-oz. answers very well. The hot-water pipes are 4-in., and slightly elevated above the floor on pipe stands as shown.

Instead of the pillars *h*, with spreading arms, many will prefer to use simple uprights and tie the main rafters together across the house by iron rods, merely stepping them into the eaves board instead of mortising. The wall, too, may with advantage be made of concrete, where the materials are handy.

Figs. 619 to 621 represent a combined greenhouse and potting shed, designed to be

portable. It is span-roofed, situated so as to be exposed on all but the north side, and erected on a bed of earth or masonry 10 or 12 in. above the surrounding ground and 6 or 8 in. wider than the base of the structure. To provide against the building being disturbed by high winds, 4 posts about 2½ ft. long, and 5 in. square, are driven into the ground near the corners, and the ground-plate of the greenhouse is secured to them by ½-in. coach screws. The size of the combined greenhouse and potting shed (the latter being at the north end) is 18 ft. long by 8 ft. wide outside. The ground-plate *a*, running all round the base, is 1½ in. deep, 5 in. wide, and is formed into a frame 8 ft. 1 in. wide and 18 ft. 1 in. long. Fastened at the corners are 4 upright posts *b*, 4 in. sq. and kept in a vertical position by 8 struts *c*, which greatly help to stiffen the framework, until the boards are fastened over it. The space between the end posts is divided

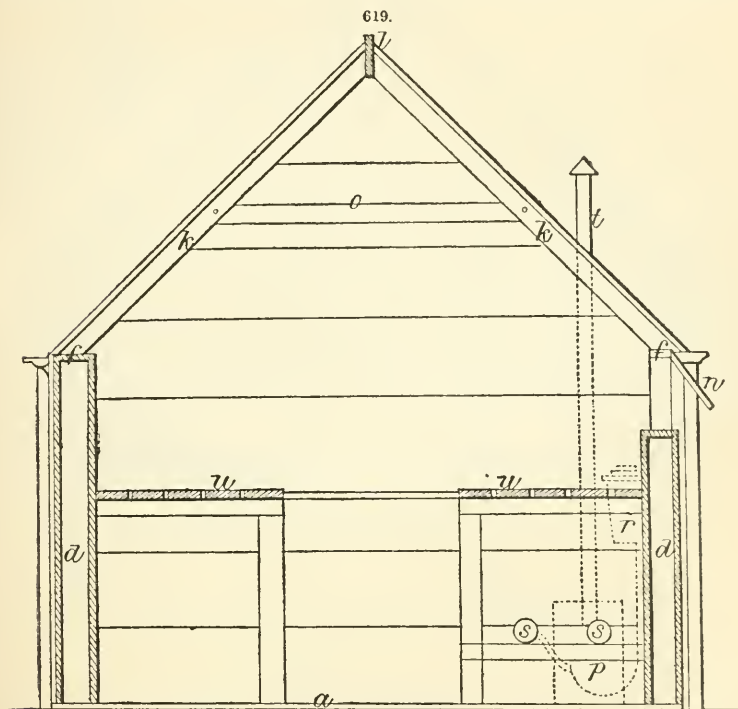

on either side of the house into 5 equal spaces by 4 posts, 3 of them *d* being 4 in. by 3 in. and the fourth *e* 4 in. by 4 in. This latter divides the potting shed from the greenhouse. These are all 4 ft. 9 in. long, and as they are mortised into the wall-plate *f* at the top, and the ground-plate *a* at the bottom, each of which is 1½ in. thick, the space between the wall-plate and ground-plate is 4 ft. 6 in. The wall-plate *f* is 4 in. wide; 6 other posts *g*, 7 ft. 4 in. long, 3 in. thick, and 4 in. wide, are mortised at one end to the ground-plate *a*, and at the other are nailed to the rafters *h*. Of these, 2 at either end form the door-posts, of which the doorways *i* are 6 ft. 3 in. high by 2 ft. 3 in. wide. The rafters *h* *k* are nailed at one end to the wall-plate *f*, and on the other to the ridge-board *l*, which is 18 ft. 3 in. long, 6 in. deep, and 1 in. thick. Those lettered *h* are 2 in. by 3 in. and those lettered *k* of the form shown in section; they are all 4 ft. 9 in. long.

These rafters can be purchased of the section shown, and should be all carefully placed at equal distances, when the width must be measured, and the glass ordered accordingly. To ventilate the house, about 9 in. next to the ridge-board on one side should be unglazed, and the space covered with $\frac{1}{2}$ -in. board, hinged in 4 lengths to the ridge-board, and arranged so as to be easily opened from the inside, as shown at *m*, and the same must be adopted at the bottom of the opposite rafters, where 4 lengths of board *n* are hinged to the wall-plate *f*. The outward thrust of the rafters can be counteracted

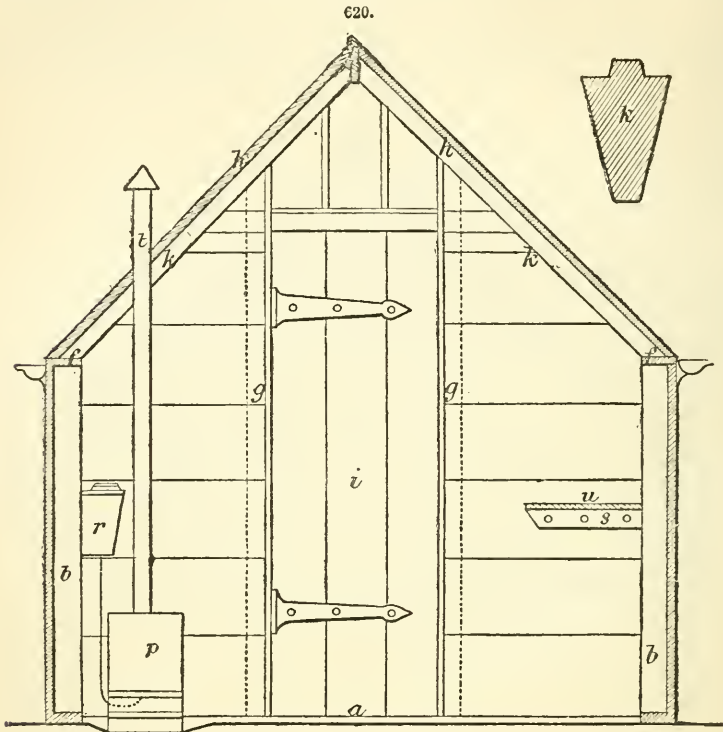

by pieces of wood used as ties, as shown at *o*. The house should be glazed with glass 16 oz. in weight to the sq. ft. With regard to doors, the amateur had better get them made by a carpenter, as, to look well, they require good work, and they are not expensive. The framing of the sides must be covered with $\frac{1}{2}$ - or $\frac{5}{8}$ -in. boarding, tarred or painted on the outside, and the spaces between the inner and outer boards filled with sawdust, which is a slow conductor of heat. The best material for construction will be thoroughly dry, soft deal, as free from knots as possible; and it will save much trouble to obtain the different pieces of the sections shown, only a little larger, from saw-mills, so that he will only have to plane them, and follow the drawings in cutting to required length. When all the woodwork has been put together, and is thoroughly dry, the knots are stopped, and the whole framing is given one coat of white-lead; this will make the putty in the glazing hold well. Then the glass is put on of the required width, the length of each piece being 15 to 18 in., and each overlapping the next to it by about $1\frac{1}{4}$ in. This completed, the inside and outside wood should receive 2 good coats of pale stone colour or

white paint. The heating apparatus employed consists of a small circular boiler *p*, tank *r*, and piping *s*, the fumes of the fuel being carried away by the capped stovepipe *t*. The pipes *s* for conveying the hot water, should be 2 in. or 2½ in. in diameter, and lie immediately under the stage *u*.

621.

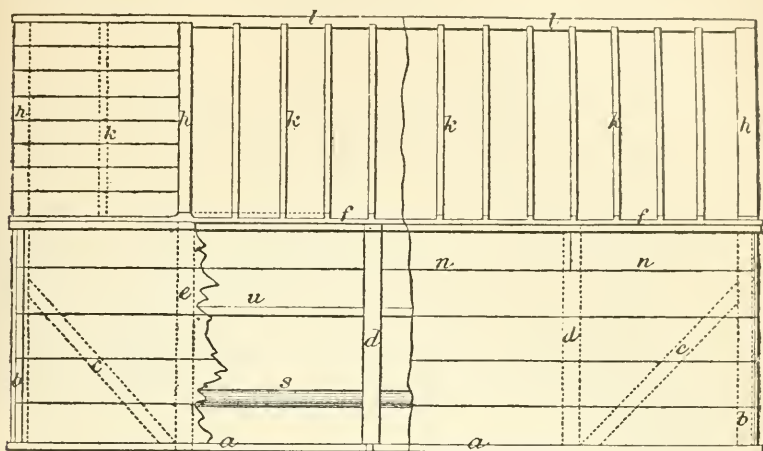

When a suitable wall is available, it is often preferred to make a lean-to greenhouse, in which case the roof is considerably modified. If the greenhouse is to be 6 ft. high in front and about 8 ft. wide, the roof must slope upwards at the back to a height of about

622.

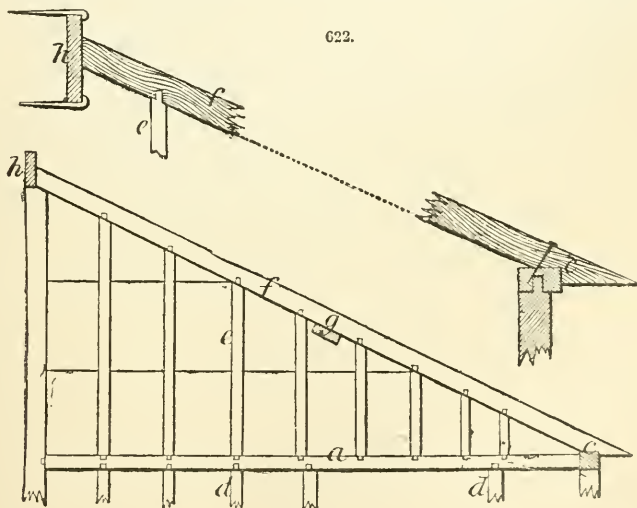

10 ft. If the back wall does not admit of this, the front wall must be made lower, or the floor must be sunk: the latter alternative is very undesirable as conducing to dampness. The construction of the roof and the upper part of the framing is shown in Fig. 622. The bar *a* is mortised at one end into the tall upright *b*, which is secured to the wall by

strong hooks; at the other end it is mortised into the front top plate *c*, and throughout its length it is supported on the ends of the uprights of the lower part of the frame *d*, all of which are mortised into the bottom plate. From the bar *a* rise a number of uprights *e* supporting the outside rafter *f*. The intermediate rafters are partially supported by a tie bar *g* running from end to end. They all abut at the upper end against the wall-plate *h*, to which they are securely nailed, and at the lower end they fit on to the top wall-plate *c* as shown. The 2 outside rafters are 4 in. by 2 in. in section, but the smaller ones are only 4 in. by 1½ in.

Summer-house.—The following remarks are intended only to describe the materials adapted for building summer-houses and the manner of putting them together. For designs, the reader must exercise his own taste, or he may refer to an interesting series of papers on rustic carpentry written by Arthur Yorke in *Amateur Work*, portions of which have been availed of here.

The wood looks best if left with the bark on, in which case it should be cut down in winter while the sap is out of it; if to be peeled, it is better cut when the sap is rising. The most suitable and durable wood for this purpose is larch, after which come silver fir, common fir, and spruce. Poles should be selected from trees grown in close plantations, these being more regular in form and less branched; smaller wood is got from the branches of trees growing in the open. Oak "bangles" (smaller branches very contorted) look best when peeled, and do well in grotesque work. Elm branches are more durable than oak. Apple branches possess the same advantage, with equal irregularity, and often cost nothing. Hazel rods, and sticks of maple and wych-elm are well adapted for interior work.

Fig. 623 shows the construction of a summer-house 8 ft. long, 4 ft. wide, and 6 ft. high to the eaves. The collar posts *a* are set 2 ft. deep in the ground, that portion having been first peeled and well tarred. The cross pieces *b* are joined to the posts in the manner shown at *c*; when the rafter *d* is added, a large spike nail is driven through all and into the post, but smaller nails may be used temporarily to hold the cross pieces until the rafter is on. The corner posts *a* are 4½-5 in. in diameter, and sawn flat at the top. Pieces called "ledgers" are nailed cross-wise at top and bottom, immediately below the wall-plate and above the ground line respectively, on the inside of the house, their juncture with the corner posts being as shown in plan at *e*. The walls *f* are formed of split poles, the splitting being best done by a circular saw, if available; they are nailed at top and bottom to the ledgers, with their sawn faces inwards, their upper ends sloping off to fit against the wall-plate, and their lower reaching 2 or 3 in. into the ground. The walls are lined inside, the lining of the lower half being formed of another row of split poles, arranged with their sawn sides towards the first, and so that they cover the spaces between them. The upper half may be lined with smaller half-stuff placed diagonally. From the top of the pediment of the roof, a ridge piece extends backwards 18 in.; this keeps the finishing point of the thatch some distance back, and enables the eaves to project over the pediment. The end of the rafters are sawn as at *g*. When the rafters are fixed, a number of rough rods about 1½ in. thick are nailed across them some 5 in. apart, for carrying the thatch. A 1-in. plank 14 in. wide and fixed at 16 or 17 in. above the floor affords a good seat. The subject of thatching will be found under the section on Roofing. The under side of the thatch is all the better in appearance for being lined. The best material for the purpose is heather (ling), and next to it comes furze. In fixing it, a layer is spread at the bottom of the roof with the brush ends pointing downwards to the wall-plate, and a strip of wood is nailed tightly across the root ends from rafter to rafter; succeeding courses are laid in the same manner, each overlapping the preceding and hiding the wooden strips. Failing heath and furze, recourse may be had to moss, fastened to the thatch by small twig buckles. Another substitute is sheets of elm bark, dried flat on the floor of a shed under pressure, and secured by flat-headed nails, moss serving to fill any interstices. Indeed moss, previously dried, is admirable

for stopping all chinks and cracks. For flooring, the best possible plan is to drive short pieces (say 6 in. long) of wooden poles into the ground leaving all their tops level. Intervals may be filled in with sand. Concreting and asphaltting are expensive, gravelling is productive of much dust, and flooring has an inappropriate appearance.

623.

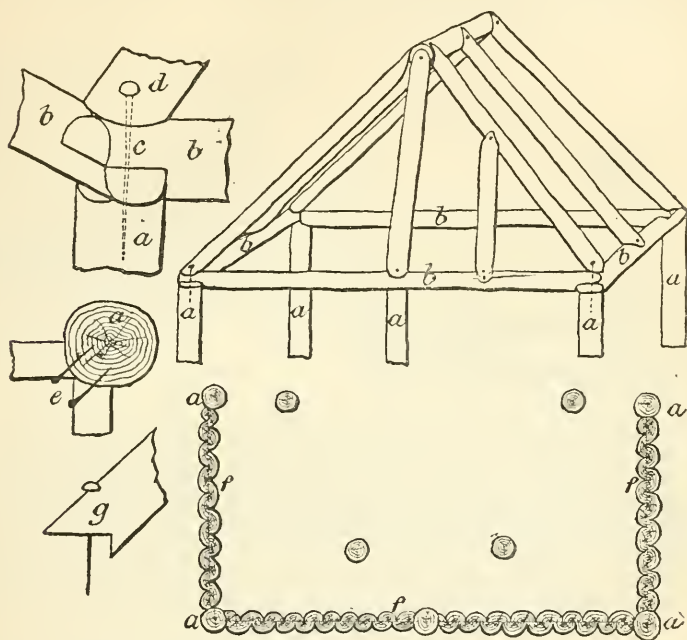

Fences.—This term may be made to include hedges, stone walls, and iron wire, but it will be restricted now to structures formed of wood.

A common fence in America is the "zigzag" or "rail," Fig. 624, in which stout rails *b* are laid about 7 deep with their ends crossed between upright stakes *a* driven into the ground. The rails may be of uneven lengths, instead of even as shown.

Lattice-fencing, Fig. 625, consists of a number of laths *a*, pegged across each other and supported by rails *b* carried on posts *c* fixed at intervals of 8–10 ft. The lattice may be made much more open, and will then consume less material.

Common wood paling is shown in Fig. 626. Stakes *a* are driven by a heavy mallet 12 in. into the ground at 5 or 6 ft. asunder; when the ground is hard, a hole may be made by the foot-pick or the driver; and such stakes will support a paling 3 ft. 3 in. in height. While 2 rails are sufficient to fence cattle, 3 are required for sheep. The rails should be nailed on the face of the stakes next the field, and made to break joint, so that the ends of all the 3 rails shall not be nailed upon the same stake; nor should the broad ends of the rails be nailed together, even though thinned by the adze, but broad and narrow ends together as at *b*, that the weight and strength of the rails may be equalized. To make the paling secure, a stake should be driven as a stay in a sloping direction behind the rails, and nailed to every third stake. The upper rail should be nailed near the top of the stakes, the lowest edge of the lowest one 6 in. from the ground, and the upper edge of the middle one 20 in. above the ground.

Lapped paling of cleft oak is illustrated in Fig. 627. The pales *a* lap over each other, and are nailed to rails *b*, tenoned into posts *c*, while a board *d* is run edgewise along the bottom.

In open paling, Fig. 628, the pales *a* are nailed flat and independently to the rails *b*, of which 2 suffice; these latter are tenoned at their ends into the posts *c*. This is a much cheaper fence than the preceding.

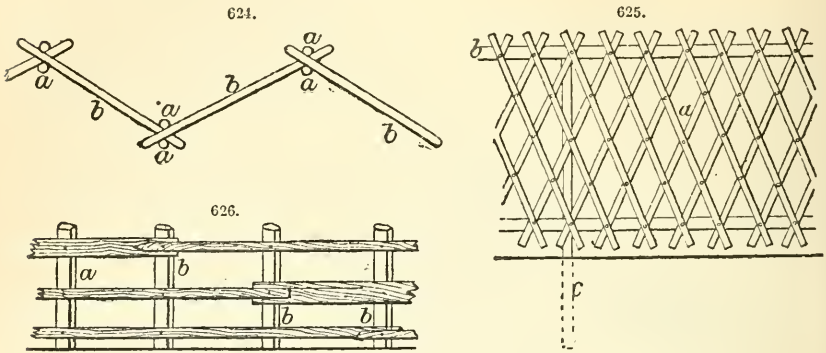

The only important difference presented by the so-called timber-merchant's fence, Fig. 629, is that the posts *a* are provided with "pockets" leading to the mortices into which the ends of the rails *b* are slipped; these pockets meet the mortices in such a way that any section or "bay" of the fence can be bodily removed by lifting it sufficiently to free the mortice and pass forwards by the pockets:

Fields are often temporarily fenced by hurdles, Fig. 630. In setting them up, the first hurdle is raised by its upper rail, and the ends of its stakes are sunk a little into the ground with a spade, to give them firm hold. The next is placed in the same way,

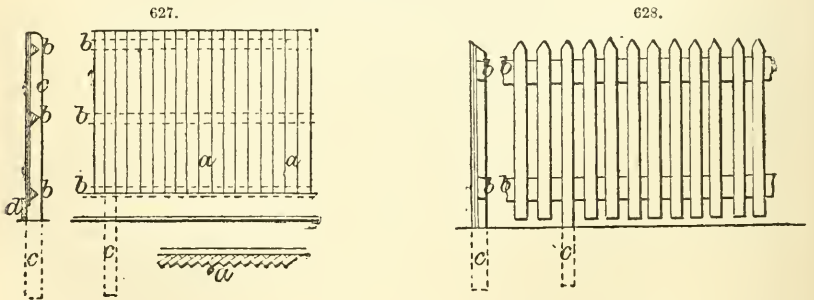

both being held in position by an assistant; one end of a stay *a* is placed between the hurdles, near the tops of their stakes, and the stay and hurdles are fastened together by the peg *b* pressing through holes in both. Another peg *c* is then passed through the stakes lower down, and the hurdles are sloped outwards until the upper rail stands 3 ft. 9 in. above the ground. A short stake *d* is driven by a mallet into the ground at a point where the stay *a* gives the hurdles the right inclination, and a peg fastens the stake and stay together. The remaining hurdles are fastened in a similar manner. It is perhaps more common to pitch these hurdles upright and dispense with the sloping stay

a, replacing it by a stake driven vertically into the ground between the ends of the hurdles. The construction of the hurdles themselves is obvious from the sketch. The 4 level rails *e* are let into slits in the sides of the stakes *f*, and the 3 cross bars *g* are nailed to the level rails *e*.

A useful form of close fence for temporary purposes is shown in Fig. 631. The boards *a* are simply slipped down one upon another in grooves cut vertically in the uprights *b*, which are let into the ground. By this means the use of nails is avoided, and the boards are but little the worse for being so employed.

629.

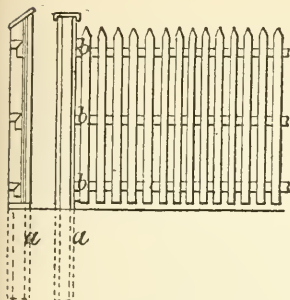

630.

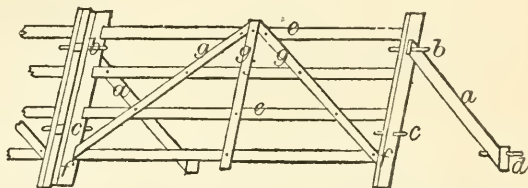

Gates.—A wooden gate, the only kind to be considered here, consists of a framework, as *a, b, c, d* in Fig. 632, hinged or hung to a gate-post *e*, which is firmly secured in the ground, and catching on a latch attached to another gate-post at the opposite side of the opening. This framework is generally filled in with 3 horizontal bars *f*. To pre-

631.

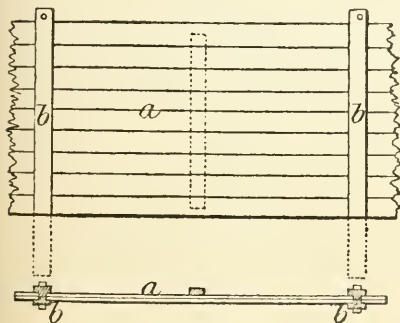

632.

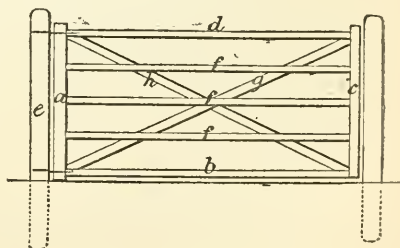

vent the weight of the gate pulling it down at the end *c*, a diagonal brace *g* is added; for uniformity sake this is sometimes supplemented by a second brace *h*. The upright bar *a* of the frame is termed the hanging style, while *c* is the falling style; the bars *b, d* and the rails *f* are mortised at each end into the bars *a, c*.

Another form of field gate is shown in Fig. 633, where the diagonal stays *a, b* meet at the centre *c*. The top and bottom hinges are fixed as shown at *d, e*.

Fig. 634 illustrates a much heavier and more substantial form of gate. The hanging post *a* here needs struts *b* placed underground; the falling style *c* is strengthened by iron bands at top and bottom.

A garden wicket is represented in Fig. 635. The frame *a, b, c, d* and the diagonal stay *e* are mortised together. Through the top and bottom rails *a, c* and the stay *e* bars *f* of wood or iron are passed. The hingeing is effected by means of iron bands with looped ends secured to the top and bottom rails and resting on somewhat similar iron loops fixed in the post *g*; an iron rod dropped through all the loops completes the hinge.

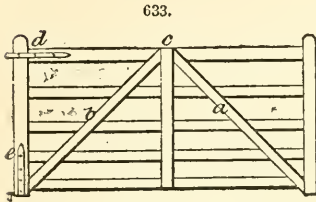

634.

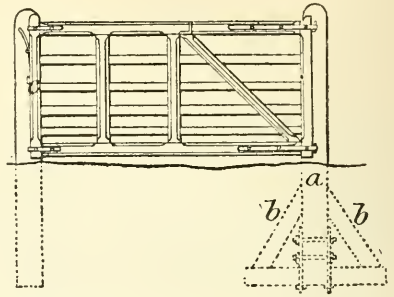
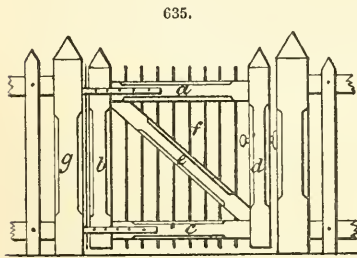
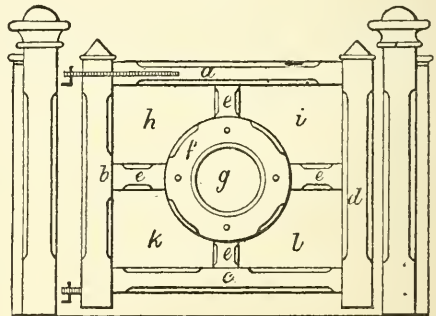

Fig. 636 is a more pretentious garden gate. The usual frame *a, b, c, d* supports by 4 arms *e* a central ring *f* secured by pegged tenons, as shown. The spaces *g, h, i, k, l* are best filled up by some lighter work. The 2 bottom ones *k, l* may have diagonal panelling while *g, h, i* may have wooden bars; or the whole may be fitted with ornamental iron castings.

636.



635.



HOUSE BUILDING.—There are 4 important matters connected with house building which come within the range of the carpenter and joiner; these are the laying of floors, the construction of the wooden framework of roofs, and the making and fixing of doors and window frames.

Floors.—The chief considerations to be borne in mind in choosing the material for a floor are: (1) wearing resistance, (2) comfort to the feet, (3) retention of warmth, (4) capability of being laid evenly and repaired conveniently. When the first condition is most essential and the second is unimportant, as in public places where there is great traffic, some form of masonry is best adapted; but for comfort, on the score of elasticity under foot and a generally heat-conserving quality, wood is unsurpassed, especially the ordinary boarded floor. In situations subject to much wear, wood-block flooring is better adapted. The blocks are generally laid to the "herring-bone" pattern upon a concrete bed, and can be equally employed for upper floors on rolled joists filled in with concrete, making a remarkably firm, durable, and comfortable floor, not too resonant or noisy for

large rooms, and in every respect more sanitary than the ordinary boarded floor. The blocks, being of a brick proportion, can be laid as parquetry, or in squares placed diagonally, the blocks alternating in direction. The shrinkage is reduced to a minimum, and when the blocks are well bedded and secured to the bed, as in Lowe's patent composition, no more durable flooring can be employed. This composition is said to prevent dry-rot. A more decorative sort of wood flooring is parquetry. The solid Swiss *parquetrie* consisted of pieces about 1 in. thick, grooved and tongued together, and secured by marine glue. Wood veneers, backed by kamptulicon and other substances, have been similarly used for effect. Thin parquet laid on a patent composition or glue (Eberhard's) is a kind of flooring that has been used with much success even on stone foundations; and stone paved floors and staircases worn hollow have been treated by this process, the unevenness of the surface being made up by the glue, which becomes a hard yet slightly elastic backing. Some parquet, as that of Turpin's, is only $\frac{5}{16}$ in. thick, and is prepared on a deal back, and the floor is said to be equal in wear to 1-in. solid parquetry. The plan of fixing thin plates of hard ornamental woods in geometrical patterns upon existing hard floors is one that will commend itself. Of all floorings there is perhaps hardly any so appropriate, so comfortable, or so artistic as parquetry, and even the plain hard woods like teak admit of being used decoratively. The custom of carpeting over the centre of the room only, allowing a border of the real floor to be seen, lends itself to parquetry borders. Smaller carpets and of better quality or design would be selected, while cleanliness and sanitary conditions would be the result of the change. There are many manufacturers who can supply borders at the low price of 6*d.* per sq. ft. A solidly-backed parquetry floor, supported upon joists partially filled up with concrete, forms an almost impassable barrier to fire. Even wooden joists, well protected by a fire-resisting plaster ceiling, or the interspaces filled up, has been found to stay the ravages of fire, while a closely-jointed block or parquet floor, laid on a good backing, is impervious to air, and would retard the progress of flames above or below it. For the floors of hospital wards no floor can be more suitable or so comfortable.

Passing now to a consideration of the most usual form of flooring, that by parallel boarding, the first feature to be explained is the arrangement of the beams and joists which are to support the boards. It may, however, be well to premise, that, as wood is found to be much more durable when exposed to the air than when built in brickwork at the ends, an effort is always made to secure that condition, and the other ends of the beams or joists are most commonly supported on wall-plates fitting into the space occupied by a course of bricks. Fig. 637 shows a simple method of securing the tie

637.

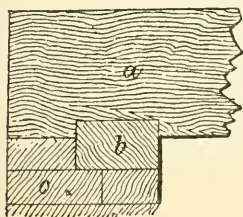

638.

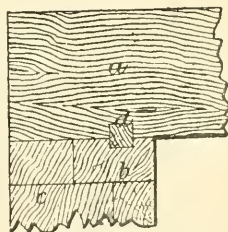

beam *a* to the wall-plate *b* lying on the brickwork *c*, the beam *a* being notched out on the under side to admit *b*. In Fig. 638 this joint is strengthened by the addition of a key or cog *d* fitting closely into grooves in *a* and *b*. Figs. 639, 640 illustrate the junction of the poleplate *a* to the tie beam *b*, both with and without the intervention of a key or cog *c*. Other methods of securing the joist *a* to the wall-plate *b* are shown in

Figs. 641, 642, 643. In Fig. 644 the joist *a*, instead of lying flat on the upper surface of the wall-plate *b*, is connected by a mortice and tenon joint, the under side of the joist being mortised as at *c*, while a tenon *d* is cut into the wall-plate.

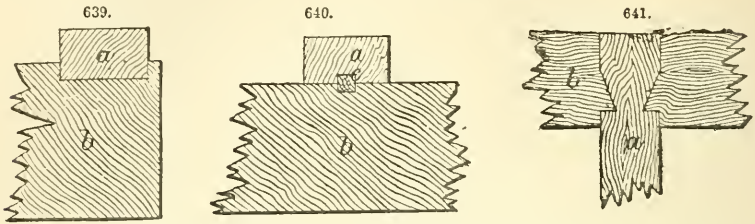

The special uses of the several kinds of joist will be best described when speaking of the sort of floor in which they are employed; but it may be well here to state their respective scantlings, i.e. their sectional dimensions. They vary of course with the

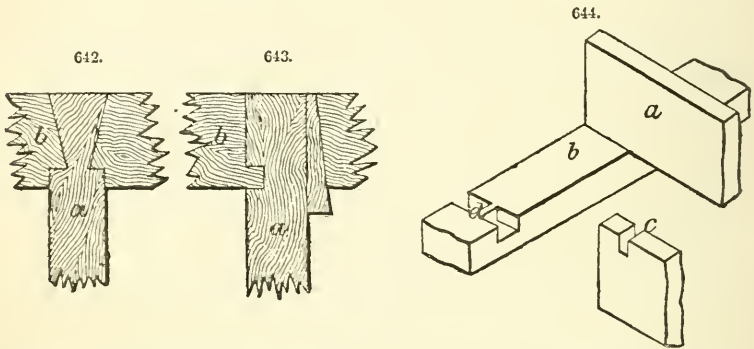

length of the bearing (the distance between the supports that hold them), as given in the first column of figures:—

Flooring joists, 1 ft. apart.

ft.	in.	in.	in.	in.	in.	in.
5	4	$2\frac{1}{2}$	$4\frac{1}{2}$	2	$3\frac{1}{2}$	3
10	9	$1\frac{1}{2}$	7	$2\frac{1}{2}$		
15	11	$1\frac{1}{2}$	10	2	9	$2\frac{1}{2}$
20	11	3	10	4		
25	12	3	11	4		

Binding joists, 6 ft. apart.

ft.	in.	in.	in.	in.
5	7	3	9	2
7 ft. 6 in.	9	3		
10	9	4	11	3
12 ft. 6 in.	11	4		
15	12	4		
20	13	$6\frac{1}{2}$		
25	15	$7\frac{1}{2}$		

Ceiling joists, 1 ft. apart.

ft.	in.	in.	in.	in.
4	2½	1½	2	2
5	2½	2		
6	3	2		
7	3½	2	3	2½
8	4	2	3	2½
9	4½	2	4	2½
10	4½	2½	4	3
12	5	3		
14	6	3		

Girders, 10 ft. apart.

ft.	in.	in.	in.	in.
10	11	5½	12	4
15	13	6½	11	11
20	15	7½	13	13
25	17	8½	14	14
30	20	10		

Flooring boards are generally cut 6¾ in. (7 in. planed up) wide, but can also be had 4¼ in. and 5½ in. wide; in thickness they run ¾ in., 1 in., 1¼ in. and 1½ in., at least they are called after these measurements, but are really somewhat less owing to planing.

The simplest kind of floor is that termed "single-joisted," in which the joists are 12 in. apart, resting on the wall-plates, and carrying the boards above, while, if there be

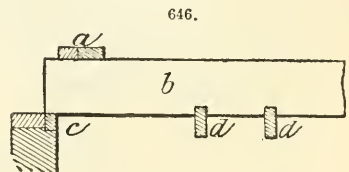
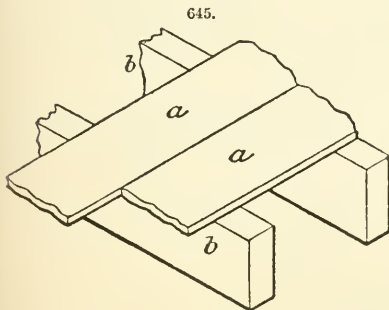

a ceiling, the ceiling laths are nailed on below. Fig. 645 shows the boards *a* as they rest on the joists *b*. When ceiling joists are used, the arrangement is as shown in Fig. 646: *a*, flooring boards; *b*, joist; *c*, wall-plate; *d*, ceiling joists. The scantling of the wall-plate will vary with the length of the bearing of the joists, as follows:—

Up to 10 ft.	3 in. × 3 in.
10 to 20 ft.	4½ in. × 3 in.
20 to 30 ft.	7 in. × 3 in.

The joists should have at least 4 in. of their length resting on the wall-plate and wall, and this may be increased up to 9 in.

When the joists are unusually deep (for greater strength), or far apart (for economy sake), there is a danger that an extra weight on them may cause them to turn over on one side. To obviate this danger, "strutting" is resorted to. In its simpler form this

consists of sections of flat thin wood placed edgewise between the joists, as seen in Fig. 647, where the joists *a* are kept vertical by the struts *b*. Great force would be required to crush these struts, but there is a risk of their ends slipping. This is sometimes remedied by attaching them at one end to triangular fillets *c* nailed to the

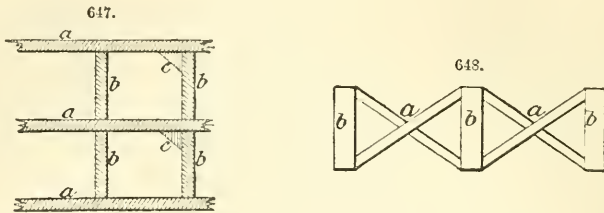

joist. The struts should all be placed in the same line, and the lines may be 2 or 3 ft. apart. A more secure way of strutting is that known as the "herring-bone," illustrated in Fig. 648. It consists of strips of wood *a* of small scantling (say $2\frac{1}{2}$ in. by 1 in., or 3 in. by $1\frac{1}{2}$ in.), crossing each other, and nailed at the top of one joist *b* and bottom of the next, maintaining regular lines at a distance of about 4 ft.

Whenever a space has to be left in a floor, to provide for the insertion of a staircase or a flue, the construction has to be modified by the introduction of a "trimmer" for the support of one end of those joists which are prevented from reaching to the wall-plate as before. Fig. 649 shows the arrangement where the hole is required next the wall: *a* is

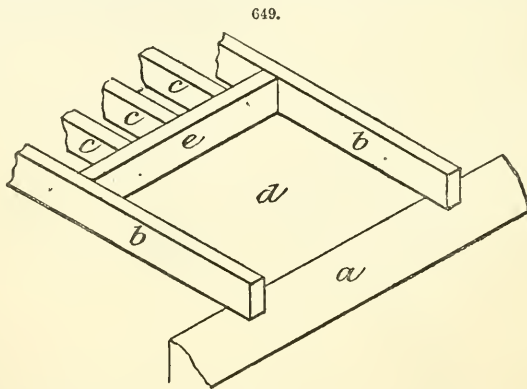

a wall, supporting the 2 joists *b*, while the 3 joists *c* are cut off to leave the space *d*. The trimmer *e* is mortised at both ends into the joists *b*, and carries the free ends of the joists *c*, which are mortised into it. As the extra strain from the 3 joists *c* is thus supported by the 2 joists *b*, it is necessary that these latter be stronger than the others. They are called the "trimming" joists, and it is usual in ordinary flooring to add $\frac{1}{8}$ in. to their thickness (not depth) for every joist trimmed. Fig. 650 illustrates the system adopted when the hole is at a distance from the wall, requiring the intervention of 2 trimmers: *a* is the wall, *b*, ordinary joists; *c*, trimmed joists; *d*, trimmers; *e*, trimming joists; *f*, hole.

The preceding paragraphs refer to "single" floors; but when the strain to be borne is great, as in warehouses and similar structures, "double" floors are adopted, as well as "double framed" floors. In the double floor, Fig. 651, a "binder" or "binding joist"

is introduced, having a thickness usually half as great again as that of the joists it supports, bearing about 6 in. on the wall, and situated at intervals of 5-6 ft. apart, centre to centre. In Fig. 651, *a* are the ordinary joists resting on the binders *b*, and supporting the flooring boards *c* above, while the ceiling joists *d* are attached to the under side of the binders.

The "double framed" floor differs in having "girders" to carry the binders at intervals of about 10 ft. centre to centre. Fig. 652 represents this plan: *a*, the ordinary

650.

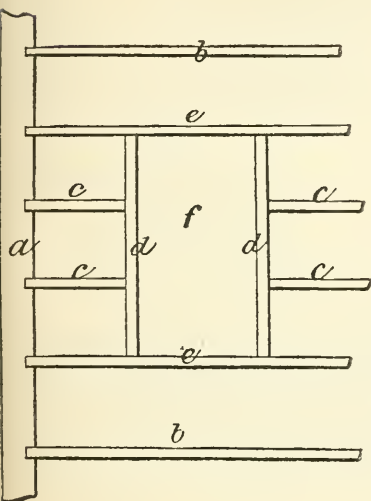

651.

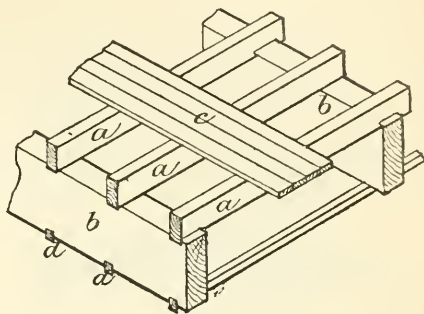

652.

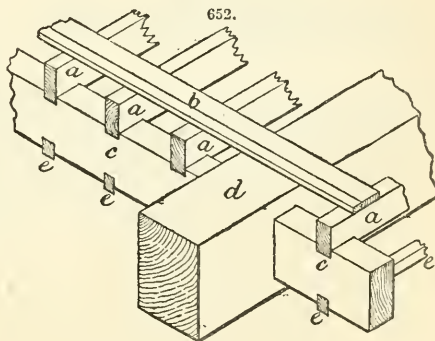

joists, carrying the floor-boards *b*, and resting on the binder *c*, supported by the girder *d*; *e*, ceiling joists. Girders should always be placed so that their ends rest on solid walls, where no window or door below weakens the structure. The weight of the girder is distributed as much as possible by resting its ends on templates of stone or iron. These templates often assume a box-like form, enclosing the sides and end of the girder but not so as to exclude all air.

Floor-boards may be laid "folding," in "straight joint," or "dowelled," the first being the commonest method. In laying boards folding, 4 or 5 boards are put in place without nailing, and the outside ones are then nailed so as to have slightly less space between them than was occupied by the others lying loosely; the others are then forced into position by putting their edges together and thrusting them down. Thus in Fig. 653, of the 5 boards *a*, *b*, *c*, *d*, *e*, the 2 outside ones *a*, *e* would be first nailed and then the intervening *b*, *c*, *d* would be forced into the space left for them. In this case, the ends of the boards are made to meet where they will fall on a rafter, and as nearly as possible in the centre of its width, as at *f* on the rafters *g*. When the floor is laid with straight joints, as in Fig. 654, each board is put down and nailed separately, being thrust up

close to the one preceding it by means of the flooring clamp. Thus the joints *a* of the ends of the boards *b* fall on the rafters *c* in straight lines with intervals between. When the flooring is "dowelled," the boards are laid separately and straight as in Fig. 654, the only difference being that their edges are united by dowels (small pegs of oak or beech) driven into holes bored for their reception, either between or over the joists. Most commonly, flooring boards simply have their edges planed smooth, and are forced into the closest possible contact, when they are held by the nails that fasten them to the joists. But there are cases when a more perfect tight-fitting joint is needed.

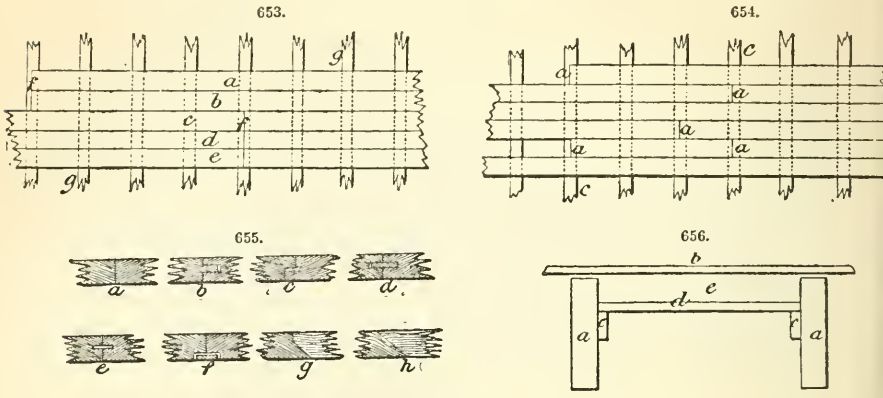
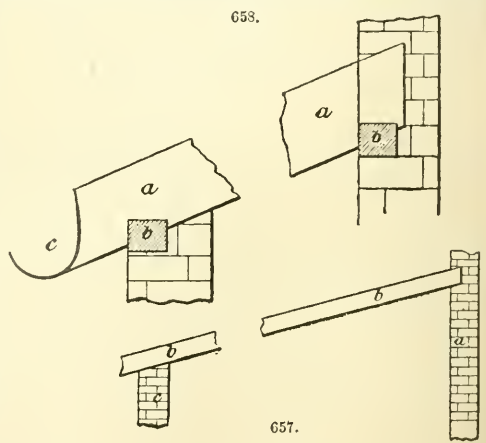

Fig. 655 shows the various ways of joining floor-boards : *a*, plain joint; *b*, ploughed and tongued; *c*, rebated; *d*, *e*, with a tongue of wood or iron inserted; *f*, with the tongue resting on the joist; *g*, *h*, splayed.

When a floor is finished, it is usual to hide the ends of the boards where they meet the wall by nailing a skirting board round. This may be plain or ornamental. It rests on the floor and rises close against the wall, to which it is fastened by occasional nails passing into wooden bricks, called "grounds," inserted in the wall to take the nails. In superior work, floors are "deadened" or "deafened" by placing a bed of non-conducting material beneath them. To support this bed, strips of wood are nailed to the flooring joists to carry thin "sounding" boards, on which is spread a thick layer of old mortar or plaster, known as "pugging." This is shown in Fig. 656: *a*, joists; *b*, flooring boards; *c*, strips called "firing pieces," bearing the sounding boards *d* loaded with pugging *e*.



Roofs.—In discussing roofs, attention will here be confined to the timber part of the structure, leaving the covering to be dealt with under the section on Roofing; and the descriptions will stop short at those kinds of roof where architectural and engineering

skill and appliances are called into requisition. Roofs of an every-day character may be divided into 2 classes—"lean-to" roofs including those which have only one slope, a gradual fall from one side to the other; while "span" roofs have 2 slopes descending from an apex at or near the centre.

The simplest kind of lean-to roof, adapted only for covering a shed of short span, and with a very light roofing material, is shown in Fig. 657. Here the back wall *a* has the upper ends of the rafters *b* simply built into it, at distances of 14-18 in. apart centre to centre, while the lower ends rest upon the front wall *c* and overhang it sufficiently to cast the rain-water off free of the wall. In Fig. 658, the top and bottom ends of the rafters *a* rest upon wall-plates *b* let into the walls, and running their whole length, while the extreme lower end of the rafters carry a guttering *c* for conveying away the rain-water. Other forms of guttering for the ends of rafters are shown in Figs. 659, 660. In Fig. 659, the rafter *a* resting on the wall *b*, has a triangular block of wood *c* nailed to it outside the line of the wall, affording support to a zinc or iron gutter *e*, having one edge

659.

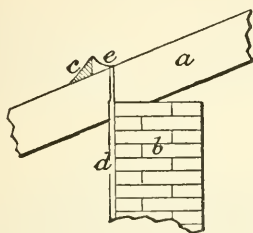

660.

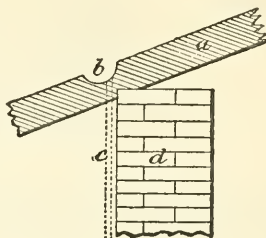

lying under the roofing material. At any point in the length of the gutter a hole is made for the insertion of a vertical pipe *d* for conveying the water away down the outside of the wall. In Fig. 660, the rafter *a* is recessed at *b* for the reception of the gutter, a pipe *c* from which passes down the front of the wall *d*. Fig. 661 illustrates a wooden gutter *a* attached by nails to the ends of the rafters *b*, and provided with a pipe *c*, bent underneath so that it may run down close to the wall *d*.

661.

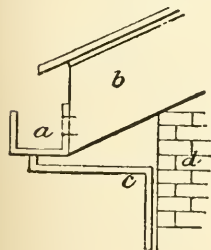

662.

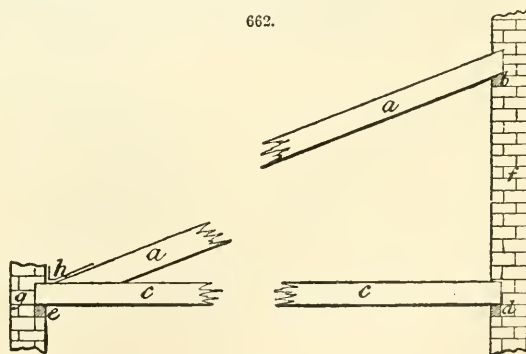

When a wider span is needed in a lean-to roof, a tie-beam has to be introduced, to counteract the outward thrust of the roof which would tend to force the walls asunder. Fig. 662 shows the arrangement adopted. The rafter *a* rests at its upper end on the wall-plate *b* and at its lower end on the tie-beam *c*, which in its turn is supported in a horizontal position on the wall-plates *d*, *e* in the back and front walls *f*, *g*. As the front

wall *g* is carried up above the bottom edge of the roof, forming a parapet surmounted by a coping, instead of lying underneath it as before, another form of gutter is demanded. This as seen at *h*, consists of sheet metal running up underneath the roofing material far enough to form a trough. Another contrivance for guttering along a parapet wall is shown in Fig. 663, and is termed a "bridged" gutter. The rafters *a*, butting against the wall-plate *b* carried by the wall *c*, support a "bridging-piece" *d* of small scantling, on which lies a board flooring *e* bearing the sheet metal (zinc or lead) gutter *f*.

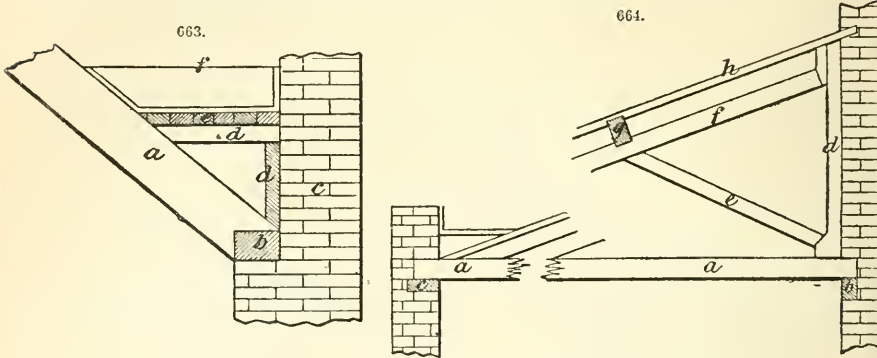

When the roof is required to possess greater strength than can be obtained with the use of a simple tie-beam, the construction assumes a more complicated character, as seen in Fig. 664. Here the tie-beam *a* rests as before on the wall-plates *b*, *c*, but at the back end it supports a king-post *d*, from which the strut *e* passes to sustain the "principal" rafter *f*, whose upper end butts against a fillet on the king-post *d* while its lower end is borne by the tie-beam *a*. Running parallel with the walls, and carried by the "principal" rafters *f*, is the "purlin" *g*, whose duty is to hold up the "common" rafters *h* on which the roofing material is laid. The common rafters lie at intervals of 14 in. centre to centre, while the principal rafters are generally about 10 ft. apart. The upper end of the strut *e* (Fig. 664) is joined to the under side of the principal rafter *f* by a tenon, which may be either simple (*a*) or angular (*b*), Fig. 665. In

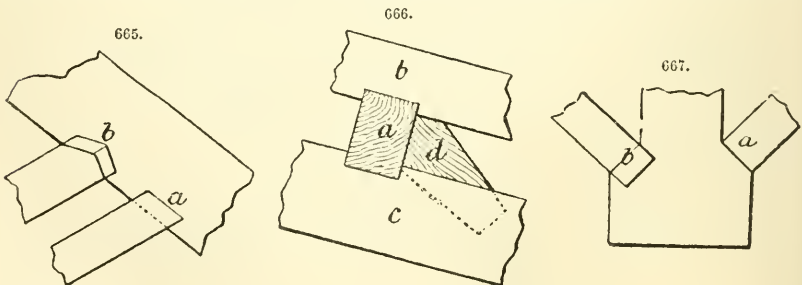
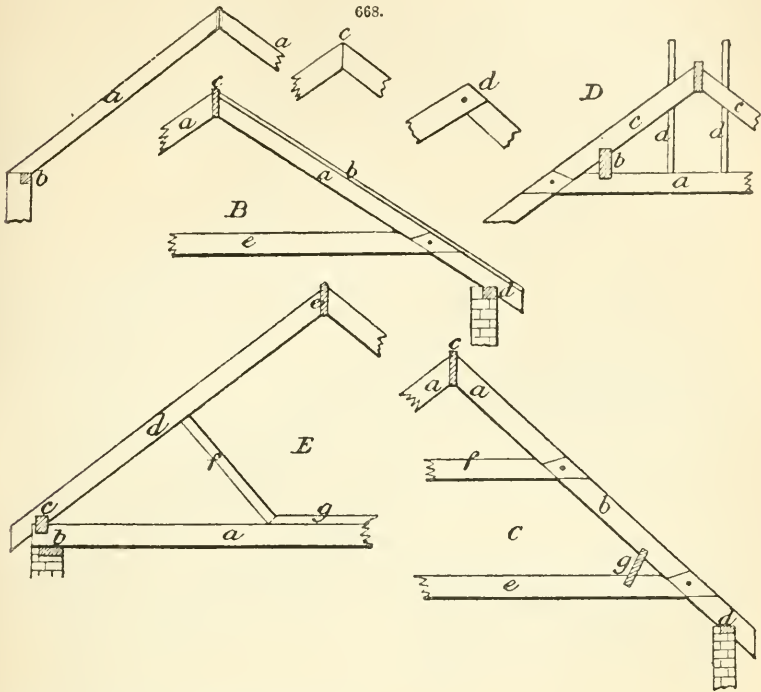

Fig. 666 is seen a way of joining the purlin to the rafters: the purlin *a* is led into grooves in the faces of the common and principal rafters *b*, *c* respectively and butts against the block *d* wedged into the upper face of the principal rafter *c*. The feet of the struts may either butt against the sloping shoulders of the king-post as at *a* (Fig. 667) or be tenoned in as at *b*.

Ordinary span roofs with various modifications are illustrated in Fig. 668. In A

which is the simplest form, the rafters *a* rest at foot on the wall-plates *b*, to which they are only nailed, while at their upper ends they either butt against each other as at *c*, or are crossed and nailed as at *d*. Obviously this is a very slender structure, and quite

668.



unfitted to bear any considerable weight of roofing material. *B*, *C* represent progressive steps in strengthening this form of roof, by the introduction of one or more "collar beams," which prevent the collapse of the sloping rafters, and give their name to this modification of the span roof. In *B*, the rafters *a*, measuring usually about $6\frac{1}{2}$ in. by $1\frac{1}{4}$ in. and carrying a covering of 1-in. boarding *b*, butt against the ridge-pole *c* at top, and are cut out for the reception of the wall-plates *d* at bottom. At rather more than $\frac{1}{3}$ of the height from the wall-plate to the ridge-pole, the rafters are tied by the collar-beams *e*, having the same dimensions as the rafters, and which may be simply nailed to them at the ends, or halved in, as here shown. *C* differs from *B* only in having a second collar-beam *f*, and the extra support of a purlin *g* let into the rafters and the lower collar-beam *e*. *D* is a modification of *B*, necessitated by the introduction

669.

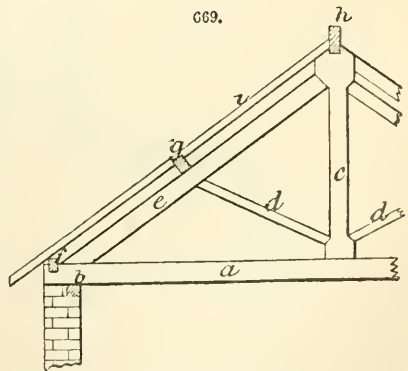

of a purlin *g* let into the rafters and the lower collar-beam *e*. *D* is a modification of *B*, necessitated by the introduction

of a ventilator in the roof: *a* is the collar-beam supporting the purlin *b* and rafters *c* as well as the uprights *d* of the ventilator. In E a new feature occurs in the shape of a "strut" or "brace" supported by a "tie-beam." Here the tie-beam *a* resting on the wall-plates *b* carries at its ends "pole-plates" *c* let in, and which in their turn bear the lower ends of the rafters *d*, butting at the apex against the ridge-pole *e*. To reduce the strain in the middle of the rafters, the struts *f* are employed, receiving their support from the ends of the straining sill *g* against which they abut.

When a strong roof of say 20 ft. span is required, the truss principle is fully carried out, as in the "king-post" roof, Fig. 669. Here tie-beams *a* measuring 9 in. by 4 in. are placed at intervals of about 10 ft. resting on the walls and wall-plates *b*. From the

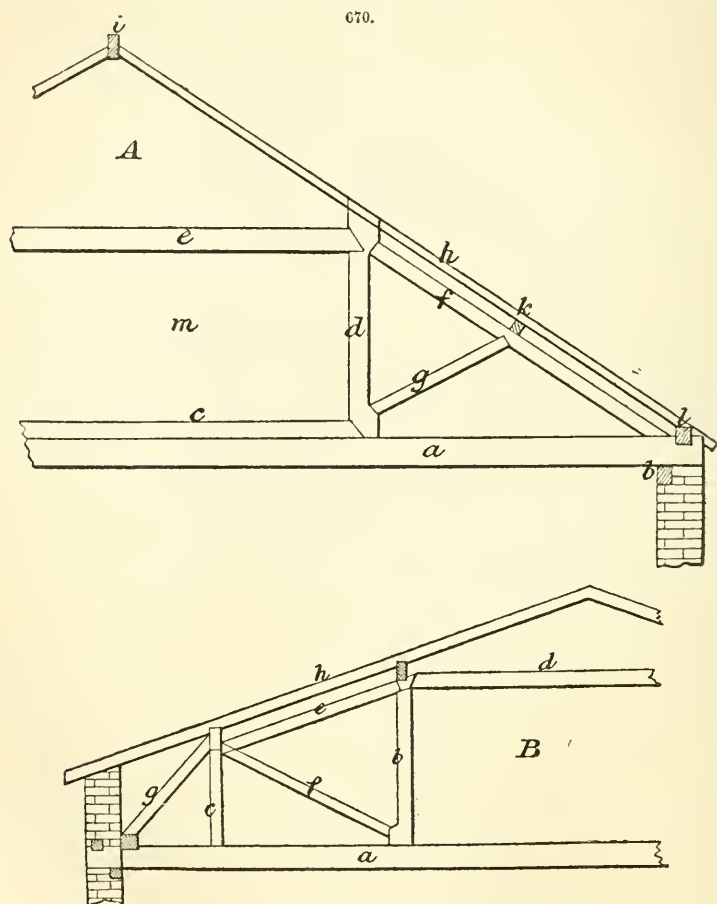

centre of each tie-beam rises the king-post *c*, measuring 5 in. by 3 in.; abutting against its lower shoulders on each side are struts *d*, $3\frac{1}{2}$ in. by $2\frac{1}{2}$ in., reaching to the middle of the principal rafters *e*, 6 in. by 3 in., whose feet rest on the tie-beam *a*, while their heads fit under the upper shoulders of the king-post *c*. Just outside the line of the wall-plate and that of the feet of the principal rafters, the tie-beams *a* have pole-plates *f*, 4 in. sq.,

let into their upper faces; and running midway along the principal rafters, just over the point where they are sustained by the struts *d*, are purlins *g*, 8 in. by 3 in. The pole-plates *f*, purlins *g*, and ridge-pole *h* (8 in. by 1½ in.), between them carry the common rafters *i*, 3½ in. by 2 in.

The king-post roof, from the manner of arranging the timbers, precludes any use being made of the roof space. When this space is a desideratum, the queen-post roof is better suited, two examples of which are seen in Fig. 670, the form A being adapted to a high-pitched roof, while B is accommodated to a low pitch. In A, the tie-beam *a*, 9 in. by 4 in., resting on the wall-plates *b*, 5 in. by 3 in., carries a straining sill *c*, 4 in. sq., separating the feet of the queen-posts *d*, 4½ in. by 4 in., which stand on the tie-beam *a*, and support at top the straining beam *e*, 7 in. by 4 in., and the upper ends of the principal rafters *f*, 5½ in. by 4 in. Struts *g*, 4 in. by 3 in., run from the lower shoulders of the queen-posts to the middle of the principal rafters, whose lower ends rest on the tie-beam *a*. The common rafters *h*, 4 in. by 2 in., abut against the ridge-pole *i*, at top, and are borne by the tops of the queen-posts *d*, the purlin *k*, 7½ in. by 4 in., and the pole-plate *l*, 4 in. sq. These measurements are suited to a roof of 30 ft. span. The space *m* is available for a room. In the form B, the timbers are differently arranged to suit the low roof. The tie-beam *a* is 11 in. by 6 in., the queen-posts *b*, *c* are 6 in. sq. and 6 in. by 4 in. respectively, the straining beam *d* is 8 in. by 6 in., the principal rafter *e* is 6 in. sq., the struts *f*, *g* are 6 in. by 4 in., and the common rafters *h* are 4½ in. by 2 in.

Fig. 671 illustrates two ways of constructing a "curb" or "mausard" roof, which enables a capacious and well-lit apartment to be formed in the roof. In A, the tie-beam *a* measures 12 in. by 4 in., the struts *b* are 6 in. by 4 in., the upper tie-beam *c* is 8 in. by 4 in., the king-post *d* is 4 in. sq., the principal rafters *e* are 6 in. by 4 in., the purlin *f* is

671.

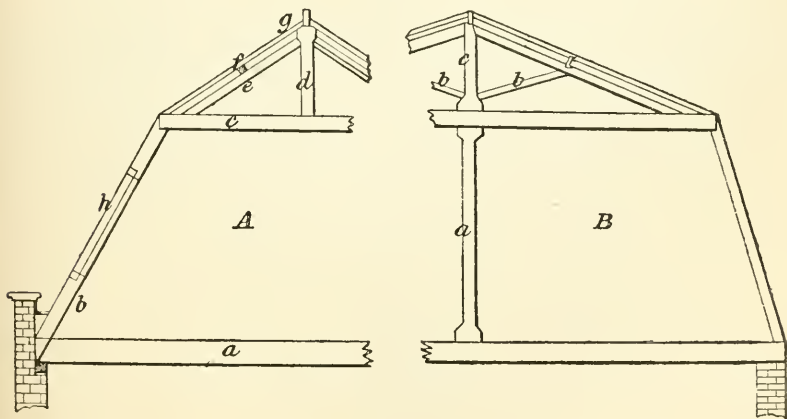

5 in. by 4 in., and the common rafters *g* are 4 in. by 2 in. The apartment may be lit by the window *h* or by a "dormer" window. The arrangement B is suited to a roof of wider span, and is strengthened by the stout king-post *a* and by 2 struts *b* from the upper king-post *c*.

The manner of joining the upper ends of the struts to the upper shoulders of the king-post is shown in Fig. 672: the ridge-pole drops into the recess *a* in the top of the king-post *b*, and the struts *c* are let into the shoulders of *b* either by a simple tenon *d* or an angular tenon *e*.

The form of gutter for the bottom between 2 span roofs is shown in Fig. 673. The

tie-beam *a* carries a strip of quartering *b*, against which abut the lower ends of the rafters *c*; a bridging-piece *d* supports the floor of the gutter *e*.

Doors.—Ordinary room doors are of 2 kinds, distinguished as “ledged” and “panelled.” The former are easier to make, heavier, and stronger, but have a commonplace appearance. Every kind of door requires a wooden frame occupying the margin

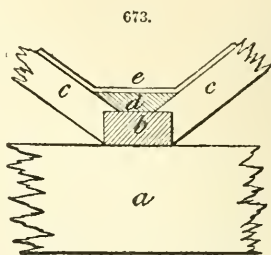
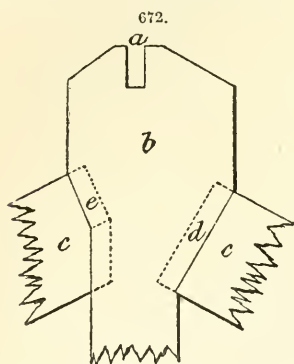

of the space to be closed, and into which the door may shut as closely as possible. If the doorway be situated in a wooden structure, the timbers of this structure will be arranged to form the door-frame; in other case, the frame must be made and secured in place ready for receiving the door. The essential parts of the frame are, as seen in Fig. 674, a lintel *a*, 2 jambs *b*, and a sill *c*; the bottom ends of the jambs are mortised into the sill. When the doorway is in a wooden structure the top ends of the jambs may also be mortised into the lintel; but when the frame has to be built into a brick wall, the lintel and jambs are usually housed or halved into each other and made to project somewhat, as shown. The door represented in the figure is a kind of ledge door, fitting closely into the space enclosed by the frame *a, b, c*; the inner side is shown, in which the latch and hinges should be fastened. On opposite faces of the jambs and on the under side of the lintel a fillet of wood is nailed in such a position as to serve as a stop against which the door may shut, leaving its outside face flush with the frame; and when hanging the door, care should be taken to support it off the sill by a thin strip of wood, so as to ensure its moving free of the sill when opened and closed. Hinges and latches are chosen according to the weight and finish of the door.

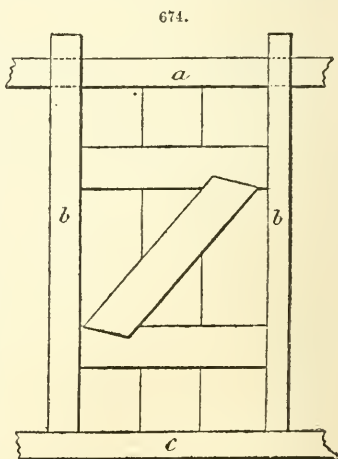

Ledged doors of several kinds are shown in Fig. 675. The simplest and most easily made is *A*, consisting only of the requisite number of 1-in. to 2-in. boards *a*, placed quite close together (tongued and grooved in better work) and held by the ledges *b*, to which they are fastened by clasp nails. In *B*, the vertical boards *a* are secured to ledges *b* as before, but these ledges are strengthened by the diagonal braces *c*, the whole forming a ledged and braced door. *C* is a framed and ledged door, in which the upright boards

a, of the same thickness as the frame, are tongued and grooved into the lintel *b*, sill *c*, and ledges *d*, while the lintel and sill are mortised and tenoned into the jambs *e* at the corners. *D* differs from *C* mainly in the introduction of the braces *f*.

675.

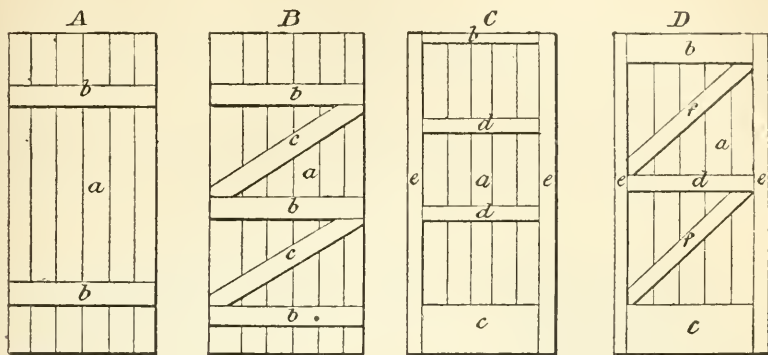

The construction of a panelled door is illustrated in Fig. 676. *a, b* are termed long styles, *c, d* are short styles, *e, f, g* are the rails, and *h, i, k, l* are the panels. The pieces *a, b, c, d, e, f, g* constitute the framing, and are joined together by mortices and tenons cut right through in the case of the outside long styles, and not fitting too tightly. When the parts of the framing have been made and fitted, their inner faces are grooved for a plough plane about $\frac{1}{2}$ in. deep and $\frac{3}{8}$ in. wide, to receive the correspondingly bevelled edges of the panels.

In better class doors, a beading is run round the edges of the panels to hide the joint and improve the appearance; when this is to be done, it is well not to fit the panels at all tightly into the framing, on account of the risk of splitting the latter. When no beading or moulding is going to be added, more accurate fitting is necessary in the panels. When the panels have been fitted to the grooves in the framing, and everything is properly adjusted, the pieces *c, d, e, f, g* are put together, glued and pegged securely; next the panels are slid in sideways, and finally the styles *a, b* are driven on to the projecting tenons, previously glued, and wedged from the outside edges.

When all is dry, the wedges are cut off, and the edges are planed smooth to fit the frame. The panels may be of very much thinner wood than the frame, thus securing lightness with solidity of appearance, and sufficient strength. Panelled doors are always hung with butt hinges let into little recesses on the frame side of the "hanging" style, as that is called which carries the hinges.

A sash door differs from an ordinary door in the frame being occupied wholly or in

676.

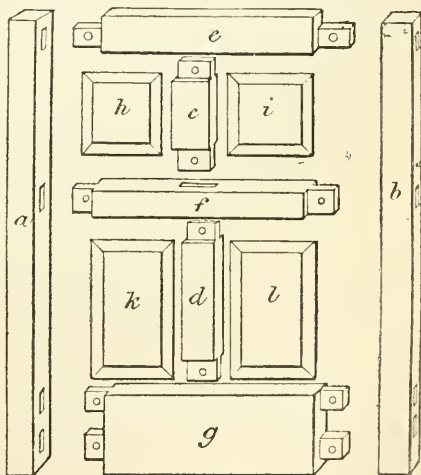

part by a window instead of wood. Light doors for cupboards, &c., may be made in a simple manner by mortising and tenoning the styles and rails together, and cutting a rebate in their inner edge all round, into which thin boards can be dropped to serve as panels, and secured by small brads, with a bead or moulding run round to hide the edges.

Windows.—Windows may be divided into 3 classes—(1) casement windows (opening on hinges or pivots), (2) sash windows (opening by sliding up and down), and (3) skylights. The construction and arrangement of the woodwork of windows—their frames—will only be dealt with here, leaving the various methods of fixing the glass for discussion under Glazing.

When a window is to be inserted in a wooden structure, provision is made for fitting it to a portion of the framing of the building; but when the walls are of brick, a special frame must be made for the reception of the window. Fig. 677 shows a plan of the

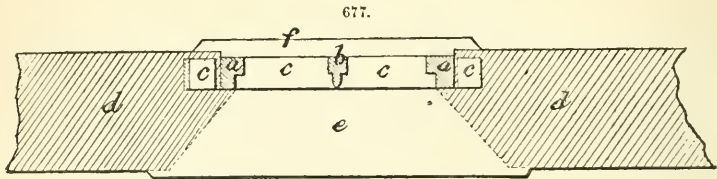

framing for a casement window 4 ft. high and 3 ft. wide. The side posts *a*, 4 in. by 3 in., are tenoned into the lintels, of the same dimensions, at top and bottom, and midway between them is the centre rail *b*, 4 in. by 2 in. The ends of the bottom lintel *c* are shown projecting into the walls *d*, and those of the upper lintel are extended in like manner; *e* is the interior window sill, a piece of 1-in. planed board, overhanging about $\frac{3}{4}$ in.; *f* is the exterior sill, consisting of a piece of quartering 3 in. sq. sloped on the upper side and grooved on the under side, and nailed on beneath the lower lintel *c*. Fig. 678 shows the construction of the glass frame in its simplest form. The uprights *a, b* and crossbars *c, d* are bevelled around their outer edge, and rebated for the reception of the glass on their inner edge; the crossbars are mortised into the uprights at the corners, and secured by pegs. Obviously the frame here shown is intended to carry only one pane of glass. In larger frames, where it would be inconvenient to have the glass in one piece, the frame space must be divided by partitions, tenoned in as the original parts of the frame, and of the sectional shape indicated at *e, f* being the glass occupying the rebate. The glazed frame is hinged or pivoted to the main frame, and provided with a hook or rack for holding it open. The frames shut against stops on the main frame, which exclude wet.

In sash windows, the glazed frames (called "sashes") are made as before, but they are fixed in pairs, each occupying half the depth of the window. The construction of the outer frame admits of the sashes passing each other, by which the opening and shutting of the window are performed. When only one of the two sashes is movable, the window is called "single hung"; when both, "double hung." Each sash is hung independently, and, if movable, supported by counterweights or ends running over small pulleys. The top sash occupies the outer position and the bottom sash the inner. The outer frame, in

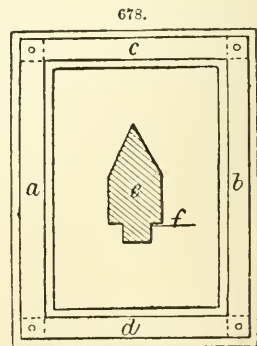

which the sash-frames work, must always be made specially and fitted into the space in the wall. The construction of the outer frame is shown in Fig. 679. The sashes work on the face of the mullion-piece *a*, separated by the parting-piece *b*, so that they may pass each other without touching. The counterweights *c* are similarly separated by the strip *d*; *e* is the front lining and *f* the back, joined by the end piece *g*; *h* is the top sash and *i* the bottom. The manner of cutting the bottom bar of the upper frame, and the top bar of the lower one, so as to make a close joint, is shown in Fig. 680: *a*, top sash; *b*, bottom sash. The bars of sash-frames are generally more or less ornamentally moulded, and a bead is run round the outer frame.

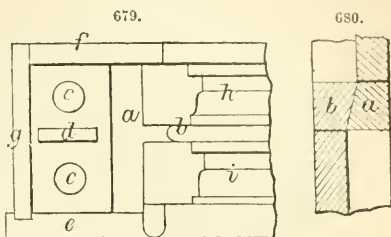

A skylight is a sloping window fixed in a roof, part of which it replaces; that is to say, a portion of the ordinary roofing material, of any desired length, and of a width corresponding to the space between 2 or more rafters, is replaced by a glazed sash. In adjusting the sash to the space, the frame may be recessed to admit the rafters, or the rafters cut off to admit the frame. As both the roof and the skylight present a slanting position, most of the cutting is on the bevel. The space to be occupied by the skylight frame is enclosed by joining the rafters which are interfered with by cross-pieces of stout quartering. The whole structure is well illustrated in Fig. 681, taken

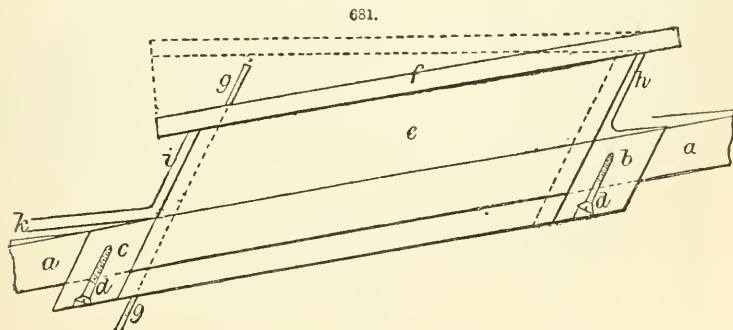

from a practical article on the subject in *Amateur Work*: *a* is one of the rafters forming a side of the hole in the roof; *b, c*, pieces of quartering constituting the top and bottom, and secured to the rafters by the screws *d* whose heads are countersunk; *e* is one side of a rectangular box made of 1-in. planed deal, about 9 in. deep, dovetailed at the corners, and sloping as shown. This box should fit tightly into the rectangular space made for it, and be secured by nails or screws to the rafters at the sides and the crossbars *b, c* at top and bottom. The top edge of this box should have a groove ploughed in it to carry off rain-water, and it may have a fillet $\frac{1}{2}$ in. high nailed all round the outside, to form an enclosure for the sash that is to lie on the top. This sash *f* is made in the usual way, and, if not to be opened, is screwed down securely on the top of the box, which it fits exactly, dropping inside the fillet; but if it is intended to be opened the top edge only must be secured, and that by hinges joining it to the box. The sash is raised and lowered by the rod *g*, which may be of any reasonable length. When the sash is fixed and completed, the roofing material must be adjusted to it, to exclude the weather. But before laying the roofing (slates, tiles, felt, &c.) up to the skylight, pieces of sheet lead are spread all round it, one at the head *h* being turned up the woodwork

of the skylight and slipped up under the slates *k*, another *i* at the foot lying over the slates *k*, and one on each side, similarly arranged for keeping out the wet. These strips of lead are nailed down in place before the roofing is secured over them. They should extend about 6 to 9 in. in each direction on the roof, besides the turn-up on all sides of the skylight. The lead must be bent and fitted by the aid of a piece of planed hard wood, on which a hammer can be used. The joints may be soldered if desired, as described under Soldering. Angular fillets nailed all round at the base of the skylight reduce the sharpness of the bend in the sheet lead, and hence help to preserve it.

CABINET-MAKING.—The art of “cabinet-making” is usually divided into two classes—“carcase work,” embracing the production of articles of chest-like form, such as book-cases, &c., and “chair work,” comprising not only chairs and their substitutes but also tables. In point of fact, it is merely joinery of a superior description, working with finer tools on more costly woods, and producing more slightly effects. The subject may be conveniently discussed under the several heads of woods, tools, and veneering, concluding with a few examples in both carcase and chair work.

Woods.—Most woods have already been described more or less fully under Carpentry, especially concerning their sources and qualities; repetition will be avoided by making cross-references to particular pages, and only points specially interesting to the cabinet-maker will be noted here. The woods in ordinary use are named below in alphabetic order.

Amboyna: the beautifully mottled wood of *Pterospermum indicum*, a native of India.

Apple: inferior in all respects to pear.

Ash: see p. 127.

Beech: see p. 128. Takes a walnut stain well.

Beefwood: a common name for the woods of the Casuarinas, described on p. 141.

Birch: see p. 128. The black or cherry kind is most esteemed, and is largely used for plain furniture. It is harder than mahogany, and often occurs beautifully figured (then called “mahogany birch”; such figured pieces are cut into veneers, but only adapted for the caul and hand-screw process, on account of the tendency to swell and shrink on wetting.

Box: see p. 129. Twists and splits in working, if not well seasoned.

Camphor: has an excellent effect when worked into small articles.

Canary: the wood of an Indian tree, *Persea indica*

Cedar: see p. 130.

Cherry: much used by cabinet-makers and musical instrument makers, especially in France.

Ebony: see p. 132. Has a tendency to split and exfoliate. Very expensive.

Holly: a light, close-grained wood, of small size, useful in small articles and for inlaying.

Kingwood: a scarce wood imported in sticks 5 ft. long from Brazil; apparently related to rosewood.

Lime: has a butter-like hue, and is easy to work.

Locust-wood: see p. 136.

Mahogany: see p. 136. Cabinet-makers distinguish 3 kinds—Spanish, Cuban, and Honduras, esteemed in the order quoted. Spanish is known by its hard, close grain, and variously mottled figure. The rarest mottle is “peacock,” something like birds'-eye maple. Of ordinary kinds, “stop” mottle is most admired, a light and dark figure being produced by waves of grain breaking up and running into each other. In “fiddle” mottle, the waves run across in nearly regular lines. In the figure called “breech,” “curl,” or “curb,” the light and dark shades slope away from the centre; veneers of this are liable to contract a number of little cracks in time. The Cuban wood is less handsome in figure, lustre, and colour, and therefore employed in large veneers as a cheaper substitute

for Spanish, also in solid work. Honduras (called Bay) wood has little artistic value, but is esteemed for the solid parts of work intended to carry veneer, being straight-grained and free from warping and shrinking. These qualities render mahogany a favourite wood in cabinet-making, another great advantage being its immunity from decay and worms.

Maple : see p. 138. The best figured birds'-eye maple is cut into veneers.

Oak : see p. 140. Oak has little beauty for furniture-making unless it is judiciously cut so as to exhibit the "champ" or silver grain to the best advantage (see p. 178). This champ is better marked in Riga than in English oak, and the former is also a more easily worked wood, consequently it is preferred for this particular purpose, though somewhat less strong and durable.

Partridge-wood : a name applied to the wood of several South American trees.

Pear : see p. 141. Takes a black stain well, and often replaces ebony.

Pine : see p. 144. The American pine, commonly called Weymouth or white pine in this country, is best suited for cabinet-making purposes, and forms the ground for nearly all veneered and hidden work.

Plane : see p. 145.

Rose : see p. 147. The best comes from Rio de Janeiro, and emits an agreeable odour. It is hard, heavy, and dark-coloured.

Sandal : chiefly esteemed for its fragrance.

Satin : see p. 147. Used in fancy articles. Has a peculiar lustre and fragrant odour.

Teak : see p. 149.

Tulip : see p. 150. Used for inlaying and marqueterie work.

Walnut : see p. 150. This wood is very popular both for solid work and veneering. The species common to Europe and Asia affords the best wood ; that native of America gives a "black" kind used as a cheaper substitute. Walnut contrasts well with lighter woods, as birds'-eye maple, ash, and satinwood, and lends itself to most delicate ornamental work.

Zebrawood : a name given to a beautiful furniture wood obtained in British Guiana from the hyawabolly (*Omphalobium Lambertii*).

In addition there are many excellent cabinet-making woods produced in our tropical colonies about which little or nothing is known in this country.

Tools.—These are mainly the same as employed in Carpentry, but some special forms are added. These will be described here, including chest and bench.

Tool-chest. A convenient chest for holding cabinet-making tools is shown in Fig. 682, as described by Cabe in *Design and Work*. It is 3 ft. 1 in., by 1 ft. 8 in., by 1 ft. 8 in. inside measurement, with a till the full length of the inside, 9 in. broad and 10½ in. deep. The body of the chest is made of ¾-in. best yellow pine, with a skirting of oak round the lid. The till and the inside of the lid are veneered with rosewood and walnut. The 2 sides are squared up 3 ft. 3 in. long and 1 ft. 8 in. broad, and the 2 ends 1 ft. 10 in. long and 1 ft. 8 in. broad.

They are previously slipped on the upper edge—that is, a thin slip of plain walnut, say ⅜ in. thick, is glued on what is to be the upper edge of each piece. These 4 pieces are dovetailed together, the dovetails 1½ in. apart

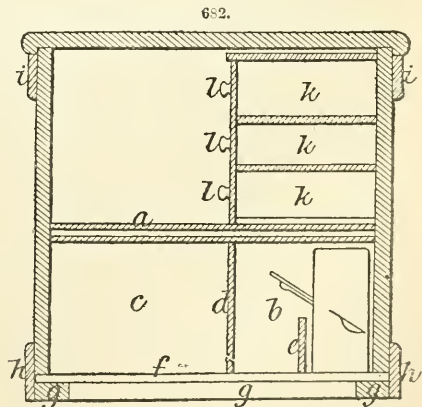

and all going quite through the thickness of the wood. Before gluing the pieces together, 2 fillets *a* of mahogany, 1 in. broad and $\frac{5}{8}$ in. thick, with a groove in the centre, are glued and screwed to the inside of the ends at a distance of $10\frac{3}{4}$ in. from the upper edge; these are to receive a sliding board 11 in. broad, which slides underneath the fill, which, when pushed back, covers the planes and tools in the space *b*, and, when pulled forward, covers the tools in the space *c*. This board may well be left out. A partition board *d* between *b* and *c* comes nearly up to the sliding board, and is grooved into the 2 ends. A second partition *e* in the middle of the space *b* is 4 in. broad, and is also let into the ends. These 2 partitions are made of $\frac{1}{2}$ -in. wood, and these grooves must be made in the ends to receive them before the body is knocked together. A stain of Venetian red and ochre, with a little glue size, is made somewhat thin, and applied hot to the wood with a piece of cotton rag; then, after standing for a few minutes, as much as will come off is rubbed with another piece of rag, stroking always with the grain. In a short time this stain will dry, when it is sandpapered, using the finest. The body is next put together with thin glue, using a small brush for the dovetails, and taking care that no glue gets on to the inner surface, as taking it off afterwards leaves an unsightly mark. It must be borne in mind that in dovetailing a box such as this, the "pins" are always on the end pieces; consequently they are cut first. In "rapping" the body together, a somewhat heavy hammer is used, and always with a piece of wood to protect the work from injury. The 4 corners are glued and rapped up close. The box has to be "squared." A rod of wood, made like a wedge at one end, and applied from corner to corner diagonally inside, is the readiest method of squaring, a pencil mark being made on the side of the rod just where the side and end meet; then the rod being placed diagonally from the other 2 corners, the pencil mark will show at once whether the box is squared or not; and, if not, the long corner must be pressed or pushed to bring it to the square. A bottom *f* is nailed on of $\frac{5}{8}$ -in. wood, with the grain running across—i. e. from back to front. Then a band *g* of wood, $2\frac{1}{2}$ in. broad and 1 in. thick, is nailed over the bottom, and flush with the outside of the box all round. The 2 long pieces are nailed on first, and the end ones are fitted between them. To secure these bars or bands properly, a few $1\frac{1}{4}$ -in. screws should be passed through the bottom from the inside into them. The box is then planed truly on the outside all round, finishing with a hand-plane and sandpaper. A band *h* is made to go round the sides at the bottom, and another *i* at the top or upper edge; that at the bottom is $3\frac{1}{2}$ in. broad and $\frac{5}{8}$ in. thick, and that at the top $2\frac{1}{2}$ in. broad and $\frac{5}{8}$ in. thick. It makes the best job to dovetail these bands at the corners, making them of a size to slip exactly on to the body of the chest. The upper edge of the bottom band, and the lower edge of the upper, are moulded either with an "ogee" or "quarter round." When the bottom band is in a position for nailing, it covers the bottom bars and the edge of the bottom, coming up the sides of the box about 2 in. The upper band is fixed $\frac{3}{8}$ in. below the edge of the body; this forms a check for the lid, the bottling for the lid being made to check down on this band. The lid is made of pine, $\frac{7}{8}$ in. or 1 in. thick; it has cross ends, $2\frac{1}{2}$ in. broad, mortised on. These prevent the lid splitting or warping. After they are glued and cramped on, the lid is evenly planed and squared to the proper size, which is $\frac{1}{16}$ in. larger than the body of the box on front and ends, and $\frac{1}{2}$ in. over the back. The lid is fitted with 3 brass butt hinges 3 in. long. The lid, being temporarily fitted, is taken off, and a skirting put round it—that is, on front and ends. This skirting is $1\frac{1}{2}$ in. broad, and $\frac{7}{8}$ in. thick, of hard wood—oak or black birch. To make a first-rate job of this skirting it should be grooved, as also the chest-lid and slip feathers inserted. It should also be nailed with fine wrought brads. After it is firmly fixed and dry, it is rounded on the outer edge. The extent of the rounding is found by shutting down the lid and drawing all round at the edge of the band, over which the skirting projects about $\frac{5}{16}$ in. The inside of the lid may be pannelled. This panneling is simply a flat veneered surface, the 2 panels being root walnut, and the borders rosewood; the veneering must be done before the

skirting is put on. The 2 panels are laid first; when dry, the cutting gauge is set to $2\frac{1}{4}$ in., and cuts away the over veneer all round, which, of course, gives a border of $2\frac{1}{2}$ in. to be veneered with the rosewood; $2\frac{1}{4}$ in. also divides the 2 panels in the centre, and the 8 corners are marked off with compasses set to $1\frac{1}{2}$ in., and cut clean out with a gouge. All the edges are planed with the iron plane, and the rosewood border is planed and jugged all round in the form of "banding"—that is, with the grain running across and not the lengthway of the borders. The round corners are fitted in in 2 pieces mitred in the centre. A till has now to be made. The body or carcase of this is entirely of $\frac{1}{2}$ -in. wood. It has 2 drawers in the length at the bottom, 3 in. deep on the face; 3 in the centre in the length, $2\frac{1}{2}$ in. deep on the face; and over these is a tray, covered by a lid. The face of this tray is in the form of 4 drawers, which are shams. The drawers are 9 in. broad from front to back, and run on shelves $\frac{1}{2}$ in. thick, with divisions between of the same thickness. The shelves and divisions, as also the edge of the lifting lid, are slipped with rosewood on the fore edges, and the drawers being veneered with root walnut, the whole has a good effect. The lifting lid is panelled with veneer, similar to the lid of the chest, the rosewood border being $1\frac{1}{2}$ in. broad. It is hinged with 3 brass butts, $1\frac{1}{2}$ in. long, to the back of the till, which projects upwards the thickness of the lid, and is veneered also with rosewood. This lid may be made of bay mahogany or good pine; and if of the latter, it must be veneered on the under side with plain walnut or mahogany, to counteract that on the top and prevent warping. The carcase (case) of this till is constructed as follows:—The 2 ends are cross-headed on the upper edge: these are $1\frac{1}{2}$ in. broad, and may be put on with the ploughs. Then the bottom and 2 shelves are squared up to the length of inside of the chest, having been previously slipped on the fore edges with rosewood $\frac{1}{2}$ in. thick. The bottom is dovetailed into the 2 ends, while the 2 shelves are mortised or let into the ends with square tenons, which pass quite through, and are wedged. The divisions between the drawers are let through, and wedged in the same manner. The front of the tray, which has the appearance of 4 drawers, is of $\frac{1}{2}$ -in. mahogany, veneered with root walnut, like the drawer fronts, and an imitation of the fore edges made on it by glueing slips of rosewood, $\frac{1}{2}$ in. broad, to represent the fore edges. The walnut front must, of course, be sandpapered before these are put on. The 5 drawers *k* are made entirely of straight, plain, bay mahogany, $\frac{1}{4}$ in. thick, excepting the fronts, which are $\frac{1}{2}$ in. The knobs *l* are of rosewood, $\frac{3}{8}$ in. diameter. The tray, covered by the hinged lid, is so deep as to hold the brace or tools of the like bulk. The left end may be occupied with 3 shallow trays, one over the other, for holding the several bits belonging to the brace, and are very handy, as the bits can be arranged in order, and the trays may be lifted out to the bench, when a number of the bits is wanted. The remainder of the tray is lined with green frieze, and holds the brace, spirit-level, gauges, squares, and other of the finer tools. The 2 long drawers at the bottom are used for chisels, gouges, spoke-shaves, mitre-squares, &c., while the 3 upper ones are for gimlets, bradawls, compasses, pliers, and sundry small tools. In the space *b*, in the body of the chest and under the till, the planes are arranged as shown. In front of them is a space 4 in. broad and the full length of the chest. In it long tools, such as the trammels, are kept, and any planes that the back space will not admit, such as raglets or grooving planes, which have 2 wedges. It is also useful for holding drawings of large dimensions, rolled up, where they are safe from damage, and in cases of removal it is the receptacle for the hand-saws and other tools which usually hang upon the wall.

Bench.—A full-sized cabinet-makers' bench is generally 7 ft. long and $2\frac{1}{2}$ ft. wide, but a very convenient size is 6 ft. by 2 ft. Such a bench is illustrated in Fig. 683. The top is in 2 parts, the front portion *a* being 15 in. wide and of $2\frac{1}{2}$ -in. red or yellow pine, sound and straight; the back portion *b* is only 9 in. wide and $1\frac{1}{2}$ in. thick. Both are supported by the cross rails *c*; and the back part has a fillet *d*, 1 in. thick, screwed to it in such a position that its top edge is flush with *a*. The rails *c*, 5 in. by 2 in., are screwed to the top ends of the 4 legs of good red pine, the 2 back ones *e* and right front one *f*

measuring 4 in. by 2 in., while the left front one *g* is 6 in. by 2 in. The back legs *e* diverge at foot to give greater steadiness to the bench. The top is secured to the rails *c* by screws put up from beneath. At bottom, the legs are joined by rails *h*, 3 in. by 2 in., dovetailed into them and held by screws; boards *i* are nailed to their under side, to form a capacious tray for holding tools. The bench stops *k* are let into holes which come

683.

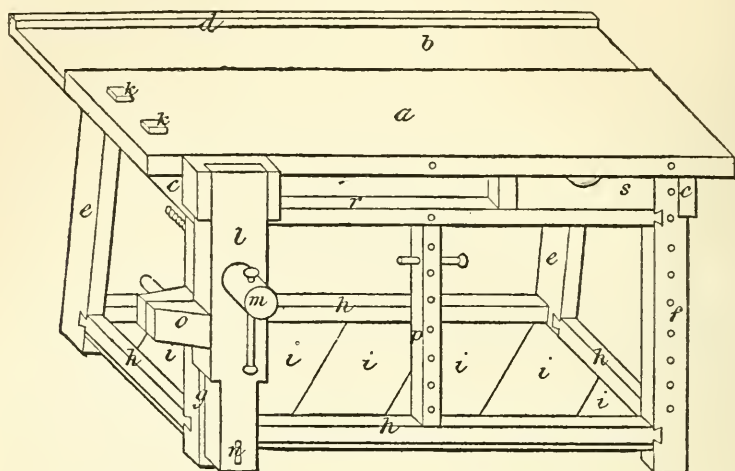

clear outside the rail *c*. The bench vice *l* has its outer cheek working against the leg *g* by means of the screw *m* passing through both. At the bottom is a "runner" or "sword" *n*, consisting of a strip of wood, 2 in. by $\frac{1}{2}$ in., mortised into the foot of *l* and sliding in a corresponding groove in *g*, where it is pegged by an iron pin at suitable distances for keeping the jaws of the vice parallel. This is further aided by the supplementary side screw *o*. The holes in the leg *f* and central bar *p* hold strong pegs for supporting the ends of work while it is being manipulated in the vice. The space between the top *a* and the rail *r* may be made into a shelf only, or partially occupied by a drawer as at *s*.

Planes.—Besides the ordinary planes, the cabinet-maker uses a "toothing" plane. This has a stock similar to the hard wood hand-plane, but the iron, instead of having a cutting edge, presents a series of sharp teeth to the wood. This serrated edge is formed by long narrow grooves on the face of the iron next the wedge, and when the iron is ground in the usual manner these ridges terminate in sharp points. In setting-up this iron on the oil-stone, only the ground back is applied to the stone. The position of the iron in the stock is nearly perpendicular, so that it is simply a scratch plane, and needs no cover like the others. Its use is to roughen the surfaces of pieces to be glued together, for while it takes off the ridges left by the half-long or panel plane, it roughens the surface by scratching, thereby adapting it better to hold the glue. All surfaces to be veneered upon, as well as the veneer itself, are scratched with this plane.

Dowel plate.—The dowel plate is a steel plate about $\frac{1}{2}$ in. thick, with holes from $\frac{3}{16}$ in. to $\frac{1}{2}$ in., and centre-bits are fitted and marked so that dowel pins made in the holes will fit holes made by the corresponding bits.

Smoothing implements.—The "scraper" is a bit of steel plate about the thickness of a hand-saw blade, 5 in. by 3 in.; its use is to take off any ridges left by the smoothing plane in planing hard wood, producing a surface perfectly free from lumpiness; it is

used before the sandpaper. Sandpapering is done with the paper wrapped round a piece of cork. The usual size for large flat surfaces is 5 in. by 4 in., and about 1 in. thick. One side is made quite flat, and on this the paper is placed. Pieces of cork are used for all kinds of sandpapering,—hollows, rounds, mouldings, &c.,—the cork being shaped with the rasp, to fit the part to be prepared.

Sawing rest.—The sawing rest or “bench boy” used by cabinet-makers differs from that employed by carpenters (p. 261) in being shorter and broader, say 10 in. by 6 in., of $\frac{3}{4}$ -in. pine, the fillets being of mahogany, $1\frac{1}{8}$ in. sq., let into grooves, glued, and screwed.

Moulding board.—This contrivance for holding strips of wood while under the moulding plane somewhat resembles the shooting board (Fig. 268, p. 191). It consists of a plank *a* of $1\frac{1}{4}$ -in. Bay mahogany, 6 ft. long and 6 in. wide, having attached on its upper surface another board *b* of the same length but only 3 in. wide, thus forming a step (see Fig. 684). The upper board *b* is free to move laterally on the lower one by means of slots *c* 2 in. long, through which screws *d* pass into the lower board *a*. Thus the width of the step is regulated. To suit mouldings of various sizes it is well to have 3 guide boards *b*, $\frac{1}{4}$ in., $\frac{1}{2}$ in., and $\frac{3}{4}$ in. thick, all slotted to fit the same screws. At each end is fixed a bench stop *e*, exactly like that shown in Fig. 683, p. 354.

684.



Mitring and Shooting board.—Here again the article used by carpenters (Fig. 260, p. 188) is replaced by a shorter form more suited to light work. It is made by screwing together 2 pieces of Bay mahogany 30 in. long, 6 in. wide, and 1 in. thick, one overlapping the other 2 in. sideways, so as to form a step 4 in. wide. This constitutes the shooting board. The mitring is effected by a triangular piece screwed to the top board, about the centre, with its apex touching the margin of the step, so that its sides form exactly angles of 45° with the step.

Vice.—A wooden vice with jaws 6 in. wide is very useful for holding small work, either on the bench or in the bench vice.

Veneering.—This name is applied to the practice of laying very thin sheets (called veneers) of a more valuable wood upon the surface of a less valuable one, in order to gain superior effects at reduced cost.

The method of cutting veneers, as conducted by the Grand Rapids Veneer Co., is thus described. In the first place the log is drawn up an inclined plane by means of tackle, and brought under a drag saw on a platform at the top, where it is cut to the length required in order to fit the cutting machine. On one side of this platform, which is outside the factory building, is a row of steam boxes, in one of which the log is placed, and allowed to remain about 12 hours, emerging in a very soft and pliable state. This is necessary to prevent chipping and breaking while going through the cutting process, and also to render it more easy to cut. It is lifted from this place by a powerful crane, and after the bark has been peeled off, placed upon the cutter. A veneer cutter resembles a gigantic turning lathe, with a knife ground to a razor-like edge running the whole length of the log to be cut. It is very massive, the knife being backed with an enormous iron beam, and the other portions are fixed in an equally solid manner; for the slightest tremor or yielding in any part would tear the veneer and render it useless. The machine used by this company weighs 10 tons. The chuck consists of a large iron shaft, which is hammered into place by a heavy swinging maul. The log having been placed in position, the cutter is set in motion. The log revolves against the knife, and the veneer is pared off in a continuous sheet. So smoothly and easily does the machine work that it is almost impossible to conceive of the enormous power that is exerted. The

feed is supplied by means of a revolving screw, which may be gauged to produce a veneer of any thickness from that of a sheet of tissue paper to $\frac{3}{8}$ in.

Of course there is a limit to the diameter which the machine can cut; and after it has done its work, a piece 7 in. in diameter is left. In plain native woods this can be easily put to other uses; but in French walnut burls it is too valuable to be lost. In such cases, therefore, the knot is fastened to a stay log on whose centre it revolves, and thus very little, and that the least valuable part, of the costly material is wasted. The ash burls, which the company are now cutting, are brought in from the surrounding country, and they avoid the necessity of a stay log by having a sufficient part of the trunk on which the burl grew left to serve for this purpose. As the sheets of veneer come off the cutter, they are taken to a saw which divides them into the required widths, and are then put through the drying machine to remove the moisture with which the steam bath that they have received has saturated them. The subject of drying has been one of the most serious problems with which those in the veneer business have had to deal. A dryer is used by this company, who claim that it is both thorough and rapid in its operation. It consists of 2 series of steam-heated rollers, enclosed in an iron box, between which the sheets of veneer pass as through a planer, emerging in a thoroughly dry state and pressed perfectly flat. The drying is still further expedited by a blast of hot air forced into the iron box referred to by a fan blower. After going through this process, the veneers are taken to the second floor, and such of them as are intended to be sold in this state are packed away, while the remainder is made into 3-ply panels to be used in the manufacture of bedsteads, for looking-glass backs, &c. These 3-ply panels are made by passing the veneers through a glue machine, and then placing them in a press. Great strength is secured in these panels by having the grain of the middle layer of veneer run at right angles with that of the 2 outer layers.

Generally speaking, straight-grained and moderately soft woods are sliced off a log by a weighted knife with a drawing cut, the log, or burl, being 10 ft. long, and the veneers varying from $\frac{1}{8}$ in. to $\frac{1}{10}$ in. in thickness, the width corresponding, of course, to the diameter of the log. A knife machine which gives a half rotary movement to a semi-cylindrical turned log, allowing a veneer to be cut following the log's diameter, produces wide veneers from logs of small diameters. But such woods as ebony and lignum vitæ cannot be cut with a knife, while finely figured and consequently close-grained mahogany, and some rosewood, are difficult to cut. The saw, therefore, has its place. Such saws must be very thin, and so finely adjusted that hardly the slightest variation will occur in the thickness of the veneers turned out. While a nicely arranged circular saw will turn out boards varying $\frac{1}{10}$ in., which would be imperceptible, such a lack of uniformity in thin sheets would prove a damaging imperfection. Before being cut, the veneer material must be carefully steamed, the same as in bending. A tight box 12 ft. long, and 4 ft. deep and wide is used, and exhaust steam is utilized. An ordinary wood like black walnut, which has an open grain, will steam sufficiently in 6 hours, but the close-grained South American woods require 36 hours. Mahogany will steam sufficiently in 24 hours. Mahogany, tulip, and rosewood, being hard to cut, require more and careful steaming, and a knife in the best condition. The veneers wrinkle when laid together, but straighten out readily when glued properly to a body. Veneers will dry in the air in about 12 hours, but are not kiln dried, although the latter method is used for lumber out of which veneers are to be made.

The softest woods should be chosen for veneering upon. Perhaps the best for the purpose are 12 ft. in length, of perfectly straight grain, and without a knot; of course no one ever veneers over a knot. Hard wood can be veneered—boxwood with ivory, for instance; but wood that will warp and twist, such as cross-grained mahogany, must be avoided. The veneer, and the wood on which it is to be laid, must both be carefully prepared, the former by taking out all marks of the saw on both sides with a fine toothed plane, the latter with a coarser toothed plane. If the veneer happens to be broken

in doing this, it may be repaired at once with a bit of stiff paper glued upon it on the upper side. The veneer should be cut rather larger than the surface to be covered; if much twisted, it may be damped and placed under a board and weight over-night. This saves much trouble; but with veneers that are cheap it is not worth while taking much trouble about refractory pieces. When French walnut burr is buckled or cockled, as not unfrequently happens, it is treated on both sides with very thin hot size, and, when quite dry, placed between hot plates of zinc, or hot wooden cauls. This is done with the whole veneer, and it is cut afterwards. The cutting is not easy, owing to the tendency of the veneer to split. It should be placed on a flat board, and marked to a size a little larger than necessary; the veneer is then cut lengthwise by a steel point or marker against a straight-edge, cuts across the grain being done with a fine dovetail saw. Very plain wood can be cut with a chisel or shoemakers' knife. Walnut burrs are best cut with scissors.

There are 2 ways of fixing the veneer, known as "hammering" and "cauling," alike in that they are both methods of applying pressure, but differing in that the former is accompanied by damp heat, the latter by dry.

In either case, the wood to be veneered must now be sized with thin glue; the ordinary glue-pot will supply this by dipping the brush first into the glue, then into the boiling water in the outer vessel. This size must be allowed to dry before the veneer is laid. Suppose now that veneering by the hammer process is about to commence. The glue is in good condition and boiling hot; the bench is cleared; a basin of hot water with the veneering hammer and a sponge in it is at hand, together with a cloth or two, and everything in such position that one will not interfere with or be in the way of another. Then:—

(1) Damp with hot water that side of the veneer which is not to be glued, and glue the other side; (2) go over as quickly as possible the wood itself, previously toothed and sized; (3) bring the veneer rapidly to it, pressing it down with the outspread hands, and taking care that the edges of the veneer overlap a little all round; (4) grasp the veneering hammer close to the pane (shaking off the hot water from it) and the handle pointing away from you; wriggle it about, pressing it down stoutly, and squeezing the glue from the centre out at the edges. If it is a large piece of stuff which is to be veneered, the assistance of a hot iron will be wanted to make the glue liquid again after it has set; but do not let it dry the wood underneath it, or it will burn the glue and scorch the veneer, and ruin the work. (5) Having got out all the glue possible, search the surface for blisters, which will at once be betrayed by the sound they give when tapped with the handle of the hammer; the hot iron (or the inner vessel of the glue-pot itself, which often answers the purpose) must be applied, and the process with the hammer repeated. When the hammer is not in the hand, it should be in the hot water. The whole may now be sponged over with hot water, and wiped as dry as can be. And observe, throughout the above process never have any slop and wet about the work that you can avoid. Whenever you use the sponge, squeeze it well first. Damp and heat are wanted, not wet and heat. It is a good thing to have the sponge in the left hand nearly all the time, ready to take up any moisture or squeezed-out glue from the front of the hammer.

The veneering "hammer" resembles an ordinary hammer in little but its shape, the manner of using it being altogether different. The form of the "hammer" too presents some variety. In Fig. 685, A is what may be termed the "shop" style of veneering hammer-head, while B, C are such as may be made by the operator himself. The form A can be purchased at a dealer's and fitted with a wooden shaft. The form B is made in the following manner: a handle *a*, 12 in. long and 1 in. thick, is inserted in a hole bored in the centre of a piece of hard wood *b*, 6 in. sq. and 1 in. thick, in the bottom edge of which a slit about 1 in. deep is cut with a thick saw, and into this slit is fitted a piece of iron or steel plate *c*, 6 in. long and 2 in. wide, secured by a couple of rivets.

This done, the corners of the top and bottom edges of the wood *b*, and the edge of the plate *c* are nicely rounded and smoothed. The construction of *C* is evident from the illustration; *a* is the handle; *b*, the head. The hammer, of whichever shape, is employed as a squeezer for pressing out superfluous glue; it is therefore held by one hand grasping the handle and the other pressing on the head, and is moved forward with a zigzag motion, each end of the head advancing alternately in short sliding steps.

It may sometimes happen that when the veneer is laid a fault may be noticed which renders it necessary to remove and relay the veneer. This is difficult to do without damaging the veneer. The best plan is to first thoroughly clean the surface by hot damp sponging; then dry and warm it by a fire, and while hot rub in linseed oil; hold to the fire again till the oil has disappeared, and repeat the oiling and warming till the glue beneath is so weakened that the veneer can be gently stripped off. Both old glued surfaces are thoroughly cleansed and roughed by the toothing plane before relaying is attempted. The projecting edges of the veneer can be taken off by a sharp chisel or plane when the whole is quite dry and firm, which end is attained by placing the work under weights supported on an even surface, and leaving it in a warm room. The difficulty with hammer veneering is that the glue is not kept always sufficiently hot and that therefore it does not get properly squeezed out at the edges, and sometimes so much hot water has to be used in the operation that the veneer swells and shrinks to a degree that spoils the look of the work. Still, with care, it is quite feasible to lay flat veneers up to 5 ft. long and 18 in. wide with the hammer in a satisfactory manner. The working

of the hammer should always be from the centre outwards. The sponge and hot water, or the heated flat-iron, is applied when the glue sets, or an air bubble gets entrapped so as to form a "blister." To veneer a convex surface, it is only necessary to wet the veneer on one side, when it will curl up so as to fit a convex object; it should be held in place by binding round with some soft string.

In veneering with a caul, the process is identical with that already described as far as the gluing; the difference commences in the mode of applying pressure to ensure adhesion between the body and the veneer. Cauls are made either of well-seasoned pine or of rolled zinc plate, with a surface exactly the converse of the veneer to be pressed. Hence cauling, while superior to hammering, and in some cases indispensable, is much more expensive, as, except in the case of small flat work, a new caul is required for every new outline presented by the various veneered articles. The substance of the caul, especially in the case of wood, should be thin enough to bend slightly under great pressure; and it should fit somewhat more closely at the centre than at the edges, so that, when pressure is applied, it will pass progressively from the centre outwards. The object of the caul is to remelt the glue which has been spread on the body and the veneer, for which purpose it is strongly heated before application; pressure is then applied in

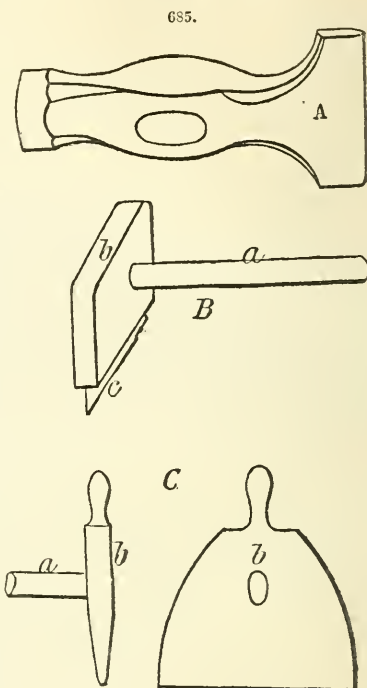

various ways to expel the superfluous glue and increase the intimacy of contact. Small cauls of 1-in. pine for flat work may be pressed by means of wooden hand-screws, applied at short intervals, commencing always in the centre. The caul should be planed true and smooth on both sides, toothed, and saturated with linseed oil, which last not only augments the heat, but prevents escaping glue from adhering to the caul. This adhesion of the glue to the caul, which would damage the work, is also avoided by soaping the caul, and by covering the veneer with a sheet of clean paper.

When the veneered surface is so large that it cannot conveniently be pressed by means of hand-screws, the work is placed in a veneering frame, as shown in Fig. 686. It consists of 2 upright bars *a*, $3\frac{1}{2}$ in. sq., with 2 rails *b*, $3\frac{1}{2}$ in. by 3 in., let into them, and having between the 2

rails *b* a clear space of about 10 in., in which works the movable bar *c*, 3 in. by $2\frac{1}{2}$ in., its position being regulated by the 3 iron screws *d*, $\frac{7}{8}$ -1 in. in diameter. The bar *c* is made with a slight curve on the under side, so that its pressure may be exerted first on the centre of the work. The middle screw is tightened up first, and followed by the others. This middle screw has a nut under a collar let into the upper side of *c*, so as to lift it when necessary, while the side screws simply press on little iron plates *e*. The frame will admit work about 2 ft. wide; a number are used

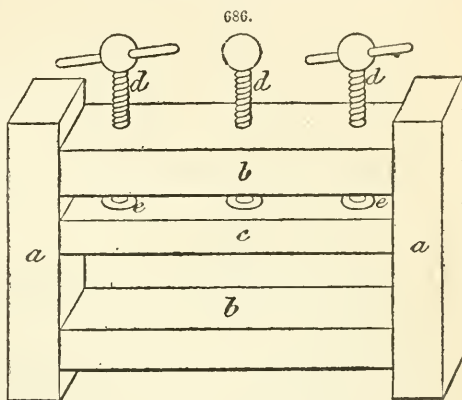

together in a row according to the length of the work. Where steam is available, advantage is taken of it to heat a couple of iron plates arranged together so as to form a shallow tray, and with their opposing faces quite true; the work is placed between them and pressure is applied by iron screws.

Wooden cauls are far inferior to those made of smooth sheet zinc $\frac{1}{4}$ - $\frac{3}{8}$ in. thick; these are more easily and quickly heated, and never adhere to the glue which comes into contact with their surfaces. For work of large size it is most convenient to use the sheet zinc in several pieces placed closely edge to edge.

So far, the veneering of flat surfaces only has been dealt with. For small corners and places where no clamp will hold, it will be found very advantageous to employ needle points such as are used by upholsterers for securing gilt mountings; these can be drawn out when the work is dry, and the small punctures remaining in the veneer will be effectually hidden by the polish subsequently applied. For simple rounded (convex) work, an effective and easy plan is to encircle the work with pieces of string or wire tied at intervals, commencing in the middle, and placing slips of wood between the string and the veneer to prevent the latter being cut into. A useful contrivance as an accessory to the hammer process for round work (Fig. 687) is made by attaching the 2 ends of a piece of stout canvas *a* by means of tacks *b* to the sides of a hard board *c*, rather narrower and longer than the work, and provided with screws *d*. The work is put into the receptacle with the veneered side towards the canvas, which latter is brought to bear tightly against it by turning the screws *d* till they hold firmly against the back of the work. When the work is thus fixed, the canvas is soaked with hot water, and warmed, the screws being meanwhile tightened a little. As the glue commences to exude, the veneering hammer is passed over the canvas covering the veneer, and the pressure is carried to a maximum degree, when the whole is put aside

for 24 hours to set. For the various forms of moulding and complicated outlines, it is necessary to make a wooden caul having exactly the converse form of the surface to be veneered; this is saturated with linseed oil, soaped, or covered with No. 12 sheet zinc shaped to it and held by tacks at the edges. The veneer may be made to assume an ogee form by wetting one half its width on one side, and the remaining half on the other. When the work admits of it, 2 pieces may be veneered at once by heating the caul on both sides. An effort should always be made to utilize the figure of the veneer to the best advantage, as will be ascertained by trying the effect of different positions. When a surface is too large to be veneered at one operation in a convenient manner, it must be done piecemeal, taking care that the consecutive pieces match well in figure. In doing work piecemeal, the uncovered surface becomes coated with the glue squeezed out of the covered portion; this escaping glue should be cleared away as fast as it appears, and even then there is a risk of its forming a thin glaze on the wood, so that it is the safest plan to scrape it and pass the toothing plane over it again before veneering.

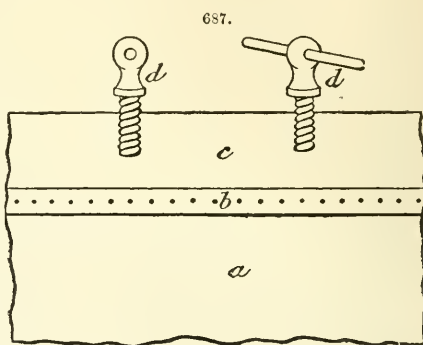

In veneering on a highly resinous wood, such as pitch pine, there is a risk of the heat employed in laying the veneer drawing some of the resin through and spoiling the work. To prevent this, the surface may be superficially charred previous to laying the veneer, by spreading over it a compound of beeswax and turpentine, in such proportions as to produce a thin and not pasty mass, and igniting it at one end. By blowing gently, the flame may be encouraged all over the surface, charring it slightly and especially attacking the resinous veins. The loose charcoal is brushed away as soon as formed, leaving a firm yet charred surface. This is gone over with the toothing plane in a transverse direction, and then well worked over with thin glue before laying the veneers.

The veneering of a bed panel whose length requires 2 veneers is thus described by Edgar. Take the 2 veneers, pair them, cut them to the sizes required, and gently dry them between 2 boards until they are perfectly flat. Then proceed to carefully tooth them on the side to be glued, and if they are roughly sawn, tooth the ridges of the outside; by so doing you will get a thoroughly flat surface when judiciously cleaned off. Should you have a caul press at your convenience, gently rub some glue over that part of the broad end of the feather that contains most end grain, placing a piece of old copy-book or other paper over the same; this will prevent it from adhering to anything by which it is laid, and also aid in strengthening the end grain parts together. When thoroughly dry, joint it to make your full length, and be careful that your joint is slightly hollow. Those end-grain parts that you recently papered, are sure to expand by the steam driven out with the glue by the heated appliances necessary to lay them. When the same class of panel is to be laid by hand with the veneering hammer, carefully dry and tooth your veneer as before mentioned, fix your panel firmly to the bench, and proceed to lay one half; have the glue well boiled, thin, and flowing clear and free from strings, and unrendered bits; glue the feather on the side to be laid, place it on your panel, and with a tack or two to keep it in position, glue all over the outside of the veneer. Now move a warm flat iron, not so hot as to scorch the glue, over the amount of surface you consider capable of laying in the one half. On no account use water.

Study to work from the centre to either end of the piece you are laying. Having got all down, clean all glue off, putting the same in your pot for further use. Now with a hot sponge, rinsed out of water in glue kettle, thoroughly clean your tools for the next operation. After a few hours, proceed to make your joint with the other half, carefully observing your joint is slightly hollow. As heretofore, with the panel firmly fixed to the bench, the glue and iron hot, proceed to lay 6 or 8 in. near the joint, working your veneer hammer as much as possible across your veneer linable with the joint. Having got your joint good, glue a piece of paper over the same to keep all air out, and proceed to lay the remainder, in no case using water till all is laid; scrape all glue off into glue-pot, and with hot sponge clean tools as before. Should the end grain blister, wait till all is laid, then with a fine needle point make 2 or 3 punctures for air to escape. Now with a small piece of hot wood, a bit of paper between, and a little pressure, you will easily master the blistered part. In making a star panel, or so many feathers graduating from a centre, it answers well to lay every alternate veneer, such as 1, 3, 5, and 7, in an 8-section panel.

To lay veneers on panel of foot end of bedstead, shoot the joints and lay alternate pieces, leaving them till quite dry. When dry, shoot the remaining pieces in. This will make good joints, and the curls will not shrink when dry. The curls can only be laid by hammer, and must not be jointed dry.

The difficult process of butt-jointing curls of Spanish or Cuban mahogany is thus described by Cowan:—

There are 3 or 4 ways of butt-jointing curls; but the only sure and certain way is by crossing the joint with a piece of inch deal. First flatten about 7 in. of the veneer from the butt with hot wood cauls or zinc plates; when gripped, dry the rest of the veneer carefully, it is so liable to crack and buckle with the fire; when set and cool, joint both on shooting board, keeping them in their natural position if you wish them well matched, but before shooting damp 1 in. of the wood from the end on both sides, and give them 10 minutes to swell, else your joint, when made, will be close in the middle and off at the ends. When shot to a joint, try, as directed in straight jointing, then take down on flat board, take a piece of soft wood 2 in. wide, warm (not hot), and glue on to the joint with pressure, in half an hour you can loose it and turn it over and see if your joint is perfection, if so you may proceed with the laying. This time you must warm your ground, and in the middle only, and glue sharp a belt 2 in. wide corresponding to the piece of deal glued on the veneer, fix quick with 2 hand-screws previously set to the size, so that there be no bungling at the critical moment. Now you may more leisurely proceed to lay the tail ends. Have 2 cauls in readiness, the size (all cauls ought to be larger than the veneer, as the heat leaves the edges first, and if the glue gets set at the edges, it will not move freely from the centre; the result is lumpy, bad work), and hot as fire can make them—as before, have your hand-screws set to the size; get help, and the quicker you get them on (one at a time) the better the work. Begin at the centre, and work out to the ends; before cauling, raise the veneer and glue the ground well; see that the glue-brush reaches the central glueing. Now all being screwed up, see there is no slackness in any one of the hand-screws, for much depends on the uniformity of the pressure. Leave to cool for 2 hours. When the screws are taken off, leave the work face down, on a wood floor for 2 days. At the expiration of that time you may remove the piece of deal from off the joint by planing, and not by heat or water; when the planing gets near to the veneer, use the toothed plane. As curls frequently pull hollow on the face, it is desirable to damp the ground on both sides, and before quite dry, size the face side, and this ought to be done so that the damping and the sizing are not quite dry at the time of laying. To ensure good work, veneering should be 2 or 3 weeks in a dry warm place previous to cleaning off. The neglect of this mars all previous painstaking. (*Amateur Work.*)

Cleaning off consists in planing, scraping, and sandpapering the veneers ready for varnishing or polishing. When the veneer is not excessively thin, it is planed with a hardwood hand-plane set very fine. If too thin to admit of this, it is gone over with a steel scraper, having a blade about $4\frac{1}{2}$ in. long by 3 in. wide, and as thick as a saw. The edges of the scraper are ground and set in the following manner. First they are treated on a grindstone, to make the edge quite square in its width, but a little bevelled (convex) in its length. The burr produced by this operation is removed by rubbing the edges and sides on an oilstone. This done, a slight barb is given to each edge by means of a sharpener consisting of a hard polished steel rod, 4 in. long and $\frac{1}{4}$ in. thick, set in an awl handle, and applied at an angle to the edge of the scraper with heavy outward strokes, the scraper being meanwhile held against a bench by the other hand. Each edge is sharpened in the same way, and will bear 5 or 6 repetitions of the process before regrinding becomes necessary. The scraper is applied to the work with drawing strokes, being held by the fingers and thumbs of both hands. When the planing and scraping are complete, the work is finished by using Nos. 1 $\frac{1}{2}$, 1, and 0 sandpaper successively.

Inlaying.—Inlaying is a term applied to work in which certain figures which have been cut out of one kind of material are filled up with another. Such work is known as marquetry, Boule work, or Reisner work. The simplest method of producing inlaid work in wood, is to take 2 thin boards, of wood, or veneers, and glue them together with paper between, so that they may be easily separated again. Then, having drawn the required figures on them, cut along the lines with a very fine, hair-like saw. This process is known as counterpart sawing, and by it the pieces removed from one piece of wood, so exactly correspond with the perforations in the other piece, that when the two are separated and interchanged, the one material forms the ground and the other the inlay or pattern. If the saw be fine and the wood very dry when cut, but afterwards slightly damped when glued in its place, the joint is visible only on very close inspection, and then merely as a fine line. After being cut, the boards or veneers are separated (which is easily done by splitting the paper between them), and then glued in their places on the work which they are to ornament.

A new method of inlaying is as follows:—A veneer of the same wood as that of which the design to be inlaid consists—say sycamore—is glued entirely over the surface of any hard wood, such as American walnut, and allowed to dry thoroughly. The design is then cut out of a zinc plate about $\frac{1}{20}$ in. in thickness, and placed upon the veneer. The whole is now subjected to the action of steam, and made to travel between 2 powerful cast-iron rollers 8 in. in diameter by 2 ft. long, 2 above and 2 below, which may be brought within any distance of each other by screws. The enormous pressure to which the zinc plate is subjected forces it completely into the veneer, and the veneer into the solid wood beneath it, while the zinc curls up out of the matrix it has thus formed and comes away easily. All that now remains to be done is to plane down the veneer left untouched by the zinc until a thin shaving is taken off the portion forced into the walnut, when the surface being perfectly smooth, the operation will be completed. It might be supposed that the result of this forcible compression of the woods would leave a ragged edge, but this is not the case, the joint being so singularly perfect as to be inappreciable to the touch; indeed, the inlaid wood fits more accurately than by the process of fitting, matching, and filling up with glue, as is practised in the ordinary mode of inlaying.

Imitation Inlaying.—Suppose an oak panel with a design inlaid with walnut is wanted. Grain the panel wholly in oil. This is not a bad ground for walnut. When the oak is dry, grain the whole of the panel in distemper. Have a paper with the design drawn thereon, the back of which has been rubbed with whiting, place it on the panel, and with a pointed stick trace the design. Then with a brush and quick varnish trace the whole of the design. When the varnish is dry, with a sponge and water

remove the distemper, where the varnish has not touched. This, if well executed, presents a most beautiful imitation of inlaid wood.

Examples.—It will be useful to conclude this section with diagrams and descriptions of a few representative articles in cabinet-making.

Couch.—The style of frame illustrated in Fig. 688 is known as German. The main points to be observed in constructing a couch are (1) let the height of the scroll be a convenient one to give the head repose, (2) let the “roll over” be so arranged that a “break

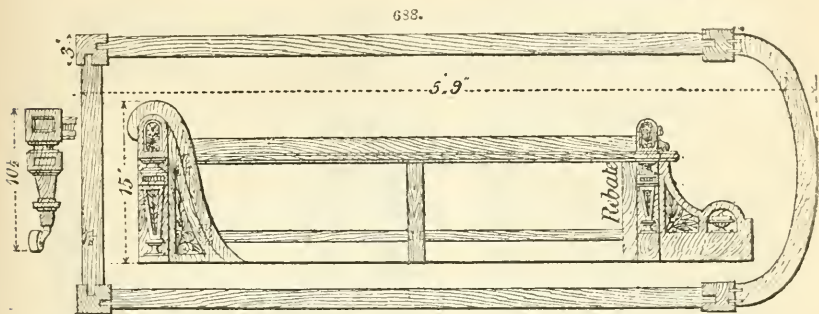

back” result is avoided, and (3) have the vacuum, that used to be occupied by the sofa pillow, filled up. As the head or shoulders frequently seek rest in the corner of the couch, let no obtrusive “show wood” work come in contact with them. Stuffing along the top of the back is the easiest way to secure comfort, but a moulded back may with care be equally successful. In the annexed illustrations the attempt is made to preserve the fashionable squareness without sacrificing the comfort of the “German cabriole” style. The manner of executing this design may be thus epitomized. Having selected suitable wood, and carefully made the moulds from the scale given, get out the long side rails, mortise the feet, and tenon the long rails; after laying moulding slips on same, glue and frame the feet on to the end of the long rails; then lay slips on end rails, cut off to length, and cross frame to 2 end rails. The slip for the elliptic end must next be laid, after which dowel the end to the 2 end feet. This will complete the groundwork of the structure and pave the way for building up the scrolls and back. Use 2-in. stuff for the front and 1 1/2-in. for the back scroll, and after laying glueing on the front scroll, place the scroll on the end of the seat, and fix them with loose dowels, then mark off for the cross rails of the scroll (the position of which is indicated in drawing), glue the scrolls on the cross rails, and then dowel and glue them on to the seat of the couch. The next portion is the back; the “stump,” demanding first attention, can be dowed or mortised into position at once; the length of top rail is thus definitely arrived at, and it simply remains to get out and fix it, as also the stuffing rail below. Iron or wooden battens should be fixed across the seat, and the couch frame is complete.

Chairs.—To make a comfortable chair some respect must be paid to the measurements of the human body in a sitting posture. Thus in a man 5 ft. 9 in. high, the distance from heel to beneath knee-joint will be 18 in.; from knee-joint to bottom of back, 21 in.; from bottom of back to shoulder-blades, 22-23 in.; thence to back of poll 6-7 in. These indicate the dimensions desirable in the legs, seat, and back of the chair, the legs being somewhat shortened in the case of easy chairs.

Fig. 689 well illustrates the construction of a strong comfortable dining-room chair. The requisite suitable wood having been procured it is dealt with as follows:—Having first of all got out the back and 2 back feet, mortise and tenon them, putting them together loose. This will give the pitch or angle of the complete back, and allow of “fits” being made for the top and splat; then mortise and tenon both the latter again,

fit up the whole of the back loose, and if the joints are close and satisfactory, nothing now prevents the gluing up of this part of the chair. The next portion to proceed with is the front; either mark off the front rail with a square and straight-edge, or make a fit, which is more convenient. The square end or templet shown can then be used for mortising and tenoning the front, and the front end of side rails. It will be noticed that the back tenons are not square; they "spring in" slightly towards the chair. This is necessary in such a shaped seat for ease in cramping, because if made square, when the chair was cramped up the tenons would break up. It is only in marking these tenons that the angle end of the templet proves useful, the square end being used for all the other joints in the chair. The close braces shown in the drawing are merely fitted and screwed into position. They are introduced more for the sake of appearance than for utility, for a well-made chair should not need such aids to strength. In this shape of chair, mortising and tenoning are secured throughout, whilst a comfortable line adapted to the body is also obtained. This is one advantage of having the back feet to "run out," or go to the top of the chair, because it makes the mortising of the top possible, whereas in put-on tops recourse must be had to dowels, which are always more or less unreliable. The importance of well-seasoned wood need scarcely be urged; more especially let the wood be dry upon which the tenons are made, for this reason, if the mortised wood should be a little fresh it will shrink to the former, and thus make the tenons hold the tighter.

639.

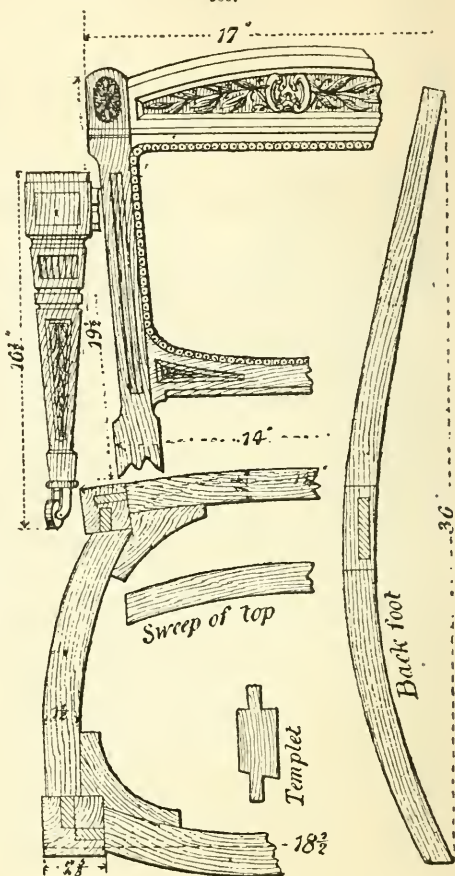
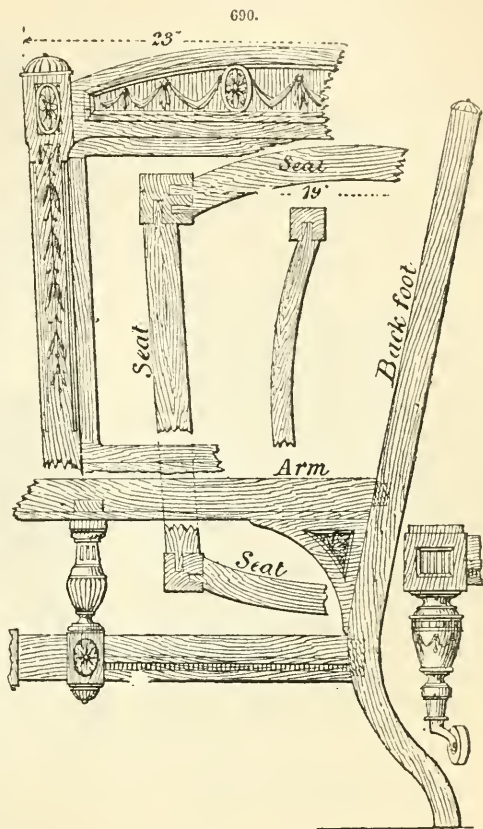

Fig. 639 represents a show-wood gentlemen's easy chair, whose construction may be summarized as follows:—Having cut all the wood to the required dimensions, proceed to mortise and tenon the back feet, top, and splat to the back, putting them together loose to test the fitting. When the back is built up, get out the beech rails and lay the moulding slips; make the mortices and tenons and put in the side rails, front and cross-frame seat to the back. Shape the arms to sleeve-board pattern, wider in front than at back. Glue and screw the moulding piece underneath them; and then loosely mortise and tenon the small end of the arm into the back, doing the same with the turned stump, which latter should be lapped over the side rail of the seat to give perfect strength, as if only dowelled or mortised on the top it is apt to get loose. The under bracket may next be marked off and shaped, then secured to both back and arm, and all

glued up completely. Rebate pieces are screwed in at the sides of the back, but are not needed at the top and splat, as sufficient wood remains for the upholsterer to tack to. In this class of chair it is difficult to secure perfect head rest without carrying the back so high as to let the stuffing come under the poll; but a stuff over back may be made by putting beech rails into the back and having the rise flat on top.

Fig. 691 shows a ladies' easy chair to match the last mentioned, and made in the same way, the dimensions and design only differing. Some makers are in favour of dowelling rather than mortising and tenoning, as taking away less wood; but unless the dowels are dry, the fitting is perfect, and the glue is good, "rickets" will soon follow. A simple protection for a dowel joint is to plaster a piece of strong canvas over. Still dowels may give way, while a tenon with a pin through it cannot.

In the divan chair illustrated in Fig. 692, the frame is set out to allow for what is known as double stuffing, or spring edges to seat. The making of such a frame is a simple matter, and may be briefly described as follows:—First make a mould for the back, taking care that it is a nice graceful line; no other mould will be required for the job, as the rest of the pieces are perfectly straight. Get out stuff to the thickness indicated, and then fit up the back, square the top and bottom, as shown; leave $4\frac{1}{2}$ in. between the top of



of the seat and the stuffing rail to allow for the double stuffing mentioned above. If the chair is to be upholstered in the ordinary way, with the usual thickness of rolls, only 2 in. need be allowed between these rails. Having thus got the back up, glue and frame up the front, and then cross-frame the chair together from back to front. In fitting the spindle stump which supports the arm, the best plan is to first fit the arm on the stump, a pin having been left on the latter, which may be allowed to come right through the arm, and can thus be wedged in the top when finally fixed. Before fixing, however, mortise and lap over the square lower portion of the stump on to the side rails; when properly adjusted, the arms can be glued up, and the chair frame is complete. It is as well to place an iron batten under the seat to give extra strength. An excellent plan to finish off a frame of this kind is to glue over the joints a strong piece of canvas; thus protected, the "rickets" are almost impossible, even if the stuff is a little "fresh." Either dowels, or mortising and tenoning, may be employed

in the manufacture. The sizes given will answer equally well for a similar chair with "stuffed-in" arms. If, however, the latter are required to be full in the stuffing, an extra 2 in. should be allowed in width of seat. For a ladies' chair to go with this, the same moulds and proportions will do, if made 2 in. less all ways (except in height of legs, which may be about the same). As a rule, ladies' chairs are better without arms, in consequence of the extensive character of the dresses sometimes adopted. Arms are possible and comforting, if made 12 or 14 in. long, to catch the elbows. If an extra amount of ease is required in any of the foregoing chairs, they should be made with a seat sloping from front to back; 1 in. longer in the front legs, and $\frac{1}{2}$ in. shorter in the back, will give a desirable angle of comfort. It must be remembered that the joints in the side rails will require adjusting in order to suit this angle.

The gossip chair represented in Fig. 693 is measured for single stuffing. The seat has an oval form, and the arms and back are adapted to almost closely encircle the sitter. No support is provided for the head. First make the moulds, then get out the beech rails and frame the seat up. In this shape of seat it is difficult to mortise and tenon, in consequence of the cross grain that would be involved; recourse must there-

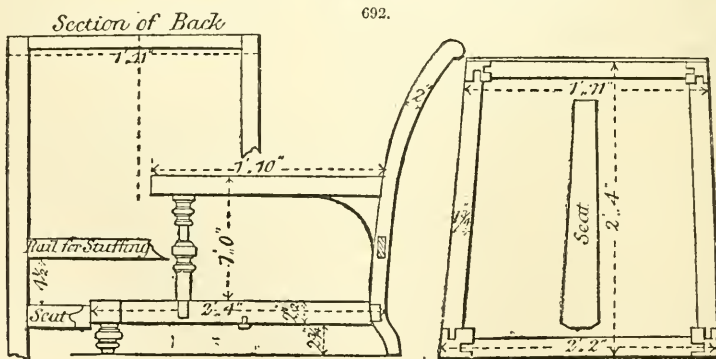
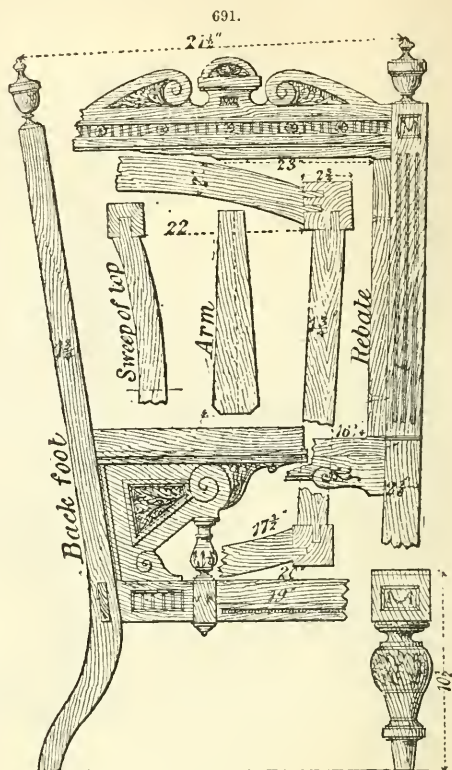

fore be had to dowels, and if they are judiciously placed, great strength will be secured. Having squared the legs and fitted the 4 parts to them with dowels, the seat can be glued

up in the following way:—First glue up and knock together a short and long rail with 2 legs, and then the other 2 rails can be similarly treated; the 2 corners will then more easily come together to the remaining legs. After glueing and knocking up, the seat must be cramped in order to perfectly close the joints. Two methods are adopted in the trade, the first of which is a long cramp from side to side, with another from end

693.

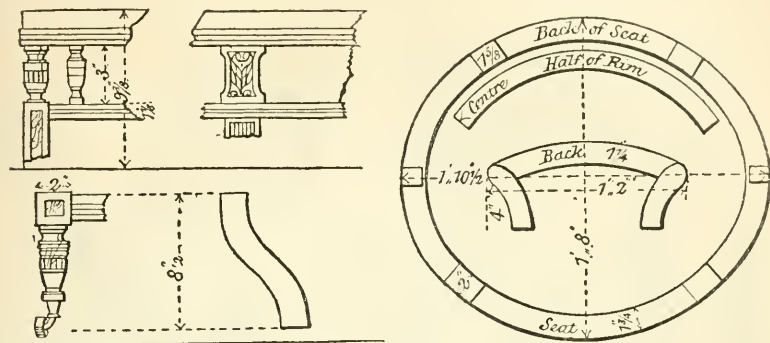

to end of seat; this is a simple way and answers very well for a single article. But if a number of such chairs have to be made, the "collar method" is more convenient. A collar is a piece of beech arranged so as to lap over seat rail, top and bottom, with an iron pin through the overlapping parts and seat rail. The swivel action thus allows the collar to be brought round so as to find a bearing on the seat rail; and when another collar is fixed to the adjoining rail in the same way, and the ends of the 2 collars are cramped up, the joints are brought together most effectively without any straining of the dowels. One pin-hole in the middle of each rail will give the needful angle for the leverage of the collars. The next stage in the work is to get out rims, viz. the 2 show-wood mouldings and the beech capping for the top. After placing stumps on the seat, lapped through as indicated, the rims must be fitted up to the stump and the banister underneath fitted loose. The spindles, rims, and centre bracket, having been carefully adjusted, can now be glued up together; and after placing the small supporting bracket on, the seat may be glued and cramped up to the stumps already in position. The foundation of the chair being perfectly sound, the joints clean, and the work free from rickets, the 2 scroll pieces can be dowelled on to the top of beech rim, and the adjustment of the top stuffing rail between the scrolls is then a simple task. Two or three dowels running through the upper beech rim and show-wood moulding will permanently bind them together. This style of chair will come out effectively without the addition of the upper scroll pieces and stuffing rail, leaving merely a stuffed pad all round; or, instead of spindles and show-wood stumps and mouldings, it may be made entirely of beech and "stuffed in" all over.

Fig. 694 is a combination of an all stuff over and a show-wood gossip chair. The arms can be made just plain "sweeps," without the turning as shown; but the latter gives an ornamental and novel appearance not otherwise obtainable. A piece left on these side arms when the stuff is cut out makes it a simpler matter for the turner to find his centre. Get out moulds, then the rails, legs, &c., and lay the slips; then let a carver do the mouldings; after this frame the back feet on to the back rail, and the front legs on to the front rail: the 2 latter, as may be observed, being square joints. Now find the angle of the side. This may be done in the following manner. The line of the outside of the side rail will be found to be $2\frac{1}{4}$ in. out of square; this gives a $2\frac{1}{4}$ -in

angle, to which "the bevel" may be set, by simply measuring $2\frac{1}{4}$ in. from a straight line 17 in. long (length of side rail), and setting the "bevel" to angle-line thus obtained. Having adjusted the angle, the seat may be cross-framed together. This pattern of seat can be readily mortised and tenoned together, as shown, if desired, although dowels are usually applied in making such chairs in the trade. Dowelling being the quicker

694.

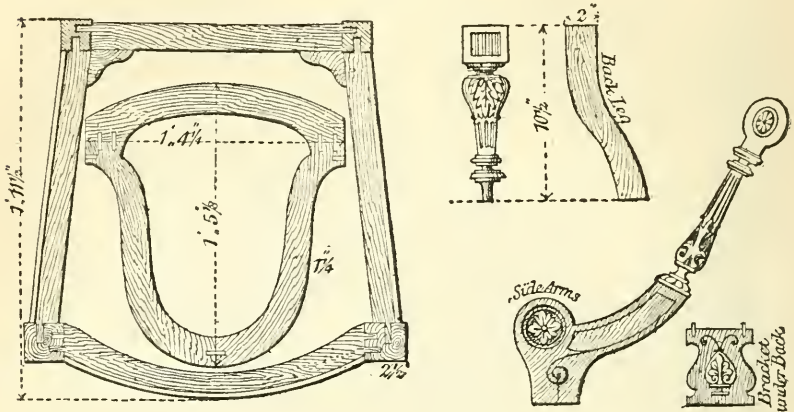

method, it is invariably adopted where price is an object. The back is made of beech, no show-wood being required in it. It can be got out and framed up independently of the other portions, there being the 3 joints in the back indicated. Before fitting the back to the arms and seat, get out the support or banister shown under the back; place it on the seat; then dowel and glue the back and banister on to the seat. The angle or pitch of the back would be determined by applying the mould of the arm and the slope desired for ease. The arms having been already got out, turned, and carved, the fitting of the seat to the back is a simple matter. Some care is necessary in placing the dowels, fixing the side arms to the back; the position shown in the sketch is, perhaps, the most reliable.

Fig. 695 illustrates the wooden frame necessary for an adult easy chair in needle-work. The construction is extremely simple. The first step is to strike out a good set of moulds, taking care to secure a nice easy line; then get out wood for the sides, allowing for the rebate as shown by the dotted line.

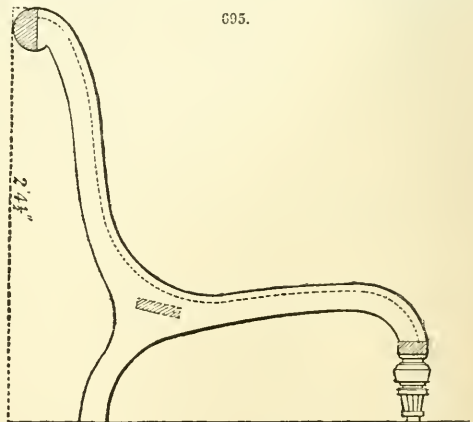

It is then wise to let the carver do as much of his work to the sides as he can. After obtaining the pieces from him, dowel, glue, and cramp up the back, feet, and sides. The cross rails can now be got out to the size indicated, let into the sides at the points shown, and the chair framed up. The front

feet of these chairs are usually dowelled on, and, if well done, they are fairly durable. A strong pin left on the leg, square or round, as the case may be, is another method. Having added the front legs, let the carver finish the incising; clean off, and the chair is made.

Bookcase (Folding).—Fig. 696 illustrates the construction of a folding portable bookcase, which may be carved and ornamented to any degree. The 2 ends *a* are 4 ft. long

over all and 1 ft. wide, either of plain board, or panelled as shown; uprights *b*, $3\frac{1}{2}$ in. wide and 1 in. thick, are fastened to the front, and similar ones *c*, $2\frac{1}{4}$ in. by $\frac{3}{4}$ in. to the back. Cross pieces are dovetailed into the bottoms, of the same width as the uprights, and similar ones are mortised into the tops, thus forming shallow boxes. The top board of the bookcase is hinged at one end underneath one cross piece, and folds down parallel to that end piece, allowing sufficient space behind it to contain

696.

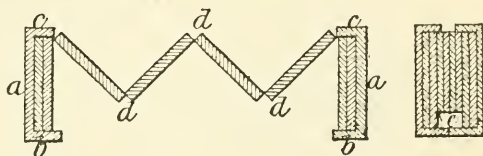
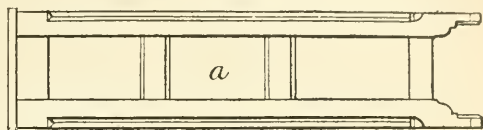

one of the shelves. The bottom board forming the lowest shelf is hinged to the cross piece at the bottom of the other end piece, with sufficient space to admit the second shelf behind it. As the bookcase is 3 ft. 6 in. wide, the back may consist of 4 boards hinged together as at *d*, and folding neatly up. The space *e* will hold the ornamental baluster railing fitted to the top, and which is held in place when the bookcase is up by shallow tenons mortised into the uprights *b*. The shelves are held up by shallow tenons. The back is made of $\frac{5}{8}$ -in. wood; the ends and shelves are $\frac{3}{4}$ in.

Chest of Drawers.—The following detailed and illustrated description of the construction of a chest of drawers has been modified from one which appeared some time since in *Amateur Mechanics*. The example here given consists of a base, surbase, and top carcase or body. In the usual method of structure, a large part of the work is veneered, the whole front included. The gables and top are solid, usually bay mahogany, $\frac{5}{8}$ in. thick, the top being clamped on the under side with pine to $1\frac{1}{2}$ in. thick, and veneered round the edges to cover the whole. The breadth across the front is 4 ft. 1 in., and the depth from front to back, 20 in. at the body or upper carcase. The base, which may be called the foundation course, is 5 in. high, having 4 ball feet under it; these raise it 3 in. from the floor. Over this base is the surbase, made to contain a large drawer, 12 in. deep on the face, and having the mouldings mitred on the face of it. The fronts of these bases have semicircular blocks on the ends, that on the base being 6 in. broad, and that on the surbase 5 in. broad; the ends of the drawer are fitted exactly between these 2 latter. The surbase is screwed to the base, and the latter projects beyond the former $\frac{1}{2}$ in. all round. The surbase is surmounted by a "thumb" moulding, $\frac{7}{8}$ in. thick, and over this is placed the body or top carcase. This contains 5 drawers; their depths on the face, starting from the bottom, being $9\frac{1}{2}$ in., $8\frac{1}{2}$ in., $7\frac{1}{2}$ in., $6\frac{1}{2}$ in., and the uppermost, that with the carving, 5 in. The top over this last drawer is $1\frac{1}{2}$ in. thick, the total height being 5 ft. 4 in. The base is made of $\frac{3}{4}$ -in. pine, and is veneered all round. The surbase has solid gables $\frac{5}{8}$ in. thick, and the semicircular front blocks veneered. The top carcase has a "ground" up each side at the ends of the drawers. This, including the thickness of the gables, is $3\frac{1}{2}$ in. broad and 2 in. thick. The faces of these grounds are veneered. At the top of the grounds are semicircular blocks, 6 in. long, at the end of the top drawer, and the top over all projects all round

1 in. It is fixed on by mortice and tenon, the tenons being cut on the ends of the gables. It has also circular blocks in front. The fore edges of the shelves between the drawers are $\frac{7}{8}$ in. thick finished. The shelves are dovetailed into the thick grounds in front, ragged into the gables, and made fast by blockings glued in underneath. The various moving drawers have fronts made of 1-in. pine, sides and backs $\frac{5}{8}$ in., and bottoms $\frac{3}{8}$ in. The fronts are covered with showy veneer; the most showy, but not the most durable, being those known as curls. These are short cuts of the log, having a strong feathery-like appearance diverging from the centre. They are usually about 2 ft. long, and the practice is to take 2, cut from each other, to make a drawer front, they being marked, when sawing, for this purpose. The drawer front has consequently a butt joint in the centre, the spreading ends of the pieces being carefully jointed, so that the same figure or marks in the veneer will appear going both ways from this centre joint. These veneers are very showy, but they are very apt, after a time, to get full of cracks, and with age they become very dark in colour. The drawer fronts are surrounded by a "cope" bead, $\frac{1}{8}$ in. thick, and projecting from the face of the veneer half that thickness.

In the construction of the chest of drawers, Fig. 697, the first work is making the base. This is 4 ft. $3\frac{1}{2}$ in. long, 1 ft. $10\frac{1}{2}$ in. broad, and 5 in. deep, made of $\frac{3}{4}$ -in. pine. The method of procedure is as follows:—Make a front *a* 5 in. broad, a back *b* 4 in. broad; plane both sides, and to an equal thickness throughout; square both ends to a length of 4 ft. 3 in.; plane and square up 2 end pieces *c* in the same way, 5 in. broad, $22\frac{1}{2}$ in. long when squared up. The front and back are dovetailed into the ends, keeping the back flush on the upper side. The ends have a lip $\frac{1}{4}$ in. thick, or, in other words, they are not dovetailed through, but made exactly as is done with a drawer front; consequently, when the base is put together, it is 4 ft. $3\frac{1}{2}$ in. long. This dovetailing is shown at *d*, where one of the circular blocks *e* is removed. It is, of course, covered up when these blocks are glued in their places. The object of not dovetailing through is to avoid having end wood on the surface at any part to be covered with veneer. This rule holds good in all veneered surfaces—namely, avoid having end wood and side wood in the same veneering surface, as they do not shrink alike: in fact, end wood does not shrink at all; consequently in a short time any such portion covered by veneer is detected, as it stands above the surrounding surface. There are cases in which this cannot be avoided, but in most cases it can be guarded against.

The base being dovetailed and glued together is to be "filled in." This filling in consists of pieces *f* of $\frac{3}{4}$ -in. wood fitted inside the base at the front and ends, and flush with the upper edges. The front piece is $2\frac{1}{2}$ in. broad, and is fitted in neatly between the ends. The end pieces, which are broad enough if $1\frac{1}{2}$ in., are fitted in between the back of the base and the edge of the front piece, glued in and pressed close with hand-screws. Then the base is turned over, and the angle formed by the base and the filling in is filled at intervals of 5 in. or 6 in. with blockings 3 in. long. A portion of the base blocked in this way is shown at *g*. The glueing surfaces of these blockings are about $1\frac{1}{2}$ in. broad. In planing them, these 2 sides must be at right angles, and roughened with the toothing plane. When the glue has set quite hard, the base is planed straight and level with a half-long plane, the ends being made square with the front, and these toothed ready for veneering.

The surbase, which rests upon the base just described, is 12 in. high, and consists of 2 gables, either of solid mahogany or pine veneered. In either case, the grain of the wood runs vertically. These gables should be $\frac{7}{8}$ in. thick, but, if of solid mahogany, they are seldom made more than $\frac{5}{8}$ in., in which case they are clamped on the inside with pine to make up the thickness. The breadth of the gables is $1\frac{1}{2}$ in. less than the base below, not including the blocks, and in the back edges a check is made to receive a $\frac{5}{8}$ -in. back lining.

The next operation is to make 2 frames of $\frac{7}{8}$ -in. pine, to form a top and bottom to

697.

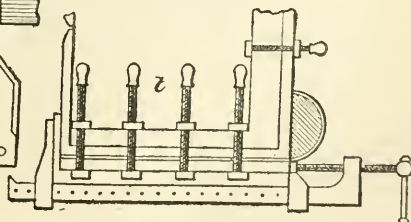
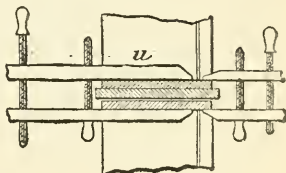
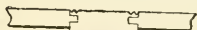
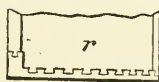
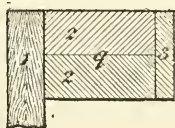
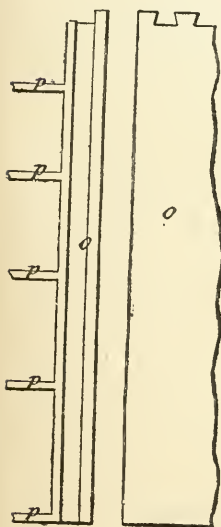
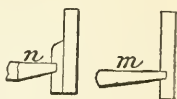
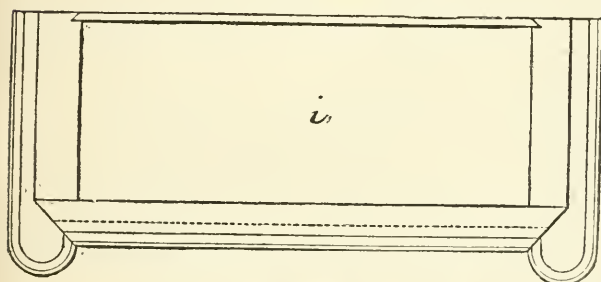
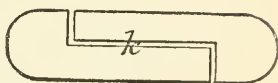
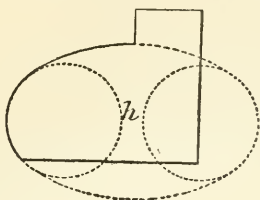
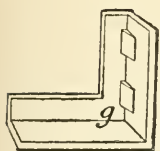
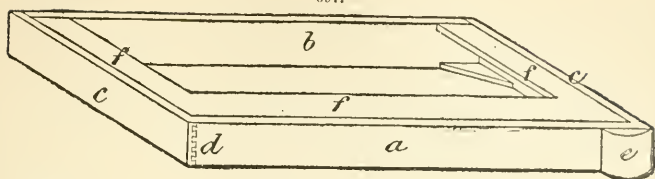

these gables; they are of a length to make the surbase 1 in. shorter than the base beneath, so that the base projects all round $\frac{1}{2}$ in. beyond the surbase—that is, when the drawer front is in its place. The breadth of the frames is the distance from the front of the gables to the check for the back lining. Each frame consists of a front and back rail, 3 in. broad, and 2 cross rails 5 in. broad, let into the former by mortice and tenon. The ends of the front and back rails being dovetailed into the gables, the cross rails fit inside these, and are then made more secure by having blockings of wood glued in the angles.

Two semicircular blocks are made of several layers of pine glued together as described for the base blocks. They are 5 in. broad on the back, the semicircle being drawn with compasses set to $2\frac{1}{2}$ in. The block is $3\frac{1}{2}$ in. thick, however, the additional inch being to allow for the thickness of drawer front, so that when this front is in its place the blocks show but $2\frac{1}{2}$ in. projecting. These blocks are veneered, dried, planed and scraped, then carefully fitted to the face of the surbase and glued down. The veneer on the block where it joins the edge of the gable must be a good joint and both flush, as the veneer, being thin, it will not allow of much reducing when cleaning off.

When this surbase is made, it should fit on to the lower base and show a margin of $\frac{1}{2}$ in. along the ends and round the blocks, and $1\frac{1}{2}$ in. along the central portion or drawer space. The upper side of the surbase is capped with a moulding, usually a “thumb.” This moulding *h* is a section of an ellipse. For the chest of drawers it is made of $\frac{7}{8}$ -in. mahogany, and in order to economize that wood the necessary breadth is made up with pine, the two being glued together previously to running the thumb. The breadth of mahogany required is $1\frac{1}{2}$ in. backed by 2 in. of pine. *i* shows the upper side of the surbase with the line of junction of pine and mahogany, also the manner of mitring at the inner corner of the circular blocks. In ordinary chests of drawers the portions of thumb moulding covering the blocks are composed of a piece of $\frac{7}{8}$ -in. mahogany turned in the lathe, and afterwards cut in halves, which do for both blocks. The portion of moulding along the front is mitred at the corners to these semicircular pieces, and the end pieces are butt-jointed behind them.

In a first-class chest of drawers, however, they are done differently. A piece of mahogany is cut large enough to make both pieces for the end mouldings and the circular portion over the blocks in one. *k* shows the method of cutting the one out of the other usually pursued. The thumb in this case is worked by hand, and the pieces do not require backing with pine. These mouldings are toothed on the under side, and glued on to the base, a few screws being put in after the hand-screws are removed. This base receives a $\frac{5}{8}$ -in. back lining, but it is not put on until a drawer is made and fitted in. The drawer front is of pine, “slipped” with a piece of Bay mahogany on the upper edge. This slipping is a process that has to be noticed. A piece of mahogany is cut about 1 in. broad and $\frac{1}{2}$ in. or $\frac{3}{8}$ in. thick, as free from warping and bending as possible. It is truly planed on one side, and toothed. The edge of the drawer front is also planed perfectly straight with half-long plane, and toothed. Then, with the drawer front in the bench lug, the slip of mahogany is wetted with a sponge, and turning its toothed side up, and on a level with the edge of the pine front, both receive a coating of glue quickly applied. The slip is turned over on the edge of the front and rubbed firmly backwards and forwards lengthways, 2 persons being necessary for the operation. The sliding motion is gradually lessened till it stops with the slip in its proper place, when a few smart rubs with a veneering hammer complete the operation. In most cases a slip thus laid will be found to adhere perfectly in its whole length. When the front is dry, it is planed up and fitted exactly in its place; care must be taken to have the heart side of the plank turned to the front for veneering upon. This drawer front is 12 in. broad, and when in its place rests upon the $2\frac{1}{8}$ -in. fore edges forming the frame of the surbase. The drawer sides pass between

these fore edges, and are consequently only $10\frac{1}{4}$ in. broad, the extra breadth of front projecting $\frac{7}{8}$ in. downwards, and the same upwards of the sides, as in *l*, which shows the drawer side as dovetailed into the front. The drawer sides are $\frac{5}{8}$ in. thick, often made of pine, sometimes of American ash, but the best wood of all is cedar, as the strong but not unpleasant odour emitted is a sure preventive of moth. A groove run in $\frac{5}{8}$ -in. wood *m* for a drawer bottom makes the side very weak. A very great improvement is the fillet clamped to the inside of the drawer side *n*, and the groove run in it.

The carcass consists of 2 gables *o* of solid mahogany, usually $\frac{5}{8}$ in., but they ought to be at least $\frac{3}{4}$ in. thick. The breadth to make these gables is $\frac{1}{4}$ in. less than the breadth of the upper side of the surbase—that is, $\frac{1}{4}$ in. within the thumb moulding. The length of the gables is sufficient to admit 5 drawers of the following breadths—namely, $9\frac{1}{2}$, $8\frac{1}{2}$, $7\frac{1}{2}$, $6\frac{1}{2}$, and 5 in., with $\frac{7}{8}$ -in. fore edges or shelves *p* between, and 1 in. additional to cut into pins or tenons to enter the top, which should show straight pins not dovetailed.

The 2 gables are planed up on both sides, “thickened,” made to the breadth, squared on the bottom ends, and marked off on the insides for grooves to receive the shelves. The rabbet plane used is $\frac{1}{8}$ in., and the depth of groove is $\frac{1}{4}$ in. A guide for the plane is made by “stitching” with tacks a thin lath of wood to the gable alongside the groove to be run. These grooves being run, the bottom ends are dovetailed—not through—to receive a $\frac{7}{8}$ -in. carcass bottom, and the top ends are squared and cut into pins as already mentioned. Two grounds have now to be built to clamp on the inside of the gables. These are of pine, faced on the inner edges with mahogany, as indicated by the lines shown vertically in *q*. The method of building these grounds is to clamp 2 pieces of $\frac{7}{8}$ -in. or 1-in. wood together for the thickness, as this stands better than one piece. Next a piece of $\frac{7}{8}$ -in. Bay mahogany is planed up and toothed on both sides. The edges of the ground pieces are also planed straight and toothed. The mahogany is heated on both sides, and glue being applied to both pieces of pine, the mahogany is placed between them and several hand-screws are applied. When this is hard, it is planed up and sawn through the centre of the mahogany, making a pair of grounds with mahogany slips about $\frac{3}{8}$ in. thick when finished.

The grounds are planed to such a breadth that when glued to the gables the total breadth of face is $3\frac{1}{2}$ in. *q* is a cross section of this arrangement of pieces; 1 is a portion of the gable, say $\frac{3}{4}$ in. thick; 2, the two thicknesses of pine, $2\frac{3}{8}$ in. broad and 2 in. thick; and 3, the clamp or slip of mahogany, $\frac{3}{8}$ in. thick. After these grounds are fixed to the gables they are squared with the gables on the face, and the inner edge is squared with the face. Then they are drawn for dovetails to receive the shelves in a line with the grooves in the gables. The dovetail is all on the under side of the shelves, and enters into the ground about $\frac{5}{8}$ in. As these shelves must be quite level in their whole breadth to allow the drawers to run smoothly, great care must be taken to cut the dovetails in the grounds with exactitude. Otherwise the shelf when entering the dovetail will be bent up or down, as the case may be, and it is hardly possible to make a good fit of the drawers in such a carcass.

The shelves are not of one thickness, or one board throughout their breadth, but are known as “clamped” shelves. About 3 in. of the front portion is $\frac{7}{8}$ -in. wood, the remainder being $\frac{3}{8}$ -in. wood clamped at the ends with pieces of $\frac{1}{2}$ -in. wood, which makes them up to $\frac{7}{8}$ in. The two are joined with matched ploughs, glued, and clamped; they are carefully made of a thickness to fit the grooves in the gables; but, previously to this, the front edge has to receive a facing of mahogany. The general practice is to “band” them—that is, to put on scrap pieces of rich veneer, with the grain running across the thickness of the fore edge. This has a showy effect, but it is false and ridiculous, as a shelf of solid wood put in in this way would be an impossibility. The result of such work is also bad, as pieces of this “banding” get easily chipped off with the pulling out of the drawers. The proper way is to “slip” them with good

mahogany, at least $\frac{1}{4}$ in. thick, with the grain of the mahogany running in the same direction as the shelf. This will last for an age without chipping. When the shelves are slipped and got to the proper thickness, the corners are cut out to admit the grounds, and the dovetails worked to fit the latter. The shelves should be fitted pretty tight into the grounds, and when driven home the mahogany slip should project beyond the face of the ground the thickness of a veneer ($\frac{1}{32}$ in.), so that when the grounds are veneered the whole will be flush. The carcass bottom—that is, the lowest shelf that rests upon the surbase—has 1 dovetail into the end of the ground. This will be readily understood by reference to *r*, which shows a portion of the under side of the carcass. The back edges of gables are checked to receive a back lining, which is nailed to the back edge of the carcass, as shown on the right in *r*.

The gables, carcass bottom, and shelves being ready, the carcass is put together by gluing and rapping up the carcass bottom first, then the top shelf, and after this the intermediate ones. A cramp is necessary to draw these shelves home, care being taken that they all project beyond the face of grounds only the thickness of veneer as above mentioned. All the shelves have now to be “blocked” on the inside—that is, 3-cornered blockings of wood, with their glueing faces at right angles, are glued in against the shelves and gables. Before these are glued in, the carcass must be tested to see that it is square, and that all the shelves are quite at the bottom of the grooves in the gables. After this is made sure, the blockings, 4 in. long, 3 to each shelf, are rubbed in with hot glue, the first one going forward pretty near the back of the ground. When these are hard the carcass will be perfectly rigid and strong.

It is usual to fit the drawer fronts and make the drawers before making a top. The upper blocks are of the same breadth as the grounds, semicircular on the face, but 1 in. thicker than the half circle, to allow for the drawer front between them, as this front projects 1 in. over those beneath it. These blocks are veneered in one length in a canvas bag, as described for the base blocks. When glued on the grounds, their lower ends are on a level with the upper side of the top shelf. The upper ends are faced with mahogany.

The top of the carcass is $1\frac{1}{2}$ in. thick, being a board of $\frac{5}{8}$ -in. mahogany, made up or clamped on the under side with pine 1 in. thick. A piece of pine 5 in. broad is glued along the front; the ends are made up with end cuts of pine 6 in. or 7 in. long. As the grain of all the clamping must run in the direction of the grain of the mahogany, a narrow clamp is fitted between the end ones at the back to nail the back lining to. These clamps are put on with large hand-screws; when hard, the top is planed to thickness and squared at the ends. The front edge of the top is veneered before the 2 semicircular blocks are rubbed on. This veneering of the edge of the top is usually “banding,” but it should be done by slipping, as described when treating the base.

The carcass has now to be fitted with drawers. The drawer fronts are of pine $\frac{7}{8}$ in. thick, fitted into the various openings in the carcass perfectly close all round, and with the heart side of each front outward for veneering upon.

The top drawer, that between the 2 semicircular blocks immediately under the top, is slipped on its upper edge with a piece of $\frac{3}{8}$ -in. Bay mahogany previously to fitting it in, the same as already mentioned for the 12-in. drawer in the surbase.

The other drawers are not slipped in this way; after they are veneered and cleaned off they receive a $\frac{1}{2}$ -in. mahogany beading all round. This is called a “cope bead,” and the manner of putting it on will be described. When all the drawer fronts are fitted in, they should be each marked on the face in pencil with a Λ or similar figure pointing upwards, so that there be no mistakes afterwards in the fitting.

The drawer sides for a first-class job are of cedar $\frac{5}{8}$ in. thick. The grooves for the bottoms should not be run in this $\frac{5}{8}$ -in. side for a good job, but in a clamp glued to the side, as shown in *n*. The drawer backs may be of $\frac{3}{8}$ -in. pine, and the bottoms of $\frac{3}{8}$ -in. pine, but this thickness would be too weak without a centre mounter.

This mounter is a bar of wood 3 in. broad and $\frac{5}{8}$ in. thick, passing across the centre of the drawer from front to back, and dividing the bottom into halves. It has grooves in its edges to receive the bottom, a pair of $\frac{1}{2}$ -in. match ploughs being used—one to make a groove in the mounter, and the other a feather on the edge of the bottom, the whole being flush on the upper or inside. A $\frac{1}{8}$ -in. bead is run on the mounter on this inside to abut against the drawer bottoms. This is called breaking the joint, and makes a neat finish inside the drawer. *s* shows this mounter and bottoms, the manner of grooving in, and the upper or inner side with the beaded joint.

The drawer fronts have a groove, corresponding to those in the sides, to receive the bottoms. The backs are so much narrower, and the bottoms nailed to them by $1\frac{1}{2}$ -in. brads. The direction of the grain of these bottoms runs lengthway of the drawers; consequently the end wood of the bottoms enters the grooves in sides and mounters.

The drawers are dovetailed, and put together in the usual manner. The bottoms are put in and filleted—that is, fillets are rubbed in with glue in the junction of the sides and bottoms, and afterwards planed off flush with the edges and sides, a few short ones being glued along the front in the same way. Of these latter, one at each end and is of mahogany, or other hard wood, these being to act against “stops” nailed to the shelves in the carcase, to stop the drawers at their proper places.

It may be mentioned that fillets for drawer bottoms are in many cases omitted, and in good jobs, too, particularly when the bottoms are of American ash, which wood is very liable to shrink or expand with dry or damp situations, and the bottoms are left unfilleted to allow of this movement. But if the wood is as well seasoned as it should be, little or no change in the breadth of the bottoms will take place, and a drawer is infinitely better filleted.

When fitting the drawers in the carcase, no more should be taken off the breadth of the drawer sides than will just admit them between the shelves, as when too much is planed off at first they can never be a satisfactory job. The proper method is to plane the under side of the drawers—which is the edges of the sides and fillets, and also the short fillets along the front—all even and flush, using a straight-edge to get these 2 edges in relation to each other to be out of winding. Then set a gauge to the breadth of the drawer front, and gauge the breadth of the sides from the bottom. When the sides are planed down to this mark, they should enter the opening between the shelves, though somewhat tightly. Next the 2 sides or ends of the drawers are planed down till the end wood of the front and back are touched at the dovetails. The drawers should enter the carcase lengthway as well as breadthway. They are all pushed in in this way, till the fronts are nearly flush with the face of the carcase; the fronts are drawn all round with a draw-point, and planed down on the bench to this mark. The method is to place 2 pieces of board across the bench, letting them project over the front 7 or 8 in., and fastening them at the back with hand-screws. The drawer is hung on the ends of the boards, with its fore end fixed in the bench lug, and in this position is planed and toothed. When planing, the front must be perfectly level across the ends. It will do no harm if a little round at the centre; the veneer has a tendency to draw the face hollow after a time.

As a rule, the base is veneered on what is termed the “banding” system—that is, the grain of the veneer runs up and down, not the lengthway of the base. This is a false principle in construction, because a base made of solid wood, with the grain upright, would be simply ridiculous. The method is resorted to for 2 reasons: It is easier done; and it is a means of using up small pieces of broken veneer, as any may be used if long enough to cover the breadth of the base.

Two blocks have now to be made for this base, similar to the one shown detached at *e*. They are 6 in. broad, 3 in. thick, semicircular on the ends, and are better built of several layers of wood, as shown in the figure, as they do not split or change their shape so readily as when made in one piece; 3 pieces, long enough to make

both blocks, are glued together, drawn on the ends with compasses, and carefully planed down to a semicircle, after which they are toothed for veneering. Before veneering, these blocks should be sized with a coat of very thin hot glue applied all over the surface to be veneered upon. When this is quite dry it is again lightly toothed. The best method to veneer these blocks is with a canvas bag and screws (see Fig. 687, p. 360). This method is only suitable when the rest of the base is veneered on the banding principle; for the grain of the veneer runs up and down on the block, so it must run in the same direction on the rest of the base. To veneer the base with banding, strip the edges of each piece with the plane on the shooting board; then lay one piece at a time with the veneering hammer. The first piece being laid, the second is fitted against it and rubbed down, pressing against the piece previously laid, to ensure a close joint.

When the veneer is dry, which will be in about 24 hours, the front only is to be planed, scraped, and sandpapered, the over wood at the edges being previously pared off with a sharp chisel. When the veneered piece for blocks is cut in two, a portion of the veneer at the inner edge is planed and papered. The veneer on the front of the base is cut to exactly the breadth of the back of the block, so that the veneer on the block and that on the end of the base will coincide, forming one surface, and, at the same time, a close joint. The blocks thus fitted are glued on, using hand-screws to ensure close contact. When the glue is hard, the upper edges of the base and blocks are planed quite level, and the end wood of the blocks receives a coat of glue size before veneering. A piece of veneer 3 in. broad is laid along the front, and 2 additional pieces over the ends of blocks. The strips of veneer along the ends of the base are 2 in. broad. When the glueing of these is hard, the whole base is cleaned off, scraped, and sandpapered. After which, provision is made for attaching 4 turned feet by fitting 2 3-cornered pieces in the back corners or under side of base, and clamping 2 pieces inside the front, immediately behind the circular blocks. The ball feet have tenons turned on them, which fit into holes bored in the base.

Following is the method of veneering the base of drawers by having the grain of the veneer running in the same direction as the grain of the groundwork. The body or groundwork of the base is made exactly as described, and the 2 blocks are made and sized for veneering. The face of the base is covered with veneer, except at the 2 ends where the blocks are to be stuck on. This veneer should be laid with a caul. When properly hard, it is planed and finished up with sandpaper; then the 2 blocks are fitted exactly in their places against the ends of the front veneer, and glued down without being previously veneered, as in last example.

The task of veneering the blocks and base ends with 1 piece of veneer is shown in *t*. A yellow pine caul is made the length of the base end, not including the semi-circular blocks; then a piece of No. 12 zinc is procured, long enough to reach from the small block of wood at the inner edge of the circular block, round the block itself, along the base end, and round the ends of the caul, as indicated by the double line in the cut. The caul should be 6 in. broad, and the zinc fixed on with tacks along the edges.

A piece of veneer has now to be cut long enough to go round the block and along the base end, with a little margin both in length and breadth. The portion that goes round the block must be well toothed, and scraped on the outside, before putting on. This is to thin it somewhat, as it has to be bent round the block. The next step is to glue a thin piece of cotton cloth on the scraped side of the veneer. This is to prevent it splitting across the grain of the wood while bending. A cut is made with a dovetail saw, close to the inner edge of the block, about $\frac{1}{4}$ in. deep in the face of the base. The end of the veneer is squared and fitted into this cut.

It will be seen, by reference to *t*, that a cramp and 5 hand-screws are brought into use. There are really 10 hand-screws, another 5 being placed exactly opposite those

shown in the drawing. All being in readiness, the zinc caul is well heated, and a copious supply of glue applied to the groundwork to be veneered, and a thin coat to the veneer. The end of the latter is fitted into the saw cut above mentioned.

The hot caul is applied by placing the end with the block close to the circular block, and applying 2 hand-screws. Then the zinc with the veneer is bent gently round the block, and when laid along the base end several hand-screws are applied, and lastly the cramp, using a small block of wood at the back to keep the paw clear of the caul end. The exposed portion of the zinc round the block, which cools very quickly, must be heated with a smoothing iron and more pressure applied to the cramp, when the glue should run out at the edges. The hand-screws are then tightened up, when, if the whole thing has been managed properly, the veneer will be lying perfectly close. This caul should stay on for at least 10 or 12 hours, when the same operation may be performed with the other end of the base.

This method of veneering is much more difficult than the slip-shod method of banding with scraps of veneer, but it is a much more tradesmanlike manner of doing it. In short, it is the method of making a first-class piece of furniture, if veneering of any sort can be called first-class work. When the glueing of the base is properly hard, the over-wood at the edges is cleaned off, the upper side is planed level, and veneered as before described.

The veneers for the drawer fronts are bought in sets of 5 or 6. They are cut from each other, and are all of one figure, being numbered by the sawyers; care being taken to place them on the fronts all in the same way, the various markings will appear almost alike in the whole fronts.

The sets of veneers may be so narrow that they will not entirely cover the 12-in. drawer in the surbase, in which case a piece has to be added to the breadth; the joint thus made is easily concealed beneath one of the mouldings to be planted on the face.

If the veneers are of the feathery curl sort, 2 pieces to each front, the butt joint must be exactly in the centre of each, passing through the centre of the keyhole. In order to make this joint properly, the whole of the veneers are placed together exactly as they were when cut at the mill, and held together by 2 pieces of board and 2 hand-screws. The ends to be jointed are squared across, and cut with a dovetail saw all together, and afterwards planed with the iron plane. Then, being taken separately, each pair is carefully fitted to each other. This done, they are laid on a flat board with the joint placed close, and a few tacks driven in at the edges. A piece of thin calico, about 2 in. broad, is now glued along the joint. When this is dry, the veneers may be laid as one piece. Cauls of zinc, $\frac{1}{4}$ in. thick, are best for this job, but very good work may be done with well-oiled pine cauls.

If wooden cauls are used to these fronts, they should remain in the screws not over 2 hours, as any glue adhering to the caul makes it difficult to remove, and some of the veneer is apt to peel off in the removal.

It is usual to veneer 2 of these drawers at a time, the caul being heated on both sides. The hand-screws require to be pretty large, with long jaws. They should be free from hard glue on the jaws, as it makes an unsightly mark on the inside of drawer fronts.

Help must be obtained to heat the caul while glue is applied copiously to the drawer fronts. The veneers must be previously toothed on the glueing side, and marked as they are to be laid. When laid upon the glued front, they are rubbed all over with the hands, and should project over the front $\frac{1}{4}$ in. or so all round. At the places to be afterwards bored for the knobs, 2 tacks are driven through the veneer into the front to prevent them slipping under the hot caul while the hand-screws are being applied. These latter should be set to about the size before glueing, so that no time may be lost afterwards; 6 large hand-screws for the front or inside, and 6 smaller for the back, are necessary to lay veneers on 2 fronts. Those inside the drawers should go quite to the bottom, so that the jaws require to be at least 8 in. long. *u* gives a clear idea of this

part of the work. It shows the 2 fronts with the caul and veneers between, and the hand-screws as applied. In applying the hand-screws to work of this kind, it is to be observed that the whole length of the jaws must bear equally on the breadth of surface pressed between them, as if they press only at the points, or at the heel, they are comparatively ineffective.

When the veneers have dried for about 24 hours they may be cleaned off. They are always planed first with a high-pitched hand-plane, set very close, then scraped and sandpapered. The drawer in the surbase and that at the top are neatly fitted into their places. They should pull easily backwards and forwards and yet appear quite close both in length and breadth. The accuracy with which they are fitted when finished is a mark of excellence in the workmanship.

The 4 intermediate drawers receive cope beads. After the fronts are planed and sandpapered they are pushed in about $\frac{1}{2}$ in. beyond the face of the carcass, when a small gauge is made to gauge the thickness to check for the beads. This gauge is a small block of hard wood with a steel point in it fully $\frac{1}{2}$ in. from the edge. This gauge is passed all round each aperture in the carcass, the steel point making a mark on the drawer front the depth of the check to receive the beads. The checks are worked out with fillester and guillaume planes. That on the upper edge is made the whole thickness of the front, so that all the pine may be covered with the bead which now serves as a slip. The under edge and the 2 ends are not checked more than $\frac{5}{8}$ in. from the face. The ends are sawn down with a dovetail saw, and worked to the gauge marks with an iron guillaume. The cope bead is bought in boards $\frac{3}{16}$ in. thick; the strips are cut off with a cutting gauge, and must be broad enough to project about $\frac{1}{4}$ in. over the veneered front. When putting them on they are wetted on the upper side with a sponge, then the glue is applied to the dry side, and also to the check, when the slip is placed in position and rubbed backwards and forwards, 2 persons being necessary in the operation. When set in its place it should have a few rubs with a veneering hammer. To ascertain if it is "lying," the glue is scraped gently off along the drawer front with a chisel. When some parts are found not close it is usual to drive in fine brads, but this is a sign of defective workmanship, as no brads are allowed except in putting on the end beads. When a drawer front is slipped top and bottom in this way the glue must be very carefully washed off with a sponge and hot water, a chisel being used to scrape it along the junction of the front with the slip. When these slips are quite dry, the ends are cut off and planed flush with the drawer sides. Then the slips are stripped with the half-long plane on the sides, so that a thickness of fully $\frac{1}{2}$ in. is left, the drawer lying on the bench during the operation. The drawer is then tried in its place in the carcass. It should fit perfectly close against the shelves above and below, at the same time not tightly, the drawer front being in flush with the face of the carcass. When the 4 drawers are fitted in this way, the next thing is to run the beads. This is done with the cope-bead plane. This is a small plane (*v*) with a hollow along the centre of the sole the size of the bead to be run. The central portion is filled in with boxwood, in which the hollow is run. The drawer is now hung upon 2 boards on the bench, front up as before. The projecting edges of the slips are planed with a half-long till they stand above the front $\frac{1}{2}$ in.; then they are rounded with the cope-bead plane, which is run till the sole of the plane touches the drawer front. This, of course, leaves the bead all of one height in its whole length. When the 2 beads are thus run, the drawer front is carefully papered, the beads included, using for the latter a small hollow cork, something like the sole of the plane shown. After all the drawers are thus treated, the end beads are put on. A piece of the cope-bead stuff is thinned to fully $\frac{1}{2}$ in., the edge made straight, and rounded with the cope-bead plane; then a strip is cut off with a cutting gauge of the required breadth, which should be $\frac{5}{8}$ in. This is cut into lengths to fit in between the long beads by mitring the one to the other and stripping to the exact breadth, so that the same height above the veneered front is obtained. When it lies close in the check,

and also close at the mitres, it receives a little glue, and is nailed on with $\frac{3}{4}$ -in. fine brads, 3 or 4 to each. These are punched below the flush, and the end beads are carefully stripped; again the drawer is fitted into the carcass, and should fit quite close at the ends also. When in flush, it will look like a plain panel with a bead all round.

Now the whole 6 drawers are in their places. If they feel too tight they should be gently stripped where tightest. This will be readily ascertained by going to the back of the carcass and looking through between the drawers and shelves or grounds. The fitting of these drawers, done as they ought to be, is considered a very nice job in the trade, but it is seldom that this is accomplished. The drawers, while they show perfectly close all round the fronts, ought at the same time to pull out and push in with the utmost ease and freedom. This will only be the case when the carcass is perfect in construction, in which case the various shelves dividing the drawers are truly parallel with each other, and of the same width of aperture from front to back. The shelves must also be truly at right angles with the upright grounds—in other words, the carcass must be truly squared. Without these conditions the moving drawers, however well they in themselves may be made, can never be satisfactorily fitted into an ill-made carcass. When the drawers have received their final stripping, they are carefully sandpapered on all parts that come in contact with the carcass when moving; the cope beads also receive a final finish with sandpaper.

Now they are ready for the guides and stops. The guides are fillets of pine running from the back to the grounds at the ends of the drawers to guide them; they are 18 in. by $1\frac{1}{2}$ in. by 1 in. The stops are pieces of hard wood, such as ash or oak, 2 in. square and $\frac{1}{4}$ in. thick, and shaped like *w*, having 3 holes for $\frac{3}{4}$ -in. wrought brads; 12 guides and 10 stops are required for the job, as the large drawer in the surbase requires no stop, the front stopping itself against the fore edges. The stops are put on before the guides. To do this a gauge is used with a groove in the head, close to the shank or stalk, to admit the projecting bead on the drawer front. The drawer is turned bottom up, and with this gauge a line is drawn from the front over the mahogany blocking glued to the bottom behind the front, the gauge being set a little bit less than the width of the front and blocking. The piece thus marked off is carefully pared to the gauge line. This being done with all 4 drawers, the shelves are also gauged from the front edge with the same setting of gauge, and the stops glued and nailed on at the gauge lines. They will thus stop the drawers exactly flush with the face of the carcass, the beads only projecting. The top drawer (that between the circular blocks) stands out 1 in. beyond the face of the carcass—consequently for this drawer the stops are 1 in. nearer the front of the shelf.

All the drawers being now in their places, provide mouldings and carvings. When mouldings or other projections are stuck on flat surfaces, the surfaces are French-polished before “planting” the moulding; the mouldings are also well coated with polish. This method is adopted because the fewer obstructions to the polishing-rubber the better the result. Another advantage is, the glue will not stick to a polished surface, so any superfluous glue, smeared about in putting on the mouldings, is easily cleaned off. In the present job, the exact place of the mouldings is marked lightly with a drawpoint both outside and inside; the space between the markings is cleaned of polish, and toothed. The mouldings are carefully mitred to length on a mitre board, and before glueing they are heated at the fire, the glue being applied to the drawer front. If the mouldings are straight on the glueing side they will only require to be held firmly down with the hands for a minute or two. If inclined to warp, pieces of pine, 12 in. long, are placed across them, and hand-screws applied to the ends. The drawer in the surbase receives a moulding $1\frac{3}{8}$ in. broad and $\frac{5}{8}$ in. thick. There are various forms of mouldings used. The moulding is mitred on the drawer front, the double mitres towards the centre having a break of $\frac{3}{8}$ in. The 2 end portions form a square of 8 in.—con-

sequently a margin of 2 in. is left outside of this portion of the moulding, and $2\frac{5}{8}$ in. along the centre. The 2 knobs are placed exactly in the centre of these squares. These mouldings are fixed on the face of the drawer with glue alone, the surface for nearly the breadth of the moulding being scraped and toothed, as also the back of the moulding. When the mouldings are "planted" and hard, all the mitres are carefully dressed off and papered. Next put on the guides. All the drawers being stopped in their proper places, as above described, the guides, 18 in. long, are bored for 3 or 4 nails. A little glue is applied to each guide, care being taken that no glue is allowed to spread and come in contact with the drawer sides; the guides are rubbed in from the back, pressing against the drawer sides; they are pushed forward to touch the back of the ground. After they stand for $\frac{1}{2}$ hour or so all the drawers are taken out, and the guides nailed with $1\frac{1}{2}$ -in. wrought nails. Screws are better, but are hardly ever put in. After this the surbase and body or upper carcase receive the back lining. This may consist of $5\frac{1}{2}$ -in. narrow yellow pine boards. A first-class back would be framed and panelled. The surbase back consists of 1 board only, running horizontally, while the carcase back in narrow wood runs vertically. A fillet is glued to the under side of the top to receive the upper ends of the back lining. They are nailed with $1\frac{1}{2}$ -in. cut nails. The cedar ends of drawers being of reddish-brown colour, the pine wood, that is the inside of front, back and bottom, is stained the same hue. This stain consists of Venetian red and yellow ochre, equal parts, with a little thin glue and water. It is made to boil, and is applied hot to the wood with a rag; after standing a few minutes, the residue is rubbed off with more rag, and is stroked in the direction of the grain; when quite dry, it is papered with flour paper. All wood that is to be stained must be particularly well planed and sandpapered, as the stains at once show up defects. The same rule holds with all work to be painted or varnished.

Wardrobe.—The description of the making of a $6\frac{1}{2}$ -ft. break-front wardrobe in solid wood, as shown in Fig. 698, by W. Parnell, received a prize from the *Cabinet-maker*. It is as follows.

When you have your job set out, get and cut out the whole of the material necessary to make it, choosing (if the choice is left to you) dry and well-seasoned wood for every part. Next shoot and glue all joints, glue on all facings on inside ends and tops and bottoms; on the 2 ends of the centre carcase it will be necessary to joint a piece of solid wood to the front edge to allow for the extra width of that carcase; this piece must be $3\frac{1}{2}$ in. wide, and of the same wood as the exterior of the job, whatever it may be. Your joints and glueings being all done, plane up to the proper thickness the whole of the wood, shooting the front edge of each piece straight and square. Do not bring your

698.

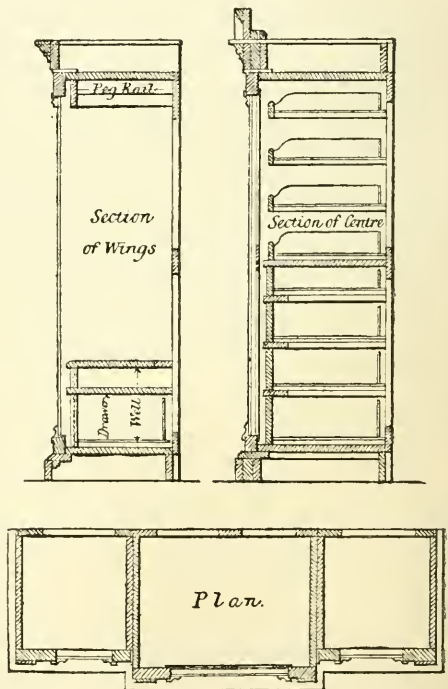

carcase stuff to the exact width until after it is squared off; but you may bring the stuff for the plinth and cornice frames to the right width, also the door stuff, allowing the stiles $\frac{1}{16}$ in. wider than the finished size, for fitting.

When you have all your wood planed, proceed to make the plinth and cornice frames: these are in pine, therefore make them $\frac{1}{2}$ in. shorter than the finished size; let the front rail of the plinth and cornice frames run the whole length less the $\frac{1}{2}$ in. Exactly as if you were going to make a straight-front wardrobe, dovetail the front and ends together, dovetail the back rail down at such a distance from the back ends of the end rail as will admit of a block being glued behind it; allow the cross dovetails to go just "hand tight," for when they are too tight they are apt to force the end of the rail out and make it crooked; dovetail down 2 cross rails to come between the carcasses, allow the plinth, back, and cross rails to be 1 in. wider than the front and end rails to allow them to stand level with the plinth mouldings, and the back and cross rails of the cornice frame to stand down $\frac{1}{2}$ in. to be level with the moulding under the cornice. Prepare your break pieces for the cornice and plinth, lining them up at each end to 3 in. thick; let the linings go the same way of the grain as the fronts, and be 5-7 in. long; square the breaks up $\frac{1}{2}$ in. shorter than finished length, and fit them in their exact positions, with 2 dowels, one at each end, but do not glue them yet. Glue your plinth and cornice frames together; set them square, glue a block in each corner, and put them on one side whilst you proceed with your doors; set out the stiles and rails from your board, gauge for the mortices and tenons, so that the outside of the tenon comes in a line with the inside of the door moulding, which will bring the tenon almost in the centre of the thickness of the stuff. The top rail of the centre door will be as much thinner as the moulding is rebated so as to allow for the arched head, which will be a piece of thin wood grooved into the stiles with a shoulder on the front side only, and after the door is glued together, to be slid down from the top and glued to the face of the top rail; this will allow the glass panel to be square. Before glueing your doors together, put them up dry and see that they are true; otherwise, when they are glued you may perhaps have a good bit of trouble with them. The small corners in the wing doors should be the same thickness as the head in the centre door, and should be tongued into the stiles, but need not be to the rail, as it is the same way of the grain, and if well jointed and glued will hold as well. When you have glued your doors together, and seen that they are true and square, and that the stiles are straight with the rails, proceed to mitre a piece of wood $\frac{1}{4}$ in. thick, of the same sort as the exterior of the job, round your plinth and cornice frames; next make the frames for the carcase, backs, and blind frame for the centre door; make your mortices and cut your tenons before ploughing the grooves in the edges to receive the panels. In putting the centre upright and cross rails together for the centre carcase, back and blind frame, allow the cross rail to cut through the upright, if halved together, so that it may appear as though the upright was in 2 pieces and mortised into the cross rail, which is done in some shops, but preferably halved together. When you have your frames ready, knock them together, dry, and hang them up out of the way.

Now work your mouldings; and in working the mouldings for the doors plough a groove on the reverse side, so that when the moulding is cut off the board it will form a rebate to rest on the doorstile. When you have worked and cleaned up all the mouldings necessary for the job, proceed to mitre and glue on those for the plinth and cornice, taking care that for the internal mitres you use parts of the same length of moulding, so that they may intersect without requiring any easing; do not at present glue the internal mitres, but when the mouldings are all on the frames take off the break pieces, easing the moulding at the mitres if necessary, and now glue the breaks on, and when dry level off any odding, and put the plinth and cornice on one side.

Next clean up the doors on the front sides, merely levelling the backs, and put in

the mouldings. Square up all the stuff for the carcasses and fittings with the exception of drawers, tray and peg-rail fronts and backs, and one end of drawers and tray bottoms. In squaring the top, shelf and bottom of the centre carcass, allow them to be a trifle large at the back so that the drawers and trays may run freely, but it must be very little, not more than the thickness of veneer ($\frac{1}{32}$ in.), otherwise it will have the contrary effect of giving them too much play. Make the carcass tops and bottoms $\frac{5}{8}$ in. shorter than the extreme length of the carcass, to allow $\frac{5}{16}$ -in. lap on each carcass end; and the shelves and partition edges $\frac{3}{4}$ in. longer than the length of the carcass *between* the ends, to allow $\frac{3}{8}$ in. at each end for a dovetail.

Gauge for the dovetails, and cut first those in the ends and chop them out; next place the top and bottom of a carcass on the bench inside uppermost, stand the corresponding carcass end in position, and mark the dovetails on the top and bottom with a marking-awl, repeating the process till you have marked all; then cut the dovetails, taking care to cut to the lines and allowing them to be tight on the outsides so that they may glue up clean and fit well. It is preferable not to cut the shoulders at the front and back now, as unless great care is taken you may, before you are ready to glue up, find the corners knocked off the outside dovetails; chop out your dovetails in the tops and bottoms.

Now take your carcass ends in pairs and set out for the drawers, trays and peg-rails, squaring them across the front edges with a marking-awl lightly, to mark where the grooves come; then square across the width of the end inside and run the grooves; those for the trays and peg-rails $\frac{3}{16}$ in. deep, and right through from front to back; for the runners between the drawers, the same depth, but commencing 4 in. from the front edge; and those for the shelves $\frac{3}{8}$ in. deep, and also commencing 4 in. from the front edge. Chop down from 4 to $7\frac{1}{2}$ in. from the front edge, in the grooves for the runners between the drawers, to $\frac{3}{8}$ in. deep, to receive partition edges. Cut a dovetail on the under side, to 1 in. from the front edge, but cut the top side straight in a line with the groove, so you will have a dovetail on the under side of the partition edge only; having cut the dovetails in the ends, put the partition edges in their respective places, and mark the dovetail on them. Cut them so that they fit, but not too tight, for if they are too tight they will force the partition edge out of square when driven home, and that would interfere with the proper working of the drawers. Plough grooves on the back edges and also on edges of runners for dust-boards. Cut a shoulder on the front edges to fit between the carcass end $\frac{3}{8}$ in. back, that it will allow the edge to come within $\frac{5}{8}$ in. of the front edge of the carcass ends, the shelves to be kept back in the same manner, having a dovetail of the same sort on their ends. The division between the drawers may be dovetailed both sides into the edge and shelf.

Rebate the back edges of the outside carcass ends, bringing them to their proper width; bring also the other ends, tops, bottoms and shelves to their proper widths, and clean up all the deal that requires to be coloured (make your colour or have it made so that it may be ready by the time you have cleaned the wood, and in sufficient quantity to do the whole, so that you may have the inside of the job one colour); before using the colour, try it on a piece of wood to see if it is right, and also if there is sufficient glue in it to prevent its being rubbed off when dry. When you have cleaned up all the parts that require colouring, commence to colour, wiping it off with soft shavings, and smoothing it nicely with the palm of your hand. When the whole is coloured, clean up your outside ends inside and out, also your drawer stuff if not already done; by the time you have done that the colour will be dry. Take the panels for the backs, lightly pass a piece of very fine glasspaper over the insides, and, if customary in the shop, wax them; then glue up your carcass backs. Serve the remainder of your coloured work the same as you did the panels, also waxing the inside of the solid ends where seen, and cutting shoulders of tops and bottoms. Level the frames outside and in, clean up and colour the insides.

Commence to glue your carcasses together. A very handy way of doing so is to lay one end on the bench (of course if it is the outside one you must have either a cloth or bench sticks under it), hand-screw it tightly to the bench, and glue the dovetails at one end; drive in the corresponding top or bottom and then the other end. Take off the hand-screws, place the other end of the carcass under the one you now have on the bench, and then turn over the end with the top and bottom glued in, and glue them into the other. Put in your shelf (if there is one), glueing the dovetail only in the groove; place the carcass on its face on the floor, square it with a rod from corner to corner, fit the back, and having waxed the frame inside, screw it in its place and level it off.

When glueing the centre carcass together, commence as with the others, but when you have turned it over to glue the top and bottom into the second end, put your partition edges into the places cut behind the dovetails to receive them; then glue and drive home your top and bottom, glue the dovetails and drive up the partition edges, put in your shelf, glueing the dovetail only; place and glue the division between the drawers in its position. Stand the carcass on the floor on 2 pieces of wood, set it square, and proceed to put the runners in their places, cutting a tenon $\frac{3}{8}$ in. long on the front ends of them to fit in the plough-groove at the back of the partition edge; plane the runner a shaving or so thinner at the back than the front, and fix it in its place; glue the tenon only, and nail the back end to the end of the carcass. Put the centre runner in with a tenon at the front, and suspend it at the back with a thin lath dovetailed into the back edge of the shelf and end of runner; allow this lath to be just a trifle longer between the shoulders than the front division; it may be $1\frac{1}{2}$ in. wide. Now fit and put the dust-boards in, putting a touch of glue to the front edge to prevent their slipping back should they shrink. Care must be taken that the runners are at least $\frac{3}{8}$ in. shorter than the width of the ends; when in their places, lay your carcass on its face, see that it still remains square, fit the back, wax the frame where necessary, and screw it in and level it. Now level the fronts, tops and bottoms of each carcass, cleaning as you go; place your plinth on the floor where your wardrobe is to stand, and put the centre carcass on it, arrange it in position and fix it there; next place and fix the 2 wings to the plinth, put the cornice on the top, place it in its proper position, and fix the carcasses to it, and to each other, putting screws where necessary, but not more than are necessary. Now block the carcasses to the plinth and cornice, with 4 blocks about $2\frac{1}{2}$ in. sq. on the top and bottom of each carcass, so that when the job is removed each carcass will immediately go into its proper position. When that is done, wedge the wardrobe up so that it stands true on the front and perpendicular, glue a lath $\frac{1}{4}$ in. thick by $1\frac{1}{2}$ in. wide, with bead or edge to the ends of the centre carcass in the angle formed by the wing, and proceed to fit your drawers, trays and peg-rails, and finish them right off, but if possible, when you are ready to glue your drawers together, let in the handles in the fronts before doing so, as it is easier and quicker, for you can lay the front on the bench to do it; when your drawers, &c., are finished, not forgetting the stops, which should allow them to stand in $\frac{1}{8}$ in. beyond the front of partition edges and shelves. The peg-rails standing back about $\frac{5}{8}$ in. from the edge of carcass, proceed to make the clothes-well: first the top should be clamped at each end, with a frame outside it consisting of a back and 2 end pieces tenoned together exactly like the lid of a w.c.; glue 2 runners 1 ft. 3 in. long to the carcass ends, $\frac{1}{4}$ in. from the front edge and $\frac{1}{2}$ in. wider than the side rails of the top frame, having a plough-groove on the edge $\frac{3}{8}$ in. deep to receive a sliding front $\frac{3}{8}$ in. thick; fit in the front and cut a hand-hole at the top to draw it up by; fit the top into top frame and hinge it at the back; place the top frame in its position, resting on the runners at the front, screw through the carcass back into the back rail, and glue blocks under the side rails to fasten them to the carcass ends. Care must be taken not to glue the rails across the ends. Next fit your doors, in doing which allow them to be a full thickness of a veneer ($\frac{3}{16}$ in.) short, so that they may not drag on the plinth, and allow them to be a trifle wide, so that they just project beyond the carcass end. When hinging

them, keep them up tight under the cornice; but previous to doing that, when your doors are fitted, glue on the pilasters, fit in the panels, fit blind frame, and clean them up, and when your doors are up with hinges and locks all in working order, place them in their respective positions. Make the beads for fixing them there, and then if you have to satisfy any one but yourself, ask the foreman or employer (as the case may be) to examine it, and afterwards take the job to pieces, colour the outside, and you have finished the task. The choice of wood for the structure and designs of the mouldings do not affect the mode of construction.

Sideboard.—Fig. 699 illustrates the construction of a 7-ft. pedestal sideboard with 3-panel back. The description gained for W. Robinson a prize in the *Cabinet-maker*. Having set out the work full size, first proceed to get out the top, which is a piece of 1-in. stuff, 7 ft. long, and shot to 2 ft. 2 in. broad. This, when finished, has a 2-in. ovolo on the top edge, and a $\frac{3}{4}$ -in. bead sunk on the face edge. Get out some $\frac{1}{2}$ -in. stuff, $4\frac{1}{2}$ in. wide, and line it up on the under side of the top, letting the end lining run the same way of the grain as the top. Cross line the top also over the inside end of the pedestals; this and the back lining may be pine. Next proceed to get out the drawer frame. It will be made of 1-in. pine, and its extreme length, with its end facings out, will be 6 ft. 5 in., and its extreme breadth from the outside of back to the front edge of the top blade will be 1 ft. $10\frac{1}{2}$ in.; the lower blade sets back 2 in. In getting out the cross rails of the frame, frame a piece of 2-in. stuff, 5 in. wide on one end, cross-ways of the grain, and in putting the frame together let the flush sides of the cross rails go next the centre drawer and the outside ends respectively. When all is fitted, place the 4 cross rails side by side, and shape all together, and leave them with the carver to run 3 flutes $\frac{5}{16}$ in. wide on each. Next proceed to get out the pedestals. These are simply a frame, with the stiles of 2-in. scantling, with $1\frac{1}{4}$ -in. cross framing, precisely the same as the door, the panels being $\frac{5}{8}$ in. thick, and bevelled in $1\frac{1}{4}$ in. from their edges. Clean off the face of the panels, and finish off the mouldings, and let the polisher body them in.

In the meantime the framing can be got on with. The top and bottom rails run across, and are framed into the pilasters or angle pieces, and the stiles are checked or sunk into the pilaster $\frac{1}{4}$ in. (see section of pedestal). The inner frame is connected with the outer frame by 4 short rails. Note: the end panels are framed in grooves, but the door panels are framed or fastened in with beads. Having got the panels from the polisher, frame the $1\frac{1}{4}$ -in. framing together, and mitre the mouldings offered to the top, give all to the polisher, and when done screw the side panels to the centre panel, place on its face, and block in the silvered glass; put on the blind frames, then screw the job all together. Screw the brackets, pediment, &c., on, and see that the doors work easily, and the locks are oiled. The doors may be hung with centre hinges, or with strong brass butts, 3 in. long, letting the knuckle stand out $\frac{3}{8}$ in. past its centre of motion, and an ornamental hinge plate screwed in, &c., first having cleaned off the face, and got it bodied in. Now proceed to frame the pilasters to the frames, and having dovetailed the top and bottom to the ends, clean all off, and let the carver flute them, and cut the elliptic pateras in the centres.

The doors may now be got out, of course letting the stiles run through.

As the moulding forms the rebate for the panels, it will be seen that the panels will be narrower by $\frac{5}{16}$ in. on each edge than the pedestal panels were, in consequence of no groove being in the stiles, &c.

The frame may now be taken in hand, the drawer fronts fitted on the rake, and the drawer sides fitted and shot to their proper shape, the front dovetails being on the rake in order to take the front.

Get out 4 blocks the same shape as the blocks between the drawers, and glue them on to the ends of the frame over the pilasters. Now get out 2 mock drawer fronts, and fix them between them, and face the frame to represent the blades over and under

the drawer. (Note that the blades have a sunk bead on the centre of their faces.) The plinth rails may now be got out and fixed, as also the bases of the pilasters.

To make the bases, get out a piece of cross-grain stuff, $4\frac{1}{2}$ in. wide by 1 in. thick,

699.

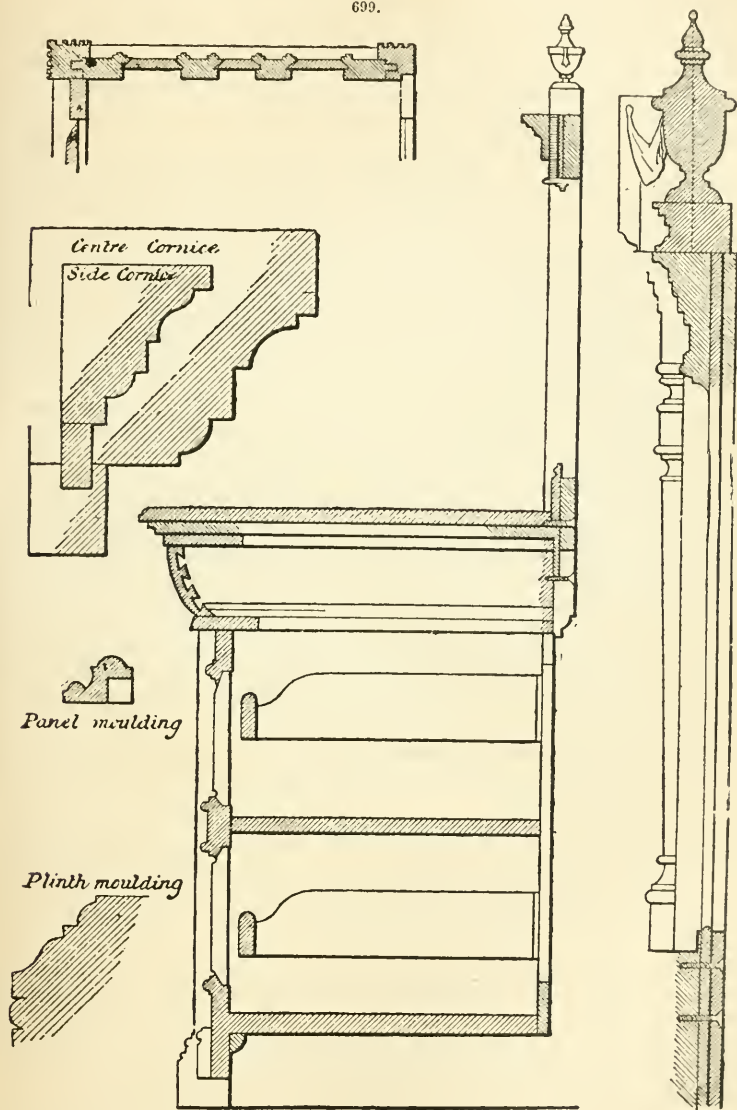

and about 2 ft. 2 in. wide, and run the moulding along the edge, and then cut it in lengths, and fix them, leaving their sides flush with the pilasters. The trays and cellorette drawer may now be made, the frame cleaned off, and pieces fitted on

the fronts &c., and carved as drapery. The flutes on the fronts of the drawers can then be carved, and the ram's head and angle brackets, and centre ornament under drawer, finished.

The door mouldings may now be mitred in, and the panels bevelled $\frac{1}{2}$ in. from the edge. Place the frame on the bench, and put on the runners for the drawers, and afterwards place it on the pedestals and block it in its place. Now fit and hang the doors, &c., and let the carver have them to cut the circular pateras at the angles.

After this take the top, shoot the back edge, joint 2 pieces of stuff $3\frac{1}{2}$ in. long by $1\frac{1}{2}$ in. wide at each end, and run the mouldings through. These are to finish the top off level with the plate glass back. The top and frame may now be finally screwed together, the drawers run and stopped, and their fittings put on. The carcass backs of the pedestals may be put in, levelled, and coloured, and all given to the polisher.

The back is composed of 3 frames, the groundwork of which is $1\frac{1}{2}$ -in. stuff; the 2 outside frames have their outside stiles faced on the outer edge by a pilaster, 2 in. sq., and which projects 2 in. above the top of the frame to receive the carved urn. The breadth of the outside frames, including the pilaster, is 1 ft. 8 in., and the extreme height is 2 ft. 2 in., exclusive of the pilaster. These 2 frames are faced with $\frac{3}{8}$ -in. stuff, and the bevelled glass is surrounded by a moulding. The pilaster is carved and fluted, and the dentilled cornice then mitred round the top, showing a $\frac{1}{2}$ -in. break. A small console is placed at the bottom as a suitable finish.

The centre frame is got out of the same stuff as the side frames, viz. $1\frac{1}{2}$ -in., and faced with $\frac{3}{8}$ -in. stuff. In getting out this frame, the breadth must be $\frac{2}{5}$ in. narrower than the finished size, in order to allow a side facing to hide the joint of the groundwork and its front facing. The extreme height of this frame will be 3 ft. 9 in., and the extreme breadth 3 ft. 1 in. Now glue 2 pilasters 3 ft. 7 in. long by 2 in. sq. on the face, keeping them flush on the top ends, also on the outsides; and on the faces of these two, glue 2 shaped pilasters of same length, but only 2 in. by $1\frac{1}{2}$ in. Mitre the cornice round, and also the necking, and leave a break of 2 in. at the centre. This tablet is to be $3\frac{1}{2}$ in. wide.

The edge of the facing on the centre frame is a $\frac{1}{2}$ -in. hollow. Get out the ogee pediment, and fit the looping of drapery to the urn, and give all other carvings, &c., to the carver. Note that it is always better to have the glass before finishing the sight measurements, as the levels can be matched to mitre with the mouldings, and a more even margin secured.

CARVING AND FRETWORK.—These artistic operations may be described under one general head, as they deal mainly with the same material—elegant woods, and can be carried on together.

Carving.—This is an industry which essentially depends upon the native talent of the operator, and in which no progress can be made by simply following directions. It will be found an excellent plan to make a model in clay of the proposed design, and then carve the wood according to the clay model, which latter can be modified till it gives satisfaction. The subject of carving may be divided into Woods, Tools, and Operations.

Woods.—The choice of the woods to be operated upon is a point of considerable importance, and the workman would do well to study the various woods and their peculiarities.

Camphor.—A very fine wood, with a close clean-cutting grain. It produces an excellent effect when worked into small articles of furniture of the Elizabethan and neo-Grecian style. Unfortunately, it is difficult to obtain in Europe.

Ebony.—Of this wood there are several varieties in the market, the only one serviceable to the carver being that with a close and even grain, so close indeed, that under the gouge it appears to have no fibre whatever. The hardness renders it extremely difficult to work, and for this reason ebony carvings are of great value. The great

defect which this wood has, is its tendency to exfoliate, and to split. An imitation ebony is sometimes offered, which is made by soaking pear-wood in an iron and tannin dye-beck for a week or more. The colour penetrates to the very heart of the wood, so that the cut is as black as ebony. Ebony is above all woods the most suitable for small carvings of every description, whether for use or ornament, the deep black colour and the hardness and fine texture of grain giving it, when polished, the appearance of black marble. This wood is also somewhat difficult to procure in large blocks—not, however, on account of the growth of the tree, which is very large, but, either from the carelessness of those who are employed in felling it, or the extreme heat to which it is exposed, it rarely arrives here in logs of any size that are not more or less riven and spoilt by cracks and flaws—"shakes," as they are termed in timber merchants' *parlance*. There are two kinds of ebony—the green and black; of these the former is for some reason the more highly prized, and consequently is the more expensive; but for carving purposes there is little or nothing to choose between them; they are both equally pleasant to use, but the blacker, being the harder of the two, is capable of taking a higher polish, its only drawback being an occasional white or red streak, but these are rare, and can be obliterated by applying a little ink to the spot after the carving is done. Black, or iron wood, as it is sometimes called, is a species of ebony, but has little to recommend it but its extreme hardness and weight; indeed, on the former account it should rather be shunned by the carver, as it will turn the edge of the tools.

Lime.—The easiest of all woods to work, being soft and equal under the tool. But it is of little use for delicate work, as it does not "hold" to fine details; for that reason it is only used for frames, or at most for coarse undercut work, which has neither to bear heavy weights nor sustain much wear. The tint of this wood is something like that of fresh butter. It is less liable to split and splinter than almost any other wood, which qualities render it of great utility to carvers for carrying out designs when lightness and boldness are equally required. It takes a stain well, and a fair polish, or it may be varnished without greatly altering the colour of the wood, but giving to it a very agreeable boxwood appearance. It is suitable, as well as for large festoons, for smaller works, such as book-stands, miniature and portrait frames.

Mahogany, owing to its tendency to chip, when reduced to thin edges or angles, is only used for carvings having a bold outline, in which fine projecting lines are not requisite. There are two very distinct kinds. That suited for carving must not be confounded with the common soft wood known as cedar mahogany, used for ordinary furniture, but is hard and dark, and known as Spanish. This wood is well suited for basso relievo, as is also the Spanish chestnut, the two woods, when polished, being much alike, though the mahogany is of a somewhat richer colouring.

Oak is so well known as not to require description. Its strong fibres and coarse texture render it unfit for the finer kinds of sculpture. The most adapted to the purposes of the carver is perhaps the variety found in the Vosges. Those trees which grow in the heart of the forests produce a softer, more brittle wood, more exempt from knots and other irregularities than those which grow on the borders. Foreign oak is much to be preferred to home-grown wood, which is of a hard, tough nature, and liable to knots, which are a great impediment to the carver, and from which the American and Norwegian forest-grown oak is comparatively free. These oaks may be known by the close and smooth grain, and somewhat grey tinge, the English wood being closer grained and of a yellower colour. Oak is especially useful for decorative work in library or large hall, and, above all, for ecclesiastical purposes.

Pear.—This wood, owing to the fineness of its grain, its cohesiveness, its durability, and its equable cut, is perhaps the best for all delicate work, such as vegetation, flowers, &c. It takes a beautiful black by staining. Much pear is sold as ebony. Pear-tree is a pleasant wood for working, and a good piece resembles lime in its pliability. It is extensively used in France for the purposes for which we employ lime.

Sandal-wood, from the texture, beautiful colour (a rich yellow brown), and the delicious scent, is especially suited to small carvings. The superabundance of oil, which emits so delightful a fragrance, causes it also to take a beautiful polish merely by rubbing it slightly with the hand. The best sandal-wood is brought from India and Ceylon. It also, like ebony, is difficult to procure in sound pieces. It is sold, as are the most valuable woods, by weight, the price varying from 6d. to 1s. per lb., according to the size and soundness of the logs. Small pieces are cheaper than large ones in proportion, unless they are prepared and squared to any even size, and then they are far more expensive, as in the course of preparation 2 or 3 logs may perhaps be cut up and spoiled before one can be found without flaw, and of course this waste is taken into account and charged for by the wood merchant.

Sycamore, holly, and chestnut are amongst the lightest of our woods. The first is greatly, and, in fact, principally used for bread-plates, potato-bowls, and other articles, when a light tint is a consideration.

Walnut.—The wood of this tree is usually of a brown colour, and on being cut shows a brilliant grain. It is soft, binding, and easy to work. Of all woods, it is the one whose colour varies most. Although its colour is generally brown, samples are to be found in which the veins are almost black on a white ground. This freak of nature is sometimes found in the same tree which at other parts is equably coloured. The best walnut for the carver is that of a brown uniform tint, slightly bronzy; its veins should be regular and offer an equal grain under the gouge. The white varieties are softer than the above named, and would be preferable, were it not for the black veins before described, which entirely disfigure the work, and necessitate the greatest attention in staining to equalize the tone. The veiny brown wood is generally too fibrous and too knotty, and is often traversed by sap-wood, which in some places becomes decomposed, forming a mass resembling a tough gritty leather, which blunts the tool without being cut. Before beginning to work, the absence of such defects should be carefully ascertained. Trees which grow near marshy lands, or near manure tanks, absorb a sap of a peculiar nature, which has a disagreeable odour of rotten eggs, plainly perceptible when the wood is heated by rubbing, either with the hand or with a tool. The walnut is rather liable to the attacks of worms, especially in the sap-wood. This may be to a great extent prevented by washing the wood with a strong decoction of walnut "shucks" and alum, applied cold. The best walnut comes from abroad, and is much in use amongst Continental carvers, especially the Austrian; but though it is pleasant and easy to work, it has a dull and dingy appearance, so that a carving would have looked better and been more effective had it been done in any of the other woods mentioned, though the labour would have been far greater. Italian walnut is a rich and beautiful wood for a variety of purposes, such as cabinets, panels, bookcases, and frames. It is hard, but the effect produced by its use amply repays the extra labour caused by the close texture of the material. American walnut is a very good wood for amateurs, and is much in favour with them for its dark colour. It has, however, a more open grain than lime, and therefore requires more care to avoid accidents. It is used for many small works where much projection is unnecessary, as book-racks, letter-boxes, and watch-stands.

Wild Cherry.—Easy to work, and of a vivid red tint, which, however, loses brilliancy with age. It is very liable to be worm-eaten, and is only used in sculpture in making little boxes.

Yew.—This extremely hard wood is well adapted to the carver, although it has almost gone out of use. The sap-wood is white, the heart-wood of a bright orange, the grain is fine and close, the cut being particularly "clean."

To procure good wood for carving, the trees should be felled at a proper time and age, and the wood thoroughly seasoned. The proper time to fell oaks and most other trees is when they fail to increase in size more than 2 ft. per annum. If cut down before that period of their existence, the heart will not be fully developed, and will not

be as hard as the other part. When oaks are about 30 years old their growth is most rapid. Autumn is generally considered the best time to fell.

If wood be used in an unseasoned state it is sure to warp and twist; and when it is so used for panels fitted into loose grooves, it shrinks away from the edge which happens to be the most slightly held; but when restrained by nails, mortices, or other unyielding attachments, which do not allow them the power of contraction, they split with irresistible force, and the material and the workmanship are thus brought to no useful service. It is therefore very necessary that the natural juices of the tree be got rid of by seasoning it before use. After a tree is lopped, barked, and roughly squared, it is left some time exposed to the weather, and may be soaked in fresh running water with advantage, and boiled or steamed. Any of these processes tends to dilute and wash out the juices, and the water readily evaporates from the wood at a subsequent period. Thin planks, if properly exposed to the air, will be seasoned in about a year, but the thicker the wood the longer the time it will take.

All woods, to carve properly, should be perfectly dry—but not too old—in this latter case they become brittle and nerveless. If possible, the wood should come from the upper portions of the trunk, as these are less subject to knots. As a rule, the branches should be rejected, as their wood has not sufficient body. The sap-wood should always be refused, as it is too soft, blackens easily, and is sure to suffer from the attacks of worms.

It is often useful to be able to stain the wood after the carving is complete. This is done, either to give an appearance of age, or to imitate some other wood. The ageing is generally performed as follows, though the ready-made oak-stains may be used with equal success. Boil 5 oz. of dry powdered walnut “shucks” in 1 qt. of water. Filter off the clear liquor, and apply cold to the work with a brush. Or, take 2 oz. Cassel earth and 2 oz. American red potash, boil in 1 qt. of water, and apply as above. This latter colour imitates well the tints of old oak, and if applied to oak itself darkens it considerably. With pear-wood, it is usual to use a decoction of gamboge and saffron, to bring up the yellow tone. Lime may be stained of various colours in the following modes. Solutions of tin salts and turmeric applied consecutively give a good orange. Brush over with madder, allowing to dry, and then applying acetate of lead, gives brown with darker veins. Walnut takes a fine mahogany tint if washed with a strong decoction of Brazil or Campeachy wood. All sculptured woods may be dyed of a full black, by being washed over with a solution composed of 1½ oz. powdered extract of logwood, 2 qt. of water, to which is added after boiling ½ oz. potash chromate.

In general terms, oak is the best wood for large surfaces, and ebony or boxwood for small, minute work; but walnut, lime, chestnut (both horse and Spanish), mahogany and plane, are all suited to the purpose, while sandal-wood, apple, pear, holly, cypress, fig, and lemon tree, being hard and fine-grained, may all be used with good effect, according to the style and size of the carving, and other circumstances. Sycamore, lime, holly, and woods of a like nature, being white or cream-coloured, are only suited to that special style of carving whose beauty depends on great purity of colouring—such, for instance, as the minute basso relievo after a picture, models of figures in imitation of ivory, groups of birds or delicate foliage; but all these woods, unless protected by glass, soon lose their extreme whiteness, and with it their chief beauty. Therefore, they are little used, excepting for the trifling purposes just mentioned. The woods of the apple and pear tree are, from the hard texture and fine grain, exceedingly pleasant to work, but the fruiting value of the trees renders the wood rare, and occasional deep-coloured veinings sometimes interfere with the design. Boxwood is equally hard and fine-grained, and is far superior in uniformity of colour, which is a rich yellow. Fig-tree wood is also much prized for small carvings, being of a very beautiful warm red colour; but even in Italy it is rare, owing to the value of the living tree, and extremely difficult to procure in England. The great bar to the free use of all these hard woods is the

difficulty of procuring them in pieces of any sizes, for, as their texture indicates, they are mostly bushes of slow growth, rarely attaining to more than 10 in. to 12 in. in diameter, added to which, as regards boxwood especially, it is largely used for other purposes besides carving, which necessarily increases the demand, and makes it more expensive.

When any very delicate designs have to be executed, and the most minute finish is required, boxwood, ebony, or any other equally hard and close-grained woods are decidedly the best to choose.

Woods with ornamental grain, as bird's-eye maple, satinwood, yew, and laburnum, are not desirable for carving purposes; the grain and colour often interfere with the effect which it is an object to produce.

Tools.—The work of the carver rarely needs a special bench, any short deal table answering every practical purpose. This should be of a convenient height to suit the operator, and be placed under a north window for the benefit of the light. The workman should stand rather than sit at his work, and will find a revolving music-stool the least inconvenient seat. The work-table should admit of holes being made in it for the reception of a screw for holding down the work. The cutting tools used are of special forms, representative examples of which are illustrated herewith. Fig. 700 is a straight

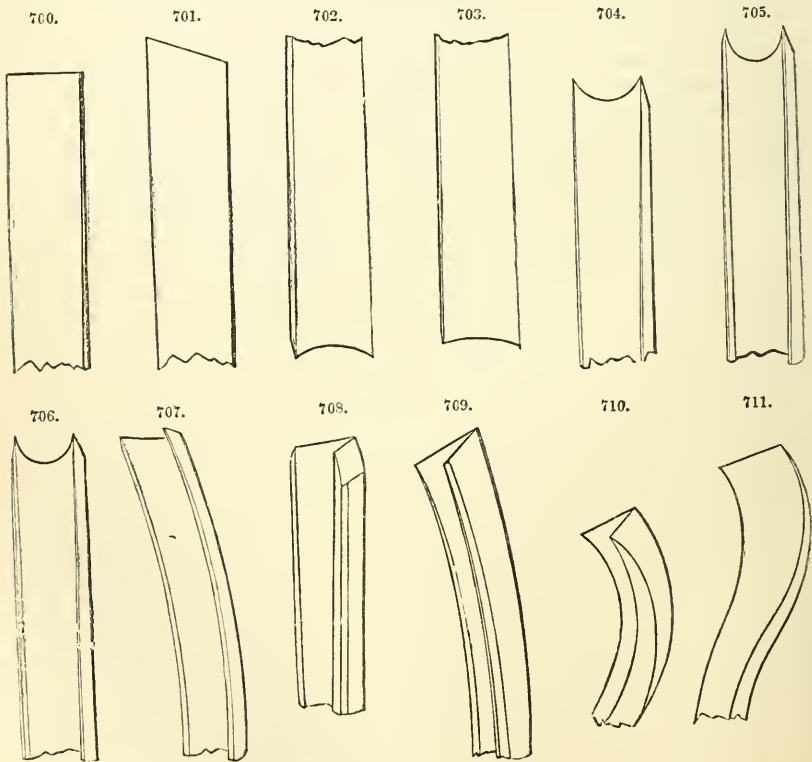

carving chisel; Fig. 701, a skew carving chisel; Fig. 702, a flat carving gouge; Fig. 703, a medium carving gouge; Fig. 704, a carving gouge for scribing; Fig. 705, a deep carving gouge; Fig. 706, a straight fluting gouge; Fig. 707, a front-bent fluting gouge

Fig. 708, a straight parting tool ; Fig. 709, a bent parting tool ; Fig. 710, a spoonbit parting tool ; Fig. 711, a spoonbit chisel ; Fig. 712, a skew spoonbit chisel ; Fig. 713, a medium front-bent carving gouge ; Fig. 714, a spoonbit gouge for scribing ; Fig. 715, a deep spoonbit gouge ; Fig. 716, a back-bent spoonbit gouge ; Fig. 717, a veining tool ; Fig. 718, an unshouldered print-cutters' chisel ; Fig. 719, a bolt chisel ; Fig. 720, a

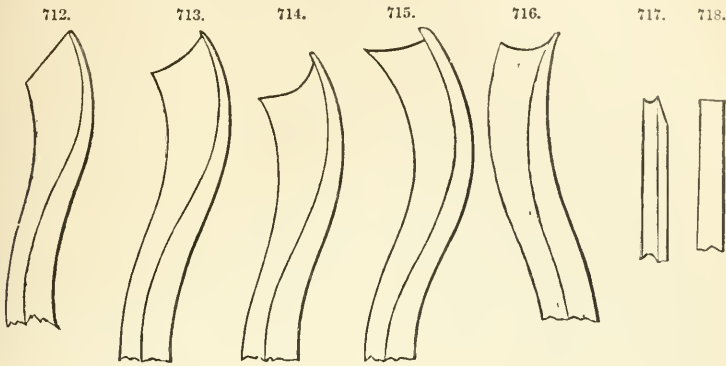

dog-leg chisel ; Fig. 721, an improved print-cutters' gouge. Of each kind of cutting tool there are some half-dozen forms, varying in the acuteness of the angle or sharpness of the curve of the cutting edge, so as to be more readily adapted to the sweep or corner of the line being cut. In bent chisels, there is one for the right corner and one for the left. Tools of unusual form can be readily extemporized from old knitting-needles or small files, by heating to whiteness, hammering to shape, and tempering in oil or sealing-wax. Usually the palm of the hand suffices for giving a blow to the cutting tool, but a small round mallet is handy for heavy work. The ordinary marking and gouging tools, and a small brush for removing chips, are necessary adjuncts.

Some order should be observed in arranging the tools on the bench, both for facility in selecting any particular one required and for preserving their cutting edges. A good plan is to lay them with the handles towards the back of the bench, and along the back margin, taking care to drop the handle first in putting them down. As regards quality, the tools should be of the best. A few words may suffice to indicate the points to be considered in selecting good tools. First, as regards substance, for general use, especially if likely to be used much with the mallet, care must be taken that they are not so thin as to make them liable to break in half when in use. The stoutest to be obtained now are hardly likely to be too stout. Especially should they be stout near the handle. Attention must be given also to what may be termed the "lines" of a tool. They should be easy and true. There is an uncertainty about the shape or lines of some tools which give the impression that the maker could scarcely have known what sort of

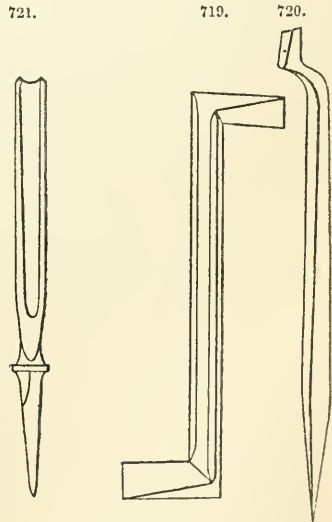

thing he wished to produce. About many that are in the market, there is something more than uncertainty, for their deficiency in this respect is of the most glaring kind. It is not that this is merely a matter of taste or fancy, which has no real effect upon the practical value of a tool. If, for example, a tool is only slightly "twisted" or slightly bent, it is very likely to break when malleted, and can never be used with pleasure. It will be useful to the learner to study, if he has opportunity, the "make" of good old tools or new ones of acknowledged merit, in order that he may be able to make a mental comparison when making purchases. One other point of importance to consider is the "temper." The proof of the "temper" is in the using. It is true that an experienced eye is not likely to be deceived in this matter; it is also true that the temper of a tool may in a measure be tested by a file, but the file must be in the hands of an experienced person. In any case, the final test is in the using. If the tool is so "soft" that the edge turns when brought into contact with hard wood—not the hardest—and that end way of the grain; or if, on the other hand, it is so "hard" or brittle that used in the same way the edge breaks, it had better be discarded.

The "parting tool" is of all tools the most easily broken, and the difficulty and trouble of sharpening it makes this mishap anything but a trivial affair. But it is a most useful and, moreover, a necessary tool, and a carver might well possess a variety—say 6 or 8—of them. Any one having the smallest acquaintance with carvers' tools will have noticed that the sides or blades of some parting tools spread considerably more than others. The carver must make choice of one or more for rough work, and there can be no question that—other things being equal—those with the most spread are the strongest, and therefore the safest for rough work. Small parting tools, with their sides brought nearer together, i. e. having little spread, are invaluable for incised work; and may, in the hands of a skilful workman, be made to do work which could only be accomplished by the help of other tools with far greater difficulty and labour, and even, at times, with a less satisfactory result. Parting tools, which are intended for such light work, must be suitably sharpened and kept for that purpose alone. If they are fit for light work, they are as certainly unfit for heavy work, as a broken tool would soon remind the incautious workman. As already stated, for heavy work, substance, as a quality in a tool, is very important. But this is especially the case with the tool under notice. There must be substance in the blades, and especially where they meet, towards which they should become somewhat stouter. In purchasing, see that the inside is truthfully cut out—i. e. that the "lines" are good—and beware of flaws.

The "voluter" is second only to the parting tool in importance and value to the carver, even if it be not equal to it. And this, again, is a tool which must receive special attention when the subject of sharpening is reached. Of this, too, it will be necessary that the carver should have a variety. Like the parting tool, it is one which affords the manufacturer an excellent opportunity of distinguishing himself, if he has any desire to do so. The sides of a voluter—if in speaking of this tool such a term is admissible—should very slightly, but only very slightly, spread. This is necessary, if it is to free itself when in use. For some purposes, the voluter makes an excellent parting tool. In cutting round leafwork, previous to setting-in, instead of always using a parting tool, try the voluter. It will even answer such a purpose better at times, and has this additional recommendation—that it is less liable to break.

A combination of circumstances and conditions in tool and workman go to make a tool that is termed "handy," i. e. eminently adapted to the work in view. Some of the points necessary to earn this denomination for a tool may be considered. For instance, one purpose for which every carver uses his scroll tools is that known as "setting-in." For this purpose, other things being equal, the tools which are the handiest are the shortest. The long tool is objectionable for one or two reasons. If it is struck hard with the mallet, as it must often be when used for this purpose, there is a certain "spring" in it, unless it is a very thick tool, which creates an uneasy feeling in the mind of the

carver, for such a tool is liable to break in half. A short tool is almost sure to be a strong tool. A long tool is objectionable, too, because the carver has to raise his mallet to an inconvenient height in order to strike it. But the main reason for giving preference to short tools when used for this purpose is, that the carver can grasp the handle and at the same time rest his hand upon the work to keep the tool in the desired position. It is obvious that with a long tool this cannot be done. The sharpening of these tools must be done equally from inside and outside. When a tool is grasped in the right hand, and used as in moulding, then it may be full length. A short tool would cramp the hand in using it. We may almost reverse the statement made in connection with tools used for setting-in, and say the handiest are the longest. Not that an inordinate length is desirable. There must be room for the right hand, which pushes, and the left hand, which guides, and more than enough for these if the tool is to have "play," and the carver is to see what he is doing. To produce a long, easy curve is almost out of the question with a short tool. The mode of sharpening tools used in this manner if employed entirely (as in the case of the voluter) or mostly for this purpose is a point of importance. Attention must be directed to the back of the tool, that is the round side, which, when it is used in the manner under notice, is generally downwards—that is, next the wood. There must be no "ridge" running from one side of the tool to the other within $\frac{1}{4}$ or $\frac{3}{8}$ in. of the edge, otherwise the surface, line, or hollow which is being worked will be one series of "dips" or hollows, which would have anything but a "beautifully undulating" effect. The sharpening on the back must be with a nicely graduated angle right up to the edge, that the tool may work in a smooth, easy, sweeping style. The necessary strength may be given to the edge by sharpening on the inside at a much shorter angle, that is by what is called "dubbing it up." These remarks apply in an especial manner to the "voluter." This tool must be brought to an edge very much from the inside, the edge being strengthened in the manner just described. If it is to work easily in a hollow, but a little larger than its own size, it must be sharpened on the back with a very long angle; the handle in this case will be inconveniently near the wood, but this inconvenience will be obviated by the use of voluters slightly—only slightly—bent. This tool is made too often, by the absurd manner in which it is sharpened, very much like a wedge. It "binds," and bruises the sides of the hollow in which it works. A third mode in which a scroll tool is often employed is, as in facing the round parts of leafwork. A short tool is perhaps the handiest for this purpose, but no rule can be laid down upon this point. When it is held in position by the left and struck by the right hand, shortness is an advantage, because of the left hand having to rest upon the work at the same time. But it is as often, perhaps, pushed as in moulding, when a longer tool is better. In sharpening, the same attention must be given to the inside as is required for the backs of those just mentioned. If there is any "ridge" near the edge on the inside, there is a constant tendency in the tool to "glance off" the work; and the tool has to be held in a position too nearly approaching the vertical before it can cut at all.

The modes of use just glanced at are the three principal. If the carver has tools well adapted for these, his tools may be described as "handy." The handiness of a tool, then, may be said briefly to consist in the readiness with which it lends itself to any particular purpose. A tool should be made subservient to the requirements of the workman. If a new tool is too long for the purpose for which it is chiefly required, there is no reason why it should not be shortened before being sharpened. It will be for the ingenuity of the workman to surmount the difficulty which arises from the circumstance that the same tool is often required for every purpose. Sometimes, however, it is worth while to have duplicates of certain tools, that they may be kept largely for one particular purpose. A workman's tools are worthy of his most careful study. Enough has been said to show that the manner in which a tool is sharpened has much to do with its utility, and that the subject of sharpening generally is deserving of special notice.

The first essentials for sharpening carving tools are grindstones and oilstones. These have already been described under Carpentry (see pp. 240-3), but more care is needed in choosing them for carving tools owing to the greater delicacy of the edges to be sharpened, so that the least flaw in a stone should suffice to condemn it. The mounted grindstone is used only to take off the thick edge of the tool, as, for instance, when the tool is new. It should be ground back to a breadth of $\frac{1}{2}$ to $\frac{3}{4}$ in., great care being taken to keep the tool cool by the use of abundant water in the trough, to avoid injuring its temper. The coarse edge is next drawn fine by applying oilstones of progressive degrees of fineness. These oilstones are obtained in slips, and their edges are gradually adapted to fit the inner sides of the curved or angular tools, while their sides become recessed and similarly adjusted to the outer side of the tools. The grinding away should be done from the inside, while the "setting" proper is done from the outside. In the rubbing out, it is well to fix the stone in a vice, with pads to protect it from the jaws, and use both hands in manipulating the tool. In sharpening the outside edge, the tool should be held in the left hand, and the stone worked upon it by the right hand. Certain slips should be reserved for certain kinds of tools, and care must be observed to commence with a coarser (generally a darker coloured) and proceed to a finer (whitish and semitransparent) grained stone. The final edge is given to the tool by stropping it on a broad strip of buff leather saturated with tallow and crocus powder rubbed in under the influence of a fire. A well-set tool should pare deal against the grain with a perfectly clean cut. The slips of oilstone will require grinding at the edges to fit the tools. The rubbing out is effected in the case of very small tools by the aid of emery powder and oil applied by a strip of wood. The oil used is generally ordinary machine oil, but petroleum is also in favour. The handles of all tools should be well adapted to the hand using them, and some system should be observed in the style (shape, colour, &c.) of handle, so that the tool may always be immediately recognized by the handle alone.

Operations.—When the carver has made a selection of a design and of a piece of wood to be carved, he proceeds to transfer the design to the wood. There are several ways of performing this. (1) Rub the surface of the wood with chalk, and then sketch the design on it. (2) Cut a piece of paper the right size, sketch the design on it, and paste it on the wood. (3) Sketch the design on paper, lay it on the wood with a sheet of carbon paper intervening, and pass a hard point over the lines, when they will be transferred to the wood. (4) In mouldings, a piece of cardboard may be cut to the design and a pencil drawn round the outline. The wood bearing the design is suitably fixed on the bench or table.

No two carvers work exactly in the same manner, but the object of all is to secure complete command over the action of the tools. In general terms, the tool should be firmly grasped by the left hand, so that the hand reaches to within about 1 in. of the cutting edge, while the right hand encompasses the top of the handle and applies the motive power. It is a great advantage to the operator to be able to reverse this order of things in left-handed work. In diaper carving, commence by cutting out the outline with the parting tool, held slanting in the right hand, with the left hand arched over the tool, and having the wrist and finger-tips resting on the work, as a check to the forward motion of the tool, and a guide in curves. The groundwork of the design is thrown up by punching. In commencing a panel in relief, the outline is gone over with a chisel or gouge held perpendicularly in the left hand, with the middle finger beside the blade, the right hand giving slight blows with the mallet. Small gouges are next used to scoop out the parts to be cut away, and chisels to reduce the ground to a uniform depth. To ensure clean cutting, the grain of the wood must be constantly watched and humoured by altering the direction of the tool. The work consists in the two operations of "blocking out" the design (cutting away the superfluous wood) and "finishing" the details, but every carver has his own way of dividing the work between

the two steps. A great choice of beautiful designs will be found in Bemrose's 'Manual of Wood Carving.'

Fretwork.—Fret or scroll sawing is a modern invention by which much handsome work is now done especially for ornamental cabinet-making. The subject may be divided into woods, tools, and operations.

Woods.—Wood for fret-sawing must be good, free from knots, and perfectly smooth. Soft woods can be hand-planed to a sufficient degree of smoothness; but hard woods require scraping down with a steel scraper, and then sandpapering. The chief woods used are:—

Bird's-eye maple is close-grained, gritty in sawing, and polishes well, but needs much filling.

Black walnut is cheap, goes well under the saw, and is very generally used. Pieces of uniform shade and free from streaks should be chosen, except where the streaks would show up well.

Ebony is well suited for inlaying, and takes a high polish: but it is costly, and the hardness and closeness of grain render sawing difficult without applying olive-oil to the blade.

Mahogany is adapted to almost all work, being easy to saw, yet hard, close-grained, and susceptible of taking a fine polish.

Rosewood is close-grained and as difficult to saw as ebony, but polishes well.

Red cedar, though not hard, is troublesome to saw and liable to split. It is pleasantly fragrant.

Spanish cedar is soft and easily worked. Small articles can be made out of old cigar-boxes, when the paper has been got off and the surface sandpapered.

Satinwood has an elegant colour and lustre, with considerable hardness and a close grain, and polishes well.

Tulipwood has a reddish streaked appearance, a finer and closer grain than satinwood, and is capable of being highly polished, but it is costly.

White holly is very popular in America, being very easy to saw, while possessing a fine close grain.

Tools.—These are very few in number. The first requisite is an ordinary table for supporting the work, which latter is held tight by clamps such as have already been described (p. 196), the jaw of the clamp being prevented from coming into contact with the fretwood by the intervention of a "rest," formed of a slot of deal about 20 in. long, 6 in. wide, 1 in. thick, and having a triangular piece cut out of one end, so as to form a couple of legs: the saw is worked in the crutch of the fork, and thus the "rest" helps to sustain the fretwood against the force of the sawing. For making a hole to admit the saw, recourse may be had to a bradawl (p. 246) or to a small archimedean drill (p. 248), the latter being preferable, and capable of doing much useful work by the aid of a set of drills.

Of saws there is an endless variety, reaching in price from 1s. 6d. to 5l. or 6l. The small hand-saws with a set of blades are best for beginners; the expensive machine-saws, such as the Fleetwood, Challenge or Rival can only be appreciated and used to advantage by skilled manipulators, in whose hands they do wonderful work. A very useful little machine with a dexter treadle, costing 25s. without or 40s. with a table, is shown in Fig. 722. These saws are made of iron and steel throughout, except the bows and treadle-rods. They are very carefully made and fitted, and neatly finished; will hold the finest to coarsest saws, and will cut 1½-in. wood, if desired, but they are recommended for light work principally. The distance from saw to the back of frame is 12½ in. The frame is a solid casting, provided with a clamp to secure it to a table or bench. The bows F, of hard ash, are fitted with iron plates on the back end. These plates have knife edges, carefully made, upon which the bows rock with little or no friction. The front ends of the bows are fitted with pivoted steel screw clamps, A, B, for

holding all sizes of saws. The plates on which these swing are adjustable, so that the pitch of the saw can be altered if desired, or corrected if it does not run straight. The straining rod D is provided with a cupped nut C containing a spiral spring. This and the stop in the back end of the frame hold the upper saw arm still, and the lower one in place, when from any cause the saw is disconnected. The machine is sold by Churchills, Finsbury, together with many other forms.

The edges left by the saw need filing down, for which purpose the operator will require a round file about 4 in. long, and half-round and flat files each 2 to 4 in. long. The filing is followed by the application of sandpaper. In this there is some art. The sandpaper should never be held in the fingers. If the work is very small, the sheet of sandpaper should be fastened down on a smooth surface and the work be rubbed on it with a circular motion. If larger, the sandpaper may be stretched round a smooth slab of wood 4 in. long, 3 in. wide, and $\frac{3}{8}$ in. thick, and secured by clamping a corresponding slab to the back of the first, making what may be called a "sand board." Or the paper may be glued to a smooth wooden cylinder and used in a lathe if at hand.

Operations.—In fretwork, the design is cut out by means of a saw, instead of by the edged tools used in carving. The mode of working has been made pretty evident in describing the tools. In sawing, care must be taken to give short gentle strokes adapted to the thinness and lightness of the wood dealt with.

One of the most general forms in which fretwork is applied is for forming an ornament called a "gallery," used for the tops of cabinets and other articles of furniture. These galleries vary in size according to the nature of the work for which they are intended. They are generally about $1\frac{1}{4}$ in. to 2 in. wide, and their length is $\frac{1}{4}$ in. to $\frac{3}{8}$ in. less than that of the top upon which they are placed. When getting out the wood, be particular to select as straight-grained a piece as possible; this is indispensable for all kinds of fretwork. Its thickness should be $\frac{3}{8}$ in. or $\frac{1}{2}$ in.; for miniature work, $\frac{1}{4}$ in. is sufficient. Before cutting out, consider the kind of gallery you are to have, and the manner in which it is to be finished at the ends, various modifications being adopted. In some, the ends are tenoned into a turned ornament, having a pin fitting into the top. In others, ends are also made at right angles to the back and tenoned into the ornaments. Where it is necessary to have ends, dispense with the turning, and secure them to the back by means of dovetails. It is necessary to have ends where the top is rather wide, and it is better, wherever possible, and where there is sufficient space, to admit one about 3 in. and upwards long. Having considered the kind of gallery, the length it is to be, and the manner of finishing the ends, plane it over, take to a width, and square it. You may with advantage get one piece out long enough to make both ends. You should now mark the gallery and ends. It will be necessary not to allow the

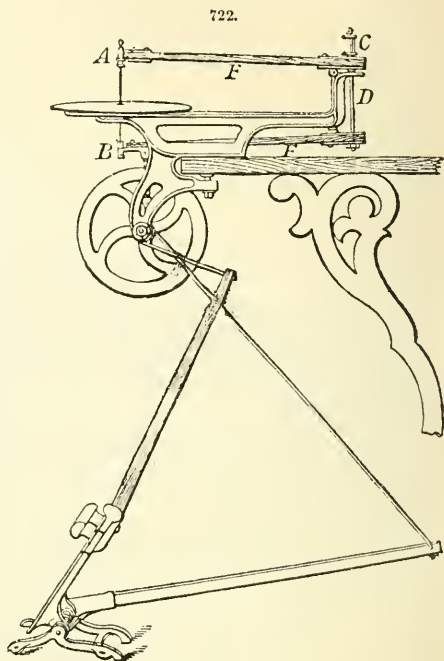

fret-cutting to come quite to the ends. Whether it is to be tenoned or devetailed, you will require sufficient for working; $\frac{1}{2}$ in. or $\frac{5}{8}$ in. should be marked and left plain for this purpose. The bottom must, of course, always be so, because of fitting, and the top is better straight or plain, whether the design is geometrical or otherwise, as a straight or plain top bar protects to a great extent the other fretwork, rendering it less liable to accident, especially if a scrollwork pattern. The bars should be about $\frac{3}{16}$ in. wide, and care should be taken that the cutting is of such a nature as to allow sufficient support to the various parts of the figure, preserving a light appearance with the requisite strength. Galleries are fixed on by means of dowels. When turned ornaments are employed, the pins are usually sufficient, with one dowel or so, to secure it. In other cases, small dowels are placed at a distance of $3\frac{1}{2}$ in. or 4 in. apart in the back, and a little closer in the ends; one or two dowels in the ends acting as a great support to the back. When marking their position, be careful to select the strongest part of the fretwork, that is, the portion connected with the bottom rail, and where you can bore deepest for the dowels. In boring, do it slowly and in the centre; glue and knock in the dowels gently. It is best to cut them in lengths first, and in pressing them into the holes made to receive them in the top, keep the gallery as upright as possible, and allow all the dowels in back and ends to enter together. Do not get one end in first, or the back ones in and not the ends, or you will be likely to break some of them.

It is sometimes required to place a gallery upon a shaped surface, with which it is necessary for it to correspond. It is then got out of thinner material, about half the thickness of that previously given, to enable it to be bent the requisite shape. The method differs from the preceding one, dowels being insufficient to hold it when bent. After the position it is to be in is determined, the thickness of the fretwork is marked bare, and a groove to receive it is cut upon the work. This should be about $\frac{1}{4}$ in. deep and of a uniform depth throughout. The work is carefully bent to this and inserted, afterwards removed and glued. When getting out work of this description, be careful to allow additional width for the bottom bar or rail, so that it will show equal with the top after insertion; that is, add the depth the groove is to be to the width of the bars.

Another application of fretwork is for "stretchers," used principally for the various kinds of tables, and sometimes for other things, both for structural and ornamental purposes. Figs. 723, 724, 725, and 726 are drawings representing forms of stretchers.

723.

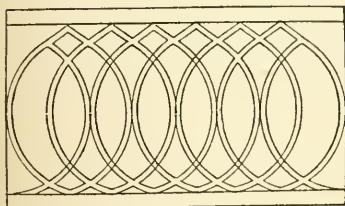

724.

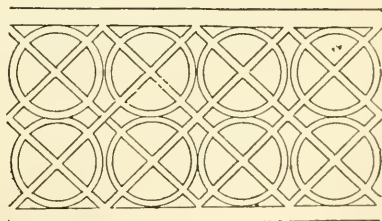

In Figs. 723 and 724 the geometrical designs are intended to be used as shown. This is a form adopted for tables in place of the turned one connecting the front and back legs with a cross one at right angles between. The rails are used diagonally, being tenoned into the alternate legs, and passing through an ornament in the centre. You must allow for the diameter of this when setting out, also a space each side equivalent to that against the legs where tenoned. You will be able to put one rail in in one length, but the other will require to be in two halves, on account of the mortices intersecting in the centre of the

ornament. The width of these rails will vary from about $1\frac{1}{4}$ in. to $2\frac{1}{2}$ in., according to the size of the work; in some of the largest octagon tables this is sometimes exceeded. The material is usually 1 in. thick; in small work $\frac{3}{4}$ in. is sufficient. The top edges may be moulded. In stretchers of this description the top and bottom bars of the rails

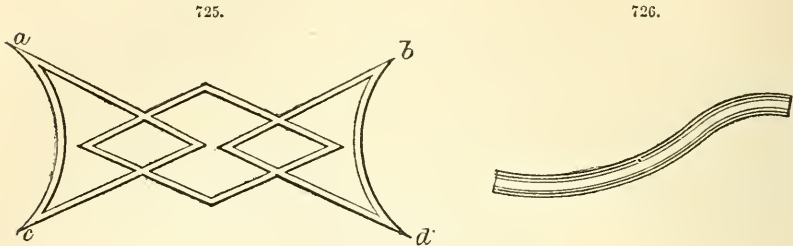

should be always left strong. Fig. 725 is a very good form if used flatways, intended for a large table, being tenoned into legs at *a b* and *c d*. The whole of the wood for this is not, as might be imagined, got out in one, for the obvious reason that the end pieces connecting *a c* and *b d* would be crossways of the grain of the wood and consequently of little use. The stretcher is fret-cut first, the ends being cut separately and afterwards connected. Fig. 726 is a portion of a stretcher where the end is tenoned into a leg and the other into a centre placed rather higher, the edges being either plain-shaped or moulded. It is sometimes required to have the centre of a stretcher cut with a more elaborate design than the remainder. The thickness of wood required for the general part of the stretcher would not admit, or at least not readily, this kind of work to be executed. The centre may then be got out of thinner material, $\frac{1}{4}$ in. or $\frac{3}{8}$ in., and fitted accurately as a panel to the framing of the stretcher. By adopting this plan, the finest description of work may be employed without affecting the requisite strength.

Outline Cutting.—This variety of work, as its name implies, is used for all purposes where outline shaping alone is required, either applied separately or to work that is to be afterwards carved. The importance of getting all carved work previously shaped by fret-cutting, so far as is possible with the nature of the design, is much greater in some cases than in others; but in all it is sufficient to demand careful consideration. It is advisable to first make a pattern the requisite shape, and to mark out from it. It should not be very thick; about $\frac{1}{8}$ in. or $\frac{1}{6}$ full will answer best. By placing this upon your wood you will be able to mark out in the best manner. If your work is straight or nearly so, there is not much difficulty; but if it curves considerably, as in some kinds of legs, cabriole, for instance, endeavour to arrange the markings so that they will to a great extent cut out of each other, getting the hollow portion of one against the rounded of another, and *vice versa*.

Brackets.—Among the varieties of brackets most used may be mentioned the following. First, those which are fitted upon a flat surface or pilaster, the front and sides being carved, like those used for bookcases and wardrobe doors. The wood for these should be got out, and the back planed, fitted, and toothed. One end should also be squared, the one that is to be the top in the upper brackets and the bottom in the lower. After carving they are fixed by simply glueing or by dowelling. Second, brackets having two of their sides straight and at right angles to each other. These have a very extensive application, and numerous forms are employed. Sometimes they are merely cut in outline, the front being moulded; the whole design fret-cut is preferable. These brackets vary in thickness from $\frac{3}{8}$ in. to 2 in., and occasionally upwards; they are used for most articles of furniture, the heavier kinds being sometimes employed

partly as a means of support for shelves, &c., and the lighter more usually for ornamental purposes. When cutting out brackets like these, it is most convenient to mark the wood so that each piece will make 2, leaving the further cutting to the fret-cutter. The advantages of this are obvious. It is necessary to plane over, and thickness, and to square the edges and ends first; this can be more easily done with a square or rectangular piece of wood than with one approximating to the shape of the brackets. When marking, you can see the size necessary to get out the shape by drawing a line from the extremities of the brackets. Let these lines be the diagonal of the rectangle, and mark your work, so that there is sufficient space to get out the outline inside it when setting the edges square with the outside. It is sometimes advisable to make a slight difference from the diagonal mark when the spaces between the top, bottom, and centre of the outline are considerable. Brackets are fixed either by dowels or screws, generally by a combination of both methods. For most purposes dowels of $\frac{1}{4}$ in. diameter are sufficient; for the lighter kinds less will do. Consider the most suitable position for them, where the work will afford the best hold, and where they will prevent it from twisting or moving. It is rarely possible to use screws from the front or face, without the work is applied in such a manner that some part is not easily discernible. They may, however, be sometimes used from the back or inside.

Many excellent designs for fretwork will be found in Bemrose's 'Fret-cutting and Perforated Carving.'

UPHOLSTERY.—This term is applied to the art of stuffing and covering seats, and the arrangement of curtains and bed hangings. The subject may be divided into sections on the tools, materials, and processes.

727.

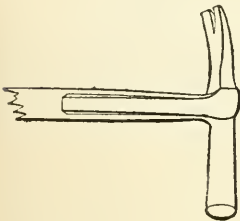

728.

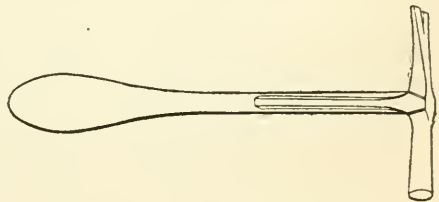

Tools.—These are few in number and inexpensive to buy. The hammers used by upholsterers are peculiar. Fig. 727 shows the ordinary form, while Fig. 728 represents that known as Benwell's. Figs. 729-730 illustrate a couple of very useful light hammers of

729.

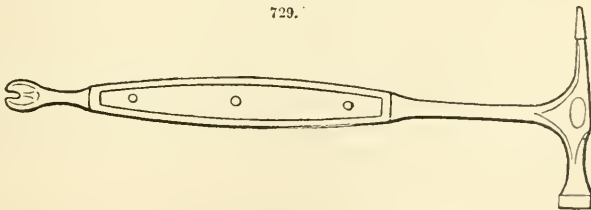

American design. The pincers employed for straining canvas are shown in Fig. 731. In addition will be required rule and tape measures, heavy and light scissors, screws and screwdriver, round needles of assorted sizes, double-pointed needles (6, 8, 10, 12, and 14 in. long), ripping chisel, bradawl, and mallet.

Materials.—These embrace stuffing or filling, coverings for springs and exteriors, springs (5, 6, 7, 8, and 10-in.) tacks, and twine.

Among stuffing materials, horsehair continues to hold the first place, ranging in price from 7*d.* to 2*s.* a lb., 18*d.* being a good average quality. It is bought in the “rope,” and

730.

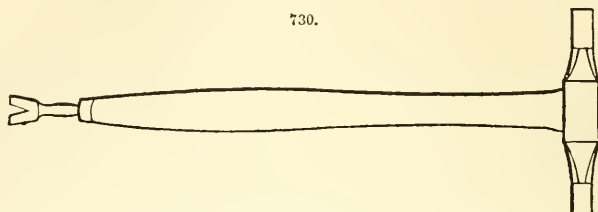

teazed out, preferably by hand, as the machines invented for the purpose are said to injure the quality and reduce the length of the staple. The poorest grades are suitable for rolls and very inferior work; that costing about 10*d.* a lb. is adapted for the last stuffing of ordinary hair-covered furniture; while only the best kind should be put into mattresses.

731.

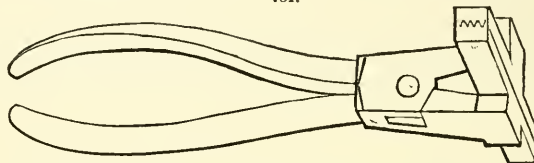

Horsehair when used alone has a tendency to manifest a crispness or harshness to the touch, and for this reason it is usual to overlay it with a little wadding, placed soft side downwards, which also prevents the ends of the hairs protruding in time through the covering of the furniture. This wadding costs about 1*s.* 6*d.* a dozen.

Feathers are popular for filling beds, being warmer and lighter. Prices range from 6*d.* to 2*s.* 6*d.* a lb., but the lowest prices are not by any means always the cheapest, as the better qualities are more elastic and consequently may be used in smaller quantities with equally good or better results. Flocks, costing 3*d.* to 10*d.* a lb., are used as cheaper substitutes for feathers in second-rate mattresses, beds, and pillows. Various vegetable fibres are used for first stuffing in furniture, among the most generally used being alfa, Spanish moss, Algerian fibre, Mexican fibre, and coconut fibre.

Leather coverings are of 2 kinds, morocco (goat skin) and roan (sheep skin). The former runs in sizes of 25 to 35 in. wide, and is far the better in point of wear and keeping its colour. Roans run larger (30 to 38 in. wide), but only cost about half as much as moroccos. Being softer they are easier to work, but are apt to be torn by buttons when these are used, and generally speaking they are only fit for the outside backs of chairs and such positions, where they do not actually get any wear and tear. Among the various other materials employed as coverings, the principal are: American leather cloth, made about 45 in. wide; Utrecht velvet, 24 in.; damasks, reps, and tapestries, 50 in.; cretonne, 30 to 36 in.; silk plush, 24 in.

Some of the most useful twines for upholstering are made by the West of England Twine Works. For tying down springs, sewing, buttoning, and stitching, select No. 28 3-cord mattress twine; and for lashing down springs, No. 360 laid cord.

Leather Work. *Small Chair; buttoned and welted.*—The construction of the frame of a chair has already been described (Figs. 689-95, pp. 363-9). The first step is to tightly strain 3 lengths of webbing (No. 10 or 12) across the seat from front to back, and

3 from side to side, securing it to the bottom of the frame with $\frac{5}{8}$ -in. tacks. Next distribute the 5 springs (6 in.) diagonally and equidistantly over the seat, and fasten to the webbing with medium twine. Knot some lashing cord to the top ring of each spring, and tie them all down to about $4\frac{1}{2}$ in. high, taking care that they are quite upright in their places. Fasten a breadth of canvas taut across the springs with $\frac{5}{8}$ -in. tacks, and, with a bent needle, sew the canvas to the top rings of the springs (still keeping them upright) with 5 equally divided stitches, knotting each separately.

Before the first stuffing is commenced, a string is run round the edge of the seat, and a moderately full body of hair is picked or strung on, avoiding too much in the middle; scrim (very coarse muslin) is next laid over the hair. Keeping the bridle square with the chair, temporarily tacked into place, and fastened to the canvas on the springs by a double-pointed needle, making 3 rows of stitches 3 in. long and 4 in. from the outside edge. Next, this outer edge has to be firmly filled in, so that after the scrim has been secured with $\frac{1}{2}$ -in. tacks all round, and stitched all over, the stuffing should rise about 3 in. above the frame, presenting the correct outline of the seat, and slightly overhanging.

To begin the second stuffing, mark a line down the centre of the seat from front to back, and mark the places for 10 buttons, putting alternately 3 and 2 in a row, commencing with 3 in the front, and allowing none to be less than 3 in. from the edges of the seat. At each button, a small hole is made with scissors through the scrim, to fix the spot. The skin for covering the seat is next placed with the neck to the back, and marked as shown in Fig. 732, *a* being the central line, *b* the plaits, and *c* the spots for the buttons, which may be $1\frac{1}{4}$ to $2\frac{1}{2}$ in. apart, according to the degree of fulness desired. The skin being filled, the hair for the second stuffing is picked on with care, so that the leather may be filled out firmly and free from creases; then the wadding and the skin are put in place, and the buttons are inserted with a slip knot of button twine and pulled half-way down, taking care to slope the hair away from under the buttons; the knots are then tied, the ends are cut off, and the plaits are worked out smooth. Work the fulness of the stuffing into the outside plaits that are square with the seat, and pin the skin to the edge of the first stuffing.

In cutting off the skin to the exact form, which is the next step, about $\frac{3}{8}$ in. must be allowed for turning in. It is well to secure the outside edges of the plaits by an occasional stitch. The margin cut off all round the skin will be available for the border and welt, for the latter of which lashing twine is used. The 2 joints necessary in the border should

come about $\frac{1}{2}$ in. from the front corners on the sides, the jointing being effected in the following manner. With a very sharp knife, the border is cut quite straight, and the ends to be joined are chamfered off so as to overlap each other about $\frac{1}{2}$ in.; the joints are made fast either by curriers' paste or by nearly cold glue: both will make ineradicable stains if they penetrate the leather, as they will do if hot. When the joints have dried tight, the border is strained into place and temporarily pinned on, 2 or 3 corresponding little notches being snipped on the border and seat in front and at both sides, as a guide in the sewing. The strip for the welt is cut and joined in the same way. After both border and welt have been dried and sewn, they are turned up and stitched to the edge of the leather seat. A little piece of buckram tacked on each front corner assists in preserving a proper outline. When some wadding has been stuffed under the border, it is fastened with $\frac{3}{8}$ -in. tacks, without creases. If studs are added with banding,

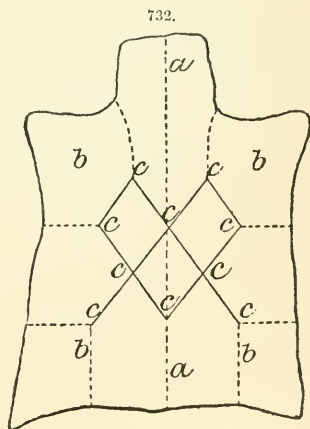

they should be about $1\frac{1}{2}$ in. apart; if close studding is adopted, no band is needed. It is only when springs are employed that canvas is used on the bottoms; and the average quantity of hair used is $2\frac{1}{2}$ lb., whether it is a spring seat or not.

Plain Seats.—In the case of chairs covered with morocco, roan, or American leather cloth, with plain seats and welted borders, the springs are usually left a little higher than in the previous case, otherwise they do not differ in the first stuffing. The skin is best cut on the first stuffing; lay it clean out without straining, pin round, allow for turning, and cut to shape; but some prefer to finish the seat in calico and cut the skin on that. The border and welt are cut and joined as before; after straining on, notching, and sewing, the welt is hammered flat, and the strain on the border prevents wrinkles. When the skin is thus prepared, the second stuffing commences by picking on the hair; then it is finished in calico, and temporary ties are stitched up through webs, springs, and seat, pulling all down flat, and knotted beneath. Now the skin can easily be drawn on, the welt is stitched to the edge of the first stuffing, and the border tacked down in place; on the temporary ties being cut and pulled out, the seat rises up tight. If the welting is omitted, as usual in all but first-class articles, the skin is tacked down to the seat-rail moulding, and the same process followed out. Plaits can be eased out by temporary tacking and shifiting, except on round articles, when care must be taken to have them vertical.

Easy Chairs.—Everything depends on adapting the height of the springs and adjustment of the stuffing to the particular character of the chair. A good rule is to keep the stuffing well to the front of the seat, in order to give it a decided throw back. The swell in the back must be regulated so as to catch the small of the back of the sitter, and not to throw the shoulders or the bottom of the spine too much forward. It is well to avoid making the stuffing very full, consequently $1\frac{1}{2}$ or $1\frac{3}{4}$ in. will suffice for each diamond, that is to say, if the diamonds on the scrim are 7 in. by 5 in., the skin may be marked $8\frac{3}{4}$ in. by $7\frac{3}{4}$ in. Easy chairs are much best without buttons, especially in leather.

Settees and Couches.—Here a new difficulty arises, in that the size of the articles necessitates 3 or more skins being joined together. If the seat is plain, the skins may be cut quite square across it, joined with a small welt, pinned over on the first stuffing, and cut to shape; the border is well strained round to avoid fulness, and joined up to the seat as in the first example, the scroll and pad at the back being dealt with in a similar manner.

If the seat is to be buttoned, the skins may not be large enough to tack down. Then the places for the tufts are marked on the first stuffing, allowing the first row to be $3\frac{1}{2}$ in. from the front edge of the seat, and the diamonds 7 in. crosswise by $5\frac{1}{2}$ in. lengthwise; small holes are cut in the scrim where the tufts come. In marking out the skins, the fulness allowed is 2 in. across the seat by $1\frac{3}{4}$ in. along it for each diamond, making 9 in. by $7\frac{1}{4}$ in. on the skin, the seat having a full sweep across it, but being straight in the length. It is convenient to mark out on a sheet of paper as many full-sized diamonds as a skin will cut, adjusting this in the most economical manner on the skin, and marking it through. Each skin added to form the length must be joined exactly at the diamond edges, as shown in Fig. 733.

The neck of each skin is placed at the back of the seat, and if the skin should not be long enough, the necessary piecing is done at the back edge. The button marks must meet accurately and be sewn through. The bordering and welting do not differ from the first example.

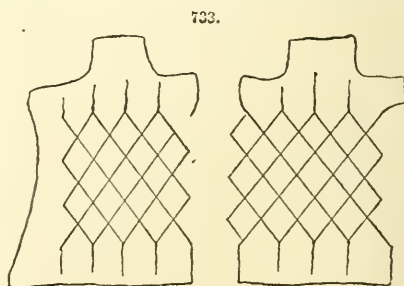

For a buttoned scroll about $1\frac{1}{2}$ skins will generally be required; and in marking the diamonds on the scrim they should begin at about 8 in. from the seat, and be 7 in. crosswise and 5 in. lengthwise, allowing $1\frac{1}{2}$ in. on each diamond for crosswise fulness, and increasing 1 in. for every line in lengthwise fulness (e. g. $1\frac{1}{2}$ in. on the first, $2\frac{1}{2}$ in. on the second, and so on), in the case of ordinary scrolls, though of course some variation will arise according to the shortness or fulness of the curve, necessitating the greatest judgment if a perfect shaped scroll is to be the result. The correct fulness allowance on each diamond in stuffing the back is about $1\frac{1}{2}$ in., and to reduce the liability to wrinkle across the diamonds the lowest row of buttons on the back may be a little above that on the scroll. For arm pads, if present, 10 in. leather will be wide enough, and small pieces may be used up by joining in the plaits; the buttons are placed about 5 in. apart, and secured by twine passed through the middle of the pad and tacked on each side.

Hair Cloth.—Woven horsehair cloth is procurable in several widths, the price increasing out of proportion to the extra number of inches; hence, cloth work is usually welted, to permit the use of narrower widths. It cannot be plaited, and is adapted only for plain seats. The article is finished in holland or canvas of black colour—light tints would show through—the seating and borders are cut to size and shape, and the border is strained round loosely, and welted. On backs and scrolls, the cloth need not be laid tightly, as the buttons will pull it into shape. Any wrinkles and creases which may appear in the cloth when placed and tacked on can be removed by moistening with water, all disappearing on drying.

Fancy Coverings.—Covering in soft fancy materials presents far fewer difficulties than when working with leather or hair-cloth. The stuffing should be kept softer and the springs may be more pliable. When joints in the covering are needed at all they may best run lengthwise, as in a wide couch for instance. The following materials would be required for an ordinary drawing-room suite, according to the style:—

	Plain Seats.	Buttoned.
Gimp	36 yd.	36 yd.
Cord	22 „	22 „
Buttons	$\frac{1}{2}$ gross	2 gross
Tapestry or rep	8-9 yd.	10-12 yd.
Cretonne	14-16 „	18-20 „
Plush or velvet	18-20 „	24-26 „

Plain Seats.—For cheap work, plain seats are first stuffed in calico; but if the covering is to be velvet or plush, the work is finished in calico before covering. Buttoned backs and scrolls may be tacked down for inferior work, or bordered and corded on the edges for better class goods.

Buttoned Seats.—In marking out the scrim for the buttons, the following allowances for fulness have to be made:—Small chairs, $1\frac{1}{2}$ in. each way; easy-chair seats, 2 in. each way; easy-chair backs, $1\frac{1}{2}$ in. each way; couch seats, $2\frac{1}{4}$ in. across and 2 in. along; couch back, $1\frac{1}{2}$ in. each way; couch scroll, $1\frac{3}{4}$ in. across, and 1 in. progressively on each diamond from the bottom row, which is often low down to the seat. For bordered work, the cover should be turned under and sewn to the edge of the scrim on the top, when it cannot move during wear; while if first stitched in under the roll, it works loose and baggy in wear.

Spring Edges.—If a spring edge is to be made, the middle springs should be soft and 8 or 9 in., and be lashed in place farther from the rails, with canvas laid over and tacked to the top of the rails on the extreme inside edge. Soft 6-in. springs are used at the edge, fastened securely in a vertical position on the rails, all to one height, the cord holding them being best knotted to the top ring of each spring, and fixed down on each side by $\frac{5}{8}$ -in. tacks. The shape of the edge is formed by bending spring

wire to the exact shape of the rail, and securing it with string tightly to the top ring of the spring edge; the canvas covering is sewn to the spring edge and to the canvas already on about 3 in. from the top level, aiming to allow the two sets of springs to work independently of each other. The first stuffing should be soft and free, with a bold overhanging stitched edge, finished on the wire edge; a strip of canvas sewn to the wire edge which is tacked to the seat rail permits the height of border to be regulated by pulling to shape; the second stuffing may be finished with a bold cord just under the roll, with a frill or one row of buttons on the border.

French Easy Chairs.—For these, the scrim is tacked down to the bottom of the frame in front, and finished with a round edge in calico slightly hanging over, but no stitched-up edge to the seat. The seat is filled with very soft 8-in. springs, and the plain part is upholstered in tapestry in the usual way, and stitched to a line previously marked on the calico. Half diamonds for the tufted front are marked on the calico, allowing the buttons about 3 in. apart, and holes are snipped for button marks. The plush is marked with a fulness allowance of $1\frac{1}{2}$ in. good. Hair of superior quality is filled in on the top of the calico, tufted round, kept in place by sewing to the tapestry, and finished with cord or gimp to cover the stitches. Festoons of plush cover the tacks on the rail, and are finished with a fringe 1 or $1\frac{1}{2}$ in. deep. The inside of the back and sides is webbed, canvassed, and finished in tapestry without any stitching. The pad which runs round the back and arms is finished in scrim cut on the skew, which renders it softer and makes it hold better. The hair is tacked rather firm on the pads and stitched only on the front scrolls. The pad is marked for buttons about 4 in. apart, and holes are snipped to let them sink a little. The wadding is laid on and covered with plush, finishing with good-sized cord. To form plaits and fulness near the bottom, the festoons are cut wider at the bottom than at the top; they are made and tacked on separately, a bold cord covering the tacks as on the inside of the back. When a bolster is added on the top of the back, it is formed in the stuffing as follows. A good body of superior hair is picked or strung on the top rail, and made firm but not tight; the scrim is cut 20 in. wide on the skew, tacked down, and stitched up to a fine edge.

Needlework Chairs.—The best shape for displaying needlework is the Spanish. For a needlework central strip, with plush sides and border, the first step is to stuff without springs, keeping it quite flat across to counteract the tendency to wrinkle. A little hair or wadding is picked or strung on, and the needlework, pinned to a correct line, is sewn in place with a 6-in. needle through canvas and webs, allowing the needle to slope outwards from the work to produce a more rigid stay. The side margins are buttoned, allowing $1\frac{1}{2}$ in. for fulness where there is little curve, increasing $\frac{1}{4}$ to $\frac{1}{2}$ in. on the top and bottom rounds, and decreasing in the hollow. Suitable cord is used to hide the point and finish the borders. When the needlework is puckered, it may be rendered quite square and straight by straining it face downwards very tight and true on the board, with a clean cloth under it, and damping and pressing it till dry.

Mattresses.—*Spring.*—The construction of the box-frame spring mattress requires sides about 6 in. high with 8 laths across the bottom, and 5 10-in. springs for each lath in a mattress $4\frac{1}{2}$ ft. wide, the latter being secured to the laths by small staples, tied down in a somewhat rounding form, and finally lashed each way. The springs are covered with strong canvas firmly sewn on as in the case of a single chair (p. 401); and a well-stitched roll 3 or 4 in. high is fixed round the box. On to the canvas is picked the hair or wool stuffing (20 lb. of the former or 25 lb. of the latter), and this is covered by ticking, laid with the stripe running lengthways, and lightly tacked; next the tick is tufted, and the whole is turned upside down, the tick being tacked on to the bottom edge of the box. Double webbing is nailed on the under side about 12 in. from the corners, for handles, and the under side is finally covered with canvas. When the mattress is made in two halves, the sides of each spring box will

only be half the length of the bed; the two middle rows of springs should almost meet, and a strip of cane lashed across the ends of the half boxes where they join preserves the squareness of the boxes and constitutes a base to work upon, but it must be stitched up all round, keeping the middle soft.

Tufted Top.—An extra allowance of $\frac{3}{4}$ in. to the ft. each way, must be made for fulness in cutting the tick top, if the mattress is to have a tufted top and welted or bound border. The diamonds may be 12 to 14 in. long and the tufts 6 in. from the edges, the border being cut to exact size and somewhat tight all round, a small plait opposite each outside tuft allowing the top to come into the border.

Folding.—For a folding spring mattress, the two half boxes, about 5 in. high, are placed together, and the springs are lashed each way; the canvas and tick are each put on in a single piece, cutting the former a little at each side where the fold comes, and allowing a fulness of $\frac{3}{4}$ in. per ft. in the latter. The top is let into a tight border $4\frac{1}{2}$ in. wide, and a second border is sewn on to give enough material to tack under the bottom of the spring box. After running a twine round on the edge of the case, a good body of hair is picked on very firm, the tick is put over and temporarily tacked, the mattress is tufted, and the border is stitched round. Next the two halves are folded together, and the open ends are covered with canvas or tick, sewn to the cut borders; then 2 pieces of web are covered with similar tick, a piece of cane or wire about 3 in. long being stitched crossways to the end of one, with a button capable of taking it in the other, and these are nailed one to each half of the frame bottom.

Stuffed.—For mattresses stuffed with hair or wool, the ticks are cut with a fulness of $\frac{3}{4}$ in. per ft. larger than the bedstead; no allowance for binding is made in the borders, which are cut $4\frac{1}{2}$ in. deep. The amount of stuffing required is computed at the rate of 9 or 10 lb. per ft. in width, assuming the hair or wool to be of fairly good quality; the tufting is done with a diamond of 10 to 12 in., some 6 in. from the edge.

French pallets.—In these, made of half wool and half hair, only 6 lb. of stuffing is reckoned per ft.; the ticks have an allowance of $1\frac{1}{2}$ in. per ft. each way for fulness, and are cut without a border, only one side being sewn together. In distributing the hair and wool, the former should occupy the centre, forming a layer which is covered on both top and bottom sides with the wool, equally divided. If it is spread on one half of the tick, the other half can be folded over it and stitched round. Tufting completes the operations.

Beds and Pillows.—The tick for a feather bed should be cut to the size of the bedstead, with a 5-in. border and a welt, the pattern running lengthways on the bed, and crossways on the border and welting. The stuffing allowance of medium quality feathers is 8 lb. per ft. in width, decreasing with a superior kind. For flock, the figure is about the same, but the tick is cut without a border.

Bolster ticks are cut 20 in. wide and of a length to suit the width of the bed; the ends are gathered and welted on the cross either to an oval piece 12 in. by 8 in., or to a square piece 14 in. by 6 in. rounded on the ends. This is for feathers, of which 8 to 10 lb. will be required. In the case of flock stuffing, they are finished square, and require about the same weight. **Pillow ticks** are cut 20 in. wide and sewn to finish square, requiring 4 to 5 lb. of feathers or flock.

PAINTING, GRAINING, AND MARBLING.—The primary object of painting is to aid the preservation of the material so treated; its secondary object is the ornamentation of the surface. Graining answers only a decorative purpose.

Painting.—Paints employed with a view of aiding preservation are of the kind known as “oil paints.” These consist of basic pigments to give “body” or covering power, colouring pigments to modify the hue, vehicles or mediums for rendering the mass soft and coherent, sometimes solvents for increasing the liquidity, and driers for hastening the removal of the moisture incident to the vehicle when the paint has been applied.

Basic Pigments.—The most important are white-lead, red-lead, zinc-white, and iron oxide.

White-lead is a form of lead carbonate. The best kind is produced by the Dutch process, which consists in placing gratings of pure lead in tan, and exposing them to the fumes of acetic acid; by these they are corroded, and covered with a crust of carbonate, which is removed and ground to a fine powder. There are other processes for manufacturing white-lead, in which it is precipitated by passing carbonic acid through solutions of different salts of lead. "Clichy white" is produced in this way by the action of carbonic acid gas upon lead acetate. The white-lead produced by precipitation is generally considered inferior to that prepared by corrosion. It is wanting in density or body, and absorbs more oil, but does not require grinding. Pure white-lead is a heavy powder, white when first made; if exposed to the air it soon becomes grey by the action of sulphuretted hydrogen. It is insoluble in water, effervesces with dilute hydrochloric acid, dissolving when heated, and is easily soluble in dilute nitric acid. Heated on a slip of glass it becomes yellow. It may be used as the basis of paints of all colours. It is often sold mixed with various substances—such as baryta sulphate, lead sulphate, lime sulphate, whiting, chalk, zinc-white. These do not combine with oil so well as white-lead, nor do they so well protect any surface to which they are applied. Baryta sulphate, the most common adulterant, is a dense, heavy, white substance, very like white-lead in appearance. It absorbs very little oil, and may frequently be detected by the gritty feeling it produces when the paint is rubbed between the finger and thumb. White-lead is sold either dry in powder or lump, or ground in oil in a paste containing 7-9 per cent. of linseed oil, and more or less adulterated. When baryta sulphate has been added, its presence is in most cases avowed; the mixture is called by a particular name, which indicates to the initiated the proportion of sulphate of baryta that it contains. "Newcastle White," "Nottingham White," "Kremnitz" or "Krems White" (known also as "Vienna White," imported from Austria in small tubes), "French" or "Silver White" (in drops, from Paris), and "Flake White" (made in England in small scales), should all be pure white-lead, but they differ considerably in density. "Venice White" contains 1 part white-lead to 1 part baryta sulphate; "Hamburg White" contains 1 part to 2; "Dutch" or "Holland White" contains 1 part to 3. When the baryta sulphate is very white, like that of the Tyrol, these mixtures are considered preferable for certain kinds of painting, as the barytes communicates opacity to the colour, and protects the lead from being speedily darkened by sulphurous smoke or vapours. White-lead improves by keeping. It should not be exposed to the air, or it will turn grey. Old white-lead of good quality goes farther and lasts better than if it is used when fresh; moreover, the paint made with fresh lead has a tendency to become yellow, and the fresh white-lead itself often has a yellowish tinge, from the presence of iron. Of all the bases for paints, white-lead is the most commonly used; for wood surfaces it affords in most cases the best protection, being dense, of good body, and permanent. It has the disadvantage, however, of blackening when exposed to sulphur acids, and of being injurious to those who handle it. Testing its quality is a very simple operation. In the case of dry white-lead, digest it with nitric acid, in which it dissolves readily on boiling. When ground with oil, the oil should be burnt off, and the residue treated with nitric acid; or the whole may be boiled for some little time with strong nitric acid, which destroys the oil and dissolves the lead on the addition of water. Baryta sulphate being insoluble in the acid remains behind, and can be collected on a filter, washed with hot distilled water, and weighed.

Red-lead or minium is produced by raising "massicot" (lead oxide) to a high temperature, short of fusion, during which it absorbs oxygen from the air, and is further oxidized. It is usually in the form of a bright red powder. The colour is lasting, and unaffected by light when the article is pure and used alone; but any preparation containing lead, or acids mixed with it, deprive it of colour, and impure air makes it black.

Red-lead is used as a drier; also for painting iron; and in the priming coat for painting wood. It is sometimes adulterated with brick-dust, which may be detected by heating in a crucible, and treating with dilute nitric acid; the lead will be dissolved, but the brick-dust will remain. It may also be adulterated with "colcothar." As a substitute for it, antimony sulphide ("antimony vermilion") has been proposed. It is sold in a very fine powder, without taste or smell. It is insoluble in water, alcohol, or essential oils, is but little acted upon by acids, and is stated to be unaffected by air or light. It is adapted for mixing with white-lead, and affords an intensely bright colour when ground in oil.

Zinc oxide, the basis of ordinary zinc paint, is prepared by distilling metallic zinc in retorts, under a current of air; the metal is volatilized, and white oxide is condensed. This is filled into canvas bags, and pressed to increase its density. It is durable in water and oil, dissolves in hydrochloric acid, does not blacken in the presence of sulphuretted hydrogen, and it is not injurious to the men who make it, or to the painters who use it. On the other hand, it does not combine so well with oil, is wanting in body and covering power, and is difficult to work. The want of density is a great drawback to its use, and the purest quality is not always the best for paint on account of its low specific gravity; in this respect the American zinc whites, which are frequently very pure, do not generally compete with the zinc-white supplied by the *Vieille Montagne Company*, in Belgium. Zinc oxy-sulphide is used as the basis of Griffith's patent white paint, stated by Dr. Phipson to be prepared by precipitating zinc chloride or sulphide by means of a soluble sulphide—of sodium, barium, or calcium. The precipitate is dried, and levigated, while hot, in cold water.

Iron oxide is produced from a brown hæmatite ore found at Torbay in Devonshire, and forms the basis of a large class of paints of some importance. The ore is roasted, separated from impurities, and ground. Tints, varying from yellowish brown to black, may be obtained by altering the temperature and other conditions under which it is roasted.

Colouring Pigments.—Many of these, such as the ochres and umbers, are from natural earths; others are artificially made. They may generally be purchased either as dry powder or ground in oil.

Blacks:—"Lampblack" is the soot produced by burning oil, rosin, small coal, resinous woods, coal-tar, or tallow; is in the state of very fine powder, works smoothly, is of a dense black colour, and durable; but dries badly in oil. "Vegetable black" is a better kind of lampblack made from oil; is very light, free from grit, and of a good colour; should be used with boiled oil, driers, and a little varnish; linseed oil or turps keeps it from drying. "Ivory Black" is obtained by calcining waste ivory in close vessels, and then grinding; is intensely black when properly burnt. "Bone Black" is inferior to ivory black, and prepared in a similar manner from bones. "Blue Black" and "Frankfort Black" of the best quality are made from vine twigs; inferior qualities from other woods, charred and reduced to powder. "Grant's Black," or "Bideford Black," is a mineral substance found near Bideford; it contains a large proportion of silicious matter, is denser than lampblack, but has not so much colouring power.

Blues:—"Prussian Blue" is made by mixing potash prussiate with a salt of iron. The potash prussiate is obtained by calcining and digesting old leather, blood, hoofs, or other animal matter with potash carbonate and iron filings. This pigment is much used, especially for dark blues, making purples and intensifying black; dries well with oil; slight differences in the manufacture cause considerable variation in tint and colour, which leads to the material being known by different names—such as "Antwerp" "Berlin," "Haerlem," "Chinese" Blue. Indigo is produced by steeping certain plants, from Asia and America, in water, and allowing them to ferment; is a transparent colour, works well in oil or water; but is not durable, especially when mixed with white-lead. French and German ultramarines are made of good colour, and cheap, by fusing

washing, and reheating a mixture of soda, silica, alum, and sulphur; used chiefly for colouring wall papers. Cobalt blue is an oxide of cobalt made by roasting cobalt ore; a beautiful pigment, and works well in water. "Smalt," "Saxon blue," and "Royal blue" are coloured by cobalt oxides. "Bremen blue" or "Verditer" is a compound of copper and lime of a greenish tint.

Browns generally owe their colour to iron oxide. "Raw umber" is a clay coloured by oxide of iron; the best comes from Turkey; it is very durable both in water and in oil, and does not injure other pigments when mixed with them. "Burnt umber" is the last-mentioned pigment burnt to give it a darker colour; useful as a drier, and in mixing with white-lead to make stone colour. "Vandyke brown" is an earthy mineral pigment of dark-brown colour; durable both in oil and in water, and useful for graining. "Purple brown" is of a reddish-brown colour; should be used with boiled oil, and a little varnish and driers for outside work. "Burnt sienna" is produced by burning raw sienna; the best colour for shading gold. "Brown ochre" is another name for "spruce ochre." "Spanish brown" is also an ochre. "Brown pink" is a vegetable pigment often of a greenish hue; works well in water and oil, but dries badly, and will not keep its colour when mixed with white-lead.

Greens may be made by mixing blue and yellow pigments, but such mixtures are less durable than those produced direct from copper, arsenic, &c.; the latter are, however, objectionable for use in distemper, or on wall papers, as they are injurious to health. "Brunswick green" of the best kind is made by treating copper with sal-ammoniac; chalk, lead, and alum are sometimes added; has rather a bluish tinge; dries well in oil, is durable, and not poisonous. Ordinary Brunswick green is made by mixing lead chromate and Prussian blue with baryta sulphate. "Mineral green" is made from bi-basic copper carbonate; weathers well. "Verdigris" (copper acetate) furnishes a bluish-green colour, durable in oil or varnish, but not in water; dries rapidly, but is not a safe pigment to use. "Green verditer" is copper carbonate and lime. "Prussian green" is made by mixing different substances with Prussian blue. Several other greens made from copper are "Brighton," "malachite," "mountain," "marine," "Saxon," "African," "French," and "patent" green. "Emerald green" is made of verdigris mixed with a solution of arsenious acid; is of very brilliant colour, but very poisonous, difficult to grind, and dries badly in oil; should be purchased ready ground in oil, in which case the poisonous particles do not fly about, and the difficulty of grinding is avoided. "Scheele's green" and "Vienna green" are also copper arsenites, and highly poisonous. "Chrome green" should be made from chromium oxide, and is very durable; inferior chrome green is made, however, by mixing lead chromate and Prussian blue, and is called "Brunswick green." The chrome should be free from acid, or the colour will fade; may be tested by placing it for several days in strong sunlight.

Lakes are made by precipitating coloured vegetable tinctures by means of alum and potash carbonate; the alumina combines with the organic colouring matter, and separates it from the solution. The tincture used varies in the different descriptions of lake; the best, made from cochineal or madder, is very expensive. The colour is not durable, and dries slowly; it mixes well with white-lead, and is used for internal work. "Drop lake" is made by dropping a mixture of Brazil wood through a funnel on to a slab; the drops are dried and mixed into paste with gum water, sometimes called "Brazil wood lake." "Scarlet lake" is made from cochineal, as are "Florentine," "Hamburg," "Chinese," "Roman," "Venetian," and "carminated" lakes.

Oranges.—"Chrome orange" is a lead chromate, brighter than vermilion, but less durable. "Orange ochre" is a bright yellow ochre burnt to give it warmth of tint; dries and works well in water and oil, and is very durable; known also as "Spanish ochre." "Orange red" is produced by a further oxidation than is required for red-lead; is a brighter and better pigment.

Reds.—"Carmine," made from the cochineal insect, is the most brilliant red pigment

known; but too expensive for ordinary house painting, and not durable; sometimes used for internal decoration. "Red-lead" ground by itself in oil or varnish forms a durable pigment, or it may be mixed with ochres; white-lead and metallic salts generally destroy its colour. "Vermilion" is mercury sulphide found in a natural state; best comes from China; artificial vermilion is also made both in China and on the Continent from a mixture of sulphur and mercury; genuine is very durable, but it is sometimes adulterated with red-lead, &c., and then will not weather; on heating some in a test tube it should entirely volatilize, and the powder crushed between sheets of paper should not change colour. German vermilion is antimony tersulphide and of orange-red colour.

"Indian red" is a ground hematite ore brought from Bengal, sometimes artificially made by calcining iron sulphate; tints vary, but a rosy hue is considered the best; may be used with turpentine and a little varnish to produce a dull surface, drying rapidly, or with boiled oil and a little driers, in which case a glossy surface will be produced, drying more slowly. "Chinese red" and "Persian red" are lead chromates, produced by boiling white-lead with a solution of potash bichromate; the tint of Persian red is obtained by the employment of sulphuric acid; these are much used for painting pillar post boxes. "Light red" is a burnt ochre, and shares the characteristics of raw ochres already described. "Venetian red" is obtained by heating iron sulphate produced as a waste product at tin and copper works; is often adulterated by mixing lime sulphate with it during the manufacture; when pure it is known as "bright red"; when special tints of purple and brown are required, these should be obtained in the process of manufacture, and not produced by mixing together a variety of different shades of colour; when the tint desired is attempted to be obtained by this latter course it is never so good, and the pigments produced are known as "faced colours" and are of inferior value. "Rose pink" is a chalk or whiting stained with a tincture of Brazil wood; fades very quickly, but is used for paperhangings, common distemper, and for staining cheap furniture. "Dutch pink" is a similar substance made from quercitron bark.

Yellows.—Chrome yellows are lead chromates, produced by mixing dilute solutions of lead acetate or nitrate and potash bichromate; this makes a medium tint known as "middle chrome." The addition of lead sulphate makes this paler, when it is known as "lemon chrome," whereas the addition of caustic lime makes it "orange chrome" of a darker colour. The chromes mix well with oil and with white-lead either in oil or water; stand the sun well, but, like other lead salts, become dark in bad air. Chrome yellow is frequently adulterated with gypsum. "Naples yellow" is a salt of lead and antimony; is not so brilliant as chrome, but has the same characteristics. "King's yellow" is made from arsenic, and is therefore a dangerous pigment to use in internal work; is not durable, and injures several other colours when mixed with them. "Chinese yellow," "arsenic yellow," and "yellow orpiment" are other names for king's yellow. Yellow ochre is a natural clay, coloured by iron oxide, and found abundantly in many parts of England; is not very brilliant, but is well suited for distemper work, as it is not affected by light or air; does not lose its colour when mixed with lime, as some other pigments do. "Spruce ochre" is a variety of brownish-yellow colour. "Oxford ochre" is of a warm yellow colour and soft texture, absorbent of both oil and water. "Stone ochre" is found in the form of balls imbedded in the stone of the Cotswold hills; varies in tint from yellow to brown. "Raw sienna" is a clay, stained with oxides of iron and manganese, and of a dull yellow colour; is durable both in oil and water, and useful in all work, especially graining. "Yellow lake" is a pigment made from turmeric, alum, &c.; is not durable, and does not mix well with oil or metallic colours.

Vehicles or Mediums.—A vehicle to be perfect should mix readily with the pigment, forming a pasty mass of treacly consistence; it should exert neither colouring nor chemical action upon the pigments with which it is mixed; spread out in a thin layer upon a more porous substance, it should solidify and form a film not liable to subsequent disintegration or decay, and sufficiently elastic to resist slight concussion. No vehicle yet

introduced complies with all these conditions; those which most nearly approach them are the drying-oils. The use of oil in painting is said to have been invented in the 14th century, and soon reached considerable perfection. Even the best of recent painters have not succeeded in giving to their works that durability which the originators of the method attained. All organic substances are liable to a more or less rapid oxidation, especially if exposed to light and heat. Oil is no exception to this rule; but it seems that, in its pure state, it is much more durable than when mixed with other substances. Although ground-nut- and poppy-oils are sometimes employed by artists where freedom from colour is essential, linseed-oil is the vehicle of by far the larger proportion of paint for both artistic and general purposes.

Oil-paint appears to have been unknown to the ancients, who used various vehicles, chiefly of animal origin. One of these, which was in high repute at Rome, was white-of-egg beaten with twigs of the fig-tree. No doubt the indiarubber contained in the milky juice exuding from the twigs contributed to the elasticity of the film resulting from the drying of this vehicle. Pliny was aware of the fact that when glue is dissolved in vinegar and allowed to dry, it is less soluble than in its original state. Many suggestions have been made in modern times for vehicles in which glue or size plays an important part. In order to render it insoluble, various chemicals have been added to its solution, such as tannin, alum, and a chromic salt. None of these vehicles, however useful for special purposes, has become sufficiently well known to warrant description.

Linseed-oil, to be suitable for painting, must dry well. A test which will indicate whether this be the case or not is to cover a piece of glass with a film of the raw oil, and to expose it to a temperature of about 100° F. (38° C.). The time which the film requires to solidify is a measure of the quality of the oil. If the oil has been extracted from unripe or impure seed, the surface of the test-glass will remain "tacky" or sticky for some time, and the same will happen if the oil under examination has been adulterated with an animal or vegetable non-drying oil.

Until recently, linseed-oil was frequently adulterated with cottonseed-oil, extracted from the waste seeds of the cotton-plant. Where the admixture was considerable, it could easily be detected by the sharp acrid taste of the cottonseed-oil. Now, however, means have been found for removing this disagreeable taste, and the consequence has been that cottonseed-oil is so largely used for adulterating olive-oil, or as a substitute for it, that its price has risen above that of linseed-oil. Another adulterant which is rather difficult to detect is rosin. Oil containing this substance is thick and darker in colour than pure oil. When the proportion of rosin is considerable, its presence may be ascertained by heating a film of the oil upon a metallic plate, when the characteristic smell of burning rosin will be perceptible. When the percentage of rosin is too small for detection in this manner, a film of the oil should be spread upon glass and allowed to dry. When quite hard, the film should be scraped off, and treated with cold turpentine, which will dissolve any rosin which may be present, without materially affecting the oxidized oil. The presence of rosin may also be detected by the following simple chemical test:—The oil is boiled for a few minutes with a small quantity of alcohol (sp. gr. 0.9), and is allowed to stand until the alcohol becomes clear. The supernatant liquid is then poured off, and treated with an alcoholic solution of lead acetate. If the oil be pure, there will be very slight turbidity, while the presence of rosin causes a dense flocculent precipitate. Should linseed-oil be adulterated with a non-drying oil, it will remain sticky for months, when spread out in a thin film upon glass or other non-absorbent substance.

The sp. gr. of linseed-oil is in some cases of value in estimating its quality; but as the variations are slight, it would be difficult to detect them in so thick a liquid by means of an ordinary hydrometer. A simple method of obtaining an approximate result is to procure a sample of oil of known good quality, and to colour it with an aniline dye. A drop of this tinted oil will, when placed in the oil to be tested, indicate, by its sinking

or swimming, the relative density of the liquid under examination. Freshly-extracted linseed-oil is unfit for making paint. It contains water and organic impurities, respecting the composition of which little is known, and which are generally termed "mucilage." By storing the oil in tanks for a long time, the water and the greater part of the impurities are precipitated, forming at the bottom of the cistern a pasty mass known as "foots."

To accelerate the purification of the oil, and to remove at least a portion of the colouring matter, various methods are in use. The action of sulphuric acid upon linseed-oil is not so favourable as upon other oils. It is, however, sometimes employed, in the proportion of 2 parts of a mixture of equal volumes of commercial sulphuric acid and water to 100 of oil. The dilute acid is poured gradually into the oil, and the mixture is violently agitated for several hours, then run into tanks, and allowed to settle. A concentrated solution of zinc chloride has been substituted for sulphuric acid in the proportion of about $1\frac{1}{2}$ per cent. of the weight of the oil. When the reaction is complete, steam or warm water is admitted into the liquid to clarify it. Oil treated in this way loses a considerable proportion of the colouring matter which it originally contained. When the oil is to be used for white paint, it is sometimes bleached by exposing it to the action of light. On a large scale, this is done in shallow troughs, lined with lead and covered with glass. The lead itself appears to have some influence upon the bleaching of the oil, for the decoloration is not so rapid if the troughs be lined with zinc. For small quantities, a shallow tray of white porcelain gives very good results, the white surface increasing the photo-chemical action. It is not quite clear whether the presence of water accelerates the bleaching of oil by this method; some manufacturers consider its presence necessary, others omit it. Various salts are added to the water, the one most in use being copperas. However the oil may have been prepared, it will, if kept for a long time, deposit a sediment. At first this contains mucilage; but the sediment from old oil consists chiefly of the products of decomposition of the oil itself. Oxygen is not necessary for this decomposition; but it is increased by the action of light. Raw linseed-oil dries more slowly than boiled; but the resulting film is more brilliant and durable. Raw and boiled oils are therefore usually mixed in proportions varying according to the time which can be allowed for the paint to dry, or to the properties required of the film. For ordinary kinds of paint, equal parts of boiled and raw oils are customary. Linseed-oil heated to 350° to 400° F. (176° to 204° C.) dries much more rapidly than in its raw state.

Driers.—The maximum drying power is obtained by the addition of certain metallic oxides, which not only part with some of their own oxygen to the oil, but also act as carriers between the atmospheric oxygen and the heated liquid. This heating of the oil with oxides is known as boiling, although the liquid is not volatilized without decomposition, as is the case with water. At about 500° F. (260° C.), bubbles begin to rise in the oil, producing acrid white fumes on coming into contact with the air. The gas thus given off consists chiefly of vapour of acrolein mingled with carbonic oxide. There is no advantage in heating the oil higher than 350° F. (176° C.); the drying properties of the oil are not increased by heating beyond this point, while its colour is considerably darkened. For the finer qualities of boiled oils, it is essential that the raw oil should have been stored for some time, so that it may be free from mucilage. This mucilage is the chief source of the dark colour of some boiled oils; when heated, it forms a brown substance, which is soluble in the oil itself, and extremely difficult to remove. The oxides usually added to the oil during boiling are litharge or red-lead, the former being preferred on account of its lower price. About 2 to 5 per cent. by weight of the oxides or driers is gradually stirred into the oil after it has been slowly raised to about 300° F. (149° C.). The stirring should be continued until the litharge is dissolved, or it would cake on the bottom of the pan, and cause the oil to burn. Litharge may even be reduced to a cake of metallic lead when the fire is brisk. Some pans are furnished with stirrers and gearing by which the latter can be worked by hand or steam. The material of which the pans are made is wrought- or cast-iron. Copper pans are sometimes used

with the object of improving the colour of the oil. Little is known respecting the chemical reactions which take place during the boiling of oil. Even when the air is excluded during the process, the drying properties are greatly increased, and, if boiled long enough, the oil is converted into a solid substance. The loss of weight which ensues is dependent upon the temperature and the time during which the operation continues. It is less when the air is freely admitted than if the pan is covered with a hood. The vapours given off by the oil are of an extremely irritating character, and should be destroyed by passing through a furnace. As their mixture with air in certain proportions is explosive, this furnace should be situated at some distance, and the gases be conducted into it by an earthenware pipe.

Since it has been tried to substitute zinc oxide for white-lead in painting, researches have been made to replace litharge as a drier by a substance free from the inconveniences which caused the abandonment of white-lead. If sulphuretted hydrogen impairs the whiteness of painting done with white-lead, it is not logical to employ a lead drier with zinc paints, because the latter substances will lose their advantage of not becoming dark. Several metallic oxides and salts, especially zinc sulphate, manganese oxide, and umber, have the property of combining with oils, which they render drying. To these may be added the protoxides of the metals of the third class, i. e. iron, cobalt, and tin. But these oxides are very unstable and difficult of preparation; hence it became desirable to discover some means by which they might be combined with bodies which would enable them to be prepared cheaply, and at the same time leave unimpaired their desiccating powers. Moreover, it is acknowledged that driers in the dry state are preferable in many respects to drying oils. Following are some of the recently-introduced driers:—

(1) Cobalt and Manganese Benzoates.—Benzoic acid is dissolved in boiling water, the liquid being continually stirred, and neutralized with cobalt carbonate until effervescence ceases. Excess of carbonate is removed by filtration, and the liquor is evaporated to dryness. The salt thus prepared is an amorphous, hard, brownish material, which may be powdered like rosin, and kept in the pulverulent state in any climate, simply folded in paper. Painting executed with a paint composed of 3 parts of this drier with 1000 of oil and 1200 of zinc-white, dries in 18 to 20 hours. Manganese benzoate is prepared in the same way, substituting manganese carbonate for that of cobalt. Applied under similar circumstances, it dries a little more rapidly, and a little less is required. Urobenzoic (hippuric) acid is equally efficacious.

(2) Cobalt and Manganese Borates.—These salts also, in the same proportions, are found to be of equal efficacy. The latter is extremely active, and requires to be used in much smaller proportions.

(3) Resinates.—If an alkaline resinat of potash or soda be dissolved in hot water, and this solution be precipitated by a solution of a proportionate quantity of a cobalt or manganese chloride or sulphate, an amorphous resinat is formed, which, after being collected on cloth filters, washed, and dried, forms an excellent drier.

(4) Zumatic (Transparent) Drier.—Take zinc carbonate, 90 lb.; manganese borate, 10 lb.; linseed-oil, 90 lb. Grind thoroughly, and keep in bladders or tin tubes. The latter are preferable.

(5) Zumatic (Opaque) Drier.—Manganese borate, as a drier, is so energetic that it is proper to reduce its action in the following way:—Take zinc-white, 25 lb.; manganese borate, 1 lb. Mix thoroughly, first by hand, then in a revolving drum; 1 lb. of this mixed with 20 lb. paint ensures rapid drying.

(6) Manganese Oxide.—Purified linseed-oil is boiled for 6 or 8 hours, and to every 100 lb. boiled oil are added 5 lb. of powdered manganese peroxide, which may be kept suspended in a bag, like litharge. The liquid is boiled and stirred for 5 or 6 hours more, and then cooled and filtered. This drying oil is employed in the proportion of 5 to 10 per cent. of the zinc-white.

(7) Guynemer's.—Take pure manganese sulphate, 1 part; manganese acetate, 1 part;

calcined zinc sulphate, 1 part; white zinc oxide, 97 parts. Grind the sulphates and acetate to impalpable powder, sift through a metallic sieve. Dust 3 parts of this powder over 97 of zinc oxide, spread out over a slab or board, thoroughly mix, and grind. The resulting white powder, mixed in the proportion of $\frac{1}{2}$ or 1 per cent. with zinc-white, will enormously increase the drying property of this body, which will become dry in 10 or 12 hours.

In using driers, observe that you (1) do not employ them needlessly with pigments which dry well in oil colour, (2) nor in excess, which would retard the drying, (3) nor add them to the colour until about to be used, (4) nor use more than one drier to the same colour, (5) nor use any at all in the finishing coat of light colours.

Grinding.—In working any form of grinding-rollers, great care must be taken to clean them thoroughly immediately after use. If the paint be allowed to dry upon the surface of the rollers, it is difficult of removal, and interferes with the perfect action of the machine. Should the working parts become clogged with solidified oil, a strong solution of caustic soda or potash will remove it. By means of the same solutions, porcelain rollers may be kept quite white, even if used for mixing coloured paints. Although the colour of most pigments is improved by grinding them finely in oil, there are some which suffer in intensity when their size of grain is reduced. Chrome red, for instance, owes its deep colour to the crystals of which it is composed, and when these are reduced to extremely fine fragments, the colour is considerably modified.

Storing.—When paint is not intended for immediate use, it is packed in metallic kegs. For exportation to hot climates, the rim of the lid is soldered down, a practice which effectually prevents access of atmospheric oxygen. White-lead paint is frequently packed in wooden kegs; these prevent the discoloration sometimes caused by iron kegs. When paint is mixed ready for use, it will, if exposed to the air, become covered with a skin, which soon attains sufficient thickness to exclude atmospheric oxygen, and prevent any further solidification of the oil. The paint may be still better protected by pouring water over it, or it may be placed in air-tight cans. It it has been allowed to stand for some time, it must be well stirred before using, as the pigments have a tendency not only to separate from the oil, but also to settle down according to their specific gravity.

Applying.—Of whatever nature the surface may be to which the paint is to be applied, great care must be taken that it is perfectly dry. Wood especially, even when apparently dry, may on a damp day contain as much as 20 per cent. of moisture. A film of paint applied to the surface of wood in this condition prevents the moisture from escaping, and it remains enclosed until a warm sun or artificial heat converts it into vapour, which raises the paint and causes blisters. Moisture enclosed between two coats of paint has the same effect. Paint rarely blisters when applied to wood from which old paint has been burnt off; this is probably due to the drying of the wood during the operation of burning.

Priming.—The first coat of paint applied to any surface is termed the "priming-coat." It usually consists of red-lead and boiled and raw linseed-oil. Experience has shown that such a priming not only dries quickly itself, but also accelerates the drying of the next coat. The latter action must be attributed to the oxygen contained in the red-lead, only a small portion of which is absorbed by the oil with which it is mixed. Kall, of Heidelberg, prepares a substitute for boiled oil by mixing 10 parts whipped blood, just as it is furnished from the slaughter-houses, with 1 part of air-slaked lime sifted into it through a fine sieve. The two are well mixed, and left standing for 24 hours. The dirty portion that collects on top is taken off, and the solid portion is broken loose from the lime at the bottom; the latter is stirred up with water, left to settle, and the water poured off after the lime has settled. The clear liquid is well mixed up with the solid substance before mentioned. This mass is left standing for 10 or 12 days, after which a solution of potash permanganate is added, which decolorizes it and prevents putrefaction. Finally the mixture is stirred up, diluted with more water to give it the consistence of very thin size, filtered, a few drops of oil of lavender added, and the

preparation preserved in closed vessels. It is said to keep a long time without change. A single coat of this liquid will suffice to prepare wood or paper, as well as lime or hard plaster walls, for painting with oil colours. This substance is cheaper than linseed-oil, and closes the pores of the surface so perfectly that it takes much less paint to cover it than when primed with oil.

Drying.—The drying of paint is to a great extent dependent upon the temperature. Below the freezing-point of water, paint will remain wet for weeks, even when mixed with a considerable proportion of driers; while, if exposed to a heat of 120° F. (49° C.), the same paint will become solid in a few hours. The drying of paint being a process of oxidation and not evaporation, it is essential that a good supply of fresh air should be provided. When a film of fresh paint is placed with air in a closed vessel, it does not absorb the whole of the oxygen present; but after a time the drying process is arrested, and the remaining oxygen appears to have become inert. Considerable quantities of volatile vapours are given off during the drying of paint; these are due to the decomposition of the oil. When the paint has been thinned down by turpentine, the whole of this liquid evaporates on exposure to the air. There must, therefore, be a plentiful access of air, to remove the vapours formed, and afford a fresh supply of active oxygen. The presence of moisture in the air is rather beneficial than injurious at this stage. Especially in the case of paints mixed with varnish, moist air appears to counteract the tendency to crack or shrink. Under the erroneous impression that the drying of paint is a species of evaporation, open fires are sometimes kept up in freshly-painted rooms. It is only when the temperature is very low that any benefit can result from this practice: as a rule, it rather retards than hastens the solidification of the oil, which cannot take place rapidly in an atmosphere laden with carbonic acid. The first coat of paint should be thoroughly dry before the second is applied. Acrylic acid is formed during the oxidation of linseed-oil, and unless this be allowed to evaporate, it may subsequently liberate carbonic acid from the white-lead present in most paints, and give rise to blisters. Sometimes a second priming-coat is given; but usually the second coat applied contains the pigment. This, as soon as dry, is again covered by another coat, and subsequently by two or more finishing-coats, according to the nature of the work.

Filling.—Before the first coat is applied to wood, all holes should be filled up. The filling usually employed is ordinary putty; this, however, sometimes consists of whiting ground up with oil foots of a non-drying character, and when the films of paint are dry, the oil from the putty exudes to the surface, causing a stain. The best filling for ordinary purposes is whiting ground to a paste with boiled linseed-oil. For finer work, and for filling cracks, red-lead mixed with the same vehicle may be employed. For porous hard woods, use boiled oil and corn starch stirred into a very thick paste; add a little japan, and reduce with turpentine. Add no colour for light ash; for dark ash and chestnut, use a little raw sienna; for walnut, burnt umber and a slight amount of Venetian red; for bay wood, burnt sienna. In no case use more colour than is required to overcome the white appearance of the starch, unless you wish to stain the wood. This filler is worked with brush and rags in the usual manner. Let it dry 48 hours, or until it is in condition to rub down with No. 0 sandpaper, without much gumming up; and if an extra fine finish is desired, fill again with the same materials, using less oil, but more japan and turpentine. The second coat will not shrink, being supported by the first. When the second coat is hard, the wood is ready for finishing up by following the usual methods. This formula is not intended for rosewood.

Coats.—There is no advantage in laying on the paint too thickly. A thick film takes longer to dry thoroughly than two thin films of the same aggregate thickness. Paint is thinned down or diluted with linseed-oil or turpentine. The latter liquid, when used in excess, causes the paint to dry with a dull surface, and has an injurious effect upon its stability. Sometimes the last coat of paint is mixed with varnish, in order to give it greater brilliancy. In this case, special care must be taken that the previous coats have

thoroughly solidified, or cracks in the final coat may subsequently appear. The same remark applies when the surface of the paint is varnished. The turpentine with which the varnish is mixed has a powerful action upon the oil contained in the paint, if the latter is not thoroughly oxidized. The exterior of the paint is thus softened, and the varnish is enabled to shrink and crack, especially in warm weather.

Brushes.—The bristles are frequently fastened by glue or size, which is not perceptibly acted upon by oil, and if brought into contact with this liquid alone, there would be no complaints of loose hairs coming out and spoiling the work. It is a common practice to leave the brushes in a paint-pot, in which the paint is covered with water to keep it from drying. The brushes are certainly kept soft and pliant in this way; but at the same time the glue is softened, and the bristles come out as soon as the brush is used. After use, brushes should be cleaned, and placed in linseed-oil until again required, when they will be found in good condition. Treated in this way, they will wear so much better that the little additional trouble entailed is amply repaid. When brushes will not again be required for some time, the oil remaining in them should be washed out by means of turpentine, after which they may be dried without deterioration. On no account should oil be allowed to dry in a brush, as it is most difficult to remove after oxidation has taken place. The best means are steeping in benzoline for a few days, or in turpentine, with occasional washing in soda-water and with soft-soap, avoiding too violent rubbing.

Surface.—When the surface to be painted is already covered with old paint, this should be either removed or rubbed down smooth before applying the new. When the thickness of the old coat is not great, rubbing down, accompanied by a careful scraping of blisters and defective parts, will suffice. When the thickness of the old paint necessitates its removal, it may either be burned off, or softened by a solution of caustic alkali, and afterwards scraped. The burning process is the most effective, and leaves the wood in a fit condition to receive the fresh coat of paint; but it is not applicable in the case of fine mouldings. When caustic potash or soda is used, the paint is left in contact with it for some time, when the linoleic acid of the oxidized linseed-oil becomes saponified, and can easily be scraped or scrubbed off the surface of the wood. Whenever an alkali is employed, it is of the greatest importance that the wood should afterwards be thoroughly washed several times with clean water, in order to remove every trace of the solvents. Any soda or potash remaining in the pores of the wood would not only retain moisture and cause blistering, but would also have an injurious action upon the vehicle of the paint subsequently applied, and in many cases upon the pigment itself. The remarks already made as to the necessity of an absolutely dry surface should be borne in mind in this instance. When the surface of the paint is to be protected by a coat of varnish, the latter should not be applied until the whole of the oil contained in the paint has solidified. The wrinkling of varnish upon paint is frequently erroneously attributed to the bad quality of the varnish, when the real cause is the incomplete oxidation of the paint itself. Following are some recipes for removing and cleaning old painted surfaces:—(1) Dissolve 2 oz. soft soap, 4 oz. potash, in boiling water, add $\frac{1}{2}$ lb. quicklime. Apply hot, and leave for 12-24 hours. This will enable the old paint to be washed off with hot water. (2) Cleaning old paint is effected by washing with a solution of pearlash in water. If the surface is greasy it should be treated with fresh quicklime mixed in water, washed off, and reapplied repeatedly. (3) Extract of Lethirium is a ready-made preparation which removes old paint very quickly. For this purpose the pure extract must be thinly brushed over the surface twice or thrice. To remove a single coat of paint the extract is diluted with 30 times its bulk of water. To clean painted surfaces it is diluted with 200 or 300 parts of water. The extract must be carefully washed off with vinegar and water before laying on another coat of paint. (4) Wet the place with naphtha, repeating as often as is required; but frequently one application will dissolve the paint. As soon as it is softened, rub the surface clean.

Chloroform, mixed with a small quantity of spirit ammonia, has been employed very successfully to remove the stains of dry paint from wood, silk, and other substances. (5) Mix 1 oz. pearlash with 3 oz. quick stone lime, by slaking the lime in water and then adding the pearlash, making the mixture about the consistence of paint. Lay the above over the whole of the work required to be cleaned, with an old brush; let it remain 14 or 16 hours, when the paint can be easily scraped off.

Knotting.—Knotting is the material used by painters to cover over the surfaces of knots in wood before painting. The object is to prevent the exudation of turpentine, &c., from the knots, or, on the other hand, to prevent the knots from absorbing the paint, and thus leaving marks on the painted surface. Ordinary knotting is often applied in 2 coats. "First size" knotting is made by grinding red lead in water and mixing it with strong glue size. It is used hot, dries in about 10 minutes, and prevents exudation. "Second" knotting consists of red lead ground in oil, and thinned with boiled oil and turpentine. Patent knotting is chiefly shellac dissolved in naphtha. Following is a recipe for a similar knotting:—Add together $\frac{1}{4}$ pint japanners' gold size, 1 teaspoonful red lead, 1 pint vegetable naphtha, 7 oz. orange shellac. This mixture is to be kept in a warm place whilst the shellac dissolves, and must be frequently shaken. Sometimes hot lime is used for killing knots. It is left on them for about 24 hours, then scraped off, and the surface coated with size knotting; or if this does not kill the knots, they are then painted with red and white lead ground in oil, and when dry rubbed smooth with pumice. Sometimes after application of the lime the knots are passed over with a hot iron, and then rubbed smooth. When the knots are very bad they may be cut out, or covered with silver leaf.

Water-colours.—The manufacture of water-colour paints is more simple than that of oil-paints, the pigments being first ground extremely fine and then mixed with a solution of gum or glue. The paste produced in this manner is allowed to dry, after having been stamped into the form of cakes. As soon as the hardened mass is rubbed down with water, the gum softens and dissolves, and if the proportion of water be not too great, the pigment will remain suspended in the solution of gum, and can be applied in the same manner as oil-paint. To facilitate the mixing with water, glycerine is sometimes added to the cake of paint, which then remains moist and soft.

Removing Smell.—(1) Place a vessel of lighted charcoal in the room, and throw on it 2 or 3 handfuls of juniper berries; shut the windows, the chimney, and the door close; 24 hours afterwards the room may be opened, when it will be found that the sickly, unwholesome smell will be entirely gone. (2) Plunge a handful of hay into a pail of water, and let it stand in the room newly painted.

Discoloration.—Light-coloured paints, especially those having white-lead as a basis, rapidly discolour under different circumstances. Thus white paint discolours when excluded from the light; stone colours lose their tone when exposed to sulphuretted hydrogen, even when that is only present in very small quantity in the air; greens fade or darken, and vermilion loses its brilliancy rapidly in a smoky atmosphere like that of London. Ludersdorf thinks that the destructive change is principally due to a property in linseed-oil which cannot be destroyed. The utility of drying oils for mixing pigments depends entirely on the fact that they are converted by the absorption of oxygen into a kind of resin, which retains the colouring pigment in its semblance; but during this oxidization of the oil—the drying of the paint—a process is set up which, especially in the absence of light and air, soon gives the whitest paint a yellow tinge. Ludersdorf therefore proposes to employ an already formed but colourless resin as the binding material of the paint, and he selects two resins as being specially suitable—one, sandarach, soluble in alcohol; the other, dammar, soluble in turpentine. The sandarach must be carefully picked over, and 7 oz. is added to 2 oz. Venice turpentine and 24 oz. alcohol of sp. gr. 0.833. The mixture is put in a suitable vessel over a slow fire or spirit-lamp, and heated, stirring diligently, until it is almost boiling. If the mixture be

kept at this temperature, with frequent stirring, for an hour, the resin will be dissolved, and the varnish is ready for use as soon as cool. The Venice turpentine is necessary to prevent too rapid drying, and more dilute alcohol cannot be employed, because sandarach does not dissolve easily in weaker alcohol, and, furthermore, the alcohol, by evaporation, would soon become so weak that the resin would be precipitated as a powder. When this is to be mixed with white-lead, the latter must first be finely ground in water, and dried again. It is then rubbed with a little turpentine on a slab, no more turpentine being taken than is absolutely necessary to enable it to be worked with the muller ; 1 lb. of the white-lead is then mixed with exactly $\frac{1}{2}$ lb. of varnish, and stirred up for use. It must be applied rapidly, because it dries so quickly. If when dry the colour is wanting in lustre, it indicates the use of too much varnish. In such cases, the article painted should be rubbed, when perfectly dry, with a woollen cloth to give it a gloss. The dammar varnish is made by heating 8 oz. dammar in 16 oz. turpentine oil at 165° to 190° F. (74° to 88° C.), stirring diligently, and keeping it at this temperature until all is dissolved, which requires about an hour. The varnish is then decanted from any impurities, and preserved for use. The second coat of the pure varnish, to which half its weight of oil of turpentine has been added, may be applied. It is still better to apply a coat of sandarach varnish made with alcohol, because dammar varnish alone does not possess the hardness of sandarach, and when the article covered with it is handled much, does not last so long.

Miscellaneous Paints.—Under this head the following few varieties deserve notice :—

Cement paint for carton-pierre.—Composed of 2 parts washed graphite, 2 red-lead, 16 freshly-prepared cement, 16 barium sulphate, 4 lead protoxide, 2 alcoholized white litharge. The paint must be put on as soon as the roofing is securely fastened, choosing the dry season and a sunny day. Care must be taken to put it on well over the joints ; it is recommended that an extra coating should be given to the portions that overlap each other, so as to render them water-tight. As a rule, two coats are put on. The first, whilst still wet, is covered with an even layer of fine dry sand sprinkled over it through a sieve. This is done bit by bit, as the roof is painted, so as to prevent the workmen stepping on the wet paint. The second coat is put on about a week later, the sand which has not stuck fast being first swept off. The second coat is not sanded. It is merely intended to combine with the under-coat and form a durable waterproof surface, which will prevent the evaporation of the tar-oil, the usual cause of the failure of carton-pierre roofing, and present a good appearance as well.

Coloured paints.—Coloured lead paints are produced by adding a suitable pigment to a white-lead paint until the required tint is obtained. A few of the most common tints produced by mixing 2 or more colours may be mentioned. The colours used are generally divided into classes. The following list shows the pigments added to white-lead paint to produce compound colours. The same pigments, except those containing lead, may be used with a zinc-white basis for coloured zinc paint :—

Common.	{	Stone colour ..	Burnt umber.	} For darker shades.
			Raw umber.	
			Yellow ochre.	
			Raw umber and lampblack.	
			Yellow ochre and lampblack.	
	Drabs		Burnt umber.	
			Burnt umber and yellow ochre for a warm tint.	
	Bufs		Yellow ochre.	
			Yellow ochre and Venetian red.	
	Greys		Lampblack.	
			Indian red—indigo—for a warm shade.	
	Brown		Burnt sienna, indigo.	
		Lake, Prussian blue (or indigo) and yellow ochre.		

{	Superior.	Yellows	Chrome yellow.
		Green	Prussian blue, chrome yellow. Indigo, burnt sienna (or raw umber). Prussian blue, raw umber. Avoid arsenical greens.
		Salmon	Venetian red. Vermilion.
		Fawn	Stone ochre and vermilion
{	Delicate.	Sky-blue	Prussian blue.
		Pea-green	Brunswick green. French green. Prussian blue, chrome yellow.

Copper paint.—Bessemer's copper paint gives a glossy and elegant covering to metal, wood, or porcelain; when united with oils, it assumes an antique green appearance.

Floors, paint for.—A paint for floors, which economizes the use of oil colours and varnish, is described in the German technical press as having been composed by Mareck. It is remarked that this paint can also be used on wood, stone, &c. For flooring, the following mixture has been found applicable: $2\frac{1}{2}$ oz. good, clear joiners' glue is soaked overnight in cold water. It is dissolved, and then is added (being constantly stirred) to thickish milk of lime heated to boiling-point, and prepared from 1 lb. quicklime. Into boiling lime is poured (the stirring being continued) as much linseed-oil as becomes united by means of saponification with the lime, and when the oil no longer mixes no more is poured in. If there happens to be too much oil added, it must be combined by the addition of some fresh lime paste. For the quantity of lime previously indicated, about $\frac{1}{2}$ lb. oil is required. After this white, thickish foundation paint has cooled, a colour is added which is not affected by lime, and in case of need the paint is diluted with water, or by the addition of a mixture of lime water with some linseed-oil. For yellowish-brown or brownish-red shades about $\frac{1}{4}$ the entire bulk is added of a brown solution obtained by boiling shellac and borax with water. This mixture is specially adapted for painting floors. The paint should be applied uniformly, and is described as covering the floor most effectually, and uniting with it in a durable manner. But it is remarked that it is not suitable for employment in cases where a room is in constant use, as under such circumstances it would probably have to be renewed in some places every 3 months. The most durable floor paint is said to be that composed of linseed-oil varnish, which only requires to be renewed every 6 or 12 months. It penetrates into the wood and makes it water resisting; its properties being thus of a nature to compensate for its higher cost in proportion to other compositions used for a similar purpose. Its use is particularly recommended in schools and workrooms, as it lessens dust and facilitates the cleaning of the boards.

Gold paint.—Do not mix the gold size and powder together, but go over the article to be gilded with the size alone, giving an even and moderate coating. Let it dry (which will not take long) till it is just sticky, or, as gilders call it, "tacky." Then over a sheet of smooth writing-paper dust on the dry gold powder by means of a stout, soft, sable brush.

Iron paint.—The 'Photographisches Wochenblatt' mentions that Spangenberger has a paint composed of pulverized iron and linseed-oil varnish. It is intended for painting damp walls, kettles, outer walls, or any place or vessel exposed to the action of the open air and weather. Should the article be exposed to frequent

changes of temperature, linseed-oil varnish and amber varnish should be mixed with the paint intended for the first 2 coats, without the addition of any artificial drying medium. The first coat should be applied rather thin, the second a little thicker, and the last in a rather fluid state. It is not necessary to free iron from rust, grease, &c., by means of acid before applying the paint, as a superficial cleaning is sufficient. The paint is equally adapted as a weather-proof coating for iron, wood, and stone.

Iron, paint for.—The value of red-lead as a preservative for iron has been generally accepted. Wrought iron requires a hard and elastic paint, which will hold itself together even if the scale beneath gives way. The following experiments, made under the auspices of the Dutch State railroads, may be instructive. Iron plates were prepared for painting as follows: 16 plates were pickled in acid (hydrochloric), then neutralized with lime (slaked), rinsed in hot water, and while warm rubbed with oil. The same number of plates were cleared of scale, so far as it could be removed by brushing and scraping. Plates from each set were then painted alike—namely, 4 with coal-tar and 4 with iron oxide A; another set with iron oxide B, and the remaining set with red-lead. They were then exposed 3 years, and the results observed were as follows: The coal-tar on the scrubbed plates was quite gone, that put on the pickled plates was inferior to the others. The iron oxide A on the scrubbed plates was inferior to the other two, while on the pickled plate it held well. The oxide B was found superior to that of A, but inferior to red-lead, while the plates covered with red-lead stood equally well on both prepared plates, and were superior to all others. From these results it is evident that pickling the iron removes all the black oxide, while scrubbing does not. It is also shown that the red-lead unites with oil to form a hard, oxy-linseed-oil acid soap, a harder soap than that given by any other combination. The red-lead is shown by those experiments not to give way under the sealing; it is more adherent to the surface, more elastic and cohesive. On the Cincinnati Southern Railroad, experience extending over some years has shown that red-lead has proved the most durable paint in the many miles of iron trestle and bridgework. It is found that the iron oxide is washed away by the rain and perishes in spots, although a valuable paint if frequently renewed. Red-lead, on the other hand, is more expensive than iron oxide, and is difficult to be obtained pure. Referring to white-lead as a material for painting iron, one authority observes that white-lead should not, if possible, be used in priming iron, nor in any priming coat; moreover, it is a less desirable overcoat than iron oxide. The class of iron paints compounded of ores of natural iron rust, combined with clay or some other form of silica, are very useful, as they contain no water nor sulphuric acid. Magnetic oxide, or pure iron oxide, is an excellent protection for iron, says one writer; it is impossible to scrape it off. It is also of value in woodwork, and resists the action of salt water and sulphurous gases, so destructive to most paints. There is no doubt the great protective element in paint is the oil, and the conditions required for success are stated to be to prevent the drying part of the oil from becoming hard dry; the soft-keeping, non-drying acids must be kept from flying away in such a quantity as to reduce the oil to a brittle mass. In other words, the elastic qualities of the oil must be protected from the action of the oxygen. According to Louis Matern, red-lead possesses the following advantages for the preservation of the iron, which is the main object to be gained:—(1) It dries easily with raw linseed-oil, without an oil-destroying drier. All known driers decompose oil. (2) After drying, it remains elastic, giving way both to the extension and contraction of the iron, without causing the paint to crack. (3) It imparts no oxygen to iron, even when constantly exposed to damp. (4) It hardens, where it has been spread thickly, without shrivelling, forming the toughest and most perfect, insoluble combination of all paints.

Lead paints.—For white-lead paint, the best pure white-lead is chosen, kept secure

from the air. It possesses good covering power, but blackens in contact with air containing sulphuretted hydrogen, and is injurious to those using it. Coloured lead paints consist of a basis of white-lead with a certain quantity of colouring pigment, separately ground in oil, and added to the 2 last coats. When the white-lead is bought dry, it must be ground up with raw linseed-oil by means of a stone muller on a marble slab. The thick paste thus produced is thinned and softened by adding a little oil and turps and working well with a palette knife. The colouring pigments are added at this stage, and the consistence is rendered creamy by adding more oil and turps; the whole is finally passed through a canvas strainer. Just before use, it is thinned down to a working consistence by adding more oil and turps, and the driers are then introduced.

Lime paints.—(a) For deal floors, wood, stone, and brick work. Dissolve 15 dr. good glue by boiling with thickish milk of lime, which contains 1 lb. caustic lime. Then add linseed-oil just sufficient to form a soap with the lime. This mixture can be used for making up any colour which is not altered by lime. A solution of shellac in borax can be added for brown-red or brown-yellow colours, and is very suitable in painting deal floors. With a coating of varnish or lake, the substances thus painted assume a fine lustre. They can be polished with linseed-oil or turpentine.

(b) A lime paint which will bear washing. 3 parts flint, 3 marble fragments and sandstone, 2 calcined white china-clay, and 2 slaked lime, all in powder, furnish a paint to which chosen colours, that may be employed with lime, are added. This paint, by repeated applications, becomes as hard as stone, without losing porosity.

Silicated.—When the surface to be painted is of a mineral nature, such as the exterior of a house, the pigments may be mixed with a vehicle consisting chiefly of water-glass, or soda or potash silicate. This method of painting requires some care, and a knowledge of the chemical nature of the pigments used. Some colours are completely destroyed by the alkali contained in the water-glass. Among those pigments which are not altered by the alkali may be mentioned lime carbonate, baryta white, zinc white, cadmium yellow, Naples yellow, baryta chromate, chrome red, red ultramarine, blue ultramarine, cobalt blue, cobalt green, chrome green, ivory black. When a wall is to be painted, it should first be prepared with a mortar composed of pure fat lime and clean sharp sand. The water used should also be free from saline impurities, as these might subsequently effloresce and destroy the surface of the paint. When the surface of this plaster is dry, a weak solution of water-glass should be applied, and the operation repeated several times. A strong solution cannot be used, because it forms a thin skin on the surface of the plaster, which closes the pores, and prevents the penetration of the water-glass. The pigments are rubbed down with a very weak solution of water-glass, and applied in the ordinary manner. When thoroughly dry, the painted surface is treated with a warm solution of potash silicate applied in the form of a spray. Soda silicate may also be used, but the soda carbonate which is then formed is liable to cause efflorescence. A pigment fixed on the surface of a wall in this manner is as durable as the wall itself, and can be exposed to the weather without any fear of deterioration.

Steatite paint.—In the United States this is made from a native hydrated magnesia silicate, and is applied to ships' bottoms, to walls for preventing dampness, and to roofs for making them fireproof.

Tin roofing, paint for.—Perhaps the best paint for a tin roof is made from common Spanish brown, Venetian red, or yellow ochre, mixed with either pure raw linseed-oil, or equal parts linseed and fish oils; the only partial drying of the latter causing a degree of elasticity in the coat of paint, which prevents its cracking during the expansion and contraction of the metal.

Transparent paints.—If in a position to coat the glass before putting in frame, excellent effects may be got by using ordinary shellac varnish (made with bleached

shellac) tinted with aniline dye. The glass must be slightly warmed before applying the varnish. The strongest spirit of wine should be used for dissolving the shellac and the powdered (not liquid) aniline colours. Sufficient of the colour must be added to the varnish to give the required tint: 1 part of shellac to 8 of spirit is a good proportion. Methylated spirit will do. The varnish should be poured on and placed evenly over the glass (not painted on), and the superfluous quantity returned to the bottle.

Tungsten paints.—The mineral colours from tungsten are obtained by decomposing soluble tungstates by means of salts of the metals yielding insoluble phosphates. The tungstate of nickel produces a light green, tungstate of chromium a dark grey, tungstate of cobalt a violet or indigo blue, and tungstate of barium a bright white colour. Tungstic acid alone gives a fine light greenish-yellow. All these colours may be employed for water- or oil-colour paints; the last is a really desirable and probably quite unchangeable colour.

Window-paint.—Mix with white-lead, boiled oil or varnish, and a small quantity of driers (no turps, which hardens for the time, being a volatile oil, and therefore objectionable in this case); paint this over the glass thinly, and stipple it. If you have not a proper brush, make a large pledget of cotton wool or tow, cover it with a clean bit of linen rag, and quickly dab it over the paint.

Zinc, paint for.—The difficulty of making oil colours adhere to zinc is well known. Some time since, Prof. Böttger published a process which consists in applying with a hard brush a mordant composed of 1 part copper chloride, 1 copper nitrate, 1 sal-ammoniac, and 64 water, to which is added afterwards 1 hydrochloric acid. The zinc immediately becomes intensely black, which changes in drying (12 to 24 hours) to a dirty whitish grey, on which oil colours may be laid, and to which they will adhere firmly.

Composition of Paints.—The composition of paints should be governed—(1) by the nature of the material to be painted: thus the paints respectively best adapted for wood and iron differ considerably; (2) by the kind of surface to be covered—a porous surface requires more oil than one that is impervious; (3) by the nature and appearance of the work to be done: delicate tints require colourless oil, a flatted surface must be painted without oil (which gives gloss to a shining surface), paints for surfaces intended to be varnished must contain a minimum of oil; (4) by the climate and the degree of exposure to which the work will be subjected: for outside work boiled oil is used, because it weathers better than raw oil, turps is avoided as much as possible, because it evaporates and does not last; if, however, the work is to be exposed to the sun, turps is necessary to prevent the paint from blistering; (5) the skill of the painter affects the composition; a good workman can lay on even coats with a smaller quantity of oil and turps than one who is unskilful; extra turps, especially, are often added to save labour; (6) the quality of the materials makes an important difference in the proportions used: thus more oil and turps will combine with pure than with impure white-lead; thick oil must be used in greater quantity than thin; when paint is purchased ready ground in oil, a soft paste will require less turps and oil for thinning than a thick; (7) the different coats of paint vary in their composition: the first coat laid on to new work requires a good deal of oil to soak into the material; on old work, the first coat requires turpentine to make it adhere; the intermediate coats contain a proportion of turpentine to make them work smoothly; and to the final coats the colouring materials are added, the remainder of the ingredients being varied according as the surface is to be glossy or flat.

The exact proportions of ingredients best to be used in mixing paints vary according to their quality, the nature of the work required, the climate, and other considerations. The composition of paint for different coats also varies considerably. The proportions

given in the following table must only be taken as an approximate guide when the materials are of good quality:—

TABLE showing the COMPOSITION of the different COATS of WHITE PAINT, and the QUANTITIES required to cover 100 yd. of NEWLY-WORKED PINE.

	Red-lead.	White-lead.	Raw Linseed-oil.	Boiled Linseed-oil.	Turpentine.	Driers.	REMARKS.
<i>Inside work,</i>							
<i>4 coats not flatted.</i>							
Priming	1 $\frac{1}{2}$ lb.	16 lb.	6 pt.	1 lb.	Sometimes more red-lead is used and less drier. * Sometimes just enough red-lead is used to give a flesh-coloured tint.
2nd coat *	15	3 $\frac{1}{2}$..	1 $\frac{1}{2}$..	
3rd coat *	13	2 $\frac{1}{2}$..	1 $\frac{1}{2}$..	
4th coat	13	2 $\frac{1}{2}$..	1 $\frac{1}{2}$..	
<i>Inside work,</i>							
<i>4 coats and flattng.</i>							
Priming	1 $\frac{1}{2}$	16	6	..	$\frac{1}{2}$	1-8	When the finished colour is not to be pure white, it is better to have nearly all the oil boiled oil. All boiled oil does not work well. For pure white, a larger proportion of raw oil is necessary, because boiled oil is too dark.
2nd coat	12	4	..	1 $\frac{1}{2}$	1-10	
3rd coat	12	4	1-10	
4th coat	12	4	1-10	
Flattng	9	3 $\frac{1}{2}$	1-10	
<i>Outside work,</i>							
<i>4 coats not flatted.</i>							
Priming	2	18 $\frac{1}{2}$	2	2	..	1-8	
2nd coat	15	2	2	..	1-10	
3rd coat	15	2	2	..	1-10	
4th coat	15	3	2 $\frac{1}{2}$..	1-10	

For every 100 sq. yd., besides the materials enumerated in the foregoing, 2 $\frac{1}{2}$ lb. white-lead and 5 lb. putty will be required for stopping. The area which a given quantity of paint will cover depends upon the nature of the surface to which it is applied, the proportion of the ingredients, and the state of the weather. When the work is required to dry quickly, more turpentine is added to all the coats. In repainting old work, two coats are generally required, the old paint being considered as priming. Sometimes another coat may be deemed necessary. For outside old work exposed to the sun, both coats should contain 1 pint turpentine and 4 pints boiled oil, the remaining ingredients being as stated in the foregoing table. The extra turpentine is used to prevent blistering. In cold weather more turpentine should be used to make the paint flow freely.

Measuring Painters' Work.—Surface painting is measured by the superficial yd., girting every part of the work covered, always making allowance for the deep cuttings in mouldings, carved work, railings or other work that is difficult to get at. Where work is very high, and scaffolding or ladders have to be employed, allowances must be made. The following rules are generally adopted in America in the measurement of work:—Surfaces under 6 in. in width or girt are called 6 in.; from 6 to 12 in., 12 in.; over 12 in., measured superficial. Openings are deducted, but all jambs, reveals, or castings are measured girt. Sashes are measured solid if more than 2 lights. Doors, shutters, and panelling are measured by the girt, running the tape in all quirks, angles,

or corners. Sash doors measure solid. Glazing in both windows and doors is always extra. The tape should be run close in over the battens, on batten doors, and if the stuff is beaded, add 1 in. in width for each bead. Venetian blinds are measured double. Dentels, brackets, medallions, ornamented ironwork, balusters, lattice work, palings, or turned work, should all be measured double. Changing colours on base boards, panels, cornices, or other work, one-fourth extra measurement should be allowed for each tint. Add 5 per cent. to regular price for knotting, puttying, cleaning, and sandpapering. For work done above the ground floor, charge as follows:—Add 5 per cent. for each storey of 12 ft. or less, if interior work; if exterior work, add 1 per cent. for each ft. of height above the first 12 ft.

Painters' Cream.—This is a preparation sometimes employed by painters when they are obliged to leave work unfinished for a length of time. Cover the already painted parts with it; it will preserve the freshness of the colours, and can be easily removed on returning to the work. It is made as follows:—Take $\frac{1}{2}$ oz. best mastic, finely powdered, and dissolve it over a gentle fire, in 3 oz. very clear nut-oil. Pour the mixture into a marble mortar, with 2 dr. pounded sugar of lead at the bottom. Stir with a wooden pestle, and keep adding water in small quantities till the whole has the appearance and thickness of cream, and refuses to admit more water, so as to mix freely.

Wall Painting.—If a plastered wall be new, and has not been whitewashed, it will do to size it with glue water; but if it has been kalsomined or whitewashed, which is often the case, no glue sizing should ever touch it. Any preparation of that kind is liable, sooner or later, to peel off and spoil the surface for any future finish. A safer way is to take oil and coat the whole surface before painting, which makes a fast union of any wash to the wall. On such a base oil paints will adhere perfectly. But the principal trouble in painting walls is found in the defective character of the plastering. If one is building a house, he can place the studding 12 in. from centre to centre, so that strong laths will not spring and break up the mortar at every pressure. The laths, too, should be spread $\frac{1}{4}$ in. apart, and the mortar have 12 lb. of hair to the barrel of lime. This will make a wall that will stand like the walls of a house plastered 100 years ago. The reason why the plastering falls off from our modern houses is because the laths are laid so close that the immediate swelling cuts off the clinch, and the mortar is usually too sandy, and has but 6 lb. of hair. On such a surface are laid 3 coats, when the clinch will fail to hold. Professional lathers or masons themselves ought to lay the laths and be sure of a large spread; then if the mortar is strong or rich, with plenty of hair, there can be no falling off. If the work is well done, the ceiling as well as the side walls may be painted to advantage. When any portion becomes soiled or smoked, it will then be an easy matter to wash it off. Rooms once thoroughly prepared in that way last for a lifetime, and always look substantial and neat. In case of cracks, make some putty of the same colour as the paint and fill up.

The following remarks are condensed from an interesting paper on mural painting by Rev. J. A. Rivington, read before the Society of Arts.

Fresco-painting, properly so-called, is the process of painting in water-colours upon wet mortar containing lime. In this process, the action of the carbonic acid in the atmosphere converts the lime of the mortar into carbonate of lime, and this latter it is which forms the preservative or fixing medium for the colours. The carbonic acid is driven out of the limestone or chalk originally by the process of burning, and the lime remains. When slaked, the lime is converted into a pulp of hydrate of lime. In this form it exists in the mortar, and greedily absorbs the water with which the colours are applied. This water, together with that already in the mortar, dissolves a portion of the hydrate of lime, and after a time this solution finds its way, through the supervening layer of colour, to the surface, where it absorbs carbonic acid gas from the atmosphere. By this means it becomes converted into carbonate of lime, and lies upon the surface of the painting in the form of a thin crystalline film, protecting and securing it to such a

degree that it will admit of being washed, provided no great amount of friction be employed.

Experiment has shown that in fresco-painting the colour does not sink farther into the ground than in the case of any water-colour laid on a dry ground. On the contrary, the pigment becomes saturated with the solution of hydrate of lime which exudes from the mortar, and which can only become converted into a film of carbonate of lime on the surface; beneath this, the adherence of the pigment to the mortar is very slight, as may be easily proved when the crystalline film has been scraped off, or dissolved away by the application of an acid, or even removed, as is sometimes possible, by merely rubbing the surface with the moistened finger. After the removal of the protecting film of carbonate of lime by some such means, the pigment gives way readily when rubbed with the finger, and with even still greater readiness if moisture be also applied. A very striking illustration of this is afforded by the fate of the frescoes executed about 18 or 20 years ago on the exterior of the new Pinakothek in Munich. On the northern and eastern sides, the hail and rain have destroyed and washed away not only the protecting film of carbonate of lime, but also almost every vestige of colour. The tendency to peel off in flakes, which paintings executed in fresco have often shown, admits likewise of a very simple explanation.

As a consequence of the greedy absorption by the mortar of the water contained in the pigments, the particles of the latter adhere mechanically to the surface of the mortar by capillary attraction, and that so closely as to permit of a second layer being very shortly after laid upon the first, without mixing with it in any way. Similarly, the second layer will admit of a third being superimposed. All 3 layers now become saturated with the solution of hydrate of lime, and are united by a real process of cohesion. This process is, however, only in the highest degree perfect where the superimposed layers have been applied before the hydrate of lime has completely penetrated the pigments. In those cases where it has so penetrated, and the crystalline film has already partly formed, the saturation cannot be so perfect; and where colours have been laid on after the film is fully developed, these can only adhere to the surface in a very imperfect degree. It follows that damp, or other causes, are sufficient to induce them to peel off very readily from the more firmly attached layers beneath.

The more or less inefficient modern substitutes for fresco are infinitely less deserving of respect. Most of them, if not all, such as wax colour, casein, as employed abroad, do not profess to be capable of resisting the influence of weather, when exposed to the open air. They are, therefore, only comparatively permanent, even when used for interior decoration, and may be dismissed without further mention.

Gambier Parry's process of "spirit fresco" appears to possess merits beyond such methods as are employed abroad, but, like them, it is not intended for exposure to the open air, and cannot enter into competition with Keim's process. It is, perhaps, unnecessary to remark that the only sure guarantee for the permanence of any painting must rest its claims on a thoroughly scientific observance of, and adherence to, the laws of chemistry. Unless the painting is executed under conditions which can be proved to comply with the demands of chemical laws, its permanence is a mere matter of haphazard experiment, and a perfectly open question, which even the test of time itself can hardly settle conclusively, since, without a thoroughly scientific basis, there is no real guarantee that the conditions will not vary. A substitute for fresco-painting has been adopted of late years in this country, for paintings on a small scale, by the employment of oil colours, with a matt medium to destroy the gloss peculiar to oil pigments, and to impart the dead surface so necessary to mural decorative paintings. Very little consideration is required to show that this method presents, perhaps, the least guarantee of any process, for the permanence of the painting. In oil colours, it is the oil which, by filling the pores of the pigments, serves at once as a preservative and binding medium, while the varnish forms an additional protection against atmospheric influence. The

various mediums used to destroy the characteristic effect of oil, effect this by expelling or neutralizing it. The volatile elements of the mediums then evaporate, leaving the pores open for the chemical action of carbonic acid gas, sulphuretted hydrogen, or any other deleterious agent in the atmosphere, to destroy the colour, while little or nothing remains to bind the substance of the pigments together. The comparatively rapid ruin of such paintings is the only possible result.

Keim's process claims attention as being the result of nearly 12 years' thoroughly scientific labour and research on the part of the inventor, and is based on the stereo-chrome process of Schlotthauer and Fuchs, differing however from that in such important particulars as to constitute, practically, an entirely new process of itself.

In 1848, Prof. Schlotthauer, of the Munich Academy, who had for some time been engaged in experiments with a view to discovering some permanent process for mural paintings, turned his attention to the substance known as water-glass (sodium silicate), the invention of the chemist Fuchs. The result was the adoption of the stereo-chrome process. In this process the surface to be painted on consisted of an ordinary mortar of lime and sand, impregnated with water-glass. Upon this surface the painting was executed in water-colour, and was then fixed by water-glass thrown against the surface in the form of a fine spray, the water-glass in this case forming the fixative for the painting. In practice, it soon became evident that a simple spraying of water-glass, applied to heterogeneous pigments, without reference to their peculiar properties as regards chemical composition, cohesive capability, &c., was not sufficient to ensure their permanence. Certain colours in particular, as ultramarine, umber, and black, were observed to be always the first to detach themselves in the form of powder, or by sealing off from the painting; thus pointing to the fact that their destruction was not owing to any accidental defect in the manner of their application, but to some radical unsuitability arising from the chemical conditions of the process.

In Keim's process regard is paid in the first instance to the ground upon which the painting is to be executed. A careful study of the best examples of the fresco paintings of former times, convinced him that the painting ground was a feature of supreme importance. The wall to be treated must contain no damp or decaying stones or bricks, and the latter must have been sufficiently baked, otherwise they will develop an efflorescence most injurious to the process. If the wall be already covered with stucco or mortar, this will serve as the first ground, provided it be in a thoroughly sound and dry condition, and it will then be sufficient to clean and level it before applying the second, or painting ground. If not, the stucco must be cleared off, the bricks laid bare, and the mortar between the bricks picked out to a depth of about $\frac{3}{4}$ in.

This more thorough preparation is always preferable in a work of greater importance, or where special pains are advisable to secure durability, as, for instance, when undertaking the exterior decoration of a building. Upon this surface a thin squirting is cast, composed of the following mortar—coarse quartz sand, infusorial earth, and powdered marble, mixed in certain proportions. Of this mixture 4 parts are taken to 1 of quicklime, slaked with distilled water. Upon this squirting-cast, the object of which is to secure adhesion to the surface of the wall, follows mortar of ordinary consistency, composed of the same ingredients, to fill up all inequalities and produce a smooth surface, and upon this, again, the second or painting ground is applied.

The painting ground is composed of the finest white quartz sand, marble sand, artificially prepared, and free from dust, marble meal, and calcined fossil meal (infusorial earth). The sand composed of these materials, carefully mixed in the proper proportions, is mixed with quicklime slaked with distilled water, in the proportion of 8 parts sand to 1 of slaked lime. This mortar is applied to the wall as thin as possible, not exceeding $\frac{1}{2}$ to $\frac{1}{4}$ in. in depth.

For work executed on the exterior of buildings, Keim recommends the employment of pumice sand, in addition to the other ingredients of the mortar. When coated with

a stucco of this composition, the wall presents so hard a surface as to admit of sparks being struck from it with a steel. It is absolutely essential that throughout the work, only distilled or filtered rain-water be employed. The reason for this is to obviate any possibility of the water containing lime, as that would affect the solution employed for fixing so as to impair the effect of the painting.

In this process Keim not only is careful to follow the best examples of antiquity in the manner in which the stucco is laid on the wall, but he has adopted the use of a mortar composed of carefully selected materials, in preference to that of an ordinary kind, such as was employed in the stereo-chrome process. The object of this is to attain a far higher degree of durability. The nature of the sand selected for this purpose is eminently calculated to ensure this. Marble sand, such as he employs (calcium carbonate in crystalline form), has been proved by experiment to add very greatly to the firmness of the mortar, containing many advantages above quartz sand, such as greater porosity for the absorption of the colours and fixing liquid, &c. Again, the infusorial earth mixed with it (a form of silica) has a double effect in consolidating the mass. First, it acts mechanically, cementing and binding together, with the lime, the coarser particles. Secondly, it forms, to some extent, with the lime, a calcium silicate, such as afterwards results from the addition of the water-glass. The presence of this silicate within the mortar adds, in a very high degree, to its hardness and power of resistance to chemical and mechanical influences.

When the mortar is perfectly dry, down to the stone or brick of the wall, it is treated to a solution of hydro-fluo-silicic acid, to remove the thin crust of crystalline lime carbonate which has formed on the surface, and thus to open the pores. It is then soaked with 2 applications of potash water-glass (potassium silicate) diluted with distilled water, and when dry, the ground will be found hard, but perfectly absorbent, and ready for painting.

The surface layer of mortar, or painting ground, can be prepared in various degrees of coarseness of grain to suit the artist's requirements. The more smooth and polished, however, the surface is made, the greater are the difficulties in the subsequent process of fixing, owing to the absorbent qualities of such a ground being necessarily less perfect. The ground can also be prepared in any tint or colour that may be desired, and can be applied to any suitable substance, if needed for a removable decoration. Stone, tile, slate, wire-gauze, glass, and canvas form efficient substitutes for the wall in such cases. If applied to canvas, it can in this form be fixed to wood panels, millboard, ceilings, &c., and admits of being rolled with perfect safety. The advantage of this to the artist is sufficiently obvious. If a ceiling, for instance, has to be decorated by this process, it can be painted with the same convenience as an ordinary picture in the studio. After it is fixed, it can be rolled up, taken to its destination and fastened on to the ceiling, either temporarily or permanently, at the cost of very little expenditure of time or labour. Similarly (unless it were permanently fastened up), the ceiling would admit of being removed for the purpose of being cleaned.

As to the colours used in this process. Certain pigments only are admissible, in order to ensure permanence, and regard must be had to the purity of these, and to their absolute freedom from adulteration. All the colours found available for the stereo-chrome process can be employed; these are, for the most part, composed of natural earths or metallic oxides, since experience has proved that the most permanent colours are those derived from such sources. In their preparation, due account has been taken of the well-known law in optics, which teaches that colour does not lie in the substances themselves, but in the rays of light, which are divided, reflected, or absorbed by the substances in such a manner as to produce the effect of colour upon the eye. Substances, therefore, which readily undergo change, whether by reason of their affinity to other substances with which they are brought into contact, or by the action of the light itself, which often causes molecular change, must, whenever such change takes place, lose or

modify their original colour, since under their altered conditions they absorb or reflect the ray of light in a different manner.

It is clearly then of the greatest importance that each pigment should remain chemically unaffected by the substance of the painting ground on which it is laid, and by the substance of any other pigment employed, as well as by that of the material used for fixing them. To meet this end, the colours in this process are treated beforehand with alkaline solutions (of potash or ammonia), to anticipate any change of hue which might result from the use of the alkaline liquids which form the fixative. In addition to this, they are further prepared with certain other substances, such as zinc oxide, baryta carbonate, felspar, powdered glass, &c., as required by the peculiar properties of each, in order to obviate any other danger of chemical change taking place.

The colours found available present a very full scale. They are 38 in number, and there are several other colours which could be added if required. They consist, speaking in general terms, of 4 varieties of white, 6 of ochre, 2 of sienna, 10 of red, 2 of brown umber, 2 of Naples yellow, 2 of ultramarine, 5 of green, 3 of black, and cobalt blue. Cadmium will shortly be added to them. The whites are, perhaps, in unnecessary profusion. Zinc white, for its opaque qualities, and baryta white for purposes where great opacity is not desirable, would be probably found quite enough in practice.

Zinc white is especially valuable in this process, forming a silicate in combination with the fixing solution, and thus adding greatly to the hardness and durability of any colours with which it is mixed.

Baryta white is useful for giving a lighter tone to colours without greatly detracting from their transparent qualities, and is on this account useful in glazing, where zinc white would be too opaque.

The reds are chiefly oxides. The chrome is a lead sub-chromate. This colour is prepared in dry powder instead of in a moist paste, as in the case of the others. The reason for this lies in the fact that the colour depends on the size of the crystals, which would be destroyed by further grinding, with the result of the pigments assuming an orange hue. It will therefore only admit of being mixed with water by the means of the brush.

The lake is only suitable for interior decoration, and has been prepared by Keim, under protest, for artists who found themselves unable to forego its use. He does not guarantee its permanence if exposed to weather in the open air. He has proposed an ultramarine red as an efficient substitute.

The colour named *menüig* is a lead oxide.

The umber is an iron and manganese oxide, combined with silica.

The Naples yellow is a compound of lead oxide and antimony, or lead antimoniate.

The ultramarine is artificial, and consists of silica, alumina, and sodium sulphate.

The cobalt blue is cobalt protoxide, compounded with alumina.

The cobalt green is cobalt protoxide, in combination with zinc oxide.

The green earth consists chiefly of silicic iron protoxide. It also contains magnesia alumina, and potash.

The chrome oxide green is chromium oxy-hydrate.

Over no part of his process has Keim expended more labour and thought than in the preparation of the colours. From the various nature of the properties possessed by some of the pigments, it was found that their capacity for absorbing the alkaline silicate with which they were fixed varied very greatly. There was also a marked difference in the degree of mechanical cohesive capacity which they respectively possessed. To equalize them in these respects, without which the fixing would have been a work of great difficulty and uncertainty, alumina, magnesia, and silica hydrate were added as required. The result is, that all the colours are equally acted upon by the fixing solution, and all attain an equal degree of durability after fixing, both as regards the mechanical and chemical action of this process upon them.

It is significant of the success which has attended Keim's thorough appreciation of the requirements of the pigments, that his labours in this direction have so perfectly adapted them to the chemical condition of the ground as to show that, to a very appreciable extent, fixation will be found to have already taken place before even the application of the solution employed for that purpose.

In 1878, a large mural painting was executed by this process on the exterior of the parish church at Eichelberg, near Regensburg. Before its completion, and therefore before any of the fixing solution had been applied to it, it was drenched by a heavy storm of rain. Contrary to anticipation, it was found that the painting, so far from being in any degree washed away, had held perfectly firm, and even in some places seemed to be as hard as if already fixed. Keim's explanation of this unexpected result, which he subsequently confirmed by experiments, was, that a chemical cohesion had already taken place by the action of the alkali set free in the mortar upon the silicates in the pigments.

Again, when it was determined to execute the mural paintings in the Franciscan Monastery, at Lechfeld, in 1879, it was desired to wash off a painting executed in this process a year previously, which had never been fixed. Neither water, nor even a tolerably strong solution of acetic acid, had the slightest effect upon it.

So far from approaching in any degree the difficulties or inconveniences possessed to a greater or smaller extent by fresco-painting, or any of its more modern substitutes, this process is even far pleasanter and easier to work in than oils or water-colours. Every variety of treatment is possible, and it adapts itself to any individual style of painting. It presents perfect facility for transparent glazing as a water-colour; and for painting in body colour it even surpasses the capabilities of oil colours in its power of opaque treatment.

The most delicate tints, when laid over darker tones, do not in the slightest degree darken over them, as they are apt to do in oils, but keep their full value perfectly. Retouching and correction can be effected with the greatest ease, and to an almost unlimited extent. The system admits also of great economy. To begin with, the pigments are by no means expensive, in spite of the labour expended on their preparation, and a very sparing use of them is sufficient to meet all possible requirements in painting, a far less amount requiring to be expended than in other processes. This is due mainly to their being ground so exceedingly fine, so that they need only be very thinly laid on; in fact, this consideration has always to be borne in mind, that the thinner the coat of painting is, the greater the degree of security that can be attained by the fixing. Moreover, there need be no waste of pigment at the end of the day's work, as in oils. The palettes employed for the process are constructed with small pans to hold the pigments. If any paint remains after the work is finished, it can either be replaced in the bottle, or it can be kept moist in the pan with distilled water for the next day's work. Even if a considerable amount of the pigment should by inadvertence have been allowed to become dry, all that need be done is to grind it up again with a little distilled water, a task involving no labour. The process has the further recommendation of great cleanliness, distilled water being the only medium used in painting. The porous nature of the ground, and its peculiar texture, have had great fascination for those who have made practical acquaintance with the working of it.

The last stage in the process is the work of fixing. In the stereo-chrome process the fixing medium employed was potash silicate, thoroughly saturated with silica, in combination with sufficient sodic silicate to prevent it from opalescing. The chief defect of this lay in the fact that it was often apt to produce spots upon the painting. Keim has substituted potash silicate treated with caustic ammonia and caustic potash. The action of the carbonic acid in the atmosphere and in the water during the process, leads to the formation of carbonated alkali, which makes its way to the surface, and would form, when dry, a whitish film over the painting. To obviate this danger, as well as to

expedite the process of converting the potash silicate with the basic oxides existing in the substance of the painting into silicate, the fixing solution is treated further with ammonia carbonate. The effect of this upon potash silicate is that silica is precipitated in a fine gelatinous form, and ammonia set free. This latter volatilizes, and potash carbonate is formed, which is easily removed by washing after the completion of the fixing.

Having regard to the value of heat in accelerating the action of chemical processes, the fixing solution is employed hot, with the advantage of obtaining a quicker and more perfect formation of silicate than was possible in the stereo-chrome process, where the solution was applied cold.

The effect of the fixing is not very difficult to understand. It has been already pointed out, in speaking of the pigments, that the result of their being treated with certain substances is to effect the formation of silicate, both in the constituent parts of the pigments themselves, as well as of those in combination with the painting-ground. The additional presence of the fixing solution intensifies this process to the greatest extent. The free alkali of the solution acts upon certain of the substances which have been added to the pigments—such as zinc oxide, alumina hydrate, and silica hydrate—at first by dissolving them. By the action of the carbonic acid in the atmosphere, these solutions are again decomposed by parting with the hydrates, which, through this process, are converted into silicates. The pure colours are enclosed in these silicates; whenever that is, the pigments themselves do not take part in the formation of silicate.

The hardening process of mortar has been described—in speaking of fresco-painting—to be due to the formation of a crust of lime carbonate upon the surface. The action of the fixing solution in Keim's process, when applied before and after the painting, is to form, in addition, a calcium silicate with the particles of lime, the presence of which within the mortar increases beyond comparison the hardness and durability of the whole; calcium silicate, no less than lime carbonate, being, as is well known, a constituent of some of the hardest marbles.

Briefly described, then, the effect of the fixative as it sinks into the ground, which has already absorbed the pigments, is to convert the painting into a veritable casting, uniting with colours and ground in one hard homogeneous mass of artificial stone, partaking of the nature of marble in its power of resistance to mechanical disturbance, partaking of the nature of glass in the impervious front it presents to the chemical action of the atmosphere.

The finished painting has proved itself absolutely impervious to all tests. It will admit of any acid, even in a concentrated form, being poured over it (save, of course, hydrofluoric acid). Caustic potash, also, has no effect upon it; indeed nothing can be employed with greater advantage than this for cleansing the painting when its condition requires that process. Soap and water may be applied with a hard brush, as vigorously as desired. The surface is so hard as to present a perfect resistance if scratched with the finger-nail. The hardness and durability of the finished painting have been subjected to very severe trials abroad. It has defied the elements in very bad climates, having been exposed to the weather on the exterior of buildings for some years. In Munich a specimen of the process was subjected to incessant tests for 2 years, and, at the end, was as fresh and uninjured as at the beginning.

Graining.—This branch of the painter's art consists in imitating the grain, knots, &c., of different woods. The following is an outline of the process. If there are any knots or sappy places in the article, they should be covered with one or two coats of glue size, or parchment size, to prevent them showing through. The work is then ready for the paint, three different shades being necessary. These are called the ground colour, the stippling colour, and the graining or oil colour, and they are laid in the order named. An infinite number of combinations of colours is possible, obtained by the use

of various colouring pigments in the different coats, and no two grainers agree as to the precise proportion of the ingredients to be used in imitating different woods; the learner can vary the proportions to suit his taste, as experience dictates, and to suit the work in hand. The ground colour is used to represent the lightest part of the grain of the wood, the stippling colour the intermediate shades, and the graining colour the darkest parts; a close study of natural woods will, therefore, be necessary to determine the colour and depth of each. The proper ground being selected, apply one or more coats—as many as are necessary to thoroughly cover the surface. As soon as the ground colour is hard, the stippling coat may be applied. This is prepared by mixing the dry pigments without oil, with either very thin gum-water, stale beer, or vinegar containing a small portion of dissolved fish-glue. The pigments to be used are usually about the same as those used for the ground colour, but of different proportions to produce a deeper shade. Apply the stippling colour, and before it dries beat it softly with the side of the stippler, the long elastic hairs of which, disturbing the surface of the laid coat, cause the lighter coat beneath to become indistinctly visible, and produce the effect of the pores of wood. Next apply the graining colour; as soon as it is laid, take the rubber and with it wipe out the larger veins to be shown, after each stroke wiping the paint from the rubber with a cloth, held in the other hand, for that purpose. Some grainers use a small sponge for veining, and others a small piece of cloth over the thumb, but the rubber is probably the most convenient. When the veins have been put in, to imitate as closely as possible the markings of natural wood, the various steel combs are brought into use, and the edges of the veins, and sometimes other portions of the work, combed with them, to soften the abrupt transition from the dark to the lighter shades. The blender is also now brought into use, and wherever the work may require it, the colours are still more softened and blended by its soft hairs. When too much colour has been removed in veining, or when a certain figure, such as a knot, is required, the work is touched up with a fine brush, and again softened with the blender. When dry a coat of transparent varnish should be applied, having considerable oil to render it durable, as grained work is frequently washed. Ready-made graining colours are recommended as best and cheapest.

Colours.—In ground colours the essential condition is to have them light enough; the same tint will do for ash, chestnut, maple, light oak and satinwood, but a deeper tone is needed for black walnut. The most important point is to have the ground smooth and uniform. Graining colours should be chosen from the very best qualities of umber, sienna, and Vandyke brown, according to the demands of the work.

Tools.—The implements employed by the grainer comprise, in addition to the ordinary painters' tools (a dusting brush and 2 or 3 flat fitches) for applying the graining colours to the groundwork, a badger-hair blending brush or softener, a set of combs, overgraining brushes suited for maple and oak, and a camels'-hair cutting brush for maple. You may add a large cotton rag, a sponge, a lining tool, a veining horn, and combing and graining rollers. The combs may be of steel or leather. A set of steel combs contains 3 of each size—1-in. wide, 2-in., 3-in., and 4-in., of fine, medium, and coarse teeth. A cloth put round a steel comb is often substituted for a leather comb.

STYLES OF GRAINING.—The various styles of graining differ according to the kind of wood which it is intended to imitate. These may be considered in alphabetic order, premising that as oak is the wood most commonly copied, the fullest details will be found under that head.

Ash.—Ash graining differs from light oak almost solely in the absence of the dapples found in the commoner wood. The ground colour is prepared in the same way, and the same system of combing and wiping is followed. Excellent ash-graining colour can generally be purchased to greater advantage than it can be made up.

Chestnut.—It is difficult to get the ground colour for chestnut sufficiently yellow: the best composition is white-lead, yellow ochre, and orange chrome. The graining

colour is composed of burnt umber with small quantities of burnt sienna and Vandyke brown. The operations followed resemble those with oak, a coarse comb being used.

Mahogany.—This wood demands a bright ground colour, which may be obtained by using deep orange chrome yellow and royal red, or vermilion, or orange mineral. Burnt sienna with a little Vandyke brown constitute the graining colour. The style of grain varies. Generally in panels “crotching” is resorted to. The cutter is used to take out the lights; and the fine lines are put in with the overgrainer, used almost in its normal condition, without being broken up into teeth, the lines running in a wavy pattern across the panel, like an inverted letter V. On the stiles and rails of the door, the blender is drawn over the fresh graining colour in a series of jerky strokes 3 or 4 in. long. When the first distemper colour is dry, a very thin coat of “quick rubbing” varnish is put on; this should be dry in a day or so, when a glazing colour of the same composition as the original graining coat is rubbed in, and stippled with the blender. A finishing coat of hard-drying coach-body varnish is flowed on with a thick badger brush.

Maple.—This is imitated in water-colours or distemper on a very smooth ground, using a white containing the smallest possible addition of raw sienna for the ground colour, and raw sienna mixed with a little Vandyke brown and burnt sienna for the graining colour. Fine sandpaper is employed for smoothing the ground, and the graining colour is applied in very small quantity to a patch at a time. The best way of taking out the lights is by means of the cutter already mentioned, drawn lengthwise over the work; blending follows in a crosswise direction. The overgrain colour is applied by a piped tool in which the pencils are separated, this being drawn longitudinally in an undulating manner. Putting in the birds’ eyes may be done by patting the wet work with the finger-tips, or by a piece of cloth rolled into a point.

Oak, light.—The best ground colour is white-lead tinted with raw sienna or golden ochre. This is preserved in a covered vessel, and sufficient only taken out to cover the area immediately wanted. This need be but a very small quantity; it is thinned before use by adding oil and turpentine and just enough boiled oil to delay the drying, so that the glazing coat can be applied on the following day. To hasten the drying, a little Japan size or drier is added. Instead of completing small sections of work, it is better to prepare a large surface with ground colour, so that it may commence to set before “wiping out.” This wiping out must precede the combing on veins and sap-wood, but follow it on dapples.

The complete mode of procedure for light oak graining a panel door is as follows. Apply the ground colour; when dry, smooth the surface with fine sandpaper. Rub in the graining colour uniformly with a medium stiff sash-brush; and stipple the beads, corners, and mouldings with a dry brush. Commence on the panels, and make opposite ones correspond; wipe out in streaks lengthwise with a cotton cloth, and then go over with combs of progressive fineness. Take out the lights to show the dapples, either by the veining horn or by a cotton cloth wrapped around the thumb. Next comb the mouldings plainly. The most work is usually put on the rails and stiles; begin with the middle stiles, and finish them before proceeding to the rails, which may be done all together. On the sap-wood or veined work, use the coarse comb as much as possible, and the wiping rag as little, remembering that here the wiping out precedes the combing. Allow the work to dry, rub down slightly with fine worn sandpaper, and apply the glazing coat. This is best ground up in water, the colours being a combination of raw and burnt sienna and Vandyke brown, mixed very thin, and used in very small quantity.

The tone may be varied to correct the appearance of the under coat; and as some parts of the work will require it thinner than others, it is well to have the colour on a palette, and thin it to requirements by wetting the brush. Rub in the glazing colour with a stiff brush, and remove any streaks by softening with a blender. Deal with only one panel at a time, or the glazing will dry ahead of you. Put in the top grain

with an overgrainer dipped into thin colour and then parted into a series of pencils by passing a comb through it; draw it lengthwise with a light hand, and soften down the result with a blender. Remember that the panels should be the lightest coloured portion of the door, and the mouldings the darkest, while the rails and stiles occupy an intermediate place in this respect.

To grain light work in distemper, which is not often done, proceed as follows. Lay on a coat of size and whiting; then a ground colour consisting of white-lead and golden ochre mixed with fine boiled oil; when this has dried (say in 2 days), add the graining colour, consisting of raw and burnt sienna and Vandyke brown, ground in water, and mixed with the same quantity of smooth flour paste; thin this down with water, brush it on, and comb one portion and have the other stippled by the whitewash brush to afford contrast; when all is dry, apply a heavy flowing coat of elastic varnish.

Oak, dark.—This differs from light oak graining only in the colours. The ground colour may be composed of white-lead, royal red, and golden ochre or chrome orange. The graining colour has the same constituents as for light oak, only in other proportions.

Rosewood.—For rosewood graining, the ground is rubbed in with crimson vermilion, then smoothed, and glazed with a coat of crimson lake or rose pink before putting in the grain. This is done with best ivory black, which can be bought ground in quick-drying vehicles, and needs letting down with raw linseed-oil. The graining coat is blended with the badger-hair pencil as fast as it is laid on. When quite dry, a very thin glazing coat of black is added.

Satinwood.—This is grained in distemper, using the same ground and graining colours as for bird's-eye maple, taking out the lights with a cutter, and putting on the overgrain as in mahogany.

Walnut.—The ground colour may consist of white-lead, golden ochre, black, and royal red, without fear of making it too bright. The graining colour should be preceded by a coat of deep black and Vandyke brown ground in water; and before it has set, this is stippled by dabbing with a dry bristle brush. On this is laid the walnut oil-graining colour, procurable at the shops, previously thinned with turpentine and boiled oil. When the graining coat has partially set, the veins and figures are put in, preferably with a fine hair pencil, and softened with the blender. This last having dried, say in a day or two, a glazing coat of deep black and Vandyke brown is put on and finished as in light oak.

Hints.—To prevent a graining coat from "cissing" at a water-colour overgraining coat, that is repelling the water by antagonism of the oil, rub the grain with a sponge dipped into a thin paste of fullers' earth or whiting, which will prepare an absorbent surface for the water colour.

The two kinds of graining, distinguished as distemper graining and oil graining, differ in the following respects. In distemper graining, the older branch of the art, the colours are thinned with stale beer, size, &c., and the varnishing coat can be added quickly; it is best adapted to hard close-grained woods. In oil graining, the colours are thinned with raw or boiled linseed-oil, turpentine, &c., and are better suited to the soft coarse-grained woods.

Marbling.—The decoration of painted surfaces so as to imitate natural marbles bears a close relation to graining in imitation of woods. It varies according to the figure of the marble simulated, the principal kinds being as follows.

Black and Gold.—The ground colour is black, laid on very smooth, and slightly oiled; the marble colour will be composed of white, ochre, orange chrome, Indian red, and black, in varying proportions. The marble colour is rubbed in in disconnected irregular patches by a large pencil, fine irregular lines being added both connecting the patches and crossing the general direction. An overgraining of dark and light lead colour may occupy the spaces between the fine lines, and a glazing of white touches will help to develop the patches.

Black Bardilla.—Use light lead colour as a ground, and put in a confused mass of fine lines in black by the aid of a feather; soften with a badger blender, and, when dry, glaze with thin white of unequal strength.

Derbyshire Spar.—Use light grey for a ground colour, and glaze it with a thin mixture of black and Vandyke brown, with a little Indian red at intervals. To simulate the fossils, use a stick with a piece of rag round it, then glaze with the same colours, and bring out the fossils by solid white and edging with fine black.

Dove.—The ground colour is a bluish lead. Put in streaks of black and white (ground in oil) alternately by dipping a feather into turpentine and then into the colour; soften with a blender, add a few white touches, and soften again.

Egyptian green.—The ground colour is black. Glaze over this with a very dark green from Prussian blue and chrome yellow, with a sash tool; on this streak with a lighter green on a feather, with a little Indian red interspersed, all in one direction; cross this with curling streaks of thin white, blend well, allow to dry, glaze with Italian pink and Antwerp blue, bring up the light streaks with touches of white, and finally blend again.

Granites.—The chief varieties are grey and red (Aberdeen). Rub in the ground colour of light grey for the former, or salmon tint for the latter. The marbling colours will be thin black for the former, and black, red, and white for the latter. These colours are put on in dots and splashes, either by stippling with a coarse sponge dipped in the colour, or by springing the colour from a short, stiff, broad brush.

Italian jasper.—Oil a ground of light green drab; rub in subcircular patches of a mixture of Victoria lake and Indian red; between these put in, with a feather dipped in turpentine, successive tints of olive green (white, raw sienna, and blue black), and grey (white, Prussian blue, and ivory black), blending well. The olive and grey tints are glazed with white, and the dark with crimson lake; and a final touching up is given with very thin white on a feather.

Royal red.—On an oiled ground of bluish grey, rub in a mixture of ochre and Indian red. Cover part of the work with a rich brown made from ivory black and Indian red, and scatter patches of black about by a paper pad dipped into the colour. Repeat the patching with light blue and with white; then wipe out a few irregular lines so as to show up the grey ground colour. Finally, glaze partially with black and Indian red.

St. Ann's.—Resembles black and gold, the ground being black, the veins white, and the spaces lead colour; the coloured patches are less in size and more numerous.

Sienna.—The ground colour is buff, made with ochre. The various marbling tints are made from the following ingredients:—A mixture of Indian red and ivory black for dark veins, with a few varying shades by the addition of white; a selection of graduated tints from white, Indian red, and Prussian blue. The glaze is made from raw sienna and ochre, with a trace of crimson lake at intervals. First put in the buff ground, and on this a pronounced irregular vein across the work of the first marbling colour, applied on a feather dipped in turpentine; lead a few veinlets from the main vein, and put in others with the second marbling colour, also on a turpentine feather; soften with a badger blender; on the dry surface rub a little linseed-oil with a silk rag; touch up with thin white on a feather; soften as before; add the glaze colour, and touch up the main vein with ivory black on a pencil.

Verd antique.—Cover an oiled black ground with dark green made from chrome yellow and Prussian blue; add, with a feather, patches of lighter green, with occasionally a little Indian red, interspersed with irregular blotches of black and white; on the dry surface, put a green glazing coat of Italian pink and Antwerp green; again touch up the whites, and give them a fine black margin.

STAINING.—There are many cases where an article constructed of wood may be more conveniently and suitably finished by staining and polishing than by painting. The practice of staining woods is much less common in America and England than on the Continent, where workmen, familiar with the different washes, produce the most

delicate tones of colour and shade. Wood is often stained to imitate darker and dearer varieties, but more legitimately to improve the natural appearance by heightening and bringing out the original markings, or by giving a definite colour without covering the surface and hiding the nature of the material by coats of paint. The best woods for staining are those of close even texture, as pear and cherry, birch, beech, and maple, though softer and coarser kinds may be treated with good effect. The wood should be dried, and if an even tint is desired, its surface planed and sandpapered. All the stains should, if possible, be applied hot, as they thus penetrate more deeply into the pores. If the wood is to be varnished, and not subjected to much handling, almost any of the brilliant mordants used in wool and cotton dyeing may be employed in an alcoholic solution; but when thus coloured it has an unnatural appearance, and is best used on small surfaces only, for inlaying, &c. The carbonized wood, of late years so much in vogue, is in many respects the most unsatisfactory of the stains, as the natural character and markings are completely blotted out, and it shows the least scratch or rubbing. Sometimes, in consequence of the quality of the wood under treatment, it must be freed from its natural colours by a preliminary bleaching process. To this end it is saturated as completely as possible with a clear solution of $17\frac{1}{4}$ oz. chloride of lime and 2 oz. soda crystals, in $10\frac{1}{2}$ pints water. In this liquid the wood is steeped for $\frac{1}{2}$ hour, if it does not appear to injure its texture. After this bleaching, it is immersed in a solution of sulphurous acid to remove all traces of chlorine, and then washed in pure water. The sulphurous acid, which may cling to the wood in spite of washing, does not appear to injure it, nor alter the colours which are applied.

Black.—(1) Obtained by boiling together blue Brazil-wood, powdered gall-apples, and alum, in rain or river water, until it becomes black. This liquid is then filtered through a fine organzine, and the objects painted with a new brush before the decoction has cooled, and this repeated until the wood appears of a fine black colour. It is then coated with the following liquid:—A mixture of iron filings, vitriol, and vinegar is heated (without boiling), and left a few days to settle. Even if the wood is black enough, yet for the sake of durability, it must be coated with a solution of alum and nitric acid, mixed with a little verdigris; then a decoction of gall-apples and logwood dyes is used to give it a deep black. A decoction may be made of brown Brazil-wood with alum in rain-water, without gall-apples; the wood is left standing in it for some days in a moderately warm place, and to it merely iron filings in strong vinegar are added, and both are boiled with the wood over a gentle fire. For this purpose soft pear-wood is chosen, which is preferable to all others for black staining.

(2) 1 oz. nut-gall broken into small pieces, put into barely $\frac{1}{2}$ pint vinegar, which must be contained in an open vessel; let stand for about $\frac{1}{2}$ hour; add 1 oz. steel filings; the vinegar will then commence effervescing; cover up, but not sufficient to exclude all air. The solution must then stand for about $2\frac{1}{2}$ hours, when it will be ready for use. Apply the solution with a brush or piece of rag to the article, then let it remain until dry; if not black enough, coat it until it is—each time, of course, letting it remain sufficiently long to dry thoroughly. After the solution is made, keep it in a closely-corked bottle.

(3) 1 gal. water, 1 lb. logwood chips, $\frac{1}{2}$ lb. black coppers, $\frac{1}{2}$ lb. extract of logwood, $\frac{1}{2}$ lb. indigo blue, 2 oz. lampblack. Put these into an iron pot and boil them over a slow fire. When the mixture is cool, strain it through a cloth, add $\frac{1}{2}$ oz. nut-gall. It is then ready for use. This is a good black for all kinds of cheap work.

(4) 250 parts of Campeachy wood, 2000 water, and 30 copper sulphate; the wood is allowed to stand 24 hours in this liquor, dried in the air, and finally immersed in iron nitrate liquor at 4° B.

(5) Boil $8\frac{3}{4}$ oz. logwood in 70 oz. water and 1 oz. blue stone, and steep the wood for 24 hours. Take out, expose to the air for a long time, and then steep for 12 hours in a beek of iron nitrate at 4° B. If the black is not fine, steep again in logwood liquor.

(6) It is customary to employ the clear liquid obtained by treating 2 parts powdered galls with 15 parts wine, and mixing the filtered liquid with a solution of iron proto-sulphate. Reimann recommends the use of water in the place of wine.

(7) Almost any wood can be dyed black by the following means:—Take logwood extract such as is found in commerce, powder 1 oz., and boil it in $3\frac{1}{2}$ pints water: when the extract is dissolved, add 1 dr. potash yellow chromate (not the bichromate), and agitate the whole. The operation is now finished, and the liquid will serve equally well to write with or to stain wood. Its colour is a very fine dark purple, which becomes a pure black when applied to the wood.

(8) For black and gold furniture, procure 1 lb. logwood chips, add 2 qt. water, boil 1 hour, brush the liquor in hot, when dry give another coat. Now procure 1 oz. green copperas, dissolve it in warm water, well mix, and brush the solution over the wood: it will bring out a fine black; but the wood should be dried outdoors, as the black sets better. A common stove brush is best. If polish cannot be used, proceed as follows:—Fill up the grain with black glue—i. e. thin glue and lampblack—brushed over the parts accessible (not in the carvings); when dry, paper down with fine paper. Now procure, say, a gill of French polish, in which mix 1 oz. best ivory black, or gas-black is best, well shake it until quite a thick pasty mass, procure $\frac{1}{2}$ pint brown hard varnish, pour a portion into a cup, add enough black polish to make it quite dark, then varnish the work; two thin coats are better than one thick coat. The first coat may be glass-papered down where accessible, as it will look better. A coat of glaze over the whole gives a London finish. N.B.—Enough varnish should be mixed at once for the job to make it all one colour—i. e. good black. (*Smither.*)

(9) For table.—Wash the surface of table with liquid ammonia, applied with a piece of rag; the varnish will then peel off like a skin; afterwards smooth down with fine sandpaper. Mix $\frac{1}{4}$ lb. lampblack with 1 qt. hot water, adding a little glue size; rub this stain well in: let it dry before sandpapering it; smooth again. Mind you do not work through the stain. Afterwards apply the following black varnish with a broad fine camel-hair brush:—Mix a small quantity of gas-black with the varnish. If one coat of varnish is not sufficient, apply a second one after the first is dry. Gas-black can be obtained by boiling a pot over the gas, letting the pot nearly touch the burner, when a fine jet black will form on the bottom, which remove, and mix with the varnish. Copper vessels give the best black: it may be collected from barbers' warming pots.

(10) Black-board wash, or "liquid slating."—(a) 4 pints 95 per cent. alcohol, 8 oz. shellac, 12 dr. lampblack, 20 dr. ultramarine blue, 4 oz. powdered rottenstone, 6 oz. powdered pumice. (b) 1 gal. 95 per cent. alcohol, 1 lb. shellac, 8 oz. best ivory black, 5 oz. finest flour emery, 4 oz. ultramarine blue. Make a perfect solution of the shellac in the alcohol before adding the other articles. To apply the slating, have the surface smooth and perfectly free from grease; well shake the bottle containing the preparation, and pour out a small quantity only into a dish, and apply it with a new flat varnish brush as rapidly as possible. Keep the bottle well corked, and shake it up each time before pouring out the liquid. (c) Lampblack and flour of emery mixed with spirit varnish. No more lampblack and flour of emery should be used than are sufficient to give the required black abrading surface. The thinner the mixture the better. Lampblack should first be ground with a small quantity of spirit varnish or alcohol to free it from lumps. The composition should be applied to the smoothly-planed surface of a board with a common paint-brush. Let it become thoroughly dry and hard before it is used. Rub it down with pumice if too rough. (d) $\frac{1}{2}$ gal. shellac varnish, 5 oz. lampblack, 3 oz. powdered iron ore or emery; if too thick, thin with alcohol. Give 3 coats of the composition, allowing each to dry before putting on the next; the first may be of shellac and lampblack alone. (e) To make 1 gal. of the paint for a black-board, take 10 oz. pulverized and sifted pumice, 6 oz. powdered rottenstone (infusorial silica), $\frac{3}{4}$ lb. good lampblack, and alcohol enough to form with these a thick paste,

which must be well rubbed and ground together. Then dissolve 14 oz. shellac in the remainder of the gallon of alcohol by digestion and agitation, and finally mix this varnish and the paste together. It is applied to the board with a brush, care being taken to keep the paint well stirred so that the pumice will not settle. Two coats are usually necessary. The first should be allowed to dry thoroughly before the second is put on, the latter being applied so as not to disturb or rub off any portion of the first. One gallon of this paint will ordinarily furnish 2 coats for 60 sq. yd. of black-board. When the paint is to be put on plastered walls, the wall should be previously coated with glue size—1 lb. glue, 1 gal. water, enough lampblack to colour; put on hot. (f) Instead of the alcohol mentioned in *b*, take a solution of borax in water; dissolve the shellac in this and colour with lampblack. (g) Dilute soda silicate (water-glass) with an equal bulk of water, and add sufficient lampblack to colour it. The lampblack should be ground with water and a little of the silicate before being added to the rest of the liquid.

(11) 17.5 oz. Brazil-wood and 0.525 oz. alum are boiled for 1 hour in 2.75 lb. water. The coloured liquor is then filtered from the boiled Brazil-wood, and applied several times boiling hot to the wood to be stained. This will assume a violet colour. This violet colour can be easily changed into black by preparing a solution of 2.1 oz. iron filings, and 1.05 oz. common salt in 17.5 oz. vinegar. The solution is filtered, and applied to the wood, which will then acquire a beautiful black colour.

(12) 8.75 oz. gall-nuts and 2.2 lb. logwood are boiled in 2.2 lb. rain-water for 1 hour in a copper boiler. The decoction is then filtered through a cloth, and applied several times while it is still warm to the article of wood to be stained. In this manner a beautiful black will be obtained.

(13) This is prepared by dissolving 0.525 oz. logwood extract in 2.2 lb. hot rain-water, and by adding to the logwood solution 0.035 oz. potash chromate. When this is applied several times to the article to be stained, a dark brown colour will first be obtained. To change this into a deep chrome-black, the solution of iron filings, common salt, and vinegar, given under (11) is applied to the wood, and the desired colour will be produced.

(14) Several coats of alizarine ink are applied to the wood, but every coat must be thoroughly dry before the other is put on. When the articles are dry, the solution of iron filings, common salt, and vinegar, as given in (11), is applied to the wood, and a very durable black will be obtained.

(15) According to Herzog, a black stain for wood, giving to it a colour resembling ebony, is obtained by treating the wood with two fluids, one after the other. The first fluid to be used consists of a very concentrated solution of logwood, and to 0.35 oz. of this fluid are added 0.017 oz. alum. The other fluid is obtained by digesting iron filings in vinegar. After the wood has been dipped in the first hot fluid, it is allowed to dry, and is then treated with the second fluid, several times if necessary.

(16) Sponge the wood with a solution of aniline chlorhydrate in water, to which a small quantity of copper chloride is added. Allow it to dry, and go over it with a solution of potassium bichromate. Repeat the process 2 or 3 times, and the wood will take a fine black colour.

Blue.—(1) Powder a little Prussian blue, and mix to the consistency of paint with beer; brush it on the wood, and when dry size it with glue dissolved in boiling water; apply lukewarm, and let this dry also; then varnish or French polish.

(2) Indigo solution, or a concentrated hot solution of blue vitriol, followed by a dip in a solution of washing soda.

(3) Prepare as for violet, and dye with aniline blue.

(4) A beautiful blue stain is obtained by gradually stirring 0.52 oz. finely-powdered indigo into 4.2 oz. sulphuric acid of 60 per cent., and by exposing this mixture for 12 hours to a temperature of 77° F. (25° C.). The mass is then poured into 11–13.2 lb.

rain-water, and filtered through felt. This filtered water is applied several times to the wood, until the desired colour has been obtained. The more the solution is diluted with water, the lighter will be the colour.

(5) 1·05 oz. finest indigo carmine, dissolved in 8·75 oz. water, applied several times to the articles to be stained. A very fine blue is in this manner obtained.

(6) 3·5 oz. French verdigris are dissolved in 3·5 oz. urine and 8·75 oz. wine vinegar. The solution is filtered and applied to the article to be stained. Then a solution of 2·1 oz. potash carbonate in 8·75 oz. rain-water is prepared, and the article coloured with the verdigris is brushed over with this solution until the desired blue colour makes its appearance.

(7) The newest processes of staining wood blue are those with aniline colours. The following colours may be chosen for the staining liquor:—Bleu de Lyon (reddish blue), bleu de lumière (pure blue), light blue (greenish blue). These colours are dissolved in the proportion of 1 part colouring substance to 30 of spirit of wine, and the wood is treated with the solution.

Brown.—(1) Various tones may be produced by mordanting with potash chromate, and applying a decoction of fustic, of logwood, or of peachwood.

(2) Sulphuric acid, more or less diluted according to the intensity of the colour to be produced, is applied with a brush to the wood, previously cleaned and dried. A lighter or darker brown stain is obtained, according to the strength of the acid. When the acid has acted sufficiently, its further action is arrested by the application of ammonia.

(3) Tincture of iodine yields a fine brown coloration, which, however, is not permanent unless the air is excluded by a thick coating of polish.

(4) A simple brown wash is $\frac{1}{2}$ oz. alkanet root, 1 oz. aloes, 1 oz. dragons' blood, digested in 1 lb. alcohol. This is applied after the wood has been washed with aqua regia, but is, like all the alcoholic washes, not very durable.

Ebonizing.—(1) Boil 1 lb. logwood chips 1 hour in 2 qt. water; brush the hot liquor over the work to be stained, lay aside to dry; when dry give another coat, still using it hot. When the second coat is dry, brush the following liquor over the work:—1 oz. green copperas to 1 qt. hot water, to be used when the copperas is all dissolved. It will bring out an intense black when dry. For staining, the work must not be dried by fire, but in the sunshine, if possible; if not, in a warm room, away from the fire. To polish this work first give a coating of very thin glue size, and when quite dry paper off very lightly with No. 0 paper, only just enough to render smooth, but not to remove the black stain. Then make a rubber of wadding about the size of a walnut, moisten the rubber with French polish, cover the whole tightly with a double linen rag, put one drop of oil on the surface, and rub the work with a circular motion. Should the rubber stick it requires more polish. Previous to putting the French polish on the wadding pledget, it ought to be mixed with the best drop black, in the proportion of $\frac{1}{4}$ oz. drop black to a gill of French polish. When the work has received one coat, set it aside to dry for about an hour. After the first coat is laid on and thoroughly dry, it should be partly papered off with No. 0 paper. This brings the surface even, and at the same time fills up the grain. Now give a second coat as before. Allow 24 hours to elapse, again paper off, and give a final coat as before. Now comes "spiriting off." Great care must be used here, or the work will be dull instead of bright. A clean rubber must be made, as previously described, but instead of being moistened with polish it must be wetted with spirits of wine placed in a linen rag screwed into a tight even-surfaced ball, just touched on the face with a drop of oil, and then rubbed lightly and quickly in circular sweeps all over the work from top to bottom. One application of spirits is usually enough if sufficient has been placed on the rubber at the outset, but it is better to use rather too little than too much at a time, as an excess will entirely remove the polish, when the work will have to be polished again. Should this be the case, paper off at once, and commence as at first. It is the best way in the end. (*Smither.*)

(2) Lauber dissolves extract of logwood in boiling water until the solution indicates 0° Beaumé. 5 pints of the solution is then mixed with $2\frac{1}{2}$ pints pyroligneous iron mordant of 10° , and $\frac{1}{2}$ pint acetic acid of 2° . The mixture is heated for $\frac{1}{4}$ hour, and is then ready for use.

(3) To imitate black ebony, first wet the wood with a solution of logwood and copperas, boiled together and laid on hot. For this purpose, 2 oz. logwood chips with $1\frac{1}{2}$ oz. copperas, to 1 qt. water, will be required. When the work has become dry, wet the surface again with a mixture of vinegar and steel filings. This mixture may be made by dissolving 2 oz. steel filings in $\frac{1}{2}$ pint vinegar. When the work has become dry again, sandpaper down until quite smooth. Then oil and fill in with powdered drop-black mixed in the filler. Work to be ebonized should be smooth and free from holes, &c. The work may receive a light coat of quick-drying varnish, and then be rubbed with finely-pulverized pumice and linseed-oil until very smooth.

(4) 1 gal. strong vinegar, 2 lb. extract of logwood, $\frac{1}{2}$ lb. green copperas, $\frac{1}{4}$ lb. China blue, and 2 oz. nut-gall. Put these in an iron pot, and boil them over a slow fire till they are well dissolved. When cool, the mixture is ready for use. Add to the above $\frac{1}{2}$ pint iron rust, which may be obtained by scraping rusty hoops, or preferably by steeping iron filings in a solution of acetic acid or strong vinegar.

(5) Common ebony stain is obtained by preparing two baths; the first, applied warm, consists of a logwood decoction, to every quart of which 1 dr. alum is added; the second is a solution of iron filings in vinegar. After the wood has dried from the first, the second is applied as often as is required. For the first-named bath, some substitute 16 oz. gall-nut, 4 oz. logwood dust, and 2 oz. verdigris, boiled in a sufficient quantity of water. A peculiar method of blackening walnut is in use in Nurnberg. On one of the Peguiz Islands there is a large grinding-mill, turned by the stream, where iron tools are sharpened and polished. The wood is buried for a week or more in the slime formed by the wheels; when dug out it is jet black, and so permeated by silica as to be in effect petrified. Another way to ebonize flat surfaces of soft work is to rub very fine charcoal dust into the pores with oil. This works beautifully with the European linden and American whitewood. A brown mahogany-like stain is best used on elm and walnut. Take a pint decoction of 2 oz. logwood in which $\frac{1}{2}$ oz. barium chloride has been dissolved. This gives also, when diluted with soft water, a good oak stain to ash and chestnut. But the most beautiful and lasting of the browns is a concentrated solution of potash permanganate (mineral chameleon). This is decomposed by the woody fibre, and forms hydrated manganese oxide, which is permanently fixed by the alkali.

(6) For the fine black ebony stain, apple, pear, and hazel wood are the best woods to use; when stained black, they are most complete imitations of the natural ebony. For the stain take—gall-apple, 14 oz.; rasped logwood, $3\frac{1}{2}$ oz.; vitriol, $1\frac{3}{4}$ oz.; verdigris, $1\frac{3}{4}$ oz. For the second coating a mixture of iron filings (pure), $3\frac{1}{2}$ oz., dissolved in strong wine vinegar; $1\frac{1}{2}$ pint is warmed, and when cool the wood already blackened is coated 2 or 3 times with it, allowing it to dry after each coat. For articles which are to be thoroughly saturated, a mixture of $1\frac{3}{4}$ oz. sal-ammoniac, with a sufficient quantity of steel filings, is to be placed in a suitable vessel, strong vinegar poured upon it, and left for 14 days in a gently-heated oven. A strong lye is now put into a suitable pot, to which is added coarsely-bruised gall-apples and blue Brazil shavings, and exposed for the same time as the former to the gentle heat of an oven, which will then yield a good liquid. The woods are now laid in the first-named stain, boiled for a few hours, and left in it for 3 days longer; they are then placed in the second stain and treated as in the first. If the articles are not then thoroughly saturated, they may be once more placed in the first bath, and then in the second. The polish used for wood that is stained black should be "white" (colourless) polish, to which a very little finely-ground Prussian blue should be added.

(7) Wash with a concentrated aqueous solution of logwood extract several times;

then with a solution of iron acetate of 11° B., which is repeated until a deep black is produced.

(8) Beech, pear-tree, or holly steeped in a strong liquor of logwood or galls. Let the wood dry, and wash over with solution of iron sulphate. Wash with clean water, and repeat if colour is not dark enough. Polish either with black or common French polish.

(9) Oak is immersed for 48 hours in a hot saturated solution of alum, and then brushed over several times with a logwood decoction prepared as follows:—Boil 1 part best logwood with 10 of water, filter through linen, and evaporate at a gentle heat until the volume is reduced one-half. To every quart of this add 10 to 15 drops of a saturated solution of indigo, completely neutral. After applying this dye to the wood, rub the latter with a saturated and filtered solution of verdigris in hot concentrated acetic acid, and repeat the operation until a black of the desired intensity is obtained. Oak thus stained is said to be a close as well as handsome imitation of ebony.

(10) 1 lb. logwood chips, 3 pints water; boil to 1 pint; apply hot to wood; let dry; then give another coat; let dry slowly; sandpaper smooth; mix 1 gill vinegar with 3 tablespoonfuls iron or steel filings; let stand 5 hours, then brush on wood; let dry; then give another coat of the first. This sends the vinegar deeper into the wood and makes a denser black; after which paper smooth. Then polish with white French polish, as the white brings out the black purer than common French polish. The woods observed to take on the stain best are pear-tree, plane-tree, and straight-reeded birch; mahogany does not stain nearly so well as the former woods.

(11) Get 1 lb. of logwood chips and boil them down in enough water to make a good dark colour; give the furniture 3 or 4 coats with a sponge; then put some rusty nails or old iron into a bottle with some vinegar, and when it begins to work give the furniture a coat of the vinegar. This, if you have well darkened it with the first, will give you a good black. Oil and polish in the usual way, rubbing down first with fine paper if required. A quicker way is to give the wood a coat of size and lampblack, and then use gas-black in your polish rubber.

(12) Make a strong decoction of logwood by boiling 1 lb. in 1 qt. water for about 1 hour; add thereto a piece of washing soda as large as a hazel-nut. Apply hot to the wood with a soft brush. Allow to dry, then paint over the wood with a solution of iron sulphate (1 oz. to the pint of water). Allow this to dry, and repeat the logwood and iron sulphate for at least 3 times, finishing off with logwood. Once more allow to dry thoroughly, then sandpaper off very lightly (so as not to remove the dye) with No. 0 paper. Now make a very thin glue size, boil in it a few chips of logwood and a crystal or two of iron sulphate, just sufficient to make it inky black. Paint this lightly over the work, allow to dry once more, again sandpaper lightly, and finally either varnish with good hard white varnish, or polish with French polish and drop black.

Floors.—(1) Get the wood clean, have some Vandyke brown and burnt sienna ground in water, mix it in strong size, put on with a whitewash or new paint-brush as evenly as you can. When dry, give 2 coats of copal or oak varnish.

(2) If the floor is a new one, have the border well washed. Polish with glass-paper, rubbing always with the grain of the wood. Varnish with good oak varnish, put colouring matter into the varnish to suit your taste, but umber is best; if the floor is old and blackened, paint it.

(3) If old floors, you will not make much of staining anything but black. The floor is to be well washed (lime and soda is best—no soap), the dye painted on, and, when dry, sized over and varnished with elastic oak varnish.

(4) Take $\frac{1}{2}$ lb. logwood chips, boil them briskly for $\frac{1}{2}$ hour in about 5 qt. rain-water, and strain through muslin. To this liquor add 6 oz. annatto (in the form of cake—not the roll); add also 1 lb. of yellow wax cut up in very small pieces. Place these

over the fire, and let the wax melt gently, stirring it all the while. When melted, take the mixture off the fire; do not let it boil. Then with a paint-brush lay it on the floor as hot as possible, brushing it always the way of the grain. Next day polish with a hard flat brush made of hair, which may have a strap nailed to the back of it in which to insert the foot. The floor is afterwards kept bright with beeswax alone, a little of which is melted and put on the brush. Take care that the floor is thoroughly dry before commencing operations.

(5) Melt some glue size in a bottle; next get a piece of rag, roll it into a ball so that it will fit the hand nicely, cover this with a bit of old calico to make a smooth face; dip this into the size, and rub in a bit of brown umber; then go ahead with your floors, working the stuff light or dark as required. Keep the motion with the grain of wood; when dry, stiffen with polishers' glaze.

(6) Take Judson's dyes of the colour required, mix according to the instructions given with each bottle, and apply with a piece of rag, previously trying it on a piece of wood to see if colour would suit; rub with sandpaper to get off any roughness that may be raised with the damp, and varnish with fine pale hard varnish, then slightly sandpaper and varnish again. Another method is to boil 1 lb. logwood in an *old* boiler, then apply with a piece of rag where the stain is required; when thoroughly dry, sandpaper as before, and well rub with beeswax to polish. This last process looks best when finished, but it requires a lot of elbow grease for a few months, and is extremely durable. To prevent the stain running where you do not want it, paste some stout paper.

(7) As a general rule, 1 qt. of the staining liquid will be found sufficient to cover about 16 sq. yd. of flooring; but different kinds of woods absorb in different proportions, soft woods requiring more for the same space than hard woods. The colours of the stains are various, so that one may either choose ebony, walnut, mahogany, rosewood, satinwood, oak, medium oak, or maple, according to the paleness or depth of colour desired. Besides this, 4 lb. of size and $2\frac{1}{2}$ pints of the best varnish are required to finish the 16 yd. above mentioned. The necessary purchases are completed by a good-sized painters' brush and a smaller one. The work can then be commenced. If the wood is uneven, it must be planed, and rubbed down to a smooth surface; whilst the cracks and spaces between the boards, if very wide, may be disposed of by a process called "slipping," by which pieces of wood are fitted in. The floor must next be carefully washed, and allowed to dry thoroughly. The actual staining may now be proceeded with. The liquid is poured out into a basin, and spread all over the floor with the aid of the large brush, the small one being used to do the corners and along the wainscoting, so that it may not be smeared. It is always best to begin staining at the farthest corner from the doorway, and so work round so that one's exit may not be impeded. It is also a good plan to work with the window open, if there is no danger of much dust flying in, as the staining dries so much quicker. After the floor is quite covered, the stainer may rest for about an hour whilst the drying is going on, during which there is only one thing relative to the work in hand which need be attended to. This is the size, which should be put in a large basin with $\frac{1}{2}$ pint of cold water to each pound, and then stood in a warm place to dissolve. Before re-commencing work also the brushes must be washed, and this is no great trouble, as a little lukewarm water will take out all trace of the stain and clean them quite sufficiently. The sizing is then laid on in exactly the same manner as the staining, always being careful to pass the brush lengthwise down the boards. If the size froths or sticks unpleasantly, it must be a little more diluted with warm water, and sometimes, if the sediment from it is very thick, it is all the better for being strained through a coarse muslin. The sizing takes rather longer than the varnish to dry, 2 or more hours being necessary, even on a warm, dry day. Not until it is quite dry, however, can the last finish be put to the work with the varnish. For this it is always safest to get the very

best, and to lay it on rather liberally, though very evenly, and over every single inch, as the staining will soon rub off when not protected by it. The best way to ascertain whether it is varnished all over is to kneel down and look at the floor sideways, with one's eyes almost on a level with it.

Green.—(1) Mordant the wood with red liquor at 1° B. This is prepared by dissolving separately in water 1 part sugar of lead and 4 of alum free from iron; mix the solutions, and then add $\frac{1}{32}$ part of soda crystals, and let settle overnight. The clear liquor is decanted off from the sediment of lead sulphate, and is then diluted with water till it marks 1° B. The wood when mordanted is dyed green with berry liquor and indigo extract, the relative proportions of which determine the tone of the green.

(2) Verdigris dissolved in 4 parts water.

(3) 4·2 oz. copper, cut up finely, are gradually dissolved in 13 oz. nitric acid (aqua-fortis), and the articles to be stained are boiled in this solution until they have assumed a fine green colour.

Grey.—(1) Greys may be produced by boiling 17 oz. orchil paste for $\frac{1}{2}$ hour in 7 pints water. The wood is first treated with this solution, and then, before it is dry, steeped in a beek of iron nitrate at 1° B. An excess of iron gives a yellowish tone; otherwise a blue grey is produced, which may be completely converted into blue by means of a little potash.

(2) 1 part silver nitrate dissolved in 50 of distilled water; wash over twice; then with hydrochloric acid, and afterwards with water of ammonia. The wood is allowed to dry in the dark, and then finished in oil and polished.

Mahogany.—(1) Boil $\frac{1}{2}$ lb. madder and 2 oz. logwood chips in 1 gal. water, and brush well over while hot. When dry, go over with pearlash solution, 2 dr. to the quart. By using it strong or weak, the colour can be varied at pleasure.

(2) Soak 1 lb. stick varnish in 2 qt. water until all the colour is dissolved out; strain off the water, and add to the residue 25 dr. powdered madder. Set the mixture over the fire until it is reduced to $\frac{3}{4}$ of its original volume. Then mix together 25 dr. cochineal, 25 dr. kermes berries, 1 pint spirits of wine, and $\frac{1}{2}$ oz. pearlash, out of which the colour has been washed by soaking in a gill of soft water. Add this mixture to the decoction of madder and varnish, stirring well together, and adding so much aquafortis as will bring the red to the desired shade.

(3) Dark Mahogany.—Introduce into a bottle 15 gr. alkanet root, 30 gr. aloes, 30 gr. powdered dragons' blood, and 500 gr. 95 per cent. alcohol, closing the mouth of the bottle with a piece of bladder, keeping it in a warm place for 3 or 4 days, with occasional shaking, then filtering the liquid. The wood is first mordanted with nitric acid, and when dry washed with the stain once or oftener, according to the desired shade; then, the wood being dried, it is oiled and polished.

(4) Light Mahogany.—Same as dark mahogany, but the stain being only applied once. The veins of true mahogany may be imitated by the use of iron acetate skilfully applied.

(5) The following process is recommended in *Wiederhold's Trade Circular*:—The coarse wood is first coated with a coloured size, which is prepared by thoroughly mixing up, in a warm solution, 1 part commercial glue in 6 of water, a sufficient quantity of the commercial mahogany brown, which is in reality an iron oxide, and in colour stands between so-called English red and iron oxide. This is best effected by adding in excess a sufficient quantity of the dry colour with the warm solution of glue, and thoroughly mixing the mass by means of a brush until a uniform paste is obtained, in which no more dry red particles are seen. A trial coat is then laid upon a piece of wood. If it is desired to give a light mahogany colour to the object, it is only necessary to add less, and for a darker colour more, of the brown body-colour. When the coat is dry, it may be tested, by rubbing with the fingers, whether the colour easily separates or not. In the former case, more glue must be added until the dry trial coat no longer

perceptibly rubs off with the hands. Having ascertained in this way the right condition of the size colour with respect to tint and strength, it is then warmed slightly, and worked through a hair sieve by means of a brush. After this, it is rubbed upon the wood surface with the brush, which has been carefully washed. It is not necessary to keep the colour warm during the painting. Should it become thick by gelatinizing, it may be laid on the wood with the brush, and dries more rapidly than when the colour is too thin. If the wood is porous and absorbs much colour, a second coat may be laid on the first when dry, which will be sufficient in all cases. On drying, the size colour appears dull and unsightly, but the following coat changes immediately the appearance of the surface. This coat is spirit varnish. For its production 3 parts spirits of wine of 90° are added in excess to 1 part of red acaroid resin in one vessel, and in another 10 parts shellac with 40 of spirits of wine of 80°. By repeated agitation for 3 or 4 days, the spirit dissolves the resin completely. The shellac solution is then poured carefully from the sediment, or, better still, filtered through a fine cloth, when it may be observed that a slight milky turbidity is no detriment to its use. The resin solution is best filtered into the shellac solution by pouring through a funnel loosely packed with wadding. When filtered, the solutions of both resins are mixed by agitating the vessel and letting the varnish stand a few days. The acaroid resin colours the shellac, and imparts to it at the same time the degree of suppleness usually obtained by the addition of Venetian turpentine or linseed-oil. If the varnish is to be employed as a coat, the upper layers are poured off at once from the vessel. One or two coats suffice, as a rule, to give the object an exceedingly pleasing effect. The coats dry very quickly, and care must be taken not to apply the second coat until the first is completely dry.

(6) 7·5 oz. madder, 8·75 oz. rasped yellow wood, are boiled for 1 hour in 5·5 lb. water, and the boiling liquor is applied to the articles until the desired colour has been produced.

(7) 1·05 oz. powdered turmeric, 1·05 oz. powdered dragons' blood, are digested in 8·75 oz. of 80 per cent. strong alcohol, and when the latter seems to be thoroughly coloured it is filtered through a cloth. The filtrate is heated and applied warm to the article.

(8) 17·5 oz. madder, 8·75 oz. ground logwood, are boiled for 1 hour in 5·5 lb. water. This is filtered while still warm, and the warm liquor is applied to the wood. When this has become dry, and it is desired to produce a darker mahogany colour, a solution of 0·525 oz. potash carbonate in 4·4 lb. water is applied to the wood. This solution is prepared cold, and filtered through blotting-paper.

(9) 0·35 oz. aniline is dissolved in 8·75 oz. spirits of wine 90 per cent. strong. Then another solution of 0·35 oz. aniline yellow in 17·5 oz. spirits of wine 90 per cent. strong is made, and this is added to the aniline solution until the required reddish-yellow colour is obtained. By adding a little of a solution of aniline brown (0·35 oz. aniline brown in 10·5 oz. spirits of wine 90 per cent. strong), the colour is still more completely harmonized, and a tint very closely resembling mahogany can be given to elm and cherry wood with this mixture.

(10) 0·7 oz. logwood is boiled in 3·5 oz. water down to about $\frac{1}{2}$. This is then filtered, and 0·12 oz. baryta chloride is dissolved in it.

Oak.—(1) Mix powdered ochre, Venetian red, and umber, in size, in proportions to suit; or a richer stain may be made with raw sienna, burnt sienna, and vandyke. A light yellow stain of raw sienna alone is very effective.

(2) Darkening Oak.—Lay on liquid ammonia with a rag or brush. The colour deepens immediately, and does not fade; this being an artificial production of the process which is induced naturally by age. Potash bichromate, dissolved in cold water and applied in a like manner, will produce a very similar result.

(3) In Germany, the cabinet-makers use very strong coffee for darkening oak. To

make it very dark: iron filings with a little sulphuric acid and water, put on with a sponge, and allowed to dry between each application until the right hue is reached.

(4) Whitewash with fresh lime, and when dry brush off the lime with a hard brush, and dress well with linseed-oil. It should be done after the wood has been worked, and it will make not only the wood, but the carving or moulding, look old also.

(5) Use a strong solution of common washing-soda, say one or two coats, until the proper colour is obtained. Or you may try potash carbonate. Paper and finish off with linseed-oil.

(6) A decoction of green walnut-shells will bring new oak to any shade, or nearly black.

(7) A good method of producing the peculiar olive brown of old oak is by fumigation with liquid ammonia; the method has many advantages beyond the expense of making a case or room air-tight and the price of the ammonia. It does not raise the grain, the work keeping as smooth as at first. Any tint, or rather, depth of the colour can be given with certainty; and the darker shade of colour will be found to have penetrated to the depth of a veneer, and much farther where the end grain is exposed, thus doing away with the chance of an accidental knock showing the white wood. The colouring is very even and pure, not destroying the transparency of the wood. It is advisable to make the furniture from one kind of stuff, not to mix English oak with Riga, and so on. They both take the colour well, but there is a kind of American red oak that does not answer well. In all cases care must be taken to have no glue or grease on the work, which would cause white spots to be left. The deal portions of the work are not affected in the least, neither does it affect the sap of oak. The best kind of polish for furniture treated in this manner is wax polish, or the kind known as egg-shell polish. The process of fumigation is very simple. Get a large packing-case, or better still, make a room in a corner of the polishing shop about 9 ft. long, 6 ft. high, and 3 ft. 6 in. wide; pass paper over the joints; let the door close on to a strip of indiarubber tubing; put a pane of glass in the side of box or house to enable you to examine the progress of colouring. In putting in your work see that it does not touch anything to hinder the free course of the fumes. Put 2 or 3 dishes on the floor to hold the ammonia; about $\frac{1}{2}$ pint is sufficient for a case this size. The ammonia differs in purity, some leaving more residue than other. Small articles can be done by simply covering them with a cloth, having a little spirits in a pot underneath. A good useful colour can be given by leaving the things exposed to the fumes overnight. The colour lightens on being polished, owing to the transparency thus given to the wood.

Purple.—(1) Take 1 lb. logwood chips, $\frac{3}{4}$ gal. water, 4 oz. pearlash, 2 oz. powdered indigo. Boil the logwood in the water till the full strength is obtained, then add the pearlash and indigo, and when the ingredients are dissolved the mixture is ready for use, either warm or cold. This gives a beautiful purple.

(2) To stain wood a rich purple or chocolate colour, boil $\frac{1}{2}$ lb. madder and $\frac{1}{4}$ lb. fustic in 1 gal. water, and when boiling brush over the work until stained. If the surface of the work should be perfectly smooth, brush over with a weak solution of nitric acid; then finish with the following: put $4\frac{1}{2}$ oz. dragons' blood and 1 oz. soda, both well bruised, into 3 pints spirits of wine. Let it stand in a warm place, shake frequently, strain and lay on with a soft brush, repeating until a proper colour is gained. Polish with linseed-oil or varnish.

(3) 2·2 lb. rasped logwood, 5·5 lb. rasped Lima red dyewood are boiled for 1 hour in 5·5 lb. water. It is then filtered through a cloth and applied to the article to be stained until the desired colour has been obtained. In the meanwhile a solution of 9·175 oz. potash carbonate in 17·5 oz. water has been prepared, and a thin coat of this is applied to the article stained red. But strict attention must be paid not to apply too thick a coat of this solution, or else a dark blue colour would be the result.

Red.—(1) The wood is plumed first in a solution of 1 oz. of curd soap in 35 fl. oz.

water, or else is rubbed with the solution; then magenta is applied in a state of sufficient dilution to bring out the tone required. All the aniline colours behave very well on wood.

(2) For a red stain, a decoction of $\frac{1}{4}$ lb. logwood and $\frac{1}{2}$ oz. potash in 1 lb. water is used as the bath, being fixed by a wash of alum water. For scarlet, use 1 oz. cochineal, 6 oz. powdered argol, 4 oz. cream tartar, in 12 oz. tin chloride (scarlet spirits).

(3) Take 1 qt. alcohol, 3 oz. Brazil-wood, $\frac{1}{2}$ oz. dragons' blood, $\frac{1}{2}$ oz. cochineal, 1 oz. saffron. Steep to full strength and strain. It is a beautiful crimson stain for violins, work-boxes, and fancy articles.

(4) Beside the aniline colours, which are, however, much affected by sunlight, cochineal gives a very good scarlet red upon wood. Boil 2 oz. cochineal, previously reduced to a fine powder, in 35 oz. of water for 3 hours, and apply it to the wood. When dry, give it a coating of dilute tin chloride to which is added a little tartaric acid—1 oz. tin chloride, and $\frac{1}{2}$ oz. tartaric acid in 35 fl. oz. water. If, instead of water, the cochineal is boiled in a decoction of bark (2 oz. bark to 35 oz. water), and the tin chloride is used as above, an intense scarlet and all shades of orange may be produced according to the proportions.

(5) Take 1 gal. alcohol, $1\frac{1}{2}$ lb. camwood, $\frac{1}{2}$ lb. red sanders, 1 lb. logwood extract, 2 oz. aquafortis. When dissolved, it is ready for use. It should be applied in 3 coats over the whole surface. When dry, rub down to a smooth surface, using for the purpose a very fine paper. The graining is done with iron rust, and the shading with asphaltum thinned with spirits of turpentine. When the shading is dry, apply a thin coat of shellac; and when that is dry, rub down with fine paper. The work is then ready for varnishing—a fine rose tint.

(6) Monnier recommends steeping the wood for several hours in a bath of 1200 gr. potassium iodide to the quart of water, and then immersing it in a bath of 375 gr. corrosive sublimate, when it will assume a beautiful rose-red colour by chemical precipitation. It should subsequently be covered with a glossy varnish. The baths will not need renewal for a long time.

(7) 2·2 lb. finely-powdered Lima red dyewood and 2·1 oz. potash carbonate are put in a glass bottle and digested in 5·5 lb. water for 8 days in a warm place; the bottle should be frequently shaken. It is then filtered through a cloth; the fluid is heated, and applied to the article to be stained until the latter acquires a beautiful colour. If it is desired to brighten the colour, a solution of 2·1 oz. alum, free from iron, in 2·2 lb. water is applied to the article while it is still wet. The last solution can be prepared by heat; when it has been accomplished, it is filtered. As soon as the stains have become dry, they should be rubbed with a rag moistened with linseed-oil, after which the varnish may be applied.

Satinwood.—Take 1 qt. alcohol, 3 oz. ground turmeric, $1\frac{1}{2}$ oz. powdered gamboge. When steeped to its full strength, strain through fine muslin. It is then ready for use. Apply with a piece of fine sponge, giving the work 2 coats. When dry, sandpaper down very fine. It is then ready for polish or varnish, and is a good imitation of satinwood.

Violet.—The wood is treated in a bath made up with $4\frac{1}{4}$ oz. olive-oil, the same weight of soda-ash, and $2\frac{1}{2}$ pints boiling water, and it is then dyed with magenta to which a corresponding quantity of tin crystals has been added.

Walnut.—Deal and other common woods are stained to imitate polished walnut in various ways. (1) One method is, after careful rubbing with glasspaper, to go over the surface with a preparation of Cassel brown boiled in a lye of soft-soap and soda. After drying, the surface is rubbed over with pumice and oil, and polished with shellac. The Cassel brown will not take equally well on all kinds of wood, so that if not laid on thick it sometimes comes off under the subsequent pumicing; whilst on the other hand this same thickness conceals, more or less, the grain on the wood beneath, giving it the appearance of having been painted.

(2) Others use instead a decoction of green walnut-shells, dried and boiled in the same lye, or in soft water to which soda has been added. The decoction of walnut-shells is apt to come off on the clothes as a yellowish adhesive substance.

(3) Others, again, employ catechu and potash chromate in equal parts, boiled separately and afterwards mixed. The mixture of catechu and potash chromate leaves a reddish-brown deposit on the surface of the wood, very unlike real walnut.

(4) The following is said to be a very superior method for staining any kind of wood in imitation of walnut, while it is also cheap and simple in its manipulation. The wood, previously thoroughly dried and warmed, is coated once or twice with a stain composed of 1 oz. extract of walnut peel dissolved in 6 oz. soft water by heating it to boiling, and stirring. The wood thus treated, when half dry, is brushed with a solution of 1 oz. potash bichromate in 5 oz. boiling water, and is then allowed to dry thoroughly, and is to be rubbed and polished as usual. Red beech and alder, under this treatment, assume a most deceptive resemblance to American walnut. The colour is fixed in the wood to a depth of one or two lines.

(5) Mix dragons' blood and lampblack in methylated spirits till you get the colour required, and rub it well into the grain of the wood.

(6) Light Walnut.—Dissolve 1 part potassium permanganate in 30 of pure water, and apply twice in succession; after an interval of 5 minutes, wash with clean water, and when dry, oil and polish.

(7) Dark Walnut.—Same as for light walnut, but after the washing with water the dark veins are made more prominent with a solution of iron acetate.

(8) In the winter season get some privet berries (black), which grow in most gardens, and put 2 oz. in $\frac{1}{2}$ pint solution of liquid ammonia. This, applied to pine, varnished or polished, cannot be detected from real walnut itself.

(9) Take 1 gal. very thin sized shellac; add 1 lb. dry burnt umber, 1 lb. dry burnt sienna, and $\frac{1}{4}$ lb. lampblack. Put these articles into a jug and shake frequently until they are mixed. Apply one coat with a brush. When the work is dry, rub down with fine paper, and apply one coat of shellac or cheap varnish. It will then be a good imitation of solid walnut, and will be adapted for the back boards of mirror-frames, for the back and inside of casework, and for similar work.

(10) Take 1 gal. strong vinegar, 1 lb. dry burnt umber, $\frac{1}{2}$ lb. fine rose pink, $\frac{1}{2}$ lb. dry burnt Vandyke brown. Put into a jug and mix well; let the mixture stand one day, and it will then be ready for use. Apply this stain to the sap with a piece of fine sponge, it will dry in $\frac{1}{2}$ hour. The whole piece is then ready for the filling process. When the work is completed, the stained part cannot be detected even by those who have performed the job. By means of this recipe, wood of poor quality and mostly of sap can be used with good effect.

(11) Darkening Walnut.—Slaked lime, 1 to 4 of water, will do for some kinds of walnut; a weak solution of iron sulphate for others; and yet again for other kinds a weak solution of pearlash. Try each on the wood, and choose the one you like best.

(12) To give to walnut a dark colour resembling rosewood, Hirschberg uses a solution of 0·17 oz. potash bichromate in 1·05 oz. water. This solution is applied to the walnut with a sponge, and the wood is then pumiced and polished.

(13) By a simple staining, furniture of pine or birch wood can be easily made to appear as if it had been veneered with walnut veneer. For this a solution of 3·15 oz. potash manganate, and 3·15 oz. manganese sulphate in 5·25 qt. hot water, is made. This solution is applied to the wood with a brush, and must be repeated several times. The potash manganate is decomposed when it comes in contact with the woody fibre, and thus a beautiful and very durable walnut colour is obtained. If small wooden articles are to be stained in this manner, a very diluted bath is prepared; the articles are dipped into it, and kept there 1 to 9 minutes according as the colour is desired lighter or darker.

Yellow.—(1) Mordant with red liquor, and dye with bark liquor and turmeric.

(2) Turmeric dissolved in wood naphtha.

(3) Aqua regia (nitro-muriatic acid), diluted in 3 parts water, is a much-used though rather destructive yellow stain.

(4) Nitric acid gives a fine permanent yellow, which is converted into dark brown by subsequent application of tincture of iodine.

(5) Wash over with a hot concentrated solution of picric acid, and when dry, polish the wood.

(6) Orange-yellow Tone to Oak Wood.—According to Niedling, a beautiful orange-yellow tone, much admired in a chest at the Vienna Exhibition, may be imparted to oak-wood by rubbing it in a warm room with a certain mixture until it acquires a dull polish, and then coating it after an hour with thin polish, and repeating the coating of polish to improve the depth and brilliancy of the tone. The ingredients for the rubbing mixture are about 3 oz. tallow, $\frac{3}{4}$ oz. wax, and 1 pint oil of turpentine, mixed by heating together and stirring.

(7) 0·5 oz. nitric acid (aqua fortis) is compounded with 1·57 oz. rain-water, and the article to be stained is brushed over with this. Undiluted nitric acid gives a brownish-yellow colour.

(8) 2·1 oz. finely-powdered turmeric are digested for several days in 17·5 oz. alcohol 80 per cent. strong, and then strained through a cloth. This solution is applied to the articles to be stained. When they have become entirely dry, they are burnished and varnished.

(9) 1·57 oz. potash carbonate are dissolved in 4·2 oz. rain-water. This solution is poured over 0·52 oz. annatto, and this mixture is allowed to stand for 3 days in a warm place, being frequently shaken in the meanwhile. It is then filtered, and 0·175 oz. spirit of sal-ammoniac is added to it. The stain is now ready, and the articles to be stained will acquire a very beautiful bright yellow colour by placing them in it.

(10) Bright Golden Yellow.—0·52 oz. finely-powdered madder is digested for 12 hours with 2·1 oz. diluted sulphuric acid, and then filtered through a cloth. The articles to be stained are allowed to remain in this fluid 3 to 4 days, when they will be stained through.

GILDING.—This method of ornamentation, adapted chiefly to articles of wood, consists in applying a coat of gold leaf to the surface by the aid of an adhesive medium termed gold size.

Leaf metal.—There are several kinds of gold leaf and substitutes for the genuine article. The chief real sorts are “deep” or reddish gold, and “pale” gold, the latter being alloyed with silver. The best of these comes from Italy. Silver leaf is often employed for economy sake, and afterwards coloured or varnished yellow. Dutch leaf is a base metal alloy exhibiting almost the characteristic appearance of gold. The various kinds of leaf are sold in “books”: gold books contain 24 leaves 3 in. square and cost 1s. 6d.; Dutch books have the same dimensions, and cost about 4d.; silver books contain 48 leaves $4\frac{1}{2}$ in. square, and cost about 9d.

Sizes.—The composition of size for attaching gold leaf varies not a little. One of the most common kinds is that called “oil gold size.” It is made by boiling litharge in linseed-oil (1 oz. of litharge in 1 pint of oil). Its only disadvantage is that it takes about 12 hours to dry sufficiently to receive the leaf; but it possesses the important advantage of resisting the effects of the weather, even when not varnished. It is often sold in admixture with ochre (either yellow or red), ready for application. A substitute generally employed on indoor work is “japanners’ gold size”; this dries in 2 or 3 hours, but is not nearly so durable, and necessitates the application of a coat of varnish to the gold, which is not improved thereby. For bright gilding on glass, Brunswick black, copal varnish, or japanners’ gold size containing chrome yellow is often resorted to; but the best medium is a “water size,” made of isinglass dissolved in boiling water, with an equal volume of spirits of wine added, and the whole strained through silk.

Tools.—These are not numerous. One of the most essential is the gilders' brush, or "tip," Fig. 734, which is a broad thin brush, made by gluing camel-hair between 2 pieces of thin card. Next comes a cushion or pad on which to cut the leaves to the required size. This pad, Fig. 735, is a strip of flat wood, of convenient size for receiving the leaves (say 6 to 8 in. sq.), covered with 2 or 3 thicknesses of tightly stretched flannel or baize overlaid by chamois leather, provided with a loop beneath for the thumb, and partially surrounded by a wall of parchment to ward off draughts. Some 2 or 3 paint brushes of various dimensions are useful for fastening the leaf and laying on the size. A very sharp and smooth edged knife is necessary for cutting up the leaves as they lie on the pad. A "bob" (Fig. 736) of soft chamois leather stuffed with cotton wool, for pressing the leaves down in place, completes the equipment.

Dead gilding.—This is the simplest phase of the art. As usually performed, a leaf is taken from the book, laid on the pad, blown flat and smooth by puffs from the mouth, and then cut to shape for the surface to be gilded, allowing a small surplus margin. The shaped leaf is removed from the pad by the aid of the tip, which is first passed across the

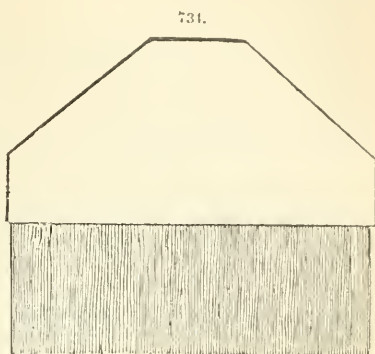

735.

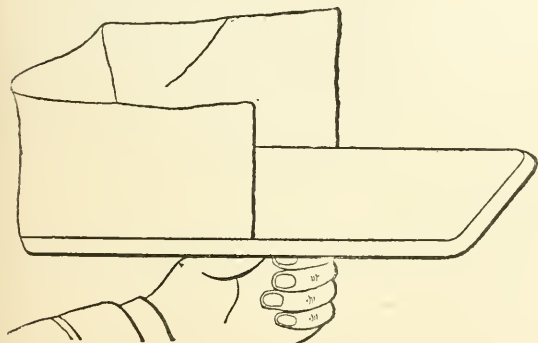

736.

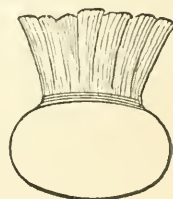

skin or hair of the operator to render it just adhesive enough to retain the leaf sufficiently long for its transference to the work. But readier ways of transferring the leaf are often adopted. For instance, the leaves may be cut to shape by a penknife while in the book, and carried to the work on intervening slips of paper. Or the leaves may be picked up quite flat by a piece of waxed paper, or by breathing on the surface of a stick covered with cloth. But absolute stillness of the air in the apartment is essential to success in every case.

The surface intended for the reception of the leaf must be previously sized, and this sufficiently long in advance (varying with the kind of size used) to allow the size to dry to the correct degree. It is important that the sizing coat be equally distributed, and that no more ground be sized at once than can be conveniently gilded at a single operation. To judge exactly the best moment for laying the leaf on the size requires some experience: the size should be as dry as is compatible with the security of the leaf. The

degree of moisture necessary varies with the kind of leaf, being least for gold leaf, more for silver, and most for Dutch leaf. If the sized ground should from any cause become too dry, the evil may be remedied by a short warming at the fire, observing the precaution to lay the leaves the moment they will stick, as the adhesiveness soon disappears after the heating.

The leaves being laid all over the sized surface, any remaining gaps are made good, and the whole gilded surface is gently pressed with the bob, to ensure its complete adhesion. This operation is often performed with a large paint brush, by dabbing it lightly down endwise, "stippling" in fact; indeed a brush is much more convenient and effective when the surface is uneven. The gilded surface should be carefully brushed to remove stray fragments of leaf, and then painted over with a clear size made by dissolving parchment shreds in water to the consistence of thin jelly, or with a varnish made by dissolving dammar in turpentine or spirits of wine.

Obviously the process of dead gilding must undergo some modification according to the ground on which the leaves have to be laid. These conditions will now be considered in reference to the articles ordinarily selected for gilding.

On plain wood.—Before gilding plain wood, its absorbent character must be destroyed by the application of a ground colour, which may be jappanners' gold size mixed with yellow ochre previously ground very fine in turpentine, or a compound of boiled linseed-oil and a pigment of good body, such as white-lead. The painted ground, when dry, is rubbed down smooth with fine glasspaper, and any required number of coats added and similarly smoothed, when the sizing and gilding follow in the usual manner.

On polished wood.—In the case of polished wood, the coat of polish serves the purpose of a ground colour, and renders the latter needless. Should the gilding be desired to cover only portions of the surface, the precaution must be taken, before applying it, to rub whitening on the parts not to be gilded, so as to prevent the adhesion of the leaf to the otherwise sticky surface. The sizing and gilding are conducted in the ordinary way.

On cards.—For gilding on cards, the surface must first be rendered non-absorbent by the application of a water size, made from isinglass, gum arabic, or parchment shreds boiled down. The number of coats of size needed will depend on the nature of the card; then oil sizing and gilding follow in due course. An exception to this rule obtains with photographs, in which the albumenizing serves as a substitute.

On textiles.—The surfaces of textile materials require a similar grounding of water size, which may be weak glue for coarse fabrics.

On painted and japanned surfaces.—The same rules hold good as for polished wood.

On metals.—These are unsatisfactory materials for gilding on, as they so soon suffer oxidation and decay. They are best painted first.

On masonry.—The porous surface of stone or plaster must first be rendered water-proof and "satisfied" by coats of either a solution of shellac and gutta-percha in naphtha, or of shellac in methylated spirit, great care being taken that the surface is previously dry, and that the oil size afterwards applied does not extend beyond the "satisfied" portion.

On ivory.—Ivory is not so easy to gild as articles made of wood: wood, being porous, retains a portion of the gold size; yet, on the other hand, bone or ivory may be so gilt that it shall resemble gold. Free the ivory from dirt or grease; when quite dry, give the article a thin coat of gold size laid on evenly with a fine hair brush; lay aside until set, which may be known by feeling whether tacky to the finger. The gold size should be just the least warm; the article may, with advantage, be warmed before applying the gold size; great care must be used to keep the dust from the article until gilt and quite dry. Cut the gold leaf in suitable-sized pieces, and apply with the tip; the gold leaf may then be pressed into shape with a piece of white wool. Should any part appear not gilt, apply a dab of gold size, then a piece of gold leaf. When quite dry, it may be burnished with an ivory paper-knife, or even a glass penholder, always inserting a piece of tissue

paper between the burnisher and the article to be gilt. When finished off, the appearance will be much improved by giving the article a coat of gold lacquer.

On plaster of Paris.—This needs 3 or 4 coats of boiled linseed-oil laid on at intervals of 24 hours, followed by a water size containing finely-ground yellow ochre for delicate work, or a coat of japanners' size and yellow ochre for coarser work; the gold size and leaf follow when this is dry.

Bright Gilding.—The bright effect is gained either by having a smooth polished ground, or by burnishing the coat of gold leaf. The adhesive medium employed is water size. There are two important modifications of the process, according as the surface to be gilt is transparent or opaque.

On transparent material.—The commonest transparent material is glass, and the polish, smoothness, and hardness of its surface adapt it well to the process. The operation is performed on the back of the sheet of glass, and this must be borne in mind with reference to the reversed position of the pattern. The surface to be gilt is thoroughly freed from adhering grease, &c., by rubbing with whiting, and the latter is removed by the aid of a silk cloth. Adhesion of the leaf is secured by simply moistening the surface of the glass with the tongue or the breath. When it has become attached and has dried, it is breathed on again, pressed all over with a pad of cotton wool, then warmed by the fire, and finally rubbed with dry clean cotton wool to bring up a polish. Next, on the gilded ground is marked the pattern which is to be exhibited, and such portion of the leaf is fixed by a coat of Brunswick black or of japanners' gold size containing a pigment such as yellow ochre, which is allowed to dry quite hard before proceeding to rub off the leaf from the portions which are not to be gilt. This rubbing off is done with pieces of wet cotton wool, the hand being meantime held off the work by a strip of wood supported across it at a suitable elevation. If the pattern is to be made up of different kinds of leaf (deep and pale golds and silver), each kind is applied in turn, in the same manner, all over the unoccupied space, and rubbed out where not wanted. The background is finished by a coat of paint or bronze powder, the latter being rubbed with a "bob" upon a layer of varnish. The preliminary fixing of the leaf may be done with a water size, such as already described, if desired; this takes longer to dry, and, if allowed to get too dry, holds so firmly that it is difficult to remove the superfluous leaf.

On opaque material.—For fixing the leaf on polished or japanned surfaces, the water size used as a ground should contain no spirit. The best fixative for the pattern is Brunswick black. A final coat of copal varnish over the gilding is desirable. By bronzing a portion of the ground (rubbing bronze powder on a coat of japanners' gold size and chrome yellow), and gilding all over, the bronzed part will exhibit dead gilding and the remainder bright.

Many useful hints with reference to gilding picture-frames, book-covers, illuminated documents, and various other articles, will be found in the first series of 'Workshop Receipts.'

POLISHING.—It is a common proceeding to impart a brilliant lustrous surface to finished work by the operation of polishing. The methods of conducting the operation and the materials employed to produce the effect vary with the nature of the substance forming the ground to be polished. Hence it is best to divide the subject into appropriate sections, e. g. marble, metals, and woods.

Marble.—(1) If the piece to be polished is a plane surface, it is first rubbed by means of another piece of marble, or hard stone, with the intervention of water and two sorts of sand; first with the finest river or drift sand, and then with common house or white sand, which latter leaves the surface sufficiently smooth for the process of gritting. Three sorts of grit stone are employed; first, Newcastle grit; second, a fine grit brought from the neighbourhood of Leeds; and lastly, a still finer, called snake grit, procured at Ayr, in Scotland. These are rubbed successively on the surface with water alone; by

these means, the surface is gradually reduced to closeness of texture, fitting it for the process of glazing, which is performed by means of a wooden block having a thick piece of woollen stuff wound tightly round it; the interstices of the fibres of this are filled with prepared putty powder (peroxide of tin), and moistened with water; this being laid on the marble and loaded, it is drawn up and down the marble by means of a handle, being occasionally wetted, until the desired gloss is produced. The polishing of mouldings is done with the same materials, but with rubbers varied in shape according to that of the moulding. The block is not used in this case; in its stead a piece of linen cloth is folded to make a handful; this also contains the putty powder and water. Sand rubbers employed to polish a slab of large dimensions should never exceed $\frac{2}{3}$ of its length, nor $\frac{1}{3}$ of its width; but if the piece of marble is small, it may be sanded itself on a larger piece of stone. The grit rubbers are never larger than that they may be easily held in one hand; the largest block is about 14 in. in length and $4\frac{1}{2}$ in. in breadth.

(2) Polishing includes 5 operations. Smoothing the roughness left by the burin is done by rubbing the marble with a piece of moist sandstone; for mouldings, either wooden or iron mullers are used, crushed and wet sandstone, or sand, more or less fine according to the degree of polish required, being thrown under them. The second process is continued rubbing with pieces of pottery without enamel, which have only been baked once, also wet. If a brilliant polish is desired, Gothland stone instead of pottery is used, and potters' clay or fullers' earth is placed beneath the muller. This operation is performed upon granites and porphyry with emery and a leaden muller, the upper part of which is incrustated with the mixture until reduced by friction to clay or an impalpable powder. As the polish depends almost entirely on these two operations, care must be taken that they are performed with a regular and steady movement. When the marble has received the first polish, the flaws, cavities, and soft spots are sought out and filled with mastic of a suitable colour. This mastic is usually composed of a mixture of yellow wax, rosin, and Burgundy pitch, mixed with a little sulphur and plaster passed through a fine sieve, which gives it the consistency of a thick paste; to colour this paste to a tone analogous to the ground tints or natural cement of the material upon which it is placed, lampblack and rouge, with a little of the prevailing colour of the material, are added. For green or red marbles, this mastic is sometimes made of lac, mixed with Spanish sealing-wax of the colour of the marble; it is applied hot with pincers, and these parts are polished with the rest. Sometimes crushed fragments of the marble worked are introduced into this cement; but for fine marbles, the same colours are employed which are used in painting, and which will produce the same tone as the ground; the lac is added to give it body and brilliancy. The third operation of polishing consists in rubbing it again with hard pumice, under which water is constantly poured, unmixed with sand. For the fourth process, called softening the ground, lead filings are mixed with the emery mud produced by the polishing of mirrors or the working of precious stones, and the marble is rubbed with a compact linen cushion, well saturated with this mixture; rouge is also used for this polish. For some outside works, and for hearths and paving tiles, marble workers confine themselves to this polish. When the marbles have holes or grains, a leaden muller is substituted for the linen cushion. In order to give a perfect brilliancy to the polish, the gloss is applied. Well wash the prepared surfaces, and leave them until perfectly dry; then take a linen cushion, moistened only with water, and a little powder of calcined tin of the first quality. After rubbing with this for some time, take another cushion of dry rags, rub with it lightly, brush away any foreign substance which might scratch the marble, and a perfect polish will be obtained. A little alum mixed with the water used penetrates the pores of the marble, and gives it a speedier polish. This polish spots very easily, and is soon tarnished and destroyed by dampness. It is necessary, when purchasing articles of polished marbles, to subject them to the test of water; if there is too much alum, the marble absorbs the water, and a whitish spot is left.

(3) To polish imitation marbles, when you have finished marbling, let the work stand for a day or two; then gently rub it down with the back or smooth side of a sheet of sandpaper; this will take off the knits or bits of skin which may be upon it, without scratching it; now give it 3 coats of the best pale polishing copal varnish, allowing an interval of 2 days after each coat. Let this stand for 3 weeks; then cut it down with ground pumice and water, using a piece of wash-leather or rag for that purpose. When you have got it tolerably smooth and level, wash it well with plenty of clean water, taking particular care to clean off all the pumice; give it 5 coats of varnish. It ought now to stand for 3-6 months before it is polished, for if it is done before it is almost certain to crack. When the varnish is sufficiently hard, cut it down with finely-ground pumice as before; then use rottenstone and olive-oil, with the ball of the hand; then flour and oil; finish off with dry flour. This takes a deal of time to do properly.

Metals.—The following general remarks on polishing metallic surfaces by hand are from a paper by T. F. Hagerty, in the *American Machinist*:—The practice generally employed by machinists in grinding and polishing either new or old work is to mix the polishing material with oil, usually refuse machinery oil; in most cases this is a great mistake, and has caused the loss of time, patience, and money. Take, for instance, the grinding to a true bearing of a stopcock, a valve seat, or a slide valve. There are few machinists but what have had more or less of that class of work to do, particularly in jobbing shops, and we seldom find one who uses the same method of accomplishing the job that is practised in shops where that class of work is made a speciality. In fitting and grinding the plug into the barrel of a cock, a little judgment and care will save a great deal of hard labour, and in no case should oil be mixed with any of the grinding material, for the following reasons: If fine emery, ground glass, or sand is used with oil, it requires but a few turns of the plug in the barrel to break up the grains of the grinding material into very fine particles; the metallic surfaces also grind off, and the fine particles of metal mixing in with the grinding material and oil, make a thick paste of the mass. At this stage it is impossible to grind or bring the metallic surfaces to a bearing, as the gluey paste keeps them apart; if more grinding stuff is applied, it will prevent the operator from seeing what part of the barrel and plug bears the hardest. Again, if the grinding material be distributed over the whole surface, the parts that do not bear will grind off as fast as the parts that touch hard, as the particles work freely between the surfaces; should the barrel and plug bear equally all over when fitted it requires more care than if it were a top or bottom bearing, as that part of the barrel and plug across the "waterway" grinds twice as fast as the other parts; therefore it should be kept the driest. Now this objection holds good in the grinding of valve seats or slide valves, to wit: the separation of the surfaces of the metal by a thick, pasty, grinding material. In order to bring the surfaces to a perfect bearing rapidly and with little labour, the following directions will be found worth a trial:—To grind a stopcock of any kind, first see that the plug fits the barrel before it is taken from the lathe. Run a half-round smooth file up and down the barrel to break any rings that may be in it; a few rubs of a smooth file back and forth over the plug will break any rings or tool marks on it. Wipe both parts clean. Use for grinding material fine moulders' sand sifted through a fine sieve. Mix with *water* in a cup, and apply a small quantity to the parts that bear the hardest. Turn rapidly, pressing gently every few turns; if the work is large and the lathe is used, run slowly; press and pull back rapidly to prevent sticking and ringing; apply grinding sand and water until a bearing shows on another part, then use no more new sand, but spread the old that has worked out over the whole surface. Turn rapidly, pressing gently while turning: withdraw the plug and wipe part of the dirt off, and rub on the place a little brown soap; moisten with water and press the surfaces together with all the force at hand, turning at the same time. Remove the plug and wipe both parts clean; next try the condition of the bearing by pressing the dry surfaces together with great force. If the parts have been kept closely

together while grinding, and the plug has not rubbed against the lower part of the barrel, the surfaces will be found bright all over and a perfect bearing obtained. If an iron barrel and a brass plug are used, or two kinds of brass, a hard and soft metal, soap should be used freely when finishing up, as the tendency to form rings is greater when two different metals are used. In grinding a slide valve which has been in use until hollow places have worn in the surface, emery mixed with water, or sand and water, will be found better than oil, unless a light body of oil, such as kerosene, is used. If water is used with the grinding material, soap should be rubbed on hollow places, and the grinding stuff should be applied to the high parts in small quantities, keeping the low parts clean and dry until an even surface is obtained all over; then the worn-out stuff should be used for finishing up. In polishing metal, oil that will "gum up" should not be used with the polishing material unless for a dead fine polish. In polishing old brasswork which has been scratched and tarnished by wear, pumice or bathbrick should be used with soap and water for scouring off with, and rottenstone with kerosene oil for the wet finish, and dry for the final polish. The same method should be used for new brasswork. New work should require, after leaving the lathe and vice tools, but little polishing or grinding, and every good workman should try to avoid using an emery stick or emery cloth, as with proper care in the use of tools a great deal of grinding and polishing can be dispensed with. The polishing of metals varies somewhat according to their character, but the main principle underlying all is the substitution of progressively finer scratches for those left by the material last used, until they become so delicate as to be invisible without the aid of a microscope.

Belgian Burnishing Powder.—Mix together 1 oz. fine chalk, 3 oz. pipeclay, 2 oz. dry white-lead, $\frac{3}{4}$ oz. carbonate magnesia, and $\frac{3}{4}$ oz. rouge.

Brass-polishes.—(1) Make a paste of equal parts of sulphur and chalk, with sufficient vinegar to reduce it to the proper consistency; apply it to the metal while moist, allow it to dry on, and rub with a chamois skin. For ornaments or engraved work, clean with a brush. (2) Another process, and one that gives to the brass a very brilliant colour, is to make a wash of alum boiled in strong lye, in the proportion of 1 oz. alum to 1 pint lye. Wash the brass with this mixture, and afterwards rub with chamois and tripoli. (3) A weak solution of ammonia in water makes an excellent wash. Apply it with a rag, dry with a piece of shammy, and afterwards rub with a piece of shammy and a very small quantity of jewellers' rouge. (4) Place 2 oz. sulphuric acid in an earthen vessel, and add 1 qt. cold soft water; after the heat that is generated has passed off, add 1 oz. each tripoli and jewellers' rouge. When well mixed, put in a bottle for use. (5) Brass may be polished without a burnisher, by using an exceedingly fine cut file, and fine emery cloth. (6) Small articles to be polished should be shaken by themselves for a short time; then some greasy parings of leather should be put in the barrel with them. After they have been shaken smooth, the greasy leather parings are replaced by clean ones, and the shaking is continued as long as necessary. (7) When the brass is made smooth by turning, or filing with a very fine file, it may be rubbed with a smooth fine-grained stone, or with charcoal and water. When it is made quite smooth and free from scratches, it may be polished with rottenstone and oil, alcohol, or spirits of turpentine.

Burnishing.—To burnish an article is to polish it, by removing the small roughness upon its surface; and this is performed by a burnisher. This mode of polishing is the most expeditious, and gives the greatest lustre to a polished body. It removes the marks left by the emery, putty of tin, or other polishing materials; and gives to the burnished articles a black lustre, resembling that of looking-glass. The form and construction of the burnisher is extremely variable, according to the respective trades; and it must be adapted to the various kinds of work in the same art. In general, as this tool is only intended to efface inequalities, whatever substance the burnisher is made of is of little consequence to the article burnished, provided only that it is of a harder substance than that article.

Burnishers.—The burnishers used are of two kinds, of steel and of hard stone. They are either curved or straight, rounded or pointed, and made so as to suit the projecting parts, or the hollows of the piece. Stone burnishers are made of blood-stone, cut, and either rounded with the grindstone, or rubbed, so that they present, at the bottom, a very blunt edge, or sometimes a rounded surface. These are polished with emery, like steel burnishers, and are finished by being rubbed upon a leather, covered with crocus martis. The stone is mounted in a wooden handle, and firmly fixed by a copper ferrule, which encircles both the stone and the wood. The best blood-stones are those which contain the most iron, and which, when polished, present a steel colour. The operation of burnishing is very simple; take hold of the tool very near to the stone, and lean very hard with it on those parts which are to be burnished, causing it to glide by a backward and forward movement, without taking it off the piece. When it is requisite that the hand should pass over a large surface at once, without losing its point of support on the work-bench, in taking hold of the burnisher be careful to place it just underneath the little finger. By this means the work is done quicker, and the tool is more solidly fixed in the hand. During the whole process, the tool must be continually moistened with black soapsuds. The water with which it is frequently wetted causes it to glide more easily over the work, prevents it from heating, and facilitates its action. The black soap, containing more alkali than the common soap, acts with greater strength in cleansing off any greasiness which might still remain on the surface; it also more readily detaches the spots which would spoil the beauty of the burnishing. In consequence of the friction the burnisher soon loses its bite, and slips over the surface of the article as if it were oily. In order to restore its action, it must be rubbed, from time to time, on the leather. The leather is fixed on a piece of hard wood, with shallow furrows along it. There are generally two leathers—one made of sole leather and the other of buff leather. The first is impregnated with a little oil and crocus martis, and is particularly used for the blood-stone burnishers; the other has only a little putty of tin scattered in the furrows, and is intended exclusively for rubbing steel burnishers, as they are not so hard as the blood-stones. Blood-stone being very hard, the workman uses it whenever he can, in preference to the steel burnisher. It is only in small articles, and in difficult places, that steel burnishers are used; as they, by their variety of form, are adapted to all kinds of work. In general, the blood-stone greatly reduces the labour. When the articles, on account of their minuteness, or from any other cause, cannot be conveniently held in the hand, they are fixed in a convenient frame on the bench; but under all circumstances be very careful to manage the burnisher so as to leave untouched those parts of the work which are intended to remain dull. When, in burnishing an article which is plated or lined with silver, there is any place where the layer of precious metal is removed, restore it by silvering these places with a composition supplied by the silverer, which is applied with a brush, rubbing the part well, and wiping it afterwards with an old linen cloth. The burnishing being finished, remove the soapsuds which still adhere to the surface of the work; this is effected by rubbing it with a piece of old linen cloth. But when there are a great number of small pieces to finish, to throw them into soapsuds and dry them afterwards with sawdust is more expeditious. The burnishing of gold leaf or silver, on wood, is performed with burnishers made of wolves' or dogs' teeth, or agates, mounted in iron or wooden handles. When about to burnish gold, applied on other metals, dip the blood-stone burnisher into vinegar; this kind being exclusively used for that purpose. But when burnishing leaf gold on prepared surfaces of wood, keep the stone, or teeth, perfectly dry. The burnisher used by leather gilders is a hard polished stone, mounted in a wooden handle—this is to sleek or smooth the leather. The ordinary engravers' burnisher is a blade of steel, made thin at one end, to fit into a small handle to hold it by. The part in the middle of the blade is rounded on the convex side, and is also a little curved. The rounded part must be well polished, and the tool be very hard. This burnisher is used to give the last polish to such parts

of copper and steel plates as may have been accidentally scratched, or speckled, where false lines are to be removed, and also to lighten in a small degree such parts as have been too deeply etched or graved. In clockmaking, those pieces or parts are burnished which, on account of their size or form, cannot be conveniently polished. The burnishers are of various forms and sizes; they are all made of cast steel, very hard, and well polished; some are formed like sage-leaf files, others like common files—the first are used to burnish screws and pieces of brass; the others are used for flat pieces. The clockmakers have also very small ones of this kind, to burnish their pivots—they are called pivot burnishers.

Book Edges.—This is done with a wolf's or dog's tooth, or a steel burnisher; for this purpose place the books in a screw press, with boards on each side of them, and other boards distributed between each volume; first rub the edges well with the tooth to give them a lustre. After sprinkling or staining and when the edges are dry, burnish the front; then turning the press, burnish the edges at the top and bottom of the volume. Burnish the gilt edges in the same manner, after having applied the gold; but observe in gilding, to lay the gold first upon the front, and allow it to dry; and on no account to commence burnishing till it is quite dry.

Cutlery.—The burnishing of cutlery is executed by hand or vice burnishers; they are all made of fine steel, hardened, and well polished. The first kind have nothing particular in their construction; but vice burnishers are formed and mounted in a very different manner. On a long piece of wood, placed horizontally in the vice, is fixed another piece, as long, but bent in the form of a bow, the concavity of which is turned downwards. These two pieces are united at one of their extremities by a pin and a hook, which allows the upper piece to move freely around this point as a centre. The burnisher is fixed in the middle of this bent piece, and it is made more or less projecting, by the greater or lesser length which is given to its base. The movable piece of wood, at the extremity opposite to the hook, is furnished with a handle, which serves the workman as a lever. This position allows the burnisher to rest with greater force against the article to be burnished, which is placed on the fixed piece of wood. The burnisher has either the form of the face of a round-headed hammer, well polished to burnish those pieces which are plain or convex; or the form of two cones opposed at their summits, with their bases rounded, to burnish those pieces which are concave or ring-shaped.

Pewter.—The burnishing of pewter articles is done after the work has been turned, or finished off with a scraper. The burnishers are of different kinds, for burnishing articles either by hand or in the lathe; they are all of steel, and while in use are rubbed with putty powder on leather, and moistened with soapsuds.

Silver.—Commence by cleaning off any kind of dirt which the surfaces of the silver articles had contracted whilst making, as that would entirely spoil the burnishing. For this purpose, take pumice powder, and with a brush, made very wet in strong soapsuds, rub the various parts of the work, even those parts which are to remain dull, which, nevertheless, receive thus a beautiful white appearance; wipe with an old linen cloth, and proceed to the burnishing.

Crocus.—Put tin, as pure as possible, into a glass vessel—a wineglass does very well when making small quantities—and pour in sufficient nitric acid to cover it. Great heat is evolved, and care must be taken not to inhale the fumes, as they are poisonous. When there is nothing left but a white powder, it is heated in a Hessian crucible, to drive off the nitric acid.

Emery Paper.—Emery paper is extensively employed for cleaning and polishing metals, but all the kinds in use hitherto have the great disadvantage of not retaining an equal efficiency. The fresh parts bite too much, and the paper itself soon gets worn through in places. Emery on linen has been tried, but without success. The emery paper recommended by the *Manufacturer and Builder* is not a pasteboard with emery on

both sides, but a board in which emery enters as a constituent part. Fine and uniform cardboard pulp must be procured, and $\frac{1}{3}$ to $\frac{1}{2}$ its weight of emery powder thoroughly mixed with it, so that the emery may be equally distributed. The mass is then poured out in cakes of 1 in. to 10 in. in thickness. They must not be pressed hard, however, but allowed to retain a medium pliability. This paper will adapt itself to the forms of the articles, and will serve until completely worn out.

Emery Wheels.—(1) Can be made with shellac powdered fine, and a small portion of rosin, a piece about the size of a walnut to 1 oz. shellac, and a piece of old vulcanized indiarubber about the same size, which gives it toughness. Shellac about 1 oz. to 1 lb. of emery, well melt, and stir about in a small frying-pan; well mix the powders before applying heat. Be careful not to burn it, or get grease in it; have a ring of iron and a piece of plate iron prepared with black-lead and beer pretty thick; place the ring upon the plate and make a mould, turn the stuff into it, and well ram down evenly; put on one side to cool; when cold, turn out and chuck in lathe, and with a piece of red-hot iron bore a hole for spindle; after spindled put between centres, and trice-up with hot iron. Very good grindstones may be made with silver-sand mixed with powdered glass, and it is necessary to have some body besides shellac for coarse emery to form a body to bed the grains in. Emery dust from grinding glass, and Turkey stone slips, and slate, may be used as a substitute for the flour. (2) The best emery wheels are formed of clean emery compounded with just enough boiled linseed-oil, the mixture being agitated for a sufficient period under exposure to a considerable heat and free access of atmospheric air, or some still more powerful oxidizing agent; it assumes the necessary degree of tenacity, and whilst warm, being exposed to hydraulic pressure in a suitable mould, and subsequent drying in a stove, the emery wheel is complete.

Friction Polish.—A good polish for iron or steel rotating in the lathe, is made of fine emery and oil; which is applied by lead or wood grinders, screwed together. Three very good oils for lubrication are olive oil, sperm, and neats'-foot.

German Silver.—Take 1 lb. peroxide of iron, pure, and put half of it into a wash-basin, pouring on water, and keeping it stirred until the basin is nearly full. While the water and crocus are in slow motion, pour off, leaving grit at the bottom. Repeat this a second time, pouring off into another basin. Cleanse out grit, and do the same with the other half. When the second lot is poured off, the crocus in the first will have settled to the bottom; pour off the water gently, take out the powder, dry it, and put both when washed clear of grit, and dried, into a box into which dust cannot get. If the silver work is very dirty, rub the mixture of powder and oil on with the fingers, and then it will be known if any grit is on the work. If the work is not very black, take a piece of soft chamois leather, and rub some dry crocus on, and when well rubbed, shake out the leather, and let the powder fall off that is not used, or rub it off with a brush. Do not put down the leather in the dust.

Glaze Wheels for Finishing Steel.—For hollow finishing, the following wheels are required:—A mahogany wheel for rough glazing. A mahogany wheel for smooth glazing. A lead wheel, or lap. For flat finishing: A buff wheel for rough. A buff wheel for smooth. A buff wheel for finishing. Lastly, a polisher. To make the glaze wheels: Get the spindles, and point them on each end; then get a block of beech and wedge it on the steel at one end with iron wedges, and turn it for the pulley for the band to run on. Take two pieces of flat mahogany and glue and screw them together, so that the grain of one piece crosses the other, to prevent warping. Let it get thoroughly dry, and wedge it on the spindle and turn it true. The lead wheel is made the same way but wider, and has a groove turned in the edge. The wheel is put into sand, and a ring of lead run round the edge; it is then turned true. To make the buff wheels, proceed as with the glaze; but to save expense, pine or deal wood will do as well as mahogany, only leave it about double the width of the glaze, which is about $\frac{1}{2}$ in. wide, by 12 or 14 in. across. The buff wheels are covered with glue, and then the

leather is tacked on with tacks driven in about half-way, so that they may be easily drawn out again. The leather is then turned true. The polisher is made the same way, but the size of the polisher must be a little less than any of the other wheels, say, about 1 in. The buff wheels are dressed by laying on a fine thin coat of clear glue, and rolling them round—No. 1, in superfine corn emery; No. 2, in smooth emery; No. 3, by making a cake of equal parts of mutton suet, beeswax, and washed emery; then it is held on the wheel while it is going round. The glaze wheels are dressed while using, by mixing a little of the emery with oil, and putting it on the wheel with a stick or the finger. The leather of the polisher is not covered with glue, but dressed with a mixture of crocus and water, not oil. Care must be taken to keep each wheel and substance to themselves, the work must be carefully wiped after each operation, and cleanliness must be studied above all things in using the polisher, as the slightest grease getting on it stops the polishing.

Gold and Silver lace.—Gold lace, spangles, clasps, knots, &c., may be brushed over with the following composition: $1\frac{1}{2}$ oz. shellac, $\frac{1}{2}$ dr. dragons' blood, $\frac{1}{2}$ dr. turmeric root; digest with strong alcohol, decanting the ruby-red coloured tincture thus obtained. After coating with this composition, a warm flat-iron is gently brushed over the objects, so as to heat them only very slightly. Gold embroidery can be similarly treated. Silver lace or embroidery may be dusted over with the following powder and well brushed. Take alabaster, and strongly ignite it, and whilst still hot place it in corn brandy; a white powder is thus obtained, which is fit for use after heating over the flame of a spirit lamp. It should be dusted on from a linen bag.

Grindstone, Artificial.—Washed silicious sand 3 parts, shellac 1 part; melt the lac, and mould in the sand, while warm. Emery may be substituted for sand. Used for razors and fine cutlery.

Iron and Steel.—(1) Take an ordinary bar of malleable iron in its usual merchantable state, remove the oxide from its surface by the application of diluted sulphuric acid, after which wash the bar in an alkaline solution, then cover the entire bar with oil or petroleum. The bar is then ready for the chief process. A muffle surface is so prepared that a uniform, or nearly uniform, heat can be maintained within it, and in this furnace the bar is placed. Care must be taken that too great a heat is not imparted to it, for on this depends the success of the operation. When the bar approaches a red heat, and when the redness is just perceptible, it is a certain indication that the proper degree has been attained. The bar is then at once removed, and passed through the finishing rolls 5 or 6 times, when it will be found to have a dark polished uniform surface, and the appearance of Russian sheet iron. (2) Keys, Key-rings, and other articles of iron.—Finish them well with a dead smooth file, then mix some fine emery and oil together, hold the key in wood clamps, take some long strips of wash-leather, dip in the above, and polish well every part until all scars disappear; then tie 2 or 3 dozen on a piece of iron binding-wire, put them in an iron box with leather scraps burnt and made into a fine powder, cover bottom of box $\frac{1}{2}$ in. thick, spread out the keys on this, cover them up with the powder or leather-dust, put a lid on, tie down, put in a slow fire until the box is red hot, soak about 20 minutes, then open the box, take out the keys quick, plunge them in oil—water makes them too brittle; now repeat the polishing as before, with long leather strings dipped in the oil and emery, until all the black from the "hardening" is off every part, then take them to the brushing-frame, charge your brush well with flour of emery, keep turning the key in every direction until the polish begins to appear; after this dip them in slaked lime, and get off every particle of grease. Take them to another brushing-frame, the brush charged with crocus and water; keep dipping the key in occasionally, and follow up process on the brush until the polish comes up well. To put the extra gloss or polish on, take the leather strings as before, this time dipped in a mixture of putty-powder and water; work the string well over every part until dark polish comes up. If you wish a higher polish, it is done by hand—that is, girls dip

their hands in the putty-powder mixture above, and rub every possible part up with the palm of the hand, and this gives the beautiful polish that is upon them. (Aubin.) (3) Boden recommends the following method of brightening the surfaces of iron plates, wire, &c., as the result of numerous experiments made in the laboratory of the Industrial Museum at Munich:—The object, whatever it may be, just as it comes from the forge, is laid for the space of one hour in dilute sulphuric acid ($\frac{1}{20}$ part acid). The action of the acid may be increased by the addition of a little carbolic acid (?). The forge scales are loosened by the action of the acid, and the object is then washed clean with water, and dried with sawdust. Next, it is held for an instant in nitrous acid, the operator of course being on his guard against the nitrous fumes, washed again carefully, dried in sawdust, and rubbed over clean. Iron goods thus treated acquire a perfectly bright, pure surface, having a white glance, without the intervention of any mechanical process of polishing. (4) Steel.—Use bell-metal polishers for arbors, having first brought up the surface with oilstone dust and oil and soft steel polishers; for flat pieces use a piece of glass for the oilstone dust, a bell-metal block for the sharp red stuff, and a white metal block for the fine red stuff. The polishing stuff must be well mixed up and kept very clean; the polishers and blocks must be filed to clean off the old stuff, and then rubbed over with soft bread; put only a little red stuff on the block and keep working it until it is quite dry, the piece will then leave the block quite clean; use bread to clean off the surplus red stuff before using the brush. If the piece is scratched, put on some more red stuff, which must not be too wet, and try again. (5) The polish on flat steel pieces in fine watchwork is produced with oilstone dust, burnt Turkey stone, and a steel polisher, soft steel, bell-metal, and sharp stuff, grain tin and glossing stuff. The metals are squared with a file, and vary in shape according to the work in hand. (6) Get an 18-gal. barrel and put an iron spindle through the two ends; mount it on trestles in the same way as a butter churn, with a winch to turn it by; cut out a hole in the side by which to introduce the articles to be polished; have a tight-fitting cover to the hole; procure some worn-out casting pots or crucibles, such as used by casters, and pound them in an iron mortar, until fine enough to pass through a sieve which will not allow the steel articles to pass through. Put equal quantities of this grit and of the articles in the barrel; fasten on the cover, and turn the barrel for about an hour, at the rate of about 50 turns a minute; take all out of the barrel and sift out the grit. If a finer polish than this is required, put them through another turning, substituting for the grit small scraps of leather, called mosings, which can be procured from curriers, and emery flour. Do not more than half fill the barrel.

Plate Powders.—(1) Take equal parts precipitated subcarbonate of iron, and prepared chalk. (2) An impalpable rouge may be prepared by calcining the oxalate of iron. (3) Take quicksilver with chalk, $\frac{1}{2}$ oz., and prepared chalk 2 oz., mix them. When used, add a small quantity of spirits of wine, and rub with chamois leather. (4) Put sulphate of iron into a large tobacco pipe, and place it in a fire for $\frac{1}{4}$ hour, mix with a small quantity of powdered chalk. This powder should be used dry. (5) The following makes a liquid polish for silver plate—3 to 4 dr. cyanide of potassium, 8 to 10 gr. nitrate of silver, and 4 oz. water; apply with a soft brush, wash the object thoroughly with water, dry with a soft linen cloth, and polish with a chamois skin. Neither whitening nor powder of any kind should be used for cleaning and polishing—they only waste and scratch the silver. (6) Take 2 oz. hartshorn powder and boil it in 1 pint water; soak small squares of damask cloth in the liquid, hang them up to dry, and they will be ready for use, and better than any powders. (7) Add by degrees 8 oz. prepared chalk in fine powder to a mixture of 2 oz. spirits of turpentine, 1 oz. alcohol, $\frac{1}{2}$ oz. spirits of camphor, and 2 dr. aqua ammonia; apply with a sponge, and allow it to dry before polishing. (8) Mix together 1 oz. fine chalk, 2 oz. cream of tartar, 1 oz. rottenstone, 1 oz. red-lead, and $\frac{3}{4}$ oz. alum; pulverize thoroughly in a mortar. Wet the mixture, rub it on the silver, and, when dry, rub off with a dry flannel, or clean with a small

brush. (9) An excellent preparation for polishing plate may be made in the following manner:—Mix together 4 oz. spirits of turpentine, 2 oz. spirits of wine, 1 oz. spirits of camphor, and $\frac{1}{2}$ oz. spirits of ammonia. To this add 1 lb. whiting, finely powdered, and stir till the whole is of the consistency of thick cream. To use this preparation with a clean sponge, cover the silver with it, so as to give it a coat like whitewash. Set the silver aside till the paste has dried into a powder; then brush it off, and polish with a chamois leather. A cheaper kind may be made by merely mixing spirits of wine and whiting together.

Prepared Chalk.—(1) Pulverize chalk thoroughly, and mix with distilled water in the proportion of 2 lb. to the gal.; stir well, and then allow it to stand about 2 minutes, during which time the gritty matter will have settled to the bottom; then pour the chalky water into another vessel, being careful not to disturb the sediment, and allow the fine chalk to settle to the bottom; pour off the water, and place the chalk in a warm oven to dry. This is an excellent powder for restoring silver, and it is also useful as a base for other polishing powders. (2) Spanish whiting treated in the same manner, with a small quantity of jewellers' rouge added, makes a powder that is a little sharper than the prepared chalk, and which is well adapted to cleaning polished steel articles. (3) A third powder, and one that is still sharper than either of the above, is made of rottenstone treated in the same manner as the chalk. The addition of bone black to any of these powders will prevent their discolouring leather.

Putty Powder.—A solution of commercial tin chloride is prepared by pouring on 1 part of the salt 6 of boiling distilled water, and the solution is filtered through a cloth into a cylindrical glass vessel, in order to allow the foreign substances which are sometimes found in the chloride to deposit. The filtration by means of filtering-paper is too slow, and it is always attended with the loss of a subchloride which does not pass through filtering-paper; therefore this filtration is not practicable, and may be completely replaced by passing the solution through linen. Into the still hot and almost clear solution of tin chloride is poured a concentrated solution of oxalic acid; a white precipitate of oxalate of protoxide of tin is formed. After complete cooling, the liquor is decanted, and the precipitate is washed on a cloth with cold water until the washing water has no longer an acid reaction. The tin oxalate is afterwards heated, dried on an iron plate, or in a boiler of the same metal, over a small charcoal fire. The decomposition of the salt commences at red heat, and there remains, after the disengagement of carbonic acid gas, and carbonic oxide, a quantity of tin oxide in the state of extreme division. During the decomposition, which must be accelerated by stirring with an iron wire, the matter undergoes a considerable increase of bulk, consequently it is necessary to employ for this operation very spacious vessels, so as to avoid loss. (Watt.)

Razor Paste.—(1) Mix fine emery intimately with fat and wax until the proper consistency is obtained in the paste, and then rub it well into the leather strap. Prepare the emery by pounding thoroughly in a mortar the coarse kind, throwing it into a large jug of water and stirring well. Immediately the large particles have sunk, pour off into a shallow plate or basin, and let the water evaporate. This emery is better for engraving and other purposes than that prepared at the emery mills. (2) The grit from a fine grindstone is very efficient for a razor paste. (3) Levigated oxide of tin (prepared putty powder), 1 oz.; powdered oxalic acid, $\frac{1}{4}$ oz.; powdered gum, 20 gr.; make into a stiff paste with water, and evenly and thinly spread it over the strop. With very little friction, this paste gives a fine edge to the razor, and its efficiency is still further increased by moistening it. (4) Emery reduced to an impalpable powder, 2 parts; spermaceti ointment, 1 part; mix together, and rub it over the strop. (5) Jewellers' rouge, black-lead, and suet, equal parts; mix.

Rottenstone (Tripoli).—This very useful polishing medium is a natural product, originally obtained from Tripoli, from which it derives its name. It is of a yellowish-grey colour, and its particles are impalpably fine, hence its employment for polishing

silver, brass, and other metals. When examined under a powerful microscope, it is found to be composed of the skeletons of animalculæ. It is found in Derbyshire, Bohemia, France, Corfu, &c., but that which comes from the latter place is considered by some persons as the best for polishing brass and other metals. It is used either with water or oil, more generally with the latter, and is applied either with a leather or a buff-stick—a flat piece of wood having a strip of soft leather glued to it on one side. In large operations, the polishing is done at a lathe worked by a treadle or steam-power. After using rottenstone and oil in the polishing of articles of jewellery or plate, the article is afterwards “finished” by hand or machine with jewellers’ rouge. The rouge is moistened with water, and when this is rubbed on the article previously polished with rottenstone, a brilliant surface is produced with very little labour, and articles of silver, electroplate, gold, and gilt work assume under this treatment the highest degree of brightness which they are capable of receiving. (Watt.)

Rouge.—(1) The rouge used by machinists, watchmakers, and jewellers is a mineral substance. In its preparation crystals of sulphate of iron, commonly known as copperas, are heated in iron pots, by which the sulphuric acid is expelled and the oxide of iron remains. Those portions least calcined, when ground, are used for polishing gold and silver. These are of a bright crimson colour. The darker and more calcined portions are known as crocus, and are used for polishing brass and steel. For the finishing process of the specula of telescopes, usually made of iron or of steel, crocus is invaluable; it gives a splendid polish. (2) Others prefer for the production of rouge the peroxide of iron precipitated by ammonia from a dilute solution of sulphate of iron, which is washed, compressed until dry, then exposed to a low red heat and ground to powder. (3) A rouge suitable for fine work may be made by decomposing a solution of sulphate of iron with oxalic acid also in solution; a precipitate of oxalate of iron falls, which must be well washed and dried; when gently heated, the salt takes fire, leaving an impalpable powder of oxide of iron.

Wood.—Polished woods are chiefly employed in furniture making, hence wood polishes are most commonly known as furniture creams. They are also often termed French polishes. The operation of wood polishing consists in nothing more than the distribution of a solution of lac in spirits of wine—by means of a rubber made of cotton wool and calico rag—over the surface of wood, using pressure, until the pores are entirely filled, and the strata of deposited resin adhering form a smooth, hard, and brilliant glaze. The first operation in polishing is called “filling-in”—that is, some substance, other than polish, is rubbed into the pores of the wood to economize time and materials; in fact, this is the foundation on which the superstructure is built; consequently it is of no small importance, as good beginnings generally make good endings. The general modes of filling-in are multiform, the following being a few of them:—Plaster of Paris is the most common ingredient, and is thus used. Roll up a piece of rag into a rubber, saturate it with water, dip it into the plaster, taking up a goodly supply, and rub it well into the pores, bit by bit, until you have as it were plastered or whitewashed the article of furniture all over, taking care, however, to wipe off the superfluous plaster with another piece of dry rag, before it sets; otherwise there will be difficulty in getting an even surface without much papering. When this is done let it stand till thoroughly dry.

Another method is to beat up some plaster in water sufficiently thin to prevent setting too soon, and go over the wood with this as before. Some beat up plaster in linseed-oil, and use that alone; while another adds a little polish stirred into the above, to cause it to set a little quicker. Another compound is Russian fat, plaster of Paris, and some pigment to suit the wood it is intended for; these are heated together and laid on hot, wiping off the superfluous mass with rag. The only advantage in the two last being, that polishing can be commenced upon them directly, whereas the others have to dry first. Some even utilize mutton-suet in its solid form, to rub into the pores, others melt

size, and stir in plaster, using this hot, which is as good as any; for, when dry, it does not absorb so much oil as the plaster and water methods.

A system that was practised for some years consists in dissolving alum in cold water, until the water will take up no more; in other words, a saturated cold solution; powder some whiting, and pour into it the alum solution; decomposition with effervescence takes place, the sulphuric acid quitting the alumina, and seizing the lime by its superior affinity, driving off the carbonic acid, which is set free, thus producing sulphate of lime, with a little alumina and potash, or ammonia, instead of carbonate of lime and sulphate of alumina.

This is cheap, easily made, and is a powerful astringent; containing more acid than plaster, which is also sulphate of lime with the greater part of its acid driven off by heat.

The next operation consists in oiling the wood with linseed-oil; but previous to this, it should be well papered with glasspaper No. 1, or coarser if required; then take a piece of cotton wool, saturate it with the oil, and go carefully over every part that shows white from the filling-in, taking care to "kill" that filling-in, as it is called, or totally obliterating it. This done, wipe all the superfluous oil off, thoroughly; bearing in mind, the less there is of this in your foundation, the more solid will be your work.

Now roll up a piece of cotton wool into a compact and suitable rubber, pour into it as much polish as it will hold; cover it over with a piece of open calico rag, and pass this over every part in a horizontal direction, floating the surface with polish, which must then be set aside to sink and harden. There should be no attempt at polishing in this operation, the first consideration being to obtain a good concrete to build upon.

When properly dry, the fibre, which has risen from the floating coat of polish, must be thoroughly papered down with glasspaper No. 1½, and if upon a flat surface, a cork rubber will be necessary; for no work, however highly-laboured out, will acquire an even and proper surface unless it is well grounded. A practical man knows the importance of this; how it saves him time and labour; therefore he is very careful not to begin polishing before his foundation is perfectly satisfactory. This being so, the process of polishing is commenced. The rubber used for floating the work will answer for this purpose, provided it has been kept moist by excluding air from it.

The rubber being charged with polish much less copiously than in floating, a piece of calico rag is placed over it, and so twisted up, that the excess of rag and rubber is confined in the palm of the hand; and with this arrangement the polish is conveyed to the wood. The polisher now proceeds to body-in his work, using, occasionally, pumice powder sprinkled over the surface, which not only keeps that surface smooth, but materially assists in filling the pores; in fact, it is invaluable in the hands of a skilful man.

As a solid foundation is a great desideratum, he applies as little oil as possible; just sufficient to prevent dragging of the rubber, which would produce a harsh and uneven appearance. The natural repugnance between oil and spirit, as manifested in their unwilling amalgamation, is strong evidence against their friendly union by compulsion; therefore, to prevent serious eruptions, no more is used than the polish can conveniently neutralize. Rubber after rubber is applied with varied pressure, now lightly, now heavily, working in small circles, a beautiful dull smear following its course as the surface approaches to fulness; the rubber slightly biting, partly from the adhesive nature of the polish, but more from the partial vacuum produced by the flat rubber on the smooth surface of the wood. The pores being filled, and the work presenting a solid and compact body, it is set aside for some hours to settle and harden. In a day or two the polisher takes it up again, and although full when set aside, it is not so full now, having slightly sunk, and showing just a little of the pores. With No. 0 paper he frees the surface of any slight imperfections that may appear, or if it is at all unsatisfactory or presents an uneven surface he cuts it down with glasspaper No. 1, in order that it

may with this body be perfectly level and mirror-like. This done, he proceeds as before to body-up the work, using great care in working it up to a point approaching a finish, full, clear, and hard; so that it shall require as little wetting as possible at the next, or finishing coat; which done he sets it aside again to harden.

On taking it up again, he removes any dust that may have settled upon it, by wiping it all over; thus also removing any little oil that may have sweated out from the previous operation. He then selects an old rubber, one that has become close and compact from long use and pressure, from his rubber caister, where he keeps various sizes to suit the area of his work; this canister being fitted with a cover, excluding air, keeps the rubbers constantly moist and ready for use. The why and wherefore of that old rubber is this: by the closeness of its texture, it has a less capacity for polish, and consequently gives that polish out much more sparingly than would a new one, made of the same material; and as in this final operation there must be no approach to wetness, its use is obvious. He charges this rubber with half-and-half, that is, half polish and half clear spirit, only just sufficient that when forced into the rubber by squeezing, it shall be a little moist: for if the body is wetted, it will re-dissolve, and greatly deteriorate the quality of the finished surface. Placing over his rubber a piece of soft calico rag, and twisting them up in a proper manner, with a drop of oil applied to its surface, he passes it over the work in a horizontal direction until the whole has received a portion, and the rubber is in a fit state to be worked. He has now arrived at the most important part of his work, namely, that of giving to it that unexceptionable glaze, which is the genuine stamp of a well-finished piece of work.

The polisher exercises the utmost care and ingenuity in the manipulation of his rubber, judging of its proper working by the dull, satiny smear, as he calls it, following the course of his movements; which dull smear consists of an inconceivably fine stratum of resin, the spirit from which is driven off by friction, assisted by temperature. Two chargings of the rubber should be sufficient for this operation, and with these he so elaborates his work that, the rubber being completely dried out, the surface of his work is smearless, hard, and brilliant; and should require nothing more, although it is customary to give it a final touch by means of a rubber of soft calico rag, slightly damped with clear spirit, and passed lightly over the surface until dry.

Work thus executed will stand for years, creditable both to the workman who did it, and the employer who turns it out; the only thing required to keep it in order being to keep it clean and dry by frequent wiping with soft dusters.

It is certainly much to be regretted that such a thing as time should interfere to mar work which otherwise could be made exceedingly beautiful; especially with a trade in which time itself is such an essential and even indispensable requisite; yet such is the case, and the consequence is, that 90 per cent. of those employed in polishing are totally ignorant of what degree of proficiency they are capable. In the preceding example, rules are given limiting the operations to three; but in the shops of good firms that number is often exceeded; while in minor houses it oftener consists of one or two. The carrying out of the foregoing work in polishing-shops is usually as follows: the filling-in, the oiling, and often the floating, are done by the boys, or learners; the bodying and finishing by the men.

The original recipe for making it is as follows. To 1 pint spirits of wine add $\frac{1}{2}$ oz. shellac, $\frac{1}{2}$ oz. lac, $\frac{1}{2}$ oz. sandarach, placing it over a gentle heat, frequently agitating it until the gums are dissolved, when it is fit for use. Make a roller of list, put a little of the polish upon it, and cover that with a soft linen rag, which must be slightly touched with cold-drawn linseed-oil. Rub them on the wood in a circular direction, not covering too large a space at a time, till its pores are sufficiently filled up. After this, rub in the same manner, spirits of wine, and a small portion of the polish added to it, and a most brilliant effect will be produced.

The original process, with little variation, or simplifying, has kept in use ever since;

not because it is so perfect as not to admit of improvement, for it has never been so compounded that surfaces produced from it would resist a very high degree of heat without suffering partial decomposition, and consequently it could not be employed for many purposes which otherwise it is desirable that it should be, but chiefly because those who make polish—that is, the wholesale makers—are not themselves sufficiently acquainted with its requirements.

With regard to its lustre-yielding properties, it is everything that can be desired; and surely the resources of chemistry would not be exhausted in discovering something that would make it more impervious to heat. In the hands of competent persons it is not unreasonable to suppose that some beneficial result might be arrived at, namely, the combination of a heat-resisting with its lustre-yielding properties. As an example of what is required, one may point particularly to the dining-tables of the ante-French polishing period, which were brought up to a marvellously brilliant surface by means of linseed-oil and years of hard rubbing, a surface that would resist equally the heat of the hot dishes and the tricklings of wine from the decanters. The lac substance, of itself a yellowish-brown colour, semi-transparent, and very brittle, produces, when dissolved in spirits of wine, a solution of a yellowish-brown colour, which, when applied to woods of various and delicate shades, such as the white, silver, gold, purple, black, &c., which enter into marquetry, was found to communicate a false hue, and tended to mar the harmony it was wished to improve. Hence arose the necessity for bleaching it, so that a solution might be prepared suitable for any combination of colours without destroying or injuring their effect. But, as there is no good without an evil, the process of bleaching acts very detrimentally on the more soluble constituents of the lac, depriving them of a considerable portion of their original body and density.

This is easily proved by pouring a solution from one bottle to another, when it will be seen to flow in a light, frothy-like stream, much less dense than a solution of the unbleached article. Further evidence is in the fact that polishers using it in high temperatures are commonly heard to say that they cannot get it to lie flat, a term as applicable and correct as any, perhaps, when carefully examined; for the heat, acting upon the chlorine, which has undoubtedly entered into combination with it in the process of bleaching, causes that gas to expand, so that the more polish he applies, the more gas he has to contend with, in impeding that cohesion and crystallization which he is endeavouring to bring about.

Polish, under its most favourable conditions, is a compound so liable to change by variations of temperature, humidity, pressure, &c., that makes its use very variable and uncertain. Lac in its dry state, and in a temperature higher than is ever required for polishing, is totally unaffected; but put into boiling water, it speedily becomes soft and plastic, and on being removed from the water resumes its original character of hardness quickly, from its inferior capacity for heat. Not so is it with spirits of wine, its menstruum; this has an extraordinary capacity for heat, insomuch as that it will volatilize in the ordinary state of the atmosphere, its briskness increasing with increase of temperature.

Now, although boiling water has no action on lac, other than to soften it for the time it is immersed in it, having no power to dissolve it of itself, still that substance is very differently affected when in combination with spirits of wine, its true solvent, the strong affinity for heat of the spirit entirely overcoming the feeble capacity for it in the lac; and so strong is the affinity of the spirit for the lac, that it separates its last portions from that substance, when fairly combined, with the greatest difficulty. Thus the necessity, in polishing, of a moderate degree of heat, to assist that produced by the friction of the rubber, in forcing out that clinging portion of spirit before solidity and brilliancy can be obtained.

The most favourable temperature for polishing appears to be 60–70° F. (16–21° C.); ascending above this, one portion of the spirit evaporates before a proper distribution

of the lac can be brought about, while the other portion, which adheres so tenaciously to that substance, impedes its solidification. Descending below that degree, there is a tendency in the materials to chill, the more especially if the room in which the work is done be at all damp, the activity of the evaporation being checked by the absence of heat necessary for its conveyance. This is an evil more easily remedied than the former, as in most cases all that is required is to light a fire, and by that means supply the deficiency. Not so convenient would it be in the height of summer, with the thermometer indicating 80° or 90° F., to remove the work to an ice-house; and being so removed, the remedy would be worse than the evil. But of all the injurious influences attending polishing, none is comparable to humidity. If the atmosphere be saturated with moisture, as it not unfrequently is, when the clouds, or aqueous vapour, instead of being buoyed up in the sky, hang about the earth's surface, even though the thermometer stands at 70° F., as favourable a point as any, polishing becomes extremely difficult; the materials appear to be so completely neutralized, as to render them incapable of performing their office. Increased pressure and friction seem inadequate to supply or make up for the atmospheric derangement. The cause of this may perhaps be thus explained:—All liquids in becoming solids part with heat. Now this liquid, being compounded of spirit, not only has it become enfeebled, being spread on a surface, and thus exposed to a body for which it has the strongest affinity, but becomes so diluted by it, that it has lost in a great degree the power of evaporation or means of parting with heat, consequently assuming the solid form with difficulty.

Atmospheric pressure is undoubtedly the surest guide to the experienced polisher, showing him the power nature is employing for his advantage, or detriment; for, carefully observing the movements of the mercury, he will not fail to realize the fact, that as it ascends his labour will be considerably lightened, while, on the other hand, it will be greatly augmented by a corresponding depression—regard being paid, of course, to temperature.

It may be proper, however, to acknowledge that this theory rests on supposition. It is nevertheless a fact, that when the air is most suitable to ourselves—when it is bracing and buoyant—infusing as it were more life into us, it is also found to be more suitable for the performance of our work. It must not, however, be inferred, from these remarks, that polish will not work under the influence of these atmospheric changes, for it is found to do so in our climate, even under its extremest fluctuations; but what is meant is, that its effects are less under a low than under a high pressure, in a moist than in a dry atmosphere, and either in a low or high temperature, than in a medium one. The cause of this may be thus explained:—By pressure, the polish is condensed, the spirit flying off to find its natural level, and thus favouring the solidification of the exposed strata of resin. The dry atmosphere offers facilities for the escape of the spirit; whilst the moderate temperature so regulates its volatility that it neither passes off before the resin can be properly worked, nor remains inactive in discharging the necessary amount to produce solidification.

From observations of the effects of polish, together with its daily use, the following conclusions present themselves, namely, that it is not in the nature of the materials, as at present compounded, to withstand the antagonistic influences constantly opposed to them; that the effects produced on polish by variations of temperature, show the necessity of so preparing it as to render it proof against such changes; and, finally, that it be so prepared as to withstand a much higher degree of heat than in its present simple form it is able to do. (John Dalton.)

The following directions for polishing are said to represent the practice followed in the United States. It should be remembered that as regards the polishing the different climatic conditions should be allowed for, as the normal dryness of the atmosphere in the United States favours many processes in polishing which require special conditions in this country. In preparing and filling-in, first see that the work is smooth and free

from dust, then oil the parts to be polished with raw linseed-oil, and prepare filling-in. That is done with a mixture of whiting and turpentine made into a paste; rub well into the grain of the wood with a piece of rag or tow, and wipe clean off. For mahogany, add rose pink to colour; for oak, birch, and ash, add a little yellow ochre. Work to be polished white requires no colour in the filler. For polishing, prepare a rubber of cotton-wadding; in size according to job; wet it with polish, and, with the point of the finger, put a little raw linseed-oil on it, then cover the rubber with a piece of rag; twist the end of the rag and keep it tight over rubber, and proceed to rub the job over in a circular direction, keeping rubber constantly in motion; when dry, wet it again, with oil, and continue to work it until a sufficient body of polish has been obtained, then place it on one side for about 12 hours to sink. Polish always sinks after being bodied-up. In spiriting off or finishing, if the work be sunk in before spiriting, give a few rubbers of polish, then prepare a rubber the same as for bodying-up, and wet it with proof alcohol from a bottle with a little cut out of the side of the cork, so that the spirits will drop out: 3 or 4 drops will be enough for a learner to put on at one time. Take care the rubber is not too wet, or it will soften the polish and tear it up. When the rubber is nearly dry, rub smartly until all the job is clear of oil and rubber-marks. No oil is used in finishing. Varnishing is done with a camel-hair brush for turned or carved work. First give the work 2 or 3 rubbers of polish, and then, having stained the varnish, proceed to give the work a coat, passing the brush smartly over the job, taking care to keep it level, and do not go too often over the same place; 2 or 3 coats may be given in the same manner, rubbing down after each coat with fine glasspaper. Work that is varnished should stand 12 hours before it is handled. For glazing, prepare the rubber the same as for polishing, but make it much wetter, and pass it smartly over the work from right to left. Always begin at the same end of the job, and bring the rubber straight to the other end in one stroke; do not go too often over the same place or you are apt to tear it up. This is used for common work in place of spiriting, and for mouldings, &c. A rubber of spirits, passed quickly over a job that has been glazed, very much improves it, and makes it smooth, but it must be done very lightly and quickly, and passed straight up and down.

A correspondent of the Boston (U.S.) *Cabinet-Maker* gives the following details of the methods of polishing wood. He first describes the method of polishing pianos used in all first-class factories. The same process will answer for any other piece of furniture by merely substituting for the scraping, where scraping is not practicable, a filling, properly coloured. First, give the work 3 coats of scraping or No. 2 furniture varnish, allowing each coat to become perfectly hard before applying the next; then scrape off the varnish with a steel scraper, properly sharpened on an oilstone, and in scraping be careful not to cut into the wood, but merely remove the varnish from the surface, leaving the pores filled. Smooth with No. 1 sandpaper, and the work will be ready for the polishing varnish, 4 coats of which must be put on, allowing each coat to harden. To determine the proper time required for the hardening, one coat will not be ready for the next until it is so hard that you cannot make any impression on it with your thumb-nail. The 4 coats having been put in, and the work having stood a few days—and the longer the better—rub down with fine-ground pumice and water, applied with a woollen rag. The work must be rubbed until all lumps and marks of the brush are removed; wash off with a sponge and dry with a chamois skin; let the work stand out in the open air for a day or two, taking it into the shop at night. The work should now receive 2 coats more of polishing varnish and a second rubbing, after which it is ready for polishing. Furniture may be polished after the first rubbing, and in that case the polishing is performed with lump rottenstone and water applied with a woollen rag. Put plenty of rottenstone on your work, with water enough to make it work easy. Rub until all marks and scratches are removed. Rub the rottenstone off with your bare hand, keeping the work wet. What cannot be removed with the hand should be washed off with a sponge. After

drying with a chamois skin, bring up the polish with the palm of your hand, moving it lightly and quickly, with a circular motion, over the work. Clean up the work with a piece of soft cotton, dipped into sweet oil, and lightly touch all the white spots and marks of the rottenstone. Remove the oil with wheat flour, applied with soft cotton, and finally dust off with a soft rag or silk handkerchief. The following method is known as the Shellac or French Polish. In preparing for this process, add to 1 pint shellac varnish 2 tablespoonfuls of boiled oil; the two to be thoroughly mixed. If you want the work dark add a little burnt umber; or you can give the work any desired shade by mixing with the shellac the proper pigment in the dry state. Apply the shellac thus prepared with a small bunch of rags held between your fingers. In applying it, be particular in getting it on smooth and even, leaving no thick places or blotches. Repeat the process continually until the grain is filled and the work has received sufficient body. Let it stand a few hours to harden, and then rub your work lightly with pumice and oil, applied with a rag. A very little rubbing is required, and this is to be followed by the cleaning of the work with rags as dry as possible. With a piece of muslin wet with alcohol, go over the work 2 or 3 times, for the purpose of killing the oil. Have ready $\frac{1}{4}$ lb. pure gum shellac dissolved in 1 pint 95 per cent. alcohol. With this saturate a pad made of soft cotton, covered with white muslin, and with the pad thus formed go over your work 2 or 3 times. To become proficient in this work, practice and close attention are required.

The following are recipes for furniture creams or French polishes.—(1) 1 pint spirits of wine, $\frac{1}{4}$ oz. gum copal, $\frac{1}{4}$ oz. gum arabic, 1 oz. shellac. Bruise the gums and sift them through a piece of muslin. Place the spirits and gums together in a vessel closely corked, near a warm stove, and frequently shake them; in 2 or 3 days they will be dissolved. Strain through a piece of muslin, and keep corked tight. (2) Shellac, 6 oz.; naphtha, 1 qt.; benzoin, $\frac{3}{4}$ oz.; sandarach, 1 oz. (3) Dissolve 1 $\frac{1}{2}$ oz. shellac, $\frac{1}{4}$ oz. sandarach, in $\frac{1}{2}$ pint naphtha. To apply the polish, fold a piece of flannel into a sort of cushion, wet it well with the polish, then lay a piece of clean linen rag over the flannel, apply one drop of linseed oil; rub your work in a circular direction lightly at first. To finish off, use a little naphtha applied the same as the polish. (4) Pale shellac, 2 $\frac{1}{4}$ lb.; mastic and sandarach, each 3 oz.; spirits, 1 gal. Dissolve, and add copal varnish, 1 pint; mix well by agitation. (5) Shellac, 12 oz.; wood naphtha, 1 qt.; dissolve, and add $\frac{1}{2}$ pint linseed oil. (6) Crush 3 oz. shellac with $\frac{1}{2}$ oz. gum mastic, add 1 pint methylated spirits of wine, and dissolve. (7) Shellac, 12 oz.; gum elemi, 2 oz.; gum copal, 3 oz.; spirits of wine, 1 gal.; dissolve. (8) Shellac, 1 $\frac{1}{4}$ oz.; gum juniper, $\frac{1}{2}$ oz.; benzoin, $\frac{1}{2}$ oz.; methylated alcohol, $\frac{1}{2}$ pint. (9) 1 oz. each of gums mastic, sandarach, seed lac, shellac, and gum arabic, reduce to powder; then add $\frac{1}{4}$ oz. virgin wax; dissolve in a bottle with 1 qt. rectified spirits of wine. Let stand for 12 hours, and it is then fit for use. (10) 1 oz. gum lac, 2 dr. mastic in drops, 4 dr. sandarach, 3 oz. shellac, $\frac{1}{2}$ oz. gum dragon. Reduce the whole to powder. (11) Yellow wax, 4 oz.; yellow soap, 2 oz.; water, 50 oz.; boil, with constant stirring, and add boiled oil and oil of turpentine, each 5 oz. (12) Soft water, 1 gal.; soap, 4 oz.; white wax, in shavings, 1 lb. Boil together, and add 2 oz. pearlsh. To be diluted with water, laid on with a paint brush, and polished off with a hard brush or cloth. (13) Wax, 3 oz.; pearlsh, 2 oz.; water, 6 oz. Heat together, and add 4 oz. boiled oil and 5 oz. spirits of turpentine. (14) Raw linseed oil, 6 oz.; white wine vinegar, 3 oz.; methylated spirit, 3 oz.; butter of antimony, $\frac{1}{2}$ oz.; mix the linseed oil with the vinegar by degrees, and shake well so as to prevent separation; add the spirit and antimony, and mix thoroughly. (15) Boiled linseed oil, 1 pint; yellow wax, 4 oz.; melt, and colour with alkanet root. (16) Acetic acid, 2 dr.; oil of lavender, $\frac{1}{2}$ dr.; rectified spirit, 1 dr.; linseed oil, 4 oz. (17) Linseed oil, 1 pint; alkanet root, 2 oz.; heat, strain, and add lac varnish, 1 oz. (18) Linseed oil, 1 pint; rectified spirit, 2 oz.; butter of antimony, 4 oz. (19) For Darkening Furniture.—1 pint linseed oil, 1 oz. rose pink, 1 oz. alkanet root, beaten up in a metal mortar; let the mixture stand for a day or two; then pour off the oil, which will be found of a rich colour. (20) Or, mix 1 oz. alkanet root

with 4 oz. shellac varnish, 2 oz. turpentine, 2 oz. scraped beeswax, and 1 pint linseed oil: this should stand a week. (21) Reviver.—Pale linseed oil, raw, 10 oz.; lac varnish and wood spirit, each 5 oz. Mix well before using. (22) For Turners' Work.—Dissolve 1 oz. sandarach in $\frac{1}{2}$ pint spirits of wine; shave 1 oz. beeswax, and dissolve it in sufficient spirits of turpentine to make it into a paste, add the former mixture to it by degrees; then, with a woollen cloth, apply it to the work while it is in motion in the lathe, and polish it with a soft linen rag; it will appear as if highly varnished. (23) Mahogany.—Take 1 pint furniture oil, mix with it $\frac{1}{2}$ pint spirits of turpentine and $\frac{1}{2}$ pint vinegar; wet a woollen rag with the liquid and rub the wood the way of the grain, then polish with a piece of flannel and soft cloth. (24) Melt 3 or 4 pieces of sandarach, each of the size of a walnut, add 1 pint boiled oil, and boil together for 1 hour. While cooling, add 1 dr. Venice turpentine, and if too thick a little oil of turpentine also. Apply this all over the furniture, and after some hours rub it off; rub the furniture daily, without applying fresh varnish, except about once in 2 months. Water does not injure this polish, and any stain or scratch may be again covered, which cannot be done with French polish. (25) For Wainscot.—Take as much beeswax as required, and, placing it in a glazed earthen pan, add as much spirits of wine as will cover it, and let it dissolve without heat. Add either ingredient as is required, to reduce it to the consistence of butter. When this mixture is well rubbed into the grain of the wood, and cleaned off with clean linen, it gives a good gloss to the work. (26) For Carved Cabinet-work.—Dissolve 2 oz. seed lac, and 2 oz. white resin, in 1 pint spirits of wine. This must be laid on warm, and if the work can be warmed also, it will be so much the better; at any rate, moisture and dampness must be avoided. Used with a brush for standards or pillars of cabinet-work. The carved parts of cabinet-work are also polished thus: varnish the parts with the common wood varnish, and having dressed them off where necessary with emery paper, apply the polish used for the other parts of the work. (27) Copal Polish.—Melt with gentle heat finely-powdered gum copal, 4 parts, and gum camphor, 1 part, with ether to form a semi-fluid mass, and then digest with a sufficient quantity of alcohol. (28) French Polish Reviver.—Linseed oil, $\frac{1}{2}$ pint; spirits of camphor, 1 oz.; vinegar, 2 oz.; butter of antimony, $\frac{1}{2}$ oz.; spirit of hartshorn, $\frac{1}{4}$ oz. (29) $\frac{1}{2}$ gill vinegar; 1 gill spirits of wine; 1 dr. linseed oil. (30) Naphtha, 1 lb.; shellac, 4 oz.; oxalic acid, $\frac{1}{4}$ oz. Let it stand till dissolved, then add 3 oz. linseed oil. (31) Pastes.—To keep wood light, scrape $\frac{1}{2}$ lb. beeswax into $\frac{1}{2}$ pint of turpentine. By adding linseed oil the wood is darkened. (32) Dissolve 6 oz. pearlsh in 1 qt. hot water, add $\frac{1}{4}$ lb. white wax, and simmer for $\frac{1}{2}$ hour in a pipkin; take off the fire; and when cool, the wax will float; it should be taken off, and, with a little hot water, worked into a paste. (33) Beeswax, spirits of turpentine, and linseed oil, equal parts; melt and cool. (34) Beeswax, 4 oz.; turpentine, 10 oz.; alkanet root to colour; melt and strain. (35) Digest 2 dr. alkanet root in 20 oz. turpentine till the colour is imparted; add yellow wax in shavings, 4 oz.; place on a water bath and stir till the mixture is complete. (36) Beeswax, 1 lb.; linseed oil, 5 oz.; alkanet root, $\frac{1}{2}$ oz.; melt, add 5 oz. of turpentine, strain and cool. (37) Beeswax, 4 oz.; resin, 1 oz.; oil of turpentine, 2 oz.; Venetian red to colour. (38) 1 lb. white wax; 1 oz. black resin; 1 oz. alkanet root; and 10 oz. linseed oil. (39) 1 lb. yellow wax, 2 oz. yellow soap, 2 pints spirits of turpentine, 2 pints boiling water; melt the wax and soap over a slow fire, add the turpentine, and lastly stir in the water gently till it is quite cold. (40) $1\frac{1}{2}$ lb. beeswax, 4 pints spirits of turpentine; dissolve in a closed vessel by means of a water bath, and add $\frac{1}{2}$ lb. common soap previously dissolved in 4 pints water, and stir well together till nearly cold. (41) 5 oz. yellow wax, 1 pint turps, $1\frac{1}{2}$ oz. Castile soap; cut the beeswax in small pieces, and dissolve in the turps by a gentle heat; when nearly cool, add the soap (first powdered and rubbed up with 2 oz. water), stirring continually till it becomes thick. (42) $2\frac{1}{2}$ oz. yellow wax, 1 oz. white wax, 1 oz. Castile soap, 10 oz. turpentine oil, 10 oz. boiling water, 1 dr. potash carbonate; melt the wax and turpentine together,

dissolve the soap and potash carbonate in the water and mix while warm, stirring till cold. (43) Beat 5 lb. stearin out into thin sheets with a wooden mallet, and mix with 7 lb. oil of turpentine, after which subject the mass to a water bath and heat up; when hot, add $\frac{1}{2}$ oz. ivory- or bone-black, stirring well to prevent crystallization. To cool it off, it should be emptied into another vessel and stirred until cold. To use, warm it until it is reduced to a liquid state, and apply in small quantities with a cloth; afterwards rub it well with a piece of silk or linen cloth to bring up the polish. (44) A good polish for furniture, to use upon new wood for hand polishing, in place of French polish, but one that requires constant manual labour, may be made of beeswax and turpentine spirit melted together, with red sanders wood to colour it. This has been tried for many years and well repays the trouble attending it. It should not be used upon work that has been French polished, but the following will be found better than most that can be bought for reviving the brilliancy of French-polished goods. Take equal parts of turpentine, vinegar, spirits of wine (methylated), and raw linseed oil, and place them in a bottle in the order in which they are mentioned; great care must be taken in this last particular, if not, the mixture will curdle and become useless. (Smither.) (45) Derby cream is made by adding 6 oz. linseed oil to 3 oz. acetic acid. This is agitated well, and $\frac{1}{2}$ oz. butter of antimony and 3 oz. methylated spirit are added. (46) Soft water, 1 gal.; soap, 4 oz.; beeswax in shavings, 1 lb. Boil together, and add 2 oz. pearlash. To be diluted with water, laid on with a paint brush, and polished off with a hard brush or cloth. (47) Wax, 3 oz.; pearlash, 2 oz.; water, 6 oz. Heat together, and add 4 oz. boiled oil and 5 oz. spirits of turpentine. (48) The name is sometimes given to a mixture of 1 oz. white or yellow wax with 4 of oil of turpentine. (49) Rain-water, 1 gill; spirits of wine, 1 gill; beeswax, 1 oz.; pale yellow soap, 1 oz. Cut the wax and soap into thin slices, and boil them in the rain-water until dissolved. Take off the fire, and occasionally stir till cold. Afterwards add spirits of wine, bottle, and it is ready for use. The above compound should be applied with a piece of flannel, and afterwards rubbed with a soft cotton cloth. (50) Useful for family use:—1 oz. beeswax, $\frac{1}{4}$ oz. white wax, 1 oz. Castile soap. The whole to be shred very fine, and a pint of boiling water poured upon it; when cold, add $\frac{1}{2}$ pint turpentine and $\frac{1}{2}$ pint spirits of wine; mix well together. To be rubbed well into the furniture with one cloth and polished with another. (51) Pearlash, 1 oz.; water, 8 oz.; beeswax (genuine), 6 oz. Mix with heat, and add sufficient water to reduce it to the consistency of cream. For use, add more water, and spread it on the wood with a painters' brush. Let it dry, and polish with a hard brush or cloth. If white wax is used, it may be applied to polish plaster casts, statues, &c. (52) 2 gal. raw linseed oil, $1\frac{1}{2}$ gal. turpentine, $\frac{1}{4}$ lb. dragons' blood, $\frac{1}{4}$ lb. rosin, $\frac{1}{4}$ lb. alum, 2 oz. iodide potassium, $\frac{1}{2}$ lb. sulphuric acid, 8 oz. nitric acid; using avoirdupois weight for the dragons' blood, rosin, alum, iodide potassium, and sulphuric acid; common wine or liquid measure for the oil and turpentine; apothecaries' measure for the nitric acid. The directions for preparing the polish are as follows:—First, put the oil and turpentine into an earthen vessel; then pulverize the dragons' blood, rosin, alum, and iodide potassium to a fine powder. Stir this powder slowly into the oil and turpentine; then add the sulphuric acid, slowly, stirring continually. Let this mixture stand 10 hours, then add the nitric acid. Slowly stir the mixture while adding. Apply with a sponge or cloth. (53) Messer, of Berlin, dissolves $6\frac{3}{4}$ lb. shellac in about 28 pints pure spirit (alcohol), and then mixes this with another obtained by dissolving 25 dr. gun cotton in 25 dr. high-grade sulphuric ether to which is added $12\frac{1}{2}$ dr. camphor and enough 96 per cent. alcohol to completely dissolve the mass. This polish is finally rubbed up with pure linseed oil. To 100 parts of it, 5 parts of a saturated solution of camphor in oil of rosemary are then added. A very dilute solution of benzole in alcohol is used for polishing off. (54) 1 gal. soft water, 4 oz. soap, 1 lb. white wax in shavings; boil these together and add 2 oz. pearlash. This is to be diluted with water, laid on the furniture with a paint

brush, and polished off with a cloth or a hard brush. (55) Dissolve $1\frac{1}{2}$ lb. potash and 1 lb. virgin wax in 1 gal. hot water, and boil the whole for $\frac{1}{3}$ hour; then stand to cool. Remove the wax from the surface, put it into a mortar, and triturate it with a marble pestle, adding sufficient soft water to form a soft paste. This laid neatly on furniture, or even on pictures, and carefully rubbed when dry with a woollen rag, gives a polish of great brilliancy and softness. (56) Household furniture is readily cleaned by washing it with a little warm ale, the polish being brought up subsequently by means of a cloth damped with paraffin oil. The following has been strongly recommended for renovating old furniture and bringing up a good polish:—Take olive oil 1 lb., rectified oil of amber 1 lb., spirits of turpentine 1 lb., oil of lavender 1 oz., tincture of alkanet root $\frac{1}{2}$ oz. Saturate a piece of cotton batting with this polish, apply it to the wood, then, with soft and dry cotton rags, rub well and wipe off dry. Keep the polish in a stoppered bottle. (57) Pure beeswax, $1\frac{1}{4}$ lb.; linseed oil, $\frac{1}{4}$ lb. Melt together and remove from the fire, and when the mixture has cooled a little, add 1 qt. turpentine, and mix well. The way to make it with soda would be to dissolve the soda in hot water, add the wax in small pieces, and mix well over the fire. The former method is preferable. (58) A high polish on ebony, one that will be durable. Give the work 2 coats of fine copal varnish, and rub this down (when dry) quite smooth with fine pumice, put on a third coat of the same, and rub down with rottenstone; clean and put on a flowing coat of best spirit copal varnish, and when this has become quite dry, polish with chamois skin and the palm of the hand. (59) Polishing Black Woodwork.—Procure $2\frac{1}{2}$ oz. spirits of wine, 1 dr. oil of almonds, 1 dr. gum elemi, $\frac{1}{2}$ oz. orange shellac, pounded fine and put together in a bottle to dissolve; when dissolved, rub on with white wadding. (60) Orange shellac, 2 oz.; wood naphtha, $\frac{1}{2}$ pint; benzoin, 2 dr. Mix and put in warm place for a week, and keep the materials from settling by shaking it up. To apply it, after having prepared your wood by rubbing some raw linseed oil into it, and then wiping it well off again, make a rubber of cotton-wool, and put some old calico over the face, and till you have a good body on your wood keep the rubber well saturated with polish. When your rubber sticks, put a very little linseed oil on and rub your polish up. Allow it to stand a few hours, and give it another coat, using rather more linseed oil on your rubber, so as to get a finer polish. Then let it stand again and finish off with spirits of naphtha, if you can; if not, add a small quantity of polish to your spirit. (61) Polishing Deal.—To as much yellow ochre as you can take in your hand add $\frac{1}{2}$ teaspoonful of Venetian red. Mix to the thickness of paint (or rather thinner) with glue size. Let the mixture simmer for some time in a pan, keeping it well stirred. Apply with a brush, and when dry run it over with fine sandpaper and polish with French polish, or, if preferred, turpentine and beeswax. If a deeper colour is required, add more Venetian red. Or (62) Melt about $\frac{1}{4}$ lb. Russian glue in 1 qt. water; grind in some Venetian red until sufficiently coloured; give the wood a coat with a brush when dry. (63) Egg-shell Polish for Antique Furniture. This is done by first bodying-up your work, and, after standing 12 hours, again body-up with white polish; it is next rubbed down with a felt rubber and pumice until sufficiently dull; it is then wax-polished, giving the work a gloss instead of a polish. (64) Dry Shining.—This is a new system of polishing or shining called the American system, and is used mostly for American black walnut. First oil, fill in then with a wet rubber passed smartly over the work straight from end to end until a shine or gloss appears. No oil to be used in the rubber, and no spiriting-off is required. Be careful to dry rubber well, and have the work free from rubber marks. This system is becoming very popular in the trade. (65) Imitation Polish for Woodwork.—The wood is first varnished over with gelatine, and, after drying and smoothing, with a mixture of $2\frac{1}{4}$ lb. fluid copal varnish, and 4 dr. pure drying linseed oil; after drying, the wood is polished with an ethereal solution of wax. (66) Wax Polishing.—There is no particular art in wax-polishing floors, the principal requirements being plenty of elbow-grease and a good hard brush. The floor, after being well scrubbed, is allowed to dry. When dry it is painted

over with a large, soft whitewash-brush dipped in oak stain. This is allowed to dry for 24 hours. The floor is then gone over with thin size, and this is in turn allowed to dry for 24 hours. After this, the floor is painted over with a kind of varnish made by dissolving beeswax in spirits of turpentine, the proportions being about 1 lb. of wax to 2 qt. of turps. The wax is shredded, placed along with the turps in a stone bottle, and the whole put on the hob and frequently shaken. When this varnish has soaked well in, the whole floor is polished with a rather hard brush until a good surface is obtained. Special brushes, adapted to polishing waxed floors, are sold by oilmen. (67) Wood Finish.—Richness of effect may be gained in decorative woodwork by using woods of different tone, such as amaranth and amboyna, by inlaying and veneering. The Hungarian ash and French walnut afford excellent veneers, especially the burls or gnarls. A few useful notes on the subject are given by a recent American authority. In varnishing, the varnishes used can be toned down to match the wood, or be made to darken it, by the addition of colouring matters. The patented compositions known as "wood fillers" are made up in different colours for the purpose of preparing the surface of wood previous to the varnishing. They fill up the pores of the wood, rendering the surface hard and smooth. For polishing mahogany, walnut, &c., the following is recommended: Dissolve beeswax by heat in spirits of turpentine until the mixture becomes viscid; then apply by a clean cloth, and rub thoroughly with a flannel or cloth. A common mode of polishing mahogany is by rubbing it first with linseed oil and then by a cloth dipped in very fine brickdust; a good gloss may also be produced by rubbing with linseed oil, and then holding trimmings or shavings of the same material against the work in the lathe. Glasspaper, followed by rubbing, also gives a good lustre. (Scient. Amer.) (68) A good polish for walking-canes and other hard wood.—The following process gives the most satisfactory and hardest finished surface: Fill with best clear filler or with shellac; dry by heat; rub down with pumice; then put on 3 coats of clear spirit copal varnish, hardening each in an oven at a temperature as hot as the wood and gum will safely stand. For extra work, the 2 first coats may be rubbed down and the last allowed a flowing coat. For coloured grounds, alcoholic shellac varnish with any suitable pigment (very finely ground in) can generally be used to advantage. (69) Mahogany.—The wood having been stained, paper off smooth with No. 0 glasspaper enough to give an even surface. Add $\frac{1}{2}$ gill French polish, to $\frac{1}{4}$ oz. best dragons' blood, well mix and strain through muslin; polish as usual; if wanted very dark, apply a little dragons' blood to the rubber, but the rubber must be covered twice with linen rag. (70) Ebony.—Add $\frac{1}{4}$ oz. best drop black to $\frac{1}{2}$ gill French polish, use as in (69). A little of the drop black may be used on the inside rubber, but covered twice with linen rag. (71) Satinwood or Maple.— $\frac{1}{4}$ oz. chrome yellow to 1 gill light French polish; use as before described; a little chrome yellow on the rubber is desirable. In French polishing always use a drop of linseed on the rubber. (72) Black and Gold Work.—The work to be polished and gilt must be stained with black stain; when quite dry, give a very weak solution of glue size, paper off smooth. Care must be used not to remove the black stain with the paper. The part to be gilt must not be touched with the size, or the gold will not adhere so well; polish the part not to be gilt according to directions given for French polishing, using the black polish drop black; when the work is polished ready for spiriting off, lay the work on a table in a warm room, procure a portion of the best oil gold size, pour in a cup, with a very fine stiff brush lay a thin even coat of gold size on the work, let the gold size dry for 2 hours till it becomes tacky, then having the gold leaf ready, with great care lay a leaf (or part of a leaf, as required) on the cushion, cut to size required with the tip, lay the gold leaf on the sized work, then with a pad made of white wadding press the gold leaf in the crevices, blow off surplus leaf; let it stand aside to dry; when quite dry, polish gently with a very smooth bone pointed (or a dog's tooth is best) fixed in handle. Surplus parts and the edges should be cleaned off evenly afterwards. Finish the black work off with

spirits. Very fine crevices may have gold leaf rubbed in with a brush, if used carefully, then blow off surplus parts. For commoner work, gold paint laid on with a brush answers very well. (73) White and Gold.—Brackets, console tables, whatnots, chairs, and other furniture are frequently done in white and gold. The grain of the wood should be first filled in with whiting and glue size, one or two coats well papered off and white polished, but the wood should not be finished off with spirits until gilt, leaving the last coat to be done when the gilding is finished; the gilding is done as in (72). (74) A cheaper mode and much easier for the amateur: First well clean the article (if not new) with soda and water; when dry, scrape and paper all over, stop up cracks with white-lead and driers, one of driers to two of white-lead; mix some good white paint made of turps, driers, and white-lead, not oil. Give the article 3 coats, rubbing down the first coat when dry with pumice and water; when the third coat of paint is quite dry, proceed to gild as before described, using either gold leaf or gold paint; when so done, give the gold a coat of transparent enamel varnish, after which varnish the white work with clear copal varnish. Give the work 2 coats; it will set in a day. Small boxes and other fancy articles may be done by this process. (75) 1 pint linseed-oil, 1 oz. alkanet root, $\frac{1}{2}$ oz. rose pink, boil for $\frac{1}{2}$ hour, strain through muslin so that the oil may be clear; to use it pour a little oil on flannel; rub briskly. After 2 or 3 applications, the effect will be apparent. (76) 1 pint best vinegar, 1 pint linseed-oil, 2 oz. gum arabic finely powdered; mix in a clean bottle for use. Requires no rubbing, merely laying on with a clean rubber of flannel. (77) $\frac{1}{4}$ lb. beeswax melted in an earthenware pot, add gradually $\frac{1}{2}$ pint turps, coloured with $\frac{1}{2}$ oz. alkanet root, add $\frac{1}{2}$ pint linseed-oil; well mix, and keep in wide-mouth bottles for use. The bottles should be kept well corked. To use, wipe the dust from the furniture, apply a portion of the polish on a clean rubber of flannel, rub every part accessible, briskly finish off with an old silk handkerchief. This polish should not be used on new articles, it merely restores a gloss on old polished furniture. (78) $\frac{1}{2}$ pint rectified wood naphtha, $1\frac{1}{2}$ oz. shellac, $\frac{1}{4}$ oz. benzoin; crush the gum, mix in a bottle; when dissolved it is ready for use. Keep on a shelf in a warm room until dissolved. (79) Put 2 dr. shellac and 2 dr. gum benzoin into $\frac{1}{2}$ pint best rectified spirits of wine in a bottle closely corked; keep the bottle in a warm place and shake frequently until the gums are dissolved; when cold add 2 teaspoonfuls of clean poppy oil; well shake it and it is fit for use. This finish can be carefully laid with a soft rubber or hair brush.

Polishing in the lathe.—The beauty of good work depends on its being executed with tools properly ground, set, and in good order; the work performed by such tools will have its surface much smoother, its mouldings and edges much better finished, and the whole nearly polished, requiring, of course, much less subsequent polishing than work turned with blunt tools. One of the most necessary things in polishing is cleanliness; therefore, previous to beginning, it is as well to clear the turning-lathe or work-bench of all shavings, dust, and so on, as also to examine all the powders, lacquers, linen, flannel, or brushes which may be required; to see that they are free from dust, grit, or any foreign matter. For further security, the polishing powders used are sometimes tied up in a piece of linen, and shaken as through a sieve, so that none but the finest particles can pass. Although, throughout the following methods, certain polishing powders are recommended for particular kinds of work, there are others applicable to the same purposes, the selection from which remains with the operator; observing this distinction, that when the work is rough and requires much polishing, the coarser powders are best; but the smoother the work, the less polishing it requires, and the finer powders are preferable.

Soft woods may be turned so smooth as to require no other polishing than that produced by holding against it a few fine turnings or shavings of the same wood whilst revolving, this being often sufficient to give it a finished appearance; but when the surface of the wood has been left rough, it must be rubbed smooth with polishing paper,

constantly varying the position of the hand, otherwise it would occasion rings or grooves in the work. When the work has been polished with the lathe revolving in the usual way, it appears to be smooth; but the roughness is only laid down in one direction, and not entirely removed, which would prove to be the case by turning the lathe the contrary way, and applying the glasspaper; on which account work is polished best in a pole-lathe, which turns backwards and forwards alternately, and therefore it is well to imitate that motion as nearly as possible.

Mahogany, walnut, and some other woods, of about the same degree of hardness, may be polished by either of the following methods:—Dissolve, by heat, so much beeswax, in spirits of turpentine, that the mixture when cold shall be of about the thickness of honey. This may be applied either to furniture or to work running in the lathe, by means of a piece of clean cloth, and as much as possible should then be rubbed off by means of a clean flannel or other cloth. Beeswax alone is often used; upon furniture it must be melted by means of a warm flat iron; but it may be applied to work in the lathe by holding the wax against it until a portion of it adheres; a piece of woollen cloth should then be held upon it, and the lathe turned very quickly, so as to melt the wax; the superfluous portion of which may be removed by means of a small piece of wood or blunt metal, when a light touch with a clean part of the cloth will give it a gloss. A very good polish may be given to mahogany by rubbing it over with linseed-oil, and then holding against it a cloth dipped in fine brickdust. Formerly nearly all the mahogany furniture made in England was polished in this way.

Hard Woods.—These, from their nature, are readily turned very smooth; fine glasspaper will suffice to give them a very perfect surface; a little linseed-oil may then be rubbed on, and a portion of the turnings of the wood to be polished may then be held against the article, whilst it turns rapidly round, which will, in general, give it a fine gloss. Sometimes a portion of shellac, or rather of seed lac, varnish is applied upon a piece of cloth, in the way, formerly described. The polish of all ornamental work wholly depends on the execution of the same, which should be done with tools properly sharpened; and then the work requires no other polishing but with a dry hand-brush, to clean it from shavings or dust, this trifling friction being sufficient to give the required lustre.

Japanese lacquer, Shiunkëi.—This is so much superior to our best methods of polishing that while the best European and American pianos are readily spoiled by atmospheric influences, Japanese lacquered wooden ware can resist boiling water. The following note gives a sketch of the process, and full details will be found in ‘Workshop Receipts,’ Third Series.

If the wood to be varnished be very porous, and the pores large enough to be visible to the naked eye, they are filled with a mixture of stone-powder and the lacquer called *seshime*, which is merely the sap of the branches of the varnish-tree, without any mixture. This paste of stone-powder and lacquer is put on with a wooden spatula, the workman taking good care to press hard on the spatula, so as to fill up all the pores, and to rub the varnish off the surface of the wood, which is kept as clean as possible. After the varnish is well hardened, the whole surface is polished with a soft stone—a kind of wedge-stone—so that the veins of the wood come out again. This filling process can be repeated, if necessary. Next, in order to give it a colour, the wood is painted over with a thin water-colour, or it is stained. When thus prepared, the object is then varnished with the lacquer *shiunkëi*, of which a thin coating is put on with a brush, otherwise it would look too dark. On account of this lacquer taking its gloss in hardening, it requires a skilful person with a light hand to obtain a good result. Only one coating is given.

In case the wood is close-grained and of even surface, the preliminary work will be unnecessary. The *seshime* lacquer is alone used. It is rubbed into the wood with a ball of cotton, which is saturated with it. After it has been rubbed in, that which remains

on the surface is taken off by rubbing with Japanese soft paper, so that in fact only a very thin layer remains.

It sometimes occurs that a Japanese lacquer is too thick, and will not spread evenly with a spatula, as occasionally happens when it is mixed with stone-powder. When this is the case, the Japanese workmen add powdered camphor to the varnish they are about to use. By this means it becomes more liquefied and flows much better.

There is another thing about the Japanese method of using this varnish that is worth knowing. The atmosphere in which it is to harden, after it has been applied, should be moist, and the room darkened. The Japanese lacquerers have in their work-rooms large boxes fixed against the walls. These are furnished with sliding-doors. The insides of these boxes are wetted with towels dipped in water; the lacquered ware is introduced, and the doors are closed. It generally requires 48 hours to harden the lacquer.

VARNISHING.—Varnish is a solution of resin in oil, turpentine, or alcohol. The oil dries and the other 2 solvents evaporate, in either case leaving a solid transparent film of resin over the surface varnished. In estimating the quality of a varnish the following points must be considered:—(1) Quickness in drying; (2) hardness of film or coating; (3) toughness of film; (4) amount of gloss; (5) permanence of gloss of film; (6) durability on exposure to weather. The quality of a varnish depends almost entirely upon that of its ingredients; much skill is, however, required in mixing and boiling the ingredients together. Varnish is used to give brilliancy to painted surfaces, and to protect them from the action of the atmosphere, or from slight friction. It is often applied to plain unpainted wood surfaces in the roofs, joinery, and fittings of houses, and to intensify and brighten the ornamental appearance of the grain. Also to painted and to papered walls. In the former case, it is sometimes “flatted,” so as to give a dead appearance, similar to that of a flatted coat of paint.

Ingredients of Varnish.—Gums are exudations from trees. At first they are generally mixed with some essential oil; they are then soft and viscous, and are known as balsams; the oil evaporates and leaves the resin, which is solid and brittle. Resins are often called “gums” in practice, but a gum, properly speaking, is soluble in water, and therefore unfit for varnishes, while resins dissolve only in spirits or oil. Gum-resins are natural mixtures of gum with resin, and sometimes with essential oil found in the milky juices of plants. When rubbed up with water, the gum is dissolved, and the oil and resin remain suspended.

The quality of the resin greatly influences that of the varnish. The softer varieties dissolve more readily than the others, but are not so hard, tough, or durable. Common rosin or colophony is either brown or white; the brown variety is obtained by distilling the turpentine of spruce fir in water; the white is distilled from Bordeaux turpentine. The principal resins used in good work are as follows:—

Amber, obtained chiefly from Prussia, is a light yellow transparent substance found between beds of wood coal, or, after storms, on the coasts of the Baltic; is the hardest and most durable of the gums, keeps its colour well, and is tough, but difficult to dissolve, costly, and slow in drying. Gum animi is imported from the East Indies; is nearly as insoluble, hard, and durable as amber, but not so tough; makes a varnish quick in drying, but apt to crack, and the colour deepens by exposure. Copal is imported from the East and West Indies and America, &c., in 3 qualities, according to colour, the palest being kept for the highest class of varnish; these become light by exposure. Mastic is a resinous gum from the Mediterranean; it is soft, and works easily. Gum dammar is extracted from the Kawrie pine of New Zealand, and comes also from India; makes a softer varnish than mastic, and the tint is nearly colourless. Gum elemi comes from the West Indies, and somewhat resembles copal. Lac is a resinous substance which exudes from several trees found in the East Indies; more soluble than the gums above mentioned; stick lac consists of the twigs covered with the gum; seed lac is the insoluble portion left after pounding and digesting stick lac; when

seed lac is melted, strained, and compressed into sheets, it becomes shell lac; of these 3 varieties, shell lac is the softest, palest, and purest, and it is therefore used for making lacquers. Sandarach is a substance said to exude from the juniper tree; resembles lac, but is softer, less brilliant, and lighter in colour, and is used for pale varnish. Dragons' blood is a resinous substance imported from various places in dark brown-red lumps, in bright red powder, and in other forms; used chiefly for colouring varnishes and lacquers.

Solvents must be suited to the description of gum they are to dissolve. Boiling linseed-oil (and sometimes other oils, such as rosemary) is used to dissolve amber, gum animi, or copal. Turpentine for mastic, dammar, and common rosin. Methylated spirits of wine for lac and sandarach. Wood naphtha is frequently used for cheap varnishes; it dissolves the resins more readily than ordinary spirits of wine, but the varnish is less brilliant, and the smell of the naphtha is very offensive, therefore it is never employed for the best work.

Driers are generally added to varnish in the form of litharge, sugar of lead, or white copperas. Sugar of lead not only hardens but combines with the varnish. A large proportion of driers injures the durability of the varnish, though it causes it to dry more quickly.

Kinds of Varnish.—Varnishes are classified as oil varnish, turpentine varnish, spirit varnish, or water varnish, according to the solvent used. They are generally called by the name of the gum dissolved in them.

Oil varnishes, made from the hardest gums (amber, gum animi, and copal) dissolved in oil, require some time to dry, but are the hardest and most durable of all varnishes; are specially adapted for work exposed to the weather, and for such as requires polishing or frequent cleaning; are used for coaches, japan work, for the best joinery and fittings of houses, and for all outside work. Turpentine varnishes are also made from soft gums (mastic, dammar, common rosin) dissolved in the best turpentine; are cheaper, more flexible, dry more quickly, and are lighter in colour than oil varnishes, but are not so tough or durable. Spirit varnishes or lacquers are made with softer gums (lac and sandarach) dissolved in spirits of wine or pyroligneous spirit; dry more quickly, and become harder and more brilliant than turpentine varnishes, but are apt to crack and scale off, and are used for cabinet and other work not exposed to the weather. Water varnishes consist of lac dissolved in hot water, mixed with just so much ammonia, borax, potash, or soda, as will dissolve the lac; the solution makes a varnish which will just bear washing; the alkalis darken the colour of the lac.

Mixing Varnishes.—This requires great skill and care. Full details of the process are given in Spens' 'Encyclopædia.' Here may just be mentioned one or two points useful in mixing varnishes on a small scale; but as a rule, it is better to buy varnish ready mixed when possible.

Oil Varnishes.—The gum must first be melted alone till it is quite fluid, and then the clarified oil is poured in very slowly. The mixture must be kept over a strong fire until a drop pinched between the finger and thumb will, on separating them, draw out into filaments. The pot is then put upon a bed of hot ashes and left for 15 or 20 minutes, after which the turpentine is poured in, being carefully stirred near the surface. The mixture is finally strained into jars and left to settle. Copal varnishes should be made at least 3 months before use; the longer they are kept, the better they become. When it is necessary to use the varnishes before they are of sufficient age, they should be left thicker than usual. The more thoroughly the gum is fused, the stronger the varnish and the greater the quantity. The longer and more regular the boiling, the more fluid the varnish. If brought to the stringy state too quickly, more turpentine will be required, which makes the varnish less durable.

Spirit and Turpentine Varnishes.—Here the operation simply consists in stirring or otherwise agitating the resins and solvent together. The agitation must be continued

till the resin is all dissolved, or it will agglutinate into lumps. Heat is not necessary, but is sometimes used to hasten the solution of the resin. The varnish is allowed to settle, and is then strained through muslin. In many cases the resin, such as mastic, dammar, or common rosin, is simply mixed with turpentine alone, cold or with slight heat. Care must in such cases be taken to exclude all oil.

Application.—In using varnish, great care should be taken to have everything quite clean, the cans should be kept corked, the brushes free from oil or dirt, and the work protected from dust or smoke. Varnish should be uniformly applied, in very thin coats, sparingly at the angles. Good varnish should dry so quickly as to be free from stickiness in 1 or 2 days. Its drying will be greatly facilitated by the influence of light; but all draughts of cold air and damp must be avoided. No second or subsequent coat of varnish should be applied till the last is permanently hard, otherwise the drying of the under coats will be stopped. The time required for this depends not only upon the kind of varnish, but also upon the state of the atmosphere. Under ordinary circumstances, spirit varnishes require 2–3 hours after every coat; turpentine varnishes require 6 or 8 hours; and oil varnishes still longer, sometimes as much as 24 hours. Oil varnishes are easier to apply than spirit varnishes, in consequence of their not drying so quickly. Porous surfaces should be sized before the varnish is applied, to prevent it from being wasted by sinking into the pores of the material. Varnish applied to painted work is likely to crack if the oil in the paint is not good; also, if there is much oil of any kind, the varnish hardens more quickly than the paint, and forms a rigid skin over it, which cracks when the paint contracts. The more oil a varnish contains the less likely it is to crack. All varnishes improve by being kept in a dry place. One pint of varnish will cover about 16 sq. yd. with a single coat.

RECIPES.—The following recipes give the proportions of ingredients for varnishes in connection with house painting:—

Oil Varnishes.—Copal Varnishes.—(1) Best Body Copal Varnish.—Fuse 8 lb. fine African gum copal; add 2 gal. clarified oil. Boil very slowly for 4 or 5 hours till quite stringy, and mix with $3\frac{1}{2}$ gal. turpentine. This is used for the body part of coaches, and for other objects intended to be polished. The above makes the palest and best copal varnish, possessing great fluidity and pliability, but it is very slow in drying, and, for months, is too soft to polish. Driers are therefore added, but they are injurious. To avoid the use of driers, gum animi is used instead of copal, but it is less durable and becomes darker by age. The copal and animi varnishes are sometimes mixed; 1 pot of the latter to 2 of the former for a moderately quick drying varnish of good quality, and 2 pots of the animi to 1 of the copal for quicker drying varnish of common quality.

(2) Best Pale Carriage Copal Varnish.—Fuse 8 lb. second sorted African copal; add $2\frac{1}{2}$ gal. clarified oil. Boil slowly together for 4 or 5 hours until quite stringy; add $5\frac{1}{2}$ gal. turpentine mixed with $\frac{1}{4}$ lb. dried copperas, $\frac{1}{4}$ lb. litharge; strain, and pour off. In order to hasten drying, mix with the above while hot 8 lb. second sorted gum animi, $2\frac{1}{2}$ gal. clarified oil, $\frac{1}{4}$ lb. dried sugar of lead, $\frac{1}{4}$ lb. litharge, $5\frac{1}{2}$ gal. turpentine. This varnish will, if well boiled, dry hard in 4 hours in summer or 6 in winter. Some copal varnish takes, however, 12 hours to dry. This varnish is used for carriages, and also in house painting for the best grained work, as it dries well and has a good gloss. A stronger varnish is made for carriages, known as Best Body Copal Varnish.

(3) Second Carriage Varnish.—8 lb. second sorted gum animi, $2\frac{3}{4}$ gal. fine clarified oil, $5\frac{1}{4}$ gal. turpentine, $\frac{1}{4}$ lb. litharge, $\frac{1}{4}$ lb. dried sugar of lead, $\frac{1}{4}$ lb. dried copperas, boiled and mixed as before. Used for varnishing black japan or dark house painting.

(4) Pale Amber Varnish.—Pour 2 gal. hot clarified oil on 6 lb. very pale transparent amber. Boil till strongly stringy, and mix with 4 gal. turpentine. This will work very well, be very hard, and the most durable of all varnishes, and improves other copal varnishes when mixed with them; but it dries very slowly, and is but little used on account of its expense.

(5) White Coburg varnish is of a very pale colour, dries in about 10 hours, and in a few days is hard enough to polish.

(6) Wainscot varnish is made of 8 lb. gum animi (second quality), 3 gal. clarified oil, $\frac{1}{4}$ lb. litharge, $\frac{1}{2}$ lb. sugar of lead, $\frac{1}{4}$ lb. copperas, boiled together till strongly stringy, and then mixed with $5\frac{1}{2}$ gal. turpentine. It may be darkened by adding a little gold size. This varnish dries in 2 hours in summer, and is used chiefly for house painting and japanning.

Spirit Varnishes—Cheap Oak Varnish.—Dissolve $3\frac{1}{2}$ lb. clear good rosin in 1 gal. oil of turpentine. Darken, if required, by adding well-ground umber or fine lampblack. Oak varnish is used for common work. It dries generally in about 10 hours, though some is made to dry in half the time, and known as “Quick Oak Varnish”; another variety is called “Hard Oak Varnish,” and is used for seats.

Copal Varnish.—By slow heat in an iron pot melt $\frac{1}{2}$ lb. powdered copal gum, 2 oz. balsam of capivi, previously heated and added. When melted, remove from the fire and pour in 10 oz. spirits of turpentine, also previously warmed. Copal will more easily melt by powdering the crude gum; let it stand for a time covered loosely.

White hard spirit varnish may be made by dissolving $3\frac{1}{2}$ lb. gum sandarach in 1 gal. spirits of wine; when solution is complete, add 1 pint pale turpentine and shake well together.

Brown hard spirit varnish is made like the white, but shellac is substituted for the sandarach. It will bear polishing.

French Polish.—The simplest and probably the best is made by dissolving $1\frac{1}{2}$ lb. shellac in 1 gal. spirits of wine without heat. Other gums are sometimes used, and the polish may be darkened by adding benzoin, or it may be coloured with dragon’s blood. It is used chiefly for mahogany work, in joinery, hand-rails, &c., and is applied by rubbing it well into the surface of the wood, which has been previously made smooth by sandpaper, &c. (See also p. 465.)

Hardwood lacquer is made by dissolving 2 lb. shellac in 1 gal. spirits of wine. It is generally used for turned articles, being applied to them with a rag while they are on the lathe.

Lacquer for Brass.—The simplest and best lacquer for work not requiring to be coloured is made by dissolving with agitation $\frac{1}{2}$ lb. best pale shellac in 1 gal. cold spirits of wine. The mixture is allowed to stand, filtered, and kept out of the influence of light, which would make it darker.

Turpentine Varnishes.—Turpentine varnish consists of 4 lb. common (or bleached) rosin dissolved in 1 gal. oil of turpentine, under slight warmth. It is used for indoor painted work, and also to add to other varnishes to give them greater body, hardness, and brilliancy.

Black Varnish for Metal Work.—Fuse 3 lb. Egyptian asphaltum; when it is liquid, add $\frac{1}{2}$ lb. shellac and 1 gal. turpentine.

Brunswick Black.—Boil 45 lb. asphaltum for 6 hours over a slow fire. During the same time boil 6 gal. oil which has been previously boiled, introducing litharge gradually until stringy, then pour the oil into the boiling asphaltum. Boil the mixture until it can be rolled into hard pills, let it cool, and then mix with 25 gal. turpentine, or as much as will give it proper consistency.

Varnish for Ironwork.—The following is recommended by Matheson as very effective:—30 gal. of coal tar, fresh, with all its naphtha retained; 6 lb. tallow; $1\frac{1}{2}$ lb. rosin; 3 lb. lampblack; 30 lb. fresh slaked lime, finely sifted—mixed intimately and applied hot. When hard, this varnish can be painted on by ordinary oil paint if desired.

MECHANICAL MOVEMENTS.—Those means by which motion is transmitted for mechanical purposes are known as mechanical movements. Motion, in mechanics, may be simple or compound. Simple motions are,—those of straight

translation, which, if of indefinite duration, must be reciprocating; simple rotation, which may be either continuous or reciprocating, and when reciprocating is called oscillating; helical, which, if of indefinite duration, must be reciprocating. Compound motions consist of combinations of any of the simple motions. Perpetual motion is an incessant motion conceived to be attainable by a machine supplying its own motive forces independently of any action from without, or which has within itself the means, when once set in motion, of continuing its motion perpetually, or until worn out, without any new application of external force; also the machine itself by means of which it is attempted, or supposed possible, to produce such motion; an invention much sought after, but physically impossible.

Fig. 737. In this the lower pulley is movable. One end of the rope being fixed, the other must move twice as fast as the weight, and a corresponding gain of power is consequently effected.

Fig. 738 is a simple pulley used for lifting weights. In this the power must be equal to the weight to obtain equilibrium.

Fig. 739. Blocks and tackle. The power obtained by this contrivance is calculated as follows:—Divide the weight by double the number of pulleys in the lower block; the quotient is the power required to balance the weight.

Fig. 740 represents what are known as White's pulleys, which can either be made with separate loose pulleys, or a series of grooves can be cut in a solid block, the diameters being made in proportion to the speed of the rope; that is, 1, 3, and 5 for one block, and 2, 4, and 6 for the other. Power as 1 to 7.

Figs. 741, 743 are what are known as Spanish bartons.

Fig. 742 is a combination of two fixed pulleys and one movable pulley.

Figs. 744 to 747 are different arrangements of pulleys. The following rule applies to these pulleys:—In a system of pulleys where each pulley is embraced by a cord attached at one end to a fixed point, and at the other to the centre of the movable pulley, the effect of the whole will be the number 2, multiplied by itself as many times as there are movable pulleys in the system.

Fig. 748. Mangle-wheel and pinion—so called from their application to mangles—converts continuous rotary motion of pinion into reciprocating rotary motion of wheel. The shaft of pinion has a vibratory motion, and works in a straight slot cut in the upright stationary bar to allow the pinion to rise and fall, and work inside and outside of the gearing of the wheel. The slot cut in the face of the mangle-wheel and following its outline is to receive and guide the pinion-shaft, and keep the pinion in gear.

Fig. 749. Fusee-chain and spring-box, being the prime mover in some watches, particularly in those of English make. The fusee to the right is to compensate the loss of force of the spring as it uncoils itself. The chain is on the small diameter of the fusee when the watch is wound up, as the spring has then the greatest force.

Fig. 750. A frictional clutch-box, thrown in and out of gear by levers at the bottom. This is used for connecting and disconnecting heavy machinery. The eye of the disc to the right has a slot which slides upon a long key or feather fixed on the shaft.

Fig. 751. Clutch-box. The pinion at the top gives a continuous rotary motion to the gear below, to which is attached half the clutch, and both turn loosely on the shaft. When it is desired to give motion to the shaft, the other part of the clutch, which slides upon a key or feather fixed in the shaft, is thrust into gear by the lever.

Fig. 752. Another kind of clutch-box. The disc-wheel to the right has 2 holes corresponding to the studs fixed in the other disc; and being pressed against it, the studs enter the holes, when the 2 discs rotate together.

Fig. 753. Used for throwing in and out of gear the speed motion on lathes. On depressing the lever, the shaft of the large wheel is drawn backward by reason of the slot in which it slides being cut eccentrically to the centre or fulcrum of the lever.

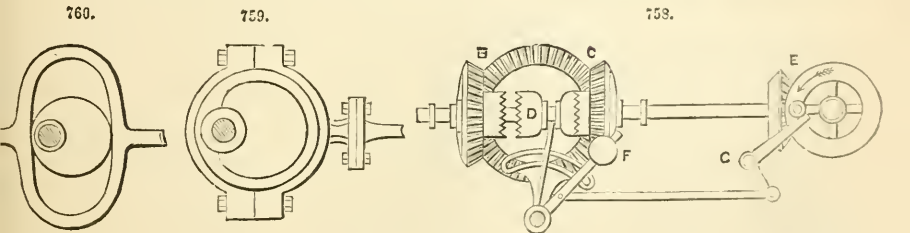
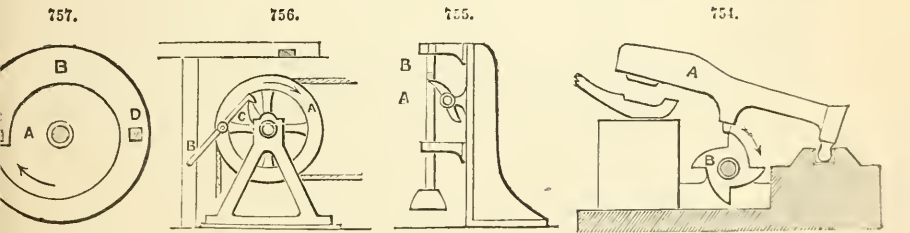
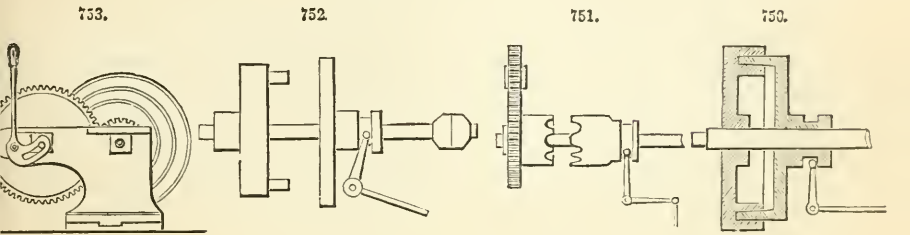
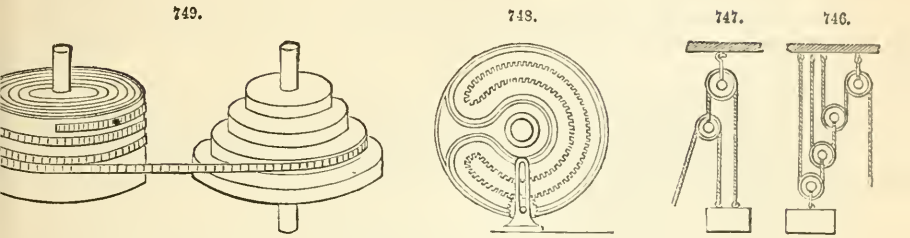
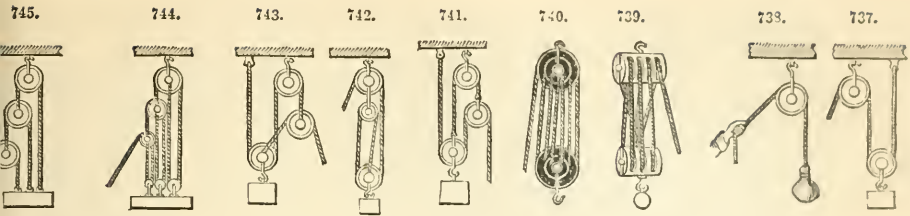

Fig. 754 is a tilt-hammer motion, the revolution of the cam or wiper-wheel B lifting the hammer A 4 times in each revolution.

Fig. 755. Intermittent alternating rectilinear motion is given to the rod A, by the continuous rotation of the shaft carrying the 2 cams or wipers, which act upon the projection B of the rod, and thereby lift it. The rod drops by its own weight. Used for ore-stampers or pulverizers, and for hammers.

Fig. 756. A method of working a reciprocating pump by rotary motion. A rope carrying the pump-rod is attached to the wheel A, which runs loosely upon the shaft. The shaft carries a cam C, and has a continuous rotary motion. At every revolution the cam seizes the hooked catch B, attached to the wheel, and drags it round, together with the wheel, and raises the rope until, on the extremity of the catch striking the stationary stop above, the catch is released, and the wheel is returned by the weight of the pump-bucket.

Fig. 757. Continuous rotary converted into intermittent rotary motion. The disc-wheel B, carrying the stops C, D, turns on a centre eccentric to the cam A. On continuous rotary motion being given to the cam A, intermittent rotary motion is imparted to the wheel B, the stops free themselves from the offset of the cam at every half revolution, the wheel B remaining at rest until the cam has completed its revolution, when the same motion is repeated.

Fig. 758. A contrivance for a self-reversing motion. The bevel-gear between the gears B and C is the driver. The gears B and C run loose upon the shaft, consequently motion is only communicated when one or other of them is engaged with the clutch-box D, which slides on a feather on the shaft, and is shown in gear with C. The wheel E at the right is driven by bevel-gearing from the shaft on which the gears B, C, and clutch are placed, and is about to strike the bell-crank G, and produce such a movement thereof as will cause the connecting rod to carry the weighted lever F beyond a perpendicular position, when the said lever will fall over suddenly to the left, and carry the clutch into gear with B, thereby reversing the motion of the shaft until the stud in the wheel E, coming round in the contrary direction, brings the weighted lever back past the perpendicular position, and again causes it to reverse the motion.

Fig. 759. An eccentric generally used on the crank-shaft for communicating the reciprocating rectilinear motion to the valves of steam engines, and sometimes used for pumping.

Fig. 760. A modification of the above; an elongated yoke being substituted for the circular strap to obviate the necessity for any vibrating motion of the rod, which works in fixed guides.

Fig. 761. Triangular eccentric, giving an intermittent reciprocating rectilinear motion, used in France for the valve-motion of steam engines.

Fig. 762. Ordinary crank-motion.

Fig. 763. Crank-motion, with the crank-wrist working in a slotted yoke, thereby dispensing with the oscillating connecting-rod or pitman.

Fig. 764. Variable crank, 2 circular plates revolving on the same centre. In one a spiral groove is cut; in the other a series of slots radiating from the centre. On turning one of these plates around its centre, the bolt shown near the bottom of the figure, and which passes through the spiral groove and radial slots, is caused to move toward or from the centre of the plates.

Fig. 765. On rotating the upright shaft, reciprocating rectilinear motion is imparted by the oblique disc to the upright rod resting upon its surface.

Fig. 766. A heart-cam. Uniform traversing motion is imparted to the horizontal bar by the rotation of the heart-shaped cam. The dotted lines show the mode of striking out the curve of the cam. The length of traverse is divided into any number of parts; and from the centre a series of concentric circles are described through these points. The outside circle is then divided into double the number of these divisions,

764.

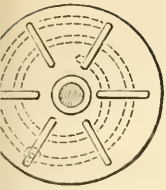

763.

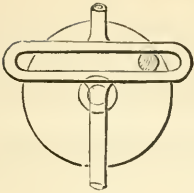

762.

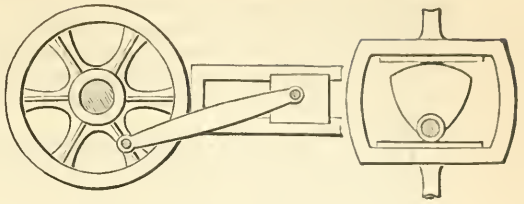

761.

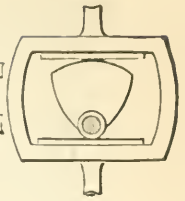

762.

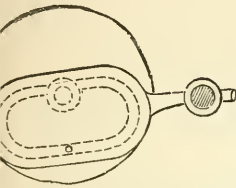

767.

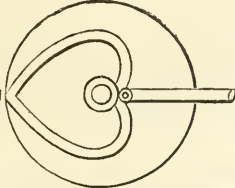

766.

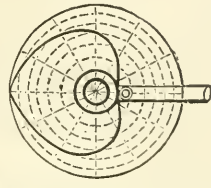

765.

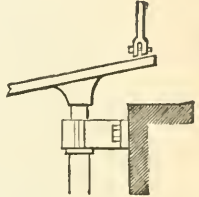

773.

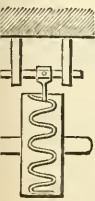

772.

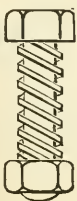

771.

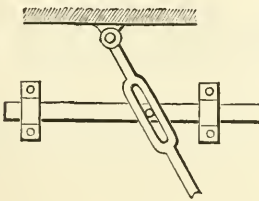

776.

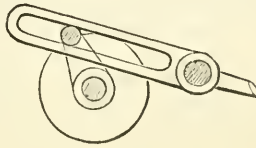

769.



778.

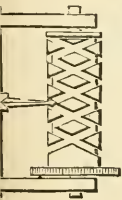

777.

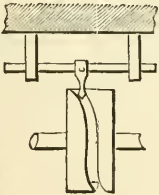

776.

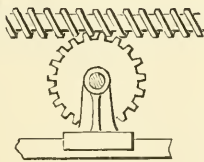

775.

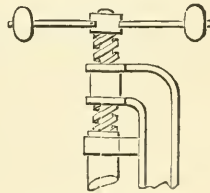

774.

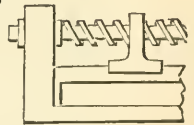

784.



783.



782.



781.



780.

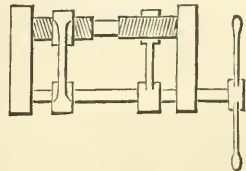

779.

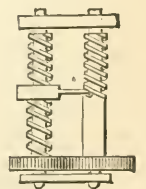

and lines drawn to the centre. The curve is then drawn through the intersections of the concentric circles and the radiating lines.

Fig. 767. This is a heart-cam, similar to Fig. 766. except that it is grooved.

Fig. 768. Irregular vibrating motion is produced by the rotation of the circular disc, in which is fixed a crank-pin, working in an endless groove, cut in the vibrating arm.

Fig. 769. Spiral guide attached to the face of a disc; used for the feed-motion of a drilling machine.

Fig. 770. Quick return crank-motion, applicable to shaping machines.

Fig. 771. Rectilinear motion of horizontal bar, by means of vibrating slotted bar hung from the top.

Fig. 772. Common screw bolt and nut; rectilinear motion obtained from circular motion.

Figs. 773, 777. Uniform reciprocating rectilinear motion, produced by rotary motion of grooved cams.

Fig. 774. Rectilinear motion of slide produced by the rotation of screw.

Fig. 775. Screw stamping-press; rectilinear motion from circular motion.

Fig. 776. In this, rotary motion is imparted to the wheel by the rotation of the screw, or rectilinear motion of the slide by the rotation of the wheel. Used in screw-cutting and slide-lathes.

Fig. 778. Uniform reciprocating rectilinear motion from uniform rotary motion of a cylinder, in which are cut reverse threads or grooves, which necessarily intersect twice in every revolution. A point inserted in the groove will traverse the cylinder from end to end.

Fig. 779. The rotation of the screw at the left-hand side produces a uniform rectilinear movement of a cutter, which cuts another screw-thread. The pitch of the screw to be cut may be varied by changing the sizes of the wheels at the end of the frame.

Fig. 780. Uniform circular into uniform rectilinear motion; used in spooling frames for leading or guiding the thread on to the spools. The roller is divided into 2 parts, each having a fine screw-thread cut upon it, one a right and the other a left-hand screw. The spindle, parallel with the roller, has arms which carry 2 half-nuts, fitted to the screws, one over and the other under the roller. When one half-nut is in, the other is out of gear. By pressing the lever to the right or left, the rod is made to traverse in either direction.

Fig. 781. Micrometer screw. Great power can be obtained by this device. The threads are made of different pitch, and run in different directions; consequently a die or nut, fitted to the inner and smaller screw, would traverse only the length of the difference between the pitches for every revolution of the outside hollow screw in a nut.

Fig. 782. Persian drill. The stock of the drill has a very quick thread cut upon it, and revolves freely, supported by the head at the top, which rests against the body. The button or nut, shown on the middle of the screw, is held firm in the hand, and pulled quickly up and down the stock, thus causing it to revolve to the right and left alternately.

Fig. 783. Circular into rectilinear motion, or the reverse, by means of rack and pinion.

Fig. 784. A cam acting between two friction-rollers in a yoke. Has been used to give the movement to the valve of a steam engine.

Fig. 785. Rotary motion of the toothed wheels produces rectilinear motion of the double rack, and gives equal force and velocity to each side, both wheels being of equal size.

Fig. 786. A substitute for the crank. Reciprocating rectilinear motion of the frame carrying the double rack produces a uniform rotary motion of the pinion-shaft. A separate pinion is used for each rack, the two racks being in different planes. Both

pinions are loose on the shaft. A ratchet-wheel is fast on the shaft outside each pinion, and a pawl attached to the pinion to engage in it, one ratchet-wheel having its teeth set in one direction, and the other having its teeth set in the opposite direction. When the racks move one way, one pinion turns the shaft by means of its pawl and ratchet; and when the racks move the opposite way, the other pinion acts in the same way, one pinion always turning loosely on the shaft.

Fig. 787. A mode of doubling the length of stroke of a piston-rod, or the throw of a crank. A pinion revolving on a spindle attached to the connecting rod or pitman is in gear with a fixed rack. Another rack carried by a guide-rod above, and in gear with the opposite side of the pinion, is free to traverse backward and forward. Now, as the connecting rod communicates to the pinion the full length of stroke, it would cause the top rack to traverse the same distance, if the bottom rack was alike movable; but as the latter is fixed, the pinion is made to rotate, and consequently the top rack travels double the distance.

Fig. 788. Reciprocating rectilinear motion of the bar carrying the oblong endless rack, produced by the uniform rotary motion of the pinion working alternately above and below the rack. The shaft of the pinion moves up and down in, and is guided by, the slotted bar.

Fig. 789. Each jaw is attached to one of the two segments, one of which has teeth outside and the other teeth inside. On turning the shaft carrying the two pinions, one of which gears with one and the other with the other segment, the jaws are brought together with great force.

Fig. 790. Alternating rectilinear motion of the rod attached to the disc-wheel produces an intermittent rotary motion of the cog-wheel by means of the click attached to the disc-wheel. This motion, which is reversible by throwing over the click, is used for the feed of planing machines and other tools.

Fig. 791. The rotation of the 2 spur-gears, with crank-wrists attached, produces a variable alternating traverse of the horizontal bar.

Fig. 792. Fiddle drill. Reciprocating rectilinear motion of the bow, the string of which passes around the pulley on the spindle carrying the drill, producing alternating rotary motion of the drill.

Fig. 793. Intended as a substitute for the crank. Reciprocating rectilinear motion of the double rack gives a continuous rotary motion to the centre gear. The teeth on the rack act upon those of the 2 semicircular toothed sectors, and the spur-gears attached to the sectors operate upon the centre gear. The two stops on the rack, shown by dotted lines, are caught by the curved piece on the centre gear, and lead the toothed sectors alternately into gear with the double rack.

Fig. 794. A modification of the motion shown in Fig. 791, but of a more complex character.

Fig. 795. A bell-crank lever, used for changing the direction of any force.

Fig. 796. Motion used in air-pumps. On vibrating the lever fixed on the same shaft with the spur-gear, reciprocating rectilinear motion is imparted to the racks on each side, which are attached to the pistons of 2 pumps, one rack always ascending while the other is descending.

Fig. 797. A continuous rotary motion of the shaft carrying the 3 wipers produces a reciprocating rectilinear motion of the rectangular frame. The shaft must revolve in the direction of the arrow for the parts to be in the position represented.

Fig. 798. Chinese windlass. This embraces the same principles as the micrometer screw, Fig. 779. The movement of the pulley in every revolution of the windlass is equal to half the difference between the larger and smaller circumferences of the windlass barrel.

Fig. 799. Shears for cutting metal plates. The jaws are opened by the weight of the long arm of the upper one, and closed by the rotation of the cam.

787.

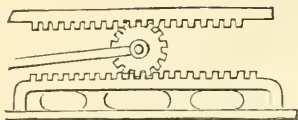

788.

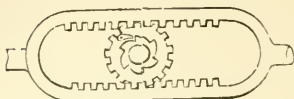

785.

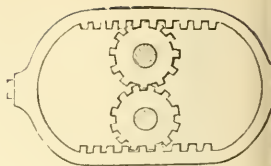

792.

791.

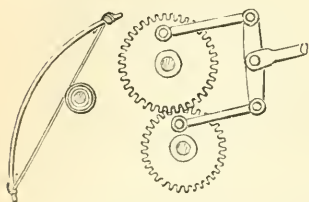

790.

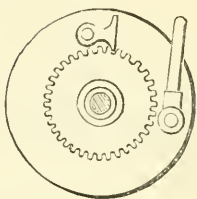

789.

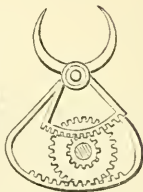

783

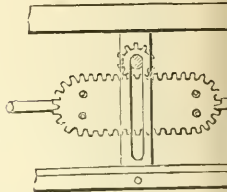

797.

796.

795.

794.

793.

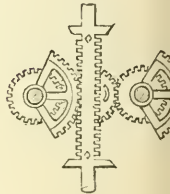
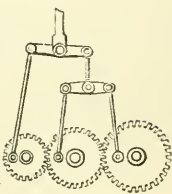
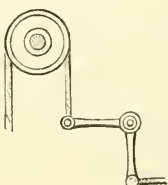
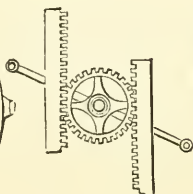
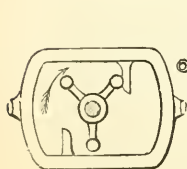

801.

800

799.

798.

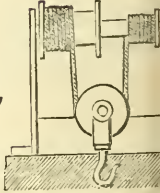
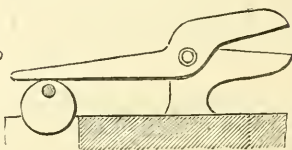
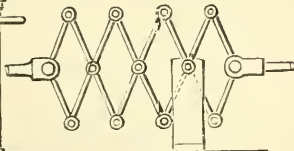
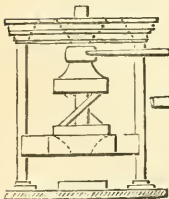

806.

805.

804.

803.

802.

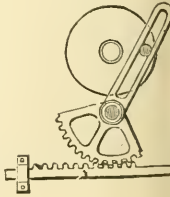
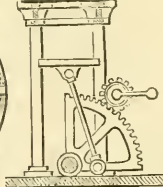
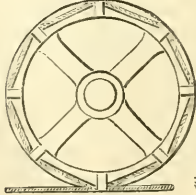
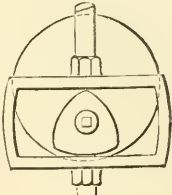
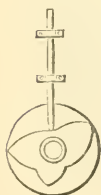

Fig. 800. A system of crossed levers, termed lazy tongs. A short alternating rectilinear motion of rod at the right will give a similar but much greater motion to the rod at the left. It is frequently used in children's toys. It has been applied in France to a machine for raising sunken vessels; also applied to ships' pumps three-quarters of a century ago.

Fig. 801. This is a motion which has been used in presses, to produce the necessary pressure upon the platen. Horizontal motion is given to the arm of the lever which turns the upper disc. Between the top and bottom discs are 2 bars which enter holes in the discs. These bars are in oblique positions, as shown in the drawing, when the press is not in operation; but when the top disc is made to rotate, the bars move toward perpendicular positions and force the lower disc down. The top disc must be firmly secured in a stationary position, except as to its revolution.

Fig. 802. On rotating the disc carrying the crank-pin working in the slotted arm, reciprocating rectilinear motion is imparted to the rack at the bottom by the vibration of the toothed sector.

Fig. 803. A simple press-motion is given through the hand-crank on the pinion-shaft, the pinion communicating motion to the toothed sector, which acts upon the platen, by means of the rod which connects it therewith.

Fig. 804. Uniform circular motion into rectilinear, by means of a rope or band, which is wound several times around the drum.

Fig. 805. Modification of the triangular eccentric, Fig. 761, used on the steam engine in the Paris Mint. The circular disc behind carries the triangular tappet, which communicates an alternate rectilinear motion to the valve-rod. The valve is at rest at the completion of each stroke for an instant, and is pushed quickly across the steam-ports to the end of the next.

Fig. 806. On turning the cam at the bottom a variable alternating rectilinear motion is imparted to the rod resting on it.

Fig. 807. A cam-wheel, of which a side view is shown, has its rim formed into teeth, or made of any profile form desired. The rod to the right is made to press constantly against the teeth or edge of the rim. On turning the wheel, alternate rectilinear motion is communicated to the rod. The character of this motion may be varied by altering the shape of the teeth, or profile of the edge, of the rim of the wheel.

Fig. 808. Expansion eccentric, used in France to work the slide-valve of a steam-engine. The eccentric is fixed on the crank-shaft, and communicates motion to the forked vibrating arm, to the bottom of which the valve-rod is attached.

Fig. 809. The internal rack, carried by the rectangular frame, is free to slide up and down within it for a certain distance, so that the pinion can gear with either side of the rack. Continuous circular motion of the pinion is made to produce reciprocating rectilinear motion of rectangular frame.

Fig. 810. Endless band-saw. Continuous rotary motion of the pulleys is made to produce continuous rectilinear motion of the straight parts of the saw.

Fig. 811. The toggle-joint arranged for a punching machine. Lever at the right is made to operate upon the joint of the toggle by means of the horizontal connecting link.

Fig. 812. Movement used for varying the length of the traversing guide-bar, which in silk machinery guides the silk on to spools or bobbins. The spur-gear turning freely on its centre, is carried round by the larger circular disc, which turns on a fixed central stud, which has a pinion fast on its end. Upon the spur-gear is bolted a small crank, to which is jointed a connecting-rod attached to traversing guide-bar. On turning the disc, the spur-gear is made to rotate partly upon its centre by means of the fixed pinion, and consequently brings crank nearer to centre of disc. If the rotation of disc was continued, the spur-gear would make an entire revolution. During half a revolution the traverse

810.

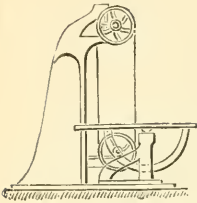

809.

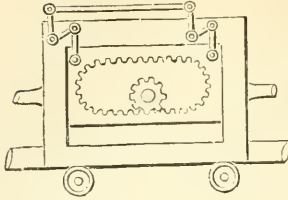

808.

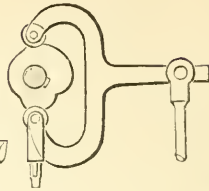

807.

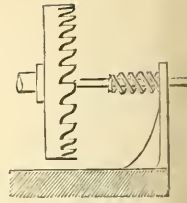

815.

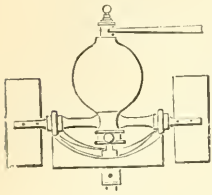

814.

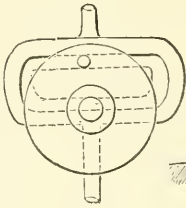

813.

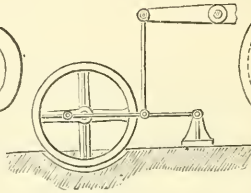

812.

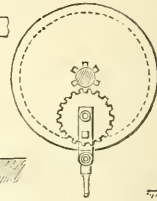

811.

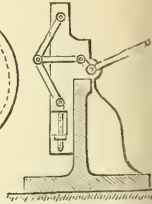

819.

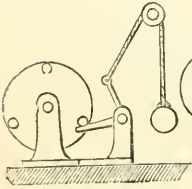

818.

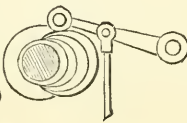

817.

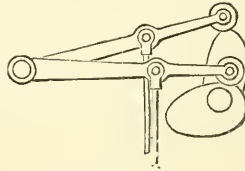

816.

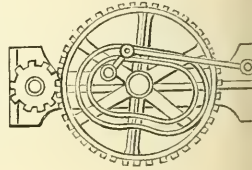

823.

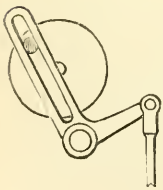

822.

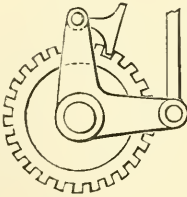

821.

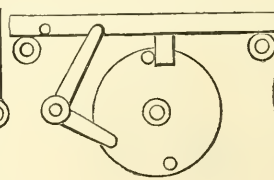

820.

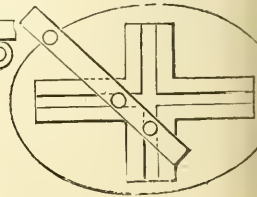

827.

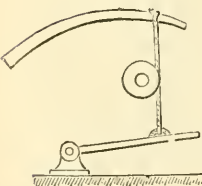

826.

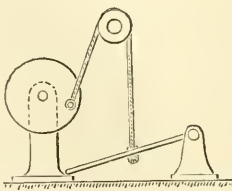

825.

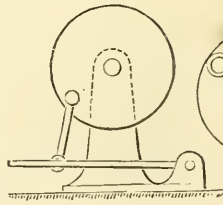

824.

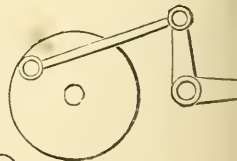

would have been shortened a certain amount at every revolution of disc, according to the size of spur-gear; and during the other half it would have gradually lengthened in the same ratio.

Fig. 813. Reciprocating curvilinear motion of the beam gives a continuous rotary motion to the crank and fly-wheel. The small standard at the right, to which is attached one end of the lever with which the beam is connected by the connecting rod, has a horizontal reciprocating rectilinear movement.

Fig. 814. Continuous rotary motion of the disc produces reciprocating rectilinear motion of the yoke-bar, by means of the wrist or crank-pin on the disc working in the groove of the yoke. The groove may be so shaped as to obtain a uniform reciprocating rectilinear motion.

Fig. 815. Steam-engine governor. The operation is as follows:—On engine starting, the spindle revolves and carries round the cross-head, to which fans are attached, and on which are also fitted two friction-rollers, which bear on two circular inclined planes attached securely to the centre shaft, the cross-head being loose on the shaft. The cross-head is made heavy or has a ball or other weight attached, and is driven by the circular inclined planes. As the speed of the centre shaft increases, the resistance of the air to the wings tends to retard the rotation of the cross-head; the friction-rollers, therefore, run up the inclined planes and raise the cross-head, to the upper part of which is connected a lever operating upon the regulating valve of the engine.

Fig. 816. Continuous circular motion of the spur-gears produces alternate circular motion of the crank attached to the larger gear.

Fig. 817. Uniform circular converted, by the cams acting upon the levers, into alternating rectilinear motions of the attached rods.

Fig. 818. A valve-motion for working steam expansively. The series of cams of varying throw are movable lengthwise of the shaft, so that either may be made to act upon the lever to which the valve-rod is connected. A greater or less movement of the valve is produced according as a cam of greater or less throw is opposite the lever.

Fig. 819. Circular motion into alternating rectilinear motion by the action of the studs on the rotary disc upon one end of the bell-crank, the other end of which has attached to it a weighted cord passing over a pulley.

Fig. 820. An ellipsograph. The traverse bar, shown in an oblique position, carries 2 studs, which slide in the grooves of the cross-piece. By turning the traverse bar an attached pencil is made to describe an ellipse by the rectilinear movement of the studs in the grooves.

Fig. 821. Circular motion into alternating rectilinear motion. The studs on the rotating disc strike the projection on the under side of the horizontal bar, moving it in one direction. The return motion is given by means of the bell-crank or elbow-lever, one arm of which is operated upon by the next stud, and the other strikes the stud on the front of the horizontal bar.

Fig. 822. Reciprocating rectilinear motion into intermittent circular motion, by means of the pawl attached to the elbow-lever, and operating in the toothed wheel. Motion is given to the wheel in either direction according to the side on which the pawl works. This is used in giving the feed-motion to planing machines and other tools.

Fig. 823. Circular motion into variable alternating rectilinear motion, by the wrist or crank-pin on the rotating disc working in the slot of the bell-crank or elbow-lever.

Fig. 824. A modification of the movement last described, a connecting rod being substituted for the slot in the bell-crank.

Fig. 825. Reciprocating curvilinear motion of the treadle gives a circular motion to the disc. A crank may be substituted for the disc.

Fig. 826. A modification of Fig. 825, a cord and pulley being substituted for the connecting rod.

Fig. 827. Alternating curvilinear motion into alternating circular. When the

treadle has been depressed, the spring at the top elevates it for the next stroke; the connecting band passes once round the pulley, to which it gives motion.

Fig. 828. Centrifugal governor for steam engines. The central spindle and attached arms and balls are driven from the engine by the bevel-gears at the top, and the balls fly out from the centre by centrifugal force. If the speed of the engine increases, the balls fly out farther from the centre, and so raise the slide at the bottom, and thereby reduce the opening of the regulating valve which is connected with the slide. A diminution of speed produces an opposite effect.

Fig. 829. Water-wheel governor acting on the same principle as Fig. 828, but by different means. The governor is driven by the top horizontal shaft and bevel-gears, and the lower gears control the rise and fall of the shuttle or gate over or through which the water flows to the wheel. The action is as follows:—The 2 bevel-gears on the lower part of the centre spindle, which are furnished with studs, are fitted loosely to the spindle, and remain at rest so long as the governor has a proper velocity; but immediately the velocity increases, the balls flying farther out, draw up the pin which is attached to a loose sleeve which slides up and down the spindle, and this pin, coming in contact with the stud on the upper bevel-gear, causes that gear to rotate with the spindle, and to give motion to the lower horizontal shaft in such a direction as to make it raise the shuttle or gate, and so reduce the quantity of water passing to the wheel. On the contrary, if the speed of the governor decreases below that required, the pin falls and gives motion to the lower bevel-gear, which drives the horizontal shaft in the opposite direction, and produces a contrary effect.

Fig. 830. Another arrangement for a water-wheel governor. In this the governor controls the shuttle or gate by means of the cranked lever, which acts on the strap or belt in the following manner:—The belt runs on 1 of 3 pulleys, the middle one of which is loose on the governor spindle, and the upper and lower ones fast. When the governor is running at the proper speed the belt is on the loose pulley, as shown; but when the speed increases, the belt is thrown on the lower pulley, and thereby caused to act upon suitable gearing for raising the gate or shuttle and decreasing the supply of water. A reduction of the speed of the governor brings the belt on the upper pulley, which acts upon gearing for producing an opposite effect on the shuttle or gate.

Fig. 831. A knee-lever, differing slightly from the toggle-joint shown in Fig. 811. It is often used for presses and stamps, as a great force can be obtained by it. The action is by raising or lowering the horizontal lever.

Fig. 832. Circular into rectilinear motion. The waved wheel, or cam, on the upright shaft communicates a rectilinear motion to the upright bar through the oscillating rod.

Fig. 833. A drum, or cylinder, having an endless spiral groove extending all around it, one half of the groove having its pitch in one, and the other half its pitch in the opposite direction. A stud on a reciprocating rectilinearly-moving rod works in the groove, and so converts reciprocating into rotary motion. This has been used as a substitute for the crank in a steam engine, and as a means of transmitting motion in Foster's pressure gauge.

Fig. 834. The rotation of the disc carrying the crank-pin gives a to-and-fro motion to the connecting rod, and the slot allows the rod to remain at rest at the termination of each stroke. It has been used in a brick press, in which the connecting rod draws a mould backward and forward, and permits it to rest at the termination of each stroke, that the clay may be deposited in it and the brick extracted.

Fig. 835. The slotted crank at the left hand of the figure is on the main shaft of an engine, and the pitman which connects it with the reciprocating moving power is furnished with a pin which works in the slot of the crank. Intermediate between the first crank and the moving power is a shaft carrying a second crank, of an invariable radius, connected with the same pitman. While the first crank moves in a circular

orbit, the pin at the end of the pitman is compelled to move in an elliptical orbit, thus increasing the leverage of the main crank at those points which are most favourable for the transmission of power.

Fig. 836. A modification of Fig. 835, in which a link is used to connect the pitman with the main crank, thereby dispensing with the slot in the crank.

Fig. 837. Another form of steam-engine governor. Instead of the arms being connected with a slide working on a spindle, they cross each other, and are elongated upward beyond the top, and connected with the valve-rod by 2 short links.

Fig. 838. Valve-motion and reversing gear, used in oscillating marine engines. The two eccentric-rods give an oscillating motion to the slotted link, which works the curved slide over the trunnion. Within the slot in the curved slide is a pin attached to the arm of a rock-shaft, which gives motion to the valve. The curve of the slot in the slide is an arc of a circle, described from the centre of the trunnion, and as it moves over the cylinder it does not interfere with the stroke of the valve. The 2 eccentrics and links are like those of the link-motion used in locomotives.

Fig. 839. A mode of obtaining an egg-shaped elliptical movement.

Fig. 840. A movement used in silk machinery for the same purpose as that described in Fig. 812. On the back of a disc or bevel-gear is secured a screw, with a tappet-wheel at one extremity. On each revolution of the disc the tappet-wheel comes in contact with a pin or tappet, and thus receives an intermittent rotary movement. A wrist, secured to a nut on the screw, enters and works in a slotted bar at the end of the rod, which guides the silk on the bobbins. Each revolution of the disc varies the length of stroke of the guide-rod, as the tappet-wheel on the end of the screw turns the screw with it, and the position of the nut on the screw is therefore changed.

Fig. 841. Carpenters' bench clamp. By pushing the clamp between the jaws they are made to turn on the screws and clamp the sides.

Fig. 842. A means of giving one complete revolution to the crank of an engine to each stroke of the piston.

Figs. 843, 844. Contrivance for uncoupling engines. The wrist, which is fixed on one arm of the crank, not shown, will communicate motion to the arm of the crank which is represented, when the ring on the latter has its slot in the position shown in Fig. 843. But when the ring is turned to bring the slot in the position shown in Fig. 844, the wrist passes through the slot, without turning the crank to which the ring is attached.

Fig. 845. Contrivance for varying the speed of the slide carrying the cutting tool in slotting and shaping machines. The driving shaft works through an opening in a fixed disc, in which is a circular slot. At the end of the shaft is a slotted crank. A slide fits in the slot of the crank and in the circular slot; and to the outward extremity of this slide is attached the connecting rod which works the slide carrying the cutting tool. When the driving shaft rotates, the crank is carried round, and the slide carrying the end of the connecting rod is guided by the circular slot, which is placed eccentrically to the shaft; therefore, as the slide approaches the bottom the length of the crank is shortened, and the speed of the connecting rod is diminished.

Fig. 846. Reversing gear for a single engine. On raising the eccentric-rod, the valve-spindle is released. The engine can then be reversed by working the upright lever, after which the eccentric-rod is let down again. The eccentric in this case is loose upon the shaft, and driven by a projection on the shaft acting upon a nearly semicircular projection on the side of the eccentric, which permits the eccentric to turn half-way round on the shaft on reversing the valves.

Fig. 847. This only differs from Fig. 841 in being composed of a single pivoted clamp operating in connection with a fixed side-piece.

Figs. 848, 849. Diagonal catch and hand-gear used in large blowing and pumping engines. In Fig. 848 the lower steam-valve and upper eduction-valve are open, while

833.



832.

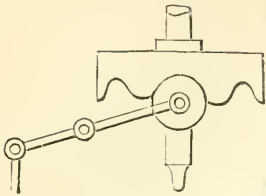

831.

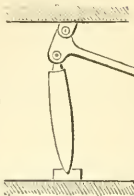

830.

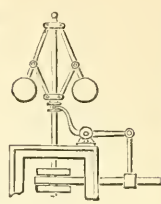

829.

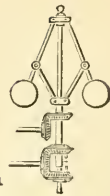

828.

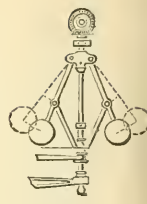

837.



836.

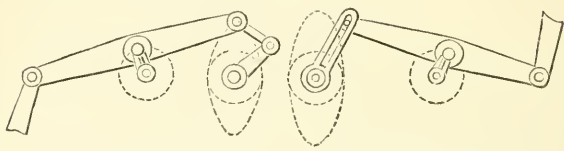

835.

834.

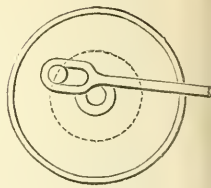

841.

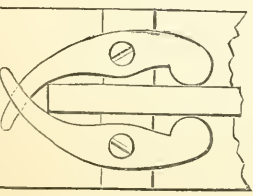

840.

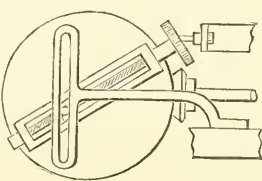

839.

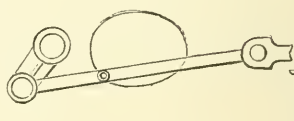

838.

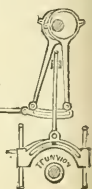

847.



846.

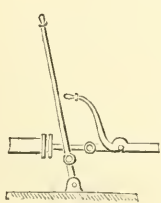

845.

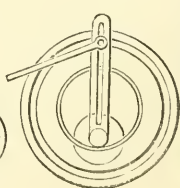

844.

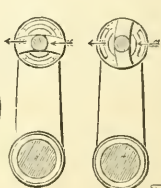

843.

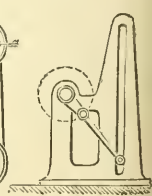

842.

853.

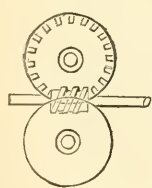

852.

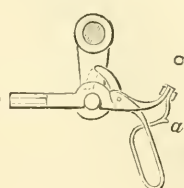

851.

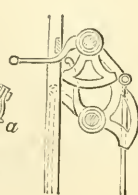

850.

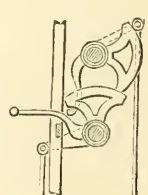

849.

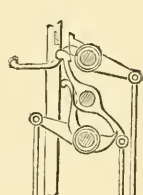

848.

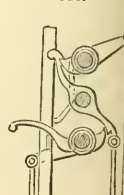

the upper steam-valve and lower eduction-valve are shut; consequently the piston will be ascending. In the ascent of the piston-rod the lower handle will be struck by the projecting tappet, and being raised will become engaged by the catch, and shut the upper eduction and lower steam valves; at the same time the upper handle being disengaged from the catch, the back weight will pull the handle up and open the upper steam and lower eduction valves, when the piston will consequently descend. Fig. 849 represents the position of the catches and handles when the piston is at the top of the cylinder. In going down, the tappet of the piston-rod strikes the upper handle, and throws the catches and handles to the position shown in Fig. 848.

Figs. 850, 851, represent a modification of Figs. 848, 849, the diagonal catches being superseded by two quadrants.

Fig. 852. Apparatus for disengaging the eccentric-rod from the valve-gear. By pulling up the spring handle below until it catches in the notch *a*, the pin is disengaged from the gab in the eccentric-rod.

Fig. 853. A mode of driving a pair of feed-rolls, the opposite surfaces of which require to move in the same direction. The 2 wheels are precisely similar, and both gear into the endless screw which is arranged between them. The teeth of one wheel only are visible, those of the other being on the back or side which is concealed from view.

Fig. 854. Link-motion valve-gear of a locomotive; 2 eccentrics are used for one valve, one for the forward and the other for the backward movement of the engine. The extremities of the eccentric-rods are jointed to a curved slotted bar, or, as it is termed, a link, which can be raised or lowered by an arrangement of levers terminating in a handle as shown. In the slot of the link is a slide and pin connected with an arrangement of levers terminating at the valve-stem. The link, in moving with the action of the eccentrics, carries with it the slide, and thence motion is communicated to the valve. Suppose the link raised, so that the slide is in the middle, then the link will oscillate on the pin of the slide, and consequently the valve will be at rest. If the link is moved so that the slide is at one of its extremities, the whole throw of the eccentric connected with that extremity will be given to it, and the valve and steam-ports will be opened to the full, and it will only be toward the end of the stroke that they will be totally shut; consequently the steam will have been admitted to the cylinder during almost the entire length of each stroke. But if the slide is between the middle and the extremity of the slot, as shown in the figure, it receives only a part of the throw of the eccentric, and the steam-ports will only be partially opened, and are quickly closed again, so that the admission of steam ceases some time before the termination of the stroke, and the steam is worked expansively. The nearer the slide is to the middle of the slot the greater will be the expansion, and *vice versa*.

Figs. 855, 856. Modifications of Fig. 852.

Fig. 857. Another modification of Fig. 852.

Fig. 858. A screw-clamp. On turning the handle the screw thrusts upward against the holder, which operating as a lever, holds down the piece of wood or other material placed under it on the other side of its fulcrum.

Fig. 859. A variety of what is known as the mangle-wheel. One variety of this was illustrated by Fig. 748. In this one the speed varies in every part of a revolution, the groove *b*, *d*, in which the pinion-shaft is guided, as well as the series of teeth, being eccentric to the axis of the wheel.

Fig. 860. Another kind of mangle-wheel, with its pinion. With this as well as with that in the preceding figure, although the pinion continues to revolve in one direction, the mangle-wheel will make almost an entire revolution in one direction and the same in an opposite direction; but the revolution of the wheel in one direction will be slower than that in the other, owing to the greater radius of the outer circle of teeth.

856.

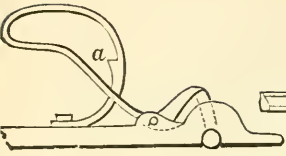

855.

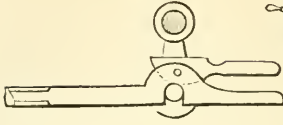

854.

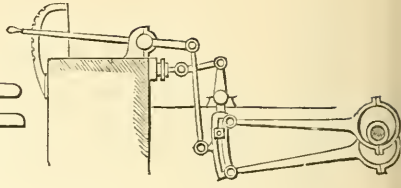

860.

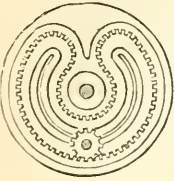

859.

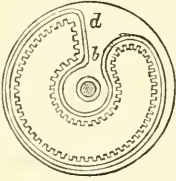

858.

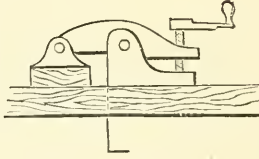

857.

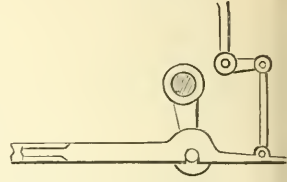

864.

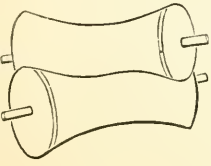

863.

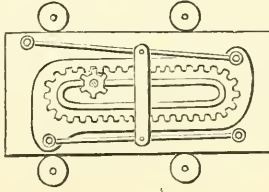

862.

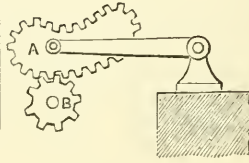

861.

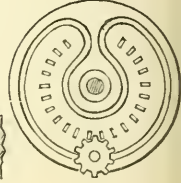

869.



868.

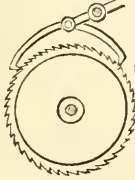

867.



866.



865.

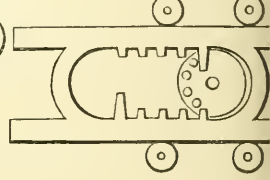

874.

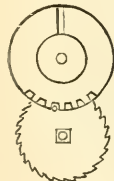

873.



872.



871.

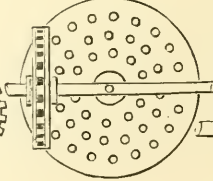

870.

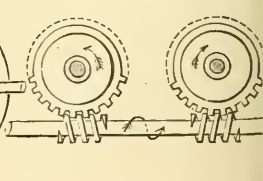

Fig. 861. Another mangle-wheel. In this the speed is equal in both directions of motion, only one circle of teeth being provided on the wheel. With all of these mangle-wheels the pinion-shaft is guided, and the pinion kept in gear, by a groove in the wheel. The said shaft is made with a universal joint, which allows a portion of it to have the vibratory motion necessary to keep the pinion in gear.

Fig. 862. The pinion B rotates about a fixed axis, and gives an irregular vibratory motion to the arm carrying the wheel A.

Fig. 863. A modification of what is called a mangle-rack. In this the pinion revolves, but does not rise and fall as in the former figure. The portion of the frame carrying the rack is jointed to the main portion of the frame by rods, so that when the pinion arrives at the end it lifts the rack by its own movement, and follows on the other side.

Fig. 864. An illustration of the transmission of rotary motion from one shaft to another, arranged obliquely to it, by means of rolling contact.

Fig. 865. Another form of mangle-rack. The lantern pinion revolves continuously in one direction, and gives reciprocating motion to the square frame, which is guided by rollers or grooves. The pinion has only teeth in less than half of its circumference, so that while it engages one side of the rack, the toothless half is directed against the other. The large tooth at the commencement of each rack is made to ensure the teeth of the pinion being properly in gear.

Fig. 866. A regular vibrating movement of the curved slotted arm gives a variable vibration to the straight arm.

Fig. 867 represents a wheel driven by a pinion of 2 teeth. The pinion consists in reality of 2 cams, which gear with 2 distinct series of teeth on opposite sides of the wheel, the teeth of one series alternating in position with those of the other.

Fig. 868. A continuous circular movement of the ratchet-wheel, produced by the vibration of the lever carrying 2 pawls, one of which engages the ratchet-teeth in rising and the other in falling.

Fig. 869. By turning the shaft carrying the curved slotted arm, a rectilinear motion of variable velocity is given to the variable bar.

Fig. 870. A modification of Fig. 853, by means of 2 worms and worm-wheels.

Fig. 871. A pin-wheel and slotted pinion, by which 3 changes of speed can be obtained. There are 3 circles of pins of equal distance on the face of the pin-wheel, and by shifting the slotted pinion along its shaft, to bring it in contact with one or the other of the circles of pins, a continuous rotary motion of the wheel is made, to produce 3 changes of speed of the pinion.

Fig. 872 represents a mode of obtaining motion from rolling contact. The teeth are for making the motion continuous, or it would cease at the point of contact shown in the figure. The fork catch is to guide the teeth into proper contact.

Fig. 873. What is called the Geneva-stop, used in Swiss watches to limit the number of revolutions in winding-up; the convex curved part *a*, *b*, of the wheel B serving as the stop.

Fig. 874. Another kind of stop for the same purpose.

Fig. 875. A continuous rotary motion of the large wheel gives an intermittent rotary motion to the pinion-shaft. The part of the pinion shown next the wheel is cut of the same curve as the plain portion of the circumference of the wheel, and therefore serves as a lock while the wheel makes a part of a revolution, and until the pin upon the wheel strikes the guide-piece upon the pinion, when the pinion-shaft commences another revolution.

Fig. 876, 877. Other modifications of the stop, the operations of which will be easily understood by comparison with Fig. 873.

Fig. 878. The two crank-shafts are parallel in direction, but not in line with each other. The revolution of either will communicate motion to the other with a varying

873.

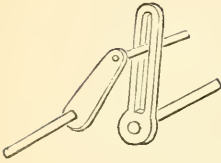

877.

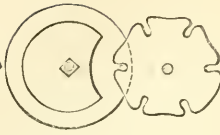

876



875,

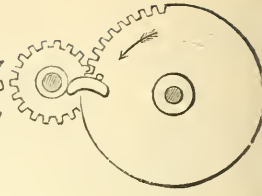

884.

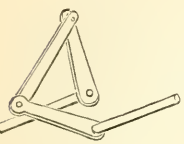

882.

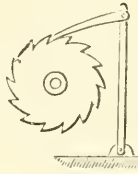

882.

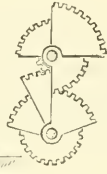

881.

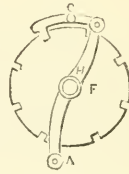

880.

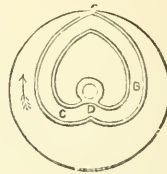

879.

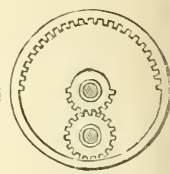

889

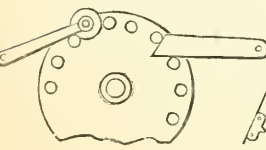

883.

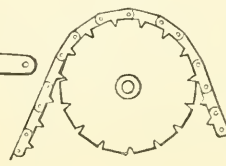

887.



880.

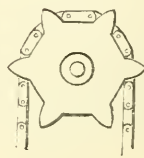

885.

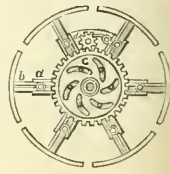

894.

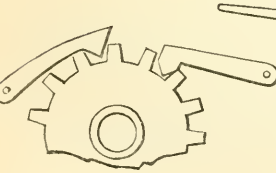

893.

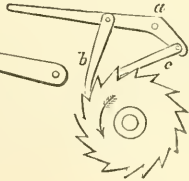

892.

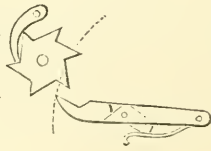

891.

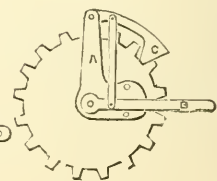

890.



898.

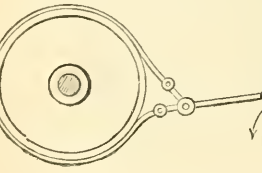

897.



896.



895.

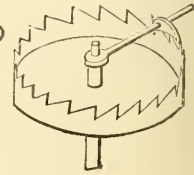

velocity, for the wrist of one crank working in the slot of the other is continually changing its distance from the shaft of the latter.

Fig. 879. The external and internal mutilated cog-wheels work alternately into the pinion, and give slow forward and quick reverse motion.

Figs. 880, 881. These are parts of the same movement, which has been used for giving the roller motion in wool-combing machines. The roller to which the wheel F, Fig. 881, is secured, is required to make $\frac{1}{3}$ revolution backward, then $\frac{2}{3}$ revolution forward, when it must stop until another length of combed fibre is ready for delivery. This is accomplished by the grooved heart-cam C, D, B, e, Fig. 880, the stud A working in the said groove; from C to D it moves the roller backward, and from D to e it moves it forward, the motion being transmitted through the catch G, to the notch-wheel F, on the roller-shaft H. When the stud A arrives at the point e in the cam, a projection at the back of the wheel which carries the cam strikes the projecting piece on the catch G, and raises it out of the notch in the wheel F, so that while the stud is travelling in the cam from e to C, the catch is passing over the plain surface between the two notches in the wheel F, without imparting any motion; but when stud A arrives at the part C, the catch has dropped in another notch and is again ready to move wheel F and roller as required.

Fig. 882. An arrangement for obtaining variable circular motion. The sectors are arranged on different planes, and the relative velocity changes according to the respective diameters of the sectors.

Fig. 883. Intermittent circular motion of the ratchet-wheel from vibratory motion of the arm carrying a pawl.

Fig. 884. Drag-link motion. Circular motion is transmitted from one crank to the other.

Fig. 885. This represents an expanding pulley. On turning pinion *d* to the right or left, a similar motion is imparted to wheel *e*, which, by means of curved slots cut therein, thrust the studs fastened to arms of pulley outward or inward, thus augmenting or diminishing the size of the pulley.

Fig. 886 represents a chain and chain pulley. The links being in different planes, spaces are left between them for the teeth of the pulley to enter.

Fig. 887. Another kind of chain and pulley.

Fig. 888. Another variety.

Fig. 889 shows two different kinds of stops for a lantern-wheel.

Fig. 890. Transmitted circular motion. The connecting rods are so arranged that when one pair of connected links is over the dead-point, or at the extremity of its stroke, the other is at right angles; continuous motion is thus ensured without a fly-wheel.

Fig. 891. Intermittent circular motion is imparted to the toothed wheel by vibrating the arm B. When the arm B is lifted, the pawl C is raised from between the teeth of the wheel, and travelling backward over the circumference again drops between two teeth on lowering the arm, and draws with it the wheel.

Fig. 892. The oscillating of the tappet-arm produces an intermittent rotary motion of the ratchet-wheel. The small spring at the bottom of the tappet-arm keeps the tappet in the position shown in the drawing, as the arm rises, yet allows it to pass the teeth on the return motion.

Fig. 893. A nearly continuous circular motion is imparted to the ratchet-wheel on vibrating the lever *a*, to which the 2 pawls *b* and *c* are attached.

Fig. 894. An arrangement of stops for a spur-gear.

Fig. 895. A reciprocating circular motion of the top arm makes its attached pawl produce an intermittent circular motion of the crown-ratchet, or rag-wheel.

Fig. 896 represents varieties of stops for a ratchet-wheel.

Fig. 897. Intermittent circular motion is imparted to the wheel A by the continuous circular motion of the smaller wheel with one tooth.

Fig. 898. A brake used in cranes and hoisting machines. By pulling down the end of the lever, the ends of the brake-strap are drawn towards each other, and the strap tightened on the brake-wheel.

Fig. 899. A dynamometer, or instrument used for ascertaining the amount of useful effect given out by any motive power. It is used as follows;—A is a smoothly-turned pulley, secured on a shaft as near as possible to the motive power. Two blocks of wood are fitted to this pulley, or one block of wood and a series of straps fastened to a band or chain, as in the drawing, instead of a common block. The blocks, or block and straps, are so arranged that they may be made to bite or press upon the pulley by means of the screws and nuts on the top of the lever D. To estimate the amount of power transmitted through the shaft, it is only necessary to ascertain the amount of friction of the drum A when it is in motion, and the number of revolutions made. At the end of the lever D is hung a scale B, in which weights are placed. The two stops C, C', are to maintain the lever as nearly as possible in a horizontal position. Now, suppose the shaft to be in motion, the screws are to be tightened and weights added in B, until the lever takes the position shown in the drawing, at the required number of revolutions. Therefore, the useful effect would be equal to the product of the weights, multiplied by the velocity at which the point of suspension of the weights would revolve if the lever were attached to the shaft.

Fig. 900 represents a pantograph for copying, enlarging, and reducing plans. One arm is attached to and turns on the fixed point C. B is an ivory tracing point, and A the pencil. Arranged as shown, if we trace the lines of a plan with the point B, the pencil will reproduce it double the size. By shifting the slide attached to the fixed point C, and the slide carrying the pencil along their respective arms, the proportion to which the plan is traced will be varied.

Fig. 901. Union coupling. A is a pipe, with a small flange abutting against the pipe C, with a screwed end; B, a nut which holds them together.

Fig. 902. Anti-friction bearing. Instead of a shaft revolving in an ordinary bearing, it is sometimes supported on the circumference of wheels. The friction is thus reduced to the least amount.

Fig. 903. A mode of releasing a sounding weight. When the piece projecting from the bottom of the rod strikes the bottom of the sea, it is forced upwards relatively to the rod, and withdraws the catch from under the weight, which drops off and allows the rod to be lifted without it.

Fig. 904. Releasing hook used in pile-driving machines. When the weight W is sufficiently raised, the upper ends of the hooks A, by which it is suspended, are pressed inward by the sides of the slot B, in the top of the frame; the weight is thus suddenly released, and falls with accumulating force on to the pile-head.

Fig. 905. A and B are two rollers, which require to be equally moved to and fro in the slot C. This is accomplished by moving the piece D, with oblique slotted arms, up and down.

Fig. 906. Centrifugal check-hooks, for preventing accidents in case of the breakage of machinery which raises and lowers workmen, or ores, in mines. A is a framework fixed to the side of the shaft of the mine, and having fixed studs D, attached. The drum on which the rope is wound is provided with a flange B, to which the check-hooks are attached. If the drum acquires a dangerously rapid motion, the hooks fly out by centrifugal force, and one or other, or all of them, catch hold of the studs D, and arrest the drum, and stop the descent of whatever is attached to the rope. The drum ought, besides this, to have a spring applied to it, otherwise the jerk arising from the sudden stoppage of the rope might produce worse effects than its rapid motion.

Fig. 907. A sprocket-wheel to drive or to be driven by a chain.

Fig. 908. A differential movement. The screw C works in a nut secured to the hub of the wheel E, the nut being free to turn in a bearing in the shorter standard, but

prevented by the bearing from any lateral motion. The screw-shaft is secured to the wheel D. The driving shaft A carries 2 pinions F and B. If these pinions were of such size as to turn the 2 wheels D and E with an equal velocity, the screw would remain at rest: but the said wheels being driven at unequal velocities, the screw travels according to the difference of velocity.

Fig. 909. A combination movement, in which the weight W moves vertically with a reciprocating movement, the down-stroke being shorter than the up-stroke. B is a revolving disc, carrying a drum, which winds round itself the cord D. An arm C is jointed to the disc and to the upper arm A, so that when the disc revolves, the arm A moves up and down, vibrating on the point G. This arm carries with it the pulley E. Suppose we detach the cord from the drum and tie it to a fixed point, and then move the arm A up and down, the weight W will move the same distance, and in addition the movement given to it by the cord, that is to say, the movement will be doubled. Now, let us attach the cord to the drum, and revolve the disc B, and the weight will move vertically with the reciprocating motion, in which the down-stroke will be shorter than the up-stroke, because the drum is continually taking up the cord.

Figs. 910, 911. The first of these figures is an end view, and the second a side view, of an arrangement of mechanism for obtaining a series of changes of velocity and direction. D is a screw on which is placed eccentrically the cone B, and C is a friction-roller, which is pressed against the cone by a spring or weight. Continuous rotary motion, at a uniform velocity of the screw D carrying the eccentric cone, gives a series of changes of velocity and direction to the roller C. It will be understood that during every revolution of the cone the roller would press against a different part of the cone, and that it would describe thereon a spiral of the same pitch as the screw D. The roller C would receive a reciprocating motion, the movement in one direction being shorter than that in the other.

Fig. 912. The shaft has two screws of different pitches cut on it, one screwing into a fixed bearing, and the other into a bearing free to move to and fro. Rotary motion of the shaft gives rectilinear motion to the movable bearing, a distance equal to the differences of pitches at each revolution.

Fig. 913. Two worm-wheels of equal diameter, but one having one tooth more than the other, both in gear with the same worm. Suppose the first wheel has 100 teeth and the second 101, one wheel will gain one revolution over the other during the passage of 100×101 teeth of either wheel across the plane of centres, or during 10,000 revolutions of the worm.

Fig. 914. Variable motion. If the conical drum has a regular circular motion, and the friction-roller is made to traverse lengthwise, a variable rotary motion of the friction-roller will be obtained.

Fig. 915. Circular into reciprocating motion by means of a crank and oscillating rod.

Fig. 916. Continued rectilinear movement of the frame with mutilated racks gives an alternate rotary motion to the spur-gear.

Fig. 917. Rotary motion of the worm gives a rectilinear motion to the rack.

Fig. 918. Anti-friction bearing for a pulley.

Fig. 919. On vibrating the lever to which the 2 pawls are attached, a nearly continuous rectilinear motion is given to the ratchet-bar.

Fig. 920. Rotary motion of the bevelled disc cam gives a reciprocating rectilinear motion to the rod bearing on its circumference.

Fig. 921. Rectilinear into rectilinear motion. When the rods A and B are brought together, the rods C and D are thrust farther apart, and the reverse.

Fig. 922. An engine governor. The rise and fall of the balls K are guided by the parabolic curved arms B, on which the anti-friction wheels L run. The rods F, connecting the wheels L with the sleeve, move it up and down the spindle C, D.

903.

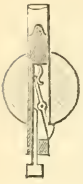

902.



901.

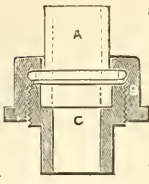

900.

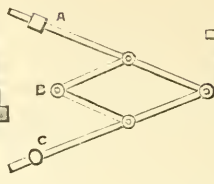

899.

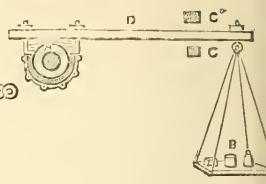

900.

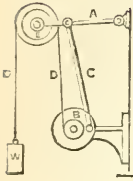

903.

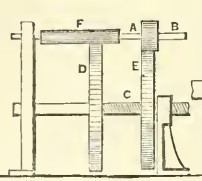

907.



906.

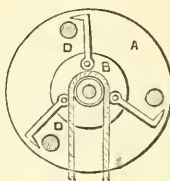

905.

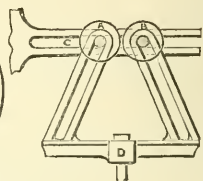

904.



913.



912.

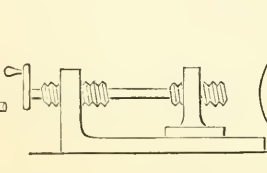

911.

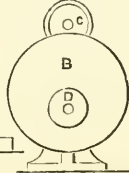

910.

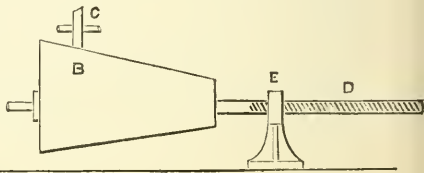

917.



916.

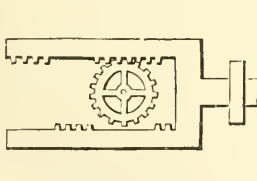

915.

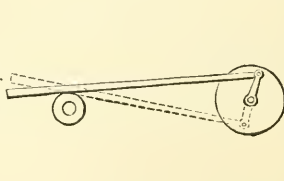

914.

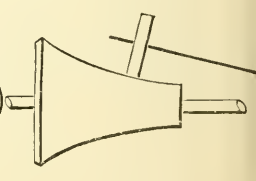

922.

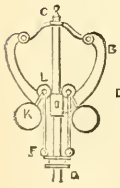

921.

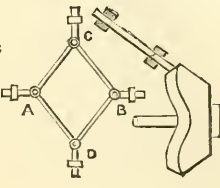

920.



919.

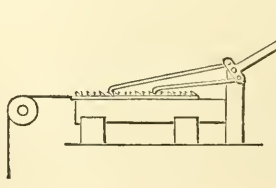

918.

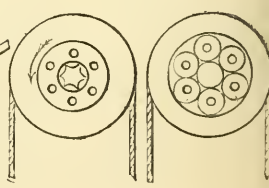

Fig. 923. Continuous rotary motion of the cam gives a reciprocating rectilinear motion to the bar. The cam is of equal diameter in every direction measured across its centre.

Fig. 924. Colt's invention for obtaining the movement of the cylinder of a revolving fire-arm by the act of cocking the hammer. As the hammer is drawn back to cock it, the dog *a*, attached to the tumbler, acts on the ratchet *b*, on the back of the cylinder. The dog is held up to the ratchet by a spring *c*.

Fig. 925. C. R. Otis's safety-stop for the platform of a hoisting apparatus. *A* are the stationary uprights, and *B* is the upper part of the platform working between them. The rope *a*, by which the platform is hoisted, is attached by a pin *b* and spring *c*, and the pin is connected by 2 elbow-levers with 2 pawls *d*, which work in ratchets secured to the uprights *A*. The weight of the platform and the tension of the rope, keep the pawls out of gear from the ratchets in hoisting or lowering the platform, but, in case of the breakage of rope, the spring *c* presses down the pin *b* and the attached ends of the levers, and so presses the pawls into the ratchets and stops the descent of the platform.

Fig. 926. Crank and slotted cross-head, with Clayton's sliding journal-box applied to the crank-wrist. This box consists of 2 taper lining pieces and 2 taper jibs adjustable by screws, which serve at the same time to tighten the box on the wrist, and to set it out to the slot in the cross-head as the box and wrist wear.

Fig. 927. Pickering's governor. The balls are attached to springs, the upper end of each of which is attached to a collar fixed on the spindle, and the lower end to a collar on the sliding sleeve. The springs yield in a proper degree to the centrifugal force of the balls, and raise the sleeve; and as the centrifugal force diminishes, they draw the balls toward the spindle and depress the sleeve.

Fig. 928. A mode of working a windlass. By the alternating motion of the long hand-lever to the right, motion is communicated to the short lever, the end of which is in immediate contact with the rim of the wheel. The short lever has a very limited motion upon a pin, which is fixed in a block of cast iron, which is made with 2 jaws, each having a flange projecting inward in contact with the inner surface of the rim of the wheel. By the upward motion of the outward end of the short lever, the rim of the wheel is jammed between the end of the lever and the flanges of the block, so as to cause friction sufficient to turn the wheel by the further upward movement of the lever. The backward movement of the wheel is prevented by a common ratchet-wheel and pawls; as the short lever is pushed down it frees the wheel and slides freely over it.

Fig. 929. The revolution of the disc causes the lever at the right to vibrate, by the pin moving in the groove in the face of the disc.

Fig. 930. By the revolution of the disc, in which is fixed a pin working in a slot in the upright bar which turns on a centre near the bottom, both ends of the bar are made to traverse, the tooth sector producing alternate rectilinear motion in the horizontal bar at the bottom, and also alternate perpendicular motion of the weight.

Fig. 931. By a vibrating motion of the handle, motion is communicated by the pinion to the racks. This is used in working small air-pumps for scientific experiments.

Fig. 932 represents a feeding apparatus for the bed of a sawing machine. By the revolution of the crank at the lower part of the figure, alternate motion is communicated to the horizontal arm of the bell-crank lever, whose fulcrum is at *a*, near the top left-hand corner of the figure. By this means, motion is communicated to the catch attached to the vertical arm of the lever, and the said catch communicates motion to the ratchet-wheel, upon the shaft of which is a toothed pinion, working in the rack attached to the side of the carriage. The feed is varied by a screw in the bell-crank lever.

Fig. 933 is the movable head of a turning lathe. By turning the wheel to the right, motion is communicated to the screw, producing rectilinear motion of the spindle, in the end of which the centre is fixed.

927.

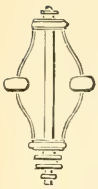

926.

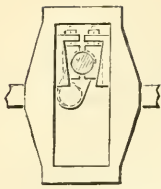

925.

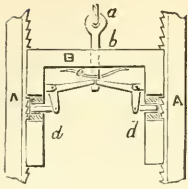

924.

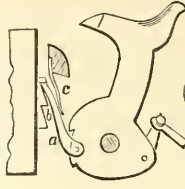

923.

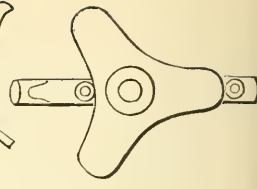

932.

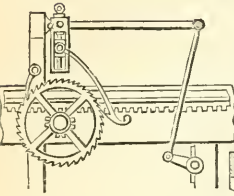

931.

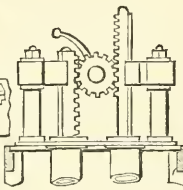

930.

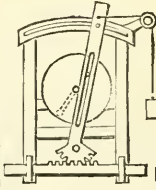

929.

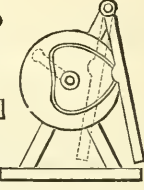

928.

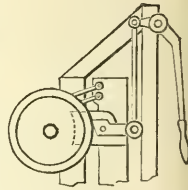

937.

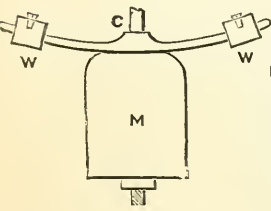

936.

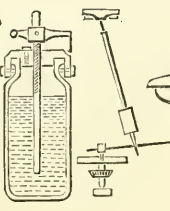

935.

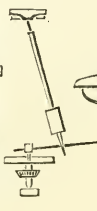

934.

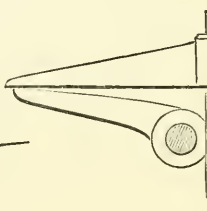

933.

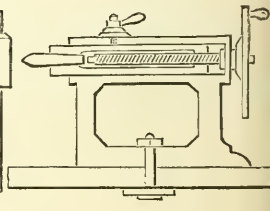

942.

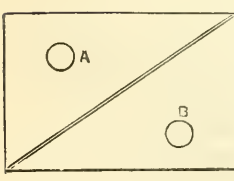

941.

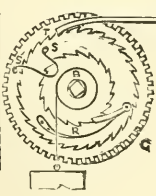

940.

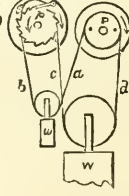

939.

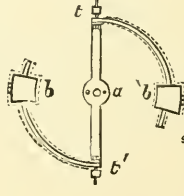

938.

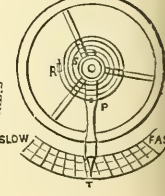

945.

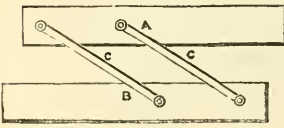

944.

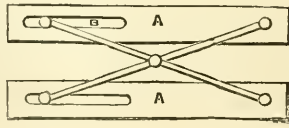

943.

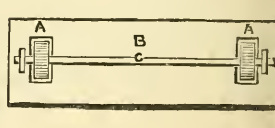

Fig. 934. Toe and lifter for working poppet-valves in steam engines. The curved toe on the rock-shaft operates on the lifter attached to the lifting rod to raise the valve.

Fig. 935. Conical pendulum, hung by a thin piece of round wire. Lower end connected with and driven in a circle by an arm attached to a vertical rotating spindle. The pendulum-rod describes a cone in its revolution.

Fig. 936. Mercurial compensation pendulum. A glass jar of mercury is used for the bob or weight. As the pendulum-rod is expanded lengthwise by increased temperature, the expansion of mercury in the jar carries it to a greater height therein, and so raises its centre of gravity relatively to the rod sufficiently to compensate for downward expansion of the rod. As rod is contracted by a reduction of temperature, contraction of mercury lowers it relatively to rod. In this way the centre of oscillation is always kept in the same place, and the effective length of pendulum always the same.

Fig. 937. Compound bar compensation pendulum. C is a compound bar of brass and iron, or steel brazed together with brass downward. As brass expands more than iron, the bar will bend upward as it gets warmer, and carry the weights W, W, up with it, raising the centre of the aggregate weight M, to raise the centre of oscillation as much as elongation of the pendulum-rod would let it down.

Fig. 938. Watch regulator. The balance-spring is attached at its outer end to a fixed stud R, and at its inner end to staff of balance. A neutral point is formed in the spring at P, by inserting it between 2 curb-pins in the lever, which is fitted to turn on a fixed ring concentric with staff of balance, and the spring only vibrates between this neutral point and staff of balance. By moving lever to the right, the curb-pins are made to reduce the length of acting part of spring, and the vibrations of balance are made faster, and by moving it to left an opposite effect is produced.

Fig. 939. Compensation balance. t, a, t' is the main bar of balance, with timing screws for regulation at the ends. t and t' are 2 compound bars, of which the outside is brass and the inside steel, carrying weights b, b' . As heat increases, these bars are bent inward by the greater expansion of the brass, and the weights are thus drawn inward, diminishing the inertia of the balance. As the heat diminishes, an opposite effect is produced. This balance compensates both for its own expansion and contraction, and that of the balance-spring.

Fig. 940. Endless chain, maintaining power on going barrel, to keep a clock going while winding, during which operation the action of the weight or main-spring is taken off the barrel. The wheel to the right is the going wheel, and that to the left the striking wheel. P is a pulley fixed to the great wheel of the going part, and roughened, to prevent a rope or chain hung over it from slipping. A similar pulley rides on another arbor p , which may be the arbor of the great wheel of the striking part, and attached by a ratchet and click to that wheel, or to clock frame, if there is no striking part. The weights are hung, as may be seen, the small one being only large enough to keep the rope or chain on the pulleys. If the part b of the rope or chain is pulled down, the ratchet-pulley runs under the click, and the great weight is pulled up by c , without taking its pressure off the going wheel at all.

Fig. 941. Harrison's going barrel. Larger ratchet-wheel, to which the click R is attached, is connected with the great wheel G by a spring S, S'. While the clock is going the weight acts upon the great wheel G, through the spring; but as soon as the weight is taken off by winding, the click T, whose pivot is set in the frame, prevents the larger ratchet from falling back, and so the spring S, S', still drives the great wheel during the time the clock takes to wind, as it need only just keep the escapement going, the pendulum taking care of itself for that short time. Good watches have a substantially similar apparatus.

Fig. 942. A very convenient construction of parallel ruler for drawing, made by cutting a quadrangle through the diagonal, forming two right-angle triangles A and B. It is used by sliding the hypotenuse of one triangle upon that of the other.

Fig. 943. Parallel ruler, consisting of a simple straight ruler B, with an attached axle C, and pair of wheels A, A. The wheels, which protrude but slightly through the under side of the ruler, have their edges nicked to take hold of the paper and keep the ruler always parallel with any lines drawn upon it.

Fig. 944. Compound parallel ruler, composed of 2 simple rulers A, A, connected by 2 crossed arms pivoted together at the middle of their length, each pivoted at one end to one of the rulers, and connected with the other one by a slot and sliding pin, as shown at B. In this the ends as well as the edges are kept parallel. The principle of construction of the several rulers represented is taken advantage of in the formation of some parts of machinery.

Fig. 945. Parallel ruler composed of 2 simple rulers A, B, connected by 2 pivoted swinging arms C, C.

Fig. 946. A simple means of guiding or obtaining a parallel motion of the piston-rod of an engine. The slide *a* moves in and is guided by the vertical slot in the frame, which is planed to a true surface.

Fig. 947 differs from Fig. 946 in having rollers substituted for the slides on the cross-head, said rollers working against straight guide-bars *a, a*, attached to the frame. This is used for small engines in France.

Fig. 948. A parallel motion invented by Dr. Cartwright in the year 1787. The toothed wheels C, C, have equal diameters and numbers of teeth, and the cranks *a, a*, have equal radii, and are set in opposite directions, and consequently give an equal obliquity to the connecting rods during the revolution of the wheels. The cross-head on the piston-rod being attached to the 2 connecting rods, the piston-rod is caused to move in a right line.

Fig. 949. A piston-rod guide. The piston-rod A is connected with a wrist attached to a cog-wheel B, which turns on a crank-pin, carried by a plate C, which is fast on the shaft. The wheel B revolves around a stationary internally-toothed gear D, of double the diameter of B, and so motion is given to the crank-pin, and the piston-rod is kept upright.

Fig. 950. The piston-rod is prolonged and works in a guide A, which is in line with the centre of the cylinder. The lower part of the connecting rod is forked to permit the upper part of the piston-rod to pass between.

Fig. 951. Table engine. The cylinder is fixed on a table-like base. The piston-rod has a cross-head working in straight slotted guides fixed on top of cylinder, and is connected by 2 side connecting rods with 2 parallel cranks on shaft under the table.

Fig. 952. An engine with crank motion like that represented in Fig. 753 and Fig. 926, the crank-wrist journal working in a slotted cross-head A. This cross-head works between the pillar-guides D, D, of the engine framing.

Fig. 953. A parallel motion used for the piston-rod of side-lever marine engines. F, C is the radius bar, and E the cross-head to which the parallel bar E, D, is attached.

Fig. 954. A parallel motion used only in particular cases.

Fig. 955 shows a parallel motion used in some of the old single-acting beam-engines. The piston-rod is formed with a straight rack gearing with a toothed segment on the beam. The back of the rack works against a roller A.

Fig. 956. An arrangement of parallel motion for side-lever marine engines. The parallel rods connected with the side rods from the beams or side levers are also connected with short radius arms on a rack-shaft working in fixed bearings.

Fig. 957. A parallel motion commonly used for stationary beam-engines.

Fig. 958. Parallel motion for direct-action engines. In this, the end of the bar B, C, is connected with the piston-rod, and the end B slides in a fixed slot D. The radius bar F, A, is connected at F with a fixed pivot, and at A midway between the ends of B, C.

Fig. 959. Mode of obtaining 2 reciprocating movements of a rod by one revolution

951.

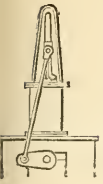

950.

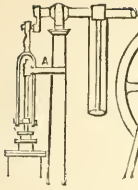

949.

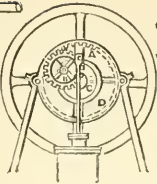

948.

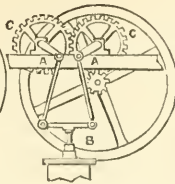

947.

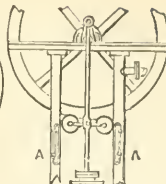

946.

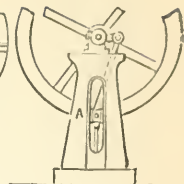

953.



955.

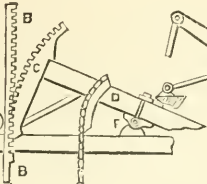

954.

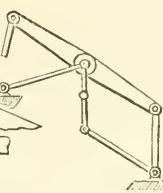

953.

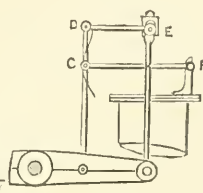

952.

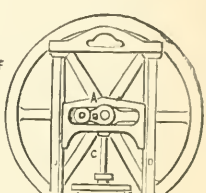

961.

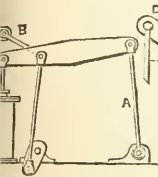

960.

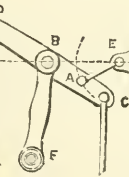

959.

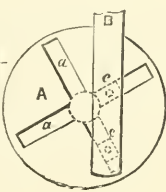

958.

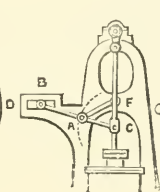

957.

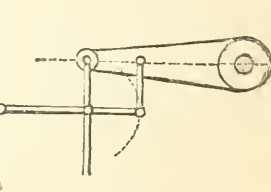

967.



966.

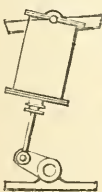

965.



964.

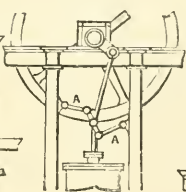

963.

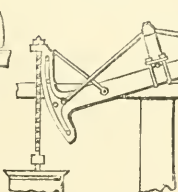

962.

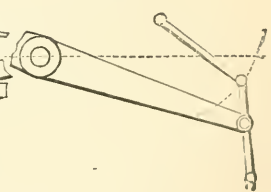

971.

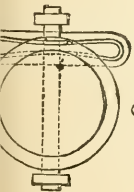

970.

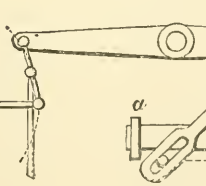

969.

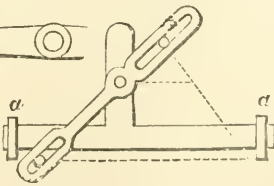

968.

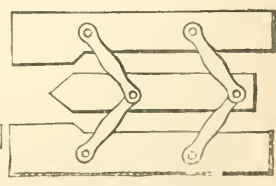

of a shaft, patented in 1836 by B. F. Snyder, has been used for operating the needle of a sewing machine, by J. S. McCurday, also for driving a gang of saws. The disc A on the central rotating shaft has 2 slots a, a , crossing each other at a right angle in the centre, and the connecting rod B has attached to it 2 pivoted slides c, c , one working in each slot.

Fig. 960. Another parallel motion. Beam D, C. with joggling pillar support B, F, which vibrates from the centre F. The piston-rod is connected at C. The radius bar E, A, produces the parallel motion.

Fig. 961. Grasshopper beam-engine. The beam is attached at one end to a rocking pillar A, and the shaft arranged as near to the cylinder as the crank will work. A is the radius bar of the parallel motion.

Fig. 962. A modification, in which the radius bar is placed above the beam.

Fig. 963. Old-fashioned single-acting beam pumping engine on the atmospheric principle, with chain connection between piston-rod and a segment at end of beam. The cylinder is open at top. Very low pressure steam is admitted below piston, and the weight of pump-rod and connections at the other end of beam helps to raise piston. Steam is then condensed by injection, and a vacuum thus produced below piston, which is then forced down by atmospheric pressure, thereby drawing up pump-rod.

Fig. 964. Parallel motion for upright engine. A, A are radius rods connected at one end with the framing, and at the other with a vibrating piece on top of piston-rod.

Fig. 965. Oscillating engine. The cylinder has trunnions at the middle of its length working in fixed bearings, and the piston-rod is connected directly with the crank, and no guides are used.

Fig. 966. Inverted oscillating or pendulum engine. The cylinder has trunnions at its upper end, and swings like a pendulum. The crank-shaft is below, and the piston-rod connected directly with crank.

Fig. 967. Stamp. Vertical percussive falls derived from horizontal rotating shaft. The mutilated tooth-pinion acts upon the rack to raise the rod until its teeth leave the rack and allow the rod to fall.

Fig. 968. Another form of parallel ruler. The arms are jointed in the middle and connected with an intermediate bar, by which means the ends of the ruler, as well as the sides, are kept parallel.

Fig. 969. Traverse, or to-and-fro motion. The pin in the upper slot being stationary, and the one in the lower slot made to move in the direction of the horizontal dotted line, the lever will by its connection with the bar give to the latter a traversing motion in its guides a, a .

Fig. 970. Parallel motion in which the radius rod is connected with the lower end of a short vibrating rod, the upper end of which is connected with the beam, and to the centre of which the piston-rod is connected.

Fig. 971. A modification of the crank and slotted cross-head, Fig. 763. The cross-head contains an endless groove, in which the crank-wrist works, and which is formed to produce a uniform velocity of movement of the wrist or reciprocating rod.

Fig. 972. Section of disc-engine. Disc-piston, seen edgewise, has a motion substantially like a coin when it first falls after being spun in the air. The cylinder-heads are cones. The piston-rod is made with a ball to which the disc is attached, said ball working in concentric seats in cylinder-heads, and the left-hand end is attached to the crank-arm or fly-wheel on end of shaft at left. Steam is admitted alternately on either side of piston.

Fig. 973. Another arrangement of the Chinese windlass, illustrated by Fig. 798.

Fig. 974. The gyroscope, or rotascope, an instrument illustrating the tendency of rotating bodies to preserve their plane of rotation. The spindle of the metallic disc C is fitted to return easily in bearings in the ring A. If the disc is set in rapid rotary motion on its axis, and the pintle F at one side of the ring A placed on the bearing

in the top of the pillar G, the disc and ring seem indifferent to gravity, and instead of dropping begin to revolve about the vertical axis.

Fig. 975. Bohnenberger's machine, illustrating the same tendency of rotating bodies. This consists of 3 rings, A, A¹, A², placed one within the other, and connected by pivots at right angles to each other. The smallest ring A² contains the bearings for the axis of a heavy ball B. The ball being set in rapid rotation, its axis will continue in the same direction, no matter how the position of the rings may be altered; and the ring A² which supports it will resist a considerable pressure tending to displace it.

Fig. 976. What is called the gyroscope governor, for steam engines, introduced by Alban Anderson, in 1858. A is a heavy wheel, the axle B, B¹, of which is made in 2 pieces connected together by a universal joint. The wheel A is on one piece B, and a pinion I on the other piece B¹. The piece B is connected at its middle by a hinge-joint with the revolving frame H, so that variations in the inclination of the wheel A will cause the outer end of the piece B to rise and fall. The frame H is driven by bevel-gearing from the engine, and by that means the pinion I is carried round the stationary toothed circle G, and the wheel A is thus made to receive a rapid rotary motion on its axis. When the frame H and wheel A are in motion, the tendency of the wheel A is to assume a vertical position, but this tendency is opposed by a spring L. The greater velocity of the governor, the stronger is the tendency above mentioned, and the more it overcomes the force of the spring, and the reverse. The piece B is connected with the valve-rods by rods C, D, and the spring L is connected with the said rods by levers N and rod P.

Fig. 977. Primitive drilling apparatus. Being once set in motion, it is kept going by hand, by alternately pressing down and relieving the transverse bar to which the bands are attached, causing the bands to wind upon the spindle alternately in opposite directions, while the heavy disc or fly-wheel gives a steady momentum to the drill-spindle in its rotary motion.

Fig. 978. Traverse of carriage, made variable by fusee, according to the variation in diameter where the band acts.

Fig. 979. Continuous rotary motion from oscillating. The beam being made to vibrate, the drum to which the cord is attached, working loose on fly-wheel shaft, gives motion to said shaft through the pawl and ratchet-wheel, the pawl being attached to drum and the ratchet-wheel fast on shaft.

Fig. 980. Another simple form of clutch for pulleys, consisting of a pin on the lower shaft and a pin on side of pulley. The pulley is moved lengthwise of the shaft by means of a lever or other means, to bring its pin into or out of contact with the pin on shaft.

Fig. 981. Alternating traverse of upper shaft and its drum, produced by pin on the end of the shaft working in oblique groove in the lower cylinder.

Fig. 982. See-saw, one of the simplest illustrations of a limited oscillating or alternate circular motion.

Fig. 983. Cylindrical rod arranged between 2 rollers, the axes of which are oblique to each other. The rotation of the rollers produces both a longitudinal and a rotary motion of the rod.

Fig. 984. Intermittent rotary motion from continuous rotary motion about an axis at right angles. Small wheel on left is driver; and the friction-rollers on its radial studs work against the faces of oblique grooves or projections across the face of the larger wheel, and impart motion thereto.

Fig. 985. A parallel ruler with which lines may be drawn at required distances apart without setting out. Lower edge of upper blade has a graduated ivory scale, on which the incidence of the outer edge of the brass are indicates the width between the blades.

Fig. 986. Drilling machine. By the large bevel-gear rotary motion is given to

977.

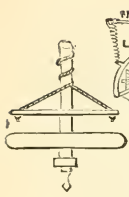

976.

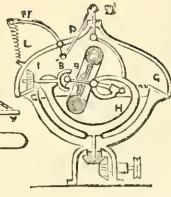

975.

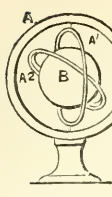

974.

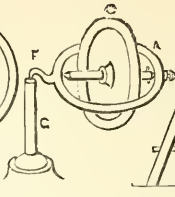

973.

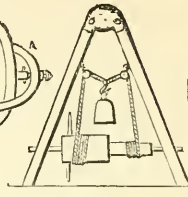

972.

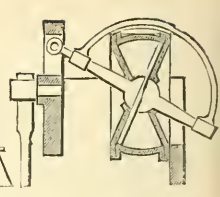

983.

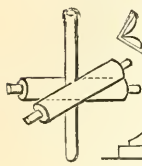

982.

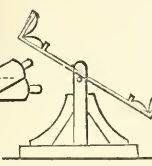

981.

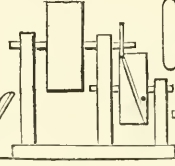

980.

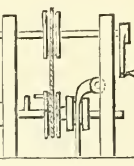

979.

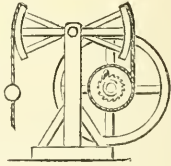

978.

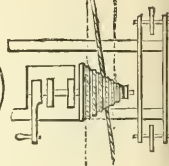

987.

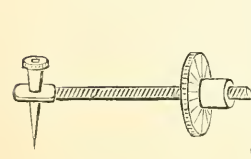

986.

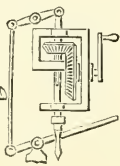

985.

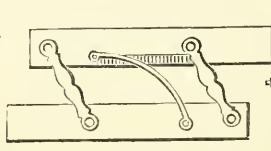

984.

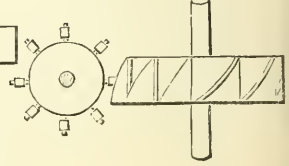

992.

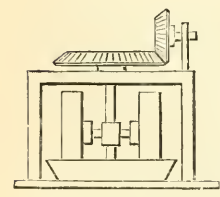

991.

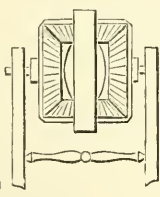

990.

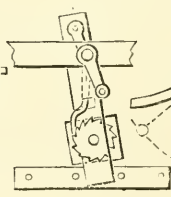

989.

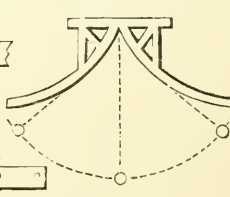

988.

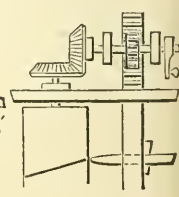

998.

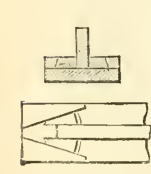

997.

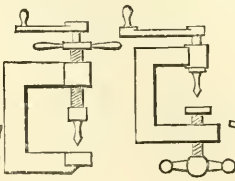

996.

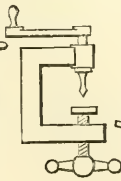

995.

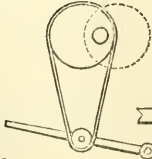

994.

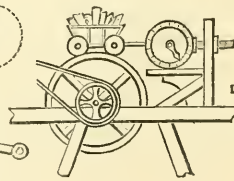

993.

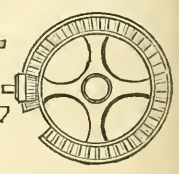

vertical drill shaft, which slides through small bevel-gear but is made to turn with it by a feather and groove, and is depressed by treadle connected with upper lever.

Fig. 987. Helicograph, or instrument for describing helices. The small wheel, by revolving about the fixed central point, describes a volute or spiral by moving along the screw-threaded axle either way, and transmits the same to drawing paper on which transfer paper is laid with coloured side downward.

Fig. 988. Describing spiral line on a cylinder. The spur-gear which drives the bevel-gears, and thus gives rotary motion to the cylinder, also gears into the toothed rack, and thereby causes the marking point to traverse from end to end of the cylinder.

Fig. 989. Cycloidal surfaces, causing pendulum to move in cycloidal curve, rendering oscillations isochronous, or equal-timed.

Fig. 990. Motion for polishing mirrors, the rubbing of which should be varied as much as practicable. The handle turns the crank to which the long bar and attached ratchet-wheel are connected. The mirror is secured rigidly to the ratchet-wheel. The long bar, which is guided by pins in the lower rail, has both a longitudinal and an oscillating movement, and the ratchet-wheel is caused to rotate intermittently by a click operated by an eccentric on the crank-shaft, and hence the mirror has a compound movement.

Fig. 991. White's dynamometer for determining the amount of power required to give rotary motion to any piece of mechanism. The 2 horizontal bevel-gears are arranged in a hoop-shaped frame, which revolves freely on the middle of the horizontal shaft, on which there are 2 vertical bevel-gears gearing to the horizontal ones, one fast and the other loose on the shaft. Suppose the hoop to be held stationary, motion given to either vertical bevel-gear will be imparted through the horizontal gears to the other vertical one; but if the hoop be permitted it will revolve with the vertical gear put in motion, and the amount of power required to hold it stationary will correspond with that transmitted from the first gear, and a band attached to its periphery will indicate that power by the weight required to keep it still.

Fig. 992. Pair of edge runners or chasers for crushing or grinding. The axles are connected with vertical shaft, and the wheels or chasers run in an annular pan or trough.

Fig. 993. Modification of mangle-wheel motion. The large wheel is toothed on both faces, and an alternating circular motion is produced by the uniform revolution of the pinion, which passes from one side of the wheel to the other through an opening on the left of the figure.

Fig. 994. Robert's contrivance for proving that friction of a wheel carriage does not increase with velocity, but only with load. Loaded wagon is supported on surface of large wheel, and connected with indicator constructed with spiral spring, to show force required to keep carriage stationary when large wheel is put in motion. It was found that difference in velocity produced no variation in the indicator, but difference in weight immediately did so.

Fig. 995. Rotary motion of shaft from treadle by means of an endless band running from a roller on the treadle to an eccentric on the shaft.

Figs. 996, 997. Portable crank drills. In Fig. 996 the feed-screw is opposite the drill, and in Fig. 997 the drill-spindle passes through the centre of the feed-screw.

Fig. 998. Bowery's joiners' clamp, plan and transverse section. Oblong bed has, at one end, two wedge-formed cheeks, adjacent sides of which lie at an angle to each other, and are dovetailed inward from upper edge to receive 2 wedges for clamping the piece or pieces of wood to be planed.

Fig. 999. Tread-wheel horse-power turned by the weight of an animal attempting to walk up one side of its interior; has been used for driving the paddle-wheels of ferry-boats and other purposes by horses. The turn-spit dog used also to be employed in such a wheel in ancient times for turning meat while roasting on a spit.

Fig. 1000. The treadmill employed in jails in some countries for exercising criminals

condemned to labour, and employed in grinding grain; turns by weight of persons stepping on tread-boards on periphery. This is supposed to be a Chinese invention, and it is still used in China for raising water for irrigation.

Fig. 1001. Saw for cutting trees by motion of pendulum, is represented as cutting a lying tree.

Fig. 1002. Adjustable stand for mirrors, by which a glass or other article can be raised or lowered, turned to the right or left, and varied in its inclination. The stem is fitted into a socket of pillar, and secured by a set screw, and the glass is hinged to the stem, and a set screw is applied to the hinge to tighten it. The same thing is used for photographic camera-stands.

Fig. 1003 represents the principal elements of machinery for dressing cloth and warps, consisting of 2 rollers, from one to the other of which the yarn or cloth is wound, and an interposed cylinder having its periphery either smooth-faced or armed with brushes, teasels, or other contrivances, according to the nature of the work to be done. These elements are used in machines for sizing warps, gig-mills for dressing woollen goods, and in most machines for finishing woven fabrics.

Fig. 1004. Feed-motion of Woodworth's planing machine, a smooth supporting roller, and a toothed top roller.

Fig. 1005. Contrivance employed in Russia for shutting doors. One pin is fitted to and turns in socket attached to door, and the other is similarly attached to frame. In opening the door, pins are brought together, and weight is raised. Weight closes door by depressing the joint of the toggle towards a straight line, and so widening the space between the pins.

Fig. 1006. Folding library ladder. It is shown open, partly open, and closed; the rounds are pivoted to the side-pieces, which are fitted together to form a round pole when closed, the rounds shutting up inside.

Fig. 1007. Self-adjusting step-ladder for wharfs at which there are rise and fall of tide. The steps are pivoted at one edge into wooden bars forming string-pieces, and their other edge is supported by rods suspended from bars forming hand-rails. The steps remain horizontal whatever position the ladder assumes.

Fig. 1008. Lifting jack operated by an eccentric, pawl, and ratchet. The upper pawl is a stop.

Fig. 1009. Jig-saw, the lower end connected with a crank which works it, and the upper end connected with a spring which keeps it strained without a gate.

Fig. 1010. Contrivance for polishing lenses and bodies of spherical form. The polishing material is in a cup connected by a ball-and-socket joint and bent piece of metal, with a rotating upright shaft set concentric to the body to be polished. The cup is set eccentric, and by that means is caused to have an independent rotary motion about its axis on the universal joint, as well as to revolve about the common axis of the shaft and the body to be polished. This prevents the parts of the surface of the cup from coming repeatedly in contact with the same parts of surface of the lens or other body.

Fig. 1011. Device for converting oscillating into rotary motion. The semicircular piece A is attached to a lever which works on a fulcrum *a*, and it has attached to it the ends of 2 bands C and D, which run round 2 pulleys, loose on the shaft of the fly-wheel B. Band C is open, and band D crossed. The pulleys have attached to them pawls which engage with two ratchet-wheels fast on the fly-wheel shaft. One pawl acts on its ratchet-wheel when the piece A turns one way, and the other when the said piece turns the other way, and thus a continuous rotary motion of the shaft is obtained.

Fig. 1012. Reciprocating into rotary motion. The weighted racks *a*, *a'*, are pivoted to the end of a piston-rod, and pins at the end of the said racks work in fixed guide-grooves *b*, *b'*, in such manner that one rack operates upon the cog-wheel in ascending and the other in descending, and so continuous rotary motion is produced. The elbow-

1004.

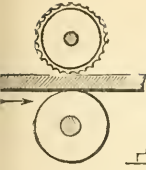

1003.

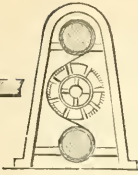

1002.

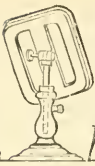

1001.

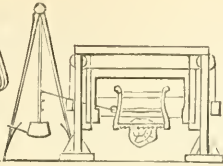

1000.



999.



1010.



1009.

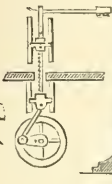

1008.

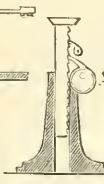

1007.

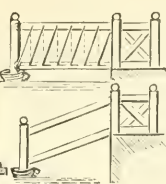

1006.

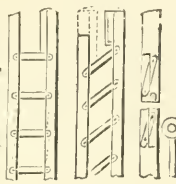

1005.

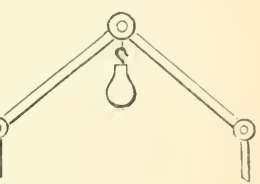

1016.



1015.

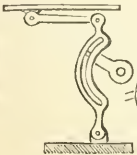

1014.

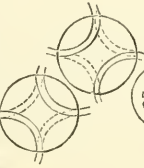

1013.

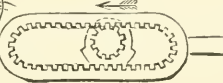

1012.

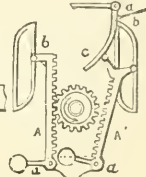

1011.

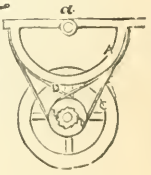

1021.

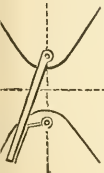

1020.

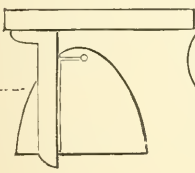

1019.

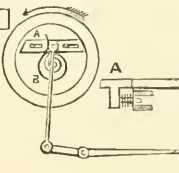

1018.

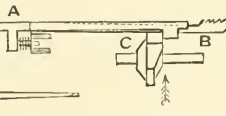

1017.

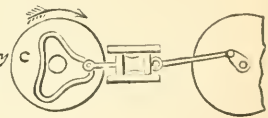

1026.

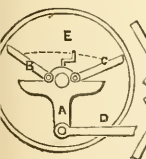

1025.

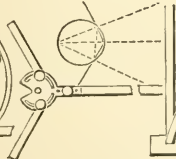

1024.

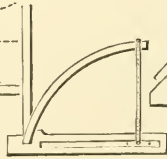

1023.

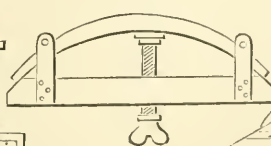

1022.



lever *c* and spring *d* are for carrying the pin of the right-hand rack over the upper angle in its guide-groove *b*.

Fig. 1013. C. Parsons's device for converting reciprocating motion into rotary, and endless rack provided with grooves on its side gearing with a pinion having 2 concentric flanges of different diameters. A substitute for crank in oscillating cylinder engines.

Fig. 1014. Four-way cock, used many years ago on steam engines to admit and exhaust steam from the cylinder. The 2 positions represented are produced by a quarter turn of the plug. Supposing the steam to enter at the top, in the upper figure the exhaust is from the right end of the cylinder, and in the lower figure the exhaust is from the left—the steam entering, of course, in the opposite port.

Fig. 1015. Continuous circular into intermittent rectilinear reciprocating. A motion used on several sewing machines for driving the shuttle. Same motion applied to 3 revolution cylinder printing-presses.

Fig. 1016. A method of repairing chains, or tightening chains used as guys or braces. Link is made in two parts, one end of each is provided with swivel-nut, and other end with screw; the screw of each part fits into nut of other.

Fig. 1017. Continuous circular motion into intermittent circular—the cam C being the driver.

Fig. 1018. A. B. Wilson's 4-motion feed, used in Wheeler and Wilson's, Sloat's, and other sewing machines. The bar A is forked, and has a second bar B, carrying the spur or feeder, pivoted in the said fork. The bar B is lifted by a radial projection on the cam C, at the same time the 2 bars are carried forward. A spring produces the return stroke, and the bar B drops of its own gravity.

Fig. 1019. E. P. Brownell's crank-motion to obviate dead-centres. The pressure on the treadle causes the slotted slide A to move forward with the wrist until the latter has passed the centre, when the spring B forces the slide against the stops until it is again required to move forward.

Fig. 1020. Mechanical means of describing parabolas, the base, altitude, focus, and directrix being given. Lay straight-edge with near side coinciding with directrix, and square with stock against the same, so that the blade is parallel with the axis, and proceed with pencil in bight of thread, as in the preceding.

Fig. 1021. Mechanical means of describing hyperbolas, their foci and vertices being given. Suppose the curves 2 opposite hyperbolas, the points in vertical dotted centre line their foci. One end of thread being looped on pin inserted at the other focus, and other end held to other end of rule, with just enough slack between to permit height to reach vertex when rule coincides with centre line. A pencil held in bight, and kept close to rule, while latter is moved from centre line, describes one half of parabola; the rule is then reversed for the other half.

Fig. 1022. Cyclograph for describing circular arcs in drawings where the centre is inaccessible. This is composed of 3 straight rules. The chord and versed sine being laid down, draw straight sloping line, from ends of former to top of latter; and to these lines lay 2 of the rules crossing at the apex. Fasten these rules together, and another rule across them to serve as a brace, and insert a pin or point at each end of chord to guide the apparatus, which, on being moved against these points, will describe the arc by means of pencil in the angle of the crossing edges of the sloping rules.

Fig. 1023. Another cyclograph. The elastic arched bar is made half the depth at the ends that it is at the middle, and is formed so that its outer edge coincides with a true circular arc when bent to its greatest extent; 3 points in the required arc being given, the bar is bent to them by means of the screw, each end being confined to the straight bar by means of a small roller.

Fig. 1024. Instrument for describing pointed arches. Horizontal bar is slotted and fitted with a slide having pin for loop of cord. Arch bar of elastic wood is fixed in

horizontal at right angles. Horizontal bar is placed with upper edge on springing line, and back of arch bar ranging with jamb of opening, and the latter bar is bent till the upper side meets apex of arch, fulcrum-piece at its base ensuring its retaining tangential relation to jamb; the pencil is secured to arched bar at its connection with cord.

Fig. 1025. Centrolinead for drawing lines toward an inaccessible or inconveniently distant point; chiefly used in perspective. Upper or drawing edge of blade and back of movable legs should intersect centre of joint. Geometrical diagram indicates mode of setting instruments, legs forming it may form unequal angles with blade. At either end of dotted line crossing central, a pin is inserted vertically for instrument to work against. Supposing it to be inconvenient to produce the convergent lines until they intersect, even temporarily, for the purpose of setting the instrument as shown, a corresponding convergence may be found between them by drawing a line parallel to and inward from each.

Fig. 1026. P. Dickson's device for converting an oscillating motion into intermittent circular, in either direction. Oscillating motion communicated to lever A, which is provided with 2 pawls B and C, hinged to its upper side, near shaft of wheel D. Small crank E on upper side of lever A is attached by cord to each of pawls, so that when pawl C is let into contact with interior of rim of wheel D, it moves in one direction, and pawl B is out of gear. Motion of wheel D may be reversed by lifting pawl C, which was in gear, and letting opposite one into gear by crank E.

Fig. 1027. Proportional compasses used in copying drawings on a given larger or smaller scale. The pivot of compasses is secured in a slide which is adjustable in the longitudinal slots of legs, and capable of being secured by a set screw; the dimensions are taken between one pair of points and transferred with the other pair, and thus enlarged or diminished in proportion to the relative distances of the points from the pivot. A scale is provided on one or both legs to indicate the proportion.

Fig. 1028. Buchanan and Righter's slide-valve motion. Valve A is attached to lower end of rod B, and free to slide horizontally on valve-seat. Upper end of rod B is attached to a pin, which slides in vertical slots, and a roller C, attached to the said rod, slides in 2 suspended and vertically adjustable arcs D. This arrangement is intended to prevent the valve from being pressed with too great force against its seat by the pressure of steam, and to relieve it of friction.

Fig. 1029. Trunk-engine used for marine purposes. The piston has attached to it a trunk, at the lower end of which the pitman is connected directly with the piston. The trunk works through a stuffing box in cylinder-head. The effective area of the upper side of the piston is greatly reduced by the trunk. To equalize the power on both sides of piston, high-pressure steam has been first used on the upper side, and afterwards exhausted into and used expansively in the part of cylinder below.

Fig. 1030. Oscillating piston engine. The profile of the cylinder A is of the form of a sector. The piston B is attached to a rock-shaft C, and steam is admitted to the cylinder to operate on one and the other side of piston alternately, by means of a slide-valve D, substantially like that of an ordinary reciprocating engine. The rock-shaft is connected with a crank to produce rotary motion.

Fig. 1031. Root's double-quadrant engine. This is on the same principle as Fig. 1030; but 2 single-acting pistons B, B, are used, and both connected with one crank D. The steam is admitted to act on the outer sides of the 2 pistons alternately by means of one induction-valve *a*, and is exhausted through the space between the pistons. The piston and crank connections are such that the steam acts on each piston during about $\frac{2}{3}$ revolution of the crank, and hence there are no dead-points.

Fig. 1032. One of the many forms of rotary engine. A is the cylinder having the shaft B pass centrally through it. The piston C is simply an eccentric fast on the shaft, and working in contact with the cylinder at one point. The induction and eduction of

steam take place as indicated by arrows, and the pressure of the steam on one side of the piston produces its rotation and that of the shaft. The sliding abutment D, between the induction and eduction ports, moves out of the way of the piston to let it pass.

Fig. 1033. Another form of rotary engine, in which there are 2 stationary abutments D, D, within the cylinder; and the two pistons A, A, in order to enable them to pass the abutments, are made to slide radially in grooves in the hub C of the main shaft B. The steam acts on both pistons at once, to produce the rotation of the hub and shaft. The induction and eduction are indicated by arrows.

Fig. 1034. Bisecting gauge. Of 2 parallel cheeks on the cross-bar one is fixed and the other adjustable, and held by thumb-screw. In either cheek is entered one of 2 short bars of equal length, united by a pivot, having a sharp point for marking. This point is always in a central position between the cheeks, whatever their distance apart, so that any parallel-sided solid to which the cheeks are adjusted may be bisected from end to end by drawing the gauge along it. Solids not parallel-sided may be bisected in like manner, by leaving one cheek loose, but keeping it in contact with solid.

Fig. 1035. Self-recording level for surveyors, consists of a carriage, the shape of which is governed by an isosceles triangle, having horizontal base. The circumference of each wheel equals the base of the triangle. A pendulum, when the instrument is on level ground, bisects the base; and when on an inclination, gravitates to right or left from centre accordingly. A drum, rotated by gearing from one of the carriage wheels, carries sectionally ruled paper, upon which pencil on pendulum traces profile corresponding with that of ground travelled over. The drum can be shifted vertically to accord with any given scale; and horizontally, to avoid removal of filled paper.

Fig. 1036. A device for assisting the crank of a treadle motion over the dead-centres. The helical spring A has a tendency to move the crank B in direction at right angles to dead-centres.

Fig. 1037. Continuous circular motion into a rectilinear reciprocating. The shaft A, working in a fixed bearing D, is bent on one end, and fitted to turn in a socket at the upper end of a rod B, the lower end of which works in a socket in the slide C. Dotted lines show the position of the rod B and slide, when the shaft has made $\frac{1}{2}$ revolution from the position shown in bold lines.

Fig. 1038. Continuous circular motion converted into a rocking motion. Used in self-rocking cradles. Wheel A revolves and is connected to a wheel B, of greater radius, which receives an oscillating motion, and wheel B is provided with two flexible bands C, D, which connect each to a standard or post, attached to the rocker E of the cradle.

Fig. 1039. Root's double-reciprocating or square piston engine. The cylinder A of this engine is of oblong square form, and contains 2 pistons B and C, the former working horizontally, and the latter working vertically within it. The piston C is connected with the wrist *a* of the crank on the main shaft *b*. The ports for the admission of steam are shown black. The 2 pistons produce the rotation of the crank without dead-points.

Fig. 1040. Another rotary engine, in which the shaft B works in fixed bearings, eccentric to the cylinder. The pistons A, A, are fitted to slide in and out from grooves in the hub C, which is concentric with the shaft, but they are always radial to the cylinder, being kept so by rings (shown dotted), fitting to hubs on the cylinder-heads. The pistons slide through rolling packings A, A, in the hub C.

Fig. 1041. The indiarubber rotary engine, in which the cylinder has a flexible lining E of indiarubber, and rollers A, A, are substituted for pistons, said rollers being attached to arms radiating from the main shaft B. The steam acting between the indiarubber and the surrounding rigid portion of the cylinder presses the indiarubber against the rollers, and causes them to revolve around the cylinder and turn the shaft.

Fig. 1042. Holly's double-elliptical rotary engine. The 2 elliptical pistons geared

1033.

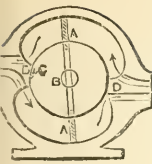

1032.

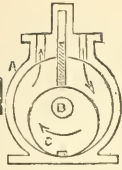

1031.

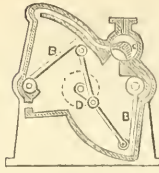

1030.

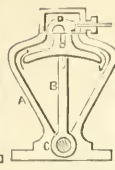

1029.



1028.

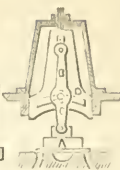

1027.



1038.

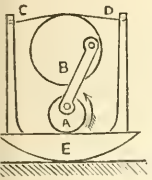

1037.

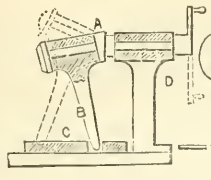

1036.



1035.

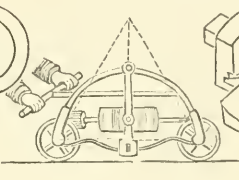

1034.

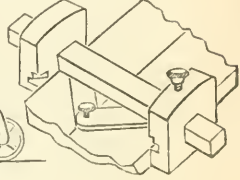

1044.



1043.

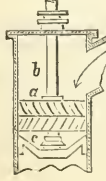

1042.

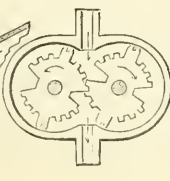

1041.

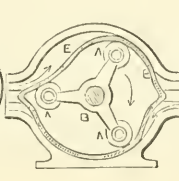

1040.

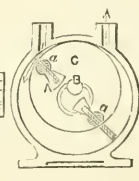

1039.

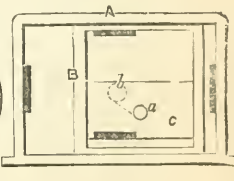

1050.

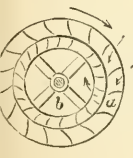

1049.



1048.

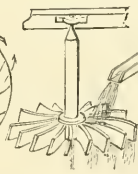

1047.

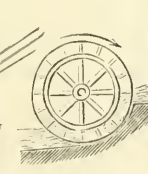

1046.

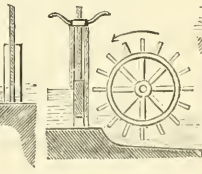

1045.

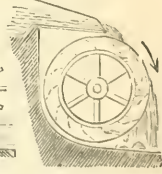

1056.

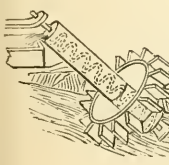

1055.

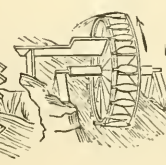

1054.

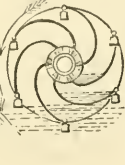

1053.

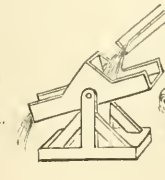

1052.

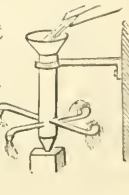

1051.

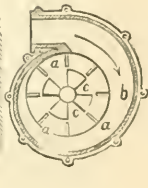

together are operated upon by the steam entering between them in such manner as to produce their rotary motion in opposite directions.

These rotary engines can all be converted into pumps.

Fig. 1043. *Jonval turbine.* The shutles are arranged on the outside of a drum, radial to a common centre, and stationary within the trunk or casing *b*. The wheel *c* is made in nearly the same way; the buckets exceed in number those of the shutles, and are set at a slight tangent instead of radially, and the curve generally used is that of the cycloid or parabola.

Fig. 1044. A method of obtaining a reciprocating motion from a continuous fall of water, by means of a valve in the bottom of the bucket which opens by striking the ground, and thereby emptying the bucket, which is caused to rise again by the action of a counterweight on the other side of the pulley over which it is suspended.

Fig. 1045. Overshot water-wheel.

Fig. 1046. Undershot water-wheel.

Fig. 1047. *Breast-wheel.* This holds intermediate place between overshot and undershot wheels; has float-boards like the former, but the cavities between are converted into buckets by moving in a channel adapted to circumference and width, and into which water enters nearly at the level of axle.

Fig. 1048. Horizontal overshot water-wheel.

Fig. 1049. A plan view of the Fourneyron turbine water-wheel. In the centre are a number of fixed curved shutles or guides *A*, which direct the water against the buckets of the outer wheel *B*, which revolves, and the water discharges at the circumference.

Fig. 1050. *Warren's central discharge turbine, plan view.* The guides *a* are outside, and the wheel *b* revolves within them, discharging the water at the centre.

Fig. 1051. *Volute wheel, having radial vanes a*, against which the water impinges and carries the wheel around. The scroll or volute casing *b* confines the water in such a manner that it acts against the vanes all around the wheel. By the addition of the inclined buckets *c, c*, at the bottom, the water is made to act with additional force as it escapes through the openings of said buckets.

Fig. 1052. *Barker, or reaction mill.* Rotary motion of central hollow shaft is obtained by the reaction of the water escaping at the ends of its arms, the rotation being in a direction the reverse of the escape.

Fig. 1053 represents a trough divided transversely into equal parts, and supported on an axis by a frame beneath. The fall of water filling one side of the division, the trough is vibrated on its axis, and at the same time that it delivers the water the opposite side is brought under the stream and filled, which in like manner produces the vibration of the trough back again. This has been used as a water meter.

Fig. 1054. *Persian wheel, used in Eastern countries for irrigation.* It has a hollow shaft and curved floats, at the extremities of which are suspended buckets or tubs. The wheel is partly immersed in a stream acting on the convex surface of its floats; and as it is thus caused to revolve, a quantity of water will be elevated by each float at each revolution, and conducted to the hollow shaft at the same time that one of the buckets carries its fill of water to a higher level, where it is emptied by coming in contact with a stationary pin placed in a convenient position for tilting it.

Fig. 1055. *Machine of ancient origin, still employed on the river Eisach, in the Tyrol, for raising water.* A current keeping the wheel in motion, the pots on its periphery are successively immersed, filled, and emptied into a trough above the stream.

Fig. 1056. *Application of Archimedes' screw to raising water, the supply stream being the motive power.* The oblique shaft of the wheel has extending through it a spiral passage; the lower end of which is immersed in water, and the stream, acting upon the wheel at its lower end, produces its revolution, by which the water is conveyed upward continuously through the spiral passage and discharged at the top.

Fig. 1057. Montgolfier's hydraulic ram. Small fall of water made to throw a jet to a great height or furnish a supply at high level. The right-hand valve being kept open by a weight or spring, the current flowing through the pipe in the direction of the arrow escapes thereby till its pressure, overcoming the resistance of weight or spring, closes it. On the closing of this valve the momentum of the current overcomes the pressure on the other valve, opens it, and throws a quantity of water into the globular air-chamber by the expansive force of the air in which the upward stream from the nozzle is maintained. On equilibrium taking place, the right-hand valve opens and left-hand one shuts. Thus, by the alternate action of the valves, a quantity of water is raised into the air-chamber at every stroke, and the elasticity of the air gives uniformity to the efflux.

Figs. 1058, 1059. D'Ectol's oscillating column, for elevating a portion of a given fall of water above the level of the reservoir or head, by means of a machine, all the parts of which are absolutely fixed. It consists of an upper and smaller tube, which is constantly supplied with water, and a lower and larger tube, provided with a circular plate below concentric with the orifice which receives the stream from the tube above. Upon allowing the water to descend, as shown in Fig. 1058, it forms itself gradually into a cone on the circular plate, as shown in Fig. 1059, which cone protrudes into the smaller tube so as to check the flow of water downward; and the regular supply continuing from above, the column in the upper tube rises until the cone on the circular plate gives way. This action is renewed periodically, and is regulated by the supply of water.

Fig. 1060. This method of passing a boat from one shore of a river to the other is common on the Rhine and elsewhere, and is effected by the action of the stream on the rudder, which carries the boat across the stream in the arc of a circle, the centre of which is the anchor which holds the boat from floating down the stream.

Fig. 1061. Common lift-pump. In the up-stroke of piston or bucket the lower valve opens and the valve in piston shuts; air is exhausted out of suction-pipe, and water rushes up to fill the vacuum. In down-stroke lower valve is shut and valve in piston opens, and the water simply passes through the piston. The water above piston is lifted up, and runs over out of spout at each up-stroke. This pump cannot raise water over 30 ft. high.

Fig. 1062. Ordinary force-pump, with 2 valves. The cylinder is above water, and is fitted with solid piston; one valve closes outlet-pipe, and other closes suction-pipe. When piston is rising suction-valve is open, and water rushes into cylinder, outlet-valve being closed. On descent of piston suction-valve closes, and water is forced up through outlet-valve to any distance or elevation.

Fig. 1063. Modern lifting pump. This pump operates in same manner as one in previous figure, except that piston-rod passes through stuffing box, and outlet is closed by a flap-valve opening upward. Water can be lifted to any height above this pump.

Fig. 1064. Force-pump, same as 1062, with addition of air-chamber to the outlet, to produce a constant flow. The outlet from air-chamber is shown at 2 places, from either of which water may be taken. The air is compressed by the water during the downward stroke of the piston, and expands and presses out the water from the chamber during the up-stroke.

Fig. 1065. Double-acting pump. Cylinder closed at each end, and piston-rod passes through stuffing box on one end, and the cylinder has 4 openings covered by valves, 2 for admitting water and like number for discharge. A is suction-pipe, and B discharge-pipe. When piston moves down, water rushes in at suction-valve 1, on upper end of cylinder, and that below piston is forced through valve 3 and discharge-pipe B; on the piston ascending again, water is forced through discharge-valve 4, on upper end of cylinder, and water enters lower suction-valve 2.

Fig. 1066. Double lantern-bellows pump. As one bellows is distended by lever, air

is rarefied within it, and water passes up suction-pipe to fill space; at same time other bellows is compressed, and expels its contents through discharge-pipe; valves working the same as in the ordinary force-pump.

Fig. 1067. Old rotary pump. Lower aperture entrance for water, and upper for exit. Central part revolves with its valves, which fit accurately to inner surface of outer cylinder. The projection shown in lower side of cylinder is an abutment to close the valves when they reach that point.

Fig. 1068. Cary's rotary pump. Within the fixed cylinder there is placed a revolving drum B, attached to an axle A. Heart-shaped cam A, surrounding axle, is also fixed. Revolution of drum causes sliding pistons *c, c*, to move in and out, in obedience to form of cam. Water enters and is removed from the chamber through ports L and M; the directions are indicated by arrows. Cam is so placed that each piston is, in succession, forced back to its seat when opposite E, and at same time other piston is forced fully against inner side of chamber, thus driving before it water already there into exit-pipe H, and drawing after it, through suction-pipe F, the stream of supply.

Fig. 1069. Hiero's fountain. Water being poured into upper vessel descends tube on right into lower; intermediate vessel being also filled and more water poured into upper, confined air in cavities over water in lower and intermediate vessels, and in communication tube on left, being compressed, drives by its elastic force a jet up central tube.

Fig. 1070. Diaphragm forcing pump. A flexible diaphragm is employed instead of bellows, and valves are arranged same as in preceding.

Fig. 1071. Common mode of raising water from wells of inconsiderable depth. Counterbalance equals about $\frac{1}{2}$ weight to be raised, so that the bucket has to be pulled down when empty, and is assisted in elevating it when full by counterbalance.

Fig. 1072. The common pulley and buckets for raising water; the empty bucket is pulled down to raise the full one.

Fig. 1073. Reciprocating lift for wells. Top part represents horizontal wind-wheel on a shaft which carries spiral thread. Coupling of latter allows small vibration, that it may act on one worm-wheel at a time. Behind worm-wheels are pulleys, over which passes rope which carries bucket at each extremity. In centre is vibrating tappet, against which bucket strikes in its ascent, and which, by means of arm in step wherein spiral and shaft are supported, traverses spiral from one wheel to other, so that the bucket which has delivered water is lowered and other one raised.

Fig. 1074. Fairbairn's bailing scoop, for elevating water short distances. The scoop is connected by pitman to end of a lever or of a beam of single-acting engine. Distance of lift may be altered by placing end of rod in notches shown in figure.

Fig. 1075. Another apparatus operating on the same principle as Fig. 1086. It is termed a Lansdell's steam siphon pump. A is the jet-pipe; B, B, are 2 suction-pipes, having a forked connection with the discharge-pipe C. The steam jet-pipe entering at the fork offers no obstacle to the upward passage of the water, which moves upward in an unbroken current.

Fig. 1076. Pendulums or swinging gutters for raising water by their pendulous motions. Terminations at bottom are scoops, and at top open pipes; intermediate angles are formed with boxes and flap-valve, each connected with 2 branches of pipe.

Fig. 1077. Chain pumps; lifting water by continuous circular motion. Wood or metal discs, carried by endless chain, are adapted to water-tight cylinder, and form with it a succession of buckets filled with water. Power is applied at upper wheel.

Fig. 1078. Self-acting weir and scouring sluice. Two leaves turn on pivots below centres; upper leaf much larger than lower, and turns in direction of stream, while lower turns against it. Top edge of lower leaf overlaps bottom edge of upper one, and is forced against it by pressure of water. In ordinary states of stream, counteracting pressures keep weir vertical and closed, as in the left-hand figure, and water flows

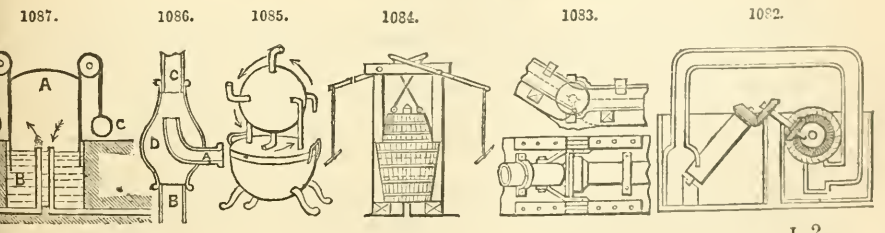
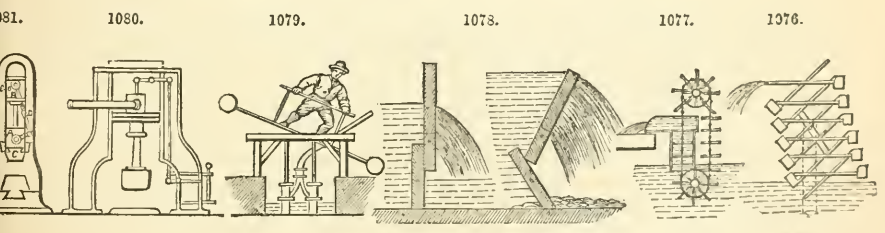
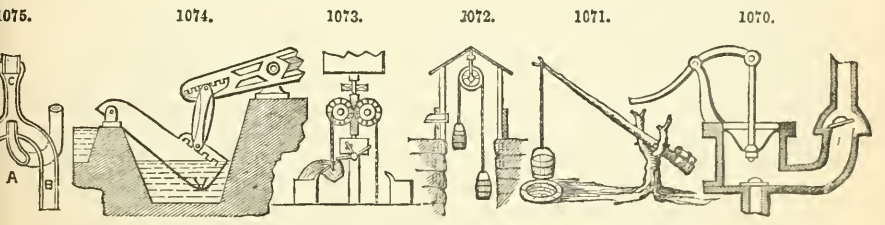
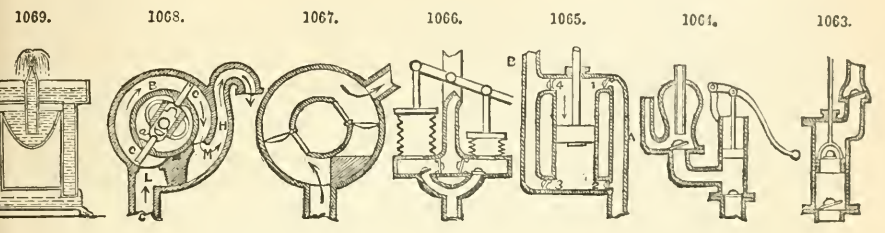
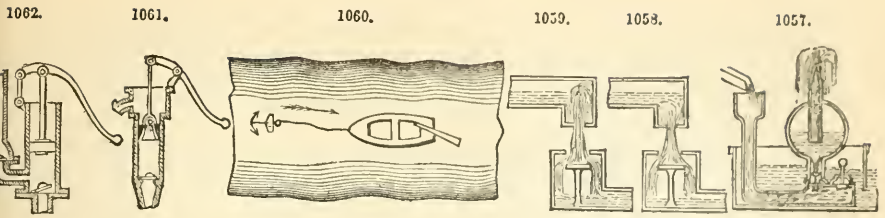

through notch in upper leaf but on water rising above ordinary level, pressure above from greater surface and leverage overcomes resistance below, upper leaf turns over, pushing back lower, reducing obstructions, and opening at bed a passage to deposit.

Fig. 1079. Balance pumps. Pair worked reciprocally by a person pressing alternately on opposite ends of lever or beam.

Fig. 1080. Steam hammer. Cylinder fixed above and hammer attached to lower end of piston-rod. Steam being alternately admitted below piston and allowed to escape, raises and lets fall the hammer.

Fig. 1081. Hotchkiss's atmospheric hammer; derives the force of its blow from compressed air. Hammer-head C is attached to a piston fitted to a cylinder B, which is connected by a rod D with a crank A on the rotary driving shaft. As the cylinder ascends, air entering hole *e* is compressed below piston and lifts hammer. As cylinder descends, air entering hole *e* is compressed above, and is stored up to produce the blow by its instant expansion after the crank and connecting rod turn bottom centre.

Fig. 1082. French invention for obtaining rotary motion from different temperatures in 2 bodies of water. Two cisterns contain water; that in left at natural temperature, and that in right higher. In right is a water-wheel geared with Archimedean screw in left. From spiral screw of the latter a pipe extends over and passes to the under side of wheel. Machine is started by turning screw in opposite direction to that for raising water, thus forcing down air, which ascends in tube, crosses and descends, and imparts motion to wheel; and its volume increasing with change of temperature, it is said, keeps the machine in motion. We are not informed how the difference of temperature is to be maintained.

Fig. 1083. Flexible water-main, plan and section: 2 pipes of 15 in. and 18 in. interior diameter, having some of their joints thus formed, conduct water across the Clyde to Glasgow Water-works. Pipes are secured to strong log frames, having hinges with horizontal pivots. Frames and pipes were put together on south side of the river, and, the north end of pipe being plugged, they were hauled across by machinery on north side, their flexible structure enabling them to follow the bed.

Fig. 1084. Air-pump of simple construction. Smaller tube inverted in larger one. The latter contains water to upper dotted line, and the pipe from shaft or space to be exhausted passes through it to a few inches above water, terminating with valve opening upward. Upper tube has short pipe and upwardly-opening valve at top, and is suspended by ropes from levers. When upper tube descends, great part of air within is expelled through upper valve, so that, when afterward raised, rarefaction within causes gas or air to ascend through the lower valve. This pump was successfully used for drawing off carbonic acid from a large and deep shaft.

Fig. 1085. Aeolipile, or Hero's steam toy, described by Hero of Alexandria, 130 years B.C., and now regarded as the first steam engine, the rotary form of which it may be considered to represent. From the lower vessel, or boiler, rise 2 pipes conducting steam to globular vessel above, and forming pivots on which the said vessel is caused to revolve in the direction of arrows, by the escape of steam through a number of bent arms. This works on the same principle as Barker's mill.

Fig. 1086. Brear's bilge ejector, for discharging bilge-water from vessels, or for raising and forcing water under various circumstances. D is a chamber having attached a suction-pipe B and discharge-pipe C, and having a steam-pipe entering at one side, with a nozzle directed toward the discharge-pipe. A jet of steam entering through A expels the air from D and C, produces a vacuum in B, and causes water to rise through B, and pass through D and C in a regular and constant stream. Compressed air may be used as a substitute for steam.

Fig. 1087. Gasometer. The open-bottomed vessel A is arranged in the tank B of water, and partly counterbalanced by weights C, C. Gas enters the gasometer by one and leaves it by the other of the 2 pipes inserted through the bottom of the tank. As

gas enters, vessel A rises, and *vice versa*. The pressure is regulated by adding to or reducing the weights C, C.

Fig. 1088. Hoard and Wiggin's steam trap for shutting in steam, but providing for the escape of water from steam coils and radiators. It consists of a box, connected at A with the end of the coil or the waste-pipe, having an outlet at B and furnished with a hollow valve D, the bottom of which is composed of a flexible diaphragm. Valve is filled with liquid, and hermetically sealed, and its diaphragm rests upon a bridge over the outlet-pipe. The presence of steam in the outer box so heats the water in valve that the diaphragm expands and raises valve up to the seat *aa*. Water of condensation accumulating reduces the temperature of valve; and as the liquid in valve contracts, diaphragm allows valve to descend and let water off.

Fig. 1089. Ray's steam trap. Valve *a* closes and opens by longitudinal expansion and contraction of waste-pipe A, which terminates in the middle of an attached hollow sphere C. A portion of the pipe is firmly secured to a fixed support B. Valve consists of a plunger which works in a stuffing box in the sphere, opposite the end of the pipe, and it is pressed toward the end of the pipe by a loaded elbow lever D as far as permitted by a stop-screw *b* and stop *c*. When pipe is filled with water, its length is so reduced that valve remains open; but when filled with steam it is expanded so that valve closes it. Screw *b* serves to adjust the action of valve.

Fig. 1090. Another kind of gasometer. The vessel A has permanently secured within it a central tube *a* which slides in a fixed tube *b* in the centre of the tank.

Fig. 1091. Wet gas meter. The stationary case A is filled with water up to above the centre. The inner revolving drum is divided into 4 compartments B, B, with inlets around the central pipe *a* which introduces the gas through one of the hollow journals of the drum. This pipe is turned up to admit the gas above the water, as indicated by the arrow near the centre of the figure. As gas enters the compartments B, B, one after another, it turns the drum in the direction of the arrow shown near its periphery, displacing the water from them. As the chambers pass over they fill with water again. The cubic contents of the compartments being known, and the number of the revolutions of the drum being registered by dial-work, the quantity of gas passing through the meter is registered.

Fig. 1092. Powers's gas regulator for equalizing the supply of gas to all the burners of a building or apartment, notwithstanding variations in the pressure on the main, or variations produced by turning gas on or off, to or from any number of the burners. The regulator-valve D, of which a separate outside view is given, is arranged over inlet-pipe E, and connected by a lever *d*, with an inverted cup H, the lower edges of which, as well as those of valve, dip into channels containing quicksilver. There is no escape of gas around the cup H, but there are notches *b* in the valve to permit the gas to pass over the surface of the quicksilver. As the pressure of gas increases it acts upon the inner surface of cup H, which is larger than valve, and the cup is thereby raised, causing a depression of the valve into the quicksilver, and contracting the opening notches *b*, and diminishing the quantity of gas passing through. As the pressure diminishes, an opposite result is produced. The outlet to burners is at F.

Fig. 1093. Dry gas meter. Consists of 2 bellows-like chambers A, A, which are alternately filled with gas and discharged through a valve B, something like the slide-valve of a steam engine, worked by the chambers, A, A. The capacity of the chambers being known, and the number of times they are filled being registered by dial-work, the quantity of gas passing through the meter is indicated on the dials.

Fig. 1094. A spiral wound round a cylinder to convert the motion of the wind, or a stream of water, into rotary motion.

Fig. 1095. Common windmill, illustrating the production of circular motion by the direct action of the wind upon the oblique sails.

Fig. 1096. Plan of a vertical windmill. The sails are so pivoted as to present their

1093.

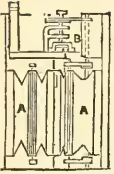

1092.

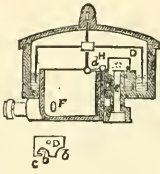

1091.

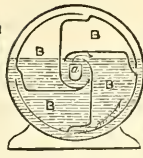

1090.

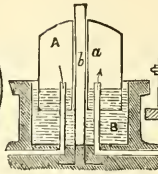

1089.

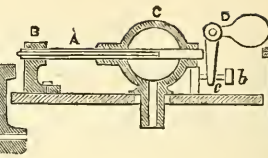

1088.



1100.

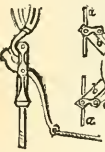

1099.

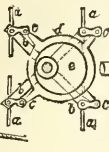

1098.



1097.

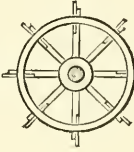

1096.

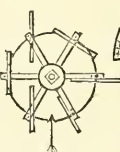

1095.

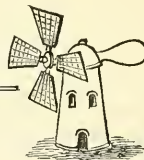

1094.

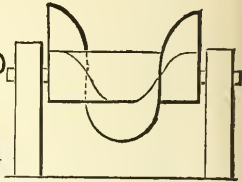

1108.

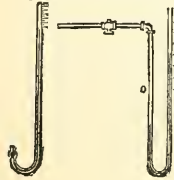

1107.

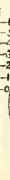

1106.

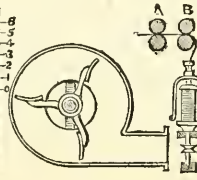

1105.



1104.

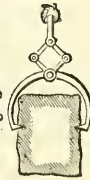

1103.

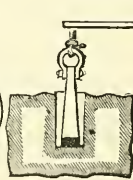

1102.

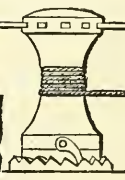

1101.

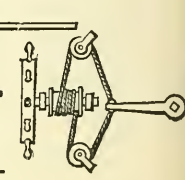

1110.

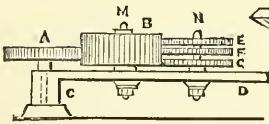

1109.

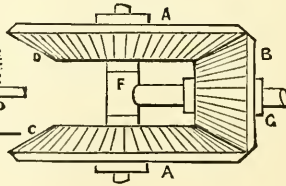

1116.

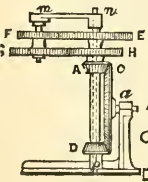

1115.

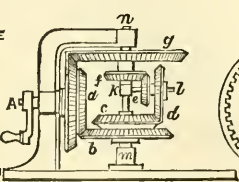

1114.

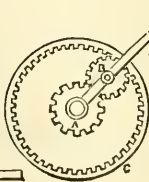

1113.

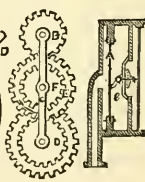

1112.

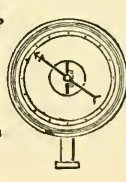

1111.

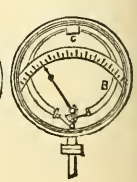

edges in returning toward the wind, but to present their faces to the action of the wind, the direction of which is supposed to be as indicated by the arrow.

Fig. 1097. Common paddle-wheel for propelling vessels. The revolution of the wheel causes the buckets to press backward against the water, and so produce the forward movement of the vessel.

Fig. 1098. Screw-propeller. The blades are sections of a screw-thread, and their revolution in the water has the same effect as the working of a screw in a nut, producing motion in the direction of the axis, and so propelling the vessel.

Fig. 1099. Vertical bucket paddle-wheel. The buckets *a, a*, are pivoted into the arms *b, b*, at equal distances from the shaft. To the pivots are attached cranks *c, c* which are pivoted at their ends to the arms of a ring *d*, which is fitted loosely to a stationary eccentric *e*. The revolution of the arms and buckets with the shaft causes the ring *d* also to rotate upon the eccentric, and the action of this ring on the cranks keeps the buckets always upright, so that they enter the water and leave it edgewise without resistance or lift, and while in the water are in the most effective position for propulsion.

Fig. 1100. Brown and Level's boat-detaching hook. The upright standard is secured to the boat, and the tongue, hinged to its upper end, enters an eye in the lever, which works on a fulcrum at the middle of the standard. A similar apparatus is applied at each end of the boat. The hooks of the tackles hook into the tongues, which are secure until it is desired to detach the boat, when a rope attached to the lower end of each lever is pulled in such a direction as to slip the eye at the upper end of the lever from off the tongue, which, being then liberated, slips out of the hook of the tackle and detaches the boat.

Fig. 1101. Ordinary steering apparatus. Plan view. On the shaft of the hand-wheel there is a barrel, on which is wound a rope, which passes round the guide-pulleys, and has its opposite ends attached to the tiller, or lever, on top of the rudder; by turning the wheel, one end of the rope is wound on and the other let off, and the tiller is moved in one or the other direction, according to the direction in which the wheel is turned.

Fig. 1102. Capstan. The cable or rope wound on the barrel of the capstan is hauled in by turning the capstan on its axis by means of handspikes, or bars inserted into holes in the head. The capstan is prevented from turning back by a pawl attached to its lower part and working in a circular ratchet on the base.

Fig. 1103. Lewis, for lifting stone in building. It is composed of a central taper pin or wedge, with 2 wedge-like packing pieces arranged one on each side of it. The 3 pieces are inserted together in a hole drilled into the stone, and when the central wedge is hoisted upon it wedges the packing pieces out so tightly against the sides of the hole as to enable the stone to be lifted.

Fig. 1104. Tongs for lifting stones. The pull on the shackle which connects the 2 links causes the latter so to act on the upper arms of the tongs as to make their points press themselves against or into the stone. The greater the weight the harder the tongs bite.

Fig. 1105. Drawing and twisting in spinning cotton, wool, &c. The front drawing-rolls *B* rotate faster than the back ones *A*, and so produce a draught, and draw out the fibres of the sliver or roving passing between them. Roving passes from the front drawing-rolls to throstle, which, by its rotation around the bobbin, twists and winds the yarn on the bobbin.

Fig. 1106. Fan-blower. The casing has circular openings in its sides, through which, by the revolution of the shaft and attached fan-blades, air is drawn in at the centre of the casing, to be forced out under pressure through the spout.

Fig. 1107. Siphon pressure gauge. Lower part of bent tube contains mercury. The leg of the tube, against which the scale is marked, is open at top, the other leg con-

nected with the steam boiler or other apparatus on which the pressure is to be indicated. The pressure on the mercury in the one leg causes it to be depressed in that and raised in the other, until there is an equilibrium established between the weight of mercury and pressure of steam in one leg, and the weight of mercury and pressure of atmosphere in the other. This is the most accurate gauge known; but as high pressure requires so long a tube, it has given place to those which are practically accurate enough, and of more convenient form.

Fig. 1108. Mercurial barometer. Longer leg of bent tube, against which is marked the scale of inches, is closed at top, and shorter one is open to the atmosphere, or merely covered with some porous material. Column of mercury in longer leg, from which the air has been extracted, is held up by the pressure of air on the surface of that in the shorter leg, and rises or falls as the pressure of the atmosphere varies. The old-fashioned weather-glass is composed of a similar tube attached to the back of a dial, and a float inserted into the shorter leg of the tube, and geared by a rack and pinion, or cord and pulley, with the spindle of the pointer.

Fig. 1109. A very simple form of the epicyclic train, in which F, G is the arm, secured to the central shaft A, upon which are loosely fitted the bevel-wheels C, D. The arm is formed into an axle for the bevel-wheel B, which is fitted to turn freely upon it. Motion may be given to the two wheels C, D, in order to produce aggregate motion of the arm, or else to the arm and one of said wheels in order to produce aggregate motion of the other wheel.

Fig. 1110. Ferguson's mechanical paradox, designed to show a curious property of the epicyclic train. The wheel A is fixed upon a stationary stud, about which the arm C, D, revolves. In this arm are 2 pins M, N, upon one of which is fitted loosely a thick wheel B gearing with A, and upon the other are 3 loose wheels E, F, G, all gearing with B. When the arm C, D, is turned round on the stud, motion is given to the 3 wheels E, F, G, on their common axis, namely, the pin N; the 3 forming with the intermediate wheel B and the wheel A 3 distinct epicyclic trains. Suppose A to have 20 teeth, F 20, E 21, and G 19; as the arm E, C, D, is turned round F will appear not to turn on its axis, as any point in its circumference will always point in one direction, while E will appear to turn slowly in one, and G in the other direction, which—an apparent paradox—gave rise to the name of the apparatus.

Fig. 1111. Aneroid gauge, known as the Bourdon gauge, from the name of its inventor, a Frenchman. B is a bent tube closed at its ends, secured at C, the middle of its length, and having its ends free. Pressure of steam or other fluid admitted to tube tends to straighten it more or less, according to its intensity. The ends of tube are connected with a toothed sector-piece, gearing with a pinion on the spindle of a pointer, which indicates the pressure on a dial.

Fig. 1112. Pressure gauge now seldom used. Sometimes known as the Magdeburg gauge, from the name of the place where first manufactured. Face view and section. The fluid whose pressure is to be measured acts upon a circular metal disc A, generally corrugated, and the deflection of the disc under the pressure gives motion to a toothed sector e, which gears with a pinion on the spindle of the pointer.

Fig. 1113. An epicyclic train. Any train of gearing the axes of the wheels of which revolve around a common centre is properly known by this name. The wheel at one end of such a train, if not those at both ends, is always concentric with the revolving frame. C is the frame or train-bearing arm. The centre wheel A, concentric with this frame, gears with a pinion F to the same axle, with which is secured a wheel E that gears with a wheel B. If the first wheel A be fixed, and a motion be given to the frame C, the train will revolve round the fixed wheel, and the relative motion of the frame to the fixed wheel will communicate through the train a rotary motion to B on its axis. Or the first wheel as well as the frame may be made to revolve with different velocities, with the same result except as to the velocity of rotation of B upon its axis.

In the epicyclic train as thus described, only the wheel at one extremity is concentric with the revolving frame; but if the wheel E, instead of gearing with B, be made to gear with the wheel D, which, like the wheel A, is concentric with the frame, we have an epicyclic train, of which the wheels at both extremities are concentric with the frame. In this train we may either communicate the driving motion to the arm and one extreme wheel, in order to produce an aggregate rotation of the other extreme wheel, or motion may be given to the 2 extreme wheels A and D of the train, and the aggregate motion will thus be communicated to the arm.

Fig. 1114. Another simple form of the epicyclic train, in which the arm D carries a pinion B, which gears both with a spur-wheel A and an annular wheel C, both concentric with the axis of the arm. Either of the wheels A, C, may be stationary, and the revolution of the arm and pinion will give motion to the other wheel.

Fig. 1115. Another epicyclic train in which neither the first nor last wheel is fixed. m, n is a shaft to which is firmly secured the train-bearing arm k, l , which carries the 2 wheels d, e , secured together but rotating upon the arm itself. The wheels b and c are united, and turn together freely upon the shaft m, n ; the wheels f and g are also secured together, but turn together freely on the shaft m, n . The wheels c, d, e , and f , constitute an epicyclic train, of which c is the first and f the last wheel. A shaft A is employed as a driver, and has firmly secured to it 2 wheels a and h , the first of which gears with the wheel b , and thus communicates motion to the first wheel c of the epicyclic train, and the wheel h drives the wheel g , which thus gives motion to the last wheel f . Motion communicated this way to the two ends of the train produces an aggregate motion of the arm k, l , and shaft m, n .

This train may be modified; for instance, suppose the wheels g and f to be disunited, g to be fixed to the shaft m, n , and f only running loose upon it. The driving shaft A will, as before, communicate motion to the first wheel c of the epicyclic train by means of the wheels a and b , and will also by h cause the wheel g , the shaft m, n , and the train-bearing arm k, l , to revolve, and the aggregate rotation will be given to the loose wheel f .

Fig. 1116. Another form of epicyclic train, designed for producing a very slow motion. m is a fixed shaft, upon which is loosely fitted a long sleeve, to the lower end of which is fixed a wheel D, and to the upper end a wheel E. Upon this long sleeve there is fitted a shorter one which carries at its extremities the wheels A and H. A wheel C gears with both D and A, and a train-bearing arm m, n , which revolves freely upon the shaft m, p , carries upon a stud at n the united wheels F and G. If A have 10 teeth, C 100, D 10, E 61, F 49, G 41, and H 51, there will be 25,000 revolutions of the train-bearing arm m, n , for one of the wheel C.

Fig. 1117. A method of engaging, disengaging, and reversing the upright shaft at the left. The belt is shown on the middle one of the 3 pulleys on the lower shafts a, b , which pulley is loose, and consequently no movement is communicated to the said shafts. When the belt is traversed on the left-hand pulley, which is fast on the hollow shaft b , carrying the bevel-gear B, motion is communicated in one direction to the upright shaft; and on its being traversed on to the right-hand pulley, motion is transmitted through the gear A, fast on the shaft a , which runs inside of b , and the direction of the upright shaft is reversed.

Fig. 1118. Spur-gears.

Fig. 1119. The wheel to the right is termed a "crown-wheel"; that gearing with it is a spur-gear. These wheels are not much used, and are only available for light work, as the teeth of the crown-wheel must necessarily be thin.

Fig. 1120. Multiple-gearing—a recent invention. The smaller triangular wheel drives the larger one by the movement of its attached friction-rollers in the radial grooves.

Fig. 1121. These are sometimes called brush-wheels. The relative speeds can be

1117.

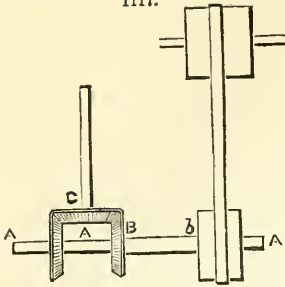

1118.

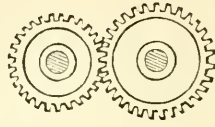

1119.

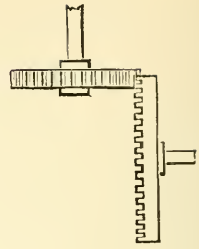

1120.

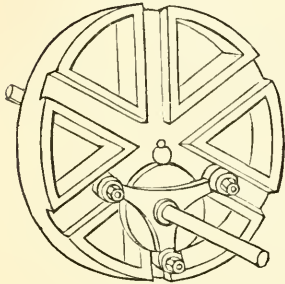

1121.

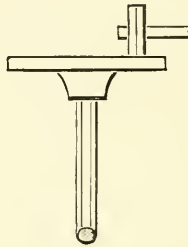

1122.

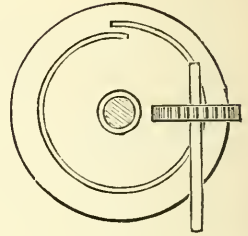

1123.

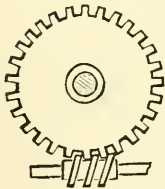

1124.

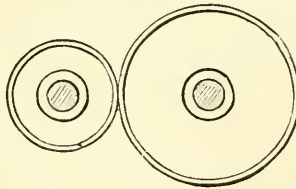

1125.

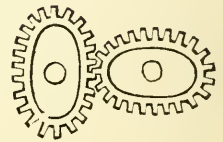

1126.

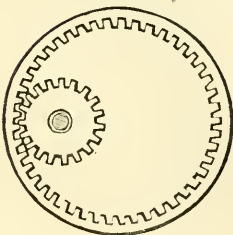

1127.

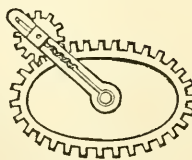

1128.

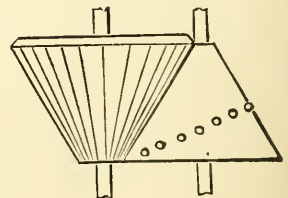

varied by changing the distance of the upper wheel from the centre of the lower one. The one drives the other by the friction or adhesion, and this may be increased by facing the lower one with indiarubber.

Fig. 1122. Transmission of rotary motion from one shaft at right angles to another. The spiral thread of the disc-wheel drives the spur-gear, moving it the distance of one tooth at every revolution.

Fig. 1123. Worm or endless screw and a worm-wheel. This effects the same result as Fig. 1122; and as it is more easily constructed, it is oftener used.

Fig. 1124. Friction-wheels. The surfaces of these wheels are made rough, so as to "bite" as much as possible; one is sometimes faced with leather, or, better, with vulcanized indiarubber.

Fig. 1125. Elliptical spur-gears. These are used where a rotary motion of varying speed is required, and the variation of speed is determined by the relation between the lengths of the major and minor axes of the ellipses.

Fig. 1126. An internally-toothed spur-gear and pinion. With ordinary spur-gears the direction of rotation is opposite; but with the internally-toothed gear, the two rotate in the same direction; and with the same strength of tooth the gears are capable of transmitting greater force, because more teeth are engaged.

Fig. 1127. Variable rotary motion produced by uniform rotary motion. The small spur-pinion works in a slot cut in the bar, which turns loosely upon the shaft of the elliptical gear. The bearing of the pinion-shaft has applied to it a spring, which keeps it engaged; the slot in the bar is to allow for the variation of length of radius of the elliptical gear.

Fig. 1128. Uniform into variable rotary motion. The bevel-wheel or pinion to the left has teeth cut through the whole width of its face. Its teeth work with a spirally-arranged series of studs on a conical wheel.

Fig. 1129. A means of converting rotary motion, by which the speed is made uniform during a part, and varied during another part, of the revolution.

Fig. 1130. Sun-and-planet motion. The spur-gear to the right, called the planet-gear, is tied to the centre of the other, or sun-gear, by an arm which preserves a constant distance between their centres. This was used as a substitute for the crank in a steam engine by James Watt, after the use of the crank had been patented by another party. Each revolution of the planet-gear, which is rigidly attached to the connecting rod, gives two to the sun-gear, which is keyed to the fly-wheel shaft.

Figs. 1131, 1132. Different kinds of gears for transmitting rotary motion from one shaft to another arranged obliquely thereto.

Fig. 1133. A kind of gearing used to transmit great force and give a continuous bearing to the teeth. Each wheel is composed of 2, 3, or more distinct spur-gears. The teeth, instead of being in line, are arranged in steps to give a continuous bearing. This system is sometimes used for driving screw-propellers, and sometimes, with a rack of similar character, to drive the beds of large iron-planing machines.

Fig. 1134. Frictional grooved gearing—a comparatively recent invention. The diagram to the right is an enlarged section, which can be more easily understood.

Fig. 1135. Alternate circular motion of the horizontal shaft produces a continuous rotary motion of the vertical shaft, by means of the ratchet-wheels secured to the bevel-gears, the ratchet-teeth of the two wheels being set opposite ways, and the pawls acting in opposite directions. The bevel-gears and ratchet-wheels are loose on the shaft, and the pawls attached to arms firmly secured on the shaft.

Fig. 1136. The vertical shaft is made to drive the horizontal one in either direction, as may be desired, by means of the double-clutch and bevel-gears. The gears on the horizontal shaft are loose, and are driven in opposite directions by the third gear; the double-clutch slides upon a key or feather fixed on the horizontal shaft, which is made to rotate either to the right or left, according to the side on which it is engaged.

1129.

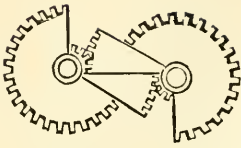

1130.

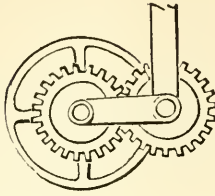

1131.

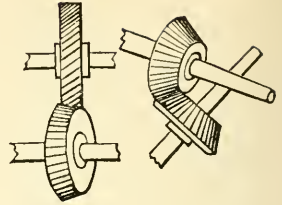

1132.

1132.

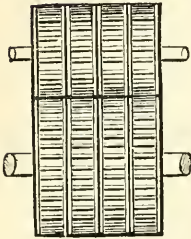

1134.

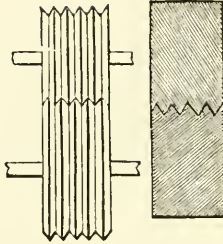

1135.

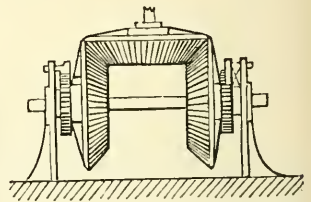

1136.

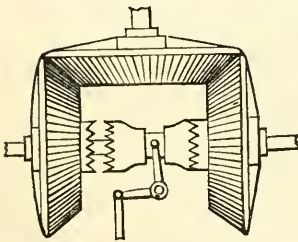

1137.

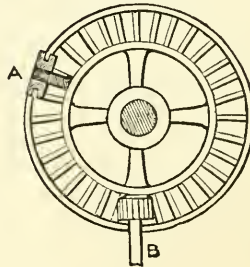

1138

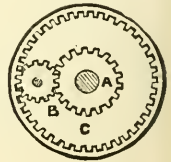

1139.

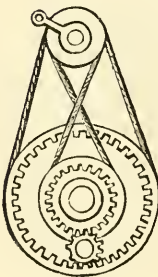

1140.

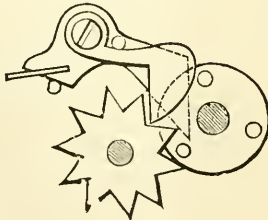

1141.

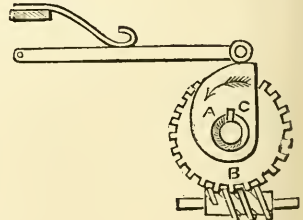

Fig. 1137. Mangle or star-wheel, for producing an alternating rotary motion.

Fig. 1138. Different velocity given to 2 gears, A and C, on the same shaft, by the pinion D.

Fig. 1139. The small pulley at the top being the driver, the large, internally-toothed gear and the concentric gear within will be driven in opposite directions by the bands, and at the same time will impart motion to the intermediate pinion at the bottom, both around its own centre and also around the common centre of the two concentric gears.

Fig. 1140. Jumping or intermittent rotary motion, used for meters and revolution-counters. The drop and attached pawl, carried by a spring at the left, are lifted by pins in the disc at the right. Pins escape first from pawl, which drops into next space of the star-wheel. When pin escapes from drop, spring throws down suddenly the drop, the pin on which strikes the pawl, which, by its action on star-wheel, rapidly gives it a portion of a revolution. This is repeated as each pin passes.

Fig. 1141. Another arrangement of jumping motion. Motion is communicated to worm-gear B by worm or endless screw at the bottom, which is fixed upon the driving shaft. Upon the shaft carrying the worm-gear works another hollow shaft, on which is fixed cam A. A short piece of this hollow shaft is half cut away. A pin fixed in worm-gear shaft turns hollow shaft and cam, the spring which presses on cam holding hollow shaft back against the pin until it arrives a little farther than shown in the figure, when, the direction of the pressure being changed by the peculiar shape of cam, the latter falls down suddenly, independently of worm-wheel, and remains at rest till the pin overtakes it, when the same action is repeated.

Fig. 1142. The left-hand disc or wheel C is the driving wheel, upon which is fixed the tappet A. The other disc or wheel D has a series of equidistant studs projecting from its face. Every rotation of the tappet acting upon one of the studs in the wheel D causes the latter wheel to move the distance of one stud. In order that this may not be exceeded, a lever-like stop is arranged on a fixed centre. This stop operates in a notch cut in wheel C, and at the same instant tappet A strikes a stud, said notch faces the lever. As wheel D rotates the end between studs is thrust out, and the other extremity enters the notch; but immediately on the tappet leaving stud, the lever is again forced up in front of next stud, and is there held by periphery of C pressing on its other end.

Fig. 1143. A modification of Fig. 1141; a weight D, attached to an arm secured in the shaft of the worm-gear, being used instead of spring and cam.

Fig. 1144. Another modification of Fig. 1141; a weight or tumbler E, secured on the hollow shaft, being used instead of spring and cam, and operating in combination with pin C, in the shaft of worm-gear.

Fig. 1145. The single tooth A of the driving wheel B acts in the notches of the wheel C, and turns the latter the distance of one notch in every revolution of C. No stop is necessary in this movement, as the driving wheel B serves as a lock by fitting into the hollows cut in the circumference of the wheel C between its notches.

Fig. 1146. B, a small wheel with one tooth, is the driver, and the circumference entering between the teeth of the wheel A, serves as a lock or stop while the tooth of the small wheel is out of operation.

Fig. 1147. The driving wheel C has a rim, shown in dotted outline, the exterior of which serves as a bearing and stop for the studs on the other wheel A, when the tappet B is out of contact with the studs. An opening in this rim serves to allow one stud to pass in and another to pass out. The tappet is opposite the middle of this opening.

Fig. 1148. The inner circumference (shown by dotted lines) of the rim of the driving wheel B serves as a lock against which two of the studs in the wheel C rest until the tappet A, striking one of the studs, the next one below passes out from the

1142.

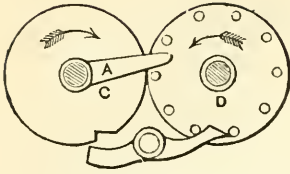

1143.

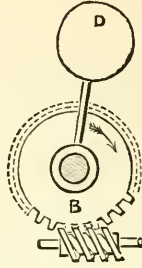

1144.

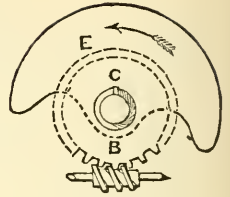

1145.

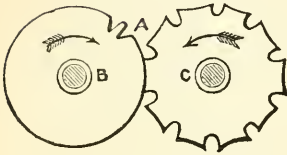

1146.

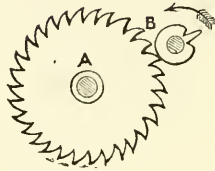

1147.

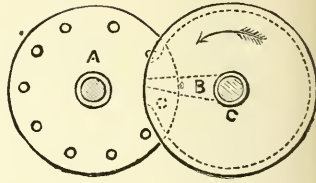

1148.

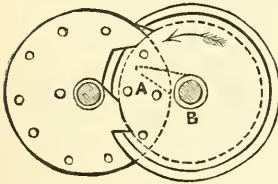

1149.

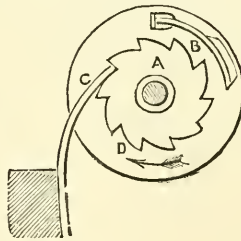

1150.

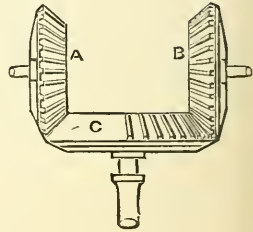

1151.

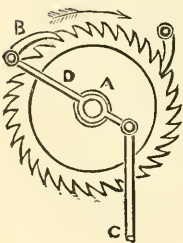

1152.

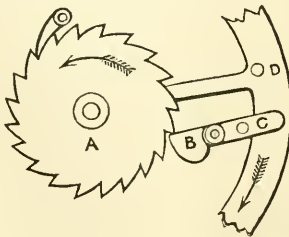

1153.

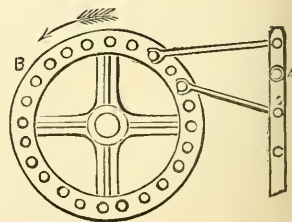

guard-rim through the lower notch, and another stud enters the rim through the upper notch.

Fig. 1149. To the driving wheel D is secured a bent spring B; another spring C is attached to a fixed support. As the wheel D revolves, the spring B passes under the strong spring C, which presses it into a tooth of the ratchet-wheel A, which is thus made to rotate. The catch-spring B, being released on its escape from the strong spring C, allows the wheel A to remain at rest till D has made another revolution. The spring C serves as a stop.

Fig. 1150. A uniform intermittent rotary motion in opposite directions is given to the bevel-gears A and B by means of the mutilated bevel-gear C.

Fig. 1151. Reciprocating rectilinear motion of the rod C transmits an intermittent circular motion to the wheel A, by means of the pawl B at the end of the vibrating bar D.

Fig. 1152 is another contrivance for registering or counting revolutions. A tappet B, supported on the fixed pivot C, is struck at every revolution of the large wheel (partly represented) by a stud D attached to the said wheel. This causes the end of the tappet next the ratchet-wheel A to be lifted, and to turn the wheel the distance of one tooth. The tappet returns by its own weight to its original position after the stud D has passed, the end being jointed to permit it to pass the teeth of the ratchet-wheel.

Fig. 1153. The vibration of the lever C on the centre or fulcrum A produces a rotary movement of the wheel B, by means of the two pawls, which act alternately. This is almost a continuous movement.

Fig. 1154. A modification of Fig. 1153.

Fig. 1155. Reciprocating rectilinear motion of the rod B produces a nearly continuous rotary movement of the ratchet-faced wheel A, by the pawls attached to the extremities of the vibrating radial arms C C.

Fig. 1156. Rectilinear motion is imparted to the slotted bar A by the vibration of the lever C through the agency of the two hooked pawls, which drop alternately into the teeth of the slotted rack-bar A.

Fig. 1157. Alternate rectilinear motion is given to the rack-rod B by the continuous revolution of the mutilated spur-gear A, the spiral spring C forcing the rod back to its original position on the teeth of the gear A quitting the rack.

Fig. 1158. On motion being given to the two treadles D a nearly continuous motion is imparted, through the vibrating arms B and their attached pawls, to the ratchet-wheel A. A chain or strap attached to each treadle passes over the pulley C, and as one treadle is depressed the other is raised.

Fig. 1159. A nearly continuous rotary motion is given to the wheel D by two ratchet-toothed arcs C, one operating on each side of the ratchet-wheel D. These arcs (only one of which is shown) are fast on the same rock-shaft B, and have their teeth set opposite ways. The rock-shaft is worked by giving a reciprocating rectilinear motion to the rod A. The arcs should have springs applied to them, so that each may be capable of rising to allow its teeth to slide over those of the wheel in moving one way.

Fig. 1160. The double-rack frame B is suspended from the rod A. Continuous rotary motion is given to the cam D. When the shaft of the cam is midway between the two racks, the cam acts upon neither of them; but by raising or lowering the rod A either the lower or upper rack is brought within range of the cam, and the rack-frame moved to the left or right. This movement has been used in connection with the governor of an engine, the rod A being connected with the governor, and the rack-frame with the throttle or regulating valve.

Fig. 1161. Uniform circular motion into reciprocating rectilinear motion, by means of mutilated pinion, which drives alternately the top and bottom rack.

Fig. 1162. Circular motion into alternate rectilinear motion. Motion is transmitted

1154.

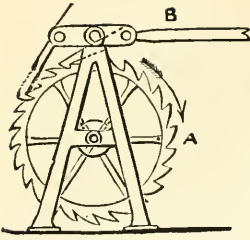

1155.

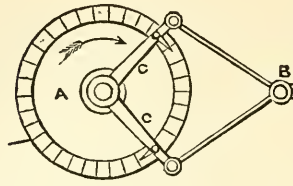

1156.

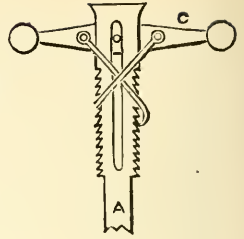

1157.

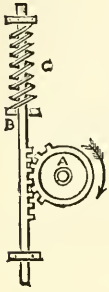

1158.

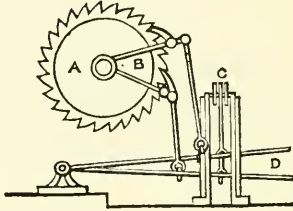

1159.

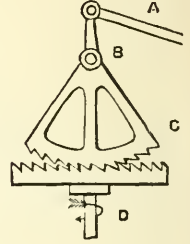

1160.

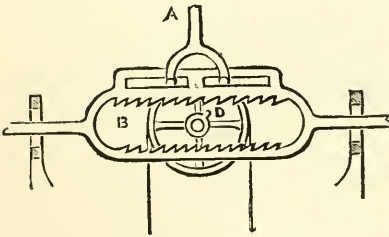

1161.

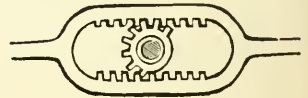

1162.

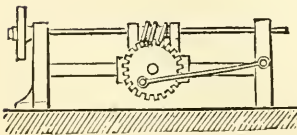

1163.

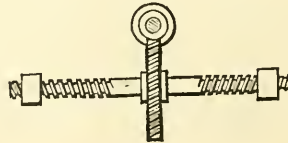

1164.

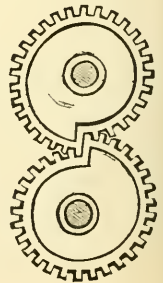

through pulley at the left upon the worm-shaft. Worm slides upon shaft, but is made to turn with it by means of a groove cut in shaft, and a key in hub of worm. Worm is carried by a small traversing frame, which slides upon a horizontal bar of the fixed frame, and the traversing frame also carries the toothed wheel into which the worm gears. One end of a connecting rod is attached to fixed frame at the right and the other end to a wrist secured in toothed wheel. On turning worm-shaft rotary motion is transmitted by worm to wheel, which, as it revolves, is forced by connecting rod to make an alternating traverse motion.

Fig. 1163. Continuous circular into continuous but much slower rectilinear motion. The worm on the upper shaft, acting on the toothed wheel on the screw-shaft, causes the right- and left-hand screw-threads to move the nuts upon them toward or from each other according to the direction of rotation.

Fig. 1164. Scroll-gears for obtaining a gradually increasing speed.

Fig. 1165. What is called a "mangle-rack." A continuous rotation of the pinion will give a reciprocating motion to the square frame. The pinion-shaft must be free to rise and fall, to pass round the guides at the ends of the rack. This motion may be modified as follows:—If the square frame be fixed, and the pinion be fixed upon a shaft made with a universal joint, the end of the shaft will describe a line, similar to that shown in the drawing, around the rack.

Fig. 1166. A mode of obtaining two different speeds on the same shaft from one driving wheel.

Fig. 1167. A continual rotation of the pinion (obtained through the irregular-shaped gear at the left) gives a variable vibrating movement to the horizontal arm, and a variable reciprocating movement to the rod A.

Fig. 1168. Worm or endless screw and worm-wheel. Used when steadiness or great power is required.

Fig. 1169. Variable circular motion by crown-wheel and pinion. The crown-wheel is placed eccentrically to the shaft, therefore the relative radius changes.

Fig. 1170. Irregular circular motion imparted to wheel A. C is an elliptical spur-gear rotating round centre D, and is the driver. B is a small pinion with teeth of the same pitch, gearing with C. The centre of this pinion is not fixed, but is carried by an arm or frame which vibrates on a centre A, so that as C revolves the frame rises and falls to enable pinion to remain in gear with it, notwithstanding the variation in its radius of contact. To keep the teeth of C and B in gear to a proper depth, and prevent them from riding over each other, wheel C has attached to it a plate which extends beyond it and is furnished with a groove *g h* of similar elliptical form, for the reception of a pin or small roller attached to the vibrating arm concentric with pinion B.

Fig. 1171. If for the eccentric wheel described in the last figure on ordinary spur-gear moving on an eccentric centre of motion be substituted, a simple link connecting the centre of the wheel with that of the pinion with which it gears will maintain proper pitching of teeth in a more simple manner than the groove.

Fig. 1172. This movement is designed to double the speed by gears of equal diameters and numbers of teeth—a result once generally supposed to be impossible. Six bevel-gears are employed. The gear on the shaft B is in gear with two others—one on the shaft F, and the other on the same hollow shaft with C, which turns loosely on F. The gear D is carried by the frame A, which, being fast on the shaft F, is made to rotate, and therefore takes round D with it. E is loose on the shaft F, and gears with D. Now, suppose the two gears on the hollow shaft C were removed and D prevented from turning on its axis, one revolution given to the gear on B would cause the frame A also to receive one revolution, and as this frame carries with it the gear D, gearing with E, one revolution would be imparted to E; but if the gears on the hollow shaft C were replaced D would receive also a revolution on its axis during the one revolution of B, and thus would produce two revolutions of E.

1165.

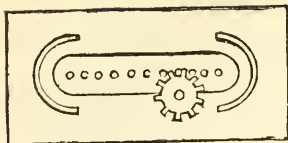

1166.

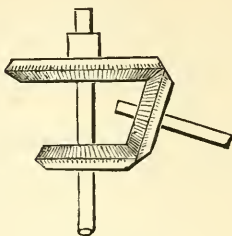

1167.

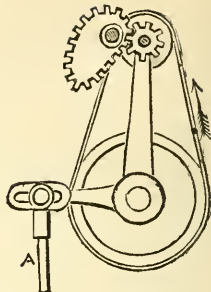

1168.

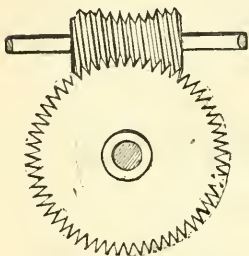

1169.

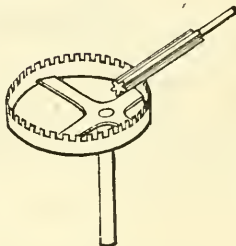

1170.

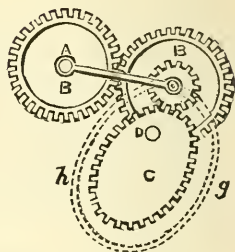

1171.

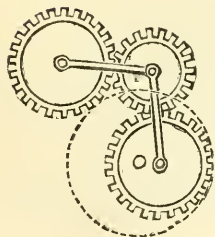

1173.

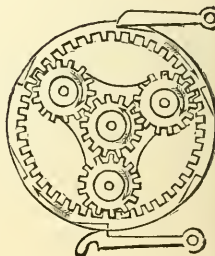

1172.

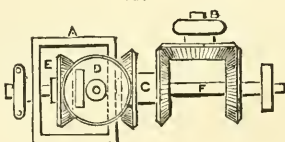

1174.

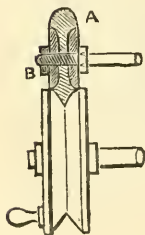

1175.

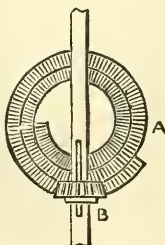

1176.

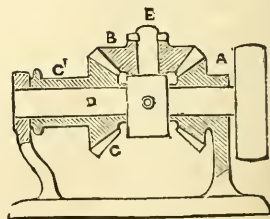

Fig. 1173. Wheel-work in the base of capstan. Thus provided, the capstan can be used as a simple or compound machine, single or triple purchase. The drumhead and barrel rotate independently; the former, being fixed on spindle, turns it round, and when locked to barrel turns it also, forming single purchase; but when unlocked wheel-work acts, and drumhead and barrel rotate in opposite directions, with velocities as three to one.

Fig. 1174. J. W. Howlett's adjustable frictional gearing. This is an improvement on that shown in Fig. 1134. The upper wheel A shown in section, is composed of a rubber disc with V-edge, clamped between two metal plates. By screwing up the nut B, which holds the parts together, the rubber disc is made to expand radially, and greater tractive power may be produced between the two wheels.

Fig. 1175. Scroll-gear and sliding pinion, to produce an increasing velocity of scroll-plate A, in one direction, and a decreasing velocity when the motion is reversed. Pinion B moves on a feather on the shaft.

Fig. 1176. Entwistle's gearing. Bevel-gear A is fixed. B, gearing with A, is fitted to rotate on stud E, secured to shaft D, and it also gears with bevel-gear C loose, on the shaft D. On rotary motion being given to shaft D, the gear E revolves around A, and also rotates upon its own axis, and so acts upon C in two ways, namely, by its rotation on its own axis and by its revolution around A. With three gears of equal size, the gear C makes two revolutions for every one of the shaft D. This velocity of revolution may, however, be varied by changing the relative sizes of the gears. C is represented with an attached drum C'. This gearing may be used for steering apparatus, driving screw-propellers, &c. By applying power to C action may be reversed, and a slow motion of D obtained.

TURNING.—This operation consists in giving a new form to objects in wood, metal, ivory, &c., by means of fixed tools held against the object while it is revolved within reach of the tool. The machine employed for rotating the object is called a lathe.

Lathes.—These are now made in a great variety of form and capacity. In looking back to the early days of the turning lathe, before the introduction of the transfer principle in the sliding rest, it is interesting to observe that even then the lathe was a perfect instrument so far as it was a copying machine; those common lathes that were made with a perfectly round spindle-neck, if any such existed, would yield a round figure in the article under operation, providing that the cutting instrument was held steadily. And even in a still higher degree was correct workmanship attained in the old-fashioned dead-centre lathes; if the centre holes in the article to be turned were formed with moderate care, and the article held steadily between the centres, then the surface developed by the cutting instrument when firmly held would be as perfect a circle as one described by a pair of compasses. With such apparatus, however, the chances of error were numerous, arising principally from the spindle-necks not being perfectly round; for even in the case of modern lathes, a perfect spindle-neck is more rarely obtained than is generally supposed, as a close examination will show, the polygonal form being much more predominant than the true circle. There are lathes, even among those of the most recent make, which have only to be handled gently to show their condition in this respect. Until recently such approximations to roundness were sufficient; but the extensive introduction of accurate gauges into workshops has, besides teaching the importance of precise dimensions, made engineers familiar with true circles. Hence there is now a much greater appreciation of positive truth of workmanship, and positive truths are always important; and in well-conducted workshops there is a constant striving after that condition and a gradual closing up of every avenue whereby error can creep in.

Such extreme accuracy is sometimes thought to be more costly than a less careful system; but practical men, like Anderson, have arrived at a contrary opinion, and are

convinced that while extreme accuracy may be more expensive at the outset, especially from the want of workmen competent to carry it out, yet with a little perseverance the advantage arising from it will be clearly perceived, and the apparently inordinate cost will shortly be brought below that of less perfect arrangements. Many articles after being carefully turned and planed have to undergo a long course of filing and scraping before they are brought to the required quality of surface; whereas, if a small fraction of this outlay were spent in making the copy in the lathe spindle or the copy in the plane perfect as patterns, the great expense of subsequent fitting would be avoided. Many examples bearing on this point could be given. The lathe is a copying machine, and just as its bearing surfaces are so is the work produced.

The apparatus generally employed by wood and ivory turners is termed a foot-lathe, on account of its being driven by the foot in the same manner as the common grinders' wheel; some are constructed partly in metal and partly in wood, but those made entirely of metal are far superior to these, and are of the following construction. A, Fig. 1177,

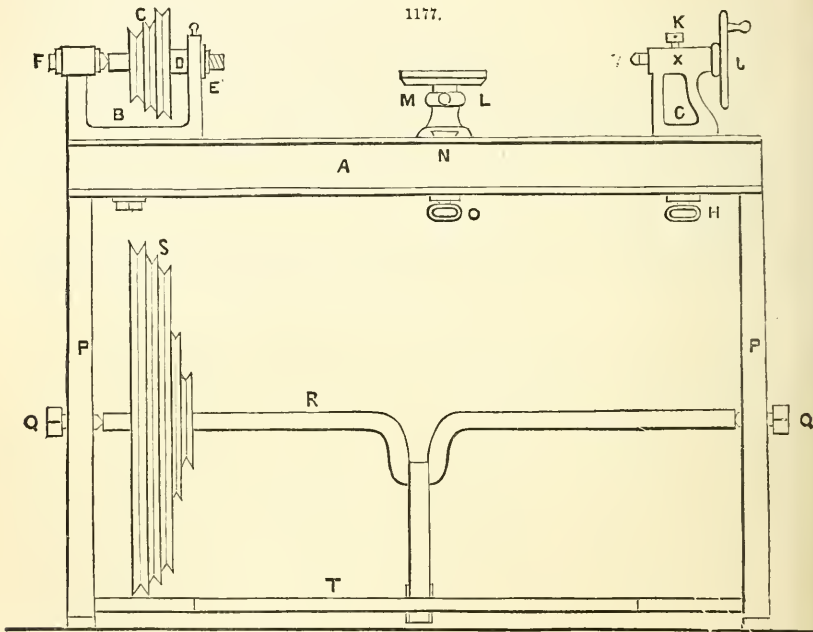

is the bed of the lathe, upon which 2 supports, called poppet-heads, rest; the surfaces of contact vary in form, in some beds both are flat, in others both angular, and in others one angular and the other flat. By many the angular or ∇ beds are preferred, from the idea that the heads are more likely to retain their proper position than when resting on plane surfaces; but the latter, when accurately planed and fitted, are quite as worthy of reliance, and far more convenient than the angular-bedded lathes. B represents the head to which the chucks are attached, and by means of which the power requisite for rotating the work is applied. This poppet-head consists of a strong frame of cast iron F B E; in the standard E is fixed a hard conical bearing, in which one end of the mandrel D revolves, and by which it is supported, the other end resting against the hard conical point of a screw placed in a nut at F; by means of this screw the mandrel is

kept tight up to its bearings, any tendency of the screw to shift being prevented by one or two nuts upon it, which are screwed up tight against the standard F.

At the bottom of the head is a solid projection, which is made to fit the opening between the sides of the lathe-bed, and by which the parallelism of the lathe-bed and mandrel is maintained. The head is firmly fixed in its position by a bolt, which draws a strip of metal up tight against the bottom of the lathe-bed. A number of groove pulleys G are attached to the mandrel, one of which is connected with the pulleys S on the driving shaft R by means of a cord of catgut or guttapercha, although in a case of necessity a sash-line may be made to answer the purpose. The catgut is, however, the most satisfactory, on account of its great durability. The plan usually adopted for joining the ends is to screw on hooks and eyes; the end of the gut is slightly tapered and damped, so that the hooks and eyes may squeeze the gut into a screw rather than cutting it, by which latter the band would be much weakened.

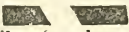
It must not be used until the gut is dry and hard. Guttapercha bands are united by heat, the ends being cut off obliquely, thus,  and gently heated by means of a hot piece of smooth clean iron, until soft, when they are firmly pressed together, and kept in that position until cold. This, of course, necessitates the stoppage of the lathe for some time, besides shortening the band every time it is united.

When the work is too long to be supported entirely by one end, a second poppet-head is required, which is of the form shown at C; this head is accurately fitted to the lathe-bed, and can slide upon it to allow of adjustment to the length of the work; it is fitted with a clamping screw H to fix it when in position, also a conical point I, called a centre, which is movable through a small space by the handle J, to allow the removal of the work from the lathe without shifting the poppet-head. The mandrel carrying the centre is fixed after adjustment by the capstan-headed screw K.

The next part of the apparatus to which attention is called is the rest, upon which the operator supports the turning tool. There are 2 kinds, the common rest and the slide-rest; the former is that represented in the figure. M L is a short hollow column, provided with a foot sufficiently long to reach across the lathe-bed; in the bottom of the foot is planed a dovetailed groove N, which retains the head of a clamping screw O, but at the same time allows of a sliding motion when not clamped. From this it is evident that the rest can be placed and fixed in any position.

Within the hollow column is a cylindrical rod, which carries a straight strip of metal, the whole being raised or lowered by sliding the rod vertically in the column; when the proper elevation has been attained, the rest is fixed by a screw working in a thread cut in the thickness of the column.

The lathe-bed is supported on standards or frames P P, which also serve to carry the crank-shaft R by means of 2 conical-pointed screws Q Q, which enter countersunk recesses in the ends of the shaft. The shaft is made with one or two cranks, or throws, according to its length. This shaft is also fitted with grooved driving pulleys S, made of various diameters, in order to obtain any speed which may be required. The pressure imparted to the treadle T is communicated to the crank by a link with a hook at each end, or by a chain; some turners preferring the former, and others the latter.

The next consideration is the means by which the work is held in the lathe and caused to rotate with the mandrel.

Fig. 1178 represents the fork, prong, or strut-chuck, so called from the steel fork or prong α , which is fitted into the square socket of the chuck; this chuck is used for long pieces, the point supporting one end of the work, the other being supported by the back centre. The chisel edges on each side of the point take hold of the work and ensure its rotation. The fork being fitted into a square recess in the chuck may be replaced by drills, &c., or small pieces of wood or ivory to be turned. It is usually made of metal, and attached to the mandrel by an internal screw corresponding to that on the nose of the mandrel.

Fig. 1179 illustrates the hollow or cup-chuck; it is used for holding short pieces, or pieces that are to be turned out hollow. Its inside is turned slightly conical so that the work may be driven tightly into it. This chuck is usually made of boxwood, sometimes strengthened by a metal ring round the mouth of it; but this is scarcely necessary, as a very slight blow is sufficient to fix the work if it has previously been reduced to a form nearly approaching the circular by the chisel, paring knife, or other hand tools.

Fig. 1180 shows the face-plate or facing chuck; it may be made of iron or other suitable material. This chuck is turned flat and perfectly true, and is fitted at its

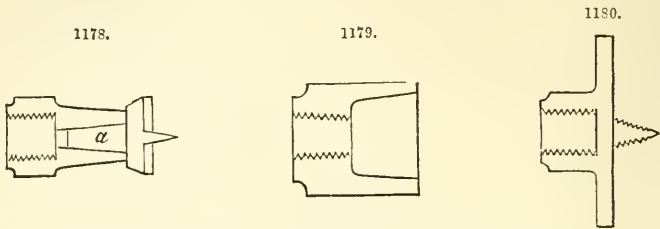

centre with a conical screw to hold objects to be turned on the face. It can only be used when the hole made in the work is not objectionable, or can be plugged up. The screw should only be very slightly taper, otherwise the work will not hold when reversed.

Fig. 1181 is a chuck for flat work, where a hole in the centre would be detrimental. It is a face-plate with 3 or more small spikes projecting from its surface to penetrate the material to be wrought, which is held against it by the back centre. A plane face-plate is used where the work cannot be conveniently fixed to either of the 2 foregoing, as in the case of thin pieces of horn, tortoiseshell, and so on. The work is attached by means of glue, or of jewellers' or turners' cement.

Fig. 1182 represents the arbor-chuck, usually made of brass. It is used for holding small hollow works or rings.

For very small work, Fig. 1178 is useful for holding the arbors in the place of a strut *a*.

Fig. 1183 shows a spring-chuck which is used for holding very slight work that

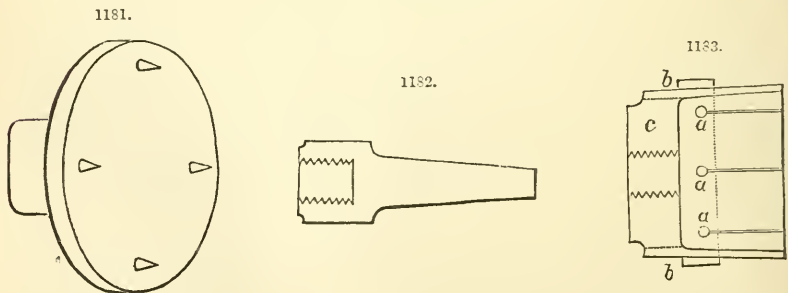

requires to be hollowed out. It is turned conical externally, the apex of the cone being to the left. A few holes *a* are drilled through the chuck near its base and at equal distances from each other. From these holes saw kerfs or slits are cut longitudinally to the front of the chuck, which allow the chuck to expand slightly to take a firm hold of the work, and when the work has been forced into the chuck, the grip is rendered still

more firm by drawing a strong ring towards the front of the chuck. These chucks are sometimes made of wood, but those of metal are much neater and more convenient; they may be made of a piece of brass tube firmly driven on a wooden block.

A similar chuck is used for holding hollow work, but instead of being provided with an external ring, it is fitted with a short solid plug, which is forced forwards after the chuck has been inserted into the work. When long and slender pieces have to be turned, an extra poppet or a support is required to keep the work from shaking, or chattering, as it is termed. It is generally made of wood, and is formed similar to Fig. 1184. It consists of a head, in which is bored a hole *c* of the proper diameter, and a tail-piece fitted to the lathe-bed and sufficiently long to receive an aperture *b*, through which a wedge may be passed to hold it down firmly upon the lathe-bed.

Another and more convenient form of support is shown at Fig. 1185: *a* is a cast-iron frame, having a foot fitted to the lathe-bed and furnished with a bolt and nut by which it is firmly bolted down to the lathe-bed; *b* is a block of wood fitted into the frame, where it is secured by the cross-bar *c*. An aperture of the required diameter is now bored in the block; it is then taken out of the frame and sawed in half, so as to form a

1186.

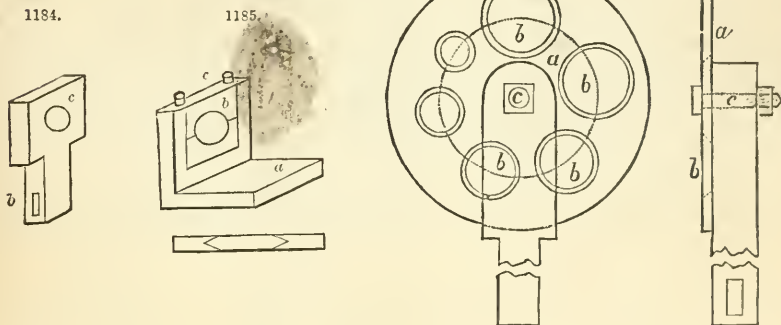

top and bottom bearing; *d* shows a section of the frame; any other form of groove may be used, but the V has been selected on account of the ease with which the blocks may be fitted to them. One great advantage of the latter apparatus is, that the 2 bearings may be brought together when the hole is worn. When a slide-rest is used, this additional support should be attached to it; it will then keep close to that part of the work on which the tool is acting, by which a more satisfactory piece of work is turned out, and the trouble of shifting the poppet avoided. The application of a little grease to these bearings will sometimes be found beneficial.

An apparatus called a boring collar, somewhat similar to that just described, is used for supporting the ends of pieces of which the ends are to be bored, and which are too long to be held by the cup-chuck alone. It consists of a plate similar to a face-chuck, Fig. 1186, through which a number of conical holes are bored, whose centres are equidistant from the centre of the plate, so that when the latter is turned on its axis any hole can be brought exactly in a line with the 2 centres. The plate may be attached to a standard similar to either of the foregoing.

It may sometimes occur that the work to be turned, as a wheel, the foot of a stand, and so on, may be rather too large for the lathe; in this case it is convenient to have frames truly planed and fitted. Such a frame is shown at Fig. 1187. It is made of cast

iron, the top being fitted to the bottom of the poppet, and the bottom being fitted to the lathe-bed, care being taken that the mandrel is retained parallel to the lathe-bed. The rest may be blocked up in a similar manner, or a temporary rest may be made of a piece of bar iron bent to a suitable form.

In some cases it will be convenient to have a self-acting slide-rest, as for turning large screws, spirals, and so on. The slide-rest is shown in Fig. 1188 (elevation) and

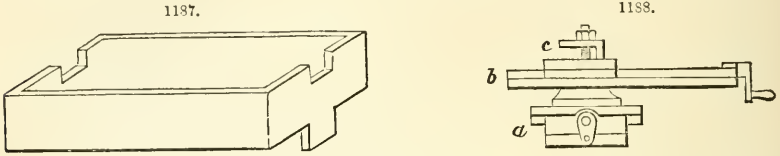
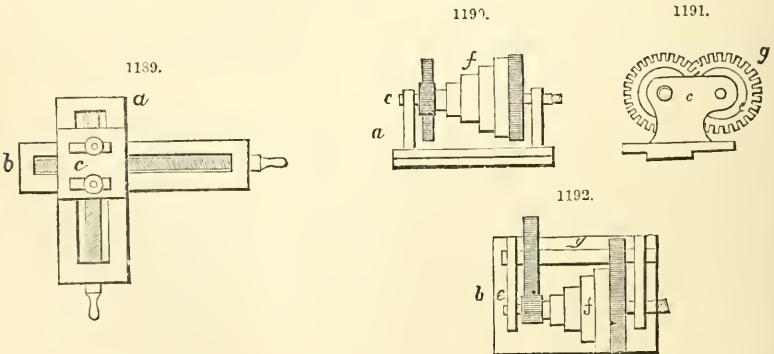

Fig. 1189 (plan). *a* is a slide which fits the lathe-bed very accurately, but will yet slide freely upon it, and in a direction exactly parallel to the axis of the object to be turned. *b* is another slide fitted to the lower one and sliding upon it in a direction at right angles to the lathe-bed. It is worked by a screw attached to the lower slide, which gears into a nut fixed to the bottom of the slide *b*. Upon the slide *b* is fitted a small slide *c*, upon which the turning tool is fixed by means of a clamp. This slide is moved in a direction parallel to the lathe-bed by means of a screw attached to the slide *b*, gearing in a similar manner to that in the slide *a*. The whole slide may be moved along the bed either by hand or by means of a screw running along the side of the bed and gearing into a nut made in 2 halves, so that it may be thrown into or out of gear by closing or opening the nut. The use of this screw, which is called the leading screw, requires a different form of fixed poppet-head, and constitutes what is called a screw-cutting lathe, on account of its suitability to that process.

The poppet-head generally fitted to self-acting lathes is represented in Figs. 1190 to 1192. *a* is a side elevation, *b* a plan, and *c* a front elevation. This head is fitted with speed



pulleys *f*, which may be made fast to the mandrel, so as to drive it direct or loosened, and geared by a tooth-wheel with the shaft *g*, which again gears into the mandrel, which is supported in bearings at each end. The wheels on the shaft *g* are thrown out of gear with those on the mandrel by sliding the shaft endwise in its bearings. It is retained in or out of gear by a pin passing into the bearing, which rests against a groove turned on the shaft *g*. On the end *e* of the mandrel a toothed wheel is slid and retained there by a nut. This wheel may act directly upon another placed on the end of the leading

screw, or may be connected with it by means of one or two intermediate wheels, according to the speed required and the direction of the intended screw.

It is evident from this arrangement that any ratio between the speeds of the mandrel and leading screw may be obtained either for cylindrical turning or screw cutting.

Fig. 1193 is a very complete double-gear foot-lathe, with planed bed, standards, anti-

1193.

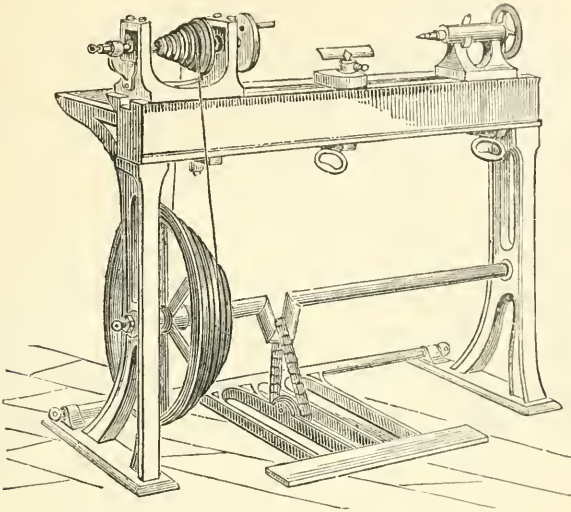

friction treadle, with chain, crank, and driving wheel, hand-rest, face-plate, drill-chuck, and 2 centres.

Fig. 1194 is a single-gear foot-lathe, with planed bed, standards, anti-friction treadle, with chain, crank, and driving wheel, hand-rest, face-plate, drill-chuck, and 2 centres.

Fig. 1195 is a compound slide-rest; another arrangement of compound slide-rest is shown in Fig. 1196.

With reference to lathe manipulation, which is perhaps the most difficult of all shop operations to learn, the following hints are given by Richards in his excellent manual on 'Workshop Manipulation.'

At the beginning, the form of tools should be carefully studied: this is one of the great points in lathe work; the greatest distinction between a thorough and an indifferent latheman is that one knows the proper form and temper of tools and the other does not. The adjustment and presenting of tools is soon learned by experience, but the proper form of tools is a matter of greater difficulty. One of the first things to study is the shape of cutting edges, both as to clearance below the edge of the tool, and the angle of the edge, with reference to both turning and boring, because the latter is different from turning. The angle of lathe tools is clearly suggested by diagrams, and there is no better first lesson in drawing than to construct diagrams of cutting angles for plane and cylindrical surfaces.

A set of lathe tools should consist of all that are required for every variety of work performed, so that no time will be lost by waiting to prepare tools after they are wanted. An ordinary engine lathe, operating on common work not exceeding 20 in. of diameter, will require 25-35 tools, which will serve for every purpose if they are kept in order and in place. A workman may get along with 10 tools or even less, but not to his own

satisfaction, nor in a speedy way. Each tool should be properly tempered and ground, ready for use when put away; if a tool is broken, it should at once be repaired, no matter when it is likely to be again used. A workman who has pride in his tools will

always be supplied with as many as he requires, because it takes no computation to prove that 50 lb. of extra cast steel tools, as an investment, is but a small matter compared to the gain in manipulation by having them at hand.

To an experienced mechanic, a single glance at the tools on a lathe is a sufficient clue to the skill of the operator. If the tools are ground ready to use, of the proper shape, and placed in order so as to be reached without delay, the latheman may at once be set down as having

1194.

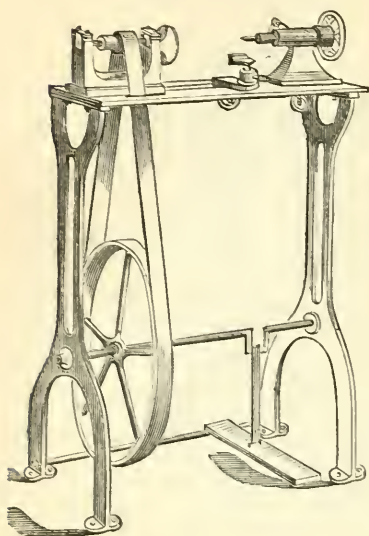

1195.

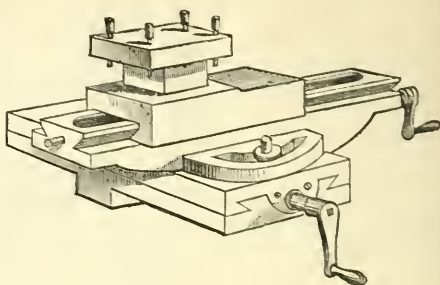

1196.

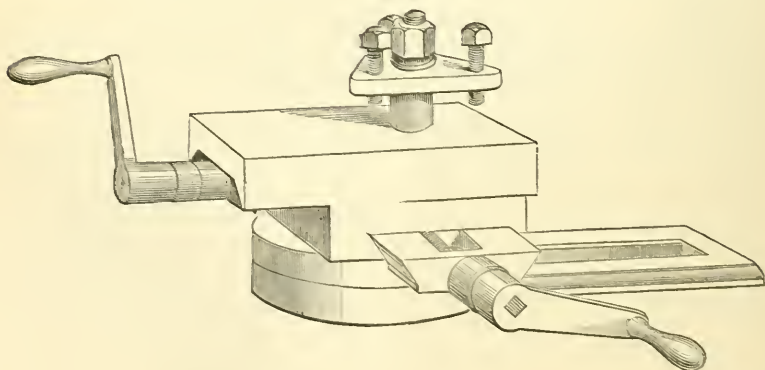

2 of the main qualifications of a first-class workman, which are order, and a knowledge of tools; while on the contrary, a lathe-board piled full of old waste, clamp-bolts, and broken tools, shows a want of that system and order, without which no amount of hand skill can make an efficient workman.

It is also necessary to learn as soon as possible the technicalities pertaining to latho work, and still more important to learn the conventional modes of performing various

operations. Although lathe work includes a large range of operations which are continually varied, yet there are certain plans of performing each that has by long custom become conventional; to gain an acquaintance with these an apprentice should watch the practice of the best workmen, and follow their plans as near as he can, not risking any innovation or change until it has been very carefully considered. Any attempt to introduce new methods, modes of chucking work, setting and grinding tools, or other of the ordinary operations in turning, may not only lead to awkward mistakes, but will at once put a stop to useful information that might otherwise be gained from others. The technical terms employed in describing lathe work are soon learned, generally sooner than they are needed, and are often misapplied, which is worse than to be ignorant of them.

In cutting screws it is best not to refer to that mistaken convenience called a wheel list, usually stamped on some part of engine lathes to aid in selecting wheels. A screw to be cut is to the lead screw on a lathe as the wheel on the screw is to the wheel on the spindle, and every workman should be familiar with so simple a matter as computing wheels for screw cutting, when there is but one train of wheels. Wheels for screw cutting may be computed not only quite as soon as read from an index, but the advantage of being familiar with wheel changes is very important in other cases, and frequently such combinations have to be made when there is not an index at hand.

The following are suggested as subjects which may be studied in connection with lathes and turning: the rate of cutting movement on iron, steel, and brass; the relative speed of the belt cones, whether the changes are by a true ascending scale from the slowest; the rate of feed at different changes estimated like the threads of a screw at so many cuts per in.; the proportions of cone or step pulleys to ensure a uniform belt tension; the theory of the following rest as employed in turning flexible pieces; the difference between having 3 or 4 bearing points for centre or following rests; the best means of testing the truth of a lathe. All these matters and many more are subjects not only of interest but of use in learning lathe manipulation, and their study will lead to a logical method of dealing with problems which will continually arise.

The use of hand tools should be learned by employing them on every possible occasion. A great many of the modern improvements in engine lathes are only to evade hand-tool work, and in many cases effect no saving except in skill. A latheman who is skilful with hand tools will, on many kinds of light work, perform more and do it better on a hand lathe than an engine lathe; there is always more or less that can be performed to advantage with hand tools even on the most elaborate engine lathes. It is no uncommon thing for a skilled latheman to lock the slide-rest, and resort to hand tools on many kinds of work when he is in a hurry. (Richards.)

Tools.—Common lathe tools may be few or many, according to the requirements of their owner, and tools for wood working or for metal working may predominate, according to taste. A workman is always adding to his stock of tools, until by-and-by he almost insensibly finds himself in possession of a very varied assortment, each member of which has a special use and a special history. From among a set of lathe tools we will select and describe those which are either absolutely essential or of very general adaptability; all the rest beside are merely modifications of these few and simple types. Excellence in the production of plain turned work, whether of wood or metal, does not necessarily follow from the possession of a large number of tools, but depends entirely upon skill in their manipulation. In the hands of a professional wood-turner a simple gouge is a marvellous tool, producing hollows, ogces, and mouldings of various shapes with swift dexterity, aided only by the chisel where sharp corners are concerned. Those who handle the gouge with confidence and skill can turn out their work quicker, cleaner, and better than those who, dreading a disastrous "kick" or "catch," scrape away cautiously with round nose and chisel and diamond point. Therefore, plenty of practice with the gouge is essential to the acquirement of a perfect

command of that tool, and he who has acquired this mastery is, to a very great extent, independent of the rest.

For Metals.—The turning of metal is effected by a slow motion, comparatively speaking, with respect to the turning of wood; yet wood-turning tools require a less obtuse angle to form the cutting edge than the tools employed to turn iron, brass, or steel. The planes forming the cutting edge of metal-turning tools make a solid angle which generally exceeds 60° . Figs. 1197 to 1213 are a set of turning tools for metal, Figs. 1212, 1213 being especially for screw cutting.

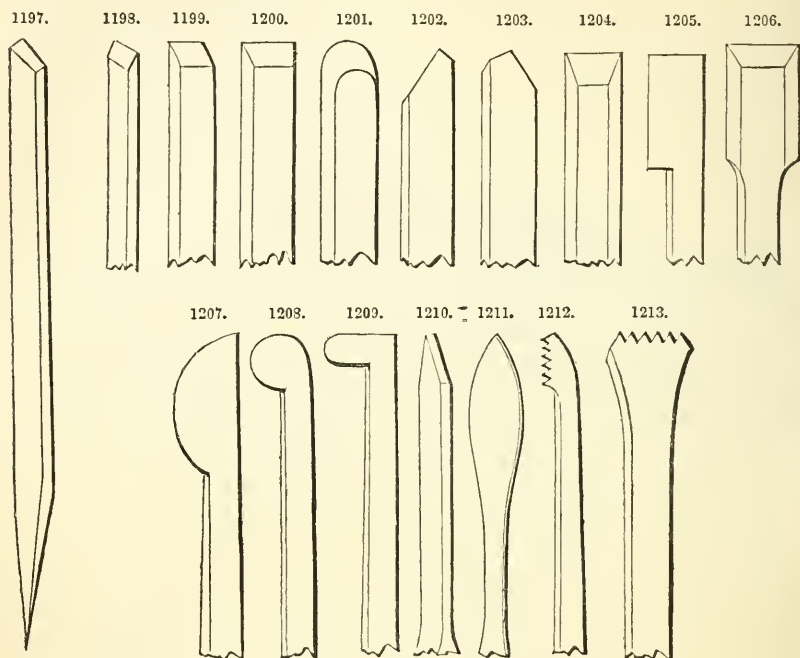

A writer in the *English Mechanic* says that metal-turning tools are made from "tool steel," different kinds of which are in the market, and may be purchased in square bars of various sizes. Few tools, except scrapers, can be used indiscriminately for cast iron, wrought iron, and brass; each metal needs its particular set of tools, differing, not so much in the shape of their cutting edges, as in the angles which they make with the surface of the work to be turned. Thus, Figs. 1214, 1215, 1216, are each intended to represent in profile the ordinary roughing-down tool; but their angles are very different the one from the other, Fig. 1214 being only suitable for wrought iron, Fig. 1215 for cast iron, and Fig. 1216 for brass. In all these, everything (temper of course excepted) depends upon the angle at which the tools are ground. The brass tool with the flat face would not cut the iron, but would simply abrade it; while the iron tools would hitch in the brass, and manifest a tendency to chatter or to "draw in." Neither would the tool ground at an acute angle for wrought iron cut cast metal, but would itself become broken off at the tip, while the thicker cast-iron tool would not take clean shavings off wrought iron, but would possess more of a scraping action. Men accustomed to metal turning know exactly how to grind their tools, so that they shall either cut or scrape wrought iron,

cast iron, or brass; but to assist others in the matter, the cutting edges of various tools are drawn to a large scale.

Taking the iron-turning tools first, Fig. 1217 is a common roughing tool for cast iron. The side view gives the proper angle to ensure a clean cut, without breaking the top across in the direction of the dotted line. The angle is drawn on the supposition that

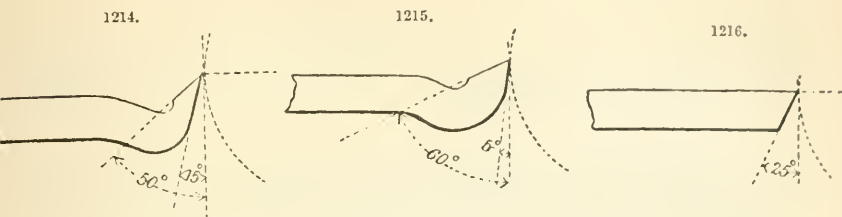

the tool is held horizontally, as indeed it ought to be. But a tool that will not cut nicely in a horizontal direction will often work by inclining it at a slight angle; hence, less care is often taken in the grinding of hand tools than in those used with the slide-rest. Neither is the angle at which a tool should be ground, in order to cut well horizontally, necessarily quite constant. It should be about 65° with the vertical for cast iron, but may vary slightly either way. In fact, not one workman in ten could say what angle he grinds his tools to: he simply judges the proper angle by the experienced eye which seldom betrays him. The angle which the front of the tool makes with the work may vary somewhat more than the upper face, depending on the diameter of the work to be turned, but should not slope more than 4° or 5° from the vertical for cast iron (Fig. 1215). If it becomes excessive, the tool is weak, and soon abrades or breaks off. Attention to these matters, apparently so trivial, is really of the utmost importance. The angles given on sketches are taken from tools in actual use, doing their work well.

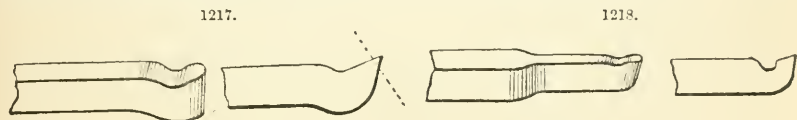
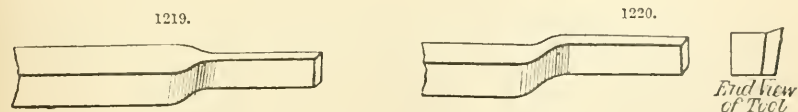
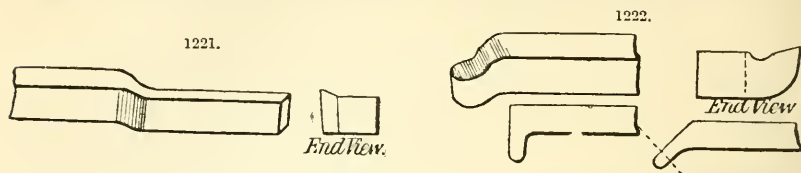

Fig. 1218 shows a round nose; Fig. 1219 a parting tool; Fig. 1220 a knife tool for finishing edges and faces of flanges, and ends and sides of work, which latter will of course be required right- and left-handed (Fig. 1221), just as we require right- and left-handed side tools in wood turning. The end views of these tools show the upper and clearance angles, which are about the same as in Fig. 1215, but may vary somewhat more without detriment to the work.



Figs. 1222 are boring tools for hollow cylinders—tools capable of much modification, their cutting edges not only taking the forms of all the other tools, but each form also being often required right- and left-handed. In reference to the more usual shape—that of the round nose for boring, when used simply as a roughing tool, the shape B showing it in plan, with the axis of the cutting angle in the direction of the dotted line is preferable to A, because in the former the true cutting edge is carried forward.

Hence, in workshops, the cutting tools generally take the form B, and the scrapers that of A. But these boring tools are not for hand use, the rigidity of the slide-rest being necessary to ensure accurate work with them. Otherwise the tools under description are suitable alike for manipulation by hand or slide-rest, the difference



between the 2 forms lying, not in the cutting edges, but in the relative stoutness. Slide-rest tools are made of stouter metal than the others; in the case of a small lathe, from $\frac{5}{8}$ in. or $\frac{3}{4}$ in. square steel, while hand tools for the same can be made from $\frac{3}{8}$ -in. steel.

Fig. 1223 is a square nose for taking finishing cuts, and Fig. 1224 a tool for scraping. Fig. 1225 is a spring tool, also used for finishing a turned surface. Figs. 1226 and 1227 are for finishing hollows and rounded parts of work, and are either kept in different

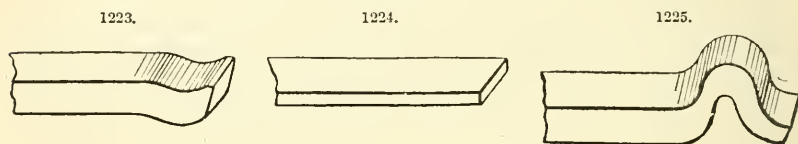

sweeps or ground to radii as wanted. These latter forms, being required only to smooth and polish, are flat on their upper surfaces, and act simply as scrapers. Graving tools are merely square pieces of steel ground slightly obliquely at the cutting end, and used in hand turning and for any metal.

Almost any tool flat on its upper surface will turn brass, and the clearance angle may vary from 20° to 30° . Fig. 1228 will cut rapidly, and will keep its edge for an immense time, and, of course, can be used bent round like Fig. 1222 for boring purposes. Yet the same tool used on iron would not cut, but would become hot immediately. Figs. 1226 and 1227 make excellent brass tools.

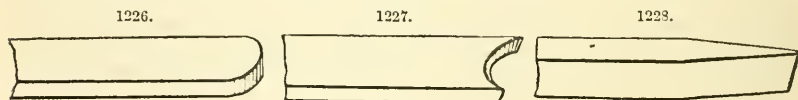

In turning cast iron and brass no water is used, but with wrought iron it becomes necessary to cool the cutter by allowing a constant supply of water to drip upon the tool. A water-can, with a tap regulated as required, is supported on the slide-rest, and travels along with it. In hand turning it must be moved where wanted.

The tools here mentioned have been typical forms; but, bearing the broad distinctions between the various angles in mind, it is easy to make or to alter tools just as wanted. In making tools for the slide-rest, a piece of steel is cut off longer than is necessary for immediate use, and the amount of metal in it allows for the wear of a lifetime. Often also, both ends of the steel are forged into cutting edges (Fig. 1229), and hence the workman can usually find a tool at any time, either suitable for the work in hand, or which may be rendered suitable by a little alteration.

A grindstone may be made in this fashion. (Fig. 1230.) A piece of broken grindstone, 2 in. thick, is rudely clipped round to 7 in. diameter, and a $\frac{1}{2}$ -in. hole bored through the centre with a common stone bit; 2 wooden washers *a*, $\frac{1}{2}$ in. thick by 4 in. diameter, also have $\frac{1}{2}$ -in. holes bored in their centres. A $\frac{1}{2}$ -in. bolt *b* thrust through the

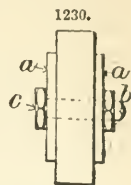
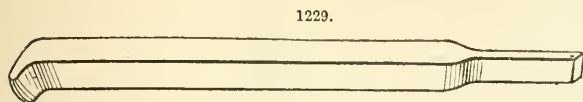

whole keeps them together firmly with the stone in the centre. Intended to chuck between centres, a small drilled hole is run both into the bolt head and into the screwed end, and a V-shaped slit *c* is filed in the head to take the fork. Turned up in place, it is an efficient little grindstone, in readiness for use the moment it is slipped into the lathe. Its only drawback is that it makes the bed in a mess—a most serious objection in the case of a bright iron bed; in that case, rig up an intermediate spindle driven from a wheel in the crank axle, and from that turn the grindstone somewhere beyond the end of the bed.

Grinding alone is required with roughing-down tools; but, in those used for smoothing and polishing, the edge should be finished with an oilstone or gouge slip, as with wood-turning tools.

A milling tool is necessary for screw heads: you can make one with little trouble, thus (Fig. 1231): In a piece of wrought iron, 6 in. by $\frac{3}{4}$ in. by $\frac{1}{2}$ in., file a slot $\frac{3}{8}$ in. long by $\frac{1}{4}$ in. wide. At $\frac{1}{2}$ in. from the same end drill 2 $\frac{1}{8}$ -in. holes. Then take a short broken piece from the end of a flat file, and, after lowering the temper in the fire, grind it roughly to $\frac{3}{8}$ in. in diameter; afterwards drilling an $\frac{1}{8}$ -in. hole through the centre of this, chuck and finish the outside true and slightly hollow. An $\frac{1}{8}$ -in. screw bolt, passed through the holes in the bar and in the wheel, retains the latter in place. Then procure what is called a "hob," or master tap, used for cutting steel dies, and running that round between centres, cut the edge of the milling wheel by pressing the latter against the revolving tap with considerable force. Hardening the wheel completes the tool.

Centre punches can be made from pieces of broken rat-tail files or from round steel rod. Common drills can be forged as wanted, or purchased. Files—flat, $\frac{1}{2}$ round, 3-cornered, and round—will be bought as necessity arises. They will all have short handles, 4-5 in. long. Spanners are needed for the nuts of the head-stock cap and for the back centre, as also for the centres of the crank, so for one and all, as for jobs of work beside, a screw wrench having a range of about 2 in. is most convenient. Callipers inside and outside, in 2 sizes, should be purchased, or a combination of the 2 forms in one can be had at the toolshops.

The last article needed is the scribing block for marking heights and centres. A simple form can be made thus (Fig. 1232): Get a base of metal, *a*—say 3 in. by 2 in. by $\frac{1}{2}$ in. Procure also a bit of iron or steel rod *b*, 7 in. by $\frac{3}{8}$ in. by $\frac{1}{4}$ in., and have a piece about $1\frac{1}{2}$ in. diameter welded on one end to form a base and moulding, and a $\frac{1}{2}$ -in. screw beyond, *c*; turn and screw this into the base, keeping it as upright as possible. Temporarily unscrew and file a slot, as shown, opening it first by drilling a string of holes with a $\frac{3}{8}$ -in. drill, then replace. A bit of $\frac{1}{8}$ -in. steel bar, drawn out at the ends to about 8 in. long, will form the scribe *d*. A $\frac{1}{4}$ -in. slot hole in the centre will



receive the set screw, which is shown in sectional plan in Fig. 1233. *a*, upright; *b*, scribe cut through the slot; *c*, sliding screw; *d*, tightening nut, which can be round as shown or a wing nut.

The following notes treat of some of the processes of cutting metals adopted by W. F. Smith, Salford, and described by him in a paper read before the Institution of Mechanical Engineers. In a former paper, the author described mainly what have since become known as right- and left-hand round tool-holders. They are used in different machine tools principally for "roughing out," or, in other words, for rapidly reducing castings, forgings, &c., from their rough state nearly to their finished forms and dimensions. The tool-holders are so called from their cutters being made of round steel cut from the bar. Notwithstanding that they are very widely applicable, take heavy cuts, and do the bulk of all machine work in lathes, and in planing, shaping, and slotting machines, it was soon found that they could not compass the whole of the work required in the shops; and it was, therefore, necessary still to allow the use of some of the common forged tools in conjunction with the round tool-holders. This, however, was objectionable, as no positive rule could then be laid down to define what number of forged tools should be allowed to each workman; and it became apparent that the tool-holder system, in order to reach the highest degree of efficiency, must be made complete and independent in itself. This led to the designing of another tool-holder of the most general kind the writer could possibly devise, in the hope thereby to complete the system.

With this object in view, all the remaining forged tools then in use were collected together, and the swivel tool-holder (Figs. 1234, 1235) was schemed, with cutters so adjustable that they could not only be swivelled round and then fixed to any desired angle, but could be made to project at pleasure to any required distance in order to reach and cut into all sorts of difficult and awkward corners; in fact, to machine any work which the round tool-holder could not finish. Two of the principal objects aimed at were to devise a system of cutters which should not require any forging or smithing, and yet should be capable of being adapted by the simplest possible means, and by grinding the ends only, to all forms which the round cutters would not admit. The special section of steel decided upon was a sort of deep V section, the lower part of which is slightly rounded, as shown in Fig. 1235. The angles of the sides give the same amount of clearance (1 in 8) as that given in the round tool-holders, and this same angle of clearance is given to the ground parts. The section of the swivel cutter is very deep, in order to obtain ample strength in the direction of the pressure it has to support when

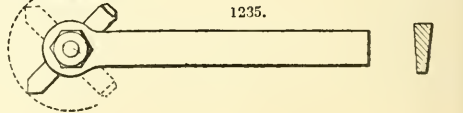
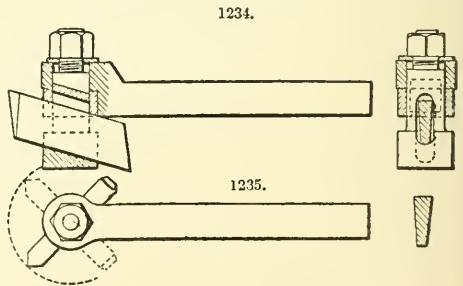
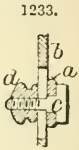
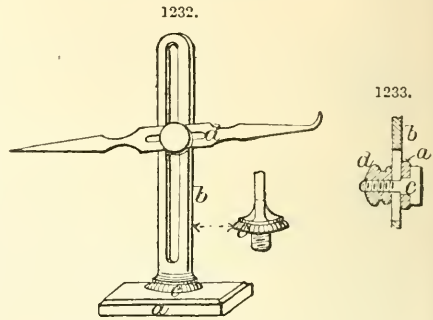

cutting. The angle in Fig. 1234 is common to every swivel tool-holder. In the cutter for the round tool-holder two angles had been fixed upon as standards, one to cut all kinds of wrought metals, the other all cast metals. To avoid complication, however, in the swivel tool-holders one cutting angle was fixed upon for all metals, and applied to all cutters. The angle selected is one slightly differing from that of the round cutters, but is that which worked the best in practice. The cutters of the round tool-holder system are found most advantageous in producing and finishing standard-size round corners in journals of shafts, &c., and in other cases, where the engineer of the present day is anxious to preserve all the strength he can in the parts he is constructing; but there are still cases where square, angular, or undercut surfaces must be produced, as illustrated by Figs. 1236 to 1241. These are front views showing the tool-holders at work planing or shaping. They are supposed to be travelling forward, or the work to be moving in the opposite direction; and the arrows in each figure indicate the direction in which the tool-holder is being fed at each stroke of the machine, to take the next cut.

Fig. 1237 shows the mode of planing the under horizontal surface of a lathe-bed. The cutter shown in use is ground to an angle of 86° , or 4° less than a right angle, and thus has a clearance of 2° at each side when cutting either horizontally or vertically

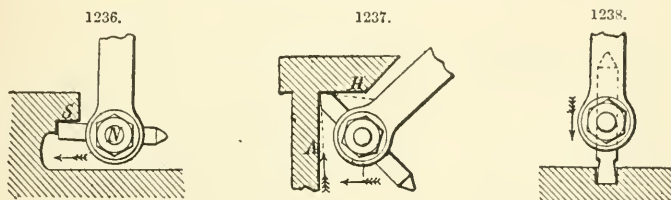

This cutter is very general in its applicability, and is devised so as to finish with one setting, both the vertical surface A, and the horizontal surface H, without the necessity for disturbing the cutter in any way. The ordinary system is to use, at least, 2 tools for roughing out, and 2 for finishing, on 2 surfaces right angles with each other.

Fig. 1236 shows the method of planing in a very limited space the under horizontal surface S; the corresponding surface is planed afterwards, without disturbing the tool-holder, by simply swivelling the cutter half-way round in the holder and securing it there by the nut N.

Fig. 1240 shows a swivel tool-holder clearing without difficulty a boss which projects, and would be very much in the way of an ordinary tool. The cutter in this case planes

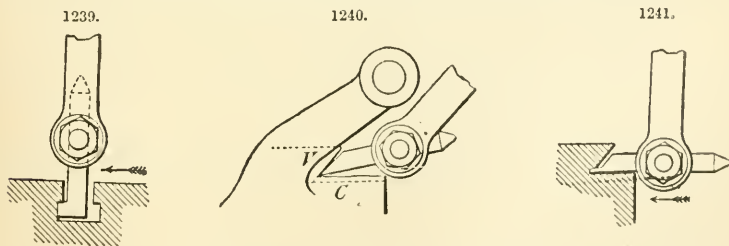

not only the horizontal surface but the vertical surface also, with one setting and without being disturbed in the tool-box.

Fig. 1238 shows the method of cutting a vertical slot in a horizontal surface of metal. The cutter in this case is called a parting tool.

Fig. 1242 is a side elevation of this same cutter, showing the cutting angle.

Figs. 1239 and 1241 are tool-holders with cutters of rather special forms. The former is shown planing out or undercutting a T-shaped slot, and the latter is planing out a small rectangular clearance corner.

Figs. 1243 and 1244 show a swivel tool-holder with a round shank, such as is used on the slide-rest of a screw-cutting lathe, for cutting square threads. It is carried on a wrought-iron or steel block, provided with a groove, semicircular in section, in which

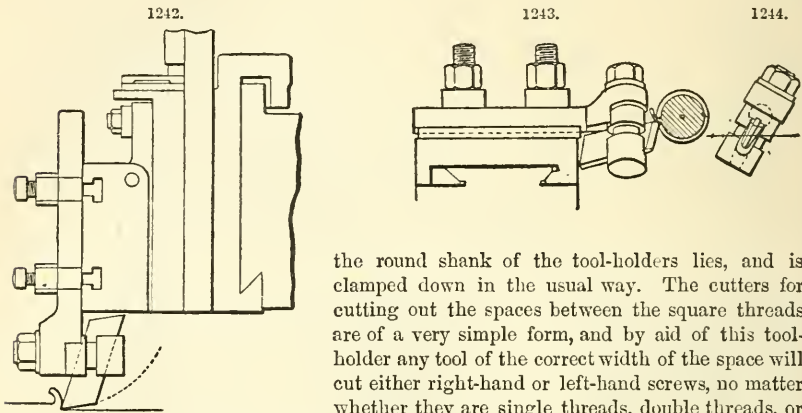

the round shank of the tool-holders lies, and is clamped down in the usual way. The cutters for cutting out the spaces between the square threads are of a very simple form, and by aid of this tool-holder any tool of the correct width of the space will cut either right-hand or left-hand screws, no matter whether they are single threads, double threads, or any other. To cover the same ground with forged

tools, no less than 6 expensive cutters would be required, each forged from square steel, and carefully filed up and hardened. With the tool-holder only one cutter is required, and it costs, probably, not more than 10 per cent. of one of the 6 forged tools, while it maintains its size much better, and, consequently, lasts much longer. It also takes about twice the weight of cuttings per hour as compared with an ordinary forged tool. This system is useful where many screws of odd forms and pitches are required; but where there are sufficient numbers to be cut, special chasing lathes are far preferable to ordinary screw-cutting lathes, as they will do about 6 times as much chasing of V threads, or cutting of square threads, as can be accomplished in the ordinary lathe in the same time. Instead of carrying one chaser, the chasing lathes carry, in a chasing apparatus, 3 or 4 chasers: and these have their threads, whether square, V, rounded, or any other form, cut in their places by aid of a master tap. They are then tapered at the mouths, backed off, and hardened ready for work. The number of shavings cut simultaneously from a screw by this process varies from 12 to 24, according to the size, strength, and pitch of the thread. Screws up to 6 in. diameter can be very rapidly cut by this system, on which very much more might be said if space permitted. A few screws cut by this process are exhibited.

When the 2 systems—the round and the swivel tool-holder—are worked in conjunction with each other, their universality of application is so thorough that almost every difficulty is met; and it was only in the case of paring and shaping articles in the slotting machine that 2 modifications had to be made in the holders, the same cutters being still applicable.

The cast-iron bed chasing lathes made by the writer's firm have now become much used; and as a large amount of their work is done upon black bars of iron, steel, or other metals, each of which has to be finished at its extremities and cut or parted off, it was found advisable to make one special tool-holder, Fig. 1257, to carry tools of the correct sections to produce the desired shapes for the ends; the tedious and unreliable

process of turning the ends with hand-turning tools is thus avoided. Each cutter is of absolutely the same section throughout its entire length, and the resharpening is done by grinding the end of the cutter only, so that it can only produce the same standard form as long as it lasts—that is to say till it is ground too short to be used any longer. The parting off might have been accomplished by the swivel tool-holder; but a special form, Fig. 1256, is found to be more convenient in parting off close up to the chuck or lathe spindle.

To produce a maximum amount of cutting in a minimum space of time, there are 2 main points which must be carefully attended to. These seem to be applicable to all cutters for cutting metals, whether they happen to be those fixed rigidly in tool-boxes, as in turning lathes, planers, sharpeners, slotters, &c.; or those which cut while they revolve, as milling cutters, twist-drills, boring-bits, &c. These 2 important points are:—(1) The angle of the cutting surface (or cutting angle), Fig. 1253,—i. e. that surface which removes the shavings of metal, and upon which the pressure of the cut comes, as shown by the arrow. (2) The angle of the clearance surface (or clearance angle)—i. e. that surface which passes over the surface of the metal which has been cut, and does not come in contact with the metal at all.

To produce the best results, and to ensure the utmost simplicity, it is important that these 2 angles be correctly constructed in the first instance. The best measure for both angles has been arrived at from actual practice and a series of experiments. When once obtained and started with, they should not alter by use, but always remain constant, if the greatest amount of cutting efficiency is to be achieved. When aided by a mechanical system of regrinding, and the use of standard angle gauges, Figs. 1254, 1255, there is no difficulty in maintaining the exact angles. The only changes that take place are that the cutters in tool-holders become gradually shorter and shorter by grinding, and that milling cutters during a long period of time become very gradually smaller in diameter, by the process of resharpening them on a fine emery wheel. In the case of the tool-holders, as already explained, the cutting angle is maintained by the system of regrinding, and the tool-holder itself always maintains the clearance angle. The system is thus simplified, as will be clearly understood when it is remembered that each one of the tool-cutters (no matter of what description) is ground on its end only. The section is thus never altered, no smithing or alteration in form is necessitated, and consequently no repairing has to be done in the smiths' shops. The objects aimed at have been:

1. To produce the highest class of workmanship, by providing the best known form of cutters, carefully made, and capable of having the cutting edges accurately reground, so that the surfaces of the machined work may be produced direct from the cutters so highly finished that no hand-work could possibly improve them. All the turning of wrought iron, for instance, is so perfectly finished that there is no necessity to polish it by means of emery or emery cloth.

2. To make all the cutters so free from complication, and simple to keep in order, that no difficulty or error may take place in regrinding them.

3. Since finely-polished surfaces cannot be obtained without the most perfect cutting edges, to make all cutters not only of the best steel, but with their cutting edges most carefully and accurately ground up, in almost all cases by mechanical means. The durability of the cutters, from their construction and high class of material, is very great, and they are thus capable of removing a great weight of metal in a given time.

The grinding or resharpening of all cutting edges is reduced to the greatest simplicity; and only three descriptions of machines are requisite for this purpose. They are all arranged to grind mechanically; that is to say, the cutters while being ground are carried and pressed on the grindstone or emery wheel by mechanism. The requisite forms and angles are also obtained by mechanism, it being found in practice that sufficient accuracy cannot be secured by hand grinding.

The machines are as follows:—

1. A grindstone with slide-rest, for grinding all the cutters used in tool-holders.
2. A twist-drill grinder; this also is by preference a grindstone, with mechanism for holding and guiding the twist-drills. A machine with an emery wheel in place of the stone is also used for the grinding of twist-drills, with much the same mechanism for carrying the drills. In practice, however, the stone grinds about double the number of drills per day, and with less risk of drawing the temper. Both stone and emery-wheel are run at a high speed, and used with water.

3. A small but very complete machine (Fig. 1262) for regrinding milling cutters. In this case gritstone does not answer, and the grinding wheels are obliged to be emery or corundum. They are very small in diameter, and many of them are exceedingly thin, and so delicate in form that if made of gritstone they would rapidly lose their shapes. They are run at a high speed, and are turned into form while revolving by means of a diamond. A milling cutter will work for a day, and in many cases for 2 days, without showing signs of distress.

Before the cutting edges are visibly blunted, but as soon as the sense of touch shows their keenness to be diminished, the cutter should be put into this machine; and the probability is that not more than $\frac{1}{1000}$ in. need be ground off each tooth, before it is restored again to a cutting edge almost as fine as that of a wood chisel. Each cutting edge, or in other words each tooth of the milling cutter, is only passed rapidly once or twice under the revolving wheel, which is itself of very fine emery. It can therefore be readily understood how delicate an operation this is, and why emery alone will answer for it.

In order to maintain the correct forms of angles of all cutters for tool-holders, sheet steel angle gauges, Fig. 1254, are provided, and the process of grinding is thus reduced to a complete and exceedingly simple system. In well-regulated shops a young man is selected to work each machine for cutter grinding; and in practice each man so engaged can keep a works employing 150 men (exclusive of moulders or boiler makers) well supplied with all the necessary cutting tools from day to day. A very great saving is thus effected, as no machine need ever stand idle for want of cutters.

Take for instance an engineering works employing 250 men. The requisite number of improved grinding machines, with special mechanical appliances, is as follows:— 2 patent grindstones for resharpening cutters mechanically; 1 patent twist-drill grinder for resharpening twist-drills mechanically; 1 improved cutter-grinder with small emery wheel, for the resharpening of cutters used in milling machines.

To follow the system out satisfactorily, the man working the grindstone goes round to each machine every morning, collects together those cutters which have been blunted by use the previous day, carries them to his grindstone, resharpens them, and distributes them again to each machine; which is thus kept well stocked with an ample number of cutters, always ready for immediate use.

The cutters for tool-holders do not require any repairing in the smithy; consequently that operation, which is costly in so many ways, is avoided, and jobbing or tool smiths with their strikers are almost entirely dispensed with.

For rehardening the cutters, a rule is made that when the grinder meets with cutters which are not as hard at their cutting points as they ought to be, he puts them on one side, and periodically, say once each fortnight, he sends the lot into the smithy for the end of each to be retempered. This is a very inexpensive operation. They are placed in a small oven by dozens and very slowly heated up to a dull red; the end of each cutter is then plunged into a perforated iron box, the bottom of which is covered with the required depth of water, to harden the cutter to the proper distance from its point. The cutters are left standing in a nearly vertical position in the box of water, until they have gradually cooled down sufficiently to be removed. They are then sent to the grindstone, reground, and given out with the other cutters to be again used in the

different machines. With steel of the highest qualities for the cutters it is most important to keep it out of the smith's fire entirely, if possible. That object is here attained, the cutters never going to the fire except for rehardening. During the life of a cutter it only sees the fire probably 6 times.

As the weight of each cutter is small, not probably more than $\frac{1}{15}$ to $\frac{1}{20}$ that of a forged tool used for the same purpose, the outlay for best tool steel is not heavy; and the engineer is not tempted to purchase any but that of the highest quality. With such steel, especially when used in the best manner, each machine is capable of cutting at a high rate of speed, and the cuts may be coarser than those ordinarily taken. When the swivel tool-holders were first used on planing machines, cutting slots 1 in. broad into solid castings, it was found that 2 teeth of the feeder could be used at each stroke. Previously a forged tool of the same breadth, ground to form by the planer to the best of its ability, had been used in the same machines; but he found, on trial from time to time, that it was impossible to use more than one tooth of the feed; or, in other words, the tool-holder cut a given depth into the metal in half the time of the forged tool.

Again, when the swivel tool-holders were first used in cutting square-threaded screws, the utmost the lathe could do with forged tools was to take 4 degrees of feed at each cut, as indicated by the micrometer feed-wheel. The tool-holder on the other hand took 7 degrees of feed in the same lathe, doing the same work, and producing quite as good or a better finish with the same expenditure of steam power.

The cutters for the swivel tool-holders can not only be made at the outset, but also constantly maintained, at the best and most efficient angles which practice can teach; it therefore follows that a very much better class of machine work can be produced. The finished surfaces obtained from the tool-holders show a striking superiority over those from forged tools, especially when in the latter the angles are ground by hand by each man or boy working a machine. The tendency then is to grind the cutters to all sorts of incorrect forms, which more or less tear the surfaces of the machined work, and leave bad finishes, such as require a considerable amount of hand labour bestowed upon them afterwards, in filing, scraping, and polishing.

Again, the tool-holders have led up to a considerable extension of what is called broad-finishing, in planing, turning, shaping, slotting, &c.

Broad-cutting feeds, varying from $\frac{1}{2}$ in. to $1\frac{1}{2}$ in. in width, are very commonly taken by the swivel tool-holders and more accurate surfaces produced than with finer feeds. The advantages in point of time saved are very great; the time occupied in finishing by broad-cutting being $\frac{1}{12}$ to $\frac{1}{20}$ of that consumed by finishing with ordinary feeds and in the usual manner. The width of broad-cutting can be increased to any desired limit, and there have been special cases where it has been advantageous to take thin shavings 3 in. to 6 in. in width.

The principal limits to broad-cutting are as follows:—

1. The power of grinding the cutting tool to a sufficiently straight or true cutting edge; the best plan, of course, being to do this by mechanical means.

2. The securing a sufficient stability in the machine tool to hold the broad-cutter so rigidly up to its work that neither the cutter itself nor the work may spring away, and that no jarring or injurious vibration may be produced, and impart its evil effect to the finished surface.

3. The securing of sufficiently accurate work to answer the purpose for which it may be required: for instance, the piece of work planed or turned by this process may be a portion of a large railway bridge, where absolute accuracy is not required, or it may be some portion of a machine tool, where the utmost accuracy is needed; or, again, some portion of an engine, where the builder is anxious to obtain all the accuracy which can possibly be produced direct from the machine tool.

During the last 30 years many attempts have been made to introduce a better system of drilling and boring. Many engineers have used square bar steel, which the black-

smith has twisted, and then flattened at one end to form a drill. The object of the twisted stem was to screw the cuttings out of the hole, and to some extent this succeeded, but not perfectly. The twisted square section revolving in the round hole had a

1245.

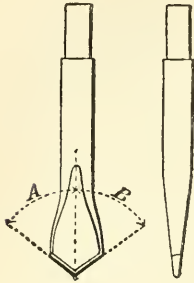

1246.

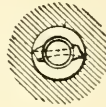

1252.

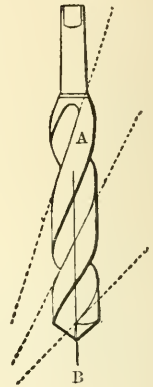

1247.

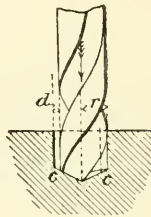

1248.

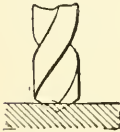

1249.

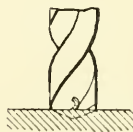

1250.



1251.



1253.

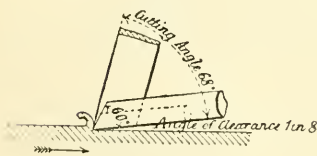

1254.

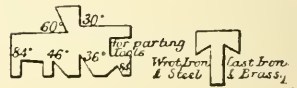

1255.

1256.

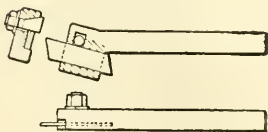

1257.

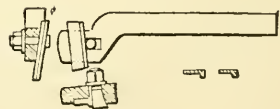

tendency to crush or grind up the cuttings; and if they were once reduced to powder it was difficult (especially in drilling vertically) for the drill to lift the powdered metal out of the hole. In most cases the lips of the drills were of such form that the cutting

angle, or face of each lip, which ought to have been about 60° , Fig. 1253, was 90° , or even still more obtuse; this being an angle which would scrape only, but could hardly be expected to cut sweetly or rapidly.

Again, there were attempts to make the cutting angles of the 2 lips of much the same number of degrees as that given by the twist itself in a good twist-drill. This was done by forging or filing a semicircular or curved groove on the lower face F of each lip, Figs. 1250, 1251. For a short time lips thus formed cut fairly well, but a very small amount of regrinding soon put them out of shape, and made them of such obtuse cutting angles that good results could no longer be expected from them; and to be constantly sending such drills to the jobbing or tool smith, and then to the fitter to file into form again before they were rehardened, was found to be too tedious and too expensive. Again, to arrive at the best results in drilling, each of the cutting lips should make the same angle with a central line taken through the body of the drill: in other words, the angles A and B, Fig. 1245, should each have exactly the same number of degrees, say 60° . The clearance angles also should be identical, and the leading point P should form the exact centre point of the drill. From practice it is found that if these proportions are not correct, the drill cannot pierce the metal it is drilling at more than about half the proper speed, and the hole produced will also be larger than the drill itself, as will be exemplified a little later on. To give an idea of the excessive accuracy which must be imparted to a twist-drill, we must bear in mind that even a good feed is only $\frac{1}{100}$ in. to each revolution; and as two lips are employed to remove this thickness of metal, each lip has only half that quantity to cut, or $\frac{1}{200}$ in. This $\frac{1}{200}$ in. is as much as can be taken in practice by each lip in drills of ordinary sizes.

It will therefore be readily understood that if one lip of a drill stands before the other to the extent of $\frac{1}{100}$ in. only, the prominent lip, or portion of a lip, will have to remove the whole thickness of the metal from the hole at each turn. The lip of the drill will not stand such treatment; and it is therefore obvious that if this were attempted the prominent lip would either break or become too rapidly blunted. To get over these difficulties, the driller would no doubt reduce his feed by one-half, or to $\frac{1}{400}$ in. per turn, which would mean about half the number of holes drilled in a given time.

This nice accuracy, although absolutely required, cannot be produced by hand grinding; neither can a common drill, having a rough black stem more or less eccentric, be ground accurately, even by aid of a grinding machine with mechanism for holding it. To grind any drill accurately, it must be concentric and perfectly true throughout with the shank, as that part has to be held by the drill-grinding machine. If the drilling is to be done in the most rapid manner, in other words, at the smallest cost, and if the best class of work is also desired, it seems certain that a twist-drill, with all the accuracy which can possibly be imparted to it in its manufacture, and the greatest care employed in the resharpening, is the only instrument which can be employed.

About a quarter of a century ago both Sir Joseph Whitworth and Greenwood, of Leeds, made some twist-drills; but it is to be presumed that a large amount of success was not achieved with them, and for some reasons the system was not persevered with. After that period the Manhattan Firearms Company in America produced some beautifully finished twist-drills. Though the workmanship in these was of a superior description, the drills would not endure hardship. It was found that the 2 lips were too keen in their cutting angles, and that they were too apt to drag themselves into the metal they were cutting, finally to dig in and to jam fast, and to twist themselves into fragments. Morse then took the matter up, and by diminishing by about 50 per cent. the keenness of the cutting lips of the twist-drills, made a great success of them. He used the grinding line A B, Fig. 1252, and an increasing twist. In such a drill, of the standard length, and before it is worn shorter by grinding, the twist is so rapid towards the lips that the angle they present, or what has been already referred to as the angle of the

cutting surface, is very nearly the same as that which W. F. Smith had previously established for cutters cutting metals, as in Fig. 1254.

If, however, the angle of twist is made to increase towards the lips, it will of course decrease towards the shank, as in Fig. 1251. The shorter the drill is worn, the more obtuse the cutting angle becomes, and the less freedom will it have; supposing, of course, that the angle, when the drill was new, was the most efficient. Suppose this decrease of twist were carried still further by lengthening the drill, a cutting angle of 90° would eventually be arrived at. The old common style of drill usually has a cutting edge which is so obtuse as not to cut the metal sweetly, but on the contrary to have more of a tearing action, and thus put so much torsional strain on the drill that fracture is certain to take place, even if what the writer would now consider a moderate feed was put on by the drilling machine.

It is therefore obviously advantageous to adopt from the first the best cutting angle for all twist-drills, and to preserve this same angle through the whole length of the twisted part, so that, however short the drill may be worn, it always presents the same angle, and that the most efficient which can be obtained. This cutting angle is easy to fix, and becomes an unalterable standard which will give the best attainable results. This has been adopted at the Gresley Works, Manchester, and of course applies to both lips.

A common drill may "run," as it is usually termed, and produce a hole which is anything but straight. This means that the point of the drill will run away from the denser parts of the metal it is cutting, and penetrate into the opposite side which is soft and spongy. This is especially the case in castings; where, for instance, a boss may be quite sound on the one side, while on the other a mass of metal may be full of blow-holes, or so drawn away by contraction in cooling as to be very soft and porous. In such cases, it is perfectly impossible to prevent a common drill from running into the soft side. This sort of imperfect hole is most trying to the fitter or erector, and if it has to be tapped, to receive a screwed bolt or stud, is most destructive to steel taps. The taps are very liable to be broken, and an immense loss of time may also take place in attempting to tap the hole square with the planed face. A twist-drill, on the other hand, from its construction is bound to penetrate truly, and produce holes which are as perfect as it is possible to make them.

The next important step in twist-drills has been to fix a standard shape and angle of clearance for both lips, which should also give the best attainable result. This angle might be tampered with if the regrinding were done by hand, and too much or too little clearance might easily be imparted to the drill from want of sufficient knowledge on the part of the workman. If too little clearance, Fig. 1248, or in some cases none at all, is given to the drill, the cutting lips then cannot reach the metal, consequently they cannot cut. The self-acting feed of the drilling machine keeps crowding on the feed until either the machine or the drill gives way. Usually it will be the latter.

Again, if too much clearance is given, Fig. 1249, the keen edges of the lips dig into the metal and imbed themselves there, and of course break off.

The grinding line A B, Fig. 1252, was introduced in the States to assist the operator in keeping both lips of the drill identically the same. To arrive at this, however, is more than can be accomplished by hand grinding, as not less than 3 points have to be carefully watched, viz.: (1) That both lips are exactly the same length; (2) that both make the same clearance angles; (3) that both make the same angle with the centre line on the body of the drill. If these are not attended to, the drill lips may for instance be both ground so as to converge exactly to the grinding lines at the point of centre of the drill, and may still be of such different lengths and angles as to produce very bad results in drilling.

Much ingenuity has been expended on machines for the grinding of the 2 lips with mechanical accuracy. The one which has been the most successful in the United States

has 3 motions, ingeniously combined with each other. So many motions, however, entail complication; and this, added to a system of holding the drill which was not sufficiently reliable, failed to produce the extreme accuracy it is requisite to impart to the 2 angles.

The grinding line, too, is found to be more or less a source of weakness. It is therefore advisable to dispense with it if possible; and where a good twist-drill grinding machine is used, the grinding line is seldom or ever looked at, and in that case is useless. If it is still desirable to have grinding lines (as in some cases where hand grinding has to be relied upon), they should be made as faint as possible, and not cut deeply into the thin central part of the drill so as to weaken it.

Fig. 1247 is drawn exaggerated, in order to show the ill effect of grinding one lip of a drill longer than the other.

A simple and efficient twist-drill grinding machine was so much needed, that within the last 3 years the writer has designed one. The twist-drill in this machine has only one motion imparted to it to produce the 2 lips of each drill as perfect fac-similes of each other and with the desired amount of clearance. Many of these machines are now at work. That the drills ground by them are accurate is proved by the holes drilled being so nearly the size of the twist-drill itself that in many cases the drill will not afterwards drop vertically through the drilled hole by its own gravity; in other words, the hole is no larger than the drill which has drilled it.

It is not generally known that this is the most severe test that can be made of the accuracy of regrinding, and of the uniformity of all parts of the twist-drill.

The whole of the drilling in many establishments is now done entirely by twist-drills. Since their introduction it is found that the self-acting feed can be increased about 90 per cent.; and in several engineering works the feeds in some machines have been increased by fully 200 per cent., and consequently 3 holes are now being drilled in the same time that one was originally drilled with the old style of drill and with old machines.

It may be interesting to give a few results out of numerous tests and experiments made with twist-drills. Many thousands of holes $\frac{1}{2}$ in. in diameter and $2\frac{3}{4}$ in. deep have been drilled, by improved $\frac{1}{2}$ -in. twist-drills, at so high a rate of feed that the spindle of the drilling machine could be seen visibly descending and driving the drill before it. The time occupied from the starting of each hole, in a hammered scrap-iron bar, till the drill pierced through it, varied from 1 min. 20 sec. to $1\frac{1}{2}$ min.

The holes drilled were perfectly straight. The speed at which the drill was cutting was nearly 20 ft. per minute in its periphery, and the feed was 100 revolutions per in. of depth drilled.

The drill was lubricated with soap and water, and went clean through the $2\frac{3}{4}$ in. without being withdrawn; and after it had drilled each hole, it felt quite cool to the hand, its temperature being about 75° F. It is found that 120 to 130 such holes can be drilled before it is advisable to resharpen the twist-drill. This ought to be done immediately the drill exhibits the slightest sign of distress. If carefully examined, after this number of holes has been drilled, the prominent cutting parts of the lips, which have removed the metal, will be found very slightly blunted or rounded, to the extent of about $\frac{1}{100}$ in.; and on this length being carefully ground by the machine off the end of the twist-drill, the lips are brought up to perfectly sharp cutting edges again.

The same sized holes, $\frac{1}{2}$ in. in diameter and $2\frac{3}{4}$ in. deep, have been drilled through the same hammered scrap iron at the extraordinary speed of $2\frac{3}{4}$ in. deep in 1 minute and 5 seconds, the number of revolutions per in. being 75. An average number of 70 holes can be drilled in this case before the drill requires resharpening. The writer considers this test to be rather too severe, and prefers the former speed. The drills in both cases were driven by a true-running, drilling machine spindle, having a round taper hole, which also was perfectly true; and the taper shank and body, or twisted part of the drills, also ran perfectly concentric when placed in the spindle, or in a reducer, or socket having a taper end to fit the spindle. When the drills run without any eccentricity, there is no

pressure, and next to no friction on the sides of the flutes; the whole of the pressure and work being taken on the ends of the drills. Consequently they are not found to wear smaller in diameter at the lip end, and they retain their sizes, with careful usage, in a wonderful manner. The drills used were carefully sharpened in one of the twist-drill grinders mentioned above.

In London upwards of 3000 holes were drilled $\frac{5}{8}$ in. in diameter and $\frac{3}{8}$ in. deep, through steel bars, by one drill without regrinding it. The cutting speed was in this instance too great for cutting steel, being from 18 ft. to 20 ft. per minute; and the result is extraordinary.

Many thousands of holes were drilled $\frac{1}{8}$ in. in diameter, through cast iron $\frac{7}{16}$ in. deep, with straight-shank twist-drills gripped by an eccentric chuck in the end of the spindle of a quick-speed drilling machine. The time occupied for each hole was from 9 to 10 seconds only. Again, $\frac{1}{4}$ -in. holes have been drilled through wrought copper, $1\frac{3}{8}$ in. thick, at the speed of one hole in 10 seconds.

With special twist-drills, made for piercing hard Bessemer steel, rail holes, $\frac{3}{8}$ in. deep and $\frac{3}{8}$ in. in diameter, have been drilled at the rate of one hole in 1 minute and 20 seconds, in an ordinary drilling machine. Had the machine been stiffer and more powerful, better results could have been obtained. A similar twist-drill, $\frac{3}{8}$ in. in diameter, drilled a hard steel rail $\frac{1}{16}$ in. deep in 1 minute, and another in 1 minute 10 seconds. Another drill, $\frac{5}{8}$ in. in diameter, drilled $\frac{3}{4}$ in. deep in 38 seconds, the cutting speed being 22 ft. per minute. The speed of cutting rather distressed the drill; a speed of 16 ft. per minute would have been better. The steel rail was specially selected as being one of the hardest of the lot.

The writer considers milling the most important system used in the cutting of metals. It is found practicable, and in most cases it is exceedingly advantageous, to finish (or as it is usually termed to "machine") almost every class of work, such as is now usually finished by planing, shaping, or slotting machines, in one or other of the numerous kinds of milling machines already in use. It may not be generally known that in this class of machine, milling cutters are being used of diameters ranging from 20 ft. used for heavy engine work, down to $\frac{1}{2}$ in. or $\frac{3}{4}$ in., used principally for the intricate work required in sewing machines, small arms, &c.

By the former, the work done is what is known as face-milling; the mill itself is somewhat similar to a large lathe face-plate, and the several cutting portions are steel tools inserted into and firmly secured to it by a series of set screws or keys. On the other hand, the milling cutters of the small sizes from $\frac{1}{2}$ in. up to about 8 in. in diameter, are made from solid blocks of cast steel, or blanks, as shown in Fig. 1261.

The term milling is more generally understood in the United States than in this country. It means the cutting of metals by the aid of serrated revolving cutters, each having a number of cutting teeth. Milling cutters have been used in this country for many years, but until recently with only a limited amount of success, owing to the expense and difficulty of producing their cutting edges and keeping them in order. This was next to impossible before the introduction of a machine, with a small emery wheel, and compound slides, &c., for carrying the milling cutter whilst being re-sharpened. Hence in the old system of milling, which did not permit of the resharpening of the hard teeth, the results were, that after much expense and time had been bestowed on a cutter (including a quantity of hand labour spent upon it while in its unhardened state), the whole was as it were upset by the process of tempering; the accuracy which had previously been imparted to it being usually quite destroyed by the action of the fire and sudden cooling. In some cases the cutter would be found slightly warped or twisted; in others it would be oval or eccentric; and most frequently, when set to work on a truly-running mandrel in the milling machine, not more than $\frac{1}{3}$ of the number of its teeth were found to be cutting at all, the others not coming in contact with the work. This really meant that not more than $\frac{2}{3}$ of the proper feed per revolution could

be applied, and not more than $\frac{2}{3}$ of the proper work produced. Nor was this the only drawback; the quality of the workmanship produced by such a milling cutter was not of the best, and deteriorated hourly from blunting and wear. Such a cutter would probably not work for more than 2 whole days before it would require to be again softened by being heated red hot and allowed to cool gradually. The expensive and unreliable process of resharpening by hand-filing had to be gone through again once more; then the retempering, which caused the cutter to again become warped, swelled, or eccentric; and each time it was subjected to the heat of the fire, it ran the risk of being destroyed by cracking when plunged into the cold bath.

It is necessary now to describe the modern system of making and maintaining the improved milling cutters. A cast-steel forging, or blank as it is usually styled, is bored, and then turned to its proper shape in a lathe. The teeth are then machined out of the solid to their required forms, in a universal milling or other machine. This work is so accurately produced, direct from the machine, that no expensive hand labour need be expended upon the milled cutter, which is taken direct from the milling machine to the hardening furnace, and tempered. The hole in the centre of the cutter is then carefully ground out to standard size, so that it may fit naturally and without shake both on the mandrels of the grinding machine and on that of its own milling machine.

The cutter or mill B, Fig. 1262, is now placed on the mandrel M of the small cutter-grinding machine; the mandrel itself is adjusted by means of a worm W and worm-wheel C to its required angular, vertical, or horizontal position, and each tooth is ground or resharpened by passing it once rapidly forward and backward under the small revolving emery wheel H. The mandrel fits easily into the cutter which is being ground, so that the latter may be readily turned round by the thumb and finger of the operator.

The exact mode of setting such cutters is as follows:—The clearance angle J L K on each tooth is obtained and maintained by the emery wheel H, one of which is exhibited. The clearance is obtained by adjusting the centre E of the emery wheel H a short distance horizontally to the left of the vertical line through the centre O of the milling cutter. The shorter this distance E C the less the amount of the clearance imparted to each tooth of the milling cutter A. The lower L K is a tangent to the circumference of the milling cutter, drawn from the point of contact L; and the upper line L J is a tangent to the emery wheel from the same point. The angle formed by these 2 lines is the angle of clearance.

Each tooth is held in its correct position by means of a stop S, while the milling cutter is rapidly passed once forward and backward under the emery wheel. As will be seen by the arrows, the tendency of the emery wheel is to keep the cutting edge which is being ground close up against the stop S. There is no more difficulty in grinding spiral cutting edges than straight ones; and the face and conical cutters can also be ground correctly, and with the same amount of ease.

Milling cutters are made of the required form to suit the various shapes they are intended to produce; and all the ordinary forms can be used in any milling machine either of the horizontal or vertical class.

The face-milling cutters, Fig. 1258, are of disc form, and are among the most useful. They are constructed to cut on one face and on the periphery, and produce very perfect finish, especially on cast iron. This form is also very useful for stepped work, which, even when not of the simplest form, can be readily and reliably finished to standard breadths and depths; so that the pieces may be interchangeable, and fit together without the slightest shock, just as they leave the machine, and without any hand labour bestowed on them.

Another ordinary but very useful form is the cylindrical cutter, Fig. 1259, with teeth cut spirally over its circumference. This is largely employed for cutting flat, vertical, or horizontal surfaces, for finishing concave and convex curves, and for complicated forms.

made up of straight lines and curves. With this spiral arrangement of the teeth, and with reliable means of regrinding or resharpening them, very high-class machine work can be produced. Some experiments have been made by cutting a spiral groove or thread into the outer surface of one of this class of mill, and thus reducing the aggregate length of its cutting surface. The results appear to be practically as follows: If half the length of cutting edges are dispensed with, only about $\frac{1}{2}$ the maximum feed per

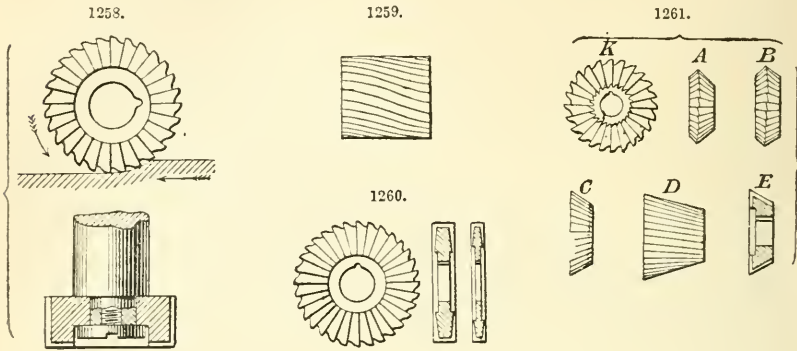

revolution of the cutter can be applied by the machine; if $\frac{3}{4}$ of the length of the cutting lips are left intact, $\frac{3}{4}$ only of the aggregate feed can be used, and so on in the same proportions.

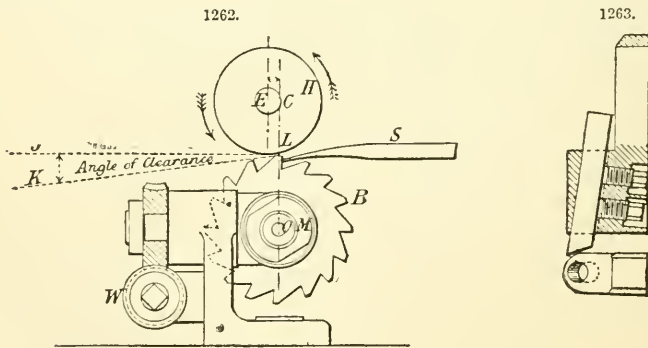

Other mills, again, are made in the form of small circular saws, varying from $\frac{1}{4}$ in. to $1\frac{1}{2}$ in. or more in thickness. The teeth in some of these are simply cut around the circumference; others have these teeth extending some distance down each side, their edges radiating from the centre of the mill, as in Fig. 1260. Towards the centre they are reduced in thickness so as to clear themselves. These cutters are useful for a very great variety of work; for instance, the cutting of key-ways, parting off or cutting through pieces of metal, and making parallel slots of various widths, for the broader of which 2 or more cutters may be used side by side.

Conical and annular milling cutters, Fig. 1261, are much employed for a great variety of work, such as the cutting of reamers, the making of milling cutters themselves, bevelling, cutting the serrated part of hand- and thumb-screws, nuts, &c. In Fig. 1261,

A, B, C, D are edge views of some of these cutters; K represents a face view, and E a section of one of them.

Any complex forms, such as the spaces between the teeth of spur, mitre, and other wheels, can be machined by using what are known as the patent cutters, which can be resharpened as often as required by simply grinding the face of each tooth. They are so constructed that however often they are reground they never lose their original curved forms, and always produce the same depths of cut. One of these cutters, for instance, will cut the same standard shapes of teeth in a spur-wheel, after it has been used for years, as it did the first day it was started.

There is risk of fracture in making large milling cutters out of one solid cast-steel blank, the principal difficulty being in the tempering. In practice it is found that if they are required of larger diameter than about 8 in. they are better made of wrought iron or mild steel discs, with hardened cast-steel teeth, so securely fitted into them that they do not require to be removed. The cutting edges can then be resharpened in their own places, as in the case of the ordinary milling cutter; thus ensuring that each shall have the same angle of cutting and clearance, run perfectly concentric, and therefore do a maximum amount of cutting in a given time. It must, however, be borne in mind that the smaller the diameter of the milling cutter the better finish it will produce; and cutters of large diameters should only be used to reach into depths where one of smaller diameter could not. Again, the smaller the cutter, the less does it cost to make and maintain.

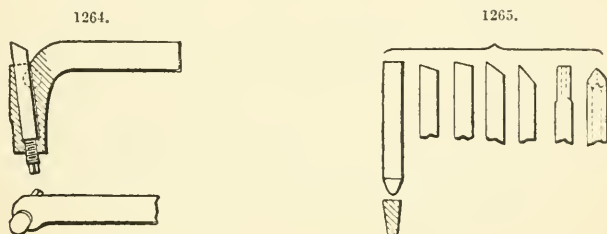

The writer has not had an opportunity of actually testing the relative amounts of engine power required for driving milling machines; but as far as he can judge from ordinary practice in doing ordinary work, he has not perceived that any more power is required to remove a given weight of shavings than that required for a lathe, planing machine, or shaping machine, with efficient cutting tools in all cases.

The cutting speed which can be employed in milling is much greater than that which can be used in any of the ordinary operations of turning in the lathe, or of planing, shaping, or slotting. A milling cutter, with a plentiful supply of oil, or soap and water, can be run at from 80 ft. to 100 ft. per minute when cutting wrought iron.

The same metal can only be turned in a lathe, with a tool-holder having a good cutter, at the rate of 30 ft. per minute, or at about $\frac{1}{3}$ the speed in milling. Again, a milling cutter will cut cast steel at the rate of 25 ft. to 30 ft. per minute.

The increased cutting speed is due to the fact that a milling cutter, having some 30 cutting points, has rarely more than 3 of these cutting at the same time. Each cutting point therefore is only in contact with the metal during $\frac{1}{10}$ of each revolution. Thus, if we suppose it is cutting for one second, it is out of contact, and therefore cooling, for the succeeding 10 seconds, before it has made a complete revolution and commences to cut again. On the other hand, a turning tool, while cutting, is constantly in contact with the metal; and there is no time for it to cool down and lose the heat imparted to it by the cutting. Hence, if the cutting speed exceeds 30 ft. per minute, so much heat

will be produced that the temper will be withdrawn from the tool. The same difficulty to a great extent applies to the cutting tools in planing, shaping, and slotting machines. The speed of cutting is governed also by the thickness of the shaving, and by the hardness and tenacity of the metal which is being cut; for instance, in cutting mild steel, with a traverse of $\frac{3}{8}$ in. per revolution or stroke, with a shaving about $\frac{5}{8}$ in. thick, the speed of cutting must be reduced to about 8 ft. per minute. A good average cutting speed for wrought or cast iron is 20 ft. per minute, whether for the lathe, planing, shaping, or slotting machine. (W. F. Smith.) See also p. 55.

For Wood.—The chief tools usually required for wood turnery are plain gouges and chisels. An inch gouge, that is, one 1 in. wide, is the largest that can well be used with a light treadle lathe, and to use that effectively means hard leg work; $\frac{1}{2}$ in., $\frac{3}{8}$ in., or $\frac{1}{4}$ in. will be more generally useful. The gouges should be well rounded in grinding, Fig. 1266, so that the point, and not the corners, shall be used for cutting, and they, in common with most of the other tools, should be furnished with long handles—of which more presently.

In turning straight stuff, either between centres or on the face-plate, the gouge may be held flat on its back without any danger of its catching in the wood; but, in turning mouldings and in boring holes with the cup-chuck, the tool must be held sideways, and the corner of the gouge which is lowest, or rather, speaking more correctly, some portion of that half of the gouge which is lowest, is the one that will be used for cutting, the higher corner being carefully kept away from the revolving wood to prevent a catch. Even, however, in rapidly roughing down plain wood surfaces, it is advantageous to handle the gouge in this fashion, using both sides alternately, since it cuts the wood quicker, cleaner, and with less friction than when used on the flat. Many amateurs become disheartened in their first attempts at turning, because of the difficulty [of guiding and controlling the gouge. This is a lesson only to be learned by practice. The great thing is to “feel” the work. Thus, if turning down a moulding or, say, the ball on the end of a curtain pole, from circumference towards centre, there is the centrifugal force very sensibly tending to thrust the gouge outwards, and this, of course, is the force which must be resisted. The point of the gouge, or a portion just below the point, will be used, as offering least friction, and it must be grasped very firmly. In turning a flat surface, no such force exists, and the gouge may be held indifferently in any position and comparatively slack. Always the end of the gouge handle is held in the right hand, while the 3 last fingers of the left grasp the lower portion of the gouge itself. The requisite guidance is imparted to the tool by the thumb of the left hand, while the opposite forefinger passes underneath the rest, in opposition to the thumb, thus gripping the tool as in a vice (Fig. 1284). Lastly, keep the rest close to the work. If you have a wide space, you get too much leverage on the overhanging portion of the tool, and may catch and break your tool. The big gouges are stout enough to stand rough work safely; but the $\frac{1}{4}$ -in. gouge is a more delicate tool, and should not be used at all for roughing down stuff in the lathe, except it be of small diameter. These remarks may appear slight, but they really embody about all that can be said on the subject. Let the young aspirant bear in mind each direction, down to the very minutest, and he will find, when by much practice he has gained expertness in the use of the gouge, that all essential hints have been comprised in these few words.

Shopkeepers are always ready to “warrant” the tools of a respectable manufacturer—that is, if found useless on trial, they engage to exchange them, sending the bad articles back to the manufacturer. But sometimes, in the case of broken tools, they will dispute the justice of the claim made by the purchaser. The tool may have been broken by the purchaser’s carelessness, and the only way in which the latter can prove his claim to have the article exchanged is by showing the presence of a flaw in the broken part. If, when the tool breaks, a dark spot (Fig. 1267) is seen to occupy a portion of the line of fracture, that is a “flaw,” or crack, and is quite sufficient to

account for the breakage, and to condemn the tool. The dark spot is simply the film of rust which has formed over the old line of fracture. It should be taken back while the new fracture is fresh and clean, and easily distinguishable from the old.

A gouge for soft wood is generally ground at a long angle, similar to that shown in

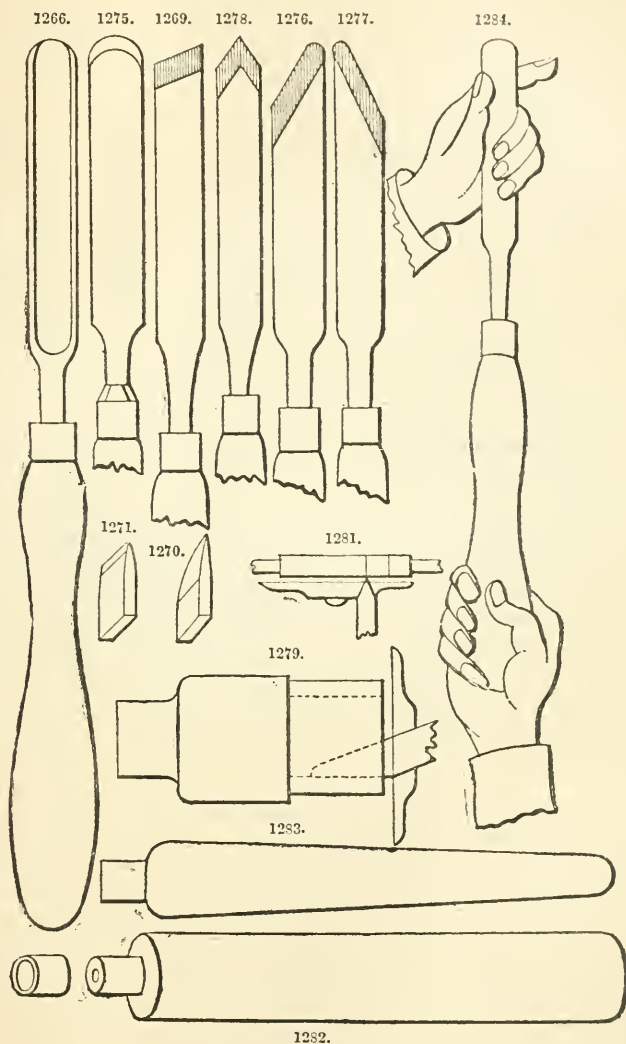

Fig. 1268; for hard wood it may be a trifle less. But practically the same gouges are used indiscriminately for both woods, and the angle is always being rendered more obtuse by the process of sharpening. When newly ground the angle in the figure will be a good one.

For side chisels we may select a large one, 1 in. or $1\frac{1}{4}$ in., and a $\frac{1}{2}$ -in. and $\frac{1}{4}$ -in. A beginning may be made with one gouge and one chisel, say a $\frac{1}{2}$ -in. in each case, the others being added as required.

Grind the chisels to an angle of about 20° (Fig. 1269). It should not be less—else they are liable to kick, and they should be kept thin and sharp (Fig. 1270), for cutting down end grain with facility. If thick (Fig. 1271), they “wobble” when cutting down across grain, with the result of leaving the work uneven (Fig. 1272).

In grinding, some impart a slight amount of rounding to the cutting edge (Fig. 1273). When turning, cut near the obtuse-angled end (Fig. 1274), for if you get near to the opposite end, and slacken your grasp for a moment, the acute-angled corner will surely catch, and produce woful consequences. It is well to practise this side turning in preference to scraping, because the oblique cut is more like the action of a plane, and leaves the surface of the wood cleaner than does the tearing action of the scraping chisel. Yet 2 or 3 firmer chisels, say $1\frac{1}{2}$ in., $\frac{3}{4}$ in., and $\frac{3}{8}$ in., for truing up wooden face-chucks, and pieces of work of large diameter, and for recessing grooves, may be added with advantage.

Fig. 1275 shows a round-nosed tool, necessary in many instances where mouldings have to be finished, and indispensable also to the pattern-maker; $\frac{3}{4}$ in., $\frac{1}{2}$ in., and $\frac{1}{4}$ in. will be useful sizes. Of course these can only be used as scraping tools.

Side tools (Figs. 1276 and 1277) and diamond points, or parting tools (Fig. 1278), are for turning, or rather finishing, the internal portions of rings (Fig. 1279) or edges (Fig. 1280), either inner or outer, which could not be got at by tools having less bevel. These, as well as the round-nosed tools, can be purchased; but they can be readily made, and will be quite as serviceable as the purchased ones, from worn-out fine-cut flat files of different sizes. Grind off the greater portion of the cuts from their faces, and grind also the points to the required bevel or curve, as the case may be, and these will make excellent turning tools. You will be able to afford a greater variety by this means than if every tool had to be purchased. Always manage to utilize the old files in some way or another. Scrapers, screw-drivers, and metal-turning tools, can be made from old files.

When purchased, tools are without handles, and though the ironmonger will supply you with the latter at about 2*d.* each, they may just as well be made as bought. Get some hard wood, almost any common wood, oak, ash, beech, birch, apple tree, &c., and saw into strips, some 11 in. or 12 in. long by $1\frac{1}{2}$ in. sq. for the gouges and chisels, and others 8 in. or 9 in. long by $1\frac{1}{2}$ in. sq. for the scraping tools. Chop off the edges, start centres in ends with a gimlet, and run a cut in at one end with a tenon saw for the fork chuck. Get some brass tubing, $\frac{1}{2}$ -in., $\frac{3}{8}$ -in., $\frac{1}{4}$ -in. for different-sized tools, and cut off in lengths for ferruling. The neatest way to cut it off is this:—Say it is $\frac{1}{2}$ -in. tubing. Get a piece of hard wood, not too long, say 5 in. or 6 in., and turn down to $\frac{1}{2}$ in., so that the tubing can be driven tighly over it by tapping with the hammer. When thus driven on, re-chuck the wood in the lathe, and cut off the ferrules with the point of a side chisel, or of a diamond point (Fig. 1281). Tap out the wooden mandrel, file the burr from the inside of the ferrules, after which they are ready to go on their handles. Turn down one end of the wood intended for the handle—that end nearest the poppet—with callipers set to the inside diameter of the ferrule (Fig. 1282), and drive the wood



1268.

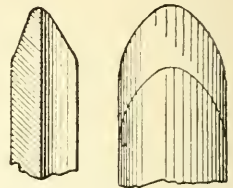

Section Back of Gouge,

1272.

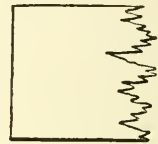

into the ferrule tight, opening the jaws of the vice wide enough for the edges of the ferrule to rest upon while doing so. Then replace in lathe and turn to shape, which may be either that of Fig. 1283 or that of Fig. 1266, the latter being preferable, as affording a larger grip for the hand. Bore the hole for the tool either with a gimlet or brace and bit, as straight as may be, sighting down gimlet and handle from time to time while boring. Open the hole out at the top with a taper shell bit, until the tool will drop in

1280.

1273.

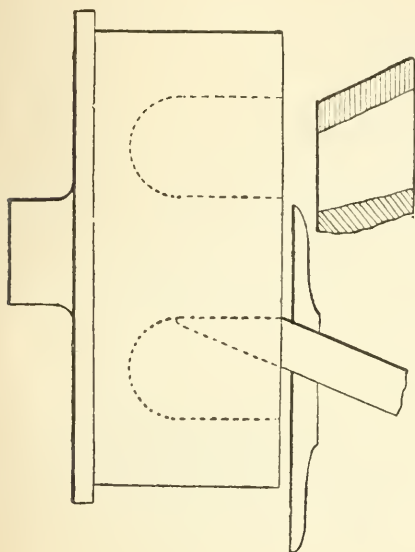

1274.

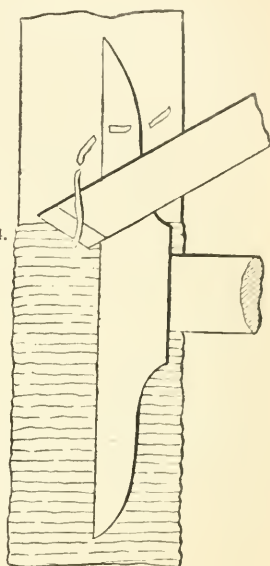

to within $\frac{3}{4}$ in. or 1 in. of its proper position, when the handle must be driven on over the shank with a hammer or mallet, holding the tool in a vice or against a block of hard wood while doing so. A couple of coats of shellac varnish given to the handles will improve their appearance and keep them clean.

Turning tools lose their edges very rapidly, and a quick fretting stone should be used for restoring them. A Charnley Forest stone is hardly coarse enough for turning gouges. It may be used for the chisels, which require a finer edge; but for gouges a Grecian or a Washita stone is quicker in its action, or, even a piece of common slate will serve the purpose. Another reason why a special stone should be kept for the gouges is that they rapidly groove it out, and so render it useless for chisels and other tools having straight cutting edges. A slip of Charnley Forest will do for fretting the hollow portion of the gouge. Even that is not necessary when the tool is roughing down, since the revolving wood itself will knock off immediately the "burr" or "wire edge," which has been produced by sharpening the bevelled face.

Those requiring a more comprehensive treatise on turning cannot do better than refer to Campin.

MASONRY.—The term masonry is here used in a wide sense, embracing the work of the stonemason and bricklayer as well as concrete building.

Stonework.—In selecting stone for constructive purposes, it is necessary to ascertain its qualities with regard to the following characteristics.

Durability.—The power of resisting atmospheric and other external influences, is the first essential in a stone for almost any purpose. The durability of a stone will depend upon its chemical composition, its physical structure, and the position in which it is placed; and the same stone will greatly vary in its durability according to the nature and extent of the atmospheric influences to which it is subjected. To make sure that a stone will “weather,”—that is, will wear well under exposure to the weather—many points have to be inquired into.

The chemical composition of the stone should be such that it will resist the action of the atmosphere, and of the deleterious substances which, especially in large cities, the atmosphere often contains. These destroying substances are taken up by the moisture in the air, or by the rain, and are thus conveyed into the pores of the stone. The sulphur acids, carbonic acid, hydrochloric acid, and traces of nitric acid, in the smoky air of towns, and the carbonic acid which exists even in the pure atmosphere of the country, ultimately decompose any stone of which either lime carbonate or magnesia carbonate forms a considerable part. The oxygen even in ordinary air will act upon a stone containing much iron, and the fumes from bleaching works and factories of different kinds very soon destroy stones whose constituents are liable to be decomposed by the particular acids which the fumes respectively contain. In addition to the direct chemical action of the sulphuric and sulphurous acids upon the constituents of stones, sulphates are sometimes formed by them which crystallize in the pores of the stone, expanding and throwing off fragments from the surface. The durability of a stone depends, therefore, to a great extent upon the relation between its chemical constituents and those of the atmosphere surrounding. A stone which will weather well in the pure air of the country may be rapidly destroyed in the smoke of a large town.

A stone will weather very differently according to the nature and extent of the atmospheric influences to which it is subjected. Obviously most stones will stand a pure atmosphere better than one which is charged with smoke, or with acids calculated to attack the constituents of the stone; and the stone will be less attacked in dry weather than during rain: the destructive acids cannot penetrate so deeply, and the frost has no influence whatever when the stone is dry. Therefore the number of days on which there is rain in any district has a great influence on the durability of stone used there. Wind has a considerable effect upon the durability of stone. A gentle breeze dries out the moisture, and thus favours the lasting qualities. A high wind, however, is itself a source of destruction; it blows sharp particles against the face of the stone, and thus grinds it away. Moreover, it forces the rain into the pores, and may thus cause a considerable depth to be subject to the effects of acids and frost. Variation of temperature, apart from the action of frost, is also a source of decay, the expansion and contraction due to it causing the opening of undetected natural joints; but its effect must be comparatively slight as a destructive agent.

The position of a stone in a building may very much influence its durability. The stone in that side which faces the prevailing rain is most liable to decay. Faces that are sheltered altogether from the sun and breeze, so that the moisture does not quickly dry out, are very liable to decay. This may be noticed especially in buildings of an inferior stone situated in a bad atmosphere. In these it will be seen that the soffits of arches and lintels, the shady sides of window jambs, and parts of carvings which the sun never gets at, are always the first portions to suffer. Stone exposed to very different degrees of heat on its different faces is liable to crack from unequal expansion and contraction.

The physical structure of a stone is of great importance, for upon it largely depends its power of resisting the action of the atmosphere. Chalk and marble are of the same chemical composition—both nearly pure lime carbonate—yet the latter, especially when polished, will resist an ordinary atmosphere for a long time, while the former is rapidly disintegrated and destroyed. Hence stones which are crystalline in structure are found

to weather better than those that are non-crystalline. No stone intended for the exterior of a building should have a porous surface, otherwise the rain conducts the acids from the atmosphere into the pores of the stone, which soon becomes decomposed. Also in winter the wet penetrates the pores, freezes, expands, and disintegrates the surface, leaving a fresh surface to be similarly acted upon, until the whole stone is gradually destroyed. If the other qualities of two stones are the same, then that which has the closer and finer grain is likely to be the more durable. It is important that a stone be homogeneous in its structure. If the grains and the cement uniting them are both of lasting material, the stone will be very durable. If the grains be easily decomposed and the cementing material remains, the stone will become spongy and porous, and then liable to destruction by frost. If the cementing material is destroyed, the grains will fall to pieces. Stone should contain no soft patches or inequalities; unequal weathering leaves projections which catch the rain, &c., and hasten decay.

Alexis A. Julien, of the School of Mines, Columbia College, sums up the results of a series of papers read before the New York Academy of Sciences on the decay of building-stones as follows:—If a rough estimate be desired, founded merely on the observations made of the comparative durability of the common varieties of building-stone used in New York city and vicinity, there may be found some truth in the following approximate figures for the "life" of each stone, signifying by that term, without regard to discoloration or other objectionable qualities, merely the period after which the incipient decay of the variety becomes sufficiently offensive to the eye to demand repair or renewal.

	Life in years.
Coarse brownstone	5-15
Laminated fine brownstone	20-50
Compact fine brownstone	100-200
Limestone, coarse fossiliferous	20-40
" fine oolitic (French)	30-40
Marble (dolomite), coarse	40
" " fine	60-80
Marble, fine	50-200
Granite	75-200
Gneiss	50 years to many centuries.

Working.—The readiness with which stone can be converted by the mason into the various shapes in which it is required for different kinds of work is of importance from an economical point of view. The characteristics of a stone in this respect will depend in some cases upon its hardness, but will also be influenced by the soundness of its texture; by its freedom from flaws, shakes, vents, &c.; also by its natural cleavage and other peculiarities. A soft stone of even grain and without distinct beds would naturally be selected for carved work, while a hard stone in thin layers, easily separated, would be well adapted for building good and economical rubble masonry.

Hardness.—The hardness of stone is often of importance, especially if it is to be subjected to a considerable amount of wear and friction, as in pavements. It is, moreover, important when the stone is to be used for quoins, dressings, and other positions where it is required to preserve a sharp angle or "arris." Hardness combined with toughness is also essential in good road metalling, which should not, however, be liable to splinter or to grind readily into dust. It does not follow because a stone is hard that it will weather well; many hard stones are more liable to atmospheric influence than those of a softer texture, whose chemical composition is of a more durable nature. Stone used for work exposed to the action of water should be hard; running or dripping water soon wears away the surface. Blocks of stone in marine

works are subject to serious injury, not only from the impact of the waves themselves, but from the sand and stones thrown against them by the force of the sea.

Strength.—The strength of stone should be ascertained if it is to be subjected to any excessive or unusual stress. Stones in ordinary building works are generally under compression, occasionally subject to cross strain, but never to direct tension. It is generally laid down that the compression to which a stone should be subjected in a structure should not exceed $\frac{1}{10}$ of the crushing weight as found by experiment. Practically, however, the compression that comes upon a stone in any ordinary building is never sufficient to cause any danger of crushing. The greatest stress that comes upon any part of the masonry in St. Paul's Cathedral is hardly 14 tons per sq. ft. In St. Peter's, Rome, it is about 15½ tons per sq. ft. These stresses would be safely borne even by the softer descriptions of stone. The weakest sandstones will bear a compression of 120 tons per sq. ft., while the resistance of ordinary building stones ranges from 140 to 500 tons per sq. ft., and in the case of granites and traps rises as high as 700 or 800 tons per sq. ft. It is possible, however, in some forms of arches, in retaining walls, and in other structures, that a considerable pressure may be concentrated upon certain points, which are liable to be crushed.

Weight.—The weight of a stone for building has occasionally to be considered. In marine engineering works it is often advisable to use heavy stones to resist the force of the sea. A light stone would be best adapted for arches, while heavy stones would add to the stability of retaining walls.

Appearance.—The appearance of stone is often a matter of importance, especially in the face work of conspicuous buildings. In order that the appearance may be preserved, a good weathering stone should of course be selected, free from flaws, clayholes, &c. All varieties containing much iron should be rejected, or they will be liable to disfigurement from unsightly rust stains caused by the oxidation of the iron under the influence of the atmosphere. Stones of blotched or mottled colour should be regarded with suspicion. There is probably a want of uniformity in their chemical composition, which may lead to unequal weathering.

Position in Quarry.—In order to obtain the best stone that a quarry can furnish, it is often important that it should be taken from a particular stratum. It frequently occurs that in the same quarry some beds are good, some inferior, and others almost utterly worthless for building purposes, though they may all be very similar in appearance. To take Portland stone as an example. In the Portland quarries are 4 distinct layers of building stone. Working downwards, the first bed of useful stone that is reached is the True or Whitbed Roach—a conglomerate of fossils which withstands the weather capably. Attached to the Roach, and immediately below it, is a thick layer of Whitbed—a fine even-grained stone, one of the best and most durable building stones in the country; then, passing a layer of rubbish, the Bastard-Roach, Kerf, or Curf is reached, and attached to it is a substantial layer of Basebed. The Bastard-Roach or Basebed-Roach and the Basebed are stones very similar in appearance to the True Roach and Whitbed; but they do not weather well, and are therefore not fitted for outdoor work. Though these strata are so different in characteristics, the good stone can hardly be distinguished from the other even by the most practised eye. Similar peculiarities exist in other quarries. It is therefore most important to specify that stone from any particular quarry should be from the best beds, and then to have it selected for the work in the quarry by some experienced and trustworthy man.

Seasoning.—Nearly all stone is the better for being seasoned by exposure to the air before use. This seasoning gets rid of the moisture, sometimes called "quarry sap," which is to be found in all stone when freshly quarried. But in hot climates it is sometimes an advantage to retain the quarry sap, for (1) it makes the stone easier to cut, and (2) it prevents the moisture from being sucked out of the mortar. Unless this moisture (in cold climates) is allowed to dry out before the stone is used, it is acted upon

by frost, and thus the stone, especially if it be one of the softer varieties, is cracked, or, sometimes, disintegrated. The drying process should take place gradually. If heat is applied too quickly, a crust is formed on the surface, while the interior remains damp, and subject to the attacks of frost. Some stones, which are comparatively soft when quarried, acquire a hard surface upon exposure to the air.

Natural Beds.—All stones in walls, but especially those that are of a laminated structure, should be placed “on their natural bed,”—that is, either in the same position in which they were originally deposited in the quarry, or turned upside down, so that the layers are parallel to their original position, but inverted. If they are placed with the layers parallel to the face of the wall, the effect of the wet and frost will be to scale off the face layer by layer, and the stone will be rapidly destroyed. In arches, such stones should be placed with the natural bed as nearly as possible at right angles to the thrust upon the stone,—that is, with the “grain” or laminæ parallel to the centre lines of the arch stones, and perpendicular to the face of the arch. In cornices with undercut mouldings the natural bed is placed vertically and at right angles to the face, for if placed horizontally, layers of the overhanging portion would be liable to drop off. There are, in elaborate work, other exceptions to the general rule. It must be remembered that the beds are sometimes tilted by upheaval subsequent to their deposition, and that it is the original position in which the stone was deposited that must be ascertained. The natural bed is easily seen in some descriptions of stone by the position of imbedded shells, which were of course originally deposited horizontally. In others it can only be traced by thin streaks of vegetable matter, or by traces of laminæ, which generally show out more distinctly if the stone is wetted. In other cases, again, the stone shows no signs of stratification, and the natural bed cannot be detected by the eye. A good mason can, however, generally tell the natural bed of the stone by the “feel” of the grain in working the surface. A stone placed upon its proper natural bed is able to bear a much greater compression than if the laminæ are at right angles to the bed joints. Fairbairn found by experiment that stones placed with their strata vertical bore only $\frac{9}{10}$ the crushing stress which was undergone by similar stones on their natural bed.

Destructive Agents.—The 2 principal classes of agents which destroy stone have already been described: they are—chemical agents, consisting of acids, &c., in the atmosphere; and mechanical agents, such as wind, dust, rain, frost, running water, force of the sea &c. There are other enemies to the durability of stones, which may be glanced at, viz.—lichens, and worms or molluscs.

Lichens.—In the country, lichens and other vegetable substances collect and grow upon the faces of stones. These are in many cases a protection from the weather, and tend to increase the durability of the stone. In the case of limestones, however, the lichens sometimes do more harm than good, for they give out carbonic acid, which is dissolved in rain-water, and then attacks the lime carbonate in the stone.

Molluscs.—The *Pholas dactylus* is a boring mollusc found in sea-water, which attacks limestone, hard and soft argillaceous shales, clay, and sandstones; but granite has been found to resist it successfully. The animals make a number of vertical holes close together, so that they weaken and eventually destroy the stone. By some it is supposed that they secrete a corrosive juice, which dissolves the stone; others consider that the boring is mechanically done by the tough front of the shell covering the *Pholas*. These animals are generally small, but sometimes attain a length of 5 in.—the softer the rock the bigger they become.

The *Saxicava* is another small mollusc, found in the crevices of rocks and corals, or burrowing in limestone, the holes being sometimes 6 in. deep. It has been known to bore the cement stone (clay-ironstone) at Harwich, the Kentish Rag at Folkestone, and the Portland stone used at Plymouth Breakwater.

Examination.—Speaking generally, in comparing stones of the same class, the least

porous, most dense, and strongest, will be the most durable in atmospheres which have no special tendency to attack the constituents of the stone. A recent fracture, when examined through a powerful magnifying glass, should be bright, clean, and sharp, with the grains well cemented together. A dull, earthy appearance betokens a stone likely to decay. A stone may be subjected to various tests, some of which afford a certain amount of information as to its characteristics. An important guide to the relative qualities of different stones is obtained by immersing them for 24 hours, and noting the weight of water they absorb. The best stones, as a rule, absorb the smallest amount of water: good traps and granites, $\frac{1}{10}$ - $\frac{1}{2}$ per cent.; good sandstones, 8-10 per cent.; good limestones, $1\frac{1}{2}$ -15 per cent.

Brard's Test.—Small pieces of the stone are immersed in a concentrated boiling solution of soda sulphate (Glauber's salts), and then hung up for a few days in the air. The salt crystallizes in the pores of the stone, sometimes forcing off bits from the corners and arrises, and occasionally detaching larger fragments. The stone is weighed before and after submitting it to the test. The difference of weight gives the amount detached by disintegration. The greater this is, the worse is the quality of the stone. This action is not similar to that of frost, inasmuch as water expands in the pores as it freezes, but the salt does not expand as it crystallizes.

Acid Test.—Simply soaking a stone for some days in dilute solutions containing 1 per cent. sulphuric and hydrochloric acids, will afford a rough idea as to whether it will stand a town atmosphere. A drop or two of acid on the surface of the stone will create effervescence if a large proportion of lime or magnesia carbonate is present.

Smith's test is useful for any stone in determining whether it contains much earthy or mineral matter easy of solution. Break off a few chippings about the size of a shilling with a chisel and a smart blow from a hammer; put them into a glass about $\frac{1}{4}$ full of clear water; let them remain undisturbed at least $\frac{1}{2}$ hour. The water and specimens together should then be agitated by giving the glass a circular motion with the hand. If the stone be highly crystalline, and the particles well cemented together, the water will remain clear and transparent; but if the specimens contain uncrystallized earthy powder, the water will present a turbid or milky appearance in proportion to the quantity of loose matter contained in the stone. The stone should be damp, almost wet, when the fragments are chipped off.

The durability of a stone to be obtained from an old-established quarry may generally be ascertained by examining buildings in the neighbourhood of the quarry in which the stone has been used. If the stone has good weathering qualities, the faces of the blocks, even in very old buildings, will exhibit no signs of decay; but, on the contrary, the marks of the tools with which they were worked should be distinctly visible. Exposed cliffs or portions of old quarries, or detached stones from the quarry, which may be lying close at hand, should also be examined, to see how the stone has weathered. In both cases care should be taken to ascertain from what stratum or bed in the quarry the stones have been obtained.

Quarrying.—In quarrying stone for building purposes, there should be as little blasting as possible, as it shakes the stone, besides causing considerable waste. Care should be taken to cut the blocks so that they can be placed in the work with their natural beds at right angles to the pressure that will come upon them. If this is not attended to, the blocks will be built in in a wrong position, or great waste will be incurred by converting them.

Classification.—The different kinds of stone used for building and engineering works are sometimes divided into 3 classes:—(1) siliceous, (2) argillaceous, (3) calcareous; according as flint (silica), clay (formerly called "argile"), or lime carbonate, forms the base or principal constituent. In describing the physical characteristics of stones, for practical purposes it is better to classify them as follows:—(1) granites and other igneous rocks, (2) slates and schists, (3) sandstones, (4) limestones.

Granite.—Granite generally contains more felspar than quartz, and more quartz than mica. The colour of the stone depends upon that of the predominating ingredient, felspar. An average granite may be expected to contain $\frac{2}{3}$ to $\frac{3}{4}$ of crystals of quartz or crystalline quartz; about the same, more or less, of felspar, also partly crystalline and chiefly in definite crystals; and $\frac{1}{10}$ of mica. But the mica may form $\frac{2}{10}$ or $\frac{3}{10}$, and the quartz $\frac{2}{3}$ or more, while the proportion of the felspar, as well as the particular composition of the felspar, both vary extremely. The durability depends upon the quantity of the quartz and the nature of the felspar. If the granite contains a large proportion of quartz, it will be hard to work; but, unless the felspar is of a bad description, it will weather well. The felspars that occur most commonly in granite are potash felspar (orthoclase) and a lime and soda felspar (oligoclase). Sometimes both these varieties are found in the same stone. Of the two, potash felspar is the more liable to decay: Mica is easily decomposed, and it is therefore a source of weakness. If the mica or felspar contain an excess of lime, iron, or soda, the granite is liable to decay. The quantity of iron, either as oxide or in combination with sulphur, affects the durability of granite, as well as of all other stone. The iron can generally be seen with a good glass; a very short exposure to the air, especially if assisted in dry weather by artificial watering (better if 1 per cent. of nitric acid be added to the water), ought to expose this. The bright yellow pyrites crystallized in a cubical form appear to do little harm. The white radiated pyrites (marcasite), on the contrary, decompose quickly. Where the iron stains are large, uneven, and dark coloured, the stone may be rejected for outside work. When the discoloration is of a uniform light yellow, it is probable that little injury will be done to the stone in a moderate time, and unless appearance is a matter of great importance, such granite would not be rejected. In red granites, the discoloration from iron does not show so easily, but still sufficiently if bad enough to cause rejection. The quality of granite for building purposes depends upon its durability, and upon the size of the grains. The smaller these are, the better can the granite be worked, and the more evenly will it wear. In using granite for ornamental purposes, the coarser-grained stones should be placed at a distance from the eye, the finer-grained stones where they can be easily inspected. Without attention to this point, very little better effect is produced than by a stone of uniform colour. Granite is quarried either by wedging or by blasting. The former process is generally reserved for large blocks, and the latter for smaller pieces and road metal. It is better to have the blocks cut to the desired forms in the quarries; first because it is easier to square and dress the stone while it contains the moisture of the ground or "quarry-sap"; also because the local men, being accustomed to the stone, are able to dress it better and more economically, and part of the work can be done by machinery. Moreover, the bulk of the stones being reduced by dressing, the cost of carriage is saved, without much danger of injuring the arrises in transit, as the stone is very hard. It is used chiefly for heavy engineering works, such as bridges, piers, docks, lighthouses, and breakwaters, where weight and durability are required. It is also used especially for parts of structures exposed to blows or continued wear, such as copings of docks, paving, &c. The harder varieties make capital road metal. In a granite neighbourhood the stone is used for ordinary buildings; but it is generally too expensive in first cost, transport, and working, and is therefore reserved for ornamental features, such as polished columns, pilasters, heavy plinths, &c. The granular structure and extreme hardness of granite render it ill adapted for fine carving, and its surface is entirely destroyed by the effects of fire.

Serpentine.—Serpentine derives its name from the mottled appearance of its surface, which is supposed to resemble the skin of a serpent. Pure serpentine is a hydrated silicate of magnesia, but it is generally found intermixed with lime carbonate, steatite or soapstone (a magnesia silicate), or with diallage, a foliated green variety of hornblende and dolomite. The prevailing colour is generally a rich green or red, permeated by veins of the white steatite. Some varieties have a base of olive green, with bands or blotches

of rich brownish red, or bright red, mixed with lighter tints, or olive green, with steatite veins of greenish blue; some are red, studded with crystals of green diallage; some clouded, and some striped. Serpentine is massive or compact in texture, not brittle, easily worked, and capable of receiving a fine polish. It is so soft that it may be cut with a knife. It is generally obtained in blocks 2 to 3 ft. long, and it has been found that the size and solidity of the blocks increase with their depth from the surface. This stone is greatly used in superior buildings for decorative purposes. It is, however, adapted only for indoor work, as it does not weather well, especially in smoky atmospheres. The red varieties weather better than those of a greenish hue, and those especially which contain white streaks are not fit for external work.

Sandstones.—Sandstones consist of quartz grains cemented together by silica, lime carbonate, magnesia carbonate, alumina, iron oxide, or mixtures of these substances. In addition to the quartz grains are often other substances, such as flakes of mica, fragments of limestone, argillaceous and carbonaceous matter, interspersed throughout the mass. As the grains of quartz are imperishable, the weathering qualities of the stone depend upon the nature of the cementing substance, and on its powers of resistance under the atmosphere to which it is exposed. Sometimes, however, the grains are of lime carbonate imbedded in a siliceous cement; in this case the grains are the first to give way under the influence of the weather. Sandstones are found in great variety of colour—white, yellow, grey, greenish grey, light brown, brown, red, dark blue, and even black. The colour is generally caused by the presence of iron. Thus iron carbonate gives a bluish or greyish tint; anhydrous sesquioxide, a red colour; hydrated sesquioxides, various tints of brown or yellow, sometimes blue and green. In some cases the blue colour is produced by very finely disseminated iron pyrites, and in some by iron phosphate. Sandstones used for building are generally classed practically, according to their physical characteristics. “Liver Rock” is the term applied, perhaps more in Scotland than in England, to the best and most homogeneous stone which comes out in large blocks, undivided by intersecting vertical and horizontal joints. “Flagstones” are those which have a good natural cleavage, and split therefore easily into the thicknesses appropriate for paving of different kinds. The easy cleavage is generally caused by plates of mica in the beds. “Tilestones” are flags from thin-bedded sandstones. They are split into layers—sometimes by standing them on their edges during frost,—and are much used in the North of England and in Scotland as a substitute for slates in covering roofs. “Freestone” is a term applied to any stone that will work freely or easily with the mallet and chisel—such, for example, as the softer sandstones, and some of the limestones, including Bath, Caen, Portland, &c. “Grits” are coarse-grained, strong, hard sandstones, deriving their name from the “millstone grit” formation in which they are found. These stones are very valuable for heavy engineering works, as they can be obtained in large blocks.

The recent fracture of a good sandstone, when examined through a powerful magnifying glass, should be bright clean, and sharp, the grains well cemented together, and tolerably uniform in size. A dull and earthy appearance is the sign of a stone likely to decay. Sandstones may be subjected to Smith’s or to Brard’s test. Recent experiments have led to the conclusion that any sandstone weighing less than 130 lb. per cub. ft. absorbing more than 5 per cent. of its weight of water in 24 hours, and effervescing anything but feebly with acid, is likely to be a second-class stone, as regards durability, where there is frost or much acid in the air; and it may be also said that a first-class sandstone should hardly do more than cloud the water with Smith’s test. It is generally considered that the coarse-grained sandstones, such as the millstone grits, are the strongest and most durable; but some of the finer-grained varieties are quite strong enough for any purpose, and seem to weather better than the others. Perhaps, for external purposes, the finer-grained sandstones, laid on their natural bed, are better than those of coarser grain. In selecting sandstone for undercut work or for carving, care must be taken that the layers are thick; and it is of course important that stones

should rest in most cases on their natural beds. The hardest and best sandstones are used for important ashlar work; those of the finest and closest grain for carving; rougher qualities for rubble; the well-bedded varieties for flags. Some of the harder sandstones are used for sets, and also for road metal, but they are inferior to the tougher materials, and roads metalled with them are muddy in wet, and very dusty in dry weather.

Limestones.—The term limestone is applied to any stone the greater proportion of which consists of lime carbonate; but the members of the class differ greatly in chemical composition, texture, hardness, and other physical characteristics. Chalk, Portland stone, marble, and several other varieties of limestone, consist of nearly pure lime carbonate, though they are very dissimilar in texture, hardness, and weathering qualities. Other limestones, such as the dolomites, contain a very large proportion of magnesia carbonate. Some contain clay, a large proportion of which converts them into marls, and makes them useless for building purposes. Many limestones contain a considerable proportion of silica, some iron, others bitumen. The lime carbonate in stones of this class is, of course, liable to attack from the carbonic acid dissolved in the moisture of ordinary air, and is in time destroyed by the more violent acids and vapours generally found in the atmosphere of large towns. A great deal depends, therefore, upon the texture of the stone. The best weathering limestones are dense, uniform, and homogeneous in structure and composition, with fine, even, small grains, and crystalline texture. Some limestones consist of a mass of fossils, either entire, or broken up and united by cementing matter. Others are made up of round grains of lime carbonate, generally held together by cement of the same material. Many give a preference to limestones as a class, on account of their more general uniformity of tint, their comparatively homogeneous structure, and the facility and economy of their conversion to building purposes; and of this class they prefer those which are most crystalline. Many of the most easily worked limestones are very soft when first quarried, but harden upon exposure to the atmosphere. This is said to arise from a slight decomposition taking place, which will remove most of the softer particles and leave the hardest and most durable to act as a protection to the remainder. By others it is attributed to the escape of the "quarry damp." The difference in the physical characteristics of limestones leads to their classification into marbles, and compact, granular, shelly, and magnesian limestones.

Practically, the name "marble" is given to any limestone which is hard and compact enough to take a fine polish. Some marbles—such, for example, as those from Devonshire—will retain their polish indoors, but lose it when exposed to the weather. Marble is found in all great limestone formations. It consists generally of pure lime carbonate. The texture, degree of crystallization, hardness, and durability, of the several varieties differ considerably. Marble can generally be raised in large blocks. The handsomer kinds are too expensive, except for chimney-pieces, table slabs, inlaid work, &c. The less handsome varieties are used for building in the neighbourhood of the quarries. The appearance of the ornamental marbles differs greatly. Some are wholly of one colour, others derive their beauty from a mixture of accidental substances—metallic oxides, &c., which give them a veined or clouded appearance. Others receive a varied and beautiful "figure" from shells, corals, stems of encrinites, &c., imbedded in them. Marble is used in connection with building chiefly for columns, pilasters, mantelpieces, and for decoration. Its weight makes it suitable for sea-walls, breakwaters, &c., when it is cheaply obtainable, but some varieties are liable to the attacks of boring molluscs. In the absence of better material, marble may be used for road metal and paving sets, but it is brittle and not adapted to withstand a heavy traffic. Roads made with it are greasy in wet weather and dusty when dry.

Compact Limestones.—Compact limestone consists of lime carbonate either pure or in combination with sand or clay. It is generally devoid of crystalline structure, of a dull earthy appearance, and of a dark blue, grey, black, or mottled colour. In some

cases, however, it is crystalline and full of organic remains. It is then properly known as a crystalline limestone. Some of the Carboniferous limestones are of the compact class; also the Lias limestone, which contains a considerable amount of clay, and is used for making hydraulic lime; also Kentish Rag from the Cretaceous system. Compact limestones are good for building purposes, where their dull colour and the difficulty of working them are not objections. They are useful for paving setts and road metal under a light traffic. They weigh 153 to 172 lb. per cub. ft., and absorb very little water, taking up generally less than 1 per cent. by weight in 24 hours.

Granular Limestones.—These consist of grains of lime carbonate cemented together by the same substance, or by some mixture of lime carbonate with silica or alumina. They are generally found in the Oolitic formation. The grains vary greatly in size: in some cases they are very small and uniform, very few being of a larger size; when the whole of the grains are somewhat larger, they constitute what are called "Roestones," the structure resembling that of the roe of a fish; when the grains are as big as peas, the stones are known as "Pisolites," or pea stones. These stones nearly all contain fossil shells; in some cases, the shelly matter occurs in larger quantity than the grains: they are then called shelly granular limestones. The colour of these stones is very variable, being sometimes white, light yellow, light brown, or cream-coloured. They are generally soft and somewhat absorbent; therefore liable to the attacks of acid atmospheres, and of frost, but otherwise are fairly durable. The stone is generally obtainable in large blocks, and it is often difficult when the stone has been sawn to detect its natural bed. This may be sometimes done by directing a jet of water on the side of the block, and it is well to do this, as it is of great importance with some of the less durable sorts that they should be set upon their natural bed. The weight of this class of stone varies from 116 to 151 lb., the lighter and more absorbent stones being the less durable. Their absorption of water in 24 hours is hardly ever less than 4 per cent. of their weight, while it is sometimes as much as 12 per cent. This class affords some of the principal building stones of this country. The very fine grained stones may be represented by Chilmark; those with larger grains by Portland, Ancaster, and Painswick; and those with large spherical grains by Ketton and Castleton; while Bath stone has large egg-shaped grains. Some of these stones (e. g. certain varieties of Portland) are well adapted for outdoor work; others (such as Bath, Caen, Painswick), for internal work, carving, &c.; while some of the harder kinds (Seacombe, Painswick, and some of the beds of Chilmark and Portland) are adapted for internal staircases where there is not likely to be much wear.

Shelly Limestones.—There are 2 classes of this stone. The first consists almost entirely of small shells cemented together, but shows no crystals on fracture: Purbeck is an example. Stones of the second class consist chiefly of shells, but break with a highly crystalline fracture: Hopton Wood and Nidderdale stones are examples. Stone of this class is chiefly used for paving. The weight is about 157–169 lb. per cub. ft., and the absorption is very small, generally much less than 2 per cent. of the weight.

Magnesian Limestones.—Magnesian limestones are composed of lime and magnesia carbonate in variable proportions, together with a small quantity of silica, iron, and alumina. Many limestones contain magnesia carbonate, but those with less than 15 per cent. do not come into the class now under consideration. The better varieties are those in which there is at least 40 per cent. of magnesia carbonate, with 4 or 5 per cent. of silica. When the magnesia is present in the proportion of 1 molecule of magnesia carbonate to 1 of lime carbonate (i. e. 54·18 and 45·82), the stone is called a dolomite. Prof. Daniel states that the nearer a magnesian limestone approaches dolomite in composition, the more durable it is likely to be. It is not merely the nature of the constituents or their mechanical mixture that gives dolomite its good qualities; there is some peculiarity in the crystallization which is all-important. Some peculiar combination takes place between the molecules of each substance; they possess some inherent

power, by which the invisible or minutest particles intermix and unite with each other so intimately as to be inseparable by mechanical means. On examining with a highly magnifying power a specimen of genuine magnesian limestone, such as that of Bolsover Moor, it will be found not composed of 2 sorts of crystals, some formed of lime carbonate, others of magnesia carbonate, but the entire mass of stone is made up of rhomboids, each of which contains both the earths homogeneously crystallized together. When this is the case, the stone is extremely durable. Some magnesian limestones contain sand, in which case their weathering qualities are greatly injured; while some are peculiarly subject to the attacks of sulphuric acid, which forms a soluble sulphate of magnesia easily washed away.

Preserving.—Many processes for preserving stone from decay are successful in the laboratory of the chemist; but none is likely to be of use in practical execution which is not economically applicable on a large scale. Any preservative solution, to be of practical value, must be capable of application to the surface to be protected by means of a brush.

One of the most common methods of preserving the surface of stone is to paint it. This is effectual for a time, but the paint is destroyed by atmospheric influence in the course of a few years. In London the time hardly amounts to 3 years, even under favourable circumstances. Moreover, it cannot well be used in important buildings, where appearance has to be considered. Oil has also been used as a coating; it fills the pores of the stone and keeps out the air for a time, but it discolours the stone to which it is applied. Paraffin is more lasting than oil, but is open to the same objection as regards discoloration of the stone. Soft-soap dissolved in water ($\frac{3}{4}$ lb. soap per gal.), followed by a solution of alum ($\frac{1}{2}$ lb. alum per gal.), has been frequently employed. Paraffin dissolved in naphtha, $1\frac{1}{2}$ lb. paraffin to 1 gal. coal-tar naphtha, and applied warm, is perhaps superior to the 2 preceding for this purpose. There is, however, no evidence to show that any methods such as these are likely to be successful in affording permanent protection to stone. Beeswax dissolved in coal-tar naphtha has also been proposed, or, when the natural colour of the stone is to be preserved, white wax dissolved in double distilled camphine. Another plan is to melt 2 parts wax in 8 of pure essence of turpentine. The surface should be cleaned with water dashed with hydrochloric acid, but should be perfectly dry, the solution applied hot and thin.

There is a large class of preparations whose preservative influences depend upon the presence of soluble silica, which combines with substances contained in, or added to the stone under treatment. By this means insoluble silicates are formed, which not only preserve the stone from the attacks of the atmosphere, but also add considerably to its hardness. Unfortunately the use of these substances sometimes causes efflorescence on the face of the wall to which they are applied. The soluble alkaline salts left in the pores of the stone are drawn to the surface; these crystallize in the form of white powder, and disfigure, or in some cases injure, the wall. The soluble silica is sometimes found in the natural state. A large proportion may be obtained from the Farnham rock, or from the lower chalk beds of Surrey and Hampshire by merely boiling with an alkali in an open vessel. Ordinary silica in the form of flints may be dissolved by digesting with caustic soda, or potash, under pressure. If a piece of porous limestone or chalk be dipped into this solution, part of the silica in solution separates from the alkali in which it was dissolved, and combines with the lime, forming a hard insoluble lime silicate; part of it remains in the pores and becomes hard.

Kuhlmann's process consists in coating the surface of stone to be preserved with a solution of potash or soda silicate. The hardening of the surface is due to the decomposition of the silicate. If the material operated upon be a limestone, potash carbonate, lime silicio-carbonate, and silica will be deposited; besides which the carbonic acid in the air will combine with some of the potash, causing an efflorescence on the surface, which will eventually disappear. When applied to lime sulphate, crystallization takes place,

which disintegrates the surface. In order to correct the discoloration of stone sometimes produced by the application of preservative solutions, Kuhlmann proposed that the surfaces should be coloured. Surfaces that are too light may be darkened by treatment with a durable manganese and potash silicate. Those that are too dark may be made lighter by adding baryta sulphate to the siliceous solutions. By introducing the iron, copper, and manganese sulphates, he obtained reddish-brown, green, and brown colours.

Ransome's indurating solutions consist of soda or potash silicate, and calcium or barium chloride. The surface of the stone is made thoroughly clean and dry, all decayed parts being cut out and replaced by good. The silicate is then diluted with 1 to 3 parts of soft water until it is thin enough to be absorbed by the stone freely. The less water used the better, so long as the stone is thoroughly penetrated by the solution. This is applied with an ordinary whitewash brush. After say a dozen brushings over, the silicate will be found to enter very slowly. When it ceases to go in, but remains on the surface glistening, although dry to the touch, it is a sign that the brick or stone is sufficiently charged; the brushing on should just stop short of this appearance. No excess must on any account be allowed to remain upon the face. After the silicate has become perfectly dry, the solution of calcium chloride is applied freely (but brushed on lightly without making it froth) so as to be absorbed with the silicate into the structure of the stone. The effect of using these two solutions in succession is that a double decomposition takes place, and insoluble lime silicate is formed, which fills the pores of the stone and binds its particles together, thus increasing both its strength and weathering qualities. In some cases it may be desirable to repeat the operation, and as the lime silicate is white or colourless, in the second dressing the prepared calcium chloride may be tinted so as to produce a colour harmonizing with the natural colour of the stone. Before applying this second process, the stone should be well washed with rain-water and allowed to dry again. Special care must be taken not to allow either of the solutions to be splashed upon the windows or upon painted work, as they cannot afterwards be removed therefrom. Upon no account use any brush or jet for the calcium that has previously been used for the silicate, or *vice versa*. Under ordinary circumstances about $\frac{1}{2}$ gal. of each solution will be required for every 100 yd. of surface, but this will depend only on the porosity of the material coated. This material has been used with success not only for the preservation of stone from decay, but also to keep out damp. It is applicable both to stone and brick surfaces, as well as to those rendered with cement or lime plaster.

Szerelmeý's stone liquid is stated by Prof. Ansted to be a combination of Kuhlmann's process with a temporary wash of some bituminous substance. The wall being made perfectly dry and clean, the liquid is applied in 2 or 3 coats with a painters' brush until a slight glaze appears upon the surface. This composition was used with some success in arresting for a time the decay of the stone in the Houses of Parliament. The stone liquid is transparent and colourless, but Szerelmeý's stone paint is opaque and of different colours, and is applied like ordinary paint.

The petrifying liquid of the Silicate Paint Company is stated in their circular to be a solution of silica, thinned with warm water, and applied to clean wall surfaces, which must be warmed if they are not already dry; 1 cwt. will cover 120 to 150 sq. yd.

Among other processes which have been tried are—Solution of baryta followed by solution of ferro-silicic acid so as to fill the pores of the stone with an insoluble ferro-silicate of baryta; solution of baryta followed by solution of superphosphate of lime producing an insoluble lime phosphate and baryta phosphate. Soluble alumina oxalate applied to limestones produces insoluble lime and alumina oxalate. These 3 processes last alluded to all possess the advantage of producing by the changes they undergo within the structure of the stone an insoluble substance, without at the same time giving rise to the formation of any soluble salt likely to cause efflorescence, which necessarily attends the use of alkaline silicates.

During the erection of large buildings, the surface of the masonry built in the earlier stages of the work is smeared over with a sort of thin mortar, so as to preserve it from atmospheric influence, and to make it easier to clean down.

Stonemasons' Tools.—The tools employed by the stonemason are neither numerous nor intricate.

The saw employed by the stonemason has the peculiarity of having no teeth, which those used in other trades have. It is made of a long thin plate of steel, having the lower edge slightly jagged, and is fixed in a frame. The saw cuts the stone by its own weight, being moved backwards and forwards horizontally. Some stone is of such a character as not to cleave with sufficient degree of certainty into pieces of the desired size and shape, as to make that process of cutting it advisable. The saw is then utilized. Two men usually sit one on either side of block that is being divided, and work the saw as above mentioned. The operation is facilitated by allowing water to wash the sand in the saw cut. It is done by placing a heap of sharp sand on an inclined plane over the stone, and permitting water to trickle through it. In this age of invention and machinery, for sawing marble, and almost all other materials used by the mason, steam-power is employed, which, of course, is fast superseding manual labour, more especially is this the case in the making of chimney-pieces. There are, however, some stones which can be sawn with facility with a toothed saw worked in a similar manner to the stonemasons' saw. Gay has invented an endless band saw, which consists of a steel wire rope passing over 2 pulleys. It not only receives a rapid rotary motion, but also one of twisting upon itself in such a way that the strands of steel wire cut their way into the stone, and clear their passage. The work done is said to be 25-30 times that which can be done by hand in the same time.

The mallet is somewhat similar to a dome in contour, excepting the portion at the other extremity to that at which the hand is. This portion is rather cylindrical. (See Fig. 1285.) The handle is of sufficient length to enable the artisan to firmly grasp it, and no more. The mallet is, of course, used for striking the chisels and knocking stones into position. The stonemason uses a wooden mallet, because it delivers just the kind of dull blow that is required. His mallet head is made circular, because his tools are steel, and have no wooden handles, and he is able to use the whole circumference, and thus prevent the tools from wearing holes in the wooden mallet face. The handle of his mallet is short, because it will strike a sufficiently powerful blow without being used at a great leverage.

The chisels used by masons are of various sizes, made to meet the divers requirements. Prof. Rankine states that the principal tools employed in the dressing of stone are the scrabbling hammer, whose head is pointed at one end like a pick and axe-formed at the other, and various chisels, of which one is pointed at the end and the others flat, and of breadths ranging from 1 to 3 in. or thereabouts. The chisel first referred to is the "point"; that instrument need not necessarily be pointed at the end, but may have a breadth of $\frac{1}{2}$ in. or thereabouts. This is the smallest description of chisel. Other forms are the "inch tool," the "boaster," and the "broad tool." The first is 1 in. broad, the second, 2 in., and the last, $3\frac{1}{2}$ in. The operation of working with the point is called "pointing," and with the boaster, "boasting." Points are usually employed in taking stones out of winding, and they are followed by the inch tool. The point, when used, leaves the stone in narrow furrows, having rough ridges between them. The inch tool is brought to bear upon the stone, and these ridges are cut away, and by the use of the boaster the whole is brought to a comparatively smooth surface. In those parts of the country where the stone saved by the operation of sawing is not enough to compensate for the labour, the operation is altogether performed with mallet and chisel.

1285.

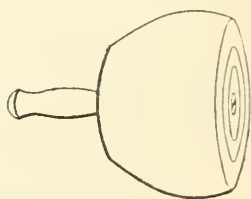

The other implements incidental to the stonemason's craft are similar to those employed by bricklayers, and will be found described under that section.

Laying stonework.—In constructing walls of stone, several methods are available for selection, according to the size and character of the stone to be dealt with. These will be described in progressive order, commencing with the plan adapted to the lowest class of material.

1286.

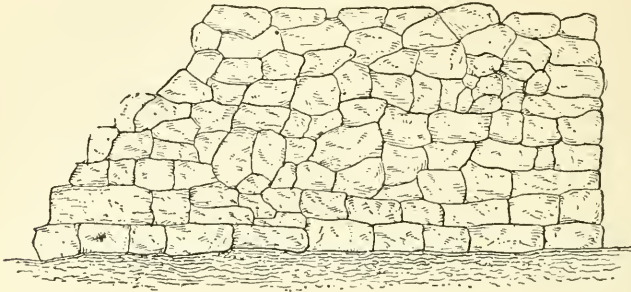

Rough rubble.—In this system, Fig. 1286, unsquared and undressed pieces of stone of all sizes are used indiscriminately, fitted into each other's broken surfaces as closely

1287.

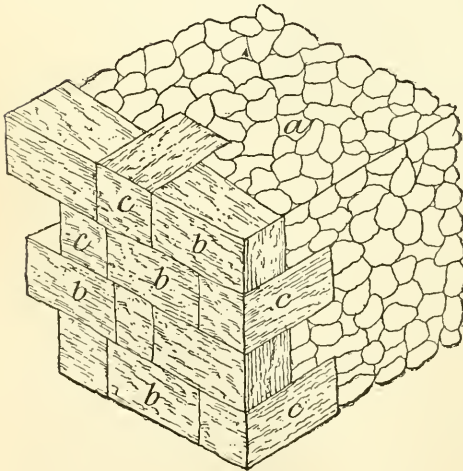

1288.

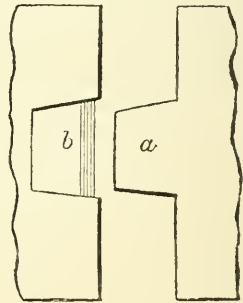

1289.

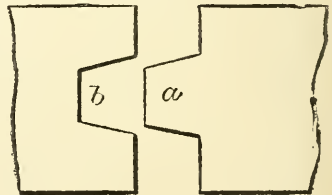

as possible, with large stones at intervals the full width of the wall, and all held firmly together by a plentiful use of first-class mortar, so as to make a compact mass when set. Very much stronger work can be done by substituting Portland cement for the mortar, thus forming a kind of coarse concrete.

Coursed rubble.—The same class of stone is used, but instead of mixing up the various sizes indiscriminately, pieces of like size are confined to one course, and those of a smaller size to the next above, and so on, commencing with the largest and finishing with the smallest, but adding a final course of larger size on the top. Each course is laid regularly and uniformly in good mortar, and solidity is given by occasionally laying a large stone crosswise so as to form a “binder” or “through.”

Combined rubbles.—When the wall is sufficiently thick to admit of it, an economic yet substantial plan is to combine a facing of large coursed rubble with a backing of rough rubble, as in Fig. 1287: *a* is the rough rubble; *b*, “stretchers,” or stones laid parallel with the wall; *c*, “headers,” or stones laid at right angles to the line of the wall, and contributing to the solidity of the structure.

1290.

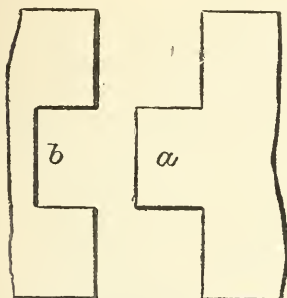

1291.

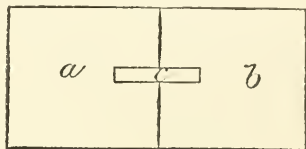

1292.

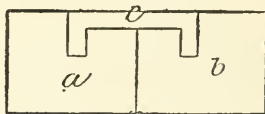

Ashlar work.—Ashlar forms the main feature in true masonry. The stones are always set in true courses, and the depth may be from 12 in. to any available thickness. The beds and joints should always be chisel dressed; that is, drafted and boasted off. The stones for the facing of the wall are generally 2 ft. 4 in. to 2 ft. 6 in. long, 12–18 in. deep, and $4\frac{1}{2}$ –10 in. thick, headers being thickest. It is a common practice to cut the stones in a somewhat tapering form, so that they closely abut only for a short distance (1–4 in.) back from the face, the spaces thus left being filled in with mortar and chips. The joints are either left close, or dressed back with a square or triangular recess. Hewn ashlar masonry set stone and stone, or with thin beds of mortar, and having the face-work backed up with rubble or bricks, is always weak, and will not preserve a true line on the face either vertically or horizontally, owing to unequal shrinkage.

1293.

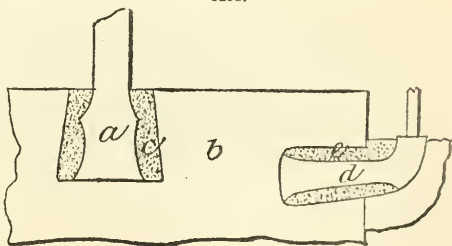

Joining stones.—When unusual strength is required, the stones are not only united by laying in mortar or cement, but are further held by joggles, dowels, cramps, and bolts. Simple forms of joggle are shown in Figs. 1288, 1289, 1290, where a tenon *a* on one stone is fitted into a mortice *b* on the next. Fig. 1291 illustrates the operation of dowelling, in which the 2 stones *a b* are joined by the dowel *c* let into grooves cut in the face of the stones. Joining by cramps is shown in Fig. 1292, *a b* being the 2 stones as before, and *c* the iron cramp dropped into holes cut for its reception. The operation of scurrying railings in stone by leading is represented in Fig. 1293. When the upper surface of the stone

carries the railings, the bar *a* stands in a dovetailed hole in the stone *b*, and is surrounded at foot by molten lead *c* poured in up to the top. But when the rail is to be fixed to the side of a stone, the bar *d* is bent so as to go to the end of the hole, and in order to fix it with the lead *e*, a bay of clay *f* is made to support the lead while it remains in a molten state, the clay being knocked away and the lead dressed flush when it is cold.

Walls.—In building stone walls, the same care is needed with regard to breaking joint as in brick walls. Footings should be done with the largest stones available, and the size may decrease with the rising courses; but all stones in one course should be of the same thickness. The arrangement of the stones in the courses will depend upon their shapes and sizes. Fig. 1294 illustrates an arrangement where the long stones *a* are

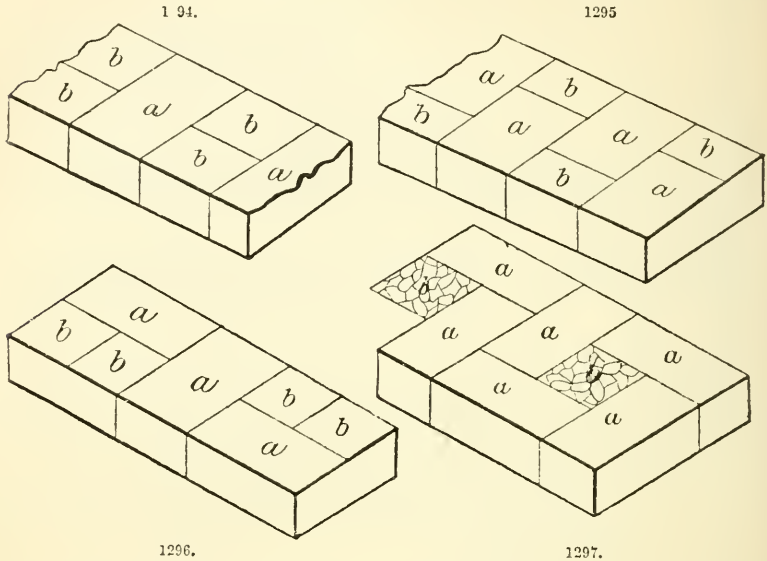

equal to the full width of the wall, alternating with the short ones *b*. In Fig. 1295 the long stones *a* require the addition of the short ones *b* to make the full width. In Fig. 1296 the long stones *a* are alternately used as headers and stretchers, the small ones *b* filling up the intervals. In Fig. 1297 there are no small stones, the spaces between the large ones *a* being filled with broken pieces or grouted rubble *b*. In "setting off" stone walls, there should not be a difference of more than 3 or 4 in. between succeeding courses.

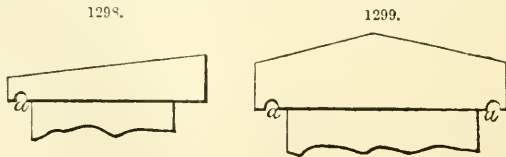

Enclosing walls of stone, if of no great height, are often built dry, i. e. without any mortar. There is frequently in stone walls a slope or "batter" on both sides amounting to 1/4 part of breadth of base to 6 of height, either carried gradually up or with offsets. Rubble walls have generally both sides vertical, the average thickness being $\frac{1}{16}$ of the

height. Superior walls are commonly provided with a coping at the top, to throw off the wet. This may have either a single slope to one side as in Fig. 1298, or to both sides as in Fig. 1299, the throating *a* in either case causing the water to drip away from the wall. Precisely the same plan is adopted with window sills.

Brickwork.—A most important element in nearly all structures of a permanent character is the ordinary building brick used in the formation of house walls. It consists of a mixture of clay and other earths, formed in moulds, and burned hard; numbers of these are laid in courses and held together by means of a lime cement known as mortar.

Bricks.—The art of making and burning bricks does not come within the range of the artisan who employs them, and need not be described here. Bricks may be divided into 3 classes:—(1) “Cutters” or “rubbers,” i. e. bricks intended to be cut or rubbed to some shape different from that in which they were originally moulded. (2) Ordinary bricks, intended to be used without cutting except where required to form the bond; the best of these are selected for fronts, and are termed facing bricks; specially hard varieties are used for coping, also for paving, quoins, and other positions where they will be subjected to unusual wear. (3) Under-burnt and misshapen bricks, only fit for inside work. Of each of these classes there are in most brickfields several varieties, varying in quality according to circumstances. Their general characteristics are as follow.

Cutters or rubbers are purposely made sufficiently soft to be cut approximately to the shape required with a trowel, and then rubbed to a smooth face and to an accurate shape. To ensure this, they are made of washed earth carefully freed from lumps of all kinds, and uniform in composition throughout its mass. The best rubbers are burnt to a point little short of vitrification. Inferior kinds are often stinted in firing; the cohesion between the particles is small, and they are easily destroyed by rain or frost. For the sake of durability, it is better to avoid rubbers in all exposed work, and to use “purpose-made” bricks moulded to the shape required and thoroughly well burnt. This is often done in good work.

Ordinary building bricks include the bulk of those required for building. The qualities and characteristics of these vary, not only in different localities, but also in the same brickyard. Such bricks are made either from washed earth or malm, from partly washed earth, or from earth which has merely been tempered, not washed at all. They should be hard and well shaped, those most uniform in colour being selected for facing, and the whole of the remainder being fit to use for good sound work.

Under-burnt bricks are generally known as “grizzle” or “place” bricks, in some places as “samel” bricks. They are always soft inside, and sometimes outside also, are very liable to decay, and unfit for good work. They are, however, often used for the inside of walls.

The names given to different classes of bricks vary in different districts, and even in different brickfields of the same district. The subjoined list of names for clamp-burnt bricks may be taken as a specimen, with the relative prices per 1000. The bricks are divided generally into 3 classes—“malms,” “washed,” and “common”—according to the manner in which the earth for them is prepared. For the third or common class the earth is not washed at all. All 3 classes are moulded and burned in exactly the same manner, and are then further sorted into a number of varieties according to the manner in which they have been affected by the fire.

The classes are subdivided as follows:—(*Malms*) cutters, 110s.; best seconds, 85s.; mean ditto, 75s.; pale ditto, 45s.; brown facing paviers, 55s.; hard paviers, 50s.; shippers, 37s. 6d., 48s.; bright stocks, 50s.; grizzle, 38s.; place, 35s. (*Washed*) bright fronts, 60s.; stocks, 45s.; shippers, 48s.; hard stocks, 42s.; grizzles, 36s.; place, 34s. (*Common*) shippers, 48s.; stocks, 44s.; grizzles, 36s.; rough stocks, 35s.; place, 33s.

Cutters have already been described. Seconds are similar to cutters, but with some slight unevenness of colour. Facing paviers are hard-burned malm bricks of good shape and colour used for facing superior walls. Bright fronts are the corresponding quality

from "washed" earth. Hard paviers are rather more burned, and slightly blemished in colour; used for superior paving, coping, &c. Shippers are sound, hard-burned bricks, not quite perfect in form; chiefly exported, ships taking them as ballast. Stocks are hard-burned bricks, fairly sound, but more blemished than shippers; used for the principal mass of ordinary good work. Hard stocks are over-burnt bricks, sound, but considerably blemished both in form and colour; used for ordinary pavings, for footings, and in the body of thick walls. Grizzle and place bricks are under-burnt, very weak, and 2 out of 5 "common" or unwashed place bricks are allowed to be bats, the stones left in the unwashed earth making them very liable to breakage. These two last-mentioned descriptions are only used for inferior or temporary work, and are commonly covered with cement rendering to protect them from the weather when intended to be permanent. Chuffs are bricks upon which rain has fallen while they were hot, making them full of cracks, and perfectly useless. Burrs are lumps of bricks vitrified and run together; used for rough walling, artificial rock-work, &c. Bats are broken bricks. Of these varieties, those from "common" or unwashed clay are hardly ever quite perfect in form, on account of the stones left in the earth, which make them shrink unequally, and become distorted in burning. Bricks from "washed" clay suffer in the same way to a less degree.

Kiln-burnt bricks are generally pretty equally burnt, and are classed chiefly according to the process by which they are made.

Bricks used in ordinary buildings generally are, or should be, the best that are made in the neighbourhood. Some descriptions of bricks, however, are universally known, and are used even outside the locality in which they are made, either for special purposes, or in buildings of such importance as to justify incurring the expense of carriage.

Good building brick should be sound, free from cracks and flaws, also from stones, or lumps of any kind. Lumps of lime, however small, are specially dangerous; they slake when the brick is exposed to moisture, and split it to pieces. A small proportion of lime finely divided and disseminated throughout the mass is an advantage, as it affords the flux necessary for the proper vitrification of the brick. In examining a brick, lumps of any kind should be regarded with suspicion, and tested. In order to ensure good brickwork, the bricks must be regular in shape and uniform in size. Their arrises (edges) should be square, straight, and sharply defined. Their surfaces should be even, not hollow; not too smooth, or the mortar will not adhere to them. The proportion of water that a brick will absorb is a very good indication of its quality. Insufficiently burnt bricks absorb a large proportion, and are sure to decay in a short time. It is generally stated in books that a good brick should not absorb more than $\frac{1}{15}$ of its weight of water. The absorption of average bricks is, however, generally about $\frac{1}{6}$ of their weight, and it is only very highly vitrified bricks that take up so little as $\frac{1}{15}$ or $\frac{1}{10}$. Good bricks should be hard, and burnt so thoroughly that there is incipient vitrification all through. This may be seen by examining a fractured surface, or the surface may be tested with a knife, which will make hardly any impression upon it unless the brick is under-burnt. A brick thoroughly burnt and sound will give out a ringing note when struck against another. A dull noise indicates a soft or shaky brick. A well-burnt brick will be very hard, and possess great power of resistance to compression. A really first-class rubber will not be easily scored by a knife even in the centre, and the finger will make no impression upon it. Such a brick will be of uniform texture, compact, regular in colour and size, free from flaws of any description. It is easy to distinguish clamp-burnt, kiln-burnt, and machine-made bricks. In clamp-burnt bricks, the traces of the breeze mixed with the clay can generally be seen. Kiln-burnt bricks very often have light and dark stripes upon their sides, caused by their being arranged while burning with intervals between them. Where the brick is exposed, it is burnt to a light colour; where it rests upon or against other bricks, it is dark. In some cases care is taken to prevent this, and the best kiln-burnt bricks are of uniform colour. Machine

ade bricks may generally easily be distinguished, if wire-cut, by the marks of the res; if moulded, by the peculiar form of the mould, letters on the surface, &c., or sometimes by having a frog on both sides. In many cases the marks made by pronged rks, used for packing the bricks, may be seen on their sides.

Before 1839 a duty was paid upon bricks; their size was then practically fixed by et of Parliament, and it has since remained materially unaltered. Ordinary bricks in e neighbourhood of London are about $8\frac{3}{4}$ in. long, $4\frac{1}{2}$ in. wide, and $2\frac{1}{2}$ in. thick, and igh about 7 lb. each. In different parts of the country, the size and weight vary ghtly; in the north of England and in Scotland they are larger and heavier. A very ege brick is inconvenient for an ordinary man to grasp, and a heavy brick fatigues the icklayer, who has to lift it when wet and lay it with one hand. In order to obtain od brickwork, it is important that the length of each brick should just exceed twice breadth by the thickness of a mortar joint.

The best method of testing bricks is to see if they ring when struck together; to certain the hardness by throwing them on to the ground, or by striking them against er bricks. The fractured surface should also be examined in order to ascertain if it hibits the characteristics mentioned. Brard's test is sometimes used for bricks, but is t of much practical benefit. The amount of water absorbed by bricks is to a certain tent an indication of their quality, and their resistance to compression, either singly or en built into brickwork, will show whether they are strong enough for the purpose uired.

Terracotta.—Blocks of terracotta are now being frequently used in place of bricks, epecially for the facing of buildings. The blocks should be so shaped as to form a good nd with the brickwork, or whatever material is used for the backing. They are usually de 12-18 in. long, 6-15 in. high, and $4\frac{1}{2}$ -9 in. thick on the bed. These dimensions e suitable for bonding into brick backing. When the blocks are of the thicknesses e mentioned, the joints are made square and flush as in ordinary ashlar work. In ne cases, however, the blocks are made 6 in. and $1\frac{1}{2}$ in. thick alternately. A "lip nt," as shown in Fig. 1300, is then employed. This plan, however, is not often adopted,

1300.



1301.

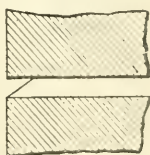

er does it afford such substantial work as the other. The mortar joints may be elled as in Fig. 1301. Such joints throw off the water, prevent the terracotta from shing, and relieve the face of the work better than if the joints were full and flush h the surface of the blocks.

The advantages of terracotta are as follows :—(1) If properly burnt, it is unaffected e atmosphere, or by acid fumes of any description. (2) If solid, it weighs 122 lb. e ft. cube; but if hollow, as generally used, it weighs only 60-70 lb. per ft. cube, or f the weight of the lightest building stones. (3) Its resistance, when solid, to com- sion is nearly $\frac{1}{3}$ greater than that of Portland stone. (4) Page found by experiment t it lost $\frac{1}{10}$ in. in thickness, while York stone lost $\frac{1}{4}$ in. with the same amount of ction. It is, therefore, well adapted for floors. (5) It is cheaper in London than the better rcriptions of building stone. It is so easily moulded into any shape, that for intricate rk, such as carvings, &c., it is only half the cost of stone. On the other hand, terrac- ta is subject to unequal shrinkage in burning, which sometimes causes the pieces to twisted. When this is the case, great care must be taken in fixing the blocks, other-

wise the long lines of a building, such as those of the string-courses or cornices, which are intended to be straight, are apt to be uneven, and the faces of blocks are often "in winding." Twisted and warped blocks are sometimes set right by chiselling, but this should be avoided, for if the vitrified skin on the surface be removed, the material will not be able to withstand the attacks of the atmosphere, &c. Terracotta is made in several colours, depending chiefly upon the amount of heat it has gone through. White, pale-grey, pale-yellow, or straw-colour, indicate a want of firing. Rich yellow, pink, and buff varieties are generally well burnt. A green hue is a sign of absorption of moisture, and of bad material. A glazed surface can be given to terracotta if required. Inferior terracotta is sometimes made by overlaying a coarsely-prepared common body with a thin coating of a finer and more expensive clay. Unless these bodies have been most carefully tested and assimilated in their contraction and expansion, they are sure in course of time to destroy one another; that is, the inequality in their shrinkage will cause hair cracks in the fine outer skin, which will inevitably retain moisture, and cause the surface layer to drop off in scales after winter frosts. Another very reprehensible custom is that of coating over the clay, just before it goes into the kiln, with a thin wash of some ochreish paint, mixed with finely ground clay, which produces a sort of artificial bloom, very pretty looking for the first year or two after the work is executed, but sure to wear off before long.

Lime.—"Rich" or "fat" limes are those calcined from pure, or very nearly pure, lime carbonate, not containing sufficient foreign constituents to have any appreciable effect upon either the slaking or setting actions. The solubility and want of setting power of fat lime render it unsuitable for making mortar, except for the walls of out-houses and for other similar positions. It is nevertheless frequently used for the mortar in structures of a much more imposing character. It is, however, better than hydraulic limes for sanitary purposes (being purer), and is very useful for plastering and for white-washing. It is also extensively employed in the manufacture of artificial hydraulic limes and cements. Fat lime requires to be mixed with a great deal of sand to prevent excessive shrinkage, but this addition does not materially injure it, as it attains no strength worth mentioning under any circumstances. The only setting that takes place in it is the formation of a thin surface crust, bearing a small proportion to the whole bulk; mortar made from such lime may therefore be left and re-worked repeatedly without injury. Some of the lime which finds its way into the London market, under the assumed names of Dorking, Halling, and Merstham, is merely fat lime tinged with iron sufficiently to give it the buff colour characteristic of the hydraulic lime made out of the grey chalk from these localities. Of course, this stained lime makes mortar of the same inferior description as would be obtained from a common fat white lime, and has no hydraulic properties whatever.

"Poor" limes are those containing 60-90 per cent. of lime carbonate, together with useless inert impurities, such as sand, which have no chemical action whatever upon the lime, and therefore do not impart to it any degree of hydraulicity. These limes slake sluggishly and imperfectly, the action only commences after an interval of a few minutes to more than an hour after they are wetted, less water is required for the process, and it is attended with less heat and increase of volume than in the case of the fat limes. If they contain a large proportion of impurities, or if they are over-burnt, they cannot be depended upon to slake perfectly unless first reduced to powder. The resulting slaked lime is seldom completely pulverized—is only partially soluble in water, leaving a residue composed of the useless impurities, and without consistence. The paste formed from the slaked lime is more incoherent, and shrinks less in drying, but behaves in other respects like that made from fat lime—in fact, it is like a fat lime mortar containing a certain proportion of sand. Mortar made from poor lime is less economical than that from fat lime, owing to the former increasing less in slaking, bearing less sand (as the lime already contains some in the form of

impurities), and requiring a more troublesome manipulation than the latter. It is in every way superior as regards setting, and should therefore only be used when no better can be had.

“Hydraulic” limes are those containing, after calcination, enough quicklime to develop more or less the slaking action, together with sufficient of such foreign constituents as combine chemically with lime and water to confer an appreciable power of setting without drying or access of air. Their powers of setting vary considerably. The best of the class set and attain their full strength when kept immersed in water. They are produced by the moderate calcination of stones containing 73–92 per cent. of calcium carbonate, combined with a mixture of foreign constituents of a nature to produce hydraulicity. Different substances have this effect, but in the great majority of natural hydraulic limes commonly used for making mortar, the constituent which confers hydraulicity is clay. In some varieties, a portion of the lime carbonate is replaced by magnesia carbonate, which increases the rapidity of setting, and adds to the ultimate strength of the mortar. The phenomena connected with the slaking of limes vary greatly according to their composition. With none is it so violent as with the pure lime carbonate, and the more clay the limes contain the less energy do they display, until we arrive at those containing as much as 30 per cent. of clay, when hardly any effect at all is produced by wetting the calcined lime, unless it is first ground to powder. The setting properties of hydraulic lime also differ very considerably in proportion to the amount they contain of the clay or other constituent, which gives the lime its power of setting without drying or the access of air.

Artificial hydraulic lime may be made by moderately calcining an intimate mixture of fat lime with as much clay as will give the mixture a composition like that of a good natural hydraulic limestone, of which the product should be a successful imitation. A soft material like chalk may be ground and mixed with the clay in the raw state. Compact limestone, on the other hand, is more commonly burnt and slaked the first instance (as being the most economical way of reducing it to powder), then mixed with the clay and burnt a second time. Lime so treated is called “twice kilned” lime. The mixture may be made by violently agitating the materials together in water by machinery, or by grinding them together in a dry state, afterwards adding water to form them into a paste. The paste in either case is moulded into bricks, which are dried, calcined, and otherwise treated like ordinary lime. Artificial hydraulic limes are not much manufactured or used in this country.

Sand.—Sand is known as “argillaceous,” “siliceous,” or “calcareous,” according to its composition. It is procured from pits, river-shores, sea-shores, or by grinding sandstones; and is chiefly used for mortar concrete and plaster. Pit sand has an angular grain, and a porous, rough surface, which makes it good for mortar, but it often contains many and similar impurities. River sand is not so sharp or angular in its grit, the grains having been rounded and polished by attrition; it is fine and white, and therefore suited for plastering. Sea sand also is deficient in sharpness and grit from the same cause; it contains alkaline salts, which attract moisture. When sand contains lumps or stones it should be “screened,” or, if required of great fineness, passed through a sieve. Sand found to contain impurities, such as clay, loam, &c., which unfit for almost every purpose, should be washed by being well stirred in a wooden trough, leaving a current of water flowing through it, which carries off the impurities. It is sometimes washed by machinery, such as an Archimedean screw revolving and carrying up the sand, while a stream of water flows down through it. Clean sand should leave no stain when rubbed between the moist hands. Salts can be detected by the taste, and the size and sharpness of the grains can be judged of by the eye.

Substitutes.—Burnt clay is sometimes used as a substitute for sand in mortar. It is prepared by piling moistened clay over a bonfire of coals and wood. As the clay becomes burnt and the fire breaks through, fresh layers of clay and coal, “breeze,” or

ashes, are piled on, and the heap may be kept burning until a sufficient supply has been obtained. The clay should be stiff. Care must be taken that it is thoroughly burnt. Raw or half-burnt pieces would seriously injure mortar. Sand is sometimes very economically obtained by grinding the refuse "spalls" left after working stones for walling. It is generally clean if carefully collected, but the sharpness of its grit depends upon the nature of the stone from which it is procured. Scoræ from ironworks, slag from furnaces, clinker from brick kilns, and cinders from coal, make capital substitutes for sand when they are quite clean and properly used. Wood cinders are too alkaline.

Mortar.—Ordinary mortar is composed of lime and sand mixed into a paste with water. When cement is substituted for the lime, the mixture is called cement mortar. The use of mortar in brickwork or masonry is to bind together the bricks or stones, to afford them a soft resting-place, which prevents their inequalities from bearing upon one another, and thus to cause an equal distribution of pressure over the beds. It is also used in concrete as a matrix for broken stones or other bodies to be amalgamated into one solid mass; for plastering, and other purposes. The quality of mortar depends upon the description of materials used in its manufacture, their treatment, proportions, and method of mixing.

Fat limes should only be allowed for inferior or temporary work. On account of their being cheap and easy to manipulate, they are often used in positions for which they are entirely unfit. Mortar made from fat lime is not suitable for damp situations nor for thick walls. In either case it remains constantly moist; when placed in positions where it is able to dry it becomes friable, and in any case is miserably weak. Even the economy of fat lime mortar is in many cases doubtful; for walls built with it are injured by frost, require constant repainting, and perhaps before many years rebuilding. Vicat says of fat limes that their use ought for ever to be prohibited, at least in works of any importance. Pasley adds with regard to fat lime mortar that when wet it is a pulp of paste, and when dry it is a little better than dust. If a pure or feebly hydraulic lime mortar is used in massive brickwork or masonry, it is only the outer edges of the joints that are affected by the carbonic acid in the air. A small portion of the exterior of the joints sets, but the mortar in the inside of the wall remains soft. The result of this is that a heavy pressure is thrown upon the outer edges of the bricks or stones, and they become "flushed," that is, chipped off. In some cases, from the same cause, the headers of brickwork are broken, so that the face of the wall becomes detached, and liable to fall away. Again, these weak mortars retain or imbibe moisture, which, when it freezes, throws off the outer crust. Pointing is then resorted to. If this is done with the same sort of mortar, the same result ensues, and in an aggravated degree, for as the operation is repeated, the joint becomes wider. In the end it will often be found that more has been expended in patching up work done with bad mortar than would have sufficed to provide good mortar at the first.

Hydraulic lime or cement should, therefore, always be used in mortar for work of any importance. In subaqueous constructions it is, of course, absolutely necessary. If there is any choice, the class of hydraulic lime used will depend upon the situation and nature of the work to be done. For ordinary buildings, not very much exposed, slightly hydraulic limes will suffice to form a moderately strong joint, and to withstand the weather. For damp situations, such as foundations in moist earth, a more powerful hydraulic lime should be prepared. For masonry under water an eminently hydraulic lime or cement mortar will be necessary. If the work be required to set very quickly, Roman cement, or a cement of that class, would be used; whereas, if quick setting be not necessary, but great ultimate strength is required, a heavy Portland cement should be adopted.

Sand is used in mortar to save expense and to prevent excessive shrinkage. Ordinary sands are not in any way chemically acted upon by the lime, but are simply in a state of mechanical mixture with it; with hydraulic limes and cements the effect of sand is

to weaken the mortar. When fat lime is used, however, the porous structure, caused by the sand, enables the carbonic acid of the air to penetrate farther, and to act upon a larger portion of the joint. Moreover, the particles of fat lime adhere better to the surfaces of the grains of sand than they do to one another; therefore the sand is in 2 ways a source of strength in fat lime mortar. It is of the utmost importance that the sand used for mortar should be perfectly clean, free from clay or other impurities which will prevent the lime from adhering to it. Sand for this purpose should have a sharp angular grit, the grains not being rounded, their surfaces should not be polished, but rough, so that the lime may adhere to them. It has been found that, speaking generally, the size of the grains of sand does not influence the strength of the mortar. Experiments tend to show that in samples 4 weeks old, Portland cement mortar made with fine sand was weaker than that made with coarse sand. Very fine sand is objectionable for fat lime mortar, as it prevents the air from penetrating, which is necessary in order that the mortar may set. Although coarse irregular-grained sand may make the best mortar, finer sand is sometimes necessary when very thin joints are used. Calcareous sands, on the whole, give stronger mortars than siliceous ones. Sea sand contains salts, which are apt, by attracting moisture, to cause permanent damp and efflorescence. This moisture will effectually prevent a fat lime from setting, or rather drying, but would tend to increase the strength of a hydraulic lime or cement. Great care must be taken to exclude all organic animal matter from the sand, or substitutes for sand, that may be used in mortar for building or plastering the walls of dwellings, otherwise they will putrefy, and render the walls and ceilings sources of unwholesome emanations.

The water used for mixing mortar should be free from mud, clay, or other impurities. Salt water is objectionable in some situations, as it causes damp and efflorescence. The salts it contains attract moisture, which improves the strength of hydraulic limes and cements by preventing them from drying too quickly, but is fatal to a pure lime for the reasons given above. Dirty water, and water containing organic matter, are of course objectionable for the same reasons as dirty sand.

Lime is much more expensive than sand. It is, therefore, a source of economy to add as much sand as is possible without nuduly deteriorating the strength of the mortar. So long as the joints of masonry or brickwork are weaker than the stones or bricks, the strength of the wall will increase in proportion as the strength of the mortar increases, until they are nearly equal in power of resistance. The mortar need not be quite equal in strength to the bricks, because in a bonded wall the fracture is constrained to follow a longer path than when the work is put together without breaking joint. The object, then, is to produce such an equality of resistance as will compel the fracture to follow a straight line, i.e. to break the material of the wall straight across rather than to follow the joints. This cannot always be done, with a due regard to economy, where the wall is built with very hard stone, but it can be done with the generality of bricks. In some cases a stronger mortar, no doubt, adds to the strength of the wall. For example, when the bricks are very bad, they will sometimes weather out on the face, leaving a honeycomb of mortar joints. Again, unusually strong mortar is required sometimes for the voussoirs of arches—to prevent sliding—for the lower joints of chimneys and walls, &c. As a rule, however, it can hardly be economical to make the strength of the mortar joints greater than that of the bricks or stones they unite.

In considering the proportion of sand to be mixed with different limes and cements it is necessary to bear in mind that the strength of the joint formed by the mortar will have an influence upon that of the wall. The proportion of the ingredients in mortar is generally specified thus:—1 quicklime to 2 (or more) of sand, meaning that 1 measure of quicklime in lump is to be mixed with 2 measures (or more) of sand. The quantities of sand put at different times into a measure vary a little, according to the amount of moisture the material contains; but so little that practically it makes no difference, and this mode of measuring sand is very convenient and sufficiently accurate. With the

lime, however, many conditions have to be fulfilled in order to make it certain that the same quantity always fills the same measure. The specific gravity of the calcined stone, the size of the lumps, the nature of the burning, the freshness of the lime, all cause the actual quantity contained in a given measure to differ considerably. In order to avoid this uncertainty, it has been proposed that the weight of lime for a given quantity of sand should be specified. Practically, however, this has not been carried out to any great extent, and the bulk of lime to be used is generally specified as well as that of the sand. The following proportions are given by General Scott for mortar in brickwork built with ordinary London stock bricks.

	Parts by Measure.	
	Quicklime.	Sand.
Fat limes	1	3
Feebly hydraulic limes	1	2½
Hydraulic limes (such as Lias)	1	2
Roman cement	1	1 or 1½
Medina „	1	2
Atkinson's „	1	2
Portland „	1	5
Scott's „	1	4

The proportions here recommended apply only to works above the surface of the ground, or free from the action of a body of water. For hydraulic purposes and foundations, 1 sand to 1 quicklime is as much as should be admitted. With cement mortar, 2 sand may be used with 1 cement, unless actually in contact with water, when 1 part of sand should be the limit allowed.

The quicklime and sand having been procured, and their proportions decided, the preparation of the ingredients commences. A convenient quantity of the quicklime is measured out on to a wooden or stone floor under cover, and water enough to slake it is sprinkled over it. The heap of lime is then covered over with the exact quantity of sand required to be mixed with the mortar; this keeps in the heat and moisture, and renders the slaking more rapid and thorough. In a short time—varying according to the nature of the lime—it will be thoroughly slaked to a dry powder. In nearly all limes, however, there will be found over-burnt refractory particles, and these should be carefully removed by screening—especially in the case of hydraulic limes; for if they get into the mortar and are used, they may slake at some future time, and by their expansion destroy the work. The fat limes may be slaked in any convenient quantity, whether required for immediate use or not. Plenty of water may be used in slaking without fear of injuring them, and they will be found ready for use in 2 or 3 hours. Hydraulic limes should be left (after being wetted and covered up) for a period varying from 12 to 48 hours, according to the extent of the hydraulic properties they possess; the greater these are, the longer they will be in slaking. Care should be taken not to use too much water, as it absorbs the heat and checks the slaking process. Only so much should be slaked at once as can be worked off within the next 8 or 10 days. With strong hydraulic limes, or with others that are known to contain over-burnt particles, it is advisable to slake the lime separately, and to screen out all dangerous lumps, &c., before adding the sand; or the safest plan is to have the lime ground before using it. When lime is purchased ready ground, there is sometimes danger of its having become “air-slaked,” by which, wear and tear of machinery in grinding is saved at the expense of loss of energy on the part of the lime. At the same time, if unadulterated and fresh, ground lime is likely to be of good quality. The quantity of water required for slaking varies with the pureness and freshness of the lime, and is generally between $\frac{1}{3}$ and $\frac{1}{2}$ of its bulk. A pure lime requires more water than one with hydraulic properties, as it evolves more heat and expands more in slaking. A recently-burnt lime requires more water than one that has been allowed to get stale.

The great object in mixing is to thoroughly incorporate the ingredients, so that no 2 grains of dry sand should lie together without an intervening layer or film of lime or cement. On extensive works, a mortar-mill is universally adopted for mixing the ingredients, and, indeed, is absolutely necessary for the intimate incorporation of large quantities. The heap of slaked lime covered with sand is roughly turned over and shovelled into the revolving pan of the mortar-mill, enough water being added to bring the mixture to the consistency of thick honey. When the ingredients are thoroughly mixed and ground together, the mortar is shovelled out of the pan on to a "banker" or platform to keep it from the dirty ground, whence it is taken away by the labourers in their hods. A good deal has been said regarding the number of revolutions that should be given to the pan. Nothing seems to have been settled upon this point except that the mortar should be thoroughly mixed, yet not kept so long in the mill as to be ground to pap. On very small works the mixing is effected by hand or in a pug-mill. It is evident, however, that such a mixture must be very incomplete unless a great deal of time is devoted to it. Before hydraulic lime is mixed in this manner it is absolutely necessary that it should first be ground to a fine powder, and with any description of lime the smallest refractory unslaked particles should be carefully screened out. Mortar, especially when made with cement, is sometimes mixed dry, the ingredients being carefully turned over together 2 or 3 times before the water is added. By this process a very thorough incorporation of the materials can be effected, but in many cases it would involve a separate grinding of the lime, and would be too expensive. If a hydraulic mortar is allowed to commence to set and is then disturbed, it is greatly injured. Care should be taken, therefore, to mix it only so long as is required for thorough reduction and incorporation of the ingredients, and only to prepare so much as can be used within a few hours. With fat limes it matters little whether large or small quantities of mortar are made at once, because they set very slowly. Very quick-setting cements must be used immediately they are mixed. The bulk of mortar produced in proportion to that of the ingredients differs greatly according to the nature of the lime or cement and the quantity and description of the sand added to it. The more hydraulic limes produce a smaller quantity of mortar because they expand less in slaking.

Selenitic mortar is generally made by mixing selenitic cement and sand. It was at one time made by mixing a small proportion of calcined sulphate with ordinary lime and sand. The licences now issued by the patentees render it necessary that selenitic cement should be used. The proportion of sulphate required to develop the characteristics of the material is added to the cement before it is sold, and the process of mixing the mortar is carried on under the following rules:—1 bush. (1.28 cub. ft.) of prepared selenitic lime requires about 6 gal. of water (2 full-sized pails). If prepared in a mortar-mill: (1) Pour into the pan of the edge-runner 4 full-sized pails of water; (2) gradually add to the water in the pan 2 bush. prepared selenitic lime, and grind to the consistency of creamy paste, and in no case should it be thinner; (3) throw into the pan 10 or 12 bush. clean sharp sand, burnt clay, ballast, or broken bricks, which must be well ground till thoroughly incorporated; if necessary, water can be added to this in grinding, which is preferable to adding an excess of water to the prepared lime before adding the sand. When the mortar-mill cannot be used, an ordinary plasterers' tub (containing about 30-40 gal.) or trough, with outlet or sluice, may be substituted. If prepared in a plasterers' tub: (1) Pour into the tub 4 full-sized pails of water; (2) gradually add to the water in the tub 2 bush. prepared selenitic lime, which must be kept well stirred until thoroughly mixed with the water to the consistency of creamy paste, and in no case should it be thinner; (3) measure out 10-12 bush. clean sharp sand or burnt clay ballast, and form a ring, into which pour the selenitic lime from the tub, adding water as necessary; this should be turned over 2 or 3 times, and well mixed with the larry or mortar hook. Both the above mixtures are suitable for bricklayers' mortar or for first

coat of plastering on brickwork. A box measuring inside $13\frac{1}{8}$ in. by $13\frac{1}{8}$ in. by $13\frac{1}{8}$ in. would contain about 1 bush, and would be useful for measuring the lime, and should be kept dry for that purpose; and a box without a bottom, measuring inside 36 in. by 18 in. by 18 in. would contain about $5\frac{1}{4}$ bush., and would be very useful for measuring the sand. Increase or decrease the quantities given proportionately with the requirements. The prepared selenitic lime must be kept perfectly dry until made into mortar for use. It is of the utmost importance that the mode here indicated of preparing the mortar, concrete, &c., should be observed, viz. first well stirring the prepared selenitic cement in the water before mixing it with the sand, ballast, or other ingredient, otherwise the cement will slake and spoil.

A few years ago persons using selenitic mortar were permitted to add the sulphate for themselves, and where selenitic cement is not procurable the process might still be useful. It is conducted as follows:—3 pints plaster of Paris are stirred in 2 gal. water; after the mixture is complete, it is poured into the pan of a mortar-mill; 4 gal. water are added, and the mill revolved 3 or 4 times, so as to ensure thorough mixing: 1 bush. finely-ground unslaked lime is added; the mixture is continued till the whole becomes a creamy paste, and then 5 bush. sand are gradually introduced, the whole being thoroughly mixed. No more is mixed than will be required during the day. If the water gets heated or sets too rapidly, a little more plaster of Paris should be added, but not more than $\frac{1}{2}$ pint extra per bushel of lime. When the lime used in this last-described process is deficient in hydraulic properties, a proportion of selenitic clay should be added so as to bring the total amount of clay in the prepared lime up to about 20 per cent. It will be seen that the addition of the plaster of Paris, clay, &c., requires considerable skill and judgment, and the simpler process is to use the selenitic cement, in which the necessary additions have already been carefully made.

Bad lime is much improved by mixing Portland cement with it. Gillmore says that lime paste may be added to a cement paste in much larger quantities than is usually practised in important works without any considerable loss of tensile strength or hardness. There is no material diminution of strength until the volume of lime paste becomes nearly equal to that of the cement paste, and it may be used within that limit without apprehension under the most unfavourable circumstances in which mortars can be placed. The following was used in the outer wall of the Albert Hall:—1 Portland cement, 1 grey lime (Burlam), 6 clean pit sand. The lime was slaked for 24 hours, then mixed with sand for 10 minutes; the cement was added, and the whole ground for 1 minute. Such a mixture must be used at once.

“Grout” is very thin liquid mortar, sometimes poured over courses of masonry or brickwork, in order that it may penetrate into empty joints left by bad workmanship or owing to the uneven character of the building material. It may also be necessary in deep narrow joints between large stones. It is deficient in strength, and should be avoided when possible.

Fat lime mortars, unless improved by adding pozzuolana and similar substances, are so wanting in strength that any precautions in using them are of little avail. In using hydraulic limes and cements it should be remembered that the presence of moisture favours the continuance of the formation of the silicates, &c., commenced in the kiln, and that the setting action of mortars so composed is prematurely stopped if they are allowed to dry too quickly. It is, therefore, of the utmost importance, especially in hot weather, that the bricks or stones to be imbedded in the mortar should be thoroughly soaked, so that they cannot absorb the moisture from the mortar, as well as to remove the dust from their surfaces, which would otherwise prevent the mortar from adhering. Mortar should be used as stiff as it can be spread; the joints should be all well filled. Grout should never be used, except where, from the position of the joint, it cannot be filled by mortar of proper consistence. In frosty weather, the freezing and expansion of the water in the mortar disintegrates it and destroys any work in which it may be laid. Mortar

should always be placed for the use of the builder on a small platform or "banker," or in a tub, to keep it from the dirt.

Tools.—The tools required by the bricklayer are not of a complicated nature, nor is it a matter of difficulty to become proficient in their use. They are illustrated below. Fig. 1302 is a masons' trowel; Fig. 1303, a pointers' cutting trowel; Figs. 1301, 1305,

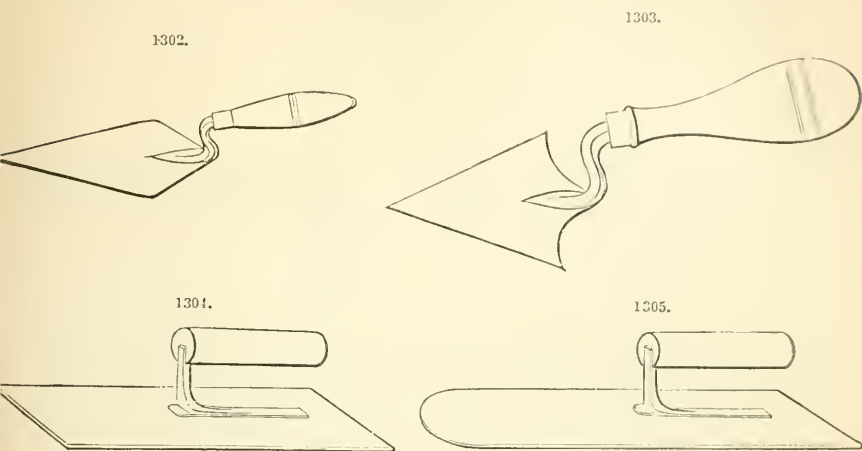

plasterers' trowels; Figs. 1306, 1307, plasterers' moulding tools; Figs. 1308, 1309, forms of bricklayers' hammers. The level employed by bricklayers is composed of a plumb level (Fig. 251, p. 186), fastened at right angles to a straight-edge, with struts at the sides to preserve the relative positions.

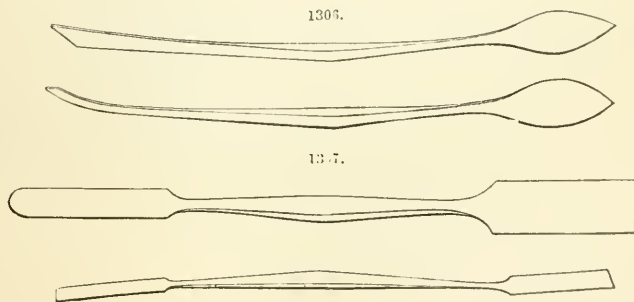

Laying Bricks.—The average size of bricks in this country is a fraction under 9 in. long and $2\frac{1}{2}$ in. thick; and, in consequence of this uniformity of size, a wall of this material is described as of so many bricks in thickness, or of the number of inches which result from multiplying 9 in. by any number of bricks—a 9-in., or 1-brick wall; a 14-in. wall, or $1\frac{1}{2}$ brick ($13\frac{1}{2}$ in. would be more correct, in fact; for, although a joint of mortar must occur in this thickness, yet the fraction under the given size of the brick is enough to form it); 18 in., or 2 bricks, and so on. The great art in bricklaying is to preserve and maintain a bond, to have every course perfectly horizontal, both longitudinally and transversely, and perfectly plumb, which last, however, may not mean upright, though

that is the general acceptation of the term, for the plumb rule may be made to suit any required inclination, as inward, against a bank, for instance, or in a tapering tower, and also to make the vertical joints occur perpendicularly over each other; this is vulgarly and technically called keeping the perpend.

By bond in brickwork is intended that arrangement which shall make the bricks of every course cover the joints of those in the course below it, and so tend to make the

1308.

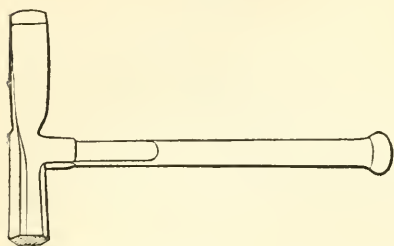

1309.

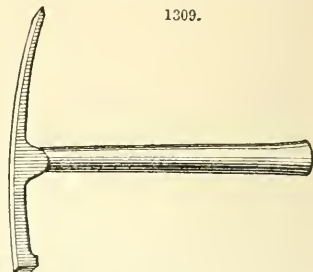

whole mass or combination of bricks act as much together or dependently upon one another as possible. A brick, being exactly half its length in breadth, it is impossible, commencing from a vertical end or quoin, to make a bond with whole bricks, as the joints must of necessity fall one over the other. This difficulty is obviated by cutting a brick longitudinally into 2 equal parts, which are called half headers. One of these is placed next to a whole header, inward from the angle, and forms with it a $\frac{3}{4}$ length between the stretchers above and below, thus making a regular overlap, which may then be preserved throughout. Half headers, so supplied, are technically termed closers. A $\frac{3}{4}$ stretcher is obviously as available for this purpose as a $\frac{1}{2}$ header, but the latter is preferred, because, by the use of it, uniformity of appearance is preserved, and whole bricks are retained on the returns. In walls of almost all thicknesses above 9 in., to preserve the transverse and yet not destroy the longitudinal bond, it is frequently necessary to use half bricks; but it becomes a question whether more is not lost in the general firmness and consistence of the wall by that necessity than is gained in the uniformity of the bond. It may certainly be taken as a general rule, that a brick should never be cut if it can be worked in whole, for a new joint is thereby created in a construction, the difficulty of which consists in obviating the debility arising from the constant recurrence of joints. Great attention should be paid to this, especially in the quoins of buildings in which half bricks most readily occur, and there it is not only of consequence to have the greatest degree of consistence, but the quarter bricks used as closers are readily admitted, and the weakness consequent on their admission would only be increased by the use of other bats or fragments of bricks.

Another mode of bonding brickwork is, instead of placing the bricks in alternate courses of headers and stretchers, to place headers and stretchers alternately in the same course. This is called Flemish bond. Closers are necessary to both varieties of bond in the same manner and for the same purpose; half bricks will also occur in both, but what has been said in reference to the use of them in the former applies even with more force to the latter, for they are more frequent in Flemish than English, and the transverse tie is thereby rendered less strong. Their occurrence is a disadvantage which every pains should be taken to obviate. The arrangement of the joints, however, in Flemish bond, presenting a neater appearance than the English bond, it is generally preferred for external walls when their outer faces are not to be covered with stucco or plaster composition of any kind, but English bond should have the preference when the greatest degree of strength and compactness is considered of the highest importance, because it

affords a better transverse tie than the other. It is a curious fact, that what is known in England as the Flemish bond, in brickwork, is unknown in Flanders, and is practised in the British Isles alone. In Flanders, Holland, and Rhenish Germany, which are all bricklaying countries, no kind of bond is found but what is known in England as English bond.

It has been attempted to improve the bond in thick walls by laying raking courses in the core between external stretching courses, and reversing the rake when the course recurs. This obviates whatever necessity may exist for using half bricks in the heading courses, but it leaves triangular interstices to be filled up with bats. Skilful and ingenious workmen are well aware of the necessity of attending to the bond, and are ready both to suggest and to receive, and practise an improvement; but generally the workmen themselves are both ignorant of its importance and careless in preserving it, even according to the common modes. Their work should, therefore, be strictly supervised as they proceed with it, for many of the failures which are constantly occurring may be referred to their ignorance or carelessness in this particular.

Not second in importance to bonding in brickwork is that it be perfectly plumb or vertical, and that every course be perfectly horizontal or level, both longitudinally and transversely. The lowest course in the footings of a brick wall should be laid with the strictest attention to this latter particular; for, the bricks being of equal thickness throughout, the slightest irregularity or incorrectness in that will be carried into the superimposing courses, and can only be rectified by using a greater or less quantity of mortar in one part or another; so that the wall will, of course, yield unequally to the superincumbent weight, as the work goes on, and perpetuate the infirmity. To save the trouble of keeping the plumb rule and level constantly in his hands, and yet to ensure correct work, the bricklayer, on clearing the footings of a wall, builds up 6 or 8 courses at the external angles, which he carefully plumbs and levels across, and from one to the other. These form a gauge for the intervening parts of the courses, a line being tightly strained from one end to another, resting on the upper and outer angles of the gauge bricks of the next course to be laid, and with this he makes his work range. If, however, the length be great, the line will, of course, "sag," and it must, therefore, be carefully set and propped at sufficient intervals. Having carried up 3 or 4 courses to a level with the guidance of the line, the work should be proved with the level and plumb rule, and particularly with the latter at the quoins and reveals as well as on the face. A smart tap with the end of the handle of the trowel will generally suffice to make a brick yield what little it may be out while the work is so green, and not injure it. Good workmen, however, take a pride in showing how correctly their work will plumb without tapping. To work which is circular in the plan, both the level and the plumb rule must be used, together with a gauge mould or a ranging trammel, to every course; as it must be evident that the line cannot be applied to such in the manner just described. To every wall of more than 1 brick thick 2 men should be employed at the same time, one outside and the other in; one man cannot do justice from one side even to a 14-in. wall. Inferior workmen and apprentices are generally employed as inside men, though the work there is of quite as great importance as exteriorly, except for neatness, and for that only if the brickwork is to show on the outside.

Bricks should not be merely laid. Every brick should be rubbed and pressed down in such a manner as to force the slimy matter of the mortar into the pores of the bricks, and so produce a perfect adhesion. Moreover, to make brickwork as good and perfect as it may be, every brick should be made damp or even wet before it is laid, otherwise it immediately absorbs the moisture of the mortar; and its surface being covered with dry dust, and its pores full of air, no adhesion can take place; but if the brick be damp and the mortar moist, the dust is enveloped in the cementitious matter of the mortar, which also enters the pores of the brick, so that when the water evaporates their attachment is complete, the retention and access of air being altogether precluded. To wet the

bricks before they were carried on to the scaffold would, by making them heavier, add materially to the labour of carrying; in dry weather they would, moreover, become dry again before they could be used; and for the bricklayer to wet every brick himself would be an unnecessary waste of time. Boys might then be advantageously employed to dip the bricks on the scaffold, and supply them in a damp state to the bricklayer's hand. A watering pot with a fine rose to it should also be used to moisten the upper surface of the last laid course of bricks, preparatory to strewing the mortar over it. In brick-laying with quick-setting cements, these things are even of more importance; indeed, unless bricks are quite wet to be set with cement, it will not attach itself at all.

A matter of importance in connection with face-brickwork is "finishing," commonly called "striking," the joints, a matter which has undergone during the last 20 years, more or less, a complete transformation of character, in style of work, skill displayed, and mode of execution. Various causes have brought about this change, foremost amongst them being the prevailing fashion of forcing the progress of brickwork in a manner entirely out of keeping with the time necessary for its natural growth. This has given rise to the now almost invariable practice of leaving the joints "rough," to be afterwards "pointed down," as it is termed, when the building is being completed, and the scaffolds removed; whilst a bricklayer facing his joints "off the trowel," must of necessity exercise a certain amount of care in selecting his bricks, so as to secure the best face outwards, because, the more they are free from defects, the less difficulty is found in "striking" the joints.

Nor would this pointing business be so bad if the joints were raked out effectually, so as to give a sufficient "key," and the material of a proper description and quality, judiciously mixed, and beaten to the necessary state of consistency, used by an efficient workman with handy tools, and a reasonable allowance of time for execution; for then there would be some guarantee of future stability, and also some possibility of mitigating the evil effects of slovenly bricklaying.

There are doubtless some cogent reasons why, during the winter months, face-brickwork should be left rough for after-pointing. We all know what even one night's hard frost will do in the way of injury to the finished joints which have not had time to get sufficiently hard or dry to resist it. But why should not this be avoided?

To safeguard brickwork from injury by frost, in the first place, the bricks, previous to using, should be kept dry, the mortar made up under cover, with fresh lime (kept fresh in a weather-tight shed), which, if not ground in a mill, should be dry-slaked, and only just sufficient water used in the mixing to bring it into a fit state of consistency; the top and face of all walls, so soon as built, completely and effectually covered up, and during building to be covered every night; the covering to remain until the danger is past, or only uncovered to meet the exigencies of the work.

Another specially noticeable change has also taken place in the form of the joints, whether struck in the first instance or pointed afterwards. This is brought about by the almost universal adoption of what is called the "weather joint," commonly known amongst bricklayers in and about London as the "School Board joint"—presumably so because it was on the Board School buildings that this system became more generally adopted. Now it is one of the conditions of the weather joint (so called) that the face shall be bevelled inwards, thus leaving the bottom arris of the bricks above bare and square undercut; and that the lower edge of the joint may have some pretence to a straight line, it is usual for the bricklayers to cut it, in which case the top arris of the bricks beneath is to a certain extent undercut also. So there are in reality 2 open "furrows" or channels to every joint laid open to receive any amount of moisture. With the old and legitimate system of pointing it would not be so, because (always providing the work is skilfully done) the whole surface of the joint would be struck flush to the face of the bricks, and completely sealed at both edges to the arrises of the course above and below, with no undercutting whatever. But supposing, for the sake of argu-

ment, that the new style has an advantage over the old in respect to the weather, so much cannot by any means be said in regard to the general appearance. And moreover the new system is exceedingly distasteful to all practical bricklayers for one especial reason, if for no other—the “awkward handling of the tools” involved in its “manipulation.” For instance, when commencing to build from off the ground or scaffold, it is extremely difficult to get the trowel to the required angle for striking it, and it is only when the courses are raised 6 or 8 high that it can be accomplished with any degree of convenience, leaving accuracy out of the question.

Another style is commonly known as “tuck-pointing.” It is only of late years that this system of pointing has been applied, except in very rare instances, to new brickwork, although common enough in renovating or dressing up the face of old buildings, to give them a smart appearance—by the bye, a short-lived one—for which purpose only it may be, to a certain extent, excusable. But the only possible excuse for its application to new work, is for the purpose of covering a multitude of sins, in the shape of inferior bricks, unskilfully laid in execrably bad mortar, the walls “shoved” up (the correct scaffold definition) with but little regard either to perfect face-bond or correct perpend. Another contingency will surely follow—that once brickwork has been subjected to this kind of pointing, a very few years will have elapsed ere it will require a similar treatment, and never be fit to receive any other. This tuck-pointing is the least of all adapted to resist the action of the weather, easily explained by the character of the materials, the system of manipulation, and form of the joints. In the first place the “stopping” or groundwork of the pointing is mixed with large proportions of vegetable colouring-matter to produce the necessary tint—such, for instance, as lampblack, umber, “Venetian red,” “Spanish,” or “purple brown,” &c.; neither of which contains a particle of “grit,” and when softened with water all are like so much mud, will never set hard, and when dry are little or no better than dust, having no cohesion in themselves or their surroundings.

In the next place the stopping when filled into the natural joints of the brickwork, even if tuckd in sound (which is not always the case), is “ironed” up to a smooth surface level with the face of the bricks, leaving nothing in the character of a key, by which the “artificial joint” when planted on its face may become incorporated with it. These artificial joints when “laid on” and completed consist of a network of raised bands of parallel width, bearing a strong resemblance to a fine mesh “trellis-work,” stuck on to the brick face, and having no useful purpose whatever, beyond defining the bond and courses, and not always that truthfully, because, the brickwork being carried up without any particular regard to truth, the artificial joints are frequently placed upon the surface of the brick instead of the natural joint.

The whole secret of forming these joints depends upon the dexterity with which a workman can plaster on the face of the stopping a ridge of pointing material $\frac{1}{2}$ – $\frac{3}{4}$ in. wide, and then drag two-thirds of it off again with a “Frenchman,” which is supposed to cut it off. This Frenchman is simply an old dinner-knife ground to a point, the tip of which is dragged down square to form a hook, the hook being intended for cleaning off the superfluous material cut by the edge of the knife as it passed along the straight-edge. But it is seldom sufficiently sharp for cutting it, so it simply drags off, leaving to each joint a couple of jagged edges, standing out $\frac{1}{16}$ – $\frac{1}{8}$ in. in thickness, upon which the moisture, dust, and sooty matters can deposit themselves to any extent, and eat their way into the mudlike stopping, which requires but a very short space of time to become entirely rotten and disintegrated, and if the surface or artificial joint has not by this time already fallen off from the want of cohesion, the whole will gradually bulge out from the face of the wall, and ultimately tumble together.

There is another description of pointing, sometimes called “bastard tuck,” the mode being somewhat similar to the last, only that it is done without any previous stopping. The pointing mortar is generally laid on with a tool called a “joiner,” guided by a straight-

edge. This tool has a face the same width as the intended joint, and leaves its impress upon the material, the superfluous margins being cut or dragged off by the Frenchman, the same as before. This kind of work is preferable to tuck-pointing, inasmuch as it is capable of being made sound and durable, especially if the original joints have been previously and effectually raked out; also the mortar may contain a greater proportion of grit, and need not contain any colouring matter to depreciate its setting qualities. It can also be pressed into the natural joints with greater effect, thereby ensuring stability, and finished flush with the face, which will be a nearer approach in appearance to work legitimately struck off the trowel.

There is yet another kind of "bastard tuck-pointing," which used occasionally to be applied to brickwork, faced with yellow malms, which consists of a method of stopping in the natural joints, while yet soft, and at the same time rubbing over the whole surface with a piece of brick of the same kind as those in the wall. By these means, the particles ground from the friction of the bricks become mingled with the mortar, so that the face of the wall, bricks, and joints are one level surface, and as nearly as possible one tint. It is then left until the time arrives for finishing, when the artificial joints are laid on in the same manner as described in tuck-pointing. One thing in favour of this method is the fact that the stopping becomes nearly as hard as the bricks, and therefore very little danger occurs of early decay. But with the disappearance of yellow malm bricks, this system of pointing appears to have disappeared also, and it would be well to be enabled to say the same of all other pointing in so far as new brickwork is concerned.

If pointing is to be done, and must be done, then let it be done properly—that is to say, neatly and sound, with good material, say Portland cement, spread out in a dry place for several days to air it, and mixed with a fair proportion of good sharp, fine grit, well washed; the natural joints raked out to a depth of not less than $\frac{3}{8}$ in., easily done when the work is being built, before it has had time to get hard, with a piece of wood shaped as a raker; it should not by any means be done with an iron instrument, which, in the hands of an unskilful workman, will tear off the arris of the bricks. After raking, the face of the wall should be cleaned, and the joints well swept with a hard broom. It should be borne in mind, that if the bricks are cleaned at this stage, the cleaning can be done at half the cost, because the dirt and mortar spots will not have had time to case-harden; if allowed to do so, there is no hope of removing them without destroying the face of the brick. In hot, dry weather each piece of work should be well saturated with water before pointing, which should not be commenced while the water is standing upon the face. The joints should also be "roughed in," and finished while sufficiently moist to be pliable; the tool should be a trowel, because what little trimming is necessary on the score of neatness is best done with the trowel, for the reason that it does not tear the edges. Red brickwork especially, when pointed in this way, will look remarkably well; because, when toned down by a few months' wear, the tint of the cement harmonizes with the colour of the brick with a very pleasing effect. The strength and tone of the material will be greatly improved by a few drenchings of water, after the work is done, and sufficiently hard to bear it, providing the season of the year will permit it. In the absence of cement, the best "greystone lime" should be used. This should not be "run," the common way of treating this kind of lime, but "air-slaked," sifted dry through a very fine sieve, and mixed with the sand before wetting, in the same way as with cement, only the whole quantity required for the job should if possible be made up at one time, and kept moist; not by continual adding of water, but in a damp place, shaded from the sun and wind, and before using beaten into a fit state of consistency, with a wooden or iron beater.

Those who are called upon to use "black" pointing mortar should never stain it with "lamp-black," "foundry sand," or "forge blowers," but procure from a powder manufactory a refuse called "green charge"; it is in a wet state like mortar, very cheap,

and a little will go a long way. It should be thoroughly mixed when the pointing "stuff" is being made up, so as to avoid different shades of colours when the work becomes dry.

Much has been said about the various kinds of bond in brickwork, which will be more clearly understood by reference to the following diagrams. Fig. 1310 illustrates English

1310.

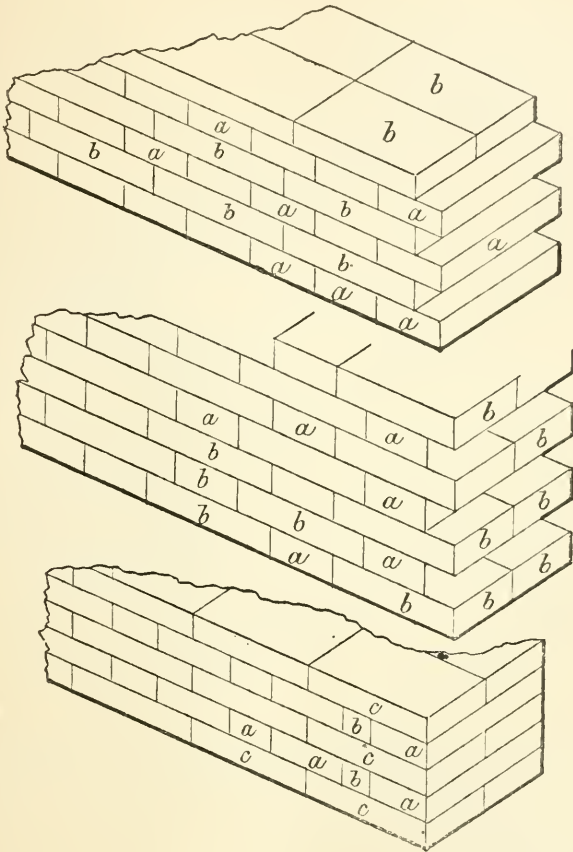

1311.

bond, the courses being made up alternately of a row of headers *a* and stretchers *b*; Fig. 1311, Flemish bond, wherein the headers *a* and stretchers *b* occur alternately in the same course. In angles of walls it is often necessary to introduce "closers" in order to make the courses break joint; these closers are halves or quarters of bricks, cut either lengthways or crossways, and introduced last but one in the course, so that a whole brick may always come at the end. Figs. 1312, 1313 illustrate respectively the 1st and 2nd courses of the corner of a 9-in. wall in English bond: *a* headers, *b* closers, *c* stretchers. Figs. 1314, 1315 indicate respectively the 1st and 2nd courses of a wall 2 bricks thick in English bond: *a* headers, *b* closers, *c* stretchers; and Figs. 1316, 1317, respectively the 1st and 2nd courses at an angle of the wall. Figs. 1318, 1319

show respectively the 1st and 2nd courses of a 1-brick wall in Flemish bond ; and Figs. 1320, 1321, the same in a 2-brick wall. Figs. 1322, 1323 are the 1st and 2nd courses respectively of the corner of a 1-brick wall in Flemish bond ; and Figs. 1324, 1325, the same of a 2-brick wall. The bond used for garden walls consists of 3 stretchers

1312.

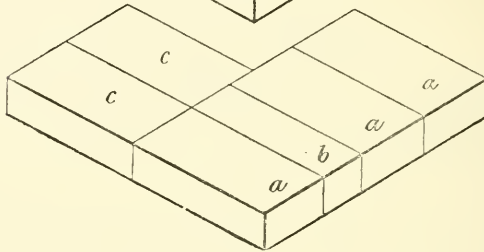
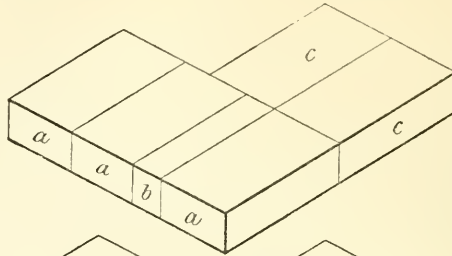

1313.

1314.

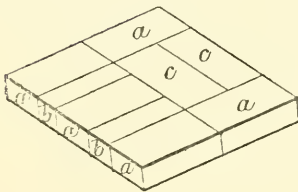

1315.

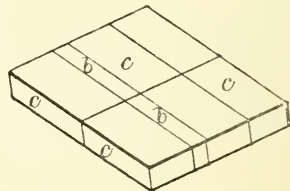

and 1 header alternating in each course. A bond much used in Scotland has 5 courses of stretchers to 1 of headers. In the junction at right angles of 1-brick English bond walls, the 1st and 2nd courses respectively are as in Figs. 1326, 1327 ; in Flemish bond, they resemble Figs. 1328, 1329.

Hollow walls.—Brick walls are sometimes built hollow, with the view of gaining one or more of the following objects,—(1) economy of materials, (2) equalizing the temperature and preventing damp in the apartment enclosed, (3) providing a flue for the passage of smoke. In Dearn's plan for a hollow wall, the bond is arranged as in Fig. 1330, rows of headers *a* alternating with rows of stretchers *b* set on edge, *c* being closers, and *d* the hollow spaces. Another plan is shown in Fig. 1331 ; where some of the stretchers *b* are 14 in. long, so as to break joint and avoid the use of closers.

Fireplaces.—Fig. 1332 shows the manner of supporting the hearth-stone of a fireplace when timber joists are used. Into the front wall *a* or chimney breast, below the grate, is built the hearth-stone *b*, supported at one end by the wall and at the other by a trimmer arch *c* having its base situated in the wall *a*, and its crown abutting against the trimmer joist *d*.

1316.

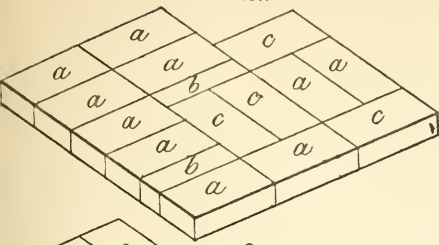

1318.

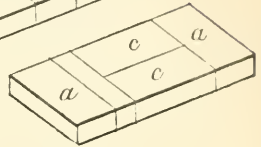
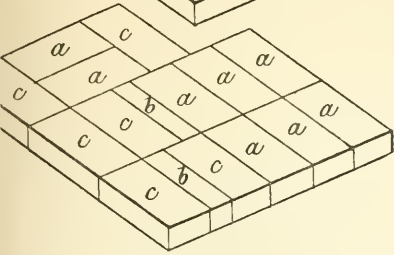
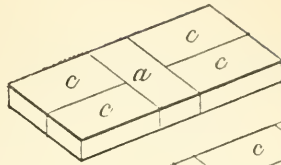

1319.

1317.

1320.

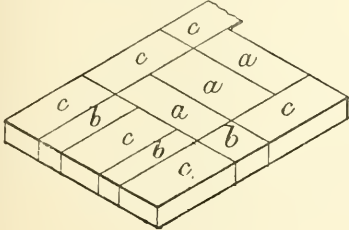

1321.

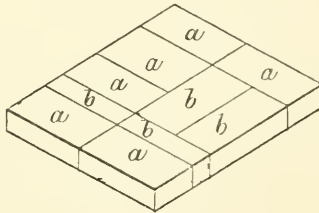

1324.

1322.

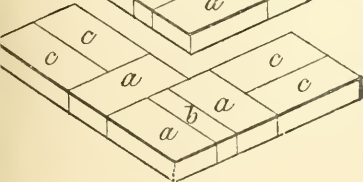
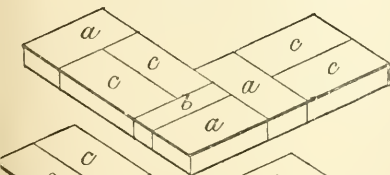
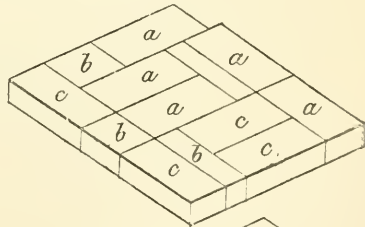

1323.

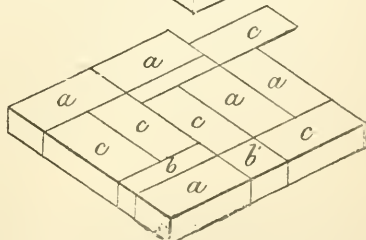

1325

Concrete.—Concrete is an artificial compound, generally made by mixing lime or cement with sand, water, and some hard material, such as broken stone, gravel, burnt

1326.

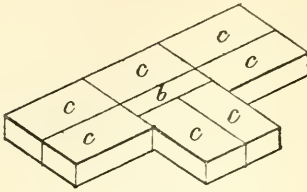

1327.

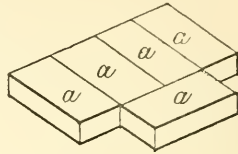

1328.

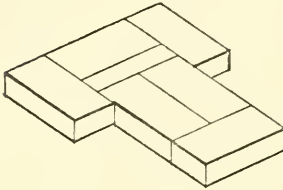

1329.

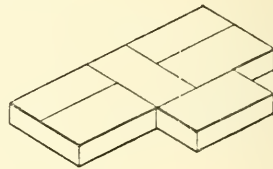

1330.

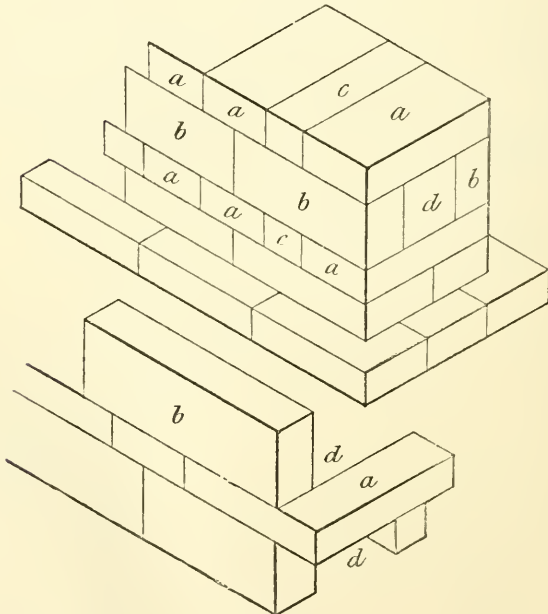

1331.

clay, bits of brick, slag, &c. These ingredients should be thoroughly mixed so as to form a sort of conglomerate. The lime, or cement, sand, and water, combine to form a lime

or cement mortar in which the hard material is imbedded, so that the result is a species of very rough rubble masonry. The broken material is sometimes for convenience called the "aggregate," and the mortar in which it is encased the "matrix." The strength and other qualities of concrete depend chiefly upon the matrix. They are, however, influenced also by the aggregate.

As to the matrix, the lime, or cement, sand, and water, should be so proportioned that the mortar resulting from their mixture is the best that can be made from the materials available. As a rule it should be better than the mortar used for walling, especially if the concrete is to be used in important positions. The reason for this is that, in concrete, the mortar receives less assistance, from the form and arrangement of the bodies it cements together, than it does in masonry or brickwork. In some cases the mortar is mixed separately, just as if it were to be used in building brickwork or masonry, and then added to the hard material. More generally, however, the ingredients are mixed together in a dry state.

The aggregate is generally composed of any hard material that can be procured near at hand, or in the most economical manner. Almost any hard substance may be used when broken up, e. g. broken stone, slag, bits of brick, of earthenware, burnt clay, breeze, and shingle. Preference should be given to fragments of a somewhat porous nature, such as pieces of brick or limestone, rather than to those with smooth surfaces, such as flints or shingle, as the former offer rough surfaces to which the cementing material will readily adhere. Any aggregate of a very absorbent nature should be thoroughly wetted, especially if it is used in connection with a slow-setting lime or cement, otherwise the aggregate will suck all the moisture out of the matrix, and greatly reduce its strength. Many prefer aggregates composed of angular fragments rather than those consisting of rounded pieces, e. g. broken stone rather than shingle. The reason for this is that the angular fragments fit into one another, and slightly aid the coherence of the mortar or cement by forming a sort of "bond," while the round stones or the shingle are simply held together by the tenacity of the matrix. Moreover, the angular stones are cemented together by their sides, the rounded stones only at the spots where they touch one another. The aggregate is generally broken so as to pass through a $1\frac{1}{2}$ - or 2-in. mesh. Very large blocks cause straight joints in the mass of the material, which should be avoided if the cement is to bear a transverse stress or to carry any considerable weight. Of the aggregates in common use, broken brick, breeze or coke from gasworks if clean, and burnt clay if almost vitrified throughout, all make very good concrete. Gravel and ballast are also good if angular and clean. Shingle is too round and smooth to be a perfect aggregate. Broken stone varies; some kinds are harder, rougher on the surface, and therefore better, than others. Flints are generally too round, or, when broken, smooth and splintery. Chalk is sometimes used, and the harder varieties make good concrete in positions where they are safe from moisture and frost. Slag from iron furnaces is sometimes too glassy to make good concrete, but when the surface is porous it is one of the best aggregates that can be used. It is hard, strong, and heavy, and the iron in it combines chemically with the matrix, making it much harder than it would otherwise be.

The size of the pieces of which the aggregate is formed influences the content of the void spaces between them, and therefore the quantity of lime and sand that must be used. Unless the mortar is of such a description that it will attain a greater hardness than the aggregate, the object should be for the concrete to contain as much broken material and

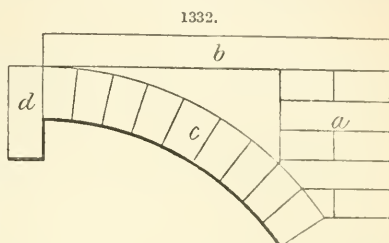

as little mortar as possible. The following Table shows the amount of voids in 1 cub. yd. of stone broken to different sizes, and in other materials :—

								1 Cub. Yd. contains Voids amounting to
Stone broken to	2½-in. gauge	10 cub. ft.
Do.	2 do.	10 ² / ₃ do.
Do.	1½ do.	11 ¹ / ₃ do.
Shingle	9 do.
Thames ballast (which contains the necessary sand)	4 ¹ / ₂ do.

A mixture of stones of different sizes reduces the amount of voids, and is often desirable. The contents of the voids in any aggregate may be ascertained by filling a water-tight box of known dimensions with the material, and measuring the quantity of water poured in so as to fill up all the interstices, or by weighing 1 cub. ft. of the aggregate and comparing its weight with that of a cub. ft. of the solid stone from which it is broken.

In building walls, or other masses of concrete, large pieces of stone, old bricks, chalk, &c., are often packed in for the sake of economy. Care should be taken that the lumps thus inserted be at least 1 in. apart, and some distance clear of the face, so that they may be entirely surrounded by cementing matter. Where lumps of chalk or absorbent material are used, care must be taken that they are not exposed so as to absorb wet or moisture, otherwise they will be liable to the attacks of frost, and may become a source of destruction to the wall.

The proportion of each material is determined by custom, rule of thumb, or experience. A common mixture consists of 1 quicklime, 2 sand, 5 or 6 gravel, broken stone, or brick; or 1 quicklime, 7 Thames ballast (which contains sand and shingle). The same proportions are often blindly adhered to, whatever may be the nature of the materials used. The best proportions for the ingredients of 1 cub. yd. of concrete to be made with any given materials may, however, always be arrived at by ascertaining the contents of the voids in a cub. yd. of the aggregate (without sand), and adding to the latter such materials as will make mortar of the best quality and in sufficient quantity to perfectly fill those voids. If the aggregate contain sand (as in the case of gravel or ballast), the sand should be screened out of the sample before the voids are measured, and the amount of sand thus screened out will be deducted from that required for the mortar which is to form the matrix of the concrete. In practice, a little more mortar than is actually required to fill the voids is provided, in order to compensate for imperfect mixing. Drake recommends 1 Portland cement, 8 gravel, for walls of buildings; and 1 Portland cement, 6 gravel, for roofs, floors, &c. On the Metropolitan Main Drainage Works the following proportions were adopted:—1 Portland cement, 5½ ballast, including sand, for sewers; and 1 Portland cement, 8 ballast, including sand, for backing walls and other work, except sewers.

Concrete is much used for paving, being made into slabs, and then laid like ordinary stone flags. For this purpose it is preferable to use an aggregate, such as shingle, much harder than the matrix, and to use very little sand in the latter. As the matrix becomes worn away, the pebbles of the aggregate project slightly, making the surface a little rough, and therefore less slippery, and at the same time the matrix is protected from further wear.

Mixing.—The materials are generally mixed in a dry state. The proportions decided upon are measured out either roughly by barrow-loads, or in a more precise manner by means of boxes made of sizes to suit the relative proportions of the ingredients to be used. Such boxes, in which the quantities to be mixed together can be accurately gauged, should always be used in mixing cement or other concretes intended for important work. The measured materials are then heaped up together, and turned over at least 2, better 3, times, so as to be most thoroughly incorporated. The dry mixture should then be sprinkled, not drenched, the water being added gradually through a “rose,” no more

being used than is necessary to mix the whole very thoroughly. If too much water be added, it is apt to wash the lime or cement away. The mixture should then again be turned over once or twice. When lime is used it should be in a fine powder. If a fat lime (which is almost useless for concrete in most positions), it should be slaked and screened. If a hydraulic lime, it should be finely ground, or, in the absence of machinery or grinding, it should be carefully slaked, and all unslaked particles removed by passing it through a sieve or fine screen. The lime is often used fresh from the kiln, piled on to the other ingredients during the mixing. This is apt to leave unslaked portions in the lime, and is a dangerous practice. When Portland cement is used for concrete, it must be thoroughly cooled before mixing. Cements of the Roman class should be fresh.

When the mortar is prepared separately, and then added to the aggregate, it may be mixed in mortar-mills, or by any other means available, the same precautions being taken as in mixing mortar for other purposes. The mortar should not be too wet, but should, when added to the dry material, contain about as much moisture as coarse brown sugar. It can then be readily turned over and incorporated with the aggregate. The aggregate should be wet throughout, so that it may not suck the moisture out of the mortar.

Some engineers consider it important that the lime or cement and sand should be mixed dry with the aggregate; others think that it is better to mix the mortar separately and then add it to the dry material. The relative advantages of these 2 methods depend upon circumstances. When the aggregate is in the form of sandy ballast or gravel, the second method could not be adopted without the expense of screening. The most intimate mixture, and therefore (other conditions being the same) the best concrete, can probably be produced by mixing the matrix separately and adding it in a moist (not wet) state to the moistened aggregate. With quick-setting cements, this method seems to be open to the objection that the mortar will begin to set before being added to the aggregate, and that the setting process will be disturbed by the after process of mixing with the aggregate. As a rule, however, the second method is more expensive than that in which the dry materials are all mixed together; and when such is the case, it is not worth while to adopt it for ordinary concrete.

Laying.—A common practice, which until lately was much insisted upon, is to tip the concrete, after mixing, from a height of 10 ft., or more, into the trench where it is to be deposited. This process is now considered objectionable, on the ground that the heavy and light portions separate while falling, and that the concrete is therefore not uniform throughout its mass. Wooden shoots or steeply-inclined troughs are sometimes used, down which the concrete is shot from the place where it is mixed to the site where it is to be used. Such shoots are also objectionable, because the larger stones have a tendency to separate from the soft portions of the concrete. Concrete should, after thorough mixing, be rapidly wheeled to the place where it is to be laid, gently tipped (through a height of not more than 3 ft.) into position, and carefully and steadily rammed in layers about 12 in. thick. Each layer should be left till it is perfectly set before another layer is put upon it. It is essential that the layers should be horizontal; if, not, the water trickling off will carry the cement with it. Each layer, after it is thoroughly set, should be carefully prepared to receive the one that is to rest upon it. Its surface should be carefully swept clean, wetted, and made rough by means of a pick. This is especially necessary if it has been rammed, for in that case the finer stuff in the concrete works to the top, as also a thin milky exudation, which will, unless removed, prevent the next layer from adhering. The joints between the layers are the most important points to be attended to in concrete. When the proper precautions have not been taken, they are found to be sources of weakness, like veins in rocks, and the mass can easily be split with wedges. When there is not time to allow each layer to set before the concreting is continued, it is better to ram it as quickly as possible, and, before it is set, to add the layers above it. Anything is better than to allow the layers to be disturbed by ramming,

by walking over them, or in any other way, after they have commenced to set. Concrete made with a very quick-setting cement should therefore not be rammed at all. When concrete has to be laid under water, care must be taken that it is protected during its passage down to the site of deposit, so that the water does not reach it until it is laid. This protection is afforded sometimes by shoots, by boxes, or by specially contrived iron "skips," which can be opened from above when they have reached the spot where the concrete is to be deposited, so as to leave it there. Sometimes the concrete is filled into bags and deposited without removing the bags. Concrete is also made into blocks varying in size from 2 to 200 tons. These are allowed to set on shore, and deposited, the smaller ones in the same way as blocks of stone, those of enormous size by special arrangements which cannot here be described.

In the construction of walls or buildings of concrete, the latter has to be kept in place or supported by boards or otherwise, until dry and firm enough to be self supporting. Various kinds of suitable apparatus have been invented and patented, all more or less costly. A strong, simple, and inexpensive set may be made after the plan described and illustrated below. In Fig. 1333, which is a perspective view, the boards *a b c d e*

1333.

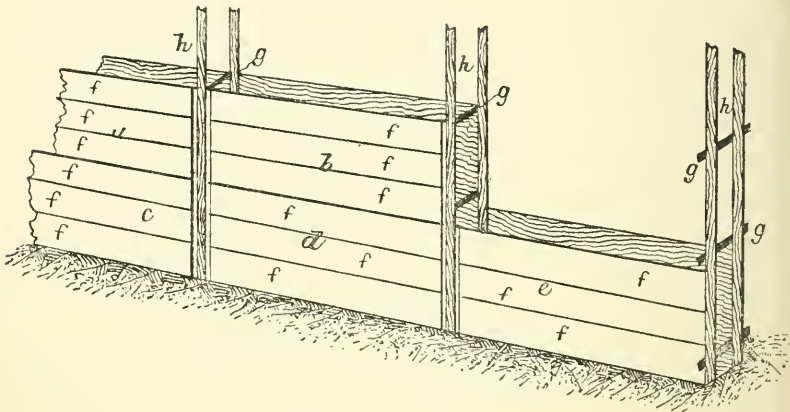

are each made of 3 planks *f* 9 in. wide and $1\frac{1}{4}$ in. thick, planed on the inner side. The width of each board is thus 2 ft. 3 in., and the length may be various, —4 ft., 5 ft., 6 ft. The 3 planks *f* forming each board are held together by a piece of angle iron, screwed on at each end, which also serves to retain the bolts *g* by which the boards are secured to the uprights *h*. The last are formed of a strip of board 2 in. wide by about 6 ft. long, to which is screwed a piece of channel iron (—) of the same width and length. The iron bolts *g* hold each pair of uprights at the required distance apart, to suit the thickness of the wall, as well as helping to tie together the boards on each side of the wall, and resisting the pressure of the moist concrete. As the wall advances in height, the bottom boards *c d e* can be removed and placed above the next row *a b*, and so on; and when the wall is sufficiently firm, the uprights can be removed and fixed higher. In addition to the straight boards, there will be needed some angle boards for turning corners. Fig. 1334 is an elevation, and Fig. 1335 a horizontal section of the structure. Fig. 1336 is a nearly full sized section showing details.

Cementing Material.—It is hardly necessary to say that when there is a choice, the strength and quality of the cementing material should be in proportion to the importance of the part the concrete has to play. Thus fat lime concretes would be objectionable

almost anywhere, except as filling in the spandrels of arches. Hydraulic lime, or cement, is advisable for concrete in nearly all situations. Eminently hydraulic limes should be used for concrete foundations in damp ground, and in the absence of cement for sub-aqueous work of any kind. Portland cement concretes are adapted for all positions, especially for work under water, or where great strength is required; also in situations where the concrete has to take the place of stone, as in facing to walls, copings, &c. For work to be executed between tides, where the concrete is required to set quickly but not to attain any great ultimate strength, Roman or Medina cement may be used with advantage. When, for the sake of its strength, Portland cement concrete is necessarily used under water, it must be protected by canvas covering or other means from any action which would wash it away before it had time to set. When concrete is likely to be exposed to great heat, as in fire-proof floors, gypsum has been used as a matrix.

Bulk produced.—The bulk of concrete obtained from a mixture of proper proportions of lime, sand, and aggregate, varies considerably according to the nature and proportions of the materials and method of treatment; but it should in general be a little more than the cubic content of the aggregate before mixing, as the other substances, if in proper proportion, should nearly fit into and disappear in its voids.

The following examples show how the bulk of concrete produced varies according to circumstances—(a) Concrete of 1 Portland cement to 6 shingle (or broken stone) and 2 sand: 27 cub. ft. shingle or broken stone, 9 cub. ft. sand, $4\frac{1}{2}$ cub. ft. Portland cement ($3\frac{1}{2}$ bush.), 25 gal. water, make 1 cub. yd. concrete. (b) Concrete of 1 Portland cement to 7 Thames ballast (consisting of 2 stone 1 sand): 33 cub. ft. ballast, $4\frac{1}{2}$ cub. ft. Portland cement ($3\frac{1}{2}$ bush.), 30 gal. water, make 1 cub. yd. of concrete. (c) Concrete of 1 Portland cement to 12 gravel, used at Chatham dockyard: 32 cub. ft. gravel (before shrinkage), 2 cub. ft. Portland cement, 50 gal. water, made 1 cub. yd. of concrete *in situ*. (d) Concrete of 1 Portland cement to 8 stone and sand, used at Cork Harbour works: 27 cub. ft. stone broken to $1\frac{1}{2}$ -in. gauge, 9 cub. ft. sand, $4\frac{1}{2}$ cub. ft. Portland cement, made 1 cub. yd. of concrete *in situ*. (e) In some concrete landings made with breeze from gasworks and Portland cement: 29 cub. ft. breeze broken to $\frac{3}{4}$ in. gauge, 8 cub. ft. Portland cement, made 1 cub. yd. of concrete *in situ*. (f) Concrete used at Portland Breakwater Fort, stone used in 2 sizes and mortar mixed separately: 14 cub. ft. stones broken to $3\frac{1}{2}$ -in. gauge, 14 cub. ft. stones broken to $1\frac{1}{2}$ -in. gauge, 10 cub. ft. sand, 5 cub. ft. Portland cement, 23 $\frac{1}{2}$ gal. water, made 1 cub. yd. of concrete *in situ*.

1334.

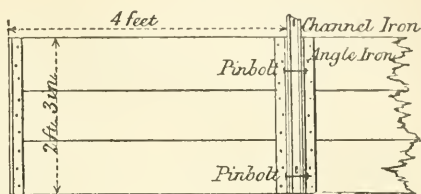

1335.

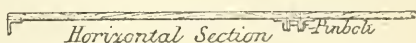

1336.

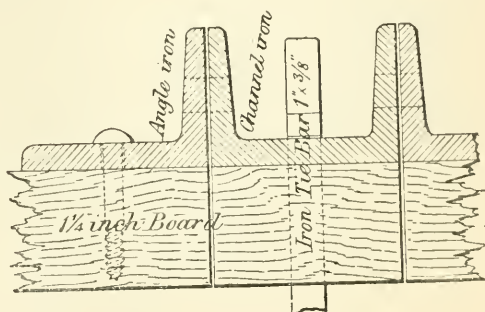

After being rammed, the concrete is compressed into about $\frac{9}{10}$ the volume it occupies when first made.

Selenitic Concrete.—Concrete may be made with selenitic cement mortar as the matrix. Portland cement is sometimes added in small quantities to the selenitic cement. From a series of experiments it appears that a mixture of 1 part Portland, 4 of selenitic cement, and 25 of sand, was if anything superior to the same Portland used with 4 of sand. The directions for preparing the concrete are as follows: 4 full-sized pails of water, 2 bush. prepared selenitic lime, 2 bush. clean sand. These ingredients are mixed in the edge-runner or tub, and then turned over 2 or 3 times on the gauging-floor, to ensure thorough mixing with 12 or 14 bush. ballast. When the tub is used, the sand will be first mixed dry with the ballast, and the lime poured into it from the tub and thoroughly mixed on the gauging-floor. An addition of $\frac{1}{6}$ best Portland cement will be found to improve the setting.

Expansion.—Concrete, when made with hot lime or cement, swells to an extent amounting to $\frac{1}{8}$ – $\frac{3}{8}$ in. per foot of its linear dimensions. This is owing to the imperfect slaking or cooling of the lime or cement. It is probable that when such expansion takes place there is a slight disintegration throughout the mass of concrete, and that its coherence is destroyed. It has been ascertained by experiment that when lime is carefully slaked, the concrete does not expand at all, and concrete should be so carefully prepared that no expansion will take place. The expansion which occurs in concrete made with hot lime or cement has, however, been taken advantage of in “underpinning” walls that have settled in parts; hot concrete forced tightly into openings made below the faulty portions expands and sets, filling the opening, and lifting the superincumbent work into its proper position.

An indispensable guide to those interested in concrete construction is Reid's ‘Practical Treatise on Natural and Artificial Concrete.’

Saltpetreing of walls.—The surfaces of walls are often covered with an efflorescence of an unsightly character, formed by a process known as “saltpetreing.” It shows itself chiefly in the case of newly built walls, but also in those parts of older walls which are exposed to damp. It varies somewhat in appearance and chemical composition, and is most apparent in dry weather. It is generally white in colour and crystalline in structure: the crystals presenting the appearance of very fine fibres or needles, or looking like a thin coating of snow or white sugar. Chemical analysis has shown that these crystals vary considerably in composition. They often consist of magnesia sulphate, also of lime sulphate; of soda carbonate, sulphate, or nitrate; of soda and potash chlorides, and potash carbonate. Efflorescence is attributable sometimes to the bricks or stones of a wall, sometimes to the mortar. Dampness is favourable to its formation. Cold as low as the freezing point stops it. In bricks burnt with coal fires, or made from clay containing iron pyrites (iron bisulphide), the sulphur from the fuel converts the lime or magnesia in the clay into sulphates. When the bricks are wet, these dissolve; when dry, they evaporate, leaving crystals on the surface. The magnesia sulphate is generally found in much greater quantity than the lime sulphate, as it is far more soluble in water. Many limestones contain magnesia; these are acted upon during calcination by the sulphur in the fuel; sulphates are formed, which find their way into the mortar and produce effects similar to those above mentioned. Again, the sulphur acids evolved from ordinary house fires attack the magnesia and lime in the mortar joints of the chimney; these dissolve and evaporate on the surface. The formation of chlorides is nearly sure to take place, if sea sand or sea water be used, or in bricks made from clay which has been covered by salt water. In some situations the formation of the nitrates has been attributed to the absorption of ammonia from the air. The potassium and sodium salts are supposed in many cases to be derived partly from the limestone used for the mortar, and partly from the fuel employed in burning the lime.

Not only does the efflorescence present a disagreeable appearance, but it causes

damp patches on the surface of the wall; it will eat through any coat of paint that has been applied after the efflorescence has once commenced, and will even detach small fragments of the materials composing the wall. Prevention in this case is better than any attempt at cure. The best plan is to avoid all the materials above mentioned as likely to give rise to efflorescence. In the case of bricks, clay containing pyrites or much magnesia should not be used; special bricks may be burnt with coke or wood. As regards mortar, the use of limestones containing magnesia to any great extent may generally be avoided. If, however, it does occur in spite of all precautions, the following remedies may be tried. (a) In the case of ashlar work: (1) The surface may be covered with a wash of powdered stone, sand, and water, which is afterwards cleaned off; this fills up the pores of the stone, and temporarily stops the efflorescence; when the wash is removed, the saltpetreing will recommence, but in a weaker degree than before. (2) Painting the surface is sometimes efficacious if it is done before the efflorescence commences. (b) The mortar before use may be treated to prevent it from causing efflorescence: (1) By mixing with it any animal fatty matter; Gillmore recommends 8–12 lb. of fatty matter, 100 lb. quicklime, and 300 lb. cement powder. (2) Potash salts may be rendered harmless by adding hydrofluosilicic acid.

Damp walls.—The walls of a stone house, and sometimes of a brick house, are often covered with dampness. This is due to the same cause by which dew is deposited on grass, or moisture on the side of a glass or pitcher filled with ice water and brought into a warm room. The walls become cold, and as stone is a non-conductor of heat, they remain cold for a long time. When the weather changes suddenly from cold to warm, the air becomes filled with moisture, for the warmer the air is the more moisture it will absorb. When this warm air strikes the cold wall, the moisture is deposited on it from the air, which is suddenly cooled by contact with the walls, and as the warm air is continually coming in contact with the walls, the dampness accumulates until it appears like a dew upon them, and pours down in streams at times. It is easily prevented. No plaster should be put directly upon brick or stone, but “furring” strips should be nailed to the wall, and the laths be put on these. Cellars are frequently made very damp in the same way by too much ventilation in warm weather.

Scaffolding.—The scaffolding used by bricklayers consists of (1) poles which are usually 20–30 ft. long, or even more, and 6–9 in. in extreme diameter at the butt end; (2) putlogs, which are short poles about 6 ft. long, and seldom more than 4 in. diam., but chopped square to prevent them from rolling; the ends are also square, but cut still smaller, so as not to exceed $2\frac{1}{2}$ by $3\frac{1}{2}$ in. or thereabout, in order that they may be less than the end of a brick; (3) lashings and wooden wedges; the former of $1\frac{1}{2}$ -in. rope, about 3 fathoms long; (4) planks of the usual length of 12–14 ft., all $1\frac{3}{4}$ in. thick, generally hooped at the ends to prevent splitting.

With these materials the scaffolding for brickwork is put together in the following manner:—First a line of upright scaffolding poles is erected on each side, parallel to the walls, at the distance of about 5 ft., and at intervals of 8–10 ft. apart. They are usually sunk about 2 ft. into the ground at the butt end, and the earth rammed round them. Next a line of horizontal poles of the same description is lashed and wedged to those upright poles, in the position intended for the first scaffold (or platform).

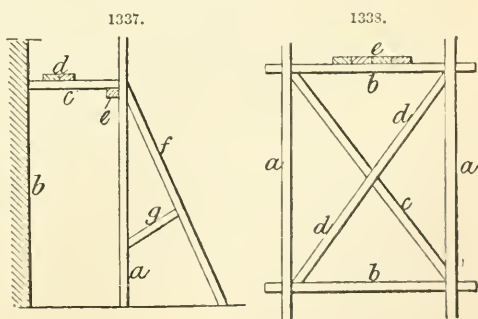

These horizontal poles, which are called "ledgers," are continued all round the building, and where 2 meet it is usual to make their ends overlap, and to lash them not only to the upright poles but also to each other. The ledgers and poles combine in supporting the superstructure of the scaffold, which is formed by the putlog and the planks. The putlogs have a bearing of about 6 in. in the walls, and are laid in a position that ought to be the place of a heading brick. At the other end they rest on the ledgers. They are usually placed about 5-6 ft. apart, excepting between doors and windows, where the piers are sometimes so narrow as to require them to be placed nearer; they cannot of course be introduced where there is an opening without inserting any extra piece of timber across that opening as a beam. The planks are placed longitudinally over the putlogs parallel to the wall, and it is common to use 4 or 5 planks alongside of each other, which forms a platform 3 or 4 ft. in width. Care should be taken that the planks do not project any distance beyond the putlogs upon which they rest. See Figs. 1337, 1338.

PLASTERING AND WHITEWASHING.—These operations are inseparable in the case of ceilings, and are often combined in other instances.

Plastering.—*Materials.*—A great variety of compositions are used by plasterers, among the most important being cements of various kinds. Many of these are used also for building purposes; others are very deficient in strength and weathering properties, and are suitable only for covering the surfaces of internal walls. In addition there are several mixtures made up of lime, sand, and other materials, distinguished by various names, and also used for covering surfaces of walls. The basis of most plasters is a native hydrated lime sulphate occurring as a soft stone, usually of a more or less crystalline texture, and varying in colour from white through shades of brown and grey to black. The very fine-grained pure white varieties are termed "alabaster," or, when transparent, "selenites." The raw stone is prepared either by simple calcination, or by calcination and combination with various salts of the alkalies. Plaster of Paris is produced by the gentle calcination of gypsum to a point short of the expulsion of the whole of the moisture. The raw stone is sometimes ground in the first instance and calcined in iron vessels. Paste made from it sets in a few minutes, and attains its full strength in an hour or two. At the time of setting it expands in volume, which makes it valuable for filling up holes and other defects in ordinary work. It is also added to various compositions in order to make them harden more rapidly; and is used for making ornaments for ceilings, &c., which are cast by forcing it, in a pasty state, into wax or gutta-percha moulds. Where it is plentiful, it is used in all parts of house-construction where it will be free from exposure to the weather, for which it is unfit, as it is very soluble in water. There are 3 qualities in the market—"superfine," "fine," and "coarse"; the 2 former being whiter and smoother in grain than the last. The superfine is sold in casks, and the other qualities in casks or sacks. Both casks and sacks contain 2 cwt.

Portland cement is much used by plasterers for external rendering, the lighter varieties, weighing 95-105 lb. per bush., being best adapted for this purpose. They set more quickly, and thus save expense not only in their first cost, but also in the labour that is bestowed upon them by the plasterer. Roman cement, and others of the same class, are used for internal rendering. Keene's cement is a plaster produced by recalcining plaster of Paris after soaking it in a saturated solution of alum: 1 lb. alum is dissolved in 1 gal. water, and in this solution are soaked 8½ lb. calcined plaster of Paris in small lumps; these lumps are exposed 8 days to the air, and then recalcined at a dull red heat. The addition of ½ lb. copperas gives the cement a cream colour, and is said to make it better capable of resisting the action of the weather. This cement is harder than the other varieties made from plaster of Paris, and is consequently used for floors, skirtings, columns, pilasters, &c.; it is also frequently painted to imitate marble. It is made in 2 qualities, coarse and superfine: the former is white, and capable of receiving a high polish; the latter is not so white, or able to take so good a polish, but

sets hard. The superfine quality is sold in casks containing $3\frac{1}{2}$ bush., and the coarse in casks of the same size, and in sacks containing 3 bush.

Parian or Keating's cement is said to be produced by mixing calcined and powdered gypsum with a strong solution of borax, then recalcining, grinding, and mixing with a solution of alum. There are 2 qualities in the market—"superfine" and "coarse." They are sold in casks and sacks of the same sizes as those used for Keene's cement. Parian is said to work freer than either Keene's or Martin's cement, and is therefore preferable for large surfaces, which have to be hand-floated before trowelling; but the 2 latter cements are fatter, and produce sharper arrises and mouldings. Martin's cement is made in a similar way to Parian—potash carbonate (pearlash) being used instead of borax, and hydrochloric acid being sometimes added. It is made in 3 different qualities—coarse, fine, and superfine—the coarser kinds being of a reddish-white colour, and the finer pure white. It is said to cover more surface in proportion to its bulk than any other similar material. Metallic cement has a metallic lustre, is suitable for outside work, and is intended to dispense with colouring or painting, but is not much used. One variety is made by mixing ground slag from copper-smelting works with ordinary cement stone. Portland cement stucco is a mixture of Portland cement and chalk. It is of a good colour and close texture; weaker than Portland cement, but not so liable to crack. Lias cement is produced from Lias shales containing a large proportion of soluble silica. It resembles Lias lime in appearance, sets in 8 or 10 minutes, and is used for lining water-tanks, or other purposes for which a light quick-setting cement is required. John's stucco cement is used as a wash or paint, and when mixed with 3 parts of sand as a stucco. It is said to adhere well, to be hard when set, impervious to wet, and fit for mouldings or castings.

These so-called "cements" or plasters are largely used for the best class of internal plastering, and, as they set very quickly, they can be painted within a few hours, which is a great advantage. They are capable of receiving a very high polish, to obtain which the surface is rubbed down with gritstones of various degrees of coarseness; afterwards stopped or paid over with semi-liquid neat cement which fills up the pores; rubbed again with snake-stone, and finished with putty powder. The plasters should not be used in situations much exposed to the weather, on account of their solubility.

The materials used in ordinary plastering are laid on in successive coats, which differ from one another in composition. In all of them the lime used should be most thoroughly slaked, or it will throw out blisters after being spread. For this reason the "stuff" is generally made long before it is required, and left for weeks to cool. Pure or fat limes are generally used for the sake of economy, and for safety. Hydraulic limes would require special attention to prevent them from blowing. Moreover, the surface of plaster made with fat lime is more absorbent, and less liable to encourage condensation, than that of plaster made with hydraulic lime. Salt water and sea-sand should not be used, as the salts they contain would cause permanent dampness and efflorescence. The hair used by the plasterer in order to make his "coarse stuff" hang together is obtained from the tanners' yard. It should be long, sound, free from grease and dirt, thoroughly separated, beaten up, or switched with a lath, so as to separate the hairs, and dried. It is classed according to quality as Nos. 1, 2, and 3, the last being the best. A bushel weighs 14-15 lb. White hair is selected for some work, but as it should all be thoroughly covered by the coats subsequent to that in which it occurs, its colour is not of importance.

"Coarse stuff" is a rough mortar containing 1-1 $\frac{1}{2}$ part sand to 1 of slaked lime by measure. This is thoroughly mixed with long, sound ox hair (free from grease or dirt, and well switched, or immersed in water to separate the hairs) in the proportion of 1 lb. hair to 2 cub. ft. of the stuff for the best work, and 1 to 3 for ordinary work. The sand is generally heaped round in a circular dish form; the lime, previously mixed with water to a creamy consistence, is poured into the middle. The hair is then added, and well

worked in throughout the mass with a rake, and the mixture is left for several weeks to "cool," i. e. to become thoroughly slaked. If mixed in a mill, the hair should only be put in at the last moment, or it will get broken and torn into short pieces. If there is sufficient hair in coarse stuff for ceilings, it should, when taken up on a slate or trowel, hang down from the edges without dropping off. For walls, the hair may be rather less than in top stuff for ceilings. "Fine stuff" is pure lime slaked to paste with a small quantity of water, and afterwards diluted with water till it is of the consistence of cream. It is then left to settle; the water rising to the top is allowed to run off, and that in the mass to evaporate until the whole has become thick enough for use. For some purposes a small quantity of hair is added. "Plasterers' putty" is pure lime dissolved in water, and then run through a fine sieve. It is very similar to fine stuff, but prepared in a more careful manner, and is always used without hair. "Gauged stuff" or "putty and plaster," contains $\frac{2}{3}$ — $\frac{1}{3}$ plasterers' putty, the remainder being plaster of Paris. The last-named ingredient causes the mixture to set very rapidly, and it must be mixed in small quantities, not more being prepared at a time than can be used in $\frac{1}{2}$ hour. The proportion of plaster used depends upon the nature and position of the work, the time available for setting, the state of the weather, &c., more being required in proportion as the weather is damp. An excess of plaster causes the coating to crack. It is used for finishing walls and for cornices; in the latter, the putty and plaster should be in equal proportions.

Selenitic plaster is made with selenitized lime, otherwise known as selenitic cement, described on p. 585. The method of mixing the material for the first coat of plastering on brickwork is exactly similar to the process as carried out for mixing mortar. For plastering on lath work and other coats the following directions should be followed. To the same quantities of water and prepared lime, as given, add only 6–8 bush. clean sharp sand and 2 hods well-haired lime putty; the hair being previously well hooked into the lime putty. Lime putty should be run a short time before being used, to guard against blisters, which will sometimes occur. This mixture will be found to answer equally well for ceilings as for partitions. If the sand is very sharp, use only 6 bush. sand for covering the lath, and when sufficiently set, follow with 8 bush. sand for floating (or straightening). For common setting (or finishing coat of plastering), the ordinary practice of using chalk lime putty and washed sand is recommended. But if a hard selenitic face is required, care must be taken that the prepared selenitic lime be first passed through a 24 by 24 mesh sieve, to avoid the possibility of blistering, and used in the following proportions:—4 pails water, 2 bush. prepared selenitic lime (previously sifted through a 24 by 24 mesh sieve), 2 hods chalk lime putty, 3 bush. fine washed sand. This should be treated as trowelled stucco; first well hand-floating the surface, and then well trowelling. A very hard surface is then produced. For selenitic clay finish, take 5 pails water, 1 bush. prepared selenitic lime, 3 bush. prepared selenitic clay, 2 bush. fine washed sand, 1 hod chalk lime putty. This mixture, well hand-floated to Parian or Keene's cement, and will be found suitable for hospital walls, public schools, &c. Being non-absorbent, it is readily washed. The use of ground selenitic clay improves the mortar, and renders it more hydraulic. When the selenitic clay is used, 2 bush. may be added to 1 bush. prepared selenitic lime, the proportion of sand, ballast, &c., being the same as for prepared selenitic lime. The use of selenitic clay effects a considerable saving, as it is much cheaper than lime. For outside plastering, use 6–8 bush. clean sand; and for finishing rough stucco face, 4–5 bush. fine washed sand, to the proportions of lime and water given.

"Rough cast" is composed of washed gravel mixed with hot hydraulic lime and water; it is applied in a semi-fluid state.

"Stucco" is a term very loosely applied to various substances which differ considerably from one another. These may be classed as follows:—(1) Compounds of hydraulic

lime, formerly much used for external covering to walls. (2) Mixtures of lime, plaster, and other materials for forming smooth surfaces on internal walls, chiefly those intended to be painted. (3) All sorts of calcareous cements and plasters used for covering walls. "Common stucco" consists of 3 parts clean sharp sand to 1 of hydraulic lime. It was much used at one time as an external covering for outside walls, but has to a great extent been superseded by cements of recent introduction. "Trowelled stucco" is used for surfaces intended to be painted, and is composed of $\frac{2}{3}$ fine stuff (without hair) and $\frac{1}{3}$ very fine clean sand. "Bastard stucco" is of the same composition as trowelled stucco, with the addition of a little hair. "Rough stucco" contains a larger proportion of sand, which should, moreover, be of a coarser grit. The surface is roughened, to give it the appearance of stone.

"Scagliola" is a coating applied to walls, columns, &c., to imitate marble; it is made of plaster of Paris, mixed with various colouring matters dissolved in glue or isinglass; also with fragments of alabaster or coloured cement interspersed through the body of the plaster.

"Marezzo marble" is also a kind of plaster made to imitate marble. Upon a sheet of plate glass are placed threads of floss silk, which have been dipped into the veining colours previously mixed to a semi-fluid state with plaster of Paris. Upon the experience and skill of the workman in placing this coloured silk the success of the material produced depends. When the various tints and shades required have been put on the glass, the body colour of the marble to be imitated is put on by hand. At this stage the silk is withdrawn, and leaves behind sufficient of the colouring matter with which it was saturated to form the veinings and markings of the marble. Dry plaster of Paris is now sprinkled over to take up the excess of moisture, and to give the plaster the proper consistence. A canvas backing is applied to strengthen the thin coat of plaster, which is followed by cement to any desired thickness; the slab is then removed from the glass, and polished. Imitation marble of this description is employed for pilasters and other ornamental work. The basis of Marezzo marble, as well as of Scagliola, being plaster of Paris, neither of them is capable of bearing exposure to the weather. The "artificial marble" now manufactured in London is made on the same principle as the Marezzo, but differs from it in the character of the cement used. A less expensive table is also substituted for the plate glass, and the canvas backing is altogether omitted.

Plasterers require a great variety of mouldings, ornaments, pateras, flowers, and other enrichments for the decoration of the work. These may be made either in plaster of Paris composition or in papier-maché. Plaster ornaments are cast either in wax or in plaster, the latter process being used chiefly for large ornaments which have an undercut pattern. The ornament is in either case first modelled in clay and well oiled. In making wax moulds, the wax is melted, mixed with rosin, and poured in upon the model, arrangement having been made to prevent its escape; the whole is then steeped in water, and the wax becomes detached in one mass. When plaster is used as the material for the mould, it is laid on the model in plastic pieces fitted together, and then the whole, when dry, is immersed in boiled linseed oil. In casting, the plaster in a semi-fluid state is dabbed with a brush into the mould. Composition ornaments are made with a mixture of whiting, glue, water, oil, and rosin. The oil and rosin are melted together and added to the glue, which has been dissolved in water separately. This mixture is then poured upon pounded whiting, well mixed, and kneaded up with it to the consistency of dough. When used, the material is warmed to make it soft, and is forced into boxwood moulds carved to the patterns required. Papier-maché is a much lighter material for ornaments than either composition or plaster, and it is much used for the purpose. Cuttings of paper are boiled down and beaten into a paste, mixed with size, placed in a mould of metal or sulphur, and pressed by a counter-mould at the back, so as to be reduced to a thickness of about $\frac{1}{4}$ in., the inner surface being parallel to the outer surface, and roughly formed to the same pattern. Papier-maché is sometimes made

of sheets of paper glued together, and forced into a metal mould to give the pattern required. In some cases, a composition of paper pulp and rosin is first placed in the mould. This adheres to the paper ornaments moulded as above described, and takes the lines and arrises of the mould more sharply than the paper alone would do. Carton pierre is a species of papier-maché made with paper pulp, whiting, and size, pressed into plaster moulds. Fibrous plaster consists of a thin coating of plaster of Paris on a coarse canvas backing stretched on a light framework. This material has great advantages. Large surfaces can be quickly covered without much preparation for fixing, as it is very light, and it can, if required, be painted at once.

Tools.—The “trowel” (Fig. 1339) should measure about 12 in. long, 4 in. wide, the blade being of light good steel, and the handle well rounded. The “hawk” (Fig. 1340) has a blade of hard wood, 14 in. sq., $\frac{3}{4}$ in. thick in the middle and reducing to $\frac{1}{4}$ in. at

1339.

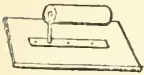

1340.

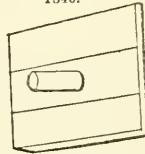

1341.



the edges, with a cleat in the back to resist warping; the wooden handle is barely 6 in. long and under $1\frac{1}{2}$ in. thick. The “float” (Fig. 1341) is a hard board about 12 in. by 4 in. and $\frac{3}{4}$ in. thick, with a cleat let into the back to which the handle (bentwood) is attached. The “darby” (Fig. 1342) is a pine board 4 ft. long and 4 in. wide, with a

1342.

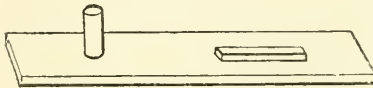

1343.

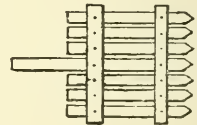

handle like that of the hawk near one end, and a narrow flat strip near the other. The “scratcher” (Fig. 1343) consists of a few short strips of wood, pointed at the end, and secured to cross-pieces at about 1 in. apart. In addition there are required a straight-edge, a long plumb level, an angle block for corners, a whitewash brush, a pointing trowel, a paddle for finishing angles, mitreing tools and moulds, and light scaffolding.

Lathing.—The arrangement of the joists, &c., of floors and ceilings has already been described under Carpentry, pp. 334–40. Before beginning to lath a ceiling, it is necessary to prove the under surface of the joists by applying a long straight-edge, and to make up for any slight inequalities in them, when the work is not to be of a superior character, by nailing on laths or strips. A framed floor with ceiling joists is tolerably sure to be straight; but the carpenter must previously have tested the lower surfaces of the beams or binders, to ensure their accuracy of level with that of the ceiling joists, unless the ceiling joists have been nailed to the beams. If a ceiling is to be divided into compartments or panels, the projecting or depending portions must be bracketed or cradled down to receive the laths. It is an important point to be attended to in plastering on laths, and in ceilings particularly, that the laths should be attached to as small a surface of timber as possible, because the plastering is not supported by its adhesion or attachment to the wood, but by the keying of the mortar itself, which passes through between the laths, and bends round over them. If, therefore, the laths are in constantly recurring contact with thick joists and beams, the keying is as constantly intercepted, and the plastering in all such places must depend on the portions between that are properly

keyed. Under a single floor, in which the joists are necessarily thick, a narrow fillet should be nailed along the middle under the whole length of them, to receive the laths, and keep them at a sufficient distance from the timber to allow the plastering to key under it; thus, too, the surface may be made more perfectly even, as it is in single floors that inequalities mostly occur.

This being all arranged, the plasterer commences lathing. The laths should be of the stronger sort. Thin, weak laths, if used in a ceiling, are sure to produce inequalities by sagging with, or yielding to, the weight attached to them. One or two weak ones in a ceiling of otherwise strong laths may be the ruin of the best piece of work. Laths should be previously sorted, the weak, the crooked, and knotty, if there be such, being reserved for inferior work, and the best and strongest selected for the work of most importance, so that the workman shall find none to his hand that is not fit to be brought in. Taking a lath that will reach over 3 or 4 openings, the plasterer strikes a nail into it on one of the intermediate joists, at about $\frac{3}{4}$ in. from the one before it, and then secures the ends of that, and the one that it meets of the last row with one nail, leaving the other end of the lath he has just set, to be secured in the same manner with the end of that which shall meet it next in continuation.

It is of importance in ceilings to pay attention to the bonding of the work. In lathing or quartering partitions or battened walls, the bonding is not a matter of such material consequence as in a ceiling, because the tothing which the thickness of the lath itself affords to the plastering, is enough to support it vertically; but, nevertheless, the more complete the keying, even in work of this kind, the better, as the tothing above will not always protect it from any exciting cause to fall forward or away from the laths. The thinner or weaker sort of lath is generally considered sufficiently strong for partitions. In common lathing, the spaces between the laths should be $\frac{1}{4}$ in. If they be made less than that, the clinches will not be strong enough; and if more, they will sag down on the ceiling, and drop off with their own weight on the sides. In no case should the spaces exceed $\frac{3}{4}$ in., except when the furring is very thin, like strips of lath nailed on inside sheeting or ceiling. Most lathers break joints at every 6th lath, and some every 10th; but it is better to break joints every 2nd lath. When ordinary laths are used, $\frac{3}{4}$ – $\frac{5}{8}$ in. thick, the studding, joists, &c., should never be over 16 in. apart—12 in. would be better. Lathing is estimated by the sq. yd., and is measured the same as plastering, without deducting openings for doors, windows, &c., except when the opening exceeds 63 sq. ft.

Laying and Pricking up.—When the lathing is finished, the work is either laid or pricked up, according as it is to be finished with 1, 2, or 3 coats. “Laying” is a thick coat of coarse stuff, or lime and hair, brought to an even surface with the trowel only; for this the mortar must be well tempered, and of moderate consistence, thin or moist enough to pass readily through between the laths, and bend with its own weight over them, and at the same time stiff enough to leave no danger that it will fall apart, a contingency, however, that in practice frequently occurs, in consequence of badly-composed or badly-tempered mortar, unduly close lathing, or sufficient force not having been used with properly consistent mortar to force it through and form keys. If the work is to be of 2 coats, i. e. “laid and set,” when the laying is sufficiently dry, it is thoroughly swept with a birch broom or scratcher to roughen its surface, and then the “set,” a thin coat of fine stuff, is put on. This is done with the common trowel alone, or assisted by a wetted hogs'-bristle brush, which the workman uses with his left hand to strike over the surface of the set, while he presses and smooths it with the trowel in his right. If the laid work should have become very dry, it must be slightly moistened before the set is put on, or the latter, in shrinking, will crack and fall away. This is generally done by sprinkling or throwing the water over the surface from the brush.

For “floated,” or 3-coat work, the first, or “pricking up,” is roughly laid on the laths, the object being to make the keying complete, and form a layer of mortar on the

laths to which the next coat may attach itself. It must, of course, be kept of equal thickness throughout, and should stand about $\frac{1}{4}$ – $\frac{3}{8}$ in. on the surface of the laths. When it is finished, and while the mortar is still quite moist, the plasterer scratches or scores it all over with the end of a lath or the scratcher. These scorings should be made as deep as possible, without laying bare the laths; and the rougher their edges are the better, as the object is to produce a surface to which the next coat will readily attach itself.

When the "pricked-up" coat is so dry as not to yield to pressure in the slightest degree, preparations may be made for the "floating." Ledges, or margins of lime and hair about 6 in. in width, and extending across the whole breadth of a ceiling, or height of a wall or partition, must be made in the angles or at the borders, and at distances of about 4 ft. apart throughout the whole extent. These must be straight with one another, and be proved in every way by the application of straight-edges. Technically these ledges are termed "screeds." The screeds are gauges for the rest of the work; for when they are ready, and the mortar in them is a little set, the interspaces are filled up flush with them, and a darby float, or long straight-edge, being made to traverse the screeds, all the stuff that projects beyond the line is struck off, and thus the whole is brought to a straight and perfectly even surface.

To perfect the work the screeds on ceilings should be levelled, and on walls and partitions plumbed. When the floating is sufficiently set and nearly dry, it is brushed with a birch broom as before described, and the third coat, or "set," is put on. This, for a fine ceiling that is to be whitened or coloured, must be of what plasterers call "putty"; but if it is to be papered, ordinary fine stuff, with a little hair in it, will be better. Walls and partitions that are to be papered are also faced with fine stuff, or rough stucco, but for paint the set must be of bastard stucco trowelled.

Plastering in external walls requires the addition of some hydraulic cement to the mortar. The scaling of plaster liable to the action of water and frost is said by Cameron to be prevented by mixing sawdust with the mortar.

Whitewashing.—This is also known as calcimining and distemper painting.

Whitewash is made from pure white lime mixed with water. It is used for common walls and ceilings, especially where, for sanitary reasons, a frequent fresh application is considered preferable to any coating which would last better. It readily comes off when rubbed, will not stand rain, nor adhere well to very smooth or non-porous surfaces. It is cheap, and where used for sanitary reasons should be made up of hot lime and applied at once, under which conditions it also adheres better. It is improved by adding 1 lb. pure tallow (free from salt) to every bushel of lime. The process is generally described as "lime whiting." The following is a method recommended for making whitewash for outside work. Take a clean water-tight barrel, and put into it $\frac{1}{2}$ bush. lime. Slake it by pouring water over it boiling hot, and in sufficient quantity to cover it 5 in. deep, and stir it briskly till thoroughly slaked. When the slaking has been effected, dissolve it in water, and add 2 lb. zinc sulphate and 1 of common salt; these will cause the wash to harden, and prevent its cracking.

Common colouring is prepared by adding earthy pigments to the mixtures used for lime whiting. The following proportions may be used per bushel of lime; more or less according to the tint required:—Cream colour, 4–6 lb. ochre; fawn colour, 6–8 lb. umber, 2 lb. Indian red, 2 lb. lampblack; buff or stone colour, 6–8 lb. raw umber, and 3–4 lb. lampblack.

Whiting is made by reducing pure white chalk to a fine powder. It is mixed with water and size, and used for whitening ceilings and inside walls. It will not stand the weather. The best method of mixing it is in the proportion of 6 lb. whiting to 1 qt. double size, the whiting to be first covered with cold water for 6 hours, then mixed with the size and left in a cold place till it becomes like jelly, in which condition it is ready to dilute with water, and use. It will take 1 lb. jelly to every 6 super. yd. Whiting is made in 3 qualities—"common," "town," and "gilders." It is sold by weight in casks

containing 2-10 cwt., in sacks containing 2 cwt., in firkins (very small casks), in bulk and in small balls.

Distemper is the name for all colouring mixed with water and size. White distemper is a mixture of whiting and size. The best way of mixing is as follows:—Take 6 lb. best whiting and soak it in soft water sufficient to cover it for several hours. Pour off the water, and stir the whiting into a smooth paste, strain the material, and add 1 qt. size in the state of weak jelly; mix carefully, not breaking the lumps of jelly, then strain through muslin before using; leave in a cold place, and the material will become a jelly, which is diluted with water when required for use. Sometimes about $\frac{1}{2}$ table-spoonful of blue black is mixed in before the size is added. It is sometimes directed that the size should be used hot, but in that case it does not work so smoothly as when used in the condition of cold jelly, but on the contrary drags and becomes crumpled, thus causing a rough surface. When the white is required to be very bright and clean, potato starch is used instead of the size. Coloured distemper is tinted with the same pigments as are used for coloured paints, whiting being used as a basis instead of white-lead or zinc white. In mixing the tints, the whiting is first prepared, then the colouring pigment, the latter being introduced sparingly; size is added, and the mixture is strained. The colours are classed as “common,” “superior,” and “delicate.”

If the ceiling is new, nothing further is required than a coat of good Paris white (whiting of a superior kind), with just sufficient glue-size added to bind it, provided the finishing plaster was of good workmanship; but if inferior and very porous, it will require a preparation of strong size, soft-soap, and a handful of plaster of Paris. For old ceilings, all the previous whiting, &c., must be thoroughly washed off with an old whitewash brush and hot water, and allowed to dry before re-whitening. When this is done, if the ceiling is “hot”—i. e. porous, and soaks in the moisture very quickly—it must be prepared with a mixture of 1 handful lime, the same of whiting, $\frac{1}{2}$ lb. glue, $\frac{1}{4}$ lb. soft-soap, and, if smoky or damp, about 2 oz. alum, to make a pail $\frac{3}{4}$ full. When this is dry, it is ready for the finish. Use the preparation thin. To prepare whitewash properly, the whiting should be soaked overnight in plenty of water, thoroughly stirred up to wash it, and allowed to settle till the morning, when all the water possible should be drained off. The size should likewise be melted the night before use, so as to be jellied by the morning. It works better when cold. About $\frac{1}{2}$ lb. glue is required to 1 gal. water, which, with the water taken up by the whiting, will make it ready for use. Before using, the size and whiting should be broken up separately and strained through a fine sieve; then mixed and strained again. Before putting on the whiting, shut all doors and windows to exclude the draught, take a sweep right across the room, and continue till finished. If 2 are engaged at it, so much the better, as it requires to be done quickly: be careful to cover well, or you will not make a nice job. When finished, the doors and windows can be opened, as the sooner it dries after it is once on the more even and solid will it look. For whitening and colouring walls, great care is required in preparing them; all the old stuff is to be cleared off, well rubbed down with dry lump pumice, all holes well and evenly stopped with plaster of Paris, and a preparation of strong size, whiting, and alum, thickly laid on, of the colour you are going to finish, but a little darker in shade. When this is well dry, rub it well down to a good level and smooth face with lump pumice or coarse sandpaper. The finishing coat may be made in the same way for the ceilings; but if exposed to the liability of being touched or rubbed against, a little more or stronger size is to be used; and if in any way to damp, a little alum. To get any of the colours required, it is merely necessary to get the dry powders and rub up with the whiting, prior to mixing with size, adding by degrees till the required depth of tone is arrived at. For the different shades of drab or stone-colour yellow ochre, umber, black, and red are used. For shades of blue, from the French grey to sky blue, ultramarine, &c. (*Painting for the Million.*)

If glue is employed to give body, it is destroyed by the corrosive action of the

lime, and in consequence the latter easily rubs off the walls when dry. This is the case also if the lime is employed, as is often absurdly recommended, simply slaked in water, and used without any fixing material. Limewash is prepared by placing some freshly-burned quicklime in a pail, and pouring on sufficient water to cover it; boiled oil (linseed) should then be immediately added, in the proportion of 1 pint to 1 gal. of the wash. For coarser work, any common refuse fat may be used instead of the boiled oil. The whole should then be thinned with water to the required consistency, and applied with a brush. Care should be taken not to leave the brush in the lime-wash for any length of time, as it destroys the bristles. In lime-washing, Russian tallow is frequently used in preference to any other fatty matters. (*Tegetmeier.*)

No brick wall that ever is intended to be painted should be whitewashed. All washes absorb water, and in damp weather lose their colour. For 1 barrel of colour wash take $\frac{1}{2}$ bush, white lime, 3 pecks hydraulic cement, 10 lb. umber, 10 lb. ochre 1 lb. Venetian red, $\frac{1}{4}$ lb. lampblack. Slake the lime, cut the lampblack with vinegar. mix well together, add the cement, and fill the barrel with water. Let it stand for 12 hours before using, and stir frequently while putting it on. This is not white, but of a light stone colour, without the unpleasant glare of white. The colour may be changed by adding more or less of the colours named, or other colours. This wash covers well, needing only one coat. A rough board barn washed with this will look well for 5 years, and even longer, without renewing. The cement hardens, but on a rough surface will not scale. (*Scient. Amer.*)

A wash which can be applied to lime walls and afterwards become waterproof so as to bear washing. Resenschek, of Munich, mixes together the powder from 3 parts siliceous rock (quartz), 3 parts broken marble and sandstone, 2 parts burned porcelain clay, and 2 parts freshly slaked lime, still warm. In this way a wash is made which forms a silicate if often wetted, and becomes after a time almost like stone. The 4 constituents mixed together give the ground colour to which any pigment that can be used with lime is added. It is applied quite thickly to the wall or outer surface, let dry one day, and the next day frequently covered with water, which makes it waterproof. This wash can be cleansed with water without losing any of its colour; on the contrary, each time it gets harder, so that it can even be brushed, while its porosity makes it look soft. The wash or calcimine can be used for ordinary purposes as well as for the finest painting. A so-called fresco surface can be prepared with it in the dry way.

Well wash the ceiling by wetting it twice with water, laying on as much as can well be floated on, then rub the old colour up with a stumpy brush and wipe off with a large sponge. When this is done, stop all the cracks with whiting and plaster of Paris. When dry, claircole with size and a little of the whitewash. If very much stained when this is dry, paint those parts with turps, colour, and, if necessary, claircole again. To make the whitewash, take 12 lb. whiting (in large balls), break them up in a pail, and cover with water to soak. During this time melt over a slow fire 4 lb. common size, and at the same time, with a palette knife or small trowel, rub up fine about a dessert-spoonful of blue black with water to a fine paste; then pour the water off the top of the whiting, and with a stick stir in the black; when well mixed, stir in the melted size and strain. When cold it is fit for use. If the jelly is too stiff for use, beat it well up and add a little cold water. Commence whitewashing over the window, and so work from the light; lay off the work into that done, and not all in one direction, as in painting. Distemper colour of any tint may be made by using any other colour instead of the blue black—as ochre, chrome, Dutch pink, raw sienna for yellows and buff; Venetian red, burnt sienna, Indian red, or purple brown for reds; celestial blue, ultramarine, indigo, for blues; red and blue for purple, grey, or lavender; red-lead and chrome for orange; Brunswick green for greens. (*Smither.*)

1 doz. balls of whiting, 2 lb. size, and 1 oz. celestial or ultramarine blue, will cover about 12 sq. yd. Take the whiting and break up in just enough water that you can

work it about in a bucket with a stout stick. Put about 1 pint water in a 3-qt. saucepan, and boil; take off the fire, and drop your size into it, and let it stand upon the hob until melted. When tolerably warm, pour into your whiting, being careful to keep stirring it. Mix up your blue with a flat stick upon a slate or board, and add until it becomes of the shade required. Lime that will produce a fast limewash is burnt in the bottom of brick kilns, the bricks upon the top, and fired with heath, fir loppings, coal, wood, ferns, and gorse. The sand from the bricks, the chalk, and the potash from the wood combined, cover the chalk or lime with a silicate soluble in water. To use this, get it fresh burnt, break it up, and pour boiling water upon it; it subsides into a beautiful cream-like consistence. This, owing to the soluble silicate in it, must be used and made fresh. It is fast, and frequently presents a glazed surface, and, if not put on too thick, is very durable. A peck of lime will do about 20 sq. yd.; this is merely lime—the fresher the better. Slake it. Make it of the proper consistence, and add to every bucket one gill of turps and linseed oil, mixed. Some use tallow, some size.

Lime is always apt to turn a bad colour. The way to whitewash a ceiling is to first thoroughly wash with clean water—not one pail, which speedily gets dirty, but with several. Then steep balls of whiting in water, and the next day reduce them to a thick cream. Put a kettle on the fire, with sufficient size, and when hot pour it on the whiting, adding at the same time some finely-ground blue black. The proportions are, say, 6 balls whiting, 2 lb. size, and $\frac{1}{4}$ –1 oz. of blue black, according to taste. The mixture must be allowed to cool before using. To limewash, clean first, and then proceed to make up the following: Take $\frac{1}{2}$ bush. lime, and slake it; add 1 lb. common salt, $\frac{1}{2}$ lb. white vitriol, and 1 gal. skim milk. With a clean surface, this will not shell off, neither will limewash and size, when properly prepared and laid on a clean surface.

Milk distemper is almost equal for body and durability to oil paint, besides being free from offensive odour. In houses where sick and weakly persons are located, the milk paints may with advantage be used for ceiling and wall painting. The ingredients for making this paint are as follows: 1 gal. skim milk, 1 lb. newly slaked lime, $\frac{1}{2}$ lb. pale linseed oil, and about 8 lb. Spanish white, or best washed whiting. Beat up the oil in the lime with a little milk, having previously put the powdered white in the skim milk to dissolve. When the lime and oil are thoroughly amalgamated, add the paste so formed to the milk and Spanish white mixture, and stir up the whole with a spatula. This paint dries in about 1 hour. One coat is usually sufficient for walls or ceilings, but 2 coats are absolutely necessary for new work. Care must be taken that the milk is not sour, for in that case it would, by uniting with the lime, form an earthy salt, which could not resist any moisture that may be in the air, nor even dampness that sometimes finds its way into the interior of walls. The milk paint may be tinted any colour by the addition of ordinary dry or damp colours.

ROOFING.—The subject for consideration in this section is the covering of buildings for the purpose of protecting them from the weather. The wooden framework for supporting the covering material has been already described under Carpentry (pp. 340–6); there remain for discussion here the various kinds of material used for covering, and the methods of securing them in place. The first detail to be decided on is the “pitch” or slope to be given to the roof, and this will depend both on the nature of the covering material and the character of the climate. In the tropics, where rain falls in torrents, a flat pitch helps to counteract the rush of water; in colder regions the pitch must be such as to readily admit of snow sliding off as it accumulates, to prevent injury to the framework by the increased weight. The pitches ordinarily observed, stated in “height of roof in parts of the span,” are as follows:—Lead, $\frac{1}{10}$; galvanized iron or zinc, $\frac{1}{2}$; slates, $\frac{1}{4}$; stone, slate, and plain tiles, $\frac{2}{3}$; pantiles, $\frac{2}{3}$; thatch, felt, and wooden shingles, $\frac{1}{2}$ to $\frac{1}{4}$. The various methods of roofing will be discussed in order.

Thatching.—In country districts the roofs of cottages and outbuildings are frequently covered with thatch. This consists of layers of straw—wheaten lasts twice as long as oaten—about 15 in. in thickness, tied down to laths with withes of straw or with string. Thatch is an excellent non-conductor of heat, and consequently buildings thus roofed are both cooler in summer and warmer in winter than others, and no better roof covering for a dairy can be found. Thatch is, however, highly combustible, and as it harbours vermin and is soon damaged, it is not really an economical material, though the first cost is small. A load of straw will do $1\frac{1}{2}$ “squares” of roofing, or 150 superficial feet. First class thatching is an art not readily acquired. While really good thatching will stand for 20 years, average work will not endure 10.

The operation may be briefly described as follows. For renewing an old thatch the best and cheapest material is “stubble” (the lower and stiffer half of wheaten straw); but for new thatch, stubble is not long enough alone, and must be used with straw, or be replaced entirely by straw. The material is thoroughly soaked with water, and then straightened out with the hands so as to arrange the straws all in one direction, termed “drawing.” When a double handful (called a “yelven”) has been thus prepared, it is laid aside, until a sufficient number are ready to fill a “jack” (large forked stick), in which they are placed just so much out of the parallel as to be easily separated. A small hook in the jack permits it to be hung from the thatcher’s ladder.

Commencing at the eaves and working upwards to the ridge, he proceeds to lay a strip of thatch on the opposite side of the ladder from that carrying the jack. The strip laid (technically a “stetch”) is of convenient width for the workman’s reach; it will be of equal breadth throughout if the section of roof is square, or taper gradually upwards if the area is triangular. The thatcher commences by forming the eaves at the bottom of the stetch, and fastens this portion securely before proceeding to the next yelven. The mode of fastening varies: in renewing old thatch, the new material is secured by thrusting the upper ends into the old thatch by a wooden spur; in new thatching, the straw is bound to the rafters and laths with tar cording, passed, by means of a huge needle, through the straw near the upper end of the yelven, where it will be covered by the next instalment. Each succeeding addition as the work advances towards the ridge is made to overlap the preceding one, all except the lower end, and is secured by the tar cording.

When the whole stetch is finished from eaves to ridge, the thatch is combed straight by a short-toothed wooden rake. Every succeeding stetch must be so united to its predecessor that no gap or weak part is left to mark their junction, or such a spot will never be watertight. The security of the thatch is further ensured by furnishing it with a series of buckles and runners on the outside. Buckles are a kind of huge wooden hair-pin, made by splitting withes, shaving the middle somewhat thinner than the remainder, twisting it 2 or 3 times, bending it end to end, cutting it to a length of 12–18 in., and pointing the ends. Runners are simply long strips of split withe, laid in horizontal bands on the thatch, and held by the buckles, which are thrust upwards into the thatch, as shown at Fig. 1344: *a*, thatch; *b*, laths; *c*, rafters; *d*, tar cording; *e*, buckles; *f*, runners.

The buckles are placed at 6 to 12 in. apart, and 2 series of buckles and runners are generally adopted, an upper series just below the ridge, and a lower just above the eaves, with additional series whenever there is exposure to strong winds. The eaves are trimmed off evenly with shears. The best method of finishing off at the ridge is by a kind of plaiting of the straw, not easily described. A simpler substitute is to plaster with road-dirt, and plant a weed such as houseleek or stonecrop in the soil.

In the western counties of England, the word straw is applied only to the stems of barley and oats; wheaten straw, after it has been deprived of leaves by a rough combing, is tied in small bundles called “niches,” and known as “reed.” In thatching, the butt end of the reed is laid outwards and the head inwards; and the finished thatch on

buildings (but not on ricks) is shaved over with a sharp sickle. Long strong reeds found in the marshes, such as Slapton Lea, are cut at certain seasons and stacked in bundles for similar application.

Byrne describes thatching as generally made of wheaten straw, laid on lathing and rafters, which may be of the same strength and placed the same distance apart as for a common slated roof; but in country places, where thatching is mostly used, the rafters are generally formed of the branches of trees of 3-6 in. in diameter; the slighter they are, the better, provided they are sufficiently strong, as the lighter the roof, the less strain there is on the walls: of course, if the rafters are stout, they should be placed farther apart than slight rafters; and if the rafters are far apart, the lathing must be stronger, otherwise the thatching will bag, or lie in hollows between the rafters. The straw is laid on the lathing in small bundles called "hellams," until it attains a thickness of 12-16 in.; it is fastened to the rafters with young twigs and rope-yarn.

1344.

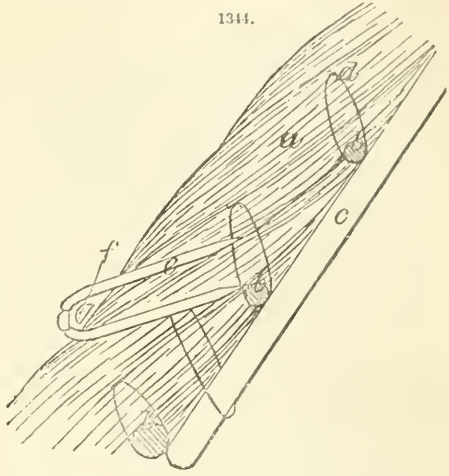

A good pitch for a thatched roof is 45° , or, as it is technically called, a true pitch: if the pitch is made less, the rain will not run off freely; and if a greater pitch than 45° is used, the straw is found to slip down from its fastenings.

Thatchers' tools are as follows:—A common stable fork is used to toss the straw up together when it is wetted, preparatory to its being made into bundles for use. A thatchers' fork, Fig 1345, is a branch of some tough kind of wood, cut with 2 smaller branches proceeding from it, so as to form a fork, as shown; the joint of the 2 branches is generally strengthened by a small cord, to keep it from splitting when it is used. A small cord is fastened by one end into one of the ends of the fork, and a loop is spliced on the other end of the cord; this loop is made to pass over the other end of the fork,

1345.

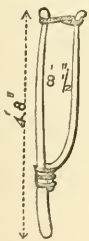

1346.

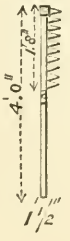

1347.

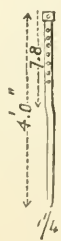

1348.



1349.

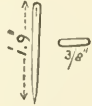

and to fit into a notch cut to receive it. This tool is used to carry the straw from the heap, where it has been wetted and prepared, up to the thatcher on the roof, where it is to be used.

The thatchers' rake, Figs. 1346 to 1348, should have a handle of ash or some tough

wood, made square, so that it may be grasped firmly without fear of its slipping round in the hand: the arrises may be slightly rounded off, so as not to hurt the hand. It will be seen by referring to Fig. 1347 that a crook is formed in the handle; the reason for this will be explained when we come to speak of the manner of using the different tools. The use of this tool is, after the straw is laid, to comb it down straight and smooth.

The thatchers' knife, or eaves' knife, is similar in shape and make to the reap-hook, except that it is larger, and not curved so quickly. The use of this tool is to cut and trim the straw to a straight line at the eaves of the roof.

The thatcher also requires a knife shaped something like a bill-hook, to point the twigs used for securing the straw; a half-glove or mitten, of stout leather, to protect the hands when driving in the smaller twigs, called spars; a long flat needle, Fig. 1349; a pair of leather gaiters, to come up above the knees, to protect his knees and shins when kneeling on the rafters; a sharp grit-stone to sharpen the knives.

As before stated, the rafters for a thatched roof may be of round timber, such as the branches of trees, and young trees, of 3-6 in. diam., placed not more than 14 in. from centre to centre, but sometimes the rafters are of sawn timber: in that case they should be cut about the same scantling as for a slated roof, not as for a tiled roof. The lathing in a thatched roof being very liable to rot, it should be split out of heart of oak, or some other equally durable wood; the laths are about $1\frac{1}{2}$ in. wide, and $\frac{1}{4}$ - $\frac{3}{4}$ in. thick, and are nailed on the rafters about 8 in. apart in a horizontal direction, just the same as for a tiled or slated roof. If the laths are placed farther apart than 8 in., the straw is apt to bag or sink down between them; the rain lodges in the hollows, and of course soon rots the straw. An eaves' board about 7 in. wide is required to start the first part of each course of thatching upon.

The rafter and eaves' board being fixed, and the lathing nailed on in rows at the prescribed distance apart before mentioned, as much straw is taken as it is thought will be required for the whole roof, which may be got at by estimating a square to take $3\frac{1}{4}$ - $3\frac{3}{4}$ cwt. of wheaten straw: care should be taken to keep the fibres or stalks as parallel to each other as possible. As each truss of straw is opened, it is spread out and wetted, using about 3-4 gal. of water to each truss. The straw is then tossed over and mixed together in one great heap with the stable fork, so that every part may get an equal portion of the water. If the weather is fine and dry, the straw may be used directly; but if the weather is damp or rainy, the straw should be allowed to lie for a day or so to drain, and be once more turned over. The reason for wetting the straw is to make it lie close, and to enable the thatcher's labourer more easily to draw the stalks out parallel.

The thatcher and his labourer being now ready to commence, the labourer spreads as much of the straw on the floor as will make a bundle 12 in. wide and 4 in. thick; the labourer then stooping down, with his left hand draws the straw, little by little, to his feet, and while doing so, with his right hand draws out any loose straws that may be lying crosswise: by this means he gets a compact bundle of straw 3 ft.-4 ft. long according to the goodness of the straw, and all the stalks are parallel. This bundle is called a "hellam." The labourer having placed 4-6 hellams crosswise in his thatching fork, he carries it on his shoulder up to the thatcher on the roof, in the same manner as a bricklayer's labourer carries a hod of mortar: the fork is secured on the roof by a small peg and a piece of string.

The thatching is now laid in courses 3 ft. wide, beginning at the right end of the roof, so that the thatcher works from right to left. The courses are laid parallel with the rafters, and not parallel with the lathing (as is the case in slating and tiling). Care must be taken at starting the eaves to have a good firm body of thatch, letting the straw hang over, to be afterwards trimmed with the eaves' knife to a straight and good-looking edge. A row of 3 hellams is placed on each succeeding lath in the course, and each

row of hellams is secured to the rafters with a young tough twig, called a "ledger," about 4 ft. long and 1 in. diam.: each row of hellams is also secured to the row underneath it with 3 split twigs, called spars, about 2 ft. long, and 8 can be split out of a branch 2 in. in diameter; they are pointed at both ends, and are then doubled in two, and the thatcher gives them 2 twists round in his hand, in the same manner as a rope is twisted: this gives the spar a splintery surface, and enables it to hold on when driven into the straw.

The thatcher has a leather glove on his right hand: and keeping his hand flat or open, he gives the spar 2 or 3 smart blows, sufficient to drive it into the straw; the leather serves as a protection to the hand. The spars must be soaked in water for some hours before they are used, in order that they shall not break in the doubling up.

The "ledger" is a tough twig, about 4 ft. long and 1 in. thick, as before described; one end is pointed, and driven or rather pushed 6 in. under the outside rafter of the course: it is then brought over the top of 2 rafters, and over the top of the hellams, and then secured to the inside rafter of the course with about 8 ft. of rope-yarn, by means of the long flat needle, thus holding down the row of hellams, and preventing them from slipping off the roof. In speaking of the outside and inside rafter of a course, it is meant by the outside rafter, the rafter that is farthest from the thatcher; and by the inside rafter the one that is nearest to him; and thus the inside rafter of one course becomes the outside rafter of the next course.

The thatcher gives each course, as it is laid, a combing down with his rake, to get out the loose straws: he then takes a bucket of water, and throws it right down the course, and gives the straw a good beating with the back of his rake, to break any stubborn straws and to make it all lie close: he then finally gives it another combing, and after that smooths it down with the back or flat side of his rake, and it is finished.

It will be seen by referring to Figs. 2078 and 2080, that a crook is formed in the handle of the rake. The reason for thus crooking the handle is to keep the thatcher's hand from contact with the straw, and thereby save his knuckles.

The ridge and hips are managed thus:—The thatcher, in doing one side of his roof, takes care to leave a good length of screw hanging over and past the ridge. As he finishes the top of each course on the other side of the roof, he bends down the tops of the first side, and covers them over with the last row of hellams on the last side, bending these last in their turn down over the other side of the roof. The ridge is then secured on each side with 3 rows of bands or spars, placed end to end, and each spar is secured with 3 other spars to thatch. In the case of the hips, there are no bands of spars, but single spars, 12 in. apart, are bent crosswise over the hip, and secured with 3 other spars, as before. The eaves are also secured with 2 rows of bands of spars. Wheaten straw thatching, done as here described, will last in our climate for 15–20 years. Oat straw, about 8 years.

Shingles or shides.—A convenient roofing material when wood is cheap and abundant consists of a kind of "wooden slates," split pieces of wood measuring about 9 in. long, 5 in. wide, and 1 in. thick at one end but tapering to a sharp edge at the other.

Shingles, or wooden slates, are made from hard wood, either of oak, larch, or cedar, or any material that will split easily. Their dimensions are usually 6 in. wide by 12 or 18 in. long, and about $\frac{1}{4}$ in. thick. They are laid in horizontal courses of 4 or 5 in. gauge, nailed upon boards, the joints broken, commencing with the eaves' course. The ridge is secured by what is called a ridge-board, or a triangle of such stuff of 6 or 8 in. each side. In America, where this roof is common, the mechanics have a special tool for shingling, called a shingle-axe, with a hammer at the back.

Felt.—Roofing felt is a substance composed largely of hair saturated with an asphaltic composition, and should be chosen more for closeness of texture than excessive thickness. It is sold in rolls 2 ft. 8 in. wide and 25 yd. long, thus containing 200 ft. super in a roll. Before the felt is laid on the boards ($\frac{3}{4}$ -in. close boarding), a coating composed of 5 lb.

ground whiting and 1 gal. coal tar, boiled to expel the water, is applied, while still slightly warm, on the boards themselves; the felt is then laid on, taking care to stretch it smooth and tight, and the outside edge is nailed closely with $\frac{3}{8}$ -in. zinc or tinned tacks. The second width of felt laps the first 1 in. at least, the joint receiving a little of the composition, and the tacks pass through both thicknesses of felt, and so on till the whole of the roof is covered. Then the surface requires a coat of the composition, and in 3 or 4 weeks a second or finishing coat, when it will need nothing for 3 or 4 years, but should receive one the moment it begins to bleach. The gutters and ridge are generally in 2 thicknesses of felt. A dry day should be selected for the work. The most common application on the felt is simple coal tar brushed on hot and sprinkled with sharp sand while still fresh.

Dachpappe.—This is a kind of asphalt pasteboard much employed in Denmark; it is laid on close boarding at a very low pitch, and forms a light, durable covering, having the non-conducting properties of thatch. It is sold in rolls 2 ft. 9 in. wide and 25 ft. long, having a superficial content of $7\frac{1}{2}$ sq. yd., at the rate of 1*d.* per sq. ft. When laid, it requires dressing with an asphalt composition called "Erichsen's mastic," sold at 9*s.* 9*d.* per cwt., 1 cwt. of the varnish sufficing to cover a surface of 65 sq. yd.; iron wire nails, for fastening down the pasteboard, cost 13*d.* per 1000, this number being enough to nail down 15 sq. yd. The method adopted in laying the pasteboard is as follows:—The framework of the roof is covered in with dry well seasoned boards, $\frac{3}{4}$ in. to 1 in. thick, and not above 6 in. broad. If they are not sufficiently dry, they should be split lengthwise before being laid down, in order to keep them from warping, and every board should be fastened with 3 nails at least to each of the rafters. This splitting prevents the shrinkage of the wood from exercising any injurious effect on the pasteboard roofing.

Willesden paper.—This is another extremely light, durable, and waterproof roofing material, which differs essentially from the 2 preceding substances in needing to be fixed to rafters or scantling, and requiring no boarding on the roof. It is a kind of cardboard treated with cuprammonium solution, and has become a recognized commercial article. It is made in rolls of continuous length, 54 in. wide, consequently, when fixing the full width of the card (to avoid cutting to waste), the rafters should be spaced out 2 ft. 1 in. apart from centre to centre, so that the edge of one sheet of card laid vertically from eaves to ridge will overlap the edge of the adjoining sheet 4 in. on every alternate rafter, and be there fixed with outside batten as specified below. For sides and ends of sheds, partitions, ceilings, &c., the uprights or timbers against which the adjoining sheets of the card are overlapped and fixed should be placed 4 ft. 2 in. apart from centre to centre, with or without an intermediate upright. In all cases the card must be fixed with outside wooden battens (2 in. by 1) and strong nails (or screws) driven through the batten and card to the rafter or framework. The card is thus gripped between the batten and the framework. For ordinary roofing, the nails or screws should not be less than $2\frac{1}{4}$ to $2\frac{1}{2}$ in. long, so as to provide firm holding. Iron bands bolted or screwed through the card will serve in place of battens (when desired) for curved roofs, lean-to's, &c.

At every joint the edges of the adjoining sheets must overlap each other 3 or 4 in., and be fastened by outside batten, as above specified; by this method very secure fixing and waterproof joints are ensured. An occasional screw is also recommended. Each sheet for roof should be cut long enough to extend from eaves to ridge, allowing sufficient length, not only to permit an overlap at the ridge, but also for turning up under the eaves-boards, there to be secured by a batten as before described.

In small structures, where the span is inconsiderable, the card by preference may be laid from eaves to eaves in one length, without joint at ridge. The sheet or panel when in position may be tacked down, while the battens are being fixed as already described. Previous to fixing, the card, being in a contracted state when cut from the roll, should be exposed to a cold or moist atmosphere, say for 12 hours, or sponged on both sides with water, in order to obtain flatness of surface. The sharp edges of the ridge-piece or

curved-boards round which the card is strained should be chamfered off. When a large sheet or panel of the card is required, two or more widths can be joined by overlapping the edges of the card 3 in., and riveting them together with copper rivets, or sewing by strong needle and waxed or "Willesden" treated thread. When advisable to strengthen the edge, it can be bent over and then sewn or riveted, or a strip of the card made in the form of a clip can be sewn or riveted on the edge of the sheet. In all cases before a sharp bend is made the card should be placed in cold water for a few hours, or sponged with hot water on both sides, to prevent cracking. The card may be painted or tarred, and thus will not corrode or blister, as painted wood or iron, but remain practically indestructible.

A rapid, easy mode of covering may be named as follows:—Cut a length of card from the roll, grip each end between 2 battens firmly screwed together, and draw the sheet or sheets thus secured over a roof, ridge, rick, pole, or anything requiring protection, and make fast to the ground or other holding, and, when desirable, for such temporary and portable covering the edges of the card may be bound with "Willesden" webbing, and

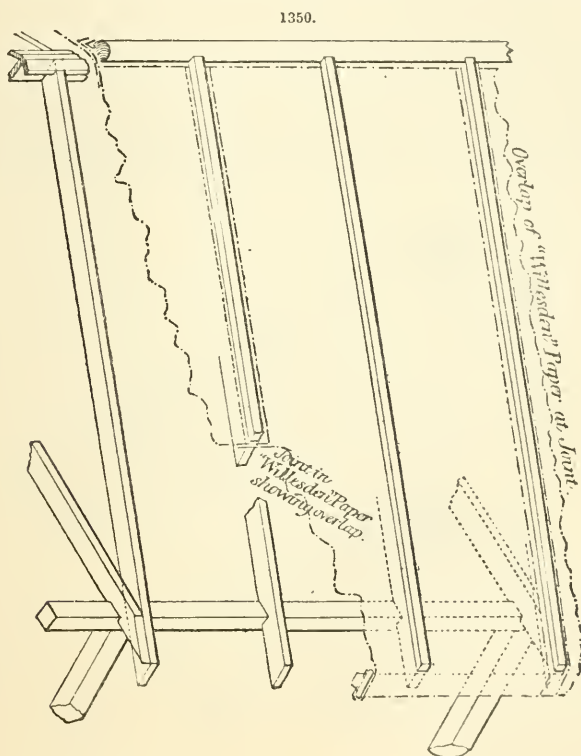

eyeleted to enable the sheet to be easily made fast by cords or ropes. Similarly, a piece or strip of "Willesden" canvas may be riveted or sewn on to the card at any place, and serve as a flap, or for any purpose where canvas may be required.

The "Willesden" card possesses great practical advantage, by the ease with which repairs may be effected without skilled assistance. In case of accidental damage, a piece

of card may be placed respectively on inner and outer side of the damaged part, and then be sewn together by strong needle and waxed thread, or riveted with copper rivets.

Referring to the illustrations, the solid lines represent woodwork, while the broken lines indicate the roofing card. Fig. 1350 is a view of a shed roof; Fig. 1351, cross section of shed; Fig. 1352, detail of ridge and eaves, with alternative ridge construction, showing the usual fixing for sheds; Fig. 1353, detail of ridge and eaves, when the roof is to be made airtight; Fig. 1354, detail section of the rafters.

Slates.—By far the most important roofing material, and the one in most general use at the present time, is slate. Slate is an argillaceous sedimentary rock which, after being deposited as clay at a very early geological epoch, has been subjected to enormous mechanical pressure, the result of which has been that the beds have been squeezed together and the material rendered very dense and compact, while the original lines of stratification have been almost obliterated, and the particles have been rearranged in fresh planes perpendicular

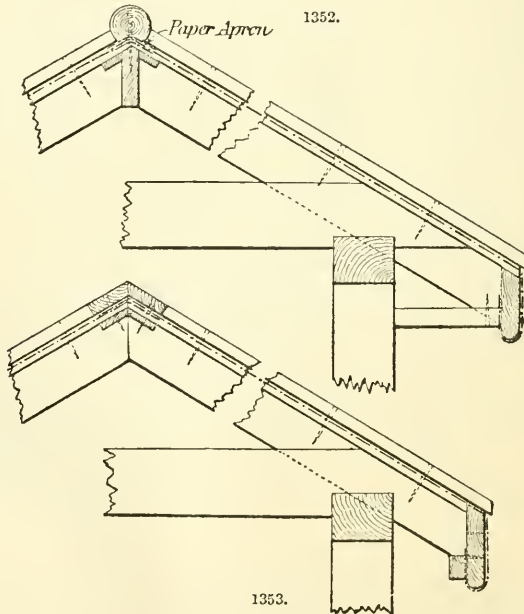
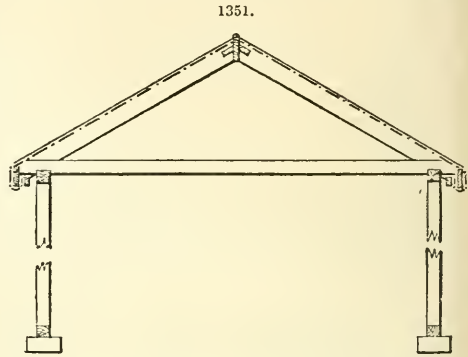

to the direction in which the pressure was exerted; along these planes the rock splits with great ease. The strength of the material has thus no connection with its natural bed, even when the latter can be discovered. This splitting or fissile property makes

slate eminently useful as a building material, as, notwithstanding the fact that it is one of the hardest and densest of rocks, it can be obtained in such thin sheets that the weight of a superficial foot is very small indeed, and consequently, when used for covering roofs, a heavy supporting framework is not required. Slate absorbs a scarcely perceptible quantity of water, and it is very hard and close-grained and

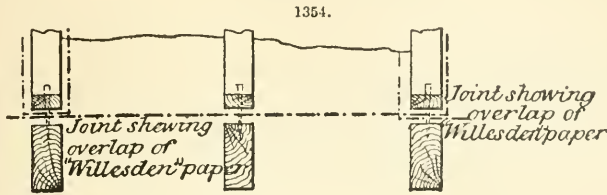

smooth on surface; it can be laid safely at as low a pitch as $22\frac{1}{2}^\circ$. In consequence of this, the general introduction of slate as a roofing material has had a prejudicial effect upon the architectural character of buildings. The bold, high-pitched, lichen-covered roofs of the middle ages—which, with their warm tints, form so picturesque a feature of many an old-fashioned English country town—have given place to the flat, dull, slated roofs.

The best roofing slate is obtained from North Wales, chiefly in the neighbourhood of Llanberis, where there are numerous quarries, those at Penrhyn being the largest; the slates from this district generally go by the name of Bangor. At Ffestiniog and in the neighbourhood there are also numerous quarries, the slates from which are generally designated Portmadoc slates, as they are shipped from this port. The colour varies from green to purple and black, and a good effect can be obtained in buildings by using alternate bands of different colours in the roof. Good slates are also obtained from Cornwall, where the quarries have been worked for a long period; and from the Lake district, those which come from the neighbourhood of Maryport being of a bright sea-green colour. As a general rule, the finer the grain of the slate and the cleaner and smoother the surface with which it splits, the better it will be. When the surface is coarse and uneven, it is probable that the slates have been obtained from a bed where the pure rock was in close proximity to, and partly mixed with, some foreign substance, such as sandstone; and such slates would be likely to absorb more water than the fine-grained varieties.

The large demand for roofing slates has led to the opening of many new quarries during the last few years, the slates from which are of varying degrees of excellence. Non-absorption of water is, of course, the most valuable characteristic; an easy test of this can be applied by carefully weighing one or two specimens when dry, and then steeping them in water for a few hours and weighing them again, when the difference in weight will of course represent the quantity of water absorbed. The light-blue coloured slates are generally superior to the blue-black varieties.

The chemical analysis of an average specimen of slate may be taken as

Silica	54.75	per cent.
Alumina	22.90	„
Iron oxide	9.66	„
Magnesia	1.90	„
Potash and soda	5.14	„
Water	5.45	„

Its specific gravity is 2.8.

Roofing slates are sorted into various sizes, which are sold under the following names :—

Queens, the size of which is 36 in. by 24 in.	Countesses, size of which is 20 in. by 10 in.
Imperials " " 30 in. by 24 in.	Viscountesses,, " 18 in. by 9 in.
Princesses " " 24 in. by 14 in.	Ladies " " 16 in. by 8 in.
Duchesses " " 24 in. by 12 in.	Doubles " " 13 in. by 6 in.

Of these the Duchess and Countess slates are the most extensively used.

Slates should always be laid with a certain lap, that is, each course should overhang the next but one below it to a certain extent, and this should not be less than 2 in. Thus there will be a certain width of slate in each course exposed, and this is called the gauge, its width diminishing as the lap increases. The gauge for any kind of slating is found by deducting the lap from the length of the slate, and then halving the remainder :

thus, if Countess slates are laid with a 3-in. lap, the gauge will be $\frac{20-3}{2} = 8\frac{1}{2}$ in.

Each course of slates "breaks joint" with the one below it. The average weight of ordinary slating may be taken as 7 cwt. per square of 100 superficial ft. The valleys of slated roofs are generally laid with lead turned up under the slates, and the hip rafters are either covered with lead—which is the best plan—or with thick saddle-back slates finished at top with an ornamental roll. Some years ago a system was introduced called patent slating. This consisted in laying large thick slates so that they butted against one another in a vertical line, the joints coming exactly over a rafter to which the slates were firmly screwed. The successive courses overlapped one another a few inches, and when the roof was covered, thin fillets of slate about 3 in. wide were bedded in putty over the vertical joints, tightly screwed down to the rafters, and pointed carefully all round. Slating could be laid in this manner to a very low pitch, and yet remain water-tight for a considerable time, but it was found that a slight settlement of the roof was sufficient to injure it, and as the putty also soon perished, the system was abandoned, and it is now never adopted. It gave, however, a distinctly ornamental appearance to a roof.

The usual method of laying slates is illustrated in Fig. 1354*, which represents 3 courses, the distance between *a* and *b* being the lap, and that between *b* and *c* the gauge. Slates are sometimes laid on close boarding nailed to the rafters, in which case it is usual to put a layer of sheathing felt on the boarding before laying the slates; but they oftener rest on battens or slate laths, as in Fig. 1355, placed at a distance apart equal to the gauge to be given to the slates. It is usual to fasten slates by 1 or 2 zinc or copper nails,

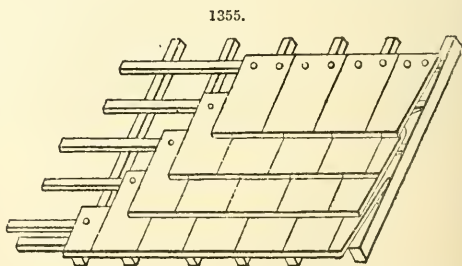
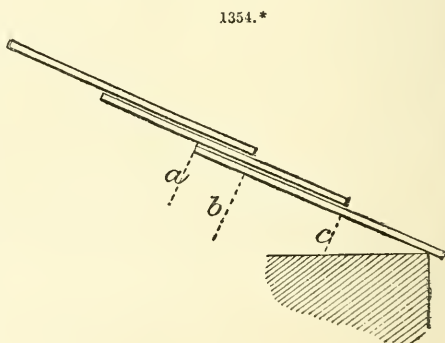

according to size, passed through holes punched near the centre and top of the slates. Slating is measured by the square of 100 ft. super, 12 in. extra being allowed for eaves, hips, valleys, and irregular angles; circular slating is $\frac{1}{3}$ extra. A good slate should emit a clear ringing note when struck, and feel hard and rough to the touch. The

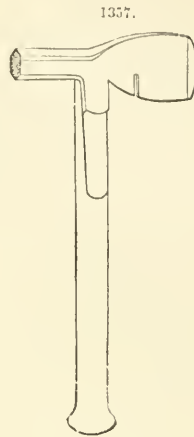
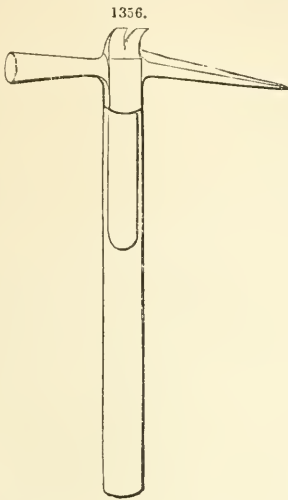

“back” of a slate is its upper surface; the “bed,” its under side; the “head,” its upper edge; the “tail,” its lower edge. Fig. 1356, is a slater's pick hammer; Fig. 1357, a bath hammer; Fig. 1358, a cutting iron for reducing the dimensions of slates; Fig. 1359, a slater's axe having a cutting edge and a pick at the back.

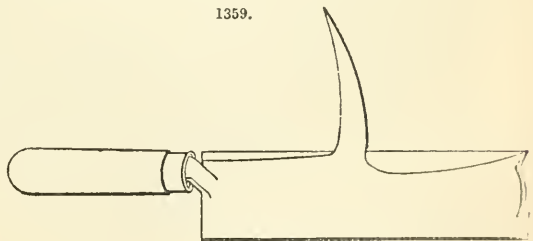
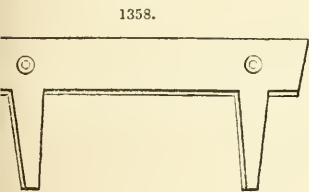

The effect of wind pressure on slated and tiled roofs is important. The cause of slates being blown off is not quite so simple as might at first be imagined. When loose ridge tiles or broken slates occur, these are blown off as a matter of course, but it frequently happens that roofs which were perfectly sound are seriously damaged. As the direction in which the force of the wind acts is horizontal, there would seem to be no tendency to rip up or break off materials lying so closely upon one another as slates. The true explanation is probably this: any exceptionally strong gust of wind is succeeded by a momentary vacuum, and as under ordinary circumstances the atmospheric pressure inside and outside a roof is equal, it follows that during the brief continuance of the vacuum outside the pressure inside is considerably in excess, and the weakest points of the roof covering will have a tendency to be pushed outwards. Now in roofs covered

with battens, to which the top only of the slates are nailed, the lower portions of the slates would be much less able to resist any such outward pressure, and would be forced upwards, and if at such a moment another gust of wind were to occur it would find its way under the slate and break it. If the rafters were covered with close boarding instead of battens this would offer a far more even resistance, and for this reason close boarded roofs are much less liable to damage from wind. The whole question of the action of wind upon sloping roofs has not received the attention from professional men that its importance demands.

An architect says he has been in the habit for many years of bedding his roofing slates in hydraulic cement, instead of having them nailed on dry in the usual way, which leaves them subject to be rattled by the wind, and to be broken by any accidental pressure. The cement soon sets and hardens, so that the roof becomes like a solid wall. The extra cost is 10 or 15 per cent., and he thinks it good economy, considering only its permanency, and the saving in repairs; but, besides this, it affords great safety against fire, for slate laid in the usual way will not protect the wood underneath from the heat of a fire at a short distance.

Tiles.—If all tiles were of the brilliant hue that is occasionally met with in country districts, it is probable that their use as a roofing material would have remained restricted. But lately manufacturers have succeeded in producing a warm reddish-brown tint closely approximating to that of old weathered tiles, than which nothing can be more pleasing. Tiles are made from clay in much the same manner as bricks, but as they are thinner, they require a tougher clay, and considerably more care in their manufacture. The clay is dug and weathered, and then ground in a pug mill, so that it acquires great consistency. It is then formed into the required shape by being pressed into an oak mould, plated with iron. The clay is kept from sticking to the mould by dusting the latter with sand or fine coaldust. The tiles are then dried in the open air, and afterwards baked in a kiln, constructed on much the same principle as a brick kiln, but enclosed in a conical building called a dome. The period of burning depends upon the quality of the clay and the colour to which the tiles are to be burnt. This general description applies to nearly all roofing tiles, but of course the moulding processes vary according to the kind of tile that is being made. Till quite recently, pantiles and plain tiles were the only kinds made, the former having a double curved surface, on the one side convex and the other concave, which shape is given to the plastic clay by hand. A small hollow in the mould gives the projecting nib by which pantiles are hung on the laths of a roof. The ordinary size of pantiles is $14\frac{1}{2}$ by $10\frac{1}{2}$ in. and they are generally laid to a gauge of 10 or 11 in. These tiles are only used for an inferior class of building, as it is difficult to keep a roof covered with them watertight for a length of time, because they can never be made to fit closely over each other at their lower edges, and therefore the rain has a tendency to drift up underneath them. They partially overlap laterally, but not sufficiently to make a watertight joint, and they are consequently frequently pointed with mortar, which forms a thick and ugly joint, and soon perishes. The weight per square is about 10 cwt. The Bridgewater tiles are very similar to pantiles, but wider, and formed with a double roll.

Plain tiles are oblong in shape, with a very slightly curved surface, and they are either moulded with nibs for hanging on the laths, or are formed with two holes for nails or pegs. Their size is $10\frac{1}{2}$ by $6\frac{1}{4}$ in. Many excellent specimens of plain tiles have been shown at the various building exhibitions which have been held lately, but it would be difficult to find any superior to the best Broseley tiles, which are well burnt, even in texture, and of a very pleasant tint. Plain tiles, of the size mentioned above, should be laid to a $4\frac{1}{2}$ -in. gauge, and they are either hung to the laths by their nibs or by pegs driven through the holes in their surface. Some builders are fond of bedding the heading joints in mortar, but it is very doubtful if this is a good plan. Of course it makes the roof somewhat tighter at first, but experience shows that tile roofs almost

always fail in consequence of the laths becoming decayed and allowing the tiles to slip, and the presence of the mortar accelerates this decay. It is, moreover, certain that if mortar be used the tiler will be disposed to depend upon it for keeping the tiles in position, and will not devote so much care to the proper hanging and pegging of each tile, and as all roofs are subject to slight movements due to changes of temperature and to varying wind pressures—have in fact a certain amount of “spring”—this will instantly act upon the mortar joint and will tend to disturb it, and in a very short time the mortar begins to fall away and helps to block up the roof gutters. In some country districts, it is the practice to lay the tiles on a bed of hay laid over the laths, and this plan appears to answer very well if proper care be taken, and it adds to the warmth of a building in winter. It is not desirable to give tiled roofs a less pitch than 45° , and 50° is preferable.

With ordinary plain tiles, those in any one course do not overlap laterally; consequently each course must overlap to a certain extent the next but one below it, or the rain would enter between the joints. Of late years many attempts have been made to obviate this necessity, which is the cause of the great weight of this kind of roofing,—nearly a ton per 100 sq. ft. If tiles can be moulded so that they will fit into one another, and form a watertight joint laterally, the successive courses need only overlap sufficiently to prevent the rain driving upwards, and this can be prevented by forming a groove at the upper edge of one tile into which a corresponding projection on the lower edge of the next tile would fit. This method has been adopted with considerable success in Phillips' patent lock-jaw roofing tiles, which interlock with one another on all 4 sides, and form such closely-fitting joints that nothing can penetrate them; and the patentee claims that by exerting great pressure on the clay during the process of manufacture he is able to ensure uniformity and perfect fit, without which the tiles would of course be practically useless. These tiles are of two different kinds: the “single grip,” and the “double grip.” The latter are suitable for the most exposed situations, and will stand the roughest usage. Half tiles are made for hanging next to a gable in alternate courses, in order to secure a perfect bond, in the same way that closers are used in brickwork. No mortar is required with them, nor any special skill in laying them. The difference between these tiles and the ordinary kind in the weight per square, $5\frac{1}{2}$ cwt., and the number required, 150, is very striking, the weight being less than one-third that of ordinary tiles. Taylor's patent tiles are moulded with a different kind of lateral overlapping arrangement. All these patent tiles give a decidedly ornamental appearance to roofs, as they break up the plain surface into a series of elevations and depressions.

It is curious to notice how closely some of the new patent systems of tiling resemble those in use among the Romans and in the early part of the middle ages. Tiles were used at a very early period for roof coverings, and were first made with rims on each side, and under the rims were notches forming a lap laterally; and hollow tiles, similar to common hip and ridge tiles, were laid over the vertical joints, themselves overlapping each other. An improvement was effected by making the tiles trapezoidal in shape, instead of rectangular, and thus the narrow end of one tile was pushed down till it closely fitted between the rims of the one below it; the notches under the rims were then discontinued, but the vertical joints were covered as before.

In the thirteenth and fourteenth centuries, in the old French province of Champagne, tiling was carried to very great perfection; and it is probable that no better tiles have ever been made than those which can be still seen in many buildings in Troyes and its neighbourhood. The tiles are very like the modern Broselys, but were made with one nib for hanging on the laths and one hole for nailing; and to show the extreme care which was taken with them, the positions of the nib and hole were reversed in each alternate course of tiles. This was done in order that, as the alternate courses were laid “breaking joint,” the nail-hole should always come over the centre line of each rafter, and the nib always midway between the rafters. The rafters were of course fixed in the

proper position for the tiles, which were laid to a gauge of about $4\frac{1}{2}$ in.; and as the length was $12\frac{3}{4}$ in., there was always a lap of nearly 4 in. In some of the tiles of this period, the exposed portion of each tile was glazed, and thus rendered non-porous. This would be an excellent plan to adopt with modern tiles, but it would render them too expensive for general use. There is, however, another peculiarity in the best of these old French tiles which might easily be adopted by modern manufacturers, and which would be a great improvement, and that is the chamfering of the lower edge of the tile. The mould could easily be made of the shape requisite to form this chamfer, which would greatly diminish the risk of the tiles being ripped up by the action of a strong wind. The tiles of this period are frequently found in as good condition now as when first burnt.

The great objection to all tiles is their porosity, which causes them to absorb a considerable quantity of water, and this tends to rot the woodwork underneath. This wooden substructure consists in the case of both slates and tiles, either of fillets of wood nailed on the rafters at intervals corresponding to the gauge required, or of close boarding similarly nailed to the rafters. For slates, these fillets are generally $2\frac{1}{2}$ in. or 3 in. wide and 1 in. thick, called slating battens, and the slates are nailed to them by nails—2 to each slate—passing through small holes pierced in the slate itself. For tiles, which are much heavier, stouter fillets are required, and the tiles are hung on to these by pegs passing through the holes in the tiles, or by the projecting nibs which have been already described. Close boarding is far preferable for either kind of covering, as it keeps the roof tighter and warmer, and in case it should be necessary for workmen to pass over the roof for any purpose after its completion there is much less danger of the slates or tiles being broken than with battens. The risk of damage from high winds is also much less.

Metallic roofing.—The structural arrangement of a building frequently renders it impossible to form a sloping roof over all parts of it, and hence flats are necessary. When this is the case, metallic coverings are the best that can be adopted.

Formerly it was not uncommon in buildings where cost was not a consideration to use sheet copper for covering flats or slight slopes. Copper forms a very light covering, as it may be safely used in sheets not more than .03 in. thick, which would weigh about 20 oz. per ft. super. Copper slowly oxidizes when exposed to the air, but the oxide does not eat into the substance of the metal as is the case with iron; it seems rather to form a protective coat. The cost of copper renders its use very limited, and zinc has to a large extent taken its place.

Zinc is also a very light covering; in fact its specific gravity is slightly less than that of copper, but it has not a good reputation, owing to the fact that on its first introduction it was used in very thin sheets, and sufficient care was not taken in laying it. Its expansion is greater than that of any other metal, and therefore it should always be laid with ample play, or it will soon buckle and crack. The Vieille Montagne Company have greatly improved the methods of laying zinc, and they have also introduced thicker sheets than could previously be obtained; if zinc is used at all, it should never be less than No. 16 gauge, which weighs about 24 oz. to the ft. super, and is as nearly as possible $\frac{1}{16}$ in. thick. Zinc resembles copper in the fact that it oxidizes on the surface only; but in smoky districts it will not last at all, as sulphuric acid completely destroys it.

The surface oxidation only of zinc when exposed to ordinary atmospheric influences, suggested the attempt to prevent the rusting of iron by giving it a thin coating of zinc. This led to the production of "galvanized" iron for roofing purposes. This "galvanizing" process consists in first precipitating tin upon sheets of iron by means of weak galvanic action, and then placing the plates in a bath of liquid zinc. Iron thus treated will last, under favourable circumstances, for a long time; but when used for roofing, it is almost impossible to avoid nailing the sheets in some places, and where the nail holes occur, moisture invariably makes its way to the iron itself, which rusts internally, and the thin zinc coating then comes off in flakes. What was previously stated as to the

action of sulphuric acid upon zinc will show the utter uselessness of galvanized iron in smoky districts.

The most durable metal covering for roofs is milled lead. This is lead which, after being cast, is passed through a mill between rollers adjusted so as to give the requisite thickness to the sheets which are rolled out. This thickness varies from .075 in. to .236 in., the weight of these qualities being 4 lb. and 14 lb. respectively per superficial ft. The qualities chiefly used for roofing are the 5-, 6-, and 7-lb. lead, the latter being the lightest that should be used for flats or gutters. In laying lead on flats, the latter should be close boarded, and care must be taken to allow for expansion and contraction of the metal; consequently the joints of 2 adjacent sheets must not be soldered together. In order to prevent the water from penetrating at the joints, fillets of wood, $2\frac{1}{2}$ in. by 2 in., rounded at the top, called rolls, are nailed to the boards, and one sheet of lead is dressed close up to and half-way over the roll, while the next sheet is brought up to the opposite side of the roll, and lapped completely over the roll and the turned-up portion of the first sheet. If the lead is closely hammered down with wooden mallets, no nails are required, and they are better omitted. When it is necessary to nail the lead round skylights or in other positions, copper nails should always be used.

Thin flat plates of iron rendered "rustless" by the Bower-Barff process have lately been introduced for roofing purposes by Horn, Black & Co., and many advantages are claimed for it on the score of cheapness, durability, and appearance, as compared with other metallic roofings. There are several modifications in the pattern and mode of fixing, but the simplest is illustrated in Fig. 1360. Here plain flat plates, 24 in. by 12 in., are laid like ordinary slating, except that oxidized hoop iron is laid over each line of plates, through holes in which, as well as in the slates, are driven the nails which fasten both to the boards beneath. The use of this iron lath allows any accidentally damaged plates to be removed at any time, when specially-made plates can be substituted. These special "mending-plates" are so formed as to hook easily and securely upon the iron lath, and to be so fixed without the necessity of cutting the nails which fasten the adjoining plates. All these plates, both ordinary and special, are supplied ready bored with the holes for the nails; and suitable nails, similarly protected with the oxide, are furnished at a reasonable price.

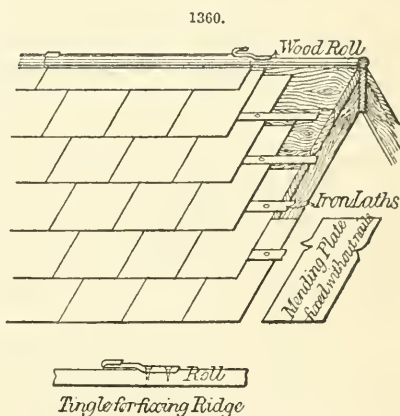

It is only fair to say that much of the preceding information has been gathered from a paper on Building Materials by John Slater, B.A., in the *Sanitary Record*.

GLAZING.—By this term is here meant the fixing of sheets of thin glass in windows for the admission of light to the interior of structures while excluding the weather.

Glass.—Glass is of several kinds. "Crown" glass is made in circular discs blown by hand; these discs are about 4 ft. diameter, and the glass averages about $\frac{1}{15}$ in. thick. Owing to the mode of manufacture, there is a thick boss in the centre, and the glass is throughout more or less striated or channelled in concentric rings, frequently curved in surface, and thicker at the circumference of the disc. Consequently, in cutting rectangular panes out of a disc there is a considerable loss, or at least variety in quality: one disc will yield about 10 sq. ft. of good window glass, and the largest pane that can be cut

from an ordinary disc is about 34×22 in. The qualities are classified into "seconds," "thirds," and "fourths."

"Sheet" glass is also blown by hand, but into hollow cylinders about 4 ft. long and 10 in. diameter, which are cut off and cut open longitudinally while hot, and therefore fall into flat sheets. A more perfect window glass can be made by this process, and thicker, and capable of yielding larger panes with less waste. Ordinary sheet glass will cut to a pane of 40×30 in., and some to 50×36 in. It can be made in thicknesses from $\frac{1}{10}$ in. to $\frac{1}{2}$ in.

"Plate" glass is cast on a flat table, and rolled into a sheet of given size and thickness by a massive metal roller. In this form, when cool, it is "rough plate."

"Ribbed plate" is made by using a roller with grooves on its surface. Rough and ribbed plate are frequently made of commoner and coarser materials than polished plate, being intended for use in factories and warehouses.

"Polished plate" is rough plate composed of good material and afterwards polished on both sides, which is done by rubbing 2 plates together with emery and other powders between them. Plate glass can be obtained of almost any thickness from $\frac{1}{8}$ in. up to 1 in. thick, and of any size up to about 12×6 ft.

In the glazing of a window the sizes of the panes, that is to say, the intervals of the sash-bars, should be arranged, if practicable, to suit the sizes of panes of glass which can conveniently be obtained, so as to avoid waste in cutting; this consideration is of more consequence in using crown and sheet glass than with plate glass. The woodwork of the sash should receive its priming coat before glazing, the other coats should be put on afterwards. With crown glass, which is sometimes curved, it is usual to place the panes with the convexity outwards. When the glazier has fitted the pane to the opening with his diamond, the rebate of the sash-bar facing the outside of the window, he spreads a thin layer of putty on the face of the rebate and then presses the glass against it into its place, and holding it there, spreads a layer of putty all round the side of the rebate, covering the edge of the glass nearly as far as the face of the rebate extends on the inner side of the glass, and bevelling off the putty to the outer edge of the rebate. The putty is then sufficient to hold the pane in its place, and hardens in a few days. The glass should not touch the sash-bar in any part, on account of the danger of its being cracked from an unusual pressure; there should be a layer of putty all round the edges. This precaution is especially necessary in glazing windows with iron or stone mullions or bars.

Putty.—Glaziers' putty is made of whiting and oil. The whiting should be in the form of a very dry fine powder; it should be specially dried for the purpose, and passed through a sieve of 45 holes to the inch, and then mixed with as much raw linseed oil as will form it into stiff paste; this, after being well kneaded, should be left for 12 hours, and worked up in small pieces till quite smooth. It should be kept in a glazed pan and covered with a wet cloth. If putty becomes hard and dry, it can be restored by heating it and working it up again while hot. For special purposes, white-lead is sometimes mixed with the whiting, or the putty is made of white-lead and litharge entirely.

Soft Putty.—10 lb. whiting and 1 lb. white-lead, mixed with the necessary quantity of boiled linseed oil, adding to it $\frac{1}{2}$ gill best salad oil. The last prevents the white-lead from hardening, and preserves the putty in a state sufficiently soft to adhere at all times, and not get hard and crack off, suffering the wet to enter, as is often the case with ordinary hard putty.

To Soften Putty.—(a) 1 lb. American pearlash, 3 lb. quick stone lime; slake the lime in water, then add the pearlash, and make the whole about the consistence of paint. Apply it to both sides of the glass, and let it remain for 12 hours, when the putty will be so softened that the glass may be taken out of the frame with the greatest facility. (b) A correspondent of the *Garden* says:—After many trials, and with a variety of differently shaped tools with various success, I at last accomplished my end by the

simple application of heat. My first experiment was with a soldering iron, when I found the putty become so soft that the broken glass could be removed by the fingers and the putty be easily scraped away. All that is required is a block of iron about $2\frac{1}{2}$ in. long by $1\frac{1}{2}$ in. square, flat at the bottom, and drawn out for a handle, with a wooden end like a soldering iron. When hot (not red) place this iron against the putty or flat on the broken glass, if any, and pass it slowly round the sides of the square. The heat will so soften the putty that it will come away from the wood without difficulty. Some of it may be so hard as to require a second application of the hot iron, but one experiment will give sufficient instruction to meet all difficulties.

Tools.—The tools employed by glaziers comprise a rule, for measuring the glass; putty knives of the form shown in Fig. 1361 which needs no pressure but that of

1361.

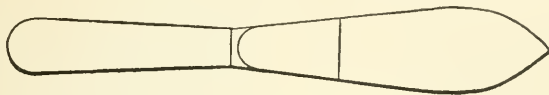

1362.

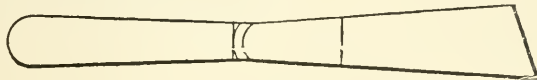

the hands, and of the form in Fig. 1362 which requires the assistance of a hammer for removing old hard putty; and a diamond or other contrivance for cutting glass. The diamond is unquestionably the most perfect tool for cutting glass, but it is often replaced by the American substitute illustrated in Fig. 1363, which consists of a stout blade carrying a small hard steel wheel at the tip, with notches in the blade for breaking off projecting edges that have not parted cleanly. Non-professional glaziers would do well to purchase their glass ready cut to accurate dimensions.

Lead glazing.—Several species of glass are employed for this kind of glazing. Amongst these may be specified "sheet" and "plate" glass of various kinds; "coloured glass," either "pot-metal" or "flashed" ("pot-metal" being coloured throughout its

1363.

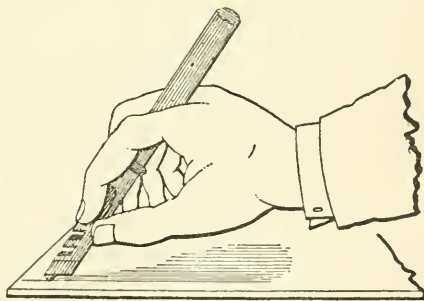

substance by the addition of metallic oxide while the glass is in a state of fusion, while the "flashed" glass is white, with one surface covered by a thin film of coloured glass); "flashed" glass being made in ruby, blue, opal, green, violet, and pink. These colours can be also modified to red, orange, amber, and lemon colour by staining. Another species, called "cathedral glass" (rolled and sheet), is generally applied to light tints of a positive colour, and is principally used for glazing the windows of churches. "Antique" glass is made in various shades of colour, and is usually employed in figure work in stained-glass windows. It is an imitation of that which is found in old leaded lights, and is rough, nubby, and of uneven thickness. It has recently been made with the colouring oxides encased, and also striped with various colours to produce a more striking effect in the fold of garments in figure work. "Aventurine" is a glass made in

slabs, and used occasionally in mosaic figure work. It is generally of a brown semi-transparent colour, and has a peculiar striking effect, caused by the suspension of metallic particles, principally copper filings, which is the chief ingredient. "Ambilti" (single and double) is a sheet glass, originally of Italian manufacture, and much prized by glass painters on account of its softness for staining, and generally brilliant appearance. "Quarries" is the term applied to small square pieces of stained glass, such as are used in the borders of windows; and "roundels" and "bullions" are small discs of glass, some made with a knob in the centre, and used in fretwork with cathedral glass.

The use of lead "calmes" for fixing window panes is of venerable antiquity, the employment of wooden sash-bars being quite a modern innovation. The calmes or leads for the fretwork are slips prepared in the tool known as the "glaziers' vice," wherein a slip of lead is drawn between 2 horizontal rollers of the thickness of a piece of glass, and the calme, as it emerges from the mill, has a section exactly like the letter I. The German vices are the best, and turn out a variety of lead of different sizes. There are moulds with these vices in which bars of lead of the proper sizes are easily cast. In this form the mill receives them, and turns them out with 2 sides parallel with each other, and about $\frac{3}{8}$ in. broad, and a partition connecting the 2 sides together, about $\frac{1}{8}$ in. wide, forming on each side a groove near $\frac{3}{16}$ by $\frac{1}{8}$ in. and 6 ft. long. At the present day most glaziers buy their calmes at the warehouse. The ancient calmes were apparently cast in a mould. Antique calmes are nearly of one uniform width, and much narrower in the "leaf" than modern leads. That this was the case, can be proved not only by the existence of the original leads themselves, but more satisfactorily perhaps by the black lines drawn upon the glass, with which the glass painters were accustomed sometimes to produce the effect of leads without unnecessarily cutting the glass. The process of compressing the modern calmes between rollers to the proper dimensions makes them more rigid than the old leads.

The ordinary leaded casement is still to be found plentifully in cottage windows in the provinces. These are formed of every shape and size, some glazed with rectangular and some with diamond-shaped panes. The calmes in which these are set are often very broad in the leaf, much more so than could be used for fretwork. Glaziers differ as to the best tool for soldering the calmes, some adhering to the old soldering iron without a handle, while others prefer the ordinary copper bit (see Soldering, p. 108). The cutting knife, used for dividing the calmes, has sometimes the form shown at *a*, Fig 1364, and is sometimes shaped as at *b*. In the latter, the blade has its cutting edge at *c*, and the top of the handle *d* is usually formed of a lump of solder, which is handy for driving home the panes in the calmes, driving a brad or tack, &c. *e* is the "ladikin," which is a small tool of bone, box, or beech, about 6 in. long, 1 in. in width, and $\frac{3}{8}$ in. thick, with one end bevelled off for about $\frac{1}{2}$ in. as shown. This is used for opening the leaves of the calme as shown at *f*. The first step in making a lead-light of square panes is to measure the opening and set out on a board or the work-bench in chalk the number of panes decided on; next the glass can be cut, not forgetting to allow for the thickness of the calme, and, this being done, proceed to put the casement together as shown, Fig. 1365.

Tack down to the bench a couple of laths at right angles as shown at *a b*, *a c* (Fig. 1366). Take a calme, and putting your foot on one end to hold it steady, stretch it out, by pulling, perfectly straight; now cut a piece of about the depth of the window and place it against the lath *a b*, as shown at *d e*, and secure it to the bench by a couple of brads as

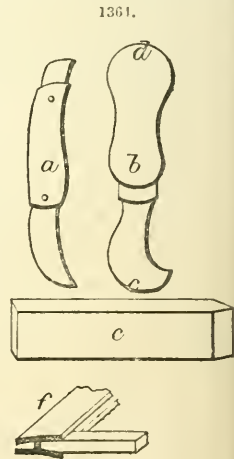

shown. Next cut another length of the calme the breadth of the casements; open the end of the calme *de* with the ladikin, as shown at *f*, Fig. 1364, insert the end of the calme just cut in the one already fixed at *d*, taking care to see that this end is bright, and brad this second calme down, as at *d f*, at right angles to the former, and along the lath *ac*. The

1365.

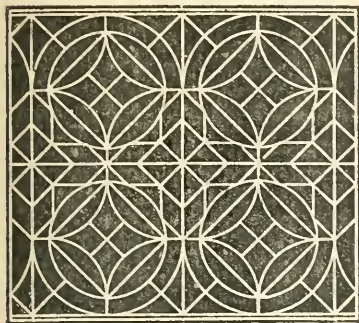

1366.

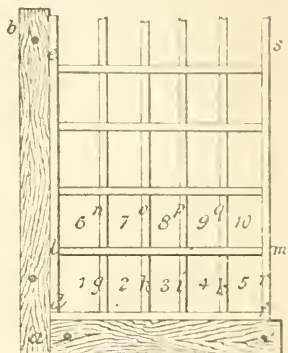

calmes are cut with the cutting knife. The pane of glass 1 is now taken, the ends of the calmes *de* and *df* opened out with the ladikin, the square of glass is placed in and tapped up home with the heavy handle of the cutting knife. Having set pane No. 1, cut with the knife a piece of calme of the exact length of the side of the square, taking care to see that the end is bright; open both sides with the ladikin, then place the end in the calme *df*, as shown at *g*; pane 2 is now placed in this, and carefully tapped home with the handle of the knife; then the lead *h* is cut and placed; next follow pane 3, calme *i* and pane 4, &c., and the first row is glazed. Take especial care that each pane has been knocked in home and that the whole row is tight. Now comes the cross calme *lm*. Stretch another calme and cut it to the proper length and open it up with the ladikin. Insert the end of this in the vertical calme *de*, and place the ends of the spurs *ghik* in it. Now begin another row with the pane 6, follow this with the short lead *n*; then the pane 7, lead *o*, pane 8, and till the second row is complete. When all the panes are fixed in and the casement is complete, the end calme is fixed, and then the side one *rs*. All is now ready for the soldering. The bit or soldering-iron is heated, and the operator takes a strip of fine solder, in his left hand, of an easily fusible kind. He then sprinkles a small quantity of black rosin at the place to be soldered, places the end of the solder strip to the first and applies the heated bit until a good joint is made, and the solder makes a neat little raised circle at the place. This operation is repeated at each joint until all are secured. Some workmen prefer "killed" spirits of salts (see p. 101) to rosin for the flux. The bit or iron should not be too hot, and should not be held in contact with the calmes too long. It is important that the ends of the lead be bright, or a good joint cannot be secured. The bands which secured calmes *abd*, *be* to the brads must now be loosened, the light turned over, and the other side be soldered in a similar manner.

Next the "bands" or "ties" have to be fixed. These are small strips of lead or little bits of copper wire, intended to secure the lights to the "saddle-bars" of the window. The saddle-bars are horizontal bars of small iron rod crossing the window-opening, their ends being set in the stonework or wood, and are intended to support the glass. As many bands should be soldered on as the glazier deems requisite. Copper wire ties are generally preferred for fretwork. In the rectangular iron frame for opening casements, to which the lead light is fitted, the smith generally drills small holes all round, and the

glazier will require to solder his ties around the lead light at such places as will correspond with these holes and in such a manner that the ties stand up at right angles to the calme to which they are soldered. They must also be of such size that they will pass through the holes. These ties are put through the holes in the casement frame, cut off flush with the top surface of the iron. A bead of solder is now dropped on the end of the tie, well spread with the bit, and finally pressed down into a nice flat round bottom by the sudden and momentary application of the thumb, well wetted with saliva.

The lead-light is now finished all but the "cementing." This process is adopted for several reasons. In the first place it helps to secure the glass in the lead-work, something as putty does in sash-windows, then it keeps the whole window watertight and windtight, &c. Proceed thus:—Take an old sash-tool and a little stiff lead-coloured paint, and rub the joints and calmes therewith. Then take a small blacklead brush and a small quantity of whiting, and with this brush rub the paint until it appears all brushed out of the crevices, brush off the whiting, and repeat the process with some lampblack, and brush away until the joints become as lustrous as if blackleaded. Finally clear off and clean the glass in the usual way.

Special methods.—Recently have been introduced a number of methods of glazing not depending on putty, thereby simplifying the operation of fixing and replacing the glass, though probably in all cases also facilitating the operations of the burglar, which must limit their application for domestic purposes. They may be described in alphabetic order.

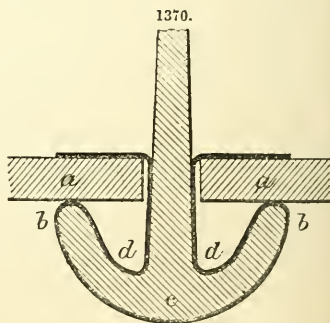
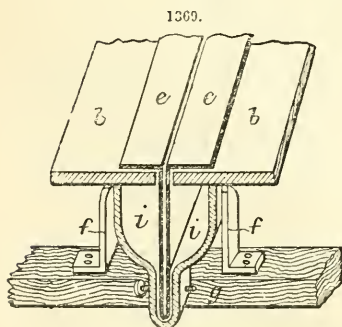
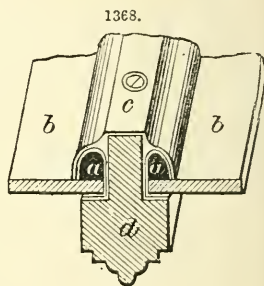
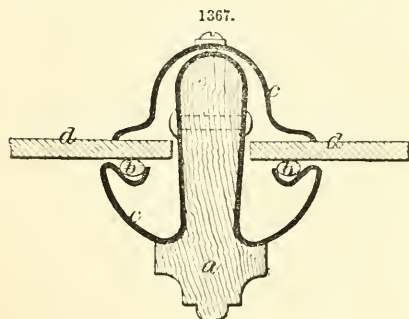

Braby's.—This is shown in Fig. 1367: *a*, wooden core; *b*, oiled packing; *c*, zinc bar and capping. The glass *d* is clipped between the zinc bars with the intervention of the oiled packing.

Drummond's.—This requires a specially prepared putty, and is illustrated in Figs. 1368, 1369: *a*, side slips fitting close on the edges of the glass *b*, and filled with a putty

that will not dry nor harden; *c*, cap of zinc, copper or lead, with allowance for side slips to expand or contract with the glass; *d*, wooden or T-iron bar; *e*, head flanges folded down on glass *b*; *f*, chair for fixing bars to purlins *g* when required; *h*, bolt and nut to secure lead flange inside at bottom; *i*, water gutter.

Lawrance's.—This plan is adapted for greenhouses and similar structures, entailing the use of special metallic sash bars. It is light, strong, watertight, free from drip, and durable.

Mackenzie's.—This is essentially a malleable iron glazing bar sheathed in lead (Fig. 1370). The glass *a* rests upon the lead sheath *b* surrounding the iron bar *c*, and is held in place by a fold of the lead above. Condensed moisture collects in the gutter *d*.

Messenger's.—This is a system of glazing with leaden bars, which may be described thus. Purlins about 2 to 3 ft. apart are placed over the rafters, which as in ordinary construction are 4 to 5 ft. apart. These purlins are grooved to receive the top edge of

1371.

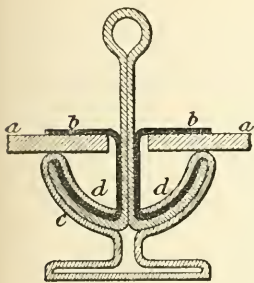

1372.

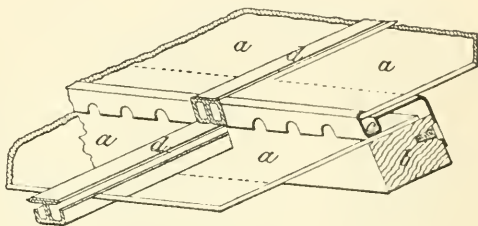

1373.

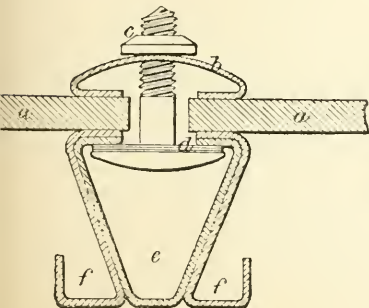

1374.

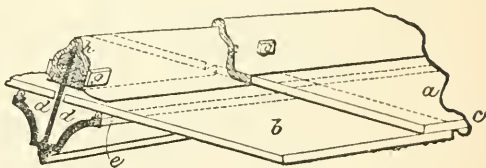

one square of glass, the bottom edge of the square above it projecting over it, and entirely covering it from the weather. On these purlins are placed lead bars of a stout I section running vertically; the recesses of these lead bars are filled with putty, into which the glass is bedded; the bars are screwed to the purlins at the bottom, and the core and bottom table are cut away and the top table turned down and nailed, forming a clip to hold up the glass. The woodwork, not covered by the lead bars, such as the ridge, end-rafters, &c., is flashed with thin sheet lead.

Pennycook.—This system, Fig. 1371, consists of a series of sash bars constructed of sheet zinc, copper, or other metal, forming a double gutter on each sash bar for carrying off condensed moisture. The glass is held in position by folding down narrow flanges of sheet lead. The sash bars are fixed to the wooden or iron roof by shoes or clips, and

the upper and lower edges of the glazing are protected by flashings of sheet lead or zinc. *a* is the glass; *b*, lead; *c*, metallic sash bar; *d*, internal gutter.

Rendle's.—Fig. 1372 represents the "acme" system: *a*, glass; *b*, wooden purlin; *c*, horizontal bar with perforated channel to carry off condensed moisture from inside; *d*, vertical bar forming junction of 2 squares of glass. Fig. 1373 represents the "invincible" system: *a*, glass; *b*, capping; *c*, screw bolt and nut; *d*, washer; *e*, water channel; *f*, condensation gutters.

Shelley's.—Fig. 1374: *a*, upper square of glass; *b*, lower square of glass; *c*, metallic channel to convey condensed moisture from top to outside of under square, if considered necessary; *d*, channels to convey away water that may get in; *e*, hollow vulcanite tube or other packing as bed for glass; *f*, movable stop to prevent upper square sliding down; *g*, locking stud for securing capping on glass; *h*, movable saddle secured to bar to which locking stud is made fast.

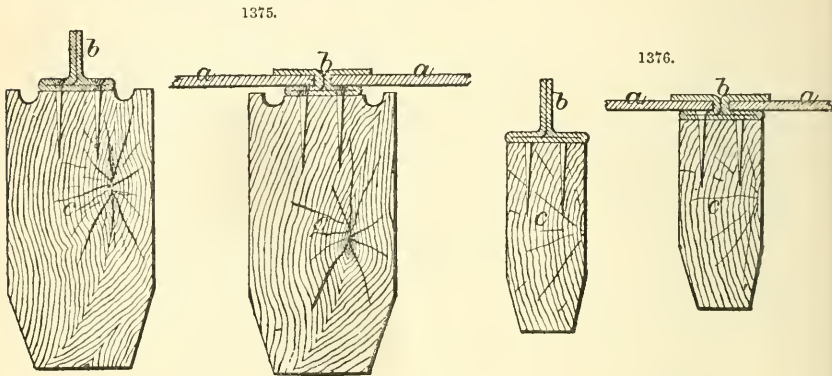

Simplex.—This is composed solely of strips of sheet lead. Fig. 1375 shows a section of a sash bar before and after glazing, and Fig. 1376 of a window bar: *a*, glass; *b*, lead; *c*, woodwork.

BELL-HANGING.—The art of domestic bell-hanging is quite modern, and was but little in practice before the present century. At first it was usual to expose the wires to view along the walls and ceilings, even in the best houses, until the "secret system" was introduced, which consists in carrying the wires and cranks in tubes and boxes concealed by the finishings of the walls. The tubes are generally of tinned iron or zinc; but they ought to be either of brass or strong galvanized iron. Zinc cannot be depended upon: in some places it will moulder away; if not soldered, it opens, and the wires work into the joinings of the tube, which stops their movement. The proper time to commence bell-hanging is when the work is ready for lathing; but it should not be delayed till after the rough-cast plastering has commenced. If the work be performed at this period, it enables the bell-hanger to see his way more clearly, and prevents much cutting away of the plasterers' work afterwards.

The bells are usually hung in a row on a board placed in a convenient position for being seen and heard by the attendant; each bell having some mark by which to distinguish the room whence the summons proceeds. Each bell is connected by a separate wire with a handle fixed in the room to which it relates. The wire of communication, which transfers the jerk of the handle of the bell-pull to the bell, can only travel in straight lines following the walls of the rooms or passages traversed, consequently at each change of direction the continuity of the wire must be broken, and

the ends attached to the arms of a suitable crank. These are made in several forms to suit the situations which occur, and must be chosen accordingly. It is important to have as few cranks as possible, because they all help to increase the wear on the wires, tubes, &c. In some houses no provision is made for bells. Where it is desired to remedy this defect, a very long handled (2-3 ft.) gimlet, called a "bellhanger's gimlet," Fig. 1377, is needed for boring passages for the wires, unless the additional expense is incurred of letting in tubes for the wires to run in. The wire used is of copper, Nos. 16, 17, or 18 gauge for indoor work, and 14 or 15 for outdoor. The wire should be strained quite tight when put up, and secured at one end to the chain on the bell-pull, and at the other to the lower arm on the bell, allowing the latter to hang perpendicularly. The bell-pull, bell, and cranks must be very firmly secured in their places; joints in the wire are always made by looping and twisting, with the aid of a pair of pliers which also cut off the ends. The whole system is very crude as compared with the electric system, which is now coming into general use.

Electric Bells.—An ordinary electric bell is merely a vibrating contact-breaker carrying a small hammer on its spring, which hammer strikes a bell placed within its reach as long as the vibration of the spring continues. The necessary apparatus comprises a battery to supply the force, wires to conduct it, circuit-closers to apply it, and bells to give it expression.

The Leclanché battery (Fig. 1378) is the best for all electric bell systems, its great recommendation being that, once charged, it retains its power without attention for several years. 2 jars are employed in its construction: the outer one is of glass, contains a zinc rod, and is charged with a solution of ammonium chloride (sal-ammoniac). The inner jar is of porous earthenware, contains a carbon plate, and is filled up with a mixture of manganese peroxide and broken gas carbon. When the carbon plate and the zinc rod are connected, a steady current of electricity is set up, the chemical reaction which takes place being as follows:—The zinc becomes oxidized by the oxygen from the manganese peroxide, and is subsequently converted into zinc chloride by the action of the sal-ammoniac. After the battery has been in continuous use for some hours, the manganese becomes exhausted of oxygen, and the force of the electrical current is greatly diminished; but if the battery be allowed to rest for a short time, the manganese obtains a fresh supply of oxygen from the atmosphere, and is again fit for use. After about 18 months' work, the glass cell will probably require recharging with sal-ammoniac, and the zinc rod may also need renewing; but should the porous cell get out of order, it is better to get a new one entirely, than to attempt to recharge it.

On short circuits, 2 cells may suffice, increasing up to 4 or 6 as required. It is false economy to use a battery too weak to do its work properly. The battery should be placed where it will not be subject to changes of temperature, e. g. in an underground cellar.

The circuit wire used in England for indoor situations is "No. 20" copper wire, covered with guttapercha and cotton. In America, "No. 18, first-class, braided, cotton-covered, office wire" is recommended, though smaller and cheaper kinds are often used. The wire should be laid with great regard to keeping it from damp, and ensuring its perfect insulation. Out of doors, for carrying long distances overhead, ordinary galvanized iron wire is well adapted, the gauge running from "No. 4" to "No. 14," according to conditions. Proper insulators on poles must be provided, avoiding all

1377.



1378.

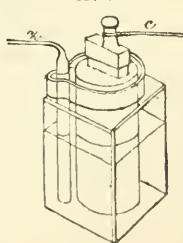

contact with foreign bodies; or a rubber-covered wire encased in lead may be run underground.

The circuit-closer, or means of instantaneously completing and interrupting the circuit, is generally a simple press-button. This consists of a little cylindrical box, provided in the centre with an ivory button, which is either (1) attached to a brass spring that is brought into contact with a brass plate at the back of the box on pressing the button, or (2) is capable of pressing together 2 springs in the box. A wire from the battery is attached to the spring of the press-button, and another from the bell is secured to the brass plate. Platinum points should be provided on the spring and plate where the contact takes place. While the button is at rest, or out, the electric circuit is broken; but on being pressed in, it completes the circuit, and the bell rings.

The relative arrangement and connection of the several parts is shown in Fig. 1379: *a*, Leclanché cell; *b*, wire; *c*, press-button; *d*, bell. When the distance traversed is great, say $\frac{1}{2}$ mile, the return wire *e* may be dispensed with, and replaced by what is known as the "earth circuit," established by attaching the terminals at *f* and *g* to copper plates sunk in the ground.

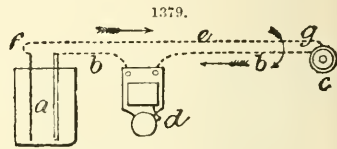

The bells used are generally vibrating ones, and those intended for internal house use need not have a higher resistance than 2 or 3 ohms. At other times, single-stroke and continuous-ringer bells have to be provided, the latter being arranged to continue ringing until specially stopped. The bell may or may not be fitted with an annunciator system; the latter is almost a necessity when many bells have to ring to the same place, as then 1 bell only is requisite. A single-stroke bell is simply a gong fixed to a board or frame, an electro-magnet, and an armature with a hammer at the end, arranged to strike the gong when the armature is attracted by the magnet. A vibrating bell has its armature fixed to a spring which presses against a contact-screw; the wire forming the circuit, entering at one binding-screw, goes to the magnet, which in turn is connected with the armature; thence the circuit continues through the contact-screw to the other binding-screw, and out. When set in motion by electricity, the magnet attracts the armature, and the hammer strikes the bell; but in its forward motion, the spring leaves the contact-screw, and thus the circuit is broken; the hammer then falls back, closing the circuit again, and so the action is continued *ad libitum*, and a rapid vibratory motion is produced, which makes a ringing by the action of the successive blows of the hammer on the gong.

The following useful hints on electric bell systems are condensed from Lockwood's handy little volume on telephones.

With regard to the battery, he advises to keep the sal-ammoniac solution strong, yet not to put so much in that it cannot dissolve. Be extremely careful to have all battery connections clean, bright, and mechanically tight, and to have no leak or short circuit. The batteries should last a year without further attention, and the glass jars never ought to be filled more than $\frac{3}{4}$ full.

(a) 1 Bell and 1 Press-button.—The simplest system is 1 bell operated by 1 press-button. The arrangement of this is the same whether the line be long or short. Set up the bell in the required place, with the gong down or up as may be chosen; fix press-button where wanted, taking all advantages offered by the plan of the house; e.g. a wall behind which is a closet is an excellent place to attach electrical fixtures, because then it is easy to run all the wires in the closets, and out of sight. Set up the battery in a convenient place, and, if possible, in an air-tight box. Calculate how much wire will be requisite, and measure it off, giving a liberal supply; joints in inside work are very objectionable, and only admissible where absolutely necessary. Cut off insulation

from ends of wire where contact is to be made to a screw. Only 3 wires are necessary, i. e. (1) from 1 spring of the press-button to 1 pole of the battery, say the carbon, (2) from the other spring of the button to 1 binding-screw of the bell, (3) from the other pole of the battery to the other binding-screw of the bell. In stripping wires, leave no ragged threads hanging; they get caught in the binding-screw, and interfere with the connection of the parts. After stripping the wire sufficiently, make the ends not only clean but bright. Never run 2 wires under 1 staple. A button-switch should be placed in the battery-circuit, and close to the battery, so that, to avoid leakage and accidental short circuiting when the bells are not used for some time, it may be opened.

(b) *1 Bell and 2 Press-buttons.*—The next system is an arrangement of 2 press-buttons in different places to ring the same bell. Having fixed the bell and battery, and decided upon the position of the 2 buttons, run the wires as follows:—1 long covered wire is run from 1 pole of the battery to 1 of the springs of the most distant press-button, and where this long wire approaches nearest to the other press-button it is stripped for about 1 in. and scraped clean; another wire, also stripped at its end, is wound carefully around the bared place, and the joint is covered with kerite tape; the other end of the piece of wire thus branched on is carried over and fastened to the spring of the second press-button. This constitutes a battery wire branching to 1 spring of each press-button. Then run a second wire from 1 of the bell binding-screws to the other spring of the most distant press-button, branching it in the same manner as the battery-wire to the other spring of the second button; connect the other pole of the battery to the second binding-screw of the bell, and the arrangement is complete—a continuous battery-circuit through the bell when either of the buttons is pressed. Before covering the joints with tape, it is well to solder them, using rosin as a flux.

(c) *2 Bells and 1 Press-button.*—When it is required to have 2 bells in different places, to ring from 1 press-button at the same time, after erecting the bells, button, and battery, run a wire from the carbon pole of the battery and branch it in the manner described to 1 binding-screw of each bell; run a second wire from the zinc pole of the battery to 1 spring of the button, and a third wire from the other spring, branching it to the remaining binding-screw of both bells. It will not answer to connect 2 or more vibrating bells in circuit one after another, as the 2 circuit-breakers will not work in unison; they must always be branched, i. e. a portion of the main wire must be stripped, and another piece spliced to it, so as to make 2 ends.

(d) There are other methods, one of which is, if more than 1 bell is designed to ring steadily when the button is pressed, to let only 1 of the series be a vibrating bell, and the others single-strokes; these, if properly set up and adjusted, will continuously ring, because they are controlled by the rapid make and break of the 1 vibrator.

(e) *Annunciator system.*—To connect an indicating annunciator of any number of drops with a common bell, to be operated by press-buttons in different parts of a house, is a handy arrangement, as one drop may be operated from the front door, another from the drawing-room, a third from the dining-room, and so on. The annunciator is fastened up with the bell near it. All the electro-magnets in the annunciator are connected by 1 wire with 1 binding-screw of the bell, and the other binding-screw of the bell is connected with the zinc of the battery. It is a good plan to run a wire through the building from top to bottom, at one end connecting it with the carbon pole of the battery. It ought to be covered with a different coloured cotton from any other, so as to be readily identified as the wire from the carbon. Supposing there are 6 press-buttons, 1 in each room, run a wire from 1 of the springs of each of the press-buttons to the main wire from the carbon pole, and at the point of meeting strip the covering from both the main wire and the ends of the branch wires from the press-buttons, and fasten each branch wire to the main wire, virtually bringing the carbon pole of the battery into every press-button. Next, lead a second wire from the other spring of each press-button to the annunciator

screw-post belonging to the special drop desired. This will complete the circuit when any of the press-buttons is pushed; for, as each annunciator magnet is connected on 1 side to its own press-button, and on the other side to the common bell, it follows that when any button is pressed, the line of the current is from the carbon pole of the battery, through the points of the press-button, back to the annunciator, thence through the bell to the zinc pole of the battery; and that, therefore, the right annunciator must drop and the bell must ring. In handsome houses, run the wires under the floor as much as possible, and adopt such colours for wire covering as may be harmonious with the paper and paintings. Also test each wire separately, as soon as the connection is made.

(f) *Double system*.—A system of bells in which the signalling is done both ways, that is, in addition to the annunciator and bell located at one point, to be signalled by pressing the bottom in each room, a bell is likewise placed in each room, or in a certain room, whereon a return signal may be received—transmitted from a press-button near the annunciator. This is a double system, and involves additional wires. One battery may furnish all the current. Run the main carbon through the house, as before, in such a manner as to admit of branch wires being easily attached to it. Run a branch wire from it to the spring of one of the press-buttons, a second wire from the other spring of the same button to the screw-post of the bell in room No. 2, and from the other screw-post of the said bell to the zinc pole of the battery. This completes one circuit. The other is then arranged as follows:—The main carbon, besides being led, as already described, to the spring of the press-button in room No. 1, is continued to one of the binding-screws of the bell in the same room; the other terminal of that bell is carried to one spring of the press-button in room No. 2; the complementary spring of that press-button is then connected by a special and separate wire with the zinc of the battery, and the second circuit is then also completed.

An alternative method is to run branches from the main carbon wire to all the press-buttons, and from the main zinc wire to all the bells, connecting by separate wires the remaining bell terminals with the remaining press-button springs. In the latter plan, more wires are necessary. Although the connections of but one bell either way have been described, every addition must be carried out on the same principle.

When 2 points at some distance from one another, e. g. the house and a stable 100 yd. distant, are to be connected, it is easy to run 1 wire, and use an earth return. If gas or water pipes are in use at both points, no difficulty will be found in accomplishing this. A strap-key will in this case be found advantageous as a substitute for a press-button. The connecting wire at each end is fastened to the stem of the key; the back contact or bridge of the key, against which when at rest the key presses, is connected at each end with one terminal of the bell, the other terminal of each bell being connected by wire with the ground. A sufficient amount of battery is placed at each point, and 1 pole of each battery is connected with the earth, the other pole being attached to the front contact of the strap-key. If impossible to get a ground, the second terminal of both bell and battery at each end must be connected by a return wire.

(g) *Bell and Telephone*.—It is a very easy matter to add telephones to bell-signalling appliances, when constructed as here described. The only additions necessary are a branch or return circuit for the telephones, and a switch operated by hand, whereby the main wire is switched from the bell return wire to the telephone return wire. A very simple plan for a bell-call and telephone line from one room to another, can be made as follows: Apparatus required—2 bells, 2 telephones, 2 3-point switches, 2 strap-keys with back and front contacts, and 1 battery. Run 1 wire from the stem of the key in room No. 1 to the stem of the key in room No. 2. This is the main wire. Fix the bell and 3-point switch below it in each room. Connect the back contact of each key by wire to the lever of the 3-point switch, attach 1 of the points of the switch to 1 of the bell terminals, and the other bell terminal to a return wire. The return wire will now connect the second bell terminal in one room with the second bell in the other room.

The other point of the switch in each room is now connected by a wire with 1 binding-screw of a telephone, and the other telephone screw is attached by another wire to the bell return. Connecting 1 pole of the battery also to the return wire, and the other pole to each of the front contacts of the keys, the system is complete. When at rest, each switch is turned on to the bell. To ring the bell in the other room, the key is pressed. The battery circuit is then from battery, front contact of the pressed key, stem of key, main wire, stem of distant key, switch, bell, and through return wire to the other pole of the battery. After bell signals are interchanged, the 3-point switches are transferred to the telephone joint, and conversation can be maintained. (Lockwood.)

Making an Electric Bell.—The following description applies to 3 sizes—viz. for a 2-in. bell, hereafter called No. 1; 2 $\frac{3}{4}$ -in., or No. 2; 4-in., or No. 3, which sizes are sufficient for most amateurs' purposes, and, if properly made, a No. 3 Leclanché cell will ring the largest 2 through over 100 yd. No. 24 (B. W. G.) wire.

The Backboard and Cover.—This may be of any hard wood, by preference teak, oak, or mahogany, and if polished, so much the better; the size required will be—

No. 1, 5 $\frac{1}{2}$ in. long, 3 $\frac{3}{4}$ in. wide, $\frac{1}{2}$ in. thick.

No. 2, 7 in. „ 3 $\frac{3}{4}$ in. „ $\frac{3}{4}$ in. „

No. 3, 8 $\frac{1}{2}$ in. „ 5 in. „ $\frac{3}{4}$ in. „

The cover must be deep enough to cover all the work, and reach to within about $\frac{1}{4}$ in. of the top and sides of back, and allow $\frac{3}{8}$ in. to $\frac{1}{2}$ in. between the edge of bell and cover; the making of this had better be deferred until the bell is nearly complete.

The Electro-Magnet.—This should be of good round iron, and bent into a horse-shoe shape (Fig. 1380). The part *ab* must be quite straight, and not damaged by the forging; the bend should be as flat as possible, so as to make the magnet as short as may be (to save space). When made, the magnet is put into a clear fire, and when red hot, taken out and laid in the ashes to slowly cool; care must be taken not to burn it. Lastly, 2 small holes are drilled in the centre of the ends at *c*, about $\frac{1}{16}$ in. deep;

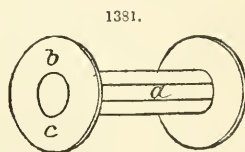
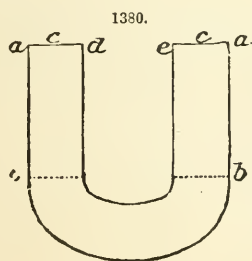

drive a piece of brass wire tightly into the holes, and allow the wire to project sufficiently to allow a piece of thin paper between the iron and the table when the iron is standing upon it; this is to prevent the armature adhering to the magnet from residuary magnetism, which always exists more or less. The measurements are—

No. 1 size iron $\frac{1}{4}$ in., *d* to *e* $\frac{5}{16}$ in., *a* to *b* 1 $\frac{1}{4}$ in.

No. 2 „ $\frac{5}{16}$ in., „ $\frac{3}{4}$ in., „ 1 $\frac{3}{8}$ in.

No. 3 „ $\frac{7}{16}$ in., „ $\frac{3}{4}$ in., „ 1 $\frac{1}{2}$ in.

The Bobbins or Coils.—These are made by bending thin sheet copper round the part *ab* of the magnet; the edges at *a* (Fig. 1381) must not quite meet. The thickness of this copper must be such that 4 pieces just equal in thickness the edge of a new

threepenny-piece (this is rather an original gauge, but then all can get at the thickness this way). The hole in the brass end *b* must be just large enough to push on firmly over the copper when on the iron; they must then be set true, and soldered on. The brass for the ends may be about as thick as a sixpence; a $\frac{1}{16}$ -in. hole must be drilled at *c*, close to the copper. The other measurements are as follows:—

No. 1, diameter	$\frac{3}{8}$ in.,	length over all	$1\frac{1}{8}$ in.
No. 2, „	$\frac{3}{4}$ in.,	„	$1\frac{1}{4}$ in.
No. 3, „	1 in.,	„	$1\frac{3}{8}$ in.

The brass ends should be neatly turned true and lacquered.

To fill the Bobbins with Wire.—For this purpose, No. 28 wire should be used, which is better if varnished or paraffined. The bobbins should be neatly covered with paper over the copper tube and inside of ends, to prevent any possibility of the wire touching the bobbin itself; the bobbin is best filled by chucking it on a mandrel in the lathe, or a primitive winding apparatus may be made by boring a hole through the sides of a small box, fit a wire crank and wooden axle to this, and push the bobbin on the projecting end—thus (Fig. 1382): *a*, crank; *b*, box; *c*, bobbin; *d*, axle. The box may be loaded to keep it steady; on any account do not attempt to wind the wire on by hand—the bobbin must revolve. Leave about $1\frac{1}{2}$ in. of wire projecting outside the hole *d*, in end of bobbin, and wind the wire on carefully and quite evenly, the number of layers being respectively 6, 8, and 10; the last layer must finish at the same end as the first began, and is best fastened off by a silk or thread binding, leaving about a 3-in. piece projecting. Both bobbins must be wound in the same direction, turning the crank from you, and commencing at the end nearest the box. The bobbins must now be firmly pushed on the part *a b* of the magnet, and the two pieces of wire projecting through the hole *c* soldered together.

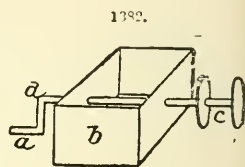

To put the Bell together.—First screw on the bell. This should be supported underneath by a piece of $\frac{1}{4}$ -in. iron tube, long enough to keep the edge of the bell $\frac{3}{8}$ to $\frac{5}{8}$ in. above the backboard. Cut off the hammer-rod, so that when the head is on it will come nearly as low as the bell screw, and in a line with it. Make a hole in the backboard, and drive the armature post in tightly—it must be driven in so far that when the magnet is laid upon the backboard, the centre of the magnet iron and the armature are the same height. Place the magnet so that when the armature is pressed against it, the hammer-head all but touches the bell; screw it into its place by a wooden bridge across the screw passing between the bobbins. By afterwards easing this screw, any little adjustment can be made. The armature spring should tend to throw the hammer-head about $\frac{5}{8}$ in. from the bell. The contact-post should be so placed that when the armature touches the magnet, there is a slight space between the platinum point on the screw and the platinum on the spring. In putting in the posts, a piece of copper wire must be driven in with them to attach the wire to. One post can be moved round a little either way to alter the tension of the spring; the screw in the other post can be turned in or out, to just allow the proper break to take place. By screwing it in and out, the ear will soon judge where the bell rings best. (Volk.)

Those desiring further information on batteries, telephones, and all electrical matters, are referred to the Third Series of 'Workshop Receipts,' where diffuse instructions are given.

GAS-FITTING.—This is an eminently simple operation, capable of being performed by any one who has had any practice in soldering joints (see p. 114). It consists merely in making connections between a series of iron and "compo" pipes and

the "burners," as well as fixing the latter. The ordinary arrangement of the gas supply of a house is as follows. An inlet pipe of iron brings the gas from the street main to the meter. This latter belongs to the Gas Company, and is of a size to supply a certain number of burners. It is placed in an out-of-the-way situation, generally a cellar, as near the street as may be. From it an iron pipe passes up to the level of the first floor requiring a supply of gas; here branch pipes are led off to the various rooms, while the principal pipe is continued upwards through the other stories as far as desired.

The mode of procedure is first to fix the burner in place, and then to lead a pipe from it to the nearest point on the supply pipe, and there to make a joint. Burners may be broadly classed in two divisions, brackets and pendants; the former are placed against a wall, the latter hang from a ceiling. In choosing a situation for a bracket, care must be taken that it does not reach any movable article of an inflammable nature, e.g. curtains, cupboard-doors, &c.; in the case of a pendant, the chief care will be to let it be out of the way of persons occupying the room: of course there is a great variety in both brackets and pendants, but this has no influence on the mode of fixing, except in the case of the chandelier with universal joint.

Commencing with a bracket, as being simplest, a spot on a wall having been chosen for its site, the first step is to prepare the wall for its reception. The pipe to supply the bracket should be carried as directly and as secretly as possible to the main supply, which may be in the ceiling above the room or in the floor beneath it, or in the wall of an adjoining room or passage. Secrecy is secured by chiselling out a small recess in the brick wall sufficient to admit the pipe, carrying it behind skirting-boards, or in angles where it can be papered over, and in other ways that suggest themselves according to the circumstances of the case. Everything being ready for laying the new pipe, one end of it is "blown on" (see Soldering, p. 114) to an "elbow nose-piece" or piece of $\frac{3}{8}$ -in. brass tube, bent at right angles, tinned ready for soldering at one end and having a screw-thread on the other, as shown in Fig. 1383, *a* being the elbow nose-piece and *b* the blown joint.

Whilst the pipe is held securely in place, the mahogany block *c* is slipped over the nose-piece and nailed, screwed, or plugged to the wall *f*, leaving the thread end of the nose-piece projecting. Having well luted the thread with white-lead, proceed to screw on the bracket *d* till its flange *e* is tight against the mahogany block, when it is fastened there

by 3 screws. Be very careful that the joint between the bracket and the nose-piece is a good sound one. The burner being fixed, it only remains to lead the pipe away to the main supply, and "blow" it on by means of a union suited to the case.

In hanging a pendant, the supply pipe is brought between the joists of the ceiling of the room, as in Fig. 1384, where *a* are the joists; *b*, the floor of the room above; *c*, the ceiling; *d*, a piece of board nailed to the joists *a* for supporting the mahogany block *e*;

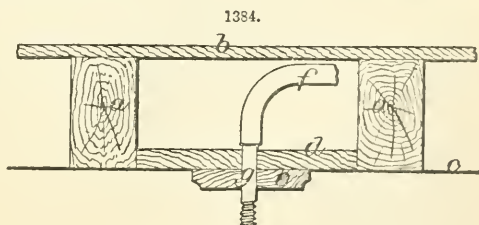
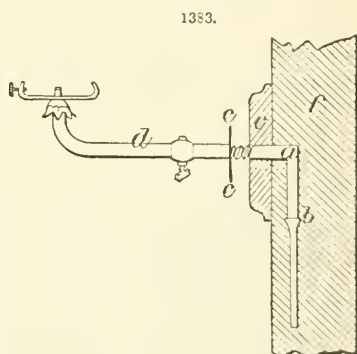

f, the supply pipe; *g*, a straight nose-piece carrying a thread on which the pendant is screwed as before. The pendant may either be a stationary one incapable of being moved in any direction, or one having a swing joint to permit its being hitched up out of the way flat against the ceiling. Care must be taken during the fixing of the pendant that it does not rest its unsupported weight on the nose-piece *g*, or there is danger of straining the blown joint between *f* and *g*.

Chandeliers being much heavier are attached to iron pipe instead of the weak copper tubing used in other cases, and this iron pipe is allowed to rest across 2 joists, in notches cut for the purpose. A short section of iron pipe, attached to the supply by a T-piece, comes sufficiently far through the ceiling for the cup and ball of the chandelier to screw on to it.

Plugs for stopping the ends of pipes, bends, T-pieces, equal sockets, elbow sockets, diminished sockets for joining pipes of unequal sizes, can easily be procured of standard dimensions. The only tools required are the gas tongs shown in Fig. 1385 for screwing

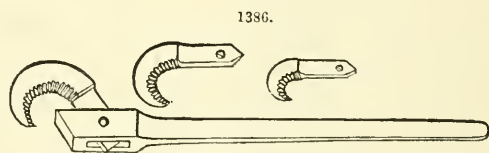
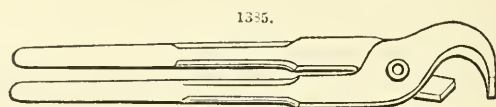

the joints tight. Iron piping required should be bought ready cut to length and with the necessary threads cut on the ends, unless the operator is possessed of a set of thread cutting tools, as described on p. 60. Patent gas tongs are shown in Fig. 1386.

PAPERHANGING.—Wall papers may be divided into 3 classes:—(1) “Common” or “pulp” papers, in which the ground is the natural colour of the paper as first made, the pattern being printed upon it. (2) “Satin” papers, of which either the whole ground, or the pattern, or both, are of a polished lustre, having somewhat the appearance of satin. They are made by painting the paper over with the required colour, mixed with Spanish white, &c., after which it is polished with a burnisher. Or the colour is mixed with plaster of Paris, laid on, sprinkled with powdered French chalk, and then rubbed over with a hard brush to give the appearance of satin. Satin papers are very susceptible to damp, even from the paste used in hanging them; they require to be hung with care, on dry walls, and should be protected by a lining paper. When once hung, if thoroughly dry, they can be kept clean for a long time, as the smooth surface of the paper prevents dust and dirt from adhering to it. (3) Flock papers, the design on which is formed by the adhesion of flock sheared off from the surface of woollen cloth. The pattern is first printed on the paper in size, next in varnish, the flock is then thickly sprinkled on, and adheres to the varnish, thus forming the pattern.

The pattern on the best papers is printed from wooden blocks. The position of each block is guided by 4 pins in its corners, and a separate block is required for each colour. Wall papers are printed also in large quantities, and very cheaply, by machinery, the patterns being engraved on metallic rollers, one for each colour required, and printed on continuous bands of paper several 100 yd. long. Machine-printed papers are inferior to those printed by hand; the colours of the former often wear off from not being properly

set. Some of the common grained, marbled, and granite papers are roughly coloured by hand, and elaborate papers of the highest class are painted by artists.

“Pulp” papers can easily be recognized, as the back is of the same colour as the ground of the front. Hand-printed papers can be distinguished from machine-printed, as the former retain the marks of the pins used as guides for the position of the wood blocks.

Wall papers are sold by the “piece,” except in the case of borders, which are sold by the yd., or 12 yd. run. The prices vary according to the description and quality of the paper, and the nature of the pattern, extra being charged for every additional colour. The introduction of gold or silver in the pattern also enhances the price considerably, in proportion to the amount used. Down each side of the paper is a blank margin about $\frac{1}{2}$ in. wide. In hanging good papers, both these margins are cut off, and the adjacent pieces are placed edge to edge. In common papers, however, only one margin is cut off, and the cut edge of one piece of paper overlaps the margin of the next. In English papers, each “piece” is 12 yd. long and 21 in. wide; it therefore contains 7 sq. yd. After the margins are removed, the paper is 20 in. wide. Each yard in length of the paper then contains 36×20 in. = 5 ft. super., and each piece $12 \times 5 = 60$ ft. super. The number of pieces of paper required for a room is therefore equal to the number of super. ft. to be covered divided by 60. An allowance of $\frac{1}{8} - \frac{1}{10}$ must be made for waste: more for good papers and large patterns than for common papers and small patterns. French papers are made in “pieces” containing $4\frac{1}{2}$ sq. yd. The length and breadth of a piece vary considerably, according to quality, but they often run about 9 yd. long and 18 in. wide. Borders are sold in pieces containing 12 yd., technically known as “dozens.” Lining paper is common uncoloured paper placed under the better classes of paper, in order to protect them against damp and stains from the wall below, and to obtain a smoother surface to work upon.

The colouring pigments used for wall papers are as a rule harmless; some of the white grounds contain, however, a proportion of white-lead, and in some red papers arsenic is used to fix the dye. Papers containing green are as a rule very objectionable, because they are often coloured with pigments containing arsenic, mercury, copper, copper arsenite (Schcele's green), and other deleterious substances. These fly off in the form of dust, and may poison the occupants of the room in which the paper is hung.

Damp walls should be covered with a thin sheet of some waterproof material before the wall paper is hung. Thin sheet lead, tinfoil, indiarubber, guttapercha, and thick brown paper have all been used for this purpose, the metals being the best but most expensive. The foil is made so thin that it may be fastened to the wall with paste.

For hanging paper on damp walls the Germans coat a lining paper on one side with a solution of shellac spirit, of somewhat greater consistency than the ordinary “French polish,” and then hang it with the side thus treated to the damp wall. The paper-hanging is then performed in the usual manner with paste. Any other resin that is equally soluble in spirits may be used in place of the shellac.

Wall papers (except the most delicate) may be finished with good copal varnish over 2 coats of size, or they may be bought ready varnished. Flock papers may be painted (after well sizing) when they become shabby. In some cases they have a roller covered with wet paint passed over them, so that the raised pattern only receives the paint. Washable paperhangings, made by Wilkinson and Son, of London, are said to become as hard as stone when hung, to withstand washing, and to be non-absorbent of the contagion of infectious disorders. Such papers would of course be better than those of the ordinary description for a sick-room. The walls of hospital wards, however, are generally rendered in cement, and brought to a highly polished non-absorbent surface, thus avoiding the use of paper altogether.

Wall papers are intended chiefly for ornament; they relieve the bareness of the walls, and give the room a bright cheerful appearance. A plain white paper may some-

times be applied with advantage to ceilings, especially where, from want of stiffness in the floor above, or from some defect in the plastering, the ceiling is inclined to crack.

With regard to the choice of paper, Edis has lately offered some well-considered remarks. The sizes of rooms should first be thought of, for papers with large patterns and wide dados are not generally adapted for small rooms, and *vice versâ*, insignificant designs do not suit spacious rooms. In the first instance, a cramped effect is obtained where there should be freedom and expanse, and in the second a feeling of vacuity is produced, and the intention of the design is lost, owing to the vast extent of wall exposed to view. A good deal also depends on the design. No strongly marked patterns should be accepted—such as birds seemingly in flight, or cherubs holding festoons, frozen into rest, or bunches of flowers fossilized into unnatural forms, so as to present longways and crossways, or any way they are looked at, clearly marked lines or spots on the general surface, at all times fatiguing to the eye, and tending to discomfort and mental annoyance. In the main, broad, free designs suit nearly all classes of rooms, and plant-life offers most opportunities for producing pleasing and elegant figures embodying these qualifications, which possess the advantages of a simplicity and purity of form that never wearies or grows tame and conventional. Moreover, with careful treatment, and an observance of natural conformation, floral designs may be rendered far more consonant to nature and adapted to harmonize more thoroughly with surroundings than birds or figure subjects. Squares or circles at regular distances, or conglomerations of mathematical or architectural figures are to be avoided, for they invest a room with a solidity and formality that can only be wearisome, and the sameness of pattern, which is rendered doubly apparent by the methodical arrangement of lines, angles, and circles, tends to tire both the eye and brain.

As to colour, drawing-rooms are usually furnished with lighter tinted paper than morning rooms. It is not advisable, however, to select a monochromatic paper, for although when first put up it may present a very clean and light appearance, yet the absence of variety, more especially in dull weather, invests it, after a time, with cold and commonplace appearance. A paper should be selected, therefore, that appears to contain to the most advantage pleasing diversity of colour without gorgeousness, and easy and natural outlines without formality. Papers with considerable gold in them are suitable for drawing-rooms, because gold is in itself warm and at the same time light. Cheap gold papers unfortunately soon lose their gloss and look dull, but generally speaking, gold, if used sparingly and discreetly, forms a rich addition, and combines agreeably with ordinary tints.

The dado is an indispensable addition to a modern room, and should be of a slightly darker colour than the wall paper; this arrangement serves to show the paper to greater advantage than if the whole were of the same tint. The top of the dado is usually finished off with a narrow strip of printed paper, and though this is apparently of minor importance, it will if properly treated form a pleasing bond or connecting link between the dado and paper. The frieze is also an important item, and this Edis suggests should be treated in good decorative subjects of figures, birds, or natural flowers: but papers modelled on the latter are, as already pointed out, the simplest if not the best suited for ordinary decorative purposes, where agreeable effects are sought without any great expenditure of money or artistic skill. A frieze may also be formed of thick flock paper, stamped leather, or raised plaster-work slightly tinted or gilded. This destroys the deadness of the wall, and conceals the junction of the paper with the ceiling.

As regards the dining-rooms, and other rooms of a similar nature, it is advisable that the paper selected be of a dark, warm hue, not necessarily elaborate, but simple and appropriate. Here the dado may be finished at top with a small oak or deal moulding, in lieu of the narrow paper band before mentioned; this prevents the walls being broken by chairs or other furniture pushed against them. In choosing colours it should be remembered that gaslight completely changes the effects of some tints, such

as blue, green, and yellow, and the 2 former also, in a measure, absorb light, and thus, unless employed with discretion, render a room somewhat darker than other colours. The so-called æsthetic "washed out" colours rarely suit the surroundings of ordinary life. Respecting bedroom papers, much might be written in condemnation of the hideous and artificial productions that pass by this name, and it is really surprising, considering how essential to health and comfort a light and cheerful sleeping apartment is, bedroom wall papers have not suffered greater improvements in accordance with the requirements of the age.

The papering of halls, staircases, and passages are points that require very careful deliberation if we wish to render them something more than long vaults walled in with blocks of imitation marble. As a rule we find varnished marble paper selected for these places, and the plea for its adoption usually hinges on the supposition that it renders passages "light," and possesses the property of being clean. Now it does not require much deep thought to arrive at the fact that there are 50 papers at least in existence that will bear varnishing, prove equally "light," and yet be more appropriate to every-day life and every-day surroundings.

The entrance hall should present a comfortable appearance, and a dark, rich paper with Indian matting dado is very suitable for covering the walls. Light coloured papers are not adapted for this purpose, as they show the smallest particle of dirt or the faintest trace of a fingermark with alarming distinctness. And *apropos* of this point, it may not be out of place to suggest that hanging a few etchings, drawings, or paintings on the walls of landings, stairways, and halls will prove a simple and effective way of introducing a little "portable" decoration in places where the eye usually finds merely an infinite deal of nothingness.

Respecting wall coverings for kitchens and similar apartments, plain, washed walls are undoubtedly cleaner than any papers, but if the latter are to be employed, a plain, white tile paper is perhaps most in keeping with the fittings and furniture. If varnished, such papers may be easily washed, and thus rendered always clean and fresh.

Expensive papers require to be hung with the most skill and care. At the same time, common papers are more difficult to hang well, as they are very apt to tear with their own weight when saturated with paste. In hanging flock or other thick papers, the paste should be applied some time before they are hung, in order that it may soak well into them. The ceilings should be finished before the paperhanging begins.

Before commencing to paper a wall, it is essential to see that the plaster is in a perfect condition and free from holes; if not, these must be made good and allowed to dry. If the wall is being repapered, the old paper must first be stripped off thoroughly and all hidden defects remedied. The stripping is accomplished by well wetting the paper with a whitewash brush dipped into hot water. When soft enough, it is pulled away from the wall in a careful manner by the aid of a broad so-called chisel knife, or any smooth and square edged substitute, repeating the operation on obstinate spots. It is best to burn at once the paper scraped off, especially when there has been illness in the room.

The walls being in a fit condition to receive the paper, a point is chosen at which the hanging shall begin, and, if necessary, a perpendicular line to work by is drawn in pencil by the aid of a plumb-level. A line in the pattern is decided on for the top margin, where it meets the ceiling or frieze, and this must be carefully adhered to all round the room. In unrolling a piece of wall-paper, it will be found that it commences at the top of the pattern; consequently, as the papering should proceed towards the right, commencing at the left corner of the room farthest from the window, the right blank margin will be the one to cut off, and this can be conveniently done as the unrolling progresses. Bearing in mind the top margin, strips are next cut off, of the required length, in succession, always allowing a small margin in excess to be cut off at the bottom. Each strip is pasted by laying it face downwards on a long smooth table

(3 yd. long if obtainable) at least a few in. wider than the paper. The paste is made by mixing old flour with lukewarm water to a smooth consistence, then stirring and pouring in boiling water till the paste is complete; to this may be added, while hot, a solution of alum, at the rate of 1 oz. alum in 1 pint water, say $\frac{1}{2}$ pint of the solution to the pail of paste, or $\frac{1}{2}$ oz. dissolved mercury bichloride if vermin abound.

The paste is allowed to cool, and is applied in a thin even coat by a small whitewash brush, avoiding splashes and careless strokes. Some care is needed in lifting the pasted strip from the table to the wall, as it is rendered rotten by the moisture. There are 2 ways of folding the paper to facilitate its transport, as follows:—(1) Double back about 2 ft. of the lower end of the pasted paper and form a loop of it; then fold about 1 ft. of the top back on the unpasted side, so as to form a loop for the hands; lift the paper by this loop, attach it to the wall a little high but square in place, adjust the top edge accurately and pull off the first patch which adhered, letting it fall smoothly back into place; press it sufficiently to hold, and then proceed to unloop the bottom fold, and allow it to fall into place. Finally, from the top, gently press down the centre of the piece with a soft clean duster, and from the central line perform the same operation sideways, till the whole has been gone over. (2) This plan is better when the strip is very long, and is shown in Fig. 1387, which almost explains itself: 18 in. at the bottom is folded paste to paste; a treble fold the same depth is made at the top, leaving enough for the hands to hold by, the thumbs being put under *a* and the fingers under *b*. The same mode of procedure is followed, always avoiding anything like rubbing the paper, but rather patting it flat. Excess of paste should be wiped off immediately from the edges with a damp rag, renewed as soon as it gets dirty, and the top and bottom margins are pressed in close with the scissors, and cut off to pattern while damp. Soft brushes and padded rollers sometimes replace the simple clean duster for patting close. The scissors should have very long blades.

LIGHTING.—The lighting of a dwelling is a most important consideration, as regards comfort and health. Natural lighting is provided for by windows, the construction of which has been described under Carpentry (pp. 348-50) and Glazing (pp. 627-34). The window area of a room should be well proportioned. In dwelling rooms it may amount to half the area of the external wall containing the windows; in churches, &c., $\frac{1}{3}$ will suffice. Artificial lighting may be effected by means of candles, oil-lamps, gas, or electricity. Candles will always retain a place in domestic illumination from their safety and convenience; they need no description. Oil-lamps cannot be passed over without a few lines concerning their principles and management, though their necessarily dangerous character and generally unpleasant odour are great drawbacks to their adoption in the house. Gas-fitting has been described in a previous section (pp. 640-2), but mainly from the mechanic's point of view; something remains to be said, about burners and the employment of gas. Electric lighting, which will one day be almost universal, is as yet unsuited to domestic application, except under unusual conditions, and requires many precautions to

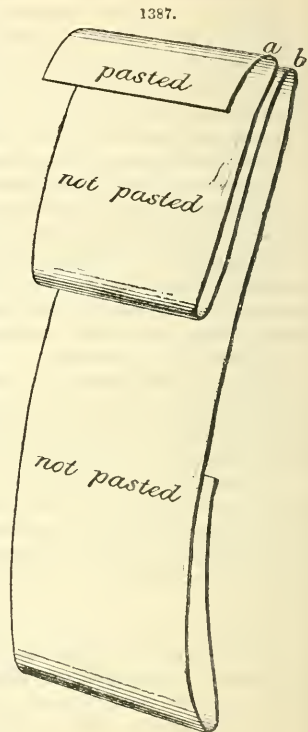

prevent fires and serious accidents. The aid of a skilled electrician is necessary in fitting up an electric lighting system, or mischief is sure to arise.

Oil-lamps.—The first lamp worthy of notice is that introduced by Argand; it consisted of an annular tube, on which the wick was stretched; of a reservoir containing the oil; of a pipe leading from the reservoir to the wick; and of a holder for the glass, which imparted, on turning, a spiral motion to the wick and thereby adjusted the flame. The reservoir was of the kind known as the "bird fountain," whereby a bubble of air entering the small orifice at the base allows the egress of a small quantity of oil. This principle has since been applied to a very numerous class of lamps, especially those known as "reading lamps," where the reservoir is higher than the wick. Argand's lamp was suitable for both colza and sperm oils. As the shape was ungainly, many expedients were devised whereby the flame could be fed from a reservoir below. Carcel, in 1798, brought out a lamp which was almost universally used for many years in France. The principle of this was pumping, by 2 little clockwork pumps, a supply of combustible to the wick. The only objection to this is the constant need of repair to which the delicate mechanism is liable. The supply, when in good order, however, was so extremely steady as to cause this lamp to be taken on the Continent as a standard of illumination. The problem of securing an unvarying supply of oil without such complicated mechanism was one which taxed the ingenuity of many makers. A very favourite means was that of hydrostatic power, whereby a heavier liquid solution was made to raise the lighter oil equably, as it consumed.

Keir, in 1787, made a very ingenious lamp, consisting of 2 cylinders, the smaller floating in the larger. The wick was attached to the apex of the interior cylinder which contained the oil, and was open at the base, the exterior being filled with salt water. As the oil diminished, the salt water rose in the interior, and sank in the exterior reservoir, while the height of the interior cylinder was adjusted by means of a wooden float. Porter, in 1804, invented a lamp which deserves mention, and which consisted of a rectangular box, balanced eccentrically, so that the position—horizontal at the commencement—during burning, gradually approached the vertical. A larger amount of oil being removed from the posterior, caused this to lose weight more rapidly than the anterior, the oil in which was thereby maintained at a level. The name of Smethurst is closely associated with lamps. He was the first to give a slope to the chimney, which Argand had left straight, thus directing the air-current more accurately, and thereby increasing the draught and the brilliancy of the flame. The next invention of importance took place in 1836, when Fanchot invented the moderator lamp as at present used. This had already been foreshadowed in the inventions of Stokes (1787), Allcock (1807), and Fayre (1825), all of whom used pistons which forced the oil up under pressure. Fanchot gave the lamp its present form, which is, briefly, as follows:—The piston fits tightly in the reservoir, being provided with a leather collar, which admits of being raised with ease while the reservoir is full, but the descent is impeded by the collar being pressed against the sides by the liquid. There is, therefore, no outlet for the oil but by a fine tube passing through the piston up to the wick, which is, by this means, fed by a constant stream of oil, the surplus dropping down into the reservoir above the piston. When the piston has fully descended, it is re-elevated by a cog and ratchet apparatus. The flow of liquid up the tube is regulated by a fine piece of wire, which partly closes the same and helps to cleanse it. By these means, very heavy oils can be burnt, and perhaps no lamp has enjoyed greater popularity than this. Its defects are the constant need of winding up, and liability of the fine tube to become clogged. Young's "Vesta" lamp, first used in 1834, burnt "camphine," or turpentine, with a very brilliant snow-white flame. The "Diacon" lamp was a modification of the moderator, invented and used in America.

The wick has been the subject of numerous modifications. As early as 1773, we find one Leger producing a flat-ribbon wick. Though a great improvement on that of the

older cord wick, the flame was too thin, being blown out with every puff of air. Argand introduced the circular wick, which has maintained its form. A great step was made when the flat wick was forced, as in modern lamps, to adjust itself exactly to an annular tube, thus obviating the necessity of pushing the tube into an ill-fitting wick. In 1865, Hincks, of Birmingham, brought out a lamp with two parallel flat flames, called the Duplex, which gives a remarkably good light, and has a world-wide reputation. To the same firm are due ingenious devices for extinguishing and re-lighting the flame without moving the shade, by merely pressing a trigger.

An entirely different variety is Holliday's vapour burner lamp, of which many thousands are to be seen burning on costermongers' stalls in East and South London. The conical reservoir at the top is filled with light hydrocarbon oil, passing through a tap and tube into a burner of peculiar construction, and being ignited by holding in a flame for a few seconds, will continue to burn without wick furiously and safely as long as the supply is properly regulated. This may be said to be the first lamp which burnt hydrocarbon oils, and no doubt for an open-air flame no better can be, or at any rate has been, devised. Invention has been very active to devise means of burning hydrocarbon oils with safety in household lamps. In 1866, Leichenstadt invented a lamp for burning a mixture of benzole and camphor, but the dangerous nature of benzole rendered this form undesirable. Aaronson, in 1875, by a clever combination of oil and water, constructed a lamp to be extinguished directly it was overturned, or even deflected from the vertical. This masterpiece could also be trimmed, filled, and lighted without moving the shade and chimney. Young and Silber are 2 names most prominent in the lamp problem. James Young, as the discoverer and first manufacturer of paraffin oil from shale, was naturally the appropriate inventor of means for its safe combustion, and Young's Company now still supply "Vesta" lamps for burning their own productions.

All the inventions thus briefly epitomized, have one or other of the following objects in view:—To supply oil regularly to the wick; to apportion the supply of air to the description and quantity of oil to be burnt; to provide simple means for regulating the height of the wick, and consequently, the flame; and finally, to place the burning portion of the lamp in such a position as not to be obscured by the reservoir and other portions. The oldest lamps, as the antique Etruscan, and the cruise of Scotland, were on the suction principle, and the wick depended for its supply upon its own capillary action. As the level of the oil was constantly varying, so the light varied also, and the first attempts of inventors were directed to maintaining an equal level of oil. The bird-fountain and hydrostatic reservoirs partly attained this end, and the Carcel and Moderator systems were perfect of their class, mechanical or pressure lamps. It is evident that suction lamps depend for their efficacy upon the gravity of the combustible. A spirit lamp, with a good wick, will burn very well, though the wick be several inches above the liquid. With liquids volatilizing at low temperatures, there is always a danger of the formation of explosive mixtures.

In 1834, Beale patented a lamp for burning mineral and wood naphthas, and oils from the distillation of coal tar, vegetable tar, and the like; the principle being the vaporization by means of a small secondary flame, from a separate source, which soon burns out, having started the vaporization. This lamp had no wick; the supply of fluid was regulated by forced air.

Parker's lamp, patented 1840, should also be mentioned, as the most successful attempt at heating the oil before combustion. Here the upper part of the chimney was made of copper, and passed through the reservoir filled with a heavy luminant (preferably coconut oil or tallow). The air being expended, the oil fed the wick by its own expansion, regulated by an ingenious mechanism. This was a so-called "sinubral" lamp, and appears to have been held, by some, superior even to Carcel's as a standard for photometry.

The supply of oil to the wick in all pressure lamps was in excess of the demand, and

the surplus fell back into the reservoir. This can only be feasible in the case of heavy oils, especially animal and vegetable. The Russians boast of having constructed a lamp to solve the problem of burning their own heavy hydrocarbon oils, of which Baku produces so vast a quantity; but as the demerits of such oils, especially the clogging of the wick, cannot be ascertained in the few hours their committee appear to have spent upon the investigation, we must defer our meed of applause. The light hydrocarbons, such as petroleum, photogen, solar oil, and their polynomial varieties, must reach the arena of combustion in as small quantities, and at as high a temperature as possible, while the supply of air, both from inside and out, can scarcely be too abundant.

At first sight, the burner of the Silber lamp appears to be a simple aggregation of concentric tubes—and this, in fact, it is. The use of these, especially of the innermost, bell-mouthed pipes, becomes very apparent in the lighted lamp. Remove the interior tube, and immediately the flame lengthens and darkens, wavers and smokes. The current of air which is, by this internal conduit, directed into the interior flame surface, is the essential principle of Silber's invention. The wick is contained in a metal case, surrounded by an air-jacket, which passes down the entire length of the lamp, leaving a small aperture at the base, through which the oil flows from the outer reservoir to the wick chamber. Thus, by the interposition of an atmospheric medium, the bulk of the oil is maintained throughout at a low temperature; 2 concentric bell-mouthed tubes pass down the interior of the wick case, and communicate with the air at the base of the lamp, which is perforated for the purpose; 2 cones, perforated, the inner and smaller throughout, the largest only at the base, surround the wick, and heat the air in its passage through the holes to the flame. The effect of these appliances is, firstly, by the insulation of the outer reservoir, to avoid all danger of vaporization of the oil, till actually in contact with the wick. As it is drawn nearer and nearer the seat of combustion, the hot metal wick-holder heats, and ultimately vaporizes the luminant, so that at the opening of the wick tube concentrically with the air conduits—all of which are exceedingly hot—a perfect mixture of vapour and hot air is formed, and burned. An all-important feature is the shape and position of the chimney, which influences the flame to the extent of quadrupling its brilliancy if properly adjusted.

The preceding remarks have been condensed from Field's Cantor Lecture on Illuminating Agents, read before the Society of Arts.

Gas.—Coal gas, being much lighter than air, flows with greatest velocity in the upper floors of houses; hence the supply pipe may diminish in size as it rises, say from $1\frac{1}{4}$ in. at the basement to $\frac{3}{8}$ in. on the 3rd floor. At a point near the commencement of the supply pipe it should be provided with a "siphon," which is simply a short length of pipe joined at right angles in a perpendicular position and closed at the lower end by a plug screwed in. As all gas-tubes should be fixed with a small rise, this siphon will collect the condensed liquids, which may be drawn off occasionally by unscrewing the plug end. When the lights flicker, it shows there is water in the pipes: the siphon prevents this.

The number of gas burners requisite for lighting a church or other large building may be computed thus. Take the area of the floor and divide this by 40, will give the number of fish-tail burners to be distributed according to circumstances. Example: a church 120 ft. long by 60 ft. wide, contains 7200 ft. area; divided by 40, gives 180 burners required for the same.

Burning gas without a ventilator or pipe to carry off the effluvia, is as barbarous as making a fire in a room without a chimney to carry off the smoke. If a pipe of 2 in. diameter were fixed between the joists, with a funnel elbow over the gaselier, and the other end carried into the chimney, it would be a general ventilator. Of course, an open ornamental rosette covers the mouth of the tube; or an Arnott valve ventilator over the mantelpiece would answer the same purpose.

In turning off the gas-lights at night, it is usual, first, to turn off all the lights,

except one, and then turn off the meter main cock, and allow the one light to burn itself out, and then turn it off. The evil of this system is this,—by allowing the one light to burn itself out, you exhaust the pipes and make a vacuum, and of course the atmospheric air will rush in. The proper way is to turn off all lights first, and finally the meter, thus leaving the pipes full of gas and ready for re-lighting.

These few remarks have been derived from Eldridge's 'Gas-Fitter's Guide,' an eminently useful and practical handbook.

It was formerly the practice to make all gas burners of metal; the openings, whether slits or holes, from which the gas issued to be burned being small, in order to check the rate of flow. This was an error, for heat and light go together, and the metal, being a good conductor of heat, kept the lower part of the flame cold. The part of burners actually in contact with the flame is now invariably of some non-conducting material, such as steatite; and the effect of this simple improvement is most noteworthy. Bad burners show a great proportion of blue at the lower part of the flame, and the upper or luminous portion is small and irregular in shape, and dull in colour. These effects are due to gas issuing at too great velocity from small holes in burners, as well as to improper material in the latter. The illuminating power of coal gas depends upon the incandescence, at the greatest possible heat, of infinitesimal particles of carbon which it contains, invisible until heated. In the lower, or blue portion of the flame, the heat is not sufficient to render these particles incandescent; and it is necessary that this effect should be secured at the nearest point to the burner. Unless this is done, the light is not only lessened, but the unconsumed carbon passes off and is deposited as soot on ceilings and furniture. Blackened ceilings are a measure of the badness of the burners. It will now be seen why a material which cools the flame should not be used for a burner, for the hotter the flame, the more perfect is the incandescence of the carbon for which in reality the consumer pays, and the less danger there is of blackened ceilings. But in addition to the better material, the construction of even the cheapest modern burners is very greatly improved; although even a good burner may be subjected to such conditions—e. g. allowing gas to be driven through it at a high velocity, a condition usually accompanied by a hissing or roaring sound—as to give a bad result. The capacity of burners should moreover bear a reasonable proportion to the quality of the gas for which they are required to be used. Thus with rich Scotch gas, burners with very small holes, consuming only about $1\frac{1}{2}$ cub. ft. hourly, are sometimes adopted for economical reasons. Occasionally these burners find their way South, but their use for the ordinary qualities of English gas is the worst possible economy. It is difficult to lay down hard and fast rules for the sizes of burners, the purposes for which gaslight is required being so various. For an ordinary apartment, however, wherein distributed lights are adopted, 5-ft. burners with 14 or 15 candle gas, 4-ft. burners with 16 or 17 candle gas, 3 or $3\frac{1}{2}$ ft. burners with 18 or 20 candle gas, and $2\frac{1}{2}$ -ft. burners with richer gas will be found to give satisfactory results. It may be remarked that these figures apply to burners regulated in some way to the given rates of consumption, and not to those merely reputed to be of the stated sizes. Various means are adopted for checking the flow of gas, not at the point of ignition, but at some prior point of its course; because it has been found that the slower the rate of flow at the commencement of combustion, the better the result obtained.

Clustering of gas lights is bad. All parts of a room should be as nearly as possible equally lighted, the only noteworthy exception to this rule being in the case of a dining-room, where concentration of light upon the table is not only permissible but is even demanded. Hence in most cases wall brackets give the best effect, and such masses of light as are afforded by pendants of many arms are to be avoided, or are only required in very large rooms where portions of the floor area would otherwise be insufficiently lighted. When it is desired to light a drawing-room with wax candles—than which nothing is more beautiful—they are distributed wherever support can be found for

them. As every gas flame may be considered equal to 12 or 15 candles, with all their wicks together, the inadvisability of further concentration is evident. In fact, gas is if anything too brilliant for living-rooms, and if it were always properly distributed, many a dimly-lighted apartment would be perfectly illumined with the same number of burners which, when massed, appear insufficient. Where concentrated ceiling lights are needed for dining-rooms, many-armed pendants are seldom satisfactory, owing to the shadows which most of them cast. In these cases a single powerful argand light in a suitable reflecting pendant, or a cluster of flat flames similarly provided, will give a better result than the usual branched chandelier, and with a material saving in gas. For it is a curious and valuable property of gas, that large burners can be rendered much more economical in proportion than smaller ones. Thus, if the 4 burners of a branched chandelier give altogether the light of (say) 50 candles, the same illuminating power may be obtained from a greatly reduced quantity of gas when concentrated in a single burner of the most improved kind.

With regard to the smaller flat flames, which are the most general for ordinary lighting, the selection of glass globes is a very important matter. It may be said at once that all the old-fashioned style of glasses, with holes in the bottom about $2\frac{1}{2}$ in. diam., for fitting into the brass galleries of the older pattern pendants and brackets, are objectionable. The reasons for this condemnation are few and simple. It seems never to have occurred to the makers of these things that the gas flames inside the globes are always wider than the openings beneath them, through which the air required for combustion passes; and that, as a rule, the light of the flame is required to be cast downward. Gas flames always flicker in these old-fashioned glasses, because the sharp current of entering air blows them about. And the light cannot come downward because of the metal ring and its arms, and the glass, which is always thicker and generally dingier at this part of the globe. Perfectly plain and clean glass absorbs at least $\frac{1}{10}$ of the light that passes through it; ground glass absorbs $\frac{1}{3}$; and the ordinary opal obstructs at least $\frac{1}{2}$, and generally more. Only those globes should be chosen therefore which have a very large opening at the bottom, at least 4 in. wide, through which the air can pass without disturbing the flame. The glass then fulfils its proper duty, screening the flame from side draughts, and not causing mischief by a perpetual up-current of its own. Good opal or figured globes of this pattern may be used without disadvantage, because the light is reflected down through the bottom opening more brightly than if there were no globe, while the flame is shaded and the light diffused over other parts of the room.

The degree to which the luminosity of gas is utilized depends very largely upon the burner, people too often setting down as the fault of the gas, defects which should really be ascribed to the burner. In 1871, the Commission appointed by the Board of Trade to watch over the London gas supply, and whose prescriptions in these matters are more or less recognized by the whole country, made an examination of a collection of gas burners from a large number of sources, and including those in general use. The greater portion of these gave only $\frac{1}{2}$, some even only $\frac{1}{4}$, of the light that the gas was actually capable of affording. Two points very often neglected are: (1) that the size of the burner should be proportionate to the quantity of gas required to be consumed by it, and (2) that the gas should issue at a very low velocity. In good argands, the pressure at the point of ignition is almost nil; and in flat flame burners, the pressure should be only just sufficient to blow the flame out into the form of a fan. It is also very necessary that the body of the chamber below the point of ignition should be of material with low heat-conducting power, so that the gas may undergo no increase in volume which would occasion a proportionate increase of velocity, and that the heat may not be conducted away from the flame. To establish this, Evans had 2 argand burners made, differing only in that one had the combustion chamber of brass, and the other of steatite. The latter gave more light than the former in the proportion of

15 to 13 for the same quantity of gas. As another example a No. 8 metal flat flame burner, consuming 5 cub. ft. of gas per hour, gave a light equal to 11·5 candles, while a steatite burner of corresponding size, with non-conducting combustion chamber, gave 14·6 candles. Another metal burner of a description somewhat generally used, gave about $\frac{2}{3}$ of the light that the gas was capable of yielding. Worn-out metal burners generally give the best results, as the velocity of the issuing gas is lower than when the burners are new. A much better result is obtained by burning, say 20 cub. ft. of gas from one burner, than by using 5 burners, each of which consumes 4 cub. ft. This is the reason why the modern argands give so much more light than the older ones, which were drilled with a very large number of holes, and were more suitable for boiling water than for illuminating. If the air which is to support the combustion be heated, before it reaches the flame, especially in the case of flat flame burners, better results are produced, as was pointed out by Prof. Frankland more than 10 years ago, and this principle is now being carried out by some Continental burner makers. Of modern argands there are many excellent varieties, which can evolve 15-30 per cent. more light for the same quantity of gas than the best flat flame burners. One kind consisting of 3 concentric rings of flame with steatite gas chambers was first used in the public lighting of Waterloo Road in 1879. In another the products of combustion are brought down in a flue fastened round the burner, so as to heat the air which supports the combustion as it passes in pipes through the flue above-mentioned to the flame; while a third kind has an arrangement for admitting separate currents of cold air to keep the chimney cool. There seems little doubt that the argand lamp will play a leading part in the gas lighting of the future. An important point connected with the use of gas is that the heat generated by combustion, may be made to do the work of ventilation, as in the fish-gill ventilator invented by the late Goldsworthy Gurney. In this strips of calico are nailed, by the 2 upper corners, across an opening in the wall, in such a way that each strip laps over the strip next below it. This contrivance, opening and closing like the gills of a fish, is self-acting, as the heated air passes away through the porous material, and cold air is admitted without draught.

Electric Lighting.—The following rules and regulations are drawn up by a committee of the Society of Telegraph Engineers and Electricians for the reduction to a minimum, in the case of electric lighting, of those risks of fire which are inherent in every system of artificial illumination, and also for the guidance and instruction of those who have, or who contemplate having, electric lighting apparatus installed in their premises. The difficulties that beset the electrical engineer are chiefly internal and invisible, and they can only be effectually guarded against by "testing," or proving with electric currents. They depend chiefly on leakage, undue resistance in the conductor, and bad joints, which lead to waste of energy and the dangerous production of heat. These defects can only be detected by measuring, by means of special apparatus, the currents that are, either ordinarily or for the purpose of testing, passed through the circuit. Should wires become perceptibly warmed by the ordinary current, it is an indication that they are too small for the work they have to do, and that they should be replaced by larger wires. Bare or exposed conductors should always be within visual inspection, and as far out of reach as possible, since the accidental falling on to, or the thoughtless placing of other conducting bodies upon, such conductors, would lead to "short circuiting," and the consequent sudden generation of heat due to an increased current in conductors not adapted to carry it with safety.

The necessity cannot be too strongly urged for guarding against the presence of moisture and the use of "earth" as part of the circuit. Moisture leads to loss of current and to the destruction of the conductor by electrolytic corrosion, and the injudicious use of "earth" as a part of the circuit tends to magnify every other source of difficulty and danger. The chief dangers of every new application of electricity arise from ignorance and inexperience on the part of those who supply and fit up the requisite plant. The

greatest element of safety is therefore the employment of skilled and experienced electricians to supervise the work.

(a) The Dynamo Machine.—(1) The dynamo machine should be fixed in a dry place. (2) It should not be exposed to dust or flyings. (3) It should be kept perfectly clean and its bearings well oiled. (4) The insulation of its coils and conductors should be practically perfect. (5) All conductors in the dynamo room should be firmly supported, well insulated, conveniently arranged for inspection, and marked or numbered.

(b) The Wires.—(6) Every switch or commutator used for turning the current on or off should be constructed so that when it is moved and left it cannot permit of a permanent arc or of heating. (7) Every part of the circuit should be so determined that the gauge of wire to be used is properly proportioned to the currents it will have to carry, and all junctions with a smaller conductor should be fitted with a suitable safety fuse or protector, so that no portion of the conductor should ever be allowed to attain a temperature exceeding 150° F. ($65\frac{1}{2}^{\circ}$ C.). (8) Under ordinary circumstances, complete metallic circuits should be used; the employment of gas or water pipes as conductors for the purpose of completing the circuit should not in any case be allowed. (9) Bare wires passing over the tops of houses should never be less than 7 ft. clear of any part of the roof, and all wires crossing thoroughfares should invariably be high enough to allow fire escapes to pass under them. (10) It is most essential that joints should be electrically and mechanically perfect, and united by solder. The form of joint recommended is shown in Fig. 1388. (11) The position of wires when underground should be clearly indicated, and they should be laid down so as to be easily inspected and repaired.

(12) All wires used for indoor purposes should be efficiently insulated, either by being covered throughout with some insulating medium, or, if bare, by resting on insulated supports. (13) When these wires pass through roofs, floors, walls, or partitions, or where they cross or are liable to touch metallic masses, like iron girders or pipes, they should be thoroughly protected by suitable additional covering; and where they are liable to abrasion from any cause, or to the depredations of rats or mice, they should be efficiently encased in some hard material. (14) Where indoor wires are put out of sight, as beneath flooring, they should be thoroughly protected from mechanical injury, and their position should be indicated. N.B.—The value of frequently testing the apparatus and circuits cannot be too strongly urged. The escape of electricity cannot be detected by the sense of smell, as can gas, but it can be detected by apparatus far more certain and delicate. Leakage not only means waste, but in the presence of moisture it means destruction of the conductor and its insulating covering, by electric action.

(c) Lamps.—(15) Arc lamps should always be guarded by proper lanterns to prevent danger from falling incandescent pieces of carbon, and from ascending sparks. Their globes should be protected with wire netting. (16) The lanterns, and all parts which are to be handled, should be insulated from the circuit.

(d) Danger to Person.—(17) Where bare wire out of doors rests on insulating supports, it should be coated with insulating material, such as india-rubber tape or tube, for at least 2 ft. on each side of the support. (18) To secure persons from danger inside buildings, it is essential so to arrange and protect the conductors and fittings, that no one can be exposed to the shocks of alternating currents of a mean electromotive force exceeding 100 volts, or to continuous currents of 200 volts. (19) If the difference of potential within any house exceeds 200 volts, the house should be provided with a "switch," so arranged that the supply of electricity can be at once cut off.

With reference to par. (10), Bolas says that the best way to make an electrical joint is, first to thoroughly tin the wires, and then wipe them carefully while they are still

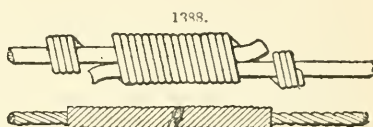

hot; any chloride of zinc which may have been used being next removed by a damp cloth. The wires are then bound, and subsequently well grouted with solder, rosin only being used as a flux.

Killingworth Hedges, in a paper recently read before the British Association, alludes to some sources of danger not previously mentioned. Thus, in reference to the development of heat caused by an increased resistance, he recalls Matthiessen's experiment showing that the conducting power of "commercial" copper wire is only 13·6 as against 99·95 for pure copper: hence the wire used must be pure throughout. An absolute essential is a cut-out or fusible plug in the circuit, arranged to melt if the current is more than 10 to 15 per cent. in excess of the working strength.

VENTILATING.—This subject has long been left in a very unsatisfactory state of neglect, despite its importance with regard to health. The following remarks are mainly gathered from a paper on the subject recently read by Arthur Walmisley before the Civil and Mechanical Engineers' Society, in which he reviews the principal systems.

As regards window ventilators, Lockhead's perforating panes of glass are a useful form when placed in the highest pane of the window farthest from the fireplace. A system in very general use is found in Moore's patent ventilator, which consists of glass louvres fixed so as to open at any angle required with facility by means of a cord, which, when set free, allows the louvre plates to close of themselves airtight. Moore's sliding glass ventilators, which are usually made in circular plates of 9 in. or 10 in. diameter, with egg-shaped openings neatly cut and turning on slips of glass with bevelled edges, are very effective for the admission or extraction of air in a room, but admit the rain in wet weather. Another method of admitting fresh air to a room consists in leaving an aperture in the external wall, at a level between the ceiling of one apartment and the floor of the room immediately above, then to convey the fresh air through a channel from the external wall to the centre of the ceiling of the apartment below, where the air can be admitted by an opening, and dispersed by having a flat board or disc to impinge against, suspended 4 in. or 6 in. below the opening of the ceiling, and so scattered over the room. The cold air, however, thus admitted, plunges on the heads of the occupants of the room and mixes with the hot air which has risen near the ceiling. A top window-sash lowered a little to admit fresh air has the same disagreeable effect, the cold air being drawn towards the floor by the chimney draught, and leaving the hot air to stagnate near the ceiling. In any siphon system placed vertically the current of air will enter by the short arm, and take its exit by the long arm, and thus the chimney flue acts as the long arm of a siphon, drawing the fresh air from the nearest opening. Fresh air may be introduced through perforations made in the woodwork of the bottom rail of the door to the room, or through apertures in the outer wall, admitting the fresh air to spaces behind the skirting board, and making the latter perforated. The only objection to this plan is the liability for vermin to lodge between the skirting board and the wall. This may be prevented by covering the outside apertures with perforated zinc, but such covering also helps to keep out the full supply of fresh air.

Butler recommends, while admitting the cold air through side walls near the floor level, and allowing the foul air to escape at the ceiling, that the fire draught should be maintained quite independent of the air inlet to the room, the requisite amount of air for combustion being supplied by a separate pipe led through the hearthstone with its face towards the fire, the latter acting as a pump, which is sure to procure its own allowance from the nearest source; thus the draught which would otherwise be felt by the fire drawing its supply from the inlet across the room is considerably reduced. The foul air may enter the ceiling in the centre, and be conducted by an air-flue either to the outside or to the chimney. The chimney is the best extractor, as its heated condition greatly favours the ventilating power.

Dr. Arnott was one of the first to draw attention to the value of a chimney as a means of drawing off the foul air from the interior of an apartment. He invented a ventilator

consisting of a well-balanced metallic valve, intended by its instantaneous action to close against down draught and so prevent the escape of smoke into a room during the use of fires. If the fire is not alight, what is known as the register of the stove should be closed, or a tight-fitting board placed in front of the fireplace, with the adoption of all chimney-ventilators fixed near the ceiling.

A very ingenious device was described by Prof. Morse at a recent meeting of the "American Association for the Advancement of Science," held in Minneapolis, having for its object the utilization of the sun's rays for warming and ventilation. The device consists mainly of a slaty surface painted black, placed vertically on the outside wall of a building, with flues to conduct the warm air to the inside. The slates are inserted in a groove-like glass in a frame. A library measuring 20 ft. by 14 ft., by 10 ft. high, was warmed in this way by an apparatus measuring 8 ft. long by 3 ft. wide, and was thus kept comfortable throughout the winter except on a few of the coldest days. Prof. Morse states that as a general result of the experiments a difference of 30° could thus be secured during 4 or 5 hours of the day. He found in the morning that when the sun's rays rested directly on the apparatus the air passing through it was raised about 30° , and that it discharged 3206 cub. ft. of warm air per hour. The sun, by heating the solid objects upon which its rays fall, causes a gentle and regular circulation of air along the surface of the ground. This fact suggests the advantage of so placing a building that a maximum amount of sunshine is admitted into the rooms most occupied. Where air without the sun's heat is required, as in the case of meat markets, the method adopted in the design for the Metropolitan Cattle Market may be recommended, where 5 louvre boards, each 8 in. by $\frac{3}{4}$ in., are made to revolve on pins fixed near the lower ends of support; these louvres open or close by means of a chain passing over pulley blocks.

In America the plan most generally adopted for the ventilation of some of their large institutions is to admit the fresh air in the middle of the room, after warming it by a stove or other heating appliance, placed either in the room or in another compartment, and connected by an air-duct to the centre. The air so admitted first ascends to the ceiling, and then is supposed to be drawn down from apertures near the floor in the walls of the room, whence it is allowed to escape by passages to the smoke-flue, and so to the outside. In some of their hospitals fresh air is admitted through a series of long narrow apertures, covered with a perforated plate, situate one over each bed a little above the patient's head, and drawn out through a tube at the foot of the bed, which is placed in communication with a suction flue, the object of this arrangement being to free the neighbouring patients from the danger of inhaling the heavy gases generated in disease.

In St. Thomas's Hospital, Lambeth, each ward contains central fireplaces facing the end of the room. The fresh air is admitted at the floor level, after passing through a flue open at one end to the external air, and warmed by passing through a hot-air chamber behind the fire. The vitiated air escapes into an up-cast flue through a grating at the level of the ceiling, from whence it is drawn into an iron flue enclosing the smoke flue of each fireplace, the heat of the latter being considered sufficient to create the required suction for its extraction.

A better arrangement, in the author's opinion, is that adopted at Guy's Hospital, London, where advantage is taken of the girders carrying the floor for ventilating the wards. The fresh air is drawn down 2 lofty shafts, one on each side of the main entrance, into a compartment in the basement, where it is heated by hot-water pipes before passing through the air-ducts into the wards, entering them through gratings on the floor level. The upper flue is embedded in the concrete of the floor, while the lower flue is below the ceiling of the ward. After passing through the wards, the hot air is extracted through apertures near the ceiling into a series of independent flues communicating with a shaft placed near the centre of the building, so as not to interfere with the action of the down shafts, and carried up outside the roof to a greater height than the other shafts. The velocity of an escaping current will be proportional to the square root of the

excess of the temperature of the heated air in a flue over the air outside the flue, and also to the square root of the height of the flue or chimney, and the volume of air extracted is consequently proportional in addition to the sectional area of the flue.

Harding's ventilators are better known in the north of England than the south. They are recommended by Pridgin Teale, surgeon to the General Infirmary at Leeds, as a means of securing freshness of atmosphere without draught, and free from all mixture of dust, soot, or fog. The outside air is conducted through a grate and aperture in the wall about 7 ft. 6 in. above the floor level, where it is made to pass through a series of small tubes fixed at an angle of about 30° with the wall. The currents of air are said to be compressed while passing through the tubes, but to expand and diffuse in all directions as soon as they are liberated into the apartment. In all filtering arrangements it must be remembered that if air is to pass through a screen or filter without retarding the current entering the room through a tube, the area of the screen must be greater than the area of section of the tube. This can be effected by placing the screen diagonally within the tube which admits the air. In some buildings the filter is dispensed with, and the apparatus is used simply to diffuse the air as it enters the room. An outlet for the vitiated air is provided by the chimney flue, either through the fireplace or by a mica valve placed in the flue near the ceiling. In rooms where flues do not exist an air extractor is provided, consisting of 2 perforated cones and a central tube. The external air impinging upon the perforated cones is deflected, creating an induced current up the vertical tube, drawing the foul air from the interior of the room, and expelling it through the perforations. In fixing the extractor, a wooden base or frame is placed on the ridge and covered with lead to make it watertight; the extractor is then placed over this and fixed in the ordinary manner. A small inner cone is provided simply to prevent rain from getting into the tube. Harding's extractors are so designed that they may be easily fixed inside an ornamental turret without in any way affecting their action. They can be obtained in London from Strode and Co., at prices varying from 15s. to 6l. and upwards. Their action is illustrated in Fig. 1389: *a*, wall; *b*, grating outside; *c*, filter.

Another system for admitting fresh air into a room, free from fog and other impurities, is that recommended by the Sanitary Engineering and Ventilating Co., 115, Victoria Street, Westminster. They provide for the introduction of fresh air in vertical currents by means of a suitable number and disposition of vertical tubes, varying in size, section, and weight according to each special case. The current can be regulated in amount by throttle valves, and the heated or vitiated

air is removed by means of exhaust ventilators, placed directly over the roof or in connection with air flues and shafts. The exhaust ventilator is thus described by the makers: There are no working parts to get out of order, and no attention is required

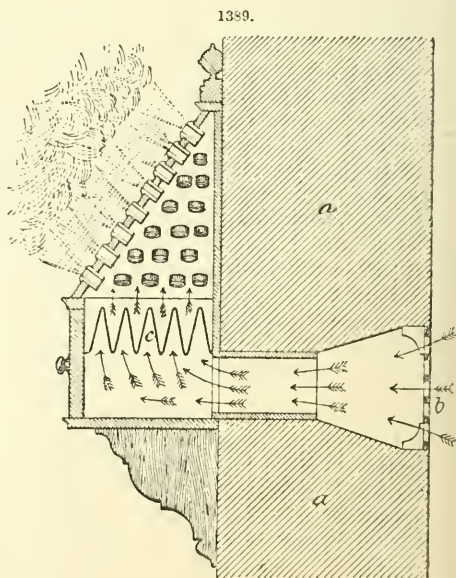

to ensure its constant action. In this respect, a great improvement is claimed over the numerous forms of revolving cowls, which require occasional lubrication, otherwise the working parts become corroded and the cowl ceases to act. They are made of circular or rectangular section, or other shapes to suit special circumstances. One great merit of the system is the element of length which is introduced by means of the tube arrangement, and thus a current is continually passing which diffuses itself over the room. The system admits of a patent air-cleansing box being built into the wall at the foot of the tube, fitted with special deflector plates and a tray to hold water or, when necessary, disinfectants. Where the arrangements of furniture or fittings in a room preclude the use of vertical tubes fixed near the ground, they recommend the substitution of a ventilating bracket fixed at 6-7 ft. above the floor. This bracket may contain an air purifying or cleansing box; if required, a valve is provided for regulating the admission of fresh air, and a 9 in. by 6 in. hinged air grating to cover the opening outside. The air-cleansing box is illustrated in Fig. 1390: *a*, inside of room; *b*, floor; *c*, trough or tray for holding water or disinfectant fluid; *d*, tube.

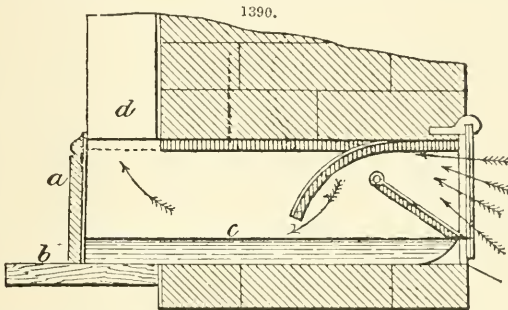

Boyle's patent self-acting air-pump ventilators are well known, and are found to answer well in their continuous action under all varieties of wind pressure; they are often adopted without any inquiry being made as to the scientific principles on which they are constructed. They consist of 4 sections, each acting independently of the other. The exterior curved baffle-plate prevents the wind blowing through the slits formed in the immediate interior plates, and tends to concentrate the current. These interior plates are curved outwards, so as to take the pressure off the vertical slits, which form a communication with the internal chambers, through which the air impinges on inner deflecting plates, and is further directed by the radial plates. The external air impinging on the radial plates is deflected on to the side plates, and creates an induced current. In its passage it draws the air from the central vertical chambers, expelling it at the opposite opening. The vitiated air immediately rushes up the shaft connecting the ventilator with the apartment to be ventilated, extracting the air and producing a continuous upward current without the possibility of down draught. The partitions separating the chambers prevent the external air being drawn through the slits upon which the wind is not directly acting. The whole arrangement being a fixture, with no mechanical movement, it is never liable to get out of order, and the apparatus can be easily fixed over a wood base or frame covered with zinc or lead to secure a good watertight connection. Where Boyle's ventilators are used the air is renewed imperceptibly, the vitiated air being extracted as rapidly as it is generated.

A somewhat similar arrangement to Boyle's ventilator is patented by Arnold W. Kershaw, of Lancaster, and consists of 3 rims of deflectors or plates with openings in each, so arranged that the openings in one rim are opposite the deflectors in the next inner or outer rim, the effect being that whatever the direction of the wind, it passes

through the ventilator without being able to enter the central shaft, and in passing creates a partial vacuum, which induces an upward current in the upcast shaft without the possibility of down draughts. Both Boyle's and Kershaw's roof ventilators are suitable for fixing in ventilating towers or turrets. While Kershaw's is somewhat simpler in construction, Boyle's is said to possess the additional advantage of preventing the entrance of snow by the curve in which the inner plates are fixed. In the case of chimney flues where there is any obstruction that breaks the wind and produces a swirl, such as would be caused by close proximity to higher buildings or raised gables, a down draught may be prevented by the use of a properly-constructed chimney cowl. Kershaw's chimney cowl is a modification of his pneumatic ventilator, and consists of deflecting plates so arranged that there is no possibility of a down draught. Boyle's chimney cowl is better known than Kershaw's, and is very effective. It consists of deflecting plates so fixed that if a body of air is forced in at the false top, instead of passing down the vent, it is split up by an inner diaphragm, deflected over the real top, and passed over at the side openings, thus checking the blow down and assisting the up draught. Kershaw's patent inlet and air diffuser consists of a tube connection between the outside and inside of an apartment rising vertically on the inside, the upper extremity having radiating plates, which diffuse the incoming current. Generally speaking, a sufficient amount of fresh air enters under the door to a room or between the window sashes or frames; but in apartments where doors and windows fit tightly, some arrangement for the admission of fresh air becomes indispensable. In this climate, during 7 months of the year, the external air is usually too cold to be admitted directly into the room. The plan of admitting fresh air to a space behind the grates, leading up the air through channels on each side of the fireplace, and ultimately passing it through perforated gratings within the wall or through perforations in the skirting board on each side of the fireplace cannot be commended, as the passages are apt to get choked up with dust, and the temperature of the air cannot be well regulated in its passage into the room. The true object of a fire and chimney flue should not be to supply fresh air, but to extract it after it has done its work.

WARMING.—In connection with warming an apartment, it is obviously a necessary condition that the warmth shall be conserved as much as possible. Hence there is an evil in having too much glass, as it cools the room too fast in the winter season: 1 sq. ft. of window glass will cool $1\frac{1}{2}$ cub. ft. of warm air in the room to the external temperature per second; that is, if the room be warmed to 60° F., and the thermometer stands at 30° F. outside, there will be a loss of 90 cub. ft. of warm air at 60° per second from a window containing a surface of glass of 60 sq. ft. In colder climates than that of England, this subject is of much greater importance. In America, for instance, during the cold weather, there will always be found, no matter how tightly or closely the sashes are fitted and protected with weather-strips, a draught of cold air falling downward. This arises from the contact of the heated air with the cold glass, which renders the air cooler and heavier, and causes it to fall. The air, at the same time, parts with a considerable proportion of its moisture by condensation upon the glass. The cold air thus formed falls to the floor, forming a layer of cold air, which surrounds the feet and legs, while the upper part of the body is enveloped in overheated air. The layers of cold and warm air in an apartment will not mix. The warm air will not descend, and the cold air cannot go upward, except the one is deprived of its heat by radiation, and the other receives its heat by actual contact with a heated surface. This radical difference in the upper and lower strata of atmosphere of the rooms, in which people live during the cold season, is the prolific cause of most of the throat and lung diseases with which they are afflicted. Double windows to the houses, therefore, would not only be a great economy as to fuel, but highly conducive to human longevity.

There are only 2 ways in which dwelling-houses can be heated, namely, by radiant

heat and by hot air. The former is produced by the open fire, and by it alone. The latter is obtained in various ways. The question whether we shall use hot air or radiant heat in our rooms is by no means one to be lightly passed over. Instinct tells us to select radiant heat, and instinct is quite right; it is so because radiant heat operates in a very peculiar way. It is known that as a matter of health it is best to breathe the air considerably below the natural temperature of the body—98° F.; in air heated to this temperature most persons would in a short time feel stifled. But it is also known that the body likes, as far as sensation is concerned, to be kept at a temperature as near 98° F. as may be, and that very much higher temperatures can be enjoyed; as, for example, when we sit before a fire, or bask in the sun. Now radiant heat will not warm air as it passes through it, and so, at one and the same time, we can enjoy the warmth of a fire and breathe that cool air which is best suited to the wants of our system. Herein lies the secret of the popularity of the open fireplace. But in order that the open fireplace may succeed, it must be worked within the proper limits of temperature. If air falls much below 40° F. it becomes unpleasant to breathe and it is also very difficult to keep the body warm enough when at rest by any quantity of clothes. In Russia and Canada the temperature of the air outside the houses often falls far below zero, and in the houses it cannot be much above the freezing-point. Here the open fire fails; it can only warm air by first heating the walls, furniture, and other materials in a room, and these, in turn, heat the air with which they come in contact. But this will not do for North American winters; and accordingly in Canada and the United States the stove or some other expedient for warming air by direct contact with heated metal or earthenware is imperatively required. But this is the misfortune of those who live in cold climates, and when they ask us to follow their example and take to close stoves and steam-pipes, and such like, they strongly remind us of the fable of the fox who had lost his tail. How accurately instinct works in the selection of the 2 systems is demonstrated by the fact that a succession of mild winters is always followed in the United States by an extended use of open grates; that is to say, the English system becomes, or tends to become fashionable, while, on the other hand, a succession of severe winters in this country brings at once into favour with builders and others a whole host of close stoves and similar devices which would not be looked at under more favourable conditions of the weather. While English winters remain moderately temperate, the open fireplace will enjoy the favour it deserves, as not only the most attractive, but the most scientific apparatus available for warming houses. (*Engineer.*)

In discussing the various methods of warming, it will be convenient to classify them under general heads.

Open Grate.—The ordinary open grate is too familiar to need any description, but it is wasteful of fuel to a degree that could only be tolerated in a mild climate where fuel was cheap. As a matter of fact, only some 10-12 per cent. of the heat generated in an open grate is utilized, the remainder going up the chimney. But this very fault is in one sense a virtue, in that it performs the ventilation of the apartment in an eminently satisfactory manner. By the addition of a contrivance for regulating the combustion in an open grate, the fuel consumption is much reduced, the combustion is rendered more perfect (diminishing or preventing smoke), the radiated heat is much increased, while the appearance of an open grate is retained, though it is in reality converted into an open stove.

Open Stove.—This subject has been most ably discussed by Dr. Pridgin Teale, in connection with the economising of fuel in house fires. His remarks will well bear repeating.

“It is hardly possible to separate the 2 questions of economy of fuel and abatement of smoke. None who, in their own person, or as the companion or nurse of friends and relatives, have gone through the miseries of bronchitis or asthma in a dense London fog, can fail to perceive that this is a serious medical, not less than a great

economical, question. Nine million tons of coal—one-fourth of the domestic fuel consumption in this kingdom—is what I estimate as a possible reward to the public if they will have the sense, the energy, and the determination to adopt the principles here advocated, and which can be applied for a very small outlay. Much has been said by scientific men about waste of fuel, and strong arguments have been advanced which make it probable that the most economical and smokeless method of using coal is to convert it first of all into gas and coke, and then to deliver it for consumption in this form instead of coal. Theoretically, no doubt, this is the most scientific and most perfect use of fuel, and the day may come when its universal adoption may be possible. But before that time arrives many things must happen. The mode of manufacture, the apparatus on a mighty scale, and the mode of distribution must be developed, nay, almost created, and a revolution must be effected in nearly every fireplace in the kingdom. At present its realization seems to be in a very remote future. Meantime I ask the public to adopt a method which is the same in principle, and in perfection not so very far short of it. It is nothing, more nor less, than that every fireplace should make its own gas and burn it, and make its own coke and burn it, and this can be done approximately at comparatively little cost, and without falling foul of any patent, or causing serious disturbances of existing fireplaces. We must, first of all, do away with the fallacy that fires won't burn unless air passes through the bottom or front of the fire. The draught under the fire is what people swear by (aye, and many practical and scientific men too), and most difficult it is to sweep this cobweb away from people's brains. They provide 2 or 3 times as much air as is needed for combustion, $\frac{1}{3}$, perhaps, being the necessary supply of oxygen, the remainder serving to make a draught to blow the fire into a white heat, and to carry no end of waste heat rapidly up the chimney; $\frac{2}{3}$ of cold air chilling the fire, $\frac{2}{3}$ more than needful of cold air coming into the room to chill it; and much of the smoke and combustible gases hurried unburnt up the chimney. The two views which I am anxious to enforce upon the attention of the public, of builders, of ironmongers, and of inventors, are these: that the open grating under the fire is wrong in principle, defective in heating power, and wasteful of fuel, and that the right principle of burning coal is that no current of air should pass through the bottom of the fire, and that the bottom of the fire should be kept hot. This principle is violated by the plan of closing the slits in the grate by an iron plate resting on the grate, which cuts off the draught, but allows the chamber beneath the fire to become cold, and when cinders reach the plate they become chilled, cease to burn, and the fire becomes dead. The right principle is acted upon by the various grates with fire-brick bottoms, and the English public owes much to the inventor of this principle as carried out in the Abbotsford grates, which have done much to educate the British public in the appreciation of the fact that a fire will burn well with a current of air passing over it, and not through it. But there is a better thing than the solid fire-brick bottom, and that is a chamber underneath the grating, shut in from the outer air by a shield resting on the hearth and rising to the level of the bottom bar of the range. This hot-air chamber, into which fine ash can fall, produces on the whole a brighter and cleaner fire, and one which is more readily revived when low, than the solid fire-brick. There is another mighty advantage in the principle of the "economiser"—an unspeakable advantage, it is applicable to almost every existing fireplace, and it need not cost more than 3-4s. This idea has now been long on its trial. It has been applied in hundreds of houses. It has been submitted to the very severe test of being applied to an infinite variety of grates, under a great variety of circumstances, and tried with coke, anthracite, and coal, good, bad, and indifferent. The effect has been, in an enormous number of instances, a marked success in saving coal and labour, and in more comfortable uniform warmth to the room. The failures have been very few indeed. I have drawn up 7 rules for the construction of a fireplace, all of which are pronounced to be sound:—

1. As much fire-brick, and as little iron as possible.
2. The back and sides of the fireplace should be fire-brick.
3. The back of the fireplace should lean or arch over the fire, so as to become heated by the rising flame.
4. The bottom of the fire or grating should be deep from before backwards, probably not less than 9 in. for a small room nor more than 11 in. for a large room.
5. The slits in the grating should be narrow, perhaps $\frac{1}{4}$ in. wide, for a sitting-room grate, $\frac{3}{8}$ in. for a kitchen grate.
6. The bars in front should be narrow.
7. The chamber beneath the fire should be closed in front by a shield or economiser.

There is one caution which should be given. There is no doubt about the fact that immediately beneath the fire the hearthstone is hotter, and the ashes remain much hotter when the 'economiser' is used. This may increase the risk of fire whenever wooden beams lie under the fireplace. In any case of doubt, the best plan would be to take up the hearthstone and examine, and relay with safe materials; but should this be impossible, safety may be secured by covering the hearthstone with a sufficient thickness of fire-brick, just within the space enclosed by the 'economiser'—leaving a space of 2 or more in. between the fire-brick hearth and the bottom of the fire. In lighting the fire, if there be no cinders on which to build the fire, it is well to draw away the 'economiser' for a short time until the fire has got hold; but, if there be cinders left from the previous day, on the top of which the paper and wood can be placed, then the fire may be lighted with the 'economiser' in its place. There is a great art in mending a fire. It is wasteful to throw lumps of coal higgledy-piggledy on a fire. The red embers should be first broken up so as to make a level surface, then pieces of coal should be laid flat on the fire and fitted in almost like pavement; lastly, if the fire is intended to burn slowly and last very long, small coal should be laid on the top. An 'economised' fire so made will, in a short time, heat the coal through, and give off gases, which will ignite and burn brightly on the surface of the black mass, and when the gases are burnt off there is a large surface of red-hot coke."

The annexed illustrations show the application of the economiser. Fig. 1391 is a kitchen range, *a* being the economiser and *b* the front damper. The latter should always be used in warm weather, unless the front of the fire is needed for roasting, and should be put on at night. Fig. 1392 is a bedroom fireplace having fire-brick sides *a*, fire-brick back *b* leaning over the fire, narrow front bars *c* movable, grating *d* with narrow slits, chamber under the fire closed by economiser *e*, and front damper *f* which can close the lower $\frac{2}{3}$ of the front of the fire at night or when a slow fire is needed.

The "economiser" is a shield of sheet iron which stands on the hearth, and rises as high as the lowest bar of the grate, against which it should fit accurately, so as to shut in the space or chamber under the fire. If the front of the range be curved or angular, as in most register stoves, the economiser will stand, owing to its shape—but if the front be straight, the economiser needs supports such as are shown. "Ordinary economisers" are made of 16-gauge charcoal iron plate, with $\frac{3}{8}$ -in. bright steel moulding at the top, $\frac{1}{2}$ -in. moulding at the bottom, and 1 or 2 knobs as required. "Kitchen economisers" are made of 16-gauge iron, with $\frac{1}{2}$ -in. semicircle iron at the top edge; and with supports in scroll form of $\frac{1}{2}$ -in. semicircle iron. Some makers use rather thinner iron plate and give strength by the mouldings. Some have used too thin plates, little better than tin, which have warped and so become more or less useless. Great care should be spent in taking the dimensions—as every grate has to be measured—as a foot for a boot. This renders it almost impossible to send orders to a maker by post. Some skilled person must take the measure, and take it accurately. The dimensions to be taken are; firstly, the outline of the bottom bar of the grate. If it be curved, or angular, the outline can be well taken by a piece of leaden gas-pipe, which, moulded to the outline, can then be traced upon paper or carried carefully away to the makers; secondly, the

height must be measured from the hearthstone to the bottom bar. This is the “economiser” in its simplest and cheapest form, as applicable to nearly every ordinary range.

Ornament can be added to taste. It is obvious that the adaptation of the economiser need not displace the old-fashioned ash-pan, and that the 2 can be combined, or that the economiser may be made like a drawer and catch the ashes. All such varia-

1391.

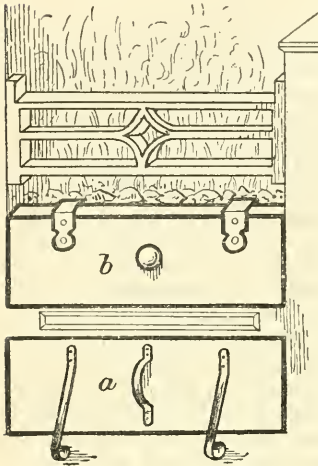

1392.

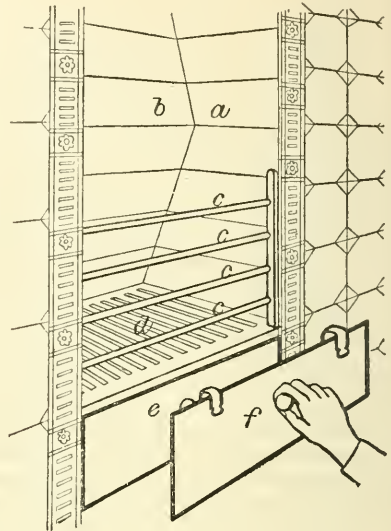

1393.

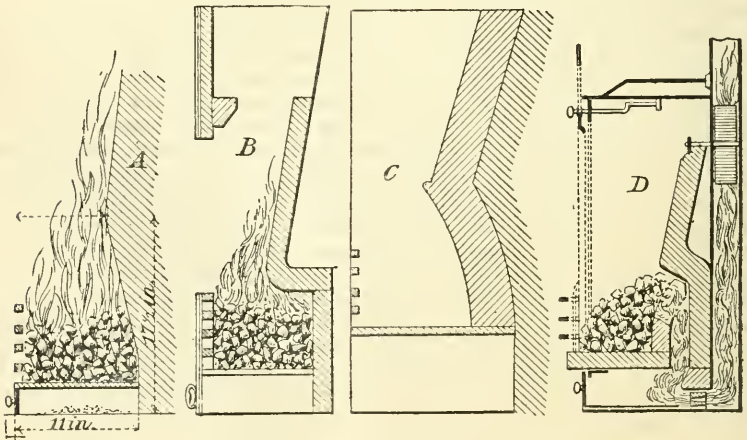

tions will work well provided that the main principles be adhered to of cutting off the under current,” and “keeping the chamber under the fire hot.” But the simplest form is the best.

Fig. 1393 illustrates a few typical specimens of modern improved open grates devised

to increase the radiation of heat and perfect the combustion of the fuel: A is a combination of Parson's grate and economiser with a Milner back; B is Nelson and Sons' "rifle" back; C is a Galton back; D, Jaffrey's grate.

Close Stove.—Where a continual genial warmth is required at little cost in an apartment, the slow combustion stove, such as that made by the Thames Bank Iron Company (Fig. 1394), may be employed. The external air is drawn in by a smoke-pipe channel and impelled through orifices in the stove. The smoke can be made to pass out at any level in the stove that may be found most convenient, but unless there is a high chimney shaft an underground flue connection is not recommended. The fuel, consisting of coke or cinders broken small, is supplied at the top, the ashes or cinders being removed through a sliding door at the base; a special soot-door is provided for clearing the flue before lighting the fire.

Roberts' patent terracotta stoves operate also by slow combustion and are self-acting, but possess the additional advantage of purifying and radiating the heat by the terracotta, which is contained between 2 concentric cylinders of sheet iron united at the base and top, the outer cylinder being perforated to allow of direct radiation of heat from the terracotta. The stove consists of 4 separate parts, namely, the stove body, its top or cover, the fire-box, which can be lifted in and out, and the stand, with drawer and damper. The fire is lighted at the top and burns downwards, the air sustaining it being drawn upwards through the bottom of the fire-box and thence through the fuel. The stove can be placed in any position on an iron or stone base and connected with the nearest chimney flue by an iron pipe provided with soot-door elbows, care being taken to form a complete connection by abandoning any other open fire-grate in the room and screening it off by an iron or zinc plate. They admit no effluvia, as the terracotta gradually and completely absorbs all the caloric in its permeation through the shell before it is communicated to the outer air, which is thus warmed and diffused in a healthy condition over the room. The top of the stove is movable, so that the fire-box can be removed to be cleaned and recharged without moving the stove body, and a sand groove is inserted at the top where the cover rests, which is filled with fine dry sand to prevent any escape of smoke.

Hot-air Furnace.—The close stove is really a hot-air furnace, but it is restricted to heating the air in the room. Other apparatus are designed to obtain a supply of fresh air and heat it before passing it into the room. The heated air from a fireplace is available to the apartment for only about 12 per cent. of the total amount of heat produced; all the rest passes up the chimney. The close stove, on the contrary, utilizes 85–90 per cent. of the heat produced, and loses through the smoke-pipe only about as much as the open fireplace saves—10–15 per cent. And herein lies the striking difference between the relative healthiness of the atmosphere heated by a close stove and an open fireplace. The amount of air which hourly passes through a close stove, heated with a brisk fire, is, on an average, equal to only about $\frac{1}{10}$ the capacity of the room warmed, and consequently such stove requires, if unaided, 10 hours to effect a change of the atmosphere in every such apartment. Thus stagnant and heated, the air becomes filled with the impurities of respiration and cutaneous transpiration.

Moisture, too, is an important consideration. The atmosphere, whether within doors or without, can only contain a certain proportion of moisture to each cub. ft., and

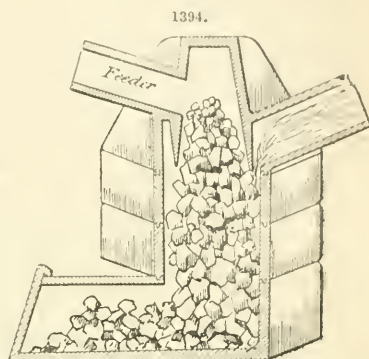

no more, according to temperature. At 80° F. it is capable of containing 5 times as much as at 32° F. Hence, an atmosphere at 32° F., with its requisite supply of moisture, introduced into a confined space and heated up to 80° F., has its capacity for moisture so increased as to dry and wither everything with which it comes in contact; furniture cracks and warps, seams open in the moulding, wainscoting, and doors; plants die; ophthalmia, catarrh, and bronchitis are common family complaints, and consumption is not infrequent. But this condition of house air is not peculiar to stove-heat. It is equally true of any overheated and confined atmosphere. The chief difference is, that warming the air by means of a close stove is more quickly accomplished and more easily kept up than by any other means. Sometimes, by the scorching of dust afloat in the atmosphere, an unpleasant odour is evolved which is erroneously supposed to be a special indication of impurity, caused by the burning air. It is an indication of excessive heat of the stove. But the air cannot be said to burn in any true sense of the word, for it continues to possess its due proportion of elementary constituents. Such is the close stove and its dangers, under the most unfavourable circumstances.

The essentials for healthy stove-heat are a brick-lined fire-chamber, exhaust-flue for foul air, means for supplying moisture, and provision for fresh-air supply. A brick lining is requisite for the double purpose of preventing overheating, and for retaining heat in the stove. For the supply of moisture the means are simple and easy of control, but often inadequate. An efficient foul-air shaft may be fitted to the commonest of close stoves by simply enclosing the smoke-pipe in a jacket—that is, in a pipe of 2 or 3 in. greater diameter. This should be braced round the smoke-pipe, and left open at the end next the stove. At its entry into the chimney, or in its passage through the roof of a car, as the case may be, a perforated collar should separate it from the smoke-pipe. For stoves with a short horizontal smoke-pipe, passing through a fire-board, the latter should always be raised about 3 in. from the floor. A smoke-pipe thus jacketed, or fire-board so raised at the bottom, affords ample provision for the escape of foul air.

Hot-air furnaces are simply enclosed stoves placed outside the apartments to be warmed, and usually in cellars or basements of the buildings in which they are used. The manner of warming is virtually the same as by indirect steam heat—by the passage of air over the surface of the heated furnace or steam-heated pipes, as the case may be, through flues or pipes provided with registers. The most essential condition of satisfactory warming by a hot-air furnace is a good chimney-draught, which should always be stronger than that of the hot-air pipes through which the warmed air is conveyed into the rooms, and this can be measured by the force with which it passes through the registers. A chimney-draught thus regulated effectively removes all emanations; for, if the chimney-draught exceeds that of the hot-air pipes, all the gaseous emanations from the inside of the furnace, and if it have crevices, or is of cast iron and overheated, all around it on the outside will be drawn into the chimney. Closely connected with this requirement for the chimney-draught is the regulating apparatus for governing the combustion of fuel—the draught of the furnace. This should all be below the grate; there should be no dampers in the smoke-pipe or chimney, and all joints below and about the grate should be air-tight. The fire-pot should be lined with brick and entirely within the surface, but separate from it, so that the fresh air to be warmed cannot come in contact with the fuel-chamber.

It should go without saying that the air which passes from furnaces into living-rooms should always be taken from out of doors, and be conveyed in perfectly clean air-tight shafts to and around the base of the furnace. Preferably, the inlet of the shaft, or cold-air box, should be carried down and curved at a level (of its upper surface) with the bottom, and full width of the furnace. Thus applied, the air is equally distributed for warming and ascent through the hot-air pipes to the apartments to be warmed. On the outside the cold-air shaft should be turned up several feet from the surface of the ground, and its mouth protected from dust by an air-strainer. A simple but effectual way is to

cover the mouth with wire cloth, and over this to lay a piece of loose cotton wadding. This may be kept in place with a weight made of a few crossings of heavy wire, and it should be changed every few months. And here, too, outside the house, should be placed the diaphragm for regulating the amount of cold-air supply, and not, as commonly, in the cellar.

As the best means of regulating the temperature and purity of the atmosphere from hot-air furnaces, it is necessary to provide sufficiently large channels for both the inlet fresh air and its distribution through the hot-air pipes. The area of the smallest part of the inlet (or inlets, for it is sometimes better to have more than one) should be about $\frac{1}{6}$ sq. ft. for every lb. of coal estimated to be burnt hourly in cold weather; and to prevent, in a measure, the inconvenience of one hot-air pipe drawing from another, the collective area of the hot-air pipes should not be more than $\frac{1}{2}$ greater than the area of the cold-air inlet. These proportions will admit the hot air at a temperature of about 120° F. when at zero outside, and the velocity through the register will not exceed 5 ft. per second.

A large heating surface of the furnace is a well-recognized condition of both economy and efficiency. As a rule, there should be 10 sq. ft. of heating surface to every lb. of coal consumed per hour, when in active combustion; and the grate area should be about $\frac{1}{10}$ of that of the heating surface. For the deficiency of heat, or the failure of some of the hot-air pipes of hot-air furnaces in certain winds and weathers in large houses or specially exposed rooms, the best addendum is an open fire-grate. With this provision in northerly rooms, to be used occasionally, hot-air furnaces may be made to produce all the advantages of steam heat in even the largest dwelling-houses.

Boyle's system of warming fresh air is suitable where hot air, water, or steam pipes are not available. The arrangement (Fig. 1395) consists of a copper or iron pipe a about

1½ in. diam. placed in an inlet tube b, preferably of the form of a bracket. This pipe is not vertical, as in the so-called Tobin's shafts, but of zigzag shape, crossing and recrossing the tube from top to bottom, and so causing the incoming air to repeatedly impinge in its passage through the tube. At the bottom of the tube an air-tight chamber, so far as the interior of the tube is concerned, is fixed, in which a Bunsen gas-burner c is placed the flame of which plays up into one of the lower ends of the pipe, the upper portion being about 5 ft. 9 in. from the floor. The other lower end of the pipe either dips into a condensation box d in the bottom of the tube or is continued into an existing flue or extraction shaft. If the pipe terminates in a box, the vapour is condensed there and carried off through the outside wall by means of a small pipe. At the bottom of the box is placed some loose charcoval, which needs renewing at intervals. This charcoval absorbs any products of combustion which have a tendency to rise. The heat thus passes through the entire length of the pipe, and warms the air as it travels through the tube to the room or hall as required.

Fig. 1396 illustrates Shortland's "Manchester warm-air grate back": a, fireplace; b, outer wall; c, inner wall; d, smoke flue; e f, cold-air inlets; g h, warm-air passages; i, inlet for cold or warm air into room.

Hot Water.—This is often used for heating greenhouses, churches, schoolrooms, &c.

1395.

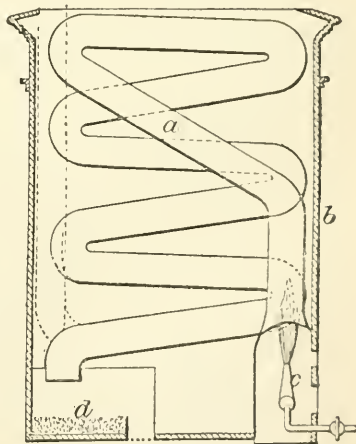

The following simple plan is adapted for a greenhouse. If the kitchen boiler is one that is fed from a cistern at the side of the fireplace, it may be utilized by connecting it by the means of $\frac{3}{4}$ -in. or 1-in. iron or lead pipe with the cast-iron (2-in. or 3-in.) pipes in the greenhouse. If iron connecting-pipes are used, they could be screwed into the boiler with a nut on each outside to keep them watertight, by means of a grummet and red-lead paint. One should go into the boiler at the top and be connected with the top line of pipes, called the flow, and the other should go in at the bottom and be connected with the bottom line of pipes, called the return. If lead pipes are used they could be connected with the boiler and greenhouse-pipes by means of brass unions, to be purchased at any plumber's. The pipes should rise from the boiler to the farthest end about 1 in. to the yard, and in the bend at that point should be screwed a $\frac{3}{8}$ -in. gas-tap, and from it a small lead pipe should be carried up to the roof inside. This tap should always be open, to allow any steam to escape. If the kitchen boiler is supplied from the top of the house, it is more satisfactory to put up a small gas-boiler, as the pressure of the water would try the joints and prevent the vent-tap being kept open. The kitchen fire would, of course, be required to be kept in all night in frosty weather, and there should be taps on the connections between boiler and pipes, to shut off the heat when not required.

Steam Heat.—Steam heat may well be compared with stove and furnace heat. Stove heat corresponds to direct radiation by steam, and furnace heat to indirect. The supply of fresh air from the outside to and over the hot-air furnace, and through hot-air flues into the rooms through registers, is virtually the same as when it is conveyed by means of steam-heated flues in the walls. Exhaust flues, for getting rid of foul air, are equally essential. The stove, as representing direct radiation in the same manner as the steam coil, or plate, in the room, has the advantage over the latter of some exhaust of foul air, however little, even when the smoke-pipe is not jacketed, for the steam heat has none. In comparison with open-stove heat, steam heat is at still greater disadvantage; for open stoves supply all the qualities of complete radiation—the introduction of fresh air and the escape of foul—to a degree wholly unattainable by steam heat, whether direct or indirect, or by hot-air furnaces, which always require special provision for the escape of foul air.

The advantage of stove and furnace heat over steam may be summed up thus:—It is more economical, more uniform, more easy of management, more suitable for small areas to be warmed, and is free from the noises and dangers of steam. Irregularities of the fire in steam heating are a constant source

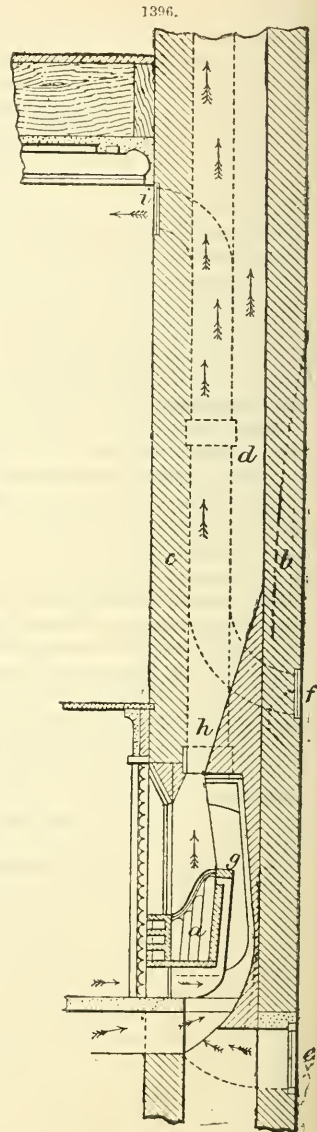

of inconvenience, and sometimes of danger. The going down of the fire during the night-time, or its neglect for a few hours at any time, is followed by condensation of the steam. On the addition of fuel and increase of heat, steam again flows quickly into the pipes where a partial vacuum has formed, and here, on coming in contact with the condensed water, it drives the water violently, and creates such shocks as sometimes occasion explosions; or, at least, produces very disagreeable noises and general uneasiness, and frequently causes cracks and leaks. Hence direct steam heat, which for warming purposes alone is altogether superior to indirect, has been well-nigh abandoned. Indirect steam heat places the leaks out of sight, but they commonly lead to mischief, and require special and expensive provision for access and repair.

FOUNDATIONS.—The foundation of a building is the horizontal platform, either natural or artificial, prepared for carrying the walls and super-structure. It must not be confounded with “footings,” which are the bases of walls made broader to distribute the weight more equally over the foundation; nor with piers, although it is not always easy to define where a foundation ends and where a pier begins: in general, all those parts of a structure which are sunk in the natural soil, the conditions of which are therefore different from those parts above ground, are foundations. There are 3 important points which should be considered in all foundations:—(1) That the weight to a unit of area imposed upon it should not be more than it and the subsoil below it can bear. (2) That it should be as nearly as possible homogeneous and equally strong throughout. (3) That the upper surface should be horizontal: if not in one, then in several planes.

Rock.—It is generally supposed that rock is a dangerous substratum to make a foundation platform from; for it is rarely that rock is found so homogeneous as to provide a large horizontal surface without artificial filling in; and it is difficult to make the filling in as hard as the rock itself, which it should be, that the settlement, if any, may be uniform. Also in many cases of inclined strata there is the danger of one part of the strata slipping over the other from the additional pressure of the building. A foundation in rock should never be less than 1 ft. in depth, for security against slipping and detrusion.

Gravel.—Many consider a sound thick stratum of gravel to be the most secure foundation possible. In such cases it is only necessary to sink a little into the stratum, rather more than into rock, and to take care that the area of foundation is proportional to the weight per square unit the gravel is calculated to bear. When the gravel is not sound, besides the latter precaution, it is advisable to sink deeper and fill in with an artificial foundation of concrete or large stones or hard durable timber.

Sand.—When in thick strata, and not liable to be moved by water or other disturbing cause, sand forms a very good foundation; it is desirable to sink deeper into sand than into gravel, and to fill in with an artificial foundation to counteract any irregular settlement of the sand. When exposed to the action of water or any other moving action, however slight, sand is a dangerous foundation to trust to, on account of its great mobility.

Clay appears to be considered an uncertain and troublesome substratum for a foundation, on account of the irregularity of its strata, and its action on being disturbed; for there is a tide in the land as well as in the sea. In consequence of clay's plasticity and its retention of water, it is liable to yield unequally to the pressure of a building, and to move irregularly when exposed or cut into: consequently, care must be taken both to spread the structure over a large area of foundation and to load the foundation uniformly in the course of the construction. A bed of clay can be sometimes made firmer by piling or by making holes in it and filling them with stones or gravel: the elasticity of clay is sometimes so great that piles are often forced up again by the action of driving the neighbouring piles.

It frequently happens, especially in the alluvial banks of rivers, that below the soft

ground of the immediate surface lies a hard stratum, and when the thickness of the soft superstratum is not great (30 ft. may be considered a maximum for ordinary cases), a secure foundation may be obtained by carrying piles or piers down to the hard ground below, and supporting a horizontal platform on their tops. These may be wooden or iron piles driven till they enter the hard bottom; or piers formed by sinking well-holes through the soft ground and filling them up with masonry, loose stones, or even sand, though this last should only be used when the superstratum is sufficiently firm to resist the lateral pressure of the sand. The tops of these, if piles, may be connected by beams and planks forming a horizontal platform; or if piers, by arches filled in at the spandrils to a horizontal surface. These piles or piers must be considered as columns fixed at the bottom and calculated accordingly, without trusting to the lateral support of the intermediate strata.

Firm Ground overlying Soft Ground.—In some cases of alluvial foundations, a comparatively firm stratum of gravel or clay is found at the surface or near it, the substrata below that being much softer. In such cases, if the weight of the structure is not very great, it is frequently desirable to leave the hard crust unbroken; but then the area of foundation should be enlarged, beyond what would be used for the same stratum, if of considerable thickness; and special care should be taken to distribute the pressure equally. Also in these cases the hard crust should be cut into as little as possible for any purpose; if it is clay, there is danger of it yielding by exposure to air and wet; if the substratum is sand, there is danger of its being moved by the action caused by drainage or any operations of that kind, consequent on the building.

Soft Ground of Indefinite Thickness.—When the soft superstratum is of indefinite or very great thickness, and not hard enough to “float” the building upon it, by extending the area of the foundation, it must be supported upon piles or piers, carried sufficiently deep that the friction on their sides will be enough to carry the weight. In the case of piling, they should be closer together than in the former case, and the heads of the piles, besides being connected together with timber framework, should be surrounded with a mass of masonry or concrete, to distribute the weight and add to the resistance. If piers are employed they may be of masonry, sunk in the manner that wells are formed, and which are used as foundations by the natives in India, or they may be hollow cylinders of iron.

When the ground is exceedingly soft, there is considerable danger of the pressure on the part underneath the building causing the part surrounding it to rise above its original level; to counteract this, as far as possible, the piling or piers should be extended beyond the area of the foundation, and the ground in the immediate neighbourhood should be consolidated or weighted with stones or concrete, and as few excavations as possible should be made in the natural soil. It is also necessary in these cases to equalize the pressure all over the area of the foundation, because there is sure to be a settlement, however small, and the smallest irregular settlement will cause a break in the structure. Equalization of the pressure on the foundation will not, however, prevent an absolute settlement, nor a rising in the neighbouring ground, which latter can only be counteracted by piling and counterbalancing the pressure by weighting the surrounding parts.

Concrete.—The nature of concrete that should be used for a foundation depends on the nature of the soil it is to be laid in: the object in all cases being to get as nearly as possible a homogeneous bed under the structure. If the soil is dry, a concrete of sand, gravel, and as much ordinary lime as is necessary to produce a coherence of it altogether is sufficient; as it is little more than a bed of coherent gravel; but then it must be spread over such an area that it might be sloped at an angle of 45° from the outside of the footings of the walls, down to the bottom of the foundation; and of such a thickness that it will not be liable to crack under the pressure. For ordinary buildings probably 2-3 ft. is sufficient. If the soil is wet, or the building is of great weight or special

character, the concrete should be made of hydraulic lime and sand and broken stones, in about the same proportions as would be used in rubble masonry; that is to say, the lime should be about $\frac{1}{7}$, the sand about $\frac{2}{7}$, and the broken stones about $\frac{4}{7}$. These, however, must be considered only as average proportions for medium hydraulic lime and ordinary wet soils; the proportion of lime must be varied inversely as its quality is better or worse, or as the circumstances are more or less important. In such cases the concrete, if properly constituted and laid, may be considered as a solid coherent mass, capable of bearing without crushing the weight per sq. ft. mentioned in recognized tables as the crushing resistance of different kinds of concrete, a proper coefficient of safety being used. The bed of concrete must also be thick enough not to break by transverse strain, but so as to settle in one mass if the subsoil yields. These 2 considerations will determine the area of the bed for the foundation.

With moderate hydraulic limes and common limes there will be an expansion of the mixed concrete, consequent on the slaking; in some cases the lime increases to double its original bulk; this may be almost entirely provided for by allowing time for the lime to be thoroughly slaked before laying the concrete; in some cases, however, the lime, or parts of it at least, will take so long to slake, that the process is completed after the concrete is laid, and it is therefore generally desirable to consider this expansion in preparing the site for the concrete.

As the principal object in laying a bed of concrete is to form a solid cohesive mass when it hardens, it has been sometimes recommended that it should be thrown in from a height to consolidate it; this practice, however, has the disadvantage of separating the fine from the coarse particles: it is better to lay the concrete from barrows or boxes on the level of the site, and to consolidate it afterwards by ramming; in ordinary foundations, to effect this properly and to allow the lime to set, the concrete should be laid in strata of not more than 1 ft. thick each; it is very desirable to bond these strata into each other in the process of laying, as the joint between 2 days' work is always a weak part in the mass. In large foundations, or with strong hydraulic lime, it is better to make the strata 2-3 ft. thick; on that account, for the same reason, the whole of one stratum should be laid as quickly as possible.

Fascines.—In soft marshy ground of great depth, a foundation of fascines is frequently employed in places where suitable brushwood is plentiful, in Holland for instance; and in such places it is highly approved of. Its recommendations appear to be that when carefully made it is elastic, durable, and uniform. Authorities differ as to the best size of fascine for foundations; Paisley recommends 6 in. diam.; Lewis used them 12 in. diam. successfully.

Piling.—There are 2 modes in which piles may be used to form a foundation:—(1) When the soil is soft for a considerable depth; in which case a large area should be covered with piles connected together by framework at the top, and so forming one united body, which would resist settlement chiefly by the friction of the subsoil against the sides of the piles. (2) When there is a stratum of hard ground below the soft; in which case the piles should be driven into the hard stratum and each pile would act as an independent column bearing a certain proportion of the whole weight, and resisting settlement both by friction and by its own transverse strength. But this does not come within the range of ordinary house-building.

Footings.—In the process of constructing a wall, the mason or bricklayer first lays the "footings" on the foundation platform. The footing is an enlarged portion of the wall for the purpose of distributing the weight over the foundation: it is properly a portion of the wall and not of the foundation, although it is not always easy to draw the line between them. When the pressures pass down through the centre of the wall, the footings may project equally on each side; when otherwise, the footings should be so arranged that the line of pressure shall pass nearly through the centre of them into the foundation. The size of footings and the mode of forming them increase to the thickness of the wall

must depend on the circumstances and the material. For ordinary buildings, Tredgold recommends that the extreme breadth of the footing, when the subsoil is clay or sand, be double the thickness of the wall; if on gravel or chalk subsoil, that its breadth be to that of the wall as 3 to 2.

Supposing the whole pressure per lineal foot on the wall to be equally distributed over the breadth of footing ab , Fig. 1397, then the reaction of the subsoil on the part bc will be equivalent to that proportion of the whole pressure, acting upwards and tending to break the projecting part bc about the section cd , which section must be strong enough to resist that transverse strain; in brickwork it is usual to make the projection of a footing for light buildings $\frac{1}{2}$ of a brick in every course, and for heavy buildings $\frac{1}{4}$ of a brick in every 2 courses. In stonework the proportional projection for a given height of course may be greater, according to the relative transverse length of the stone. The footings should always be made of large stones or of picked bricks, laid in very good mortar, and well bonded, with the object of distributing the pressure as uniformly as possible over the foundations. The foundation platform should, if feasible, be in one horizontal plane, and the footings should be equal in height throughout the main walls of a building, in order to avoid, as much as may be, irregularity of settlement from unequal heights of wall.

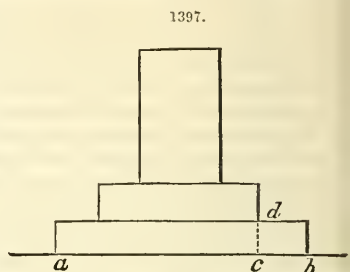

The "damp course," as it is commonly called, is a course of some impervious material to prevent the damp rising from the ground through the masonry into the body of the wall. It is generally placed immediately above the footings, if these project above ground; but the damp course should be, if possible, 1 ft. above the ground. It generally consists of 2 or 3 courses of hard-burnt bricks laid in hydraulic mortar. A highly-burnt glazed hollow brick is made for the purpose, the perforations being horizontal, so that a current of air passes through the wall at that point. Perforated bricks are liable to crack under pressure.

ROADS AND BRIDGES.—These subjects may be brought together under a single head as constituting the means of approach to a building.

Roads.—Ordinary roads may be divided into 2 classes,—temporary and permanent. Attention will here be confined to the former.

The first idea of a road is a path or track on which a foot-passenger can travel. In the American forests the trees are blazed or marked to show the direction. On the prairies men travel by compass or by the stars; or by watching their own shadows, or noting the direction of the wind. Successive travellers following the same route will tread down a forest path, which is the first step towards road-making. On such a road, rivers will be crossed by swimming or wading, or by rafts; or felled trees might be used on very narrow streams; while ranges of hills would be passed by following the beds of mountain torrents. The employment of animals necessitates the improvement of the roads. The footpaths are widened, the forest is cleared, rude bridges of logs are formed, or rafts made of wood, of empty vessels, or of inflated skins.

Suppose it is required to make a temporary road from one settlement to another in a wild unmapped country. If a traverse were run by compass and chain between the 2 places, and plotted on paper, the magnetic bearing of the one place from the other would be ascertained, and a straight line could be run between them by means of the compass. If 2 flags are set up in the proper direction at some distance apart, then, by means of a third flag brought into line with the 2 former, a straight line could be run for many miles with a very slight deviation from accuracy. Where a compass is not available, a

fire lighted at one place may, by its smoke, enable its direction to be seen from the other.

This line so run, and marked by a trench cut in the ground, will often be a practicable line for the road in a new country; if not, it will at any rate be a valuable guiding line towards which all deviations caused by various obstacles should return. The line so marked out should be cleared for a width of 10, 20, or 30 ft.; a ditch cut on either side to serve as a drain, and the earth excavated thrown in the centre of the road to assist the rain-water to run into the ditches. Inequalities of surface can then be levelled as far as possible. Small streams may be crossed by temporary bridges if wood is available; if not, their banks must be cut down, if necessary, to a gentle slope, so as to enable carts to pass where the stream is dry or nearly so, and such slopes, as well as the bottom of the stream, may be paved, if material is available.

The following is a description of a temporary road of this kind made over the dry bed of the Chenab river in the Punjab, and may be taken as a general example.

The total length for the roadway across the Chenab measures 10,600 running ft., of which 1350 ft. consist of a metalled road; 3500 ft. rest on firm soil, extending from the road embankment to within 1000 ft. of the south side of river, and the remaining 5800 ft. extend across entire sand.

The roadway consists of one layer of grass fascines, each fascine being 24 ft. long, 6 in. in diameter, and tightly bound with grass, packed closely together and covered with 6 in. of clay. On the surface of the clay, and to prevent its cutting into grooves, a very thin layer of loose grass is constantly maintained. An inch of clay is first laid down on the sand, all hollows are filled in and low points somewhat raised, that the foundation may not suffer from the lodgment of water. In other places the finished road is 1 or 2 in. above the sand.

Whatever improvements are made in such roads should be directed towards the most formidable obstacles at first; this is, indeed, self-evident, the strength of a road, as of a beam, being only that of its weakest part; but it is not always easy to determine what are the most formidable obstacles, nor whether it will be more economical to lay out a given sum in raising a portion of embankment, cutting down a hill, improving the surface, or building a bridge, but much of course will depend on the peculiar circumstances of each case.

Similarly to the trellis road used on the early railways in the United States, ordinary roads of a temporary character are sometimes constructed exclusively of timber, and are termed plank roads.

The method most generally adopted in constructing plank roads consists in laying a flooring, or track, 8 ft. wide, composed of boards 9–12 in. in width, and 3 in. thick, which rest upon 2 parallel rows of sleepers, or sills, laid lengthwise in the road, and having their centre lines about $\frac{1}{2}$ ft. apart, or 2 ft. from the axis of the road. Sills of various-sized scantling have been used, but experience seems in favour of scantling about 12 in. in width, 4 in. in thickness, and in lengths of not less than 15–20 ft. Sills of these dimensions, laid flatwise, and firmly imbedded, present a firm and uniform bearing to the boards, and distribute the pressure they receive over so great a surface, that, if the soil upon which they rest is compact and kept well drained, there can be but little settling and displacement of the road surface, from the usual loads passing over it. The better to secure this uniform distribution of the pressure, the sills of one row are so laid as to break joints with the other, and to prevent the ends of the sills from yielding, the usual precaution is taken to place short sills at the joints, either beneath the main sills or on the same level with them.

The boards are laid perpendicular to the axis of the road, experience having shown that this position is more favourable to their wear and tear than any other, and is beside the most economical. Their ends are not in an unbroken line, but so arranged that the ends of every 3 or 4 project alternately, on each side of the axis of the road, 3 or 4 in.

beyond those next to them, for the purpose of presenting a short shoulder to the wheels of vehicles, to facilitate their coming upon the plank surface, when from any cause they may have turned aside. On some roads, the boards have been spiked to the sills, but this is unnecessary, the stability of the boards being best secured by well packing the earth between and around the sills, so as to present, with them, a uniform bearing surface to the boards, and by adopting the usual precautions for keeping the subsoil well drained, and preventing any accumulation of rain-water on the surface. The boards for plank roads should be selected from timber free from the usual defects, such as knots and shakes, which would render it unsuitable for ordinary building purposes, as durability is an essential element in the economy of this class of structures. Boards 3 in. thick offer all the requisites of strength and durability that can be obtained from timber in its ordinary state, in which it is used for plank roads.

Besides the wooden track of 8 ft., an earthen track of 12 ft. in width is made, which serves as a summer road for light vehicles, and as a turn-out for loaded ones; this, with the wooden track, gives a clear road surface of 20 ft., the least that can be well allowed for a frequented road. It is recommended to lay the wooden track on the right-hand side of the approach of a road to a town or village, for the proper convenience of the rural traffic, as the heavy trade is to the town. The surface of this track receives a cross slope from the side towards the axis of the road outwards of 1 in 32. The surface of the summer road receives a cross slope in the opposite direction of 1 in 16. These slopes are given for the purpose of facilitating a rapid surface drainage. The side drains are placed for this purpose parallel to the axis of the road, and connected with the road surface in a suitable slope.

Where, from the character of the soil, good summer roads cannot be had, it will be necessary to make wooden turn-outs, from space to space, to prevent the inconvenience and delay of miry roads. This can be effected by laying at these points a wooden track of double width to enable vehicles meeting, to pass each other. It is recommended to lay these turn-outs on 4 or 5 sills, to spring the boards slightly at the centre, and spike their ends to the exterior sills.

The angle of repose, by which the grade of plank roads should be regulated, has not yet been determined by experiment, but as the wooden surface is covered with a layer of clean sand, fine gravel, or tan bark, before it is thrown open to vehicles, and as it in time becomes covered with a permanent stratum of dust, it is probable that this angle will not materially differ from that on a road with a broken-stone surface, like that of M'Adam or of Telford, when kept in a thorough state of repair.

In some of the earlier plank roads made in Canada, a width of 16 ft. was given to the wooden track, the boards of which were laid upon 4 or 5 rows of sills. But experience soon demonstrated that this was not an economical plan, as it was found that vehicles kept the centre of the wooden surface, which was soon worn into a beaten track, whilst the remainder was only slightly impaired. This led to the abandonment of the wide track for the one now usually employed which answers all the purposes of the traffic, and is much more economical, both in the first outlay and for subsequent renewals and repairs. The plank roads possess great advantages in a densely-wooded country, and will be found superior to every other kind as a temporary expedient.

Pavements.—The London method of laying pavements is, first, to carefully grade the ground, sometimes using concrete to secure a firm foundation, where the soil is too soft; generally, sand spread over the level ground is considered good enough. The curbing is made of roughly "pene-hammered" grey granite, 12 in. wide on the top, and 6 in. high. Beside this run the gutters draining the roadway. The flagging is generally 3-4½ in. thick. The edges are all squared, not being just pitched under, as is the practice in America. The edges are chiselled, not very elaborately, but sufficiently for the purpose, so that when the flagging begins to wear away, under the continuous traffic, the joints will continue good until it is threadbare, if ever it is allowed to

remain long enough to get into that condition. A liberal allowance of mortar is thrown down on the sand in which to bed the stones. The stones are placed close together, the inspector of sidewalks generally demanding that the joints should not be more than $\frac{1}{4}$ in. apart, and well filled with binding and hardening cement. The surfaces of the flags are machine-dressed, or rubbed, so that they always meet evenly at the joints. The rough stones are brought to the streets to be paved and are stacked in piles. The pavers take them, preparing the edges with wonderful rapidity. They have a good way of splitting the flags: anything under 6 in. thick is broken in the same way that American marble-workers use to break up their slabs. American flaggers can break a stone very quickly, but no quicker than the English workmen, who also do it more neatly, and with less waste of material. A line is drawn on the face where a break is required; this is "strummed" in with a "pitching-tool" or "nicker"; the edges are also strummed in. Then the stone is smartly struck on the back with a round-faced hammer, 3 blows generally breaking it neatly down the line. This method can be used by American flaggers, as it is successfully done with North River bluestone and with all kinds of sandstone in the brownstone cutters' yards, when cutting up sawn slabs for ashlar. Almost any kind of thin stone can be broken in this way, without the use of either wedges or plugs.

The pavements between the gutters are generally macadamized, although, as with us, stone and wooden blocks are used quite extensively. In the city proper most of the leading thoroughfares have recently been laid with a new patented preparation of asphalt. Asphalt-covered roads are a great improvement. The noise of heavy traffic is greatly diminished, and it becomes possible for pedestrians to hear each other speak without effort. At first this new system met with the unqualified approval of owners and drivers of horses; but complaints have recently been made that the least drop of rain renders the road so slippery that it is as bad as driving on ice, and the horses continually stumble and lame themselves. This could probably be obviated by sprinkling sand over the asphalt. It will require very strong remonstrance to induce the authorities to cease using the new material. Its two great qualities, cleanliness and quietness under heavy traffic, will outweigh a host of minor objections.

Near the opera-house at Vienna a small piece of the road is laid in the same way as that just mentioned. It is the best piece of road in the whole city. Asphalt pavements for interiors are also much used in Vienna. The finest example is in the hall of the Vienna Museum of Art and Industry. This is laid in different colours. The following is a translation of Suppantchitch's instructions for laying it. (1) Bring your caldron as near as possible to the place where you intend to lay your floor, in order that you may lay it down as hot as you can get it. (2) Put into the caldron 10–15 lb. of pitch; into the pitch put your asphalt. This latter must be placed in the caldron when the pitch is red-hot. (3) The asphalt must be pounded into small fragments before mixing with the pitch. (4) After the asphalt has been in the pitch 1 or $1\frac{1}{2}$ hour, stir it up well with an iron bar, broad at the end, until the asphalt is perfectly dissolved. Once this is done, fill the caldron with fine sharp sand; allow this sand to get warm for $\frac{1}{2}$ hour by a good fire before mixing, so that it may of itself combine with the asphalt. (5) Next stir up the contents of the caldron at short intervals. If the composition become stiff and difficult to stir, add a few lb. of pitch, using judgment as to how much. (6) In laying it on bridges, thoroughfares, or viaducts, it is advisable to use more pitch. as the composition will then become more elastic. The asphalt will set without cracking. (7) If, in stirring it, yellow vapours arise, that is an indication that the composition is ready for use. In order to prove the fact, make the following trial: dip a chip of wood into the composition, and observe if a greasy substance adheres to it; if such is the case, boil it more, until you are able to take the chip of wood out perfectly clean. The foreman must see that the ground to be covered is well swept, and clear of mud, damp clay, or any such substance. He then lays down iron rails, 3–4 ft. apart.

Those rails serve as a rest for the float used to make a level surface. One man attends to the caldron, another carries the prepared composition, in iron or wooden pails, to the operator. The workman who empties the caldron must not neglect to stir the contents of the caldron during this time, as the sand, being heavier than the pitch or asphalt, is liable to sink to the bottom, causing an uneven surface.

In order to produce asphalt in colours it is necessary to observe the following rules:— (1) A foundation of concrete, 1-1½ in. thick. (2) Float upon this a covering of black asphalt, ½ in. thick, as silicates will combine easiest with this. (3) Put down thin wooden strips according to the pattern you desire to produce. These rails of wood should be cemented to the floor with hot asphalt. (4) Then commence laying out the black part of the design. This should always be done first, as the black composition would be apt to soil the light colours if not laid down first. (5) In order to make the edges straight and even, it is necessary to smooth them with the curling-iron, Fig. 1398. The wooden forms can be taken away when the composition becomes hard enough to stand without support. (6) Once the design is all laid, commence polishing it with a piece of smooth sandstone attached to a handle, as shown in Fig. 1399. (7) Production of artificial black: 40 per cent. chalk, 40 fine soft sand, 20 evaporated coal-tar. (8) White silicate: 35 per cent. chalk, 35 pure white sand (silver sand), 22 pure white rosin, 8 tallow; first put the rosin into the caldron—it must be well melted; then put in your chalk; ½ hour afterwards mix in the sand; stir well and add the tallow. Asphalt in colours (red, blue, yellow, and brown) is to be boiled like the white composition, only adding the respective mineral colours.

Cement floors.—Portland cement, and compositions that resemble that material, are used for a variety of purposes in Vienna; among others, for making artificial-stone sidewalks. A dry soil is to be preferred; but if it should be moist, marshy, or a clayey soil, great care must be taken to make the foundation as firm as possible. This will be a matter in which the workman must exercise his own judgment and experience. The first layer of concrete should be composed of 1 part cement and 3 of coarse gravel. This is laid upon the soil which is already smoothed and graded. The thickness of this layer will vary according to the nature of the soil. The second layer should be mixed in equal parts, 2 of cement and 2 of fine sand. Then a third layer, equal parts cement and sand, completes the work.

The workman finishes a piece about 3 ft. wide, from the wall to the curb, before he attempts to touch another length. The first layer is to be well rammed down to make it compact; the other 2 layers are to be floated on as quickly as possible. It requires about 4 days for the sidewalk to harden. During this time it should be frequently sprinkled with water. Spring or autumn is the best season in which to lay the cement. Summer is too dry, and winter weather is too severe. A sidewalk thus prepared will last about 15 years.

The curbing is also made of cement. This is generally formed in a mould. The joints are made to fit into each other to prevent shifting after they are set. The body of this curb is composed of 3½ parts broken stone or gravel to ½ of cement; it is coated with a surface of equal parts fine sand and cement. Steps are made in the same way. These would serve for door-steps if they had no weight to carry. The makers of such

1398.



1399.

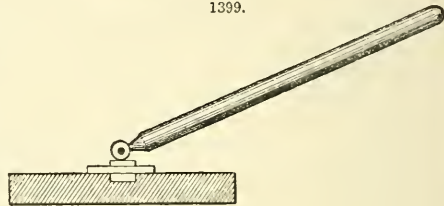

concrete-work claim that, when properly hardened, it is stronger than stone. This is doubtful.

Bridges.—Obviously, to discuss the construction of bridges of large dimensions is quite beyond the scope of the present work.

A simple form of timber bridge is shown in Fig. 1400, in which stout beams *a* are supported on posts *b*, duly fixed and strutted, with a flooring *c* carrying posts *d* and hand-rails *e* braced as at *f*. When the stream admits, central posts may be dispensed with,

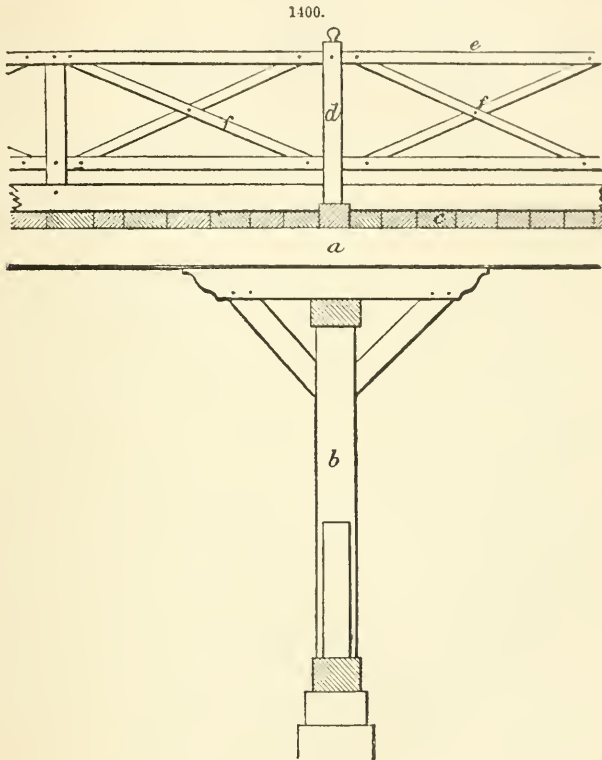

and the beams supported only at the ends. The arrangement must be adapted to meet the requirements of the force of the stream, height in flood, liability to change of course, silting up of the bed, and probability of ice, fallen trees, &c., being carried down against the structure. Usually the narrowest point on a stream is the best for a bridge.

An efficient substitute for a bridge, often used in India on watercourses which contain little water during a great portion of the year, and are only flooded occasionally, consists of a paved causeway. The banks are cut down to a gentle slope on each side, and a pavement or solid flooring of masonry or concrete is built to afford a firm roadway for vehicles, at such a level that the water does not enter them. One across the river Soane is a mile long and 12 ft. wide. Boat bridges are useful under some conditions, and are constructed by laying a plank platform on balks of timber resting on the banks of the stream and on boats lashed together. In hilly districts foot passengers can cross rivers in travelling cradles suspended from a single cable; or there may be a rope for

the feet and 2 others for the hands, kept in position by triangular sticks; or 2 foot-ropes may be laid parallel and support a platform of bamboo. In India, beams weighted with stones are made to gradually project from each side till they meet in the centre; these are called *sangloos*.

BANKS, HEDGES, DITCHES, AND DRAINS.—Every house possessed of a garden or standing in the country will have more or less need for fences to exclude stray animals, and the means of carrying off surplus water during storms.

In making banks, the necessary material is thrown or wheeled into position, and piled up in such a way that it will retain the position given to it. To ensure this it is essential to observe a correct slope. Most materials will lie naturally at an angle not exceeding 40° with the horizon, while 20° or even 10° will suffice if the surface is covered with turf, the binding together of the earth by the roots of the grass preventing the scouring effect which would otherwise be exerted by every shower of rain. When such materials as large stones are available, the bank may assume more the nature of a wall, and be built on one side at least very nearly vertical. The same object may be attained by driving 2 or 3 rows of stakes into the firm ground beneath, and ramming the earth tightly around them; or a sort of hurdle may be made by winding brushwood among the stakes.

Banks are seldom used alone for the purpose of a fence, being usually supplemented by a hedge planted at the top. This is generally of hawthorn, from its impenetrable character, though many other shrubs are available in different regions, for instance fuchsias are so planted in Ireland. The hedge serves a double purpose of great utility in forming a serviceable fence and presenting an obstacle to the wind and a shelter for cattle. On the other hand it harbours vermin. In connection with the hedge and bank, a ditch is needed. This increases the effectiveness of the fence, and drains the roots of the hedge, besides being a ready means of supplying the material required to form the bank. As the hedge and ditch occupy a considerable space of land, it is a pity that some tree or shrub affording a useful product cannot be more generally adopted.

Drains, not to be confounded with sewer pipes, are provided for the purpose of easily and effectively carrying off the excess of water which falls during heavy rain, preventing its lying in a stagnant condition to the detriment of health and vegetation. Obviously this could be accomplished by simple open ditches having the requisite amount of fall, i.e. being cut in such directions as suited the undulation of the surface, in order to accommodate the natural tendency of the water to find the lowest available level. But an open drain is very costly to keep free from weeds and fallen earth, and becomes a receptacle for the best portion of the soil, washed into it by the rushing water. Therefore the first principle in draining is to provide a channel for the water at such a depth beneath the surface as the nature of the ground determines: that is to say, when the subsoil is a stiff clay impervious to moisture, the drain channel should be only so far beneath the surface as to escape all possibility of contact with the plough or spade used in tilling the surface; while in more porous soil the depth may be 3–4 ft.

The first step is to set out the lines which the drains are to follow, choosing the lowest level for the main channel, and letting the others meet it at an angle of about 30° . On these lines trenches are dug with a trenching tool to the requisite depth and with contracting sides. In these trenches a water channel is formed in various ways. In stiff clays, filling the bottom with brushwood and then replacing the surface earth will often be effective for years. But a far more enduring and efficient method is to occupy the lower space with stones in some form. Fig. 1401 shows several methods of using stones in drains: at A, clean round stones *a* are packed closely in half the depth of the trench, and covered by a turf clod *b* to prevent dirt washing down among them; at B, the round stones *a* rest on a triangle of 3 flat stones forming an open channel *c*; at C, the 2 flat stones *a* placed on edge are kept apart by a large rough stone *b*, and smaller stones *c* and a clod *d* complete the arrangement; at D, 2 flat stones *a* on edge

support a third *b* lying flat, and this is overlaid by rough stones *c* and elod *d*; at E, the whole channel is formed of flat stones, 2 on edge and 2 flat, the earth coming immediately on the lid *a*. All these are cheap, enduring, and effective plans,

1401.

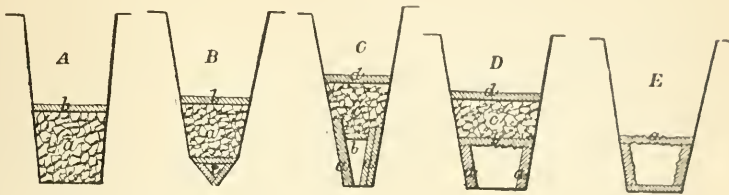

adapted to almost any country. The most perfect system is to lay earthenware drain-pipes in the bottom of the trench, placing them end to end without joining them, so that the water may enter at the interstices.

WATER SUPPLY AND SANITATION.—The supply of good water to the house and its outbuildings is of primary importance. The chief sources of supply are rivers, springs, wells, and ponds.

In the case of river water, there is nothing special to mention, the supply being drawn by simple pumping. River water is usually contaminated by organic matters and mud, which can be removed by subsidence and filtration to a certain extent; but in populous districts the surface drainage and the impurities often contributed by manufactories, &c., render river water perhaps the least wholesome.

Spring water is generally free from organic matter, having been cleansed as it were in passing through the porous strata of the earth; but it is liable to have absorbed mineral matters by its action on the rocks met with, and often becomes very dirty at its point of issue from contact with the surface soil. The following simple contrivance may be adopted to deprive it of suspended impurities. Provide a stone or wooden trough, 12-15 in. deep, 2½ ft. long, by 12 in. or so broad. Divide this by a watertight partition, so that a space of 9 in. broad shall be left at one end, and of the depth of the trough. This partition should only reach to within 2 in. of the top edges of the trough. The bottom of the large division must be perforated with numerous holes. Dig a hole in the earth from whence the spring issues, and put this trough therein, so that the upper edges shall be a little above the level of the ground. Ram tightly all round it stiff and good clay—the harder the better. The water from the spring will issue through the holes in the bottom of the large division of the trough, and any mud brought up will be deposited therein. As the clear water fills the trough, it will reach the top of the partition and run over it into the small divisions at the end, free from deposit. The supplies required should be taken from this division.

Wells constitute another method of obtaining the supplies of water gathered in fissures in the lower strata, compelling the liquid to collect in artificially constructed openings rather than escaping naturally to the surface in the form of a spring. The choice of a locality for sinking a well cannot be determined upon without some knowledge and application of the character of the strata. The gravel, clay, and sand beds of the recent sedimentary formations generally yield more or less water at a reasonably shallow depth; in the older formations, it will be necessary to go much deeper, but the supply is more abundant and less likely to be contaminated by organic matter. Hence the latter source is preferable for large waterworks supplying towns.

A well may be defined as a deep cylindrical hole, walled round by bricks laid loosely in succeeding courses. The manner of sinking it varies somewhat according to the soil. In the case of a clay soil with intervening beds of sand and stones, a circle of 8 ft. diam. is

described on the surface of the ground, from whose area the surface soil is removed to be used elsewhere as compost. After throwing out a depth of 8-9 ft. with the spade, a winch and rope and bucket is set up to draw the earth out of the well. While the digging is proceeding, a sufficient number of flat stones are laid down near the winch, by which they are sent down to build the ring. A depth of 16 ft. will probably suffice; but if no water is found, the digging must proceed to the requisite depth. A ring of 3 ft. diam. will be large enough bore for the well; the rest of the space should be filled up with dry rubble masonry, and drawn in at the top to 2 ft. diam. When the building is finished, the water should be removed from the well with buckets if the quantity is small, and with a pump if it be large, to allow the bottom to be cleared of mud and stones. A thick flat stone, reaching from the side of the ring to beyond the centre, is firmly placed on the ground at the bottom of the well for the wooden pump to stand upon, or for the lead pipe to rest on. If a wooden pump is used, a large flat stone, having a hole in it to embrace the pump, is laid on a level with the ground upon the ring of the well; but if a lead pipe is preferred, the flat stone should be entire and cover the ring, and the clayey earth be thrown over it.

Where the well has to be sunk in loose gravel or sand, a different plan has to be adopted. The diameter of the well will be 3 ft. 6 in. inside of the building, and the building, instead of rubble, will be of droved ashlar, each stone 8 in. broad in the bed, 12 in. deep, about $21\frac{2}{3}$ in. long, in the chord of the arc of circle on the one side, and 17 in. long in a straight line on the other side. The outside of the stones is formed neatly to a circle, and their inside into an octagon. Beds square; ends properly bevelled and wrought correctly to a mould; each course to contain 8 stones of equal size; a ring-board to be formed of willow, not to flavour the water, $8\frac{1}{2}$ in. broad, $1\frac{1}{2}$ -2 in. thick, and $\frac{1}{2}$ in. larger than the outside circle of the stones. The ring-board could be made stronger in 2 courses of 4 pieces of equal size. In building upon the ring-board, the first course of stones to have the centres of their face raised perpendicular to the inside of the ring-board. The centres of each stone of the second course to be placed over the joints of the preceding course, and also perpendicular to the inside of the ring-board. The inside face of each stone being a straight line, the inside diameter of the well being $3\frac{1}{2}$ ft., and the ring-board being correctly made, the inside ends of each stone will be back $1\frac{2}{3}$ in. from the centre of the face of each stone in the course immediately above it, and so on with every course. A small stick made as a gauge at one end, of $1\frac{2}{3}$ in. length, will be found handy for setting the stones. The outside circle must be most carefully made. The upper course to form a square instead of an octagon for the covers to rest on, and to slope to one side, to carry the water off the top of the well. The covers to be droved, and in 3 pieces, one of which to cover the building on one side and half of the well, and to be half-checked where the other 2 stones meet it in the middle, and they are to be half-checked into it, also half-checked into each other where they meet in the middle, and to cover the other side of the building. One of the stones covering a portion of the well to have an iron ring in it, by which to lift it freely out of the checks of the other 2 stones. The joints of the covers to be filled with putty well mixed with white-lead, to prevent water from the surface getting into the well.

Where the interior of the well is faced with bricks—"steined" as it is termed—a simple method of proceeding is as follows:—A dram-curb is provided, being a circular frame of wood, with a strong flat ring, of the same diameter as the intended well at top and bottom, the breadth of the ring being equal to the breadth of a brick; the depth of curb is 5 ft. or so. The ground being excavated to a depth equal to that of the curb, this is lowered into the excavation. The operation of digging is continued, the curb gradually descending—the excavated earth being removed by buckets lifted by tackle supported above the excavation by a triangular frame. The steining or brickwork is then built on the upper ring of the curb; the bricks are laid without mortar, care

being taken to arrange them so as to keep the form of the circle as perfect as possible, each course breaking joint with the one under it. As the sinking of the curb goes on, the laying of the bricks is proceeded with, until the necessary depth is obtained. It is scarcely requisite to point out the absolute necessity of making all wells circular: the sides of square ones would inevitably be forced in.

Well-sinking is performed in the following simple way in India:—A curb (*neemchuk*) or ring of wood 9–18 in. thick is laid on the ground, the masonry built upon it about 4 ft. high, and left to dry. The earth inside the curb is then scooped out, and the well descends gradually, when another 4 ft. of masonry is added, and the sinking continues till water is reached. In making a further descent, a sort of hugo hoe (*jham*) is used, being worked from above into the soil, and hoisted up with its load; meantime a *churus* is kept going to prevent the work being impeded by the inflow of water.

Of all the methods in use for raising the water from the wells, the ascending and descending buckets (the empty one descending as the full one is being pulled up) form the simplest. The buckets must be comparatively heavy to allow of their sinking into the water on being let down. The rope to which the buckets are attached is wound round a wooden barrel, revolving on 2 uprights at each side of the well mouth, and turned by a winch or handle. The well-covering should be made in 2 halves opening upwards, and hinged at the outer edges to a wooden frame placed round the mouth of the well. A small space should be left between the edges of the flaps, to admit of the rope passing freely. A small curb-wall should be made round the mouth, in order to prevent surface water running into the well; and a railing, some 3–4 ft. high, to prevent children having access. Especial care should be taken to sink the well at a spot where the surface drainage from the house, yard, &c., and underground drainage from cess-pools and such barbarous structures cannot possibly contaminate the water.

Several ingenious contrivances are in use in uncivilized countries for raising water for irrigation and other purposes. In India, when the lift does not exceed 3 or 4 ft., and when the hole or excavation is not too small, a swing basket covered with leaves or matting is used as a bale, being swung by 2 men. Water may be lifted in this way some 12–16 ft. in 3 or 4 stages, by as many pairs of men, at the rate of 1800 gal. per hour. For higher lifts, in Bengal use is made of the *paecotta*, or lever bucket, the counterpoise on the short arm being a heavy stone or mass of clay; this is the *shadoof* of Egypt, common throughout the East and even in Hungary, and naturalized among the gold miners of Australia, where it is called a “hand whip.” In the N.W. provinces of India a large leathern bag drawn up by bullocks, with the aid of a roller, is the generally adopted contrivance; it is termed a *churus* or *chursah*. The Chinese pump, or Persian wheel, consisting of an endless chain of buckets, worked by bullocks or other power, is often to be seen in Australian and Californian gold diggings.

Ponds are generally understood to be hollows filled with water which has flowed from higher ground around into a low-lying depression. Such water is generally very impure from stagnation and the accumulation of impurities washed in by the torrents during heavy rain. But it is available for all save drinking purposes. Even the water of under-drainage on clay lands may be collected in ponds or underground reservoirs for irrigating, supplying steam threshing machinery, &c. According to Bailey Denton, in some parts of the chalk districts underground tanks have been made by burrowing into the earth, and making a chamber or cavern (with an opening at the top for the removal of the soil), which, being lined inside with a thin covering of cement, is made perfectly watertight. Thus the most capacious tanks may be provided for comparatively a few pounds. This mode of constructing tanks might also be adopted in other geological formations besides the chalk, where the water level is low in the earth, with a considerable depth of drained subsoil above it, within which to make the “cavern tank.” Such a receptacle for water can only be adopted where the soil is naturally drained, and where there is no pressure of external subsoil water.

Much more important in many respects is the so-called "dew-pond," which is really an artificial rain-pond. The one described by Slade is situated immediately on chalk strata in the highest part of the Berkshire hills, and is entirely fed by rain and snow. In shape it resembles a shallow rain-gauge, without a vertical rim. Its greatest diameter is 69½ ft. The straight sides meet nearly at a point in the bottom, and form an angle of 11° 21' with the surface horizon. A layer of clay, about 12 in. thick, mixed with lime to stay the progress of earthworms, and covered over with first a coating of straw (to prevent the sun cracking the clay), and finally with loose rubble, make up its waterproof bed. The extreme depth is 80 in. It does not, however, hold this head of water, since a ring of the slope, extending from the top, and some 4 ft. in width, is unpuddled, in order to avoid an overflow and the consequent deterioration of the sides. In 40 years it has been only once known to fail, and that instance resulted principally from the growth of rushes whose roots struck through the clay bottom, causing leakage. The rush of cattle down its sides also helped to damage the clay bed. The ponds, kept free from these pernicious influences, have never been known to fail even in seasons of extraordinary drought. It remains to point out the weak features of the pond. Its efficiency is most impeded by evaporation and slope absorption. This absorption should be removed, since it is also associated with capillary attraction, and, in a twofold character, tends to weaken the supply and increase the loss. Were the slopes formed of a non-absorbing, non-conducting material, not only would all the rain be drained into the basin, but the capillary attraction of the sides would be banished, and evaporation from this cause cease. The faulty points, then, are the absorption by the rubble slopes and capillary attraction.

The stoneware drain pipes used for conveying refuse water, slops, &c., from the house to the main sewer or to the liquid manure tank, should be throughout laid watertight, and as smooth and even inside as possible. Where stoneware pipes cannot be procured, a good sound drain may be made of timber, in the form of a square covered trough, which is much used in Sweden. The entrance to all drain pipes and sewers must be carefully "trapped," to prevent the reflux of the bad gases arising from the decomposing fluids conveyed through the pipes. The principle of the trap is shown in Fig. 1402: *a*, bed of sink trough; *b*, pipe leading into drain; *c d*, the 2 arms of the trap, which are so formed as to always retain a certain quantity of fluid in the angle, and thus prevent the passage of any vapour from *d* towards *c*. Should the angle at any time become choked with solid matters, the perforated lid of *c* is taken off to admit of their removal.

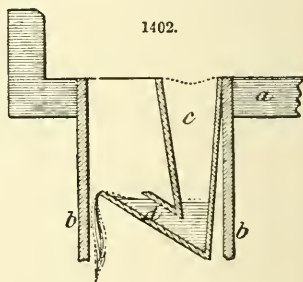

HOUSE CONSTRUCTION.—In many localities, the aid of an architect in planning a building has to be dispensed with, and various means have to be adopted with a view to utilizing the materials at hand. A few instructions under this head cannot fail to be useful.

Log Huts.—Where timber abounds this is the simplest and cheapest form of house. The logs are cut to the length determined on for the walls, and merely squared on 2 opposite faces, as in Fig. 1403, to make them lie close. Where doors and windows intervene, shorter lengths are laid, to afford the necessary space. The vertical position of the wall is ensured by driving posts into the ground and building the logs up between them; or by spiking the logs together with large nails; or by the employment of squares of board, as in Fig. 1404, secured by nails or treenails; or by laying the logs so that they cross alternately, as in Fig. 1405, where the side log *a* comes between the 2 end logs *b*, the ends of all 3 being protruded 1 ft. or more from the corner, while the inter

mediate end log *c* only comes so far as to abut against *a*: corner posts driven down both inside and outside the corner render it very strong. In forming the roof, provision must be made for sloping it, so as to throw off the rain and snow. A convenient height for the walls all round is 8 ft.; when this is reached, the amount of slope required in the

1403.



1404.

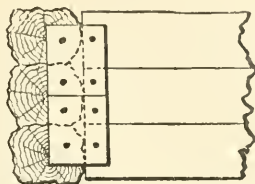

1405.

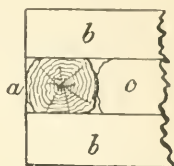

roof is determined, and from this is deduced the extra height to which one of the walls (say the front) must be carried. A rod *b* of the required length is fixed to the top *a* of the side wall (Fig. 1406), and from the top of *b* a second rod *c* is laid with its lower end resting on the back wall. Then the front wall must be taken up as high as the top of *b*, while the side walls are built up of logs *d* of diminishing lengths within the triangle described by *abc*. The remaining spaces *e* can be filled up afterwards with odd bits of wood.

1406.

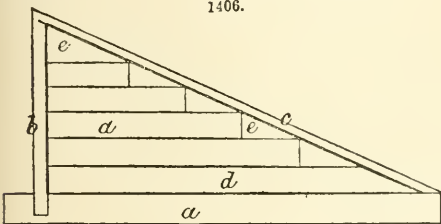

1407.

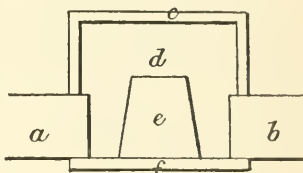

The ever necessary fire is best supplied in the form of a stove, the smoke pipe from which is carried through a large hole in the roof and well surrounded with clay to prevent any possibility of the rafters being ignited. Failing a stove, an open fireplace must be built, of bricks, stones, or other available fireproof material. The method of constructing a fireplace is shown in Fig. 1407: *ab* are the logs constituting the back wall of the hut; in them a space 3 ft. high and 2½ ft. wide is cut out; at the back of this is placed a frame *c* of any hard durable wood, measuring 18 in. from back to front, 3 ft. 3 in. high, and 2 ft. 9 in. long; a board *f* on the inside of the hut completes the fourth side of the frame, enclosing a space *d*, which is rammed full with good binding clay; when this is quite firm, an excavation is made in the clay, of the shape indicated at *e* in Figs. 1407, 1408; *g* is the front of the fireplace formed by inserting iron bars; *h* is the combination of the wall of the hut; *i* is the smoke flue, better illustrated in plan in Fig. 1409, and made by inserting a smooth

1408.

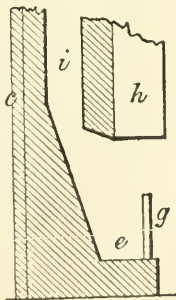

1409.

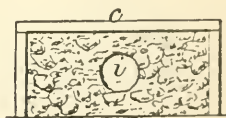

wet pole about 10 in. diam., round which the clay can be packed, and which can be readily withdrawn after the shrinkage due to drying. Bricks or squared stones may be used to carry the chimney a little higher than the roof.

Frame Houses.—These should commence with a foundation of brick or stone work carried up about $1\frac{1}{2}$ ft. above ground, or failing these materials, stout logs may be laid down. At proper intervals, the upright posts are inserted in this foundation, and prepared to receive the walling. This may consist of hewn slabs of timber for the outside lining, with an inner one of felt, Willesden paper, canvas, match-boarding, or whatever may be convenient, the intermediate space between the 2 linings, representing the thickness of the uprights, being packed full with earth, dry moss, or other non-conducting substance. Simple uprights will suffice when there is to be only one storey—a “ground floor”; but when a second storey is added, struts and braces must be provided to strengthen the uprights. The Americans have much improved upon the ordinary system of constructing wooden frame houses, by arranging the timbers so that nearly all strains come lengthwise on the fibres, and by relying upon nails driven diagonally rather than on tenons, scarfs, and other weakening cuts into the wood. Thus in erecting a small timber house, the site is levelled, and a few inches in depth of the soil is removed and replaced by a layer of non-absorbent material, such as furnace clinker; on this is laid a sill *a* (Fig. 1410) forming the whole foundation, measuring 6 to 8 in. by 3 in., and carrying

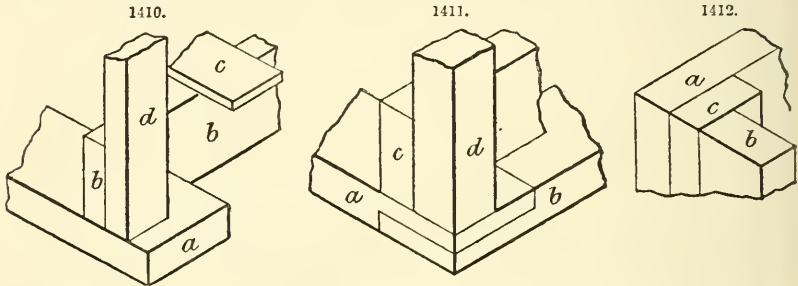

the joist *b* and stud *d*, each simply nailed by spikes driven diagonally, the joist *b* supporting the floor boards *c*. If the spaces between the joists are filled with non-absorbent material up to the level of the floor, an advantage will be gained in dryness, quietness, and general comfort; concrete will be even more desirable. Generally the sills simply

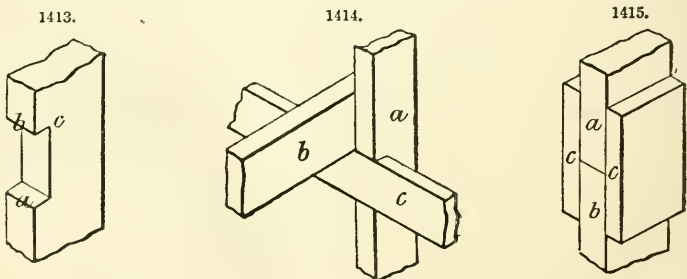

meet at the corners, but they may be halved together as at *ab*, Fig. 1411, if preferred, *c* being the joist, and *d* the stud. In small buildings, the studs are best set as in Fig. 1412, where *a* is the joist and *b* *c* the 2 studs. When an upstairs floor is to be built, a notch is cut in the inner face of the studs, as at *abc*, Fig. 1413, measuring 4 in. deep and

in. wide, for the reception of a bearer to carry the joists: see Fig. 1414, where *a* is the end, *b* the flooring joist, and *c* the intervening bearer, 1 in. wide and 4 in. deep. If it should be necessary to lengthen a stud, this is done by putting the extra piece end to end with the first, as at *a b*, Fig. 1415, either with or without a mortice and tenon joint, and nailing pieces of 1-in. board *c* on each side. To support the roof, a wall plate *c* is

1416.

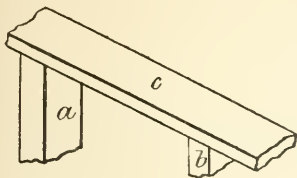

1417.

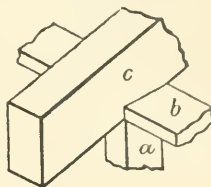

nailed on the square tops of the studs *a b*, Fig. 1416; the lower ends of the rafters are notched out to fit on the wall plate, one falling exactly over each stud as in Fig. 1417, *a* being the stud, *b* the wall plate, and *c* the rafter.

Earth Walls.—These are made by ramming cohesive earth into a mould. The earth selected should contain no stones larger than 1 cub. in., and those which are admitted must be of a rounded form. No organic remains liable to decay must be present. The consistency and degree of moisture of the earth should be carefully regulated in accordance with the conditions proved by experiment to be best adapted for securing the most perfect cohesion of the mass. The foundation for an earth wall should be a few courses of brick or stone. To erect an earth wall on this, recourse must be had to a mould, after the manner of concrete building. The construction and arrangement of such a mould are illustrated in Fig. 1418. The joists *a*, 4 in. wide and $2\frac{1}{2}$ in. deep, are laid on the

foundation wall *b* at intervals corresponding to the lengths of the boards forming the sides; on their upper face near each end a mortice is cut for the reception of the uprights *d*, at points allowing sufficient width for the boards *e* and a breadth of earth wall *c* equal to that of the foundation wall *b* below. The uprights *d*, which tenon into the joists *a* below and the cap pieces *f* above, should be about 30 in. high in the clear. Inside these uprights *d*, are fitted edge to edge, and united by tongues or pins, a series of 1-in., clean, well-seasoned pine boards *e*, not exceeding 14 ft. in length, while half that figure will often be more convenient. To strengthen the boards, they have battens nailed across them, outside, at intervals of about 30 in., and iron handles may be attached for facilitating removal. The wedges *g* are for the purpose of tightening the cap *f* on the uprights *d*, and adjusting the width of the wall. Angle moulds for the corners of walls may be made on exactly the same principles.

When a wall is intended to end abruptly, a head is put into the mould by fastening strips of batten to the boards *e* and dropping in a head board. In commencing to build, a few courses of brick are carried up with the joists *a* built in, so as to give rigidity to the mould; as the wall rises, the mould is taken apart for further use, the joists being driven out endwise, for which purpose they are made slightly tapering. When the first mould in height has been completed, recesses

1418.

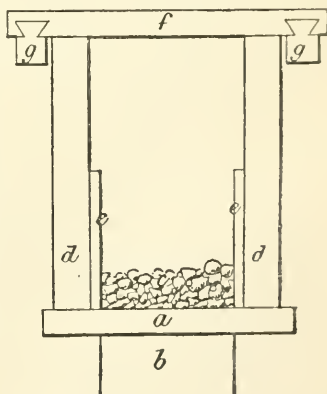

must be cut to admit the joists for the next stage. The use of the plumb level is of course as necessary with this as with any other kind of wall. In ramming the earth, a depth of 3-4 in. at a time is always enough, and the strokes should travel from the sides towards the centre and from one end to the other, leaving the end sloping where the next addition is to be made. In building the second course, care should be taken that the joists fall between the joist holes of the preceding course, and the ramming should commence from the opposite end of the wall. The joist holes may be afterwards filled up with wooden blocks, for convenience in fastening the internal fixtures, and wooden joists may be built in lengthwise at intervals. The rammer should weigh about 14 lb. Unfinished work should be kept covered from the rain.

Stairs.—The following are the technical names for the parts of stairs:—"Flight" is the term for one continued series of steps without any break; "landing" is the level flat between two flights; "tread" is the horizontal surface of a step; "riser" is the vertical part between 2 steps; "winders" are the winding steps round a curve when there is no landing.

The convenience of stairs is largely dependent upon the proportioning of the height of riser and width of tread. Blondel's rule, which adopts as a module of measurement the length of a man's pace walking leisurely on level ground, or 2 French feet = 25·56 in. English, and assumes that every 1 in. of ascent is equal to 2 in. of progress, is a correct theory within certain limits only. The energy expended by a man in lifting himself 40 ft. up a ladder nearly vertical is vastly more than twice the energy required to advance 40 ft. on a level plane. This is sufficient to show that the rule is only correct when the rate of ascent is moderate. Probably, an English architect, working out the same theory, would have adopted 2 English feet or 24 in. as his module. Corson takes the mean (nearly) of these two, or 24·75 in., as being a reliable guide to an easy stair suitable for houses of moderate size.

The height of riser, which should not be exceeded, he fixes (by experience) at 6·75 in., deducting twice this, or 13·50 from 24·75, we have 11·25 for the breadth of tread. (Blondel's rule would give 12·06, which would be found too broad for that height of riser.) Of course, the breadth of tread is from riser to riser, disregarding torus or moulding, if there is one. Obviously the experience of short and tall people will differ somewhat. Also it is necessary to consider the length of the step: the longer the step, the broader should be the tread.

Again, for steps outside, leading up to the doorway or a terrace, decrease the riser and increase the tread; how much must be matter of judgment with the architect, according to the number and length of steps and character of house. Terrace slopes ought to be 3 to 1. To suit that slope, steps of 5·10 in. rise and 15·30 in. tread would be a fit dimension, and would agree with Blondel's formula. There is, however, for stairs generally, another and very simple rule, namely: Keep the slope of the stair to 30°, or as little over that angle as possible. A step of 6 $\frac{3}{4}$ in. rise would in that case have a tread of 11 $\frac{5}{8}$ in.; but it would be better to have less rise and less tread, say 6 $\frac{1}{2}$ in. and 11·20 in. It is needful to have in mind old people and children, to whom a low riser is of great moment.

When the size of the house will not allow the use of such proportions as are given above, diminish the tread rather than increase the height of the riser. Blondel's rule becomes absurd when followed out, and the stair becomes a step ladder, as when you find steps 8 in. tread and 9 $\frac{1}{2}$ in. rise, making breakneck stairs. The minimum width of tread may be called 9 in. It is too little, but sometimes economy of space compels it, and if only the riser be kept to the maximum of 6 $\frac{3}{4}$ in., the stair will be reasonably easy and safe. There are exceptions to every rule, and it will be found that the steps of a turnpike stair winding round a 6-in. or 8-in. newel, must deviate from the proportions given above, i. e. when measured as winding stairs usually are, at the centre of the length of step. The head room must be preserved at all costs.

With regard to the planning and setting out of stairs, a volume might be written, and illustrations given without end. The staircase often is, and oftener might be, the most picturesque feature of the interior of a house; most often it is so treated that it would be best hidden away out of sight. A stair in 2 flights, with narrow well-hole, offers the least opportunity for effective design; a wide well-hole removes the difficulty, and with a stair in 3 flights almost anything may be done. A stair with the first flight (only) between 2 walls, and then opening out to the double width, is capable of great beauty and picturesque treatment. Stairs with winders are not desirable, but sometimes are unavoidable, and very well adapted for warehouses when planned with a well-hole, say, 20-30 in. wide. The winders should radiate, not to the true centre, but to a centre removed half a step or so farther back from the string; thereby the narrow ends are made wider and the ramp of the handrail is improved. The arrangement of a central stair and 2 side flights should only be used on the grand scale and in buildings of palatial character. In houses of less importance, either it will be cramped in dimensions, or it will be too large for the house, and out of keeping and pretensions.

A convenient height for the handrail of a stair is about 3 ft. from the surface of the treads. The upper surface of it should be semicircular and about $2\frac{1}{2}$ in. diam.; it should be continuous, without break of any kind from top to bottom of the stairs. The "balusters" which support the handrail are sometimes also intended to fill up the space between it and the stairs, so as to prevent any one falling through. When for the former object only, as is generally the case in barracks, the fewer balusters there are the better, as they are very liable to injury and so cause expense in repair; for this reason it is better to have a few strong posts well framed into and connected by iron straps with the bearers of the stair. In private houses, where the balusters are generally required to fill up the space, the ordinary practice is to make them square wooden bars of small size, and to place iron balusters of the same size at intervals to strengthen the whole structure. But in all public buildings, especially in military buildings, it is desirable to use balusters of a much larger size, and more firmly fixed to the stairs, and at just sufficient interval to prevent children falling through.

The construction of the steps is illustrated in Fig. 1419: the tread *a*, say 10 in. broad and 2 in. thick, is supported by the riser *b* of the same thickness and about 7 in. high, a "blocking" or "rough bracket" *c* being placed underneath the tread and behind the riser, the ends being dovetailed or notched into the face of the "outer string." The outer string is the woodwork flanking the side of the stairs not next the wall. In

front of the riser, and occupying the corner formed by it with the front edge of the tread, is a moulded fillet *d*; the rounded edge of the tread *e* is termed the nosing.

Colonial Houses.—The peculiar conditions of house building in Canada have been described in interesting detail by R. Gambier-Bousfield. He alludes to the absence, in the early days of the colony, of the means of quarrying and transporting stone, the small opportunity for making bricks, the unlimited quantities of fir wood,—these conditions have resulted in a method of building which, beginning with the rough log huts, has been perfected until it is now used for the construction of the first-class houses. He has described this method, pointed out many advantages resulting from its use, and offered a few valuable hints in the arrangement of small houses. The frame house astonishes the novice by its slenderness, and though cool enough in summer, one wonders how it is possible to keep out the intense cold of the winters. Generally, a stone foundation is used of about 16 in. thick rubble work, taken down at least 3 ft. to below the level reached by the post, and raised about 10 in. or 1 ft. above the ground line. Upon this is

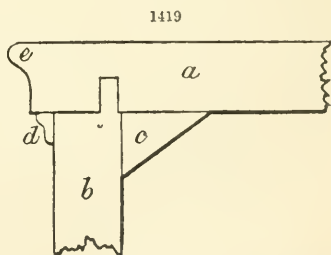

laid a sill of wood 6 in. deep and 8 in. wide, and at spaces of 16 in. centres, are erected 2 in. by 4 in. uprights, commonly called studding, mortised and tenoned to sills and heads. The length of these studs depends upon the height of the house to be built, not upon the length of the stuff, as almost any reasonable length can be obtained. If it is a two-storey dwelling, the studs will easily reach the whole height, and the frame is tied at the corners, and strengthened with angle pieces, or with matched boarding. Floor joists are always used of a much greater depth than it is the custom to use in England 12 in. deep by 2 in. wide, placed at 18 in. centres on the ground floor, and at 16 in. centres on all floors above, is the common arrangement, cross bridging being used to stiffen them. At openings for doors and windows, the studs are doubled. When the studs rise the whole height of the house, without any plate for the support of the floor joists of the first or second floors, ribbon pieces 1 in. by 4 in. are spiked between the studs, horizontally, and the joists rest on these, being spiked to the uprights. But the roofing surprises an Englishman more than any other part. The use of shingles may or may not be new to him, but the slenderness of the roof timbers makes him tremble for the future inmates. Wood shingles are infinitely lighter than slate, and the common construction is simply long rafters, 2 in. by 6 in., set at 16 in. centres, reaching from plate to ridge without purlins, king posts, or struts; the ceiling joists tie the feet in, and for a span of 20 ft. clear, collar ties 1 in. by 6 in. are just nailed to the rafters. (It will perhaps be noticed that the width of stuff is always quoted before the depth—this is the trade custom in Canada.) On top of the rafters is laid, either diagonally or straight, matched rough boarding, and upon this a coat of hair mortar, $\frac{1}{2}$ in. thick, in order to keep down fire as long as possible, in the event of a conflagration; this coat is not a necessity of construction, but is added by order of the City Building Committees. The shingles are laid on the mortar, just like slates, with about 4 in. to the weather, and each shingle is secured with 2 nails. Wood rolls cover all external angles, and except for valleys and gutters, the description of the roof is completed. For these latter there is a further entirely new custom. The heat does not admit of using lead, so in place of it tin is adopted, giving it 2 good coats of paint. Until lately tin could be procured that would stand the weather without rusting, but that quality cannot be obtained now. The tin is laid in the same way as lead; but in exposed situations it is decidedly inferior, and it is very difficult to keep out the wet in such places. Owing to the heavy falls of snow, gutters have to be avoided, small gablets being erected behind chimney stacks, to prevent the snow lodging. On this account roofs of the form of an inverted W cannot be used, as the snow would drift and fill in the whole of the intermediate gutter, and down the roof would come. Consequently, Mansard roofs are resorted to for very wide spans, and sometimes horizontal decks, which are better than inverted W's but are not to be used if it is possible to avoid them. Owing to the expansion and contraction of tin in heat and frost, the down pipes are made corrugated, which allows them to shrink or expand without fear of cracking. The advance of civilization, with local boards in its wake, has insisted upon brick exteriors for all houses within the defined "fire limits" of each city, and although stud partitions are still retained inside, it is not allowed now to have wooden exteriors. But there are differences between the methods of bricklaying here and the ways common to the old country. Generally speaking, for a one-brick wall there is hardly any bond between the inner and outer half-brick veneer.

To all appearances, there is no bond visible on either face, but it exists, however poor it may be. The plan of a course is as seen in Fig. 1420, the brick *b* being the bond, of which there is 1 at every 2 ft. or so. Another

1420.



method is to build 5 courses of stretchers, and then 1 of headers, which is better than the first, but Canadian bricklayers have yet to learn English and Flemish bonds. The severity of the climate demands that great attention should be paid to the outsides

of the houses, both walls and roof, and a precaution taken here would if adopted in England, be found of great advantage in keeping out the damp in small houses. This is the custom of fixing grounds to the inside of the brick walls, and lathing and plastering, leaving 1 in. space between the back of the laths and the wall. By this means the outer wet is not conducted to the plaster through the bricks, and the houses are thereby kept cooler in summer and warmer in winter.

Owing to there being no internal brick walls, each floor can be arranged without of necessity following the plan of the floor below; this gives endless facility in planning, and the consequence is that 8-roomed houses here are infinitely more comfortable than in the old country. In the first place, the system of stoves does away with the necessity of fireplaces, although 1 or 2 are constantly introduced, for nothing is equal to an open fire for cheerfulness. To heat an ordinary house, a large stove stands in the entrance hall, and the iron flue wanders half over the house at a distance of $1\frac{1}{2}$ ft. from the ceiling, suspended by wire fastened to screws or hooks, in the joists above. Holes are left in floors and partitions for the pipe to pass through, fitted with iron collars, air spaces being left to prevent the probability of fire, which otherwise would certainly be the result. The cooking-stove pipe conducts the hot air over another part of the house, and other rooms or passages are heated by smaller stoves, as the case may require. These stove pipes are taken to the brick chimney-stacks just where most convenient, and thus every room and passage is kept comfortably warm through the whole winter, for the fires are left in day and night. Large stoves necessitate wide halls, which are generally wisely avoided in our "tight little island" as a source of cold air and a trouble generally. Some houses have no doors to the sitting-rooms, arches being left, which are hung with curtains or left altogether open to suit the taste of the tenant. Every bedroom is allowed its hanging-closet, about 3 ft. square, and of a height equal to that of the room; and every house has its bathroom. Internal or external blinds are fitted to all the windows, made with movable slats, in small panels, hung folding in narrow leaves, and then, with a good wide verandah and a cellar to act as cool larder, the house is complete, and very comfortable it may be too. As the summer draws on, all the stove pipes are taken down and cleaned, and they and the stoves are all stowed away out of sight until the cold weather begins to set in. Glass frames are put into the window spaces in winter to form a "double" window—a very important factor in the comfort of a house.

The natives in the country districts of Ceylon generally build their houses (huts) of mud (wattle and daub), the uprights and roof timbers being common jungle wood, and thatched with the dried leaf of the coconut tree (locally known as *cadjans*). In the mountain districts of Ceylon, coffee planters' bungalows are nearly all built of wood, and of what is locally known as wattle and daub, that is, wooden uprights crossed on both sides with small bamboos (or what is better known by the name of *waratchies*) and filled in with clay made into the consistency of mortar, and plastered on both sides. They are put up very cheaply, and are well adapted to the climate. Other materials, such as bricks, would be too expensive, on account of the distance and difficulty of transport. The mode of building is to put in a stone foundation up to the floor level, and then a wooden framing all round to receive the ends of the uprights, the other ends of the uprights being tenoned into the wall plates, the window and door frames fixed between the uprights, with horizontal ties to stiffen the framing, and then filled in between the framing with wattle and daub as before stated.

The ordinary rules for ventilation are often inapplicable in India, owing to the extreme heat of the external atmosphere, which renders it necessary to exclude it entirely during the day, unless previously cooled by some artificial process. The ordinary method of doing this is by means of *tatties*, or grass screens, placed in the doorways to windward, and kept constantly wetted. In general, the air inside the house is cooled temporarily by agitating it with *punkahs*. To secure a thorough draught

through the rooms, numerous doors or windows are provided, and placed opposite to each other.

In the Punjab, the roof usually consists of a course of bricks or flat tiles, or slabs of stone, united by lime mortar, completely closing all the seams, and above the bricks a layer of earth, 3-6 in. thick, well beaten down. A good brick-earth should be used for this covering, but it will require frequent beating to consolidate it. This is termed a *kucha-terrace* roof. As a bed for the covering of earth, a layer of the reeds called *sarkunda*, or the small twigs of a common jungle-shrub called *sambhaloo* or *samaloo*, or branches of the *jhao* (tamarisk) laid down over the horizontal rafters in small bundles, tightly bound and closely packed, may be used instead of bricks. Sometimes earth is dispensed with for these roofs, and the whole upper surface is plastered. The prevention of leakage may be further secured, and the coolness of the building promoted (at the expense of additional weight on the beams) by a second course of bricks or tiles laid over, and breaking joint with, the lower course. This roof is known as a *pucka-terrace* roof, and its construction is very similar to that of the terraced floor; 3 layers of tiles laid to break joint, the upper layer being covered with a thin coating of plaster, well polished and oiled, forms a very durable flat roof, and possesses the advantages of being more quickly made and lighter than a terrace roof.

Sloping or pitched roofs are generally covered with thatch or tiles. A good thatch forms the coolest and driest roof. The thatch in India is generally formed of a long grass laid on a framework (*jafari*) of small bamboos placed over the woodwork of the roof. The *jafari* is made on the ground, of whole bamboos laid in a lattice form like trellis-work, with intervals of about 6 in., over which split bamboos are fastened about 2 in. apart, the whole being tightly secured with string. Over this *jafari* is laid the grass in layers 3 in. thick, the first layer being generally attached before the *jafari* is placed on the roof. Thatch ought to be at least 9 in. thick. It requires a thick coat of 3-4 in. thick every 3 years. The grass is brought in bundles called *poolas*, which are broken up and spread flat between 2 pieces of split bamboo. The thicker or lower ends of the grass are dressed evenly to one line, and the grass in its position on the roof lies with these ends towards the eaves. These bundles are then fastened to the bamboo framework, beginning from the eaves upwards, and so overlapping each other that the small pieces of bamboo which keep them in position are not seen from the outside. All along the eaves, larger but round bundles of grass are placed the full thickness of the thatch. The ridge of a flat roof is generally bound with a roll of *sirkee* laid horizontally; and the same is occasionally done under the eaves.

Tiles are sometimes laid over the thatch, but this combination is not recommended. A terrace roof may also be laid over a truss as well as over flat beams, when the pitch is not too great. Planking, with tarred seams, is a very common roof-covering in the Himalayan hill stations, but it requires to be made with great care, and only the best-seasoned timber should be employed, as it is exposed to very trying alternations of temperature. Shingles, which are rectangular pieces of plank applied in the same manner as slates, are likewise much used in the hills for roofing. English deal packing-cases, beer-chests, &c., are not uncommonly cut up for this purpose, the wood being well seasoned, and the boxes seldom fit for other use. Another material used for the roof-covering of hill houses is the composition called "oropholite." It is made of sharp river or pit sand and chalk, with an admixture of litharge, all finely sifted and made into a paste with linseed oil. This is spread on one or both sides of any kind of common coarse cloth, so as to form, when dry, a sheet about $\frac{3}{8}$ in. thick. These sheets, when prepared, are hung up to dry, and are then applied in pieces of such size as may be found convenient.

Besides the above, roofs are covered with slates where they are obtainable, or with tiles, lead, zinc, or corrugated iron. The last-named material is daily coming into use in India, especially for coverings for godowns, open sheds, &c.

INDEX.

- A**BIES woods, 130, 131-2, 147-8,
 155
 Acacia woods, 126, 128-9, 132, 134,
 155, 163
 Acer woods, 138, 148
 Acid test for stone, 566
 Adenantha wood, 155
 Adjustable clamp, 197
 — dado plane, 245-6
 — jack plane, 237
 — mirror stand, 506
 Adjusting surfaces by hammering,
 84-8
 Adzes, 256-7
 Aëolipile, 516
 African green, 408
 — mahogany, 138
 — oak, 141
 — teak, 141
 Aging bronze, 26
 Alanthus wood, 155
 Air pump, 516
 — motion, 481
 — rack and pinion for, 497
 — vessel for burning, 96
 Alke wood, 127
 Albizzia woods, 156
 Alburnum, 166
 Alder buckthorn wood, 132
 — wood, 127, 151
 Alcyon wood, 149, 163
 Alerce wood, 127
 Alerse wood, 127
 Alloy for casting, 16-7
 Almond wood, 129
 Alnus wood, 127
 Alubo wood, 152
 Aludel wood, 152
 Aluminium bronze solder, 90
 Amber, 472
 — varnishes, 474
 Amboyna wood, 350
 American beech wood, 128
 — black larch, 136
 — spruce, 147
 — dogwood, 132
 — hand vice, 193
 — locust wood, 126
 — white spruce, 147
 Anes's square, 192-3
 Anesbury hand-saw filer, 215
 Aneroid gauge, 520
 Angle-gauges for metal-cutting tools,
 548
 Angles, clearance and cutting, 546-7
 — metal turning tools, 540
 — wood-cutting tools, 560
 Anagophora wood, 127
 Angular bit stock, 249
 Animi, 472
 Anjilli wood, 135, 156
 Annealing steel, 64-6
 Annual rings, 166
 Anti-friction bearing, 4
 Antwerp blue, 407
 Anvils, 46-7
 Apple wood, 127, 350
 Applying paint, 413
 Aquatapana wood, 166
 Aramana wood, 152
 Araucaria woods, 130, 142
 Arbor chuck, 534
 Aristotelia wood, 138, 162
 Arsenic yellow, 409
 Art bronze, 26
 Artocarpus woods, 135, 156
 Ash graining, 430
 — wood, 127-8
 Ashlar work, 575
 Assegai wood, 128, 151
 Assisting crank over dead centres,
 Atmospheric hammer, 516 [510
 Augers, 247
 Australian apple wood, 127
 — beechwood, 128
 — boxwood, 129
 — cherry wood, 131
 — hickory wood, 134
 — mahogany, 135
 — oaks, 141
 — red cedar wood, 130
 Autogenous soldering, 92-7
 Awls, 246
 Axes, 252-6
 — form of cutting edge, 254-6
 — handle, 253-4
 — principles, 252
 — using, 252-3
 Azadirachta wood, 156
BACK SAWS, 221-2
 Bahama dogwood, 132
 Balance pumps, 516
 Balata wood, 166
 Baling scoop, 514
 Balk timber, 169
 Ballow wood, 164
 Band saws, 224-5
 — filer, 215
 — motion, 482
 — set, 217-8
 Banks, 676
 Banyan wood, 159
 Bar iron, 45
 Barker mill, 512
 Barklya wood, 163
 Barkometer, 520
 Barringtonia woods, 150
 Bartons, 476
 Basic pigments, 406-7
 Bassia woods, 156
 Bastard black pine, 130
 — ebony, 153
 — tuck, 591-2
 Battens, 169
 Bauhinia wood, 156, 163
 Bearing joints, 272-4
 Bed panels, veneering, 360-1
 Beds, 405
 Bedsteads, 304-6
 Beechwood, 128, 350
 Beefwood, 350
 Beehives, 321-4
 Belgian burnishing powder, 452
 Bell-centre punch, 191
 — crank and disc, 485
 — lever, 481
 — hanging, 634-40
 Bellows, plumbers', 97
 Bells, casting, 21-2
 — electric, 635-40
 — soldering cracked, 112
 Bench, cabinet-makers', 353-4
 — carpenters', 257-9
 — making, 290-2
 — boy, 355
 — clamp motion, 487
 — clamps, 197
 — stops, 259-60
 — vices, 261-4
 Bent-setting saws, 216-8
 Benzoate driers, 412
 Beriya wood, 152
 Berlin blue, 407
 Bermuda cedar wood, 130
 Berry wood, 156
 Betula woods, 123
 Bevel gears and double clutch, 523
 — ratchet wheels, 523
 Bevels, 187
 Beyeria wood, 166
 Bibiri wood, 133
 Bidford black, 407
 Bignonia woods, 156-7
 Bilge ejector, 516
 Billian chingy wood, 164
 — waxy wood, 164
 Binding-joists, 338-9
 Birchwood, 128, 350
 Bird's-eye maple, 138, 395
 Bisecting gauge, 510
 Bismuth solders, 91
 Bits, 107
 — and braces, 247-8
 — tinning, 161-2
 Black and gold marbling, 432
 — bardilla marbling, 433
 — birch wood, 128, 163
 — board washes, 435-6
 — dogwood, 132
 — heart birch wood, 128

- Black ironwood, 134, 151
 — malre wood, 138, 162
 — mapau wood, 163
 — pigments, 407
 — pine, 139, 141
 — stains, 434-6
 — varnish for metal, 475
 — Virginia walnut wood, 150
 — walnut, 395
 — wood, 128-9
 Blazing saws, 66
 Blind dovetails, 281-2
 Blocks and tackle, 476
 Blower, 519
 — for soldering, 104-6
 Blown castings, 20
 Blowpipe brazing, 115-6
 — burning, 94-7
 — fitting to gas supply, 105-6
 Blowpipes, 102
 Blue black, 407
 — gum wood, 133
 — pigments, 407-8
 — stains, 436-7
 Board fence, 333
 Boards, drawing, 1
 — removing drawings from, 8
 Boaster, 573
 Boat detaching hook, 519
 Bob, gilders', 447
 Bobbin bit, 248
 Bobbins, electric, 639
 Bobnenberger's machine, 503
 Boiling wood, 171
 Bolts and nuts, 278
 — forging, 69-71
 Bombax wood, 157
 Bond, 588-9, 593-5
 Bone black, 407
 Bookcase, 369
 Bookedges, burnishing, 454
 Borassus wood, 157
 Borate driers, 142
 Boring, 549-54
 — collar, 535
 — iron, 54-6
 — machine, 250
 — tools, 246-50, 541
 Boss spanners, 81-2
 Bossing irons, 107-8
 — mallets, 107
 Bourdon gauge, 520
 Bow saw, 198
 Bowery's clamp, 505
 Box-scraper, 244
 — stool, making, 302
 — woods, 129, 166, 350
 Boxes, ironfounding, 38
 — sheet-metal, 126
 Boyle's ventilator, 657
 Braby's glazing, 632
 Braces and bits, 247-8
 Brackets, fretwork, 393-9
 Bradawl, 246
 Brake for cranes, 494
 Brandering, 274
 Brard's test for stone, 566
 Brass-castings, burning, 92-4
 — founding, 16-35
 — furnaces, 17-9
 — lacquer, 475
 — moulding, 20-2
 — polishes, 452
 — pouring, 22-4
 — soldering, 114
 — to platinum, soldering, 111
 — to steel, soldering, 111-2
 — turning tools, 542
 — wire soldering, 111
 — work solder, 90
 Braziers' hearth, 108-9
 Brazil-wood lake, 408
 Brazing, 97-9
 — with blowpipe, 115-6
 Breaking-weight of woods, 126
 Brear's bilge-ejector, 516
 Breast drill, 249
 Bremen blue, 408
 Bricklayers' tools, 587
 Bricks, 577-9
 — laying, 587-94
 Brickwork, 577-95, 686
 — bond, 588-9, 593-5
 — pointing, 590-3
 Bridged gutter, 342
 Bridges, 675-6
 Bridle joint, 276
 Briedelia wood, 157
 Bright gilding, 449
 Brighton green, 408
 British Guiana woods, 150
 Broad finishing, 549
 — tool, 573
 Broadleaf wood, 129
 Broad-leaved cherry wood, 163
 Bronze, ageing, 26
 — art, 26
 — casting en cire perdue, 28-35
 — colouring, 26
 — figures, casting, 24-8
 — founding, 16-35
 — furnaces, 17-9
 — Japanese, 26-7
 — moulding, 20-2
 — ornamenting, 27-8
 — pouring, 22-4
 Brosimum wood, 150
 Brown and Level's boat-detaching
 — ochre, 408 (hook, 519)
 — pigments, 408
 — pink, 408
 — stains, 437
 Brownell's crank motion, 508
 Brunswick black, 475
 — green, 408
 Brush wheels, 521
 Brushes, paint, 415
 Bubbles in castings, 40
 Buchanan and Righter's slide-valve
 Buck-saws, 222 [motion, 509
 Building-up beams, 271-2
 — woods, 179
 Bullet-tree wood, 130
 Bunya-bunya wood, 130
 Burning (soldering), 92-7
 — machine, 95-6
 Burnishing, 452-4
 Burnt iron, 62
 — slenna, 408
 — solder, 111
 — umber, 408
 Bursaria wood, 163, 166
 Buruta wood, 152
 Butea wood, 157
 Butt joint, 277
 — jointing veneer curls, 361
 — weld, 45
 Butterwood, 166
 Buttoned seats, upholstering, 403
 Buttonwood, 145
 Buxus woods, 129, 157
 Bytneria wood, 157
 Cabinet-making woods, 350-1
 — scraper, 354
 Cæsalphinia wood, 157
 Calamander wood, 152, 158
 Calcining, 610-3
 Calliper rule, 192
 — square, 191-2
 Callipers, 189-90
 Callitris woods, 127, 131
 Calmes, 630-1
 Calophyllum woods, 145, 148, 157
 Camphor wood, 350, 386
 Cams, 478-80, 483
 Canary wood, 350
 Cane-bottomed chair, 303
 Canned goods, sealing, 91
 Cape ashwood, 151
 — ironwood, 134
 — lancewood, 128, 151
 — mahogany, 152
 — walnut, 152
 — woods, 150-2
 Capstan, 519, 531
 Carapa wood, 166
 Carcass saw, 208
 Cards, gliding on, 448
 Careya wood, 157
 Cargillia wood, 163
 Carisiri wood, 150
 Carinated lakes, 408
 Carmine, 408
 Carpentry, 126-350
 — accessories, 257-66
 — benches, 257-9
 — bench-making, 290-2
 — bench-stops, 259-60
 — bench-vices, 261-4
 — bolts and nuts, 278
 — boring tools, 246-50
 — chopping tools, 252-7
 — construction, 266-350
 — edge tools, 250-46
 — examples, 289-350
 — guiding tools, 182-93
 — hinging, 283-9
 — holdfasts, 260-1
 — holding tools, 193-8
 — house-building, 334-50
 — joints, 266-83
 — making garden requisites, 310-34
 — making rough furniture, 294-310
 — making workshop appliances,
 289-94
 — nails, 263-4, 278
 — rasping tools, 198-230
 — sawing rest, 261
 — screws, 264-5, 278
 — sockets, 279
 — straps, 278
 — striking tools, 251-2
 — tools, 182-266
 — valet, 260-1
 — woods, 126-82
 Carpinus wood, 134
 Carpodetus wood, 163
 Carriage varnishes, 474
 Carton pierre, paint for, 417
 Cartwright's parallel motion, 500
 Carving, 386-95
 — handy tools, 392-3
 — operations, 394-5
 — parting tool, 392
 — selecting wood, 388-90
 — sharpening tools, 394
 — staining, 389
 — tools, 390-94
 — voluter, 392
 — woods, 386-390
 Carya wood, 133-4
 Case-hardening steel, 66

CABINET-MAKING, 350-86
 — examples, 363-86
 — imitation inlaying, 362-3
 — inlaying, 362
 — tools, 351-5
 — veneering, 355-62

- Casement windows, 348
 Cask-cradle, making, 295
 Cast iron, brazing, 98
 — burning, 92-4
 Castanea wood, 131
 Casting and founding, 13-41
 — bells, 21-2
 — bronze figures, 24-8
 — by forma perduta, 22
 — figures, 24,
 — gas generated in, 23-4
 — iron in loam, 39
 — sand, 39
 Castings, blown, 20
 — examination of iron, 40-2
 — form of iron, 39-40
 — of fragile objects, 22
 — sand-burned, 21
 Casuarina woods, 141, 157, 350
 Cathartocarpus wood, 157
 Cauling veneers, 358-60
 Caulking joint, 272
 Cedar boom wood, 130-1, 151
 — woods, 130, 163, 164, 395
 Cedrela woods, 130, 149, 157
 Cedrus woods, 130, 132, 157
 Celery-leaved pine wood, 148
 Cement floors, 674-5
 — paint, 417
 Cements for plastering, 604-8
 — iron, 88-9
 Centre-bits, 248
 — lines of drawings, 5-6
 — punches, 191, 543
 — square, 192-3
 Centrifugal check hooks, 494
 — governor, 486
 Centrolinead, 509
 Ceylon mahogany, 135
 — woods, 152-4
 Chain and chain pulley, 493
 — pumps, 514
 Châtré bronze, 26
 Chairs, making, 303-4, 363-9, 400-4
 Chalk line, 182
 — prepared, 458
 Changes of velocity and direction, 495
 Chase mortice, 273
 — wedge, 108
 Cherry birch wood, 128
 — woods, 131, 163, 350, 388
 Chest of drawers, 306-8, 369-80
 Chestnut graining, 430-1
 — wood, 131, 388
 Chickassia wood, 157
 Chilled rolls, 43-4
 Chilling iron castings, 43-4
 Chinese blue, 407
 — lake, 408
 — red, 409
 — windlass, 481, 502
 — yellow, 409
 Chisels, 230, 3, 390-1, 558-61, 573
 — forging, 74-6
 — iron, 49-53
 — sharpening, 75-6, 240-3
 Chittagong-wood, 149
 Chloroxylon woods, 147, 157
 Hopping tools, 252-7
 Chrome green, 408
 — orange, 408
 — yellows, 409
 Hucks, 532-5
 Hucks, relations of, 117
 Circular into reciprocating motion, 495
 — melting-furnace, 18-9
 — plane, 243-4
 — saw, 222-4
 — clamp, 197
 — hammering, 86-7
 Cire perdue casting, 28-35
 Clamps, 196-8, 213-4, 359-60, 505
 Clap boarding, 141
 Classification of woods, 169
 Clay foundations, 667
 Clayton's sliding journal-box, 497
 Cleaning files, 59
 — paint, 415-6
 Clearing a projecting boss, 545
 Close jointing, 267-8
 — stoves, 663
 Cloth-dressing machine, 506
 — tracing, 8-9
 Cluster pine wood, 142
 Clutch-boxes, 476
 Coarse stuff, 605-6
 Coats of paint, 411-5
 Cobalt benzoate drier, 412
 — blue, 408
 — borate drier, 412
 Coburg varnish, 475
 Coconut wood, 153
 Cocos wood, 157
 Cog-wheels, 493
 Cogging joint, 272
 Cohesive force of woods, 126
 Coils, electric, 639
 Cold chisels, 49-53
 — shut iron, 39
 — soldering, 97
 Colonial houses, 685-8
 Colophony, 472
 Coloured paints, 417-8
 Colouring bronze, 26
 — pigments, 407-9
 — soft solder, 92
 — tracings, 8
 Colours for drawings, 7-8
 — graining, 430
 — of tempering, 63-5
 Colt's revolver movement, 497
 Combination filisters, 244-5
 — movement, 495
 — tools, 191-3
 Combined rubbles, 575
 Compass saw, 208, 222
 — wood, 170
 Compasses, 189-90, 509
 — drawing, 5
 Compensation balance, 499
 Compo pipes, soldering, 114
 Composition of paints, 421-2
 — of wood, 178-9
 Compound bar compensation pendulum, 499
 — slide rest, 537
 — solder joints, 91
 Concrete, 596-602
 — bulk produced, 601-2
 — cementing material, 600-1
 — expansion, 602
 — foundations, 668
 — ingredients, 596-8
 — laying, 599-600
 — mixing, 598-9
 — selenitic, 602
 Cones, striking out, 117-8
 Conical pendulum, 499
 Connarus wood, 158
 Conocarpus wood, 153
 Continuous circular into intermittent circular motion, 503
 — rectilinear reciprocating motion, 508
 — rectilinear reciprocating motion, 510
 — rocking motion, 510
 Conversion of wood, 175-8
 Cooling cutters, 542
 — strains, 36
 Copai wood, 166
 Copal, 472
 — varnishes, 474-5
 Copping, 576-7
 Copper paint, 418
 — roofing, 626
 Copper solder, 90
 Copying drawings, 10-3
 — papers, 10-3
 Cores, composition for, 24
 — for casting, 15
 — iron founding, 36-7
 Cork wood, 163
 Corner piecing, 279
 Corners, veneering, 359-60
 Cornus wood, 132
 Couches, 363, 402-3
 Counterbalance bucket, 514
 Countersinks, 248, 249-50
 Courbaril wood, 166
 Coursed rubble, 575
 Coverings, upholstery, 400
 Cowrie wood, 135
 Crabwood, 166
 Cramp drills, 505
 Cramps, 196-8, 213-4
 Crank and fly-wheel, 485
 — motions, 478
 — pin and bell crank, 485
 — substitutes for, 480-1
 Cranking file tangs, 76
 Creams, furniture, 459-70
 — painters', 423
 Crocoting wood, 174-5
 Crocus, 454
 Cross-cut saw, 220-1
 — rifled bronze, 26
 Crossed-leg table, 302
 Crotch punch, 206, 218
 Crueltes, 19-20
 — iron casting, 37-8
 Crushing force of woods, 126
 Cup chuck, 534
 — shakes, 167, 177
 Cupanla wood, 163
 Cupola furnace, 17
 Cupressus wood, 131
 Cups, metal, 125-6
 Curb roof, 345-6
 Curis, butt jointing, 361
 Curtisia wood, 128
 Curvature of adze, 256
 Cut deals, 169
 — off saw, 208
 Cutlery, burnishing, 454
 Cutters, milling, 554-8
 Cutting gauge, 186
 — mortice and tenon, 232-3
 — screws in lathes, 539
 — square threads, 546
 — tools, cooling, 542
 — for iron, 49-53
 — sheet metal, 119
 — vertical slot, 545
 Cyaniferous paper, 11-2
 Cyanotype paper, 10-1
 Cyclographs, 508
 Cycloidal surfaces, 505
 Cylindrical tubes, striking out, 115
 Cypress pine wood, 131
 — wood, 131.

DACHPAPPE, 618
 Dacryphyllum wood, 139
 Dacrydium woods, 139, 142, 144,
 162-3
 Dado plane, 245-6
 Dalbergia woods, 147, 158
 Damitna wood, 152.

- Dammar, 472
 Dammara wood, 135, 162
 Damp course, 670
 — walls, 603, 643
 Dangaha wood, 152
 Dantzig fir, 142-3
 Darby, 608
 Dark-yellow wood, 131
 Darroo wood, 164
 Dawata wood, 152
 Dead centres, 510
 — gilding, 447-9
 Dead-ened floors, 340
 Deal wood, 131-2
 Deals, 169
 Decay of wood, 173-4
 D'Ectol's oscillating column, 513
 Defects in wood, 167-8
 Del wood, 152
 Deodar wood, 132, 157
 Derbyshire spar marbling, 433
 Desiccating wood, 171
 Diagonal catches, 487-9
 Diaphragm forcing-pump, 514
 Dickson's device for converting oscillating into intermittent circular motion, 509
 Die square timber, 170
 Dies and stocks, 59-61
 Dietrich's copying-paper, 12-3
 Differential movement, 494-5
 Dillenia woods, 153
 Dimensions of drawings, 5-6
 Dining-chair, 363-4
 Diospyros woods, 132, 141, 152, 153
 Dipping steel tools, 65-6
 Dipterocarpus woods, 135, 158
 Disc, crank-pin and slotted connecting rod 486
 — wheels, 523
 Discoloration of paint, 416-7
 Disengaging eccentric rod, 489
 Disston's revolving saw set, 218-9
 Distemper painting, 610-3
 Ditches, 676
 Divan chairs, 365-6
 Doatiness, 167-8
 Dodonea wood, 127
 Doghead hammer, 85
 — irons, 275
 Dogwood, 132
 Door-shutting contrivance, 506
 Doorn boom wood, 132, 151
 Doors, 346-8
 — frames, 346
 — ledged, 346-7
 — panelled, 347
 — sash, 347-8
 Dormer window, 345
 Double-acting pump, 513
 — floors, 338-9
 — framed floors, 339
 — gear foot-lathe, 537
 — lantern bellows pump, 513
 — notching joint, 272
 — rack, 480
 Doubling length of stroke, 481
 — speed, 529
 Dove marbling, 433
 Dovetail saw, 198, 208
 — tenon, 274
 Dovetailing, 272, 277, 281-2, 299-300
 Dowel plate, 354
 Dowelled floors, 278, 339-40
 — joint, 277, 282
 Dowling bit, 248
 Drag link motion, 493
 Dragon's blood, 473
 Drains, 676-7, 680
 Draught of castings, 36
 Draw away, 45
 — down, 45
 Drawers, chest of, 306-8, 369-80
 — in table, making, 300
 Draw-filing, 59
 Drawing boards, 1
 — compasses, 5
 — in spinning, 519
 — instruments, buying, 1
 — instruments, keeping, 1
 — knife, 233-4
 — mechanical, 1-13
 — paper, 2
 — pens, 4-5
 — rules, parallel, 5
 — scales, 1
 — squares, 1-2
 — testing straight-edge, 5
 Drawings, centre lines, 5-6
 — colours for, 7-8
 — copying, 10-3
 — dimensions of, 5-6
 — erasing errors in, 3-4
 — finishing, 7
 — fixing pencil, 8
 — inking, 4-5
 — mounting, 2-3
 — mounting on linen, 3
 — nature of, 6-7
 — pencilling, 3
 — removing from board, 8
 — shading, 8
 — tints in, 5-6
 — title of, 6
 Dresser, 308-10
 — for flattening metal, 107
 Driers, painting, 411-3
 — varnish, 473
 Drift out, 45
 Drifts, forging, 77-8
 Drill-stocks, 56
 Drilling, 549-54
 — apparatus, 503
 — iron, 54-6
 — machine feed-motion, 480
 Drills, 55-6, 248-9, 543
 Drimys wood, 134
 Driving feed-rolls, 489
 Drop lake, 408
 Drum, 483
 Drummond's glazing, 632-3
 Dry gas-meter, 517
 — rot, 173
 Drying-oils, 410-1
 — paint, 414
 Ducalibolly wood, 150
 Duguetia wood, 150
 Dun wood, 152
 Durability of stone, 562-3
 — woods, 179
 Duramen, 166
 Dutch pink, 409
 Dynamometer, 494, 505
 Dysoxylum wood, 136, 162

EARTH-WALLS, 683-4
 East Indian mahogany, 133
 Easy chairs, 364-5, 402, 404
 Ebonizing, 437-9
 Ebony wood, 132, 152, 350, 386-7, 395
 Eccentrics, 478, 483
 Economiser for grates, 661
 Edge-runners, 505
 — tools, 230-16
 — — miscellaneous forms, 243-6
 — — sharpening, 240-3
 Egg-shaped motion, 487
 Egyptian green marbling, 433
 Elæocarpus wood, 134, 162
 Elasticity of wood, 179
 Elbow lever, 485
 Electric bells, 635-40
 — — making, 639-40
 — — systems, 636-9
 — — lighting, 652-4
 Electro-magnet, 639
 Elemi, 472
 Elkin's saw-sharpener, 215-6
 Ellipsograph, 485
 Elliptical spur gears, 523
 Elm, 132-3, 162
 Els wood, 151
 Emblica wood, 158
 Emerald green, 408
 Emery paper, 454-5
 — wheels, 455
 — — for gumming saws, 220
 — — sharpening saws, 216
 Ends, 169
 English woods, 154-5
 Engravings, mounting, 8
 Entwisle's gearing, 531
 Epicyclic trains, 520-1
 Epinette wood, 147
 Erasing errors in drawings, 3-4
 Eremophila wood, 163
 Erol wood, 175
 Erythrina woods, 153, 163
 Essen hout wood, 151
 Eucalyptus woods, 129, 133, 134, 135, 148
 Eugenia wood, 138, 162
 Euonymus wood, 141
 Eurybia wood, 139
 Even grain of wood, 179
 Examination of iron castings, 40-2
 Exæcacia wood, 163
 Exocarpus woods, 131, 163
 Expanding pulley, 493
 Expansion bit, 250
 — eccentric, 483

FACE-PLATE, 534
 Facing chuck, 534
 — moulds, 22, 23, 39
 Fagus woods, 128, 148-9, 149-50, 163
 Fairbairn's baling scoop, 514
 Fan-blower, 519
 Fancy coverings, 403-4
 Fascines, 669
 Fastenings, 268, 277-9
 Feathers, stuffing, 400
 Features of wood, 167
 Feed-rolls, 489
 Felling wood, 166-7
 Felting, 617-8
 Fences, 331-3
 Ferguson's mechanical paradox, 520
 Feronda wood, 158
 Ferro-prussiate paper, 10-1
 Ficus wood, 158-9
 Fiddle drill, 481
 Figures, casting, 24
 Filed work, finishing, 59
 Files, 227-30
 — cleaning, 59
 — fitting to handles, 76-7
 — for saws, 216
 — forms, 227-9
 — principles, 227
 — sharpening, 229-30
 — using, 229
 Filing cast iron, 59
 — guides, 214-5
 — iron, 56-9
 — saws, 213-6
 Filletsterring planes, 238, 244-5
 Filling moulds, 21

- Filling wood for painting, 414
 Fine stuff, 606
 Finish at one heat, 45
 Finishing brickwork, 530-3
 — drawings, 7
 — filed ironwork, 59
 — iron, 44-90
 — tools, 542
 Fir, silver, 133
 — white, 131-2
 Fireirons, forge, 45
 Fireplaces, 594
 Fireproofing wood, 175
 Firing pieces, 340
 — up, 274
 Fished joint, 269
 Fitting iron, 44-90
 — up files, 76-7
 Fixing pencil drawings, 8
 Flagstones, 568
 Flasks, iron-founding, 38
 Flat crown wood, 151
 Flattening tools, sheet metal, 120
 Flaws in iron castings, 40-2
 Fleam tooth, 222
 Flexible water-main, 516
 Flindersia wood, 163
 Float, 608
 Flooded gum wood, 135
 Flooring joint, 277
 Floors, 334-40
 — deadened, 340
 — double, 338-9
 — double-framed, 339
 — dowelled, 339-40
 — folding, 339
 — girders, 339
 — joists, 335-7
 — materials, 334-5
 — paint, 418
 — parallel boarding, 335-40
 — pugging, 340
 — single-joisted, 337
 — skirting board, 340
 — sounding boards, 340
 — stains, 439-41
 — strutting joint, 339
 — strutting joists, 337-8
 — trimmers, 338
 — wood for, 179
 Florentine lake, 403
 Fluxes for soft-soldering, 101
 — solders, 91
 — soldering, 109
 Fluxing-points of solders, 91
 Folding bookcase, 369
 — floors, 339
 — ladder, 506
 — tools, sheet-metal, 120-1
 Foot lathes, 532, 537
 — rule, 182-3
 Footings, 669-70
 Force-pump, 513
 Forcing-frames, 324-5
 Forest oak, 141
 — swamp oak, 141
 Forge fireirons, 45
 — plug, 44
 — stock, 44
 Forged tools superseded, 549
 Forges, 46
 Forging bolts, 69-71
 — chisels, 74-6
 — defined, 61-2
 — drifts, 77-8
 — hammers, 73-4
 — iron, 44-90
 — keys, 66-9
 — nuts, 71-2
 — punches, 78 9
 Forging scrapers, 77
 — spanners, 79-82
 — technical terms, 44-5
 — tongs, 72-3
 — wrenches, 82-4
 Form of iron castings, 39-40
 Forma perduta casting, 22
 Forming tools, sheet-metal, 121-4
 Foundations, 667-70
 Founding and casting, 13-44
 Foundry moulds, 14-5
 — patterns, 14
 — wood for, 179
 Four-motion feed, 508
 — post bedstead, 305-6
 — way cock, 508
 Fourneyron turbine, 512
 Fowl-houses, 310-21
 Foxiness, 167
 Foxtail tenon, 274
 Fragile objects, castings of, 22
 Frame-houses, 682-3
 — turning saw, 198
 Frankfurt black, 407
 Fraxinus wood, 127-8
 Freestone, 568
 French green, 408
 — polishing, 459-70
 Fresco painting, 423-9
 Fret saws, 226-7, 395-6
 Fretwork, 395-9
 — brackets, 398-9
 — gallery, 396-7
 — operations, 396-9
 — outline-cutting, 398
 — stretchers, 397-8
 — tools, 395-6
 — woods, 395
 Friction, 505
 — polish, 455
 — wheels, 523
 Frictional grooved gearing, 523
 Fuchsia wood, 136
 Fuel economiser, 661
 Furnace cupola, 17
 — for brass and bronze, 17-9
 — hot air, 663-5
 — melting, 18-9
 — reverberatory, 19
 Furniture polishing, 459-70
 — rough, making, 294-310
 — woods, 179
 Fusée-chain, 476
 Fusibility of solders, 91
G
GAL MENDORA WOOD, 152
 — mora wood, 152
 Gallery, fretwork, 396-7
 Galvanized iron roofing, 626-7
 — iron, soldering, 111
 Gap spanners, 79-80
 Garden requisites, making, 310-34
 Gardner's seasoning process, 172
 Gas fitting, 640
 — for blowpipe work, 114-5
 — generated in casting, 23-4
 — lighting, 649-52
 — meters, 517
 — pipe soldering, 93
 — vice, 186
 — regulator, 517
 — supply, fitting blowpipe to,
 105-6
 Gasometers, 516-7
 Gates, 333-4
 Gauge for screw-cutting, 60-1
 — of saws, 207
 Gauged stuff, 606
 Gauges, 186-7, 510, 519-20, 543
 Gearing, 521-31
 Geed hout wood, 150, 152
 Geneva stop, 491
 German silver polish, 455
 Gilding, 446-9
 Gimlet bit, 248
 Gimlets, 246-7
 Gipsy table, 301
 Girders in floors, 339
 Glass, 627-8, 629
 — gilding on, 449
 — to metal, soldering, 113
 Glaze wheels for steel, 455-6
 Glazing, 627-34
 — area of window, 628
 — glass, 627-8, 629
 — lead, 629-32
 — putty, 628-9
 — special methods, 632-4
 Glazing tools, 629
 Glineing, 279, 283
 Gmelina wood, 128, 159
 Godapara wood, 152
 Going barrels, 499
 Gold lace, polishing, 456
 — paint, 418
 — solder, 90-1
 — to platinum, soldering, 113
 Gomme-ferric paper, 11-2
 Gooler wood, 158-9
 Gorukina wood, 153
 Gossip-chairs, 366-8
 Gouges, 230-3, 390-1, 558-61
 Grafter saw, 198
 Graining, 429-32
 — colours, 430
 — hints, 432
 — styles, 430-2
 — tools, 430
 Granite, 567
 — marbling, 433
 Grant's black, 407
 Granulating solders, 91
 Graphite crucibles, 19-20
 Grates, open, 659
 Gravel foundations, 667
 Graving tools, 542
 Great maple wood, 143
 Green pigments, 403
 — stains, 441
 — verditer, 403
 Greenheart wood, 133
 Greenhouses, 325-30
 Grewia wood, 159
 Grey box wood, 129
 — stains, 441
 Gri-gri wood, 166
 Grinding paint, 413
 Grindstones, 240-2
 — artificial, 456
 — making, 543
 — mount, making, 292-4
 — tool-rest, 242
 — truing device, 241
 Griselinia wood, 129
 Grits, 568
 Grooved and tongued joint, 27-7
 Grout, 586
 Growth of wood, 166
 Gru-gru wood, 166
 Guaiacum wood, 136
 Guatteria wood, 150, 151
 Guava wood, 160
 Guiana woods, 150
 Guiding-tools, 182-93
 Gullet of saws, 207
 Gum resins, varnish, 472
 Gunning saws, 212-3, 220
 Gums, varnish, 472
 Gum-tree woods, 133

Gutters, 340-6
 Guynemer's drier, 412-3
 Gyroscope, 502
 — governor, 503

HACKMATAACK WOOD, 136
 Haerlem blue, 407
 Haircloth upholstery, 403
 Haika wood, 166
 Hal mendoza wood, 153
 — milila wood, 153
 — wood, 153
 Half lap joint, 231
 — round rinder, 248
 Hall's sudden-grip vice, 193-4
 Halving joint, 272
 Hamburg lake, 403
 Hammer's clamp, 197
 Hammering plates, 84-8
 — veneers, 357-8
 Hammerman, 45
 Hammers, 48-9, 241, 357-8, 399, 516
 — atmospheric, 516
 — dog-head, 85
 — forging, 73-4
 — long-cross face, 84
 — steam, 516
 — twist, 85
 Hand filing saws, 213-4
 — masts, 169
 — saws, 193-222
 — set, 217
 — vice, 193
 Handles of axes, 253-4
 Handling tools, 560-1
 Hard silver solder, 90
 — solder, 90-1
 — for gold, 90
 — spelter solder, 90
 — soldering, 97-9
 Hardening cutting tools, 548-9
 — steel, 64-6
 Harding's ventilators, 656
 Hardness of stone, 563-4
 — tools, 64
 Harpullia wood, 150, 163
 Hartison's going barrel, 499
 Hatchets, 252-6
 Havanna cedar wood, 130
 Hawk, 608
 He oak, 141
 Heart wood, 166
 Hearths, 46
 — braziers', 108-9
 Heartshakes, 167
 Heating soldering-iron, 109
 Hedges, 676
 Hedycarya wood, 135
 Heliograph, 505
 Heritiera wood, 159
 Hero's steam toy, 516
 Hickory wood, 133-4
 Hiero's fountain, 514
 Hinan wood, 134, 162
 Hinging, 283-9
 Hinoki wood, 134
 Hirikadol wood, 153
 Hives, 321-4
 Hoard and Wiggin's steam-trap, 517
 Holdfasts, 260-1
 Holding tools, 193-8
 Hollow chuck, 534
 — walls, 594
 Holly's rotary engine, 510
 Hollywood, 350, 388, 395
 Hooshe wood, 134, 151
 Hopea wood, 159
 Ho-a wood, 153
 Hornbeam wood, 134

Horoeka wood, 134
 Horopito wood, 134
 Horsehair stuffing, 400
 Hot-air furnaces, 663-5
 — seasoning wood, 171
 — water heating, 665-6
 Hotchkiss's atmospheric hammer, 516
 House-building, 334-50
 Housing, 274
 Howlett's adjustable friction gearing, 531
 Huon pine wood, 142
 Hurdles, 332-3
 Hyawa-bolly wood, 150
 Hydraulic ram, 513
 Hydrogen generator, 95-6
 Hymenaea wood, 136

ILLUMINATION, 646-54
 Inch masts, 169
 — tool, 573
 Indian ink, 409
 — woods, 155-62
 Indigo, 407
 Inflammable objects, moulding, 21
 Inga wood, 146, 159, 175
 Inherent strains, 36
 Inking drawings, 4-5
 Inlaying cabinet work, 362
 Instantaneous-grip vice, 194, 262
 Instruments, drawing, 1
 Intermittent circular motion, 493
 Internally toothed spur-gear, 523
 Iron boring, 54-6
 — burnt, 62
 — cast, brazing, 93
 — burning, 92-4
 — casting in loam, 39
 — sand, 39
 — castings, chilling, 43-4
 — examination, 40-2
 — form, 39-40
 — heavy, 41
 — shrinkage, 37, 42-3
 — cements, 88-9
 — chisels, 49-53
 — cold shut, 39
 — cutting tools, 49-53
 — drilling, 54-6
 — filing, 56-9
 — finishing, 44-90
 — fitting, 44-90
 — forges, 46
 — forging, 44-90
 — defined, 61-2
 — founders' pot, 38
 — founding, 35-44
 — flasks, 38
 — patterns, 35-7
 — tools, 37-9
 — hammers, 48-9
 — hearths, 46
 — joints, 88-90
 — oxide, 407
 — paint, 418-9
 — for, 419
 — parting mixture, 39
 — plates, warping, 41
 — polishing, 456-7
 — riveting, 89-90
 — roofing, 626-7
 — screw-cutting tools, 59-61
 — sealing in stone, 91
 — second melting, 40
 — soldering, 112
 — surfacing tools, 56-9
 — swaging tools, 56
 — tempering, 62-6
 — tools, hardness, 64

Iron turning tools, 541-2
 — varnish for, 475
 — welding, 62
 Ironbark wood, 134
 Ironwoods, 134, 146, 151, 153, 159, 163
 165, 166, 175
 Italian jasper marbling, 433
 Ivory black, 407
 — gilding on, 448-9
 Ivy-tree wood, 134

JACK PLANE, 235, 237
 — wood, 135, 153, 156
 Jaman wood, 175
 Japanese bronzes, 26 7
 — lacquer, 471-2
 — surfaces, gilding on, 443
 Japanners' gold size, 446
 Jaral wood, 135
 Jarrah wood, 135
 Jéjérécou wood, 150
 Jewellers' solders, 90-1
 Jewellery, soldering, 98-9
 Jig saw, 225, 506
 Joggle joint, 275
 Johore cedar wood, 164
 — ironwood, 165
 — rosewood, 164
 — teak wood, 164
 Joining stones, 575-6
 Joints, bearing, 272-4
 — bolts and nuts, 273
 — brandering, 274
 — bridle, 276
 — butt, 277
 — butt-jointing veneer curls, 361
 — caulking, 272
 — chase mortice, 273-4
 — classification, 268
 — close jointing, 267-8
 — cogging, 272
 — compound solder, 91
 — corner piecing, 279
 — double notching, 272
 — dovetailing, 272, 277, 281-2,
 299-300
 — dowelled, 277
 — equal bearing, 267
 — furring up, 274
 — fisbed, 269
 — flooring, 277
 — for band-saws, 224-5
 — glueing, 279, 283
 — grooved and tongued, 277
 — half-lap, 281
 — halving, 272
 — hinging, 283-9
 — housing, 274
 — in carpentry, 266-83
 — iron, 88-90
 — keying, 279
 — keys, 277
 — lap (iron), 89
 — lapped beam, 263
 — lengthening, 268-71
 — matched and beaded, 277
 — metal pipes, 124-5
 — miscellaneous, 276-7
 — mitre, 277
 — mortice and tenon, 232-3, 274-6,
 306
 — pinning, 279
 — pins, 277
 — post and beam, 274-6
 — principles, 267
 — rabbeted, 277
 — red lead, 88
 — rust, 88
 — scarfed, 270-1

- Joints, single notching, 272
 — sockets, 279
 — strains, 268
 — straps, 278
 — strengthening, 271-2
 — striped, 99
 — strut, 276
 — tenon and mortice, 232-3, 274-6
 306
 — thin woods, 283
 — toe, 276
 — Tredgold notch, 273
 — tusk tenoning, 273
 — wedges, 277
 — wiped, 99
 Joists, binding, 338-9
 — in floors, 335-7
 — trimming, 338
 Jolotong wood, 164
 Jouval turbine, 512
 Juglans woods, 133-4, 150, 159
 Jumping rotary motion, 525
 Jungle jack wood, 135
 Juniperus woods, 130
- KADOL WOOD**, 153
 Kadubberiya wood, 153
 Kafir boom wood, 151
 Kaha milla wood, 153
 Kabata wood, 153
 Kabika wood, 162
 Kabikatea wood, 145, 162
 Kaiwbiria wood, 135
 Kalukela wood, 153
 Kamahi wood, 135
 Kameel boom wood, 132, 151
 Kanyin wood, 135
 Karakane bronze, 26-7
 Karra marda wood, 175
 Kauri wood, 135, 162
 Kawaka wood, 130, 162
 Kaya merah wood, 164
 Keating's cement, 605
 Keene's cement, 604-5
 Keim's fresco painting, 425-9
 Kershaw's ventilator, 657
 Keyhole saw, 208
 Keying, 279
 Keys, 277
 — forging, 66-9
 Killing spirits of salts, 101, 109
 King post roof, 342, 344
 King's yellow, 409
 Kingwood, 350
 Kiripella wood, 153
 Kiriwalla wood, 153
 Kitchen chair, 363-4
 — dresser, 308-10
 — table, making, 295-301
 Kitul wood, 153
 Knee lever, 486
 Knife tool, 541
 Knightia wood, 146, 163
 Knotting, painters', 416
 Kobe-kobe wood, 136, 162
 Kobutuhutu wood, 136
 Kobwai wood, 136
 Kokatiya wood, 153
 Kokoh wood, 156
 Kon wood, 153
 Kottamba wood, 153
 Kouka wood, 151
 Kowhai wood, 162
 Kranglee wood, 165
 Kruen wood, 165
 Kuhlmann's stone-preserving process, 571
 Kulim wood, 165
 Kwa-wood, 151
- LAC**, 472
 Lacquers, 473-5
 — brass, 475
 — Japanese, 471-2
 Ladder-poles, 169
 Ladders, making, 294-5
 Ladle, 108
 Lagerstramia woods, 135, 146, 159
 Lake pigments, 408
 Lampblack, 407
 Lamps, soldering, 102-4
 Lancewood, 128, 150, 151
 Langdon mitre-box, 188
 Lansdell's steam syphon pump, 514
 Lantern wheel-stops, 493
 Lap joint, iron, 89
 Lapped paling, 332
 Lapping beams, 268
 Larch wood, 136
 Larix woods, 136
 Lathe beds, 532
 — boring collar, 535
 — cords, 533
 — face-plate, 534
 — fork, 533
 — frames, 533
 — mandrel, 532-3
 — manipulation, 537
 — movable head, 497
 — polishing in, 470-1
 — poppet-beads, 532
 — prong, 533
 — rest, 533
 — self-acting, 536
 — — slide-rest, 536
 — skilfulness with hand tools, 539
 — speed motion, 476
 — strut chuck, 533
 — supports, 535
 — tools, 537-61
 — angle of holding, 537-8
 — for metals, 540-58
 — wood, 558-61
 — form, 538-9
 — number required, 537
 — selection, 539
 — shape of edges, 539
 — true framed, 535
 Lathes, 531-9
 Lathing, 608-9
 Lattice fencing, 331
 Laurelia wood, 146
 Lawrance's glazing, 633
 Laying bricks, 587-94
 — concrete, 599-600
 — plaster, 609-10
 — sheet lead, 114
 — slates, 622
 — stonework, 574-5
 Lazy tongs, 483
 Lead glazing, 629-32
 — paints, 419-20
 — sheet, laying, 114
 Leaden calmes, 630-1
 — pipe, mending, 114
 — vessels, burning, 93-7
 Leaf-metal, 446
 Lean-to roofs, 340-2
 Leatherwork upholstery, 400-3
 Lebanon cedar wood, 130
 Leclanché battery, 635
 Ledged doors, 346-7
 Lengthening joints, 268-71
 Leptospermum wood, 138, 163
 Letterwood, 150
 Levels, 185-6, 510
 Lever saw-set, 219
 Lewis for lifting stone, 519
 Libocedrus woods, 127, 130, 162
- Lichens destroying stone, 565
 Lift-pump, 513
 Lifting-jack, 506
 Light red, 409
 Lighting, 646-54
 Lightwood, 129
 Lithium vitæ wood, 136
 Lime paints, 420
 — whiting, 610-3
 — wood, 350, 387
 Limes, 580-1
 Limestones, 569-71
 Limsoots wood, 151
 Line, carpenters', 182
 Linen, mounting drawings on, 3
 Link-motion valve-gear, 489
 Linseed-oil, 410-1
 Liquid slating, 435-6
 Liver rock, 568
 Loam, casting iron in, 39
 Lock saw, 208
 Locust-tree wood, 136, 166
 Log, 169
 — butts, 680-2
 Long cross-face hammer, 84
 Lunt's rabbeting and filister router, 246
 Lysiloma wood, 147
- MABA WOODS**, 147, 163
 Macharium wood, 147
 Machinery woods, 179
 Mackenzie's glazing, 633
 McNeile's seasoning process, 171
 Magdeburg gauge, 520
 Mahogany birch, 350
 — graining, 431
 — stains, 441-2
 — wood, 136-8, 175, 350-1, 387, 395
 Maire wood, 138, 162
 Mairo-taw-hake wood, 138
 Mako wood, 138, 162
 Makohala wood, 132, 151
 Mal buruta wood, 153
 Malabar blackwood, 153
 Malachite green, 408
 Malleable castings, 66
 Mallets, 251-2, 573
 Mandrels, 532-3
 — manganese benzoate drier, 412
 — borate drier, 412
 — oxide drier, 412
 Mango wood, 162
 Mangi wood, 162
 Mangifera woods, 138, 159
 Mangle-rack, 491, 529
 — wheel, 525
 — — and pinions, 476, 489-91
 Mango wood, 138, 159
 Mangrove wood, 151
 Mansard roof, 345-6
 Manuka wood, 138, 163
 Mapau wood, 163
 Maple graining, 431
 — wood, 138, 351, 395
 Marble, polishing, 449-51
 Marbling, 432-3
 Marbow wood, 165
 Marezzo marble, 607
 Marine green, 408
 Market forms of wood, 169-70
 Marking gauge, 186
 Marraboo wood, 165
 Martin's cement, 605
 Masonry, 561-604
 — brickwork, 577-95
 — concrete, 596-602
 — damp walls, 603
 — gilding on, 448
 — saltpetreing walls, 602-3

Masonry, scaffolding, 603-4
 — stonework, 561-77
 Masons' tools, 587
 Massicot, 406-7
 Mastic resin, 472
 — wood, 166
 Matal wood, 139, 141, 163
 Matapo wood, 163
 Match planes, 238
 Matched and beaded joint, 277
 Mattresses, 404-5
 Measuring painters' work, 422-3
 — wood, 180-1
 Mechanical drawing, 1-13
 — movements, 475-531
 — paradox, 520
 Mediums, painting, 409-11
 Medullary rays, 166
 Melaleuca wood, 166
 Melanorhœa wood, 159
 Melia woods, 139, 159-60, 163
 Melk hout wood, 151
 Melting-furnace, 18-9
 Memel pine, 142-3
 Mending chairs, 303-4
 — cracked bell, 112
 — leaden pipe, 114
 — tin saucepan, 114
 Mercurial barometer, 520
 — compensation pendulum, 499
 Messenger's glazing, 633
 Mesua wood, 139
 Metal, black varnish for, 475
 — boxes, 126
 — cups, 125-6
 — patterns, striking out, 116-3
 — pipes, joints, 124-5
 — plate-cutting shears, 481
 — to glass, soldering, 113
 — turning tools, 540-53
 — — — cutting angles, 540
 — — — forms, 540
 — — — grinding, 540
 — — — temper, 540
 — — — typical examples, 540
 Metallic roofing, 626-7
 Metals, gilding on, 448
 — polishing, 451-9
 Metrosideros woods, 145, 146, 163
 Mi wood, 153
 Mian milifa wood, 153
 Michelia wood, 160
 Micrometer-screw motion, 480
 Middling hard solder, 90
 Milk-distemper, 613
 Milkwood, 151
 Miller's combination filister, 244-5
 Milling cutters, 554-8
 — tools, 543
 Millingtonia wood, 160
 Minusops woods, 130, 160
 Mineral green, 408
 Mingi-mingi wood, 138
 Minium, 406-7
 Miro wood, 139, 163
 Mitre box, 187-9
 — joint, 277
 — plane, 244
 — square, 183
 Mitreing board, 355
 — tool, 189
 Mixing metals for casting, 16-7
 Mokume bronze, 28
 Molluscs destroying stone, 565
 Monkey jack wood, 156
 Monoao wood, 139, 162
 Montgolfier's hydraulic ram, 513
 Mora wood, 139
 Moreton Bay pine, 142
 Morrill's saw-sets, 219-20

Mortar, 582-7
 — for pointing, 592-3
 Mortice and tenon joints, 274-6, 279-81, 306
 — cutting, 232-3
 — gauge, 186
 Morus wood, 160
 Motooia wood, 132, 151
 Moulding board, 355
 — brass, 20-2
 — bronze, 20-2
 — in wax, 21
 — inflammable objects, 21
 — planes, 238
 — sand, 22
 — wire, 38
 Mouldings, veneering, 359-60
 Moulds, facel, 22, 23
 — filling, 21
 — for casting metals, 13-5
 — materials for, 20-1
 — metallic, 21
 — packing, 15-6
 Mountain green, 408
 Mounting drawings, 2-3
 — — on linen, 3
 — engravings, 8
 Mulberry wood, 160
 Multiple gearing, 521
 Mural painting, 423-9
 Murboo wood, 165
 Murphy's bench clamp, 197
 Muruba wood, 153
 Muskwood, 139
 Mutti wood, 139
 Myall wood, 163
 Myrsine wood, 163

NAGESWAR WOOD, 139

Nail-pullers, 264
 Nail punch, 264
 Nails, 263-4, 278
 Names of cut wood, 169-70
 Nanmu wood, 139
 Naples yellow, 409
 Natal woods, 150-2
 Native box-wood, 166
 — pear-wood, 166
 Naulœa wood, 160
 Naugia wood, 139
 Nectandra woods, 133
 Nedun wood, 153
 Needlework chairs, 368-9, 404
 Neem wood, 139, 156
 Nei-nei wood, 139
 Nelli wood, 153
 Nesodaphne wood, 148, 163
 New Zealand cedar wood, 130
 — pine wood, 135
 — woods, 162-3
 Newfoundland red pine, 148
 Niello bronze, 28
 Nies hout wood, 147, 151
 Norfolk Island pine, 142
 Northern pine, 142-3
 Norway pine, 144
 — spruce wood, 131-2
 Nosebit, 248
 Notelœa wood, 166
 Nuts, forging, 71-2

OAK-GRAINING, 431-2

— stains, 442-3
 — varnish, 475
 — woods, 140-1, 161, 351, 387
 Ochres, 408-9
 Oil for tempering steel, 65-6
 — gold size, 446

Oil lamps, 647-9
 — varnishes, 473-5
 Oiling handles and stocks, 265
 Oilstones, 242-3, 561
 Oils, painting, 410-1
 Oldfieldia wood, 141
 Olea woods, 134, 138, 162
 Olearia wood, 138
 Oliven hout wood, 151
 Omphalobium wood, 150, 351
 One-man saw, 206-6
 Omhlebe wood, 128, 151
 Oomkoba wood, 152
 Omnyamati wood, 151
 Oomsinsi wood, 151
 Oomtata wood, 151
 Oomtombi wood, 151
 Oomzimbiti wood, 151
 Opaque material, gilding on, 449
 Open grates, 659
 — paling, 332
 — stoves, 659-63
 Orange ochre, 408
 — pigments, 408
 — red, 408
 Ore-stamper motion, 478
 Ornamenting bronze, 27-8
 Oscillating column, 513
 — into intermittent circular motion, 509
 — into rotary motion, 506
 Oscillating piston engine, 509
 Otis's safety stop, 497
 Owenia wood, 163
 Oxford ochre, 409
 Oxyandra wood, 150

PACKING MOULDS, 15-6

Pad saw, 208
 Paddle-wheel, 519
 Pahantœa wood, 130
 Pai-ehh'a wood, 141
 Painted surfaces, gilding on, 448
 Painters' cream, 423
 Painting, 405-29
 — applying, 413
 — basic pigments, 406-7
 — brushes, 415
 — cement, for carton pierre, 417
 — cleaning, 415-6
 — coats, 414-5
 — coloured, 417-8
 — colouring pigments, 407-9
 — composition, 421
 — copper, 418
 — discoloration, 416-7
 — distemper, 610-3
 — driers, 411-3
 — drying, 414
 — filling ground, 414
 — for floors, 418
 — for iron, 419
 — for tin roofing, 420
 — for zinc, 421
 — gold, 418
 — grinding, 413
 — iron, 418-9
 — knotting, 416
 — lead, 419-20
 — lime, 420
 — measuring, 422-3
 — mediums, 409-11
 — miscellaneous, 417-29
 — oils, 410-1
 — priming coat, 413-4
 — removing, 415-6
 — removing smell, 416
 — silicated, 420
 — steatite, 420

- Painting, storing, 413
 — surface, 415-6
 — transparent, 420-1
 — tungsten, 421
 — vehicles, 409-11
 — walls, 423-9
 — water-colours, 416
 — window, 421
 Paling, 331-2
 Panaga wood, 165
 Panax wood, 134
 Panel saw, 198, 208
 Panelled door, 347
 Paning, 84-8
 Panther wood, 127
 Pantograph, 494
 Paperhanging, 642-6
 Papers, copying, 10-3
 — cyanoferric, 11-2
 — cyanotype, 10-1
 — drawing, 2
 — ferro-prussiate, 10-1
 — gомmo-ferric, 11-2
 — tracing, 9-10
 — transfer, 10
 Papier maché mouldings, 607-8
 Parabolas, 508
 Parallel rules, 5, 499-500
 — vice, 195
 Parian cement, 605
 Paring with a chisel, 232
 Parker's saw-filers' vice, 193
 Parry's spirit fresco, 424
 Parson's plan for reciprocating into
 rotary motion, 508
 Parting mixture, 39
 — sand, 38
 — tools, 392, 541
 Partridge-wood, 351
 Patent green, 403
 Paths, 670-4
 Patterns for iron-founding, 35-7
 — metal castings, 14
 — striking out, 116-8
 Pavements, 672-4
 Pawl and crown ratchet, 493
 — elbow lever, 485
 Pear hant wood, 151
 — woods, 141, 166, 351, 387
 Pencil drawings, fixing, 8
 Pencilling drawings, 3
 Pendulum saw, 506
 Pendulums, 499
 Pening, 84-8
 Pennycook glazing, 633
 Pepper-tree wood, 134
 Persca wood, 139, 350
 Persian drill, 480
 — red, 409
 — wheel, 512
 Persimmon wood, 141
 Pewter, burning, 92-4
 — burnishing, 454
 — soldering, 114
 Pewterers' solders, 90-1
 Phoenix wood, 160
 Phyllocladus wood, 148
 Planos, polishing, 464-5
 Picea woods, 133, 160
 Pickering's governor, 497
 Picture-frame clamp, 197
 — vice, 194-5
 Pigeon-houses, 310-21
 Pigments, basic, 406-7
 — colouring, 407-9
 Piling, 669
 Pillows, 405
 Pin wheel and slotted pinion, 491
 Pinaster wood, 142
 Piners, 193
 Pine woods, 142-5, 160, 351
 Pinkwood, 166
 Pinning, 279
 Pins, 277
 — in files, 59
 Pinus woods, 142-5, 160
 Pipes, joints in metallic, 124-5
 Piscidia wood, 132
 Piston-rods, 500
 Pitch of roofs, 613
 — saws, 207
 — pine, 143-4
 — tree wood, 135
 Pittospermum wood, 163
 Pittosporum wood, 166
 Plain seats, upholstering, 402, 403
 — wood, gilding on, 448
 Plane woods, 145, 148
 Planes, 234-40, 351
 — adjusting, 239
 — circular, 243-4
 — dado, 245-6
 — forms, 235-8
 — mitre, 244
 — principles, 234-5
 — toothing, 354
 — using, 239-40
 Planing-machine feed motion, 481, 506
 — metal, in limited space, 545
 — under horizontal surface,
 545
 Planks, 169
 Plaster of paris, gilding on, 449
 Plasterers' mouldings, 607-8
 — putty, 606
 — tools, 587, 608
 Plastering, 604-10
 — lathing, 608-9
 — laying, 609-10
 — materials, 604-8
 — pricking up, 609-10
 Platanus woods, 145
 Plate iron, 45
 — powders, 457-8
 Plating solders, 91
 Platinum to brass, soldering, 111
 — to gold, soldering, 113
 Pliers, timmen's, 118
 Plough plane, 237-8
 Plug, forge, 44
 Plum woods, 163-4
 Plumb level, 186
 Plumbago crucibles, 19-20
 Plumbers' bellows, 97
 — solders, 91
 Podocarpus woods, 139, 141, 145, 147,
 149, 162-4
 Pohutukawa wood, 145
 Point chisel, 573
 Pointed arches, 508
 Pointing brickwork, 590-3
 Points of saws, 207
 Poison-tree wood, 163
 Pol wood, 153
 Poles, 169
 Polished wood, gilding on, 448
 Polishing, 449-72
 — in the lathe, 470-1
 — lenses, 506
 — marble, 449-51
 — metals, 451-9
 — mirrors, 505
 — wood, 459-72
 Ponds, 679-80
 Pongamia wood, 160
 Poni woods, 166
 Poon wood, 144, 157, 158
 Poplar woods, 145-6
 Populus woods, 145-6
 Portable cramp drills, 505
 Post and beam joints, 274-6
 Poultry-houses, 310-21
 Pouring brass and bronze, 22-1
 Power's gas-regulator, 517
 Prepared chalk, 458
 Preserving stone, 571-3
 — tools, 265-6
 — wood, 174-5
 Pressure gauge, 519
 Prices of woods, 181-3
 Pricking up plaster, 609-10
 Priming coat of paint, 413-4
 Proportional compasses, 509
 Prosopis wood, 160
 Prussian blue, 407
 — green, 408
 Psidium wood, 160
 Pterocarpus woods, 160-1, 175
 Pterospermum wood, 350
 Peroxyion wood, 147
 Pugging floors, 340
 Pukatea wood, 146
 Pulley and buckets, 514
 Pulleys, 476
 Pumps, 512-6, 679
 Punch, 45
 Punches, forging, 78-9
 Punching-machine motion, 483
 Puriri wood, 146, 163
 Purple brown, 408
 — stains, 443
 Putranjaya wood, 161
 Putty, 628-9
 — powder, 458
 — soft, 628
 — softening, 628-9
 Pyram wood, 146
 Pyinkado wood, 146
 Pyrus woods, 141

QUARRYING STONE, 566
 Queen-post roof, 345
 Queensland woods, 163-4
 Quercus woods, 140-1, 161
 Quick-return crank motion, 480

RABBET PLANE, 237
 Rabbeted joint, 277
 Rabbeting and filister router, 246
 Rack and frame, 483
 — pinion, 480, 497
 Rail fence, 331
 Rake of saws, 212
 Ramming heavy castings, 41
 Ransome's stone-preservative, 572
 Rasping tools, 198-230
 Rata wood, 146, 163
 Ratchet and pawl, 493
 — brace, 56
 — wheel, 491
 — stops, 493
 Rate of saws, 207
 Raw sienna, 409
 — umber, 408
 Ray's steam-trap, 517
 Razor paste, 458
 Rebate plane, 237
 Reciprocating into rotary motion, 506
 — lift, 514
 — motion from continuous fall of
 water, 512
 — saw, 225
 Rectilinear motion of horizontal bar,
 480
 — of slide, 480
 Red birch wood, 149, 163
 — cedar wood, 149
 — cis wood, 151

- Red gum wood, 133, 135
 — lead, 406-7, 409
 — joints, 88
 — mangrove wood, 151
 — mapau wood, 163
 — pigments, 408-9
 — pine, 142-3, 144, 163
 — sandal wood, 161
 — spruce, 148
 — stains, 443-4
 Registering revolutions, 527
 Relations of circles, 117
 Releasing hook in pile-driving, 494
 — sounding-weight, 494
 Removing paint, 415-6
 — smell of paint, 416
 Rendle's glazing, 634
 René's seasoning process, 172
 Repairing chairs, 508
 Resinate driers, 412
 Resins, varnish, 472-3
 Retinospora woods, 134, 147
 Reverberatory furnace, 19
 Reversing gear for single engine, 487
 Revolving saw set, 218-9
 Rewarewa wood, 146, 163
 Rhamnus wood, 132
 Rhus woods, 131, 161
 Ribouté bronze, 26
 Rickers, 169
 Riga pine, 142-3
 Rimu wood, 144, 163
 Rind-galls, 167
 Ripping-saw, 198, 206-7, 208, 222
 Riveting sheet metal, 126
 Rivets, 89-90
 Roads, 670-2
 Robert's friction proof, 505
 Robinia wood, 126
 Rock els wood, 151
 — foundations, 667
 Rod iron, 45
 Roger's mltre plane, 244
 Rohun wood, 146
 Roller-motion in wool-combing machines, 493
 Rollers, wood for, 179
 Rolling contact, 491
 Rollinia wood, 150
 Roman lake, 408
 Roofs, 340-6, 613-27, 688
 — curb, 345-6
 — dachpappe, 618
 — felt, 617-8
 — king-post, 342, 344
 — lean-to, 341-2
 — mansard, 345-6
 — metallic, 626-7
 — queen-post, 345
 — shides, 617
 — shingles, 617
 — slates, 620-4
 — span, 342-6
 — thatch, 614-7
 — tiles, 624-6
 — Willesden paper, 618-20
 Root's double quadrant engine, 509
 — double reciprocating engine, 510
 Rose pink, 409
 Rosewood, 147, 351, 395
 — graining, 432
 Rosin, 472
 Rot in wood, 173-4
 Rotary engines, 509-12
 — motion from different temperatures in 2 bodies of water, 516
 — motions, 478
 — pumps, 514
 Rotascope, 502
 Rottenstone, 458-9
 Rouge, 459
 Rough cast, 606
 — furniture-making, 294-310
 — rubble, 574
 — timber, 169
 Roughing-out tools, 544
 — tool, 541
 Round-nose tool, 541
 Rounder, 244
 Rounding saws, 214
 Royal blue, 408
 — red marbling, 433
 Rubble, 574-5
 Rule, 182-3
 Russian door-shutting contrivance, 506
 Rust joints, 88
 — preventives, 265-6
 — removers, 266
SABICU WOOD, 147
 Safety stop, 497
 Saffraan hout wood, 151
 St. Ann's marbling, 433
 Sal wood, 147, 161, 175
 Salix woods, 150
 Saltpetreing walls, 602-3
 Samaran wood, 165
 Sampling casting metal, 23
 Sand, 581
 — casting iron in, 39
 — substitutes, 581-2
 Sandal wood, 138, 161, 163, 175, 351, 388
 Sandarach, 473
 Sand-burned castings, 21
 — foundations, 667
 Sand-papering, 355, 396
 Sandstones, 568-9
 Santalum woods, 138, 161
 Sap wood, 166
 Sapindus wood, 161
 Saponette blanche wood, 147
 Sapu milia wood, 154
 — wood, 153
 Sarcoccephalus wood, 164
 Sash-bit, 248
 — door, 347-8
 — saw, 208
 — windows, 348-9
 Satinwood, 146, 152, 157, 351, 395
 — graining, 432
 — stains, 444
 Saul wood, 147, 161, 175
 Sawara wood, 147
 Saw-filers' vice, 193
 Sawing-machine feed, 497
 — rest, 261, 355
 — speed, 225
 — stone, 573
 Saws, 198-227
 — back saw, 221-2
 — band saw, 224-5
 — saw-filer, 215
 — bent-setting, 216-8
 — blazing, 66
 — bow, 198
 — buck saw, 222
 — carcass, 208
 — circular, 222-4
 — clamps, 197, 213-4
 — clearance teeth, 206
 — compass, 208, 222
 — cross-cutting, 204-5, 220-1
 — cut-off, 208
 — emery wheels for, 216, 220
 — files, 216
 — filing, 211-6
 — filing guides, 214-5
 Saws, fleam tooth, 222
 — fret, 226-7, 395-6
 — gauge, 207
 — gullet, 207
 — gumming, 212-3, 220
 — hammering, 84-8
 — handles, 203
 — jig, 225
 — lever saw set, 219
 — one-man, 205-6
 — pendulum, 506
 — pitch, 203-4, 207
 — points, 207
 — principles, 198-208
 — qualities, 208
 — rake, 212
 — rate, 207
 — reciprocating, 225
 — revolving-saw set, 218-9
 — ripping, 198, 206-7, 208, 222
 — rounding, 214
 — scroll, 222
 — selecting, 208-9
 — set, 207
 — set of teeth, 206
 — setting, 211-12, 216-20
 — sharpener, 215-6
 — side-jointing, 214
 — space, 207, 211
 — teeth, 203-8
 — throat, 207
 — top-jointing, 214
 — using, 209-11
 — web, 222
 Saw-table for jig or circular, 225-6
 Saxon blue, 408
 — green, 408
 Scaffold poles, 169
 Scaffolding, 603-4
 Scagliola, 607
 Scales, drawing, 1
 Scantlings, 170
 Scarfed joints, 270-1
 Scarfing-iron, 45
 Scarlet lake, 408
 Scheele's green, 408
 Schleichera wood, 161
 Scotch pine, 142-3
 Scouring sluice, 514
 Scrapers, forging, 77
 Scraping tool, 542
 Scratcher, 608
 Screw bolt and nut, 480
 — clamp, 489
 — cutting, 539
 — cutting gauge, 60-1
 — motion, 480
 — tools, 59-61
 — driver, 265
 — propeller, 519
 — stamping-press motion, 480
 Screws, 264-5, 278
 Scribing block, 543
 Scroll gears, 529
 — saw, 222
 Sealing canned goods, 91
 — iron in stone, 91
 Seamed metal goods, 124-6
 Seamless metal goods, 124
 Seasoning stone, 564-5
 — wood, 170-3
 Seats, making, 302-4
 Second melting, iron, 40
 — seasoning, wood, 172
 Sectors, toothed, 483
 See-saws, 503
 Seesum wood, 147
 Selecting wood, 168-9
 Selenitic concrete, 602
 — mortar, 585-6

- Selenitic plaster, 606
 Self-adjusting step-ladder, 506
 — recording level, 610
 — reversing motion, 478
 Sepe wood, 166
 Seriah wood, 165
 Serpentine, 567-8
 Set of lathe tools, 537-8
 — saws, 207
 Settees, 402-3
 Setting saws, 211-2, 216-20
 Sewers, 680
 Sewing-machine feed, 508
 Shading drawings, 8
 Shakudo bronze, 28
 Shaping machine motion, 480, 487
 Sharpener for saws, 215-6
 Sharpening carvers' tools, 394
 — chisels, 75-6
 — edge tools, 240-3
 — files, 229-30
 — metal-turning tools, 540, 543,
 547-8
 — twist drills, 553
 — wood-turning tools, 560-1
 Shave-hook, 108
 Shears, 481
 She oak, 141
 — pine-wood, 147
 Sheet lead, laying, 114
 — metal boxes, 126
 — cutting tools, 119
 — flattening tools, 120
 — folding tools, 120-1
 — forming tools, 121-4
 — patterns, 116-8
 — riveting, 126
 — seamed goods, 124-6
 — seamless goods, 124
 — spinning, 124
 — tools, 118-24
 — working, 116-26
 Shell bit, 248
 Shelley's glazing, 634
 Shides, 617
 Shinehu bronze, 27
 Shingles, 617
 Shipbuilding woods, 179
 Shiunkei polish, 471-2
 Shooting boards, 188-9, 190-1, 355
 Shorea woods, 147, 161
 Short-leaved pine, 145
 Shrinkage of iron castings, 37, 42-3
 — wood, 175-8
 Sideboard, 384-6
 Side-jointing saws, 214
 — tools, 560
 Sided timber, 169
 Siding saw, 208
 Sienna marbling, 433
 Siennas, 408-9
 Silicated paints, 420
 Silicating stone, 571-2
 Silk-spooling motions, 483, 487
 Silver, burnishing, 454
 — fir wood, 133, 160
 — grain, 166
 — lace, polishing, 456
 — solder, 90-1
 — soldering, 98-9, 112-3
 Simplex glazing, 634
 Single-gear foot lathe, 537
 — notching joint, 272
 Siphon pressure-gauge, 519
 — pump, 514
 Sissu wood, 147, 158, 175
 Sizes for gilding, 446
 — of cut wood, 169-70
 Skin finish on bronze, 26
 Skins, cutting for upholstery, 401-2
 Skirting boards, 340
 Skylight windows, 349-50
 Slating, 620-4
 — liquid, 435-6
 Slide-lathe motion, 480
 — rests, 536-7
 Sliding journal box, 497
 Slotted crank, 486
 Sluice, 514
 Smalt, 408
 Smell of paint, removing, 416
 Smith's test for stone, 566
 Smiths' forges, 46
 — work, examples, 66-88
 Smoke-drying wood, 172
 Smoothing plane, 237
 Sneezewood, 147, 151
 Socket spanners, 80-1
 Sockets, 279
 Sodium amalgam for soldering, 97
 Soft-soldering, 99-102
 — solders, 91
 — colouring, 92
 Softening steel, 64-6
 Soldering, 90-116
 — apparatus, 102-9
 — autogenous, 92-7
 — blowers, 104-6
 — blowpipes, 102
 — brass, 114
 — brass castings, 92-4
 — brass to platinum, 111
 — brass to steel, 111-2
 — brass wire, 111
 — braziers' hearth, 108-9
 — burning, 92-7
 — cast iron, 92-4, 98
 — cold, 97
 — compo pipes, 114
 — cracked bell, 112
 — fitting blowpipe to gas supply,
 105-6
 — fluxes, 109
 — galvanized iron, 111
 — gas-pipes, 98
 — glass to metal, 113
 — hard, 97-9
 — hints, 109-16
 — iron, 112
 — irons, 107-8
 — heating, 109
 — tinning, 99, 101-2
 — jewellery, 98-9
 — lamps, 102-4
 — leaden vessels, 93-7
 — pewter, 92-4, 114
 — platinum to gold, 113
 — sheet copper, 100
 — silver, 98-9, 112-3
 — soft, 99-102
 — steel, 98, 112
 — stove plate, 93
 — supports, 107
 — thin sheet metals, 100-1
 — tin, 99-100
 — — saucepan, 114
 — tools, 107-8
 — without an iron, 111
 — zinc, 100, 111
 Solders, 90-2
 — burnt, 111
 — colouring soft, 92
 — composition, 90-1
 — compound joints, 91
 — contaminated, 110-1
 — fluxes for, 91
 — fluxing-points, 91
 — fusibility, 91
 — preparing, 91-2
 — purifying, 110-1
 Solders, qualities, 110
 — strong, 109-10
 — table of, 91
 Solvents, varnish, 473
 Sonneratia wood, 161
 Sophora wood, 136, 162
 Sounding-boards, 340
 Sour plum wood, 163
 Soyuzda wood, 146, 161
 Space of saws, 207, 211
 Span roofs, 342-6
 Spanish bartons, 476
 — brown, 408
 — ochre, 408
 Spanners, forging, 79-82
 Spars, 169
 Speed of sawing, 225
 Spelter, 109-10
 — solder, 90
 Spinning sheet metal, 124
 Spiral-grooved drum, 486
 — line on cylinder, 505
 Spirit fresco, 424
 — level, 185-6
 — varnishes, 473-5
 Spirits of salts, killed, 101
 Spokeshave, 233-4
 Spondias wood, 164
 Spooling-frame motions, 480, 483, 487
 Spoon bit, 248
 Spring box, 476
 — chuck, 534
 — edges, upholstering, 403-4
 — mattresses, 404-5
 — set, 212
 — tool, 542
 Sprocket wheel, 494
 Spruce, Norway, 131-2
 — ochre, 409
 — pine, 145
 — woods, 147-8
 Spur-gear stops, 493
 Spur-gears, 521
 Spurious box-wood, 129
 Square-nose tool, 542
 — rinder, 248
 — timber, 169
 Squares, 183-5, 192-3
 — drawing, 1-2
 Squaring wood, 167
 Staining, 433-46
 — carvings, 389
 Stairs, 684-5
 Stamper, iron-founding, 38
 Starrett's calliper-square, 191-2
 Starshakes, 167
 Star wheel, 525
 Statuette in bronze, 24-8
 Steam-engine governor, 485, 486, 497
 — hammer, 516
 — heating, 666-7
 — siphon pump, 514
 — traps, 517
 Steaming wood, 171
 Steatite paint, 420
 Steel, glaze wheels for, 455-6
 — polishing, 456-7
 — solder, 91
 — soldering, 98, 112
 — tempering, 62-6
 — to brass, soldering, 111-2
 — to wrought iron, welding, 62
 — tools, hardness, 64
 — welding, 62
 Steeling iron drills, 78
 Steering apparatus, 519
 Steer's hand-vice, 193
 Stenocarpus wood, 164
 Stephen's parallel vice, 195-6
 Steps, making, 294

- Sterculia wood, 161
 Stick timber, 170
 Stinkwood, 152
 Stock, forging, 44
 Stocks and dies, 59-61
 Stone, appearance, 564
 — classification, 566
 — destructive agents, 565
 — durability, 562-3
 — examination, 565-6
 — granite, 567
 — hardness, 563-4
 — joining, 575-6
 — laying, 574-5
 — limestones, 569-71
 — natural beds, 565
 — ochre, 409
 — position in quarry, 564
 — preserving, 571-3
 — quarrying, 566
 — sandstones, 568-9
 — sawing, 573
 — sealing iron in, 91
 — seasoning, 564-5
 — serpentine, 567-8
 — silicating, 571-2
 — strength, 564
 — walls, 576-7
 — weight, 564
 — working, 563
 Stonemasons' tools, 573-4
 Stonework, 561-77
 Stop-chumfer plane, 238
 Stopperwood, 148
 Stops for watches, 491
 Storing paint, 413
 Stove plate, burning, 93
 Stoves, close, 663
 — open, 659-63
 Straight-edge, 183
 — (drawing), testing, 5
 Straight-joint floors, 339
 Strains on joints, 268
 Straits Settlements woods, 164-5
 Straps, 278
 Straw thatch, 614-7
 Strength of stone, 564
 — of woods, 180
 Strengthening joints, 271-2
 Stretchers, fretwork, 397-8
 Stretching plates, 84-8
 Striking brickwork, 590-3
 — out patterns, 116-8
 — tools, 251-2
 Stringy-bark wood, 148
 Striped joints, 99
 Strong solder, 109-10
 Strut-chuck, 533
 — joints, 276
 Strutting floor joists, 337-8
 Stub-tenon, 275
 Stucco, 606-7
 Stuffed mattresses, 405
 Stuffings, upholstery, 400
 Styles of graining, 430-2
 Sudden-grip vice, 193
 Suitability of woods, 179
 Summer-houses, 330-1
 Sun and planet motion, 523
 Sundri wood, 175
 Supports for soldering, 107
 Surface for painting, 415-6
 Surfacing tools for iron, 56-9
 Suriya wood, 154
 Swaged set, 212
 Swaging tools, iron, 56
 Swamp gum wood, 133
 — tea-tree wood, 166
 Sweet plum wood, 164
 Swept up castings, 21-2
 Swietenia woods, 136-8
 Swing boat, 513
 Swinging gutters, 514
 Swivel tool-holders, 544-54
 Sycamore wood, 145, 148, 238
 Syzygium wood, 161
 Szerelmey's stone liquid, 572

T
TABLE-SAW, 208
 — stain, 435
 Tables, making, 295-302
 Taking a heat, 45
 Tal wood, 154
 Tamanu wood, 148
 Tamarak wood, 136
 Tamarind wood, 161
 Tamarindus wood, 161
 Tambooti wood, 134, 151
 Tampenis wood, 165
 Tanekaha wood, 148
 Taper bit, 248
 — vice, 196
 Tappet arm and ratchet wheel, 493
 Taraira wood, 163
 Tasmanian ironwood, 166
 — myrtle wood, 148
 — woods, 166
 Tawa wood, 148, 163
 Tawhal wood, 148
 Tawhai-rai-nui wood, 148
 Tawiri-Kohu-Kohu wood, 163
 Taxus woods, 150
 Teak, 149, 154, 161, 164, 175
 Teale's economiser, 661
 Technical terms in forging, 44-5
 Tectona wood, 149, 154, 161, 164, 175
 Telephone and bell, 638-9
 Temperature for casting, 22-3
 — of tempering, 65
 Tempering colours, 63-5
 — heats, 63-5
 — iron, 62-6
 Tenon and mortice joints, 274-6,
 279-81
 — cutting, 232-3
 — saw, 198, 208
 Terminalia woods, 129, 139, 162, 175
 Terracotta, 579-80
 Tetranthera wood, 162
 Textiles, gilding on, 448
 Thatching, 614-7
 Thespesia wood, 162
 Thick stuff, 169
 Thin woods, joining, 283
 Three-legged stool, making, 302
 Throat of saws, 207
 Tiger wood, 127
 Tilestones, 568
 Tiling, 624-6
 Tilt-hammer, 478
 Timber, 170
 — merchants' fence, 332
 Tin roofing, paint for, 420
 — saucepan, soldering, 114
 Tinmen's pliers, 118
 Tinned iron solder, 91
 Tinnets' solders, 91
 Tinning soldering-iron, 99, 101-2
 Tints in drawings, 5-6
 Tip, gilders', 447
 Title of drawings, 6
 Titoki wood, 149, 163
 Toe and lifter, 499
 — joint, 276
 Toggle joint, 483
 Tongs for lifting stones, 519
 — forging, 72-3
 — iron, 47-8
 — lazy, 483
 Tongue joint, iron, 45
 Tool-chests, making, 289-90, 351-
 — holders, 544-54
 — rest for grindstone, 242
 Tools, adapting, 542
 — boring, 246-50
 — brass-turning, 542
 — bricklayers', 587
 — cabinet-making, 351-5
 — care of, 265-6
 — carpenters', 182-266
 — carving, 390-4
 — chopping, 252-7
 — edge, 230-46
 — flaws in, 558-60
 — fretwork, 395-6
 — gilding, 447
 — glaziers', 629
 — graining, 430
 — guiding, 182-93
 — handling, 560-1
 — holding, 193-8
 — iron founding, 37-9
 — iron-turning, 541-2
 — masons', 587
 — milling, 543
 — parting, 392, 541
 — plasterers', 587, 608
 — rasping, 198-230
 — roughing-out, 544
 — sheet-metal working, 118-24
 — slaters', 623
 — soldering, 107-8
 — stonemasons', 573-4
 — striking, 251-2
 — thatchers', 615-6
 — turning, 537-61
 — upholstery, 399
 — wood-turning, 558-61
 — wood, 149, 157
 Toothed sectors, 483
 Tothing plane, 354
 Top-jointing saws, 214
 Totara wood, 149, 163
 Toughening steel, 65-6
 Toughness of wood, 179
 Towal wood, 149, 163
 Tracing cloth, 8-9
 — paper, 9-10
 Tracings, colouring, 8
 Trammel, 190
 Transfer paper, 10
 Transmitted circular motion, 493
 Transparent material, gilding on,
 — paints, 420-1
 Transvaal woods, 150-2
 Trant's dado plane, 245-6
 Treadle and disc, 485-6
 Treadwheels, 505-6
 Tredgold notch, 273
 Trestle bedstead, 304-5
 Trewia wood, 162
 Triangular eccentric, 483
 Trickett's lever-saw set, 219
 Trimming joists, 338
 Trincornalite wood, 156
 Tripoli, 458-9
 Triptolemaea wood, 147
 Tristania wood, 129
 Trowels, 587, 608
 True black pine, 139
 Trunk engine, 509
 Trying plane, 236
 Tubes for burning, 97
 — striking out, 118
 Tuck pointing, 591
 Tulp-tree wood, 164
 — wood, 150, 163, 351, 395
 Tumbler, 512
 Tumbooso wood, 165

— ingsten paints, 421
 — irrbines, 512
 — ironing, 531-61
 — lathes, 531-9
 — metals, 540-58
 — operation, 531
 — tools, 537-61
 — turpin, 108
 — turpentine varnishes, 473-5
 — urtosa wood, 141
 — usk tenoning, 273
 — svart wood, 133
 — yere, 45
 — ycer, 45
 — yist drills, 551-4
 — — hammer, 85
 — yisting in spinning, 519
 — yyer, 45

W
WABARIYA WOOD, 154
 — mus woods, 132-3, 162
 — nber, 408
 — decoupling engines, 487
 — undercutting slots, 546
 — uniform and varied rotary motion, 523
 — — into variable rotary motion, 523
 — — reciprocating rectilinear motion, 480
 — union coupling, 494
 — universal square, 192-3
 — sound iron castings, 40-2
 — wholstery, 399-405
 — — beds, 405
 — — buttoned seats, 403
 — — couches, 402
 — — coverings, 400
 — — easy chairs, 402
 — — fancy coverings, 403-4
 — — haircloth, 403
 — — leatherwork, 400-3
 — — materials, 400
 — — mattresses, 404-5
 — — needlework chairs, 404
 — — pillows, 405
 — — plain seats, 402, 403
 — — settees, 402
 — — spring edges, 403-4
 — — stuffings, 400
 — — tools, 399
 — set dies, 206, 218
 — — iron, 45
 — sets, 167

WALLET, carpenters', 260-1
 — live motion, 485
 — — — and reversing gear, 487
 — ndyke brown, 403
 — riable motion, 495
 — rnishes, ingredients, 472-3
 — — application, 474
 — — kinds, 473
 — — mixing, 473-4
 — — recipes, 474-5
 — rnishing, 472-5
 — rying speed in shaping machines, 487
 — gettable black, 407
 — hicles, painting, 409-11
 — langa wood, 154
 — neer scraper, 244
 — ncering, 355-62
 — — bed panel, 360-1
 — — butt jointing curls, 361
 — — cauling, 358-60
 — — chest of drawers, 375-8
 — — clamps, 359-60
 — — cleaning off, 362

— Veneering, corners, 359-60
 — — hammering, 357-8
 — — mouldings, 359-60
 — — on, woods for, 356-7
 — — resinous wood, 360
 — Veneers, cutting, 355-6
 — — fixing, 357-61
 — — removing and relaying, 358
 — — woods for making, 356
 — Venetian lake, 408
 — — red, 409
 — Vengay wood, 175
 — Ventilating, 654-8
 — — casting moulds, 23-32
 — Vepris wood, 134
 — Verd antique marbling, 433
 — Verdigris, 408
 — Verditer, 408
 — Vermilion, 409
 — Vertical bucket paddle-wheel, 519
 — Vibrating motions, 478-80
 — Vices, 47-8, 193-6, 261-4, 355
 — Vienna green, 408
 — Violet stains, 444
 — Virginian date-palm wood, 141
 — — red cedar wood, 130
 — Vitex wood, 146-163
 — Volute wheel, 512
 — Voluter, 392

WAINSCOT OAK, 141
 — — varnish, 475
 — Walbomba wood, 154
 — Waldomba wood, 154
 — Walls, coloured shades for, 610-3
 — — damp, 603, 643
 — — earth, 683-4
 — — footings, 669-70
 — — hollow, 594
 — — painting, 423-9
 — — papering, 642-6
 — — salt-petreing, 602-3
 — — stone, 576-7
 — — whitewashing, 610-3
 — Walnut graining, 432
 — — stains, 444-5
 — — woods, 133-4, 150, 159, 351, 388, 395
 — Walukina wood, 154
 — Waney wood, 170
 — Wardrobe, 390-4
 — Warming, 658-67, 687
 — Warping of iron plates, 41
 — Warren's turbine, 512
 — Washstand, 304
 — Watch-regulator, 499
 — Water-beech wood, 145
 — — colour painting, 416
 — — for tempering steel, 65-6
 — — in woods, 179
 — — main, 516
 — — motion into rotary motion, 517
 — — raising machines, 512
 — — seasoning wood, 171
 — — size, 446
 — — supply, 677-80
 — — varnishes, 473-5
 — — wheel governor, 486
 — — — 512
 — Waterproof whitewash, 612
 — Wax, moulding in, 21
 — Weather joint, 590
 — Web saw, 222
 — Wedges, 277
 — Weeping myall wood, 163
 — Weight of stone, 564
 — Weinmannia racemosa wood, 135
 — Weir and scouring sluice, 514
 — Welding iron, 62

— Welding steel, 62
 — — — to wrought iron, 62
 — — wrought iron, 62
 — Wellpenn wood, 154
 — Wells, 677-9
 — West Indian cedar wood, 130
 — — — woods, 166
 — Wet constructions, woods for, 179
 — — gas-meter, 517
 — — rot, 173-4
 — Wewarana wood, 154
 — Weymouth pine, 144-5
 — Wheel and pinion, 491
 — Wheelbarrows, 310
 — Wheeler's countersink, 249-50
 — — — rounder, 244
 — Wheel-teeth woods, 179
 — White birch wood, 125
 — — cedar wood, 163
 — — deal wood, 131-2
 — — elms wood, 151
 — — fir wood, 131-2
 — — gum wood, 133
 — — holly wood, 395
 — — ironwood, 134, 151
 — — lead, 406
 — — manuka wood, 133
 — — mapau wood, 163
 — — pine, 144-5
 — — walnut wood, 133-4
 — Whitewashing, 610-3
 — Whitewood, 166
 — White's dynamometer, 505
 — — pulleys, 476
 — Whiting, 610-3
 — Whole deals, 169
 — Widdringtonia wood, 130-1
 — Wild olive wood, 151
 — Wilge boom wood, 152
 — Willesden paper, 618-20
 — Willow wood, 150, 152
 — Wilson's 4-motion feed, 503
 — Wind, effect on roofs, 623-4
 — — — motion into rotary motion, 517
 — Windlass, 481, 497, 502
 — Windmills, 517-9
 — Windows, 348-50
 — — area, 628
 — — casement, 348
 — — dormer, 345
 — — glazing, 627-34
 — — paint, 421
 — — sash, 348-9
 — — skylight, 349-50
 — Windsor chair, 303-4
 — Winter's bark wood, 134
 — Wiped joints, 99
 — Witch-bazel wood, 128
 — Wooden-seated chair, 303-4
 — Wood-turning tools, 558-61
 — Woods, breaking weight, 126
 — — British Guiana, 150
 — — building, 179
 — — cabinetmaking, 350-1
 — — Cape, 150-2
 — — carpentry, 126-82
 — — carving, 386-90
 — — Ceylon, 152-4
 — — classification, 169
 — — cohesive force, 126
 — — composition, 178-9
 — — conversion, 175-8
 — — crushing force, 126
 — — decay, 173-4
 — — defects, 167-8
 — — durability, 179
 — — elasticity, 179
 — — English, 151-5
 — — even grain, 179
 — — features, 167

Woods, felling, 166-7
 — fireproofing, 175
 — for floors, 179
 — for foundry patterns, 179
 — for rollers, 179
 — for veneering on, 356-7
 — for veneers, 356
 — for wet constructions, 179
 — for wheel teeth, 179
 — fretwork, 395
 — furniture, 179
 — gilding on, 448
 — growth, 166
 — Indian, 155-62
 — machinery, 179
 — market forms, 169-70
 — measuring, 180-1
 — names of sizes, 169-70
 — Natal, 150-2
 — New Zealand, 162-3
 — polishes, 459-72
 — preserving, 174-5
 — prices, 181-2
 — Queensland, 163-4
 — seasoning, 170-3
 — selecting, 163-9

Woods, shipbuilding, 179
 — shrinkage, 175-8
 — squaring, 167
 — stains, 433-46
 — Strait Settlements, 164-5
 — strength, 180
 — suitability, 179
 — Tasmanian, 166
 — toughness, 179
 — Transvaal, 150-2
 — water in, 179
 — West Indian, 166
 — seasoning process, 172
 Woodworth's feed motion of planing
 machine, 506
 Working stone, 563
 Workshop appliances, making, 289-94
 Worm and worm-wheel, 523
 — wheels, 491
 Wrenches, forging, 82-4
 Wrought iron to steel, welding, 62
 — — welding, 62

XYLOPIA WOOD, 150

YARD REQUISITES, making,
 310-34
 Yari-yari wood, 150
 Yellow birch wood, 123
 — lake, 409
 — ochre, 409
 — orpiment, 409
 — pigments, 409
 — pine, 139, 142-3, 144, 145
 — stains, 446
 — wood, 138, 150, 152
 Yew wood, 150, 388
 Yoke bar, 485
 Yorke saran wood, 166

ZEBRAWOOD, 150, 351
 Zigzag fence, 331
 Zinc, paint for, 421
 — roofing, 626
 — soldering, 111
 — white, 407
 Zizyphus wood, 162
 Zogan bronze, 27
 Zumatic driers, 412

BOOKS RELATING

TO

APPLIED SCIENCE

PUBLISHED BY

E. & F. N. SPON.

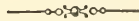

Workshop Receipts. For the Use of Manufacturers, Mechanics, and Scientific Amateurs. By ERNEST SPON. Crown 8vo, cloth, with Illustrations, Price 5s.

SYNOPSIS OF CONTENTS.

Bookbinding.	Freezing.	Painting in Oils, in Water
Bronzes and Bronzing.	Fulminates.	Colours, as well as
Candles.	Furniture Creams, Oils,	Fresco, House, Trans-
Cement.	Polishes, Lacquers,	parency, Sign, and
Cleaning.	and Pastes.	Carriage Painting.
Colourwashing.	Gilding.	Paper.
Concretes.	Glass Cutting, Cleaning,	Paper Hanging.
Dipping Acids.	Frosting, Drilling,	Photography.
Drawing Office Details.	Darkening, Bending,	Plastering.
Drying Oils.	Staining, and Paint-	Polishes.
Dynamite.	ing.	Pottery—(Clays, Bodies,
Electro - Metallurgy —	Glass Making.	Glazes, Colours, Oils,
(Cleaning, Dipping,	Glues.	Stains, Fluxes, Ena-
Scratch-brushing, Bat-	Gold.	mels, and Lustres).
teries, Baths, and	Graining.	Scouring.
Deposits of every	Gums.	Silvering.
description).	Gun Cotton.	Soap.
Enamels.	Gunpowder.	Solders.
Engraving on Wood,	Horn Working.	Tanning.
Copper, Gold, Silver,	Indiarubber.	Taxidermy.
Steel, and Stone.	Japans, Japanning, and	Tempering Metals.
Etching and Aqua Tint.	kindred processes.	Treating Horn, Mother-
Firework Making —	Lacquers.	o'-Pearl, and like sub-
(Rockets, Stars, Rains,	Lathing.	stances.
Gerbes, Jets, Tour-	Lubricants.	Varnishes, Manufacture
billons, Candles, Fires,	Marble Working.	and Use of.
Lances, Lights, Wheels,	Matches.	Veneering.
Fire - balloons, and	Mortars.	Washing.
minor Fireworks).	Nitro-Glycerine.	Waterproofing.
Fluxes.	Oils.	Welding.
Foundry Mixtures.		

E. & F. N. SPON, 125, STRAND.

Workshop Receipts (Second Series). By ROBERT HALDANE. Devoted mainly to subjects connected with Chemical Manufactures. An entirely New Volume, uniform in Size, Style, and Type with the Original 'Workshop Receipts.' Crown 8vo, cloth, 5s.

SYNOPSIS OF CONTENTS.

Acidimetry and Alkali-metry.	Dyeing.	Isinglass.
Albumen.	Staining and Colouring.	Ivory Substitutes.
Alcohol.	Essences.	Leather.
Alkaloids.	Extracts.	Luminous Bodies.
Baking Powders.	Fireproofing.	Magnesia.
Bitters.	Gelatine.	Matches.
Bleaching.	Glue and Size.	Paper.
Boiler Incrustations.	Glycerine.	Parchment.
Cements and Lutes.	Gut.	Perchloric Acid.
Cleansing.	Hydrogen Peroxide.	Pigments.
Confectionery.	Inks.	Paint and Painting.
Copying.	Iodine.	Potassium Oxalate.
Disinfectants.	Iodoform.	Preserving.

Workshop Receipts (Third Series). By C. G. WARNFORD LOCK, F.L.S. Devoted mainly to Electrical and Metallurgical subjects. Crown 8vo, cloth, 5s.

SYNOPSIS OF CONTENTS.

Alloys.	Enamels and Glazes.	Platinum.
Aluminium.	Erbium.	Potassium.
Antimony.	Gallium.	Rhodium.
Barium.	Glass.	Rubidium.
Beryllium.	Gold.	Ruthenium.
Bismuth.	Indium.	Selenium.
Cadmium.	Iridium.	Silver.
Cæsium.	Iron.	Slag.
Calcium.	Lacquers.	Sodium.
Cerium.	Lanthanum.	Strontium.
Chromium.	Lead.	Tantalum.
Cobalt.	Lithium.	Terbium.
Copper.	Lubricants.	Thallium.
Didymium.	Magnesium.	Thorium.
Electrics (including alarms, batteries, bells, carbons, coils [induction, intensity, and resistance], dynamo-electric machines, fire risks, measuring, microphones, motors, phonographs, photophones, storing, telephones).	Manganese.	Tin.
	Mercury.	Titanium.
	Mica.	Tungsten.
	Molybdenum.	Uranium.
	Nickel.	Vanadium.
	Nisbium.	Yttrium.
	Osmium.	Zinc.
	Palladium.	Zirconium.

Workshop Receipts (Fourth Series). By C. G.

WARNFORD LOCK, F.L.S. Devoted mainly to Handicrafts and Mechanical Subjects. 250 Illustrations, with complete Index and a general Index to the Four Series. Crown 8vo, cloth, 5s.

CONTENTS :

- Waterproofing** : rubber goods, cuprammonium processes, miscellaneous preparations.
- Packing and Storing** articles of delicate odour or colour, of a deliquescent character, liable to ignition, apt to suffer from insects or damp, or easily broken.
- Embalming and Preserving** anatomical specimens.
- Leather Polishes.**
- Cooling Air and Water**, producing low temperatures, making ice, cooling syrups and solutions, and separating salts from liquors by refrigeration.
- Pumps and Syphons**, embracing every useful contrivance for raising and supplying water on a moderate scale, and moving corrosive, tenacious, and other liquids.
- Desiccating** : air- and water-ovens, and other appliances for drying natural and artificial products.
- Distilling** : water, tinctures, extracts, pharmaceutical preparations, essences, perfumes, and alcoholic liquids.
- Emulsifying** as required by pharmacists and photographers.
- Evaporating** : saline and other solutions, and liquids demanding special precautions.
- Filtering** : water, and solutions of various kinds.
- Percolating and Macerating.**
- Electrotyping.**
- Stereotyping** by both plaster and paper processes.
- Bookbinding** in all its details.
- Straw Plaiting** and the fabrication of baskets, matting, etc.
- Musical Instruments** : the preservation, tuning, and repair of pianos, harmoniums, musical boxes, etc.
- Clock and Watch Mending** : adapted for intelligent amateurs.
- Photography** : recent development in rapid processes, handy apparatus, numerous recipes for sensitizing and developing solutions, and applications to modern illustrative purposes.

Mechanical Engineering. The Mechanician :

A Treatise on the Construction and Manipulation of Tools, for the use and instruction of Young Engineers and Scientific Amateurs, comprising the Arts of Blacksmithing and Forging ; the Construction and Manufacture of Hand Tools, and the various methods of Using and Grinding them ; the Construction of Machine Tools, and how to work them ; Machine Fitting and Erection ; description of Hand and Machine Processes ; Turning and Screw Cutting ; principles of Constructing and details of Making and Erecting Steam Engines, and the various details of setting out work, etc., etc., by Cameron Knight, Engineer, 96 4to *plates, containing 1147 illustrations* and 397 pages of letterpress, second edition, re-printed from the first, 4to, cloth, 18s.

Of the six chapters constituting the work, the first is devoted to forging ; in which the fundamental principles to be observed in making forged articles of every class are stated, giving the proper relative positions for the constituent fibres of each article, the mode of selecting proper quantities of material, steam-hammer operations, shaping-moulds, and the manipulations resorted to for shaping the component masses to the intended forms.

Engineers' tools and their construction are next treated, because they must be used during all operations described in the remaining chapters, the author thinking that the student should first acquire knowledge of the apparatus which he is supposed to be using in the course of the processes given in Chapters 4, 5, and 6. In the fourth chapter, planing and lining are treated, because these are the elements of machine-making in general. The processes described in this chapter are those on which all accuracy of fitting and finishing depend. The next chapter, which treats of shaping and slotting, the author endeavours to render comprehensive by giving the hand-shaping processes in addition to the machine-shaping.

In many cases hand-shaping is indispensable, such as sudden breakage, operations abroad, and on board ship ; also for constructors having a limited number of machines. Turning and screw-cutting occupy the last chapter. In this, the operations for lining, centering, turning, and screw-forming are detailed and their principles elucidated.

The Mechanician is the result of the author's experience in engine making during twenty years ; and he has concluded that however retentive the memory of a machinist might be, it would be convenient for him to have a book of primary principles and processes to which he could refer with confidence.

Spons' Dictionary of Engineering, Civil,
 Mechanical, Military, and Naval, with Technical Terms in
 French, German, Italian, and Spanish. In 97 numbers, super-
 royal 8vo, containing 3132 *printed pages* and 7414 *engravings*.
Any Number can be had separate: Nos. 1 to 95, 1s. each,
 post free; Nos. 96, 97, 2s., post free.

COMPLETE LIST OF ALL THE SUBJECTS.

	Nos.		Nos.
Abacus	1	Boilers	13, 14, 15
Adhesion	1	Bond	15 and 16
Agricultural Engines	1 and 2	Bone Mill 16
Air-Chamber 2	Boot-making Machinery 16
Air-Pump 2	Boring and Blasting 16 to 19
Algebraic Signs 2	Brake 19 and 20
Alloy 2	Bread Machine 20
Aluminium 2	Brewing Apparatus 20 and 21
Amalgamating Machine 2	Brick-making Machines 21
Ambulance 2	Bridges 21 to 28
Anchors 2	Buffer 28
Anemometer 2 and 3	Cables 28 and 29
Angular Motion 3 and 4	Cam 29
Angle-iron 3	Canal 29
Angle of Friction 3	Candles 29 and 30
Animal Charcoal Machine 4	Cement 30
Antimony 4	Chimney 30
Anvil 4	Coal, Cutting and Washing Ma- chinery 31
Aqueduct 4	Coast Defence 31, 32
Arch 4	Compasses 32
Archimedean Screw 4	Construction 32 and 33
Arming Press 4 and 5	Cooler 34
Armour 5	Copper 34
Arsenic 5	Cork-cutting Machine 34
Artesian Well 5	Corrosion 34 and 35
Assaying 6	Cotton Machinery 35
Artillery 5 and 6	Damming 35 to 37
Automatic Weights 6 and 7	Details of Engines 37, 38
Auger 7	Displacement 38
Axles 7	Distilling Apparatus 38 and 39
Balance 7	Diving and Diving Bells 39
Ballast 7	Docks 39 and 40
Bank Note Machinery 7	Drainage 40 and 41
Barn Machinery 7 and 8	Drawbridge 41
Barker's Mill 8	Dredging Machine 41
Barometer 8	Dynamometer 41 to 43
Barracks 8	Electro-Metallurgy 43, 44
Barrage 8 and 9	Engines, Varieties 44, 45
Battery 9 and 10	Engines, Agricultural 1 and 2
Bell and Bell-hanging 10	Engines, Marine 74, 75
Belts and Belting 10 and 11	Engines, Screw 89, 90
Bismuth 11	Engine, Stationary 91, 92
Blast Furnace 11 and 12	Escapement 45, 46
Blowing Machine 12	Fan 46
Body Plan 12 and 13		

	Nos.		Nos.
File-cutting Machine	46	Locks and Lock Gates	72, 73
Fire-arms	46, 47	Locomotive	73
Flax Machinery	47, 48	Machine Tools	73, 74
Floot Water-wheels	48	Manganese	74
Forging	48	Marine Engine	74 and 75
Founding and Casting	48 to 50	Materials of Construction	75 and 76
Friction	50	Measuring and Folding	76
Friction, Angle of	3	Mechanical Movements	76, 77
Fuel	50	Mercury	77
Furnace	50, 51	Metallurgy	77
Fuze	51	Meter	77, 78
Gas	51	Metric System	78
Gearing	51, 52	Mills	78, 79
Gearing Belt	10, 11	Molecule	79
Geodesy	52 and 53	Oblique Arch	79
Glass Machinery	53	Ores	79, 80
Gold	53, 54	Ovens	80
Governor	54	Over shot Water-wheel	80, 81
Gravity	54	Paper Machinery	81
Grindstone	54	Permanent Way	81, 82
Gun-carriage	54	Piles and Pile-driving	82 and 83
Gun Metal	54	Pipes	83, 84
Gunnery	54 to 56	Planimeter	84
Gunpowder	56	Pumps	84 and 85
Gun Machinery	56, 57	Quarrying	85
Hand Tools	57, 58	Railway Engineering	85 and 86
Hanger	58	Retaining Walls	86
Harbour	58	Rivers	86, 87
Haulage	58, 59	Riveted Joint	87
Hinging	59	Roads	87, 88
Hydraulics and Hydraulic Ma-		Roofs	88, 89
chinery	59 to 63	Rope-making Machinery	89
Ice-making Machine	63	Scaffolding	89
India-rubber	63	Screw Engines	89, 90
Indicator	63 and 64	Signals	90
Injector	64	Silver	90, 91
Iron	64 to 67	Stationary Engine	91, 92
Iron Ship Building	67	Stave-making and Cask Ma-	
Irrigation	67 and 68	chinery	92
Isomorphism	68	Steel	92
Keels and Coal Shipping	68 and 69	Sugar Mill	92, 93
Kiln	69	Surveying and Surveying In-	
Knitting Machine	69	struments	93, 94
Kyanising	69	Telegraphy	94, 95
Lamp, Safety	69, 70	Testing	95
Lead	70	Turbine	95
Lifts, Hoists	70, 71	Ventilation	95, 96, 97
Lights, Buoys, Beacons	71 and 72	Waterworks	96, 97
Limes, Mortars, and Cements	72	Wood-working Machinery	96, 97
		Zinc	96, 97

The Complete Work can be had in the following Bindings :

3 vols., cloth	£5 5 0
In 8 divisions, cloth	5 8 0
In 3 vols., half-morocco, top edge gilt	6 12 0

E. & F. N. SPON, 125, STRAND.

Algebra. Algebra Self-taught. By P. Higgs, M.A., D.Sc., LL.D., Assoc. Inst. C.E., Author of 'A Handbook of the Differential Calculus,' etc., second edition, crown 8vo, cloth, 2s. 6d.

CONTENTS.

Symbols and the signs of operation—The equation and the unknown quantity—Positive and negative quantities—Multiplication—Involution—Exponents—Negative exponents—Roots, and the use of exponents as logarithms—Logarithms—Table of logarithms and proportionate parts—Transformation of system of logarithms—Common uses of common logarithms—Compound multiplication and the Binomial theorem—Division, Fractions, and Ratio—Continued proportion—The series and the summation of the series—Limit of series—Square and Cube Roots—Equations—List of formulæ, etc.

Applied Science. Progressive Lessons in Applied Science. By Edward Sang, F.R.S.E., crown 8vo, cloth, each part, 3s.

Part 1. Geometry on Paper.

Part 2. Solidity, Weight, and Pressure.

Part 3. Trigonometry, Vision, Surveying Instruments.

Architect's Handbook. A Handbook of Formulæ, Tables, and Memoranda, for Architectural Surveyors and others engaged in Building. By J. T. Hurst, C.E., thirteenth edition, royal 32mo, roan, 5s.

CONTAINING :

Formulæ and Tables for the Strength of Materials, Roofs, Water Supply, Drainage, Gas, and other matters useful to Architects and Builders.

Information connected with Sanitary Engineering.

Memoranda on the several trades used in Building, including a description of Materials and Analyses of Prices for Builders' work.

The Practice of Builders' Measurement.

Mensuration and the Division of Land.
Tables of the Weights of Iron and other Building Materials.

Constants of Labour.

Valuation of Property.

Summary of the Practice in Delapidations.

Scale of Professional Charges for Architects and Surveyors.

Tables of English and French Weights and Measures.

"The tenth edition of this invaluable Pocket Book has just made its appearance; space will not permit us to describe all the changes made in it, for it has been entirely re-written. The formulæ and tables contained in former editions have been supplemented by many others, the chapter of useful Memoranda regarding different kinds of work has been greatly extended, and a most valuable addition has been made to the work in the shape of 37 pp. of admirably condensed Memoranda connected with Sanitary Engineering. The book is very well got up, and though it contains nearly twice as much matter as the last edition, the paper and type have been so arranged that it does not occupy a greater bulk."—*Royal Engineers' Journal.*

Architectural Drawing Copies. A Series of Lithographed Working Drawings of the most important details of Building Construction, drawn to a large scale, showing clearly how work is put together, and giving the technical terms used in the various trades, especially designed for instruction in Architectural Drawing and Building Construction, by W. Busbridge, First-Class Certificated Teacher of the Science and Art Department; Head Master of the Metropolitan Drawing Classes; and Instructor of Mechanical Drawing at the Royal Arsenal, Woolwich. These Plates are approved and recommended by the Science and Art Department and their Professional Examiners, and are used in the leading Colleges, and Science and Art Schools of the Country. Price 3*d.* per Sheet. Each plate is complete in itself, the first 26 sheets in one vol., 7*s.* 6*d.*

Builders' Price-Book. Spens' Builders' Pocket-Book of Prices and Memoranda, edited by W. YOUNG, Architect, royal 32mo, roan, 4*s.* 6*d.*, or cloth, vermilion edges, 3*s.* 6*d.*

Published annually.

CONTENTS.

Ancient Lights, Table of and Rules for Calculating.	Excavators' Useful Memoranda.
Approximate Cost of Buildings, by Cubing.	Fire and Insurance Memoranda.
Arches, Architects' Charges.	Five Orders of Architecture.
Bricklayers' Useful Memoranda.	Floors and Joists, Table of Wood.
Carpenters' and Joiners' Useful Memoranda.	Footings of Walls.
Cast-Iron Hollow Columns, Table of.	Gasfitters' Useful Memoranda.
Cements, Composition and Strength of.	Gas Supply.
Chimneys, How to Build.	Girders of Wood and Iron, Strength of, and Table of Safe Loads.
Chimneys, Smoky, Cause and Cure of.	Heat.
Churches, Rules of Incorporated Society.	Heights, Measurable.
Circle, Properties of.	Hoop Iron.
Coals, Space occupied by, & Weight of.	Iron Roofs, Examples of.
Columns, Strength of.	Lightning Conductors.
Concrete Building.	Limestones.
Concrete under Water.	Leads on Roofs and Floors.
Corrugated Iron Roofing.	Measurement of Builders' Work.
Cubical Contents of Floors, Roofs, etc., Table of.	Mensuration.
Damp Walls, Recipe for.	Mortar, Smeaton's, as used at Eddy-stone Lighthouse.
Decay of Wood, Cause and Cure of.	Mortars.
Dimensions of English Cathedrals and Halls.	Nomenclature, Architectural.
Drainage of Land.	Norman, Early English, Decorated, and Perpendicular Mouldings, Examples of.
Drainage of Towns, Cost of.	Paviors' Memoranda.
Drains and Sewers.	Perspective.
	Piers and Pillar
	Piles.

<p>Plasterers' Memoranda. Plumbers' Memoranda. Preservation of Wood and Stone. Rainfall. Retaining Walls. Rolled Iron Joists. Roofs, Table of Scanting, etc. Ropes. Stone, Building, Component Parts, Colour, Weight, Strength, and Price of Building Stones in England and Scotland. Surveying. Symbolism. Tenacity of Materials. Thickness of Walls. Timbers, Quality, Weight, and Strength of. Valuation of Property. Ventilation. Warming by Steam. Water, Hot. Water Supply. Waterworks.</p>	<p>Weight of Metals and all Materials used in Building. Wells. Wind, Pressure of. Zinc-workers' Memoranda. Excavators' Prices. Bricklayers' Prices. Masons' Prices. Marble Masons' Prices. Terra-cotta Prices. Paviers' Prices. Carpenters' Prices. Joiners' Prices. Steam-made Joinery Prices. Ironmongers' Prices. Slaters' Memoranda. Slaters' Prices. Tilers' Prices. Plasterers' Prices. Plumbers' Prices. Smiths' and Founders' Prices. Zinc-workers' and Bell-hangers' Prices. Painters' and Paper-hangers' Prices. Glaziers' Prices.</p>
--	---

Carpentry. Elementary Principles of Carpentry, by Thomas Tredgold, revised from the original edition, and partly rewritten, by John Thomas Hurst, contained in 517 pages of letterpress, and *illustrated with 48 plates and 150 wood engravings*, fifth edition, crown 8vo, handsomely bound in cloth, 12s. 6d.

<p>Section I.—On the Equality and Distribution of Forces. „ II.—Resistance of Timber. „ III.—Construction of Floors. „ IV.—Construction of Roofs. „ V.—Construction of Domes and Cupolas. „ VI.—Construction of Partitions. „ VII.—Scaffolds, Staging, and Gantries.</p>	<p>Section VIII.—Construction of Centres for Bridges. „ IX.—Coffer-dams, Shoring, and Strutting. „ X.—Wooden Bridges and Viaducts. „ XI.—Joints, Straps, and other Fastenings. „ XII.—Timber.</p>
--	---

Casting and Founding. A Practical Treatise on Casting and Founding, including descriptions of the modern machinery employed in the art, by R. E. Spretson, Engineer, with 82 *plates* drawn to scale, third edition, 8vo, cloth, 18s.

CONTENTS.

Fig Iron and some of its Characteristics—On Designing Castings—Furnaces and Fuel—Measures of Heat—Thermometers and Pyrometers—Refractory Materials—Crucibles—Blowing Engines—Fans and Blowers—Patterns—Materials used in Moulding—Moulding—Chill Casting—Malleable Cast Iron—Case Hardening—Casting on to other Metals—Drying Stoves—Foundry Pits—Crane Ladles—Foundry Cranes—Cast Steel—Brass Foundry—Bronze Fine Art Work—Statue Founding—Bell Founding—Cleaning and Dressing Foundings—Examples of Foundries—Cost of Moulding and Casting—Alloys, etc., etc.

Chemists' Pocket-Book. A Pocket-Book for Chemists, Chemical Manufacturers, Metallurgists, Dyers, Distillers, Brewers, Sugar Refiners, Photographers, Students, etc., etc., by Thomas Bayley, Assoc. R. C. Sc. Ireland, Analytical and Consulting Chemist, Demonstrator of Practical Chemistry, Analysis, and Assaying, in the Mining School, Bristol, fourth edition, royal 32mo, roan, gilt edges, 5s.

SYNOPSIS OF CONTENTS.

Atomic Weights and Factors—Useful Data—Chemical Calculations—Rules for Indirect Analysis—Weights and Measures—Thermometers and Barometers—Chemical Physics—Boiling Points, etc.—Solubility of Substances—Methods of obtaining Specific Gravity—Conversion of Hydrometers—Strength of Solutions by Specific Gravity—Analysis—Gas Analysis—Water Analysis—Qualitative Analysis and Reactions—Volumetric Analysis—Manipulation—Mineralogy—Assaying—Alcohol—Beer—Sugar—Miscellaneous Technological matter relating to Potash, Soda, Sulphuric Acid, Chlorine, Tar Products, Petroleum, Milk, Tallow, Photography, Prices, Wages, etc., etc.

Clerk of Works. The Clerk of Works, a Vade Mecum for all engaged in the Superintendence of Building Operations, by G. G. Hoskins, F.R.I.B.A., third edition, fcap. 8vo, cloth, 1s. 6d.

Factories and Workshops. Our Factories, Workshops, and Warehouses: their Sanitary and Fire-Resisting Arrangements, by B. H. Thwaite, Assoc. Mem. Inst. C.E., *with numerous wood engravings*, crown 8vo, cloth, 9s.

CONTENTS.

Part 1. How the Development of English Manufacturing Industries affected the Health of the English Operatives, and compelled Legislative Interference.—Part 2. On the existing Sanitary arrangements of Textile and other Manufacturing occupations.—Part 3. Factory and Workshop Sanitation.—Part 4. Arrangements for the Prevention of Accidents.—Part 5. The Origin of Conflagrations, and their Prevention.

French Measures. French Measures and English Equivalents, by John Brook. For the use of Engineers, Manufacturers of Iron, Draughtsmen, etc., 18mo, roan, 1s.

“In a series of compact tables the English values of the French measures are arranged from one to a thousand millimetres, and from one to a hundred metres; the fractions of an inch progressing in sixteenths are also reduced to French values. The little book will be found useful to almost every engineer.”—*Engineering*.

Engineers' Tables. Spons' Tables and Memoranda for Engineers, selected and arranged by J. T. Hurst, C.E., Mem. of the Society of Engineers, Mem. Phys. Soc. of London, Surveyor War Department, Author of 'Architectural Surveyors' Handbook, 'Hurst's Tredgold's Carpentry,' etc., 64mo, roan, gilt edges, fifth edition, revised and improved, 1s.

In cloth case, 1s. 6d.

Or in metal case, 2s.

CONTENTS.

EXCAVATORS' MEMORANDA	Weight of Hoop Iron	PAINTERS' AND GLAZIERS
BRICKLAYERS'	" Chains, and size of	MEMORANDA
Fire-Clay Flue Linings	Cast Iron Pipe	SUNDRY MEMORANDA
Weight of Bricks and Tiles	" Heads, Nuts, and	Weight of Metals per foot
MASONS' MEMORANDA	" Washers	" cube
Weight of Limes and Cements	" Cast Iron Socket	" Earth, Stone, &c.
" Purbeck Paving	" Pipes	" per ft. cube
" Yorkshire	" Wire	" Timber
" Marble Slabs	Size and Weight of Nails	" Liquids
SLATERS' MEMORANDA	" Spikes	" Men and Animals
Weight of Slates	Weight of Cast Iron Balls	" Forage
CARPENTERS' MEMORANDA	" Corrugated Iron	" Water
Deal Standards	" Roofing	" Oil
Purlins	" Nails	" Coal
Roof Scantlings	" Shoes for Door	Ropes
Floors	" Frames	Railway Curves
Rafters	Relative Weight of various	Measurement of Heights
PLASTERERS' MEMORANDA	Metals	Railway Road Crossings
SMITHS' & FOUNDLERS' MEMORANDA	Proportion of Wheels	Measurement of Distance
Size of Heads, Nuts, &c.	Cast Iron Pillars	MENSURATION
" Rivets	Relative Strength of Cast	Circumferences of Circles
Shrinkage of Castings	and Wrought Iron Pillars	Areas of Circles
Corrugated Iron	Safe Load for Stone Pillars	Regular Polygons
Zinc	" Floors	MONEY TABLES, English and
Weight of Round and Square	Strength of Rolled Iron	Foreign
" Iron	Beams	WEIGHTS AND MEASURES
" Flat Bar Iron	Fire-Proof Floors	Weight and size of casks
" Round Cast Iron	Wrought Iron Roofs	Size of Paper
" Various Metals per	PLUMBERS' MEMORANDA	French Measures
ft. sup.	Weight of Sheet Lead	Maltese
" Sheet Iron	" Lead Pipes	Comparison of English and
		Foreign Measures

This work is printed in a pearl type, and is so small, measuring only $2\frac{1}{2}$ in. by $1\frac{3}{4}$ in., by $\frac{1}{4}$ in. thick, that it may be easily carried in the waistcoat pocket.

"It is certainly an extremely rare thing for a reviewer to be called upon to notice a volume measuring but $2\frac{1}{2}$ in. by $1\frac{3}{4}$ in., yet these dimensions faithfully represent the size of the handy little book before us. The volume—which contains 118 printed pages, besides a few blank pages for memoranda—is, in fact, a true pocket-book, adapted for being carried in the waistcoat pocket, and containing a far greater amount and variety of information than most people would imagine could be compressed into so small a space. . . . The little volume has been compiled with considerable care and judgment, and we can cordially recommend it to our readers as a useful little pocket companion."—*Engineering*.

Engineers' Pocket-Book. A Pocket-Book of Useful Formulæ and Memoranda for Civil and Mechanical Engineers, by Guilford L. Molesworth, Mem. Inst. C. E., Consulting Engineer to the Government of India for State Railways, twenty-first edition, revised and improved, 32mo, roan, 6s.

Ditto, interleaved with ruled paper for Office use, 9s.

Ditto, printed on India paper, 6s.

SYNOPSIS OF CONTENTS.

Surveying, Levelling, etc.
 Strength and Weight of Materials.
 Earthwork, Brickwork, Masonry,
 Arches, etc.
 Struts, Columns, Beams, and Trusses.
 Flooring, Roofing, and Roof Trusses.
 Girders, Bridges, etc.
 Railways and Roads.
 Hydraulic Formulæ.
 Canals, Sewers, Waterworks, Docks.
 Irrigation and Breakwaters.
 Gas, Ventilation and Warming.
 Heat, Light, Colour, and Sound.
 Gravity—Centres, Forces, and Powers.
 Millwork, Teeth of Wheels, Shafting,
 etc.
 Workshop Recipes.
 Sundry Machinery.
 Animal Power.
 Steam and the Steam Engine.

Water-power, Water-wheels, Turbines,
 etc.
 Wind and Windmills.
 Steam Navigation, Ship - Building,
 Tonnage, etc.
 Gunnery, Projectiles, etc.
 Weights, Measures, and Money.
 Trigonometry, Conic Sections, and
 Curves.
 Telegraph.
 Mensuration.
 Tables of Areas and Circumference,
 and Arcs of Circles.
 Logarithms, Square and Cube Roots
 Powers.
 Reciprocals, etc.
 Useful Numbers.
 Differential and Integral Calculus.
 Algebraic Signs.
 Telegraphic Construction and Formulæ.

French - Polishing. The French - Polisher's Manual, by a French-Polisher, containing Timber Staining, Washing, Matching, Improving, Painting, Imitations, Directions for Staining, Sizing, Embodying, Smoothing, Spirit Varnishing, French-Polishing, Directions for Re-polishing, royal 32mo, sewed, 6d.

Handrailing. Handrailing cut square to the Plank, without a Falling Mould, as discovered and taught at the Mechanics' Institution, Liverpool, by John Jones, Staircase Builder, part 1, with plates, royal 8vo, sewed, 2s.

Ditto, ditto, Part II., containing additional examples, royal 8vo, cloth, 3s. 6d.

Mechanical Engineering. Notes in Mechanical Engineering, compiled principally for the use of Students attending the Lectures in this subject at the City of London College, by Henry Adams, Mem. Inst. M.E., Mem. Inst. C.E., Mem. Soc. of Engineers, crown 8vo, cloth, 2s. 6d.

CONTENTS.

Part 1. Section 1. Fundamental Principles of Mechanics—2. Properties of Materials—3. Behaviour of Materials under Strain—4. The Action of Chisels, Hammers, Punches, Planes, Shears, Drills—5. Tempering, Welding, Riveting, Caulking, &c.—6. Tools used in the Workshop. Part 2. Founding, Moulding and Pattern Making. Part 3. Shafting, Gearing, and General Machinery. Part 4. The Steam Engine: Stationary, Marine, and Locomotive. Part 5. Different kinds of Boilers and Boiler Fittings. Part 6. Hydraulic Machinery—Pumps—Centrifugal, and other Turbines—Water Wheels—Hoists—Pressure Engines, &c.—Operations of the Pattern Maker—Founder—Blacksmith and Turner in connection with Hydraulic Machinery.

Plan and Map Drawing. The Draughtsman's Handbook of Plan and Map Drawing, including instructions for the Preparation of Engineering, Architectural, and Mechanical Drawings, *with numerous illustrations and coloured examples*, by G. G. André, F.G.S., M.S.E., crown 4to, cloth, 9s.

CONTENTS.

Part 1. The Essential Elements; The Drawing Office and its Functions; Geometrical Problems; Lines, Dots, and their Combinations; Colours; Shading. Part 2. Applications; Lettering, Bordering, and North Points; Scales; Plotting; Civil Engineers and Surveyors; Plans; Map Drawing; Mechanical and Architectural Drawing; Copying and Reducing; Trigonometrical Formulæ; Inclined Measure; Curvature and Refraction, etc., etc., etc.

Tables of the Weight of Iron and Steel. Tabulated Weights of Angle, Tee, Bulb, Round, Square, and Flat Iron and Steel, and other information for the use of Naval Architects and Shipbuilders, by Chas. H. Jordan, Mem. Inst. N.A., Surveyor to the Underwriters' Registry for Iron Vessels, and Author of 'Particulars of Dry Docks on the Thames,' third edition, revised and enlarged, royal 32mo, cloth, 2s. 6d.

"Naval architects and shipbuilders have long been familiar with this handy little work, and have found it of great service in calculating the weights of iron ships. It has also been found very useful by engineers and others in connection with the iron work of shore structures. The chief feature in this new edition is the introduction of tables respecting the weight of mild steel; and, in view of the growing use of this material for shipbuilding, this edition considerably enhances the value of the little book. Mr. Jordan's extensive experience with iron ships, and his position as Surveyor to the Underwriters' Registry for Iron Vessels, afford a sufficient guarantee of the trustworthiness of this work, and we confidently recommend it to all who are concerned with iron and steel work as a handy compendium of useful and accurate tables."—*Nautical Magazine*.

Steam Engine. A Practical Treatise on the Steam Engine, containing Plans and Arrangements of Details for Fixed Steam Engines, with Essays on the Principles involved in Design and Construction, by Arthur Rigg, Engineer, Member of the Society of Engineers and of the Royal Institution of Great Britain, demy 4to, *copiously illustrated with woodcuts and 96 plates.* In one volume, half-bound morocco, £2 2s.

Cheaper Edition, neatly bound in cloth, £1 5s.

This work is not, in any sense, an elementary treatise, or history of the steam engine, but describes examples of Fixed Steam Engines without entering into the wide domain of locomotive or marine practice. To this end illustrations are given of the most recent arrangements of Horizontal, Vertical, Beam, Pumping, Winding, Portable, Semi-portable, Corliss, Allen, Compound, and other similar Engines, by the most eminent Firms in Great Britain and America. The laws relating to the action and precautions to be observed in the construction of the various details, such as cylinders, pistons, piston-rods, connecting-rods, cross-heads, motion-blocks, eccentrics, simple, expansion, balanced, and equilibrium slide valves, and valve-gearing are minutely dealt with. In this connection will be found articles upon the velocity of reciprocating parts and the mode of applying the indicator, heat and expansion of steam governors, and the like. The writer has drawn illustrations from every possible source, and given only those rules that present practice deems correct.

Surveying. A Practical Treatise on the Science of Land and Engineering Surveying, Levelling, Estimating Quantities, etc., with a general description of the several instruments required for Surveying, Levelling, Plotting, etc., by H. S. Merrett, 41 *fine plates with illustrations and tables*, fourth edition, revised and corrected by G. W. Usill, Assoc. Mem. Inst. C.E., royal 8vo, cloth, 12s. 6d.

PRINCIPAL CONTENTS.

Part 1. Introduction and the Principles of Geometry. Part 2. Land Surveying; comprising, general observations—the chain—offsets surveying by the chain only—surveying hilly ground, to survey an estate or parish by the chain only, surveying with the theodolite—Mining and town surveying—railroad surveying—Mapping—division and laying out of land—observations on enclosures—plane trigonometry. Part 3. Levelling—simple and compound levelling—the level-book—parliamentary plan and section—Levelling with a theodolite, gradients—wooden curves—to lay out a railway curve—setting out widths. Part 4. Calculating quantities generally, for estimates—Cuttings and Embankments—Tunnels—Brickwork—Ironwork—Timber measuring. Part 5. Description and use of instruments in surveying and plotting—the improved dumpy level—Troughton's Level—the prismatic compass—proportional compass—box sextant—Vernier—pantagraph—Merrett's improved quadrant—improved computation scale—the diagonal scale—straight-edge and sector. Part 6. Logarithms of numbers—logarithmic sines and co-sines, tangent and co-tangents—natural sines and co-sines—Tables for earthwork—for setting out curves, and for various calculations, etc., etc., etc.

Tables of Squares and Cubes. Barlow's Tables of Squares, Cubes, Square Roots, Cube Roots, Reciprocals of all Integer Numbers up to 10,000, post 8vo, cloth. 6s.

Tables of Speeds. Tables of some of the Principal Speeds occurring in Mechanical Engineering, expressed in Metres in a Second, by P. Kearayeff, Chief Mechanic of the Obouchoff Steel Works, St. Petersburg, translated by Sergius Kern, M.E., *6d.*

Turning. The Practice of Hand-turning in Wood Ivory, Shell, etc., with Instructions for Turning such work in Metal as may be required in the Practice of Turning in Wood, Ivory, etc., also an Appendix on Ornamental Turning, by Francis Campin, third edition, *with wood engravings*, crown 8vo, cloth (a book for beginners), *6s.*

CONTENTS.

On lathes, turning tools, turning wood, drilling, screw-cutting, miscellaneous apparatus and processes, turning particular forms, staining, polishing, spinning metals, materials, ornamental turning, etc.

Watchwork. Treatise on Watchwork, Past and Present, by the Rev. H. L. Nelthrop, M.A., F.S.A., *numerous illustrations*, crown 8vo cloth, *6s. 6d.*

CONTENTS.

Definitions of words and terms used in watchwork. Tools. Time. Historical summary. On calculations of the numbers for wheels and pinions, their proportional sizes, trains, etc. Of dial-wheels, or motion-work. Length of time of going without winding-up. The Verge. The Horizontal. The Duplex. The Lever. The Chronometer. Repeating Watches. Keyless Watches. The Pendulum, or Spiral Spring. Compensation. Jewelling of pivot-holes, Clerkenwell. Fallacies of the Trade. Incapacity of Workmen. How to choose and use a Watch, etc.

Warming and Ventilation. A Treatise on Warming and Ventilating Buildings, by Charles Hood, F.R.S., sixth edition, 8vo, cloth, *illustrated*, *12s. 6d.*

Treatise on Valve-Gears, with special consideration of the Link-Motions of Locomotive Engines, by Dr. Gustav Zeuner, Professor of Applied Mechanics at the Confederated Polytechnikum of Zurich. Translated from the Fourth German Edition, by Professor J. F. Klein, Lehigh University, Bethlehem, Pa., *illustrated*, 8vo, cloth, *12s. 6d.*

RECENTLY PUBLISHED.

In super-royal 8vo, 1168 pp., with 2400 illustrations, in 3 Divisions, cloth, price 13s. 6d. each; or 1 vol., cloth, 2l.; or half-morocco, 2l. 8s.

A SUPPLEMENT

TO

SPONS' DICTIONARY OF ENGINEERING.

Civil, Mechanical, Military, and Naval.

EDITED BY ERNEST SPON, ASSOC. MEM. INST. C.E., MEM. SOC. ENGINEERS, OF THE FRANKLIN INSTITUTE, AND OF THE GEOLOGISTS' ASSOCIATION.

THE success which has attended the publication of 'SPONS' DICTIONARY OF ENGINEERING' has encouraged the Publishers to use every effort tending to keep the work up to the standard of existing professional knowledge. As the Book has now been some years before the public without addition or revision, there are many subjects of importance which, of necessity, are either not included in its pages, or have been treated somewhat less fully than their present importance demands. With the object, therefore, of remedying these omissions, this Supplement is now issued. Each subject in it is treated in a thoroughly comprehensive way; but, of course, without repeating the information already included in the body of the work.

The new matter comprises articles upon

	No.		No.		No.
Abacus, Counters, Speed Indicators, and Slide Rule ..	1	Coal Mining ..	6, 7	Lifts, Hoists, and Elevators	13
Agricultural Implements and Machinery	1	Coal Cutting Machines	7	Lighthouses, Buoys, and Beacons ..	13, 14
Air Compressors ..	1, 2	Coke Ovens. Copper Docks. Drainage ..	7, 8	Machine Tools ..	14
Animal Charcoal Machinery	2	Dredging Machinery ..	8	Materials of Construction	14, 15
Antimony	2	Dynamo-Electric and Magneto - Electric Machines	8	Meters	15
Axles and Axle-boxes ..	2	Dynamometers ..	8, 9	Ores, Machinery and Processes employed to Dress	15
Barn Machinery ..	2	Electrical Engineering, Telegraphy, Electric Lighting and its practical details, Telephones ..	9, 10	Piers	15
Belts and Belting ..	2	Engines, Varieties of ..	10	Pile Driving	15
Blasting. Boilers ..	3	Explosives. Fans ..	10	Pneumatic Transmission	15
Brakes	3	Founding, Moulding and the Practical work of the Foundry	10, 11	Pumps	15
Brick Machinery ..	3, 4	Gas, Manufacture of ..	11	Pyrometers	15
Bridges	4, 5	Hammers, Steam and other Power ..	11	Road Locomotives ..	15, 16
Cages for Mines ..	5	Heat. Horse Power ..	12	Rock Drills	16
Calculus, Differential and Integral ..	5	Hydraulics	12	Rolling Stock ..	16, 17
Canals	5	Hydro-geology ..	12	Sanitary Engineering ..	17, 18
Carpentry	5	Indicators. Iron ..	12, 13	Shafting	18
Cast Iron	5, 6			Steel	18
Cement, Concrete, Limes, and Mortar ..	6			Steam Navy	18
Chimney Shafts ..	6			Stone Machinery ..	18
Coal Cleansing and Washing	6			Tramways	18
				Well Sinking	18

SPONS' ENCYCLOPÆDIA

OF THE

INDUSTRIAL ARTS, MANUFACTURES, AND COMMERCIAL PRODUCTS.

EDITED BY

C. G. WARNFORD LOCK, F.L.S., &c., &c.

*In Super-royal 8vo, containing 2100 pp., and Illustrated by nearly
1500 Engravings.*

Can be had in the following bindings:

In 2 Vols., cloth	£3 10 0
In 5 Divisions, cloth	3 11 6
In 2 Vols., half-morocco, top edge gilt, bound in a superior manner	4 10 0
In 33 Monthly Parts, at 2s. each.	

Any Part can be had separate, price 2s.; postage 2d.

~~~~~

### COMPLETE LIST OF ALL THE SUBJECTS.

|                                         | Part    |                                        | Part   |                                                | Part       |
|-----------------------------------------|---------|----------------------------------------|--------|------------------------------------------------|------------|
| Acids .. .. .                           | 1, 2, 3 | Dyestuffs .. .. .                      | 14     | Narcotics .. .. .                              | 21, 22     |
| Alcohol .. .. .                         | 3, 4    | Electro-Metallurgy .. .. .             | 14     | Oils and Fatty Substances                      |            |
| Alkalies .. .. .                        | 4, 5    | Explosives .. .. .                     | 14, 15 | Paper .. .. .                                  | 22, 23, 24 |
| Alloys .. .. .                          | 5, 6    | Feathers .. .. .                       | 15     | Paraffin .. .. .                               | 24         |
| Arsenic .. .. .                         | 6       | Fibrous Substances .. .. .             | 15, 16 | Pearl and Coral .. .. .                        | 24         |
| Asphalte .. .. .                        | 6       | Floor-cloth .. .. .                    | 16     | Perfumes .. .. .                               | 24         |
| Aerated Waters .. .. .                  | 6       | Food Preservation .. .. .              | 16     | Photography .. .. .                            | 24, 25     |
| Beer and Wine .. .. .                   | 6, 7    | Fruit .. .. .                          | 16, 17 | Pigments and Paint .. .. .                     | 25         |
| Beverages .. .. .                       | 7, 8    | Fur .. .. .                            | 17     | Pottery .. .. .                                | 25, 26     |
| Bleaching Powder .. .. .                | 8       | Gas, Coal .. .. .                      | 17     | Printing and Engraving                         | 26         |
| Bleaching .. .. .                       | 8, 9    | Gems .. .. .                           | 17     | Resinous and Gummy                             |            |
| Borax .. .. .                           | 9       | Glass .. .. .                          | 17     | Substances .. .. .                             | 26, 27     |
| Brushes .. .. .                         | 9       | Graphite .. .. .                       | 18     | Rope .. .. .                                   | 27         |
| Buttons .. .. .                         | 9       | Hair Manufactures .. .. .              | 18     | Salt .. .. .                                   | 27, 28     |
| Camphor .. .. .                         | 9, 10   | Hats .. .. .                           | 18     | Silk .. .. .                                   | 28         |
| Candles .. .. .                         | 10      | Ice, Artificial .. .. .                | 18     | Skins .. .. .                                  | 28         |
| Carbon .. .. .                          | 10      | Indiarubber Manufac-<br>tures .. .. .  | 18, 19 | Soap, Railway Grease, and<br>Glycerine .. .. . | 28, 29     |
| Celluloid .. .. .                       | 10      | Ink .. .. .                            | 19     | Spices .. .. .                                 | 29         |
| Clays .. .. .                           | 10      | Jute Manufactures .. .. .              | 19     | Starch .. .. .                                 | 29         |
| Carbolic Acid .. .. .                   | 11      | Knitted Fabrics (Ho-<br>siery) .. .. . | 19     | Sugar .. .. .                                  | 29, 30, 31 |
| Coal-tar Products .. .. .               | 11      | Lace .. .. .                           | 19     | Tannin .. .. .                                 | 31, 32     |
| Cocoa .. .. .                           | 11      | Leather .. .. .                        | 19, 20 | Tea .. .. .                                    | 32         |
| Coffee .. .. .                          | 11, 12  | Linen Manufactures .. .. .             | 20     | Timber .. .. .                                 | 32         |
| Cork .. .. .                            | 12      | Manures .. .. .                        | 20     | Varnish .. .. .                                | 32         |
| Cotton Manufactures .. .. .             | 12, 13  | Matches .. .. .                        | 20, 21 | Wool and Woollen Manu-<br>factures .. .. .     | 32, 33     |
| Drugs .. .. .                           | 13      | Mordants .. .. .                       | 21     |                                                |            |
| Dyeing and Calico Print-<br>ing .. .. . | 13, 14  |                                        |        |                                                |            |

~~~~~

LONDON: E. & F. N. SPON, 125, STRAND.
NEW YORK: 35, MURRAY STREET.

In Crown 8vo, cloth, with numerous Illustrations, price 10s. 6d.

SOAP.

A TREATISE ON THE
MANUFACTURE OF SOAP & CANDLES, LUBRICANTS & GLYCERINE.

By W. LANT CARPENTER, B.A., B.Sc.

(LATE OF MESSRS. C. THOMAS AND BROTHERS, BRISTOL).

CONTENTS.

Historical Epitome and References.—Chapter 1. Theoretical Principles—
2. Raw Materials: their Sources and Preparation—3. Raw Materials: Refining, Clarifying, and Bleaching—4. Raw Materials: their proximate Analysis—
5. Caustic Alkali and other Mineral Salts—6. Manufacture of Household Soaps; the Process of Saponification—7. Treatment of Soap after its removal from the Soap Copper; Household, Manufacturers', and Toilet Soaps—8. Theory of the Action of Soap; its Valuation and Analysis; Distribution and Position of the Trade—9. Lubricating Oils, Railway and Wagon Grease, etc.—10. Candles: Raw Materials, their Sources and Preliminary Treatment—11. Processes for the Conversion of Neutral Fats into Fatty Acids; the Manufacture of Commercial Stearin—12. The Manufacture of Candles and Night-Lights; their value as Illuminants—13. Glycerine—14. Summary of Patents—15. Bibliography—16. Index.

In Crown 8vo, cloth, with numerous Illustrations, price 10s. 6d.

TANNING.

A TEXT-BOOK OF TANNING.

A TREATISE ON THE
CONVERSION OF SKINS INTO LEATHER, BOTH PRACTICAL
AND THEORETICAL.

By HENRY R. PROCTER, F.C.S.,

OF LOWLIGHTS TANNERY; EXAMINER IN TANNING TO THE CITY AND GUILDS
TECHNICAL INSTITUTE.

CONTENTS.

Chapter 1. Anatomical Structure of Hide—2. Chemical Composition of Hide—
3. Tanning Materials—4. Chemistry of Tanning—5. Water as used in Tanning—
6. Chemical Analysis for the Tannery—7. Sole Leather; preparing the Hides—
8. Unhairing Hides—9. Tanning Materials—10. Treatment in the Tan-house—
11. Treatment in the Shed—12. Dressing Leather—13. Currying—14. Enamelled, Patent, or Japanned Leather—15. Morocco Leather—16. Russia Leather—
17. Chamois, or Wash Leather—18. Crown, or Preller's Leather—19. Mineral Tanned Leather—20. Calf Kid—21. Glove Kid—22. Construction and Maintenance of Tanneries—23. Drying Sheds—24. Statistics, &c.

E. & F. N. SPON, 125, STRAND.

33 132272

GETTY CENTER LIBRARY



3 3125 00799 2049

