

MANUAL INSTRUCTION

UC-NRLF



B 4 583 631

WOODWORK

S. BARTER

REESE LIBRARY
OF THE
UNIVERSITY OF CALIFORNIA.

Received *June* . 189*7*.

Accessions No. *66463* . Class No. .



MANUAL INSTRUCTION

W O O D W O R K

(THE ENGLISH SLOYD)



Books for Manual Training Classes.



BARTER'S DRAWING FOR MANUAL TRAINING
CLASSES. 32 Plates.

BARTER'S WOODWORK. 4th Thousand. 7s. 6d.

LELAND'S DRAWING AND DESIGNING. Second
Edition. 1s.

LELAND'S WOOD CARVING. Third Edition. 5s.

LELAND'S METAL WORK. 5s.

LELAND'S LEATHER WORK. 5s.

JACK'S LAUNDRY WORK. 2s.



LELAND'S PRACTICAL EDUCATION. Fourth Edition. 6s.

SEIDEL'S INDUSTRIAL INSTRUCTION. 4s.

WOODWARD'S THE MANUAL TRAINING SCHOOL.
5s. net.

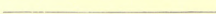

London: WHITTAKER & CO., Paternoster Square.



REESE LIBRARY
OF THE
UNIVERSITY
OF
CALIFORNIA



MANUAL INSTRUCTION

WOODWORK

(THE ENGLISH SLOYD)

By S. BARTER

ORGANIZER AND INSTRUCTOR OF MANUAL TRAINING IN WOODWORK TO THE
LONDON SCHOOL BOARD, AND ORGANIZING INSTRUCTOR TO THE JOINT
COMMITTEE ON MANUAL TRAINING IN WOODWORK OF THE
SCHOOL BOARD FOR LONDON, THE CITY AND GUILDS
OF LONDON TECHNICAL INSTITUTE, AND THE
WORSHIPFUL COMPANY OF DRAPERS

WITH 302 ILLUSTRATIONS

PREFACE BY GEORGE RICKS, B.Sc.LOND.

FOURTH THOUSAND
(REVISED)



London

WHITTAKER & CO.

2 WHITE HART STREET, PATERNOSTER SQUARE

And New York

[1892]

TT185
B3

66463

PRINTED BY

SPOTTISWOODE AND CO., NEW-STREET SQUARE
LONDON



PREFACE



THE Author of this book has invited me to write a short preface, doubtless, partly because I have taken the most active interest in the introduction of Manual Training into Public Elementary Schools as a necessary part of the school curriculum, and partly because I was the first to suggest the introduction of a modification of the Nääs Slöjd into the Woodwork-classes conducted under the joint auspices of the City and Guilds of London Institute and the School Board for London, in which classes the Author was a distinguished teacher.

I gladly accept the invitation for two reasons. (1) I am anxious to acknowledge to the full our great indebtedness to the Swedish Slöjd. In his introduction the Author points to certain defects in this system when measured by our special wants and changed conditions; but, nevertheless, the fact remains, that, without the Slöjd, we should probably have taken some years to work out such a scheme as that so graphically portrayed in the following pages. (2) I want to emphasise the principle that the Manual Training of our Public Elementary

Schools, whatever material may be used, must be a real educational process. The popular notions of Manual Training are very vague and varied; authorities even differ as to its significance. It is necessary, therefore, to lay down distinctly the scope and aims of this 'New Education.'

Manual Instruction, especially when wood is the material used, may be nothing more than the development of mechanical skill in the use of tools; and, as such, it is understood by many of its advocates. But this is not what 'Educators' conceive Manual Training to be. The Manual Training of the school must be a training which places intellectual and moral results before mechanical skill. If I may venture on a definition, I should say that Manual Training is a special training of the senses of sight, touch, and muscular perception by means of various occupations; and it is a training of these faculties not so much for their own sake, though that is important, as it is for the training of the mind. While the eye is being trained to accuracy and the hand to dexterity and manipulative skill, the mind is being trained to observation, attention, comparison, reflection, and judgment. In other words, Manual Training is a development of the manual and visual activities of the child, having for its purpose to quicken and develop the mental powers of observation, attention, and accuracy; to cultivate the moral faculties of order and neatness, perseverance and self-reliance; to awaken and train the artistic faculties, and direct the child's instincts towards the beautiful and true; to satisfy and cultivate the child's instinct for activity, and excite pleasure in the acqui-

sition of skill ; to provide opportunity for the development and practice of the inventive and constructive faculties ; and to afford scope for the imagination.

Thus the main aim of Manual Training is Educational, to perfect our system of education, and so to raise the standard of practical intelligence throughout the community. At the same time some other advantages follow, which, if secondary, are important. For instance, the special training of hand and eye cannot fail to develop and stimulate those faculties upon whose activity success in life depends. The cultivated taste, the trained eye, and the skilled hand cannot fail to bring forth fruit in the home and in the workshop, and, in fact, in whatever position in life the child may be placed. Then, again, Manual Training confers a marked benefit on the school. It attracts and delights the children, because here they find food for the imperious need of activity inherent in child nature. Manual Training lightens and brightens the work of the school, and introduces an element of attractiveness which must relieve school-life of some of the weariness and languor incidental to purely mental effort.

One word more : the essence of Manual Training lies in the *practice*, and not in the *production* ; in the *doing*, not in the *thing* done ; and any exercise is valuable only in proportion to the demand it makes upon the mind for intelligent, thoughtful work.

GEORGE RICKS, B.Sc

AUTHOR'S NOTE



IN presenting this work to the public I wish to express my thanks to Sir PHILIP MAGNUS and to Mr. GEORGE RICKS, B.Sc., for the advice which these pioneers of Manual Instruction in England kindly gave me, and to the Joint Committee of the School Board for London, the City and Guilds of London Technical Institute, and the Worshipful Company of Drapers, for the scope allowed me for experimenting in their classes during the last four years ; also to Mr. E. J. BROWN, of Oldridge Road Board School, to whom I am much indebted for the photographs of tool operations.

The book, it is hoped, will be useful to teachers, and is intended to assist those preparing for the examinations of the City and Guilds of London Technical Institute.

S. BARTER.

LONDON : *April* 1892.



CONTENTS OF CHAPTERS

	PAGE
CHAPTER I. INTRODUCTION	1
„ II. DRAWING	18
„ III. TIMBER	39
„ OTHER MATERIALS	82
„ IV. TOOLS	87
„ V. BENCH WORK	139
EXERCISE I. <i>Marking, sawing, and chiselling</i>	139
„ II. <i>Variation of Exercise I., but more difficult</i>	147
„ III. <i>Sawing with tenon saw, simple face and edge planing, planing to thickness and breadth</i>	150
„ IV. <i>Planing, sawing with tenon saw, chamfering with plane and chisel, marking with thumb-gauge</i>	159
„ V. <i>Face and edge planing, drawing with set-squares on wood, sawing with tenon saw, horizontal and vertical chiselling</i>	163
„ VI. <i>Sawing, edge shooting, and boring</i>	202
„ VII. <i>Simple parquetry, edge shooting, and use of smoothing plane</i>	210
„ VIII. <i>The angle bridle, or open mortice and tenon joint</i>	214
„ IX. <i>Lapped halving joint</i>	226
„ X. <i>A shield</i>	231
„ XI. <i>Dovetail halving</i>	234
„ XII. <i>Stopped dovetail halving</i>	236
„ XIII. <i>Wedged mortice and tenon joint</i>	251

	PAGE
EXERCISE XIV. <i>Mitred angle bridle joint</i>	269
„ XV. <i>Another form of mitred joint, showing square shoulders on the back</i>	272
„ XVI. <i>Grooved and cross-tongued mitred joint</i>	274
„ XVII. <i>Stopped, grooved, and cross-tongued mitre joint</i>	275
„ XVIII. <i>Parquetry mat</i>	281
„ XIX. <i>Box with grooved and tongued joints (across the grain)</i>	288
„ XX. <i>Stop chamfering</i>	292
„ XXI. <i>Gouging</i>	298
„ XXII. <i>Shield, edge dovetailing</i>	311
„ XXIII. <i>Framing made with another form of edge dovetailing</i>	315
MODEL I. <i>Tooth-brush rack, sawing with hand and tenon saw, vertical chiselling, smoothing with plane, boring and screwing</i>	165
„ II. <i>Soap box, sawing with hand and tenon saw, planing, horizontal and vertical paring, boring and nailing</i>	173
„ II. (a). <i>An alternative and slightly easier model than the preceding</i>	178
„ II. (b). <i>A letter or envelope case</i>	180
„ III. <i>Rack for button-hooks, keys, &c., fresh tools used, trying and smoothing planes, bevel</i>	184
„ IV. <i>A planing exercise</i>	192
„ V. <i>Planing in the direction of the grain to a prismatic form</i>	193
„ VI. <i>An elliptical mat</i>	195
„ VII. <i>A letter rack, face and edge planing, boring and screwing</i>	203
„ VII. (a). <i>Another form of letter rack</i>	206
„ VII. (b). <i>Another form of hanging rack</i>	208
„ VIII. <i>A lamp or vase stand</i>	220
„ IX. <i>A bracket</i>	223
„ X. <i>An Oxford picture frame</i>	228
„ XI. <i>A towel roller</i>	238

	PAGE
MODEL XII. <i>A newspaper rack</i>	241
„ XIII. <i>Another form of hanging newspaper rack as an alternative to the preceding</i>	245
„ XIV. <i>School pen tray</i>	248
„ XV. <i>Application of the mortice and tenon joint in making a mirror frame—rebating</i>	259
„ XVI. <i>Triangular framing carrying shelves</i>	263
„ XVII. <i>An inlaid handled tray</i>	265
„ XVIII. <i>Picture frame involving mitred angle bridle joint</i>	272
„ XIX. <i>Standing picture frame</i>	275
„ XX. <i>Inkwell with swinging lid</i>	290
„ XXI. <i>Bracket (hanging) with chamfered edges</i>	295
„ XXII. <i>Hat pegs (set of)</i>	297
„ XXIII. <i>Inkstand</i>	300
„ XXIV. <i>Pen rest</i>	301
„ XXV. <i>Footstool, involving the haunched tenon joint</i>	303
„ XXVI. <i>Framed bracket shelf</i>	306
„ XXVII. <i>Box with common dovetailed joints</i>	316
„ XXVIII. <i>Box (hanging)</i>	320
„ XXIX. <i>Inlaid parquetry tray with common dove- tailed joint</i>	322
„ XXX. <i>Book rack made with the lapped dovetailed joint</i>	326
CHAPTER VI. WORKROOM AND ITS FITTINGS	328-343
<i>Complete equipment for a class of 20 boys</i>	342, 343
<i>Cost of complete equipment</i>	343

INDEX TO ILLUSTRATIONS

	PAGE
<i>BENCH HOOK</i>	
<i>Sketch of</i>	339
<i>BENCH (WORKSHOP)</i>	
<i>Sketch of</i>	333
<i>BEVEL</i>	92
<i>A method of using</i>	186
<i>BORING</i>	
<i>Position for</i>	175
<i>Working drawings for</i>	202
<i>BOX</i>	
<i>COMMON DOVETAILED JOINTS</i>	
<i>Working drawings for</i>	317
<i>Method of marking dovetails</i>	318, 319
<i>Section of bend</i>	320
<i>GROOVED TONGUED JOINTS</i>	288
<i>Drawings for portions of</i>	289
<i>Method of marking out</i>	289
<i>HANGING, WITH LEATHER HINGES</i>	
<i>Working drawings for</i>	321
<i>SOAP</i>	
<i>Working drawings for</i>	172
<i>BRACE</i>	
<i>Section and plan of socket of</i>	123
<i>Side elevation of socket and jaws of</i>	124
<i>Various shaped bits for</i>	125

	PAGE
BRACKET	
Working drawings for	178
Method of marking out	179
Working drawings for	223
Method of marking out	224
HANGING, WITH CHAMFERED EDGES	
Working drawings for	296
BRACKET SHELF (FRAMED)	
Working drawings for	307
Method of marking out	308
Construction of	309
BRADAWL (OVAL HANDLED)	
Position of, for boring	176
BRADS	
OVAL STEEL	85
JOINERS' CUT	85
Position for inserting	177
CASE	
LETTER OR ENVELOPE	
Working drawings for	181
Method of marking out	182, 183
Method of planing bottom of	183
CHAMFERING	
Working drawings for	159
Showing action of plane in	161
STOP	
Sketch of	293
Showing methods of	294, 295
CHISEL	
Two views of	94
Showing position of, for paring	147
Working drawings for use of	148
Method of holding, in chamfering	162
Showing use of, in vertical paring	164
Position in paring	180
Scoping action of	251
FIRMER	
Position for using	219

	PAGE
MORTICE	
Two views of	96
Showing use of	254
CHISELLING	
Working drawings of	140
Horizontal and vertical	163
Working drawings of	163
CLEAT FOR A MODEL	199
COMPASS	93
CUTS, VERTICAL AND INCLINED	
Diagrams showing cuts	219
DOVETAILING	
EDGE	
Sketches of	311, 315, 316
Method of marking out	312, 313
Working drawings of frame	314
HALVING	
Method of marking out	235, 236
STOPPED	
Methods of marking out	237
EDGE SHOOTING	
Working drawings for	202
FILES	
Teeth of	121
SECOND CUT TAPER SAW	123
BASTARD	
Half round	122
Round	122
Square	122
FILING	188
Showing position for	195
FOOTSTOOL	
INVOLVING THE HAUNCHED TENON JOINT	
Working drawings for	304
Construction of angle of	305
Method of marking out legs	305
Method of marking out	306
Working drawings of buttons	306



	PAGE
FRAME	
MIRROR	
Working drawings for	258
PICTURE	
Method of closing up corners	278
Tongue of veneer for	279
Blocks for	279
Method of gluing up mount	280
PICTURE, AN OXFORD	
Working drawings for	229
Stop rebating with chisel	230
PICTURE, A STANDING	
Working drawings for	276
FRAMED BRACKET SHELF	
See BRACKET SHELF (FRAMED)	
FRAMING (TRIANGULAR)	
Working drawings of	264
GAUGE	
Adjustment of	143
Measuring distance with	143
Use of	144
MARKING	88
Stem, spin and stock of	89
MORTICE	89
THUMB	
Method of using	160, 193
GAUGING	
Method of	192
GIMLET	
Two varieties of	127
GLUEING	
Long joints	199
GOUGE	
FIRMER	
Two views of	95
SCRIBING	95

	PAGE
GOUGING	
Working drawings for	299
Showing method of	300
GRINDSTONE	
Showing support for plane-iron on	136
Cased in wood in use by two boys	137
HAMMER	128
HAT PEGS	
SET OF	
Working drawings for	297
HOLDFAST	131
INKWELL	
WITH SWINGING LID	
Working drawings for	291
Drawing of portion for cleaning up	292
INKSTAND	
Working drawings for	304
INLAYING	
Working drawings for	150
JOINTS	
ANGLE BRIDLE, OR OPEN MORTICE AND TENON	
Isometric sketch of	211
Method of marking out	215
Working drawings for	269
Method of marking out	270
Working drawings of frame rebated, showing joint	271
GROOVED AND CROSS TONGUED MITRED	274
HAUNCHED TENON	304
LAPPED HALVING	
Sketch of	226
Method of marking out	227
MITRED	
Showing square shoulders on back	272
Method of marking out	273
MORTICE AND TENON	
Showing ends of	255
Method of marking out	259, 260

	PAGE
<i>MORTICE AND TENON, WEDGED</i>	
<i>Sketches of</i>	252, 257, 258
<i>Method of marking out</i>	253
<i>STOPPED, GROOVED, AND CROSS TONGUED MITRED</i> 275	
<i>LINE</i>	
<i>Method of dividing</i>	22
<i>MALLET</i> 129	
<i>Section of</i>	129
<i>Position for using</i>	219
<i>MANUAL TRAINING ROOM</i>	
<i>Plan of</i>	330
<i>Interior of elevation of south wall of</i>	330
<i>North external elevation of</i>	331
<i>MARKING</i>	
<i>Working drawings for</i>	140, 148
<i>Method of</i>	142
<i>MATS</i>	
<i>ELLIPTICAL</i>	
<i>Drawing for</i>	196
<i>PARQUETRY</i>	
<i>Working drawings for</i>	282
<i>Dovetail wedged clamping</i>	282
<i>Pieces for star of</i>	283
<i>Drawings of edge shooting and testing</i>	284
<i>Testing</i>	285
<i>Pieces for filling in star</i>	285
<i>Method of glueing up mat</i>	286
<i>Method of glueing up slips and cutting</i>	287
<i>MORTISING</i>	
<i>Operation of</i>	219, 254
<i>NAILS</i>	
<i>CUT CLASP</i>	84
<i>WROUGHT CLASP</i>	85
<i>FRENCH</i>	86
<i>OILSTONE</i>	
<i>Method of sharpening plane and chisel on</i>	133, 134
<i>Showing action of stone on tool</i>	135

	PAGE
SLIP	
<i>Showing use of</i>	138
PANEL BOARD	
<i>Sketch of</i>	340
PARQUETRY	
<i>Working drawings for</i>	210
<i>Method of conversion of wood</i>	211
<i>Method of edge shooting</i>	212
<i>Method of glueing up</i>	213
PEN REST	
<i>Working drawings for</i>	302
PEN TRAY	
A SCHOOL	
<i>Working drawings for</i>	249
PINCERS	130
PLANE	
<i>Action of, on uneven wood</i>	97
<i>Section of, fitted with single iron, showing tearing of fibres</i>	99
<i>Section of, fitted with double iron, showing breaking action of cap iron on the fibres</i>	99
<i>Method of securing the cutting and cap iron to each other</i>	100
<i>Edge of iron of</i>	100
<i>End section of</i>	101
<i>Plan and elevation of escapement of</i>	102
<i>Wedge of jack, trying, and smoothing</i>	102
<i>Plan and section of remouthed</i>	103
<i>Setting of</i>	151, 152, 153
<i>Testing with try square</i>	157
<i>Rebating with, in horizontal position</i>	262
JACK	104
REBATE	108
<i>Iron of, and plan of mouth</i>	108
<i>Showing hole for wedge and iron of</i>	108
SMOOTHING	106
<i>Adjustment of, for sharpening</i>	189
<i>Position for holding</i>	190

	PAGE
SMOOTHING, IRON-FACED	107
<i>Elevation of screw bolt of</i>	107
<i>Plan of iron face of</i>	107
TRYING	105
PLANING	
<i>Showing position in</i>	155, 156
<i>Working drawings for</i>	163, 192
<i>Against grain on shooting board</i>	170
<i>Showing position for edge planing</i>	194
<i>Position for edge planing on shooting board</i>	197, 198
PRISM	
<i>Exercise for</i>	193
PROJECTION (ISOMETRIC)	
<i>Diagrams showing</i>	33, 34, 36, 37, 38
PROJECTION (ORTHOGRAPHIC)	
<i>Diagrams showing</i>	23, 24, 25, 26, 27, 28, 29, 30, 31, 32
PUNCH	130
RACKS	
BOOK, WITH LAPPED DOVETAIL JOINT	
<i>Working drawings for</i>	327
FOR BUTTONS, HOOKS, KEYS, &c.	
<i>Working drawings for</i>	185
<i>Method of marking out</i>	186, 190
LETTER	
<i>Working drawings for</i>	204, 207, 208
<i>Method of marking out</i>	205, 208, 209
NEWSPAPER	
<i>Working drawings for</i>	242, 246
<i>Method of marking out</i>	243
<i>Construction of</i>	244, 247
PIPE OR TOOTH-BRUSH	
<i>Working drawings for</i>	165
TOOL	
<i>See TOOL RACK</i>	
ROUTER	
<i>Two shapes of</i>	111
<i>Position for using</i>	268

<i>ROLLER (TOWEL)</i>		PAGE
	<i>Working drawings for</i>	238
	<i>Method of marking out</i>	239, 240
<i>SAWS</i>		
	<i>Views of teeth of</i>	113, 114
	<i>Shape of sharpened tooth, showing 'set'</i>	115
<i>SAW (BOW)</i>		120
	<i>Method of using</i>	200
<i>HAND</i>		
	<i>Teeth of</i>	118
<i>RIP</i>		117
	<i>Teeth of</i>	117
<i>TENON</i>		
	<i>Position of holding, in sawing across the grain</i>	145
	<i>Showing action of, throughout operation of sawing</i>	146
<i>TENON, BRASS BACK</i>		119
<i>SAWING</i>		
	<i>Working drawings for</i>	140
	<i>With tenon saw, working drawings for</i>	163
	<i>Working drawings for</i>	202
<i>HAND</i>		
	<i>Proper positions for</i>	166, 168, 169
<i>STOP WITH TENON SAW</i>		
	<i>Position for</i>	228
	<i>With tenon saw, with grain, position for</i>	216
	<i>With grain, positions of saw in</i>	217, 218
<i>SCALE (ISOMETRIC)</i>		
	<i>Construction of</i>	35
<i>SCALE (PLANE)</i>		
	<i>Construction of</i>	22
<i>SCREW</i>		86
<i>SCREW-DRIVER</i>		130
<i>SHIELD</i>		
	<i>Working drawings for</i>	231, 233, 310
<i>SHOOTING BOARDS</i>		
	<i>Sketches of</i>	339, 340

	PAGE
<i>SPOKESHAVES</i>	110
<i>Showing ends of blade turned over</i>	110
<i>With cast iron stock and steel blade</i>	110
<i>Method of using</i>	201
<i>SQUARES</i>	
<i>SET</i>	
<i>Showing use of</i>	19, 23
<i>Showing use of, on wood</i>	160
<i>Working drawings for</i>	163
' T ' <i>Showing use of</i>	20
<i>TRY</i>	90
<i>Method of testing</i>	91
<i>STAND, FOR LAMP OR VASE</i>	
<i>Working drawings for</i>	221
<i>Method of marking out</i>	222
<i>STOOL, SAWING</i>	
<i>Sketch of</i>	338
<i>TOOL RACK</i>	335
<i>Working drawings for</i>	336
<i>Plan of tool shelf</i>	336
<i>Section of</i>	336
<i>With tools in position</i>	337
<i>TRAYS</i>	
<i>INLAID HANDLED</i>	
<i>Working drawings for</i>	266
<i>INLAID PARQUETRY, WITH COMMON DOVETAILED JOINT</i>	
<i>Working drawings for</i>	323
<i>Method of conversion of material</i>	325, 326
<i>TREE</i>	
<i>Transverse section of, and vertical sections</i>	42
<i>Shrinkage of</i>	49, 50, 51
<i>Contraction of timber at right angles to medullary rays</i>	53
<i>WEDGE</i>	
<i>Showing shape of</i>	256



MANUAL INSTRUCTION—WOODWORK



CHAPTER I

INTRODUCTION

It will be readily admitted by everyone that almost the strongest impulse of the untutored infant mind is to create the semblance of something of which it already has some knowledge.

The innate constructive idea takes many familiar forms, which are regarded in an amused and half-interested manner by the child's elders, but in only very rare cases does the creative faculty receive any real encouragement, and then usually it is only because of the exhibition of exceptional artistic instincts.

It is evident that this inclination is thus, by its recognition, sometimes made one of the most powerful levers of education, and, as a means of widening the child's understanding of his surroundings, probably nothing better could be done than to rationally encourage the latent power of drawing.

The educational bearing of drawing has long been recognised, and provision for its inclusion is made in the ordinary curriculum of every school. It is only in the last decade, however, that any attention has been paid in this country to the development of the constructive aptitude of children, which is so

very apparent, and on which so many vital social questions affecting the welfare of the whole community depend. All authorities agree that education is not, or should not be, the mere accumulation of a knowledge of facts, but, primarily, a development of the natural mental powers, in connection with which the teaching of facts is only a very valuable concomitant.

This view, although perhaps as old as education itself, has not, unfortunately, been generally accepted as the standpoint from which the school course has been framed, and, as one of the results, the most powerful and necessary inclination of children, to construct, has been left to develop as well as may be, without help or interference from the schoolmaster.

Moreover, besides neglecting the constructive ability of children, the ordinary school course, in its attention to the development of the purely mental faculties, must have absolutely harmful effects on the social life of the people.

The lighter occupations, calling for purely mental powers, are naturally overcrowded by the larger number of youths who are fitted for them than formerly, and the industrial occupations are filled on all sides with incompetent workmen, who might have early discovered their unfitness for occupations involving manual skill if opportunity had been presented to them. The breaking down of the apprenticeship system, the advent of universal education, and the high pressure in every occupation, resulting from competition, have caused this problem to assume an acute form in recent years.

The school course of mental education is, by this result, brought into somewhat unmerited disfavour among the artisan classes, who frequently complain that many things are taught

them at school which appear useless in after life, while other very useful subjects are omitted, and this want of continuity between the school and after life detracts to a very considerable extent in many men's estimation from the value of the ordinary school instruction. To meet the difficulty, technical and technological schools have been established in most large towns, and admirable institutions now exist, and are doing an immense amount of good work.

As the distinct object of technical education is to make good workmen who understand the scientific principles as well as the practical work involved in their trade, its course is therefore clear; but it is still felt, and especially by technical teachers, that, as a balance to the mental work done in the school, something is wanted for quite young children, to stimulate and foster their natural creative powers, and make the wished-for bridge between the school and working life of the people. This necessity has called 'manual training' into existence.

Technical education, in the true sense, is trade teaching, but the great point of difference between technical education and manual training is, that in the latter no trade is taught, and this must be thoroughly understood and borne in mind in framing a course of instruction. Mere manual dexterity and the widening of the child's intelligence by every possible collateral means are all that are aimed at.

The degree of skill which enables a workman to unconsciously perform an operation in his trade is never reached in manual training. Each exercise is well considered and intelligently drawn before its execution, and the close attention on a novel subject is of great service in the development of the boy's mental faculties.

For the first time, probably, a boy is confronted with the importance of accuracy of measurement, and has to put into practical use the tables of measurement he has learnt at school. He finds that his drawing is to be no objectless copy, but a correct representation of an actual model, and from this drawing the exercise or model is to be executed. His knowledge of elementary geometry and mechanics is tested and made of real use, and life and vividness are imparted to these subjects which they entirely lack when taught in the abstract. Teaching of this kind, as might be expected, has a reflective effect for good on the boy's ordinary school work. The freehand and model drawing, geometry, and other subjects which may be included in the ordinary school work are much more intelligently learnt by boys who are being taught manual training, and it is usually found that the time deducted from the ordinary school hours of boys who are undergoing courses of manual training in no way causes a decreased efficiency in the ordinary subjects. Boys are also found to be more careful and observant, more self-reliant, and certainly are more likely to grow up with a real respect for the dignity of labour.

The extent to which kindred subjects can be taught, and the avidity with which boys learn anything, even remotely connected with the practical portion of the teaching, can only be understood by those who have witnessed the enthusiasm of children for manual training lessons.

The method to be adopted in manual instruction, and the most suitable materials to be used, are subjects over which much discussion has taken place, but though some manual training in metal work has been attempted with good results, and clay modelling is sometimes adopted as an early form of art train-

ing, the most suitable material in which to work has been found by experience to be, undoubtedly, wood.

Wood is readily capable of being brought to a given form, is strong, light, and clean, and a material familiar to everybody, qualities which are not combined in any other material; and, in addition, larger classes can be taken in woodwork than with most other substances.

Wirework is an exceedingly pretty form of manual training, and is admirably suited for girls, but it is too fragile, and though it can be taught in connection with art drawing, it is not sufficiently associated with good mechanical drawing, to make it a suitable material for boys to work in.

In woodworking, the methods adopted vary in different countries to a considerable extent. In devising a scheme of manual training, it is obviously necessary to examine carefully the methods of instruction already existing abroad, with a view to making a system which shall include their best points, modified, if necessary, to suit the particular conditions and requirements of English life, and which shall exclude whatever may be found defective in those systems.

The best known and oldest system in vogue is the Swedish *Slöjd*. It is now some twenty years since the classes at Naas were commenced, and the system as now perfected is undoubtedly excellent. The *Slöjd* is strictly educational in its objects; in no respect can it be said to in the least resemble technical instruction. The exercises are most carefully graded, and are, no doubt, admirably fitted to the requirements of Sweden; but the course so strictly graded and so rigidly enforced in that country is not quite suited to English requirements and English ideas. Herr Salamon certainly says that, in adopting the

system in a foreign country, the course may be altered in detail, so long as the exercise substituted for any one of those in the course embodies the characteristics of that exercise. No such modified course has, however, been given to the English public.

In some respect the Slöjd system is distinctly defective however, notably in the association and the quality of the drawing involved. The work is done more from the model than from the drawing of the model, and too many of the models give the most indifferent opportunities for drawing lessons. The construction of some of the joints in the course is not scientifically correct—*i.e.*, the mechanical principles involved are not correctly thought out and expressed in the construction of the joint. It is said they are strong enough for the Slöjd shop, and this may be the case, but the construction of a simple joint gives the teacher a good opportunity to explain the mechanical principles from which the joint derives its strength, so that it is of great importance that the joint should be correctly made.

A large proportion of the boys who will be taught woodwork in England are taught something of elementary mechanics in object lessons and by other means, and it would be a serious error to undo or falsify this instruction by bad practical tuition. Indeed, if the teaching does not proceed on rational lines it is difficult to see what good result, beyond a certain amount of mere dexterity, will result. Some joints taken in the Slöjd course are too difficult for boys, as they involve an advanced knowledge of solid geometry, and its application to material. The consequence is, that the boys learn these lessons unintelligently, and, instead of mental work and bench practice, we get rule of thumb put into practical execution. However well the work may be executed under this system of instruction, it is clear

that the lessons must lose much of their force when taught on this mechanical plan. Another serious difficulty in the adoption of the Slöjd models is the length of time required to complete the course. One prominent model alone—the spoon—takes a man from seven to nine hours to execute. Now at an estimate of two and a half hours per week (and it will generally be found impracticable to devote longer in most schools to manual training), the time occupied is formidable, especially when it is remembered that a boy would take some fourteen to eighteen hours over this one exercise. In all this time spent on the model one drawing lesson only would be practically demonstrated by actual work.

Another more technical objection is the great use made of glass-paper. When this is relied on too much, the pupil is apt to be careless in his initial work, hoping to cover its defects by the effacing influence of glass-paper. This is distinctly objectionable, apart from the fact that almost the only training obtained from glass-paper is merely physical.

In the construction of many of the models, the pupil is allowed to saw a little from the line, and pare with a chisel back to the line. When this can be avoided it is advisable to do so. The self-reliance of the pupil is not encouraged by the practice, and he will probably be undecided in his work when he has the knowledge that he has another tool to fall back on.

Colour, which plays so prominent a part in design, is entirely overlooked in the Slöjd system.

One of the most important tools used in the Slöjd course, and certainly the most unique, is the Slöjd knife. The advantages of this knife are not clearly brought out, though the importance

of it is so strongly insisted on ; and, moreover, it has been found in this country that all work that can be done with the knife can be more efficiently performed with a chisel.

Under these circumstances, there seems to be no adequate reason for adopting an 'unfamiliar' knife in preference to a tool which is in such common use by all classes of workmen.

On the other hand, the chisel may be depended upon as a means of execution for quite twice as much work in the same time as the Slöjd knife, giving the pupil a proportionately larger amount of drawing practice.

It must not be understood by this that the mere accomplishment of work is what is aimed at. The boy, not the model, is the object, but more exercises, quite as efficiently performed, must be allowed to be an advantage.

Enough has been said, it is hoped, to establish the superiority of the chisel over the Slöjd knife (always assuming that the teacher intelligently understands his subject).

The knife, so essential in the early stages of Slöjd, is almost entirely discarded in the later exercises, its place being taken by the ordinary woodwork tools, but its effect is felt throughout the whole course of instruction.

In the more advanced Slöjd models the use of too many tools is involved, and these exercises are too much like pure carpentry to be really advisable in a manual training room.

A final objection which arises in considering the Slöjd system is the length of time required to complete the course. Most teachers who have been trained in Sweden have required two terms of six weeks each—about 250 hours in all—to complete the models. Now, in calculating the time which each child can devote to the subject, it must be remembered that the age of

the children admitted to the classes will never permit of their having more than three years' instruction, and very few as long a time as this, and that only two and a half hours per week are usually available for the subject, during forty-four weeks of each year. The total amount of time taken for the subject during the three years will thus be 380 hours, and, allowing for the usual difference between the speed of a teacher and that of a child when learning a new subject, only about one-half of the course would then be accomplished.

The foregoing remarks are not intended as a sweeping indictment of the Slöjd system, for it must ever be allowed that the great central idea of the development of natural faculties, without directly teaching a trade, is steadily kept in view by the authors of the Swedish system as the main object to be attained.

The defects of and objection to the system here pointed out are urged against the *methods* adopted to attain this end, as they appear to English eyes.

Instruction in a carpenter's shop, or in a class where the spirit of the teaching is similar, is frequently adopted as a form of manual training. This kind of manual training generally means a course including a series of carpenter's joints, and models based on them, of articles distinctly connected with the carpenter's trade.

Four-panelled doors and roof trusses have been attempted, and, as might be expected, models of this nature are generally very badly finished. Few pupils can ever make these difficult objects satisfactorily, with the consequence that disappointing results are usually obtained. Even where properly made, the models, not being reduced to any scale, are entirely out of pro-

portion when finished. This is likely, especially on the mind of a boy, to produce a very bad impression of form, and would be distinctly opposed to the theoretical teaching he receives.

It is certain, too, that, however adults may understand the principles of instruction given on such advanced lines, few, if any, boys could fully grasp the scientific principles of distinct carpentry work. The performance of a succession of difficult joints, which are not capable of being used in the construction of some model, or, if used, are embodied in a much too difficult one, has a wearying and dispiriting effect on a boy. He ceases to make that effort which he would if he knew that his perseverance would be rewarded by the possession of some object of useful or ornamental nature, entirely of his own production.

It is very unusual for any attempt to be made to inculcate ideas of colour, by combinations of various woods, or of form, by making original graceful articles. The artistic effect of the models is generally the result of accident if it appears at all, and this very important and attractive element of good manual training is practically lost sight of.

This form of instruction is, of course, quite in place in the strictly technical school, but, however good training of this kind would be there, it is not suited to the elementary school, and would be out of joint with the remainder of a lad's school work. Slöjd is distinctive in its character, and in its details shares little of the features of any other system.

Most foreign systems other than the Slöjd are really a kind of carpentry, though some of the courses of instruction, notably at the Ecole Municipale Diderot, Paris, and at the Manual Training School, Chicago, will be found almost unexceptionable, when their particular requirements are considered.

Most of the boys at these institutions receive a large amount of instruction, and they are able to accomplish a full and comprehensive course, which, with the limited time available for instruction in manual training in the public elementary schools of this country, could not possibly be attempted here.

To compare Slöjd with what may be called, in general terms, carpentry, in a sentence: Slöjd has good gradation and easy exercises executed by undesirable methods, and carpentry has ill-graded models which are often too difficult, though they are performed on a good plan, but, owing to their difficulty, inefficiently.

Wood-carving is in some respects a good form of manual training, but the work does not allow of a sufficient variety of tools being used.

All sizes of the chisel and gouge are required, but very few other tools; which, moreover, cannot be kept in such good order as is necessary, by young children.

The first attempts at carving are likely to be dispiriting and the difficulty of properly grading the exercises makes this subject one fit only for exceptional boys, and for the distinctly technical workshop.

The cramped position of the pupil is injurious, and the work does not compare favourably in this respect with the free health-giving exercise afforded by ordinary woodwork. Some carvers' tools might, however, be used in connection with the usual carpenters' tools required in manual training. The great length of time required for most exercises in carving renders the gradation of a course difficult, and the fact that only art drawing, and of that but a small amount, is involved, makes it difficult to teach anything else than the mere work in hand.

Having endeavoured to point out what appear to be failings in the various methods of instruction discussed, it becomes necessary to lay down the main principles of a course of wood-work manual training.

In the first place, no work should be done of which a drawing, either full size or to scale, has not previously been made.

Perhaps it is not necessary here to enlarge on the educational value of the 'shortest of shorthands,' as drawing has been so appropriately called, for its great value as a form of hand, eye, and mental training is now generally recognised. In its relation to woodwork, however, drawing is often very useful, and frequently indispensable, in giving an impression of the internal appearance of a finished exercise or model which may not perhaps exist in reality.

Opportunity is afforded the pupil in drawing to become thoroughly familiar with the general aspect of his work. But the greatest benefit of the drawing is that the child's appreciation of what is required is more stimulated when he has to create, as it were, under the guidance of his teacher, first his drawing, and then his model from the drawing, instead of merely copying the dimensions of a completed model directly on to his wood, and from this making a precise copy of the model. A very dull lad may perhaps receive a little assistance in this way to illustrate his drawing lesson, but a clever one, on the other hand, should work entirely from a drawing, to scale, of the exercise or model required, and this will be found most valuable as a mental training, involving constant thought and close attention.

Some exercises, indeed, could not possibly be made either by man or boy, experienced or inexperienced, without first drawing them, on the wood at any rate—*e.g.*, a regular pentagon

would defy the powers of the most experienced workman. A paper drawing might appear superfluous in this case, when the surface of the wood can be made to take its place, but boys frequently have to be taught a geometrical problem of this kind before the drawing on the wood can be thought of, and, owing to the decided objection to making false lines on the wood, it is always desirable, even when a boy can draw well, for him to make a paper drawing first. The argument in favour of working drawings is really quite overwhelming, and the tyro will at once recognise this.

With a view to assisting in the teaching of drawing given in the ordinary school hours, the exercises in woodwork should each involve a good useful drawing lesson.

The usual size of the exercises and models should be as large as, but no larger than, the boys can easily perform. There are three important considerations which limit the dimensions of an exercise :

1. The strength and average height of the lads under instruction.

2. The limits of their powers of working, for it must be observed that, where a small piece of work can be done by a boy with entirely satisfactory results, a very large piece will probably prove quite beyond his powers.

3. Large work means large waste and greater expense. The accommodation in manual training rooms must be increased or the number of the boys diminished if the work to be done is very large, either alternative being very undesirable.

In preparing the course, the exercises must be designed with a view to bringing out very clearly in each one some peculiarity in the use of a tool.

The exercises are intended to cover, as far as possible, the main tool operations.

They need not be performed exactly as given in the course, but if any one is departed from, great care should be taken to substitute another at least equally useful.

The models are interspersed between the exercises, and it is not by any means necessary to take them all. The teacher must use a wise discretion in giving a boy a model within his power, but by no means below it.

The models should be the indication of skill attained in making the exercises, and should in themselves give further improvement. Almost invariably the models will be found to contain preceding exercises in a slightly more difficult form, so that, in addition to testing a boy's capabilities, fresh instruction is imparted.

After a very little instruction has been given, the difference in the ability of the boys in the class will demand the teacher's discernment in the selection of suitable models for them all. For this reason alternative models have been introduced in several parts of the course.

One of the great aims of manual instruction—the fostering of the power of construction—is attained by the making of models. To keep boys continually working at exercises, with no opportunity of putting their knowledge to practical application, is discouraging to them, and they are apt to lose that enthusiasm for the instruction which they usually possess in so marked a degree.

In designing models from familiar objects the utility should not *necessarily* be considered, for it is not required to convert the manual training room into a workshop or factory, but to develop the creative powers of the boys themselves, and any model which

will serve this purpose may be accepted. Many of the models in the present course, however, happen to combine utility with instruction, and there is no objection to the useful being included, so long as it fulfils the more important requirement of being educational.

The chief considerations which should govern the designing of a model are tabulated as follows :

1. A good drawing lesson should be afforded.
2. If of a constructional nature, the joints must be scientifically made.
3. The proportions of the model, and of the parts of the whole, should be harmonious ; and if it is of an artistic nature, the design should be graceful but not over elaborated.
4. The introduction of various coloured woods is highly recommended.

The opportunity for colour design, which is a vital consideration in art, is afforded by the jointing of different coloured woods. The use of many varieties gives practice in working wood of different textures and diverse peculiarities of many kinds, and the full value of timber as a material for manual training is thus obtained.

No instructor can err in varying the material used, as long as he does so intelligently and tastefully.

Most of the better-known woods are recommended to be used in the performance of exercises and models, but care should be taken to only use the expensive hard woods in small quantities, to obtain effective and harmonious colour design and yet give the required practice in working them.

5. The model should be attractive, in order to secure that earnestness in work which is so valuable.

The introduction of tools has been gradual—at first only one or two, and these to be well understood before any more are added. When a new tool is introduced, care has been taken in the arrangement of the course to enable the pupil to have constant use of it in each succeeding exercise or model till he is familiar with its characteristics, and then, and not till then, are further additions made.

In the selection of the tools only such as are typical of hand work have been introduced. Few tools, yet enough to give variety, are recommended; and the endeavour should be to learn as much as possible of the various uses of each tool, rather than to attain a slighter acquaintance with a great number.

The moulding planes, the plough, and other tools which are used chiefly by artisans are not included among those necessary for the manual training room. The axe, adze, and draw-knife have been omitted as being in the main unnecessary in this country, and of a highly dangerous character for young and frequently careless children.

Experience has shown that work in the elementary stages should involve only simple straight lines and flat surfaces. From these the exercises should gradually proceed to the addition of geometrical and freehand curves on flat surfaces, and the modelling of surfaces of a more or less complex nature. A number of *simple* carpenter's joints, and models showing their application, have been introduced to the course, as typical of mechanical construction.

The teacher of manual training must be a man with considerable technical ability, and a good draughtsman invariably. It will be found necessary on many occasions in the course of demonstration to execute the whole, or nearly the whole, of a

model or exercise while lecturing on it, and here a teacher's manual dexterity is of great value.

A teacher, however able with tools, should keep in constant practice. In this connection it is well to observe that nothing is more fallacious than the popular opinion that a very little practice is necessary to give skill: a very great amount of hard work and continued effort is necessary to attain that rapid, easy style that is possessed by a skilled artisan. Continued acquaintance with the subject will serve to make this abundantly evident to the teacher.

It is not to be understood, however, that artisans, as being skilled workmen, would be good teachers, for in only very rare cases would this be true, and then only when the man fully realised what the ultimate objects of the teaching were, and possessed the ability to attain them.

School teachers, though in nearly every case more or less defective in practical skill, are so used to the management of children, and, as a general rule, are themselves so unbiassed before they are trained, that they will be found to produce the best average of manual training teachers. Where, however, a skilled workman has a thorough knowledge of the educational objects in view, and is, moreover, a skilful draughtsman, he is quite equal to a trained teacher as an instructor.

CHAPTER II

DRAWING

THE importance of drawing in a system of manual training has already been urged. The drawing used in connection with manual training is, of course, sometimes mechanical and sometimes freehand, though in woodwork chiefly the former. All drawings, however, should be made to a scale. The mechanical drawing generally consists of plans, elevations, sections, and isometric projections of the models and exercises. The *theory* of elementary projection must be thoroughly understood by the teacher, who should also have a sufficient knowledge of plane geometry.

Of course, anything like an exhaustive treatise on geometry is impossible here, but, as in the case of some readers it may be useful, enough of the theory of projection, and of the particular plan of execution recommended, is given for the purpose of manual training.

For the present course only two set-squares, a T-square, scale, and a pair of dividers are required. Set-squares are flat, triangular pieces of pear wood or vulcanite, and are used for drawing lines at given angles to other lines. One of the angles of a set-square is invariably 90° , and of a necessity the sum of the other two angles is 90° . These angles vary indefinitely, but the most common, and the only set-squares used in this course,

have their angles respectively 90° , 45° , and 45° , and 90° , 60° , and 30° . The proper use of these two set-squares will be found to facilitate the drawing of the exercises very much. If a series of parallel lines either at right angles to a given line or at an angle of 30° , 45° , or 60° to it are required, the set-square containing

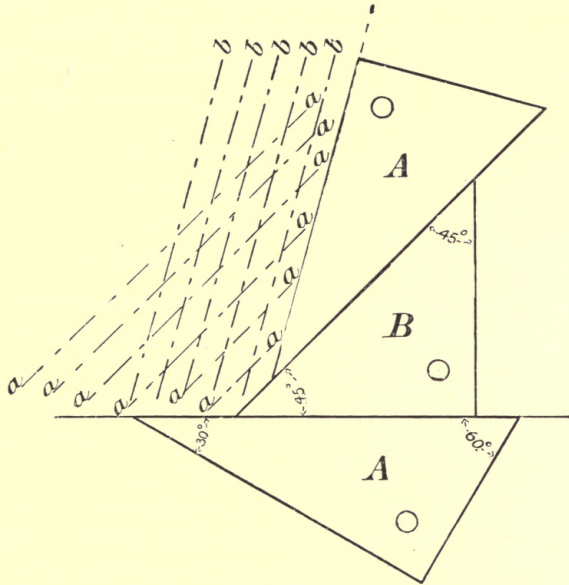

FIG. 1.

this angle may be pushed along the edge of the other one, and parallel lines drawn in its course, as at *a a a a* in fig. 1. Now if from one of these lines just drawn it should be required to draw more lines at, say, 30° , it will only be necessary to take the square A and slide it along the edge of B, as shown in the figure, making the lines *b b b b*. Parallel lines to any given line

on the paper may always be drawn with the two set-squares by this method.

Many plane geometrical figures can be drawn very rapidly by the application of this plan, which is much less liable to error than any other, while equally as scientific. The saving of time which can be made by a knowledge and proper use of the set-squares is in some drawings astonishing. It must not be understood that boys should not be taught the usual method of finding angles with the compass and straight-

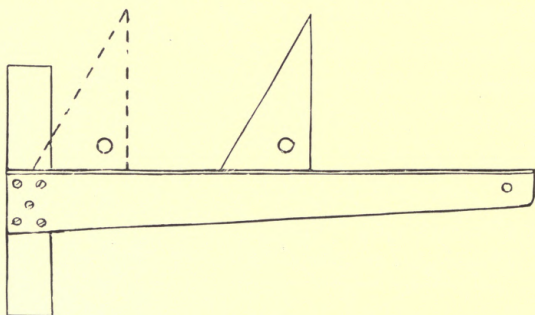

FIG. 2.

edge, but when working drawings are required the use of the two set-squares becomes a practical necessity. The T-square need not be of any particular size. It consists of a blade and a stock, usually of pear wood or mahogany. The blade should be screwed on to the stock, as shown in fig. 2, not, as is sometimes the case, mortised into it. This enables the set-square to slide along the edge of the blade across the stock when necessary.

The drawing edge of the blade should, of course, be at right angles to the stock and bevelled along the top edge, but it is

preferable for the other edge to make a slightly greater angle, the blade consequently tapering somewhat to the end.

The hole at the end of the blade is for hanging up the square when not in use, and this should be always attended to, as, besides saving risks, the hanging position helps to keep the square true. T-squares should at no time be exposed to great heat, damp, or much sunshine, which will all cause warping and other defects.

The T-square is of great use in drawing a series of parallel lines at right angles to the sides of the board, but care should be taken to always use the square with the stock on the left-hand side of the board, and all lines should be drawn along the top edge. It is to prevent the possibility of drawing from the opposite edge that the taper blade is recommended. It has been said that drawings should invariably be made to scale, and it will be found that this form of drawing necessitates thought in working, and will become a very valuable form of mental training if well taught.

Not for this reason alone should scales be used to work from. Frequently a draughtsman who may have to execute a drawing of, say, a large piece of machinery will, by reducing all the dimensions in the same ratio, make a drawing no larger than a page of this book. To avoid a separate calculation in reducing each part, the draughtsman decides what proportion his drawing must bear to the original, and constructs a scale in which a small arbitrarily fixed measurement shall always equal a given larger dimension on the original copy. Thus, if the drawing is to be 3 inches long and the machinery to be drawn is 6 feet long, then each $\frac{1}{2}$ inch on his drawing will always equal 1 foot.

This is drawing to scale $\frac{1}{24}$.

The method of dividing the line which is recommended is the usual workshop plan, and is quite as correct as, and much readier than, any other.

Draw a straight line AB on any convenient part of the paper, usually near the bottom, and from one end mark off $\frac{1}{2}$ inch to equal 1 foot.

From E mark off 6 inches, B on AB = the sum of twelve $\frac{1}{2}$ inches or 12 feet.

From A and E draw lines CD at any angles to the base line AB .

Along these lines mark off at any reasonable equal distances the number of divisions required, 12 on AC and 6 on ED . Join FE , and with the set-square, in the manner already described,

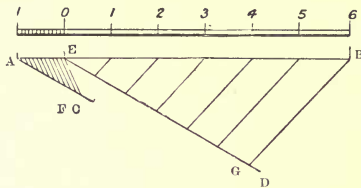

FIG. 3.

draw lines parallel to FE from each point on AC and cutting AB ; now AE is divided into 12 equal parts.

Join GB , and again draw from each point on EG parallel lines into AB .

The line being divided, finish and number the scale as shown in Fig. 3.

It will be noticed that the portion AE divided into 12 parts is in a manner additional to the scale, which, without it, represents 6 feet.

The value of this extra scale of inches will soon be appreciated in working from the scale, for if it should be necessary to mark off, say, 2 ft. 9 ins. or 4 ft. 8 ins., one point of the dividers can be at once placed on the unit of measurement required, and the distance obtained by stretching the other point out beyond zero to the number of inches required.

Orthographic projection, or right line drawing, is the system used for obtaining plans, elevations, and sections.

In all solid figures at least three dimensions exist—length, breadth, and thickness; and for the sake of clearness these are shown separately in working drawings. The plan of any object gives the space taken up horizontally by the dimensions which are either parallel or inclined to the surface of the paper, but gives no impression of their height or of their distance above this horizontal plane.

If vertical parallel rays of light fall on any object the shadow, visible or imagined, will be the plan.

Parallel horizontal rays of light would of course project the elevation on a vertical surface, and on the assumption of the existence of these rays of light the drawing of projections may be based.

If a rectangular slab of wood (fig. 4) 9 ins. by 5 ins. by 3 ins. is placed in the right angle formed by the folding up of a sheet of paper along the line XY , both the plan and the elevation can be drawn by marking with a pencil along the edges of the

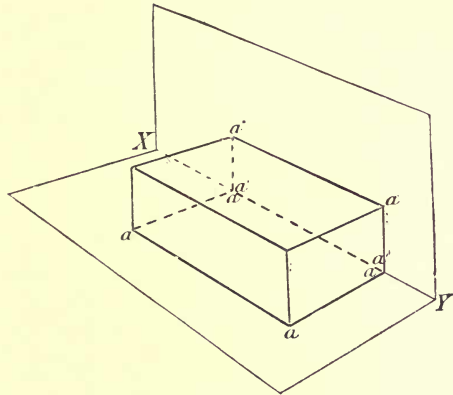

FIG. 4.

figure at the line of contact with the paper $aaaa$, $a'a'a'a'$ on the horizontal and vertical planes respectively. The plan gives the breadth and length of the wood, but does not show the thickness.

unfold it. The two planes with their 'trace' will then be given.

The arcs show the direction of the folding of the vertical plane into the horizontal plane, and the intersection, or trace, is the ground line, $x y$. The four dihedral angles of the co-ordinate planes are numbered 1 to 4.

No. 1 is in front of the vertical plane, and over the horizontal

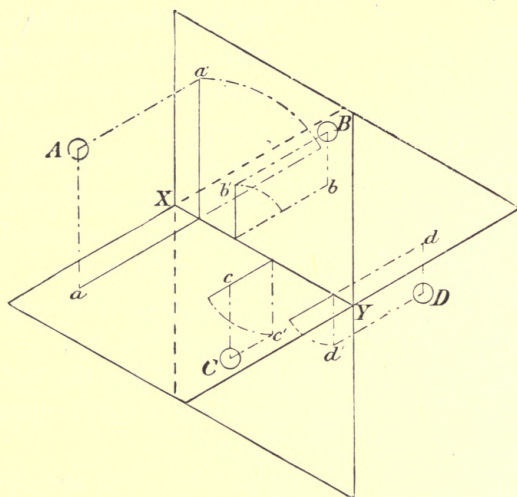

FIG. 6.

plane; No. 2 is behind the vertical plane, and over the horizontal plane.

No. 3 is below the horizontal plane, and behind the vertical plane, and No. 4 is in front of the vertical plane, but under the horizontal plane.

Suppose a point a exists 1 in. above the horizontal plane, and 1 in. in front of the vertical plane, then the plan will be 1 in. in front of the trace, or $x y$, and the elevation 1 in. above. Fig. 6

shows the method of finding the plan and elevation on the folding planes, which, when the vertical plane is turned down to the horizontal, will give the drawing as in fig. 7.

It will then be seen that the folding planes are not really requisite, and fig. 6 is only introduced to make the problem and

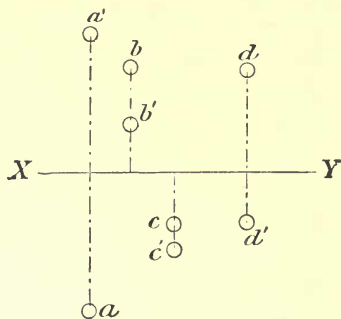

FIG. 7.

its solution clear. The distance of a given point in front of the vertical plane can then always be measured below the xy , fig. 7, or assumed trace of the co-ordinate planes, and the height above or the distance below the horizontal plane, projected by a continuous straight line passing through the xy at right angles.

Several other instances are given in figs. 6, 7.

It must be remembered that the folding of the vertical plane is downward in the portion above the xy , and upward in the portion below it.

As a consequence both plan and elevation are above the xy when a given point is behind the vertical plane and above the horizontal plane; and conversely, if the point is below the horizontal plane, and in front of the vertical plane, both plan and elevation will be below the xy . When the point is below the horizontal plane and behind the vertical plane, the plan is above the xy and the elevation below it.

Fig. 8 is a sketch showing the principle of projection in the case of a block of wood, which is some distance in front of the vertical plane, above the horizontal plane, and parallel to both.

There is nothing fresh in this. The plan to be adopted is quite the same as with the points—in fact, it merely involves the projection of a succession of points, to be afterwards joined.

From the foregoing it will be observed that lines are seen their real length in the plane to which they are parallel, and

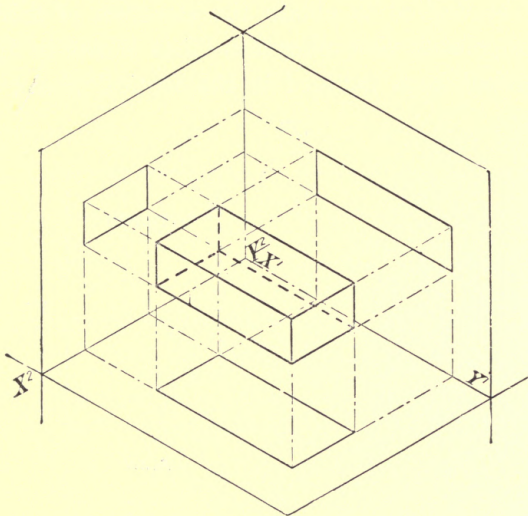

FIG. 8.

lines at right angles to these planes of projection are necessarily shown as points in them.

Now, to obtain an end elevation a new vertical plane must be set up on $x^2 y^2$, at right angles to both co-ordinate planes, and parallel to the end of the block. Draw the new $x^2 y^2$ at any convenient distance and project the end of the block in the usual way.

The elevation of the end may be turned down into the horizontal plane, opposite the end of the plan, or the new plane may

be swung round to the old vertical plane, and then turned down to the horizontal plane like any other elevation.

Fig. 9 shows the drawing of plan elevation and end elevation, as it is to be actually drawn, fig. 8 being only given to show the imaginary planes and the projectors falling on them.

It may be desired to obtain the elevation of this block of wood from a point of view other than that shown in fig. 8—*i.e.*, with its vertical faces inclined to the vertical plane, the long

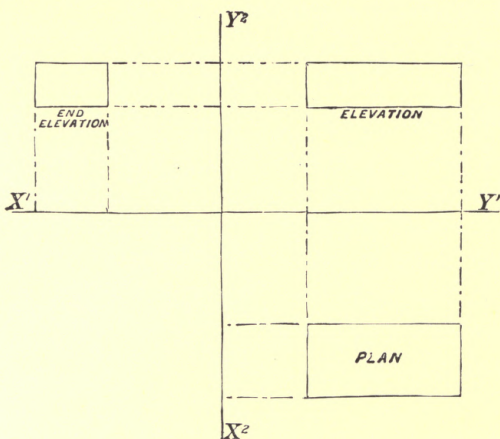

FIG. 9.

faces making, say, 30° to the vertical plane, and the short ones, of course, at 60° .

Fig. 10 shows the plan and elevation of a block of wood in a similar position as that in fig. 9, with a new $x^2 y^2$ at 30° to the long faces.

The vertical trace of this plane is omitted as unnecessary. This $x^2 y^2$ is the horizontal trace of a new vertical plane on which will be seen the new aspect of the slab.

This problem involves what is called change of ground line.

A series of projectors should be drawn at right angles to $x^2 y^2$, and the heights of the slab marked off as in elevation, for the height of the block is the same on the new plane as on the old vertical plane.

The instance just given shows the projection of lines inclined to a vertical plane, but parallel to the horizontal plane, and

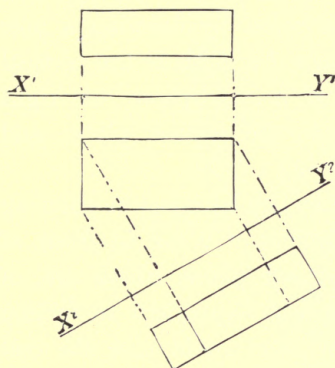

FIG. 10.

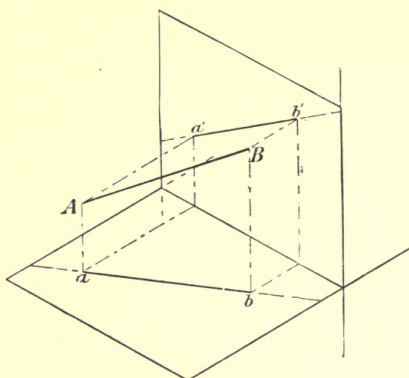

FIG. 11.

shows the shortening of the lines in projection caused by their inclination to the plane of projection; but if a line is inclined to both planes, it will not be shown its real length in either plan or elevation. Fig. 11 shows a line $A B$ inclined to both horizontal plane and vertical plane, with its projection in those planes.

Fig. 12 shows the actual drawing of this line in plan and elevation. To find its real length set up a new plane on the plan $a b$, and indicate its trace by a new $x^2 y^2$.



Now AB lies wholly in the new vertical plane, and if this is folded down, the real length of the line will be seen on the horizontal plane. Right projectors from a and b will therefore

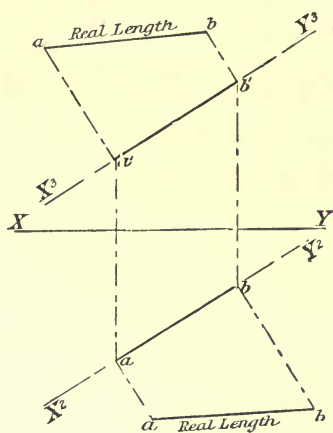

FIG. 12.

pass through the ends of the line AB , and their distance from the x^2y^2 can be obtained by reference to the heights in the elevation. The length of the line can be obtained in the same way from the elevation by drawing a new x^2y^3 on $a'b'$. This is the vertical trace of a new plane at right angles to the vertical plane, and containing A, B .

Draw right projectors showing the distance AB are in front of the vertical plane, which are, of

course, shown in the plan. This will be equivalent to folding the new plane into the vertical plane, and would give the real length of the line.

A model may be made of cardboard or paper similar to fig. 11, and will serve to bring this problem very clearly before the reader.

Sections.—To obtain the section of any figure is really a form of change of ground line. A plane is imagined through the object at any desired position, and in cutting through makes the section.

Fig. 13 shows the elevation of a slab of wood having a raised panel. Draw the traces of a plane cutting through this object, as in the illustration. This plan may be either turned down into the horizontal plane or wheeled into the vertical plane.

Project the plan from the elevation. At any convenient distance from the elevation on the vertical plane, draw a vertical line to give the back of the slab.

The shaded figure shows the development of the section on

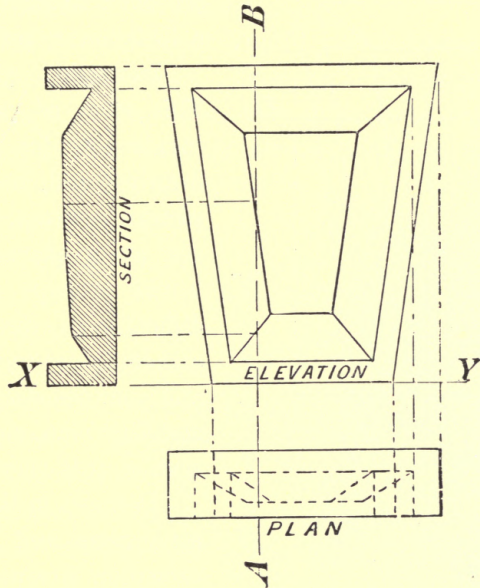

FIG. 13.

A B, the thicknesses at the various points being taken with the dividers from the plan.

It will be noticed that this plane of section was not turned down into the vertical plane in its original place, as we should then have had the elevation and section confused in one drawing, while the projection of the plane of section into a clear part of the paper saves possible difficulties from this cause.

The horizontal section of this slab on *cd*, as shown in fig. 14, is even simpler than the vertical section.

The new plane, of course, would give the new plan on top of the old one, and again, to prevent confusion, it is drawn a little lower down.

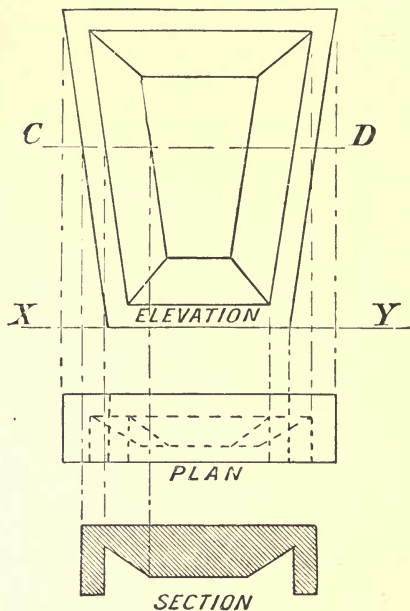

FIG. 14.

Working drawings of isometric projection cannot be used in making any other than rectilinear figures, but when it is remembered that these are by far the most numerous of mechanical drawings, the scope of this form of projection will be seen to be still great.

The theory of isometric projection can be best understood by drawing the projection of a cube standing on one corner, with

Isometric projection. — This form of projection is invaluable for rectilinear drawing, and, because of its pictorial nature, a child can see at a glance what he would perhaps have much difficulty in recognising by orthographic projection alone, and as an assistance in understanding plan, elevation, and section, it is very valuable.

Deftness in the use of the set-squares and neatness in execution are also obtained by this attractive and agreeable form of drawing.

one diagonal vertical to the plane of projection. Now all the edges of the cube are of equal length and are equally inclined to the plane of projection. They are, therefore, projected of equal lengths in that plane, though the projection will not, of course, give the real length of the edges.

Draw three lines of equal length, meeting in a point, and making 120° with each other. These make the projection of the front solid angle of the cube, and these lines are called the isometric axes, as from these all measurements are to be made.

Complete the cube, as shown in fig. 15, by drawing the opposite parallel edges to the isometric axes, using the set-square.

Notice that the diagonals of the *faces* are shown in some cases foreshortened, as AF , AG , and AE , and in the other cases, being parallel to the plane of projection, as BC , CD , and DE , they are shown their real length. Thus, none of the diagonals of the faces being inclined to the plane of projection at the same angle as the edges, measurements

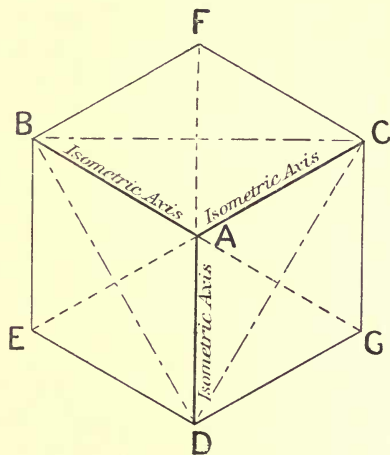

FIG. 15.

which will apply to the latter, or to lines parallel to them, will not serve for any other dimension.

Hence the unsuitability of this form of drawing for any other than rectangular figures.

The real length of the edge is reduced in the projection in

the following ratio: As $\sqrt[3]{3} : \sqrt[3]{2}$. Therefore, to put the case inversely, the isometric is to the real length as the $\sqrt[3]{2}$ to $\sqrt[3]{3}$. The proof of this will be seen by a reference to fig. 16 and to Euclid i. 47 and vi. 4.

Fig. 16 shows the section of the cube on $\triangle CEA'$, and contains

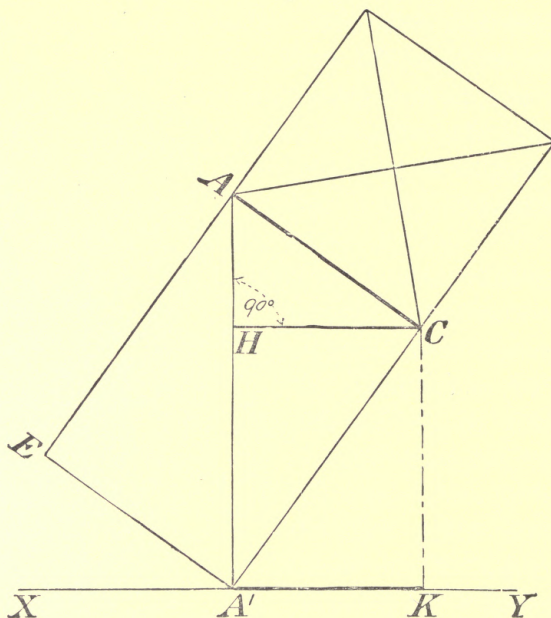

FIG. 16.

two sides, $\triangle C$ and $\triangle A'E$, and two diagonals of faces $\triangle AE$ and $\triangle A'C$.

Now the proportion of the edge of a cube to the diagonal of its face is as $\sqrt[3]{1} : \sqrt[3]{2}$ (Euclid i. 47), and as $\triangle C = \sqrt[3]{1}$ and $\triangle AE = \sqrt[3]{2}$, the diagonal of the cube $\triangle A'$, being the side which subtends the right angle formed by them, $= \sqrt[3]{3}$.

Draw CH , and project it into xy at $A'K$.

Now the triangles $\triangle EA'A'$ and $\triangle CA'A'$ are equal, and $\triangle CHH'$ and $\triangle A'A'C$ being similar triangles, their sides are in common ratio.

Therefore AC is to $CH :: \sqrt[3]{3} : \sqrt[3]{2}$; but $CH = A'K$, which is the projected length of AC , and therefore the real length of the side is to the projected length as $\sqrt[3]{3}$ to $\sqrt[3]{2}$. Based on these facts, Professor Farish devised a system of measurement to be applied to any rectilinear figure standing with its isometric axes equally

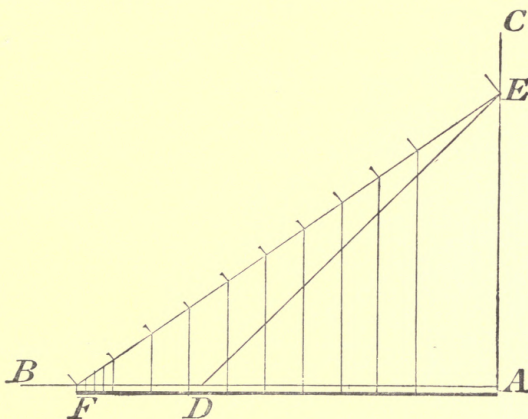

FIG. 17.

inclined to the plane of projection, with the object of making this form of drawing serve the purpose of both plan, elevation, and section. Knowing the proportion of the real to the isometric length of any line, it is an easy matter to make an isometric scale.

Draw two lines AB and AC perpendicular to each other, and mark off on them equal parts at D and E , as in fig. 17: join DE .

Now $DE = \sqrt[3]{2}$ and $AE = \sqrt[3]{1}$.

Mark off on AB , AF , equal in length to DE .

Now, as $AE = \sqrt[2]{1}$ and $AF = \sqrt[2]{2}$, therefore EF , which should now be drawn, $= \sqrt[2]{3}$.

Real length measurements on EF , therefore, can be shown isometrically on AF by dropping lines parallel to EA from any given point in EF to AF . Any of these lines will complete a triangle in common ratio to AEF .

And as AF is the isometric length of EF , so any distance in EF can be shown on AF similarly.

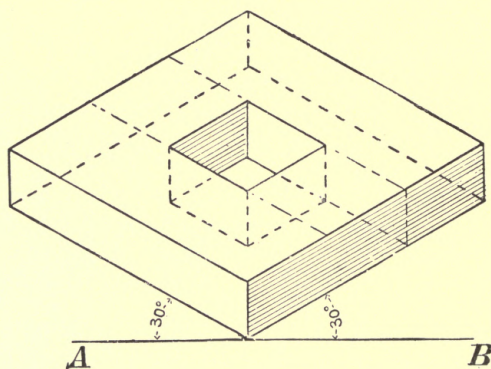

FIG. 18.

Draw on EF any plane scale, and in this way make an isometric scale of it.

The somewhat difficult reasoning of this problem is not intended for children, but the teacher must thoroughly grasp it.

Boys should be taught to use any plane scale isometrically, and, although this is not strictly correct, it has the great advantage of giving a pictorial representation, in which all measurement in, or parallel to, the isometric axes can be shown in the same scale. Fig. 18 is an instance of a plane scale used

isometrically. A slab of wood $\frac{5}{8}$ in. thick and 3 ins. square, with a square hole in the middle, is drawn to scale $\frac{1}{2}$.

On the ground line AB set up a perpendicular $\frac{5}{8}$ in. high. From the top of this draw two lines 3 ins. long at 30° to AB . These three lines give the isometric axes, and based on them the figure may be rapidly drawn with the pencil and 30° set-square.

Sometimes forms not actually rectilinear can be drawn isometrically.

Fig. 19 shows the face of a pentagonal slab, and fig. 20 the same drawn isometrically.

The rectangle is drawn round this figure in order to accom-

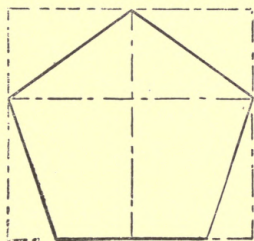

FIG. 19.

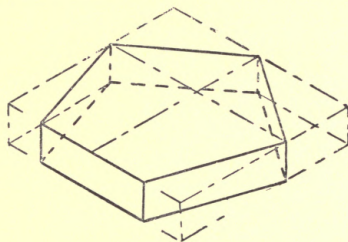

FIG. 20.

plish the object, for after putting the rectangle in isometric projection, it is a simple matter to mark the points of the pentagon on the new projection, and draw the figure in.

Round a series of points obtained in this way, the circle in fig. 21 may be sketched in isometric projection, as shown in fig. 22.

There is another way of making the isometric projection of this circle. In isometric drawing, one diagonal of a square will be shown its real length, and this may be at once drawn, AB .

Lines at 30° from each end of AB will give the inclination of

the edges, and their intersection will define their isometric length.

Join these points of intersection and the short diagonal is obtained.

The point where the circle cuts the diagonal may be obtained from fig. 21 and marked on AB . Now lines parallel to the

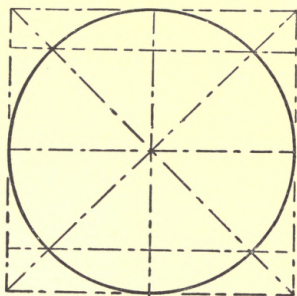

FIG. 21.

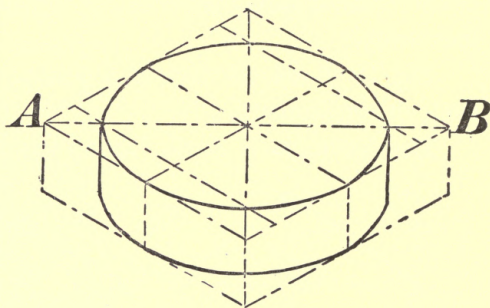

FIG. 22.

edges through these points and the centre will give all the points in fig. 21, and the circle may be drawn in.

In both the pentagon and the circle only one dimension, it will be noticed, is seen its real length, indicated by the scale, proving by illustration the practical uselessness of isometric projection for working drawings of any but rectilinear figures.

CHAPTER III

TIMBER

TIMBER as used in woodwork is the product of the felled body of the tree, stripped of its outer covering of bark.

If the transverse section of a log of, say oak, in its original condition as cut down is examined, it will be seen to consist of three broadly marked divisions: the bark, the sapwood next to it, which resembles in some degree the inner main portion, or heartwood, and in or near the middle of the tree is the section of the pith, or medulla.

Let us first consider the large inner mass of wood in detail. Closer examination will at once reveal a succession of thin concentric rings of darker colour than the remainder across the whole surface, the smallest ring enclosing the medulla, and the largest forming the margin of the central wood next to the bark.

Confining our attention for the present to these rings, we shall observe outside the largest a thin ring, dividing the sapwood from the bark.

This ring, the cambium, consists of a thin sheet of cells, which, by their growth and subsequent development, form on one side wood, and on the other, in a much less degree, cortex, or bark. The lateral growth of the tree, with which we are immediately concerned, occurs, then, next to this cylindrical plate of cambium cells.

These cells are of rectangular prismatic form, with tapered ends. In the spring, when the quickening influence of sunlight and other less-known causes stimulate the growth of vegetation into renewed activity, the cells on the inner side of the cambium split up radially, expand, and grow rapidly into tracheides or fibres.

Though they do not radically alter in shape, these tracheides become provided with a curious and little-understood series of valves in their sides, enabling them to obtain and communicate moisture. While this lateral growth is going on, a slowly flowing current of 'sap,' obtained principally by the roots, ascends the tree, and the wood-forming materials contained in it feed and thicken the walls of the tracheides.

As the summer advances, the increasing bulk of the wood, by the formation of this ring of cellular tissue, presses on the cortex, but the latter exercises a restraining influence on the growing tracheides.

These, continuing to form as rapidly as before, are then unable to grow as fast radially, and from a nearly square shape in the spring wood, the tracheides become very much flatter radially in the autumn wood.

The upward-flowing sap pauses as it were for a short time at the height of the summer, and then commences to slowly descend.

The resulting benefit of the various elements taken up by the roots and leaves of the tree is now more marked, and the sap is more fully charged with wood-forming materials. The walls of the tracheides consequently grow faster in the autumn and become thicker than in the spring wood, causing still greater contrast in the density of their appearance. Indeed, it is pro-

bable that, if the degree of vital activity in the spring were as great as that attained by the tree in the late summer and autumn, the tracheides of the spring wood would resemble very much more closely those of the autumn wood than under existing conditions of growth.

Another circumstance which must be noted as tending to make the spring wood still looser, as compared with that formed in the autumn, is the presence of a large number of air tubes, or pores, which will be noticed in examining the end section of a piece of elm or oak. These are formed in the tracheides of the spring wood, but are much fewer and smaller in the autumn wood.

These pores will accordingly be seen grouped in bands, as it were, in the earlier portion of the spring wood of elm, to take a good case, though much less distinct, and frequently invisible, in some woods.

When winter arrives, the flow of sap and the formation of cells cease, and the growth of wood with it. A complete annual ring has then been formed—in its first and greater portion light-coloured, porous, and comparatively loose fibred, and in its latter denser, tougher, and darker in colour.

The newer rings of tracheides are those in which the sap chiefly flows, and these in the course of years have gradually less sap supplied to them, and the channels down which it formerly flowed become filled simply with air and water. The walls of these older tracheides are then thoroughly lignified, and become much tougher and have more cohesion than those of the sap-wood, making the most perfect form of wood. This is the heart-wood, or true woodwork timber. .

By counting the annual rings, the age of a tree may be discovered.

Referring again to the end section of a log, a number of fine, sharply delineated streaks of lighter colour than the rest of the wood will be seen running, usually, but not always, from the

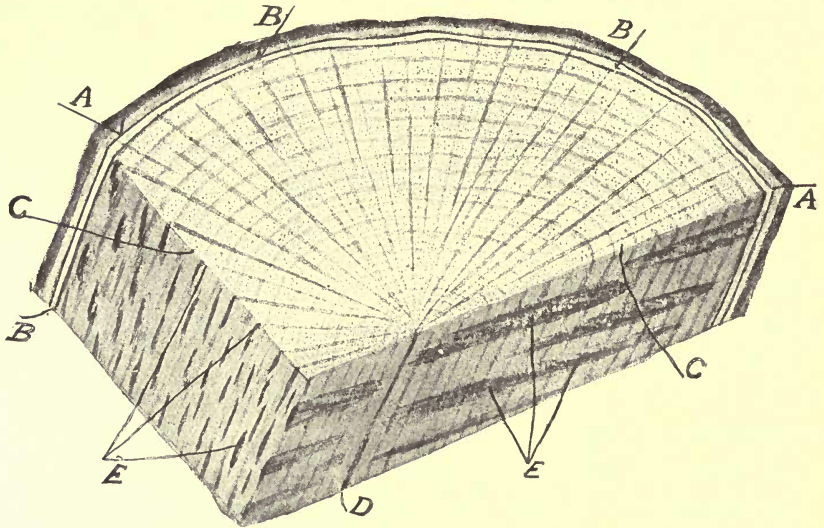

FIG. 23.—A, the cortex or bark; B, the cambium; C, the annual rings; D, the medulla or pith; E, the medullary rays: these are drawn in a darker tint, to bring them prominently into notice. They are usually lighter coloured than the remainder of the wood.

medulla completely through the heart-wood, sap-wood, and cambium, to the cortex.

These are the medullary rays.

Fig. 23 is the representation of a piece of wood showing the transverse section, and two vertical sections at right angles to each other. This illustration shows the general features

alluded to, and by showing several sections of the medullary rays, makes their real shape apparent. The wedge-like column of cells forming a medullary ray, it will be seen, extends much more in a vertical direction than tangentially to the curve of the annual rings. In shape and arrangement the medullary rays may be said to resemble, in some degree, the spokes of a wheel.

Thus the medullary rays or 'silver grain' act in the economy of the tree as ducts to convey moisture and nutrition more easily and rapidly through the tree, for the cells here, as in the vertical tracheides, are provided with lateral valves for the percolation of liquid matter.

The medullary rays also have a very strengthening effect on the tree, as they bind the outside to the inside; and being opposed vertically to crushing strains applied to a baulk or log laterally, make the resisting power of the log very much greater.

The thickness of annual rings varies in different kinds of trees, and specimens of the same species will also have rings of greatly different thicknesses. Soil, situation, and the atmospheric conditions are the chief causes of difference in growth, wide rings being formed in favourable seasons and narrow ones in seasons when the weather, or any other circumstance is not so advantageous to the growth of the tree.

Accordingly, in tropical climates, where no material checks from changing seasons take place, the formation of wood progresses frequently without any apparent difference between spring and autumn wood, giving a level, even-coloured appearance, as if no annual ring existed. Peculiarities of this and other kinds occur in every possible combination, and it is really

only possible to give here the particular characteristics of certain well-known woods, which will probably be found useful in manual training.

Felling.—A tree should always be felled at a time when the sap is at a standstill—the height of the summer, when it has ceased to run up the tree, but has not yet begun to return; or the winter, when it has completely run down. The winter is much the better time, however, in temperate climates, as there is then the least amount of sap, and probably of moisture, in the tree, and less loss of weight and less contraction from drying and seasoning will occur.

Timber, if containing much sap, is not so durable, and is more liable to warps, twists, and shakes in seasoning.

Trees are sometimes barked in the early spring, especially in the case of such trees as the oak, which has valuable bark. When this is done the tree is felled in the following winter, the debarking being said to improve the timber.

The exact time for felling timber varies according to the special characteristics of each kind of tree; but the great thing to be attended to is the condition of the sap, which must be at rest.

Seasoning.—The sap in felled timber will, by the presence of the organic substances in it, afford an opportunity for the successful attack of parasitic fungi, and the timber will, if this happens, be quickly destroyed or rendered useless. It is, therefore, essential to remove the sap together with the moisture, which frequently forms some 40 or 50 per cent., or even more, of the total weight. To effect this, the log, when stripped of its bark, is submitted to certain courses of treatment for varying periods.

It is clear that the removal of moisture from a baulk, or log, of timber will reduce it in bulk and prevent further shrinkage after it is wrought to a particular shape, when perhaps the consequences might be disastrous. Paint, or varnish, too, cannot be put upon wet or unseasoned timber, as it will almost certainly come off in flakes, and in any case will lose its virtue.

The most common form of seasoning is the 'natural,' and, generally speaking, it is the best. This plan is to stack the stripped logs, split in halves or sawn into planks, either on end or horizontally in racks. This stacked timber should be protected by a roof from sunshine and rain, but each piece must be so placed as to allow a free circulation of air round it.

On no account should the ends of the planks or logs rest on the ground, as moisture will then probably ascend through the pores, ultimately causing dry rot.

No vegetation should exist near seasoning timber, as it may transmit the germ of dry rot, and timber yards are frequently strewn with ashes to prevent its growth.

The usual plan of stacking timber to ensure a free current of air when in a horizontal position is to place thin strips of wood at intervals between the planks.

When they are stacked upright the planks are inclined alternately on opposite sides of a timber rack. The thickness of the timber in this case will separate the planks throughout their whole length, except where they cross. This mode of stacking, though taking more space, is handier, for the timber has to be frequently turned, and is more accessible in the timber rack than when stacked horizontally.

If timber is dried too rapidly it becomes dry outside while it is still very wet inside, and consequently splitting in contraction

from the outsides in the direction of the medullary ray ensues, and, if in excess, spoils the whole piece of wood.

The length of time for due seasoning cannot well be exceeded, as it must be remembered that perfect drying is impossible, and the longer timber is exposed to a free drying air the better it becomes.

As a general rule oak in logs 24 ins. square and upwards should be seasoned for two or three years, and the northern pine, to take a more readily seasoned timber, requires for a similar size about half this time. Smaller sizes, of course, will take proportionately shorter times.

Loss of weight is the chief means of measuring the success of the seasoning. Timber is usually seasoned when it has lost from one-fifth to one-third of its weight, but much depends upon the purpose for which it is required.

Water seasoning.—In order to season timber more rapidly than by the natural process, and yet cheaply, timber is frequently submerged in running water, with its fibres in the direction of the stream. The action of the water is to wash out the active portion of the sap, leaving the log merely saturated with water. This takes usually about a fortnight, and afterwards the log has only to be dried in the same manner as in natural seasoning. Partial submersion causes irregular and partial seasoning, and is very harmful. The drying after water seasoning is comparatively rapid, and consequently the timber must be turned daily, to prevent warping and twisting.

Timber which has been water seasoned is less liable to warp or twist than wood naturally seasoned, but is not so durable or elastic. If immersed in salt water the timber is better than

from fresh or brackish water, but there is danger from the attack of sea parasites.

Hot air seasoning.—This is another common process.

The timber is placed in an oven, or hot current of air.

The tendency to cause splitting by contraction in the fast-drying outer rings, while the inner portion of the heart-wood is still 'green,' is very great, and for this reason the timber is usually cut up into planks or other marketable forms before seasoning.

The planks offer a much larger surface area compared with their cubic measurement than logs, and the contrast in the conditions of the outer and inner portions is, therefore, not so marked.

The tendency to splitting is, however, always great, and for this reason the ends of the pieces of timber are usually clamped. The hot air process, as might be imagined, is rapid in its action. It usually takes about a fortnight, but it is expensive.

Wood which has been hot air seasoned loses more of its elasticity and durability than if 'naturally' seasoned, but is not, perhaps, so liable to further shrinkage after being wrought.

To obtain small pieces of timber as nearly perfect as possible, the pieces are entirely desiccated by hot air.

Gunstocks are treated in this way, as the slightest subsequent swelling or shrinkage under the varied temperatures to which rifles are exposed would possibly have a serious effect on the delicate adjustments of the mechanism.

Timbers are usually somewhat bleached by the process of hot air seasoning.

Hot water seasoning and steaming.—These are rapid but expensive methods which are somewhat undesirable, as decreasing the

durability and elasticity of timber. The liability to dry rot is, however, not so great when wood has been seasoned in this way.

Smoke drying, in a moist warm atmosphere, is an excellent but costly form of seasoning. It is not adopted to any considerable extent.

Of the various methods described the 'natural' is undoubtedly the best. All the other forms of seasoning, in a greater or less degree, destroy the natural properties of good timber, and are chiefly used on account of their speed.

Even when well seasoned, it must not be understood that, for every purpose, the wood is perfectly ready for use. Another final *second seasoning* is necessary if the wood is wanted for use in fine work, where shrinkage would cause unsightly opening of joints and splitting, when held forcibly in position, like the panel of a door.

The first seasoning would be amply sufficient for the heavier parts of carpenter's work or for out-of-door exposure.

Second seasoning.—In some woods, when a very small amount of the surface timber is removed, warping and twisting will set in almost as if the wood had not been seasoned at all; to prevent this a final second seasoning is resorted to. Timber wanted for good work is then wrought to its general shape and kept if in one piece, or put together temporarily if in several jointed pieces. This roughly made work is then put by in a room at a temperature of about 90°, and kept for periods varying from a fortnight to three months, according to the particular kind of wood and the purpose for which it is required.

Shrinkage of timber.—A log in drying is reduced in bulk, and this reduction lessens the circumference. The fibres on the outside of a felled log in shrinking continue to adhere to

each other in the main, but this fact causes a tangential contraction to arise, and at intervals cracks open from the outside, and continue, as the timber dries, to run in towards the centre of the log.

We have, then, in the longitudinal fibres a tangential and

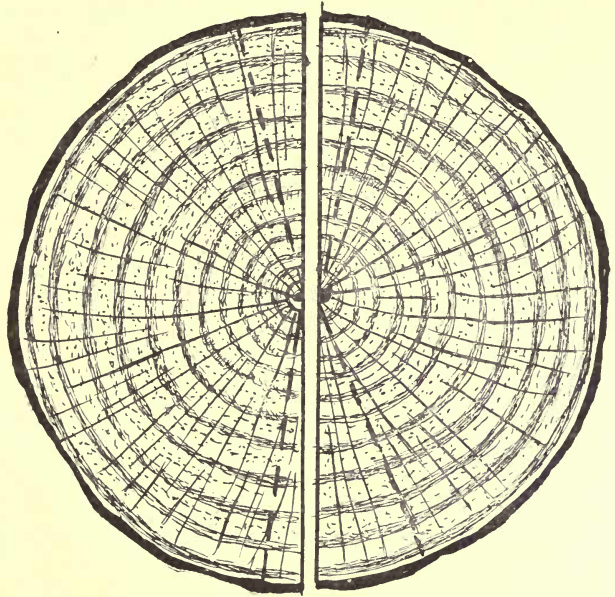

FIG. 24.

radial contraction at the same time, but the cells of the medullary rays being in the opposite direction will not contract as much radially as the annual rings, and consequently, as an inevitable result of the various contracting tendencies, splitting takes place, usually contiguous to the medullary rays.

Contraction with a strong tendency to split the timber at the

medullary rays must take place, and steps have to be taken to prevent this splitting from entirely ruining the baulk. The woodman accordingly splits the log in halves, as in fig. 24, or even in quarters, as in fig. 25. Now only a segment of

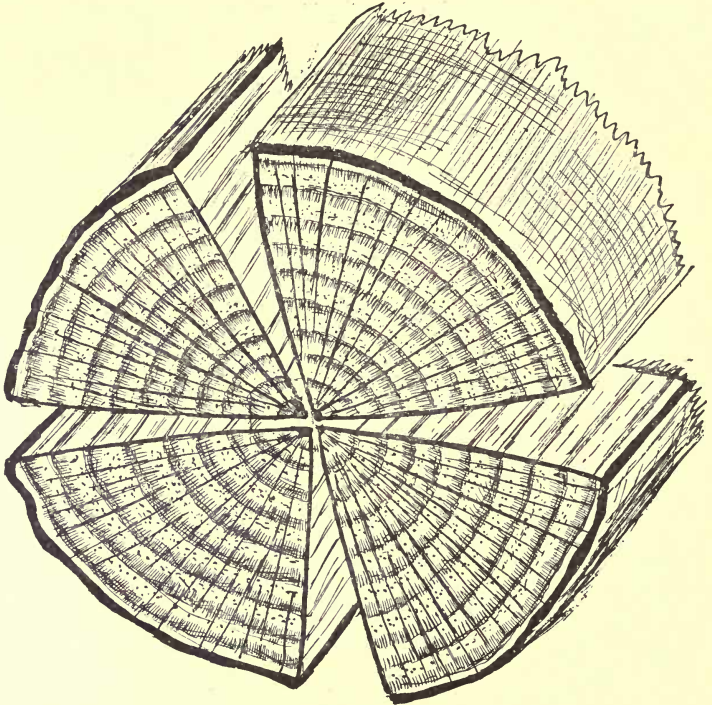

FIG. 25.

the circumference is included in each piece, which, being separated from the remainder, is able to shrink much easier in a tangential direction. The dotted lines in fig. 24 show the contraction which usually takes place. It must be observed

that logs are not split in this way because the shape is preferred to that of a log, but to save worse splitting taking place. In fact, the inevitable splitting is recognised, and the halving and quartering being the forms in which least waste in conversion would probably arise, they are cut up in this way as being the least wasteful plan.

Owing to the frequent lopping of small branches and shoots, the bending and twisting of growing trees due to prevailing winds and other causes, the fibres frequently become very twisted and even involved in an extraordinary manner, notably in the large burrs of pollard oaks and willows.

These latter wavy twisting fibres are in some woods much valued for ornamental purposes, and trees are sometimes kept well pruned with the intention of producing this peculiarity.

Let us consider now the effect of twisted longitudinal fibres in a plank.

Fig. 26 shows the end section of a series of planks cut out

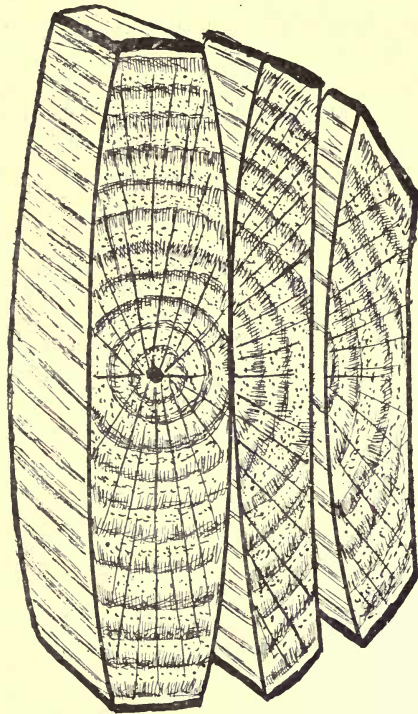

FIG. 26.

of a straight-grained tree where the pulling tendency of the contracting fibres has curved the planks at the side, and has caused the outer edges of the middle plank to become thinner than the centre.

Suppose now that the other end of the fibres in the timber are twisted, the section of, say, the large plank at a distance of twelve feet might resemble that of the next plank in the illustration, no longer containing the centre of the tree. This middle plank would be true when first cut, but it would become gradually concave at one end, while the other end remained fairly true except for the slight thinning of the edges. Irregularities from twisting will take much more complicated forms. Planks which have warped or twisted in this way involve great waste in preparation for work, as it is clear that they must be rendered true before anything can really be done with them.

A certain amount of restraint can be exercised on a plank which, on inspection, is suspected of being very liable to this twisting. A manual training teacher should avail himself of whatever knowledge of timber he may possess, in intelligent storing of his stock, which may otherwise be rendered more or less unserviceable from this twisting.

Contraction taking place almost exclusively at right angles to the medullary rays, the effect on a baulk of timber which contains the heart of the tree near the centre will cause cracks something like those in a baulk, as shown in fig. 27, and another case, where the centre of the tree is near one corner of the baulk, is shown in fig. 28.

This splitting is much more likely to happen under hot air seasoning than any other.

Heart shakes are serious defects in timber. They are

developed in the growth of the tree, but are more apparent when seasoned. If there are only one or two shakes no great harm is done, as the woodman will split the logs along their course, but if many exist, making a *star shake*, the timber is almost spoiled, only very little serviceable timber being obtainable.

Cup shakes are cracks along the line of the annual rings,

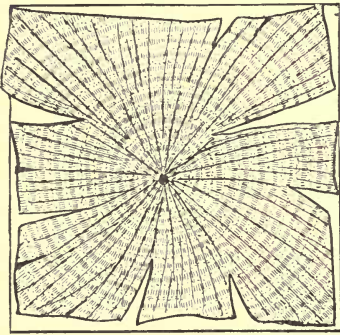

FIG. 27.

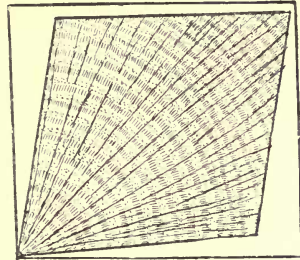

FIG. 28.

caused by some vicissitude in the growth of the tree destroying the cohesion between two annual rings.

This is much more common in certain trees, notably pitch pine, than in others, and, of course, always causes a loss of effective timber capable of conversion into planks, &c.

Diseases of timber.—The diseases to which living trees are liable do not properly concern us here, but inasmuch as wood may be, and not infrequently is, brought into the market in a more or less damaged condition from diseases which affected it previous to felling, it is perhaps worth while to say a little about two or three of the diseases of living trees.

The most common and destructive disease, in northern climates at any rate, and one which attacks the most widely-used timbers in this country, those of the conifers, is wet rot.

This disease has been traced to various fungi by the brilliant and invaluable researches of Professor Hartig of Munich, who, with other distinguished German botanists, has done so much to enlarge our knowledge of timber trees and their proper management.

I am immediately indebted for the notes given here, however, to the writings of Professor Marshall Ward, who has brought this subject in its true aspect before the English public.

Wet rot is caused most frequently by a fungus which germinates in moist ground round the roots of a tree, and entering them, sends out a large number of long white filaments, which attack and feed first on the cambium cylinder, and next on the starch and other food materials in the cells of the medullary rays, ultimately sending a complete network of arms through every part of the heart-wood, and reducing it, by delignifying the walls of the tracheides, to a soft, moist, spongy mass, with no traces of the original properties of the wood.

Of course this attack, commencing as it does from the base of the tree, rapidly kills it.

Timber which has been partially destroyed by this parasite can be distinguished by its reddish or purple tint in places, or if the disease be very advanced, by dull, yellow, soft patches with clear white spots, having a small black speck in the middle of each. It is rarely seen, however, as advanced as this.

Another fungus which is somewhat similar in its action, inasmuch as it attacks the roots of trees, is the *Agaricus Melleus*. Its distinctive features are, that it is able, by long sinuous

branches, to spread indefinitely to the roots of neighbouring trees not actually in contact.

This fungus is very common in this country, and may be detected by its fructification on and near the roots of trees, in the autumn. These fructifications appear as toadstools of a yellowish colour, with rings round their necks. The visible effect of this disease is to give timber a bright yellow colour in places, in the midst of which are visible white patches. Beech is particularly affected by this disease.

The familiar clinging, felt-like substance, of a yellow to deep brown colour, frequently seen on oak and other trees is a very destructive form of fungus, which, from this felt-like mass, sends out feeding shoots into the wood, and destroys it somewhat in the same manner as the other parasites described.

Fortunately this fungus is only able to penetrate the tree where it has been previously wounded by some other agency.

This disease is readily detected by the white filaments running in all directions in the timber, or, if only slight, by the brown patches which will appear, making the wood quite powdery to the touch.

Of course many other parasites attack trees, and rot is occasioned by old age in addition ; but if, in selecting timber, care be taken to reject such as may have any of the faults referred to, good wood will generally be obtained.

Foreign timber is not often seen in a very advanced state of decay, as it is usually not shipped by the timber merchants when found affected.

After timber is felled it is still very liable to diseases, of an equally serious character to those of living trees.

One of the fungi which attacks cut timber is very liable to

commence its ravages in any crack which the surface of the log may offer, even when yet in the forest, its effects being apparent, perhaps, only after months of storage in a timber yard.

Streaks of brown or red colour, of moist, spongy nature, probably with patches of the white fungus itself, sometimes appear in boards, and are the result of this disease. Timber with this defect should never be accepted, as the fungus will spread and entirely spoil the whole of the wood, or any other sound timber with which it comes in contact.

The exclusion by the woodman and the buyer of diseased living timber makes the defects already alluded to less frequently seen than would otherwise be the case. But a disease with which everyone is familiar, and to which even the soundest timber is liable, is the dry rot. This disease is due also to the ravages of a fungus which eats into and decomposes the wood. It can be readily discovered by the fine web of filaments running all over the surface of the wood, and, in cases of advanced disease, by felt-like patches on the surface of the timber.

The great preventive and cure of dry rot is a free circulation of air. A damp, still atmosphere, such as is found in cupboards and cellars, is very liable to produce rot.

Even in these situations, if timber be thoroughly seasoned and quite dry before being used, and be kept dry, it is impervious to dry rot.

The difficulty of keeping timber dry in spite of the exhalations from the earth in cellars and similar places is, however, usually found to be insuperable unless free ventilation is resorted to.

Timber built into walls, like the ends of beams, is very liable to dry rot (really a very inappropriate name) because of the

want of ventilation ; and if the end of a beam projects through the wall, the moisture which is so necessary for the propagation of the disease is rapidly absorbed.

One of the chief reasons for the dislike to sapwood evinced by tradesmen is its great liability to attack from dry rot, probably because its tissues contain more starch and other substances for the fungi to feed upon.

Market forms of timber.—Many of the teachers of manual training may have to buy timber, and a knowledge of the trade terms of shape and measurement will be very useful, and probably do much to prevent the supply of timber under a false name.

Timber when first felled, with the bark still on, is called ‘log.’ English logs are generally at once converted into half logs, and when seasoned are cut into boards of whatever size the tree may yield.

English timber is usually found, consequently, with a portion of the bark on the outside of the sapwood showing at one or both edges of the plank.

Foreign timber is usually roughly squared into baulks, except in the case of the conifers, of which a large amount of timber is imported ready cut up into boards.

The squaring deprives the timber of its useless sapwood, and foreign timber of the hard or leaf wood kind, at any rate, is usually found good up to the edges of the planks ; generally, however, at the rounded or ‘waney’ corner of the baulk the sapwood is left, and ‘waney’ timber should not, therefore, be accepted as first quality.

Hard or leaf woods suitable for manual instruction are generally sold by the square foot in plank, and in ordering these

woods the number of feet 'super,' and the thickness of the timber required should be given.

The Northern Pine, or, as it is usually called by timber merchants and others, '*Yellow Deal*,' is very largely imported in ready-sawn boards of various handy sizes.

If 11 ins. or more in width these boards are called *planks*. Those of 9 ins. wide, and 2 ins. to 4 ins. in thickness, are known as *whole deals*, and are usually 12 ft. long. When 2 ins. or less in thickness they are called *cut deals*. If a 3-in. deal is cut into six, the thin boards obtained are called 5-cut deals. These will be sold as $\frac{1}{2}$ -in. boards, but this dimension is not real, as the saw waste has to come out of the measurement.

We have accordingly 3-cut, 4-cut, and even 12-cut deals, though these, being only about $\frac{1}{8}$ in. thick, are very rarely seen, except in certain trades. Boards of 7 ins. wide and less are called *battens*.

Deals or battens cut in the width into narrower boards are called *quarterings*; very small pieces of this kind are called *laths*, quarterings and laths being usually bought by the 100-ft. 'run.'

The classification of timbers in such a manner as to make them readily recognisable, is a matter on which much difference of opinion exists among various authorities, but the easiest and most readily appreciated is the usual trade classification into—

I. *Conifers*, and II. *broad-leaf woods*.—These two classes may be again subdivided, as shown in the following table :—

Classification.

Main divisions	Subdivisions	Familiar examples
I. CONIFERS	a. <i>With resin canals</i>	Cedar, Northern, Weymouth, Pitch, Kawri, Red, and Oregon Pines, Spruce (Red and White), Larch
	b. <i>Without resin canals</i>	Yew
II. BROAD-LEAF WOODS	a. <i>With visible medullary ray</i>	
	1. Annual ring and pores visible	} Oak, Beech, Elm
	2. Annual ring visible, but pores invisible	
	b. <i>Without visible medullary ray</i>	Sycamore, Plane, Basswood, Poplar, Hornbeam, Alder
	1. Annual ring and pores visible	Ash, Teak, Mahogany, Jarrah, Walnut
	2. Annual ring visible, but pores invisible	} Lime, Box, Chestnut
	3. Without visible annual rings or pores	
		} Ebony, and Lignum Vitæ.

This classification, though perhaps not the most complete, will be found in the main a satisfactory guide, but the fact that all degrees of distinction exist makes it very difficult to always allot any wood to a particular class.

The detailed descriptions of certain woods which *may* be included in a course of manual instruction will prove, it is hoped, useful, but no description can ever fully convey an impression of the properties of the different timbers. Every opportunity for inspection and working in any new timber should be seized by the teacher, and a museum of specimens will be found invaluable.

It is difficult to formulate the general characteristics of timber, when the particular species vary so very much in size, colour, and density.

The following few general rules may be, however, accepted as fairly accurate in most cases :

I. Lustrous colour and a bright sheen in a varying degree, according to the kind of wood, are an indication of good quality ; and a dull colour is generally indicative of inferiority.

II. Provided the colour is even and bright, the darker the tint the better ; thus dark-coloured oak is better than light.

III. Sapwood, except that of elm, is inferior to the heart-wood.

CONIFERS

Northern Pine (*Pinus sylvestris*).—This tree is sometimes called the Red Fir, on account of the reddish-brown colour of the bark ; Yellow Fir, by reason of the colour of the wood when cut up ; and Scotch Fir, because it is commonly found in Scotland.

This tree grows in certain localities in England, thriving best on light sandy soil. By far the greater part of that used is exported from the Baltic ports of Prussia, Russia, and Sweden. It grows in Scandinavia and Northern Europe generally.

The Northern Pine has particularly well-marked annual rings, the prevailing colour in good wood being a bright very light yellow, which deepens in the thin dark autumn wood to a brownish yellow, owing partly to the larger amount of resin in the wood. The medullary ray is usually invisible, but can be detected very occasionally on close examination. The grain of pine is usually straight, and the wood can be obtained in considerable lengths. It is sometimes full of knots, but the extent of this defect depends on the particular kind, for the timber from different German and Russian ports varies very much in its characteristics.

The sapwood varies in quantity very much. It is inferior, and easily distinguished by its bluish tint.

Northern Pine is a very durable wood—in fact, it is doubtful if even oak is superior to it in this respect. In both wet and dry situations it stands the weather well, and, owing to its cheapness and reliability, it is much the commonest timber used in England. In judging this wood for quality the chief things to look for are: a bright yellowish colour with a good lustre in both spring and autumn wood, regular and narrow annual rings, showing a series of concentric, or as nearly as possible concentric, circles, not more than one-tenth of an inch wide on a transverse section. Rings of varying thickness are a bad sign, showing irregular and exceptional growth. A clammy surface which will stick on the sole of a plane and, when brought to a true surface, has not the shiny silky lustre of good wood, or wood which chokes the teeth of a saw, is bad. Shavings from good wood will always retain their cohesion better, and have greater elasticity than those from bad. A dull chalky appearance (usually found in loose-fibred, wide-ringed timber) is objectionable. Of the various kinds of the Northern Pine imported into this country, the Prussian is undoubtedly the best.

The practice is to name the kind of timber from the port of shipment. This custom was no doubt originated by the timber merchants, and though obviously defective, it still serves to indicate in a general way the quality and sizes of the timber to be obtained.

Stettin, *Memel*, and *Dantzic* send what are usually found to be the best timber, perhaps *Dantzic* the best of all.

The Russian *Riga* and *Archangel* deals are next in quality, and Swedish are most inferior.

The native Scotch Fir is of very poor quality, and is not much used except for provincial work, while the small amount of this timber in England is grown purely for landscape ornamentation, being practically useless for any woodworking trade.

Yellow deal is easy to work, clean, and when well-seasoned does not warp or twist much.

Norway Spruce, or White Fir (*Abies excelsa*).—The wood of this tree is paler than the Northern Pine both in the spring and autumn wood, and is not nearly so resinous, which probably accounts for the lighter colour of the wood. To distinguish it from the Northern Pine this wood is usually called ‘White Deal.’ The annual rings are much narrower, and the wood is more close-grained than the Northern Pine.

White deal is light, strong, and elastic, and though the knots are very hard it is fairly easy to work. It has the valuable property of holding glue well.

The sapwood is not easily distinguishable, but in planing it always seems ‘woolly,’ and can only be made smooth with great difficulty.

The best quality of White Deal is brought to this country from Russia, St. Petersburg and Archangel deals being large (usually 11 ins. in width) and very free from knots.

The true Norwegian timber is smaller, and full of large glassy knots. This kind of White Deal of the smaller sizes is often imported in log with the bark on, and these logs are then called ‘Norway spars.’

The American variety of White Deal (*Abies alba*) is of inferior quality, being extremely full of knots and more liable to twist and warp, besides being less durable than either Russian or

Norwegian. The White Deal is extensively used for internal work in building in this country, and especially where its clean appearance is a recommendation, as in floor boards. It is not so durable, however, as the Northern Pine, especially in wet situations, where it decays with comparative rapidity.

Red Spruce Fir (*Abies rubra*), a reddish-coloured timber found in Canada and Nova Scotia, whence it is usually imported for the spars of ships.

Red Pine (*Pinus rubra*).—This tree grows in Canada and the north of the United States, and is so called from the colour of its bark.

The wood is of a reddish-yellow colour, and can only be distinguished with difficulty from Memel deal. The knots, however, are larger and are more frequently 'dead' (loose). This wood is of a very good even colour. It is of fine grain, and can be obtained in large boards. It is useful for indoor work, but is not so strong or durable as the Memel timber, which it resembles, though easier to work.

American Yellow Pine, or Weymouth Pine (*Pinus Strobus*).—This is the best American pine imported for indoor work. It is clean and very soft, the annual ring is very indistinct, and the medullary ray is invisible. The sap-wood is a greenish-grey colour, and is worthless. This wood can be obtained in large sizes and very often remarkably free from knots, which, when they occur, are usually large and 'dead' (loose).

This pine can invariably be distinguished by the unique characteristic of numerous short, fine, hair-like streaks in the direction of the fibres; it is useless, or nearly so, in any wet situation, but is fairly durable in dry positions. It holds glue very well, and as it is not liable to warp or twist, is used as

backing for veneers. For the same reason it is used by pattern makers. It is easy to work, but is not sufficiently tenacious to hold nails well.

Pitch Pine (*Pinus resinosa* or *Pinus rigida*).—This pine is remarkable for the very wide, bright bands of resin, which fill up the autumn wood, and make the annual rings of this timber the most distinct of all. The rings are rather wide, and the medullary ray is invisible. The spring wood is of a pale yellow colour. Pitch pine comes from America, and chiefly from the southern part of the United States.

This timber becomes brittle and defective in age, but when from a fairly young tree is one of the very strongest timbers, bearing great loads almost as well as oak. It has also the rare quality of being durable in varying wet and dry situations. Its handsome appearance makes it much sought after for ornamental purposes also, but there is much waste in conversion owing to the large amount of sap-wood.

There is very great difficulty in shrinking this timber in seasoning, and in fact it appears impossible to thoroughly do so. Apparently well-seasoned timber will frequently, when its surface is planed off, commence to shrink again, and the writer once saw a piece of this wood, which had been glued down for more than seven years, suddenly overcome the restraining influence of the glue, and shrink quite one-eighth of an inch, the occurrence being accompanied by a loud report. As might be gathered from this experience, pitch pine does not hold glue well, and this fact, together with its tendency to split when kept from shrinking, makes it very difficult to use with safety.

The vast amount of resin in the wood makes it a very hard and difficult material to work in, as it clogs every cutting tool.

Pitch pine is liable to be brittle at the heart of the tree, and is often 'cuppy.'

The Larch (genus *Larix*).—This timber is the most durable of all the Conifers. The best is generally imported from Russia, though much good larch is grown in this country.

The wood is of a bright yellow or brownish-yellow colour, is very hard and resinous, with a more even texture than most of the Conifers. The annual ring is, however, distinct, though the medullary ray is invisible.

Two varieties exist in America, *Larix pendula* and the red *Larix microcarpa*.

They have the same characteristics as the European kinds—extreme durability in any situation. This timber is not greatly used in England, except for rough out-of-door work like posts and railings, railway sleepers, &c. It warps very much in seasoning.

Kawri Pine (*Dammara australis*).—A New Zealand pine of large size. The annual ring is distinct and the texture of an even yellow-brown colour, with dense fibres much choked with resin. The timber can be obtained in large sizes, and the absence of knots makes it very useful for ships' masts and spars.

Oregon Pine (*Abies Douglaisi*).—A fine American pine, which has been largely imported in recent years. The wood is firm and good, but shrinks in rather a marked degree in seasoning.

It will swell in the autumn wood very rapidly after being wrought, causing much difficulty in bringing it to a regular, even surface.

Cedar.—There are several kinds of cedar, but that most generally used, and which grows in England, is the Virginian

(*Juniperus virginiana*). The timber resembles Honduras mahogany, except in one important particular, that many fine black longitudinal streaks appear, scattered over the surface of a plank, as in the Weymouth pine, but they are much longer in the cedar, varying from one half inch to 3 inches. The cedar is very durable in dry situations, and, being light and not subject to warping, is useful for boat-building. The great characteristic of cedar wood is its peculiar odour, which makes it proof against the attacks of most insects, hence furniture is frequently made of it, to preserve clothes and other articles.

Yew (*Taxus baccata*).—This timber, which is fairly common all over Europe, is noted for its great durability in all weathers. The wood is of a deep yellow colour, with close, even texture. The annual rings are fairly distinct, but the medullary ray is invisible.

It is flexible and very tough, but splits easily.

This tree is remarkable for its slowness of growth and great longevity, many trees now existing in a flourishing condition being known to be many centuries old.

BROAD-LEAFED WOODS

Oak (genus *Quercus*).—The oak is the commonest of the broad-leaved trees of this country.

The annual ring is distinct, there being a somewhat marked contrast between the spring wood, which is generally very visibly porous and small in quantity, and the autumn wood, which is wide, compact and of a darker colour than the spring wood. The medullary rays, especially the larger ones, are remarkably distinct.

The smaller rays are darker and much more numerous than the larger ones, which, when the wood is cut obliquely, give such a beautiful flowered appearance, making good examples of the carpenter's silver grain.

The smaller the medullary rays are, however, the stronger and more durable the wood. The prevailing colour of good oak is a bright rich brown. Inferior kinds are more or less red in colour, or are somewhat bleached.

The sap-wood is inferior to the heart-wood, but if the wood is straight grained it can be split into good laths.

In England two common varieties exist, the stalk-fruited (*Quercus pedunculata*), which may be distinguished when growing by the short stems to the leaves and by the long stems to the acorns. This species is sometimes also called *Quercus Robur*.

The cluster-fruited or *Bay Oak* (*Quercus sessiliflora*), of which the acorns grow in clusters with short stalks, the leaves having stalks about 1 inch in length. Some doubt, however, exists as to this classification, and this latter kind is sometimes regarded as a variety of *Quercus Robur*. There does not seem to be any very great difference in the quality of these species, though a prejudice has existed in favour of the stalk-fruited oak.

The oak gives timber which is remarkably durable under any circumstances.

In wet and underground situations it has been known to endure many centuries, and in dry places it has, when well ventilated, lasted a thousand years.

Oak varies very much, even in England, according to soil, care and attention from foresters, and other causes, but usually it is tough, hard, and very strong, and can be bent very readily when steamed.



The wood being handsome, strong, and plentiful is very much used for all purposes requiring strength and endurance, as well as for purely ornamental work. There are, indeed, very few requirements which oak cannot meet.

The chief defects of oak are—that it warps and twists unless well seasoned, it is at all times liable to the attacks of insects, and, by reason of the gallic acid with which it is impregnated, it corrodes metal fastenings very quickly, especially if in the wet.

The *Durmast Oak*, which is fairly common in England, is of a very inferior character.

Oak from Scandinavia is sometimes seen in this country. It can be recognised by its small size (usually in boards). It is generally of a dull pale colour, full of white streaks, and is inferior in quality.

Dantzic and Memel Oak comes from the Baltic ports generally. It has smaller medullary rays, and its figuring is not so large as English oak. It is bright and dark in colour, though not so dark as English oak, is prettily figured, and very straight grained.

Like the Dutch wainscot oak, from which it can with difficulty be distinguished, it is less liable to warp than the comparatively cross-grained English oak, but is not so durable.

Wainscot is another kind of imported European oak, coming chiefly from Holland.

It is very similar to that from the Baltic ports, and has a more lustrous colour than English oak.

American Oak.—There are several kinds of oak imported from America.

American oak is characterised by the red tinge of colour in it. This is sometimes very marked. In a lesser degree it is noticeable for its straight grain.

All oak, and especially English, is difficult to work, and planes should always be kept in particularly good order when required to work in oak. The wood should be left smooth from the plane, subsequent scraping or glass-papering being very injurious to the appearance of the surface.

Oak can be highly polished, and it holds glue very well.

Sometimes new oak is darkened down to the colour of age by the application of a solution of ammonia.

Elm (*Ulmus*).—There are five European varieties of this wood, which grows principally in Western Europe.

The most common kind in England is the rough-leaved elm (*Ulmus campestris*).

The elm, as may be seen from the general appearance of the growing tree, has very twisted fibres, rendering it liable to warp and twist.

The spring wood is very porous, while the autumn wood is hard and darker in colour.

The prevailing shade is a reddish-brown tint, but the sap-wood is noticeable as being much paler in colour than the heart-wood, and in it the redness of the pores is noticeable by contrast.

The medullary rays are fine, but distinct and numerous.

Owing to its liability to twist, this wood is not much used for fine work, but by reason of its great strength and durability, especially under water, where its decay seems almost impossible, it is much used for the piles of piers, bridges, &c.

A peculiarity of this timber is that the sap-wood is equally

as durable as the heart-wood. Like most timber, however, it is more inclined to rot when exposed alternately to wet and dry conditions. Nevertheless, it is much used for boat-building, and heavy out-of-door construction, where strength is wanted.

It is cheap, plentiful, and enormously strong.

Though so liable to twist, even in large baulks, it is remarkably free from shakes, and as the grain is close and twisted it is difficult to split elm. For the same reason nails and bolts can be driven into it without fear of their loosening.

The Broad-leafed Wych Elm (Ulmus montana) and the *Smooth-leafed (Ulmus glabra)* are not very common in England. In Scotland and Ireland, however, they are grown in preference to the rough-leafed variety.

These trees are even larger than the rough-leafed elms, and have much straighter fibres.

The Dutch Elm (Ulmus major) is a very inferior variety; in fact, practically worthless for timber.

The Cork-barked Elm (Ulmus suberosa), found in this country, principally in Sussex, is another inferior kind.

Canada Rock Elm (Ulmus racemosa), so called from its being imported principally from Canada, and because it grows well in rocky places, is very different in many ways to the European varieties.

It is usually straight grained, in marked contrast to the rough-leafed elm.

The annual rings are close and regular, and of a brown colour. Inferior specimens have dark, irregular annual rings, and the sap-wood is more liable to decay than the heart-wood. This timber, though it does not twist so much as the common

elm, loses a great deal of its volume in seasoning, and is very apt to shakes and warping.

Beech (*Fagus*) is found in the temperate climates of the Northern Hemisphere, and in Australia also, but its characteristics vary in different countries.

The colour is a whitish-brown of various shades, the darkest being known as black beech, and the lightest as white.

The annual ring is fairly compact, the difference between the spring and autumn wood not being very marked.

The medullary rays are very numerous and distinct, and as a consequence beech is easily cleft.

Beech is apt to become 'burred,' as the white doaty spots which appear on its surface are called, when exposed to alternate wet and dry.

It is, therefore, hardly ever used for external work, except entirely under water, but, owing to its reliability and toughness, is used a good deal in chair-making and other work exposed only to a dry atmosphere.

Beech is very liable to warping or twisting, unless seasoned by desiccation or steaming, but when thoroughly seasoned is of great service where toughness, smoothness, and durability are required.

This timber is liable to the attack of worms, and, owing to a strong acid contained in it, metal fastenings are rapidly corroded.

Hornbeam (*Carpinus Betulus*).—This wood is rather common in the South of England. It is little used, though durable in exposure to weather.

The annual ring is not very distinguishable, and though the medullary rays are rather large, they are not greatly different in colour to the remainder of the wood.

It is cheap, and as the fibres are close and the wood will stand hard blows, it is used for some descriptions of tools.

Nail holes made into it soon close up when the nails are withdrawn.

The wood is never beautiful, and is not used for ornamental purposes. When old it is brittle and useless for any purpose.

Sycamore (*Acer pseudo-platanus*) is a common English tree, and is frequently miscalled the plane tree. The timber is, however, very different in appearance.

It is white or a light yellow colour, which deepens with increasing age, till it is sometimes of a brownish hue at the heart.

The medullary rays are fine, distinct, and very numerous, causing a pretty dappled effect on the surface of boards.

The sap-wood is of a very pale green tint, and it is often difficult to distinguish its limits.

The timber is even in texture, free from knots and shakes, hard, and capable of receiving very accurate finish.

It is brittle, and much attacked by worms.

Sycamore is used extensively in cabinet-making, for furniture and other ornamental work, and, as it works up so clean, is much used for turnery.

This wood can be dyed, and will retain its new colour very well; it is therefore used by marquetry-cutters and others, who require contrasting colours.

Plane Tree (*Platanus*).—There are two common kinds of this tree, one growing in Asia Minor and the East generally (*Platanus orientalis*), and the other in the United States (*Platanus occidentalis*). They are much alike, and both resemble birch, but have more medullary rays, causing the dappled appearance

of sycamore, only more intensified by their heightened colour—a medium brown.

Plane wood is brittle and difficult to work. It is apt to be loose fibred in places.

This wood is much used for ornamental purposes, and its durability is great, especially when entirely submerged in water.

Poplar (genus *Populus*).—There are five different kinds of poplars commonly growing in England, and two in America, but their general characteristics are not greatly different.

This tree is found rather plentifully distributed all over Western Europe.

The wood is white and soft, but does not shrink or swell much, and is durable in dry places.

The medullary ray is not visible, and the spring and autumn wood can be distinguished by the pores in the former.

It is not much used except by carvers and turners, who like the even texture and soft nature of the wood.

In country places it is used for the internal construction of houses because it stands well in the dry, is fairly plentiful, and consequently cheap, but it is too soft for hard wear.

Chestnut (*Castanea vesca*).—This is known as the Spanish or sweet chestnut; the latter name was given because the fruit is edible.

It is a large, fairly common tree in this country, and, like the oak, will live for a very great time.

It attains its maturity, however, quickly, and from that time—usually less than a century—slowly rots away at the heart, old specimens being almost without exception quite useless as timber-producing trees, from this cause.

The annual rings are very distinct, owing to the deep brown

colour of the autumn wood, but the medullary ray is invisible, as are also the pores in the spring wood, giving the wood a close, solid appearance.

Chestnut is, when young, very useful for all purposes where strength and durability are required.

Owing to the early decay of the tree, the best timber comes from trees about 50 or 60 years old.

The sap-wood is easily distinguishable, being light in colour, and thus contrasting with the heart-wood, but there is very little of it at any time.

Alder (*Alnus glutinosa*).—This tree is common in damp districts and by the banks of rivers. The wood is soft, of an even yellow colour, slightly tinged with red when seasoned, but is white when first cut down. The annual ring is not very distinct, but the medullary ray can be detected by its slight lustre, although nearly the same colour as the annual ring. This wood is tough and fairly strong, but is not very stiff.

It is durable under water or entirely buried in the ground, but soon rots except in dry places, and is very much subject to the attack of worms.

Ash (*Fraxinus excelsior*) is found very generally throughout the northern temperate zone of both the Old and New Worlds. The appearance of the wood varies in different countries.

English Ash has very twisted grain, is of a light brown colour, and occasionally almost white. There is a strong contrast between the spring and autumn wood in the annual rings, due to the porous nature of the former, which is of a lighter colour than the autumn wood. The medullary ray is invisible. The sap-wood in this timber is not apparent in young

wood, consequently little waste takes place in cutting it into planks or scantlings. In old wood, however, the heart becomes black, and is then of very little use.

Ash is remarkable for its toughness and flexibility, and when it is fairly straight grained is moderately easy to work, but when, as is usually the case in English ash, the wood is 'curly,' or twisted in the grain, it is very difficult, and is apt, if it is not thoroughly seasoned, to twist and warp.

When ash trees are felled they are at once quartered and even cut into planks, or numerous serious shakes would appear and quickly destroy the whole log.

Ash, owing to its great strength under sudden strains, is used for tool handles, spokes and felloes of wheels, and gymnastic apparatus.

Some better-marked ash is used for making furniture and for other ornamental purposes.

Indeed, pollard ash is sometimes purposely grown for this reason on account of the beauty of its grain.

Ash is very durable when in dry places, but soon rots when exposed to varied weathers, and is apt to snap suddenly.

American Ash can be distinguished from the English variety by its redder colour and straighter grain. In use, too, it is softer, owing to its long straight grain. American ash is much used for making oars and sweeps, where the English timber would be liable to warp and twist too much.

Hungarian Ash is entirely an ornamental wood, owing to its very twisted grain and the great contrast between the spring and autumn wood in the annual ring. This wood is beautiful, but from its twisted nature it is impossible to use it in thick pieces.

It is, therefore, usually cut into veneers and used on a foundation of some other wood.

Walnut (*Juglans regia*).—This tree thrives in England, but it is a native of the South of Europe and of the same latitudes in Asia and America, where it grows to a much greater size.

The Walnut when young produces very inferior white wood, but in old trees a marked difference exists, it being of a dark brown colour and very durable.

The wood is of even texture, the annual ring being fairly distinct, with occasional twisted veins of darker colour, except in the black walnut, as the dark-coloured American variety is called. The medullary ray is invisible.

The pores in the spring wood are rather distinct, and the wood shrinks considerably in seasoning. It should, therefore, be well dried in the second seasoning in order to get it true. It does not warp or twist much, however, and when finally shrunk will stand well.

Walnut is much used for ornamental purposes, as it can be glued very strongly, and will take a beautiful polish. The veining adds much to its appearance, especially in the roots and burr wood.

This wood does not in the least corrode metal fastenings, and for this reason, and because of its lightness and strength, it is invariably used for gun-stocks.

Italian Walnut is the best, but is dear and difficult to get.

American Walnut (*Juglans nigra*) is cheaper than English or Italian, and is extensively used. It has all the ordinary properties of walnut, except that it is not so durable and is somewhat less elastic.

This variety is straighter grained and is easier to work than European kinds.

Teak (*Tectona grandis*).—One of the most valuable of woods, from its great strength, durability, and resistance to the attacks of insects, and is therefore greatly used for all structural purposes. The Teak tree grows in India, all over the Deccan, and in Burmah and Ceylon. The wood is brown, light, straight-fibred, with no visible medullary ray. The annual ring can be distinguished and the spring wood is always porous. The characteristics of teak vary, however, in the different districts from which it comes; Johore teak is strongest and heaviest, and Moulmein, of which we have the greatest supply, is the most flexible.

The presence of the resinous oil, which is so useful in preventing the attacks of insects, and saving metal fastenings from rust, causes the unpleasant smell which is so distinctively characteristic of teak.

This resinous oil will sometimes be found in considerable deposits filling the numerous heart shakes to which this tree is liable, and will blunt the edge of any cutting tool; and, in fact, the whole substance of the timber is particularly apt to take the keenness from the edges of tools. Sometimes teak will be found with a very small amount of this oil in its composition. It is then light in weight and of a paler colour. The tree producing this wood has probably been tampered with by natives during its growth, in order to obtain the oil. Teak of this kind is brittle and generally inferior.

This wood is fairly easy to work, but care is required to prevent splintering, to which it is liable.

Mahogany (*Swietenia Mahogani*).—There are two rather

distinct kinds of this tree—the *Honduras*, growing in Central America, and the *Spanish*, flourishing in Cuba.

A slightly varied kind of the latter is from Hayti and the Bahamas.

Honduras Mahogany is of a rich reddish-brown colour, with a lustrous golden shade. Inferior kinds are paler in colour and looser fibred than the best quality.

The annual ring is visible, but there is no great difference between the spring and autumn wood. The pores are very evenly scattered and prominent, the medullary ray is not visible.

The timber shrinks and warps but slightly, and holds glue probably better than any other wood. These qualities, added to its good colour and durability in dry situations, make it very useful to cabinet-makers, pattern-makers, and other wood-workers.

It soon decays in wet places, and is not therefore suited to outdoor work.

The commoner kinds are light coloured and soft, sometimes as soft as pine, especially in the timber grown in the swampy country along the coast of Honduras. This is called the Bay Mahogany. The grey patches which occur in planks of mahogany are the effects of wet rot in the living tree. This wood is unsound, containing the germs of dry rot, and should be rejected.

Mexican Mahogany is, generally speaking, larger and more figured than Honduras, but is bad at the heart, possibly through overgrowth. It is more liable to twist and warp and frequently has heart shakes.

Spanish Mahogany.—This variety, grown on the rocky soil of

Cuba and Hayti, is much darker in colour, harder, heavier, and more beautiful than the Honduras, but not so strong or stiff.

The beauty of this wood is remarkable, the variety in the form of the figuring being greater than in any wood, and this characteristic, added to its fine rich colour, makes the best quality the most highly prized wood for ornamental purposes.

Mahogany is sometimes darkened with a solution of bichromate of potash, to give the finer colour of age.

This process is attended with a fairly satisfactory result, but does not produce such a good tone as the natural effect of long exposure.

The difference between the spring and autumn wood in the annual rings is rather more distinct than in most of the Honduras variety, but the fact that the latter is so very varied in colour and figuring makes it sometimes difficult to distinguish Spanish. The one reliable point of distinction between Spanish and Honduras mahogany is the white chalky substance with which the pores of the former are invariably choked.

This kind of mahogany is much more difficult to work, owing to its dense and twisted fibres.

All mahogany possesses the general characteristic of comparative freedom from the ravages of worms and from dry rot.

Jarrah (*Eucalyptus marginata*).—This wood is sometimes called the Australian mahogany, and is grown chiefly in Western Australia.

It is of a fine rich red colour, even textured, hard, and durable, and, having but little figure, is more like unfigured Honduras than Spanish mahogany. No medullary ray is visible, but the annual rings are fairly distinct.

It is very durable in both wet and dry situations.

The Jarrah is very subject to heart shakes and cup shakes, and for this reason the outer portion of the heart-wood is the best.

This wood is, however, in all its parts liable to shakes and to warping and twisting. It is very hard and extremely difficult to work. These reasons are objections to its general use. It is, however, very little subject to the attack of worms or other insects, and is *said* to have a disinfecting influence when used in buildings.

Box (*Buxus sempervirens*) is grown in England, and all over Southern Europe, and in Asia as far east as Persia.

This wood is very heavy, hard, and close grained, and of a light bright-yellow colour.

English box, which is much the hardest variety, is slightly darker in colour, very much more twisted in the fibres, and with more knots than foreign box.

Imported boxwood, generally called Turkey Box, is straighter grained, and is more reliable for many purposes.

There are indications of the annual ring, which cannot, however, be said to be distinct. This is especially the case in English boxwood.

Owing to its prohibitive price it is not much used except for special purposes, where its qualities render it almost invaluable.

The handles and heads of some driving tools and the handles of chisels are sometimes made of box, and it is also extensively used for engraving-blocks.

Lime.—The European lime is a soft, white, even-textured wood. The annual ring is fairly distinct, but the medullary ray is rarely visible. The wood is plain, but, being very reliable and not apt to warp, is much used by carvers. It is sometimes, therefore, called the carver's tree.

The timber of the American lime is called bass-wood, and is of a yellow-brownish colour, and sometimes quite green.

The annual ring is fairly distinct, and the medullary rays are small, numerous, and very clear.

This wood, in seasoning, loses a large amount of moisture, and consequently shrinks greatly, warping somewhat at the same time.

It is durable in the dry, but if exposed to a moist atmosphere absorbs moisture very rapidly, and swells to such an extent as to destroy any work of which it forms part.

This wood is fairly cheap, and, owing to the ease with which it can be worked, is recommended for manual instruction. The green-coloured wood is the best for this purpose.

Ebony.—A dense, heavy, hard wood of a black colour, with white, or nearly white, sap-wood.

This wood is the darkest coloured of all known timbers, and is consequently used in good cabinet-work where a black colour is wanted.

It is very liable to splinter in working, and, owing to its great price, is not much used.

Lignum Vitæ (*Guaiacum Officinale*).—One of the hardest and heaviest of woods.

It is imported from the West Indies, and is used for purposes requiring great resistance to crushing strains. The annual ring is distinct, but the medullary ray is invisible.

The sap-wood is of a dirty yellow-white colour, but the heart-wood is a dark brownish-green.

Lignum Vitæ is very dear and difficult to work.

OTHER MATERIALS

Glue.—This important material in a manual training room is sold usually in three kinds, Scotch, French, and ‘Town,’ but all are made from the hoofs and hides of oxen and other animal products.

These substances are boiled, strained, melted, re-boiled, and finally, after several operations, cast into hard square cakes of varying thickness.

Scotch glue is the strongest that is made. It is of a reddish-brown colour, but when held up to the light it should be transparent, or nearly so, and of a bright amber colour. The transparency is a sign of good quality, and it is important that no dull, cloudy spots should be apparent.

French glue is made in two thicknesses, one about a quarter inch, and the other about one-eighth inch thick, both being thinner than the best Scotch. It is very transparent, but this increased transparency is more due to the nature of the glue, which is of a light colour, than to the thinness of the sheets.

Town glue is inferior in every way.

There are various reliable modes of testing the quality of glue. If it is wetted and rubbed, good glue will at once become sticky, while a greasy surface may be taken as indication of bad material. There should be very little smell from good glue, but the odour, such as it is, should never be musty or very objectionable.

When glue is used to attach two pieces of wood, the surplus should be squeezed out by continually rubbing the two pieces of wood together. When these have been rubbed together for a

certain length of time a 'set,' as it is called, ensues, the jointed wood is then put on one side to dry. Now good glue will not 'set' too quickly, but will dry after 'setting' very soon.

If glue dries in a joint in an hour or two, or takes a very long time to dry—say more than twenty-four hours—it is inferior, and the work done with it will be defective.

In mixing glue as little moisture as may be necessary should be absorbed, and the best method of preparation is as follows:—

Break up enough glue into as small pieces as are reasonably possible, and place it in the inner of the two glue-pots, just covering it with water. Fill the outer pot with cold water and steadily boil. Stir the glue constantly while it is melting, and when it is thin enough to run off the brush in a steady stream without breaking into drops it is 'made,' and ready for use. Before the glue is quite 'made' a scum of impurities will appear on the surface, and should be removed.

Another way of making glue is to soak it for twelve hours in just sufficient cold water. The glue should not melt by this soaking, but swell considerably; and here is another test of the glue, for the more it swells in soaking the better is its quality, while if it dissolves, it is inferior. The glue and the water in which it has been soaking should now be transferred to the inner glue-pot, and boiled *steadily* for about an hour.

The first plan, however, is the best for every purpose, though the glue does not keep good so long, and will not bear re-heating so much as in the second method of preparation. Glue loses virtue every time it is heated, and if it gets dirty it is spoiled, so that it is of the utmost importance to keep both glue-pot and glue clean.

Strong Scotch glue is usually considered the best where mere strength is required, but in very fine work, where the dark colour of the glue might show at the joints, French glue is preferable, because of its lighter colour. The very best glue for strength, and the most economical in the end, is a mixture of about equal parts of Scotch and French.

Nails.—There is a very great number of kinds of nails—about 300—and only a few can possibly be described here—indeed, it would be beyond the compass and object of this work to endeavour to do more. Briefly, all nails are made to break through the fibres of wood, and are held tightly by the elastic fibres, which, endeavouring to regain their original position, press tightly on the wedge-shaped nail. The tops of nails are variously flattened out into heads, which assist very much in holding them in position, especially if there is any pulling strain at the opposite ends.

The nails recommended for the manual training room, and which will be necessary for constructing the models in the Course, are the following :—

Cut Clasp Nails (fig. 29).—These nails are cut by machinery from a rolled sheet of iron. The head is not very large, and when driven home with the hammer, the slightly projecting top of the head is driven just below the surface of the wood with the hammer and punch. These are typical of a large class of old-fashioned nails, which are, however, gradually being beaten in the market by the newer serrated steel brads.

A similar nail is the *Wrought Clasp Nail* (fig. 30). This nail is very strong, and the shape of the head gives it a better hold than that of the cut clasp nail. Owing to its fibrous nature it is much



FIG. 29.

used where it is required to clench a nail by bending the projecting point on the reverse side of the piece of work.

For the light work of the exercises of a manual training room the best kind is the *Oval Steel Brad* (fig. 31).

This nail, it will be seen, has slight shallow cannelures round it, near the head. These assist greatly in holding the nail in, and the flat head does not project so much as in the cut nails. The sharp points and oval shape of these nails make them very

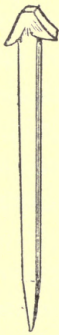

FIG. 30.

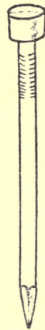

FIG. 31.

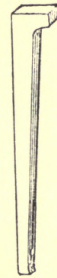

FIG. 32.

handy, as they rarely split the wood, and when boring has to be resorted to, a very small hole is necessary.

The *Joiners' Cut Brad* (fig. 32) is used where the strain is not great, and as they are required for this purpose, the head only projects on one side. They do not make such large holes as cut nails, and, owing to the very slight bend at the point, they are liable to gradually draw from an upright to a sloping position as they are driven in.

The holes for these nails should, therefore, be bored in a

slightly inclined direction, so that the pulling of the bent points will finally bring them upright.

French Nails (fig. 33).—These nails are made of round wire, pointed, and with a large round flat head which projects rather considerably. They are not punched in, but allowed to lie flat on the surface of the wood. These nails, like the steel brads, are very strong and tenacious, but the heads are unsightly, and their use is usually confined to rough, strong work, like packing-case making.

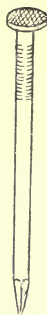

FIG. 33.



FIG. 34.

Screws of various kinds are used for very many purposes. They are much too numerous to be touched upon here in detail, except the usual flat and round-headed wood screws—the only kinds required for a woodwork manual training room.

Though the general appearance of screws is familiar, the great assistance of the tapering spiral point in making a first entry into the wood may not be fully realised till compared with the old-fashioned screw, which was blunt, and required great effort to make it enter.

It will be noticed (fig. 34) that the screw is only cut into a 'thread' for about two-thirds its length, as this is all that is really requisite. Further threading would only weaken the lateral strength of the screw.

Round-headed Screws are useful for ornamental purposes, and are usually made of brass. They are used in exposed parts of fine work, where the flat head of the iron screw would mar the appearance of the article.



Torres
Feb 11 1957

CHAPTER IV

TOOLS

THE varieties and scope of the tools to be used in manual instruction have been generally described in the introductory chapter, but there are still the important questions of the pattern and quality, as well as the demonstration of the mechanical principles of their construction. Every tool should be quite as large as it is possible for the operator, whether boy or man, to conveniently use, but it is only in the case of large tools, or those requiring great effort, that any modification in size becomes really necessary to suit children.

The tools recommended are accordingly, usually about full size, or the smaller of the ordinary trade sizes used by men, except in the case of saws and planes. The ordinary workman's pattern of these tools is decidedly too large, and special patterns are very advisable, if not quite indispensable. The question of the quality to be obtained can be disposed of in a sentence. The best tools only are advisable, for it is particularly true of tools, that real economy will be found in the best articles.

In describing the individual tools, such as are not necessary have been excluded; and though special circumstances might arise in some cases which would call for the use of other tools, the frequent occurrence of such cases is not contemplated. In the case of some of the very simple and elementary tools, a

certain knowledge by the reader has been pre-supposed, which, aided by illustrations and brief description, it is hoped will suffice; but where the more important and complex tools are concerned, the principle of their construction has been entered into at some length, in order that a teacher may be able to rationally explain them to children. Though perhaps apparently simple, the reason for the peculiar construction of particular tools is a matter which is not always properly grasped even by men whose business it is to handle them, and it is important that the teacher should fully understand—and equally important that he should impart—a proper knowledge of the general principles of the construction of such tools.

MARKING AND GUIDING TOOLS

The **Marking Gauge** is a tool or instrument used to make lines or scratches parallel to one side or edge of a piece of wood. Gauges vary in the details of their construction, but the pattern

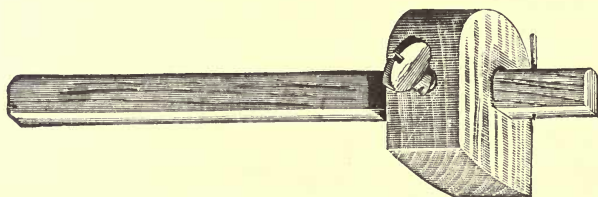

FIG. 35.

given in the illustration (fig. 35) is the best, and the one generally adopted in England.

The gauge consists of two pieces of wood, the stem and the stock, with a thumb-screw in the side of the latter, which, when

tightened, holds the stock firmly in any desired position on the stem. The spur, or tooth, is a piece of steel pointed at one end, and which passes through the stem near the end of it. It will be seen that one side of the spur is sharpened flat and the other side rounded, as in fig. 36. The round side of the spur is the nearer to the stock when in use. The reason of this is obvious. As the tool is used by pushing it away from the operator, while the tooth makes a cutting scratch on the surface of the wood, the shape of the tooth causes it to keep the stock well up to the edge of the wood. If the tooth were placed with the flat side towards the stock there would be a continual tendency in using to draw towards the edge of the wood, constant effort would have to be made to keep the stock pressed against the edge, with the result that irregular scratches, instead of a clean cut, would be made.



FIG. 36.

A good gauge may be known by the cleanness of the mortice through the stock, the straightness of the stem, and the quality of the boxwood screw. The beech stock and stem should make a good fit.

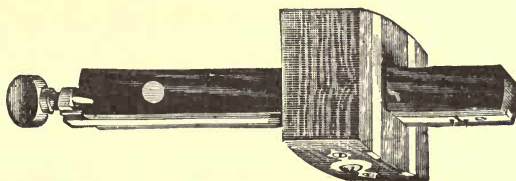

FIG. 37.

Mortice Gauge (fig. 37).—This tool is for marking two cut lines parallel to the edge of a piece of wood, usually to indicate

the limits of a mortice or slot which is to be cut in the wood. It is similar in principle to the marking gauge, but two spurs or teeth are provided, and in order to obtain the power of regulating the distance of the two cut lines from each other, one tooth is fixed into the stem, while the other is bedded in a strip of brass which slides up and down the stem, obedient to the governing screw in the end. The points of the teeth are made to cut on both edges, and are rounded somewhat on both sides. There being two teeth, the liability to run out of the straight line is not very great.

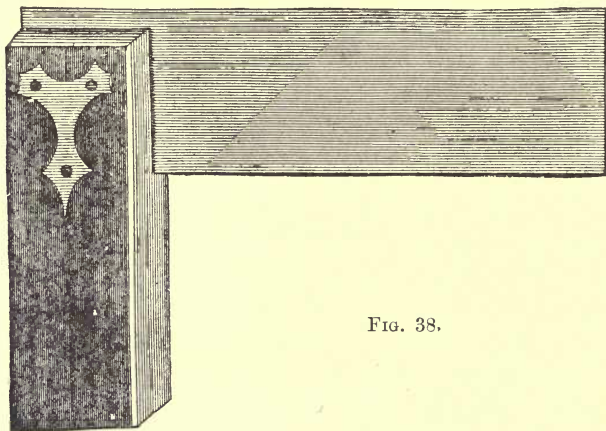

FIG. 38.

Try-Square (fig. 38).—So called because it is intended to test the accuracy of work; it is, in fact, used for a variety of purposes. The construction only of the tool will be described here. It consists of a thin blade of steel with parallel edges, fitted and riveted in, and at right angles to the stock. This is generally a piece of rosewood or ebony, shorter than the blade.

The stock of a good square generally has a piece of brass

fitted on the inside edge to prevent, as far as possible, inaccuracies arising from wear. The rivets should be placed as in the illustration. Sometimes both blade and stock are made of wood, and when long-bladed squares are required, they are, of course, appreciably lighter than iron ones, though not so reliable. Squares are also made with steel blades, and cast or wrought iron stocks, but these are almost solely used by metal-workers.

The vital point in the construction of a square is the right

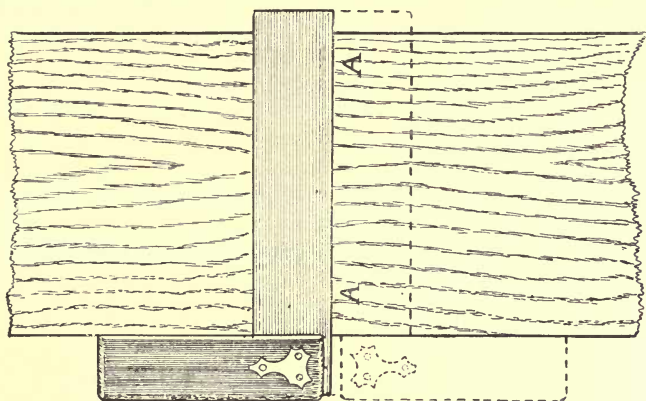

FIG. 39.

angle between the stock and blade. To test the accuracy of this all-important angle, take a piece of wood with the face trued up, or planed level, and the edge perfectly straight.

Place the stock of the square against the edge with the blade flat on the surface of the wood.

Mark a cut line along the edge of the blade *AA*, fig. 39. Reverse the square—*i.e.*, place the other side of the blade against the line already cut, with the stock against the same side of the

wood, and if the edge of the square coincides with the cut line, *AA*, then the square is true.

The reason is clear, for the angles contained by the cut line and the edge of the wood have just been demonstrated to be equal, and the second straight line falling upon the first straight line, and making equal angles with the edge of the wood, make the two angles right angles.

Should the square prove incorrect, the amount of the error is at once detected, and, if not too great, can be filed true. A great thing to look for in a square is the quality of the riveting, and this is of the utmost importance.

Squares vary greatly in size, which is always reckoned by the length in inches of the blade.

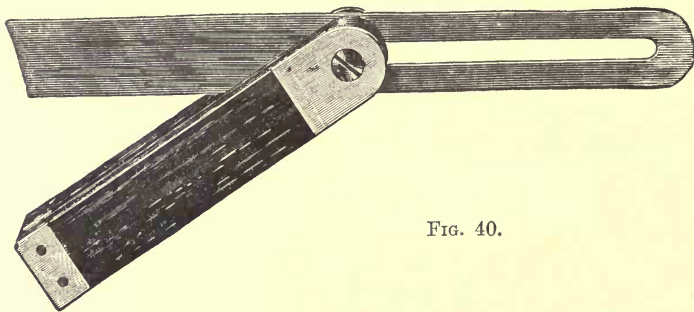

FIG. 40.

The Bevel (fig. 40) consists of a stock and blade held together by a screw pin.

The stock is made of some hard wood—rosewood or ebony—with brass mountings at each end.

The blade is made of a parallel plate of steel, with a slot to allow it to move up and down on the screw-pin at the end of the stock which passes through this slot.

The slot in the stock permits the blade to be pivoted completely round on the screw-pin, and, as it can be tightened in any position, any angle can be made between it and the stock.

In selecting this tool, be careful to see that the edges of the blade are straight and parallel, and that the screw of the stock, when tightened, grips the blade without bending it.

Compass (fig. 41).—The pattern in this illustration is the kind in common use. It is provided with a wing, which passes through a slot in the opposite leg when shut up.

The screw is useful to tighten up the legs at a particular set, as in marking curves on the surface of wood there would be a great liability for the drawing leg to open by being drawn from its course by the fibrous nature of the material.

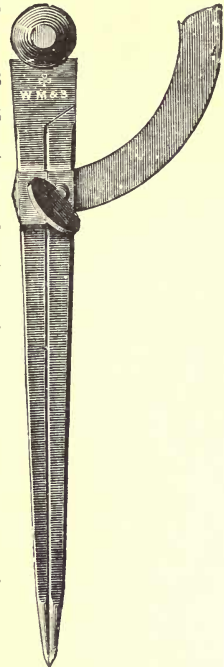

FIG. 41.

PARING TOOLS

Chisels and Gouges.—The chisel consists of two parts—the handle and the blade.

The handle is generally made of beech, but sometimes of ash, and, in some of the light carving tools, of box. It is made in different shapes, according to the kind of work for which the tool is wanted.

The chief variation is in thickness. Some handles are severely treated in doing heavy work, and must be able to resist

heavy blows with the mallet. They are accordingly stout and strong, but lighter chisels have correspondingly light handles.

The shape of the blade is also governed by the work for which the chisel is intended. Carving chisels and gouges have thin blades, inasmuch as they are required to pare or remove the wood gradually, in thin chips or shavings, and no great strength is required.

On the other hand, mortice chisels, which receive heavy blows, and must withstand great shocks and cross strain, have stiff, stout blades.

The principle of the cutting portion of chisels and gouges is alike. The face, or the under side of the chisel, when in use, is straight to the edge, but the back is cut off at the top, making the cutting angle.

This angle is small in carving gouges and light chisels, but, in chisels for heavier work and to cut harder wood, the angle is greater.

The tangs of chisels and gouges should be four-sided, with shoulders to take the wooden handle. The angles of the tang prevent the blade from turning under a twisting strain, and the shoulder prevents the handle splitting from a blow.

The Firmer Chisel (fig. 42).—The blade of this chisel is flat, the face being perfectly true, from $\frac{1}{16}$ in. to 2 ins. wide, and from 5 ins. to 8 ins. in length.

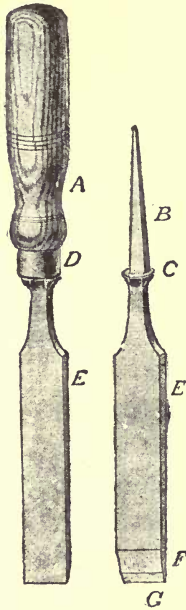

FIG. 42.—A, handle; B, tang; C, shoulder; D, ferrule; E, blade; F, grinding angle; G, cutting angle.

Very long chisels of this kind are called paring chisels.

The blade of the chisel is thin near the cutting end, and slightly stouter as it approaches the shoulder.

In the smaller sizes, $\frac{1}{16}$ in. to $\frac{1}{4}$ in., the thickness from back to front is greater to make up for the stability lost in width.

The grinding angle should be 25° , and the cutting angle 35° .

If the tool is to be used in cutting very hard wood, the angle should be slightly increased, to prevent the risk of breaking the edge under heavy blows. As soon as the cutting angle becomes too great by frequent sharpening, the chisel should be reground.

Firmer Gouge (fig. 43).—The blade of the gouge is concave, but otherwise its characteristics are the same as those of the chisel. This form of gouge is ground on the convex surface.

Scribing Gouge (fig. 44) is a little thinner in the blade than the firmer gouge, and is ground on the inside.

Mortice Chisel (fig. 45).—This tool is not much used in the present course.

It is for cutting mortices or slots through the thickness of a piece of wood, and as it is continually subjected, when in use, to heavy blows from a mallet, it is very strongly made, both in blade and handle.

The handle is sometimes bound round the bottom with copper

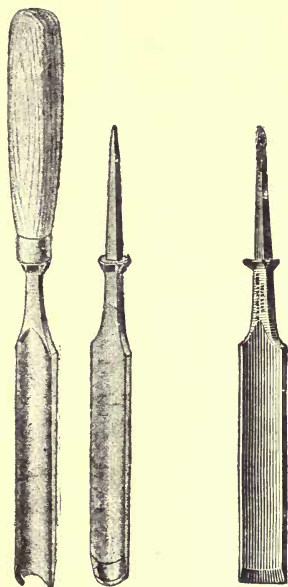

FIG. 43.

FIG. 44

wire, and the shoulder of the blade bedded on leather to prevent splitting.

Stiff Bent Gouge.—This tool is used to cut out curved depressions in the surface of the wood; it is made in various sizes and with different curves. One or two kinds will probably be found sufficient.

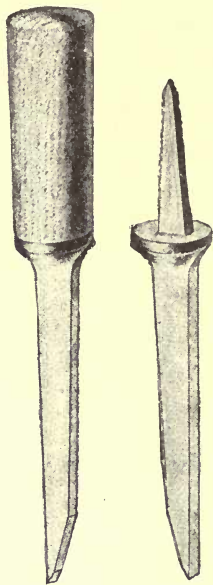

FIG. 45.

Planes.—Planes are used chiefly for reducing broad and long surfaces to perfectly smooth, flat, or curved forms, as may be required, or for making continuous grooves and mouldings of a more or less complicated nature with or across the grain, and in straight or curved directions.

When a small piece of wood is to be removed to reduce the surface to any desired level, a chisel or gouge will fulfil the purpose, but when the surface is large, it is clear that the larger and more regular the thickness of the piece of wood removed at each cut, the more easily will the task be performed by the pupil. The plane fulfils this requirement. A wide blade, practically similar to a chisel blade, is fitted into a block of wood in such a manner that its cutting edge just appears through the perfectly true surface of the face or sole of the block, at such an angle as will allow it to cut the timber to be made true in its course over the surface. When the blade is well pressed down it will thus cut just as much of the wood off, as the depth of the blade showing through the sole; and inasmuch as the block of the plane regulates the depth of the cut made by the blade, so it will enable

the blade to take more effect on portions of the objective timber which are in relief than on parts which may be depressed. Fig. 46 gives an exaggerated case of uneven wood being acted on by the plane. It is natural that in order to facilitate this reduction of the more prominent irregularities first, a long plane is more reliable than a short one, and this is the reason that jack planes and trying planes have long bodies. Though these planes are useful in reducing timber to a good level surface, absolute smoothness is impossible, for the cut of a plane-iron makes a long trough-like, though very shallow, groove. The

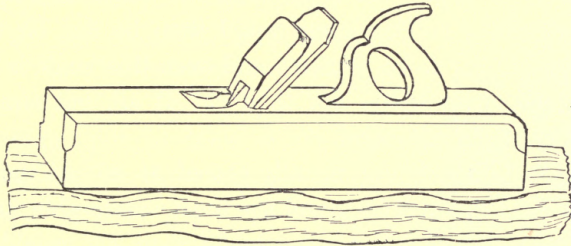

FIG. 46.

fibres, too, in the motion of the plane become somewhat broken, and cause slight roughness in places.

So long, then, as the physical power of the operator is not overtaxed, the wider the plane-iron for flat work the better, as it will leave fewer ridges and shallower grooves. Short planes, because they can be pressed down so much closer to the surface of the wood than long ones, are useful in overcoming the slight roughness left from the long trying, and jack planes, but by reason of their tendency to plane the wood hollow in the length, they should only be used sparingly.

The angle at which a plane-iron should be sharpened is, in nearly every case, 35° , the face being flat and the back sloping.

If the edge is thicker it will not cut satisfactorily, and too much force will be necessary. If it is less than 35° , it is apt to break or turn on encountering a hard substance like a knot. In all the planes *necessary* to the course of manual training in this book, the iron is placed in the block with the back towards the wood. The angle of inclination of the iron to the sole of the plane is regulated by the degree of density of the timber to be planed.

It is obvious that a less angle than 35° would be impossible, as the back of the cutting angle would then be flat on the surface of the timber to be planed; and even this angle is impracticable, as the iron would not then cut at all, but simply slip over the surface of the wood.

The iron is, therefore, usually placed at 45° to the sole of the plane, and this will be found the most serviceable angle, for experience teaches that a greater angle than 45° would, except under special and rarely obtained conditions, cause the iron to become more scraping than cutting in its action, leaving the surface rougher than is the case when placed at the usual angle.

In planing there is at all times a tendency for the wood to split in front of the cut being made, because of the lifting of the fibres split by the action of the iron as the plane progresses. If allowed to proceed unchecked, this would have the effect of causing irregularities in front of, and slightly below, the plane in which the edge of the blade is cutting.

This is especially the case when planing against the grain, *i.e.*, when the fibres dip into the wood away from the operator.

The sketch (fig. 47) shows clearly the natural splitting action,

and what would be the result of using a single iron when planing against the grain. The cap-iron is intended to prevent

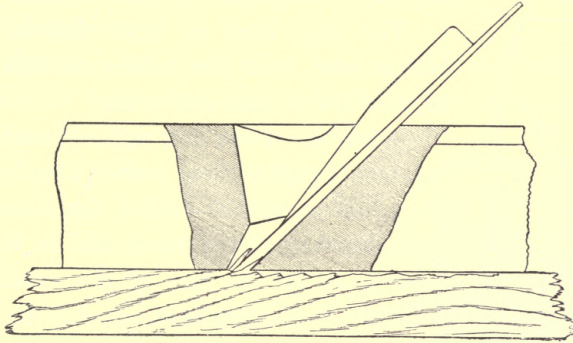

FIG. 47.—Section of plane fitted with single iron, and showing the tearing of fibres.

this running split in front of the edge, and by snapping the fibres and sharply diverting the course of the shaving immediately it begins to run up the face of the cutting iron, it prevents the tendency to splitting from becoming serious, and

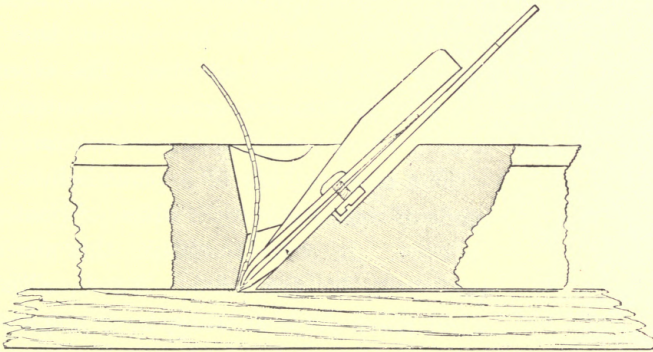

FIG. 48.—Section of plane fitted with double iron, showing breaking action of cap-iron on the fibres.

diately it begins to run up the face of the cutting iron, it prevents the tendency to splitting from becoming serious, and

causing any marked obstruction in the path of the plane. Fig. 48 shows the action of the cap-iron, and fig. 49 the method of securing the cutting and cap irons to each other.

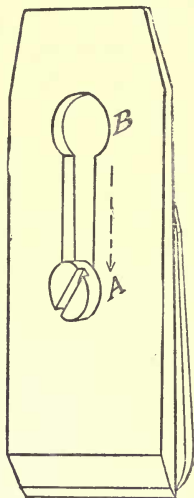

FIG. 49.— The screw A can be passed through the slot at B, and moved down in the direction of the arrow, as may be required.



FIG. 50.

The cap-iron is bent slightly at the bottom end, and the inside at this end is finished off smooth and true.

When the irons are well screwed up, the cap-iron is slightly bent inwards by the pulling of the screw, with the effect that the smooth inner surface of the lower end is kept very hard down on the face of the cutting iron, preventing shavings from running up between the two irons. This must on no account happen.

The edge of a plane-iron is not straight, but slightly curved from end to end, as in fig. 50, in which, however, the curve is much exaggerated. It will be noticed that the corners are rounded off also. The object of this is to prevent the corners from cutting and making sharp marginal edges down each cut.

The block or body of a plane is invariably made of some hard wood, which will not warp or twist. In order to ensure this desirable quality it is desiccated. Beech, although when green liable to warp, is, if prepared by being subjected to steam, the most suitable wood from which to make the bodies of planes.

The brown and red varieties are the most reliable, and the very best, clear, straight-grained pieces are used.

The annual ring should be nearly parallel to the face, and the silver grain at right angles to it, or as nearly so as possible.

Fig. 51 shows the end section of a plane with medullary ray and annual ring.

The shrinkage of the timber, which, to some extent, must occur even in seasoned wood, it must be remembered, always takes place to a greater extent across the silver grain than parallel to it, so that the sides, *A B*, will contract, while the top, *C*, and the sole, *D*, will be much less affected.

The selection of the outside of the tree will assist to lessen the contraction, as the angle of inclination of the medullary rays is not so apparent as further in towards the heart. Although the outside of the tree should be chosen, no sap-wood should be taken.

Of course the very best seasoned bodies may occasionally get untrue on the sole from shrinkage as well as from wear.

They must then be re-shot and be well rubbed with linseed oil to prevent fresh shrinkage.

The escapement of the plane is a V-shaped mortice, with one nearly upright side towards the front of the plane, and the other sloping at 45° to the face.

In this is cut another shallow mortice, to hold the head of the screw of the cap-iron, and allow the cutting iron to lie flat on the back portion of the escapement.

The sides of the mortice, as will be seen in fig. 52, are nearly upright, a diminishing slot in both sides at the back giving a shoulder to hold the wedge in. The wedge is the means of hold-

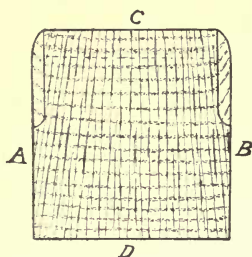

FIG. 51.

ing the iron tightly in its place. It varies in shape in different planes, but that given in fig. 53 is the general form of the wedge of the jack, trying, and smoothing planes. The points should be kept sharp, to prevent shavings from catching between them and the iron.

At the bottom of the mortice is the narrow mouth, which runs nearly across the face of the plane. The length and

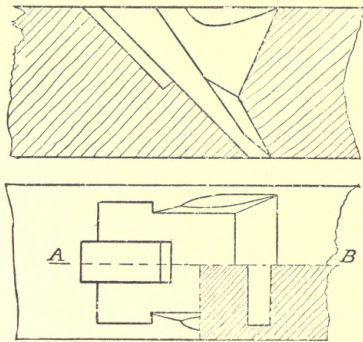

FIG. 52.—Plan and sectional elevation of the escapement of a plane. The elevation is on A B, and the plan shows in one portion the position of the mouth.

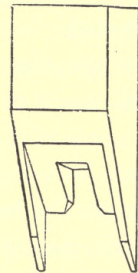

FIG. 53.

breadth of this opening vary in different planes, but, generally speaking, the narrower the mouth the more accurate will be the work performed, as the sole of the plane under pressure holds the wood down and prevents the splitting before mentioned, and the closer the face of the plane is to the edge of the iron, the more effectually is this done. In short, when the iron is in its place, ready for use, only sufficient room should be left for the shaving to pass through.

When a plane is re-shot, *i.e.*, planed true on the face after warping or wearing, the mouth necessarily becomes wider, and if the operation of re-shooting is repeated several times, the plane must be re-mouthed. To do this a piece of boxwood or beech, of the shape shown in fig. 54, is let into the face, but it is advisable to leave such a task to a tool-maker unless the teacher is very skilful.

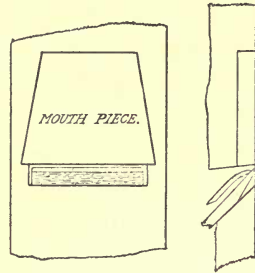

FIG. 54.—Plan and section of re-mouthed plane.

These general characteristics of planes do not apply of course to those intended for special and peculiar purposes, like the moulding plane, rebate plane, bull nose, plough, chariot, fillister, and others. These planes, though made on the same principles as those used in this course, are required only by workmen. As they are not necessary for manual instruction, this work has not been burdened with a description of their details.

The great point of difference between them and the kinds here required, however, is in the bull nose, chariot, and shoulder plane, and consists in the turning over of the iron, so that the face is downwards when in use, and in these no cap-iron is used.

The iron in these planes is placed at a very acute angle to the face, only 15° to 20° . This would be impossible if the back of the iron were down, remembering that though the iron in these planes have a somewhat finer cutting angle, it is still 30° . The cap-iron is not required, because the mouth is so narrow that splitting is practically impossible. In these special planes the mouth is sometimes $\frac{1}{16}$ of an inch in breadth, or even less.

The **Jack Plane** (fig. 55) is used for the first dressing of timber, but with care it can become the instrument for finer work also, especially if the wood operated on be originally fairly even in surface, and the iron very sharp.

The body of the plane is usually about $16\frac{1}{4}$ ins. long, 3 ins. wide across the face, and $3\frac{1}{4}$ ins. deep. The iron is $2\frac{1}{4}$ ins. wide.

The mouth of the plane is about $5\frac{1}{2}$ ins. back from the front end of the block, and is about $\frac{1}{8}$ of an inch wider than the

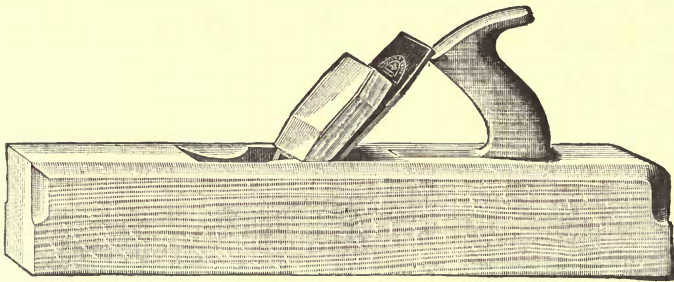

FIG. 55.

iron that fits it, making $2\frac{5}{16}$ of an inch. This leaves $\frac{1}{3}\frac{1}{2}$ of an inch on each side of the mouth for the sides of the escapement.

The illustrations show the general shape of a jack plane.

The handle, or toat, should be mortised into the body well forward near the back of the iron, in order that the downward pressure of the right hand that holds it may be nearer to the cutting portion of the plane, and therefore have more power. It will be found, too, that if the handle is set further back in the block, the back portion of the hand cannot lie comfortably on the top of the plane. The bent form of the handle is useful for either pressing downwards and forwards, or for lifting the plane, which is often necessary to cut or break a shaving. The projec-

tion at the top of the handle is also of much assistance in this lifting of the plane.

The cap-iron is never set back from the edge of the cutting iron more than $\frac{1}{8}$ to $\frac{1}{8}$ of an inch, and this latter is never allowed to project more than $\frac{1}{8}$ of an inch from the face.

Jack planes for boys should be slightly smaller than those for men; the dimensions are 16 ins. long by $2\frac{3}{4}$ ins. wide, with a 2-in. iron.

Trying Plane (fig. 56).—This plane is longer and larger than the jack plane, and with a somewhat wider iron. It is used to

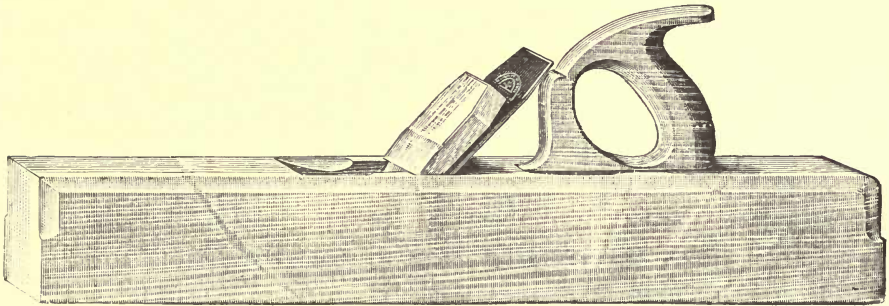

FIG. 56.

finish the surfaces of timber which are required to be very true and straight, after the jack plane has reduced them to a fairly level surface.

The jack plane in doing this would be used with the iron 'set coarse,' and would be correspondingly rapid in its action, but could not be expected to finish smooth, and, not being so long, would not produce such a straight surface as the trying plane.

The iron of this plane, as it is required for fine work, should never be set out more than $\frac{1}{32}$ of an inch, and usually much less. The cap-iron should be set equally fine.

The dimensions of the ordinary trying plane are $22\frac{1}{2}$ ins. long, $3\frac{1}{2}$ ins. across the face, $3\frac{1}{4}$ ins. deep, with $2\frac{1}{2}$ -in. iron. For boys, the dimensions should be reduced to 20 ins. long, 3 ins. across the face, $3\frac{1}{4}$ ins. deep, with $2\frac{1}{4}$ -in. iron.

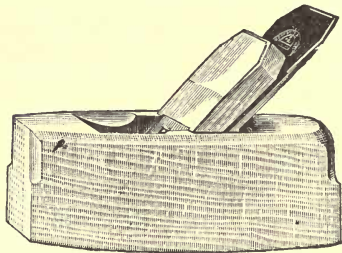

FIG. 57.

Smoothing Plane (fig. 57).—In case the surface of a piece of wood should not be smooth enough, even after the jack plane and trying plane have been used, the smoothing plane is resorted to.

In very fine work it is always necessary to use the smoothing plane to finish, for it is not possible to press down the longer jack and trying planes sufficiently tight to get smooth surfaces. They are, moreover, not so finely set, and have not such narrow mouths as the smoothing plane.

The latter, which is only $7\frac{1}{2}$ ins. to 8 ins. long, with $2\frac{1}{4}$ -in. to $2\frac{1}{2}$ -in. iron, can be pressed down, as might be imagined, much closer to the wood, the force not being spread over such a large area as in the larger planes. The sides of this plane are curved to assist in holding it. This is the more useful and essential, as there is no handle on top to hold.

The irons, wedge, and escapement are the same in principle as in the larger planes, but the iron is set invariably as finely as possible, with the cap very close to the edge, the shaving to be produced being as fine as silk.

Sometimes, to get additional accuracy and weight, smoothing planes are made with iron faces, and even wholly in iron. These faces are in two forms.

In one, the whole of the face consists of one plate, which is screwed on, the screws being countersunk, and the holes filled up level with the plate by running in molten metal.

In the other, only the portion in front of the mouth is of iron, and in this case it is held in position by a screw passing through the top, as in fig. 58.

There is a slot in the back of the iron face, as shown, which takes the flat end of the screw, and permits of the position of the

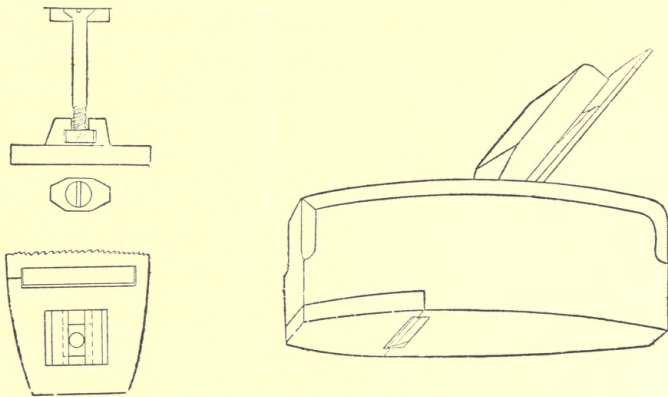

FIG. 58.—Showing an iron-faced smoothing plane, with elevation of screw bolt, plan of head and cap, and plan of iron face.

iron being altered when it becomes necessary, by the unequal wearing of the iron and wooden portions of the face.

These planes are particularly useful in finishing up the surface of hard woods, and one should be found in every manual training class room.

Boys should use slightly smaller planes than men, the dimensions recommended being $6\frac{1}{2}$ ins. to $6\frac{3}{4}$ ins. long, with 2-in. iron.

The Rebate Plane (fig. 59).—This plane is used for cutting rebates or steps on the edge of a piece of wood, or grooves in the wood at a distance from either edge.

It varies in width from $\frac{1}{2}$ in. to 2 ins., but that used in this course is $1\frac{1}{4}$ in., and this size, or a little narrower, will be found the handiest.

The great peculiarity of this plane is that it is skew-mouthed, *i.e.*, the iron is set obliquely in the plane as shown. The cutting

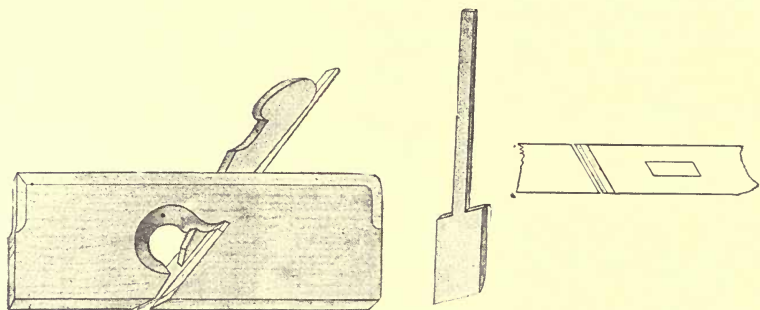

FIG. 59.—Shows the general appearance of a rebate plane, the shape of the iron, and the plan of the mouth, with the hole for wedge and iron.

of the iron has consequently a shearing action, which obviates the risk of splitting the timber in the direction of the fibres.

The angle of the edge of the iron to the side of the plane is usually 75° to 80° , and the more the iron is skewed the cleaner it cuts. The angle should not, however, be less than 75° .

The reason the larger planes are not constructed on these lines is, that it would be impossible to use them on an open surface with a straight stroke, as the large iron would, if placed obliquely in the plane, cause it to swerve in its forward course.

The risk of splitting the timber being avoided by the placing

of the iron, the necessity of the cap-iron vanishes, and it is accordingly never seen in this plane. As the rebate plane is to make rebates or grooves which will be regulated partly by the straightness of the side of the plane, the iron must cut on the corners, and the corner of the iron must of course coincide with the angle of the sides and face of the plane, or rather project out from the side very slightly, in order to make sure of its cutting well up to the side of the desired rebate.

As the entire width of the plane is taken up at the bottom by the iron, the latter is made much narrower at the top, to leave substance for the 'cheeks' of the plane.

The iron, shaped as in fig. 59, is placed in from the bottom and the wedge is driven in from the top.

The escapement of this plane, like the set of the iron, is peculiar. The front side makes a very small angle, about 5° , with the cutting edge of the iron. This assists in breaking the shaving, and in a measure replaces the cap-iron.

The escapement terminates in a semicircular hole which is larger on one side than the other, enabling the curly shavings to continually work out to the side of the plane.

Beading planes, hollows, rounds, moulding planes, and many fillisters are constructed on the same principles as the rebate plane.

The Spokeshave (fig. 60) is another form of plane used for modelling curved surfaces and edges.

The most common kind in England has a wooden stock of beech or box-wood, formed into a handle at each end. The face or sole is curved from back to front, and generally straight from end to end.

It is narrow, in order that it may pass over the curve with greater ease, and also, in cutting a concave curve, to assist in the formation of a regular surface.

The tool is made in all sizes, and the curve of the sole varies greatly, in order that they may be suited to many forms of curves. The ends of the blade are turned over, as in fig. 61,

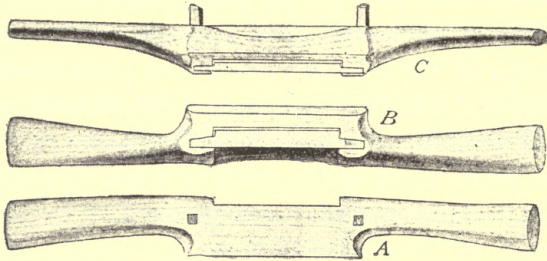

FIG. 60.—A shows the ends of the tangs of the blade; B, the sole and blade; and C, the side elevation.

and finish in two square tangs, which pass through the stock, as shown in fig. 60.

The tangs hold securely, the ends showing through on the top of the tool, but a blow on the end of either tang will drive the blade further from the sole. The space between the sole and

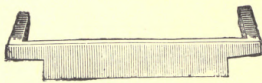

FIG. 61.

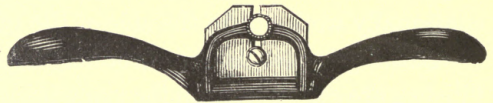

FIG. 62.

the blade may be regulated in this way, and as a consequence the thickness of the shaving also.

The cutting angle of the blade should be 10° to 15° . The blade diminishes from the back to the cutting edge.

Some spokeshaves of American pattern are made with a cast-iron stock and steel blade (fig. 62), and some have double irons, like planes.

The blade in this pattern is held in place by a thumb-screw. These spokeshaves are useful, but, like all cast-iron tools, are very apt to break if dropped on a hard substance. The wooden spokeshave is recommended as being better and cheaper, and more suitable for a boy.

The Router (fig. 63).—This tool, frequently improvised, is used for many purposes, and is accordingly made with every kind of

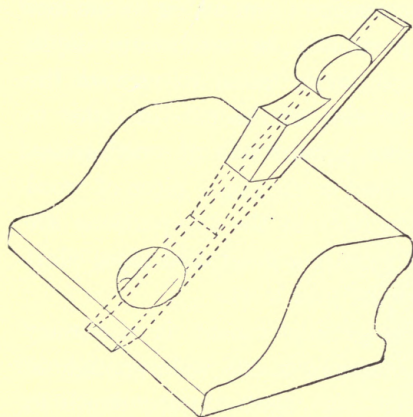

FIG. 63.

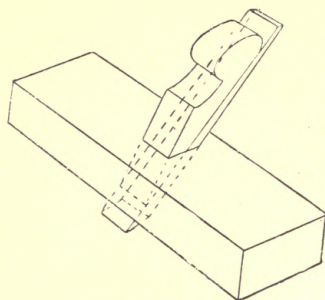

FIG. 64.

blade. The particular router illustrated in fig. 63 is intended to reduce depressed portions of work to a level surface.

The router is akin to the planes in principle: a stout single iron (usually a piece of a broken chisel) is placed in a mortice through a block of wood, and, projecting as it does some distance beyond the sole, it scrapes as it were a fairly level surface in a place which is inaccessible to a plane.

Another form of router, which is very easily made, is shown in fig. 64.



RASPING TOOLS

Saws.—Saws are used to cut timber both across and with the grain, with the smallest possible amount of waste and the greatest economy of power.

A simple cutting edge, like an axe or a chisel, can only be used across the grain with great exertion ; and owing to the fact that these tools cannot, by any possibility, be used at any depth below the surface, without steps being taken to remove the damaged and bent fibres on each side of the cut, in order to make a fresh attack on the timber, great waste of wood arises. Even when, by the agency of a chisel or an axe, a piece of wood is separated across the grain, the ends of the two portions are not by any means level, and will require a great deal more effort and some waste, to render them true and level.

It is clear, therefore, that some instrument is necessary which will make at the commencement a cut wide enough to admit the entire blade, and which can operate at any depth in this cut. The saw fulfils this requirement. A succession of teeth are cut out of the smooth edge of a plate of steel, and, when rubbed across the wood, cut or break the fibres in contact with them, somewhat in the same manner as a file. The waste timber is, of course, pushed along by the succession of teeth, and the small particles of wood are carried out at each end of the cut at every stroke, the saw gradually sinking into the wood in the direction of the planes of its surfaces. The guiding of the tool, in order to ensure a true cut, which is straight in its length, and leaves an even surface on each side when the cut is finished, is clearly an important point, and stability and weight in the

saw are also requisite. To meet these requirements saws intended to cut large pieces of timber are long and deep. This evenness of the surface of a saw is so important that the slightest 'buckle' is a serious defect, and if badly crippled in this way the tool is useless, the saw always being liable to double up in use, and never cutting freely.

Each tooth is subject to great strain in its forward movement, the degree of the resisting pressure varying with the density of the material to be cut, the amount of pressure used in sawing, and the speed of the movement.

Now it is clear that the front edge of the saw-tooth, if inclined towards the front of the saw, as in fig. 65, will cut faster



FIG. 65.



FIG. 66.

than if upright; but these teeth have a weaker base than those with a less acute angle, as in fig. 66, and are, therefore, more liable to break. Moreover, teeth of this kind have a constant tendency in use to sink into the material, clogging the spaces between the teeth with the destroyed fibres of the timber. On the other hand, saws which have teeth like those in fig. 66 are apt to rise out of the wood, and require constant downward pressure to make them cut.

On the whole the teeth of all saws for use in cutting with the grain will be found to work best if the front edges are nearly upright, and the backs are inclined to the surface of the timber at a rather smaller angle, as in fig. 67. For sawing hard woods and across the grain, the front edge is still more inclined. The

angle of inclination of the back of the teeth is regulated by the degree of stability requisite for them, and by the amount of space necessary between each tooth for the accumulation of the sawdust.



FIG. 67.

Thus in the ripping saw the teeth are usually like those in fig. 70, for, as this saw cuts faster than any other woodworking saw used by hand, the amount of sawdust made is commensurately greater. In this case, too, the resistance being generally slight, teeth are not wanted so close together as in saws intended for other purposes, where the strain is much greater. Another important characteristic which will be noticed in examining any saw is the lateral bending of each tooth. It will be observed that they alternately project to the right and left, giving a double line of cutting points.

This 'set' to the teeth makes the path of the cut slightly wider than the thickness of the saw, and enables the blade to slide freely, minimising the friction and heat of the sawing. Indeed, if the teeth were not 'set' at all, the resin and other substances in the timber, and the natural pressure of the rough ends of the bent fibres, in their attempt to regain their original position, would, after very little progress had been made, cause an almost complete stoppage in the sawing. There would be great risk of buckling the saw, too, when this difficulty arose.

The wider space obtained by the setting of the teeth for the clearing of the sawdust is another important reason for bending the teeth slightly. The amount of 'set' should not be too great, as the work is unnecessarily increased, and the tendency to deviation from the direct course of the sawing would be greater. Proceeding with the examination of the teeth of the saw, it will be

noticed that the front of each tooth is sharpened like a chisel on the outside edge, and the inner corner of the point is thus removed.

Fig. 68 shows the shape of this sharpened tooth, and also the 'set' usually given. In actual sharpening, the file also removes a small portion of the back edge of the preceding tooth. This is not requisite but is unavoidable, and only has the effect of assisting to make the points of the teeth.



FIG. 68.

Now the points of the teeth serve to help the saw in entering the wood, and the points and chisel-like front edges are almost essential to the cutting of the teeth in the forward stroke.

The angle at which this front edge should be sharpened varies, but all saws, even for the hardest woods and to overcome the greatest resistance, should have this chisel edge. It may be taken generally, however, that for soft woods, and with the grain where the saw would cause much sawdust, which must be pushed out by the teeth, the angle may be less acute than for harder woods and across the grain, where fine-edged teeth are required.

Saws are made of many shapes to fulfil particular conditions; and neither makers nor workmen are at all agreed as to the particular shape, set, or sharpening of the teeth; but all thrust-saws for use by hand have some common characteristics.

The hole for the hand should be of such a shape as will easily admit all the fingers, and allow them to grasp the handle well and easily.

The handle should be fastened to the blade at such an angle that a line drawn from the point of the front cutting tooth

through the middle of the handle will cross the hole for the fingers at right angles. When held in the hand a saw should be balanced in any position, except that which it is held in when at work. In this position a much heavier weight will appear to depend from the handle, and this it is always desirable to obtain.

The riveting of the handle to the blade is a point of great importance.

The handle must be parallel to the plane of the saw edge, and the riveting must be very secure, as if it is at all loose, the defect will rapidly become much worse and spoil the saw as an effective tool.

If the blade is made to quiver, defective riveting may be discovered by a slight jarring sound coming from it. A good saw will give out a clear, full sound if the blade is bent and then suddenly released. The blades of all saws should be thin and of a dark colour. These dark-coloured saws are usually found to be well tempered, as are also those with a greasy appearance on the surfaces of the blade.

Thick saws are generally too soft, and though it is difficult to ascertain before purchase, too highly-tempered saws will not be found the best, as the points of the teeth are liable to break off on encountering any hard substance.

A very common test of the temper of a saw, however, is to bend it at least a foot from its natural position, but this is by no means reliable, and is harmful to the saw.

Rip Saw (fig. 69).—This saw is used almost exclusively for sawing with the grain, for which purpose it is specially intended.

The blade should be 26 ins. long, and the back and cutting edges should taper somewhat; the amount varies, but the more

the blade tapers the better, provided the saw possesses the other more important qualifications already described.

Weight is a good thing in a rip saw, but the blade should not be thick.

The teeth of this saw should be as in fig. 70. There are generally about three and a half to four teeth per inch, and the throats are deep, to allow of the accumulation of waste fibres.

It is not often that boys are strong

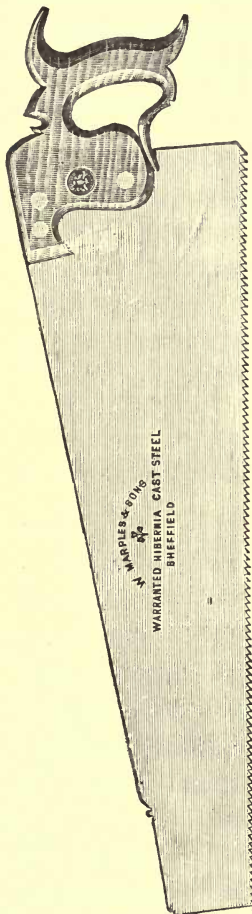

FIG. 69.

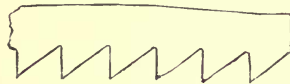

FIG. 70.

enough to use a rip saw, but if they can, the full size is the best.

Hand Saw.—The hand saw is used for sawing across the grain and for general purposes of many kinds. It is similar in general character to the rip saw, but as it is intended to overcome greater resistance, it is shorter and not so tapered. The dimensions are 24 ins. long, $7\frac{1}{2}$ ins. deep at the handle, and at the tapered end, 3 ins.

For boys, however, a smaller size, of 22 ins. long, 5 ins. deep at the handle, and $2\frac{1}{2}$ ins. at the other end, is recommended.

The teeth of this saw should be similar to those in fig. 71. They are strong, and the front edges should be sharpened so as to give blunt chisel edges, *i.e.*, inclined to the face at about 80° , and sometimes, for rough work, they are even made square.



FIG 71.

The 'set' should not be coarse, but this, again, depends very much on the nature of the work to be done.

Panel Saw.—This is similar to the hand saw, but shorter, thinner in the blade, and with smaller teeth, very finely 'set.'

The purpose of this saw is for cutting through pieces of timber, where it is important that a fine cut should be made.

The teeth are a compounded form of those of the half-rip and hand saw.

Tenon Saw.—This saw is for a similar purpose to the panel saw, but it is not intended to cut such thick pieces of wood as will necessitate passing the whole depth of the saw through the cut. The blade is made thinner, ensuring a finer cut, and has very great stability imparted to it by the strong stiffening rib of steel or brass down the back. This is called a spring back, for it is curved very slightly from end to end, exerting a slight pulling strain on the tooth edge directly from the back, and making the blade stiffer when in use.

The best quality of saws are finished by the makers with brass backs, the inferior ones with iron. The brass is not merely ornamental, as its increased weight is very valuable in this saw. Chiefly because of their better quality more pains are taken in their finish in every particular, making these brass-backed saws

very much more expensive in first cost, but more economical, by reason of the great wear they will stand.

The teeth of the tenon saw are small, about eight or ten to the linear inch, and have shallow throats. Their general shape is similar to the hand-saw teeth.

The closing of the brass back is almost invariably better done by hand than by machine. Machine-closed backs do not usually clasp the blade quite thoroughly, and gradually the saw will slip in the back, and very possibly the rivets in the handle will be cut partly through, rendering the saw unserviceable.

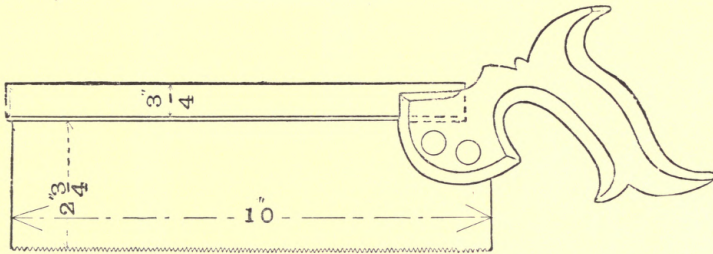

FIG. 72.

The usual dimensions of tenon saws in use by carpenters are 14 ins. to 16 ins. long, $2\frac{1}{2}$ ins. to $3\frac{1}{2}$ ins. deep, with ten teeth to the inch.

The **Dovetail Saw** is really a small kind of tenon saw, with very fine teeth for executing small work.

For all manual training purposes, however, the saw in fig. 72 will be found sufficient to fill the place of tenon saw and dovetail saw, with a corresponding saving of expense. The handle is similar to that of the dovetail saw, but the blade is longer and deeper.

The most convenient size is that shown by the dimensions in the illustration.

Bow Saw (fig. 73).—This saw is used to make sharp curves, and consequently very little substance from the teeth to the back of the saw is allowable, or it will not go smoothly round the line of cut. The difficulty of giving to so weak a blade the necessary stiffness is overcome by the peculiar frame at the back. The saw blade is fastened into the projections from the handle, and the opposite end by small, easily detachable rivets.

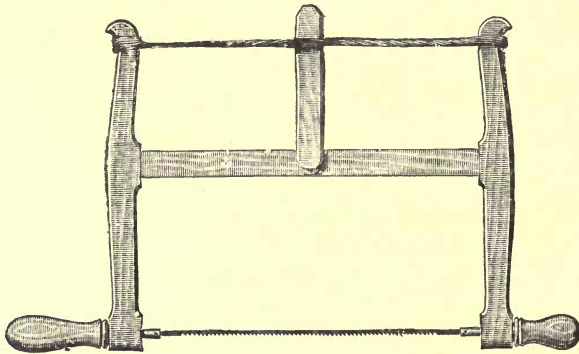

FIG. 73.

The string at the back, when twisted, contracts in length, and pulls in the tops of the bowed ends of the frame, and the lower ends of these are pressed outward, the rail in the middle acting as a fulcrum; the blade is thus kept continually in tension.

The handles containing the extremities of the blade can be turned in their sockets, rendering the saw much handier than would otherwise be the case.

The blades of these saws are in various dimensions, and present the rather characteristic feature that they are 'free' from

tooth to back, *i.e.*, diminish in thickness, so that the section is almost triangular.

The teeth should be as fine as those of the tenon saw, or even as small as in the dovetail saw, and should be used very finely set.

Files are for wearing off the substance of work where chisels, gouges, or spokeshaves cannot be used, for sharpening tools, and various other purposes.

The mechanical principle involved in the construction of all files and rasps is very much the same as the saw, the only difference being that the space operated on by the file is generally larger, and this tool is only used for reducing the surface at a particular place, and not to rasp its way entirely through. The teeth are parallel oblique ridges raised by the blows of a sharp instrument, and sometimes other parallel oblique ridges in the opposite direction are added, giving numerous front cutting angles as well as two sets of inclined cutting edges.

These are 'double cut' files, and are generally in use. The teeth of most ordinary files are similar to those in fig. 74.

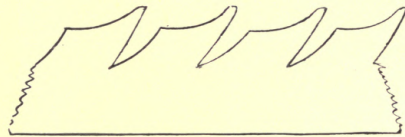
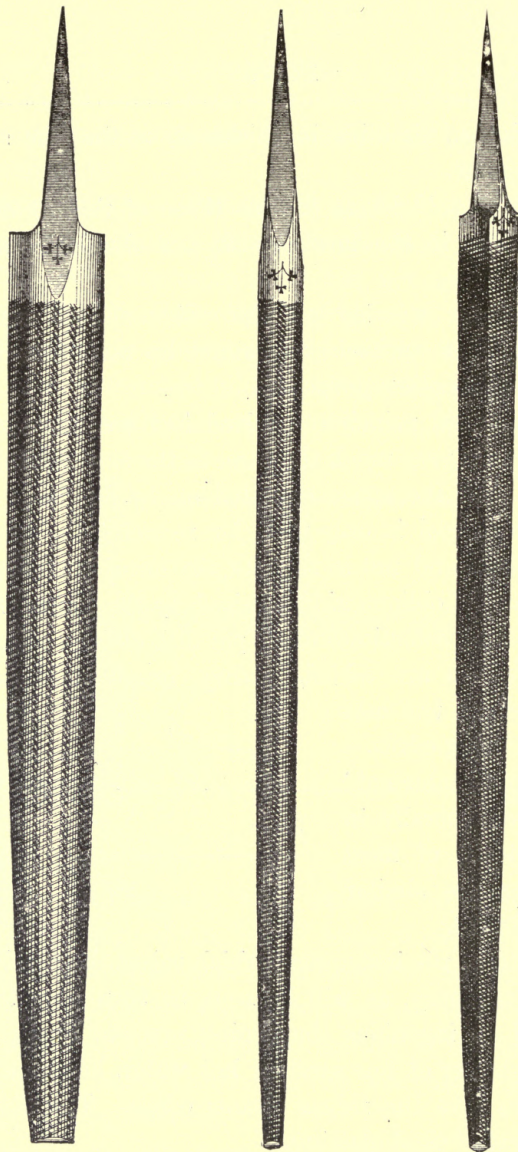

FIG. 74.

The action of the instrument which raises these ridges, however, has a tendency, as will be seen, to turn over the points slightly, and an ingenious sharpening process, by the wearing action of a shower of fine sand in hot water, has been recently introduced to give the ridges cleaner edges. The dotted lines show the effect of sand blasting.

The 10-in. half-round, the 8-in. square, and 8-in. round bastard



Half-round.

Round.

Square.

Bastard.

FIG. 75.

(fig. 75) are the varieties which will be found to be all that is necessary.

The hand-saw file *might* be used, but, unless the teacher is a very competent man indeed, he would do well to leave it for a



Second Cut Taper Saw File

FIG. 76.

skilled workman; only very few of even good workmen can satisfactorily sharpen a saw.

The hand-saw file may, however, have to be used in special circumstances

BORING TOOLS

Brace and Bits.—These are inseparable boring tools. The brace (fig. 77) is of the American pattern, with adjustable screw socket, having jaws to take any convenient sized rectangular shape.

The section of this socket in fig. 78 shows the threads of the socket, and it will be seen that the further the outer casing is screwed up the tighter will be the grip

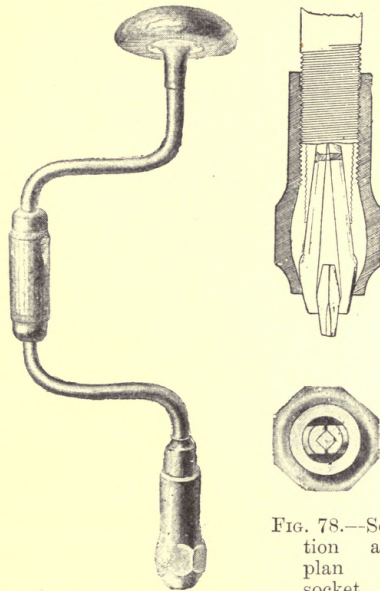

FIG. 77.

FIG. 78.—Section and plan of socket.

of the jaws on any object placed between them; in this case

a portion of a bit is shown held firmly between the jaws. Enough of the thread of the inner screw has been removed in this drawing to enable the reader to see the rivet which holds the jaws together. This rivet is only fixed tightly into one jaw, and in the other the slot which takes it is rather larger, so as to allow the necessary 'play.'

The inner screwed socket is made with an 'interrupted thread.' A slot is cut out of each side wide enough to enable the jaws to open, though the threading on the outside runs as evenly as if the gap did not exist.

The shape of the inner socket, then, is circular at the top, but finishes at its lower ends in two threaded cheeks.

These are necessary to prevent the outer socket slipping round without turning the bit, and to give the requisite stability to the remainder of the thread.

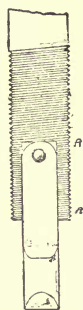

FIG. 79.—Side elevation of socket and jaws.

Fig. 79 shows the shape of this slot, with another view of the jaws.

The brace is used by continuous turning to the right, and the twisting strain offered by the resistance of the wood or other substances bored is from right to left, and in the direction of the threads on the socket.

The action of boring, then, can only have the effect of tightening the jaws in their grasp on the bit.

The bits for use in this brace, and of which a few common varieties are shown in fig. 80, are very distinctive tools, although something of the characteristics of the file, knife, and chisel are introduced into them.

The continuous spiral cutting action about the same axis,

which is the peculiar feature of all boring, is absent in all of the cutting tools mentioned. The **Centre Bit, A**, is a kind in very common use for woodwork. The cutting end consists of a central pin, and at some distance on one side is an arm with a vertical cutting edge. This arm, in the twisting action of the

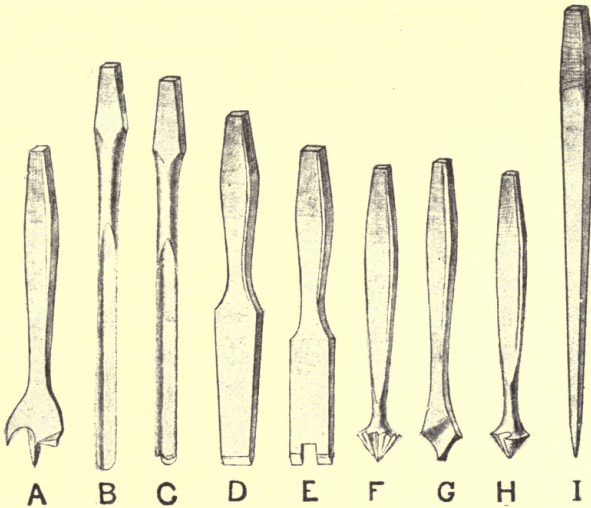

FIG. 80.

brace, cuts the outline of a circular hole, which is deepened as the operator presses the top of the tool.

On the opposite side of the central pin is a flat cutter, which pares out the waste wood by a circular shearing action, but does not operate at quite the same depth as the vertical cutter.

The **Pin Bit, B**, is used to bore deep holes, and is very fast cutting. It is like a gouge in shape, and the long groove permits

the 'core,' as the waste wood is called, to continually work upwards.

The Shell Bit, C, is like the centre bit in principle, only there is no central pin to assist in steadying and keeping it in its proper course. The sides of this gouge-like bit are of assistance, too, in the boring, as they are brought to a sharp edge by the maker, though, from the difficulty of sharpening them, they are certainly allowed to get dull in use.

The Screw-driver Bit, D, is similar to the screw-driver in use. When a large number of screws have to be put in, it is more convenient to use the brace in preference to the more laborious and time-taking screw-driver. The screws can, moreover, be turned in better and more effectually with the brace.

Forked Screw-driver Bit, E.—Sometimes screws which have a rivet in the middle have to be put in, taken out, or tightened, as may perhaps be necessary to the riveted screws in saw handles, and this bit will then prove very useful.

Rose-headed Countersink, F.—This bit is for making shallow conical holes, and is the best kind for use in brass.

The Flat Countersink, G, and the **Snail Horn, H,** are for similar use in iron and wood respectively.

The Square Rimer, I, is used to enlarge already existing holes in brass or iron.

The Gimlet (fig. 81) is another kind of bit which is much used. The point is spiral, similar to that of a screw, and the latter portion of the stem hollow, to admit the destroyed wood fibres. It is used for making holes for the easier insertion of screws.

The Twist Gimlet (fig. 82) is a better kind. It cuts faster and cleaner, and clears the waste wood better, besides making a

slightly tapered hole. Ease in cutting saves the risk of the tang wearing the square hole in the handle and loosening itself.

The **Bradawl** (fig. 83) is a more primitive boring instrument, but none the less useful.

By pressing the bradawl into the wood, and so cutting and

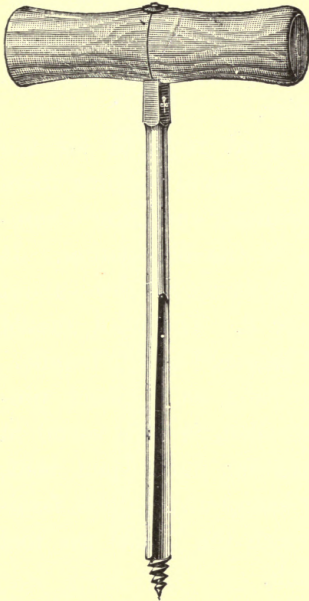

FIG. 81.

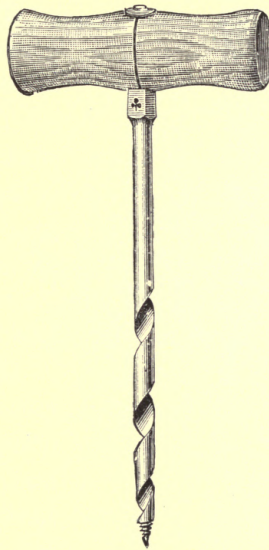

FIG. 82.

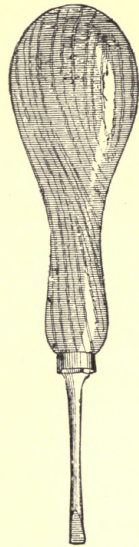

FIG. 83.

crushing without removing the adjacent fibres, a hole is made for a nail, rendering the labour of hammering easier, and decreasing the liability to breaking or bending the nail.

American bradawl pads are sometimes sold in which the

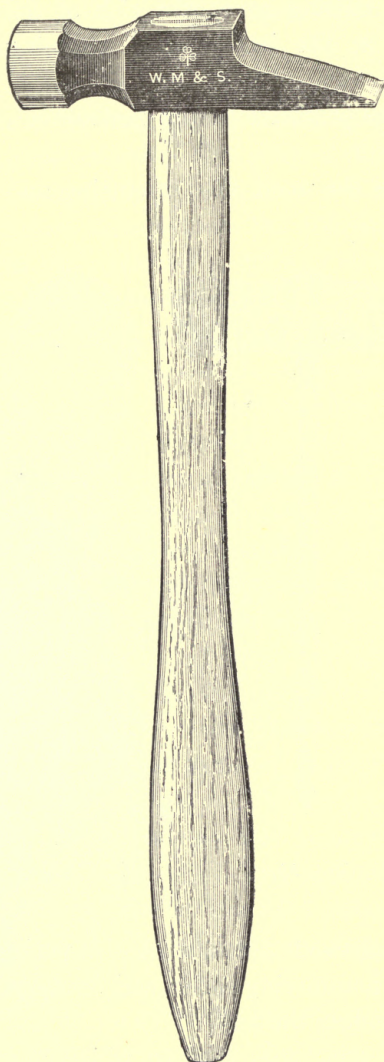

FIG. 84

blade is detachable, on the same principle as the brace and bit, but they are not necessary, and are expensive.

DRIVING AND HOLDING TOOLS

The Hammer (fig. 84).—The general appearance of this tool is familiar.

The kind required for the work of a manual training room is the ordinary carpenter's hammer, as in the illustration. It should not be very heavy—about No. 2 or 3. The head should be well balanced on the handle.

The pane, as the back process is called, is very useful in straightening nails when bent, and in many ways which familiarity with the use of the tool will teach.

The face should be of steel welded on the iron body, but hammer-heads made entirely of steel are very common. In any case a good hard face is wanted. The shape of the handle is important. When held at the

extreme end, a good easy grip should be obtained, the length being not less than 1 foot. Through the outside of the hammer-eye, a wedge is driven to tighten the handle.

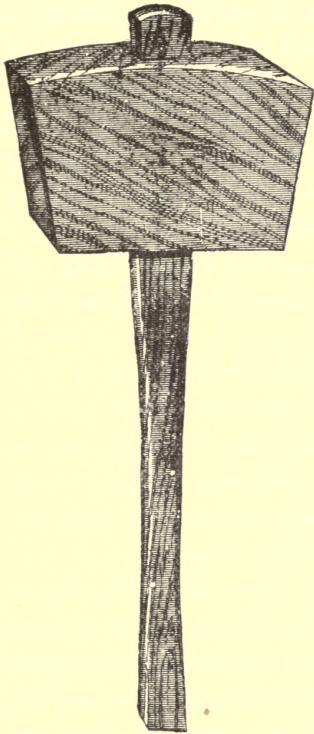

FIG. 85.

The Mallet (fig. 85).—This is a kind of wooden hammer, and is used to strike anything which the hammer would injure. The whole tool should be made of beech with



FIG. 86.

twisted fibres. The mortice should diminish from the top of the head, as in fig. 86, and in putting the handle into the head it is passed through from the top. The reason of this is, that in the swinging blows administered with the mallet, the head would naturally tighten by the centrifugal force of the blow.

Inferior mallets are made with round handles. The curve of the top of the head should coincide with the segment of a circle, having the elbow of the operator for a centre, and the sides should form part of two radii, as shown in fig. 86.

When in use this aids in giving good square blows, and should be a very important consideration in selecting a mallet.

The Punch.—Fig. 87 shows the steel punch which is used to drive the heads of nails a little below the surface, when the projecting heads would be objectionable. To avoid slipping, the point is serrated slightly.

Screw-driver (fig. 88).—The blade, it will be seen, is a spindle with the point flattened out into a wedge. It is important, however, that this should not be sharp, as chipping, both of the tool and the screws, is likely to happen. The

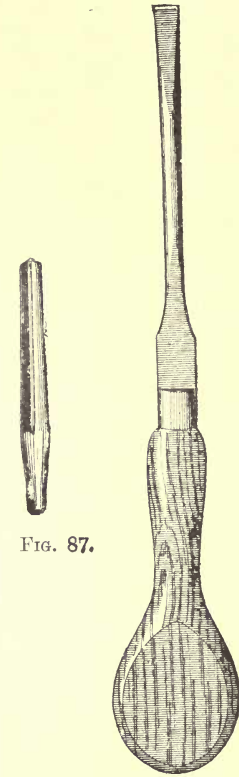

FIG. 87.

FIG. 88.

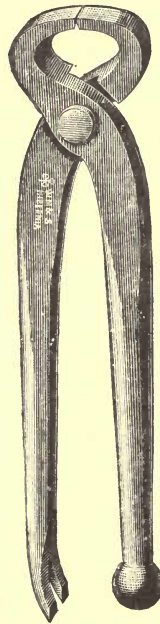

FIG. 89.

handle should be round, or preferably oval, in section, to render the twisting movement easier.

Pincers.—Fig. 89 shows the pattern recommended.

The use of this tool affords a good opportunity for illustrating the principle of lever and fulcrum.

Holdfast (fig. 90).—There are several patterns of this tool, but that in the illustration is as good as any.

The peg is placed in a round hole through the top of the bench, and the screw, when it has reached the top of the peg, not being able to go further, lifts the arm by its subsequent action, pressing the iron plate firmly on the wood. This swivel plate has the advantage of pressing square and true on the face of the wood. It is serrated to ensure a firm grip.

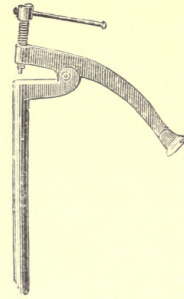

FIG. 90.

SHARPENING

The sharpening of tools is necessary to their proper management and use, and this is especially the case with good tools, where quality may be very much discounted by allowing them to get blunt. The practice of sharpening is useful, too, as a means of inculcating care and attention on the pupil; and, moreover, much expense will be saved by keeping the tools in proper order, instead of sending them to a practical man.

The sharpening of cutting tools is not an operation which can be satisfactorily performed at a first essay, and it must be borne in mind that beginners' attempts at woodwork will result in more damage to tools than the fair wear resulting from their use by experienced men.

We will first consider the sharpening of tools with simple cutting edges—plane-irons, chisels, &c.

If a tool has been slightly dulled, it is sharpened by rubbing on a stone.

The choice of a stone is a somewhat perplexing question, arising from the great variety in the market. The best stone for general purposes is the Washita, or Ouachita. It is of a very light grey colour, almost white, and, in choosing either this or any other stone, a good even colour and texture, with an absence of veins, flaws, or shells, should be looked for. This stone should be quick cutting in its action, and its quality in this respect may be roughly tested by running the edge of a finger nail down the surface once. If a good stone, the nail will be noticeably worn, and on the stone itself a very slight impression should be made, a fine hair-like scratch appearing.

The Turkey stone is an exceedingly good kind, but not so fast-cutting in its action as the preceding. On the other hand, it gives an even finer edge on the tool; it is of a creamy, opaque, yellow colour.

The Arkansas is a fast-cutting stone, and gives an excellent edge, but its price is quite prohibitive.

Stones are usually about 8 ins. to 12 ins. long, by 2 ins. to 3 ins. wide and thick.

To assist in the cutting of a tool edge, oil is poured in small quantity on the stones. Oils of various kinds are used, but the best will be found to be olive, or 'sweet,' oil. The reader should on no account use paraffin (except, perhaps, occasionally for cleansing purposes), as it has the effect of hardening, and so decreasing, the cutting power of the stone, for it must be borne in mind that the softer the stone the faster it cuts.

When not in use the oiled surface of the stone is very apt to accumulate any foreign gritty matter which may be floating in the air, and which will wear both iron and stone unevenly. To prevent this occurring, the stone is set firmly in a piece of

wood, and a lid is made to fit over it, which should invariably be put on when the stone is not in use.

Plane-irons and chisels, when new, are ground on the back at 25° to the face, but the sharpening angle is usually about 35° , and, in sharpening, the iron must simply be held steadily in this position, as in fig. 91.

To do this properly is, however, a difficult operation, for the

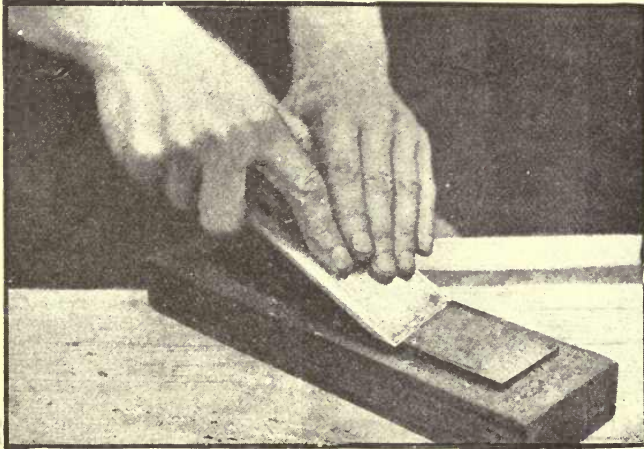

FIG. 91.

most trifling deviation from the angle of 35° will make the cutting angle of the iron slightly round, instead of quite flat.

As the substance of the iron wears away from frequent sharpening, the extent of this flat surface becomes larger, and the difficulty of keeping it perfectly flat becomes greater.

In rubbing the iron on the stone it must be remembered that it is as important to wear away the stone evenly as it is to hold the tool properly, for if the surface of the stone becomes hollow

in the middle, it necessarily makes round sharpening edges on the tools, instead of flat ones.

In sharpening, and especially on fast-cutting stones, the extreme edge is not entirely removed, but, owing partly to the pressure on it, and to the slight resistance to the forward move-

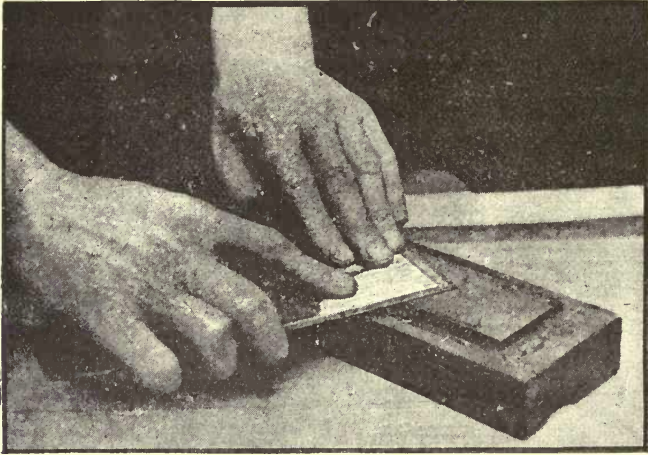

FIG. 92.

ment offered by the stone itself, a very small portion is turned up, and when examined this 'wire edge' will be visible, though, perhaps, the iron may be quite sharp. To remove the wire edge, turn the tool flat on its face, as in fig. 92, and rub it two or three times along the stone.

It is of the utmost importance that in doing this the face of the tool should be quite flat on the stone. If necessary, after rubbing on the stone in this way, the sharpening may be finished on a piece of buff leather.

Sometimes, to finish the removal of this wire edge, the tool

is stropped in the palm of the hand, but this practice is obviously very dangerous, and should not be taught.

A dangerous method of testing the keenness of a sharpened tool is to rub a finger lightly across the edge, but this should on no account be permitted. As a rule the best test is a careful scrutiny of the tool, when, if the edge is visible in a fine shining line it may be regarded as imperfectly sharpened; if the edge is invisible, it is keen.

Fig. 93 shows how the size of this sharpening surface increases by the successive removal of layers of the metal. Now as this goes on, the amount of surface to be kept true in sharpening increases; and as the stone is, perhaps, not absolutely level throughout its whole length, the sharpening surface cannot be rendered quite flat. The tool rapidly gets dull, does not do its work well, and gives more trouble in sharpening. It is now reground—*i.e.* the obtuse angle of 170° , formed by the grinding and cutting angles, is removed, the edge of the tool being once more made to 25° as when new.

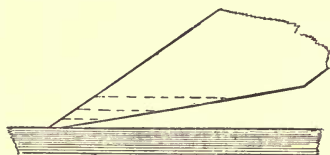

FIG. 93.

The grindstone is used for the purpose of reducing this surplus metal; it is much coarser than the oilstone, and cuts much faster in consequence, especially as it is revolved very rapidly. In order to make sure of getting the proper angle the 'support' is used. The tool is screwed firmly into this instrument, and the operation of grinding much simplified. Fig. 94 shows this grinding support in use.

The grindstone recommended is from the Bilston quarries,

and from 16 ins. to 24 ins. diameter, with $3\frac{1}{2}$ -in. edge, will be found very suitable dimensions. It should be in a high iron frame, and should have both hand and foot power. A trough containing water to assist in the grinding and keep the tools from heating and losing temper is provided; and, to prevent, as far as possible, the particles of wet grit from flying off tangentially from the stone and making the user dirty, the grindstone should be boxed in with a

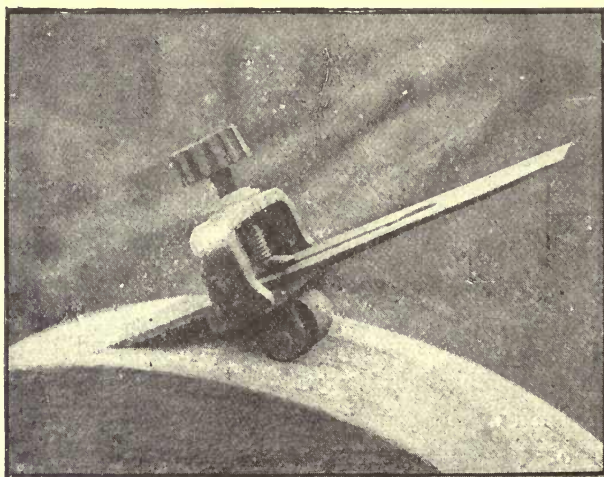

FIG. 94.

high wooden frame, leaving a small segment of the circumference of the stone visible.

Fig. 95 shows the grindstone cased in with wood, and in use by two boys. The lad who is holding the tool is not using the grinding support already alluded to, but an equally good, and much cheaper, improvised one.

Across the top of the framing is nailed a piece of wood, with

a hole mortised in it. Through this hole the tool to be sharpened is thrust, and can be held very steadily while being ground.

Grinding should take place over the whole surface of the edge of the stone in order to wear it evenly; but if it should become uneven, it can be made true by wearing down the more

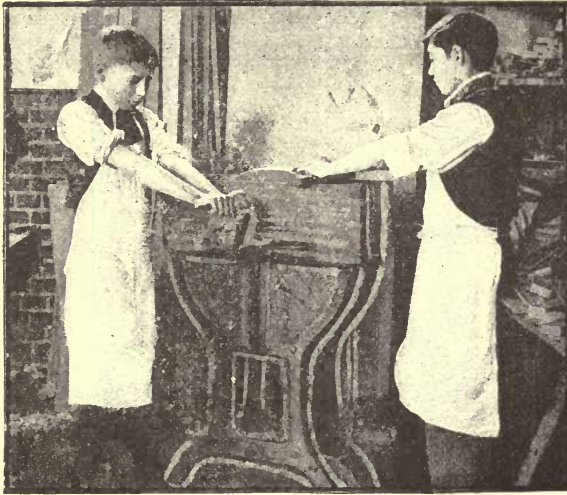

FIG. 95.

prominent parts against a bar of iron, held firmly in one position.

Stones will get too hard if exposed to sunshine; on the other hand, if allowed to stand in water the stone will become soft in one half. The water in the trough should, therefore, be run off, after use, through the outlet provided for the purpose.

Bent tools, like scribing gouges, are not sharpened on the flat

oilstones, but are rubbed with a small prepared piece of Turkey or Washita stone, which serves the purpose.

The slip should be oiled, as in the case of the larger oilstone, and rubbed firmly and steadily; and though the use of the slip

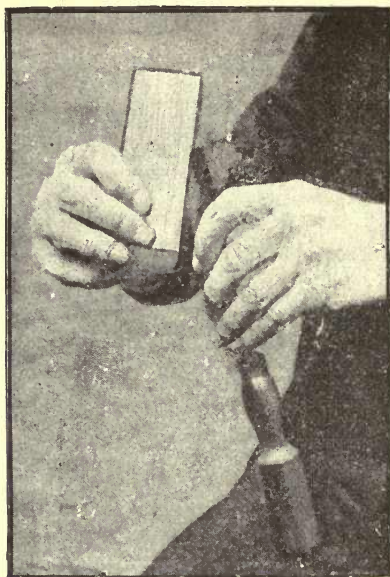

FIG. 96.

requires care and experience, no special advice beyond that of attention is possible.

Fig. 96 shows the method of using a slip.

Saws are very difficult to sharpen, and, as before mentioned, unless the teacher be an artisan, he had better not attempt it. The sharpening will be done at a tool shop or by a practical man at a merely nominal charge.

CHAPTER V

BENCH WORK

EXERCISE I

MARKING, SAWING, AND CHISELLING.

Tools used.—Small try-square, say $4\frac{1}{2}$ -in. blade; marking gauge; tenon saw, 10-in. blade; $\frac{1}{2}$ -in. or $\frac{3}{8}$ -in. firmer chisel, and the 2-ft. jointed rule.

Material required.—A carefully machine-sawn piece of wood, 11 ins. long, 2 ins. wide, and $\frac{7}{8}$ in. thick, is to be finished, as shown in fig. 97.

The preparation by the pupil of his own wood at this stage is not advisable, as the operation is too difficult, and the danger of spoiling timber consequently great.

Measure the wood to test its dimensions, and then proceed to make a drawing, full size or to scale, of the completed exercise. At first only the *outline* of the plan, side elevation, and isometric projection should be executed. This makes a picture of the piece of wood as given from three aspects. Now

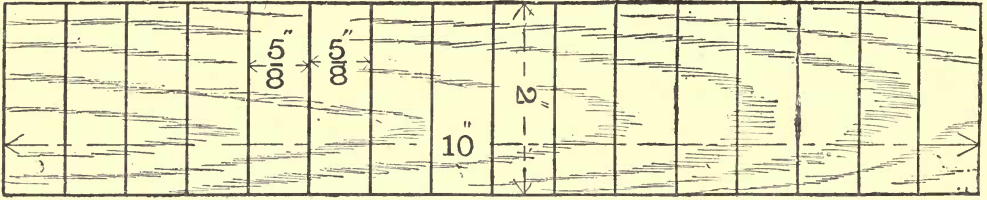

Plan.



Side elevation.

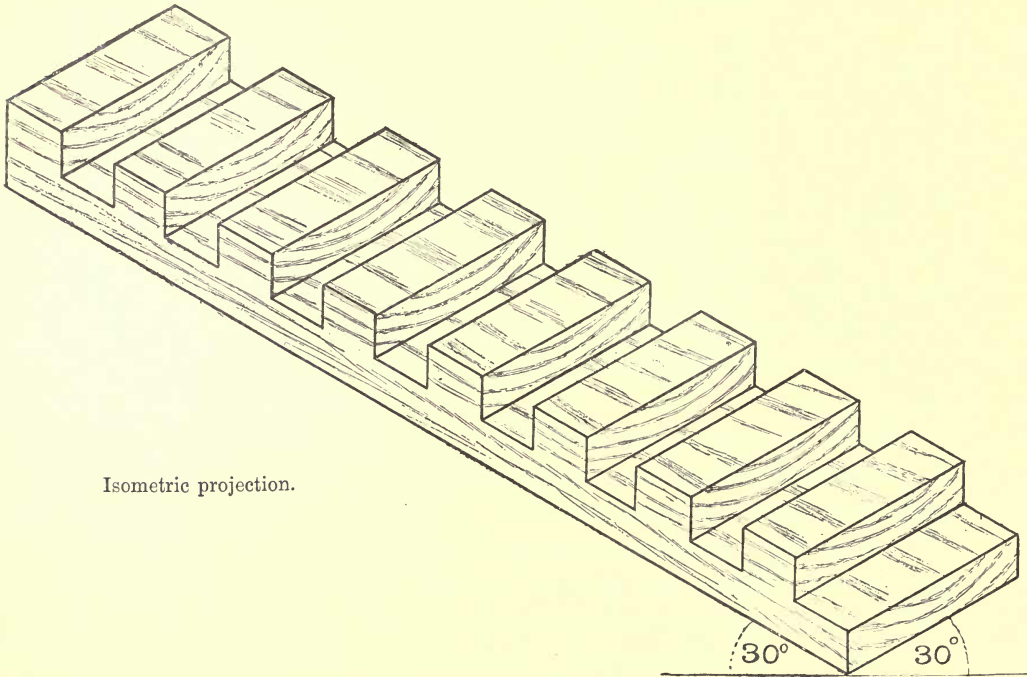

Isometric projection.

FIG. 97.

From Series IV. 'Hand and Eye Training' Cards, by kind permission of Messrs. Cassell & Co., Ltd.

mark off $\frac{5}{8}$ in. from one end, and draw a line across the plan at right angles to the side. Repeat this to the end of the plan at intervals of $\frac{5}{8}$ in., and project the lines half way into the side elevation. Mark off the isometric projection in the same way.

Care should be taken to impress the pupil with a proper understanding of the values of the divisions of the rule, and he should be made to add each $\frac{5}{8}$ in. to the next $\frac{5}{8}$ in., as he marks off each division, and shown that this equals $1\frac{1}{4}$ in., $1\frac{3}{8}$ in., $2\frac{1}{2}$ ins., and so on to the end.

Select the better side and the better edge of the wood and mark from these always. These are called the face side and face edge, and it will be found very useful to make all measurements on the face side from the face edge, and on the face edge from the face side.

This is of great importance and must always be adhered to. When once chosen, the face side and edge should be marked in pencil, to distinguish them.

The wood should now be placed in the vice, and the divisions marked off on its face side, as in the drawing of the plan. To do this the stock of the square should be held firmly against the wood, and the blade kept down with one finger, as shown in fig. 98.

Having measured off the first $\frac{5}{8}$ in., commencing from a cut line about $\frac{1}{4}$ in. from the end, place the point of the chisel at the further edge, with the face towards the square. Bring the square gently up to the chisel and draw this firmly to the other side, making a good clean cut. It will be seen that the handle of the chisel slopes away from the operator in this movement. If the chisel sloped the other way, the mark made would be a

scratch instead of a cut, and would damage the surface of the wood.

Now take the wood out of the vice. Re-insert and screw it up again with the face edge upwards.

The next operation is gauging, and the adjustment and use of this tool should be carefully taught here.

The gauge is a tool which requires to be carefully set before

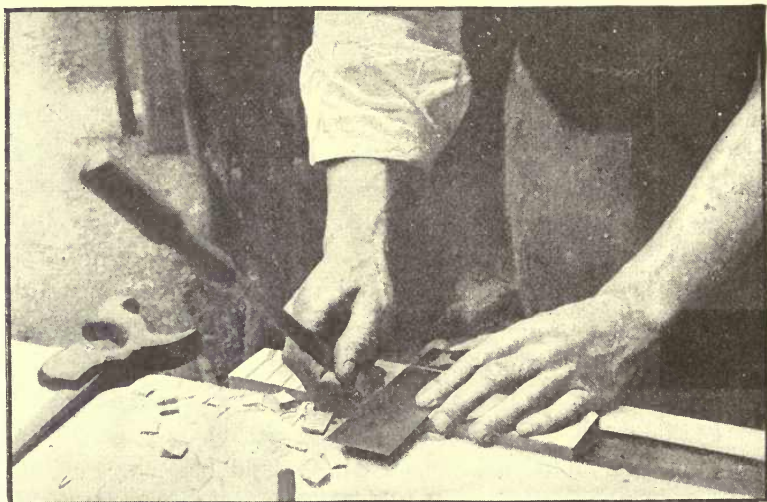

FIG. 98.

using. The edge of the sliding block must be placed at the required distance (in this case $\frac{7}{16}$ in.) from the spur or tooth. The adjustment of the gauge is not as a rule accurately done by boys, unless they are properly taught, and it will be found well to teach the whole class collectively to carefully follow the instructor as he manipulates his gauge.

The tool should be held in the left hand throughout the

operation of adjusting and using it. This is not essential, but will be found an invaluable rule to prevent confusion in the

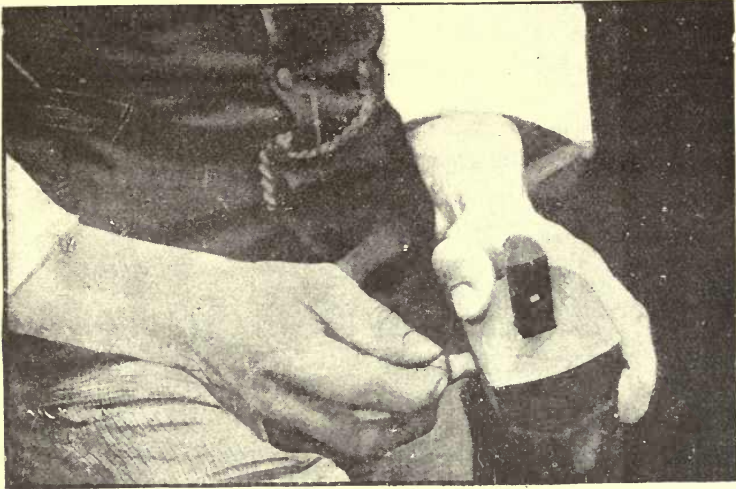

FIG. 99.

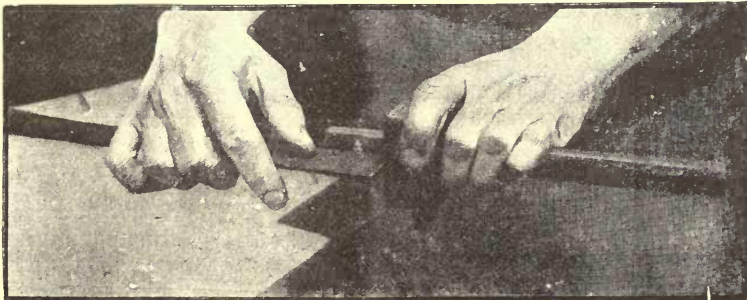

FIG. 100.

methods adopted. Loosen the screw with the right hand (fig. 99), till the block can be moved up and down the stem, by tapping

the latter on the bench at either end, as required. Measure the distance required (fig. 100), and having obtained this correctly, secure the block with the screw. Now compare with the rule to finally test accuracy before use.

Having adjusted the gauge, mark a line down the length of the wood which will be at mid distance from the face side and

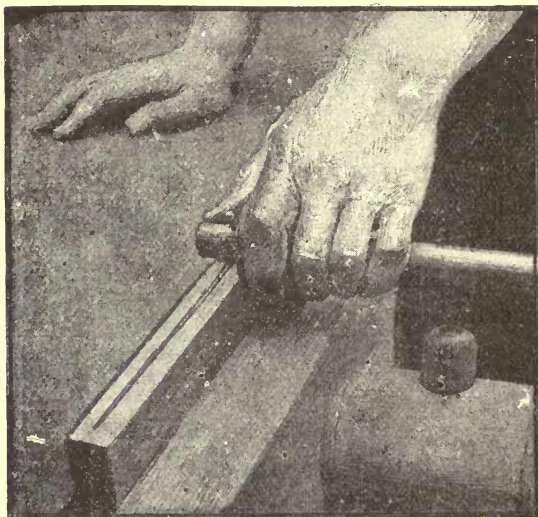

FIG. 101.

back (fig. 101). To do this, hold the block of the gauge firmly against the face side, with the spur lightly touching the wood. Still holding it well up, push the gauge to the other end of the wood, making a fine cut with the spur. Repeat if the cut is not deep enough, but do not make it too deep.

Now with the chisel mark off lines similar to those on the face down to the gauged line, and commencing from the ends of

the lines on the face—in fact, a continuation of them on the edge, but only extending to the gauged line. Now take the wood out of the vice, and again screw it up with the face side upwards.

Saw off the waste piece at one end and then proceed to saw across the grain along the lines already marked and down to the gauge line. Observe the method of holding the saw (fig. 102), and be careful to extend the forefinger and firmly press it

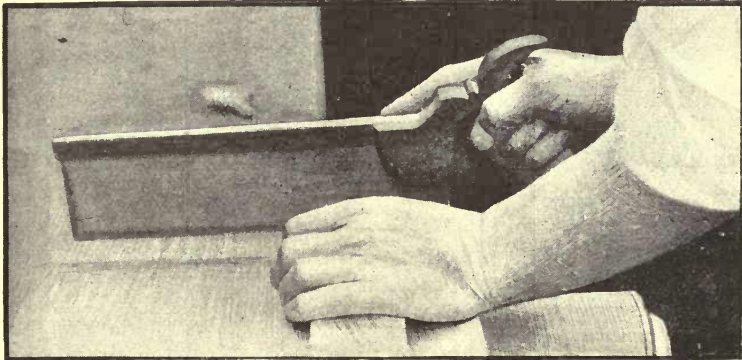

FIG. 102.

against the back. Place the left hand on the wood, as shown, and raise the thumb to steady the saw as it enters. A later illustration (fig. 170) shows this better. In sawing a certain amount of wood is cut away as sawdust. This is called the curf, and care should be taken to make this waste occur in that part of the wood which is not wanted—in this case the grooves.

The sketch (fig. 103) shows the position, A, of the saw as it enters the wood. When once a cut is made, the handle of the saw should be gradually lowered, causing the plane of the edge

to pass successively through *BB* till it reaches *c*, in which position the blade should be kept till the cut is deep enough. The dotted lines show that at the commencement of sawing the strokes are short, but when the saw arrives at *CC*, good free horizontal strokes, using the whole length of the blade, should be maintained.

Short strokes, and forcing the saw too hard, are common

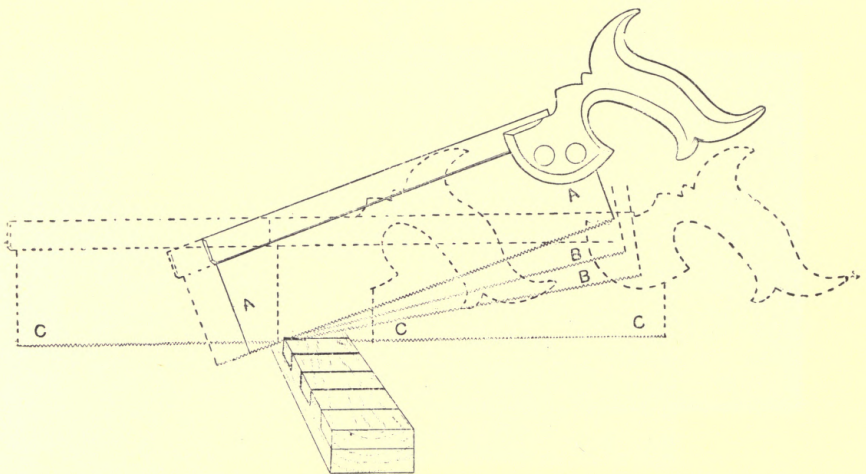

FIG. 103.

faults. Of course the saw should be held perfectly upright when in use.

Now pare out the waste wood with a chisel. To do this well, the operator should stand in a firm position, with his legs, say, a foot or more apart, and should lean with the whole of his left forearm against the top of the vice. The butt of the chisel should press against the back portion of the right palm, with the

fingers holding it firmly and easily, as in fig. 104. The left hand should hold the chisel to steady and guide it.

After paring nearly down to the gauge line by successive

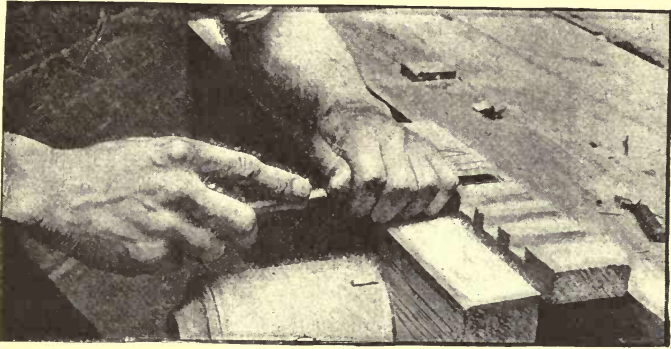

FIG. 104.

planing cuts, turn the wood round in the vice and finish from the other side. This reversing will be found of great assistance in getting the bottom of the groove flat.

EXERCISE II

A SLIGHT VARIATION OF EXERCISE I

The drawing associated with this model is an excellent one, giving a good practical application of geometry to actual work.

After drawing the outline of the plan, draw a square on one end of it equal on its side to the breadth of the wood. Draw the diagonal of the square and proceed to make lines parallel to it, and at a distance of $\frac{5}{8}$ in. from each other.

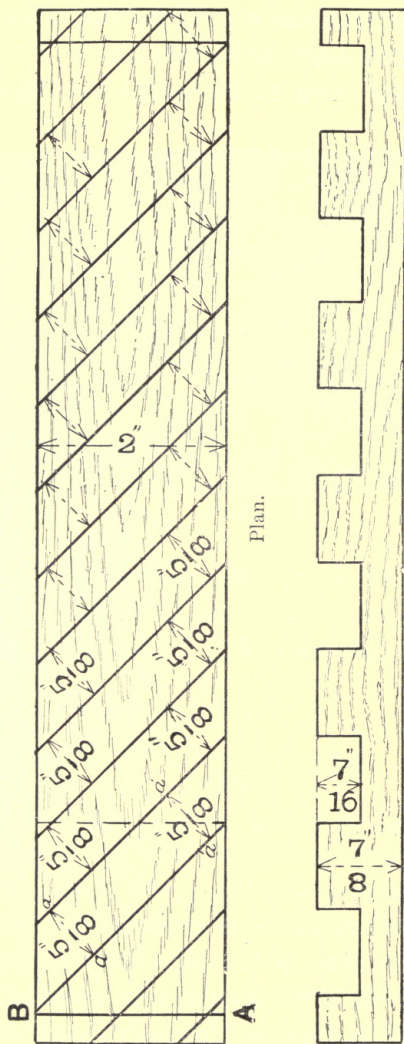

Side elevation.

FIG. 105.

From Series IV. 'Hand and Eye Training' Cards, by kind permission of Messrs. Cassell & Co.

To do this in the way which will be found most suitable to actual work, set up two parallel lines, $a a'$, from the diagonal and at right angles to it. Mark off $\frac{5}{8}$ in. on these, and join the marked points. Mark off all the lines in this way.

The elevation should be projected from the plan. Isometric projection need not be used in this case.

Having drawn the exercise on paper, the wood should be marked out for sawing.

At the end a square should be made as in the paper drawing, but as the end is probably not quite at right angles to the edges, a line which is perfectly square is set out with the try-square at a little distance from one end, as at AB in fig. 105, and this line is now considered, for the purposes of measurement, as the end of the exercise. Finish the marking as in the paper drawing.

The lines should be cut with the chisel, making use of the blade of the try-square as a straight-edge.

A carpenter would use a bevel for this purpose, but the liability to fall into the error of measuring the distances along the edge of the wood, instead of on right projectors from successive cut lines, is much greater when this tool is used than if the edge of the square is taken. Moreover, the square is now in a novel position—the stock no longer rests against the wood, and it is slightly more difficult to hold in a given position, thus giving the pupil more knowledge of the use of the tool.

EXERCISE III

SAWING WITH TENON SAW.—SIMPLE FACE AND EDGE PLANING.—
PLANING TO A THICKNESS AND BREADTH.

Tools used.—Jack plane, small try-square, marking gauge, tenon saw, and $\frac{5}{8}$ -in. or $\frac{3}{4}$ -in. chisel.

The drawing of this exercise, which should be to scale $\frac{1}{2}$,

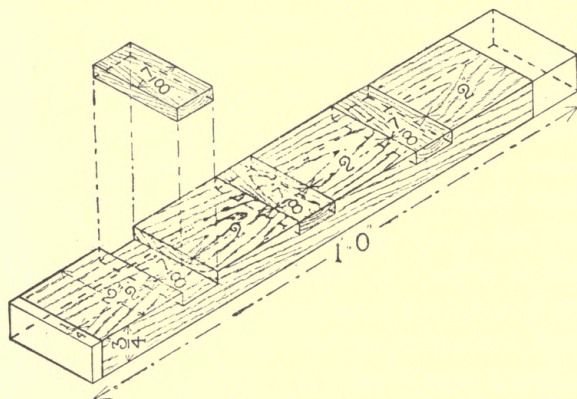

FIG. 106.

need only be made in isometric projection, and the isometric scale need not be used. The drawing should be as in fig. 106, showing one of the inlaid pieces removed.

Two pieces of wood will be required for this exercise, one of yellow deal 1 ft. long by $2\frac{1}{4}$ ins. by $\frac{7}{8}$ in., and the other some coloured wood, as cedar or sequoia, 8 ins. by $1\frac{1}{8}$ in. by $\frac{1}{4}$ in. The yellow deal should first be reduced to the proper dimensions by planing.

This is the pupil's introduction to the plane, and great care should be taken to attempt the use of this tool as well as may be possible. Before commencing to plane, the pupil should be taught to take the plane to pieces and set it. The operation is simple, but much bungling will result if care is not taken to

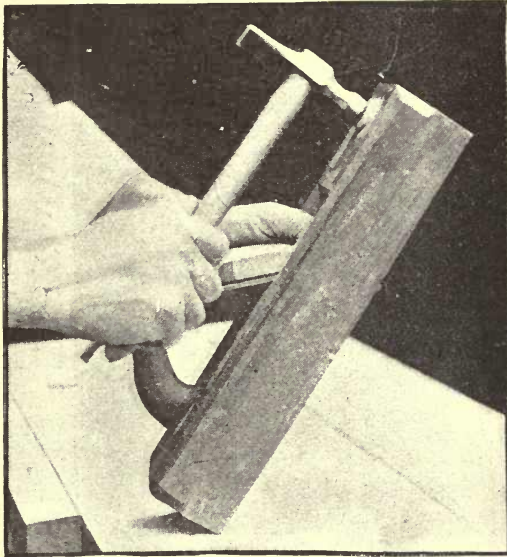

FIG. 107.

teach it systematically. This is another good opportunity for collective teaching. The pupils should stand facing the bench, the plane, with the sole down, being on the bench, with the nose pointing away. The hammer should be placed near at hand, on the right side of the plane, which should be grasped firmly with the left hand, the thumb being in the escapement,

and pressing on the plane-iron, with the fingers round the side and sole, or face.

The plane should be raised, as in fig. 107, at an angle, and



FIG. 108.

the hammer taken up, with the right hand holding it at the end of the handle. Observe this as an invariable rule.

Rest the head of the hammer on the button of the plane, or on the nose if there is no button, and strike two or three sharp blows. Take care in hammering always to strike with the whole of the face of the hammer, or the nose of the plane will be

dinted by the edge. The effect of the blows given will be to loosen the wedge and irons, but, if the left hand has held the iron and wedge firmly, they will not fall out and damage themselves, or cut the operator.

Put the hammer down and take out the wedge and iron, and lay them and the plane on the bench. Hold the iron as shown in fig. 108, and loosen the screw with the turnscrew, but do not take

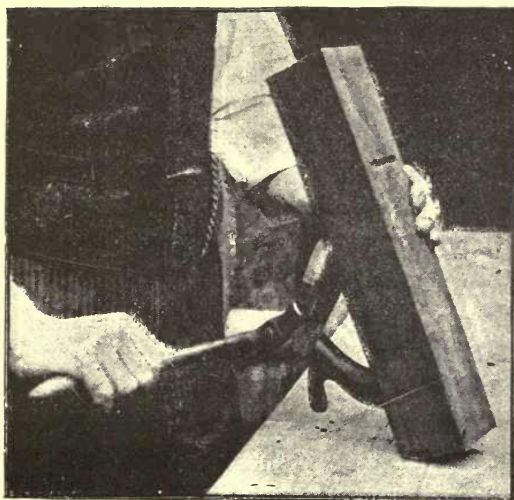

FIG. 109.

it out. Now take the cutting iron away from the back, and if necessary sharpen it (see pp. 133-5). When this is done, screw up the irons again as tightly as possible, with the edge of the back or cap iron about $\frac{1}{32}$ in. back from the edge of the cutting iron. Take the plane in the left hand again, and hold as shown in fig. 109, and with the right hand place the irons in the escapement of the plane till the centre of the cutting edge protrudes from the

mouth beyond the face of the plane as much as the thickness of the shaving required—in this case about the same as a sheet of note-paper.

Keep the irons in their right position with the thumb of the left hand, and with the right push the wedge tightly in, and with a few taps of the hammer make it secure, but do not drive it too hard in. Care should be taken not to move the irons.

Glance frequently down the face while tapping the wedge, to see that no error arises in the amount of iron showing. If, however, on tightening, either corner of the iron should appear on the face, strike the iron on the edge near to the wedge on the same side as the corner that is out. If insufficient iron shows in the centre of the plane, a light tap on the free end of the iron will put this right. Sometimes too much of the edge is out, in this case a light blow on the button will cause it to set back.

Having finally adjusted the iron the wedge should be firmly driven home. This can be done too effectually, and in extreme cases the plane gets damaged, and even split.

If it is not necessary to sharpen the plane-iron, it can be adjusted by simply striking the nose or the iron, as the case may be, and in actual work planes are often adjusted in the middle of an exercise without removing the irons.

The larger of the two pieces of wood for this exercise is 1 ft. by $2\frac{1}{4}$ ins. by $\frac{7}{8}$ in., and it will be found a useful size to commence teaching the use of the plane. If a much longer piece is taken, the result generally is to plane it hollow in length, and if much shorter, it is often planed round in the length.

A short piece will allow the plane to dip at the end on the forward stroke. A long piece generally only gets planed in the

middle at first, as the pupil does not usually take good sweeping strokes at commencing. A broad surface is too difficult to master at beginning. Place the end of the wood firmly against

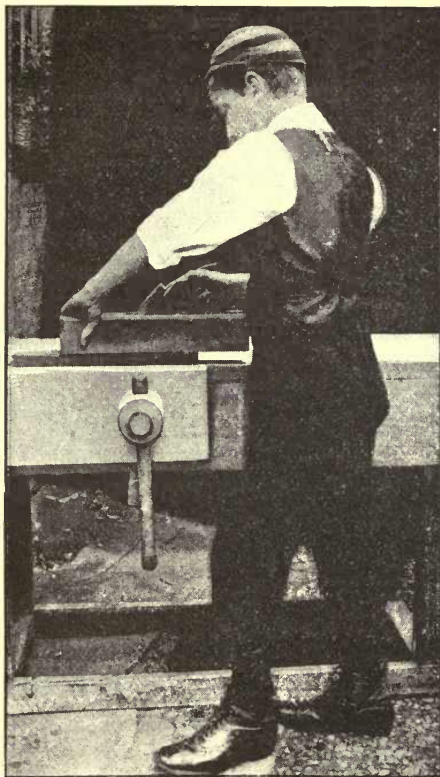

FIG. 110.

the stop and hold the plane as in fig. 110, standing with the feet apart and behind the plane. It will be seen that the left hand is on the front portion of the plane which rests on the wood.

Press the nose firmly down with the left hand at the commencement of the stroke, and push the plane forward in a straight line. As the tool progresses, press the base of the right hand with gradually increasing force on to the rear of the plane, and as the blade passes over the further end of the wood release the

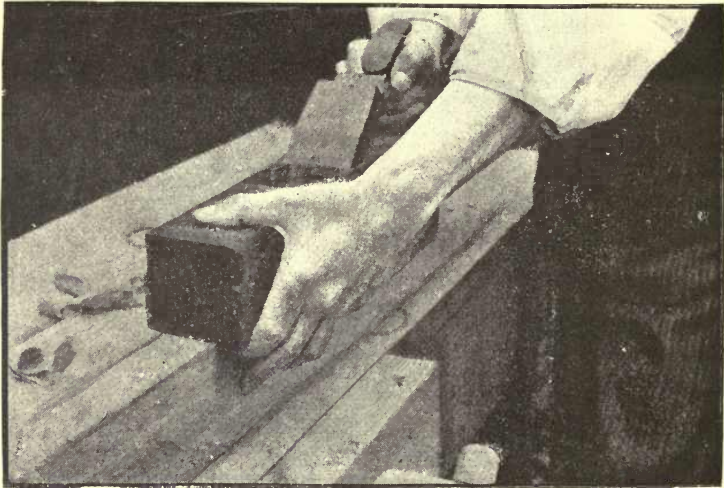

FIG. 111.

pressure with the left. In short, the iron should be kept well down while it is cutting, but no longer.

The surface of the wood having been planed till it is thought to be level, it should be tested for accuracy by placing the straight-edge across it diagonally, in opposite directions, holding the wood and straight-edge up to the light to see if any inequalities of surface exist.

The face side now being true, turn the wood on its edge in the vice with the face side towards the operator, and plane or shoot the edge.

Hold the plane as in fig. 111. The fingers of the left hand are allowed to run along the face side of the piece of wood while the plane is in motion, to steady it in its course.

Again be careful to press the plane as before, and when it is thought that the face and side make a right angle, try it with the square, as in fig. 112, and with the straight-edge, to find if it is straight. If not correct, plane off more as required.

Having made the edge true and at right angles to the face,

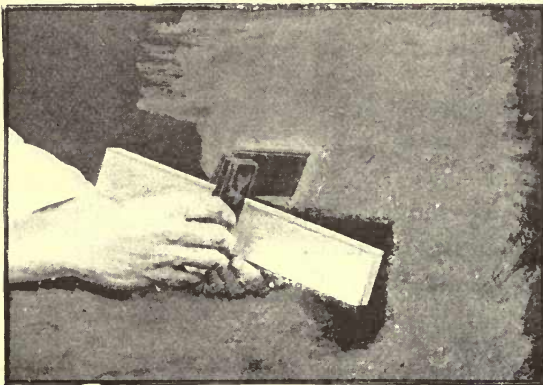

FIG. 112.

gauge the width of the wood to a shaving or two more than it is required to finish at (2 ins.), this is left a little wider than is wanted, as, on finally cleaning the exercise off, a little more will be removed, and it will then be true to the dimensions.

Turn the wood over in the vice and plane the opposite edge down to the line already gauged, taking care to make it like the other edge—true, and at right angles to the face. Now gauge *from the face side and on the face edge* the thickness of the

finished exercise— $\frac{3}{4}$ in., and leave the extra amount for the cleaning off.

The next step, having overcome the difficult task of planing, is to make cut lines on the face where the grooves are to be.

Commence by marking a cut line at right angles to the edge, about $\frac{1}{4}$ in. from the end (see fig. 106), and then alternately, at 2 ins. and $\frac{7}{8}$ in. apart, to the other end, where nearly 1 in. surplus will be found after marking off four spaces 2 ins. wide and three $\frac{5}{8}$ in. wide. Both this and the $\frac{1}{4}$ in. first marked will be finally sawn off.

Gauge down to the depths of the grooves, and saw and chisel them out as in Exercise I.

Now prepare the thin coloured wood to insert in the grooves by shooting the edges true.

To do this lay the strip on the piece of wood already finished and projecting a little from it. Rest the plane on its side, with the face against the edge of the wood. A good illustration of this form of planing is shown on pp. 197–8. In that case, however, a shooting board is used, but for the present it is enough to make use of the true edge of the wood, already planed, as an improvised shooting board.

Press the wood down hard with the left hand when planing, and, having got one edge true, try it against the groove to see how much is to be taken off the other side. Plane the required amount off and saw the strip of wood up into lengths, which should be a shade over 2 ins. each. Fit the several pieces into the grooves, where they should hold tightly, or, they may be glued in. Now clean off the face and edges with the plane set fine—*i.e.* with the iron barely showing, and saw off the end pieces not required. No glass-paper should be used.

EXERCISE IV

PLANING.—SAWING WITH TENON SAW.—CHAMFERING WITH PLANE
AND CHISEL.—MARKING WITH THUMB-GAUGE.

Tools used.—Jack plane, marking gauge, try-square, and $\frac{3}{4}$ -in. or $\frac{7}{8}$ -in. or 1-in. firmer chisel.

Timber required.—Yellow deal 1 ft. by $2\frac{1}{4}$ ins. by $\frac{7}{8}$ in.

The drawing for this exercise should only be the plan, eleva-

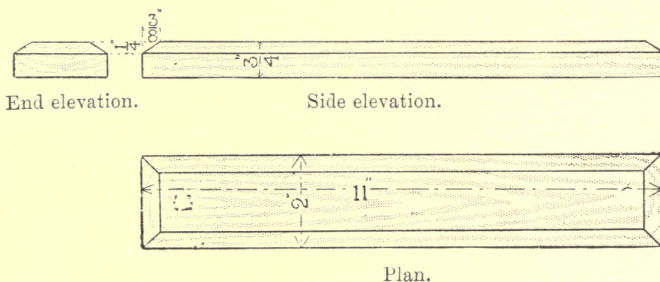

FIG. 113.

tion, and end elevation, to scale $\frac{1}{2}$. No isometric projection need be made in this case.

Plane up the piece of wood as in Exercise III., and cut lines on the face and edges at each end to leave some waste. For this purpose the wood is supplied about one inch too long. Saw off this waste, as in the preceding exercise. Of course the ends could be planed true, but it is not advisable to take up end planing yet. The marking gauge is not used to draw the lines on the face edges and ends, indicating the width of the chamfer, as the cut of the spur being at right angles to the wood would

thus destroy the angle of the chamfer, which should slope into the edge or face, and make a good clean intersection.

The pencil is, therefore, resorted to for this purpose, but the manner of its use is peculiar.

If, in measuring the depth of the chamfer on the several sides of the wood, an error is made in measurement, the corners, or 'masons-mitres' of the chamfer, will not coincide. To prevent

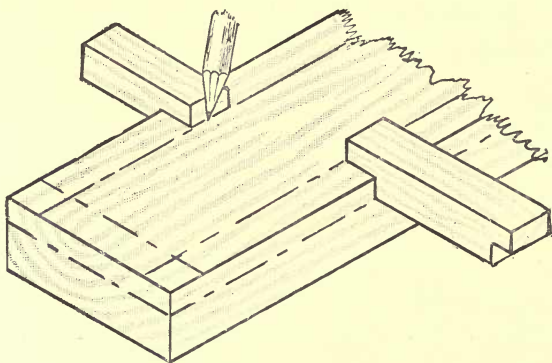

FIG. 114.

this, a thumb-gauge is used. This is a little piece of wood notched out at one corner to the same depth as the edge of the chamfer from the face, $\frac{3}{8}$ in.

Apply the notch of the thumb-gauge to the face side and edge, and place the point of the pencil against the angle formed by the gauge and the face side (see fig. 114). Draw both gauge and pencil together, down the whole length of the wood, and repeat the operation on the opposite side and at both ends.

Now cut another notch in the opposite end of the thumb-gauge $\frac{1}{4}$ in. deep. Turn the exercise on its edge and mark in the same way as on the face.

In chamfering hold the plane as in fig. 115, the left hand acting as a guide for the plane and to keep it down on the work. Take a good, steady forward stroke, the whole length of the wood, and continue planing down to the lines on the face and edge, taking care to hold the plane at such an angle that both lines are reached simultaneously, or as nearly so as possible. In any case do not go beyond either line.

When the chamfer has been made on one edge with the plane,

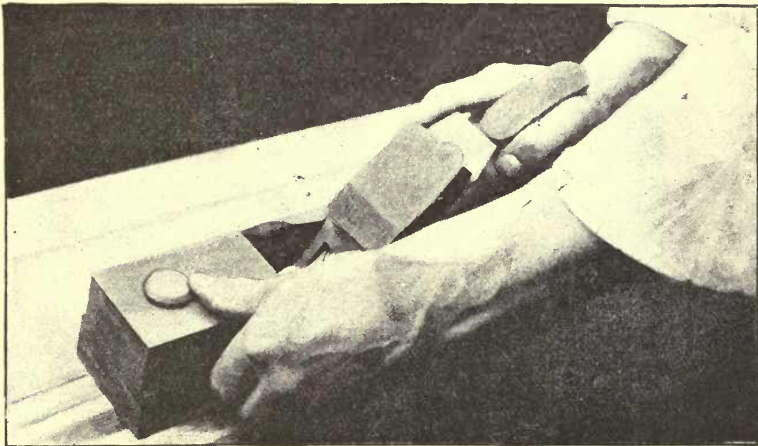

FIG 115.

take the wood out, and screwing it up in the vice, chamfer one end. Hold the chisel, as shown in fig. 116, in the right hand, with the left hand across the back of the blade; push it forward steadily with the right hand, and commence to cut with the right-hand corner of the edge. At the same time the left hand should keep the blade from cutting too deeply or lifting out, and should gently but firmly push the blade of the chisel across, so that

every portion of the blade cuts successively till the left-hand corner of the cutting edge is reached. By this time the shearing action of the chisel has carried it to the other side of the wood, and another similar cut should be made.

If the first effort is not successful, the end of the wood may

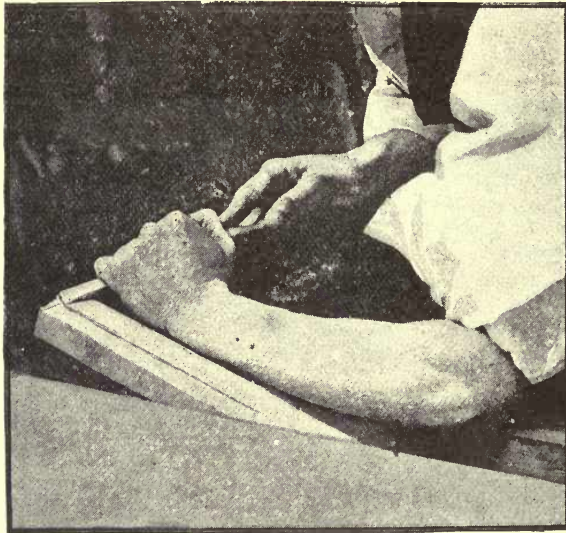

FIG. 116.

be cut off, a fresh chamfer marked, and the process of chisel chamfering repeated. Treat the remaining edges in the same way as the first, and finish the exercise.

If the exercise is well finished it may be returned to when the pupil is further advanced, and be completed into a hat-peg bearer, or some other useful object.

EXERCISE V. Fig. 117.

FACE AND EDGE PLANING. — DRAWING WITH SET-SQUARES ON WOOD.—SAWING WITH TENON SAW.—HORIZONTAL AND VERTICAL CHISELLING.

Tools used.—Jack plane, try-square, tenon saw, marking gauge, bevel, and various firmer chisels.

Timber.—Yellow or white deal, bass-wood or butternut, 1 ft. 6 ins. by $2\frac{1}{4}$ ins. by $\frac{7}{8}$ in.

The drawing of this exercise involves various plane geometri-

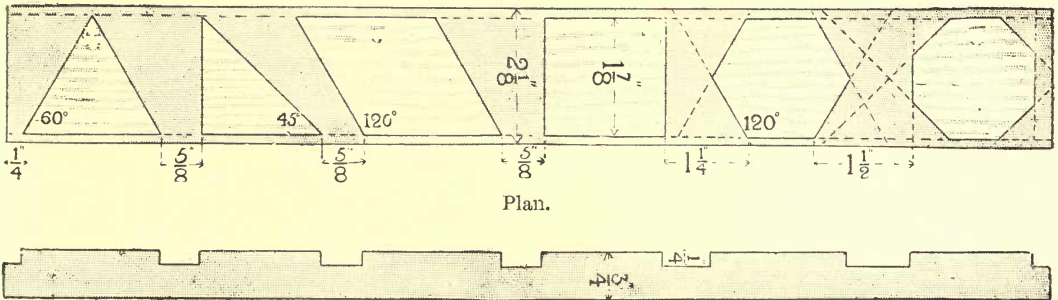

Side elevation.

FIG. 117.

cal figures, which are drawn in the usual manner, as indicated in fig. 117.

The drawing need only be plan and elevation.

Method.—Plane up the wood true to the required dimensions, *i.e.* $2\frac{1}{8}$ ins. by $1\frac{3}{16}$ in., and gauge two lines on the face, one $\frac{1}{8}$ in. and one 2 ins. from the face edge. This gives two lines running down the length of the wood $1\frac{1}{2}$ in. apart and $\frac{1}{8}$ in. from either edge.

Taking one line as the base and the other as the limit of

height, draw in the various geometrical figures with compass and pencil, using the blade of the try-square as a straight-edge. Now with the try-square and chisel cut lines over the pencil lines already made. Gauge lines $\frac{1}{4}$ in. deep on each edge.

The figures being now marked, saw them all out down to the gauged line just made—in the case of the hexagon and octagon, saw away from the cut lines $\frac{3}{8}$ in. Pare out the waste between the figures horizontally, and the hexagon and octagon will have

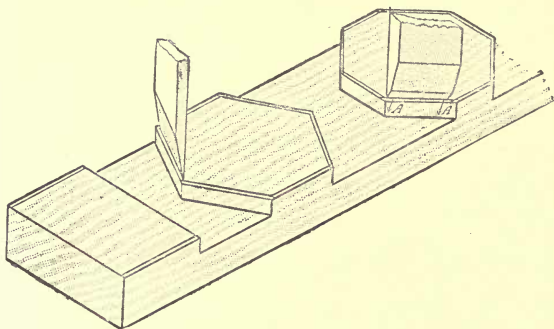

FIG. 118.

to be pared vertically to take off the $\frac{1}{8}$ in. which was purposely left on to give a little practice in this form of paring.

The chisel (fig. 118) should be held vertically, with one hand round the handle, and the other to guide the blade; it should be pressed downwards, and with a certain amount of shearing action at the same time, in the direction of AA in fig. 118. The whole of the waste should not be removed at the first cut, but several strokes should be given, and a good clean surface left.

The $\frac{1}{8}$ in. at the top and bottom of the figures first gauged is not removed with the chisel but planed away by edge planing.

Timber used.—Yellow deal, or preferably some hard wood, as sycamore, 1 ft. long by $2\frac{1}{4}$ ins. by $\frac{3}{8}$ in. to be cut out of a board.

Drawing.—The plan and front or side elevation, or the isometric projection.



FIG. 120.

Method.—In marking out on a board of sycamore the gauge, owing to the irregularities of the edges of the wood, cannot be used. The pencil, square, and straight-edge, therefore, take its place.

If the timber is some market form of a soft wood—*e.g.* a

yellow deal batten or board—the dimensions should be first tested for accuracy with the rule, and 1 foot marked off with rule, square, and pencil, from one end, and entirely across the board. On the line drawn, measure and mark $2\frac{1}{4}$ ins. + $\frac{1}{4}$ in. for waste in planing, and the same distance at the end.

The timber is now ready for sawing out, though if hard wood, with irregular edges, is used, a line must be marked off to make supposititious edges, and the irregularities outside afterwards sawn off.

Saw the wood either entirely across along the pencil line, or as far as the limits of the piece required for the exercise.

The operator should stand as in fig. 120, the wood across two sawing stools.

With a panel saw not too much 'set,' the pupil should stand with the back of the saw, the right hand, elbow, shoulder, and eye in a line, so that good steady strokes can be taken well from the shoulder. The thumb is used as with the tenon saw, to steady the blade as it enters, and the strokes at first should be firmly but lightly made.

In sawing, the edge of the blade should make an angle of about 65° with the ground. If the angle is less, the length of the cut is commensurately increased, and the physical effort becomes too much for the average boy. For this reason thin material is used in this exercise. The thicker the wood, or the greater the slope of the saw, the greater the difficulty of sawing it square to the surface line, and this is a common fault with beginners, and must be carefully watched both by pupil and instructor.

Having sawn the wood across, put the right knee on the board or the piece cut off, and saw down the pencil line to get the required piece of wood for the model (see fig. 121). An alterna-

tive plan is to put it in the vice and saw it vertically, as shown in fig. 122.

Plane or true up the wood with the jack plane, or if this is



FIG. 121.

not in first-class condition, with the trying plane, as there is really no dissimilarity in the manner of using them.

The wood is of ample length to make the model, so square a cut line across each end and cut off the waste outside it, sawing $\frac{1}{3\frac{1}{2}}$ in. outside the line. Now plane off this $\frac{1}{3\frac{1}{2}}$ in. with jack plane.

This is rather a difficult operation, but if the following directions are observed it becomes comparatively easy. It should be done again if the attempt is not successful at first, as there is enough waste in the middle of the wood to permit of this.



FIG. 122.

First cut off one corner with the chisel and place the model against the stop of the shooting board and the plane on its side against the end grain, as in fig. 123, the cut corner being away from the pupil. This will ensure the safety of the end fibres,

which otherwise would certainly break out in planing. The iron in end planing should be set fine. Having made the ends true, draw the back and shelf on the wood. From one end mark a cut



FIG. 123.

line to indicate the length of the back, and from the opposite end another to give the length of the shelf. On the portion allotted for the shelf draw the two slots. First square a line over on both sides with the pencil, at the same distance from the end as the

depth of the slot, and mark with a gauge the sides of the slots on both sides of the wood.

On the back draw the groove to take the shelf with cut lines, and mark off all the chamfers at the corners. Gauge the depth of the groove to take the shelf, and cut it out as in Exercise I. Saw down the slots a little inside the gauged lines and mortise out the waste with a small chisel, then pare away what is left from the saw, as in Exercise V. If the pupil has not sufficient strength to mortise by hand, he should give a few blows on the end of the chisel handle with the mallet. Pare off the chamfers at the corners, as in Exercise V., completing the corner first cut off. Saw off the shelf with the tenon saw, and cut off the back, leaving $\frac{1}{2}$ in. to be planed off, as in the case of the open ends. Finish the chamfering of the back. Draw and mortise the square hole in the back by which to hang the model up. Make a large gimlet hole in the middle of the little square to be removed.

When the chisel is struck this hole affords an escape for the yielding fibres, and if it did not exist, the model would probably be spoiled by splitting.

Before putting the back and shelf together, a shaving may be taken off the face side of the former, but if the model is cleanly made, this may not be necessary.

Hold the shelf in the position it is to occupy, and with a small gimlet make the two screw holes through the back and into the shelf.

The screws should fit tightly, but the holes should be large enough to allow the screws to go in without much force being employed.

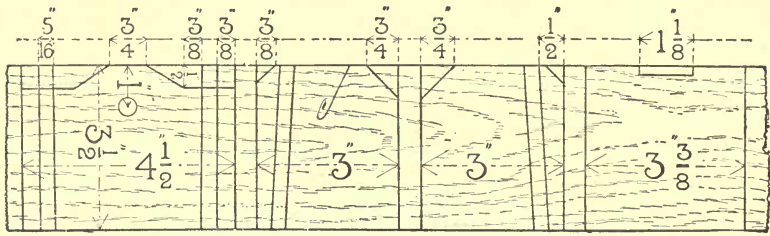

Development.

The mark on one of the sides is a lead-pencil tick made to distinguish the face from the opposite side.

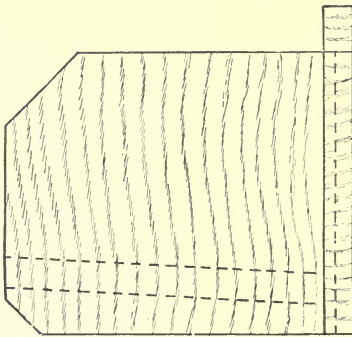

Side elevation.

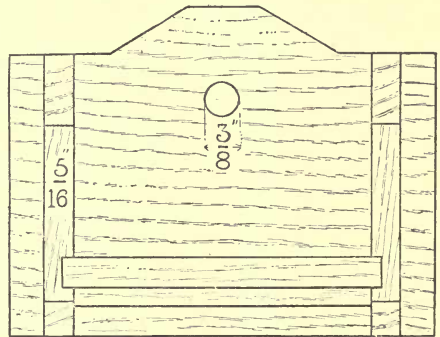

Front elevation.

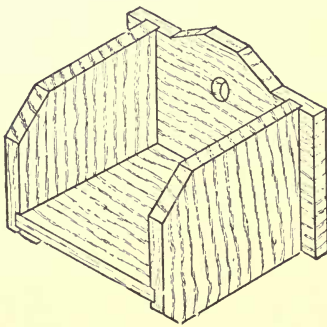

Isometric projection.

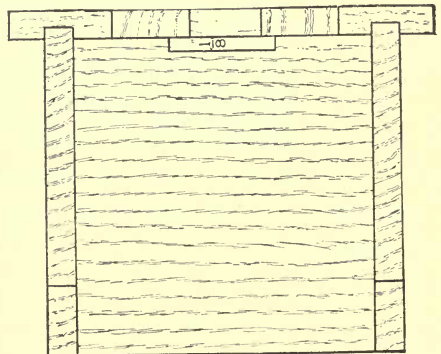

Plan.

MODEL II.—A SOAP BOX. Fig. 124.

SAWING WITH HAND AND TENON SAW.—PLANING.—HORIZONTAL AND VERTICAL PARING.—BORING AND NAILING.

Tools used.—Hand and tenon saw, jack plane, $\frac{1}{4}$ -in. and $\frac{3}{4}$ -in. firmer chisels, bradawl, hammer and square, brace and $\frac{3}{8}$ -in. centre bit.

Timber required.—A piece of yellow deal 1 ft. 4 ins. long by $3\frac{3}{4}$ ins. by $\frac{1}{2}$ in., cut from a board with a hand saw, as in Model I.

The drawing of this exercise may be either the development of the parts, or the plan, front, and side elevation. In the case of the more apt pupils, the isometric projection may be made instead of the plan, elevation, and side elevation, but the development must be made.

Having executed the drawing, prepare the wood by planing it up to the dimensions. When true, a line should be made across at, say, $\frac{1}{4}$ in. from one end.

Saw off the small portion outside this line, leaving $\frac{1}{8}\frac{1}{2}$ in. to be removed. Plane away this small amount, cutting off one corner with a chisel first, and leave the wood true and square to the cut line. Draw on the wood or 'set out' the development, as in fig. 124. Square cut lines over the face for the width of the back and the depth of the sides.

It will be noticed that the two sides are right and left handed, the groove being in one case on the left and in the other on the right hand side.

Make cut lines to indicate the grooves, and on both the face edge and the opposite edge, gauge a line $\frac{1}{8}$ in. deep opposite the marked grooves, to indicate their depth. Draw lines from the

face edge of the back $\frac{1}{2}$ in. long to the angles of the top of the back, and mark the horizontal lines with the gauge, and the inclined lines with a pencil. With a fine sharp pencil mark out the corners of the sides which have to be cut off.

It will be found better to cut out the grooves now before sawing the back, sides, and bottom apart, as the large piece of wood is easier to handle than the separate smaller pieces.

Saw down in the grooves to the gauged lines on the edges and pare out the waste with the chisel, as in Exercises I. and II. Now saw the back, sides, and bottom apart, leaving $\frac{1}{32}$ in. on both sides of each piece, to be planed away in finishing, or the pupil would find himself with the alternative of finishing his model under the dimensions, or of leaving portions of it rough sawn. Plane up these sawn edges in the shooting board.

It will be noticed that the bottom of the box slopes towards the back, to allow the moisture to drain towards the slot. The back edge of the bottom, therefore, must be bevelled with a plane so that it fits against the back.

Saw down from the back edge of the bottom $\frac{1}{8}$ in. as marked, and pare out the waste to make the slot, as in fig. 124. Now turning to the sides, saw off the corners, leaving the pencil lines just in, and remove these by vertical paring with a $\frac{1}{2}$ -in. or $\frac{3}{4}$ -in. chisel, as in Exercise V., or put the piece of wood in the vice and pare off the small amount of waste. Now with the tenon saw cut out the pieces to be removed in the top of the back, and pare down to the pencil line, as in the case of the corners of the sides.

If the hands of the operator are clean, as they always should be in doing neat work, the model will not be much soiled. However, if it is necessary, glass-paper may be lightly used, and care

should be taken not to destroy the sharp corners and edges so indicative of good work.

Bore the hole in the back to hang the box up by, with a $\frac{3}{8}$ -in.

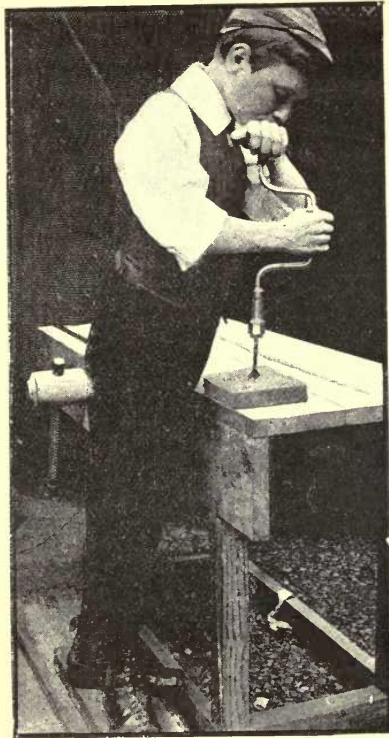

FIG. 125.

centre bit. Fig. 125 shows the operation, which is simple, only requiring care in placing the pin of the bit in the centre of the drawing of the hole, and in holding the brace firmly upright.

When the point of the bit appears through the back, stop boring, and finish from the reverse side.

The object of this is to prevent the back of the wood being splintered as the cutters of the bit come through, which would be very likely to happen.

Now put the model together, putting the sides into the back grooves, and the bottom into the side grooves, and in this order.



FIG. 126.

To hold the bottom into its place, it is nailed from the sides, and three holes are bored with a bradawl to take the nails, as shown in the isometric projection.

Hold the bradawl, as in fig. 126, with the blade at right angles to the grain of the wood, and in boring push the tool continually, and at the same time keep up a succession of twisting movements alternately to right and left, with the stem of the bradawl as a

pivot, making about one-sixth of a revolution at each turn. Should the blade of the bradawl be pressed in the least out of the vertical position, it will be liable to snap off.

Hold the brads in the finger and thumb, as in the illustration (fig. 127), and the hammer as shown, taking care to grasp it at the

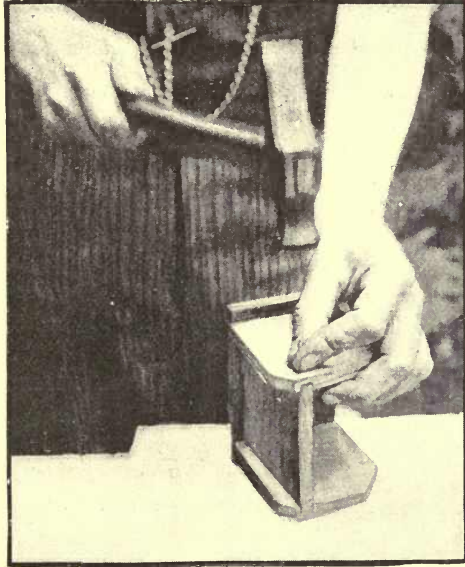

FIG. 127.

end of the handle. Tap the head of the nail, which should be an oval steel brad about 1 in. long, and having entered it, take away the supporting fingers, and drive the nail in by a succession of good square blows, which should not be too hard.

When the head is nearly level with the wood, the punch and hammer should be used to drive it still further in, so that it is just beneath the surface.

MODEL II.—A SMALL BRACKET. FIG. 128.

This is an alternative and slightly easier model than the preceding.

A piece of yellow deal $14\frac{1}{2}$ ins. long, $5\frac{1}{4}$ ins. wide, $\frac{3}{4}$ in. thick will be required. No change is necessary in tools used, except in the size of the centre bit, which should be $\frac{1}{2}$ in.

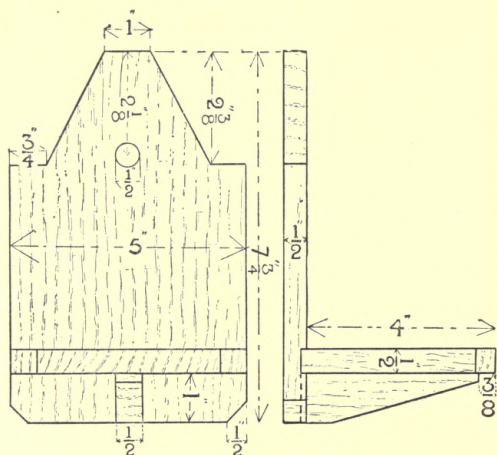

Front elevation.

Side elevation.

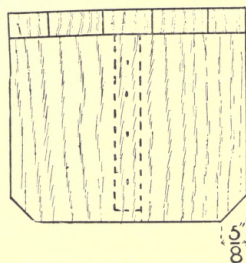

Plan.

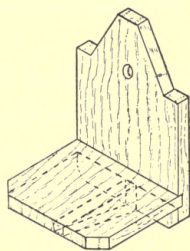

Isometric projection.

FIG. 128.

The drawings on the paper should be the usual orthographic projections, as in fig. 128.

The isometric projection is hardly necessary, as the very simple shape of the model is clearly brought out in plan and elevation, but it is given to make the drawing complete.

The wood should be first planed, and the development of the figure drawn on it, as in fig. 129. The lengths of the shelf and bracket and the limits of the grooves should be marked with square and chisel, and the remainder of the outline with a pencil. As much as possible of the work should be done before the several portions of the model are cut apart.

Commence by sawing off the waste at the end, then proceed to plane the end up true, having cut off one corner to prevent the breaking out of the end fibres. The groove for the shelf may now be made (to a gauge line $\frac{1}{8}$ in. deep). Do not cut the shelf and back apart at this stage, as the whole piece should now be put into a vice and the bracket support and the sloping sides of the top sawn down along the dotted lines, as in fig. 129, with a hand saw.

The model should now be taken from the vice, and the shelf, the shoulders of the back, and the small triangular piece of waste at the top, cut off with the tenon saw. The shelf is complete, but the lower end of the back must be finished up in the same way as the end of the shelf, and the small groove, with the grain, for the back of the bracket support, should now be pared out.

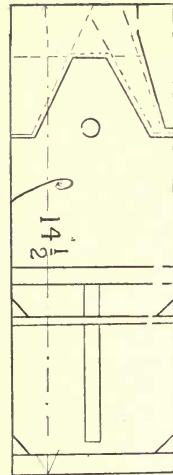

FIG. 129.

Notice the tick made to indicate the face side.

Fig. 130 shows the paring of the inner angle of the top of the back. This should be done in the vice, and the piece then taken out and laid flat, while the remainder of the waste left on from the saw is vertically pared off, as in fig. 131. The small flat top to the back should also be completed in this way. The bracket

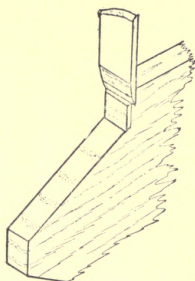

FIG. 130.

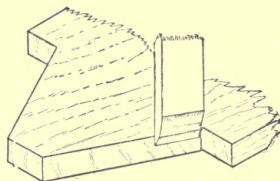

FIG. 131.

support should now be finished with plane and chisel, and before putting the parts together in their finished form, the hole in the back should be bored and the nail holes in both back and shelf made with a bradawl.

Similar nails to those for Model II. should be used.

MODEL II. B.—A LETTER OR ENVELOPE CASE. FIG. 133.

This is another model which may be taken instead of Model II.

The wood required is a piece of bass-wood, yellow deal, or some hard wood, $14\frac{1}{2}$ ins. by $5\frac{1}{4}$ ins. by $\frac{3}{8}$ in. thick, and another small piece $5\frac{3}{4}$ ins. by $2\frac{1}{2}$ ins. by $\frac{1}{2}$ in. for the bottom.

First draw the orthographic projections in fig. 132, or, if preferred, the isometric projection (fig. 133) can be made instead.

The wood having rather larger surfaces than in any previous

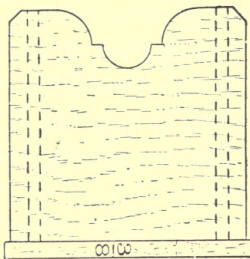

Front elevation.

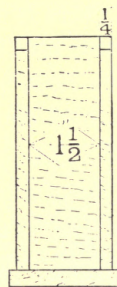

Side elevation.

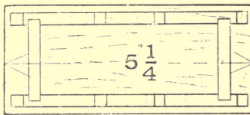

Plan.

FIG. 132.

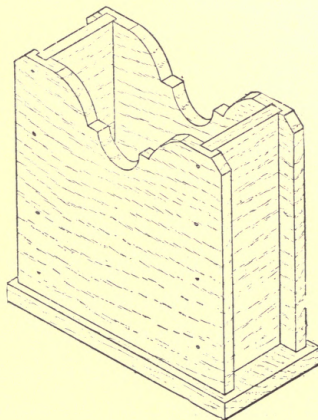

Isometric projection.

FIG. 133.

exercise, there is a little greater difficulty in planing it true in both length and breadth, but this will probably not be insurmountable now, as some practice in planing has already been obtained, and enough material— $\frac{1}{8}$ in.—has been allowed to be planed off in the preparation of the wood, to give the pupil an opportunity of making a true surface, without planing the wood thinner than the dimension in the drawing.

Having planed up the large piece of wood, mark out the parts of the model on it completely, as in fig. 134. The curved top is here shown on the inside, but the pupil should draw it on the back, opposite to where shown. The drawing is made to show the curve on the inside merely to save an illustration.

First plane one end true, however, as an accident in breaking

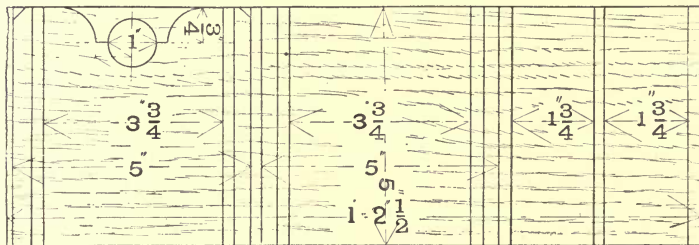

FIG. 134.

the grain will not then have such a bad effect, as a fresh end can then be made from which the markings can be set out; but if the cut lines are all made to indicate the grooves, and an accident to the end grain then happens, the wood is either spoiled or a new series of cuts for grooves, a little further in from one end, must be made, the abandoned lines disfiguring the model very much. The ornamental curves on the top of the front and back have only to be set out on one side, as after the grooves have been pared out

and the sides cut apart, the two with ornamental tops should be tacked together, as in fig. 135, and the concave curve—a semi-circle given by a hole bored with a 1-in. centre bit—made through both pieces of wood, while the wood is held tightly down. Saw out the greater part of the waste with a tenon saw. The convex curve is obtained by vertical paring, and as it will probably not be perfectly true from the chisel alone, the flat surface of a file or a piece of glass-paper can be used, to render it quite smooth.

Chamfer off the top corners of the back and front, and having bored the nail holes, they will be finished.

The wood for the base of the case is $\frac{1}{4}$ in. larger in each

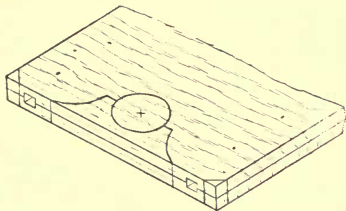

FIG. 135.

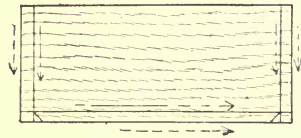

FIG. 136.

dimension than it is required to finish, and it must be completed with sharp corners. One edge is first planed true, and in order to avoid the liability of breaking out the grain, the corner is cut off, but in the waste, outside the cut and gauged lines indicating the limits of size. After planing both ends the remaining long side may be shot true to the gauge line, and the base is finished to its proper dimensions. Fig. 136 shows clearly how the cutting of the corner is managed, and the direction in which the planing is done is indicated by arrows.

In nailing the sides together, oval steel brads about $\frac{3}{4}$ in. in length should be used, but for the bottom about ten 1-in. brads

will be found quite enough. Before nailing the bottom on, the sides should be fastened together, and placed on the back of the base, as in the plan, and a pencil line round the outside will give the outline of the bottom of the sides. With this as a guide the holes for the nails can be bored with a bradawl.

MODEL III. FIG. 137.—A RACK FOR BUTTON-HOOKS,
KEYS, ETC.

FRESH TOOLS USED.—TRYING AND SMOOTHING PLANES AND BEVEL.

Material required.—A piece of bass-wood $14\frac{1}{2}$ ins. by $2\frac{1}{2}$ ins. by $\frac{3}{4}$ in. and a strip of some darker-coloured wood, say walnut or mahogany, 1 ft. by $\frac{7}{8}$ in. by $\frac{1}{4}$ in., and a similar strip of some light-coloured wood, such as sycamore, for the ribbon pattern, to afford a contrast. The beads on the top and bottom should be made from a piece of walnut or bass-wood, 13 ins. by $2\frac{1}{4}$ ins. by $\frac{3}{8}$ in.

The drawing to be made on paper should be the full elevation, the vertical section, and the plan and horizontal section. The enlarged detail of elevation need not be drawn, it is inserted to make the drawing clearer.

Plane up the large piece of wood true to $2\frac{1}{4}$ ins. width. Some care is required in planing this piece of wood true, as much depends on the good surface to be obtained. To assist in doing this the jack plane should not be much used, but the latter part of the planing should be done with the more reliable trying plane. From the face edge gauge two lines, one at $\frac{1}{8}$ in. and the other at $2\frac{1}{8}$ ins. distance, down the whole length of the wood, as seen in fig. 138. Now, with the aid of the set-square set the bevel to 60° , and take care then, to screw the blade up tight. Commence about $1\frac{1}{2}$ in. from the end, and mark a cut line com-

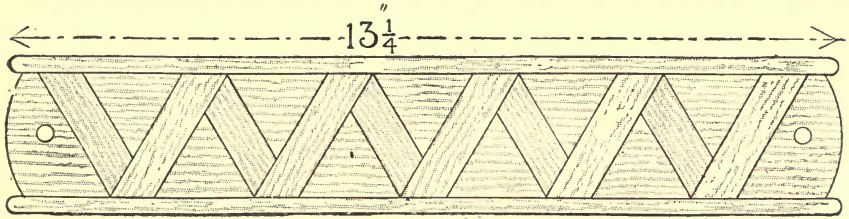

Elevation.

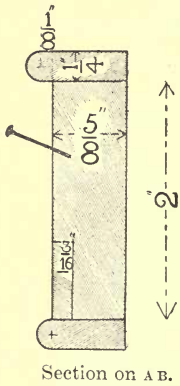

Section on A.B.

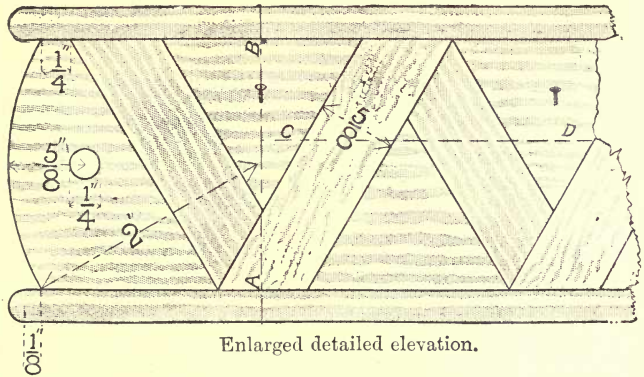

Enlarged detailed elevation.

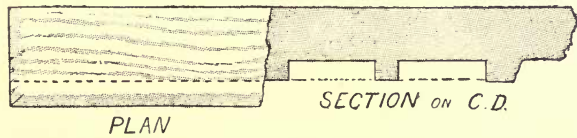

PLAN

SECTION ON C.D.

FIG. 137.

pletely across the wood (see fig. 138) in the manner shown in the illustration (fig. 139). Set out projectors $\frac{5}{8}$ in. long from this cut line, and make another parallel cut line with chisel and bevel.

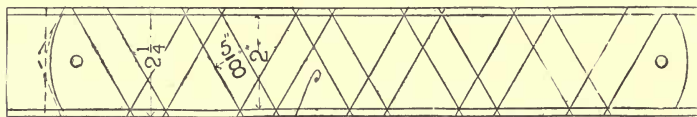

FIG. 138.

From the points where the cut lines cross the gauged line $\frac{1}{8}$ in. from the face edge, the next pair of inclined lines can be made by reversing the bevel, and in this way the whole of the lines can be drawn.

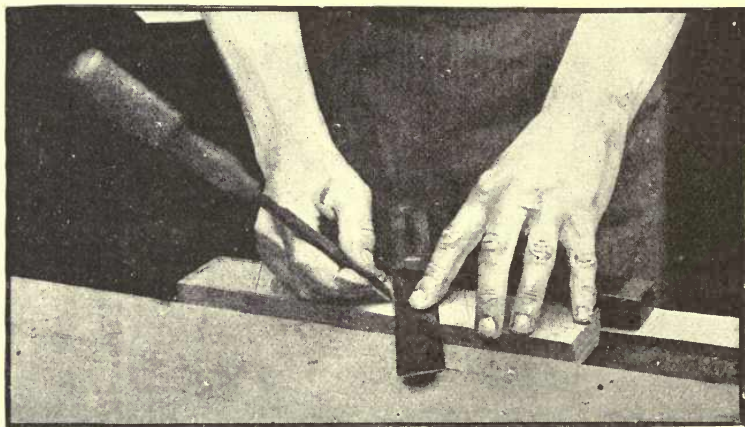

FIG. 139.

It must be borne in mind, however, that they must all be drawn from the face edge, and only the outside edge of the bevel blade should be used to mark against. Now gauge the depth of the grooves $\frac{3}{16}$ in. full, on both edges, and saw out all the parallel

grooves in one direction, keeping about $\frac{1}{3}\frac{1}{2}$ in. inside the lines, but do not touch the others at present. Cut out the grooves very carefully by horizontal and vertical paring, making them as smooth as possible. Now take the two similar strips of walnut and sycamore and shoot them true to dimensions ($\frac{5}{8}$ in. by $\frac{3}{16}$ in.) and try the dark-coloured piece in the grooves to see if it fits. When satisfactory in this respect it can be cut up into pieces which will quite fit the grooves—though it will be noticed from the drawing of the complete model (fig. 137) that triangular pieces at the ends are afterwards removed to make room for the full-length strips of sycamore.

The walnut strips can now be glued in, taking care to squeeze out the glue well, and the model may be left till dry.

This will take about eight hours, and consequently it must be left till the next lesson.

On resuming, complete the marking of the remaining grooves by finishing the old cut lines across the dark inlaid strips, and cut them out with the tenon saw, as in the first set of grooves. Glue in the light-coloured strips after preparing the material in the same way as before. Now the difference in length of the coloured strips gives them somewhat the appearance of a bent ribbon in alternate light and shade.

Plane the edges of the model when dry down to the gauged line $\frac{1}{8}$ in. in from the edges (fig. 138), and as slight irregularities in the face surface will probably exist, just run the trying plane over, to 'flush' it down, putting a little linseed oil on the face of the plane to assist in removing any small projecting pieces of hard glue.

The model should now be reduced to the proper thickness, $\frac{5}{8}$ in., by planing the back down, with a jack and trying plane.

Draw the curved ends of the model on the wood, and at the same time mark out the centre of the hole at each end.

With the tenon saw cut off the waste outside the extreme limits of the ends, and then saw off small pieces of the waste at various angles, as in fig. 138, in order to roughly give the curve, which may then be further completed by vertical paring, and if not absolutely true, the flat face of a file may be used to finish it.

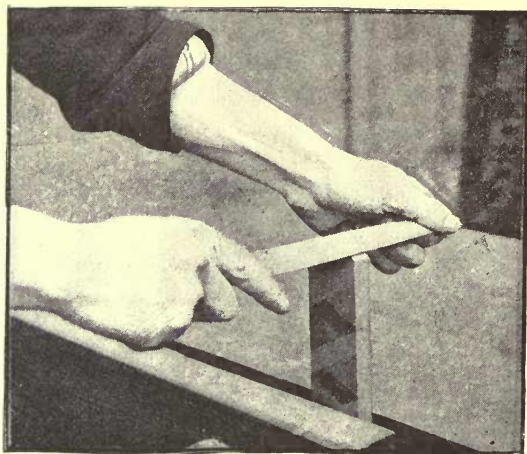

FIG. 140.

In filing care must be taken to give good, long, steady, horizontal strokes, using almost the whole length of the tool, and grasping the front end with the fingers of the left hand, as in illustration (fig. 140), the wood being screwed up in the vice. Now bore the two holes by which the model is to be suspended.

Though the face was 'flushed' down with the trying plane, it may now be rendered as smooth as a plane can make it, and the smoothing plane is introduced to do this. If the iron of the

plane requires adjustment or sharpening, it can be loosened or removed by tapping it on the rear end with a hammer, as in fig. 141, while the plane, irons, and wedge are held in the hand somewhat in the same way as the jack plane; and except for this peculiarity of tapping the back end, instead of the nose of the plane, in loosening the irons, there is no great difference in their

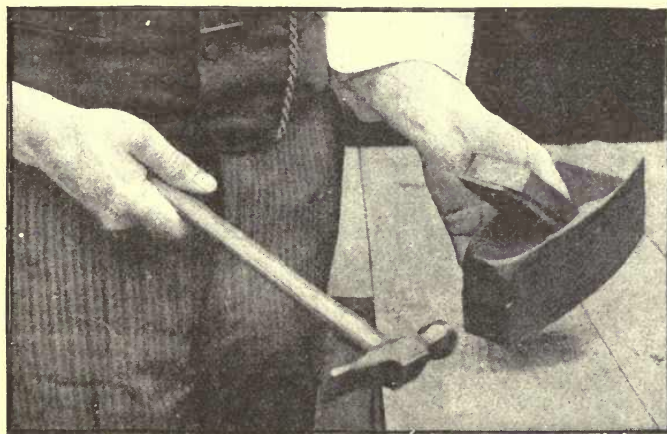

FIG. 141.

preparation for use. The smoothing plane is always set as fine as is possible.

The smoothing plane not having a handle must be grasped firmly with both hands, which should hold it very tightly down on the wood to be planed, as in fig. 142.

There is a liability for beginners in using this plane to give short spasmodic strokes, but it must be borne in mind that this plane, like the others already taken up, should be used with good free strokes extending the whole length of the wood. After the smoothing plane has been used, there might still be almost im-

perceptible imperfection from the planing. A piece of very fine glass-paper may be folded round a piece of smooth cork, and rubbed up and down the face to remove these imperfections, but



FIG. 142.

this should not be relied on, as it is of small value as a tool, and should not be resorted to as a means of covering defects in prior work. Indeed, no amount of glass-papering can ever do this.

Now turn to the remaining strip of walnut and shoot this

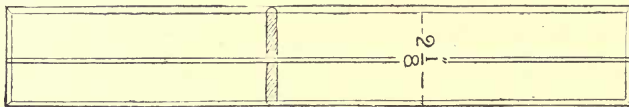

FIG. 143.

true to dimensions. It will be noticed from fig. 143 that both beads are obtained by cutting this strip in halves, but first round the edges with the jack plane and the ends with the chisel, and then finish them with file and glass-paper. These rounded edges,

it will be noticed, are $\frac{1}{8}$ in. deep, and the limits of the curve should be marked with a pencil and thumb-gauge before commencing.

It must not be overlooked that the top bead projects $\frac{1}{8}$ in. more than the bottom. Mark out the depth of these beads with the gauge, allowing a shade over the dimensions, $\frac{7}{8}$ in. from one side and $\frac{3}{4}$ in. from the other. This allows a trifling waste to be planed down afterwards, but in order to obtain a little more as a precautionary measure, saw down between the two gauged lines.

Now glue the strips on in their proper places—*i.e.*, the top strip projecting $\frac{1}{4}$ in. and the bottom one $\frac{1}{8}$ in., and nail down also, with $\frac{3}{4}$ -in. oval steel brads. Three nails through each piece will be sufficient, and care should be taken to drive them in between the ends of two grooves, where the substance is in one piece, or otherwise some of the strips might be disturbed. Finish off the model by planing the back down flush, and put in the nails to carry any articles which may be hung on them. These nails should be of brass, and about $1\frac{1}{2}$ in. long. One should be driven into the middle of each of the top row of equilateral triangles, and in order that anything put on them may be held more securely, they should be put in 10° out of the upright—*i.e.*, the stem should make 80° with the surface.

Be careful to make the angles of inclination of the nails similar, and to drive them in to the same depth, so that a good even row of nails appears.

Carelessness in putting in these nails may mar the appearance of a model which might be very well finished in every other respect.

MODEL IV. FIG. 144.—A PLANING EXERCISE.

Tools required.—Trying plane, jack plane, square, gauge, centre bit.

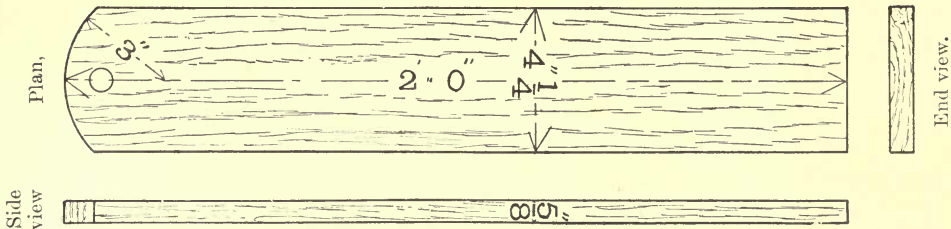

FIG. 144.

This is a very simple model, given to enable the pupil to get some practice in planing a larger piece of wood than has been

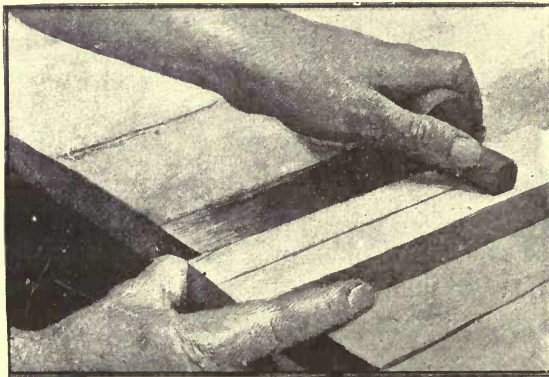

FIG. 145.

previously attempted. A piece of wood 2 ft. long, 4 1/2 ins. wide, and 3/4 in. thick will be required, and after planing it true to

dimensions with jack, trying, and smoothing planes, the end curve should be made as in the previous model, and the hole bored by which the board is to be hung.

In gauging the width of this model on the wood, an alternative method of gauging may be taught. Fig. 145 shows this form of gauging. A spare piece of wood may be given to the pupil to practice on. Hold the wood in the right hand, pressing the further end against the bench stop, and gauge with the left hand.

MODEL V. FIG. 146.—PLANING IN THE DIRECTION OF THE GRAIN TO A PRISMATIC FORM.

Tools required.—Compass, thumb-gauge, jack plane, trying plane, and tenon saw.

The illustration here given shows a regular hexagonal prism, but this particular form need not necessarily be adhered to.

Take a piece of yellow deal of about $1\frac{1}{2}$ in. square in section, and a little more than a foot long, and plane it up true to the dimensions of the rectangle which encloses the figure in the drawing, with a jack and trying plane. Cut off one end square with the faces, and on it draw the chosen polygon in the manner shown in fig. 146. With thumb-gauge and pencil draw lines from the angles made by the side of this polygon, completely down the length of the wood, and join the points made by the extremity of these lines at the other end of the wood, and a second

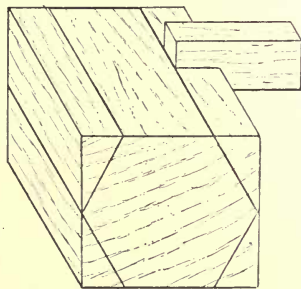

FIG. 146.

polygon, similar to the first, will be obtained. The portions to be removed by edge planing will now be indicated. Fig. 147 shows the manner in which this is done. Two small pieces of wood are screwed up in the vice and act as stops to the wood to be planed. This is not screwed in the vice, but fixed in between the two stops.

The fingers of the left hand cannot in this exercise rest on

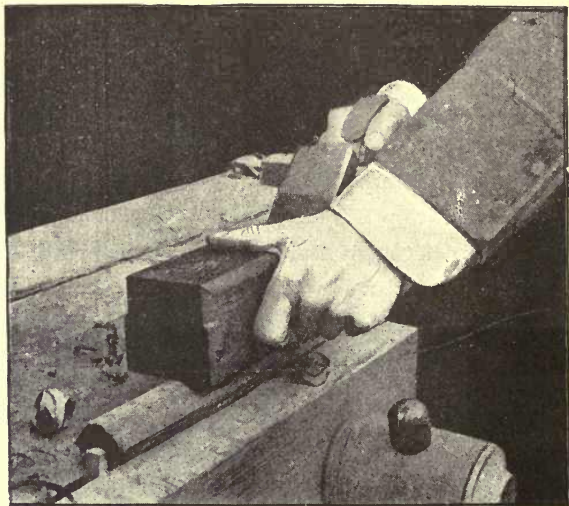

FIG. 147.

the wood below the face, but are doubled up for safety, yet the position of the hand is still useful in guiding the plane. The manner of holding the plane in surface planing, with the fingers gripping the other side of the tool, will not be found advisable now, as the action of the arm in the forward stroke is not so well calculated to send the plane in a straight line. In the present case, moreover, the surface to be planed is very small,

and sufficient downward pressure can be given with the thumb alone.

If an octagonal prism is made the angles may be removed successively and the form gradually made rounder, till it can be

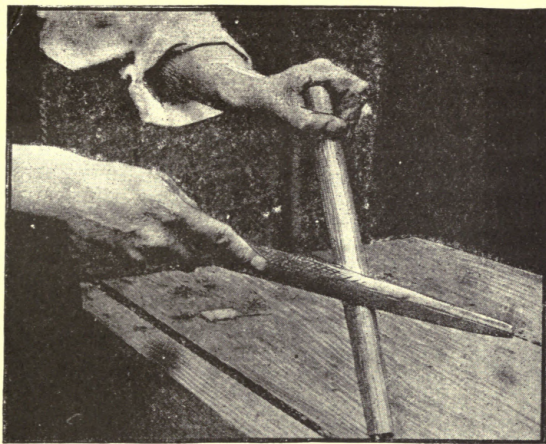

FIG. 148.

finished into a ruler with a file, as in fig. 148. As the file is steadily pushed across the wood, the model itself is turned with the other hand against the file, so that the surface is acted on by turning both the wood and file simultaneously.

MODEL VI. FIG. 149.—AN ELLIPTICAL MAT.

The new tools in this exercise are the bow saw, and spokeshave.

Gauging, edge and face planing, glueing, sawing with bow saw, and edge modelling with spokeshave are involved.

Having drawn the mat (not necessarily in isometric projec-

tion), two pieces of wood of contrasting colours should be cut up into the required lengths. To produce a pleasing effect to the eye not fewer than seven strips should be made, and even numbers should be avoided for the same reason.

In cutting up the strips, it should be remembered that the outer bands are shorter than those in the centre.

No dimensions are given, as the model can be made to any size, but we will assume that the wood is $1\frac{1}{2}$ in. wide and $\frac{3}{8}$ in thick.

Plane up the strips true, taking care not to remove too much

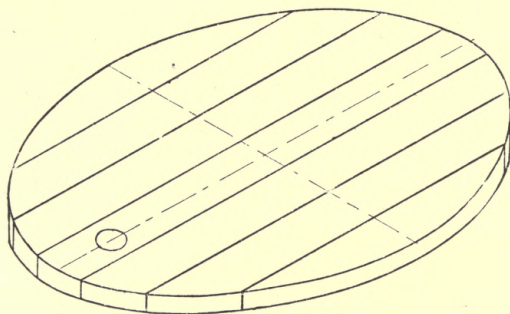

FIG. 149.

material. This planing, and, indeed, all the work of this exercise, should be very carefully done, as a new and somewhat difficult form of jointing is taken up.

The use of the shooting board is now introduced. The construction of the shooting board is too difficult for a beginner to attempt, because it must be accurate, or it is useless.

It is described on pp. 339-40, and when sufficiently advanced the pupil who may require one can make it himself; but at this

stage it is assumed that a teacher will always make these boards for the class.

Place one of the light-coloured strips on the board, face downwards, with one end against the stop and with the edge projecting about $\frac{1}{4}$ in. over the ledge. Lay the plane on its side, and hold it firmly against the edge of the wood to be planed, which should be pressed down with the outspread fingers of the left

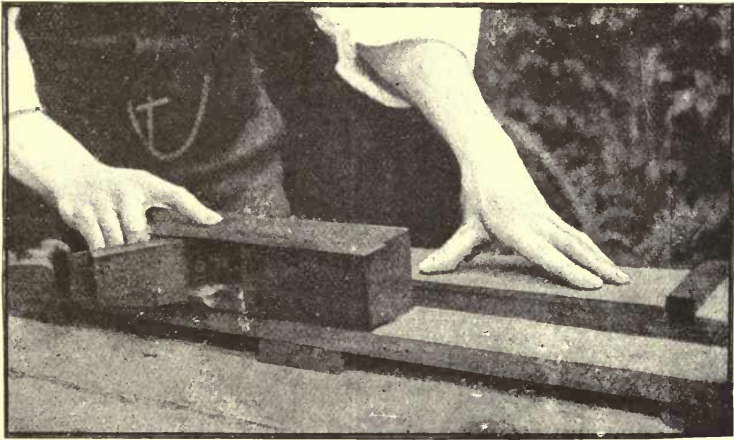

FIG. 150.

hand (see fig. 150); and when the plane is pushed forward, as in fig. 151, it is of the greatest importance that it should be still kept close up to the wood along its entire length. There is a tendency to push the heel of the plane slightly outward, as it is sent forward, and this should be carefully avoided, as it will result in planing away too much at the further end of the wood.

Plane up both edges of all the light-coloured strips in this way, keeping all face downwards on the board while being planed,

and then shoot the edges of all the dark-coloured strips similarly, but with the face side of each piece upward while being planed.

The reason of this is that a shooting board or plane rarely gives a perfectly true right angle, though when tested by ordinary methods both the plane and the angle of the shooting board may appear correct; and if all the strips were planed with the face

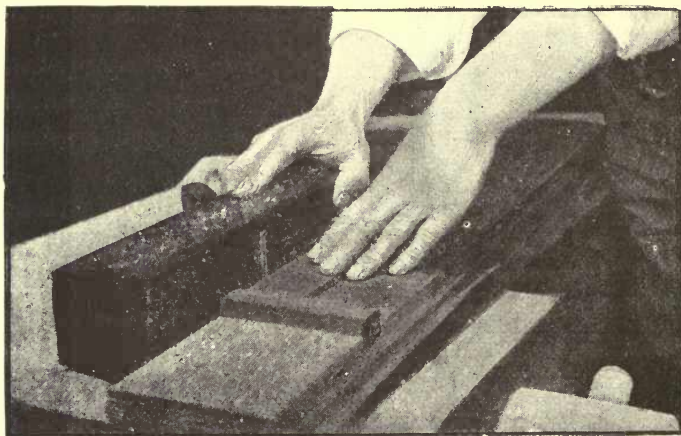

FIG. 151.

upwards, the amount of error would be multiplied by twelve, for both sides of each of the six joints would be affected.

The joints would be properly made, it is true, but the infinitesimal error on each side of the six joints, would result in a noticeable curve, either concave or convex, in the face of the completed mat. The plan of reversing the strips in the manner described entirely avoids this danger, and necessarily gives equally good joints.

In glueing up the strips, take care to rub the glue well out,

and join them first in pairs, and then glue the pairs of strips together. Before glueing, make a cleat in which to clasp the model. The cleat should be a strip of wood about 2 ins. wide, with two blocks nailed on it, a little further apart than the extreme width of the model. Insert at one end two wedges from opposite sides, as in fig. 152. These, when driven in fairly

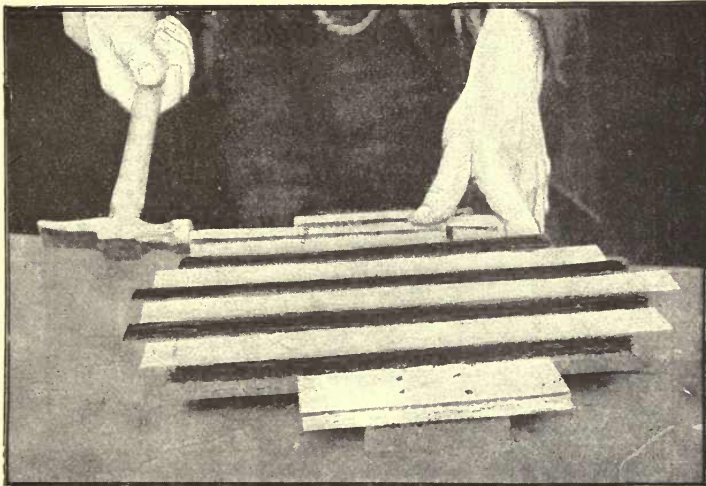

FIG. 152.

tight, will tighten the joints, and the model can be left to dry.

When the model is again taken up, the small projecting pieces of glue should be removed with a few strokes of a jack plane, and the ellipse drawn on the surface. Before using the bow saw, take care that the blade is true, for as the handles can be turned round in their sockets at will, it is possible that in adjusting the saw, the blade may be twisted, and of course

will not then cut at all well. Stretch the blade almost up to the breaking point of the back string, by turning the lever.

In using the saw, grasp it with both hands, as shown in fig. 153, and keep the saw moving with perfectly horizontal strokes, or otherwise the two sides of the cut will not be similar. In the model now being made cut in to the pencil line, at any point, and then saw the ellipse completely out, leaving about $\frac{1}{8}$ in. of waste

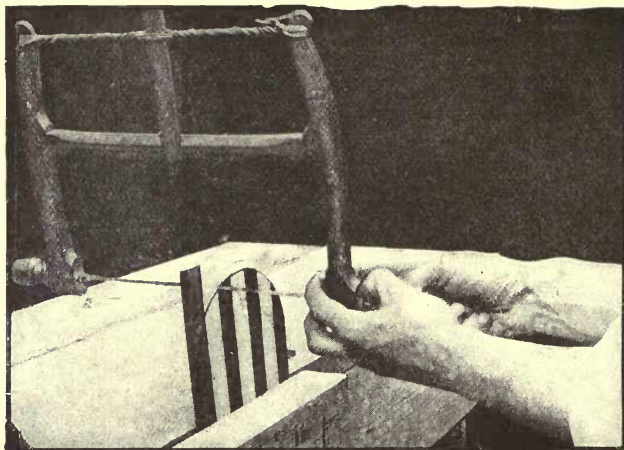

FIG. 153.

on, outside the line. This waste is to be removed with the spokeshave, as the saw would leave too rough a surface.

The spokeshave, and, in fact, any cutting tool, should, when in use, cut away from the operator. There are several reasons why this rule should be adopted. The safety of the operator, and the additional power and command when pushing any tool as compared with the reverse pulling action being the chief. Hold the spokeshave as in fig. 154, and in a horizontal position.

The surface is curved, and in pushing the tool forward make it follow the curve of the ellipse as far as possible, and do not attempt to make any part of the edge perfectly true at first, but work steadily round, removing all the irregularities, and so make a fairly even surface then go over the whole of the work again and render it quite smooth. After making the edge true, take the model out of the vice and put it on a panel board.

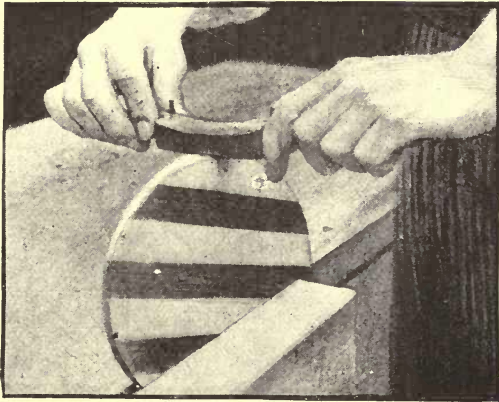

FIG. 154.

board is described on p. 340, and it is enough to say here that, as several small pieces of thin wood have to be tacked down to act as stops, the use of this board will save the top of the bench from being injured by nailing. Place the model against the stops and make the whole surface quite smooth with trying plane and smoothing plane. Complete the model by boring the hole in the end.

EXERCISE VI. FIG. 155

SAWING, EDGE SHOOTING, AND BORING.

First make the drawing of the exercise, and in doing this, all the polygons as shown need not be adhered to, but it is very important that the square should be made, though the boring in the square can be omitted at the discretion of the teacher.

A piece of yellow deal or bass-wood 1 ft. $3\frac{1}{2}$ ins. or more in length, $4\frac{1}{4}$ ins. wide and $\frac{3}{8}$ in. thick, will be required. Plane it

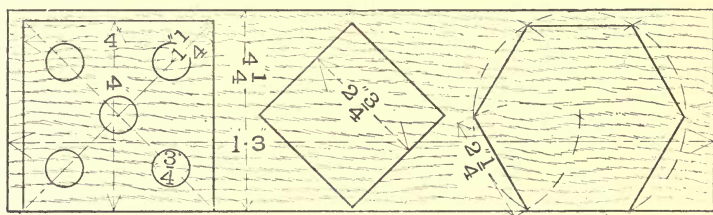

Plan.

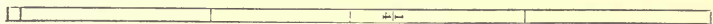

Side elevation.

FIG. 155.

up with jack and trying planes true on both sides, and on the face edge. Now set out the figures in pencil, and afterwards mark cut lines over the lead-pencil ones, using a straight-edge or the blade of a try-square for the inclined lines, and the marking gauge for the side of the square and hexagon parallel to the edge. The remaining sides of the square should be marked with chisel and try square.

Saw out the various polygons with the tenon saw, keeping

$\frac{1}{2}$ in. from the line, and then plane all the edges down to the cut lines, with jack or trying plane, using the shooting board, as in fig. 123, p. 170. Take care not to plane against the grain in shooting the edges, as splitting at the corner farther from the operator will take place.

MODEL VII. FIG. 156.—A LETTER RACK.

FACE AND EDGE PLANING, BORING, AND SCREWING.

The drawing of this model should be made to scale $\frac{1}{2}$, and should include the elevations of back and side, and the projected elevation of one of the sloping fronts (a practical illustration of change of ground line).

Two pieces of some hard, close-grained wood, as sycamore or walnut, are required, one $13\frac{1}{2}$ ins. by 4 ins. by $\frac{3}{8}$ in., and one $13\frac{1}{2}$ ins. by $3\frac{1}{4}$ ins. by $\frac{3}{8}$ in.

Plane up both faces of each piece true to dimensions, and shoot the edges of the narrow piece for the fronts, down to its width—3 ins.

The face edge of the wider piece should be planed up true, but as little wood as possible should be removed to attain this. The plan of the back shows the section of the chamfered fillet, which afterwards makes the groundwork on which the shelves are to be screwed.

From the face side, gauge the width of the back, the $\frac{1}{8}$ in. for waste between the back and the fillet, and the $\frac{1}{2}$ in. for the width of this fillet. Now plane off the back edge of the wood down true to the last made gauged line, and chamfer off the next $\frac{1}{2}$ in. with the jack and trying plane to the required angle— $22\frac{1}{2}^{\circ}$, testing the work with the bevel set at that angle. When the

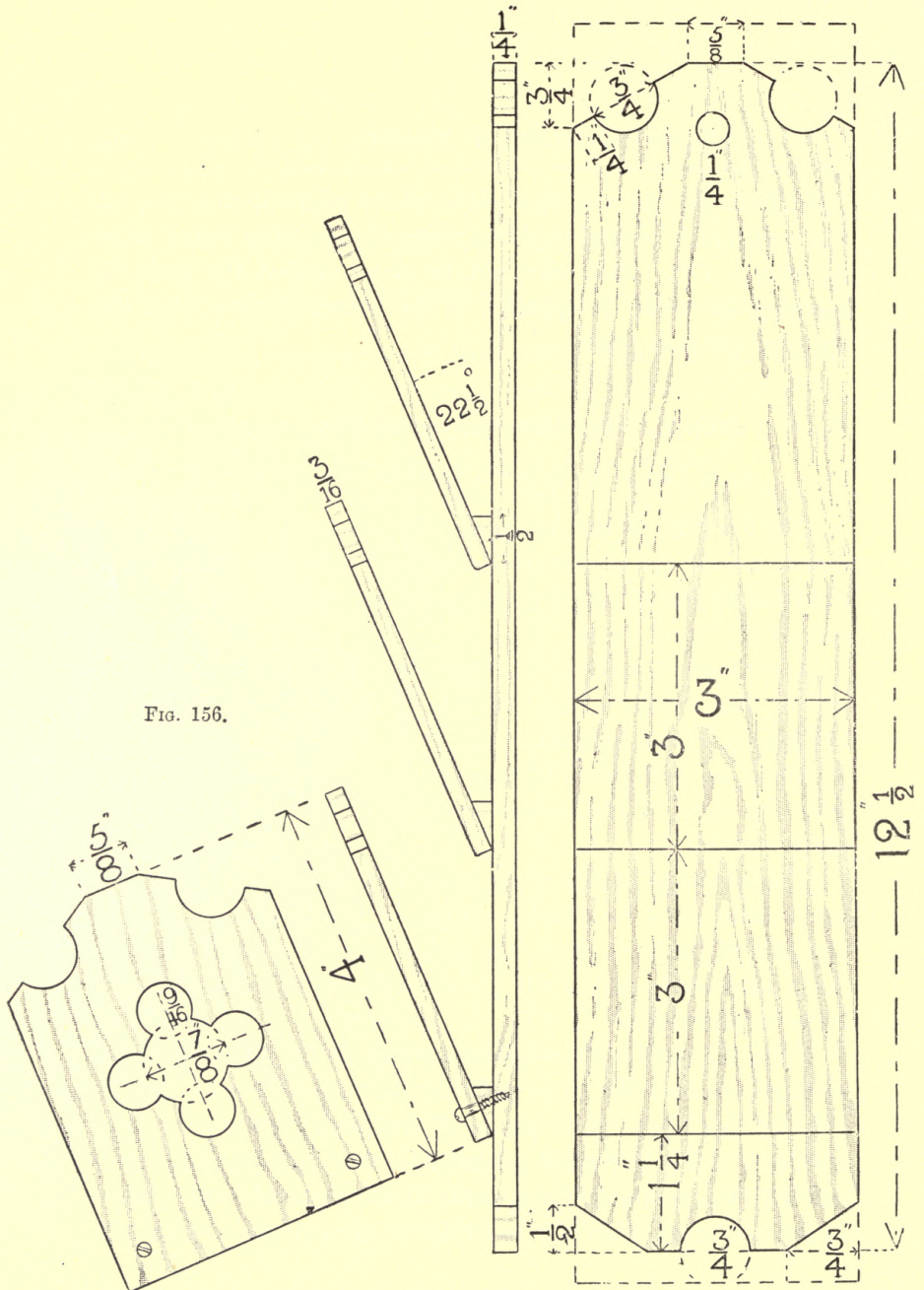

FIG. 156.

Side elevation, with projected front.

Elevation of back.

Plan of back, showing section of chamfered fillet

chamfering is correct, saw off the fillet with the panel or tenon saw, and then plane the rough edge true in the shooting board. The edge left rough from the saw cut on the back should now be planed down true to the dimensions—3 ins., and will now agree with the other piece of wood for the fronts.

Draw on the back the outline of the top and bottom. The circle and semicircles where the boring is to be done need not be made, as if the centre is carefully indicated in its proper place, the bit will create the proper curve as it cuts. Material enough has been allowed for waste at each end, and also in the piece from which the sloping fronts are to be made, as will be seen in the drawing (fig. 157), showing the manner of setting out the fronts. The tops of the fronts are not dimensioned, but they are similar to the top of the back.

To find the centres of the five bored holes which make the design in the middle of each front, draw a faint, short, gauge line, down the middle of each of the pieces, make pencil lines across each, and cutting the gauge lines at the centre of each piece of wood. From these centres the four points which give the other centres of the four holes to be bored can be obtained.

Now bore all the holes in both back and fronts before cutting the latter apart, boring partly from each side in order to avoid breaking the fibres by the pressure. Cut off the fronts, plane the bottom edges true and square, and saw off the corners of both

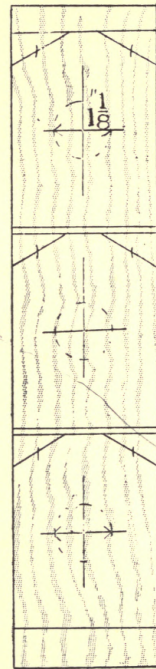

FIG. 157.

back and fronts a little away from the cut lines. Pare with a chisel back to the lines so as to leave a clean edge.

Cut the fillet up into the required lengths—3 ins., and glue a piece to the bottom of the back of each shelf. While waiting for these joints to dry, clean up the face and opposite sides of the back with a smoothing plane, and finally just touch up the surfaces with glass-paper, to make them dead smooth. Cut lines, to indicate the points where the fronts meet the back, should now be made, and the three fronts can be screwed on when dry, using $\frac{5}{8}$ -in. brass-headed screws (trade size, No. 3), as shown in 'side elevation of projected front,' if it is desired to give the finished model a good appearance.

MODEL VII. *a*. FIG. 158.—ANOTHER LETTER RACK.

This model is really very similar to the last, and the cleverer boys of a class may make it instead of the preceding one.

Two pieces of oak or bass-wood, one 1 ft. 5 ins. long, $4\frac{3}{4}$ ins. wide, and $\frac{3}{8}$ in. thick, and one 1 ft. 4 ins. long, $4\frac{1}{4}$ ins. wide, and $\frac{3}{8}$ in. thick, will be required, and the model should be made in the manner described for Model VII.

The large curves on the rack fronts and at the bottom of the back should be cut with the bow saw, and finished by vertical paring and filing. The small triangular holes should have a small hole bored in each first, and then be pared clean with a $\frac{1}{4}$ -in. chisel.

Fig. 159 shows the setting out of the fronts.

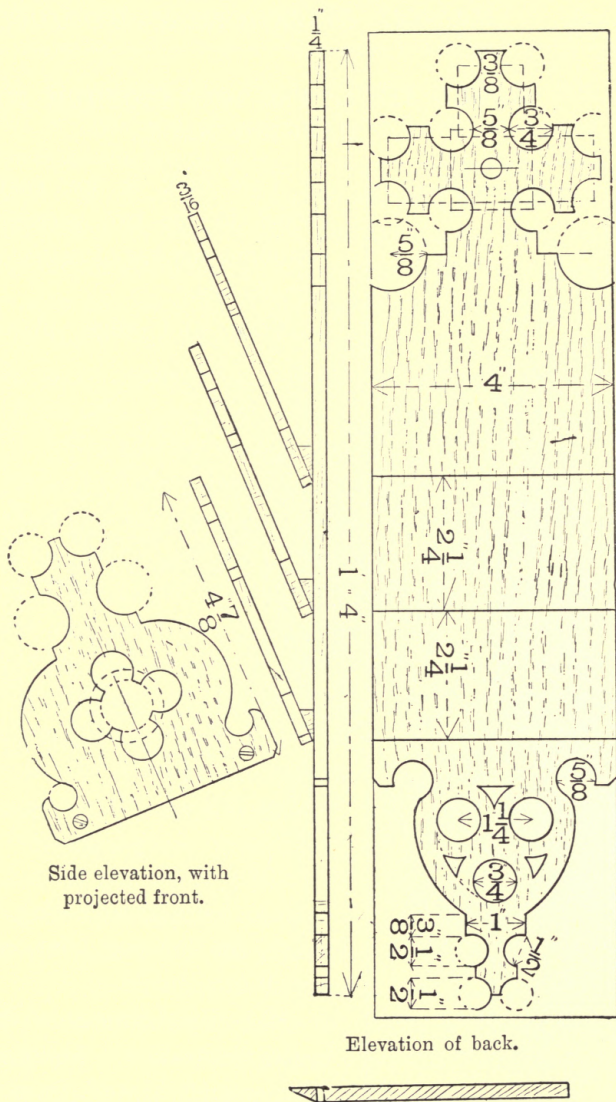

Plan of back, showing chamfered fillet.
 FIG. 158.

MODEL VII. *b.* FIG. 160.—ANOTHER FORM OF HANGING RACK.

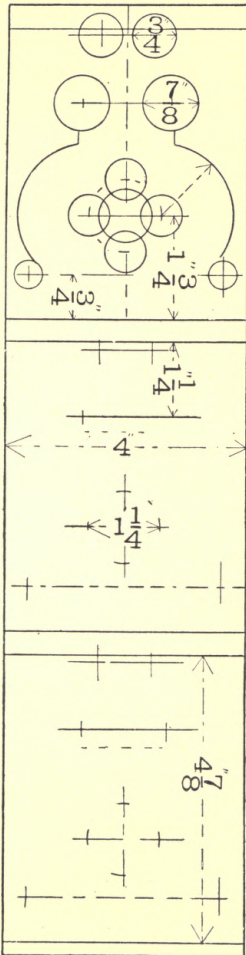
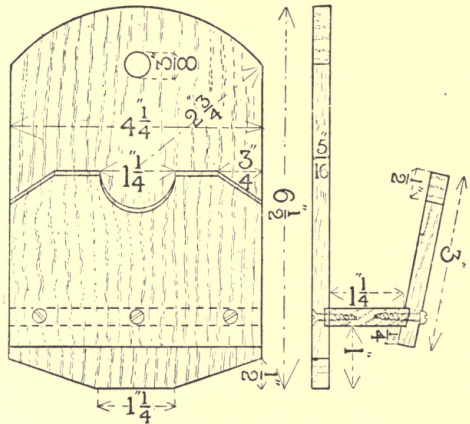

FIG. 159.

This rack is an easy alternative model to the two preceding ones, but combines the use of rather a large number of tools.

Face and edge planing, sawing,



Front elevation.

Side elevation.

FIG. 160.

paring, boring, modelling with spoke-shave, the housing joint, and screwing are all introduced.

Make the drawings of this model as in the illustration. These will be found quite enough to work from.

Two pieces of wood will be required,

one $10\frac{1}{2}$ ins. by $4\frac{1}{2}$ ins. and $\frac{3}{8}$ in. thick, if made in oak or ash, or $\frac{1}{2}$ in. if made of deal, and one $4\frac{1}{2}$ ins. long, $1\frac{3}{4}$ in. wide, and the same thickness as the larger piece.

Make the wood true on both faces and edges, with the jack and trying planes, and then set out the back and the sloping front on the large piece in the same manner as in the previous models ; but, in order to economise the wood, draw the curved top of the back at one end, and the top of the front with the hole, afterwards to be reduced to a semi-circular curve, at the other end (see fig. 161).

Now bore the two holes and cut off the waste outside the end of the front. Shoot the edge true, and cut off the corners to the dimensions by vertical paring. Turn to the other end of the piece, and screwing the wood in the vice, cut out the curve with a bow saw, and finish with spokeshave. Mark cut lines to indicate the grooves, and saw and pare them out to $\frac{1}{8}$ in. deep. Note that the groove in the front should be cut in at an angle of say 80° to the surface. Now cut the front and back apart, and model the bottom of the latter with the jack plane, using the shooting board.

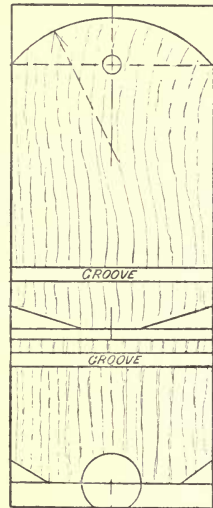

FIG. 161.

The small piece of wood for the shelf may now be planed up to an extreme width of $1\frac{1}{2}$ in., and one edge then bevelled off slightly, to fit the slot in the front. Put the model together, and with a very small bradawl carefully bore the holes for the screws from both back and front, and then screw the parts together, using No. 3 or No. 4 $\frac{5}{8}$ -in. screws—flat-headed in the back and round-headed ones through the front, for the sake of appearance.

EXERCISE VII. FIG. 162

SIMPLE PARQUETRY.—EDGE SHOOTING AND USE
OF SMOOTHING PLANE.

The drawing of the plan shows only one side of the long diagonal covered by the thin pieces of the parquetry, but the other side is left blank merely to reveal the foundation of yellow deal. In the bench work the whole surface should be covered, and the alternation of colours by the arrangement of dark and light-coloured strips repeated on the blank side. Observe that the opposite angles of the rhombus must agree in the arrangement of colour.

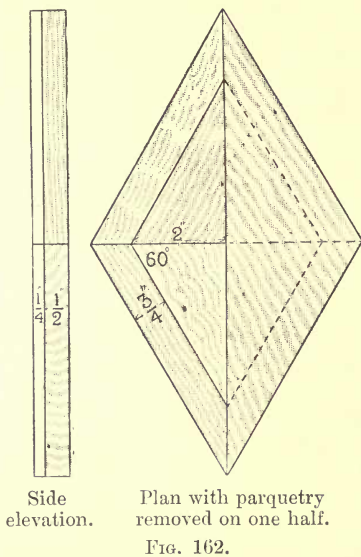

The parquetry can be made very effectively of mahogany $\frac{3}{8}$ in. thick, and sycamore, or some woods giving good colours.

It is not advisable to specify the precise dimensions of the wood required to make the base of this exercise, as much waste

would arise in cutting up the timber, which may be avoided by sawing out the diamond-shaped pieces, having sides about $6\frac{5}{8}$ ins. long, for several models, from a board $5\frac{3}{4}$ ins. wide.

The drawing shows the grain of the wood running parallel to the edge, and if the wood is cut up so as to give this result, the

appearance of the complete exercise is much better than if it is not attended to.

A strip of mahogany 2 ins. wide, planed to a thickness of $\frac{5}{16}$ in. and of 2 ft. or 3 ft. in length, may be cut up into small tri-



FIG. 163.

angular pieces, as in fig. 163, and to the dimensions shown, two being required for each exercise. A similar strip of sycamore may be cut up in the same way to give the light-coloured inner triangles.

The outer fillets may be cut from long strips of mahogany and sycamore 1 in. wide, and planed up true to $\frac{5}{16}$ in. thickness,

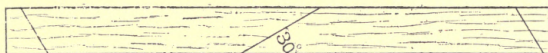

FIG. 164.

in the same manner as shown in fig. 164. The edges of the fillets should now all be planed true and parallel.

Take a triangle of mahogany and a fillet of sycamore, or *vice versa*, and prepare them for jointing by planing the edges in the same way as for the elliptical plate, pp. 197-8. Glue them together, simply rubbing them till the glue 'sets,' and then lay the jointed piece aside, and glue the remaining pieces together in the same way—they need not be cleated while drying. Now true the face and opposite sides of the deal base of the parquetry,

but do not touch the edges yet. When the glue of the joints already made is quite dry, clean off the rough pieces of glue with a jack plane, and place one of the triangles on the shooting board against a stop screwed down at an angle of 30° to the edge, as in fig. 165; plane off the side true, using the plane in the direction of the arrow, to avoid breaking the joint already made.

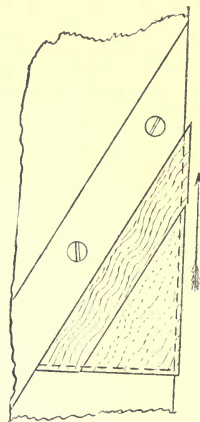

FIG. 165.

Shoot the remaining three triangular plates on the same edges, and test the accuracy of the angles by placing three of them together in the angle of a try square, lying flat on the bench, when, of course, they should exactly fill the right angle between the blade and stock.

If the result of the testing is unsatisfactory, the shooting board may be regarded as in error, and the stop should be taken off and rescrewed to the board, as may be required to make the angle correct. Having made the 30° angles of each piece, take off the stop and screw it down again at 60° to the edge, and in the same way as before, plane up the 60° angles of the pieces.

The method of testing the accuracy of these angles is to place three of them together and try the outside edge with a straight-edge. If any error is apparent, re-adjust the stop on the board and plane the strips up again till correct.

When all the inner right angles of the triangles are made, place them together to test finally the accuracy of the joint of the whole plate, and presuming they are correct, as they should now be, proceed to glue the pieces down on the surface of the wood

one at a time, taking care to leave a margin of the deal foundation projecting all round, and the inner joints true and close, with no dark lines of glue showing. There is no need to wait for the drying of each piece before glueing down the next. They may be put down immediately after each other.

Fig. 166 shows the glued up exercise, with the projection of the foundation all round.

Into this ledge nails are driven a little distance, as shown, as close as possible to the edge of the parquetry, and as they are driven in, these will tighten up the joints and serve instead of a cleat, the use of which is not practicable in this exercise.

When the joints are quite dry, the nails should be withdrawn and the outside edges shot true with the wood screwed up in the vice.

The shooting board may be used for this edge planing, but boys are frequently not strong enough to do the work well in this case; and having greater power over the plane as it is ordinarily used, the pupils should be allowed to screw the model in the vice and shoot the edges in the usual way.

The model being now practically finished, clean off the glue with the jack plane, and then finish up true and smooth on both sides and edges, with trying plane and smoothing plane.

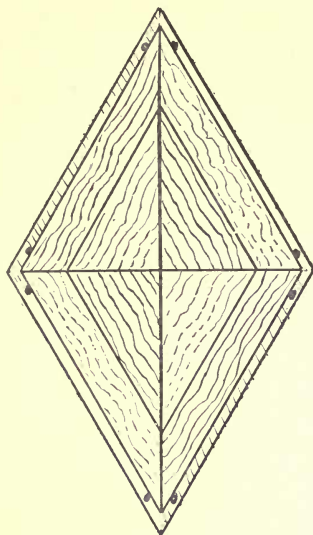

FIG. 166.

EXERCISE VIII. FIG. 167

THE ANGLE BRIDLE, OR OPEN MORTICE AND TENON JOINT.

A fresh tool—the mallet—is introduced in this exercise.

The drawing should be an isometric projection of the finished joint, but with the small projection of the tenon cut off smooth.

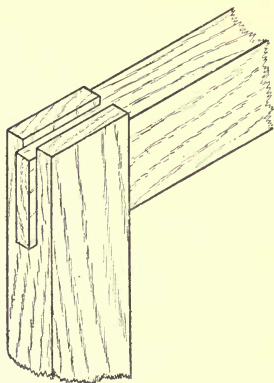

FIG. 167.

A piece of yellow deal, $1\frac{3}{4}$ in. by 1 in. and 1 ft. long, will be required, and should be planed up true to $1\frac{1}{2}$ in. by $\frac{7}{8}$ in. Mark with a square and pencil completely round one end at the depth of the mortice, $1\frac{5}{8}$ in., as at A in fig. 168, and at the other end a cut line, B, at a similar distance from the end, for the tenon. The reason of this is, that the cut line will be obliterated in sawing out the shoulders of the tenon, but, on the other hand, it would not do to mark outside of the mortice

cheeks with cut lines, as they would spoil the appearance of the joint when put together.

In setting out the wood, as in fig. 168, the mortice and the tenon should be $\frac{1}{4}$ in. thick. This will allow for cheeks $\frac{1}{16}$ in. thicker than the mortice, and will provide for sufficient strength in both the mortice and the tenon. The general rule is to make the mortice a third, or a little less than a third, of the thickness of the wood.

There are two ways of marking out the mortice and tenon. If the marking gauge is used, take a chisel nearest in size to

the width of the required mortice—in this case $\frac{1}{4}$ in., place the edge in the centre of the mortice and parallel to the end, and, with a blow of the mallet on the chisel handle, stamp a cut line

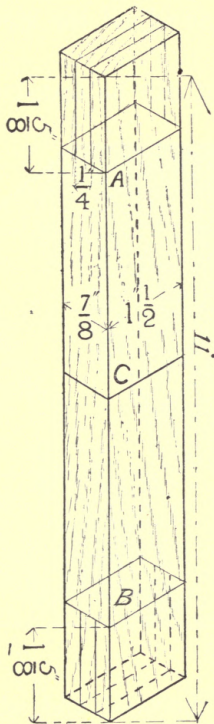

FIG. 168.

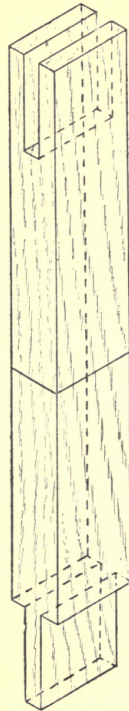

FIG. 169.

which will serve as an index to the gauging of the parallel lines of both mortice and tenon. Set the marking-gauge to the end of the stamped line, nearest the face side, and gauge a line to the end, across the end, and down the back edge to the pencil line.

At the other end, gauge corresponding lines for the tenon. Reset the gauge to the other end of the stamped line, and gauge similar lines to those first made; at both ends.

The other plan is to use the mortice-gauge. First set the teeth of the gauge to $\frac{1}{4}$ in. apart, and adjust the stock to $\frac{5}{16}$ in. from the nearest tooth.

The accuracy of this adjustment can be tested by trying it

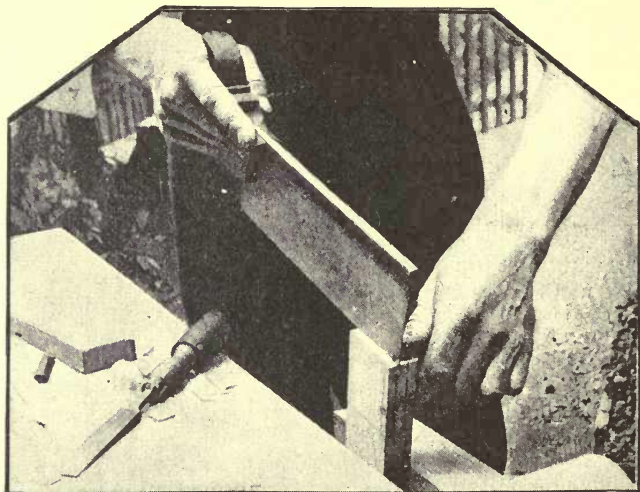

FIG. 170.

from the face and opposite sides of the wood, and, when satisfied that it is correct, mark out both mortice and tenon.

Great care must be taken in sawing out the shoulders and mortice, as in fig. 169, to ensure a well-fitting joint. Commence to saw, as in fig. 170, of course, cutting just outside the lines if the tenon end, just inside them if for the mortice. In sawing, it is as important that the cut of the saw

should be true on the back edge as on the top and face edge, which can be seen while guiding the saw.

To ensure a true cut on both front and back edges, let the saw gradually assume the positions shown by the dotted lines

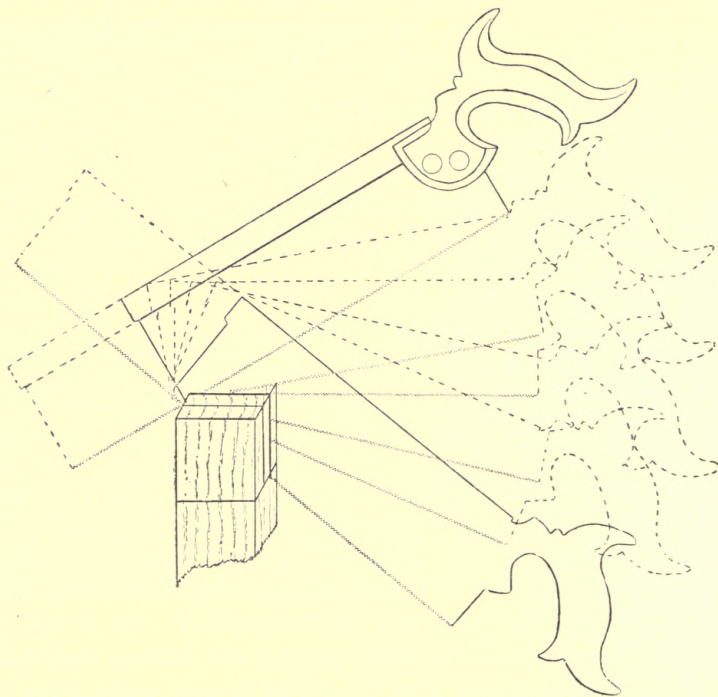

FIG. 171.

in fig. 171, till the depth on the face edge is reached. When both cuts on the face edge have been sawn in this manner, turn the wood round in the vice, and finish the cuts from the back. Those on the face edge now act as guides, but this time

the strokes of the saw should be horizontal, as shown in fig. 172.

When the mortice and tenon are sawn down in this way, the shoulders of the tenon can be cut with the tenon saw, and the mortice completed by removing the core. Hold the $\frac{1}{4}$ -in. firmer chisel vertically, near the end of the mortice, and give the end of the handle a rather smart blow with the mallet, grasping both tools as shown in fig. 173. Do not attempt to drive the chisel

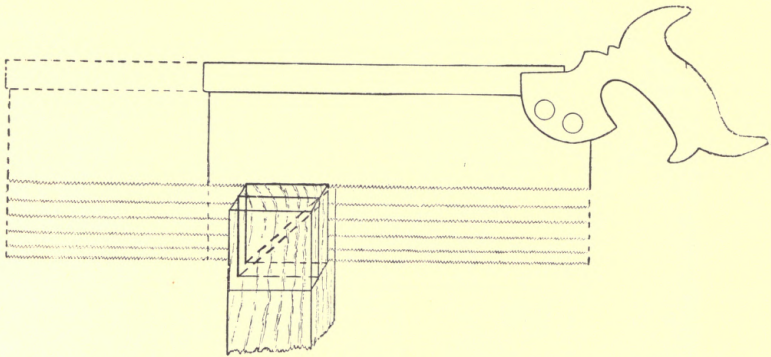

FIG. 172.

completely through when commencing. After making one vertical cut about $\frac{3}{8}$ in. deep, so that the chisel is just driven in, but can be easily removed, make another cut further away from the end of the mortice, with the chisel sloping away from the body. This cut removes a small wedge-shaped piece of waste, and the next blow, with the chisel held vertically and a little closer in towards the end of the mortice, sinks deeper into the wood. The next cut should be a little further out, and will make the wedge-shaped pit deeper and larger. Fig. 174 shows the effect of the alternate vertical and inclined cuts. The waste, or 'core,' will

work out in pieces after each blow, and the chisel should be used as a lever with the inclined side of the cut as a fulcrum, to assist in its removal.

After mortising about halfway through, finish from the

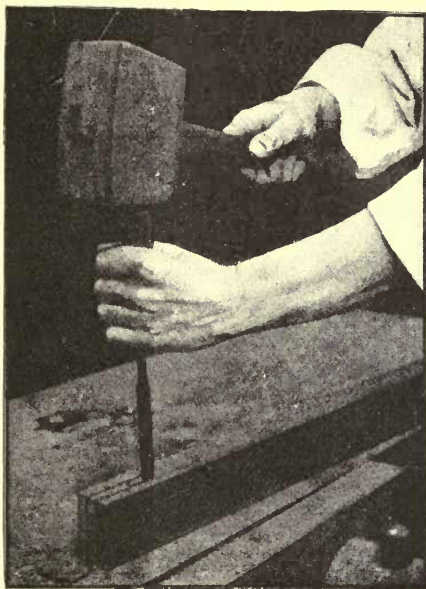

FIG. 173.

reverse side, and finally pare the end of the mortise quite smooth, but do not touch the sides, which should give a true fit from the saw, and the shoulders of the tenon also should not require any paring. Indeed, it may be re-

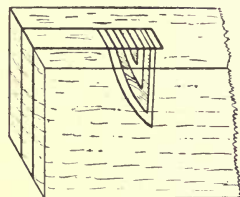

FIG. 174.

garded as a general rule that a joint which does not fit from the saw alone is to some extent a failure.

Besides the obvious desirability of performing the sawing as accurately as possible, and so saving time and trouble in using another tool, there is this important objection to paring—viz., the smooth surface left by a chisel does not hold the glue so well as does the slightly rough surface of the saw cut.

Now cut the wood in halves at *c*, fig. 168, and put the joint together, as shown in fig. 167. As a consequence of the depth of the mortice and tenon, $\frac{1}{8}$ in. of both mortice cheeks and tenon will extend beyond the joint. These projections should be removed by edge planing from the corner of the joint inwards. The fibres would be broken out if the planing were done in the opposite direction. The faces of the joint should be cleaned off with the smoothing plane, but no glass-paper should be used.

MODEL VIII. FIG. 175.—A LAMP OR VASE STAND.

Face and edge planing, angle bridle joint, parquetry laying, and blocking are involved. No fresh tools are required to make this model.

The drawing should include all those in the illustration to give a correct representation of all the dimensions of the model.

Four pieces of wood 7 ins. long and 1 in. square will be required for the outside framing. These may be in two colours, or all of the same wood.

The grain in the pieces of parquetry runs parallel to the edges of the square, and the opposite triangles being of the same wood, two rhomboidal slabs, one of mahogany or walnut, and one of sycamore or bass-wood, will be required, $6\frac{1}{2}$ ins. in length on the greater sides, but in cutting them out, as in previous exercises, timber can be saved by sawing each rhomboid successively from a plank of the correct width, $3\frac{1}{8}$ ins. and $\frac{1}{4}$ in. thick, using the bevel set at 45°

The base of the parquetry should be a slab of yellow deal $\frac{1}{2}$ in. thick and $6\frac{1}{2}$ ins. square. The blocks to support the slab are made from a strip of any common wood $\frac{1}{2}$ in. square.

Having planed all the wood true, the framing had better be made, and as each side will have a mortice at one end and a

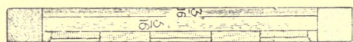

Section on A B.



Side elevation.

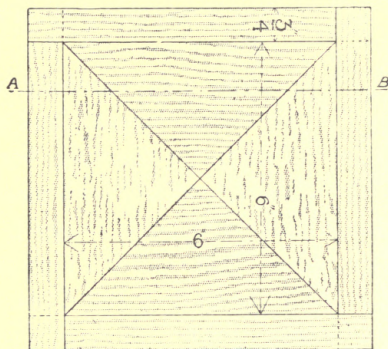

Plan.

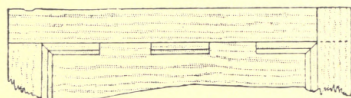

Plan of portion of back.

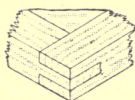

Isometric projection of joint at the angle of the framing.

FIG. 175.

tenon at the other, they can be all held together, and made of absolutely equal length by squaring a cut line across close to

each end, marked on the face side. Note the face-mark in the illustration (fig. 176). Mark a cut line at one end and a pencil line at the other, to give the depth of mortice and tenon; when the joints are fitted together, the sides will be of equal length.

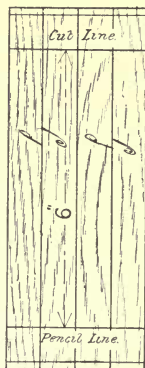

FIG. 176.

Complete the angle bridle joints as in the previous exercise, but do not glue them up yet.

The rhomboids for the parquetry should now be very carefully sawn in halves along the short diagonal, and shot true on the long edges in the shooting board. Now one of the shorter edges of each piece should be shot at 45° and the triangle finished, so that its altitude is 3 ins. full, and the long sides when finished are consequently a full 6 ins. in length. The four

pieces when placed together will make a square.

The triangles can now be glued to the foundation of yellow deal, which will be large enough to admit of nails being driven in outside the corners of the parquetry to hold the pieces together, as in Exercise VII., fig. 166.

When the glue is quite dry cut off the $\frac{1}{4}$ in. of waste in the foundation, and plane the edge of both parquetry and yellow deal down to the exact dimensions—the parquetry was purposely left 'full' dimensioned, or a shade over the measurements, to allow of this. Glue the framework round the inner plate, and glue the joints together. The top of the parquetry should be level with the joints, or stand up very slightly from the surface. Before the glue is properly dry, the blocks on the back should be inserted, as shown in the back plan of portion of the plate in fig. 175. When the glue is quite dry, finish the model with

trying and smoothing planes, taking care, in cleaning the edges, to plane inwards from the corners across the end grain of the framing to prevent breaking it out.

MODEL IX. FIG. 177.—A BRACKET.

Stop sawing is the new operation introduced here.

The drawing should be plan, elevation, and side elevation, as shown.

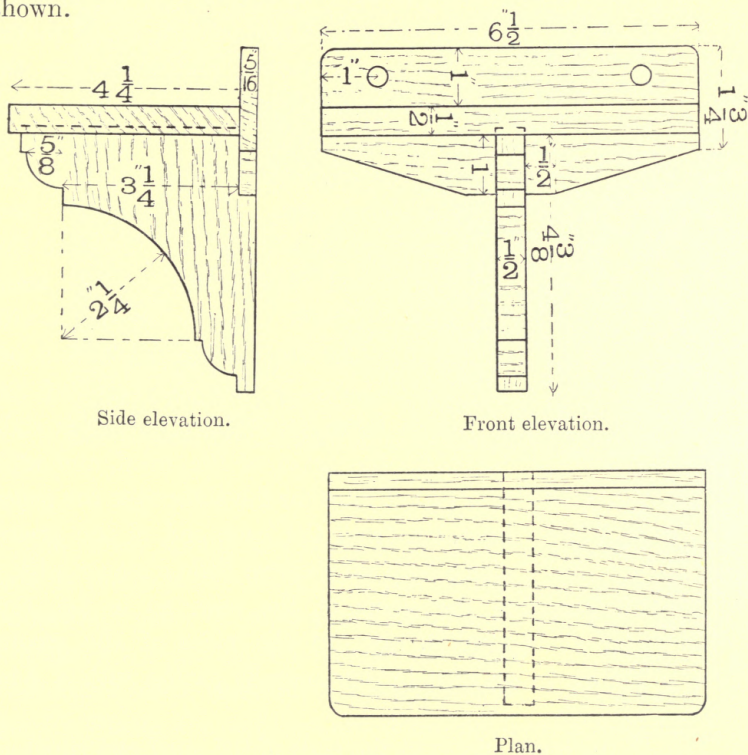

FIG. 177.

Two pieces of bass-wood or yellow deal will be required, one 7 ins. by $2\frac{3}{4}$ ins., $\frac{3}{4}$ in. thick, and the other 1 ft. long, $4\frac{1}{2}$ ins. wide, and $\frac{3}{4}$ in. thick. These are large enough to allow of waste in preparation.

After planing up the wood true, set out on the large piece the shelf and bracket, as in fig. 178, and on the small piece, the back. It will be found advisable to commence the work by cutting out the bracket. First cut out a large concave curve to the dotted line, as shown, and then with the tenon saw cut the shoulders of the small convex curves, which can be completed by vertical paring. The large curve should be completed with a spokeshave, and the small ones with a flat file, but this should be used as little as possible, being only intended to do what is impossible with the chisel. The bracket can now be cut off, and the groove in the *face side* of the shelf may be made. This groove is at right angles to the grain of the wood, and after making cut lines for the sides over the pencil lines, cut from the back end of the groove along both edges for a little distance with a

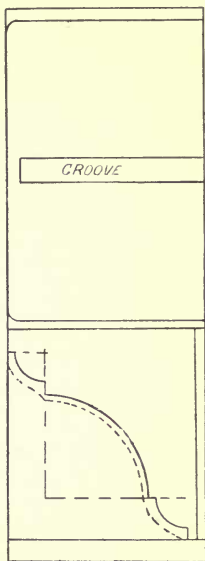

FIG. 178.

chisel, and inserting the point of the saw, as in fig. 179, making very short strokes, saw out the sides of the groove. Remove the waste, or core, by horizontally paring with a $\frac{3}{8}$ -in. chisel.

Saw off the waste pieces at the ends of the shelf and shoot all the edges true with trying plane or jack plane. Make the outside

corners of the shelf round, the curve extending, as shown, $\frac{1}{4}$ in. along each edge.

Saw the notch in the back of the bracket as in the side elevation, 1 in. long and $\frac{5}{16}$ in. deep, and saw and plane a similar amount off the back of the shelf.

The small piece for the back, which has already been planed

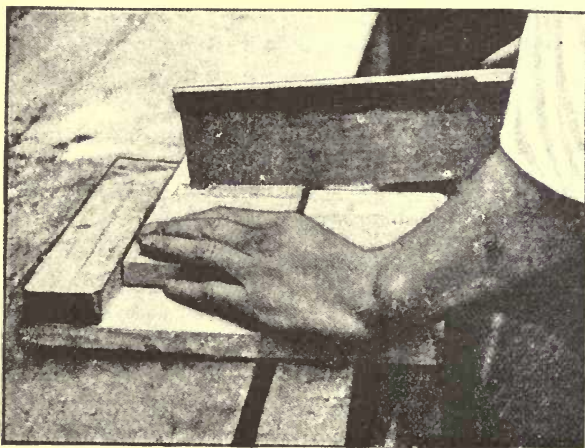

FIG. 179.

to $\frac{5}{16}$ in. thick, should now be made to the proper width, and the waste at the ends cut off. Cut off the corners to be subsequently rounded and plane the ends true and square. The fibres will not be broken if the planing is done after the corners are cut off, and, on the other hand, these must not be rounded till the ends are planed. Finish the corners and bore the two holes, using a $\frac{3}{8}$ -in. centre bit. Complete the back by sawing off the bottom corners and shooting them with the trying plane. Put the

model together by nailing the shelf on to the bracket with about three oval steel brads 1 in. long, at regular intervals, and then nail the back to the bracket and shelf similarly.

EXERCISE IX. FIG. 180

LAPPED HALVING JOINT.

This joint is really an outcome of Exercise I.

The sketch in fig. 180 is all the drawing which will be necessary on paper.

A piece of wood 10 ins. long, $1\frac{3}{4}$ in. wide, and 1 in. thick will be required. This should be set out as in fig. 181, dividing it into halves by a line completely round the wood, and marking with cut lines two grooves on opposite sides to half the depth of the wood, and of the same width, as it is to be finished, $1\frac{3}{4}$ in.

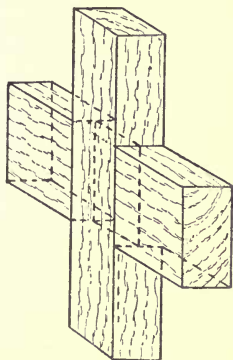

FIG. 180.

The reason for marking these grooves on opposite sides is, that when the wood is cut apart and the joint put together the original face side will appear in both pieces on the same side. This might in actual work prove an important consideration, as the best possible surface may be wanted, and the face side has originally been selected on account of its superiority. The grooves should be sawn and pared out, as in fig. 182, and in shooting the edges of the wood afterwards, be very careful to make them perfectly at right angles to the faces, and on no account

reduce the width to less than the breadth of the grooves, or there will be a loose, badly made joint when the two pieces are

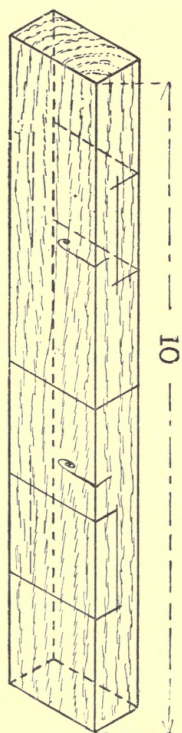

FIG. 181.

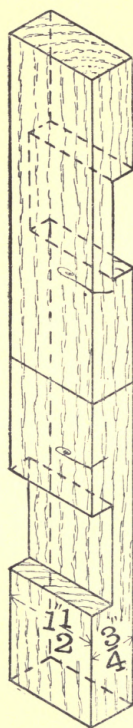

FIG. 182.

put together. When planed up correctly, cut the wood in halves, and make the joint.

If really well made, the parts can be fitted tightly yet easily, and if taken apart, and one piece turned round, it should fit equally well. The depth of the grooves, too, should be equal, and

exactly half the depth of the wood in a good joint, so that there is nothing to be 'cleaned off' when the joint is finished. There is no need to glue the joint, as it is not to be put to any practical use.

MODEL X.—AN OXFORD PICTURE FRAME. FIG. 183.

This model involves the fresh exercise of chisel modelling on the face of the frame, the mount should only be attempted in rare cases.

In drawing this model, the complete figure need not be attempted if the detailed drawings of the parts are made.

The dimensions of the frame are not given, as it may be wanted in any size, but it would be well not to attempt anything larger than 15 ins. by 10 ins.

Taking these measurements as a basis, 10 ins. by 7 ins. inside; two strips $\frac{3}{4}$ in. by $1\frac{1}{4}$ in. and 15 ins. long, and two 12 ins. long, but otherwise of similar dimensions, will be required.

These four pieces of wood are planed up true to their proper size, set out, and half-lapped together. In order to ensure a true rectangular framing, they can be sawn in pairs. Two of the pieces can be cleated together, or screwed up in the vice with the two face edges together, and the grooves in each end marked and sawn out.

The other two strips should be similarly treated, but the grooves should be cut on the reverse side.

Gauge the rebate between the grooves from the face side on the inner edge of each strip $\frac{1}{4}$ in. and on the back $\frac{3}{16}$ in. away from the inner edge, as in the section on A B, fig. 183.

The rebate could be removed with the rebate plane, but it would take out the whole of the wood to the end of the 'horns,'

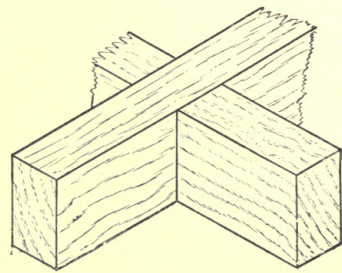
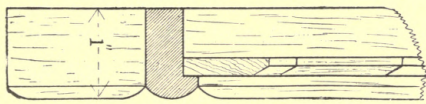
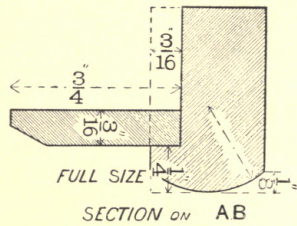
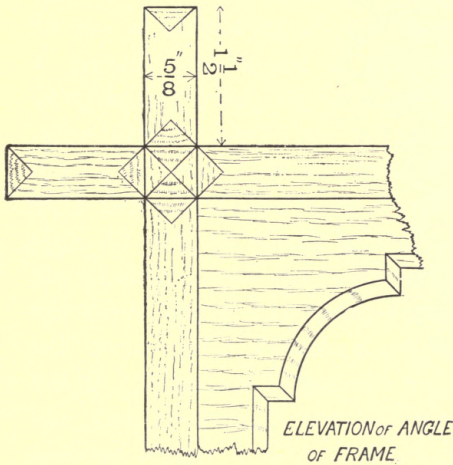
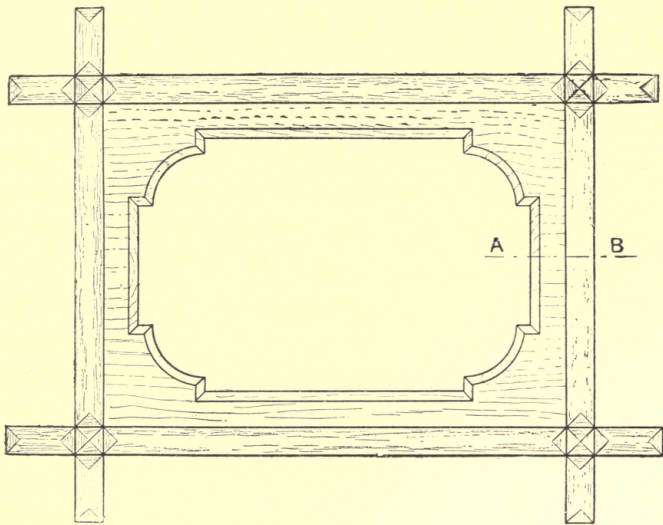

Isometric projection of angle of frame.

FIG. 183.

From Series IV. of 'Hand and Eye Training' Cards, by kind permission of Messrs. Cassell & Co. Lim.

as the small exterior processes of the frame are usually called. This is objectionable, and moreover it is not desirable to introduce the rebate plane yet. The removal of this rebate is effected with the chisel. First make cuts at right angles to the line gauged on the side, in the waste to be removed, and as deep as the rebate is required— $\frac{3}{16}$ in. (see fig. 184). This has the effect of separating the waste into many small pieces, which may be forced out with the chisel, from the gauge line on the side. The

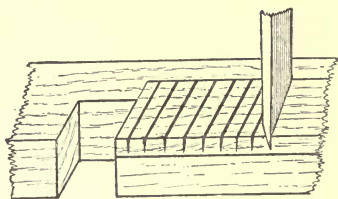

FIG. 184.

small pieces of wood which may still require to be removed can be got out by horizontal and vertical paring. The waste at the ends of the horns should be cut off with a tenon saw, leaving a little to be pared vertically in order to obtain smooth ends.

Joint up the frame dry, and smooth off both back and front true and level, and, after numbering each part, so that it may finally go into its right place, take the pieces apart. The round top of each strip should next be modelled. With thumb-gauge and pencil mark the depth of the curve on the edges, and draw a line down the middle of the face side, to show the top of the curve. It will be found of assistance to draw the line of curve on each end of the strips for guidance in working. This should be done with the jack plane in the first instance and finished off with glass-paper. Now put the framing together, and with the chisel model the transverse curves at the ends of the horns and at the joints.

When the work is finished glue up the joints.

The mount should be made from a thin piece of wood of the proper side and planed true. Draw the shape on the face side and commence by boring out the curve at the corners. Complete the rest of the form by bow sawing and paring, and then chamfer with the chisel all round.

EXERCISE X. FIG. 185

A SHIELD.

Bow sawing, and modelling with the chisel and spokeshave, are the chief exercises in this model.

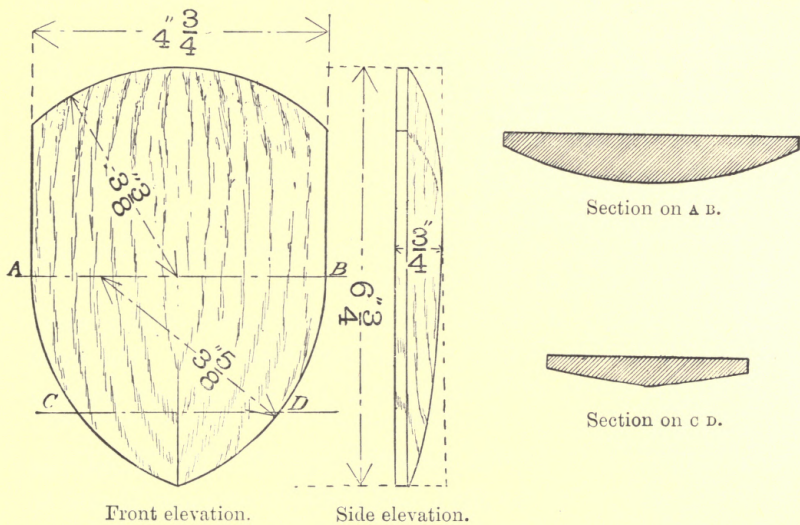

FIG. 185.

The drawing should be attended to very carefully in order to impress upon the mind the general form of the curve, as well as

the correct measurements. All the drawings in fig. 184 should be made.

The model should not be made of a very large size: the dimensions given will be found suitable. Take a piece of some soft-working wood, preferably lime or bass-wood, and having trued the face and opposite sides, draw the outline of the edges on the face, and with the bow saw cut out the shield, smoothing the edges with the spokeshave. Mark the depth of the curve on the edges, and on the back glue a block of wood of about 2 ins. square and screw this in the vice.

The work of cutting down the curve is done with the chisel. A broad-bladed firmer chisel, say 1 in., should be used, and the method of cutting is to sweep the edge, held almost horizontally, in curves, which follow the shape in the drawing, and by this shearing action the wood is gradually cut down to the proper form. In this exercise the eye alone can be relied on, and constant references should be made to the drawing, to see that the shield gradually assumes the correct form. It will be found well to take the exercise out of the vice occasionally, to see that it is being modelled on both sides correctly.

Do not attempt to finish any one part before cutting away the other parts. This would inevitably prove fatal. The wood should be gradually reduced all over the surface, and finished almost simultaneously.

The spokeshave should be taken up after the chisel has practically completed the work, and finally, glass-paper should be lightly used, but the edge all round, and ridge from the point at the bottom of the shield, which gradually dies away in the middle of the surface, should be noticeable and sharp.

When the modelling of the front is complete, the block on the

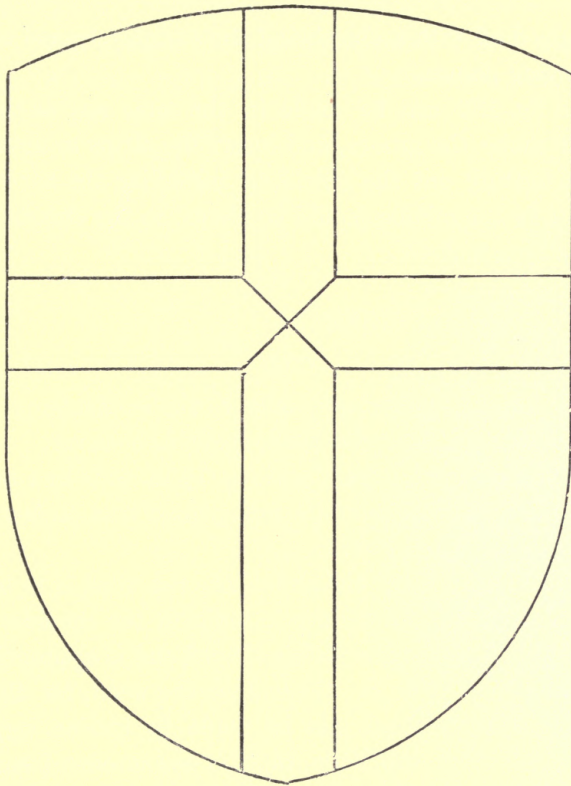

Front elevation.

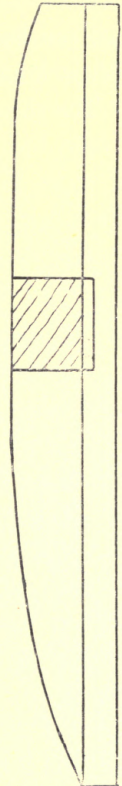

Side elevation.

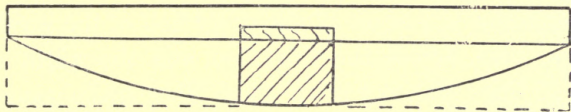

Section.

FIG. 186.

From Series V. 'Hand and Eye Training' Cards, by kind permission of Messrs. Cassell & Co. Lim.

back can be chipped off with a chisel, and the surface cleaned off with jack and trying planes.

The shield in fig. 186 can be made in the same way as the former, but first make the groove, and insert the strips to make the cross, before cutting out the shield, or modelling the curve. The mitred joints in the middle should be planed in the shooting board with the stop set at 45° .

EXERCISE XI

DOVETAIL HALVING.

The drawing of this exercise need only be the isometric projection. Plan and elevation can be made instead, however.

A piece of yellow deal about $11\frac{1}{2}$ ins. long, $1\frac{3}{4}$ in. wide by 1 in. thick, will be required, and should be first planed true on faces and edges, to the dimensions shown.

Mark the line halfway from the end where the wood is to be cut in halves, and then draw cut lines to indicate the shoulders of the 'dovetail' (fig. 187), as the wedge-shaped end is appropriately called. The pencil lines on the end of the wood, for the sloping sides of the dovetail, should be made to incline very slightly towards each other—so little, that no measurement can really be given, but the importance of this slightly diminishing dovetail will be appreciated in making the joint.

On the face and opposite edges of the other half of the wood, square two pencil lines across the thickness, and the width of the face apart, $1\frac{1}{2}$ in. Halfway down these lines make gauge lines for the depth of socket.

Saw out the dovetail, commencing by sawing down the gauged line halfway in the thickness in the same way as for a tenon (figs. 170, 171, 172).

The oblique sides of the dovetail should now be sawn down, in this case holding the saw horizontally, and finally cut the

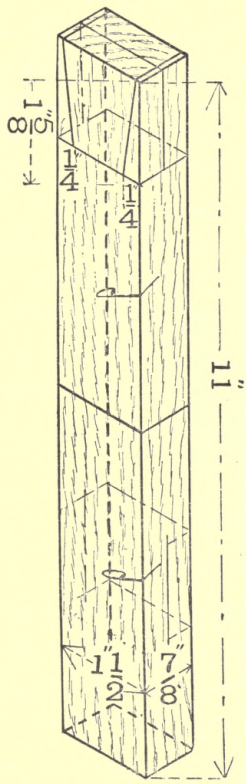

FIG. 187 shows the setting out.

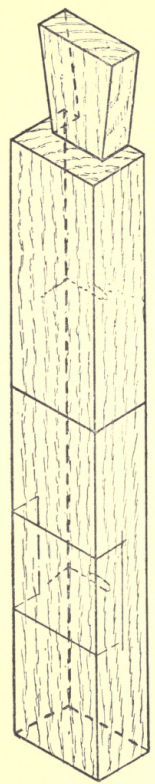

FIG. 188 shows the dovetail cut and face of the wood reversed.

shoulders. Saw the wood in halves, and apply the dovetail to the pencil marks on the face side of the other half. The side of the dovetail which is on the wood is now slightly smaller than the

face side, and along the line of contact between the dovetail and the surface of the socket piece, a cut line should be made with

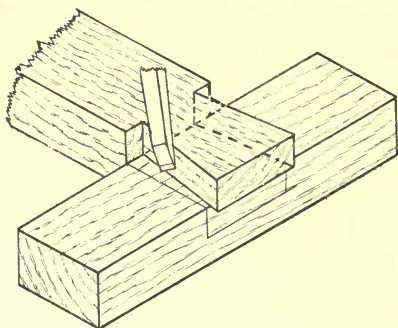

FIG. 189.

the corner of a chisel, as in fig. 189. The shape of the socket is now obtained and can be carefully sawn and pared out. Press the dovetail into the socket and clean the joint off. The advantage of tapering the dovetail will be at once apparent, as the top of the joint when pressed flush with the surface of the

other half will probably give a very good close fit.

EXERCISE XII

STOPPED DOVETAIL HALVING.

This is similar to the ordinary dovetail halving, except that the dovetail does not go completely across the width of the timber. This form of halving is used where the end grain of the dovetail showing through the outside of the socket would be objectionable.

The dovetail must then be cut to the exact length required. It is, therefore, cut off true and square before commencing. The cut line for the shoulder should be very carefully marked at the proper distance from the end of the wood, at A in fig. 190, and with the gauge set at the same measurement make the line, B B, for the socket.

The other marking on the socket half will only be on the face edge and face side, and when the dovetail is applied to the pencil lines after cutting the wood in halves at c, it will

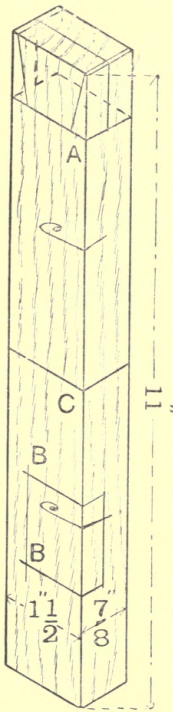

FIG. 190, showing setting out.

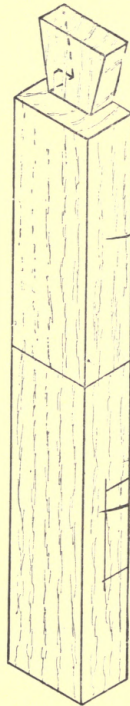

FIG. 191, showing dovetail cut.

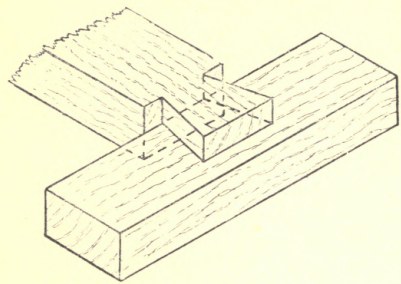

FIG. 192.

leave about $\frac{3}{8}$ in. of solid wood beyond the socket (see fig. 192).

The socket should be mortised out with a chisel, part of the inclined sides being cut with the tenon saw.

MODEL XI.—A TOWEL ROLLER. FIG. 193.

Stopped dovetail halving, boring, and modelling with plane are here involved.

The drawings showing part of the front elevation, the section of the roller, the section through the middle of the roller socket, the section through the middle of the roller socket,

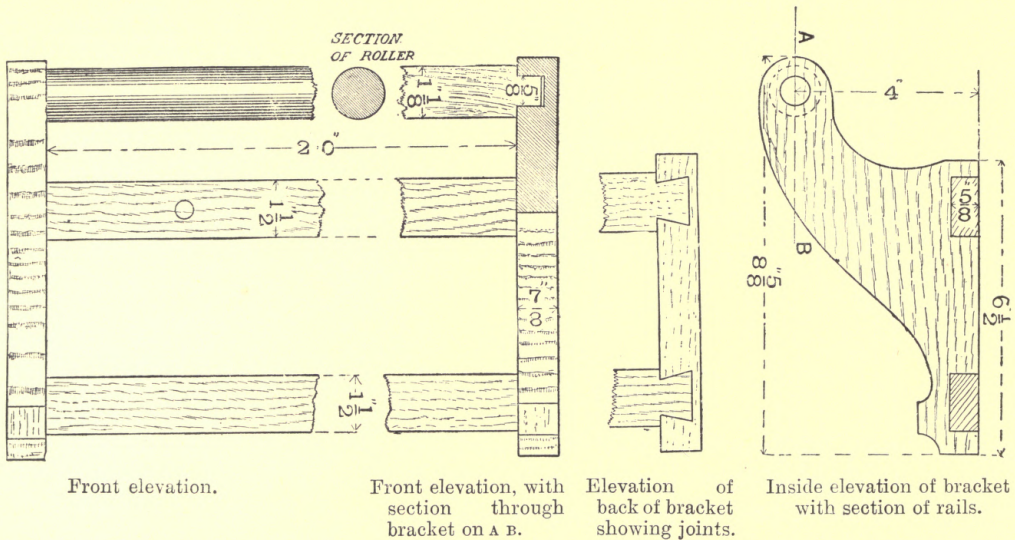

FIG. 193.

and the section through the rails showing the inside of the bracket should all be drawn, as well as the plan of the dovetail halving joint.

Yellow deal will serve very well as material for this model.

A piece of wood $5\frac{1}{4}$ ins. wide, 1 in. thick, and $13\frac{1}{2}$ ins. long will

be enough from which to make the two end brackets, if, after planing the wood up true on both faces and edges, they are marked on the surface, as shown in fig. 194. As in previous similar cases, waste of wood is prevented by doing this, and the lesson of planning development before commencing work so as to economise wood, and yet have the grain in the right direction, when the part is fitted into its place, should be thoroughly learnt at once.

The roller can be of any required length, but 2 ft. is the length chosen here. A roller of the same thickness as that

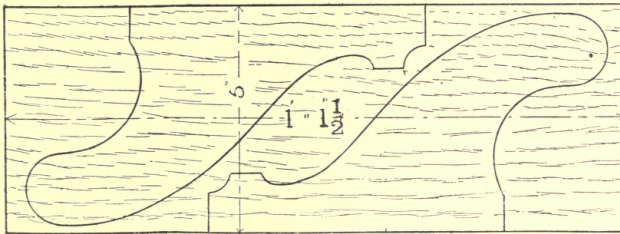

FIG. 194.

shown should be made from wood $1\frac{1}{4}$ in. square. The two supporting strips should be each 2 ft. 2 ins. long, by $1\frac{3}{4}$ in. wide, and $\frac{3}{4}$ in. thick.

Referring again to fig. 193, mark out the socket for the pin at the end of the roller, and on the edges of the wood make pencil lines at the correct position for the dovetails. Cut out the brackets with the bow saw, and screwing them together, face to face, in the vice, finish up the curve with the spokeshave and file. Bore the socket for the roller and lay the brackets aside.

Mark the shoulders of the dovetails and the roller pins, by

placing the three pieces of wood side by side, and squaring cut lines across them all, at the proper distance apart. Draw the two concentric circles, showing the curve of the roller and the pin, on each end of the square strip, as in fig. 195.

Now cut a little way in, for the shoulders of the pins, before commencing to model the wood into its finished form. When the roller is rounded with plane and file, pare down vertically to remove the waste wood round the end pins, and complete these

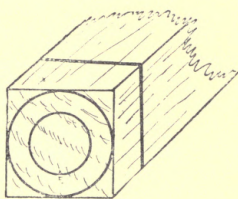

FIG. 195.

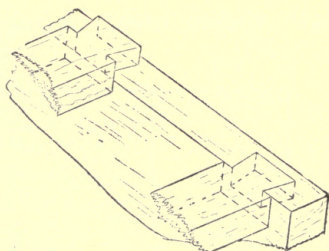

FIG. 196

with a file also. Any waste outside the proper length of the pins should now be sawn off, and the roller is complete.

The dovetails of the supporting strips should be sawn out, and the socket marked on the back of the brackets, in the manner described in the preceding exercise. Fig. 196 shows one joint made, and one dovetail applied in its proper position for marking the corresponding socket.

In putting the parts of the model together, dovetailed joints should be glued, and the roller may either be glued or made to revolve by inserting a screw from the outside, through the bracket into the ends of the pins.

MODEL XII.—A NEWSPAPER RACK. FIG. 197.

The construction of this model gives practice in planing, the half lap, and dovetail halving joint, corner chamfering, and bow sawing.

The whole of the orthographic projections should be made as in fig. 197, and if considered necessary in particular cases, the isometric projection can be made. In this latter, one arm of the model is omitted, in order not to confuse the eye by the number of lines. Bass-wood will be a very suitable material with which to make this model.

The base, which, when finished, is to be $\frac{5}{8}$ in. thick, should be made of $\frac{3}{4}$ -in. wood 1 ft. 1 in. long and $6\frac{1}{2}$ ins. wide. The two cleats under the base forming the feet of the rack are to be made from a strip of wood 1 ft. 1 in. long and 1 in. square. For the sides and middle division of the rack, not less than 8 ft. 6 ins. of bass-wood will be required 1 in. wide by $\frac{1}{2}$ in. thick, but it will be well to allow a few inches more for waste.

A strip of this length cannot conveniently be planed up. It should, therefore, be cut into three pieces, each long enough to make one of the upright pieces of framework. A strip 4 ft. 4 ins. long for the large middle division and handle, and for the two sides two strips, each 2 ft. 3 ins. long, will be large enough, and will allow for waste.

Plane all the wood true to dimensions, and cut up each of the thin strips into the required lengths for the parts. In marking the joints, and the length of the projecting pieces, as many as possible should be marked simultaneously, thus: take the four stiles (as the upright pieces are called) of the two similar sides, and arranging them so that all the face edges are in one plane,

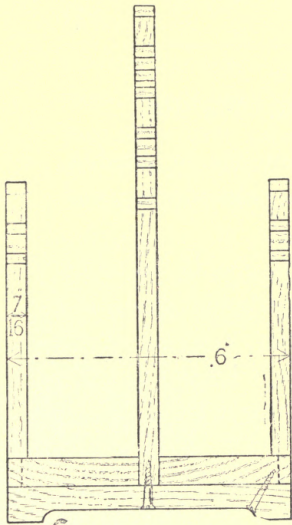

End elevation.

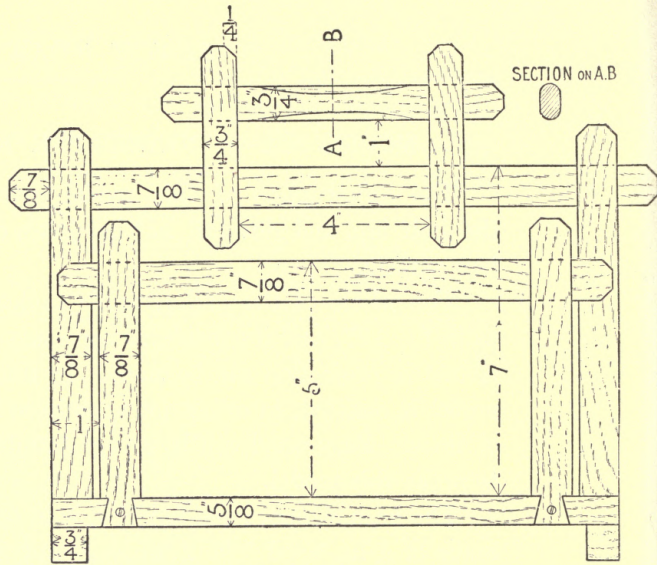

Side elevation.

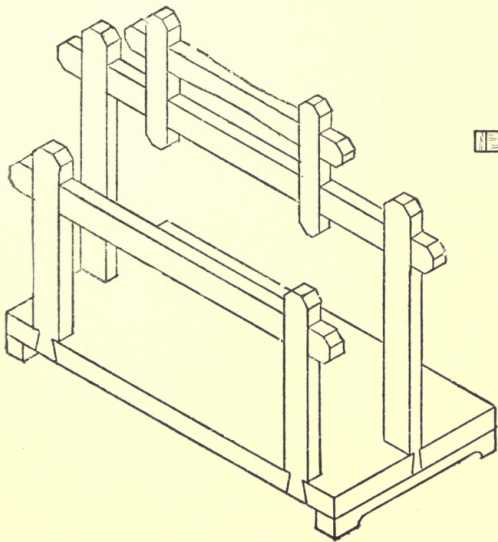

Isometric projection with one arm removed.

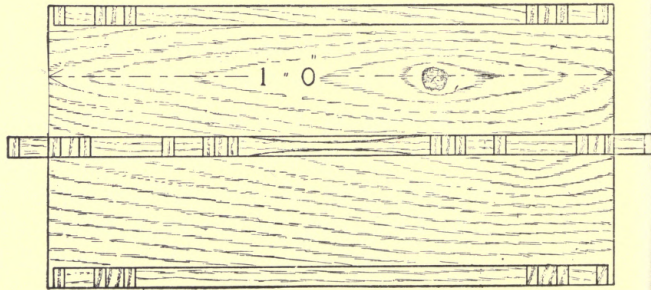

Plan.

FIG. 197.

mark the length, and the size of the half lap and dovetail halving joints, in the manner shown in fig. 198, using square and chisel. The strips and the stock of the square can all be held together with the fingers. When marked, the lines showing the joints can be continued across the back of each piece separately, as shown in fig. 199.

The grooves for the half-lap joints, it must be observed, are cut in the back of the stiles, and in the face side of the rails, so that when finished, the face sides of all the pieces are together.

In marking the dovetail halving joint, allow the dovetail to be at least two-thirds of the thickness of the stile; and though this is not, strictly speaking, halving, the joint is often made in this proportion to obtain greater strength. These joints have to sustain the side against lateral strains, and, to obtain greater strength, they may even be dovetailed in the whole thickness of the stile. Figs. 200 and 201 show the two forms of joints.

The framework should be all jointed together, and the corners of the pieces chamfered, before being finally glued up

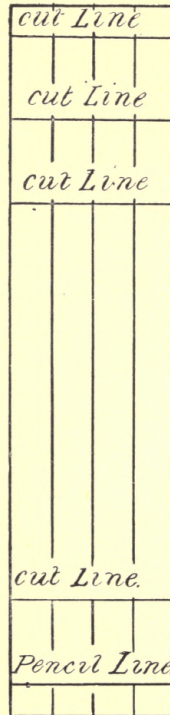

FIG. 198.

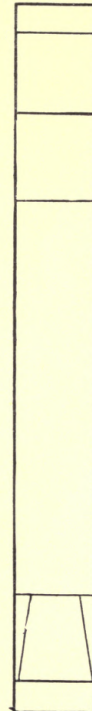

FIG. 199.

and screwed to the base. The handle should be modelled with the spokeshave, as shown in the section on A B, fig. 197. After glueing up all the joints and cleaning off the surfaces, mortise

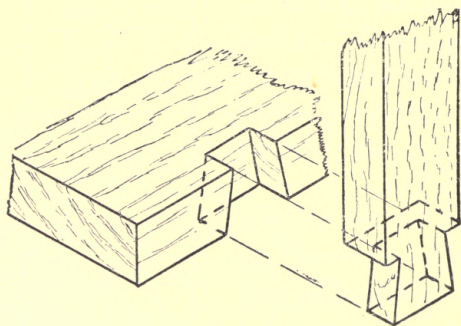

FIG. 200.

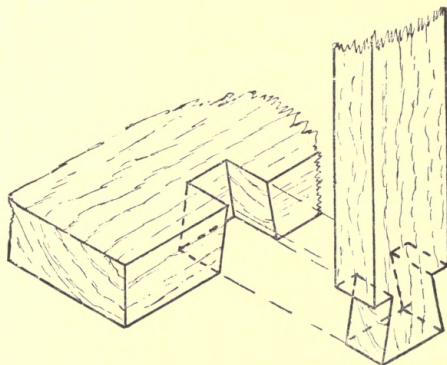

FIG. 201.

out the slot in the middle of the ends of the base to receive the stiles of the large pieces of framing, and then cut and make the dovetail halving joint on the edges, and glue all the framework in its place.

The supporting cleats for the base should now be planed up true, and the curve modelled with the spokeshave, chisel, and file. With $1\frac{1}{4}$ -in. screws fasten the cleat to the bottom.

The screws which enter the bottom of the middle stiles should be put in first, and then those which enter the base in a sloping direction. The sides should be screwed in with $\frac{5}{8}$ -in. screws, preferably brass, and either flat or round headed, to give additional strength. The complete model can now be touched up with fine glass-paper on a cork rubber, but on no account touch the sharp corners of the chamfers, or they will certainly be injured.

MODEL XIII.—A HANGING NEWSPAPER RACK. FIG. 202.
AS AN ALTERNATIVE TO THE PRECEDING.

The drawing of the front elevation shows on one side the back, and on the other the appearance of the completed rack. The side elevation should be made, and if the rails have been drawn in the elevation, they need not be made as shown in the new projection on the side elevation—another case of change of ground line. The plans show the joints of the bottom rail and the sloping front. The two methods of putting on the rails, by simply nailing, or by grooving and nailing, are also indicated.

Yellow deal, bass-wood (American lime), or walnut will all make good material for the model. For the back framing, three strips, each $13\frac{1}{2}$ ins. by $1\frac{1}{4}$ in. by 1 in., will be required, from which to make the top and uprights, and one $13\frac{1}{2}$ ins. by 2 ins. by $1\frac{1}{4}$ in. for the bottom rail.

The sloping front will require two strips $13\frac{1}{2}$ ins. long and $\frac{3}{4}$ in. thick, but one should be $1\frac{1}{4}$ in. wide while the other should be $1\frac{3}{8}$ in. These pieces are for the top and bottom rail, and on

these the laths are to be fastened. These are made from seven strips $\frac{3}{8}$ in. thick, 1 in. wide, and 1 ft. long.

The two end posts of the front can be made from two strips 1 ft. long and 1 in. square.

The back framing should be planed up and made first. The top rail is halved into the stiles, as shown in the isometric pro-

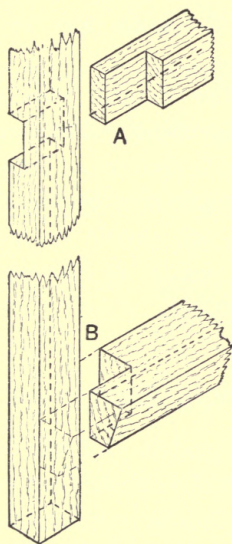

FIG. 203.

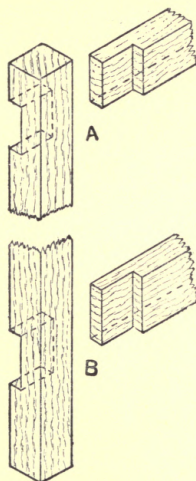

FIG. 204.

jection, A, in fig. 203. These joints are screwed up from the back with $\frac{5}{8}$ -in. screws. The bottom rail is notched out at the end, to take the upright stiles, B, in fig. 203. The bottom rail and back, it will be noticed, are not secured with the half-lap joint.

Before putting in the bottom rail, however, the front edge must be bevelled off with the plane to the required angle,

marking on the ends and one side the waste to be removed, and, as the planing progresses, testing the work with the bevel set at the same angle. Screws $1\frac{1}{4}$ in. long should be used to fasten the rail and back together.

The sloping front is made similarly to the back, the top is halved into the end rails, making the notched halving joint as shown at A, in fig. 204.

The bottom rail is jointed in the same way as shown in fig. 204, B.

The parallel strips to make the sloping rails should be planed up true to dimensions, the top corners chamfered off, and nailed on at the proper intervals. The horns on both pieces of framing should be chamfered and made true by vertical paring, and the two holes in the top back rail should be bored. The sloping front can be screwed on, using $1\frac{1}{4}$ -in. round-headed screws, when the model will be complete.

MODEL XIV.—A SCHOOL PEN TRAY. FIG. 205.

This is an easy and attractive model. All the drawings in fig. 205 should be made, and an isometric sketch can be executed as well, but the shape of the curved handle is difficult for children in this case if drawn isometrically.

Yellow deal will be good enough to make this model from, though, of course, it can be made of any more ornamental timber.

One piece, 1 ft. long, 9 ins. wide, and $\frac{3}{8}$ in. thick, will be required for the bottom of the tray, and two strips, 1 ft. long by 2 ins. wide and $\frac{3}{8}$ in. thick, for the upright sides. For the sloping ends two pieces, $8\frac{1}{2}$ ins. long by $2\frac{1}{4}$ ins. wide and $\frac{3}{8}$ in. thick, are

wanted. The middle handled division is somewhat deeper than the sides; the dimensions for this piece may be $3\frac{1}{2}$ ins. wide and 11 ins. long by $\frac{3}{8}$ in. thick.

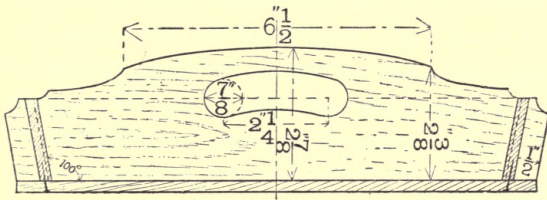

Sectional elevation on A B.

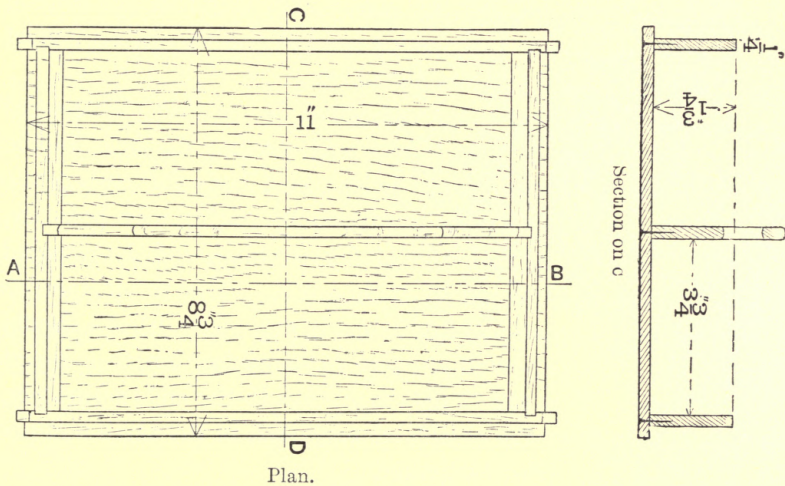

Plan.

FIG. 205.

Plane up all the wood to the required thickness— $\frac{1}{4}$ in., and set out the sides. The two sloping sides can be marked out to the dead length, $7\frac{1}{2}$ ins., and the grooves marked on them. To

obtain absolute similarity, they should be held together and marked simultaneously on the face edges, the lines being afterwards continued across the back of each piece, so as to show the face or best side outwards in the completed tray. The two upright sides should be similarly marked on the face edges, and with the bevel set at 100° the grooves and ends can be marked across the back. The four sides can now be cut off to their proper length, and the grooves cut out with tenon saw and chisel. Nail the sides together, as in fig. 206, using $\frac{3}{4}$ -in. oval steel brads. In driving these in, make the two end ones incline towards each other, as shown. This is done to give greater strength against any outward pressure on the sides. The edges of the sloping sides now project on their outer angles, and should be planed down flush with the edges of the sides.

The handle should now be prepared by cutting out the two large top curves with a bow saw and making the hole for the fingers. After boring the two holes which form the ends of the curved opening, they can be connected by sawing with bow saw, or by vertical paring with a small firmer chisel, and the rounded curve (see section) produced with a file. The small concave curve at each end should not be made yet. The handle should be cut off to the exact angle, and to the proper length. Insert the handle, making sure it fits the grooves in the ends accurately, and nail it in from the outside of each end, in the same manner as the sides were nailed together.

Next, plane the bottom on the edges, to the exact dimensions, and nail it on to the framing. There is considerable risk of driving a nail so as to show its point through the side of the tray. To prevent this, place the framing on the bottom, and with a pencil draw round the inside of each half at the junction

of the sides and bottom, and then draw parallel lines to these $\frac{1}{8}$ in. further out. This will give the precise place to insert the nails. About four in each piece will be enough, and these, like those in the side, should be inclined somewhat to give greater strength.

Holes should be carefully bored for the nails, to lessen the danger of breaking through the sides. The holes for the nails in the sloping ends must slope at the same angle, and to make sure of getting them correct, they should be bored from the inside, and the nails put in where the point of the bradawl comes through on the outside.

The small concave curves at the ends of the long sides, and the central division, should be pared out with a chisel reversed—*i.e.*, with its back downwards.

The method of using the chisel to form this curve is indicated to some extent in fig. 206. As the edge is pushed in away from the pupil, the handle should be depressed, as indicated by the arrow. The curve should be lightly touched with file and glass-paper, but the chisel, in the first instance, must be used to make the curve as true as possible.

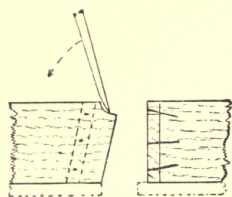

FIG. 206

EXERCISE XIII

WEDGED MORTICE AND TENON JOINT. FIG. 207.

The drawing should be plan and elevation, or isometric projection, but in the illustration other details are shown to enable the student to more readily understand the construction.

A piece of yellow deal 11 ins. long, 2 ins. wide, by $1\frac{1}{4}$ in. thick will be required.

Plane it up to the dimensions, and mark the usual line half-way from the ends.

Fig. 208 shows the setting out, and fig. 209 shows the wood prepared. In this case, however, the wood is turned round, showing reverse edge.

To set out, preparatory to commencing work, first mark the width of the mortice $1\frac{3}{4}$ in. on the face edge.

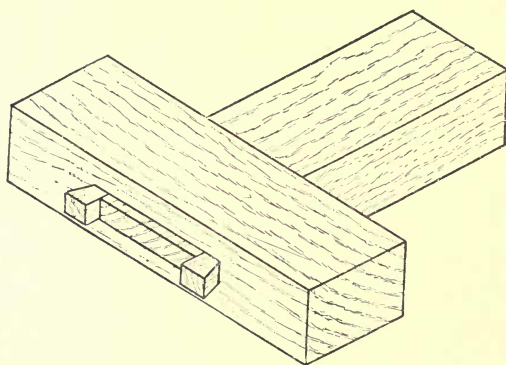

FIG. 207.

From the end of these square lines, across the face side, and continue them across the reverse edge. On this back edge make two lines each $\frac{1}{4}$ in. farther out, to give the space for the wedges.

At the end of the other half of the wood make a cut line on all four faces, for the shoulders of the tenon. This should be a little longer than the depth of the mortice, so that when put together the end will show through. The mortice and the tenon should be exactly the same size, and the mortice-gauge is used to ensure this. Take a chisel of the same width as the thickness of the tenon, and use this to test the setting of the mortice-gauge.

As a general rule the tenon should be one-third the thickness

of the wood, but chisels, nominally of the same dimensions, frequently vary slightly, and it is desirable to use one which will be the exact width of the mortice. The mortice and tenon are, there-

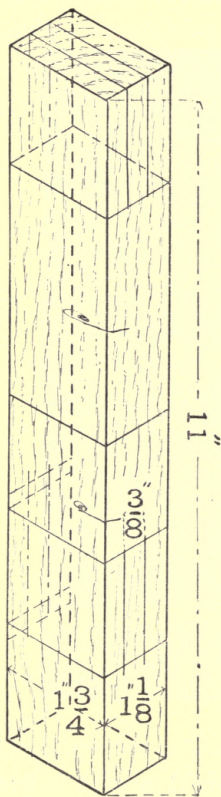

FIG. 208.

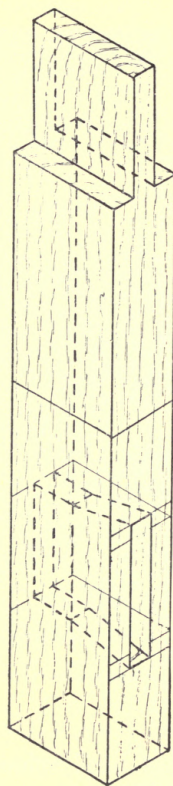

FIG. 209.

fore, made to the same size as a chisel, which is practically, though perhaps not exactly, one-third the width of the wood.

Having marked the dimensions of the mortice from the face side, using the tool in the same manner as the marking-gauge, the tenon should be marked on the end, and both edges, without altering the adjustment of the gauge. Take the mortice



FIG. 210.

chisel and carefully place the edge at right angles to grain, near the middle of the wood to be removed, on the back edge, to make the mortice, and, holding it upright, give the end of the handle a good square blow with a mallet. Fig. 210 shows the method of using the mortice chisel.

It will be noticed that the face of the chisel is towards the operator. After making one cut (not too deep) take out the chisel, and proceed towards one end by a series of parallel cuts about $\frac{1}{4}$ in. apart, prising out the waste, or core, with the chisel, by simply pulling or pushing the handle over after every cut. The chisel should be turned round after every few strokes, but the last stroke given should be with the flat face of the chisel towards

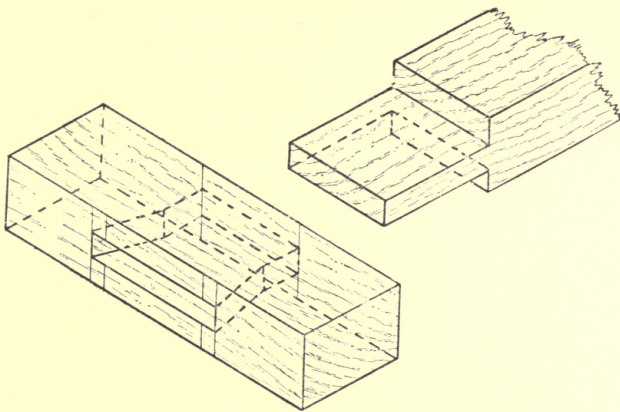

FIG. 211.

the end of the mortice, in order that a true clean surface may be left.

As the mortising goes on, the cuts should be made deeper. The ends of the mortise from this side should be made to slope inwards, as shown in fig. 211, to give room for the wedges. After mortising out rather more than half the depth, turn over the wood and finish from the face edge, making upright ends to the mortice from this side. Cut out the tenon, sawing just to

the gauge line, but be careful not to saw inside it, and then cut the wood in halves in order to join the two pieces. The two pieces of the joint, if successfully made, ought to go together without much pressure being necessary, and, on the other hand, they should not be loose.



FIG. 212.

Fig. 212 shows the shape of the wedges. They should be driven in with swinging blows from a hammer. In doing this do not give short sharp blows, but rather let the face of the hammer dwell on the top of the wedge at each stroke, in order to prevent any possible tendency to jump out.

From fig. 207 it will be seen that when the wedges are inserted, the joint becomes dovetailed in shape, and the object of the wedges is to make this dovetail, which gives the joint its strength under pulling strains. The important fact which must be considered in making this joint is the subsequent shrinkage of either half. Now as the wedge is driven in, the greatest crushing strain it has to sustain is near the blunt point, but if the wedge had a sharp point, the greatest strain would be near the thick end.

Shrinkage in the mortised half would cause the joint to open most at the outer end; and if this is the point of greatest compression, as with the pointed wedge, the joint once opened will be very insecure; but if the outside of a joint made with a blunt wedge were to open somewhat, the inner, less affected end, would still keep tight. The blunt wedge will, moreover, compress the fibres of the tenon most at the point of greatest strain—the inner end of the wedge, and will thus cause the tenon itself to assume a very slightly dovetailed shape; but with a pointed wedge the greatest strain will occur at the outer end of the tenon, and its

fibres will be crushed at that end somewhat, so that any pulling strain on the tenon from the other side would be more likely to cause the joint to come apart—in fact, destroying to some extent the very object which the introduction of the wedges is intended to attain. The wedge, as will be seen in fig. 212, should be made with nearly parallel sides, and with one corner of the point pared off.

Another method of making the joint adopted by cabinet-makers, with whom strength of construction is not so great a consideration, is to insert the wedges—pointed ones—into two

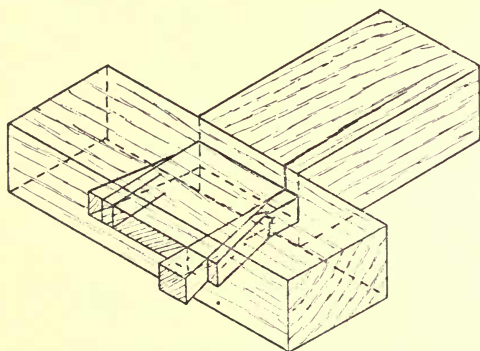

FIG. 213.

saw-cuts across the end of the tenon. These wedges have the effect of forcing out the fibres of the outer edges of the tenon till they fill the sloping portion of the mortice.

There are several objections to this method of making the joint, but the most serious is the breaking of the fibres of the tenon at the middle of the joint, where they are forced by the outward pressure of the wedges to assimilate themselves to the sloping sides of the top of the mortice. Fig. 213 shows this form of joint, with resulting broken fibres and split rail.

S



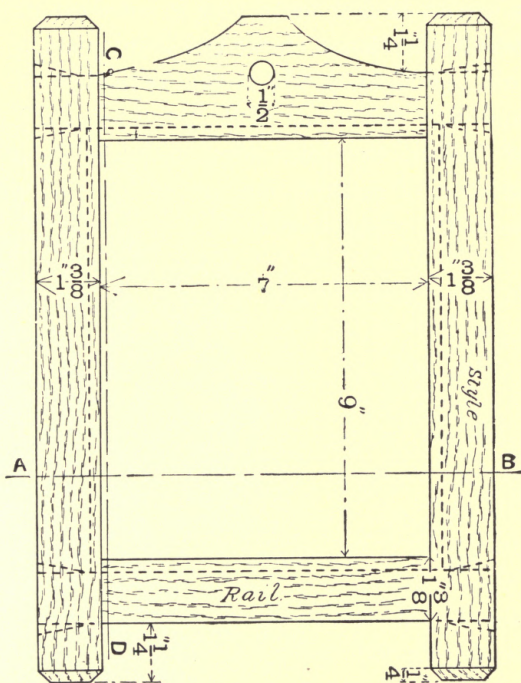

Front elevation.

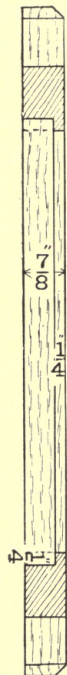

Section on c d.



Section on A B.

FIG. 214.

MODEL XV.—AN APPLICATION OF THE MORTICE AND TENON JOINT IN MAKING A MIRROR FRAME—REBATING. FIG. 214.

The drawings should be the elevation and the vertical and horizontal sections.

For the two sides and the bottom rail, three strips of yellow deal or bass-wood, $1\frac{1}{2}$ in. wide and 1 in. thick, will be required, two of them 15 ins. and one $10\frac{1}{4}$ ins. long; the top can be made from a piece $10\frac{1}{4}$ ins. long, $2\frac{3}{4}$ ins. wide, and 1 in. thick.

Plane all the pieces true, but do not make them quite to dimensions, as about $\frac{1}{32}$ in. on each face and edge will be removed after the frame is glued up, in cleaning off the work.

In setting out, as usual, mark similar pieces simultaneously, remembering that the face sides must all be together, making the front in the finished model, and the face edges must be inwards. Place the face edges of the two stiles together and mark out, as in fig. 215. After marking all the dimensions on the face edges in pencil, turn the wood over, and continue on the face side, and from there on the back edge, the two lines which show the position of the mortice—*i.e.* the second and third lines from each end. Now set out the tenons on the two pieces of wood for the top and bottom rails. These are of unequal width, and the best way to mark them is to lay one on top of the other, with the face sides together, at the edge of the bench, with



FIG. 215.

the edges together, and mark them simultaneously, using the square vertically.

Two short lines, extending about $\frac{1}{4}$ in. into each piece, and 7 ins. apart, as shown in fig. 216, should be first made, and then the long ones $\frac{1}{4}$ in. further out toward the ends. Continue the short lines on the face side, and the long ones on the back.

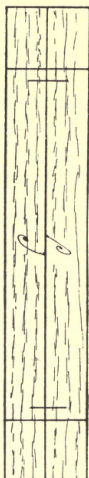

FIG. 216.

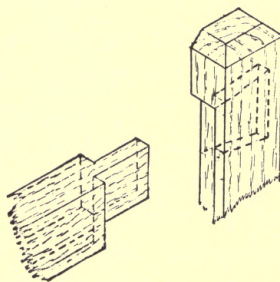

FIG. 217.

This gives the shoulders of the tenon, but the shape is shown in the isometric sketch, fig. 217.

Now mark and cut out with the bow saw the curve in the top rail. Finish this off with the spokeshave. Having removed most of the waste wood from this rail, the pupil can return to the joint, which should be marked out with the mortise-gauge set to a $\frac{1}{4}$ -in. chisel.

The rebate can now be marked with the single-toothed gauge,

set to $\frac{1}{4}$ in., on both face edge and back. Now mortise out the stiles as in the previous exercise, and saw down the cheeks of the tenon, but do not cut the shoulders yet. The rebate plane is taken up to make the rebates, for in this case it is much easier to rebate out along the entire length, and then re-insert a small piece to complete the horns to the original shape, than to laboriously cut out the rebate with the chisel. There is another method, involving the use of certain metal planes, but this plan, for various reasons, could not be adopted here.

Screw the wood up in the vice to make the rebate, hold the plane firmly round the back portion with the right hand, steadying and holding it with the left hand. At first the plane should be held vertically, and after planing nearly down to the gauge line turn the plane on its side and finish the upright side of the rebate. Fig. 218 shows the operation of rebating with plane in a horizontal position.

The ends of the rebates beyond the mortised holes should be filled up by glueing in small pieces of wood, and the tenons can now be completed by cutting the shoulders. The wedges should be prepared, and the rails can now be fitted into the stile to test their accuracy, and if correct the work may be glued up. Cover the tenons plentifully with very thin glue, and put each tenon into the mortice to which it belongs—they had better be previously numbered to prevent confusion. The iron cramp should be used, to pull each joint tight up. Two cramps can be used, one at each end close to the mortices, but not outside on the horns, or one only used alternately at each end; in any case wood should be placed between the cramp and the model to prevent injury. Unless great care is used in screwing up the cramp or cramps, the work will be pulled out of its proper rectangular form, and,

in fact, the greatest care will hardly prevent this, unless the diagonals are measured and any error corrected.

The best method of measuring is to take a strip of wood and measure one diagonal first, making a mark to denote its length, then apply this measurement to the other diagonal, and mark the new measurement over the old. If there is a difference, as there possibly will be, another mark midway between the two

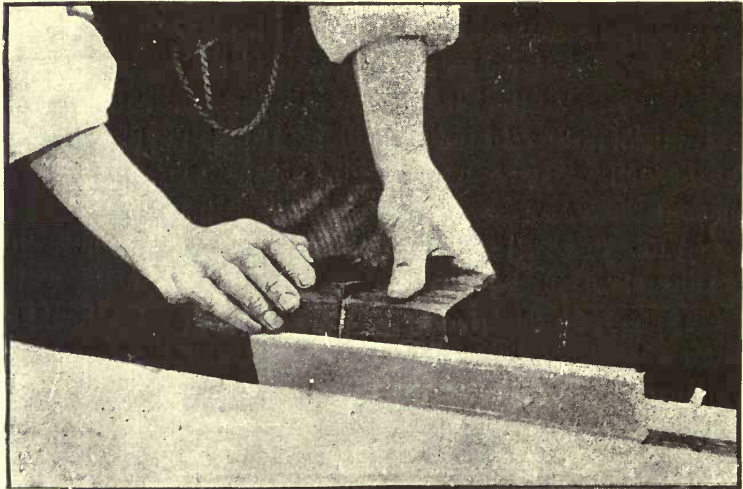

FIG. 218.

already made must necessarily give the correct measurement, and the work can then be screwed up again to give this diagonal in both directions.

Now while the joints are in the cramps drive in the wedges and leave the model till the glue is dry, taking off the cramps before the work is put aside. When the work is resumed, finish the model with a smoothing plane, just touching up the curved top with glass-paper.

MODEL XVI.—TRIANGULAR FRAMING CARRYING
SHELVES. FIG. 219.

This model gives a slight variation of the dovetailed halving joint, and another application of the wedged mortice and tenon. It is somewhat difficult, and involves a large amount of material: exceptional boys only should therefore be allowed to attempt it.

The front and side elevations, and the plan in fig. 219, should all be drawn by the pupil.

The wood required for this exercise—yellow deal or bass-wood—is as follows:—

For the stiles, two pieces 1 ft. 7 ins. long, $1\frac{3}{8}$ in. wide, and 1 in. thick; for the rails and struts under the shelves, eight pieces of 1 in. by $\frac{7}{8}$ in. wood, two of them 6 ins., two $6\frac{1}{2}$ ins., and four 8 ins. long. Two pieces of $\frac{3}{4}$ -in. wood, one of them $6\frac{1}{4}$ ins. and the other $6\frac{3}{4}$ ins. wide, and each 2 ft. 5 ins. long, will be wanted for the shelves.

Commence work on the framing, and having planed it all true and just over the dimensions, to allow for the final cleaning off, set out the mortice and tenon joints, marking the opposite similar pieces together, as in previous exercises. Make the mortices in the back, and cut the tenons and wedges.

To make the lapped dovetail joint, first cut the dovetails, then put the rails into the mortice of the back and lay the struts in the position they are to occupy; this gives the shape of the socket, which can be marked with a chisel, round the line of contact of the two pieces of wood. Cut out the sockets in both back and rails, and fit up the framing without glueing it, to test the joints. They should be correct, but in actual work a common fault is to make the two brackets on the same stile not

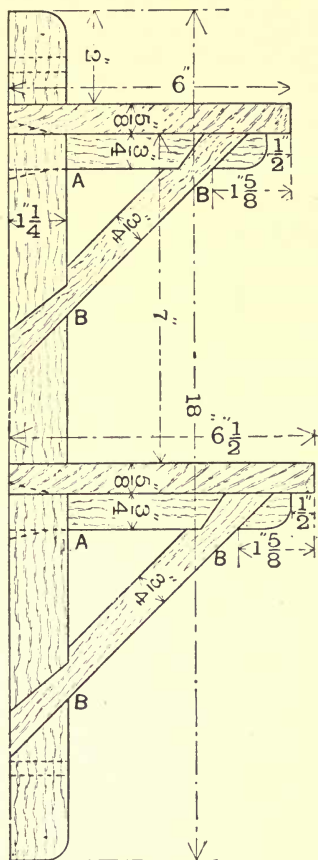

Side elevation.

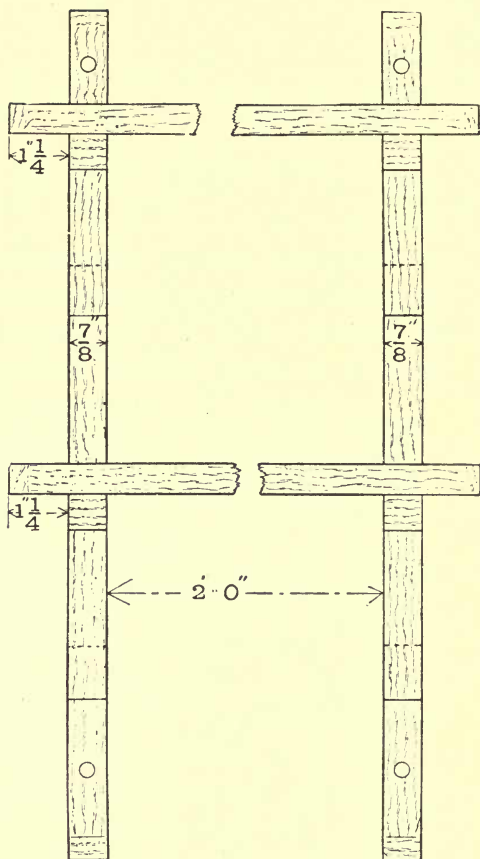

Front elevation.

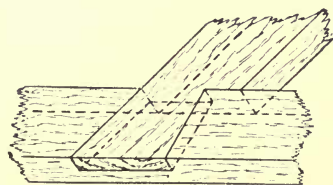

Sketch of joint of strut.

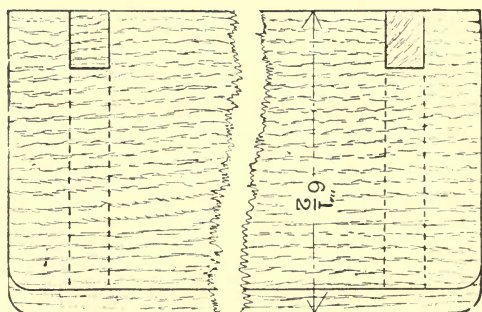

Plan.

exactly in the same plane, so that when looked at from the front one of them appears twisted.

This fault may be discovered at once, or, if not existing, it may be created in cramping up the glued joint unless great care is taken. On the other hand, any slight 'winding' which is now visible may perhaps be corrected in cramping up.

The joints may now be taken apart, plentifully glued, and cramped up. The cramps should be applied to the end of the rail and to the back, just below the mortice. This has the effect of pulling up all the joints in the triangle, and when the wedges are driven in, and the glue is well squeezed out, the cramps may be removed. The corners of the brackets and back stile should be rounded off with a chisel used vertically, finished with file and glass-paper, and the holes bored in the back. The shelves should next be planed up true to dimensions both on face edges and ends, and the corners rounded off to match those of the framing.

Saw out the notches to allow the stiles to pass through, and fasten the shelves to the rails, using three nails or screws to each bracket, $1\frac{1}{4}$ in. long.

MODEL XVII.—AN INLAID HANDLED TRAY. FIG. 220.

This is an attractive model, and gives a good drawing lesson. Both side, end elevation, and plan should be made.

The inlaying in the base of this model is the new tool operation introduced here, involving the use of the router.

The base is made from a stout piece of green-coloured bass-wood 1 ft. long, $6\frac{3}{4}$ ins. wide, and $\frac{3}{4}$ in. thick. The long sides, each 1 ft. long, $2\frac{1}{4}$ ins. wide, and $\frac{3}{8}$ in. thick, and the short sides,

$6\frac{1}{2}$ ins. long, $3\frac{1}{2}$ ins. wide, and $\frac{3}{8}$ in. thick, should not be of the same material as the base, but made of some pretty wood, such as sycamore, or, if a dark colour is preferred, of walnut or mahogany. The inlay pieces, pairs of contrasting colours, one of

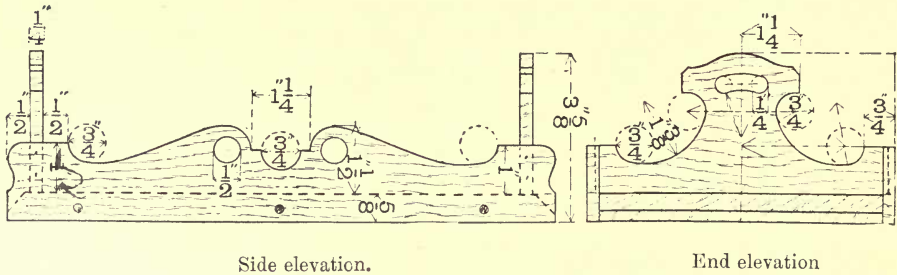

Side elevation.

End elevation

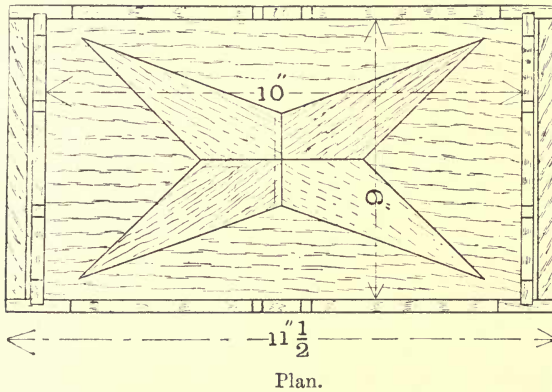

Plan.

FIG. 220.

which should be the same as the material selected for the sides, can be made from wood $\frac{1}{4}$ in. thick, and a saving can be effected by cutting the pieces for several models out of one strip of wood.

The base should first be made true on both faces and edges,

and then the pieces of thin wood for the inlay work should be shot true on the edges in the shooting board, and then carefully glued together, and to a sheet of paper face side downwards. No hard projecting pieces of glue must be allowed to show on either the edges or the surface of the inlay pieces when dry. The glue, therefore, should be very sparingly used, very little being really required.

When dry, the arris of the back edges of the inlay plate should be just taken off with a file, and, placing it in its proper position on the base, mark the outline with the point of a $\frac{1}{4}$ -in. chisel.

The inlay must be held firmly down, and if the fingers cannot be trusted the holdfast should be used.

A bevel-edged chisel will be found best for this purpose, or an ordinary firmer chisel can be readily ground as a substitute.

The corner will now be found more suitable for marking the exact outline of the inlay plate than that of an ordinary chisel.

The inlaying will be a little less than $\frac{1}{4}$ in. deep, say $\frac{3}{16}$ in. In order to facilitate the use of the router, the surface can be bored a little all over; or with the chisel used vertically and horizontally, the pupil can remove some of the waste, and when enough has been so cut out, the router should be taken up to make the surface smooth. Adjust the router to give the proper depth— $\frac{3}{16}$ in.—and grasp it as in fig. 221, which shows the recess of this inlaying being made.

The router cannot be used to cut out the waste completely into the acute angle, but this can be finished with the bevel-edged chisel or the point of a bradawl. When the base is prepared for the inlay and the recess is quite clear, the plate may be

glued in with the face side, *i.e.* the paper, upwards. The greatest care must be taken in pressing this into its place, and the reason for removing the arris on the under side will now be apparent. When the plate is put exactly into its place, it should be gently forced into the socket. To prevent the breakage of the middle joints, place a large piece of wood across the whole inlay, and lightly tap this with a hammer till the inlay is in its place. The base of the model may be left now till dry. The long sides



FIG. 221.

being similar can be tacked together where the housed joints are to be made, and after shooting true the face edges, which will go downwards in the finished model, the outline of the top should be drawn at the proper distance from this edge. Bore out the holes, partly from both sides, and finish the curved form with the bow saw and spokeshave. The two handled ends are made similarly, the curved opening of the handle should be finished with a chisel.

The housing joint in the sides can now be made, and then

the bottom planed up, to clean off the paper. The ends of the base may now be levelled and shot true, and the long sides nailed on with three brass pins, or brass screws, as shown in side elevation, the housing joint being secured by oval steel brads.

EXERCISE XIV. FIG. 222

MITRED ANGLE BRIDLE JOINT.

The drawing of the complete finished joint may be made or that of the piece of wood, with both ends cut ready to complete the joint, as in fig. 224.

This exercise can be very well performed in yellow deal or bass-wood, and a piece 1 ft. long by $1\frac{3}{4}$ in. by 1 in. will be required.

Plane it up to dimensions, and set out the work, as in fig. 223, using the bevel set very carefully at 45° for the shoulders. Make cut lines with the chisel for the sloping shoulders, and with the mortice-gauge for the mortice and tenon. Saw these out in the same manner as the angle bridle joint, but stop-

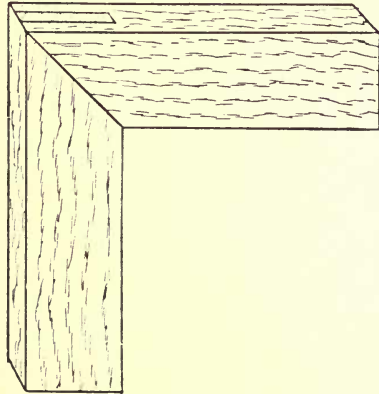

FIG. 222.

ping, of course, at the marked shoulders. In cutting the shoulders take great care, as the joint will not fit unless they are perfectly true. The sawing will be sufficient in soft wood, though even then

it must be very carefully done ; but if the joint is made in hard wood with unyielding fibres, the mere sawing will not be enough, and it will be necessary to saw a little from the line and pare

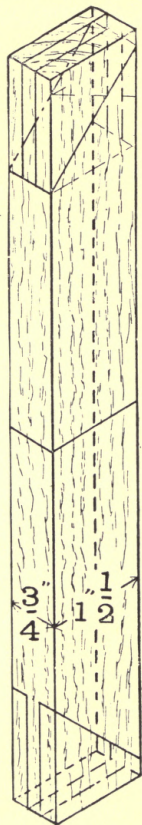

FIG. 223.

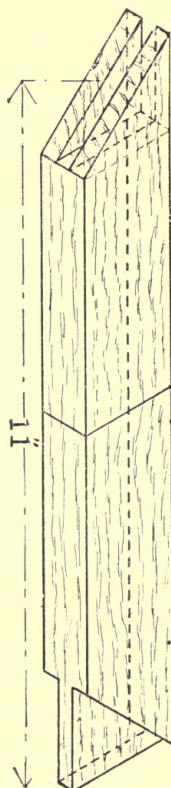
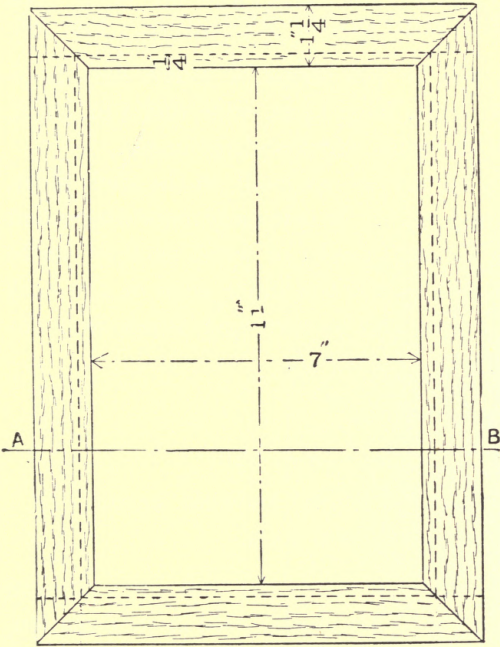

FIG. 224.

back with a chisel to the cut line. Fig. 224 shows the mortice and tenon made and ready to joint up. When glued, clean the work off with the smoothing plane.



Front elevation.



Side elevation.

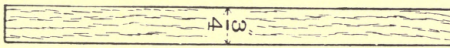

Plan.

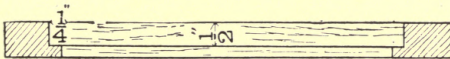

Section on A B.

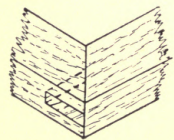

Isometric projection of joint.

FIG. 225.

MODEL XVIII.—A PICTURE FRAME INVOLVING THE USE OF THE JOINT IN THE FOREGOING EXERCISE. FIG. 225.

The wood required will be two strips of yellow deal, bass-wood, or sycamore, 1 ft. 4 ins. long, $1\frac{1}{2}$ in. wide, and 1 in. thick, and two 10 ins. long, of the same width and thickness.

In this exercise the tenons are all made on the short sides, and the mortices in the long sides. It is usually more convenient to mortise in large than in small pieces of wood, as they can be secured better. The rebate round the inner edge at the back should be made after cutting the mortice and tenon from the solid wood, but before finally jointing up.

EXERCISE XV. FIG. 226

ANOTHER FORM OF MITRED JOINT, SHOWING SQUARE SHOULDERS ON THE BACK.

This form of joint is stronger than the first form given in Exercise XIV., and is much more commonly used in construction, where it is not essential that the mitred joint should show on both faces. The drawing should be either the completed joint, or the wood with the mortice and tenon made at either end, as in fig. 228.

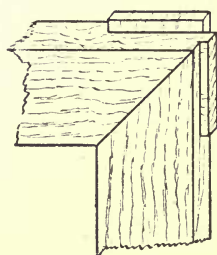

FIG. 226.

A piece of yellow deal, $1\frac{1}{8}$ in. wide, 1 in. thick, and $11\frac{1}{2}$ ins. long, will be found suitable.

Fig. 227 shows the marking on the face edge and side at both ends, and fig. 228 shows the mortice and tenon made. About $\frac{1}{4}$ in. of waste at each end is marked

out to be removed in order to obtain a true surface, to gauge on. After the completion of the joint, there is, necessarily,



FIG. 227

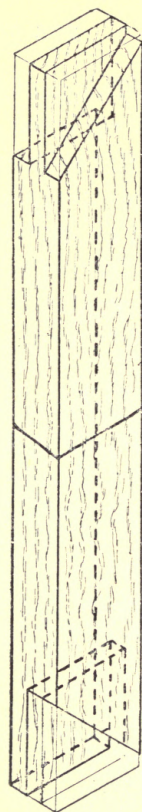
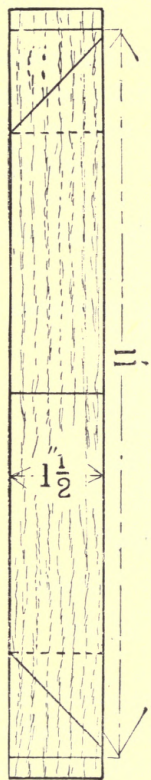

FIG. 228.

a small projection on each edge, which must be sawn off, and the surface then planed from the corner inwards, so as to avoid breaking the end grain.

EXERCISE XVI. FIG. 229

THE GROOVED AND CROSS-TONGUED MITRED JOINT.

This joint is used to secure thin pieces of wood which could not easily be strongly joined by leaving a tenon on one half. In this exercise, however, the wood is rather thick, as the pupil would probably not be able to manage with thin wood at a first attempt.

Yellow deal $1\frac{1}{2}$ in. by 1 in., and of any convenient length, will be suitable for this exercise.

The wood should first be planed true and sawn at 45° . The

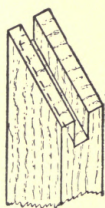

Isometric projector
of mitred piece.



Side view of groove.

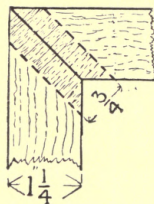

Elevation.

FIG. 229.

two pieces obtained should be planed true on the mitred edges in the shooting board, with the stop adjusted to 45° . With the marking or mortice gauge, mark the grooves on the planed edges of both pieces. The tongue is made from a thin strip of wood planed true to $\frac{3}{16}$ in. in thickness. The grain in this tongue must be at right angles to the mitred joint, as will be seen in the illustration (fig. 229), in order to give strength.

This is called a cross-tongued joint. Sometimes the tongue

is made with the grain diagonally, but this is objectionable, as swelling or twisting in the tongue, when freshly glued, would cause the joint to open.

The joint should be glued up, and it is then finished.

EXERCISE XVII. FIG. 230

STOPPED, GROOVED AND CROSS-TONGUED MITRE JOINT.

This joint is, as will be seen, very similar to the preceding, the difference being that the groove does not extend right through. The edges of the mitre should be shot true, as in the ordinary grooved mitre joint, and the groove made.

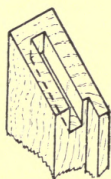

Isometric sketch of
mitred piece.



Side view of rebate
and groove.

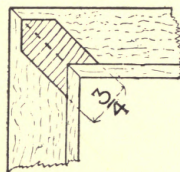

Elevation.

FIG. 230.

Saw out the waste a little way, and then finish the groove by horizontal and vertical paring. In the illustration the joint is shown rebated, as it is used in this form in the succeeding model, but the rebate is not really a part of the joint.

MODEL XIX.—A STANDING PICTURE FRAME. FIG. 231.

The drawing of this model should be the side elevation, giving the angle of the front and the back leg, the front elevation

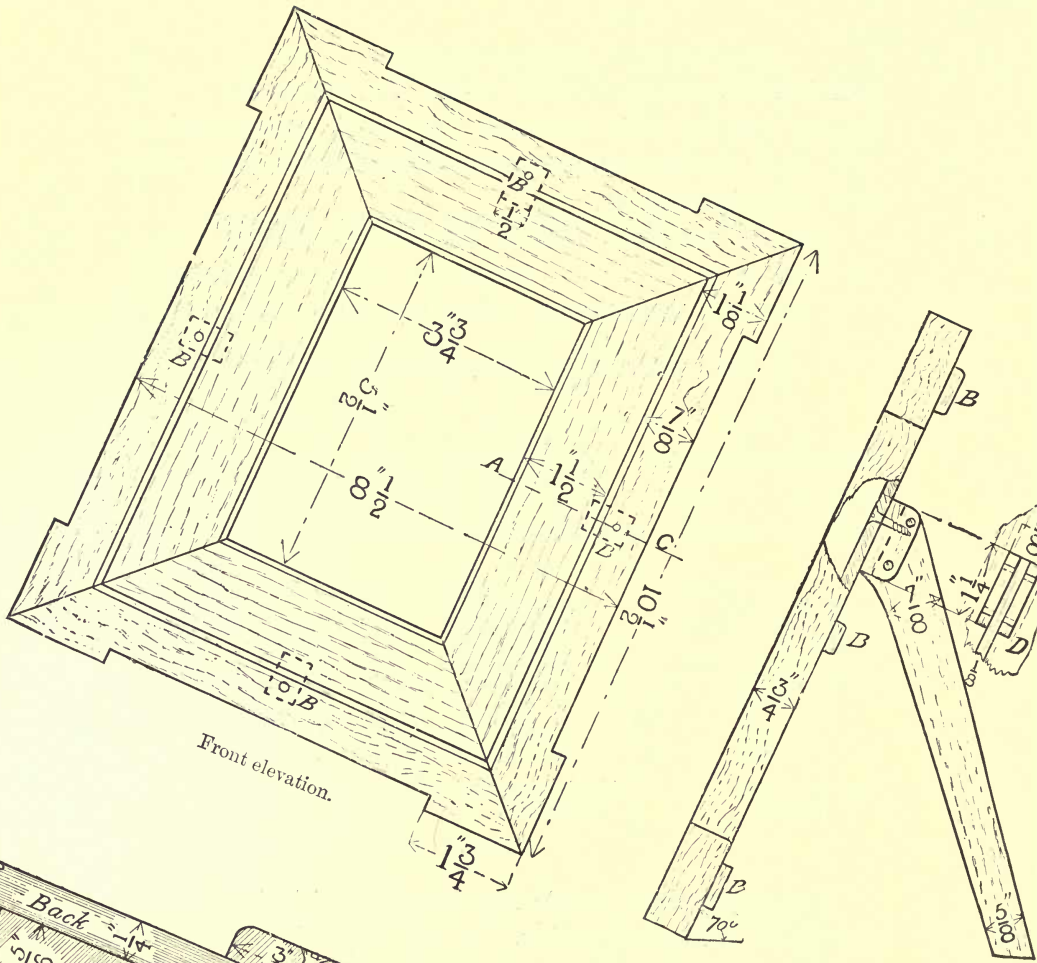

Front elevation.

Side elevation.

Enlarged section on A C.

B, Buttons ; D, Projected back view of block to receive leg.

FIG. 231.

showing a case of change of ground line, and a full-size detail of section on a c, in fig. 231.

The timber for this frame should be some ornamental wood, say walnut or mahogany, for the outside frame and the leg, and sycamore for the mount; the back may be made of bass-wood or yellow deal.

The size of this model will be regulated by the dimensions of the picture to be framed, but it is not advisable to attempt to make a very large frame, as the practical difficulty in performing a large piece of work is altogether out of proportion to the increase in the dimensions. The size of the frame recommended is shown in the illustration (fig. 231), and this will take an ordinary cabinet photograph. Presuming that this size is adopted, the timber required will be as follows:—

Walnut or Mahogany—Two strips 11 ins. long, $1\frac{1}{4}$ in. wide, and $\frac{5}{8}$ in. thick, and two of $9\frac{1}{2}$ ins. long each, and remaining dimensions similar, for the frame; one strip 8 ins. long, $1\frac{1}{4}$ in. wide, and $\frac{1}{4}$ in. thick, for the leg; one piece $3\frac{1}{2}$ ins. long, $\frac{5}{8}$ in. wide by $\frac{1}{4}$ in. thick, from which to make the four stops, and one 2 ins. long by $\frac{3}{4}$ in. square for the supporting block of the leg, **D**.

Sycamore—2 ft. 9 ins. by 2 ins. by $\frac{1}{2}$ in. for the mount.

Yellow deal—One piece 10 ins. long, $7\frac{1}{2}$ ins. wide, and $\frac{3}{8}$ in. thick for the back.

The wood should first be planed up true to dimensions except the strip for the mount, which should be left a little wide, and then the four strips for the outer framework should be taken up, and the rebate and chamfer made on the face edge of each piece, as shown in the section (fig. 231).

The mitred joint may be of any form previously attempted, but, perhaps, the stopped, grooved, and cross-tongued joint is the

best in this case, as the joint will then be similar on both sides, and no unsightly tongue will show through on the edges at the corner.

The portion to be removed on the outer edges of the frame should be cut out before glueing the frame together. The notches should be sawn down to the required depth, and the waste roughly removed with a chisel, leaving just a little more work to be done to it after glueing up.

The joints can be very conveniently brought up close, by tying a piece of string tightly round the outside of the framework,

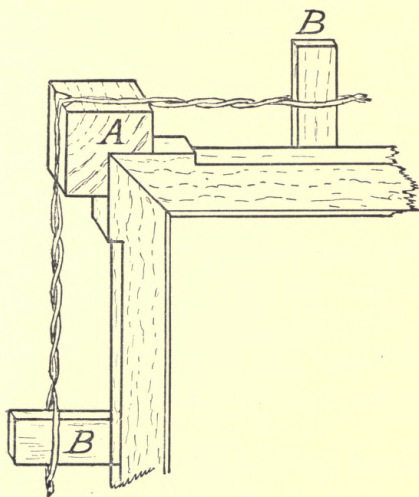

FIG. 232.

notched pieces of wood made to fit each corner of the frame, as shown at *A* in fig. 232, to act as cramps on the joints, and to prevent the string from damaging the corners of the frame. The blocks, it will be noticed, are made to give fibres at right angles to the strain of the string. They can be readily made from a small strip of wood rebated on one corner, and then cut into four pieces, as in fig. 233. The rebate, which will be in contact with the newly-made joint, should be oiled to prevent it from becoming attached.

The string is tightened up by inserting slips of wood (*B*, in

fig. 232), halfway between each corner, and turning them round in the same way as the string of a bow saw. To prevent the string from slipping off the block to either side, a little notch should be made in the middle of the outer angle of each block, and in adjusting the string for tightening, take care to make the pressure occur immediately over the middle of each joint; if the string pulls obliquely, the increasing strain might cause the joints to open, and so spoil them.

The strip of wood for the mount should now be rebated and

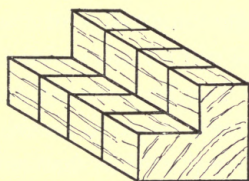

FIG. 233.

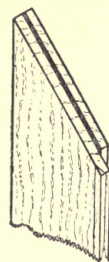

FIG. 234.

chamfered to the dimensions shown in the section, fig. 231, and then cut into the lengths for each side, and the mitres shot as usual. This wood is so thin that the only joint possible is the grooved and cross-tongued mitre. The tongue should be a small piece of veneer, or some equally thin wood, and the groove, as shown in fig. 234, ought to be made with one cut of a panel or tenon saw—about $\frac{3}{8}$ in. deep.

To make the four joints of the mount, they may, after glueing, be brought tight up by nailing just round the edges on the smooth surface of another piece of wood, as in fig. 235.

Some care in adjusting the four joints will be required, and it

is of the greatest importance to keep the whole surface quite flat.

To prevent the back of the mount from adhering to the wood under it, by the glue which will be squeezed out in putting in

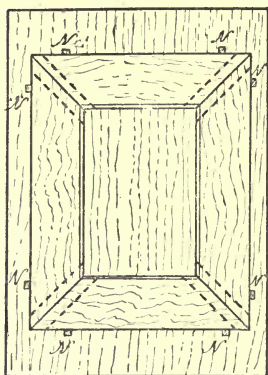

FIG. 235. Showing mount held together, after glueing, by nails at the angles marked *N*.

the nails, a piece of paper should be laid down first. When dry, the nails should be drawn with the pincers, and the outer edges of the mount shot true to the proper dimensions. The paper should be cleaned off the back, and the face also smoothed off. The paring of the outer edge of the frame can now be completed, and the mount fitted in. The back should be fitted, and the small stops to secure it prepared. They should be fastened down with $\frac{1}{2}$ -in. screws with slightly counter-sunk heads. These screws should not be driven in too far, so as to allow the buttons to be readily pivoted.

The leg may now be modelled with saw and file to dimensions, and the small block to take it prepared. They should be screwed together with two small screws—one from each side—as shown in the elevation (fig. 231).

The block for the back is screwed on to the back of the frame, as shown in the small projection *D*, in fig. 231, the screws being inserted through the back.

EXERCISE XVIII. FIG. 233

A PARQUETRY MAT.

Dovetailed wedged clamping is introduced in this exercise. The drawing should be the plan of face, and back, and section on A B, as shown.

The foundation must be made from a piece of wood (yellow deal) 9 ins. long by 9 ins. wide and 1 in. thick, and a strip of some hard wood, $2\frac{1}{2}$ ins. wide, for the key, as the wedge is sometimes called, will be required.

The inner diamond-shaped pieces can be made from two strips 9 ins. long by $1\frac{1}{2}$ in. wide and $\frac{3}{8}$ in. thick, one of them of walnut or mahogany, and the other of sycamore, plane tree, or some other light-coloured wood. The right-angled triangles which fit between the points of the star should be made from some wood, such as green bass-wood, which will bring the star more prominently into notice. The inner fillet should be made from 2 ft. 7 ins. of some dark wood to match the dark-coloured diamonds, and $\frac{3}{8}$ in. square. The next fillet should be made from a strip of 1-in. sycamore 2 ft. 7 ins. long and $\frac{3}{8}$ in. thick. The outside fillet, which encloses both the foundation and the parquetry, can be made from 2 ft. 9 ins. by $1\frac{1}{4}$ in. by $\frac{3}{8}$ in. of walnut.

Commence work by planing the yellow deal true and then set out the dovetailed groove. The wedge is intended to restrain the wood from warping or twisting, and it is therefore wedged and dovetailed, as will be seen in the section, to keep it in its place despite shrinkage of the deal, and is put in at right angles to the grain of the base.

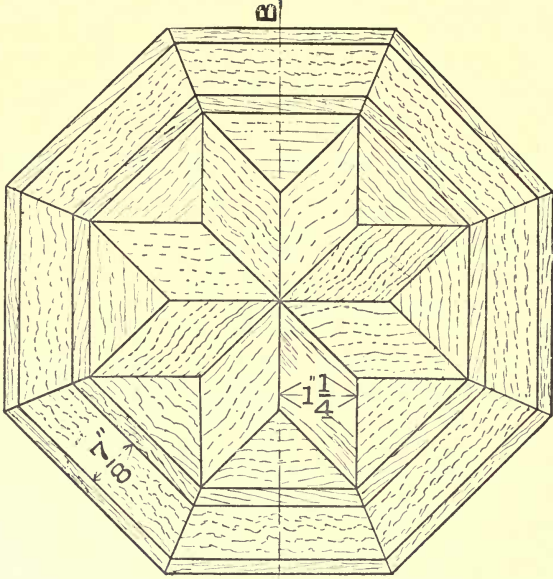

A
Plan of top.

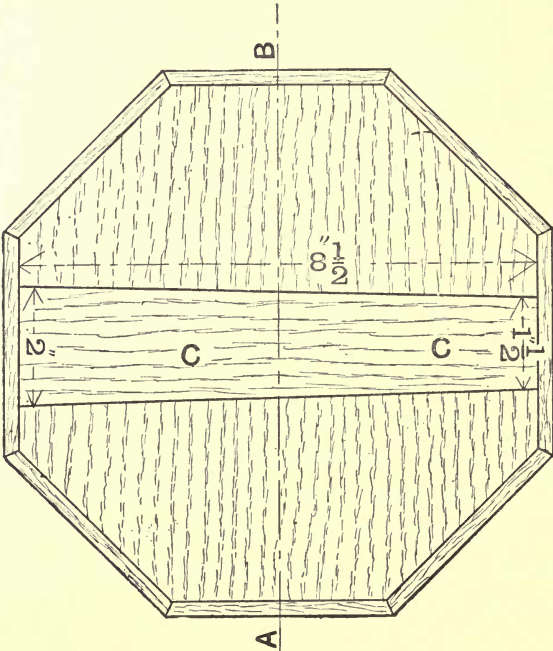

A
Plan of back.

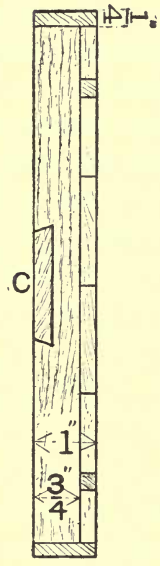

Section on A B.

FIG. 236.

The joint is a good one, but has been withheld before, as it involves sawing across a large surface with the tenon saw in an inclined plane. In marking the wood, set out the width of each end of the wedge in the middle of the opposite sides.

Prepare the key and put it in the groove, but do not glue it in yet. The reason of this is that any shrinkage taking place in the newly planed wood may perhaps cause the wedge to become a little loose, and it can, when the wood is presumed to be finally shrunk, be finally driven tightly in and glued on the heel or wide end of the wedge only; shrinkage in the foundation will then cause the wedge to draw even tighter. Glueing on the opposite end would cause wood to draw off the wedge, and would be fatal to the very object for which the wedge was introduced.

Plane up all the strips for the parquetry—not the outside fillet—to the dimensions. The strips for the star should now be shot on the edge in the shooting board. In doing this let the face side of one strip and the back of the other be upwards, as in Model VI., to obtain good joints and a level surface in the finished work. With the bevel set very accurately at 45° , the diamond-shaped pieces can now be set out as in fig. 237, allowing, as will be seen, a little waste between each piece.



FIG. 237.

In sawing this strip up into the small rhombuses, great difficulty will be experienced in making them all correct to dimensions on all four sides, unless the following plan is adopted:—

Commence by sawing off the small triangle of waste at the end and shooting the edge of the first rhombus true, before

cutting it off, as in fig. 238, which shows the shooting board with the strip of wood in position ready to be planed. Saw off the first rhombus a little full, and shoot the edge of the next one true as before.

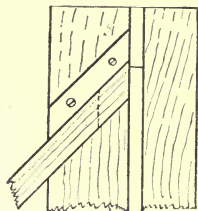

FIG. 233.



FIG. 239.

Now the first rhombus made is a little too long on the sides parallel to the grain, and exactly how much too long, must be ascertained before the pupil can be safe in shooting the rough-sawn edge last made. To do this apply the long edge to the trued-up edge of the strip, as in fig. 239. The very small amount of wood which has to be planed off is now known,

and may be removed, care being observed not to take off too much before again testing it. Complete the other rhombuses similarly. When four have been made, their accuracy, or the accuracy of the adjustment of the stop on the shooting board, may be tested by placing them together, with their acute angles meeting in a point. They now give two right angles or a straight line, and a straight-edge placed against them should fit exactly (see fig. 240).

The bass-wood strip may now be taken up, and when planed true, but wider than the dimensions, set out, as in fig. 241. Make these right-angled triangles in the same manner as the rhombuses, but, of course, each one will be a little larger than is wanted. Glue up the star on a piece of wood, and after leaving

it about ten minutes to set, insert the bass-wood triangles to complete the octagon. One half of fig. 242 shows the shape and the plan of the nails, which are placed all round in pairs at the angles, to keep the joints well up. It will be noticed that the

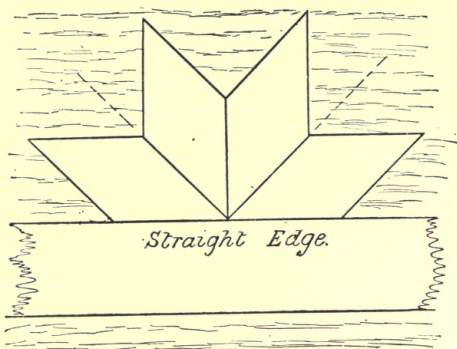

FIG. 240.

outside corners of the bass-wood triangles have to be cut off to allow of their being jointed. The banding is prepared by glueing the two strips together in the length, with the thin inner strip planed true to dimensions, and the wider strip left a little



FIG. 241.

full. This joint is so long and the wood so light that the glue might fail to hold, unless a few wedged cleats are put on at intervals, as shown in fig. 243.

The octagonal plate should be taken up, and the edges shot

down to the points of the star, and the paper scraped off the back with a saw blade used like a rake, so that the points of the teeth make scored marks. This will effectually remove the paper

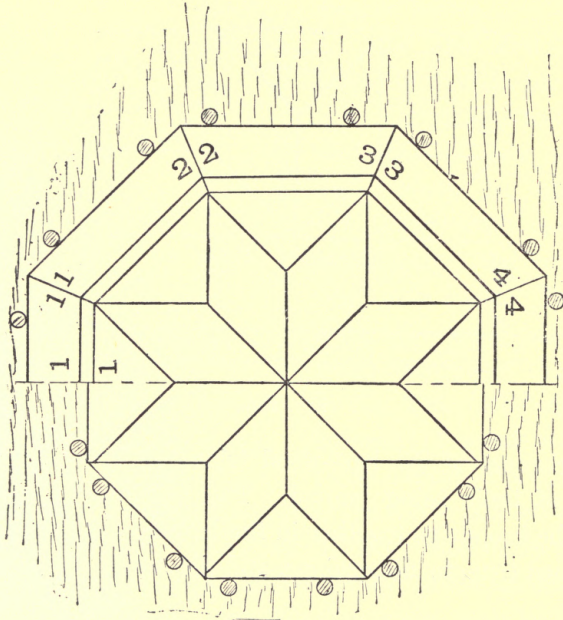

FIG. 242.

and leave the surface of the wood rough, which will be of assistance on the glueing down on the deal foundation.

The banding should be cut off, as in fig. 244, to the required lengths. These lengths should be marked on the wood after comparison with the face of the octagon, which they are required to fit. The mitred joints should be carefully fitted to each other,

and the joints numbered, as in fig. 242, so that they may be glued down in their correct position without risk of confusion.

The deal base may now be planed true, and the octagon and banding glued down. The octagon should be first put down, and be well rubbed to get out the surplus glue. When the glue 'sets,' the banding should be quickly put down piece by piece, again taking care to rub the glue well out. One half of fig. 242 shows the complete octagon glued down, and, as usual, kept well together with nails, driven in close up to the parquetry.

The yellow deal base can now be cut down to the dimensions

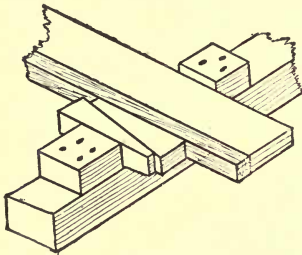

FIG. 243.



FIG. 244.

of the parquetry, and the fillet to go round the outside prepared, cut off in proper lengths, and the mitres shot true. These may be glued on as usual, and then nailed on from the outside with a few small brads.

The trying plane should be used to bring the surface true, and then the iron-faced smoothing plane should make it smooth. Finally, with a piece of No. 0 glass-paper stretched tightly on a smooth piece of cork, rub the whole surface with a circular movement, but do not destroy the sharp edges.

EXERCISE XIX. FIG. 245

A BOX WITH GROOVED AND TONGUED JOINTS (ACROSS THE GRAIN).

The drawing shows the plan of box, a longitudinal section on A B, and a cross section on C D. They should all be drawn, and preferably an enlarged section of the joint also, as in fig. 246.

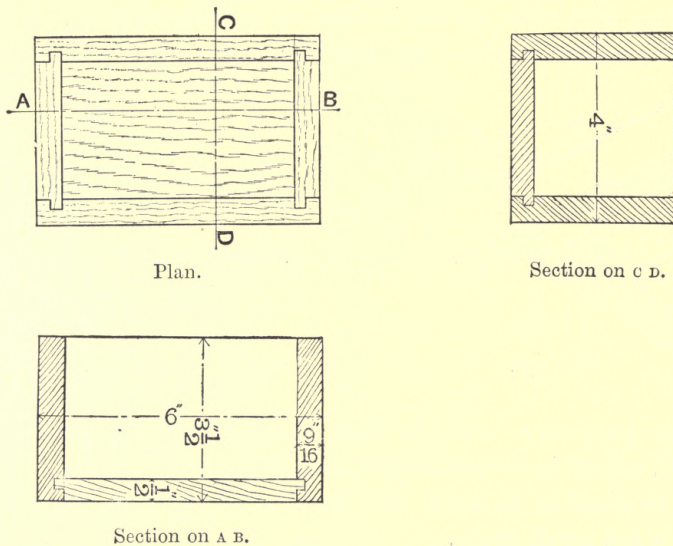

FIG. 245.

The timber required, Weymouth pine or yellow deal, will be as follows:—

For the long sides	$13\frac{1}{2}$ ins. \times $3\frac{3}{4}$ ins. \times $\frac{3}{4}$ in.
„ short sides	8 ins. \times $3\frac{3}{4}$ ins. \times $\frac{3}{4}$ in.
„ bottom	6 ins. \times $3\frac{1}{2}$ ins. \times $\frac{3}{4}$ in.

Plane up all the wood true, and saw the pieces for the sides and ends in halves across the grain. Place the long pieces with the face sides together, and mark the extreme length of the sides on them, so that the waste is equally divided at both ends.

Set out on the edges first, as in fig. 247, marking the $\frac{9}{16}$ in. for the thickness of the sides, and then from these lines mark lines $\frac{1}{4}$ in. in for the grooves; continue the lines for the grooves across the outside and on the back edges.

Fig. 248 shows the setting out of the short sides, which are placed together back to back. The inner pair of lines on the face edge which show the width of the outside will be continued across the face, but the outer pair, which give

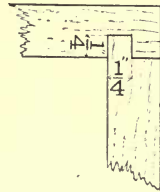

FIG. 246.

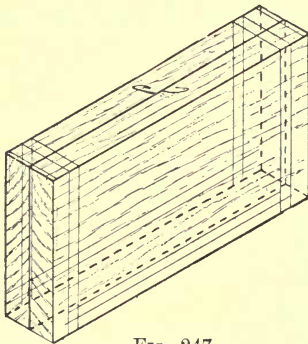

FIG. 247.

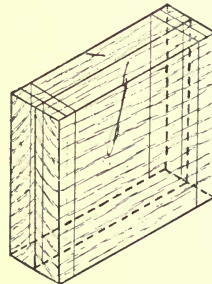

FIG. 248.

the extreme width of these sides, should be continued across the back of each piece. Gauge lines 3 ins. from the face edge on the back of each of the sides, for the grooves to take the bottom of the box. These grooves are $\frac{1}{4}$ in. deep and $\frac{1}{4}$ in. wide, and

will run from end to end of the short sides, but will join the upright grooves in the long sides.

Saw out the tongue at the ends of the short sides, and the groove along the bottom also, removing the waste with a chisel, as in Exercise I. With saw and chisel make the grooves across the grain in the long sides, and mortise out the bottom grooves between the upright ones with a $\frac{1}{4}$ -in. chisel, as in the case of the rebate in Model X., fig. 184. The bottom of the box is tongued all round, and should be gauged on the face or outside $\frac{1}{4}$ in. away from a line made all round, to indicate the exact measurement.

Saw the tongues on the ends of the bottom, and with the rebate plane make the shoulders of the tongues on the sides of the bottom. Fit the box together, and, if correct, take it apart and glue up the joints. The box should now be finally cleaned off with the smoothing plane, taking care to plane from the outside edges towards the middle of the faces on the ends and bottom, where the end grain might be broken.

MODEL XX.—AN INK-WELL WITH SWINGING LID. FIG. 249.

The chief exercise in this model is the grooved and tongued joint.

The drawing shows the plan and elevation of the box with the lid turned back. The plan shows the seat of the ink-well and the section on A B, the supports under it.

Any ornamental wood, as mahogany, walnut, beech, teak, or sycamore, will be suitable for this model. The following will be required :—

For sides, one piece	12 in. \times 2 $\frac{3}{4}$ in. \times $\frac{1}{2}$ in.
„ top and bottom, one piece	6 $\frac{1}{2}$ in. \times 3 $\frac{1}{4}$ in. \times $\frac{1}{2}$ in.
„ arms, one piece	6 in. \times $\frac{3}{4}$ in. \times $\frac{1}{2}$ in.
„ seating and supports, one piece	4 in. \times 2 in. \times $\frac{3}{8}$ in.

Plane up the wood as usual ; but the long strip should be wider than the finished measurement— $2\frac{3}{8}$ in., as some material will be removed in planing the edge of the lid. Mark out the length of the four sides and saw them apart. Set out the opposite similar sides together, as in the previous exercise ; make the grooved

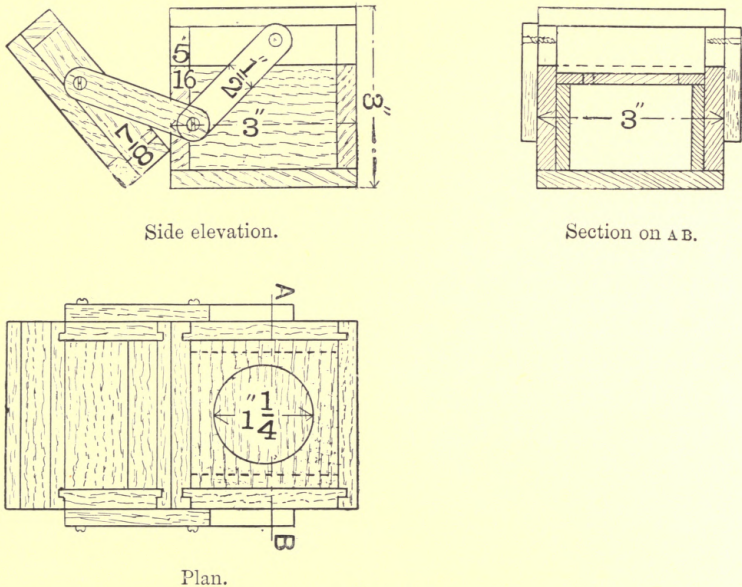

FIG. 249.

and tongued joints. Glue up the joints and make the top and bottom a little larger than the size of the finished box. Nail these on, so that the end grain of top, bottom, and sides are together, as in fig. 250. Plane off the outside of the box, and take great care not to break out the end grain. This is especially likely to happen in this small piece of work. Gauge the depth

of the lid and saw it off. Plane the edges of both box and lid true, till they make a good fit in all parts. Plane up the strip for the arms, cut it in halves, and model the rounded ends.

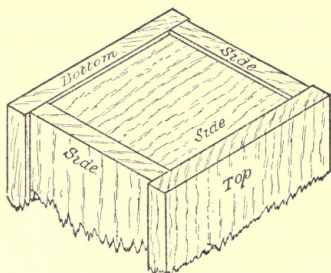

FIG. 250.

Round-headed screws should be used, and the socket in the arms should be large enough to allow them to be freely pivoted.

Saw the remaining strip in halves across the grain, and then cut one of the halves into two strips with the grain. Plane the edges of the oblong strips

till they can be fitted in well and tightly; they must, of course, be of the same width. The shelf to take the ink-well should now be planed true on the edges, till it will just slip into its place, resting on the top of the supports.

Draw the diagonals, and insert the point of the centre bit at their intersection, so that the hole is in the centre.

EXERCISE XX. FIG. 251

STOP CHAMFERING.

A piece of wood is to be chamfered on the edges, and at one end the chamfer is to be stopped with an inclined face, and at the other with a curve, making a segment of a circle.

This exercise, though it appears easy, is really too difficult to be attempted earlier in the course.

The sketches of the finished exercise need only be made, as shown in fig. 251. The wood required is a piece of deal or bass-wood about 1 ft. long and $1\frac{1}{2}$ in. square ; any piece of waste wood will do, however.

With a thumb-gauge and pencil draw lines on face and edge $\frac{3}{8}$ in. from the angle, and at one end make two straight lines at 45° to these lines to make the mitred end of the chamfer, and at the other end sketch a curve on each face to guide in making the curved end of the chamfer. Notice, that, though the chamfer itself is to make a quarter of a circle, the lines on the edges are not nearly such marked curves.

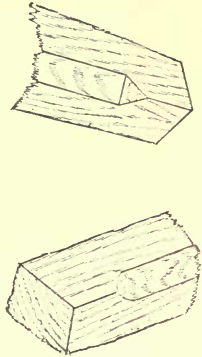

FIG. 251.

To find the precise line involves an interesting problem of solid geometry : but this is unnecessary, and the eye can be relied upon to aid in making a sufficiently satisfactory curve.

Commence chamfering by roughly removing the waste, holding the chisel as in fig. 252. In doing this, it will be found in which direction the cutting is the easier, and, when the chamfering is nearly done, including the ends, make one steady shearing cut the entire length of the chamfer, holding the chisel obliquely with the face downwards, as in fig. 252, and finish the mitred end, as in fig. 253, the face of the chisel again being downwards.

The operator in this case is resting the left fore-arm on the bench, to assist in steadying the chisel, and the cut made should make a good clean intersection with the face of the chamfer and then cease. On no account cut too deeply. To complete the curved end the chisel is turned over so that the back is down-

wards, and this, too, is finished with one cut, the handle being gradually depressed to make the cutting follow the line of curve.

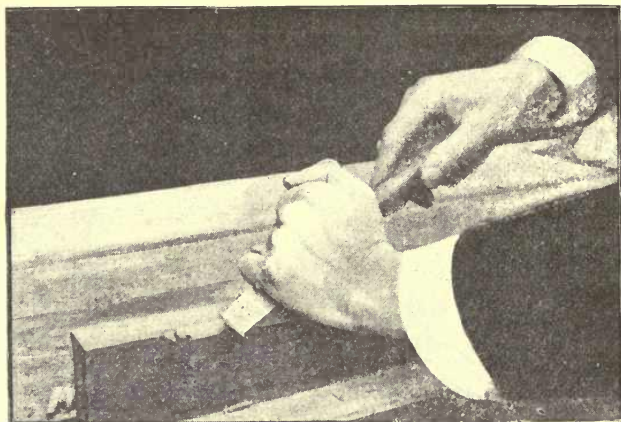

FIG. 252.



FIG. 253.

The difficulty here is to make the curve run uninterruptedly into the level portion of the chamfer. Fig. 254 shows this end being

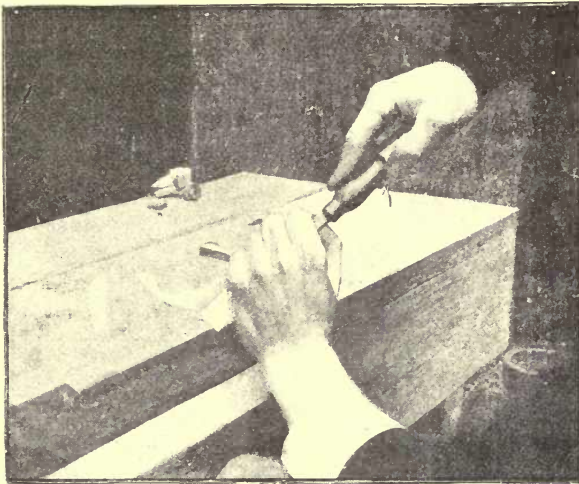

FIG. 254.

finished, but here the operator is resting his left fore-arm on the bench screw to steady the cutting.

The curved end may be finished with glass-paper, but the level portion and the mitred end should on no account be touched after the chisel has done its work.

MODEL XXI.—A HANGING BRACKET WITH CHAMFERED EDGES. FIG. 255.

The front and side elevations are all the drawings necessary.

The bracket may be made of any wood at the discretion of the teacher, but we will presume that it is made of bass-wood or walnut. Two pieces will be required, one 9 ins. by $4\frac{3}{4}$ ins. by

$\frac{3}{4}$ in. for the back, and one $5\frac{1}{2}$ ins. wide by $4\frac{3}{4}$ ins. long and $\frac{3}{4}$ in. thick for the shelf and support.

Plane up the wood and set out the back and shelf. The strip for the support under the shelf is to be obtained from one side of the smaller piece. Saw and pare out the groove in the back, draw the curved top and saw it out with a tenon saw and bow saw. The bracket and shelf may now be sawn apart,

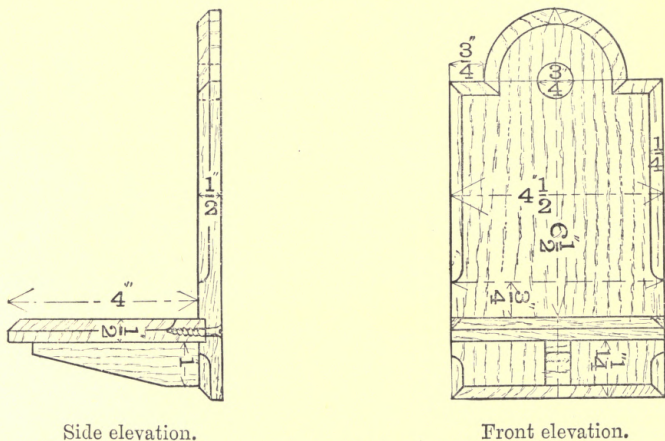

FIG. 255.

and both planed up true on the edges, bottom of back, sides of the shelf, and ends of the support.

The chamfering may now be done on both back and shelf, the curved top being roughly cut by a series of sloping cuts, across the line of the chamfer, before finishing the work, in the same manner as in the preceding exercise.

Glue and screw the shelf in, and secure the support to the shelf by a few small brads.

MODEL XXII.—A SET OF HAT-PEGS. FIG. 256.

This model makes a good chamfering exercise.

The drawing should be the front elevation, and the section showing the side view of the peg. The isometric view of the peg is given, however, as it may be of assistance. The length of rail is not given, as this can be left to the teacher to decide, and, of

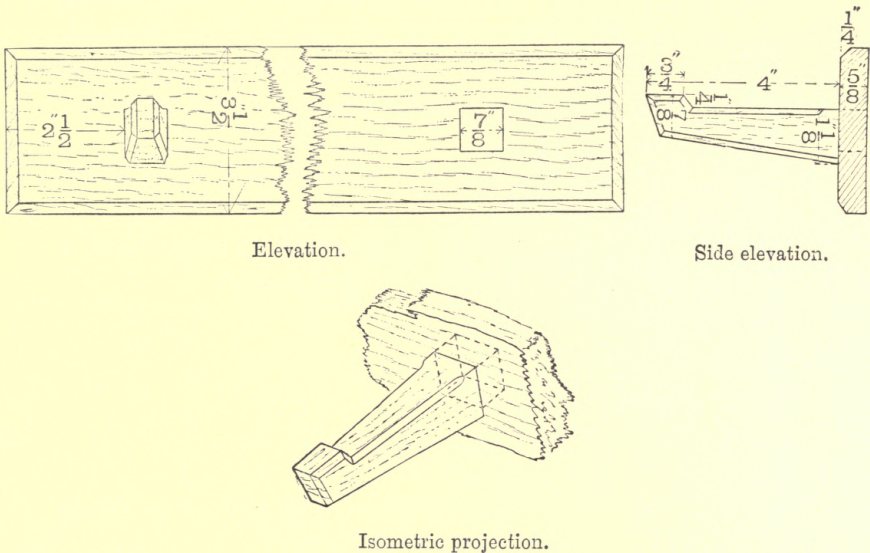

Elevation.

Side elevation.

Isometric projection.

FIG. 256.

course, the number of the pegs also. Two feet will be a suitable length for the rail, if no pressing reason exists for making it longer.

Each peg should be made from a piece of wood 5 ins. long and 1 in. by 1 1/2 in.

Plane up the rail and the wood for the pegs. It will be noticed that the pegs are shouldered on the under sides to keep them stiff under pressure on the extremity of the peg. Mark the shoulder on one end of the peg, and saw out the tenon for the mortice. Apply the end of the peg to the surface of the rail, and mark out the mortices with a chisel point, and make them as usual, boring them out roughly first.

The pegs should first be set out on the sides, and the sloping under side and the depression on the top roughly sawn out. Finish these with a jack and smoothing plane, and pare and plane the sides to make the shape shown in front elevation, fig. 256.

Complete the pegs by chamfering the angles, as in Exercise XX., and glue them into the mortices.

The ends of this rail can be ornamented by screwing on a shield, similar to those in Exercise X., at each end.

EXERCISE XXI. FIG. 257

GOUGING.

The drawing should be the plans of sides at right angles to each other, or a section, as shown in fig. 258.

A piece of wood 12 ins. long is to be grooved on all its sides, as shown.

Mark the wood across $1\frac{1}{2}$ in. from the ends, and mark lines down the length of the wood between these lines with pencil and thumb-gauge. Then draw the shape of the rounded ends outside the end lines.

The method of using the gouge is simple. Lay the rounded side

on the wood, and press forward with the right hand grasping the handle and the left hand keeping the edge firmly down, as in fig. 259.

Do not gouge too deep at first, but go over the work again

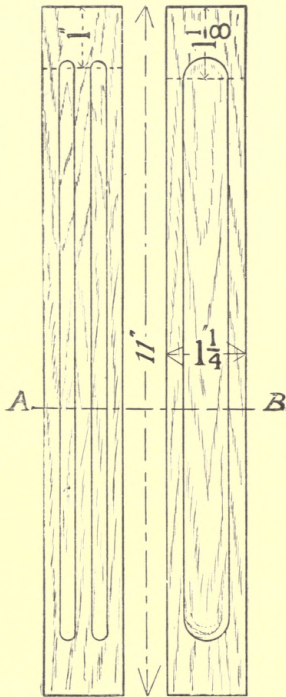

FIG. 257.

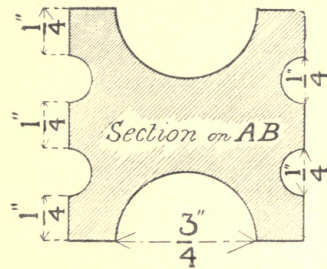

FIG. 258.

and again, finishing at last with a good clean cut. Be careful to work in the direction of the grain to avoid possible splintering.

The ends of the grooves should be modelled with the same gouge used for the corresponding groove.

Place a piece of glass-paper round a strip of wood ready planed up to the shape of the groove, and steadily rub up and

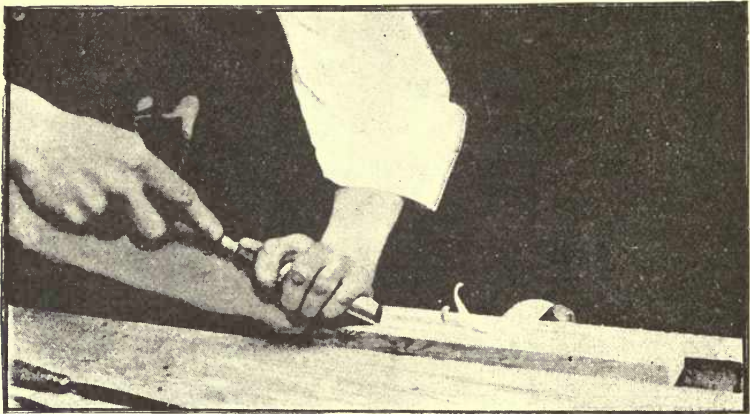

FIG. 259.

down, taking care not to damage the sharp edges of the grooves.

Saw off the waste at the ends and plane them true. The edges should also be cleaned off with the smoothing plane.

MODEL XXIII.—AN INKSTAND. FIG. 260.

Draw the plan and section as shown in the illustration.

Timber required.—Yellow deal, bass-wood, or pine, $12\frac{3}{4}$ ins. long by $2\frac{3}{4}$ ins. wide and $1\frac{3}{4}$ in. thick.

Plane up the strip of wood and set it out in pencil, making cut lines at the ends to give the exact length.

Gouge out the groove for the pens, and finish it completely.

Next bore the holes for the ink-wells, taking care in using the large bit not to bore too deeply. The point of the smaller bit

should be placed in the hole made by the pin of the large one first used.

Saw off the waste and carefully plane the end grain. This is a rather larger piece of wood than any previously planed on

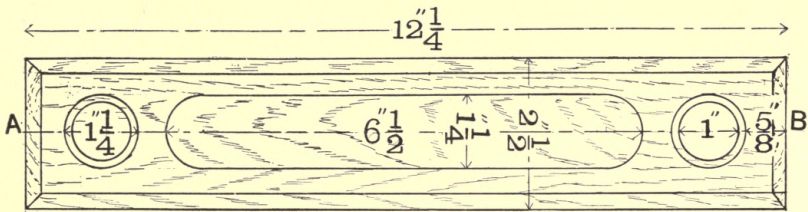

Plan.

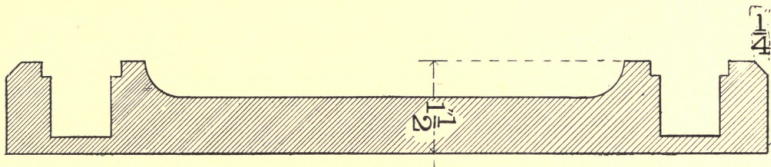

Section on A B

FIG. 260.

the ends, and, unless great care is taken, the fibres on the edges will be broken out.

Screw the wood up in the vice, and use the smoothing plane successively from every side and corner, and at no time allow it to cut completely across to the opposite edge of the model. Lift the plane to stop the cutting. Chamfer the model as in Exercise IV., and smooth the faces and edges with a smoothing plane.

some soft wood for the base—beech in the former, and yellow deal for the latter, the size of the base would make the cost of ornamental wood too great. The measurements of the material are—yellow deal, $10\frac{1}{2}$ ins. by $6\frac{1}{2}$ ins. by $1\frac{1}{2}$ in. ; beech, two pieces, 7 ins. by 5 ins. by $\frac{3}{8}$ in.

Plane up the wood to dimensions and model the groove with the gouge.

Make the mortices as shown in the plan, being very careful to get them upright, as they are the only support which the rests receive. Take up the rests, fasten them together, and draw the shape of the pen supports on one. Bore the holes, and then saw out the curves with the bow saw—in the top, sawing to the outer of the two dotted lines shown in the sectional elevation on A B, fig. 261. Finish the points between the semicircular grooves in the top of the supports with a chisel, and the remainder of the curves on the lower portion with spokeshave and file ; clean off the base and the uprights. Glue the pen supports into the mortices.

MODEL XXV.—A FOOTSTOOL INVOLVING THE
HAUNCHED TENON JOINT. FIG. 262.

The orthographic projections should be drawn.

The timber required, which may be yellow deal or pine, is as follows :—

For legs, one piece	1 ft. $5\frac{1}{2}$ in. \times $1\frac{1}{2}$ in. \times $1\frac{1}{2}$ in.
„ rails, twice	11 in. \times $1\frac{5}{8}$ in. \times 1 in.
„ „ twice	9 in. \times $1\frac{3}{8}$ in. \times 1 in.
„ top, one piece	$12\frac{1}{2}$ in. \times $10\frac{1}{4}$ in. \times $\frac{3}{4}$ in.

Plane up the wood for the legs and rails to the extreme dimensions, and saw it into four equal lengths for the legs.

Before marking the legs examine the plan of the joint in fig. 262, and the isometric projection with the haunched tenons together, fig. 263. (The leg is indicated by faint lines in order to give prominence to the joint.) It will be noticed that neither

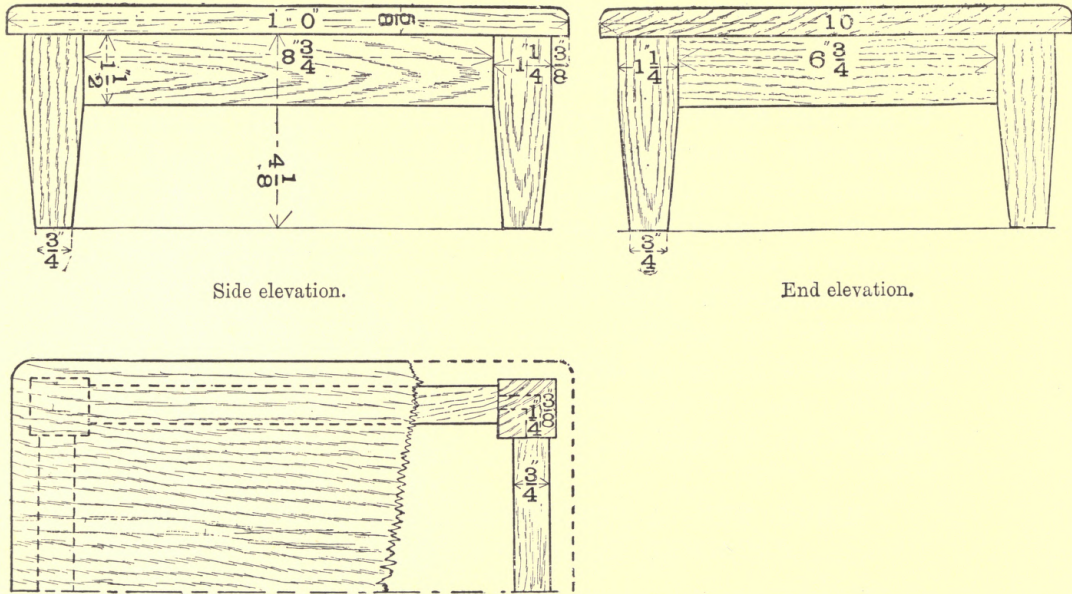

Side elevation.

End elevation.

Plan, with portion of top removed.

FIG. 262.

the mortices nor tenons are at mid-distance from the sides. This is in order to give as much strength to the inner angle of the leg as possible, and to secure longer tenons than if they were in the middle.

Put the four legs side by side with their face sides uppermost,

and gauge the limits of length and the size of the mortice, as shown in fig. 264.

Turn each leg individually, and continue the marking on the face edge. Set out the opposite rails simultaneously, and with the mortice-gauge adjusted to $\frac{1}{4}$ in. mark the tenons on the ends of the rails and the mortices on the sides of the legs. Remove the square portion of the mortices carefully, and then pare down the haunched part of each. Fig. 265 shows the shape of the leg with the mortices made.

Now cut the tenons of the rails. They should be sawn out

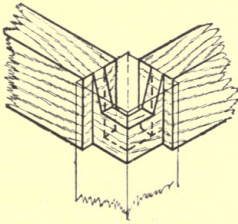

FIG. 263.

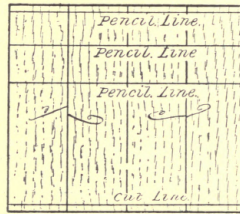

FIG. 264.

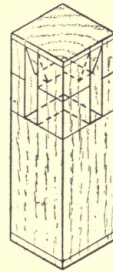

FIG. 265.

solid, and one corner then cut off to make the haunch, the extreme end of the tenon being roughly mitred with a chisel. Fit all the joints up, and if correct take them apart again, and cut off the waste at the bottom of the legs. Chamfer each leg with a jack and smoothing plane. To obtain lines to work from, mark the leg as in fig. 266, which shows the inner square drawn on the bottom end. Clean off the rails and glue up the joints. These may either be brought tight up in the cramp or they may be bound with a twisted string, as in the case of the picture-frame model.



The top should now be planed up true and the edges rounded. Before glueing or nailing the top on, plane off the tops of the legs.

Another method of securing the top, when the pupil wishes

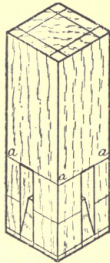
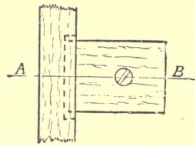
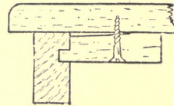

FIG. 266.



Plan.



Section on A B.

FIG. 267.

to hide the nails or screws, is to button it on from underneath. These buttons (about six in number) are tongued at one end and are inserted into shallow mortices. The screws, as shown in fig. 267, are then inserted.

MODEL XXVI.—A FRAMED BRACKET SHELF. FIG. 268.

This is a variation on the haunched mortice and tenon joint, and gouging on a curved surface is introduced.

The drawings should be the projections in fig. 268, and the section of the framing and back.

The timber required, bass-wood, Weymouth pine, or walnut, will be—

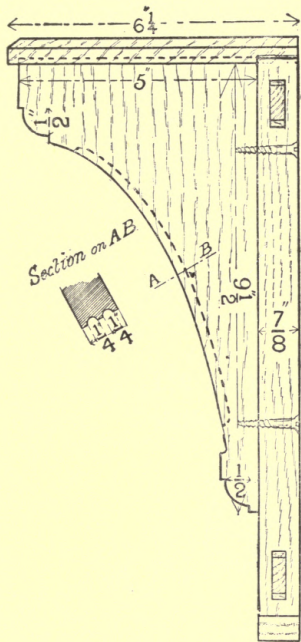

Side elevation.

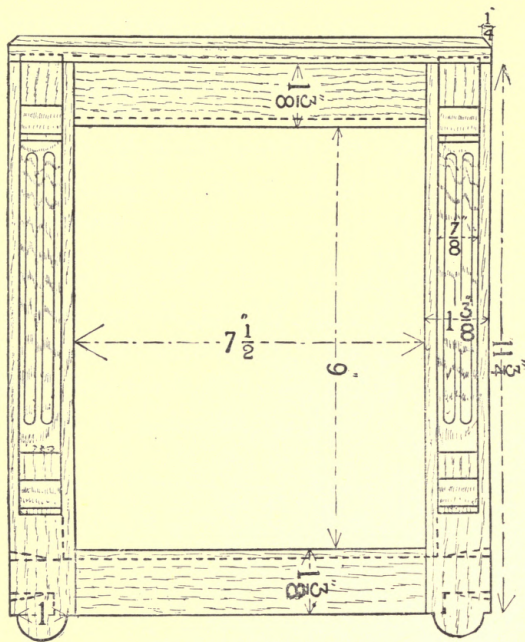

Front elevation.

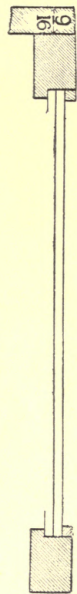

Vertical section of frame.

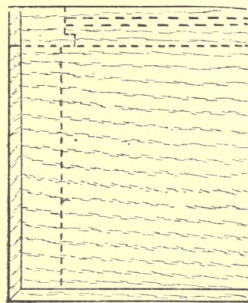

Half plan.

FIG. 268.

For framing, two pieces	.	.	14 ins. long	$\times 1\frac{5}{8}$ ins.	$\times 1$ in.
„ „	.	.	$10\frac{1}{2}$ „	$\times 1\frac{5}{8}$ „	$\times 1$ „
„ shelf, one piece	.	.	11 „	$\times 6\frac{1}{2}$ „	$\times \frac{3}{4}$ „
„ brackets „	.	.	13 „	$\times 5\frac{1}{4}$ „	$\times 1$ „
„ back „	.	.	10 „	$\times 8\frac{1}{4}$ „	$\times \frac{3}{8}$ „
„ fillets „	.	.	3 ft. long	$\times \frac{3}{8}$ „	$\times \frac{3}{8}$ „

Plane up all the wood to its proper size, and set out the framing as in fig. 269, showing the marking on the inside edges of the stiles, and fig. 270, showing the rails.

Examine the shape of the haunched tenon joint in fig. 271 before commencing; one shoulder is longer than the other



Fig. 269.

owing to the rebate on the inside of the frame, and the haunch of the tenon, instead of being sloping, is square. This form of joint is stronger than that in Model XXV., and is resorted to where the joint is not seen on the haunched edge.



FIG. 270.

Complete the setting out of stiles and rails. The face edges of all four pieces of wood should be inward, and it should be observed that the short shoulders of the tenons are in front, and

the long ones at the back. Make the four joints, glue them up, and wedge them.

The large piece of wood for the brackets should now be set out, as in the case of somewhat similar brackets in fig. 194. Saw them out with a bow saw, and put them together to complete the modelling of the curved edges, with chisel, spokeshave, file, and glass-paper. Set out the grooves with pencil and thumb-

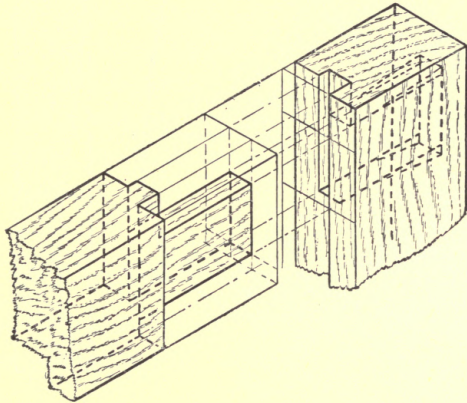
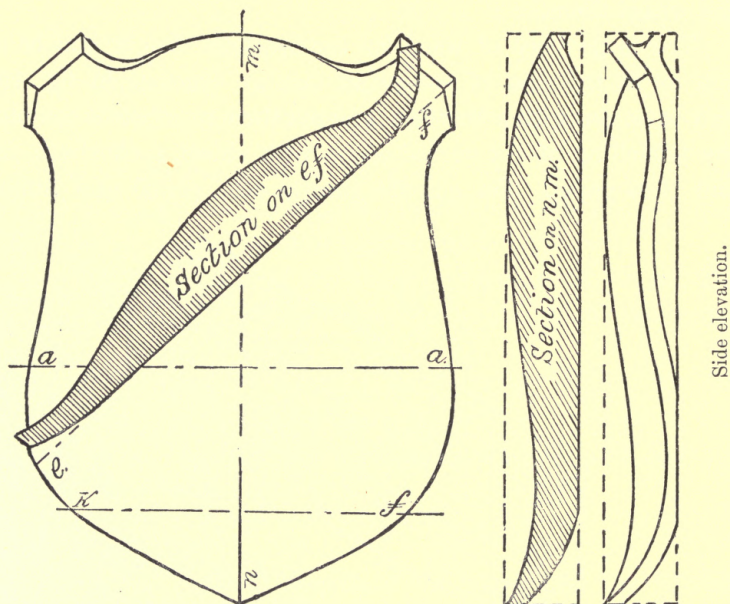

FIG. 271.

gauge, and cut out the grooves with a firmer gouge. The ends of the grooves may be finished with a carver's bent gouge.

Prepare the shelf by planing it true, chamfering the outer edges, and making the groove for housing in the brackets. Clean off the framing, cut off the ends of the tenons which show outside, and model the horns. Screw on the brackets and nail on the shelf. The back may now be prepared and fitted in.



Elevation.

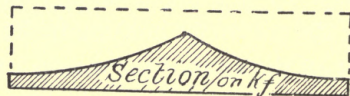
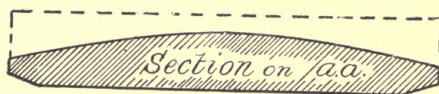

FIG. 272.

From Series V. 'Hand and Eye Training' Cards, by kind permission of Messrs. Cassell & Co., Ltd.

EXERCISE XXII. FIG. 272

A SHIELD.

This shield is much more difficult than the two given earlier in the course, as may be seen from the drawing, and involves the use of the gouge as well as the firmer chisel.

In doing the work pay continual attention to the drawing. On the middle of the surface make good sweeping shearing strokes, and at the corners a broad gouge should be used. No description can satisfactorily elucidate the modelling of this shield. The only advice that can be given is to proceed gradually, and work at every part successively, finishing with spokeshave, file, and glass-paper.

EDGE DOVETAILING. FIG. 273.

The isometric projection, as in fig. 273, only need be made.

It will be seen that this joint is very similar to the angle

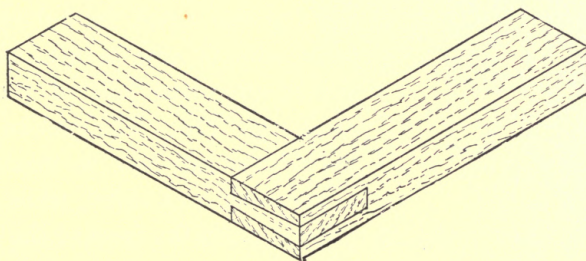

FIG. 273.

bridle joint, the difference being that the sides of the tenon are slightly inclined to each other in the joint at present under

notice, and the mortice is made with inclined walls to take this dovetailed tenon.

This joint, although apparently not much more difficult than the angle bridle, is in reality much harder to make. It is very much stronger, however, as will be readily appreciated from its appearance.

A piece of wood 11 ins. long, 1 in. thick, and $1\frac{1}{2}$ in. wide will be required to make the joint.

Set out as in fig. 274, making, as usual, cut lines for the depth line, all round the wood at the shoulders, and a pencil line at the end for the mortice. The rest of the setting out must be done in pencil, and this constitutes a source of difficulty at the commencement of the work.

Saw out the tenon, as in fig 275, and cut the wood in halves. The tenon should now be applied to the end of the other half of the wood, as in fig. 276. The precise size of the mortice can now be marked with a fine pencil, or a chisel, while the two

pieces are in contact. In order to make the faces of the finished joint true, it is advisable in placing the tenon against the end of the mortice half to lay both pieces on the flat surface of another piece of trued-up wood.

From the ends of the two cut lines gauge parallel lines

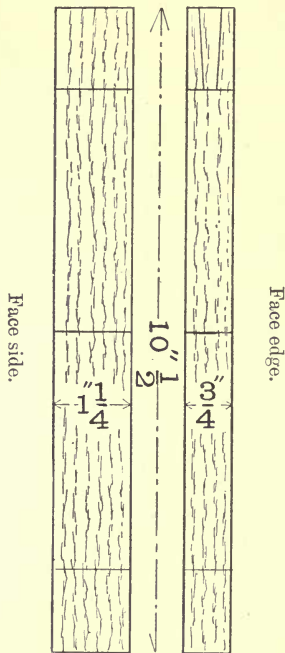

FIG. 274.

down the edges to the length of the mortice, and carefully saw and mortice out the waste, as in fig. 277.

This sawing and mortising require to be carefully done to

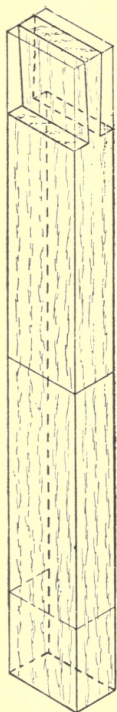

FIG. 275.

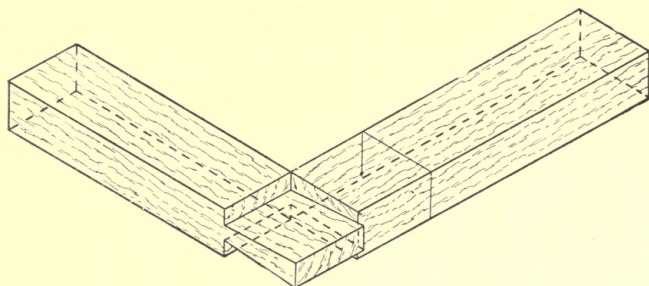

FIG. 276.

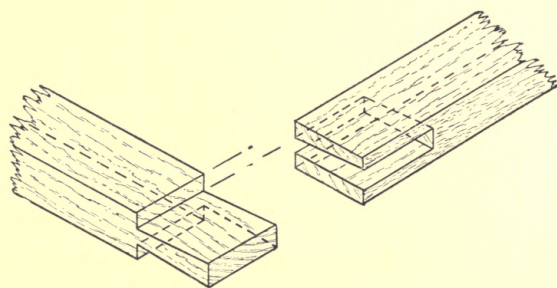
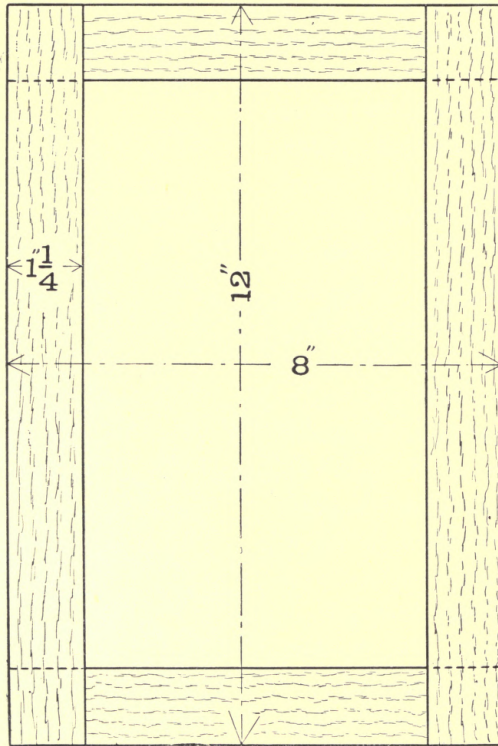

FIG. 277.

ensure a good joint. When glued up, the shape of the mortice has the effect of keeping the shoulder of the tenon well up to the side of the mortice.



Elevation.



Side elevation.

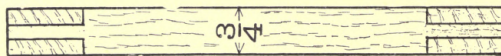

Plan

FIG. 278.

EXERCISE XXIII. FIG. 278

FRAMING MADE WITH ANOTHER FORM OF EDGE DOVETAILING.

The drawings should be as in fig. 278, showing plan, end, and side elevation.

The timber is $1\frac{3}{4}$ in. wide, $\frac{3}{4}$ in. thick, and two pieces $12\frac{1}{2}$ ins. long and two $8\frac{1}{2}$ ins. long will be required.

In this case the tenon is dovetailed from edge to edge, as will be seen in the end section of the isometric sketch of joint (fig. 279). This form of dovetailing is preferable to the preceding, where strength is required, although the altered shape does not bring the shoulders of the tenon up so well.

Set out the work, marking opposite similar pieces simultaneously, and observe that both ends of the shorter pieces or rails are cut into tenons, and the rails are mortised to

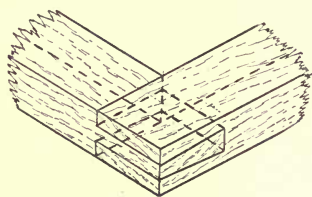

FIG. 279.

take them. This is done for convenience in cramping, for it is obviously easier to screw up a short piece than a long one. After cutting out the tenons, as in the former case, apply them to the mortices—this time, of course, to the side, not the end of the wood, and mark with a chisel as before. The gauging is done on the ends of the stiles, and there is no need to mark out the shape of the mortice on the back edge, as an inaccuracy in marking would lead to error in work. By this time, too, the pupil should not have much difficulty in sawing down the mortice without a line on the back edge to guide him.

Great care must be taken in making this framing true and square in all its joints.

Should it be wished to rebate the frame to take a picture or

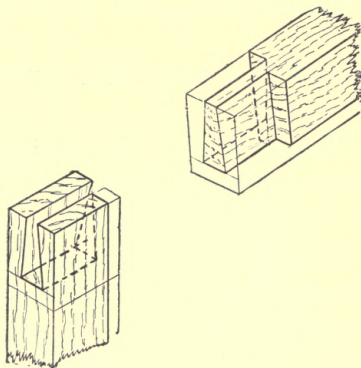

FIG. 280.

looking-glass, the shoulders of the tenon will be of unequal length, and the cheeks of the mortice will vary correspondingly. Fig. 280 shows the shape of the joint in this case.

MODEL XXVII.—A BOX WITH COMMON DOVETAILED JOINTS. FIG. 281.

The drawings should be the usual orthographic projections, as shown, but in the plan of the box a portion of the lid is removed in order to show the fillet round the lid.

Presuming that a box of the size shown in fig. 281 is to be made, the timber required—yellow deal or bass-wood—will be as follows:—

Four pieces, each	.	.	.	$8\frac{1}{2}$ ins. long	\times	$5\frac{3}{4}$ ins.	\times	$\frac{7}{16}$ in.
Two	„	„	.	$5\frac{3}{4}$ „	\times	$5\frac{3}{4}$ „	\times	$\frac{7}{16}$ „

for the sides of the box ; a strip $1\frac{1}{4}$ in. wide, $\frac{3}{8}$ in. thick, and 2 ft. 2 ins. long for the fillet.

It will be noticed from the measurements of this wood that no separate provision is made for the lid.

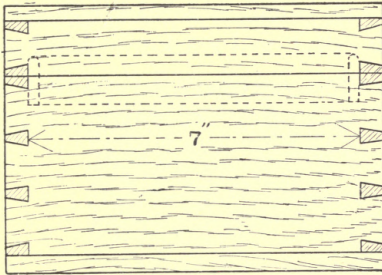

Side elevation.

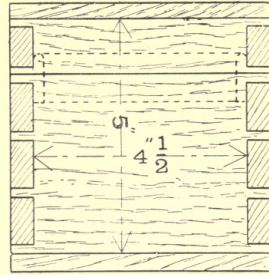

End elevation.

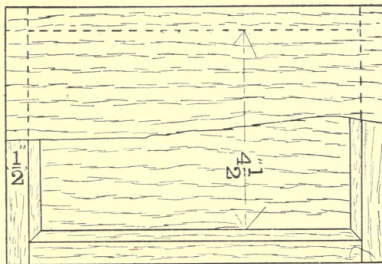

Plan, with half of the top removed to show fillets.

FIG. 281.

The practice is to make the box like a solid rectangle, and then saw off the portion for the lid.

After planing up the wood for the sides, and shooting the edges quite true, but a little wider than they are required to

finish, say, $\frac{1}{8}$ in., the opposite sides are put together, and the depth of the mortice or the tenon, as the case may be, is marked with a cut line across the pair of face edges at each end. These lines are then continued across both faces of each piece, and on the opposite edges also.

Now take the two short sides on which, as usual, are the pins, as the dovetailed projections are called, and mark out on the end the shape of the pins, as in fig. 282. It will be noticed that the second one from one end is made wider than the others. This is

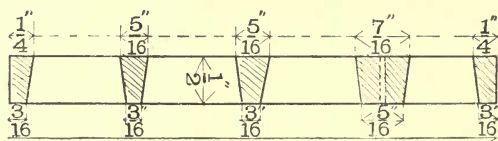

FIG. 282.

to allow for a sufficiently substantial pin after sawing the lid from the box, and planing the edges of both true.

Having marked both ends of each short side carefully, saw and pare out the waste between each pin. When this has been done, place one of the rows of pins over the end of one of the long sides touching the cut, as in fig. 283, and mark with a chisel, as shown. Make similar marking for the other joints, and to avoid confusion make a distinguishing mark or number on each side, so that the pins may ultimately be fitted into the mortices to which they properly belong.

The face sides may show either outward or inward, but they should be continuous on either the inside or the outside.

After marking the four rows of mortices in this way, they should be carefully sawn and pared out, just leaving the cut lines

showing along the edges of the mortices. These are now very slightly smaller than the pins, and some force will be required to put the sides of the box together. This mutual crushing of fibres by the pressure of the broad and narrow pins against each other is an essential feature of the dovetailed joint, but it should not be too great, or splitting may ensue. If the joints are satis-

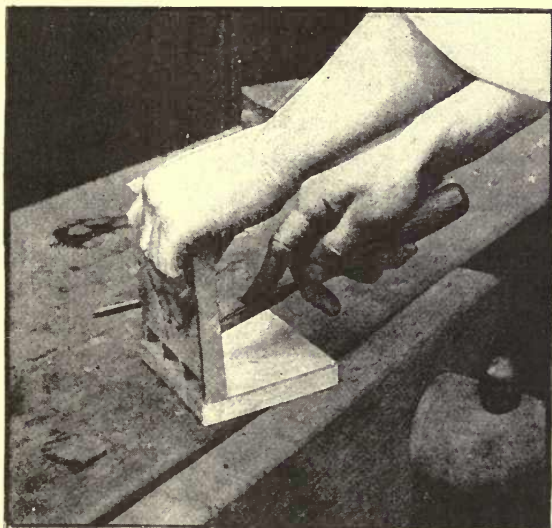

FIG. 283.

factory they should be glued, and the trued-up lid and bottom glued or nailed on.

A hollow oblong figure is now obtained, and should be sawn in halves, to a gauged line passing round the sides through the middle of each of the wide pins on the short side.

The rough edges left from the saw cut must now be very

carefully planed true, till the lid will fit close down to the box without pressure being necessary on any part. The fillets may now be prepared by planing the strip true, rounding one edge,

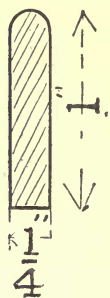

FIG. 284.

as in fig. 284, and cutting it into the required lengths. The simple mitred joints at the angles should be planed in the shooting board, and each of the four pieces may then be either glued or nailed round the top of the box, so that they project equally above the edge, and form a ledge to keep the lid on.

If the work has been done well, the lid will fit easily but not loosely, and in putting it on there should be no friction, but simply the pressure from the air within the box, unable to find a ready exit.

One angle of this box may be taken as a preliminary exercise if it is considered necessary.

MODEL XXVIII.—A HANGING BOX. FIG. 285.

This box is jointed in the same way as the preceding one, and, in fact, there is nothing new introduced except the hinging, and, as it is only required to nail two small pieces of leather on to serve as hinges, this is extremely easy.

The drawing should be the front and side elevations, or the isometric projection.

The timber required, yellow deal, will be $\frac{3}{4}$ in. thick throughout, and the other dimensions of the wood are as follows:—Two pieces 7 ins. long by $6\frac{1}{4}$ ins. wide for the ends, one piece $10\frac{1}{2}$ ins. long by $4\frac{1}{4}$ ins. wide for the front, one piece 11 ins. long by $7\frac{1}{4}$ ins. wide for the bottom, one piece $11\frac{1}{2}$ ins. long by 9 ins. wide for the

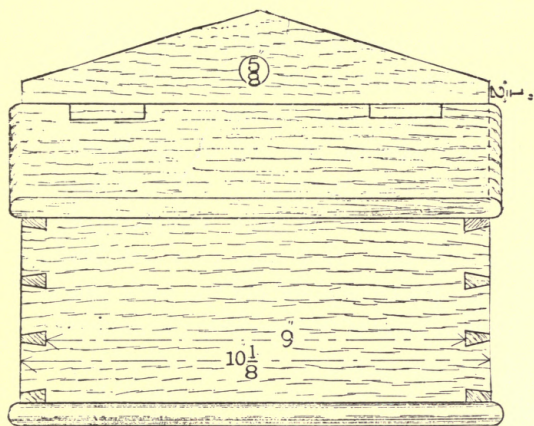

Front elevation.

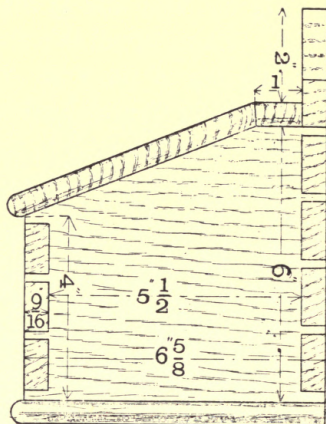

Side elevation.

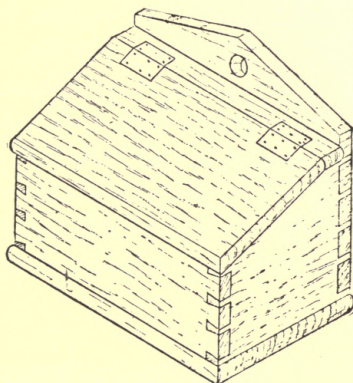

Isometric projection.

FIG. 285.

back. The lid and rail should be made from one piece of wood, $7\frac{1}{4}$ ins. wide and 11 ins. long.

Plane up all the wood to the finished dimensions. The sloping top of the ends should be sawn, and planed true, but the depth in front should be $\frac{1}{16}$ in. more than the measurement of the finished model. Set out the pins on the end of the short sides, leaving the two end ones of each row a little full— $\frac{1}{8}\frac{1}{2}$ in., and mark the depth of the mortices on the back and front of the box, as in the preceding exercise. Saw and pare out the waste between them. Apply the pins to the ends of the back and front, as in fig. 283, and mark the shape of the mortices; complete these, and glue the sides of the box together. Observe that the face edges should be downwards in the case of all the four sides.

Saw, and plane the sloping top of the back, and bore the hole in it. The sides can now be glued together, and the whole of the surfaces and edges 'flushed' off true.

Model the rounded edges of the bottom, lid, and rail, these two latter in one piece, with plane and file. Saw the rail off from the lid. Bisect the angle of inclination of the lid to the rail, and setting the bevel to the angle obtained, shoot the edge of both lid and rail. Nail the rail and bottom on, and then nail on the leather hinges. These need not necessarily be used, but if the box is intended to hold salt, leather hinges will be found much better than iron or brass, which will be quickly corroded.

MODEL XXIX.—AN INLAID PARQUETRY TRAY, WITH COMMON DOVETAILED JOINT. FIG. 286.

This is an attractive but advanced model. The drawings should be all the orthographic projections in fig. 286, and the



Side elevation.

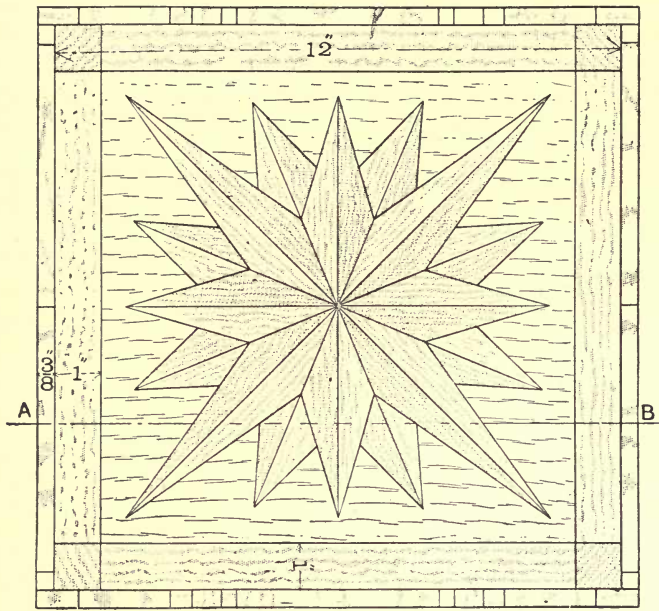

Plan.

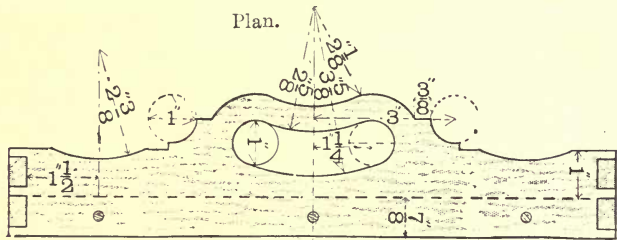

Side elevation.



Section on A B.

FIG. 286.

section on A B, as shown. An isometric projection would be too complicated to be of service here.

The timber recommended for this model is bass-wood for the base 1 in. thick and $12\frac{1}{2}$ ins. square, and four strips of sycamore $13\frac{1}{2}$ ins. long, $3\frac{1}{4}$ ins. wide, and $\frac{1}{2}$ in. thick, for the upright sides.

The key for the back may be of yellow deal, and should be made from a strip 13 ins. long, 2 ins. wide, and $\frac{1}{2}$ in. thick.

The banding round the outer edge of the base may be made of sycamore and mahogany. Four strips of sycamore, each $10\frac{1}{2}$ ins. long, $1\frac{1}{8}$ in. wide, and $\frac{1}{4}$ in. thick, and a strip of mahogany 6 ins. long, $1\frac{1}{2}$ in. wide, and $\frac{1}{4}$ in. thick for the corners.

The four long points of the star can be made from two strips, one of sycamore and one of mahogany, 16 ins. long, 1 in. wide, and $\frac{3}{8}$ in. thick.

The four other points which reach the centre should also be made of mahogany and sycamore, and a strip of each will be required 1 ft. long, 1 in. wide, and $\frac{3}{8}$ in. thick.

The remaining eight short points will contrast well, if made of ash and walnut, and these, like the others, should be made from $\frac{3}{8}$ in. wood, and a strip 16 ins. long and 1 in. wide of each kind will be wanted.

Plane up the base and shoot the edges, which are parallel to the fibres, true, but not quite down to the dimensions—about $\frac{1}{4}$ in. more.

Cut out the groove for the key, make the key, and drive it tightly in, but without glueing it, as in Exercise XVIII.

The strips of mahogany and sycamore for the star should now be made quite true on both faces, and the edges shot perfectly parallel in the shooting board. In this operation each

strip should lie face upwards while one edge is being planed, and face downwards while shooting the other.

Set out each strip for the long points as in fig. 287, and for the short points as in fig. 288, and saw the triangles out.

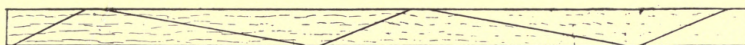

FIG. 287.

The star should now be drawn on the true surface of a piece of wood, and after shooting the inner points of each of the sixteen triangles in the shooting board, fit them all together to test the accuracy of the work. If correct, glue the pairs of dark



FIG. 288.

and light coloured woods together, to make the eight diamond-shaped points, taking care to clean off any glue which may appear outside. Again test the accuracy of the jointing by putting the eight points together, and, if correct, shoot each edge

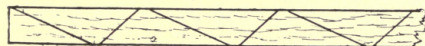

FIG. 289.

of the outer ends true. Next glue the eight points together on a piece of paper, and clean out any glue which may show between each point. Prepare the small pieces of ash and walnut, cut from the remaining strips, as shown in the setting out (fig. 289),

and glue them in to complete the star. There is no need to glue up the pairs of triangles separately in this case.

With the router and chisel, make the depressed star on the face of the bottom of the tray, to take the inlay as in Model XVII.

Make the dovetails in the sides in the usual way, and draw the shape of the handle on one side, and of the plain curves on another.

The opposite similar sides should be screwed up in the vice, and the curves sawn out with a bow saw. The handle and portion of the outer curve on those sides should be made by boring and paring. Finish the curves with a file.



FIG. 290.

The banding round the base must now be planed up true on both faces, edges, and ends, and a rebate made to receive them. Fig. 290

shows the setting out of the small strip of mahogany for the corners, and when these squares are cut out, take care to insert them with the grain in the direction shown in the plan (fig. 286), thus rendering the edge planing of the finished base easier. This should now be very carefully done, planing from the corners in towards the middle of each side, and taking care not to make the base too small—this is a very likely error. Fasten on the sides with three screws each, and glue the joints up at the same time.

MODEL XXX.—A BOOK RACK MADE WITH THE LAPPED DOVETAIL JOINT. FIG. 291.

The orthographic projections in fig. 291 should be drawn.

The timber required will be, of course, dependent upon the precise size of the book rack required ; but a larger size than that

in the drawings is not recommended, as it would be too difficult.

To make a rack similar to that shown of, say, walnut, a piece 16 ins. long, $4\frac{1}{2}$ ins. wide, and $\frac{3}{4}$ in. thick will be required

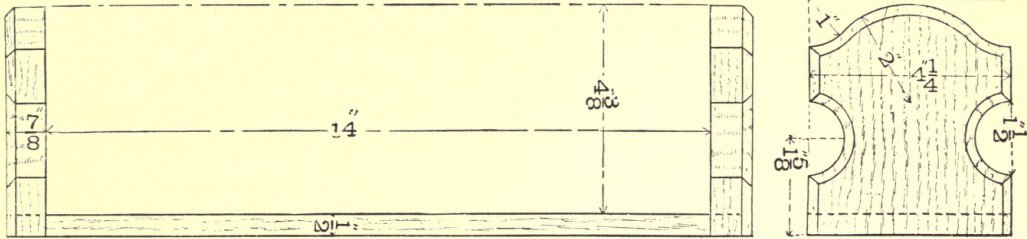

Elevation.

Side elevation.

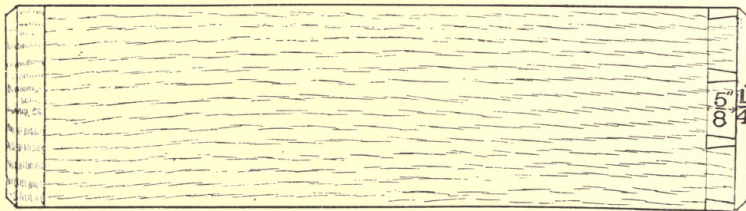

Plan.

The dovetail joint is shown at one end, A, and the plan of the lapping portion of the end is shown in fainter lines. The plan of the complete arm is shown at the other end.

FIG. 291.

for the base, and another piece 10 ins. long, $4\frac{1}{2}$ ins. wide, and 1 in. thick, will be wanted for the two ends.

Plane up the wood as usual, and make the base true on the ends and $15\frac{1}{4}$ ins. long. Cut the short piece in halves, and plane

one end of each piece true. Set the marking gauge to $\frac{5}{8}$ in., and gauge across the end of each standard, to give the depth of the mortices between the pins on the standards, and without altering the gauge, mark lines at both ends of the base, on both faces of the wood, to mark the depth of the mortices to take the pins of the standards. Another line, $\frac{1}{2}$ in. in from the edge, should be cut or gauged across the face of the standards, to indicate the depth from the edge of the mortices between the pins. These latter can now be drawn on the end, as in the case of the common dovetailed joint. Cut out the mortices with saw and chisel. Apply the pins of the standards to the end of the base, and mark out the shape of the end of the pins, as in fig. 283. Saw out the mortices in the base, cutting just inside the lines, and remove the waste with a chisel.

If the joints are found to be correct on fitting them together, take the model apart again, and putting the two standards together in the vice, and with saw, spokeshave, and file make the curves in the sides and on the top.

The chamfering should now be done, and the convex curve on the side and the curve at the top may be finished with the spokeshave and file, the straight chamfering on the sides may be shot with a plane. Clean off the inside of the base and standards, and glue up the joints. Finally, when dry, clean off the outside with trying and smoothing planes.

CHAPTER VI

THE WORKROOM AND ITS FITTINGS.

THE size of a manual training room is dependent on the number of boys under instruction, and these will be regulated by the number of instructors.

One teacher cannot conveniently take more than twenty boys. An instructor, who has an artisan assistant to help him, may manage thirty or thirty-five.

We will assume that one teacher only is to take the class, though if a system of larger classes, as centres for contributory schools, is adopted, a larger room will be necessary.

It is impossible to design a room which would invariably suit the conditions under which it may become necessary to conduct the instruction in woodwork, but figs. 292, 293 are drawings of a room, detached from the main building of a school, of the kind recommended where the only consideration is efficiency. This will accommodate twenty boys.

The details of the room may be modified in many ways to suit particular circumstances, which may be so varied, that they cannot possibly be provided for here.

It will be found well, however, to adhere as closely as possible to the arrangement of the room shown in the plan. If any important sacrifices have to be made, let the gallery and desks

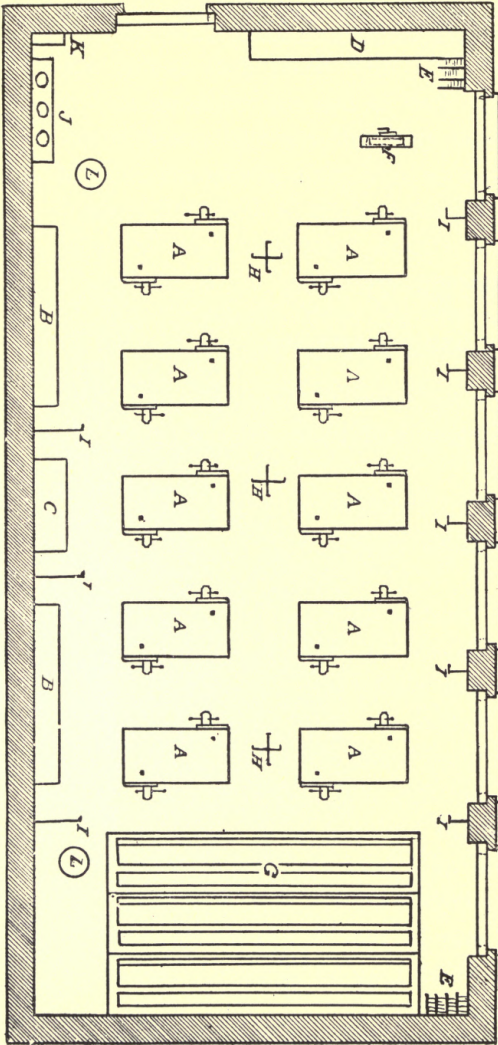

Plan of Room. (Scale, $\frac{1}{8}$ in. to the foot).

FIG. 292.

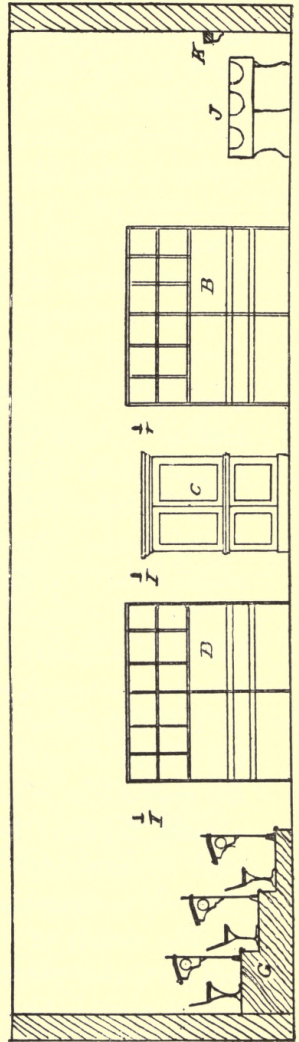

Interior of elevation of south wall. (Scale, $\frac{1}{8}$ in. to the foot).

FIG. 293.

- A, Benches ; B, Tool racks and pigeon-holes for work ; C, Tool cupboard ; D and E, Timber racks ; F, Grindstone ; G, Gallery ; H, Pendant lights ; I, Bracket lights ; J, Washing-basins ; K, Glue-pot tray ; L, Stoves.

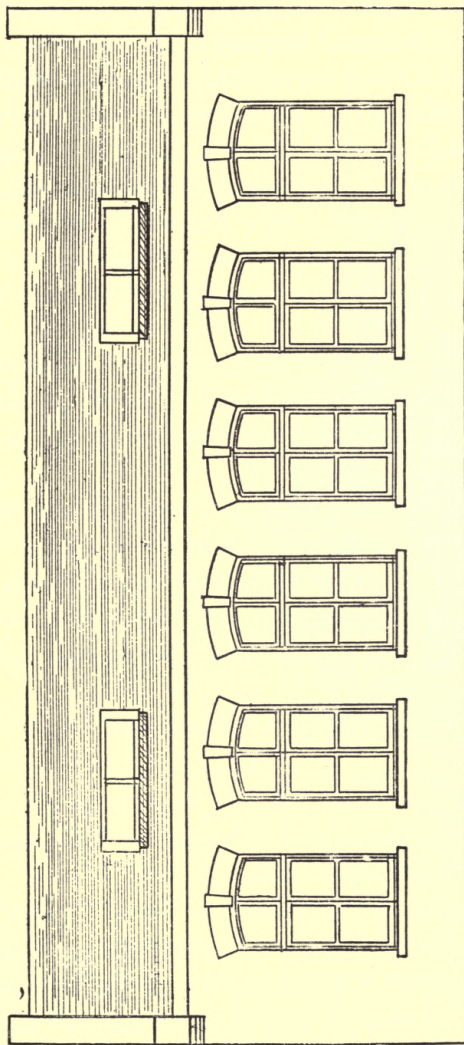

North elevation of room. (Scale, $\frac{1}{8}$ in. to the foot.)

FIG. 204.

be the first things dispensed with. No reduction of the space between the benches should be made.

The design of the exterior would, of course, be modified to suit the style of architecture of the school or building to which it belongs. It will be noticed, however, that it is well lighted, and from the plan it will be seen that the windows are all on one side of the building—the north, if possible, this aspect giving the best light. Skylights in any case should not give a south light, as the sunshine is objectionable. Wood-block flooring is the most suitable.

The room is 41 ft. long by 18 ft. wide, and a reference to the plan (fig. 292) will show the positions of the various fittings.

Benches.—It will be seen that the benches are each for two boys.

Large benches for more than two boys are objectionable, as the teacher is not able to move about so easily among them; and it will be readily understood that in this subject it is especially important for the teacher to have every boy within easy reach.

Long benches, too, are liable to become in time hollow in the middle.

The details of the bench recommended are more clearly shown in fig. 295.

Rigidity of construction, it will be seen, is attended to in the design of this bench, and this quality, in a bench, is one of the most important considerations.

The construction should be strong, not only when new, but even after many years of use, and to ensure this, a weighty bench with powerful supports is recommended. Some light benches are made, which move bodily when wood is being planed on them, and moreover soon become strained. This is obviously undesirable.

The benches could be fastened to the floor, but this, besides damaging the floor, is not a good plan, as it is a great advantage to be able to move a bench readily.

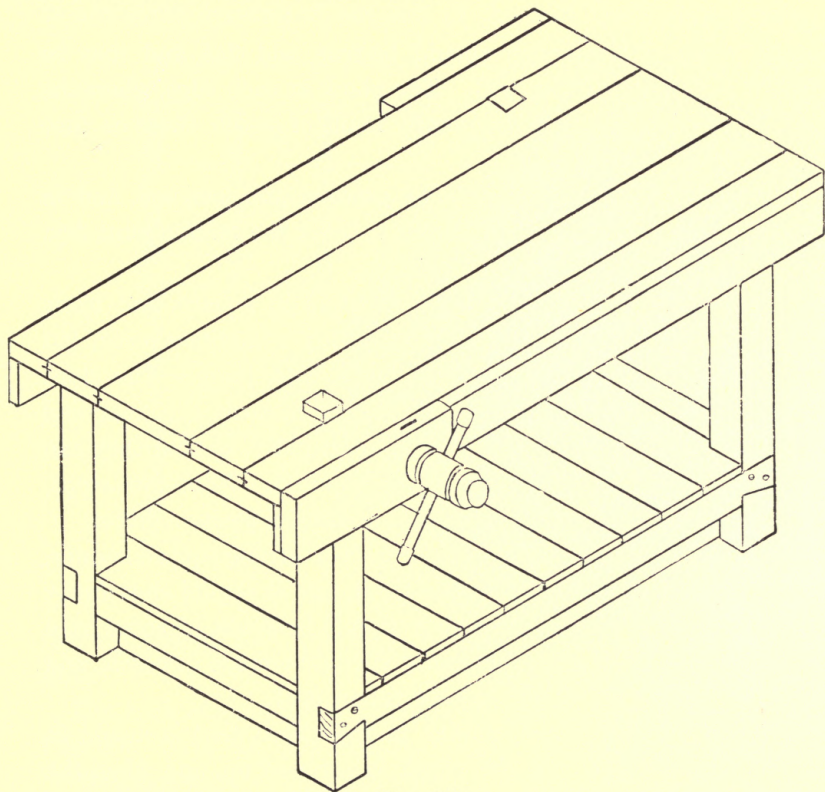

FIG. 295.

The shelf near the bottom of the legs, shown in the illustration, is useful both for its legitimate purpose, as a means of storing tools, or work temporarily laid aside, and also as a

support to the legs. The boarding round the outside between the shelf and the ground is intended to prevent tools or shavings getting underneath the bench; boys are very apt to lose their tools in this way.

The top of the bench should be true and flat, and may be made of yellow or white deal. The plank at each edge, where the bench becomes worn, is frequently made of beech three or four inches wide.

The joints of the top should be grooved and tongued, and in case the top shrinks, it is advisable to leave the middle joint dry, so that this alone will open.

The 'planing stop' should be about $1\frac{1}{2}$ in. square, and made of some good hard wood. Iron stops are sometimes used, but children are apt to damage their tools with them. The stops should be about 5° out of upright, sloping towards the near end of the bench. They should fit well and tightly, so that they can be just driven up or down as may be required. Numerous stops, or stop-holes, are unnecessary, and, indeed, a positive defect.

The vice should be provided with a strong square runner, which should fit the 'box' made for it, and it should slide freely but not loosely. The runner-box should be made of some hard wood, as oak or beech. The screw should be made of beech, and the cheek of birch, beech, oak, or yellow deal.

The most important quality in the vice is that it should fit true and close. When the cheek is screwed up, and when the vice is open, the cheek should be parallel to the side of the bench.

This bench will, of course, be more expensive than many of the cheap light benches used, but it will be found the cheapest in the end, and always preferable to work on.

Tool Rack.—This is lettered B in fig. 293, and a larger sketch is shown in fig. 296. The pigeon-holes at the top are for storing work, and the shelf underneath is for storing the tools. Fig. 297 is a working drawing of one half of the tool shelf. It contains

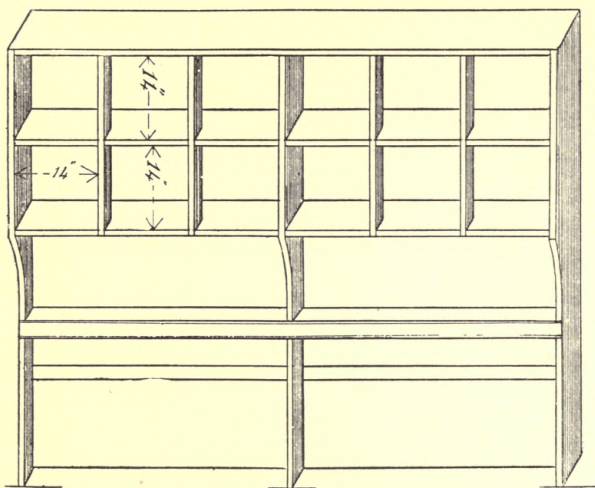
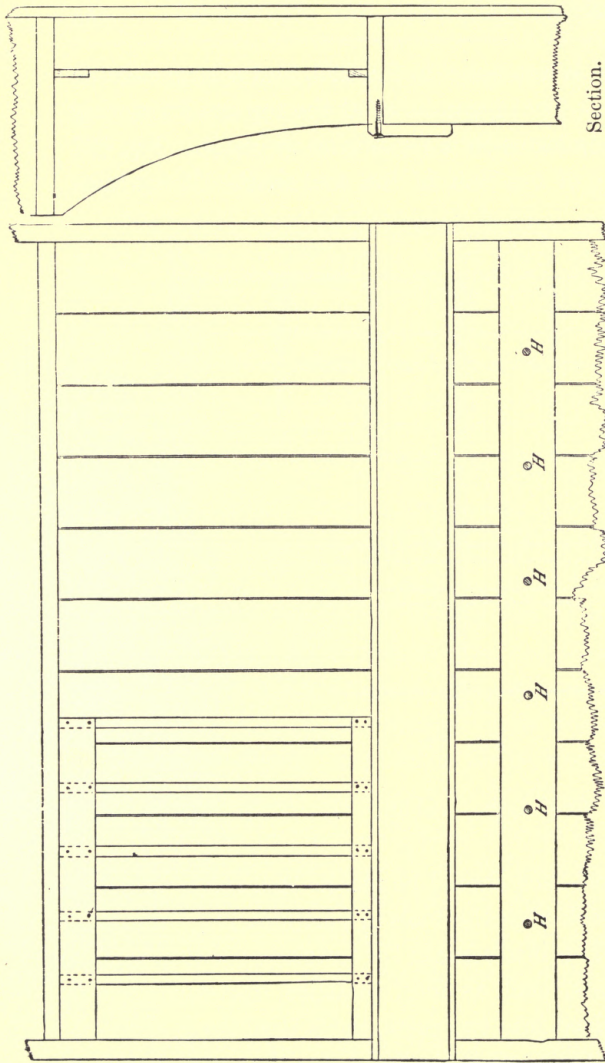

FIG. 296

the equipment for five boys, except the hand and tenon saws.

The back of the tool rack should be match-boarded, as shown. Fig. 298 shows the rack with the tools in position.

Tool Cupboard.—This is to contain the saws and the tools which are general to the class, such as files, punches, braces, and bits. This cupboard is divided into two parts, the bottom being devoted to the general kit of tools, while the top is for the saws, drawing material, &c., and should be provided with one or two drawers to hold punches, bits, and files. The latter should be wrapped



Portion of elevation of Tool Rack.

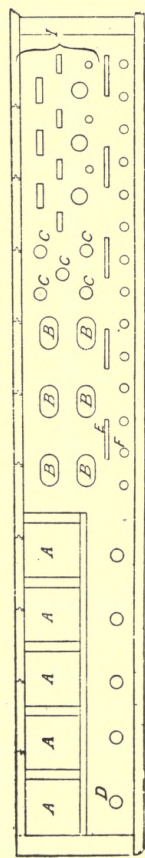

Plan of Tool Shelf.

- A, Jack planes.
- B, Hammers.
- C, Screw-drivers.
- D, Marking gauges.
- E, Try-squares.
- F, Bradaws and gim-
lets.
- G, Mallet pins.
- H, Various sizes of chisels
and gouges.
- I, Various sizes of chisels
and gouges.

Working drawings of portion of Tool Rack, showing holes and spaces provided for the various tools.

separately in brown paper, as they are very apt to rust if exposed.

Timber Racks.—Two are required. That lettered *d* in fig. 292 is for storing the boards horizontally.

The boards are laid on wooden or iron bars fixed in the wall, and a few strips of wood should be put between each board, to give a free circulation of air. There should be several rows of bars.

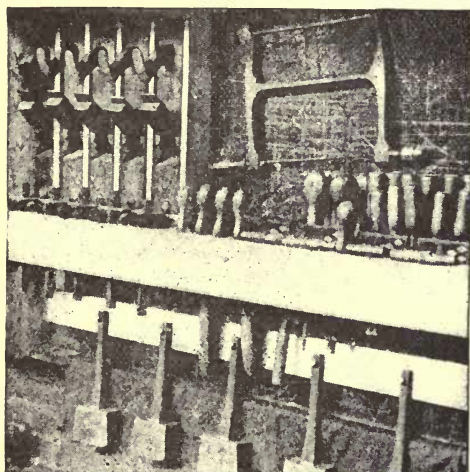

FIG. 298.

The other rack, *e*, in fig. 292 is also made by inserting bars of iron in the wall, but in this case the small batten timber which it is to contain stands upright. One row of bars only is necessary, at about 7 feet from the ground.

Gallery.—This is provided with desks for drawing. This gallery is very useful when a demonstration is to be given. Simple desks only are required.

The artificial lighting of the shop can be obtained from a few four-light pendant burners, and some elbow bracket-lights on the walls, as shown in figs. 292 and 293. The centre lights should be about 7 feet from the ground, and the bracket lights about 6 ft. 6 ins.

Glue-pot Tray.—This is about 18 ins. by 9 ins., with a 6-in. guard all round. It is made of sheet iron, and should be placed

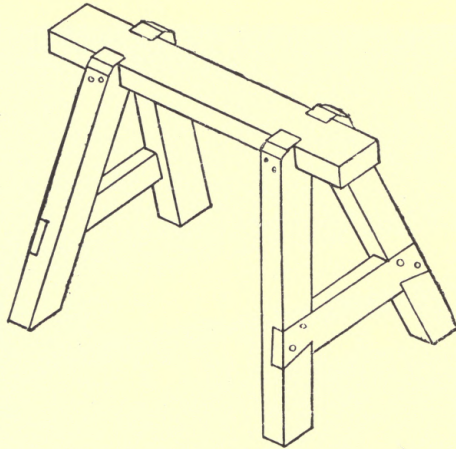

FIG. 299.

in a corner of the room, and fitted with a Bunsen's burner for heating the glue. This fitting is much safer than a fire.

The heating of the room can be best obtained from a couple of slow-combustion 'Tortoise' stoves. These, standing out in the room, give plenty of heat, and do not consume much fuel. They have also the important quality of safety.

If an open fire is used, a high guard should be placed in front to prevent shavings being accidentally ignited.

Various other movable fittings will be required. Two strong sawing stools, like that shown in fig. 299, will be wanted.

Each boy should have a bench hook. This appliance is not exactly a tool, and has been regarded more as an appurtenance.

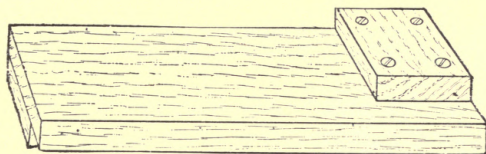

FIG. 300.

The bench hooks may be made by the teacher, or even by the boys themselves. The bench hook should be about 1 ft. long, 6 ins. wide, $\frac{3}{4}$ in. thick, and a square piece of similar wood should be screwed on opposite sides at each end, as shown in fig. 300, allow-



Side elevation.



End elevation.

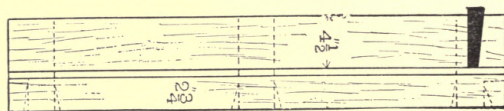

Plan.

FIG. 301.

ing a clear space for sawing along one side of each stop. The bench hook is intended to allow the operator to saw completely through a piece of wood without damaging his bench.

The shooting boards, of which five or six should be provided, can also be made in the class. Fig. 301 is a dimensioned sketch ;

the length is omitted, as it may be anything from 2 ft. 6 ins. to 3 ft. 6 ins. It consists of one stile, with three rails mortised into it, as shown, and projecting far enough to carry another wider piece of wood screwed on the top. In the plan a little space is

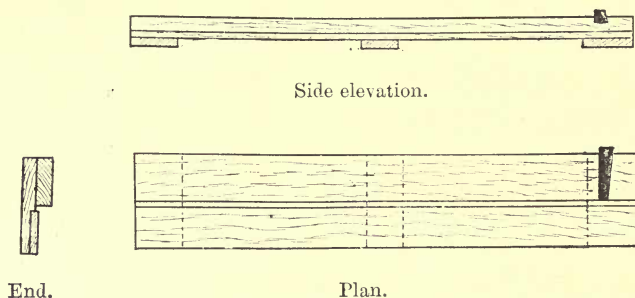

FIG. 302.

visible between the two pieces of wood, to allow the shavings to fall through.

A key of some hard wood is inserted across one end. The inner side of this key should be at right angles to the side of the

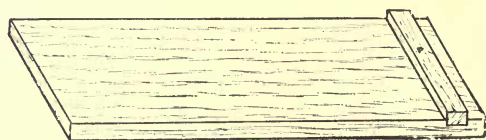

FIG. 303.

board, and the other side somewhat sloping. The use of this board is described in the exercises, but the importance of accuracy in making it may be emphasised here.

Fig. 302 shows a simpler shooting board, of a kind easier to

adjust when necessary. The rails are screwed on to two boards of different thickness, in this case.

The **Panel board**, fig. 303, is a flat piece of board, generally made of Weymouth pine, 1 in. or more thick, 11 ins. to 2 ft wide, and 2 ft. 6 ins. long. A piece of wood is grooved in across one end. This board is used to obtain a good true surface to plane the wood on when the top of the bench is worn, and to temporarily nail down light work on, such as parquetry, in order to save the top of the bench.

COMPLETE EQUIPMENT REQUIRED FOR A CLASS
OF TWENTY BOYS.

20 Jack Planes ¹	30 Bradawls, Handled, of sizes
4 Trying Planes	30 Prongs for do.
4 Smoothing Planes	20 Gimlets, of sizes
1 " " Iron Faced	4 Oilstones
2 Rebate Planes	2 Slips
20 Brass Back Tenon Saws ¹	4 Wing Compasses
5 Panel Saws	2 Braces, American pattern
3 Bow Saws, 8 ins.	2 Sets Centre Bits as follows,
2 Spare Blades for do.	$\frac{1}{4}$ in., $\frac{5}{16}$ in., $\frac{3}{8}$ in., $\frac{7}{16}$ in., $\frac{1}{2}$ in.,
1 Bow Saw, 12 ins.	$\frac{9}{16}$ in., $\frac{5}{8}$ in., $\frac{3}{4}$ in., 1 in., $1\frac{1}{4}$ in.
1 Spare Blade for do.	4 Pin do., of sizes
8 Firmer Chisels, $\frac{1}{8}$ in. ¹	2 Screw-driver do.
12 " " $\frac{1}{4}$ in. ¹	2 Countersink Wood
8 " " $\frac{3}{8}$ in. ¹	2 " " Metal
12 " " $\frac{1}{2}$ in. ¹	2 Files, Half-round, 8 ins.
8 " " $\frac{5}{8}$ in. ¹	1 " " " 10 ins.
12 " " $\frac{3}{4}$ in. ¹	3 " 8 in. Round
8 " " 1 in.	2 " 8 in. Square
4 Firmer Gouges, $\frac{1}{4}$ in.	20 Rules, Iron, 2 ft. ¹
4 " " $\frac{3}{8}$ in.	20 Mallet, Small ¹
4 " " $\frac{1}{2}$ in.	1 Steel Cramp
4 " " $\frac{3}{4}$ in.	5 Punches, of sizes
3 Scribing Gouges, $\frac{3}{8}$ in.	3 Oil Feeders, Small
3 " " $\frac{1}{2}$ in.	1 " " Large
3 " " $\frac{5}{8}$ in.	Linseed Oil, in pint tin
20 Screw-drivers ¹	Sweet Oil do.
20 Try-squares, $4\frac{1}{2}$ in. ¹	1 Grindstone with Iron Trough
5 " " 10 $\frac{1}{2}$ in.	1 Grinding Support
5 Bevels, 10 $\frac{1}{2}$ in.	20 Carpenter's Tool Baskets Small ¹
20 Marking Gauges ¹	5 Bench Holdfasts
3 Mortice "	1 Glue-pot
5 Spokeshaves, of sizes	3 " Brushes
20 Carpenter's Hammers, No. 2 ¹	3 Cork Rubbers
4 Pincers	2 Buff Leather Straps

¹ Boys' sets. The remainder belong to the general equipment.

Screws, Iron, wood, $\frac{1}{2}$ in., No. 4	Oval Steel Brads, 1 in.
" " " $\frac{5}{8}$ in., No. 3	Glass-paper, No. 1
" Brass " (round-headed), $\frac{5}{8}$ in., No. 3	" " No. 1 $\frac{1}{2}$
Brass Pins, 1 $\frac{1}{4}$ in.	Screws, 1 $\frac{1}{4}$ in., iron, No. 8's
Glue, French	" 2 in., " "
" Scotch	French Wire Nails, 1 $\frac{1}{2}$ in.
Oval Steel Brads, $\frac{3}{4}$ in.	" " 2 ins.

The probable cost of this equipment may be taken as about 25*l.*, and annual depreciation in the value of tools is about 8 per cent. of the original cost.





THIS BOOK IS DUE ON THE LAST DATE
STAMPED BELOW

AN INITIAL FINE OF 25 CENTS
WILL BE ASSESSED FOR FAILURE TO RETURN
THIS BOOK ON THE DATE DUE. THE PENALTY
WILL INCREASE TO 50 CENTS ON THE FOURTH
DAY AND TO \$1.00 ON THE SEVENTH DAY
OVERDUE.

SEP 13 1937	
JUN 4 1940	RECEIVED
8 Jan '53 SSM	MAR 27 '67 -9 AM
DEC 18 1952 LU	LOAN DEPT.
4 Mar '57 PT	APR 24 1967 65
REC'D LD	RECEIVED
FEB 18 1957	APR 25 '67 -9 AM
OV 8 1965 84	LOAN DEPT.
REC'D	OCT 18 1969 X X
JAN 21 '66 -6 PM	REC'D LD
NOV 21 1966 9 L	NOV 2 1969
	LD 21-95m-7,'37

YD 24627

TT185

B3.

66463

