

Lathe work for beginners

Raymond Francis
Yates

KD 23342



A. C. Palmer

LATHE WORK

For Beginners

A PRACTICAL TREATISE

On Lathe Work with complete instructions for properly using the various tools, including complete directions for wood and metal Turning, Screw Cutting, Measuring Tools, Wood Turning, Metal Spinning, etc., and instructions for Building Home-made Lathes with their attachments, etc.

BY

RAYMOND FRANCIS YATES

AUTHOR OF

"MODEL MAKING," "SHOP PRACTICE FOR HOME MECHANICS,"
"SOLDERING AND BRAZING," etc.

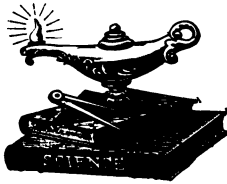

Fully Illustrated with 167 Line drawings and photographs

NEW YORK
THE NORMAN W. HENLEY PUBLISHING COMPANY.
2 WEST 45th STREET
1922



COPYRIGHTED 1922, BY
THE NORMAN W. HENLEY PUBLISHING COMPANY

Printed in the U. S. A.

PREFACE

THE lathe is the master tool. It has taken a great part in the progress of civilization and of all the machines of production, it is the most important.

In the tremendous mass of technical literature published in the United States, there is not one volume devoted wholeheartedly to the lathe from the standpoint of the beginner—the man who desires to learn its uses as an amateur. There are many volumes dealing with large lathes from the industrial viewpoint, but these are more or less useless to the man who knows little or nothing about lathe operation.

In this volume the writer has endeavored to set forth the basic principles of lathe operation and manipulation, in a way that will interest and instruct the layman. The book starts at the very bottom and ends at a point beyond which the average amateur does not care to go.

The author desires to acknowledge his thanks to the following men who assisted in the preparation of the volume. The model naval gun de-

scribed in Chapter XIII is the work of Mr. F. H. Lubby. The model engineer's lathe described in Chapter XI is the design of Mr. Henry Greenly, an English authority on model engineering. Mr. Joseph Dante, Jr., designed the jig-saw lathe attachment which forms part of Chapter IV. The author also wishes to thank his wife, who not only made stenographic notes of the contents of the entire book, but also typed the manuscript.

February, 1922.

THE AUTHOR.

CONTENTS

CHAPTER I

CHOOSING A LATHE

	PAGE
Price of Lathes—Catalogues—Wood-Turning Lathes— Metal Turning Lathes—Features of Construction— Cone Bearings — Speeds — Bearings — Bench Lathes —Tail Stock—Seneca Falls Lathe—Urban Lathes— Greenley Lathe—Millers Falls Lathe—Goodell-Pratt Lathe — Barnes Lathes — Precision Lathes, Rivett, Stark, Ames, etc.....	17

CHAPTER II

SETTING UP AND DRIVING THE LATHE

Unpacking the Lathe—Cleaning the Lathe—Setting up the Lathe — Foundation — Position—Leveling—Counter- shaft — Line Shaft — Power Necessary — Mounting Power Motor	34
--	----

CHAPTER III

THE LATHE AND ITS PARTS

Analysis of the Lathe—Back Gears—Screw Cutting Parts —Apron—Carriage—Manipulation of Carriage—Care of Lathe, etc.....	45
---	----

CHAPTER IV

LATHE ATTACHMENTS AND THEIR USE

Center Rests—Milling Attachments—Gear Cutting Attach- ments — Thread-Cutting Attachments — Grinding — Circular Saws—Turret... ..	54
--	----

CHAPTER V

MEASURING TOOLS AND THEIR USE

	PAGE
Scale—Square—Outside Calipers—Inside Calipers—Depth Gauge—Micrometer Depth Gauge—Micrometer—Vernier—Use of Micrometers—Drill Gauge—Spring Dividers—Thread Gauges—Snap Gauges—Use of Measuring Tools	86

CHAPTER VI

A LESSON IN METAL TURNING

Cutting Action of Lathe—Lathe Tools—Use of Various Tools—Grinding Tools—Simple Turning—Finding Centers—Mounting Work—Lathe Dog—Positive and Negative Rake on Lathe Tools—Hand Turning—Hand Turning Tools—Using Lathe as Drill Press—Notes on Drills—Disc Grinder.....	103
---	-----

CHAPTER VII

ADVANCED LATHE WORK

Use of Chuck—Mandrels—Boring—Boring Tools—Boring Bars—Boring Cylinders—Strapping Work to Lathe Carriage—Face Plate—Eccentric Turning—Eccentric Mandrel—Angle Plate—Taper Turning—Use of Reamers	128
---	-----

CHAPTER VIII

SCREW CUTTING

Use of Hand Chasers—Inside and Outside Chasers—Use of Screw Cutting Lathe—Change Gears—Thread Cutting Tools—Inside Tool—Outside Tool—Use of Lubricants	146
--	-----

CHAPTER IX

WOOD TURNING

	PAGE
Wood Turning Lathe—Speeds—Mounting Work—Tools— Use of Various Tools—Sharpening Tools—Finishing Surfaces—Choice of Woods.....	157

CHAPTER X

METAL SPINNING

Lathe for Metal Spinning—Tee-Rests—Tools—Use of Various Tools—Metals—Annealing—Use of Forms— Centers—Sample Turning—Mounting Work—Speeds	176
--	-----

CHAPTER XI

BUILDING AN AMATEUR'S METAL TURNING LATHE

General Description of Lathe—Lathe Bed—Patterns— Castings—Machining—Assembling—Work Bench— Countershaft—Accessories—Jig Saw Attachment— Slide Rest—Grinding Table—Hand Filing Jig—Cir- cular Saw Table.....	192
---	-----

CHAPTER XII

BUILDING A SIMPLE WOOD TURNING LATHE

Maple Bed—Patterns—Castings—Machining—Assembly —Attachments	208
--	-----

CHAPTER XIII

HOW TO BUILD A MODEL RAPID-FIRE NAVAL GUN

Gun Design—Machining of Parts—Use of D-Bit—Pol- ishing—Finishing—Assembly, etc.	217
---	-----

LIST OF ILLUSTRATIONS

FIG.	PAGE
1. A simple type of wood-turning and light metal-turning lathe.....	18
2. A power-driven wood-turning lathe.....	20
3. A good type of screw-cutting lathe with foot-power drive. This lathe can also be driven by an electric motor.....	24
4. A small bench lathe of substantial design suitable for model making and small turning.....	25
5. A bench type precision lathe.....	26
6. A bench type precision lathe with compound slide-rest.	27
7. A foot-power screw-cutting lathe with a compound slide rest.....	28
8. The lathe shown in Fig. 7 mounted for benchwork....	29
9. An English type Drummond lathe with a round bed..	30
10. A screw-cutting lathe with a motor mounted in the head	31
11. A good amateur bench lathe with parallel steel rods for the bed.....	32
12. A countershaft for use with a small lathe.....	36
13. How the lathe is set up in the shop.....	37
14. How the shaft hangers are held to the ceiling of the shop	39
15. A small countershaft for a bench lathe.....	40
16. A small power motor suitable for driving a bench lathe..	41
17. A special countershaft for use with a precision lathe....	42
18. How a small precision lathe is set up with a second countershaft to drive the grinding attachment.....	43
19. A substantial screw-cutting lathe. The names of the various parts are described in the text.....	46
20. How the cone pulley on the countershaft and lathe spindle are arranged to obtain various speeds.....	47
21. How the back gears of a lathe are arranged.....	48
22. A compound slide-rest.....	51

FIG.	PAGE
23. A micrometer collar placed on the cross-feed handle...	52
24. A three-jawed center-rest.....	55
25. A two-jawed center-rest.....	56
26. A lathe milling attachment.....	57
27. A two-inch milling cutter.....	57
28. Another type of milling attachment.....	59
29. A milling attachment for a bench lathe. This attachment has an index plate.....	60
30. A lathe gear-cutting attachment.....	61
31. A lathe gear-cutting attachment used to flute reamers..	63
32. A gear-cutting attachment fixed to the head of a precision lathe.....	64
33. A screw-cutting attachment for the precision bench lathe.....	65
34. Another type of screw-cutting attachment for a bench lathe.....	66
35. A turret for a bench lathe with which six different operations can be performed.....	66
36. A circular saw attachment for a bench lathe.....	67
37. A jig-saw attachment for a bench lathe.....	68
38. A grinding spindle attached to the slide-rest of a precision bench lathe.....	69
39. An electric tool-post grinder for a large lathe.....	70
40. A homemade jig-saw for a bench lathe.....	71
41. The drawings for a small jig-saw.....	72
42. The main casting for a file rest.....	77
43. Front view of the casting.....	79
44. Back view of the casting.....	79
45. The dimensions of the roller pins.....	81
46. The dimensions of the rollers.....	82
47. How the index attachment is fixed to the lathe.....	83
48. The index pulley for the filing attachment.....	84
49. A machinist's four-inch scale.....	86
50. A scale and square combined.....	87
51. A combined scale and square with 45° angle.....	88
52. Inside calipers.....	88

List of Illustrations

11

FIG.	PAGE
53. The use of inside calipers.....	89
54. The adjustment of inside calipers.....	89
55. Calipers for outside measurements.....	90
56. Adjustment of outside calipers.....	91
57. The use of outside calipers.....	91
58. A depth gauge.....	92
59. The use of the depth gauge.....	93
60. A micrometer depth gauge.....	93
61. A micrometer for very accurate measurements.....	94
62. A micrometer scale.....	95
63. A micrometer reading of $\frac{1}{4}$ inch (.250).....	96
64. A micrometer vernier for measuring with an accuracy of one ten-thousandth of an inch.....	97
65. A micrometer with a test piece used for maintaining its adjustment.....	98
66. A drill gauge.....	98
67. Spring dividers and scribe.....	99
68. Adjusting spring dividers.....	100
69. A small thread gauge.....	101
70. The use of a thread gauge.....	101
71. A snap gauge.....	102
72. The direction of the work in relation to the lathe tool..	103
73. A complete set of lathe tools.....	104
74. The use of lathe tools.....	106
75. A piece of sample turning.....	107
76. A self-centering punch.....	107
77. Finding a center for spring dividers.....	108
78. A centering drill.....	109
79. Proper lathe centers.....	109
80. Centers made with an ordinary drill.....	109
81. A lathe-dog.....	110
82. Methods of using a lathe-dog.....	110
83. Showing the meaning of a negative rake.....	111
84. Lathe tool in position for cutting.....	112
85. The use of the parting tool.....	115
86. The proper position for hand-turning.....	116

FIG.	PAGE
87. Hand-turning tools.....	117
88. Correct and incorrect position for the hooked tool....	118
89. Inside turning with hand tools.....	119
90. A drill chuck for the tail-stock.....	119
91. A V-center for the lathe.....	120
92. A metal drill and the names of its parts.....	121
93. A drill-grinding gauge.....	122
94. How a drill is ground for brass.....	123
95. Cutting threads on a small bench lathe.....	124
96. A disc grinder for use on a small lathe.....	124
97. A small compression chuck and its use.....	125
98. Dimensions of a bushing to be made by the use of a compression chuck.....	126
99. Using a small lathe as a grinding head.....	126
100. A piece of small turning.....	128
101. The work mounted on the chuck.....	129
102. How a ring is turned out.....	130
103. How brass tubing is mounted in a chuck.....	130
104. A pulley to be turned on a mandrel.....	131
105. The pulley mounted on a mandrel.....	132
106. How the pulley is forced onto the mandrel.....	133
107. A cup to be turned out on the lathe.....	133
108. How the boring tool is mounted.....	134
109. Improper clearance on the boring tool.....	134
110. A boring bar for short cuts.....	135
111. A large boring bar.....	135
112. How work to be bored out is mounted on the lathe carriage.....	136
113. How carriage bolts are used in mounting work.....	137
114. The lathe face-plate.....	137
115. A pulley mounted on the lathe face-plate.....	138
116. How a cylinder to be bored is mounted on the face- plate.....	138
117. Showing the use of wooden blocks in mounting work..	139
118. An eccentric mounted on a face-plate.....	140
119. An eccentric mandrel.....	140

FIG.	PAGE
120. Facing off a split bearing with an angle-plate	141
121. An adjustable counter-weight.	142
122. An elbow mounted on an angle-plate.	142
123. Turning circular plates of thin sheet metal.	143
124. Showing the use of a large reamer.	144
125. A chaser used in cutting threads by hand.	146
126. Finding the pitch of a screw without a thread gauge.	147
127. How a thread is cut by the use of hand chasers.	147
128. The proper position of a hand chaser in cutting threads	148
129. The use of an internal chaser.	150
130. A gear train on a screw-cutting lathe.	152
131. A lathe index plate.	153
132. How a thread-tool is ground.	154
133. A thread-tool gauge.	154
134. Showing the use of thread gauge.	155
135. An internal thread-cutting tool.	156
136. A good wood-turning lathe.	158
137. A spur center for use on a wood-turning lathe.	159
138. A screw center used in wood-turning.	160
139. The manipulation of a wood-turning tool.	161
140. A set of wood-turning tools.	163
141. Face-plate for wood-turning.	168
142. A tee-rest with fulcrum pins used in metal spinning.	177
143. A revolving back-center for use in metal spinning.	178
144. A set of metal-spinning tools.	179
145. A copper cup to be spun.	181
146. The copper disc mounted on the wooden block or form to make the copper cup shown in Fig. 145.	181
147. The form mounted on the face-plate.	182
148. Showing the position of the copper disc on the lathe, ready for spinning.	182
149. A more elaborate cup, and follow-up block.	190
150. A simple revolving center.	191
151. A good amateur bench lathe.	193
152. Showing the construction of the lathe pictured in Fig. 151.	195

FIG.	PAGE
153. How the babbitting for the lathe bearings is done.....	197
154. The construction of the lathe slide-rest.....	198
155. The constructional details of the amateur bench lathe.	200
156. The constructional details of the amateur bench lathe	204
157. The completed amateur's wood-turning lathe.....	208
158. Lathe patterns.....	209
159. Constructional details of wood-turning lathe.....	211
160. The lathe bed assembled.....	212
161. The model rapid-fire gun.....	218
162. The barrel of the model gun.....	219
163. The base and carriage for the model gun.....	219
164. Constructional details of the model gun.....	221
165. Constructional details of the model gun.....	223
166. Constructional details of the model gun.....	225
167. Constructional details of the model gun.....	228

LATHE WORK FOR BEGINNERS

CHAPTER I

CHOOSING A LATHE

Price of Lathes—Catalogues—Wood Turning Lathes—Metal Turning Lathes—Features of Construction—Cone Bearings—Speeds—Bearings—Bench Lathes—Tail Stock—Seneca Falls Lathe—Urban Lathe—Greenley Lathe—Millers Falls Lathe—Goodell-Pratt Lathe—Barnes Lathes—Precision Lathes, Rivett, Stark, Ames, etc.

THERE is a multitude of small, low priced lathes on the market. The more expensive machines are, of course, of the precision type and cannot in any way be compared with the inexpensive tools intended for amateur use. In this Chapter the reader is given information that will greatly assist him in making a good choice. Much depends upon the money available for expenditure, and the nature of the work to be done.

In choosing a lathe, the student should first send for the various catalogues of all the reputable manufacturers of small lathes. Each catalogue should be gone over carefully and the individual

features of the lathes noted. In this way the prospective purchaser can acquaint himself with the manufacturer's claims without finding it necessary to actually inspect the lathe. An expensive

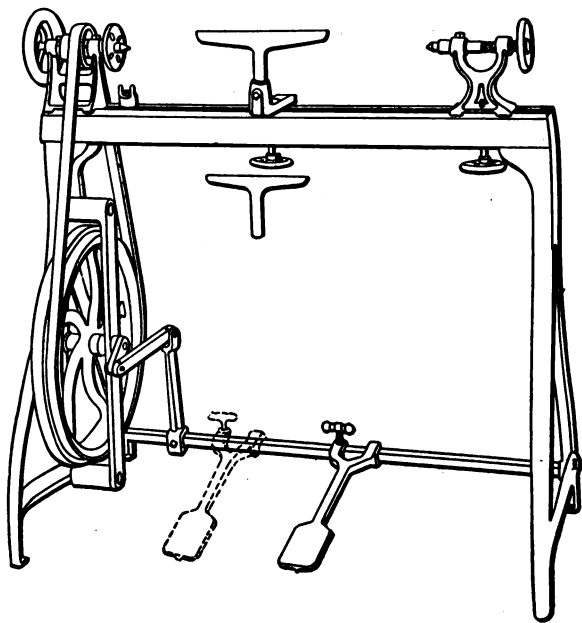

FIG. 1.—A simple type of wood-turning and light metal-turning lathe.

lathe, with all attachments, involves a considerable outlay of money, and none but an incautious purchaser would care to make this investment without first being sure of the quality of the tool he is buying.

For wood turning and light metal work, which do not demand precision, only a simple and inexpensive tool is necessary. A lathe intended entirely for this service is illustrated in Fig. 1. This is a Millers Falls lathe and sells for a very reasonable figure considering the work which comes within its range. Of course, one cannot expect to obtain great accuracy from a machine of this type, but for all ordinary purposes it will be found entirely adequate and capable of rendering good, reliable service.

The lathe shown in Fig. 1 is driven by foot power with an adjustable pedal which can be moved from place to place so that the operator can always use his right foot no matter at what point of the lathe he is working. If the foot-power feature of this lathe is not desirable, it is a very simple matter to drive the machine with a small electric motor. As before stated, light metal work can be done on this lathe. However, it is to be recommended more for wood turning than for metal work.

On a cheap lathe of this nature one cannot expect to find bronze or babbitted bearings as it would be impossible to equip the machine with these desirable features at the low price asked. Neither is the machine provided with a slide rest

of any form and therefore all turning must be done with hand tools.

A little wood-turning lathe of more substantial construction, and selling at a much higher figure,

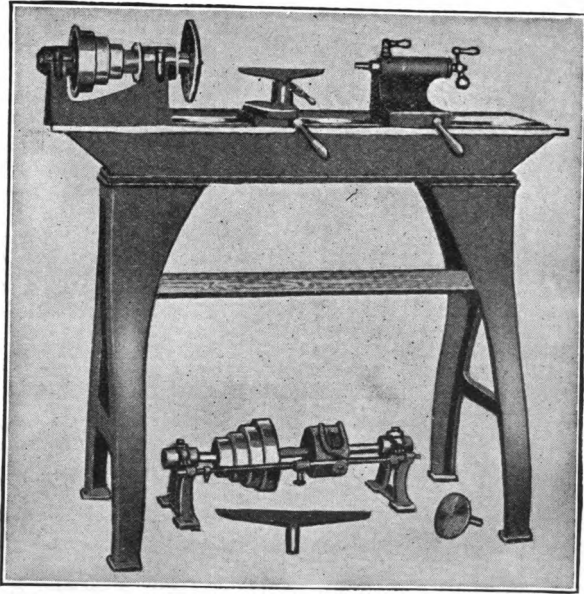

FIG. 2.—A power-driven wood-turning lathe.

is shown in Fig. 2. This is known as the Seneca Falls lathe and contains many features which are not included in the cheaper tool described above. It has a machined bed which is flat on one side and V-shaped on the other. This is a very important consideration and contributes greatly to the ac-

curacy of the machine, since it keeps centers exactly opposite one another. This lathe has a 10-inch swing and the bed is 3 feet in length. The maximum distance between centers, or in other words the maximum length of work it will accommodate, measures 14 inches. The lathe shown may be purchased with either a countershaft for power drive or with a foot-power attachment. This lathe has a cone pulley with four steps by means of which various changes in speed may be brought about.

It is to be understood that wood turning can be accomplished on any lathe but, on the other hand, accurate metal turning can only be done properly on a metal-turning lathe.

There are a few general points of construction which the purchaser should have in mind before choosing the lathe he is to use in his shop. The first thing he should look out for is a hollow spindle. This is a very important consideration and contributes greatly to the usefulness and convenience of the tool. Stock can be fed through this hollow spindle, and in the case of making duplicate parts a great saving in time and trouble is made possible. The use of the hollow spindle will be mentioned in a later chapter. Also, the end of the hollow spindle nearest the chuck should be

bored out for receiving standard No. 1, Morse taper tools, etc.

The next thing of importance to consider is the bearings. In fact, it can safely be said that a lathe is no better than its bearings. If the bearings are loose and inaccurate, it is impossible to accomplish accurate turning. The more expensive lathes are equipped with either bronze or bab-bitted bearings. These bearings should be of a cone shape so that it will be possible to take up the wear on the bearings as the lathe grows old. It is only possible to do this with a cone shaped bearing, and for this reason the amateur should try to secure a lathe with this feature. The adjustment is generally brought about by a collar at the left-hand end of the live spindle. It is possible to screw this collar up to adjust the cone bearings.

The lathe bed is an important thing and the accuracy of the machine will depend largely upon it. On smaller lathes of the bench type, the bed is generally made flat with a square slot in the center for guiding the tailstock in alignment with the headstock. On the larger sizes, the bed is usually provided with a V-shaped ridge on either one or both sides. This ridge acts as a guide for both tailstock and carriage, keeping them in the same position in relation to the centers.

The bed of the lathe should always be machined, that is, it should always be milled by the manufacturer. There are a number of amateur bench lathes on the market with un-machined beds, and they are not worth the metal that is in them.

The tailstock of a lathe should be held by a clamp to the lathe bed, and by loosening this clamp the tailstock should be readily and quickly moved to any position within its range on the bed. The little lathe shown in Fig. 3 has a very useful addition to its tailstock. There are two separate parts on the tailstock body. The top part can be moved on a swivel and thus the back or dead center can be adjusted for taper turning. The top portion of the tailstock can be held at various angles by means of a set screw at the back. Not many lathes possess this simple but useful form of tailstock, and yet, it is a feature well worth noticing.

The lathe shown in Fig. 3 is a Barnes machine of the foot-power type. It is a screw cutting tool. By this is meant that the live spindle can be connected with a train of gears to the "lead screw," which is a long rod containing threads that runs parallel to the lathe body. By means of a splined nut, the carriage of the lathe can be caused to move by this lead screw when it is revolved by

the headstock spindle through the train of gears mentioned. In this way it is possible to cut screw

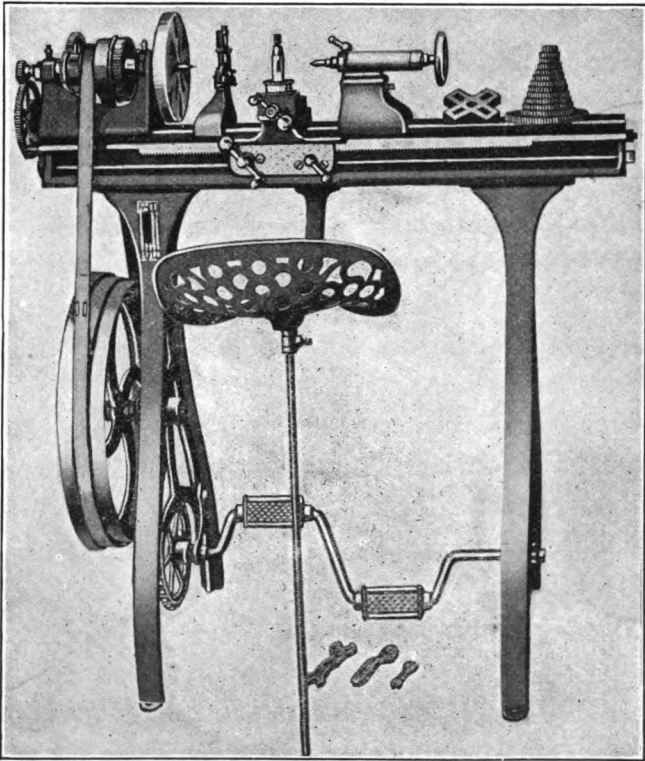

FIG. 3.—A good type of screw-cutting lathe with foot-power drive. This lathe can also be driven by an electric motor.

threads. All lathes, and especially those of the inexpensive variety, are not provided with the screw cutting fitments. A set of extra gears of

various sizes should be provided with screw-cutting lathes, so that different speeds, which correspond to different threads, can be given to the lead screw. The lathe shown in Fig. 3 also has what are known as "back gears." This is an addition of great importance which should not be overlooked. With these back gears, it is possible to

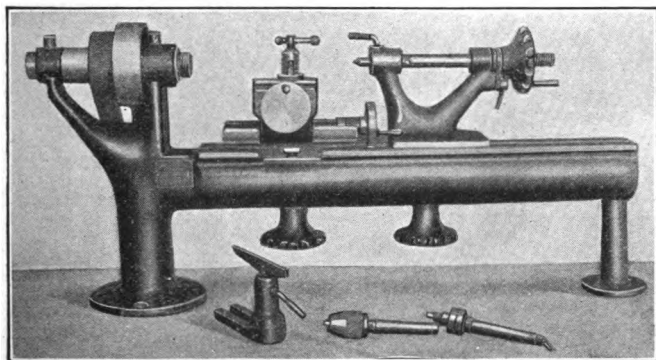

FIG. 4.—A small bench lathe of substantial design suitable for model making and small turning.

greatly reduce the speed of the spindle and to multiply the power delivered to the spindle so as to accomplish heavy turning which could not be done at a higher speed.

No lathe comes furnished with a chuck. The chuck is always considered as a separate attachment which is not included in the price of the lathe.

Fig. 4 shows a small lathe of the Goodell-Pratt make which is a very substantial and well made little tool, reasonably priced. It is capable of doing very accurate work and, although limited in its capacity, it is an extremely useful machine; with its attachments it can be used for practically any operation which the larger machines are equipped to handle. This lathe has cone bearings,

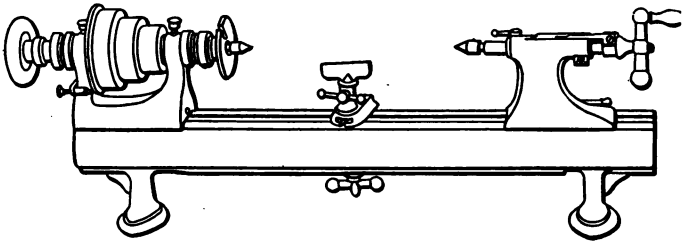

FIG. 5.—A bench type precision lathe.

a hollow spindle and a milled bed. The tailstock of this tool has a feature which is found on few machines. The tailstock spindle can be operated either by screw or lever. The lever method of moving the tailstock spindle is extremely useful when drilling, since it permits rapid motion. This lathe is furnished with the attachments shown and other useful attachments can be purchased for it, as will be described in Chapter IV.

A Stark precision bench lathe is shown in Fig. 5.

It must be understood that a lathe of the precision type is essentially an expensive machine. Small precision lathes cost several hundred dollars without attachments. This is necessary owing to the great amount of skilled labor which enters into their construction. Every part must be machined to the last degree of accuracy. However, for ordinary purposes the amateur does not

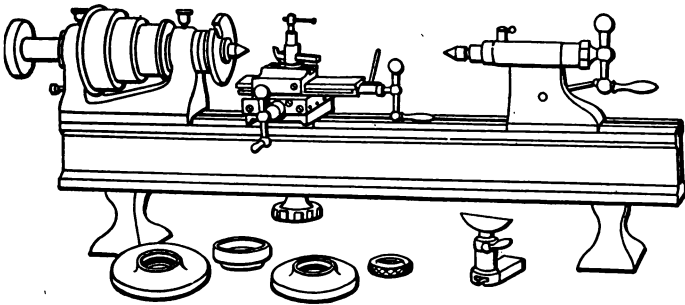

FIG. 6.—A bench type precision lathe with compound slide-rest.

need a precision lathe unless he desires to accomplish extremely accurate work. In such cases, of course, the expenditure is justified.

Another type of precision bench lathe is shown in Fig. 6. This is of the Rivett make, and while it is of the highest of accuracy and beauty of finish, there is no reason why the amateur who desires a tool for his hobby, should make the expenditure involved. Precision lathes have to be

well taken care of. Otherwise they depreciate rapidly. In fact, no lathe will stand a great deal of abuse without showing it in the work it turns out.

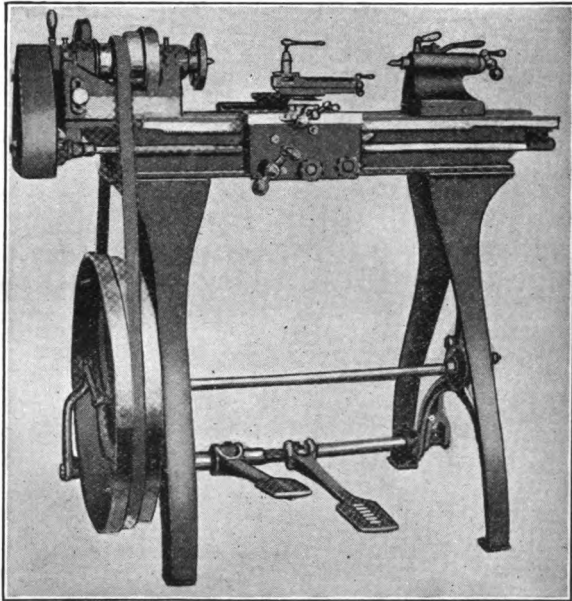

FIG. 7.—A foot-power screw-cutting lathe with a compound slide rest.

Another type of metal turning lathe is shown in Fig. 7. This is a screw cutting lathe with foot power drive. The compound slide rest is a great convenience and is a point that should not be over-

looked when purchasing a lathe. The tailstock of this machine can be off-set for turning tapers, which is another desirable feature. Another point in favor of this machine is the enclosing of the gears, which not only prevents them from getting dusty and filled with grit, but also covers them so

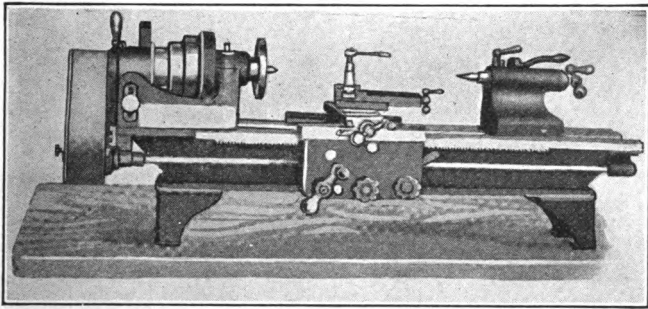

FIG. 8.—The lathe shown in Fig. 7 mounted for bench work.

that clothing or fingers cannot be caught. This lathe can be had with shorter legs to serve as a bench machine as shown in Fig. 8.

The English Drummond lathe is shown in Fig. 9. This lathe can now be purchased in America, and is one of the best experimental lathes the beginner can acquire. The round bed is an innovation in lathe construction and has certain advantages as well as some disadvantages. The writer has heard machine critics say that there would be a tendency

on the part of the carriage to twist when a real heavy cut is taken. However, this is well taken care of in its design, and this effect is unlikely in ordinary turning. The carriage of the Drummond lathe is moved by a lead screw which is placed concentrically within the bed. This screw is turned by the wheel at the end of the lathe.

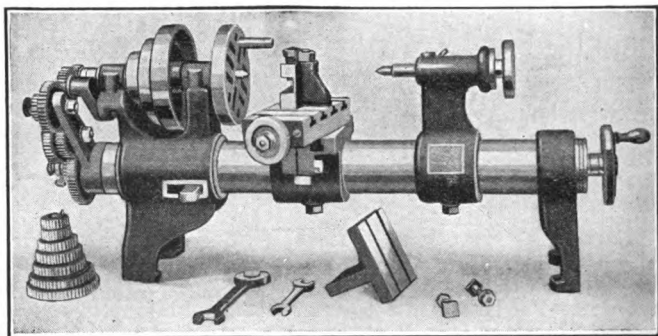

FIG. 9.—An English type Drummond lathe with a round bed.

There is one valuable feature on this lathe which can be found on no American machine—a statement to be made with regret. That is the flat boring table on the carriage, which is provided with inverted T-slots. By means of a few clamps and bolts, pieces with various shapes can be secured for boring. It is difficult to realize the utility of this boring table until one tries to ac-

comply a heavy boring operation on an ordinary lathe.

Motion is transmitted to the lead screw for screw cutting by means of a train of gears arranged on an adjustable arm as shown in the illustration. The lathe is also provided with a set of

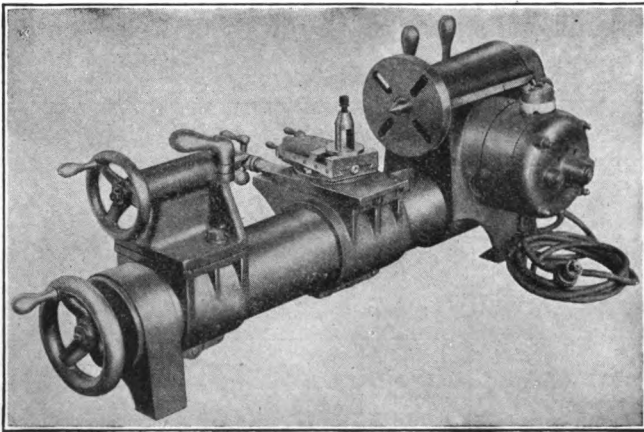

FIG. 10.—A screw-cutting lathe with a motor mounted in the head.

gears which will permit of different speeds for the lead screw.

A new lathe that has been recently brought out is shown in Fig. 10. This is a radical departure from ordinary lathe construction, and is really designed somewhat after the English Drummond machine. It has its driving motor

built into the headstock. This is an ingenious arrangement and adds much to the value of the tool. There are no belts, pulleys or countershafts to bother the operator. It is small and portable and it is only necessary to screw in the socket and turn on the current to place the machine in operation. It is a screw cutting machine and has a maximum distance of 12 inches between centers.

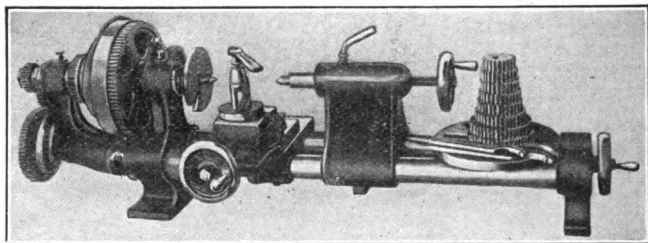

FIG. 11.—A good amateur bench lathe with parallel steel rods for the bed.

By a clever method of shifting gears, it is given speeds of 125, 250, 400, 650 and 1000 R.P.M.

A very rugged type of amateur lathe, produced by the Huhn Manufacturing Company, is illustrated in Fig. 11. The unique feature of this lathe is its bed, which is composed of two cold-rolled steel rods. The particular lathe shown is a special one made with an extra long bed. The regular lathe of this type is manufactured with a maxi-

imum distance of 12 inches between centers. This lathe has been produced after a design of Henry Greenley's, the English model engineer. A similar lathe but much simpler in construction is described in Chapter XI.

CHAPTER II

SETTING UP AND DRIVING THE LATHE

Unpacking the Lathe—Cleaning the Lathe—Setting up the Lathe—Foundation—Position—Leveling—Countershaft—Line Shaft—Power Necessary—Mounting Power Motor.

AFTER the lathe is received and the boxing and crating removed, the purchaser should carefully examine the excelsior to see that no small parts are overlooked. It will be found that the polished parts of the lathe are well smeared with vaseline or grease, which is put on to prevent rusting while the lathe is in the store room or in transit. This grease can be removed nicely with a cloth soaked in gasoline. After the grease is removed roughly in this way, the polished parts can be gone over with a dry cloth which will remove all traces of grease, and the bright parts can then be given a coat of light lubricating oil to prevent rusting.

The gears which come with the lathe will also be found covered with grease, and it might be well to immerse them in gasoline until all traces of grease are removed.

If the lathe is a heavy one, the floor upon which

it sits must be as rigid as possible. If the floor shakes it should be braced in some way, since the shaking will interfere greatly with accurate work, and will also do considerable harm to the lathe through facilitating vibration. The floor-space about the lathe should be clear, as it is sometimes necessary for the operator to work on both sides during certain operations. For this reason the lathe should not be set too close to the wall. The headstock end of the lathe should also be placed about 5 feet from the wall so that a long piece of stock can be fed through the hollow spindle. If the lathe is a fairly large one, and is to be set up in an outdoor work shop without a cellar, it is a good plan to provide a concrete foundation upon which to set it. Such a foundation can be provided for by digging a hole a foot or so deep and lining the sides with wood. A concrete mixture can be poured in and the top leveled off.

Much depends upon the way the lathe is mounted and leveled. After setting the lathe in position, it is leveled up in all directions the entire length of the bed. Shims are placed under its legs until it is brought to a perfectly level position. The lathe should then be fastened securely to the floor by means of lag screws or expansion bolts.

It will now be necessary to mount the counter-

shaft on the ceiling. A countershaft is shown in Fig. 12. The pulleys *A* and *B* are the driving pulleys. The clutch is shown in *C*. The belt which goes from *A* to the line shaft is crossed once and the belt which goes from pulley *B* to the line shaft is straight. When the clutch *C* is in the neutral position shown, neither of the pulleys are in motion. When the clutch is thrown to the right, it engages the pulley *B* with the shaft, and thereby

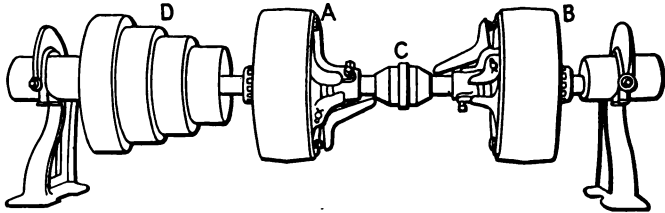

FIG. 12.—A countershaft for use with a small lathe.

turns the cone *D* which is belted to the lathe. By throwing the clutch to the left, the pulley *B* is disengaged and the lathe thrown into reverse.

The countershaft must be mounted securely on the ceiling, parallel with the lathe, but about a foot back so that the belt will incline slightly towards the operator. This is shown in Fig. 13. The shaft hangers should be fastened to the ceiling by the same method as was used in putting the countershaft in place. The line shaft should be

about 1½ inches in diameter, and the hangers placed about 6 feet apart.

One pulley on the line shaft must be belted to

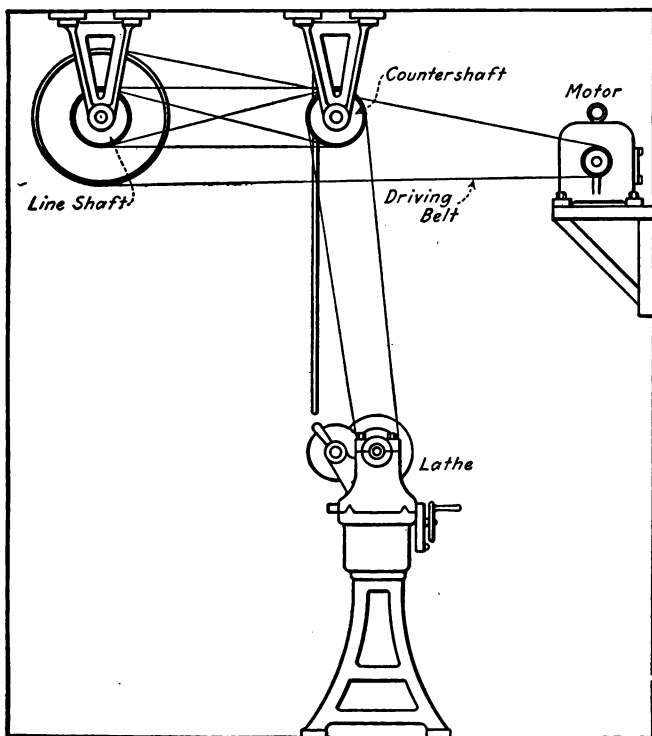

FIG. 13.—How the lathe is set up in the shop.

a pulley on the source of power, which may be a gas engine, electric motor, or, possibly, a steam engine. The size of this driving pulley will de-

pend somewhat upon the speed of the power unit. The speed of the countershaft should be 225 R.P.M. for a 11, 12 or 13 inch lathe; 210 R.P.M. for a 14 inch lathe; 200 R.P.M. for a 15 inch lathe and 180 R.P.M. for a 16 or 18 inch lathe.

The best source of power is the electric motor, since it can be started easily and does not require any attention after being started. Gas and gasoline engines are not especially desirable, but of course, it is sometimes necessary to use them when electric power is not available. The horse power delivered to the line shaft should be as follows:

11 inch lathe.....	1/2 H.P.
12 " "	1/2 H.P.
13 " "	3/4 H.P.
14 " "	1 H.P.

The average electric motor of about 1 H.P. has a speed of about 1200 R.P.M. To cause the line shaft to revolve at the proper speed and to effect a reduction, it will be necessary to use a small pulley on the motor and a large one on the line shaft. An electric motor with as low a speed as possible should be purchased. The motor can be mounted in an inverted position on the ceiling or else placed upright on the shelf close to the ceiling. It will be necessary to use a starting box with all motors,

since a severe overload would be thrown on the line if the circuit was closed without the proper resistance.

The lathe should be set in position so that the operator will have plenty of light to work with. If the lathe is to be used at night, a drop light should be placed so that it will come within about 2 feet of the chuck. The light should be provided

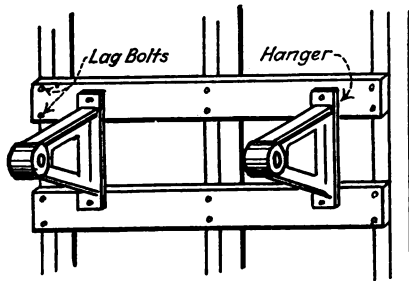

FIG. 14.—How the shaft hangers are held to the ceiling of the shop. with a shade to prevent it from shining into the operator's eyes.

The setting up of a small bench lathe does not involve such a great amount of time and expense. It is necessary to provide a very substantial bench and to bolt the lathe to it securely. A heavy work bench overcomes vibration, and the bench described in connection with the home made lathe in Chapter XI is recommended for small amateur lathes.

Bench lathes are generally provided with special countershafts which are designed especially to go with the lathes. A very ingenious and convenient little countershaft is shown in Fig. 15. This is made for the Goodell-Pratt lathe, and by its use the lathe is brought under perfect control by the operator's foot. Unlike the larger counter-

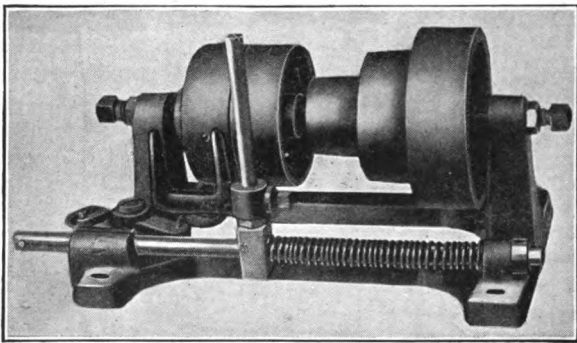

FIG. 15.—A small countershaft for a bench lathe.

shafts, this one is provided with an idle pulley. Normally, the driving belt runs on this pulley. When the strap, which is shown, is pulled, the belt shifter changes its position and lines up with the pulley opposite to the idle pulley, and in this way shifts the belt over to the pulley which is permanently connected to the shaft. This starts the lathe. The strap should be connected with a wire to a small pedal mounted under the lathe

bench, and in this way the lathe is controlled by the foot, and remains in motion as long as the foot is pressed on the pedal. This little countershaft can be mounted on the wall in back of the lathe, or else, placed directly overhead. Much depends on local conditions and no set rule can be given.

The motor used with most bench lathes need not be over 1/6 H.P., and the one shown in Fig. 16

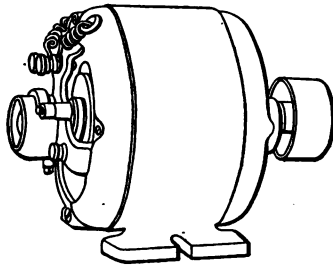

FIG. 16.—A small power motor suitable for driving a bench lathe.

is a very suitable type. This motor is provided with an iron pulley and revolves at a speed of 950 R.P.M. Such a motor will deliver sufficient power to the lathe spindle, and is very economical in both upkeep and power consumption.

Another countershaft of different construction for use with a small bench lathe is illustrated in Fig. 17. This, of course, is a more expensive type than the one previously described, although it per-

forms exactly the same service. An ideal set-up for a small bench lathe is shown in Fig. 18. The countershaft just described is employed together with what is known as an overhead gear. The overhead gear is placed just above the regular countershaft and connected to one of the pulleys

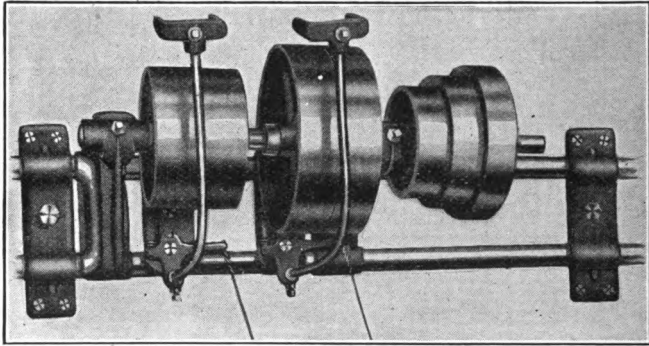

FIG. 17.—A special countershaft for use with a precision lathe.

on the countershaft with a belt. This overhead gear is really a second countershaft which has a grooved pulley mounted upon it. This pulley is used to drive grinding, drilling and milling attachments. Although it is not necessary for a lathe without these attachments, it must be included if such attachments are to be used. The control method shown in Fig. 18 is a very simple one. The lathe can be run in either direction by

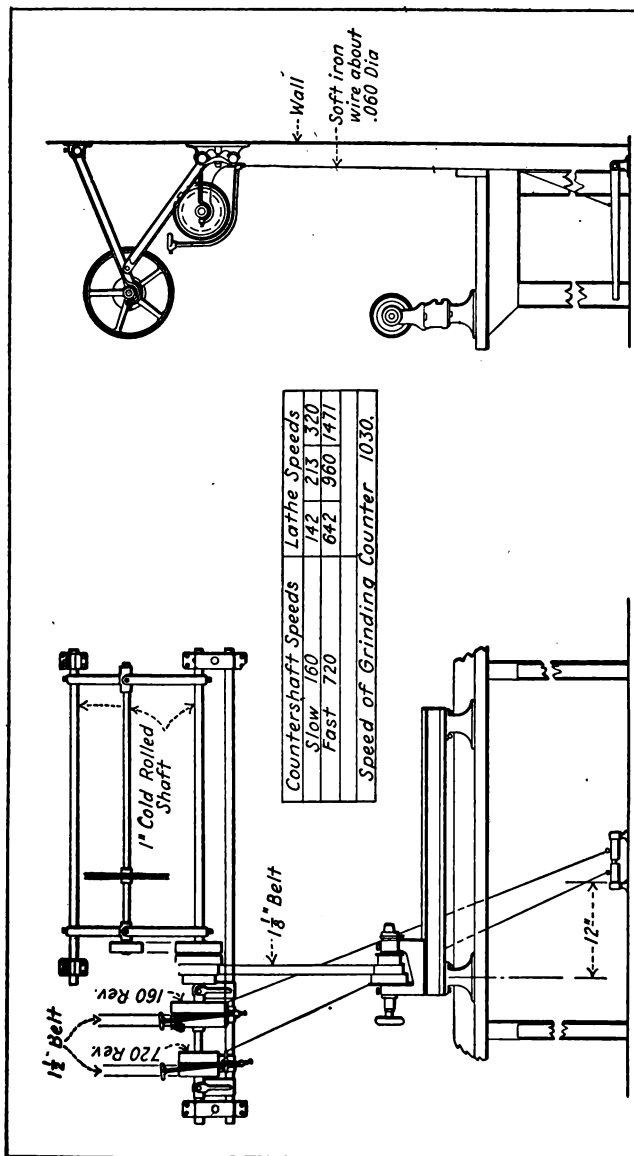

Fig. 18.—How a small precision lathe is set up with a second countershaft to drive the grinding attachment.

simply pressing the foot on the proper pedal. If the countershaft is not driven from a regular line shaft, a small line shaft just long enough to accommodate two pulleys is driven by the motor. One belt is run straight and the reverse belt is crossed.

CHAPTER III

THE LATHE AND ITS PARTS

Analysis of the Lathe—Back Gears—Screw Cutting Parts—
Apron—Carriage—Manipulation of Carriage—Care of
Lathe, etc.

THE amateur should know his lathe and understand its parts and their functions. He should also know the names of the various parts of his lathe.

Reference is made to Fig. 19. Here is shown the lathe, and each part has been given a letter. *A* is the headstock, and this includes all the parts of the working end of the lathe. The headstock is always fixed in position. *B* is what is known as the cone. On some lathes it consists of three different sized pulleys, while others have steps of four pulleys to provide four different speeds. The method of bringing about these different speeds is shown in Fig. 20. It will be seen that the pulley on the countershaft must be placed so that the large pulley will be opposite the small pulley on the lathe. If a low speed is desired, the belt is placed on the small pulley of the countershaft and

on the large pulley of the lathe. This low speed can be greatly increased by shifting the pulley belt until it reaches the large pulley on the counter-shaft, and the small pulley on the lathe. When

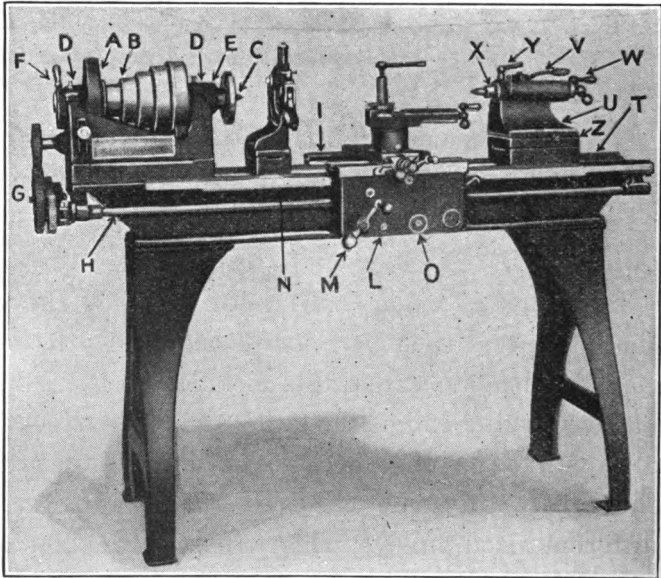

FIG. 19.—A substantial screw-cutting lathe. The names of the various parts are described in the text.

in this position, the lathe will be turning at its maximum speed. *C* is the live center which has a Morse taper shank. The live spindle has a female Morse taper into which the live center is placed. In removing this live center, it is best to

place a brass rod in the hollow spindle and knock out the center with a few gentle raps of a hammer. The headstock bearings are pointed out at *D, D*. These should be frequently oiled, and it is well to mention here that it is hard to give a lathe too much oil. *E* is the nose of the lathe. This is

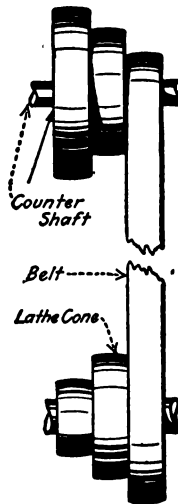

FIG. 20.—How the cone pulley on the countershaft and lathe spindle are arranged to obtain various speeds.

threaded to receive a chuck, face plate, or driving plate. The threads on the nose of the lathe should be well taken care of. When a chuck or face plate is put on, it should be held as true as possible so as not to damage the threads, and the threads should be clean and free from chips. Care

should be exercised when the chuck is removed, since it is very easy to damage the threads when it comes to the point where they disengage. The threads on the nose of the lathe should be frequently washed off with gasoline to clean out any dirt or chips which may have lodged in them. This is one of the most sensitive parts of the lathe, and it should be well taken care of.

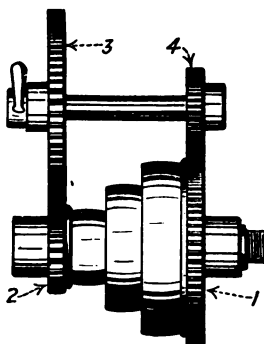

FIG. 21.—How the back gears of a lathe are arranged.

The handle *F* is used to throw the back gears in. A better understanding of the back gears will be had by referring to Fig. 21. For ordinary work the gear wheel is fastened to the first pulley on the cone. Different manufacturers have different methods of holding the cone to this gear. In most cases, the two parts can be disconnected by merely loosening a nut on the outside of the gear wheel.

When this is done, the cone is free to revolve upon the live spindle without turning the spindle of the gear wheel 1. The small gear wheel 2, at the small end of the cone is fastened to the cone and thereby revolves with it. When the back gears are thrown in mesh, the gear 3 meshes with the little gear 2 on the cone, and the gear 4 meshes with gear 1 on the live spindle. In this way, motion is transmitted to the live spindle through gears 2, 3, 4 and 1. The back gears of a lathe are so mounted that a quarter of a turn of the handle will throw them in mesh. This should never be done while the lathe is in motion, since the gears are very apt to strip. By throwing out the back gears and engaging the nut to the cone, the spindle is driven direct.

The headstock of the lathe is provided with another set of gears *G*, which transmits motion from the live spindle to the lead screw *H*. These gears will be treated more thoroughly in the Chapter on screw cutting. The lead screw on the lathe is used to move the carriage *I*. The speed of the carriage will depend upon the speed of the lead screw, and the motion of this in turn, will depend upon the ratio of the gearing between the lead screw and the live spindle. The lead screw of a lathe should be kept well cleaned and oiled, as the

accuracy of all threads cut on the lathe depend entirely upon this member.

The carriage *I* of the lathe generally has two or more handles or knobs upon the apron *L*. The handle *M* is called the apron handle, and by means of this the carriage can be moved up and down the lathe bed, assisted by the rack *N*. The small handle *O* is the apron clutch, and when this is turned a half nut clutches around the lead screw and thereby moves the carriage along the lathe bed. This is generally done when a long cut is to be taken, and the proper gear ratio will have to be chosen to produce the right speed of the carriage. Several oil holes will be found on the apron of the carriage and these should be used frequently, in oiling the working parts of the lathe in back of this member. Some small lathes and all large ones are provided with automatic cross feeds, and in this case a knob is included on the apron to control this operation.

On the top of the lathe carriage is mounted the slide rest. This can be either compound or plain. A compound rest is divided into two distinct parts. A compound rest is shown in Fig. 22. The handle *P* moves the upper portion of the rest crosswise and the handle *Q* moves the tool, which is held in the tool post *R*, parallel with the lathe

bed. The slide rest can be swung through an arc of 90 degrees in either direction. This permits the tool to be brought to any angle within this range in its relation to the work. There is a scale on the compound rest so that the angle of the path of the tool, in relation to the center line of the lathe is always known. The cutting tool is held

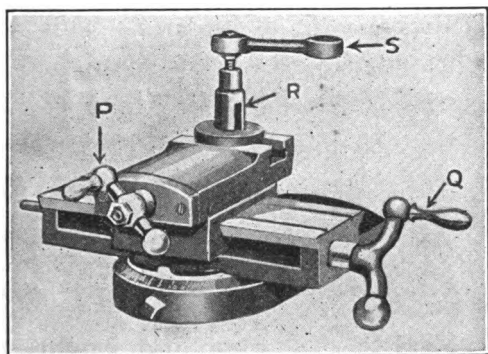

FIG. 22.—A compound slide-rest.

in the tool post *R* and clamped in position by the wrench *S*.

The feed handle *Q*, which moves the tool parallel with the lathe bed, is used only in making comparatively short cuts that will come within its range. Longer cuts which do not come within the limits of this method of moving the tool are accomplished by moving the whole carriage.

All the cross cutting is accomplished with the handle *P*. This member is able to move the tool post a distance from the center, which corresponds with the swing of the lathe and, of course, a cut greater than that can not be made. On some lathes of the more expensive type, the handle *P* is provided with a micrometer collar which is graduated in such a way that cuts can be made accurately up to $\frac{1}{2}$ of $\frac{1}{1000}$ th of an inch. This collar is

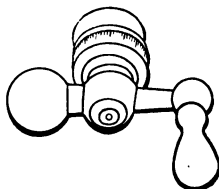

FIG. 23.—A micrometer collar placed on the cross-feed handle.

shown in Fig. 23. The graduations upon it corresponds to the pitch of the cross feed screw. If this is known it is a simple matter to graduate the collar this way, and it adds greatly to the convenience of the lathe. The compound rest should be kept well lubricated, especially along the ways where the parts swing over one another. Small oil holes will be found to lubricate the screws which control the motion of the moving parts. All chips and dirt should be kept carefully wiped off.

An ordinary slide rest is equipped with a cross feed which can travel only at right angles to the lathe bed. With such a slide rest, it is impossible to accomplish the work which can be done with a compound rest, such as taper turning, etc. The lathe bed *T* is machined to great accuracy. It should be kept well smeared with oil, and the Amateur should make it a rule never to place such tools as files, hammers and wrenches upon it. This is bad practice, and in time it will produce many little nicks upon the machined and scraped surfaces. The tailstock *U* can be made to slide along the lathe bed by loosening the binding nut which is controlled by the handle *V*. The tailstock handle *W* is used to move the tailstock spindle and center *X* either in or out, depending upon the direction upon which it is turned. The binding screw *Y* is used to hold the tailstock spindle in any position. For long taper turning, the back of the tailstock center is thrown off center by loosening the screw *Z*.

CHAPTER IV

LATHE ATTACHMENTS AND THEIR USE

Center Rests—Milling Attachments—Gear Cutting Attachments—Thread-Cutting Attachments—Grinding—Circular Saws—Turret.

By the addition of various attachments, manufacturers have greatly increased the usefulness of their machines, and such operations as sawing, milling, gear cutting and grinding can be done on lathes nearly as well as on machines designed especially for these purposes. It will be understood, of course, that each company designs its attachments for use only on machines of their own manufacture. This is true with very few exceptions. There are few tool post electric grinders that can be used on any lathe, but most of the other attachments are designed especially for the lathe on which they are to be used.

One of the few simple attachments which is provided with equipment of every lathe without additional charge is shown in Fig. 24. This is known as a center rest. This particular device slides upon the lathe bed, and the tailstock must be taken

off before it can be put in place. It is locked in any particular position on the lathe bed by the binding nut and wrench. If a long shaft of small diameter was to be placed in the lathe for a turning operation, it would spring in the center when the cutting tool was brought to bear against it. To prevent this, the three jaws of the center rest are adjusted to the surfaces of the shaft, to be

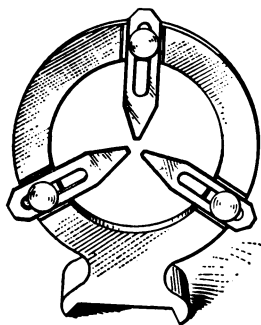

FIG. 24.—A three-jawed center-rest.

turned so that they will form a sort of temporary bearing which will prevent the shaft from springing or bending when the cutting is done. The jaws of the center rest are adjustable within quite wide limits, and they are held securely in every position by means of binding screws. When this device is used, the point of the jaws should always be well lubricated to form an easy running bearing for the revolving shaft.

It will be seen that by the use of this attachment the lathe tool cannot travel the full length of the shaft. To make this possible, a two-jawed center rest is often used. Such a center rest is shown in Fig. 25. During the turning, as the tool travels along the shaft, the center rest can be moved from one position to another until the cutting tool

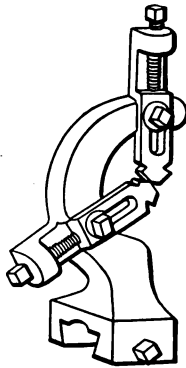

FIG. 25.—A two-jawed center-rest.

reaches a point near enough the back center where it will be safe to dispense with the center rest.

Nearly every company manufacturing lathes, makes a milling attachment for use with their machines. As before stated, a milling attachment must be purchased from the manufacturer of the lathe upon which it is to be used. A typical milling attachment is illustrated in Fig. 26. It will be

seen that the base of this attachment rests on the lathe bed. The milling cutter is mounted upon an

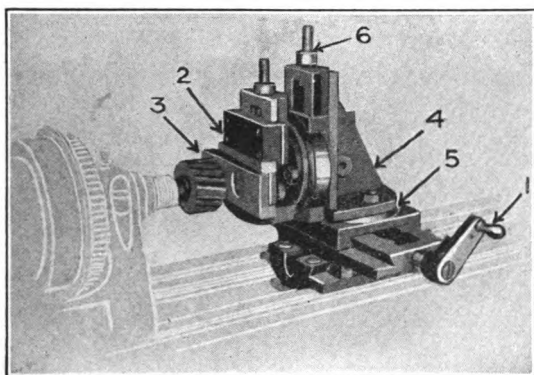

FIG. 26.—A lathe milling attachment.

arbor which is placed in the live spindle of the lathe. Milling cutters are made with various di-

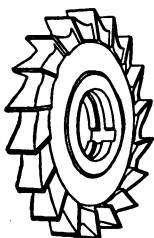

FIG. 27.—A two-inch milling cutter.

ameters, widths and faces. A sample 2 in. cutter is shown in Fig. 27.

The milling attachment shown in Fig. 26 is a

typical one. The handle 1 is for the cross feed and turns a screw which causes the whole upper portion of the milling attachment to travel across the lathe bed. Part 2 is a vise which holds the work which is to be milled. In the illustration shown, the work is indicated by 3. The standard or main frame 4 of the milling attachment is attached to the base by means of a swivel, so that this member can be turned and locked to any position up to 180 degrees. A scale reading of 5 indicates the position of the main frame.

The vise is also arranged upon a swivel and this can be turned and locked to any angle. A scale is placed on the base of the vise by means of which it can be accurately set. The vise is arranged on a vertical slide so that it can be moved up and down by means of the screw 6. It will be seen that this milling attachment is really a massive universal joint with a vise on it for holding the work. In this way, milling can be done at any angle.

In using the milling attachment, the speed of the cutter will depend upon two things, i.e., the nature of the metal being cut and the size of the cut. In the case of cutting steel, the back gears of the lathe should always be thrown in.

Another milling attachment a little more simple than the one previously described, is shown in Fig.

28. This is a substantial and well designed attachment that sells for a very reasonable figure considering the work it is capable of doing. The base of the attachment rests on the lathe bed, and is provided with a cross feed which functions in the

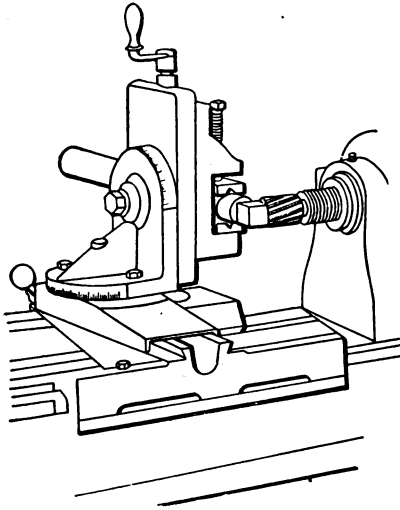

FIG. 28.—Another type of milling attachment.

same manner as the cross feed of the attachment previously described. The main frame or angle piece turns on a swivel; its lower edge is semi-circular in shape and the scale is engraved directly upon this edge. The device can be turned to any angle up to 180 degrees. The vise is a very simple one, the vertical motion of which is controlled by

a handle or crank at the top. The vise can be turned to any angle within 180 degrees by means of a swivel. The scale by which the exact angle of the vise is known, is engraved upon the upper edge of the main frame. The milling attachment just

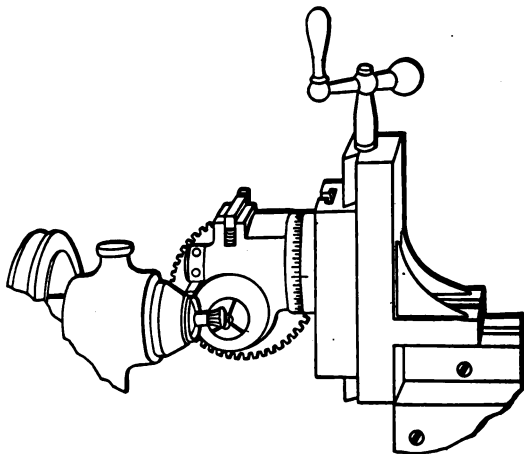

FIG. 29.—A milling attachment for a bench lathe. This attachment has an index plate.

described is designed for use on a South Bend lathe.

A little milling attachment designed for use with the Goodell-Pratt bench lathe is illustrated in Fig. 29. This little attachment is designed for very small work. The milling cutters have shanks $\frac{1}{4}$ inch in diameter, and these are held in a compression chuck. The work to be cut is also held

in a compression chuck which forms a part of the attachment. The chuck which holds the work can be revolved, and is held in any one position by an index plate and dog. The index plates are interchangeable and can be obtained with various division marks. The vertical motion of the milling attachment is controlled by the crank at the top.

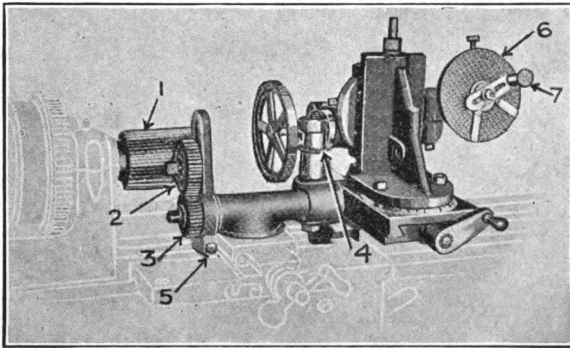

FIG. 30.—A lathe gear-cutting attachment.

Special milling cutters for use only with this device must be obtained from the manufacturer, or else, made by the operator. With this compact fitting it is possible to cut gears of various small diameters. By the use of many different types of milling cutters, which can be supplied, it is also possible to put this attachment to many other uses.

A gear cutter designed for use with the Seneca

Falls lathe is illustrated in Fig. 30. The operation of this device is very simple, and it is capable of cutting gear wheels within a wide range of diameters. A long cylindrical gear 1 is attached to the live spindle of the lathe. Meshing with this is the gear 2, which drives the gear 3. Gear 3 drives a spindle at the opposite end of which is a worm that meshes with the spiral gear. In this way motion is transmitted to the cutter 4, which is held in place on the mandrel. Different cutters, of course, can be placed upon the mandrel for different work. By manipulating the cross feed of the lathe, the cutter can be adjusted for a gear of any diameter within the range of the attachment. The gear 2 is on an adjustable arm which is locked in position by the nut 5. In cutting a gear wheel of larger diameter than the one shown in the illustration, the cross feed of the lathe would be drawn out towards the apron, and the arm which carries the gear 2 readjusted until the gear meshed properly with the large gear 1.

The gear to be cut is placed on the mandrel, which in turn is held in a chuck. This chuck can be revolved in a circle. The index plate 6 controls the movement of the chuck. The index plate has a number of small holes drilled in it. These holes are drilled at regular intervals along

lines which are concentrically arranged along the face plate. In this way, a circle can be divided into practically any number of working parts. A gear can be cut with any number of teeth, or other work can be accomplished that must be equally divided. The plate 6 together with the crank 7

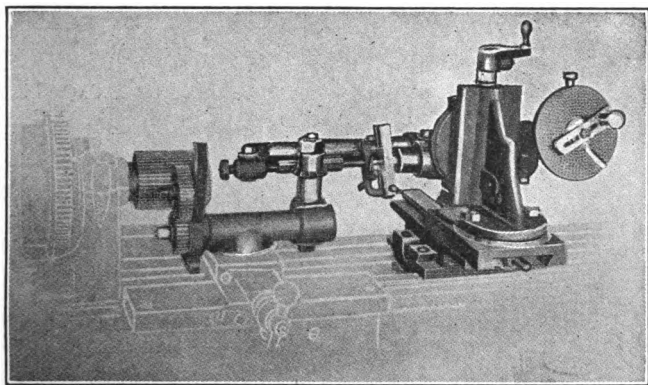

FIG. 31.—A lathe gear-cutting attachment used to flute reamers.

which carries a pin that fits into the holes, is properly called a dividing head.

The attachment shown in Fig. 30 can also be used for fluting reamers, as shown in Fig. 31. In this case an extension arm is placed on the attachment to accommodate the blank piece of stock.

A combination cutter and milling attachment of somewhat different design is shown in Fig. 32.

This is especially produced for use with a Stark precision lathe. The milling cutter is held at the outer end of the live spindle by means of a special mandrel. The milling attachment is so designed that a special compression chuck can be used for cutting gears, or an ordinary vise can be used for general milling purposes. The gear cutting device is shown in use in Fig. 32.

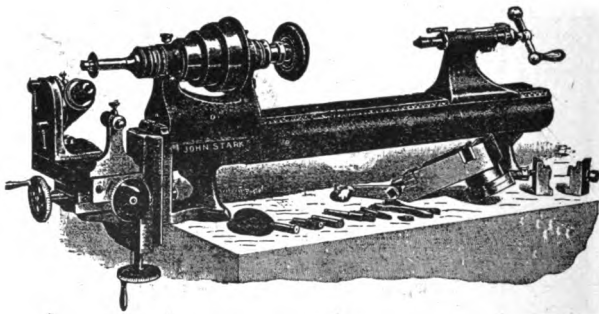

FIG. 32.—A gear-cutting attachment fixed to the head of a precision lathe.

Lathes of the larger type are provided with lead screws with which screw cutting can be done. There are a few bench lathes, however, which are not designed to accomplish screw cutting in any way. A special screw cutting attachment produced especially for use as an attachment on an Ames lathe is shown in Fig. 33. The large gear 1 meshes with a gear upon the live spindle and there-

by transmits motion to the shaft 2. This shaft carries a master screw and the pitch of this screw determines the motion of the rod 3, which slides in the bearing 4-4. The rod 3 carries an arm 5 upon which the tool holder 6 is mounted. A standard thread cutting tool is placed in the tool holder.

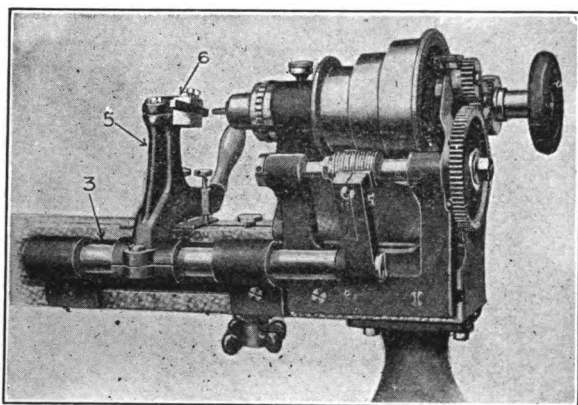

FIG. 33.—A screw-cutting attachment for the precision bench lathe.

Thread cutting is accomplished in a similar way upon the Goodell-Pratt bench lathe. This particular thread cutting attachment is illustrated in Fig. 34. The master screw in this case is attached to the outer end of the live spindle. This master screw controls the motion of the rod which carries the toolholder and standard thread cutting tool.

Another small attachment for a Goodell-Pratt

lathe is shown in Fig. 35. This is a turret which is provided with 6 half-inch holes. In these

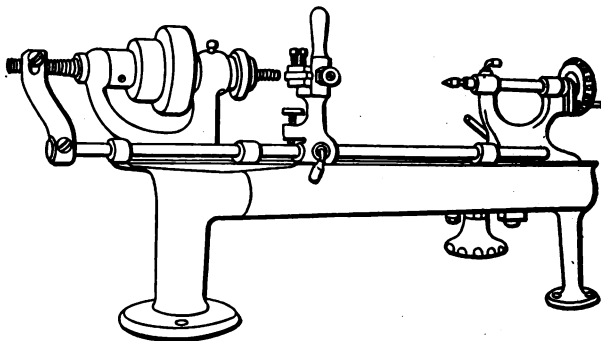

FIG. 34.—Another type of screw-cutting attachment for a bench lathe.

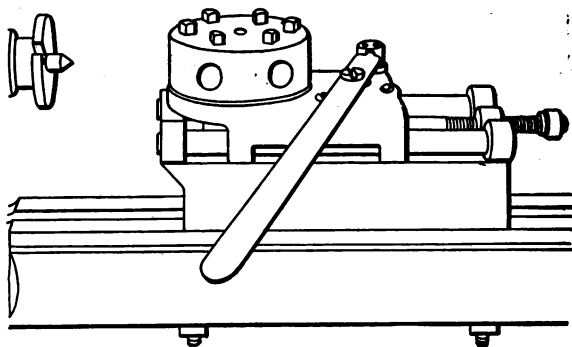

FIG. 35.—A turret for a bench lathe with which six different operations can be performed.

holes various tools can be placed such as drills, dies, hollow mills, reamers and counter-sinks. This turret revolves upon its center so that when

one operation is done, the next tool can be brought into working position by means of the lever shown. When a multitude of duplicate pieces of the same dimensions are to be made, this little attachment will prove to be of great value.

A sawing attachment for a Goodell-Pratt lathe is shown in Fig. 36. With this little device it is

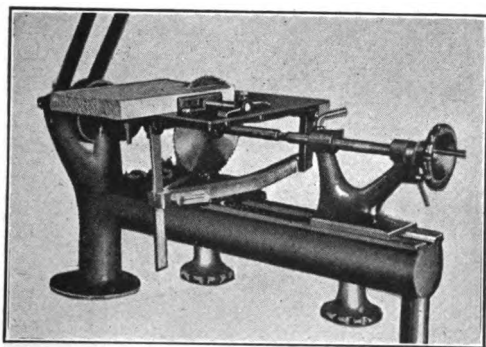

FIG. 36.—A circular saw attachment for a bench lathe.

possible to saw either wood or thin metal. The saw is mounted on an arbor which revolves between centers. A table fits over the saw upon which the work rests. There are two guides furnished with the device, one for splitting and one for mitering.

The jig saw attachment for the same make of lathe is illustrated in Fig. 37. This is a simple

little attachment which is driven by a crank held in the live spindle. The crank pin of this crank fits in a slide which causes the saw to oscillate back and forth rapidly when the lathe is in motion.

Grinding attachments are also manufactured to operate with various types of lathes. A well de-

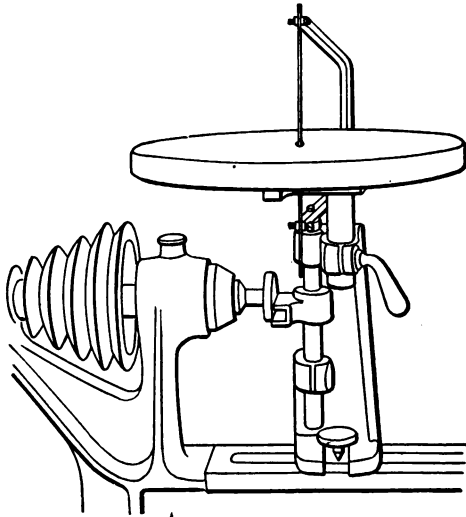

FIG. 37.—A jig-saw attachment for a bench lathe.

signed grinder for use with the Ames precision lathe is illustrated in Fig. 38. Such a grinding attachment must be driven with an overhead gear as illustrated in Fig. 18. The belt from the overhead gear revolves around one of the groups of pulleys 1. The grinding wheel 2 is thus caused to

revolve and is brought in contact with the work 3 by the proper manipulation of the cranks 4 and 5 on the compound rest. These grinders are manu-

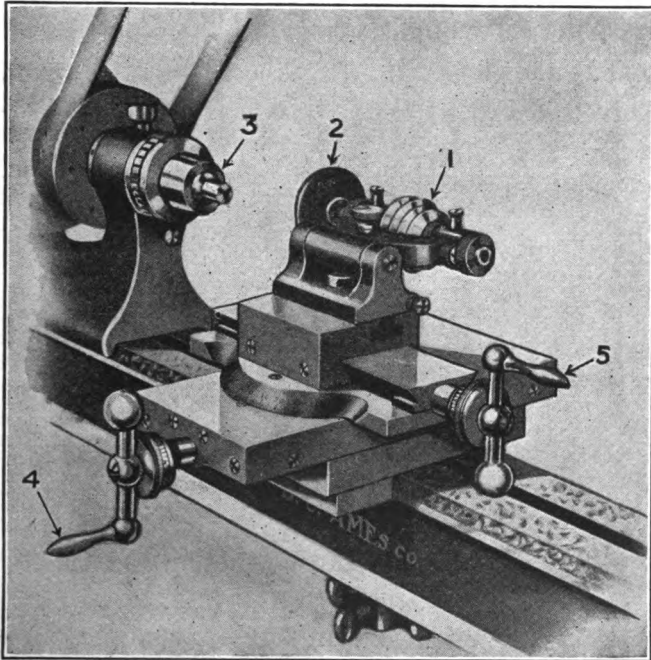

FIG. 38.—A grinding spindle attached to the slide-rest of a precision bench lathe.

factured in different forms, and an electrical one which can be placed in any tool post, is shown in Fig. 39.

In the event the amateur mechanic desires to

make a sawing attachment for his lathe the following design will prove very serviceable for use only on a Goodell-Pratt lathe. However, if the design is altered a little, the attachment can be made to serve on practically any small lathe. This attachment is shown in Fig. 40. The working drawing is given in Fig. 41. Mr. Joseph Dante, Jr., is re-

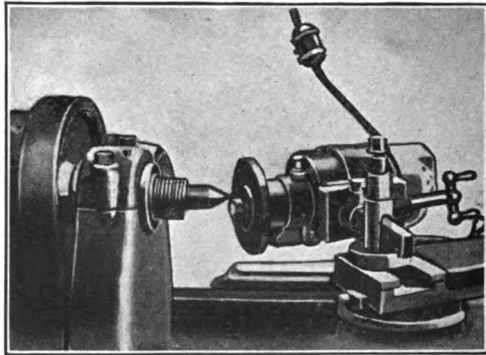

FIG. 39.—An electric tool-post grinder for a large lathe.

sponsible for the design of this particular attachment and he has described it as follows:

“The attachment is run from the spindle of a lathe using a crank to drive the machine, or, if the builder wishes, he can construct a small slide bracket and make a pulley for the same. This will make the machine a unit in itself. Note that the assembled drawing has all the parts marked

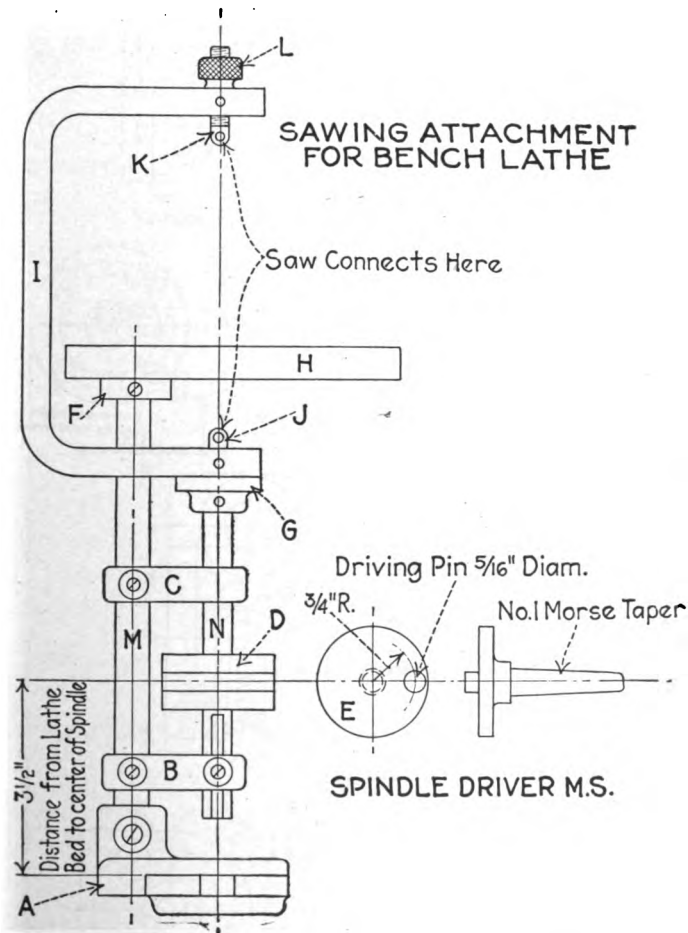

FIG. 40.—A homemade jig-saw for a bench lathe.

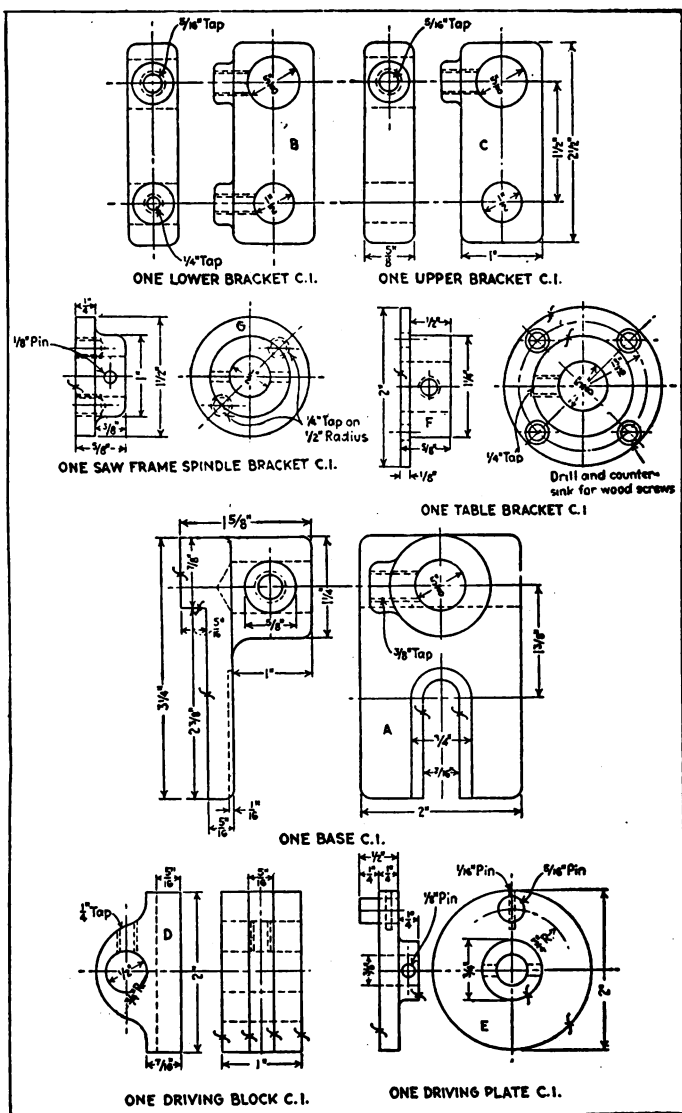

FIG. 41.—The drawings for a small jig-saw.

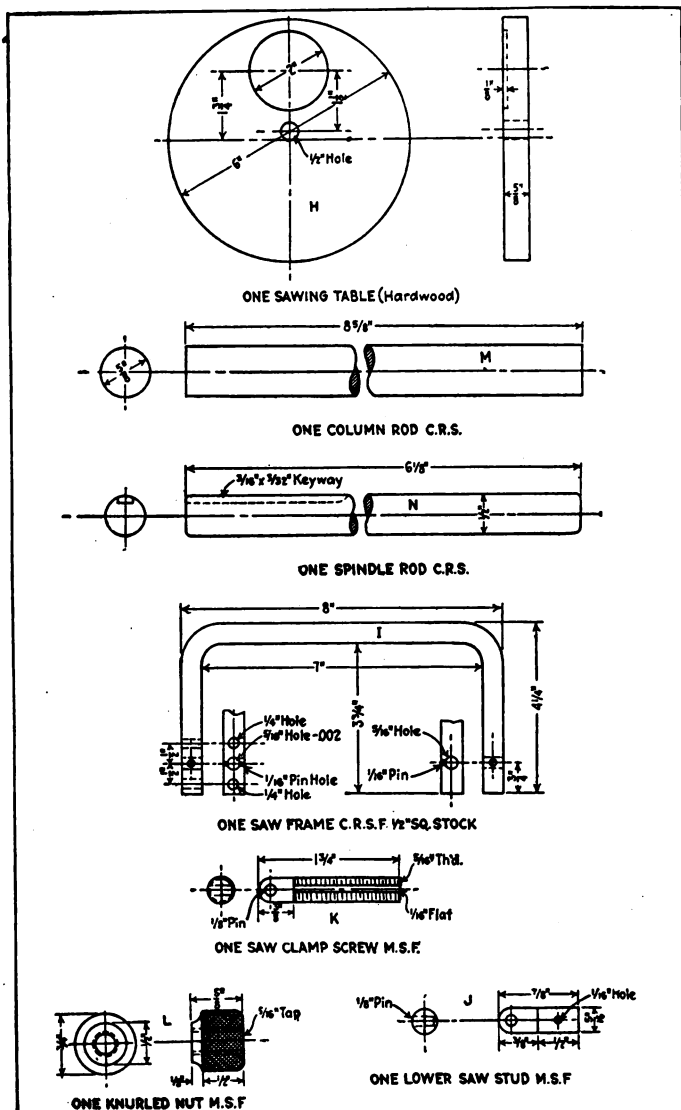

FIG. 41.—Continued. Drawings for a small jig-saw.

with letters. The same also applies to the details. Following is a description of the parts:

Part *A*. The base is cast iron. The first operation is to surface the bottom as per drawing. After this is done, drill a $\frac{5}{8}$ inch hole, drill set-screw hole and tap $\frac{3}{8}$ inches. A slot is then cut for the clamp bolt.

Parts *B* and *C*. The upper and lower brackets are cast iron. These two blocks should be drilled in pairs so as to insure perfect alignment of holes. In part *B* drill a hole and tap $\frac{1}{4}$ inch. The set screw for this hole should have a tit on one end $\frac{3}{16}$ inch in diameter so as to fit in the spline in the spindle rod and keep same in position. The set screw should have a very tight fit so that it will not work loose while running.

Part *D*. The driving block is cast iron. Mill $\frac{5}{16}$ inch. The slot is $\frac{5}{16}$ inch deep. If a milling machine is not at hand, a $\frac{5}{16}$ inch hole can be drilled and then broken open at the side. Drill a $\frac{1}{2}$ inch hole and tap $\frac{1}{4}$ inch for set screw.

Part *E*. This is the driving plate and is cast in iron. A $\frac{3}{4}$ inch hole is drilled in the center and at a $\frac{3}{4}$ inch radius from the center plate. Another hole is drilled to accommodate a $\frac{5}{16}$ inch pin. When the stud is put in place, a $\frac{1}{16}$ inch hole is drilled through the stud. Into this $\frac{1}{16}$

inch hole a pin is placed. The driving plate is 2 inches in diameter as noted on the drawing. In the $\frac{3}{4}$ inch center hole a No. 1 Morse taper shank is driven.

Part *F*. This is the table bracket and it should be cast in iron like the rest of the parts. A $\frac{5}{8}$ inch hole is drilled in its center. A $\frac{1}{4}$ inch hole is drilled into this and tapped to receive a set screw. Four holes are then drilled as shown, at a $\frac{13}{16}$ inch radius to receive wood screws. These four holes are countersunk.

Part *G*. This is the saw bracket. A $\frac{1}{2}$ inch hole is drilled .002-inch oversize so as to have a pressed fit on the end of the spindle. A $\frac{1}{8}$ inch pin hole is also drilled in this member. The bracket is not pinned to the spindle until the saw frame is made. The screw holes should be transferred from the saw frame to the bracket. The assembled view shows to which side the saw frame is located.

Part *H*. The wood table used is 6 inches in diameter, $\frac{5}{8}$ inch thick with a 2 inch recess, $\frac{1}{8}$ inch deep to accommodate the bracket *F*. Drill a $\frac{1}{2}$ inch hole for the saw through the table.

Part *I*. The saw frame is made of $\frac{1}{2}$ inch cold rolled steel bent as shown in the drawing. The two $\frac{1}{4}$ inch holes are for screws, and they should be transferred from this to the spindle bracket

which has two $\frac{1}{4}$ inch tappet holes on a $\frac{1}{2}$ inch radius.

Part J. This is the lower saw stud and it should have a pressed fit in the saw frame, a $\frac{1}{16}$ inch pin hole being drilled completely through as shown. A $\frac{1}{8}$ inch pin is used for holding the saw in place.

Part K. This is the upper stud and one end is filed halfway as shown, and a $\frac{1}{8}$ inch pin is used for holding the saw. This also applies to **part J**.

Parts M and N. *M* and *N* are the column and spindle rods and they are made from cold rolled steel stock with a bright finish.

The saws used on the small sawing attachment can be purchased at any hardware store and are what are known as 6 inch coping saws. The saws have looped ends which are very convenient for holding them to the saw frame. The price for these saws range from 12 to 45 cents per dozen.

The capacity of the sawing attachment can be increased by making the part 1 (shown in the drawing) larger. Larger saw blades must then be used."

A very good substitute for a milling attachment is shown in Fig. 42. This is a filing attachment designed for use on a small Goodell-Pratt lathe. Such a simple little attachment can also be made

for lathes of other types and by its use it is possible to cut equal flat surfaces on circular work and provide accurate squaring of small pieces. The device is really a file rest used in connection with an improvised index head. The designer describes this attachment as follows:

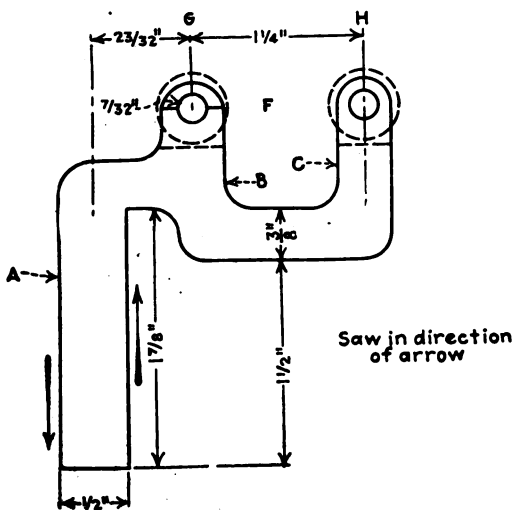

FIG. 42.—The main casting for a file rest.

“We will first describe the method of constructing the file rest. This particular attachment was designed to fit the amateur’s bench lathe No. 125 made by the Goodell-Pratt Co. Leg *A* (Fig. 42) is cast square since it is less difficult to make the pattern for a square casting than for a round

one. The pattern is cut from a solid piece of wood. Soft pine is probably the easiest to work although mahogany or cherry are undoubtedly the best on account of their freedom from warping. A jig saw is the easiest way to cut the pattern, especially with one in which the table be tipped. In this case the table is set at an angle of about 85 degrees which will give the requisite draft as shown in Fig. 44. The cuts are taken in opposite directions (see Fig. 42), and following around the outline of the piece. The metal used is crucible steel, although, if the amateur desires to save time in machining, cast iron can be used. Of course, the piece may be forged, but for anyone capable of using this method of construction, there is no need of instruction. Another method is to saw the whole piece from cold rolled stock, but unless there is a power saw available this method will be found exceedingly tedious.

“On receiving the casting from the foundry, it should be treated as follows: First run it over an emery wheel to remove the scale. Next, centers 1 and 2 (Fig. 42) should be prick-punched. In doing this, be sure that the line between the centers passes down the center of the leg and is as nearly parallel to faces *B* and *C* as possible. The casting is next center-drilled on these marks, set

between centers, and machined to the finished size. In machining, it will be found necessary to com-

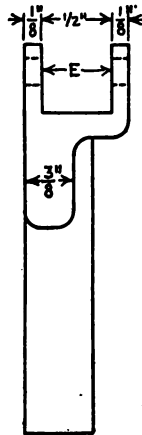

FIG. 43.—Front view of the casting.

pensate for the off-center weight of the casting by mounting a weight on the opposite side of the

In making the pattern
leave square,

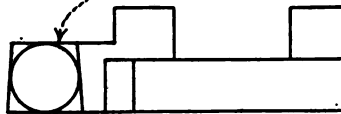

FIG. 44.—Back view of the casting.

face plate. Unless this is done it will not be possible to machine the stock truly. Scribe the lines *E* and cut the slot for the rollers with a hack

saw to the dimensions shown in Fig. 43. The sides of the slot are next filed up as true as possible with the center line of the leg *A*. It is better to make the two slots of the same width as in that case, rollers will be interchangeable. Next comes the task of drilling the holes for the roller pins. The centers of these holes are found by scribing lines *F*, which should be as nearly parallel as possible to the bed of the lathe when the casting is set in the tool rest. One of the easiest ways of doing this is to place the casting in the tool rest and scribe in the tailstock. Place the tool rest on the ways and set the casting to the desired height. Press it against the scribe and move the tool rest across the ways so that the scriber will mark a line. The intersection of line *F* with the center *G* and *H* of the arms are thus marked and may be prick-punched. The holes may now be drilled, but great care must be taken that the center lines of the holes are parallel to the lathe bed. Otherwise the work done with the tool will not be accurate. One method by which the holes may be accurately lined up is described as follows: Place the casting in the tool rest and parallel with its foot or base. Clamp the tool rest at right angles to the ways (a fairly accurate right angle setting may be obtained by use of the try square). Chuck a 7/32 drill and

true it up. Loosen the clamp of the tool rest and move the casting until the drill point touches either arm *B* or *C* at one of the points, which has already been located. Then re-clamp the rest, making sure that it is still at right angles to the ways. Bring up the tailstock and mark carefully where its center touches the work. After prick-punching on this mark, re-center on the point of the drill and the tailstock center. Unclamp the tool rest, and, holding it firmly down with the left

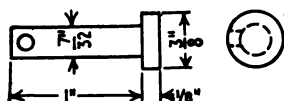

FIG. 45.—The dimensions of the roller pins.

hand, force the work against the drill point by means of the tailstock screw. When one side of the arm has been drilled, reverse the work and drill the other side. In a similar manner, drill the other side. If a reamer is handy, drill the holes slightly undersize and ream to the finished size.

“The next pieces to be machined are the pins shown in Fig. 45. These are cut from cold rolled stock and turned up on the lathe.

“The rollers are turned nearly to size from good machine steel, then hardened and ground. As will be noted from the drawing, Fig. 46, there

are two kinds of rollers. Those with a shoulder are of great use when squaring up to a definite point, while the straight rollers should be used for longer pieces.

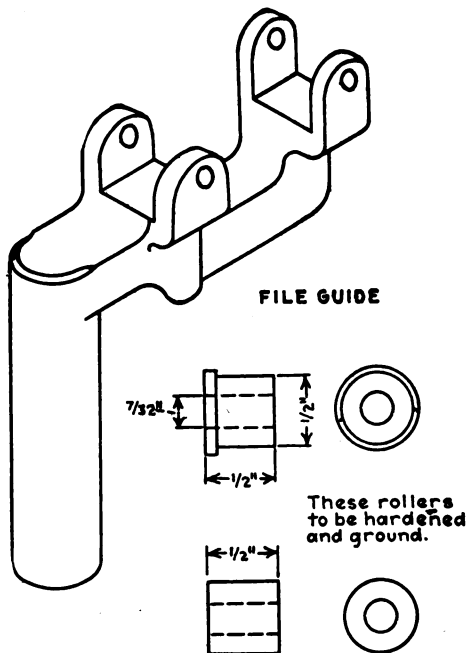

FIG. 46.—The dimensions of the rollers.

“The purpose of the index head is, first, to hold the stock fixed in one position while one side of it is being filed; and, secondly, to rotate the stock through any desired angle. A simple and practical method of construction is shown in Figs. 47 and

48. No exact dimensions are given for the reason, that in the majority of cases the design will have to be modified to fit the size of the machine and the needs of the operator. The device is made up as follows: A $\frac{1}{8}$ inch by $\frac{1}{2}$ inch cold-rolled steel bar is clamped around the headstock, as shown in Fig. 47. The bar is bent at right angles, as shown

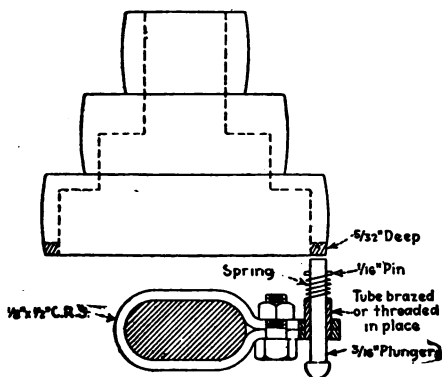

FIG. 47.—How the index attachment is fixed to the lathe.

by the dotted lines in Fig. 48, and a hole *N* drilled through it parallel to the center line of the live spindle. This hole must be large enough to take the cold-rolled tube shown in Fig. 47. The inside diameter of the tube is $\frac{3}{16}$ inch. The tube is brazed or threaded into place. A plunger, likewise shown in Fig. 47, is turned up on the lathe and a hole for a $\frac{1}{16}$ inch pin drilled through it close to one end. In assembling, the plunger is

slipped into place and a light compression spring is placed around the plunger and between the tube and the pin. In the periphery of the driving pulley nearest the headstock, slots are milled into which one end of the plunger fits. These slots should be $\frac{3}{16}$ inch by $\frac{5}{32}$ inch, and their center

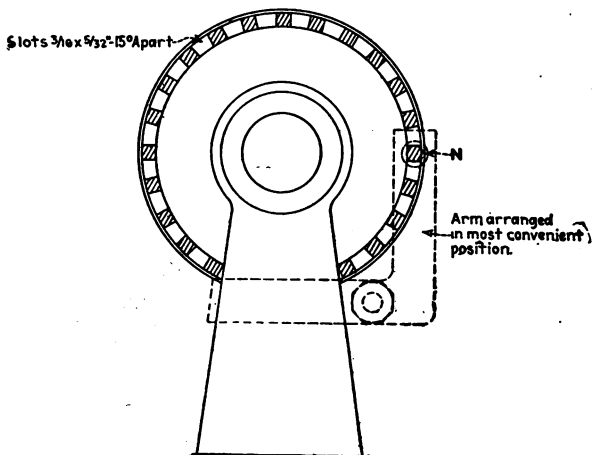

FIG. 48.—The index pulley for the filing attachment.

lines placed 15 degrees apart. The amateur is probably not equipped to mill these slots and it is much better to have this done at some properly equipped shop, than to attempt cutting them out with hacksaw and file. In sending out the pulley, a properly centered arbor should go with it as this will cut down the cost of the machine work to a considerable extent.

“A practical illustration of the way the device works is given below. Suppose it is required to square a piece of round stock of $\frac{3}{8}$ inch diameter; the diameter across the flats to be $\frac{1}{4}$ inch. To begin with, center a piece of stock and turn it down to $\frac{3}{16}$ inch diameter. Place the file in guide in the tool rest so that the arms surround the $\frac{3}{16}$ inch stock. Place a flat bar of known thickness on the rollers and above the stock. Adjust the height of the rollers until the distance from the top of the flat stock to the bottom of the $\frac{3}{16}$ inch piece is equal to the thickness of the flat stock, plus one half of the diameter across the flats, plus one-half the diameter of the stock on centers. In the illustration given, if the flat stock is $\frac{1}{4}$ inch plus $\frac{3}{32}$ inch, plus $\frac{1}{8}$ inch or $\frac{15}{32}$ inch. The height of the rollers having been properly adjusted, the stock which it is required to square, is placed in the lathe and filed. One side of the squared surface is thus obtained, and by means of the index head the other three surfaces may be accurately obtained. In squaring holes or cutting key-ways, a file of the proper width is obtained, the rollers raised to such a height that the center of the file is on a plane with the center of the stock, and the file forced against the work.”

CHAPTER V

MEASURING TOOLS AND THEIR USE

Scale — Square — Outside Calipers — Inside Calipers — Depth Gauge — Micrometer Depth Gauge — Micrometer — Vernier — Use of Micrometers — Drill Gauge — Spring Dividers — Thread Gauges — Snap Gauges — Use of Measuring Tools.

THE lathe operator must know how to manipulate mechanical measuring instruments before he can accomplish accurate work upon his ma-

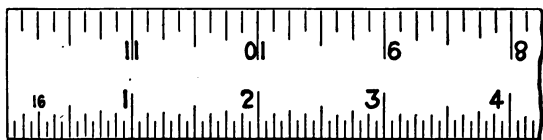

FIG. 49.—A machinist's four-inch scale.

chine. This Chapter will be given over to information regarding the use of such tools.

The most simple and widely used measuring tool is the scale. The scale is really a ruler made of thin steel. A scale is shown in Fig. 49. Steel scales always have two graduations on each side, four graduations in all. Graduations are usually in 16ths, 32nds and 64ths. Scales are made which

are graduated in 100ths, but these are very difficult to read with the naked eye. A 64th of an inch is generally the limit to work with when using an ordinary scale. Measurements beyond this can be made with a micrometer, which will be described in a latter part of this Chapter. Great care should be taken of the machinist's scales as they are made of the best steel and rust rapidly when exposed to moisture. It is best to keep the scale

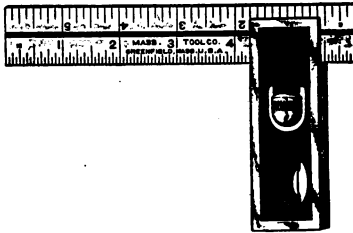

FIG. 50.—A scale and square combined.

in a little leather slip which can be kept in the vest pocket.

A combination square and scale is shown in Fig. 50. Such a square is not only convenient in squaring up work, but it also can be used as a scale. Squares of this kind are made in various sizes and it is best to have at least one small one on hand. A good substitute for this type of square, although somewhat more costly, is shown in Fig. 51. A 45 degree angle can also be meas-

ured off with this tool, and it will be seen from the drawing, that the scale is adjustable. It is held in any one position by a knurled nut. This

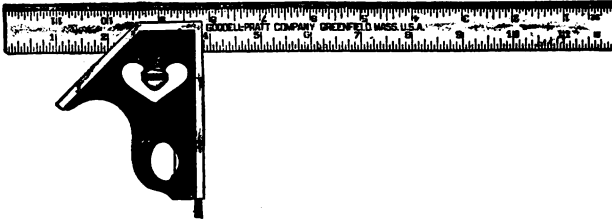

FIG. 51.—A combined scale and square with 45° angle.

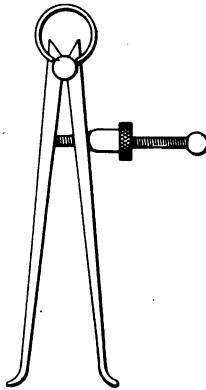

FIG. 52.—Inside calipers.

square is also provided with a water level which is very convenient for many uses.

Inside and outside calipers are measuring tools which are used a great deal in lathe work. An

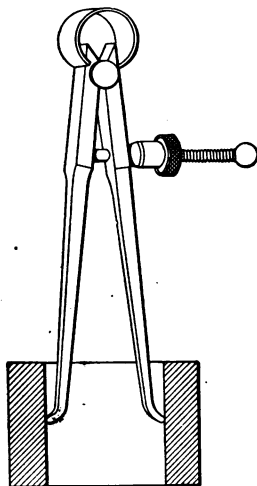

FIG. 53.—The use of inside calipers.

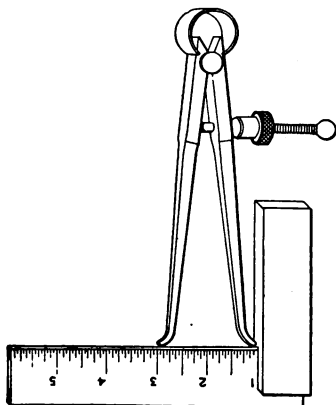

FIG. 54.—The adjustment of inside calipers.

inside caliper is shown in Fig. 52, and its use is shown at Fig. 53. If a cylinder was being turned out to a diameter of 1 inch on the lathe, the inside calipers would be adjusted as illustrated in Fig. 54. Inside calipers would then be continuously applied to the inside of the cylinder during the cutting until they just fitted. They should not

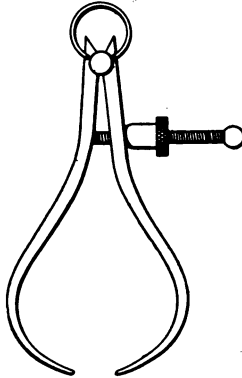

FIG. 55.—Calipers for outside measurements.

be forced into the cylinder, since this would cause them to pinch together and an accurate measurement would not be obtained. The tool should be placed on the inside of the cylinder very easily, and, after considerable use, the mechanic will find that he has developed a very sensitive “feel” in his finger tips which will tell him whether or not the inside of the cylinder is a trifle too large or

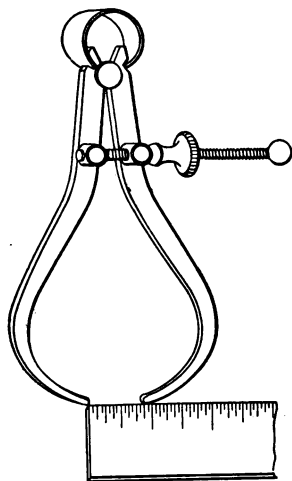

FIG. 56.—Adjustment of outside calipers.

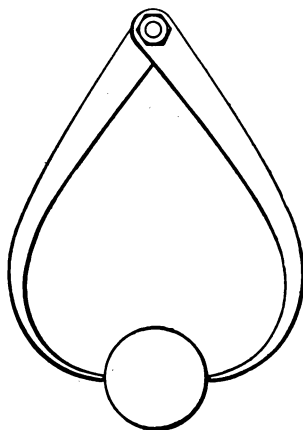

FIG. 57.—The use of outside calipers.

too small. The expert mechanic is so accustomed to the use of inside calipers that he can easily detect the difference caused by $1/1000$ th of an inch.

Outside calipers are shown in Fig. 55, and the method of adjusting them is shown in Fig. 56. The use of these calipers is shown in Fig. 57. The calipers should never be forced over the work since this will cause them to spread and the true

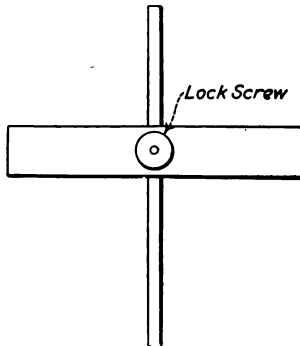

FIG. 58.—A depth gauge.

measurement will not be obtained. They should be manipulated in such a way that very small differences in size can be detected. This comes only through continued use and experience, and the beginner cannot hope to make extremely accurate measurements.

A depth gauge is illustrated in Fig. 58, and its

use is shown in Fig. 59. A depth gauge is used to measure the depth of a drilled hole. The little gauge shown can be very easily made by the mechanic. When it is withdrawn from the hole, the

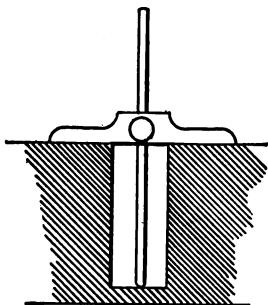

FIG. 59.—The use of the depth gauge.

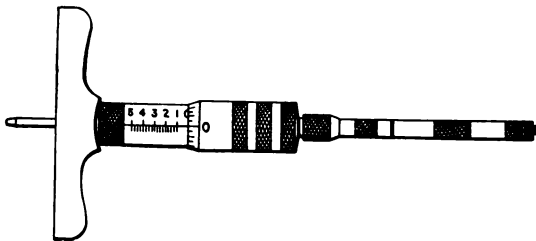

FIG. 60.—A micrometer depth gauge.

length of the wire from one end to the holder will indicate the depth of the hole. This can be measured with a scale.

A micrometer-depth gauge is illustrated in Fig. 60. This is used only for work requiring great

accuracy. The micrometer scale on this instrument is read in the same way as the scale on the micrometer described in the following paragraph.

A simple micrometer of 1 inch capacity is illustrated in Fig. 61. This instrument must be brought into use when very accurate turning is to be done. If work is to be done that is required to be accurate, within a thousandths of an inch, it is not well to rely upon the calipers. A microm-

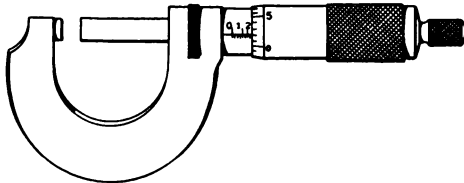

FIG. 61.—A micrometer for very accurate measurements.

eter measurement can be absolutely relied upon to be accurate within a thousandth of an inch. Reference is made to the illustration of the micrometer. Here it will be seen that there are two scales, a horizontal one upon the arm which projects from the jaws and one upon the edge of the movable thimble which either advances or recedes according to the direction in which it is turned. As this thimble is turned, the jaws move with it. The screw which controls this movement has an exact pitch of 40. Thus, it will be seen,

that for one complete revolution of the thimble, the jaw advances or recedes $1/40$ th of an inch, depending upon the direction in which it is turned. One fortieth of an inch is equivalent to .025. If the thimble was turned forty times, the micrometer would be opened to exactly an inch. The horizontal scale on the arm of the micrometer is divided into forty parts, so that for every revolution

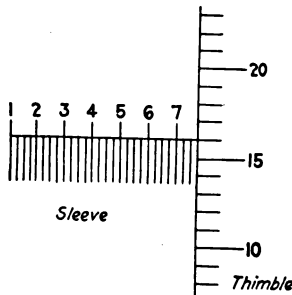

FIG. 62.—A micrometer scale.

which the thimble makes, it will move the distance of one of these divisions. If the thimble was moved from 0 to the point 5 on the horizontal scale, the jaw of the instrument would be opened $1/2$ inch or 20 divisions. It will be seen that the divisions of this scale are grouped off, every fifth line being numbered as shown clearly in Fig. 62. If there was not a scale engraved upon the edge of the thimble, it would be impossible to measure ac-

curately for certain parts of an inch. The little scale engraved on the edge of the thimble makes it possible to measure every part of an inch. The scale on the thimble is divided into twenty-five equal parts and it is marked from 0 to 20. If one complete revolution of the thimble advances the

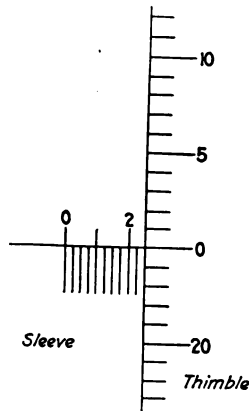

FIG. 63.—A micrometer reading of $\frac{1}{4}$ inch (.250).

jaw 0.25 of an inch, $\frac{1}{25}$ th of a revolution, which can be determined by the divisions on the scale which is placed on the edge of the thimble, will represent $\frac{1}{25}$ th of .025, or $\frac{1}{1000}$ th of an inch. Thus, if the scale is adjusted as shown in Fig. 63, the reading of the micrometer will be exactly .250 or $\frac{1}{4}$ inch. If it had passed the largest mark and gone on to 5, the reading would have been .255.

In using a micrometer the beginner will find it difficult to read the instrument quickly until a little experience is gained. It is also quite necessary to know the decimal equivalents of most of the common fractions such as $\frac{1}{4}$, $\frac{1}{2}$, $\frac{3}{8}$, $\frac{3}{4}$, $\frac{5}{8}$, etc. Common fractions can easily be changed to decimal

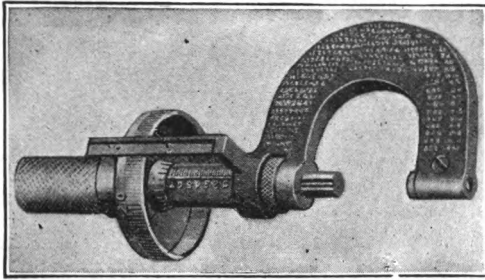

FIG. 64.—A micrometer vernier for measuring with an accuracy of one ten-thousandth of an inch.

fractions by dividing the numerator by the denominator in this way:

$$\frac{3}{4} \text{ of an inch} = 3.00 \div 4 = .750$$

The micrometer can be used to measure $\frac{1}{1000}$ of an inch, by employing a vernier attachment as illustrated in Fig. 64. This vernier attachment divides the sub-divisions on the thimble scale into 10 parts.

The more expensive micrometers are provided with means to adjust them should they become in-

accurate through abuse. All makers do not employ the same means. In the Starrett micrometer, the anvil is fixed and the correction is easily made with a small wrench which turns the line on the sleeve until it coincides with the zero mark on the sleeve until it coincides with the zero mark on the

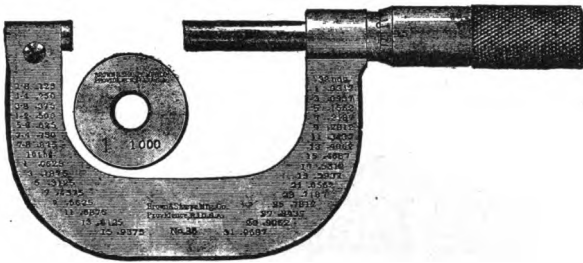

FIG. 65.—A micrometer with a test piece used for maintaining its adjustment.

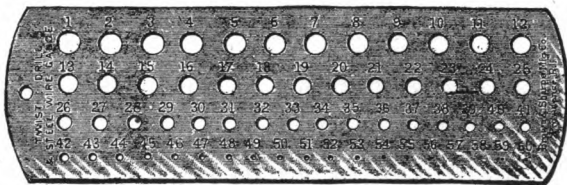

FIG. 66.—A drill gauge.

thimble. Other makers furnish a test piece as illustrated in Fig. 65. This test piece is exactly 1 inch in diameter.

The lathe operator will find frequent use of a small drill gauge, since the lathe is often pressed into service in drilling holes. Many operators

prefer to use the lathe in place of a drill press when this is possible. A drill gauge is illustrated in Fig. 66, and this type is capable of determining drill sizes from No. 1 to 60. Sizes beyond this (Nos. 61 to 80) are measured with a gauge of a

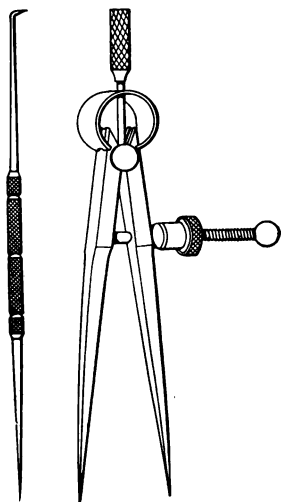

FIG. 67.—Spring dividers and scriber.

smaller size. Such drill gauges can also be had for measuring from $1/16$ th to $1/2$ inch by 64ths. When the size of the drill is to be determined, it is fitted in the holes until the hole is reached in which the drill fits tightly.

Spring dividers are used more for marking tools than for measuring. A pair of spring di-

viders is shown in Fig. 67. The points of these dividers are of hardened steel and extremely sharp, making them suitable for scribing lines on metal surfaces. They are also used in determining dimensions between points of lines, and for transferring lengths from a scale to the work.

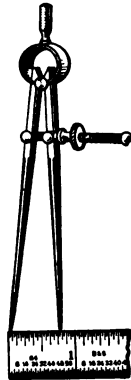

FIG. 68.—Adjusting spring dividers.

When used for this purpose, the dividers are adjusted as shown in Fig. 68.

Another important little measuring tool which should be in the possession of every mechanic is shown in Fig. 69. This is a thread gauge and is used to determine the number of threads per inch of a screw. Thus, if the mechanic has a screw which he desires to duplicate, he can first find the number of threads it has to the inch by the use of

this little instrument, and then adjust his lathe to cut a similar thread. The use of the instrument is very clearly illustrated in Fig. 70. Each one of the blades represents a certain thread. The

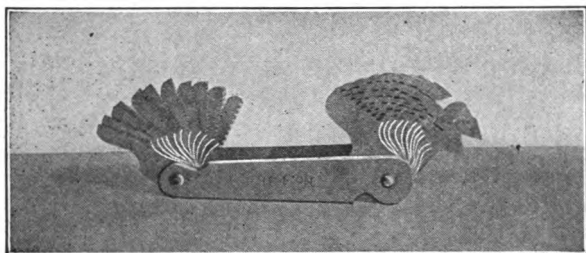

FIG. 69.—A small thread gauge.

blades are tried to the thread until one is found that will fit snugly. Each blade is marked; the thread shown in Fig. 70, indicated by the number

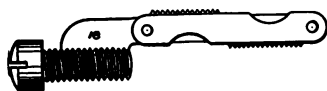

FIG. 70.—The use of a thread gauge.

on the blade, which is 18, meaning 18 threads to the inch.

For duplicate lathe work snap gauges are often employed. Such a gauge is depicted in Fig. 71. Each gauge is made for a certain dimension; they

are cut very accurately, and the work is turned down until it will fit properly between the jaws.

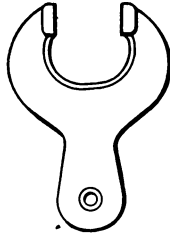

FIG. 71.—A snap gauge.

Such gauges are very expensive and the amateur mechanic will find little need for their use.

4

CHAPTER VI

A LESSON IN METAL TURNING

Cutting Action of Lathe—Lathe Tools—Use of Various Tools—Grinding Tools—Simple Turning—Finding Centers—Mounting Work—Lathe Dog—Positive and Negative Rake on Lathe Tools—Hand Turning—Hand Turning Tools—Using Lathe as Drill Press—Notes on Drills—Disc Grinder.

BEFORE the worker attempts to turn metal on his lathe, he should first thoroughly understand lathe tools and their cutting action. A lathe tool is made of hardened tool-steel, provided with a

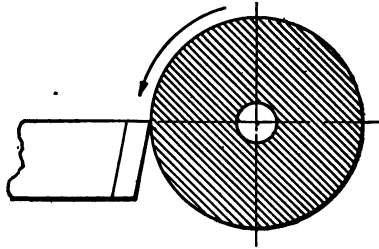

FIG. 72.—The direction of the work in relation to the lathe tool. proper cutting edge. The cutting edge of the tool is brought into contact with the metal as illustrated in Fig. 72. The direction of the work is noted by the arrow. When the tool is forced against the work in the lathe, the cutting edge of

the tool digs under the surface of the metal and curls off a **small thread**. The amount of metal which the tool is able to remove depends upon the sharpness of the tool, the softness of the metal, the size of the lathe and its driving motor. On a small amateur lathe, it will be possible to take but a very small cut.

A complete set of lathe tools is illustrated in

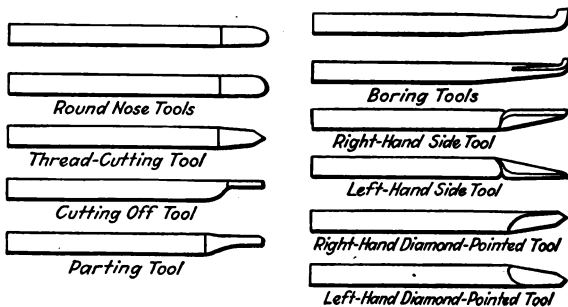

FIG. 73.—A complete set of lathe tools.

Fig. 73. Each one of these tools has a special use, and if good work is to be done each tool must be used in the proper place. Long experience has taught that several varieties of turning cannot be accomplished successfully with a single tool. Lathe tools are of different sizes. For very small lathes, tools $\frac{1}{4}$ inch square are used. On larger lathes, $\frac{3}{8}$ inch stock is employed, and sizes larger than this are generally of oblong section.

Lathe tools must be kept sharpened. This is done on a grinding wheel and some experience is necessary to properly sharpen a tool. The beginner must be careful that he does not "burn" the tool while grinding it. If the tool is allowed to remain in contact with the grinding wheel too long, its temper will be withdrawn and the part which came in contact with the wheel will turn blue. While grinding a tool it should be occasionally in a convenient receptacle of cold water. This will facilitate grinding and prevent the point of the tool from becoming soft. After this grinding operation, the finish can be put on with a few strokes of a small carborundum hand stone.

It has been stated before that each turning tool has a specific use. The reader will thoroughly understand the use of the various tools by referring to Fig. 74.

It will be assumed that a small brass pin is to be turned out according to dimensions noted in Fig. 75. The first thing necessary will be a piece of $\frac{3}{4}$ inch round brass stock 4 inches long. Since this brass stock has to be turned between centers on the lathe, it will be necessary to find the centers of the stock. Before this is done both ends of the stock must be faced up by placing the stock in the chuck and using the left hand facing tool. The

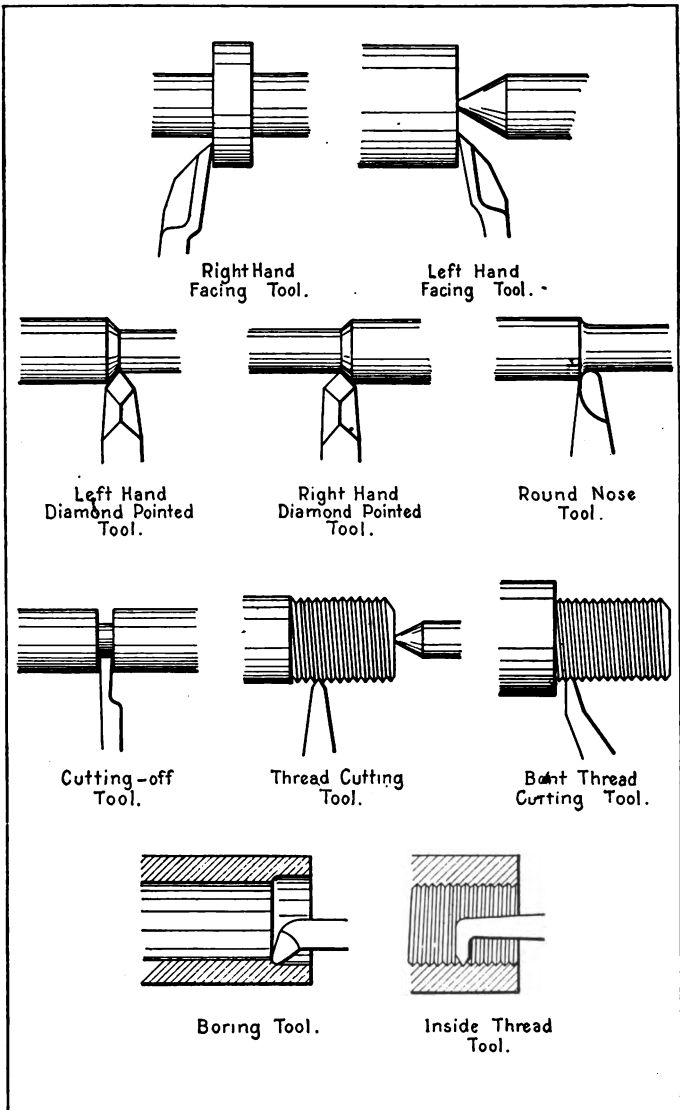

FIG. 74.—The use of lathe tools.

use of this tool is clearly shown in Fig. 74. The most convenient way of finding the centers is by the use of a self-centering punch which is illus-

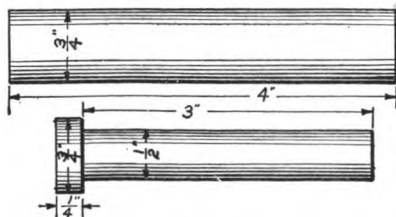

FIG. 75.—A piece of sample turning.

trated in Fig. 76. This punch is placed over the end of the stock and given a smart blow with a machinist's hammer. Both ends are treated alike.

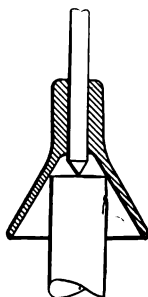

FIG. 76.—A self-centering punch.

The punch mark will then be in the center of the work.

There are several other ways of finding the approximate center of the stock. One of these is

clearly illustrated in Fig. 77. Here a pair of spring dividers are used. The four marks shown are scratched and the punch mark is then made as close as possible to the center of the enclosure formed by these marks.

Having found the center of each end of the

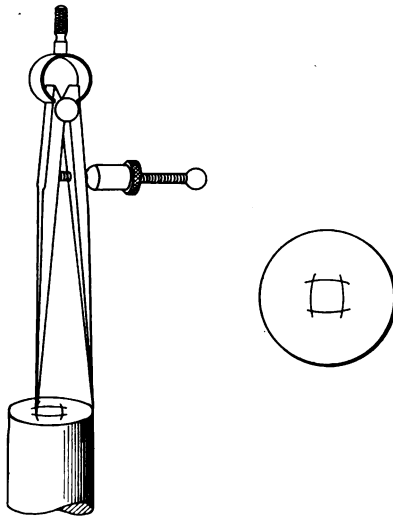

FIG. 77.—Finding a center for spring dividers.

stock, it will now be necessary to drill out the ends to receive the lathe centers. For this a small centering drill such as illustrated in Fig. 78 is used. This not only drills the centers but counter-sinks them as well, so that the centers of the lathe will fit as illustrated in Fig. 79. If an ordi-

nary drill was used for this purpose the centers would appear as shown in Fig. 80. The sharp

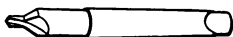

FIG. 78.—A centering drill.

edge resting on the tailstock center would soon wear down when the work was revolved and this would cause a loose bearing which would interfere



FIG. 79.—Proper lathe centers.

with accurate turning. The counter-sunk hole produced by the centering drill has the same angle as the centers of the lathe and therefore a good bearing will result.

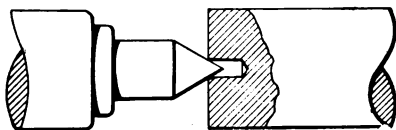

FIG. 80.—Centers made with an ordinary drill.

The chuck is now taken off the lathe and replaced by the driver plate. The tailstock center is inserted in the tailstock spindle and the live

center is placed in the hand-stock spindle. When this is done, the stock is clamped in a lathe dog. A lathe dog is shown in Fig. 81 and the method of using it on the lathe is shown in Fig. 82. It is

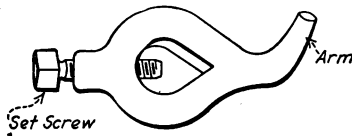

FIG. 81.—A lathe-dog.

by means of the lathe dog that the motion of the live spindle is transmitted to the work. Otherwise the live spindle would merely slip around in the center hole of the piece to be turned. In mounting the stock in the lathe, it is first placed on the

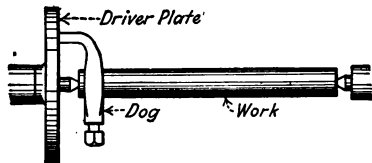

FIG. 82.—Methods of using a lathe-dog.

live center with the arm of the dog resting in the slot of the driver plate. Holding the stock in place with one hand, the tailstock is slid into place with the other and clamped. The spindle of the tailstock is then moved forward until the center comes to rest in the other center hole of the work. This

center should not force the work between the centers too tightly since this would cause undue friction. The back or tailstock center would be moved forward just enough so that the work will not be loose. When this is done, the binding screw on the tailstock spindle is tightened and a drop of oil is placed on the tail-stock center.

The work is now in position for turning. The first operation will be that of roughing the work

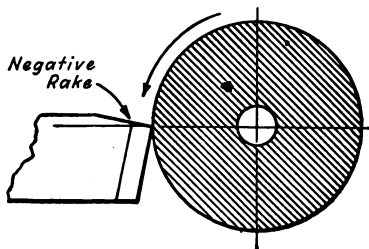

FIG. 83.—Showing the meaning of a negative rake.

down to within $1/32$ inch of its ultimate diameter. This is done with a roughing tool. Before setting this tool in the tool post, it must be remembered that brass is the metal being turned and that this particular metal has peculiar properties which necessitate what is known as a negative rake on the turning tool. A tool with a negative rake is one which is ground as shown in Fig. 83 with the cutting edge inclining to the work. A positive rake is a tool with a cutting edge which inclines

from the work. Such a tool is used for turning steel. If a tool with a positive rake was used in turning brass a very bad accident would be apt to occur. Brass is a comparatively soft metal and when such a tool is brought in contact with it has a tendency to "bite in." This sometimes causes the motor to stall due to an excessive load. If the motor is a really powerful one, the belts

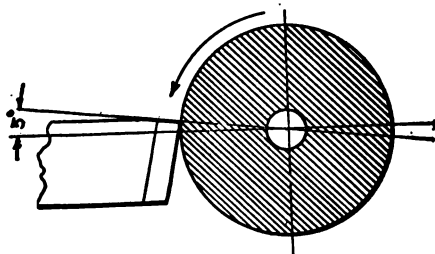

FIG. 84.—Lathe tool in position for cutting.

will merely slide around. Sometimes the lathe tool is unable to stand the strain and snaps off. The work being turned is invariably spoiled when this happens. Therefore the mechanic should always see that he has a tool ground with a negative rake for turning brass.

The roughing tool with the negative rake is mounted in the tool post and brought up to about 5 degrees above the center of the work (see Fig. 84). The lathe tool can be adjusted before the

work is placed between centers. It can be mounted in the tool post and raised or lowered until its cutting edge is exactly on the same level as the point of the centers. When the work is mounted in place the edge of the cutting tool will then be in proper position.

The piece is now ready for turning. The lathe should be run at a medium speed with the belt on the middle pulley. It is customary to turn brass at a higher speed than that used in ordinary steel or iron turning. The slide rest is manipulated until the cutting tool reaches the back edge of the stock. The cross feed is then run in about $1/16$ of an inch and left in this position. The lathe carriage is then slowly moved towards the headstock. The proper speed to move the lathe carriage in different classes of turning must be gained by experience. If it is moved too fast it will have a tendency to cut a screw in the work. It is much better for the beginner to move the carriage a little slower than is necessary, gradually increasing the speed until it reaches the safe maximum. In this instance the mechanic must remember that the distance from the end of the pin to the shoulder is about 3 inches. He should place his scale alongside of the revolving work and run the tool a distance of three inches. When the tool reaches

this point the cross feed should be manipulated in a reverse direction so that the cutting edge of the tool will be withdrawn from the work. The lathe carriage is then slid back and another cut of $1/16$ of an inch is taken. These cuts are repeated several times until the mechanic feels that he is getting somewhere near the final diameter. He should then set his calipers to $17/32$ of an inch and turn the work until this diameter is reached. The calipers should then be set to exactly $1/2$ inch. Then a very fine cut is taken. When the mechanic becomes proficient he will find that he is able to cut off $1/32$ of an inch very accurately. The beginner, however, may have to take two extremely fine cuts to arrive at the final diameter. Certainly the beginner should take two fine cuts rather than risk spoiling the work by a single heavy one. It is well to remember that a piece that is oversize can always be turned down, but there is no remedy for a piece undersize.

The roughing tool should now be replaced with a left hand facing tool. This facing tool is used to square up the shoulder on the pin since this cannot be done properly with the roughing tool owing to its circular cutting edge. The left hand facing tool cuts out this circular contour left by the roughing tool and trues the work up nicely.

The facing tool is then replaced by the parting tool (see Fig. 85). One fourth of an inch is then measured off from the shoulder of the pin towards the headstock and the point of the parting tool brought to this position. The lathe is then set in motion and the cross feed manipulated slowly until a very small amount of metal is left. When cutting between centers in this way it is not best to completely run the parting tool to the center of the work. When but a small amount of metal

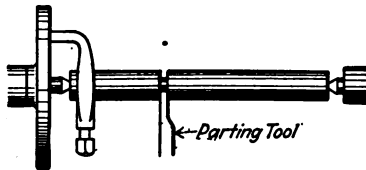

FIG. 85.—The use of the parting tool.

is left, the lathe is stopped, the back center taken out and the work broken off. When work is being turned in the chuck, however, the parting tool can run all the way through.

Hand turning must be resorted to if the lathe is not provided with a slide-rest. Small bench lathes can be purchased with or without the slide rest. In cases where the price is not prohibitive, the worker is urged to equip the lathe with the slide-rest since much more accurate can be ac-

complished with it. Then there is also to be considered the fact that hand turning requires considerable experience, and even then it has its limitations.

In hand turning, the tools are supported upon the tee-rest, with the cutting edge in contact with

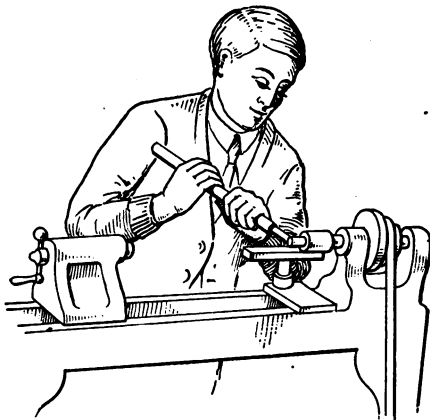

FIG. 86.—The proper position for hand-turning.

the work which is revolving in the lathe. The position for hand turning is shown in Fig. 86. Different shaped tools are employed for hand turning. The most common tools used are shown in Fig. 87. Many of these tools can be ground to shape from old files. Files are extremely hard and are very suitable for work of this nature. The tool should be as long as possible, thus in-

creasing its leverage and making its manipulation easier. When hand turning with steel, the worker should remember to grind a positive rake upon the tool. Just the reverse is true with brass. It



Graver



Hook or Heel Tool



Flat Ended Tool



Square Ended Tool



Bead Working Tool



Parting Tool

FIG. 87.—Hand-turning tools.

is especially dangerous to attempt hand turning on brass with a positive rake as the tool is apt to dig in and be pulled from the worker's hand if the machine is power driven.

In hand turning, the tee-rest should be placed as close as practical to the work. The exact position will depend upon the size of the job. Correct and incorrect positions are shown in Fig. 88. The tool shown in this illustration is the heel or hook tool. In turning iron or steel by hand plenty of

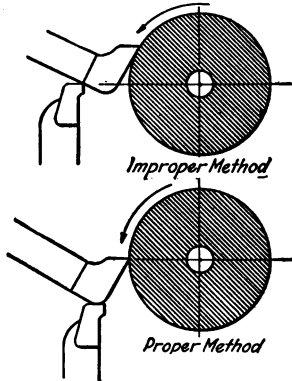

FIG. 88.—Correct and incorrect position for the hooked tool.

lubricating oil should be applied. This is not necessary when working with brass.

Inside turning can be done if the lathe is provided with a chuck. The method of accomplishing this is illustrated in Fig. 89. Here a separate tool called an arm-rest is used to support the cutting tool.

The lathe can be used as a drill press by placing a drill chuck in the tailstock or headstock,

depending upon the nature of the work to be done. The drill chuck, of course, must be provided with a Morse taper shank which will fit the tapers in the lathe. If the center of a round piece of work

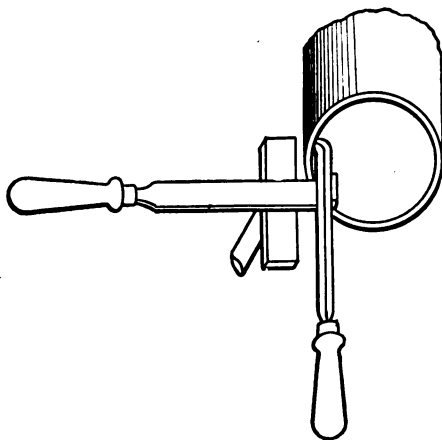

FIG. 89.—Inside turning with hand tools.

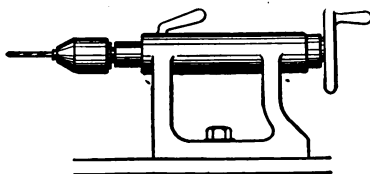

FIG. 90.—A drill chuck for the tail-stock.

is to drilled out, it can be placed in the regular lathe chuck while the drill chuck is placed in the tailstock as illustrated in Fig. 90. The tailstock is moved forward until the point of the tool

touches the work. The lathe is then set in motion and the drill fed into the work by means of the hand wheel on the tailstock.

Goodell-Pratt lathes are provided with a small drill pad. This drill pad is placed in the tailstock. The chuck is placed in the headstock spindle and in this way a power driven drill press is available. Drilling on the lathe in this way is both convenient and rapid.

In the event that a hole is to be drilled cross-wise through a round piece of stock, a small V-

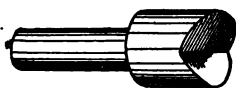

FIG. 91.—A V-center for the lathe.

center is placed in the tail-stock spindle. This V-center is illustrated in Fig. 91. Such a center will hold the round stock in position and prevent it from turning while the drilling is being done. If the regular drill pad was used for this work it would be very difficult to drill through it without slipping to one side or the other.

It might be well to give a few directions for drilling at this time. A drill, with the names of its various parts, is shown in Fig. 92. The cutting edge of a drill is always higher than the back edge. The difference in the height between these

two edges is called the clearance. The best way for the mechanic to understand the clearance is to study new drills. These drills are ground at the shop where they are made and they are as nearly perfect as it is commercially possible to make them.

In re-grinding a drill it is only necessary to

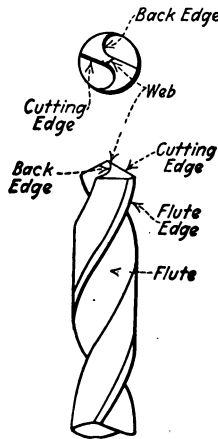

FIG. 92.—A metal drill and the names of its parts.

grind its tips. The flute edges are never touched since this would reduce the diameter of the drill and cause it to drill undersize. It is necessary to use a grinding wheel to sharpen drills. The cutting edge of the drill is placed against the grinding wheel and, with a sweeping motion, the

drill is moved upward and at the same time revolved so that the grinding wheel will touch the surface of one side. The same procedure is then followed out on the opposite side of the drill and care should be taken to see that the drill is held at the same angle in relation to the wheel each

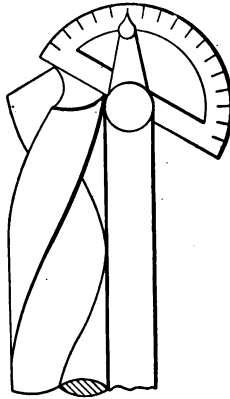

FIG. 93.—A drill-grinding gauge.

time. If this is not done, one cutting edge of the drill will be higher than the other and the drill will have a tendency to produce a hole oversize. To drill accurately, both cutting edges should be ground at the same angle. On the larger drills a gauge is used to prevent one side from being ground higher than the other. Such a gauge and its use is shown in Fig. 93.

The worker is warned not to drill brass at high speed with a drill sharpened in the ordinary manner. If this is done the drill will have a tendency to "bite in" just as a lathe tool with a positive rake does. When a drill "bites in" in this way it invariably breaks. To prevent this, the lip or cutting edge of the drill is ground flat. Reference is made to Fig. 94 which shows how a drill for brass should be ground.

In drilling steel, a lubricant should always be

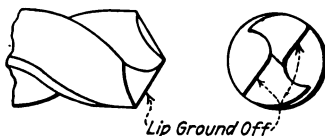

FIG. 94.—How a drill is ground for brass.

used and the lathe should be run at a medium speed. The drill should never be forced. The feed should only be fast enough to accommodate the cutting power of the drill. When drilling with drills over $\frac{1}{2}$ inch in diameter on a bench lathe, the back gears should be thrown in, providing the lathe is equipped with them.

Thread cutting can be done on a small bench lathe without a screw-cutting attachment by means of an ordinary die stock and die. This is illustrated clearly in Fig. 95. The die is backed up

against the drill pad and in this way the threads are sure to be cut square and true. When cutting

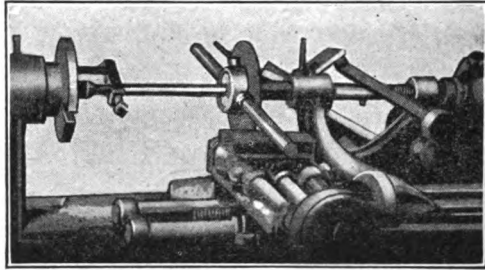

FIG. 95.—Cutting threads on a small bench lathe.

threads by this method it is best to pull the belt around by hand since the power drive would be

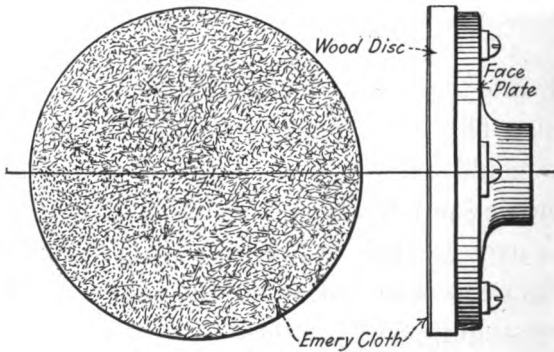

FIG. 96.—A disc grinder for use on a small lathe.

much too fast. When steel is being threaded plenty of lubricating oil is necessary.

A very convenient attachment for a small lathe is depicted in Fig. 96. This is a small wooden disc covered with emery or carborundum cloth. The disc is secured to the slotted face plate by means of wood screws as shown. The table rest is brought up to within about $\frac{1}{8}$ inch of the revolving disc. By the aid of this disc many jobs can

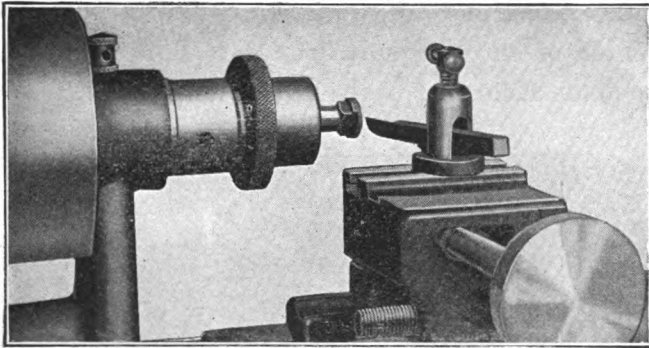

FIG. 97.—A small compression chuck and its use.

be done. The author has found this little device practically indispensable in his shop. With it, flat surfaces can be polished, pieces squared up, etc. It is equally as useful in woodworking and pattern-making as in metal work. It is a very good substitute for a file and produces more accurate results.

The little compression chuck illustrated in Fig. 97 can be used in many cases in connection with

a Goodell-Pratt lathe. By the aid of this little chuck, which is provided with different sized bush-

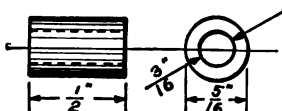

FIG. 98.—Dimensions of a bushing to be made by the use of a compression chuck.

ings, a long piece of stock can be fed through the center of the live spindle. If bushings were to be made according to the dimensions illustrated in

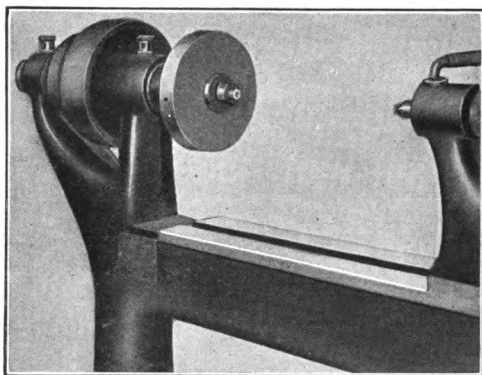

FIG. 99.—Using a small lathe as a grinding head.

Fig. 98, it would only be necessary to place the proper sized drill in the tailstock and drill the center out. The bushing could then be cut off $\frac{1}{2}$ inch long and another one cut in the same way.

When a number of such bushings are to be made the work is greatly facilitated by the use of this chuck.

The Goodell-Pratt lathe is also provided with a small circular saw or emery wheel arbor. This is placed in the live center and has a shank provided with a Morse taper. The use of this device as a grinding wheel is shown in Fig. 99.

CHAPTER VII

ADVANCED LATHE WORK

Use of Chuck — Mandrels — Boring — Boring Tools — Boring Bars—Boring Cylinders—Strapping Work to Lathe Carriage—Face Plate—Eccentric Turning—Eccentric Mandrel —Angle Plate—Taper Turning—Use of Reamers.

THIS Chapter will be devoted to more advanced lathe work and will include taper and eccentric turning, boring, etc. The beginner will find that he can use his lathe in a multitude of ways.

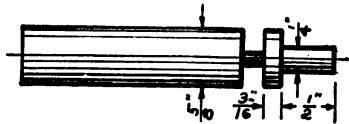

FIG. 100.—A piece of small turning.

A great amount of simple turning can be accomplished with the ordinary chuck. If it was desired to turn a pin down as shown in Fig. 100, it could be easily chucked and turned as illustrated in Fig. 101. The beginner may wonder why it was not necessary to turn this piece between centers. If the piece had been longer it would have been necessary to do this. In the case of the stock

being longer than it is, it would spring when the tool was brought in contact with it. Turning of this nature can only be accomplished successfully when the stock is of the proper diameter and short enough. If a $\frac{1}{4}$ inch piece of stock the same length as the piece shown in the chuck (Fig. 101) was being turned, it would spring when the tool was brought in contact with it. However, the

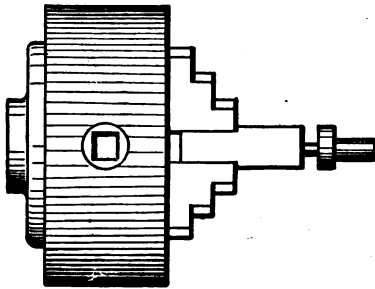

FIG. 101.—The work mounted on the chuck.

larger piece has enough body to overcome the cutting action of the tool. In all turning of this nature the beginner must use his own judgment.

If the center of a small ring was to be turned out it could be mounted in the chuck and turned very easily as depicted in Fig. 102. The reader will understand, however, that it would not be possible to chuck a square piece of stock in a three jawed chuck even though the chuck is self-center-

ing. However, it is possible to chuck a hexagonal piece of stock for turning. Lathe chucks of the type illustrated in Fig. 101, are provided with two

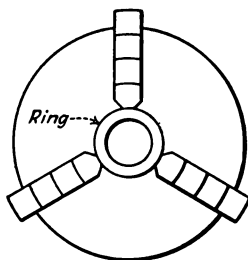

FIG. 102.—How a ring is turned out.

sets of jaws. One set is called the inside jaws. If a piece of brass tubing was to be cut and turned, it would be mounted in the chuck as illustrated in

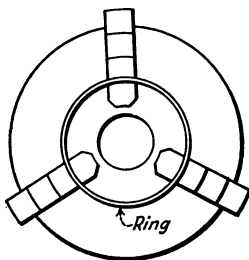

FIG. 103.—How brass tubing is mounted in a chuck.

Fig. 103. The jaws of the chuck have steps. The tubing is placed over these steps and the jaws are expanded until they grip the tubing. Just enough pressure should be exerted on the interior

of the tubing to hold it securely while turning. Otherwise the chuck will destroy its shape. The inside jaws are used for most ordinary work. The second set of jaws, which are called outside jaws, is used in cases where the work is too large to be held by the inside jaws. The outside jaws are just the reverse of the inside jaws so that work of a much larger diameter can be accommodated. In changing the chuck jaws it is necessary com-

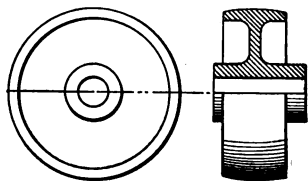

FIG. 104.—A pulley to be turned on a mandrel.

pletely to remove the one set of jaws and insert the other set. It will be found that the slots on the chuck are numbered 1, 2, 3. The corresponding numbers are placed on the jaws and each jaw must be placed in the proper slot.

If a pulley similar to that sketched in Fig. 104, was to be turned, it would not be practical to mount this in the chuck and, owing to its shape, it could not be mounted between centers since there is no place where the lathe dog could grip it. On jobs similar to this, what is known as a

mandrel is used. A mandrel is nothing more or less than a slightly tapering steel rod, hardened and ground and centered on each end. This is shown quite clearly in Fig. 105. The mandrel is inserted into the pulley and driven in tightly. The lathe dog is then placed upon the mandrel. It will be understood that the hole in the pulley must be the same size as the small end of the mandrel of which the taper is about .030 inch per

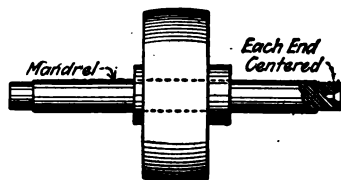

FIG. 105.—The pulley mounted on a mandrel.

foot. With the small pulley shown, a mandrel $\frac{3}{8}$ inch in diameter would be sufficient. In such a case, a $\frac{3}{8}$ -inch hole would be drilled through the center of the pulley. This could be done on the lathe with the pulley mounted in the chuck. Then a piece of $\frac{3}{8}$ -inch drill rod slightly oversize (about .378) is forced into the $\frac{3}{8}$ -inch hole. This can be done as sketched in Fig. 106. The mandrel can be removed in the same manner.

The subject of boring will now be considered. By the process of boring is meant the turning out

of a hole such as the bore of a cylinder. If the small cup shown in Fig. 107, was to be bored out, the operation could be done with the lathe chuck

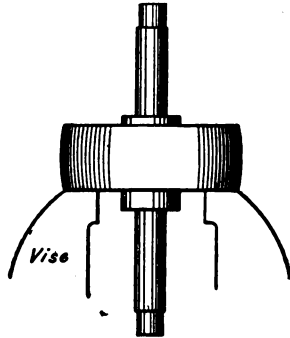

FIG. 106.—How the pulley is forced onto the mandrel.

and boring tool. The boring tool, of course, would be mounted as sketched in Fig. 108. In grinding the lathe tool for work of this nature, the begin-

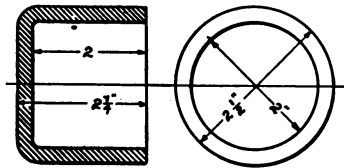

FIG. 107.—A cup to be turned out on the lathe.

ner must be careful to see that he gets the proper clearance or the result shown in Fig. 109-A, will be produced. It will be seen that the ordinary boring tool has a very limited application and can

only be used for a limited cut. If too long a cut is made, the tool will be apt to spring and produce an inaccurate result. In boring out long holes

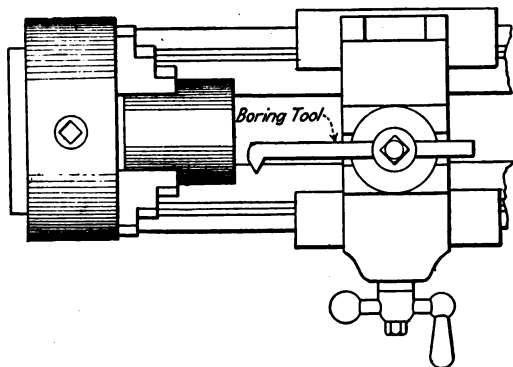

FIG. 108.—How the boring tool is mounted.

it is therefore necessary to use what is known as a boring bar. The mechanic can easily make a boring bar which will be very useful in many dif-

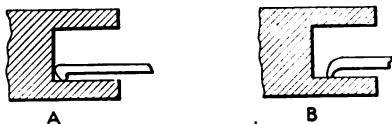

FIG. 109.—Improper clearance on the boring tool.

ferent ways. Fig. 109-B shows the proper way in which the point of a boring tool should be ground. The little boring bar illustrated in Fig. 110, can be used where it would be impossible to use the

ordinary boring tool owing to its tendency to spring. Another type of boring bar is sketched in Fig. 111. This boring bar is driven between centers by means of a dog. The work which is

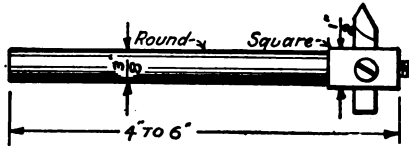

FIG. 110.—A boring bar for short cuts.

to be bored out must be strapped to the lathe carriage. An example of this kind of turning is illustrated in Fig. 112. In making a boring bar of this nature, the rod used should not be longer than necessary. The shorter it is the less tendency

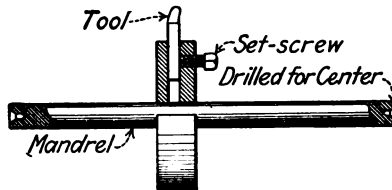

FIG. 111.—A large boring bar.

it will have to twist when the cutting is being done. The tool which is held in place by a set screw must be made of tool steel and properly hardened. In using a boring bar a very slow speed is necessary if cast iron is being cut. The

feed should also be light to prevent the bar from springing.

It will be necessary for the beginner to use his own ingenuity in finding a means for fastening the work to be bored to the lathe carriage. It must be bolted down very carefully and securely so that it will not move under the strain of cutting.

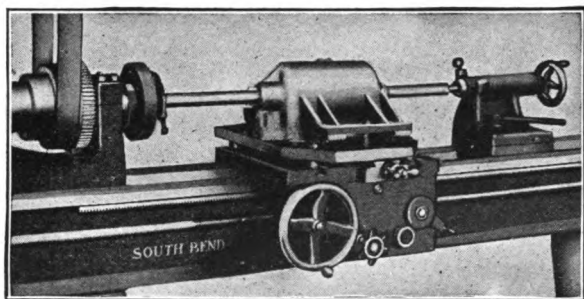

FIG. 112.—How work to be bored out is mounted on the lathe carriage.

A good example of such mounting is illustrated in Fig. 113. Here a small carriage bolt was used, and it may be well to mention here that the worker should have on hand several dozen carriage bolts of different sizes and lengths. They can be used in a multitude of cases.

The use of the face-plate will now be considered. A typical lathe face plate is sketched in Fig. 114. This is screwed onto the lathe nose in place of

the chuck. In placing the face-plate on the lathe nose, the threads on the nose should be inspected to see that there is no dirt on them since this would

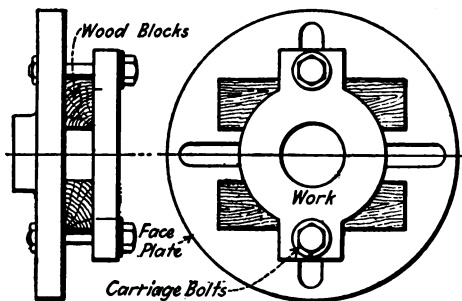

FIG. 113.—How carriage bolts are used in mounting work.

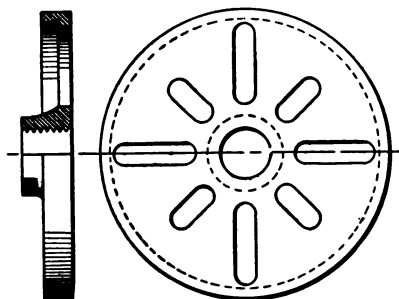

FIG. 114.—The lathe face-plate.

interfere with the proper setting of the plate. A sample of face plate turning will be seen by referring to the drawing Fig. 115. In such a case, a rather large pulley is to be faced off. It would be rather inconvenient to mount such a pulley on a

mandrel and therefore the face-plate is resorted to. It is held to the face-plate with carriage bolts and small clamps which the mechanic can easily

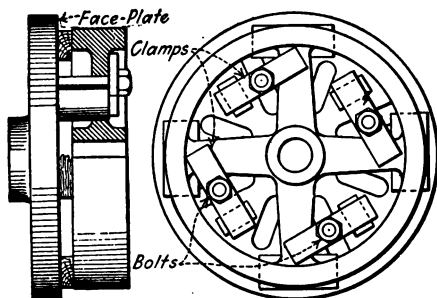

FIG. 115.—A pulley mounted on the lathe face-plate.

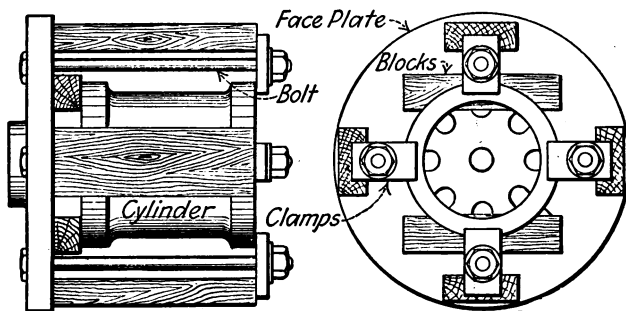

FIG. 116.—How a cylinder to be bored is mounted on the face-plate.

make. Care must be taken to mount the pulley concentric with the face-plate. Otherwise it will not be possible to tighten it accurately. When one side of the pulley is faced off, it can be turned around and the other side faced.

Another example of the use of the face-plate is shown in Fig. 116. Here a small cylinder is mounted on the face plate for boring. Small blocks are used in this instance with carriage bolts. It should be noticed that two small strips are placed between the cylinder and face-plate. This is done so that the boring tool can protrude to finish the cut and without coming in contact with the face-

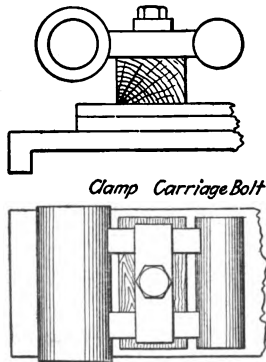

FIG. 117.—Showing the use of wooden blocks in mounting work.

plate. A number of blocks of all sizes should be kept on hand since they can often be used. An instance of how a block cut from a piece of 2×4 can be used is shown in Fig. 117.

Eccentric turning (turning off center) can also be accomplished on the face-plate in certain instances as will be seen by referring to Fig. 118. A small eccentric is mounted on the face-plate by

means of a single bolt. It will be seen that as far as the lathe is concerned this eccentric is being turned on its true center. The shaft upon which

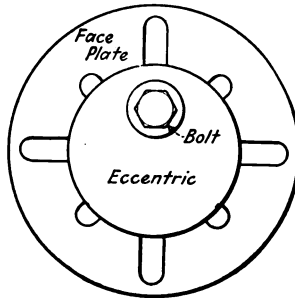

FIG. 118.—An eccentric mounted on a face-plate.

it revolves, however, on the engine or other device on which it is to be used, is eccentric.

While on the subject of eccentric turning it

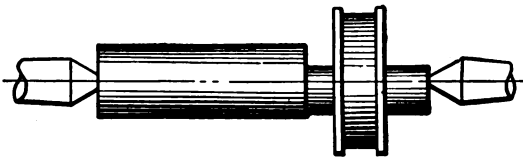

FIG. 119.—An eccentric mandrel.

may be well to mention another method which is equally successful. A small mandrel which is turned down eccentrically at one end is used (see Fig. 119). Of course it is much more troublesome to do turning in this way. In preparing the eccen-

tric mandrel for this kind of turning it is only necessary to turn it down off center on the lathe. Thus the piece is mounted off its true center. The distance will depend entirely upon the eccentricity of the piece that is to be turned upon the mandrel.

In combination with what is known as an angle-plate, a multitude of different jobs can be done on the face plate. An angle-plate is just what its

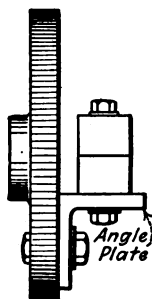

FIG. 120.—Facing off a split bearing with an angle-plate.

name implies; a piece of iron with faces at right angles to each other. An angle-plate is mounted on the face-plate by means of bolts as will be seen in Fig. 120. The work in turn is mounted on top of the angle-plate. This is also done by means of bolts. In the case where a small split bearing is to be faced off, the bearing must be mounted so that the hole in it will be in line with the hole in the center of the face-plate. It would be danger-

ous to drive the face-plate by power or other method if some means was not provided counter-weight it. With all the weight on one side caused by the angle-plate, a great vibration would be set

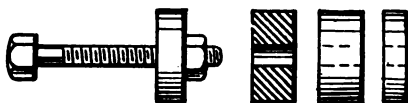

FIG. 121.—An adjustable counter-weight.

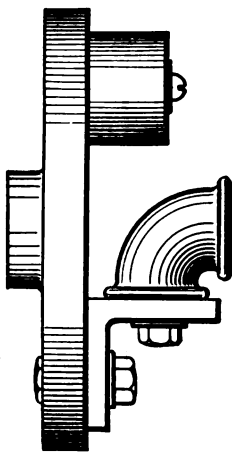

FIG. 122.—An elbow mounted on an angle-plate.

up and a great strain imposed upon the lathe. If nothing more serious happened, it would be impossible to do good turning with the lathe vibrating. To overcome this difficulty a counter-weight is mounted on the opposite side of the face-

plate. This counterweight must be of the proper size. The writer has used an adjustable counterweight. The method of making this will be seen by referring to Fig. 121. By the proper selection of weights, a combination can be found that will properly counterweight almost any job.

Another instance where an angle-plate could be used will be seen by examining Fig. 122. In this

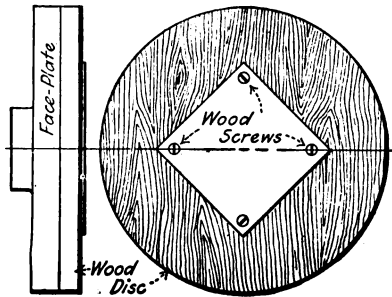

FIG. 123.—Turning circular plates of thin sheet metal.

case a small elbow is to be faced off. Here, too, the hole in the elbow must be placed on a line with the hole in the face plate of the lathe.

If circular plates of thin sheet metal are to be turned out, the kink shown in Fig. 123, will be very useful. In fact, this is the most practical method of accomplishing the job. A wooden disc is bolted to the surface-plate. On to this, the sheet metal to be cut is held with wood screws. The

wooden disc should be at least 1 inch thick so that the wood screws which hold the metal to its surface can be long enough. If too short screws were used the metal sheet would be apt to fly loose from the disc and injure the operator. Care should be taken to see that the sheet metal is mounted as near the center as possible. A right hand facing

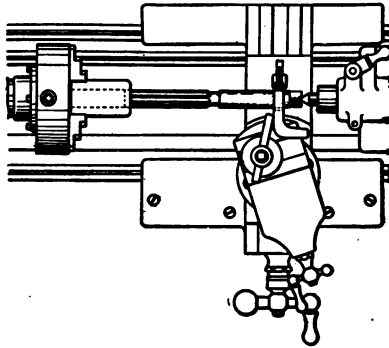

FIG. 124.—Showing the use of a large reamer.

tool can be used to cut sheet metal held in this way.

When using a large reamer, it is held in the same way shown in Fig. 124. A reamer should never be mounted in the chuck but should always be used in the way explained. The reamer should be free to follow the hole being reamed. This prevents it from being held securely. A cut over $1/64$ th of an inch should never be taken with a

reamer. It will be understood that reamers are used only in cases where a perfect fit is desired such as for the bearings. A drill $1/64$ th of an inch under the size of the reamer should be used to drill the hole.

CHAPTER VIII

SCREW CUTTING

Use of Hand Chasers—Inside and Outside Chasers—Use of Screw Cutting Lathe—Change Gears—Thread Cutting Tools—Inside Tool—Outside Tool—Use of Lubricants.

SCREW cutting is one of the most important and useful processes carried out on the lathe. It differs greatly from ordinary lathe work and the beginner will find that it requires considerable experience to produce accurate threads.

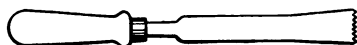

FIG. 125.—A chaser used in cutting threads by hand.

Screw cutting can be done on a simple lathe without a lead screw or other screw cutting attachments. It is then accomplished by the aid of what is known as a hand chaser. A hand chaser is sketched in Fig. 125. Thread cutting chasers are made of tool steel properly hardened and tempered. The cutting teeth in the end of the chaser correspond with the thread to be cut. If a No. 32 thread is to be cut, the teeth in the end of the

chaser should be $\frac{1}{32}$ inch apart, or if a No. 8 thread is to be cut there should be 8 teeth in the end of the chaser. Chasers can be purchased for cutting all of the standard threads.

The United States Standard thread is the favor-

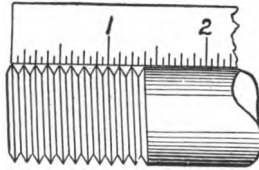

FIG. 126.—Finding the pitch of a screw without a thread gauge.

ite in this country and is therefore the most widely used. The pitch of a screw, or the number of threads that it has per inch, can be very readily found by placing a scale alongside the thread as

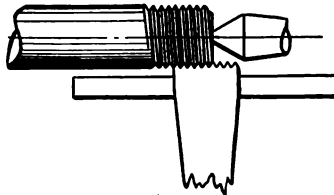

FIG. 127.—How a thread is cut by the use of hand chasers.

illustrated in Fig. 126. In the case illustrated the thread has $\frac{1}{8}$ inch pitch or, in the other words, there are 8 threads to the inch.

The use of the simple hand chaser in cutting threads between centers can be seen by referring

to Fig. 127. The work to be threaded is mounted between centers in the usual way, care being taken to see that absolutely no play is allowed. Before the threads are cut the work is set in motion and a file is brought in contact with the edge which is rounded off. This is absolutely essential in cutting threads by this method. Having rounded off the work, the tee-rest is brought to about the cen-

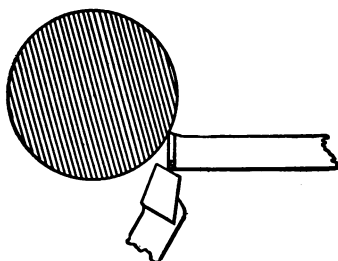

FIG. 128.—The proper position of a hand chaser in cutting threads.

ter of the work. The chaser is slightly tilted so as to bring the cutting teeth in the position shown in Fig. 128. The worker must not think that all that is necessary is to press the teeth against the work. This would do nothing more than cut a series of grooves. At the time the chaser is brought in contact with the work, it must be slid toward the left hand along the work at a definite speed which will depend upon the pitch of the screw to be cut and also upon the speed at which the work is

revolving. This is not exactly an easy job as the beginner will soon find out. It is understood that the speed at which the tool is slid along the work does not have to be absolutely correct since it would be quite impossible to achieve this accuracy by hand. However, it must be so nearly correct that the male and female threads will fit. The thread chaser should really be moved a distance of one tooth for each revolution of the work. The operator must take care to see that the motion is not jerky but is as uniform as possible. This is also true regarding the speed of the lathe. The first cut taken should be very light and the same care taken with it should be exercised with the first few cuts following until a fairly deep thread is cut. After this is done it will be easier to follow the thread without danger of spoiling it. The cutting should be continued until a well shaped V-groove results.

It will be seen that there are no limitations to the diameter of the work that can be threaded with a hand chaser. The size of the work in no way changes the procedure. However, when cutting wrought iron or steel plenty of lubricating oil or soapy water should be applied. If a good thread is not started at the first cut, it is possible by skilful manipulation of the chaser to correct it.

Internal threads are cut in the same way with the tool illustrated in Fig. 129. When cutting internal threads, it is well to remember that the internal diameter of the work should be equivalent to the diameter at the bottom of the thread of the screw on which it is to be fitted.

Threads may be produced on a screw-cutting lathe more easily than they can be cut with hand chasers unless the operator is particularly skil-

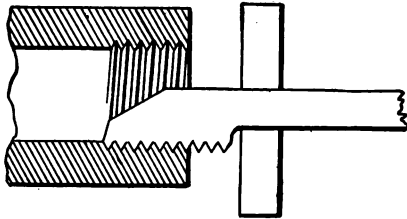

FIG. 129.—The use of an internal chaser.

ful in the use of this tool. It has been said before that if the cutting tool in the tool post can be caused to travel at a speed which has a definite relationship to the work revolving between the centers of the lathe, threads of a definite pitch can be cut, and that by changing the speed values of the moving members it will be possible to cut threads of practically any pitch. The definite relationship in speed between the spindle of the lathe and the lead screw is brought about through

a train of gears with which motion from the live spindle of the lathe is transmitted to the lead screw causing it to revolve at a speed which will depend entirely upon the ratio of the gears in the train. The lathe carriage is caused to move by a half nut which has threads that fit those on the lead screw. In this way, the speed at which the carriage travels towards the head of the lathe will depend entirely upon the R.P.M. of the lead screw. Fine threads may be cut if the speed of the lead screw is low and the threads will become coarser as the speed of the lead screw is increased. If the lead screw is caused to travel too slowly, no threads at all will be produced.

The operator must learn to choose the proper gear ratios to cut various threads. Each screw cutting lathe is provided with a complete set of change gears so that the needed ratio can always be produced. The gear which fits on the live spindle of the lathe is held in place with a nut. The gear is also keyed to the spindle. The gear that is mounted on the lead screw is held in the same manner. The idling gear, which is placed between the gears on the spindle and lead screw, revolves upon a stud the position of which can be changed. This stud is clamped onto an arm which can be moved to any position so that the idler

can be made to mesh with the two gears previously mentioned regardless of their diameter. This will be seen by referring to Fig. 130. Different lathe manufacturers employ different means for bringing all the gears into mesh. The idling gear is always made adjustable in some manner so that this can be done.

The idler does not need to bear any definite

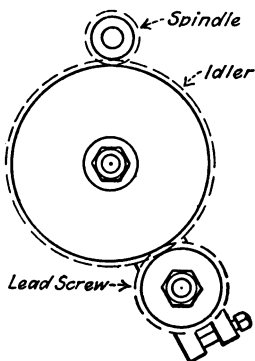

FIG. 130.—A gear train on a screw-cutting lathe.

ratio to the other gears since it is merely used to transmit motion between the two. However, the gear on the live spindle and the gear on the lead screw must have a definite ratio which will depend entirely upon the screw being cut. All screw-cutting lathes are provided with a little index plate similar to that shown in Fig. 131. This plate will show the operator the proper gears to use with-

out the necessity of making the calculation mathematically. The thread indicates the pitch. Thus if a thread with a pitch of 32 was to be cut, 32 would first be found in the thread column to extreme left. Under the column headed "spindle" and opposite to 32, 16 will be found. This means that a gear with 16 teeth must be placed upon the live spindle of the machine. The figure opposite 16 under the column headed "Screw" is 64 and this means that a gear with 64 teeth must be placed upon the lead screw to obtain a screw with 32 threads to the inch.

EMPIRE LATHE CO.

New York			N. Y.		
Thread	Spindle	Screw	Thread	Spindle	Screw
4	64	32	16	32	64
5	64	40	13	32	72
6	64	48	20	32	86
7	64	56	22	16	44
8	32	32	24	16	48
9	64	72	26	16	52
10	32	40	28	16	56
11	32	44	30	16	60
11½	32	46	32	16	64
12	32	48	38	16	72
13	32	52	40	16	80
14	32	56			

FIG. 131.—A lathe index plate.

Having considered the gearing, attention will now be diverted to the thread-cutting tool. It is very important that the thread-cutting tool be properly ground and set in the correct position in the tool post. The thread-cutting tool must be

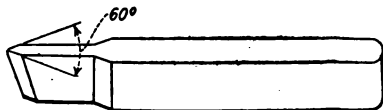

FIG. 132.—How a thread-tool is ground.

ground at exactly 60 degrees which corresponds to the United States Standard thread. The shape of a thread-cutting tool is sketched in Fig. 132. Such a tool is best ground by the aid of a little pocket gauge which will be seen by referring to

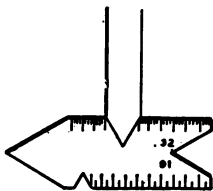

FIG. 133.—A thread-tool gauge.

Fig. 133. The use of this gauge is also shown in the illustration. The thread-cutting tool must be mounted in the tool post so that its upper edge comes exactly to the center of the stock being threaded. The mechanic must also see that the cutting tool is exactly at right angles to the work.

This is best done by applying the thread-cutting gauge as illustrated in Fig. 134.

The point of the thread-cutting tool is now brought to the end of the shaft the edge of which should have been previously rounded off slightly with a file. When the tool is brought to this position, the cross feed should be manipulated until the point of the tool will just touch the edge of the

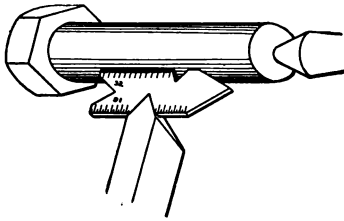

FIG. 134.—Showing the use of thread gauge.

stock. At this moment, the half nut is clamped firmly to the lead screw. The first cut should be nothing but a deep scratch, which should extend as far as the thread is to be cut. When the end is reached, the cross-feed screw is manipulated so that the tool is drawn away from the work and, at this instant, the lathe is thrown into reverse by the shipper rod. Two or three turns of the cross-feed screw are sufficient to remove the cutting tool a safe distant from the work. When the tool reaches the opposite end of the work the lathe clutch is thrown into neutral and the tool fed in so that it will take a little deeper cut than the

previous one. This operation is continued until the thread is completed. When cutting brass it will not be necessary to use any lubricant. However, when mild steel is being threaded, plenty of lard oil should be applied. Cast-iron, like brass, can be threaded dry.

The workman will understand that he can reduce the speed of his lathe by shifting the belt to a smaller pulley without affecting the pitch of the thread being cut, as long as the proper ratio between the live spindle and the lead screw is obtained.



FIG. 135. — An internal thread-cutting tool.

Internal threads can be cut on a lathe by using a bent thread tool as illustrated in Fig. 135. The bent thread tool is ground the same way as the ordinary thread tool for external work. Like the external tool, it is necessary to so mount the internal tool in the tool post that its cutting edge will come in contact with the work at the center. Otherwise an inaccurate thread will be produced.

CHAPTER IX

WOOD TURNING

Wood Turning Lathe—Speeds—Mounting Work—Tools—Use of Various Tools—Sharpening Tools—Finishing Surfaces—Choice of Woods.

THE author would consider this book incomplete if he did not devote a chapter to the work of wood turning, which is one of the most useful processes that comes within the scope of the lathe. This Chapter, although it will set forth the fundamentals of wood turning, will by no means be absolutely complete, for wood turning has many ramifications and considerable experience is necessary in order to become thoroughly proficient. The best the author can hope to do here is to outline the essentials.

Wood turning can be accomplished in the ordinary metal turning lathe when it is revolved at high speed. However, it is best done on a lathe specially designed for this purpose. A very good type of wood turning lathe is illustrated in Fig. 136. This embodies certain features which make it most adaptable for work of this kind.

The speed of a wood turning lathe should be adjustable between the limits of 1500 and 3000 revolutions per minute. With speeds between these values it is possible to turn stock up to

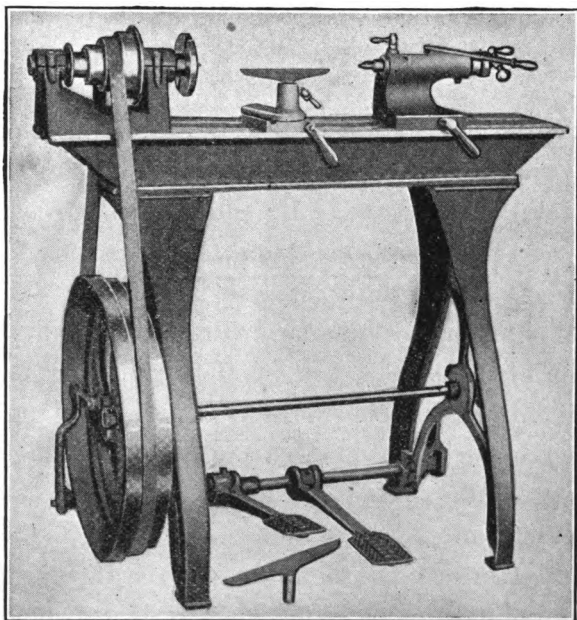

FIG. 136.—A good wood-turning lathe.

3 inches in diameter. It must be remembered that pieces beyond this diameter cannot be revolved safely at such high speeds since the centrifugal force will be considerable and any irregularity in

the balance of the piece revolving between centers would be very apt to result in an accident. The beginner must remember that a piece of wood 5 inches in diameter, revolving 3000 times per minute, would cause a bad injury to the operator, should it fly out of the lathe. Pieces beyond 3 inches in diameter are best turned at speeds in the neighborhood of from 1800 to 2000 R.P.M. It will be understood that the surface velocity of a piece 6 inches in diameter will be twice as great

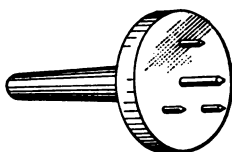

FIG. 137.—A spur center for use on a wood-turning lathe.

as that of a piece 3 inches in diameter. Therefore it is possible considerably to reduce the speed on the larger piece and obtain good cutting results.

Wood is centered in much the same as was metal. In place of using the ordinary cone-shaped center in the head-stock spindle, what is known as a spur center is used. A spur center is sketched in Fig. 137. Another type of center known as a screw center is shown in Fig. 138. Both of these centers hold the end of the wood and in this way act in the place of a chuck. When a piece of wood

is centered, it should be brought as near a balance as possible. If it is badly out of balance, the lathe should be run slowly until the cutting tool rounds it off sufficiently to bring it to a balance. The speed can then be safely increased. The writer warns beginners to heed the above directions, for serious injury may result when a piece of wood leaves the lathe while it is revolving at high speed. In centering a piece of wood the back center is always well oiled just as in metal turning. If this

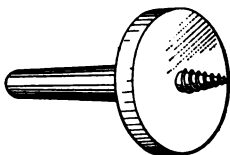

FIG. 138.—A screw center used in wood-turning.

is not done the center will become red hot through friction and cause the wood to catch fire. This is not only likely to cause the wood to fly off the centers when the hole becomes burned, but it will also deprive the center of its hardness.

A slide-rest is not used in wood turning. The tee-rest is all that is necessary and the cutting tool is rested upon this and manipulated with both hands as illustrated in Fig. 139.

It is necessary to place the tee-rest about $\frac{1}{8}$ inch from the wood to be turned. The tee-rest

must be readjusted as the turning proceeds and the stock is reduced in diameter. In readjusting the tee-rest it is always best to stop the lathe, since the stock is apt to be caught and pulled from the machine if this is not done. Before setting the lathe in motion the workman should see that

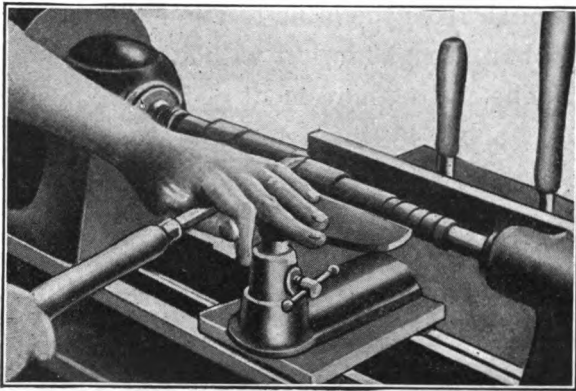

FIG. 139.—The manipulation of a wood-turning tool.

the tailstock is firmly clamped in position and that the binding screw which locks the tailstock is firmly clamped in position and that the binding screw which locks the tailstock spindle is screwed down tight.

The tools should be held firmly, but, on the other hand, they should not be gripped rigidly. The right hand must grasp the handle at the extreme

end in order to produce as much leverage as possible, which will prevent the tool from being drawn from the hands should it catch in the work. The left hand of the operator must be held somewhere near the end of the tool so that it can act as a guide to control the movement of the cutting edge. The operator must stand firmly on the floor just far enough from the lathe to allow the passing of the tool from right to left without changing position. The cutting movement of the tool should be brought about by the arms only and in no case should it be accompanied by a swinging of the body.

Before going further it will be necessary to consider the cutting tools used in the process of wood turning. A complete set of cutting tools is shown in Fig. 140. It will be noticed that there are eight different kinds of tools used in ordinary work. These are the skew, round point, square point, right skew, left skew, parting tool, spear point and gouge. Each tool must be used in the proper place if good results are to be had. The writer knows of many mechanics who prefer to use one type of tool only. This is wrong, and the beginner should habituate himself to the use of the different tools in place of becoming accustomed only to one.

The skew chisel is one of the most-used cutting tools in wood turning. Its cutting edge should have an angle of about 20 degrees with the

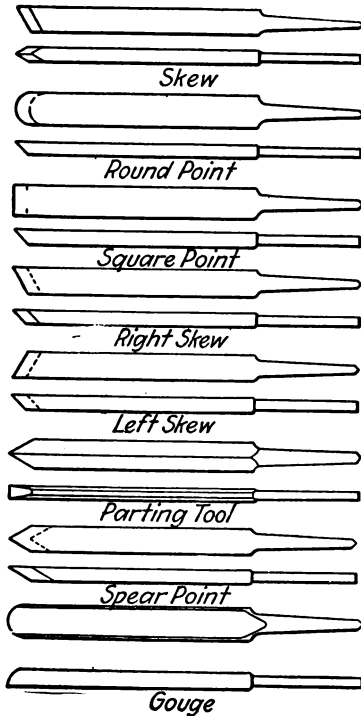

FIG. 140.—A set of wood-turning tools.

opposite edge. Since the skew is used to cut in both directions, it must be beveled on both sides. The wheel used in grinding the bevel should have

a diameter of about 5 inches so that it will leave the bevel hollow ground to a slight degree. When grinding the chisel, care should be taken to keep it cool so as not to destroy its hardness. The imperfect edge left by the grinding wheel must be taken off with a slip stone in the usual way. The tool is rubbed first on one side and then on the opposite side. The operator can test the chisel by running his thumb carefully along its edge. If any imperfections are present, the sensitive skin of the thumb will detect them.

The gouge must be beveled on the outside and is ground in such a way that the nose is almost semi-circular in shape. The bevel must extend well around the ends. This is done to avoid abrupt corners. In making shearing cuts, the round nose of the gouge makes it possible for the tool to be rolled to the side in order to prevent scraping the wood. The sharpening of gouge is difficult work for a beginner. A gouge which has a square nose may be beveled by turning it half way around and back again. The sharpening of the gouge is finished with a slip stone in the usual manner.

Parting tools for wood turning are sharpened on each side. These tools differ from ordinary chisels in that they are about $\frac{3}{4}$ inch thick and

$\frac{1}{8}$ inch wide. The bevels should meet at the center and should have an angle of about 50 degrees.

Scraping tools are much used. The square nose, the round nose, spear point, right skew and left skew have become known as scraping tools and they are used largely in pattern making and work on the face-plate. Such tools are sharpened on one edge and the bevel must be about twice the thickness of the chisel at the point where it is sharpened. Each tool must be slightly hollow ground to facilitate whetting. Since the edges of these tools come in contact with the work at right angles they become dull after a little use.

Roughing cuts in wood turning are always accomplished with a large gouge. The gouge is properly held so that the handle is a little lower than the tee-rest thereby producing a slight angle. The edge of the gouge is rolled slightly to the right so as to make it produce a shearing out instead of a scraping one. When the tool is manipulated in this way it also throws chips from the operator. The handle is lifted slightly which forces the cutting edge deep into the wood so that nearly all of the corners are removed at the first cut. Each cut should be about $\frac{3}{4}$ inch in length, working back toward the live spindle until the entire length of the work is gone over. This par-

ticular procedure is followed out in order to prevent splinters from being torn from the stock. The small gouge is used for scraping and for taking smaller cuts than can be taken with the large gouge.

The skew chisel must be handled with care for it is the one tool that is most apt to dig into the work and pull itself from the operator's hand. It is laid on the rest at an angle of about 60 degrees in relation to the surface. The chisel is drawn back slowly and at the same time the handle is raised until the chisel starts to cut. In using the skew, the operator should never start at the end since there is danger that the chisel will catch and split the wood. It will be found that very smooth turning can be accomplished by the aid of the skew and all the imperfections that were left by the gouge can be removed. The parting tool is used to cut wood in two pieces. It is fed in with a slightly rocking motion until about half an inch of wood is left. The cutting should not be continued until the wood is completely severed as this would cause it to fly from the lathe. When the tool has proceeded as far as it can safely go, the lathe is stopped and the final cut is taken with a saw or the lathe can be reduced in speed and the final cut done in this way.

A piece of wood can be nicely finished in the lathe by holding a piece of very fine-grit sand paper to the surface.

If semi-circular grooves are to be cut in a piece of wood the gouge chisels are always used. It is a very simple matter to effect cuts of this nature with these tools. If these cuts are to be placed certain distances apart, as in the turning of a pedestal, a ruler is placed along the tee-rest and the piece is marked off the proper distance by a lead pencil while it is in motion. The lines marked upon the surface will then act as guides in making the cuts.

By the use of the tools heretofore described, all ordinary turning can be accomplished. As the mechanic becomes more experienced in the manipulation of these tools he will find that by their intelligent use any desired shape can be formed.

Close-grained woods should be used whenever possible in turning. Such woods not only take a finer finish but can be turned much more easily and with less danger of splitting. Maple is a very satisfactory wood to turn and a beautiful finish can be produced. Where open-grained woods, such as oak, are used, it will be necessary to add a wood filler before the surface is in shape to receive a fine polish.

In the forerunning paragraphs only turning between the centers of the lathe was considered. At this point it will be well to take up the use of the face-plate in turning operations that cannot be accomplished in the manner heretofore described.

The equipment of the wood turning lathe will include a face-plate such as that shown in Fig. 141. The face-plate is small and in its center

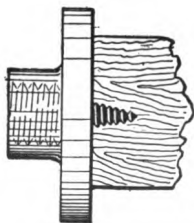

FIG. 141.—Face-plate for wood-turning.

there is placed a single screw. To use this plate the center of the stock to be turned must first be found. The center is then marked and the mark is brought in contact with the screw. By applying some pressure and at the same time turning the piece it may be screwed on the face-plate. In doing this the operator must take care to see that the piece of wood to be turned comes in contact with the face-plate at all points. To insure this it will be necessary to screw the piece of work up

tightly against the face-plate. If this is not done it will not run true, and accurate turning cannot be accomplished.

If in doing work of this nature it is found that the piece being turned works loose, a remedy can be applied by inserting a piece of sand paper with the grit side out between the face-plate and the stock. In fact if this is done when the stock is first put in plane there will be less danger of it coming loose during the turning operations.

It will be understood that pieces of different shape can be screwed to the face-plate in this manner. It is not absolutely necessary that round pieces only to be used. However, in mounting irregularly shaped pieces in this way, the mechanic must take care not to give his lathe too great a speed or an accident is apt to happen.

Oftentimes a properly shaped piece of wood for a certain piece of turning is not available from the stock at hand. If the mechanic meets this condition it is well for him to remember that a piece of proper size and shape can be built by gluing several smaller pieces together. It is quite necessary, however, that the pieces be glued together properly, for they will be subjected to great strain in the lathe under the action of the cutting tool, and if they are not glued together firmly, they will

come apart and fly out of the lathe. Good carpenter's glue should be used in gluing the pieces together and only a very thin layer is applied. The contacting surfaces should be planed off as accurately as possible and after the glue is applied the work should be placed in a clamp or vise to hold it tightly together until the glue has dried. Many mechanics have the idea that the more glue they apply the better the pieces will hold. Just the opposite is true. The glue should be applied in as thin a layer as possible and the entire surface should be covered.

When working on the face of a flat piece of wood mounted on the face-plate the tee-rest is placed parallel to the face of the wood. When the edge of the wood is being worked upon, the tee-rest is placed in its normal position.

When using the parting tool or when boring out the center of a piece, the tool should be withdrawn occasionally to take out the chips and to allow the tool to cool off. When the parting tool is forced into the work there is a tendency for it to heat up since it is pinched tightly and a great amount of friction is developed. When the tools become overheated they lose their temper and they cannot be kept in a sharpened condition since the cutting edge has no qualities.

Concave cuts will give the worker considerable trouble at first, since the grind which forms the cutting edge and which must be held perpendicular to the work at the start, is on the under side of the tool and cannot be seen. As soon as the correct angle of the tool is located, this type of cut will be found as easy as any of the others. Concave cuts should be made with a medium size gouge, either the $\frac{1}{2}$ or $\frac{3}{4}$ inch size being best suited for this work. It will be assumed that concave cuts are to be made in the cylinder revolving between centers. The gouge is placed on the tee-rest with the cutting edge all above the wood. The tool is then rolled on its side so that the grind and the cutting point, which is on the lip of the gouge well below center, is perpendicular to the axis of the cylinder. The handle is then raised slowly to force the gouge into the wood. When the gouge has taken hold, the tool is forced forward and upward by a slight lowering of the handle, and at the same time, it is rolled slowly back towards its original position. In manipulating the tool in this way, care should be taken not to roll the chisel too fast or an imperfect arc will be formed. By this triple action, the grind which comes in contact with the surfaces of the curve forces the lip sidewise and cuts $\frac{1}{4}$ of a circle. In

reversing the position of the gouge and cutting from the other side in the same manner, the other half of the semicircle is formed. The cutting should always stop at the base of the cut, since there is danger of the tool catching when cutting against the grain of the wood on the opposite side of the work. This operation is repeated until the work is within 1/16 inch of the required size. At the end of each cut the tool should have been forced far enough forward and upward to bring the nose of the tool well out on the top of the cut. The depth of the concave is calipered in the usual manner.

The worker must not forget that templates may be used to advantage in the art of wood turning. This is especially true in duplicate turning. If a number of pieces of the same dimension are to be turned, it is well to make a template of thin sheet metal, since this will save a lot of measuring with calipers and ruler.

A convex cut, or a bead, as it is sometimes called, is considered by wood turners the hardest cut to make. This particular kind of cut is made with the heel of a small skew chisel. If a cylinder is being turned, it should be marked out and all the stock between the beads roughed out with a parting tool. The shoulder cutting is done with an

ordinary parting tool. A pencil is used to mark the center of each bead to be made. The line is the starting point for all cutting. The chisel is placed on the tee-rest with the cutting edge above the cylinder, and the lower grind is placed tangent to it. The chisel is drawn back and the handle is raised to bring the heel of the chisel in contact with the cylinder at the line indicating the center of the bead. The chisel is then moved to the right, and at the same time, it is tipped repeatedly to keep the lower grind tangent to the revolving cylinder, and also to the bead at the point of contact. This cut is carried until the bottom of the bead is reached. When turning a series of beads it is well to work the same side of all before reversing to the other side.

With the directions outlined in the foregoing paragraphs, the amateur woodworker will now be in a position to try his skill at such simple little articles as tool handles, gavels, rolling pins, lamp pedestals, candle sticks, Indian clubs, etc.

It might be well at this point to add a word about the finishing of articles turned on the lathe. The final polishing, of course, is best done while the work is still revolving between centers after all the cutting has been done. The final cut is made as fine as possible, and the tool should be moved

very slowly along the surface of the work so that there will be no ridges left to be removed by the sand paper. In polishing a wooden cylinder, for instance, sand paper should be cut in strips, one of the strips wound tightly around the cylinder, and the lathe set in motion. By pulling on the sand paper and working it back and forth over the surface, a very beautiful finish will be made. It is often desirable to apply stain, varnish, or shellac to the finished article while it is still mounted between the centers of the lathe or on the face-plate. When this is done, however, the should be sure to remove all traces of dust left on the wood by the sand paper. Otherwise these fine particles of wood will mar the finish, and it may be necessary to paper it off and apply a fresh coat.

The woodworker should not forget to take good care of his lathe, since nothing will ruin it more quickly than lack of attention. If the lathe is used daily, it should be oiled daily, and if it is used less frequently it should be oiled every time it is used. The oil holes should be kept covered up to prevent dust and dirt from getting into the bearings. The ways of the lathe should be kept well oiled, and the mechanic should refrain from laying his cutting tools across the lathe bed. The tools should be kept on a little table beside the lathe, or they

may be placed in a holder directly back of the lathe where they will be within reach of the worker. After a cutting job is finished the lathe should be brushed off and then carefully wiped with an oily rag. All the tools should be wiped clean and put in their proper places. A lathe should run quietly and smoothly, and if any peculiar noise develops while it is in operation, the operator should immediately trace it down, and the first place he should look for such trouble is in the bearings. An oilless bearing or a badly worn or ground bearing will be somewhat noisy in operation, and there will be little trouble in finding it. If a bearing is badly worn it will be necessary to take it to a shop and have it rebabbitted. It is impossible to do accurate turning on a lathe with a worn bearing. If the counter-shaft is used in connection with the lathe this should also be oiled occasionally, and it is well to warn the worker that the bearings of the counter-shaft should be examined and oiled only when the driving motor is not in operation, since the fingers are apt to slip and be caught in the pulleys or in the belt, which would mean the loss of several fingers or perhaps the whole hand.

CHAPTER X

METAL SPINNING

Lathe for Metal Spinning—Tee-Rests—Tools—Use of Various Tools — Metals — Annealing — Use of Forms — Centers — Sample Turning—Mounting Work—Speeds.

EVERYONE owning a lathe should know how to use the device for metal spinning. Metal spinning is an old and useful art and was practiced extensively before the advent of the modern stamping press, which, at one stroke, is capable of producing a piece of work that would require considerable time to be done by the process of spinning. However, the stamping press must be provided with expensive dies, and unless a great number of pieces are to be stamped out it is a costly process. For one or a few pieces metal spinning is very satisfactory and can be practiced by anyone in possession of a substantial lathe capable of revolving at speeds between 600 and 1600 R.P.M.

The ordinary lathe will serve this purpose and only a few simple additions are needed to adapt it to the spinning of metal. One of these additions is a T-rest provided with fulcrum pins as illus-

trated in Fig. 142. The mechanic can very easily make such a T-rest for use on his own lathe. Another addition which is quite necessary to complete the spinning attachment is a revolving back-center. Such a back-center is illustrated in Fig. 143, and it will be seen that it consists of three parts. The nose of the tool is free to revolve upon a pin, the opposite end of which has a Morse taper

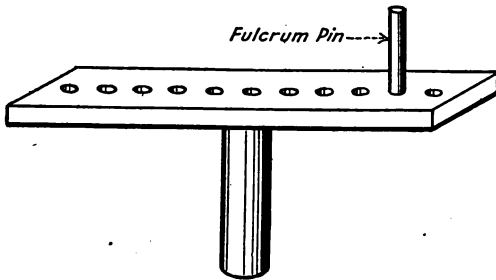

FIG. 142.—A tee-rest with fulcrum pins used in metal spinning.

which will fit the back spindle of the lathe used. Interposed between the stationary member and the nose of the tool is a hard rubber bushing which is securely fixed in place by being forced over the stationary pin. Centers of this nature are difficult to produce, but with the directions given and by the aid of the drawing (Fig. 143) the mechanic should have no trouble in turning up such a tool on his own lathe. The bearing surfaces between the nose of the tool and the pin should be kept well

lubricated in order to prevent undue friction when the device is in use.

There are certain metals that can be spun very easily. Some metals are very difficult to handle. Of course, metal spinning is done only with sheet metal ranging from Nos. 22 to 26 gauge, Brown & Sharpe. The No. 26 gauge is used for the larger work. No. 22 gauge in brass or zinc is very popular for small work varying in diameter from $2\frac{1}{2}$ to 5 inches. Of course, metals of less thickness

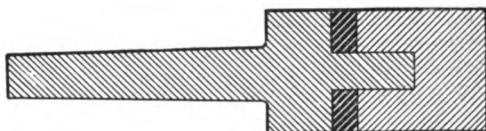

FIG. 143.—A revolving back-center for use in metal spinning.

are much more easily spun than the thicker material. It is best to use the thickest material that can be handled by the operator. This not only produces a more substantial piece of work but also lessens the danger of the spinning tool wearing through during the operation.

Copper is recommended for beginners. It is much more easily spun than any other metal. It possesses toughness and when it has been properly treated with heat it is very pliable. It must be understood that metal hardens as it is being spun,

and it is often necessary to anneal it several times before the job is finished. Copper adapts itself to this treatment much better than most of the other metals. This heat treatment can be carried out in a small annealing furnace, or, in case this

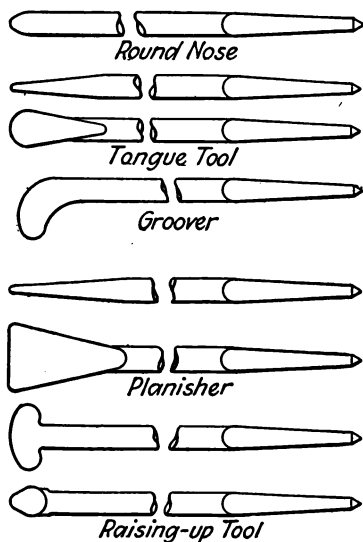

FIG. 144.—A set of metal-spinning tools.

is not at hand, it can be done over a Bunsen burner or a blow torch. Copper should be heated until it is red hot and in this condition it is thrust into a pail of cold water. It will be found to be annealed after this process.

Before going further with the instructions for

metal spinning, the use of the various tools and materials will be described. An ordinary set of metal spinning tools is shown in Fig. 144.

The round-nose tool is used in starting to spin a piece. It is especially useful in compressing metal into cavities and removing wrinkles before taking the work out of the lathe.

The raising-up tool is used in operations that require considerable force to be applied. It is used in forming concave bottoms in dishes and other operations that require surfaces to be spun concave instead of convex.

The planisher is a tool that is used a good deal. It is really used as a burnisher or finishing tool. It is brought into use after all other tools have been used to finish the forming.

The tongue tool is used principally in producing convex surfaces. It is manipulated in the same way as the rest of the tools.

The groover is rather a special tool and is used only when grooves are to be pressed into the work. It is used almost entirely in spindle forms for the production of small grooves.

It will be assumed that the copper cup illustrated in Fig. 145 is to be spun. The first thing that the workman must determine is the size of the disc from which the cup is to be made. It is best to

have this too large rather than too small. If the disc is oversize it can be cut off, but if it is under-size the work must be done over again.

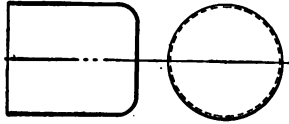

FIG. 145.—A copper cup to be spun.

After the disc is cut, it is mounted as sketched in Fig. 146. It will be seen that it is necessary to turn a wood block to correspond with the shape

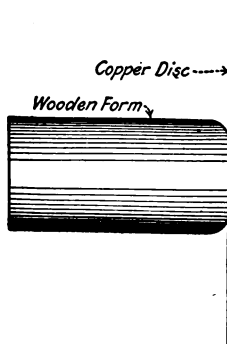

FIG. 146.—The copper disc mounted on the wooden block or form to make the copper cup shown in Fig. 145.

of the copper cup which is to be spun. The ordinary center-screw face-plate used in wood turning is also used in metal spinning. The form upon which metal is to be spun is screwed upon the face-

plate in the manner shown in Fig. 147. The center of the metal disc which is to be spun is placed

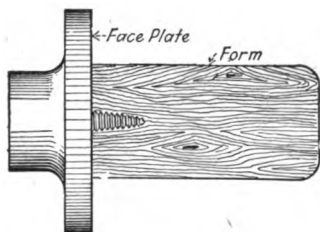

FIG. 147.—The form mounted on the face-plate.

upon the end of the metal form and the tailstock of the lathe moved forward until the revolving center comes to rest upon the surface of the copper

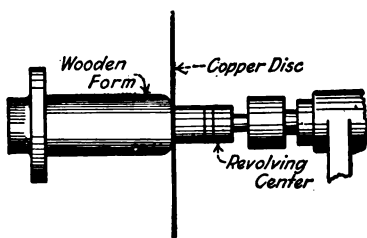

FIG. 148.—Showing the position of the copper disc on the lathe' ready for spinning

disc. Reference is made to Fig. 148, which shows just how the disc is clamped between the revolving center and the wooden form over which it is to be spun.

It is quite necessary to keep metal well greased while it is being spun. After each annealing process, the supply of lubricant on the surface of the metal is replenished and at any other time it becomes dry through excessive friction caused by the tools. Soft soap has been found to be a very satisfactory lubricant for copper.

The spinning tool is held in the right hand and the handle should come under the right arm just above the elbow. In the left hand, the end of a broom handle or a piece of hard wood of similar shape is held in a way so that it presses firmly against the metal on the side opposite the point where the end of the tool comes in contact. If this is not done the metal will have a tendency to buckle. As the spinning progresses and the copper disc starts to cover the form block, the broom handle can be dispensed with. It will be necessary for the beginner to use considerable patience on his first job. Metal spinning is largely a matter of experience since it does not require any great amount of intelligence to grasp the few fundamentals of the process.

After the disc has been spun tightly about the form block, the parting tool is used to finish off the rough edge which is left. If the edge overlaps too much a piece of the proper length is cut off.

The workman must remember to anneal the piece as it becomes hard during the process of spinning. For ordinary work it is quite necessary to repeat the annealing process several times before the final shape is brought about.

The spinning can be done by holding the tool above the center of the lathe. The movement of the body will be downward and to the right which will result in the tool point working upward.

After the spinning is done and the rough edge of the piece turned off, the polishing should be finished before the piece is taken from the lathe. To accomplish the polishing it is only necessary to wind a piece of fine emery cloth around the cup once and to hold it tightly with the hand while the lathe is revolving.

Brass is a very commonly used metal for spinning, and, although not as easy to work with as copper it is recommended for the beginner. The annealing of brass is carried out in the same way as the annealing of copper; that is, it is heated and plunged into cold water. The reader will note that these two metals are annealed in the same way that steel is hardened. This is a property peculiar to brass and copper.

Under the action of the spinning tool, brass is found to harden more rapidly than copper. There-

fore it will be necessary to anneal it more frequently. The mechanic should make it a point to use a sheet brass as thin as possible for the work on hand.

Zinc can be spun but it is a little more difficult to manipulate than either brass or copper. Before annealing zinc it is best first to immerse it in a bath of oil. Experienced metal spinners claim that this tends to soften the metal. The same procedure is often recommended for brass and copper also. Zinc is a metal which has a crystalline structure and the action of the spinning tool tends to make it more crystalline. As the process is continued the zinc is weakened considerably. This is especially true where the zinc must be turned over abrupt corners.

In annealing zinc it is advisable not to carry it over a temperature of 400 degrees. The temperature may be determined with a chemical thermometer. The metal is plunged into cold water the same way as brass or copper.

Aluminum can be spun and it has been found that the process of annealing is not quite so necessary with this metal as with the other metal mentioned. Whether or not annealing helps in the case of aluminum is a matter of opinion. Aluminum is easily worked, but on the other hand it is

also easily shattered. Often the operator will carry the spinning of a piece of aluminum to a certain point and find that it suddenly shatters, not only spoiling the work but wasting the time that has been spent upon it.

The beginner should not attempt to spin pieces with too large a diameter since the centrifugal force present will make the job difficult. The danger of the piece flying from the lathe will be increased with the increase in diameter.

The beginner must keep in mind the fact that the spinning of shallow dishes and trays is the easiest to do, therefore it is advisable to start out with some simple little tray which will require only the use of a simple wooden form, dispensing with what is known as the follow-up block. A tray or a dish with a depression of from one to one and one-half inches with a diameter of six inches makes a comparatively easy job which comes within the range of the amateur worker.

In the production of such an article simplicity of design should be adhered to. The beginner should not try to produce sharp corners since it requires the skillful manipulation of a seasoned spinner to produce these perfectly. The beginner must be satisfied with simple curves and contours. A little ash tray about five inches in diameter and

one inch deep with a simple round edge makes a good project to start with.

Some experience in wood turning will be necessary in order to turn up the form block over which the metal is to be spun. The reader is referred to Chapter IX which will acquaint him with the fundamentals of wood turning. The wooden form blocks are turned to the exact shape that the finished article is to be. They must be perfectly hard and smooth and it is best to sandpaper them down carefully after they have been turned down on the lathe. Good hard maple, free from knots and well sandpapered, makes a very desirable form for nice spinning. It might be well to mention here that where a number of things of the same size and dimensions are to be spun it might pay the worker to have a cast-iron block made, for a wooden block will not hold up for more than one or two articles.

When the metal disc for an ash tray has been cut it is centered in the lathe with the form over which it is to be spun. Since it is necessary to keep the metal well greased while spinning it is advisable to apply some lubricant to the surface before the piece is centered. Due to considerable heating, the metal being spun becomes dry during the operation and the lathe must be stopped and

the supply of lubricant replenished. For copper soft soap will be found very good. Brass and zinc require a rub from a tallow candle. A good heavy lubricating oil is suitable for white metal and aluminum since this prevents the spinning tool from cutting into the metal.

Work is started as follows: In the right hand, with the handle under the right arm above the elbow, is held the spinner's tool and in the left hand the end of a broom handle or some similar piece of wood is held. This is so arranged that it is possible to press the metal firmly against the form block and the end of the piece of wood held in the left hand is kept opposite the end of the tool as it moves from the center of revolution outward and downward. The turning of the lathe draws the tool down so that it is nearer the axis of the disc and a little lower than the end of the wooden support held in the left hand. The body of the worker throws the handle to the right which causes the end of the tool to pass to the left and consequently over the metal gradually toward and firmly against the form block. The diamond-pointed cutting tool is then brought into play to trim off the edge and the piece is complete.

With a simple piece of turning of this nature it is not always necessary to anneal the work dur-

ing the process unless it is found that the metal becomes unduly hard and fails to respond properly to the spinning tool. If a piece is allowed to become hard and it is not annealed the work will surely be shattered before it is finished.

In spinning a simple piece of work such as that just described no trouble should be experienced in keeping the metal at a uniform thickness. In other work, however, the beginner will find it difficult to do this.

While the dish is still on the form it can be papered down roughly to take out the blemishes left by the spinning tool. A good medium grade of emery paper will be suitable for this purpose.

The turning of a deeper article is not carried out as easily as the turning of the simple little dish previously described. It will be assumed that a cup similar to that shown in Fig. 149, is to be turned. Here it will be necessary to employ what is known as a following-up form. This sort of turning is a little more difficult than that previously described and the beginner must take great care to see that the metal is well annealed several times during the process to insure against shattering. The following-up form is made of maple and it is unnecessary to use it during the first of the spinning. The metal is spun until it is well

along, probably one-third way up the form. At this time the following-up form is placed over the tailstock center. It will, of course, be necessary to provide the following-up form with a hole into which the center will fit. When the following-up

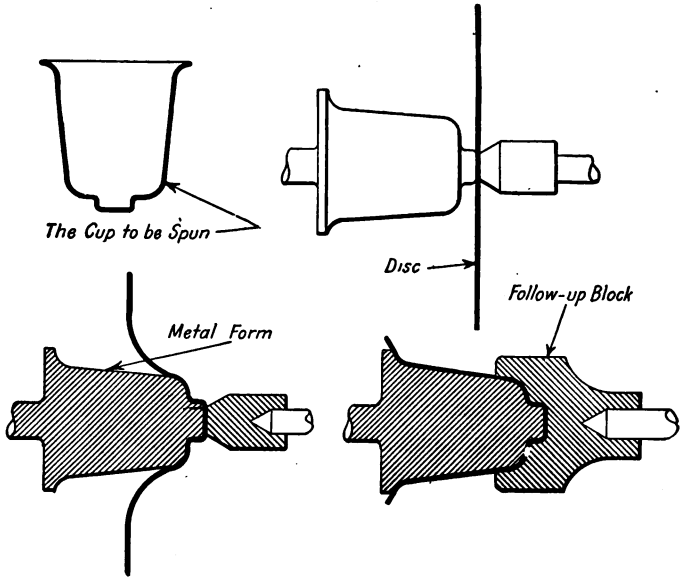

FIG. 149.—A more elaborate cup, and follow-up block.

form is in place it will tend to support the metal and hold it tightly as shown in Fig. 149.

A very simple revolving center designed to replace the one previously described in this Chapter, is shown in Fig. 150. This is a very simple type and well adapted to metal spinning. A ball bear-

ing is used between the revolving part and the stationary part. This is supplied with oil through a hole in the stationary part.

The speed used in spinning the different metals will now be given some consideration. Sheet iron, one thirty-second of an inch thick is a metal that is sometimes used in spinning and it is best to run this at a speed of six hundred revolutions per

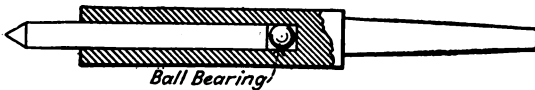

FIG. 150.—A simple revolving center.

minute. When thicker iron is used the speed should be cut down to four hundred revolutions a minute and this holds generally true of all metals; the thicker the metal is the lower the speed should be. Zinc spins very well at 1200 revolutions per minute and copper, brass and aluminum seem to work well at speeds between 800 and 1000 revolutions per minute.

CHAPTER XI

BUILDING AN AMATEUR'S METAL TURNING LATHE

General Description of Lathe—Lathe Bed—Patterns—Castings
—Machining—Assembling—Work Bench—Countershaft
—Accessories—Jig Saw Attachment—Slide Rest—Grinding
Table—Hand Filing Jig—Circular Saw Table.

THE building of a lathe sufficiently strong and true for metal turning is a problem which many amateurs have attempted to solve. The accuracy of a lathe depends largely upon the truth of the machine upon which it is made, and this accuracy is again reflected in the work subsequently turned out. In the ordinary way, the construction of even a small lathe involves the use of heavy and expensive machines such as planers and shapers. Of course, it is possible to make a fairly good lathe with a wooden bed and with the spindles simply drilled out, but for metal turning such a tool would not satisfy the model maker or careful mechanic.

In the design shown in Fig. 151, the main feature of the construction is the use of cold rolled steel shafting which is a commercial material of very reasonable accuracy and finish. The various

additions to the final fittings of the lathe may be made on the lathe itself, once the basis of the work is finished. The lathe can be finally made up into a respectable screw-cutting machine by adding part by part as time goes on. At the outset, the boring table and lead screw need not be fitted. The only work that need be done outside is the turning down of the spindle to $\frac{1}{2}$ inch at each end, the casting of the cast-iron and brass por-

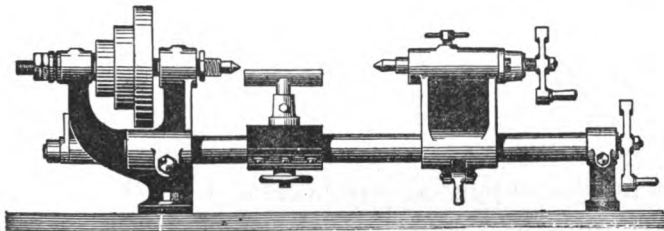

FIG. 151.—A good amateur bench lathe.

tions, and the drilling of the $1\frac{1}{8}$ inch holes in the headstock, tailstock, boring table and end supporting leg. The boring of the spindle to make it into a "hollow spindle lathe" may be left until the lathe is otherwise finished. Even the drilling of the cone pulley may be done on the lathe itself, a temporary or "jury" pulley being rigged up for the time being.

The whole scheme of the lathe depends on the use of commercial cold-rolled or Bessemer steel

rod for the bed of the lathe. This material is cheap, and is very true both in diameter and straightness. This fact is made use of to obtain a lathe without recourse to planing.

The first thing is to prepare the patterns, which may be made by any amateur, since core-boxes can be dispensed with. The $1\frac{1}{8}$ inch holes may be bored out of the solid casting, the coring of the holes for the white metal being left to the foundry to provide. As a rule the foundry can supply all round cores. Should a three-step pulley wheel be determined upon at the outset, a pattern for this must be sent to the woodturners. However, it is quite possible that some firm will adopt the suggestion of supplying the necessary castings and parts already drilled, and thus make it possible for the amateur to accomplish the work of building up the lathe with only the hand tools common to every home workshop.

Assuming that the rough castings have come to hand, extreme care and accuracy will be required in drilling the holes for the two shafts which will form the bed of the lathe. These holes should be $1\frac{1}{8}$ inches to fit the shafting, and a trial hole may be made in an odd piece of iron to test whether the drill in use will give a satisfactory result. The commercial bars should just go in the

holes, so that the set screw shown in the drawings of the head-stock will securely tighten up the parts and yet allow them to be removed at any time without trouble.

The head-stock should be tackled first and, when drilled, this may be used to form a jig (see *C* Fig. 156) for drilling the second and all the other holes, a short piece of the bar being cut off for this purpose. The back foot or support for the bed of the lathe should be drilled next and, with the piece of rod inserted through the adjacent holes, the second hole should be bored as shown in Fig. 156 at *C*. Next comes the tail-stock casting, and since the capacity of the average drilling machine and the length of the drill are not such as would take both the head-stock and tail-stock superposed on the drilling table, the back support may be utilized for this purpose. The idea is to insure that both the holes are equidistant since the success of the lathe depends on this. This, with the turning of the spindle bar down to $\frac{1}{2}$ inch diameter at each end, and the skimming up of its middle surface, is all the machining that need be given out. If a slide-rest is contemplated, then the boring table, Fig. 152, should be dealt with in a similar manner as the head-stock and at the same time.

The main parts can then be threaded on the bed bar, which should be cut into equal portions, and the holes for the set screws securing the head-stock and back foot drilled and tapped. Ordinary screws may be used, and when the lathe is finished and running these may be removed and turned down with taper points, so that they tend to thrust

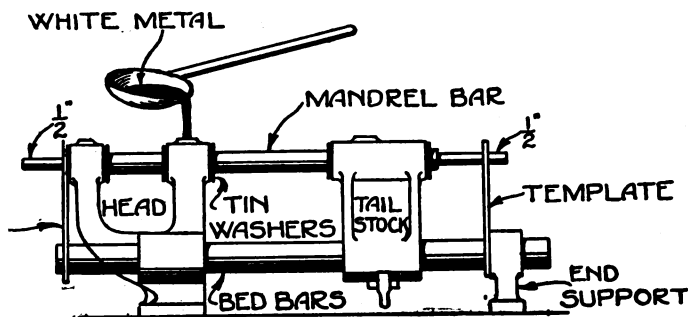

FIG. 153.—How the babbitting for the lathe bearings is done.

the bed bars in an upward direction in tightening on them.

The next process is to fit the spindle and poppet to the head and tail-stock castings truly parallel with the bed. By the devices and processes to be described, no machining is required for this work. While drilling out the two $1\frac{1}{8}$ inch holes, two templates should be prepared out of $\frac{1}{16}$ inch plate, as shown in Fig. 155. Three holes, two of $1\frac{1}{8}$ inch diameter and one of $\frac{1}{2}$ inch diameter, to

correspond with the center of the spindle and the bed bars, are required in these templates. These holes should be drilled while the plates are either riveted or clamped together, to insure accuracy. Pushing the bed bars through the headstock, well beyond their proper position, as shown in Fig. 153, the templates should be erected on these bars, and the spindle, which at the outset is in one piece with

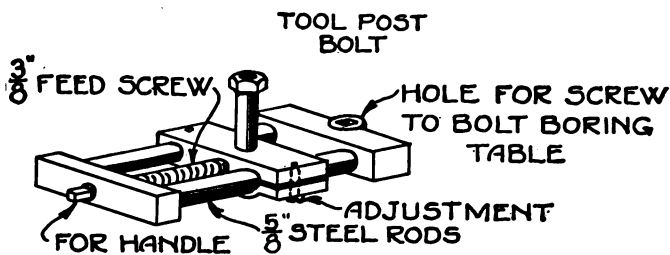

FIG. 154.—The construction of the lathe slide-rest.

the back poppet, should be rigged up as shown in Fig. 153. Assuming that the templates are true, this will provide the required parallelism in the center lines of the spindle and bed bars. Both the spindle and poppet should be blacklead^d very thinly, the blacklead being mixed with grease. When all is ready, the white metal should be heated up in a ladle and poured into the cored cavity between the several heads and the spindle. The castings should be warmed up with a gas jet

preparatory to pouring, and washers of tinplate (also blackleaded) should be clamped or bound up with wire against the open ends of the cavities. In the case of the back poppet, a small ($3/32$ inch) vent hole should be drilled from the top into each end of the cavity to let out the air. The metal is poured in by the oil holes drilled in the head-stock and by the clamp-screw hole in the tail-stock. The small vent holes in the latter may be re-drilled later on to serve as oil holes.

Before actually running the metal in, the tail-stock lock should be fitted, so that the latter can be clamped to the bed bars. This is a very simple yet efficient contrivance (see Fig. 155). A slot should be arranged in the pattern of the tail-stock and, when cleaned out to size, a piece of $1/2$ inch by $5/8$ inch steel rod with two circular recesses filed in it should be fitted. In the jaws of the tail-stock castings, a small eccentric headed handle made out of steel bar is filed up and fitted in. The pivot pin is a small piece of $1/4$ inch steel rod. This eccentric handle forces up the bar and clamps the tail-stock to the bed bars.

When the white metal is cold, the spindle may be removed and sawed in half to form the spindle and the sliding poppet. This is screwed $1/2$ inch standard on the reduced diameter to fit a gun-

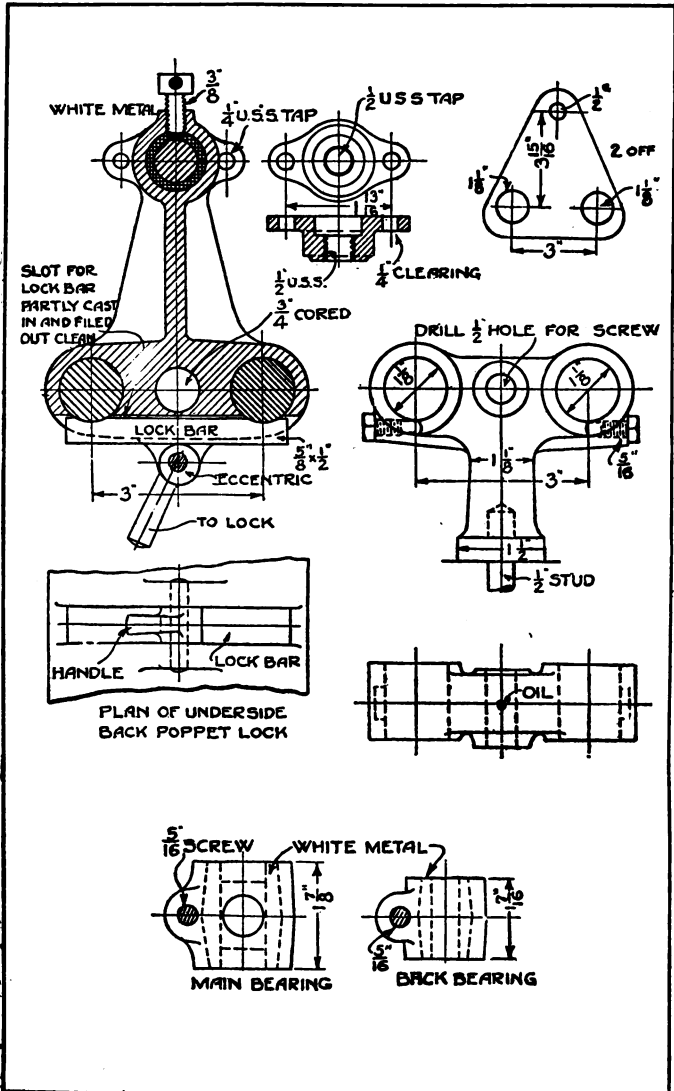

Fig. 155.—The constructional details of the amateur bench lathe.

metal cap tapped with the same thread. This cap is screwed on to the end of the tail-stock with two $\frac{1}{4}$ inch screws, and the end of the poppet is squared for the handle. The screw holes are marked out from those in the cap flange, with the cap in position on the tail-stock feed-screw. The set-screw is a $\frac{3}{8}$ inch set-screw with a hole through the head for a $\frac{3}{16}$ inch pin. To protect the poppet from damage, a pad of brass rod is dropped into the bottom of the hole (see Fig. 152).

Progress having been made so far, the spindle may be removed and, if there is any tendency to shake, the two bearings of the head-stock may be slit with a hack saw as shown in the drawings. In any case this had better be done, since it will enable the bearings to be adjusted for wear. To effect this adjustment, screws are fitted into the lugs provided in the castings. Another idea would be to cut the slits before running in the white metal. The slits could be forced open slightly by pushing in a piece of plate or wood just before running the metal. This piece would then be removed, any white metal being cleared out of the slit, and the tendency then would be for the head to grip the white metal independently of any pressure put onto the latter by the adjusting screws at the side. The nose of the spindle should be

screwed with the dies $\frac{3}{4}$ inch standard thread, and a standard steel locknut should be driven on tightly to the end of the thread. This lock-nut may be faced as soon as the tool-rest and driving mechanism are completed. The main bearing is a bearing only; the thrust and end adjustment of the spindle are all arranged for at the other bearing. Two commercial ball thrust bearings or collars for $\frac{1}{2}$ inch spindle are fitted on the reduced diameter of the spindle. These are brought up to the inner and outer faces of the outer bearing of the head-stock by double nuts, and where a screw cutting lathe is considered as a final development of the lathe the spindle should be left about $\frac{3}{4}$ inch longer than ordinarily required at the outer end. The thrust having been fitted, the pulley may be fixed on the spindle. With a reasonably true and clean casting this need only to be bored, the belt faces being skimmed up one by one with a file after the lathe is fitted up. If the boring is to be done on the lathe itself, then a "jury" pulley made of wood must be rigged up, as already mentioned, and a face-plate provided on which to bolt it. This job, however, is one which may be "done out" with the drilling for the bed bars. By the time the lathe has reached this stage some sort of driving mechanism must be provided. The

making of a pattern and getting a wheel cast in iron is the proper method, but this will be found beyond the resources of the average amateur. Very often an old wheel and crank shaft or a wheel which will run on a stud pin can be picked up at a scrap iron dealer's. An old sewing machine treadle might be pressed into service, the wheel being weighted up with lead pipe. The writer has seen a very respectable treadle made up out of layers of $\frac{3}{4}$ inch floorboards, laid cross grain, with a center bearing made by driving in a piece of iron gas barrel and nutting the same on each end.

The next operation will be to bore the back poppet for its center. For accuracy nothing is better than the conical center and if the Morse taper is adopted a standard chuck may be fitted in either the spindle or the back poppet. A master chuck, consisting of a piece of brass or iron, may be drilled and tapped to suit the lathe spindle nose, and in this a $\frac{3}{8}$ inch drill may be fixed, and the poppet drilled up for a distance of at least $\frac{1}{2}$ inch. A coned "D" bit or a Morse taper reamer may be used to finish the hole. This bit should then be reversed and used in the spindle hole to insure their being of exactly the same taper.

The tee-rest for hand turning is shown in Fig.

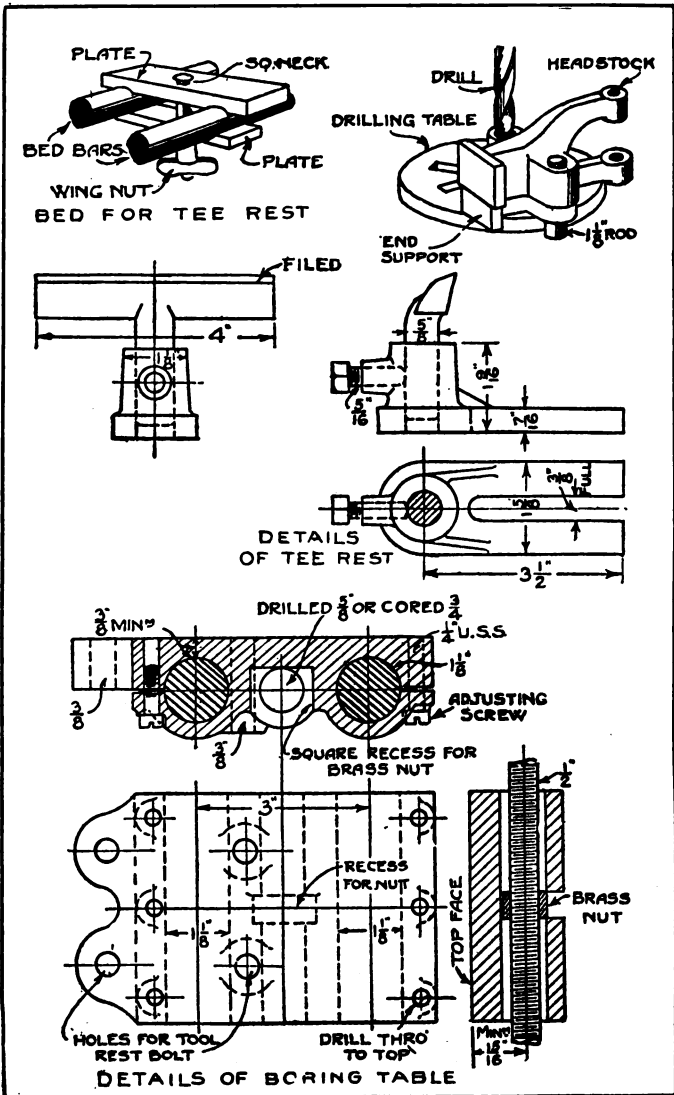

FIG. 156.—The constructional details of the amateur bench lathe.

156. This may be used in conjunction with the boring table, or by arranging two slabs of iron as shown. With a square necked $\frac{3}{8}$ inch carriage bolt and fly nut a good fixing may be obtained without damaging the surfaces of the bed bars. The square neck of the bolt should be $\frac{3}{8}$ inch deep. This neck will then prevent the bolt from falling through the hole in the top slab of iron, and yet allow the bolt to draw down on the tee-rest fork. Further by inclining the fork at the foot of the tee-rest, the latter should readily slide under the head of the bolt. The square neck also holds the bolt while the fly nut (or wing nut) is being tightened up. The tee-rest may be swiveled in any desired position and the height adjusted to requirements. The tee-rest itself is best cast in malleable iron, but it may, of course, be built up of rectangular iron bar and a piece of $\frac{5}{8}$ inch round steel rod.

As an improvement on the two flat bars, a boring table is illustrated in Figs. 152 and 156. This is a step in the direction of finally making the tool a screw cutting lathe. The same system of adjusting the bearing on the bed bars as used in the head-stock spindle bearings is employed. The casting is sawed after boring and after the $\frac{1}{4}$ inch holes for the adjusting screws have been drilled

and tapped. The later holes, it will be noticed, are drilled and tapped right through the upper surface. This may as well be done at the outset as the holes may be subsequently found of service in bolting work down to the boring table. The boring table will require to be planed, filed, or turned up quite true with the surface of the bed bars. The table will just swing in the lathe itself, but unless the iron is very soft it would hardly do to attempt it. However, when a slide rest is made, the latter may be rigged up on a temporary boring table and a cut taken over its surface. For this work the table should be bolted to the face-plate, a casting for which may be obtained at any tool dealer. The face-plate casting should be drilled and tapped $\frac{3}{4}$ inch standard, run on the nose, the boss faced at the back, and the plate then reversed. The front of the face-plate may then be faced.

The boring table has two lugs on the front for the bolt holding the slide rest. These holes are used only when large diameter work such as boiler shell tube is in the lathe being skimmed up or trued at the ends. A stiffer support for the slide-rest can be obtained by bolting into either one of the two holes provided in the boring table between the bed bars.

With regard to further developments, the slide rest that may be at some time fitted may be of the usual type with V slides, or, if desired, the scheme for making the bed of the lathe may be used, namely, two bars. These should be at least $\frac{5}{8}$ inches diameter and about 6 inches long so that a traverse of $3\frac{1}{2}$ inches could be obtained. Fig. 154, is a sketch of the idea. For screw cutting, a bearing should be provided for the outer extension of the lead screw, this also forming a bearing for the "eye" of the quadrant, on which the change wheels are arranged.

CHAPTER XII

BUILDING A SIMPLE WOOD TURNING LATHE

Maple Bed — Patterns — Castings — Machining—Assembly—
Attachments.

THIS Chapter will be devoted to the construction of an amateur's wood-turning lathe. The lathe is of very simple construction and has a swing of 7 inches and a 3 foot bed. The pattern

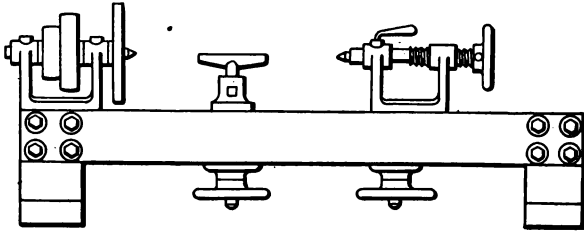

FIG. 157.—The complete amateur's wood-turning lathe.

can be made with the few tools found in the average amateur's workshop.

The first thing to make will be the patterns. As only a few castings are to be made the patterns can be made of any wood that is handy. The pattern *A*, Fig. 158, answers for both the head-stock and tail-stock. A solid one piece pattern will do, though if a large number of castings were to be

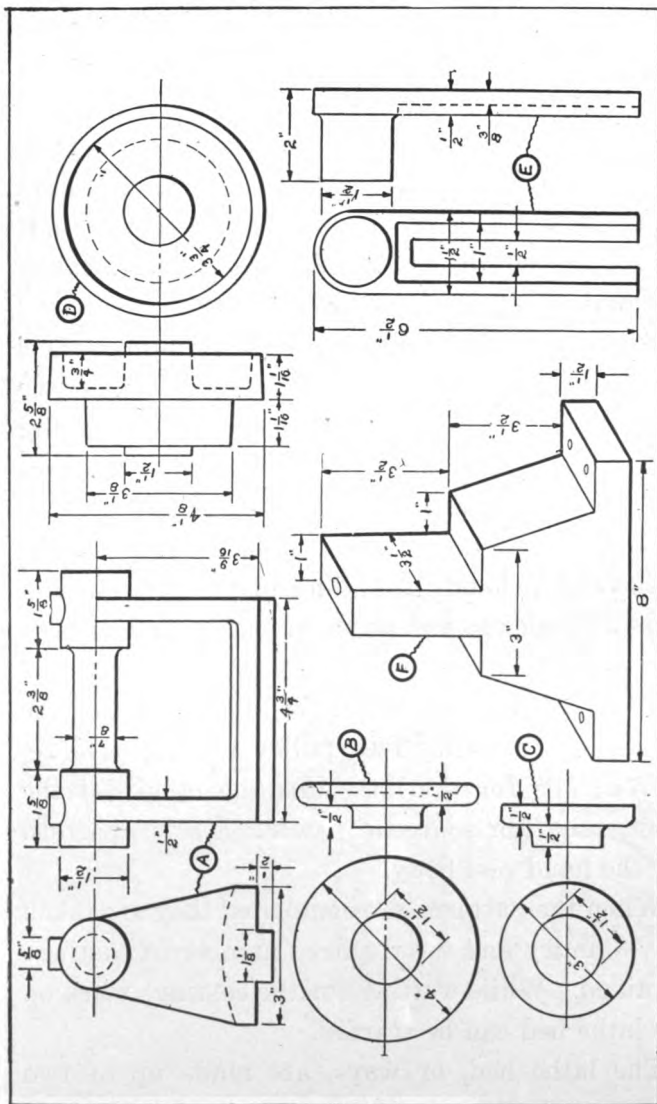

Fig. 158.—Lathe patterns.

made it would be best to split the pattern along its center line. The connecting piece between the two bearings is to prevent the casting from springing after being poured and also to prevent springing while drilling out for the bearings. A slight taper should be given the pattern from each side of the center line to facilitate the withdrawal of the pattern from the mold.

The hand wheel *B* is used as the clamping wheel for securing the hand rest and tail-stock to the bed of the lathe. It is also used as the turning wheel for the tail-stock spindle. Three castings are required from this pattern and two from the pattern *C*. If there should happen to be an old junk yard at hand the builder may be able to find some old wheels and washers that would answer the purpose.

The cone pulley pattern is turned up to the dimensions shown. Two pulley castings are required; one for the lathe and the other for the countershaft or source of power. *E* is the pattern for the hand rest body.

When the patterns are completed they are taken to a foundry and the required number of castings obtained. While waiting for the castings work on the lathe bed can be started.

The lathe bed, or ways, are made up of two

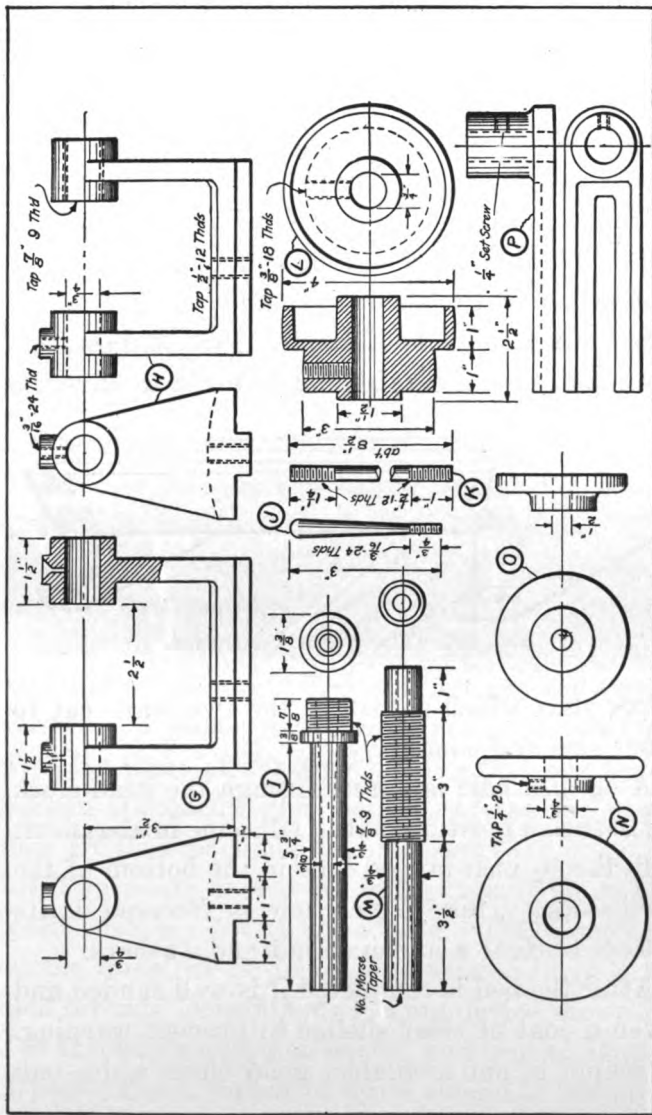

Fig. 159.—Constructional details of wood-turning lathe.

strips of good, clear, hard maple, free from knots and splits. The dimensions are 1 inch thick, 4 inches wide and the length about 36 inches. If a longer bed is desired the thickness should be increased to about $1\frac{1}{2}$ inches. A trip to any wood-working or cabinet shop and the amateur will be able to obtain a piece of maple and have it planed, dressed and cut to shape at small cost. The bench legs *F* are also made of maple. Two of these legs are required and care should be taken to have the

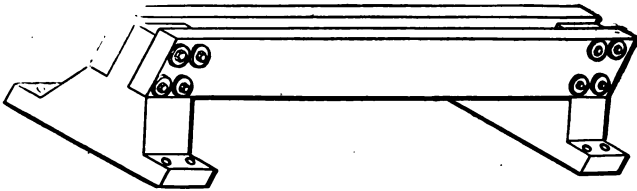

FIG. 160.—The lathe bed assembled.

upper part which separates the two ways cut to exact size and square.

A $\frac{5}{8}$ inch hole is bored through the head-stock leg in such a position that it will come in alignment with the $\frac{1}{2}$ inch tapped hole in the bottom of the head-stock. This $\frac{5}{8}$ inch hole is recessed at its bottom to clear a half inch nut and washers.

After the bed is completed it is well sanded and given a coat of clear shellac to prevent warping. If maple is not available, good clear white oak

will answer the purpose. The assembled bed is illustrated in Fig. 160. The method of securing the bed to the legs by means of eight $\frac{3}{8}$ inch carriage bolts will be seen in this illustration.

When the castings are obtained the first work will be on the head-stock and tail-stock casting. These two pieces are set up in the shaper or milling machine and the outside ends of the bearings faced off. The centers of the bearings are laid off and centerpunched and the bearings drilled out between centers in a lathe with a $\frac{47}{64}$ inch drill. The center piece is now sawed off and the inside ends of the bearings faced off to dimensions. The bearings are reamed out with a $\frac{3}{4}$ inch reamer and the two castings are placed in their proper relation to each other upon a piece of $\frac{3}{4}$ inch shafting or mandrel. The castings are set up on the bed of a planer, miller or shaper and leveled up with the piece of shafting holding the four bearings in alignment. The bottoms of the two castings are then machined to dimensions.

Oil holes are drilled out in the lugs of the head-stock bearings for that purpose. The front lug on the tail-stock is drilled and tapped for a $\frac{3}{16}$ inch thread. A clamp, or locking device shown in *J* is turned up and then heated and bent to shape. A piece of soft copper or brass should be inserted

between the clamp and the tail-stock spindle to prevent scoring of the spindle. The rear bearing of the tail-stock is tapped out with a $\frac{7}{8}$ inch 9 thread tap. Half inch holes are tapped out as shown.

The head-stock spindle *I* is turned up from a piece of $1\frac{3}{8}$ inch machine steel and has a $\frac{3}{8}$ inch hole drilled clear through. The spindle is $\frac{3}{4}$ inch in diameter and the nose is $\frac{7}{8}$ inch in diameter and threaded 9 threads to the inch. This end is reamed out with a No. 1 Morse taper reamer. The tail-stock spindle *M* is made from a piece of $\frac{7}{8}$ inch stock and is also $\frac{3}{4}$ inch in diameter except the threaded part which is $\frac{7}{8}$ inch, 9 threads.

When turning up these spindles it is best to first accurately center the piece of stock and drill half way through with a $\frac{3}{8}$ inch drill, reverse and then drill through from the other end. If the stock has been accurately centered the two holes will meet correctly. After drilling the last hole the piece is reamed out with the taper reamer and then turned and finished between centers.

The cone pulley *L* is turned up to dimensions and the pulley faces given a crown finish. The width should be such that it makes a nice easy running fit between the two bearings. After

assembling the pulley and the spindle in the head-stock the small pulley can be drilled through in to the spindle and tapped out for a $\frac{3}{8}$ inch headless set screw.

The hand wheel *N* is drilled out $\frac{3}{4}$ inch to fit the rear end of the spindle *M* and is held in place by means of a $\frac{1}{4}$ inch set screw. The two other wheels are drilled and tapped for a $\frac{1}{2}$ inch thread.

The two washers *O* are faced off and drilled out with a 9/16 drill. The stud *K* is for securing the head-stock to the bed and passes clear through the $\frac{5}{8}$ inch hole in the head-stock leg and is set up on from underneath the leg. Another $\frac{1}{2}$ inch stud about 7 inches long is required for the tail-stock, also a $\frac{1}{2}$ inch square headed bolt for the hand rest body *P*.

The hand rest *P* is planed off on the bottom and drilled out with a $\frac{3}{4}$ inch drill. A $\frac{1}{4}$ inch set screw is used to secure the tee-rest. A very good tee-rest can be made from a piece of $\frac{1}{4}$ inch by 1 inch flat steel welded to a piece of $\frac{3}{4}$ inch shafting. Several of these rests should be made up of different lengths.

Cast iron makes an excellent bearing metal for a lathe of this type though if the builder so desires he can bore the bearings out and fit them with bushings or else Babbitt them.

A lathe of this type will prove very serviceable in the amateur's workshop, especially if he adds such attachments as a circular saw and table, jig saw attachment, grinding table and sand disc wheel, buffing and emery wheel attachments, etc.

CHAPTER XIII

HOW TO BUILD A MODEL RAPID-FIRE NAVAL GUN

Gun Design—Machining of Parts—Use of D-Bit—Polishing—
Finishing—Assembly, etc.

WHEN the beginner learns how to properly manipulate his lathe, he will naturally look for some project on which to try his skill. For this reason the author decided to add a chapter describing the model naval gun which is a dandy shop project that comes within the scope of the small lathe.

The beautiful model illustrated (Fig. 161) is that of a six-inch naval gun which involves features of both French and American origin. The gun is twenty-four times smaller than a regular six-inch naval gun. Since it was constructed from memory, there may be many parts which are more or less original with the builder although, at the same time, they should not be far from general ordnance practice. One good feature of the gun for those who wish to construct it, is that it involves no castings of any kind, all parts being cut from solid steel or brass stock.

The barrel of the gun measures $8\frac{1}{4}$ inches in length without the breech mechanism. This is shown in Fig. 162. It has a bore of .25 inch and fires a standard .25 calibre Winchester center-fire

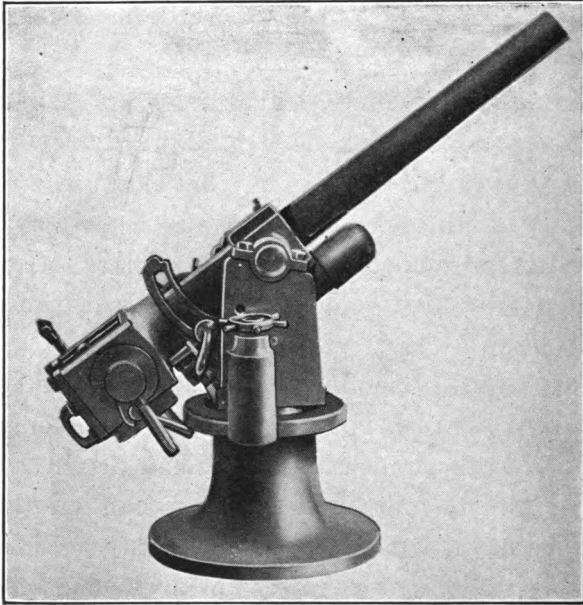

FIG. 161.—The model rapid-fire gun.

bullet. The total length of the barrel and breech mechanism is 10 inches over all. The barrel is turned into shape from a piece of 1 inch cold-rolled steel stock. A taper $5\frac{3}{8}$ inches long is turned, on the barrel. The muzzle of the gun, after the

taper is turned, should have a diameter of $9/16$ inch, while the breech end of the barrel measures

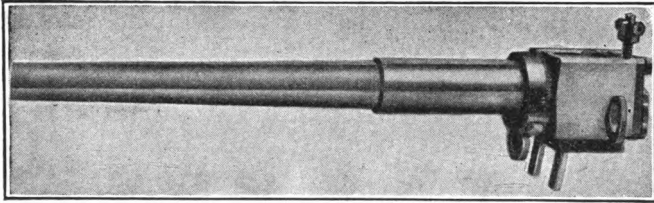

FIG. 162.—The barrel of the model gun.

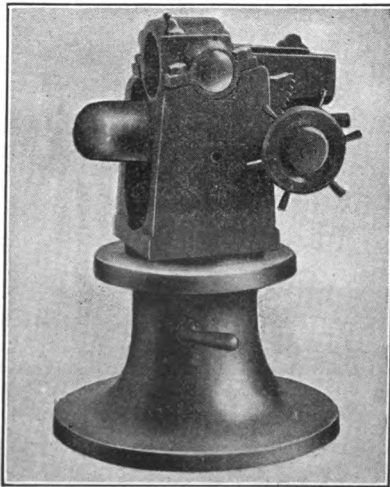

FIG. 163.—The base and carriage for the model gun.

$11/16$ inch. The portion of the barrel which rests on the carriage is turned to $13/16$ inch. After

this work is done, the barrel of the gun is bored out. This can be done with a D-bit, or it may be bored in by an extension drill fixed to the end of a silver steel rod. Great care should be used in boring this, and the drill should be taken out frequently to remove the chips. Otherwise the drill will catch and break, and this will probably necessitate the making of a new barrel. Plenty of oil should be used to lubricate the drill and but a slight pressure should be used.

The breech housing (Fig. 164) is next cut into shape from a piece of $1\frac{3}{8}$ inch steel stock. This is chucked off the center, and one end of it is turned down to a diameter of $1\frac{1}{16}$ inches. A hole is then drilled in this piece $\frac{13}{16}$ inch in diameter, to receive the barrel of the gun. A very close fit should be produced here, and the barrel of the gun is heated and shrunk into this hole. This obviates all pinning and screwing which is not in accordance with good practice in the manufacture of arms. The builder can now proceed to finish the breech housing. This is sawed out and finished with a file, as shown in the detail drawing. The inside width of the breech is $\frac{3}{4}$ inch, and it measures $1\frac{3}{4}$ inches in length, without the back cover plate. The cover plate is cut into shape from a piece of $\frac{1}{8}$ inch steel, and this is

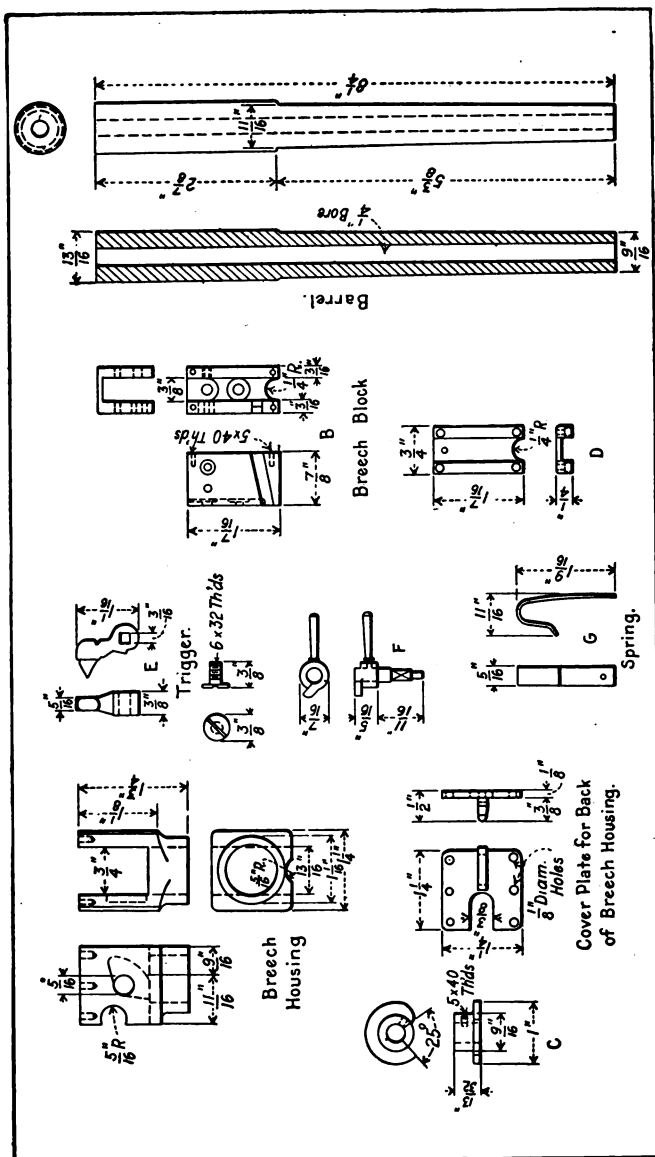

Fig. 164.—Constructional details of the model gun.

held to the back of the breech housing with six hexagon head machine screws, which were made especially for the gun.

It will be advisable to pass on to the remainder of the gun, leaving the breech mechanism to the last. Starting with the base of the gun and building up to the carriage would probably be the most logical procedure. The base (Fig. 166) presents a nice job in turning, since it is made from a solid piece of 4 inch cold rolled steel stock. If the builder does not have a lathe large enough to accommodate such a piece of work, or if the job of turning it looks too big, a wooden pattern for this piece could be cast in iron. In this event, it would not be necessary to core the pattern, since the center hole of the base, in which the carriage is riveted, could be drilled out with a $\frac{7}{8}$ inch drill, or in the event that such a drill is not available, the hole could be turned out on the lathe. A small hole is drilled in the base, as shown in the drawing, and this is threaded to receive a 6×32 set screw. This set screw has a handle bent at an angle so that it can be tightened with the fingers. A steel pin is driven in the top of the base, and this engages with a hole drilled in a $2\frac{3}{8}$ inch steel gear wheel, which has 95 teeth. The center of this gear is drilled out with a $\frac{7}{8}$ inch drill, so

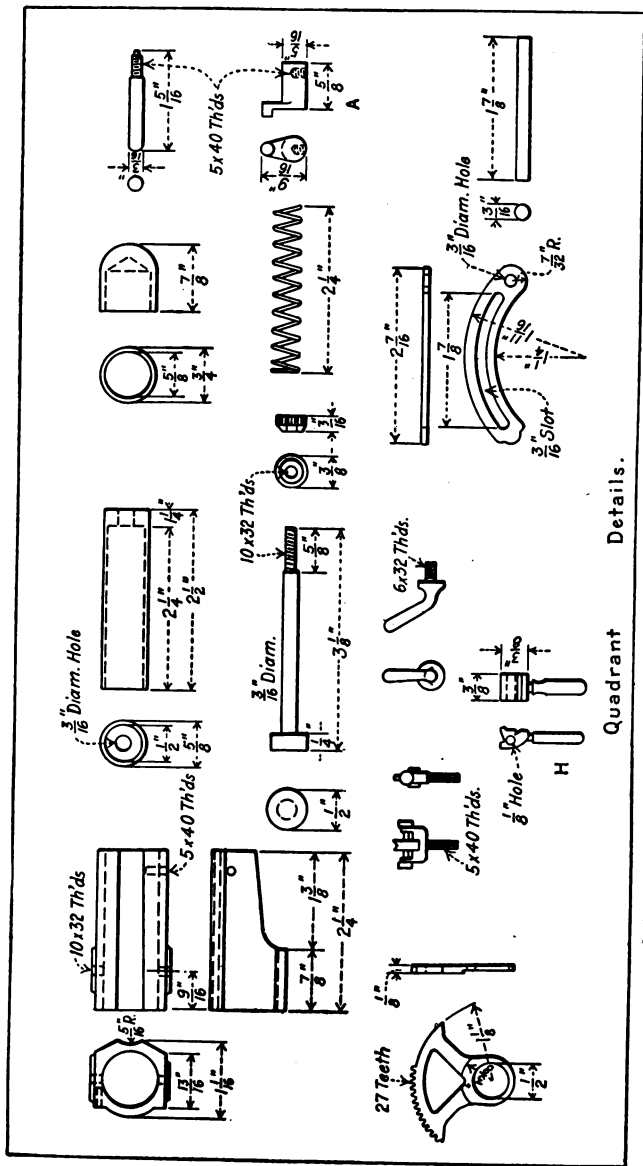

Fig. 165.—Constructional details of the model gun.

carriage of the gun. After the hole is drilled in place, the top of the carriage, for three-quarters of its length, is cut away. The bearings for the barrel are placed on this member and consist of two steel studs $\frac{1}{2}$ inch in diameter and provided with a 10-32 thread, which screws into the side of the cradle. Between one of these shaft studs and the brass cradle, a gear quadrant is fixed (Fig. 165). This quadrant has a radius of $1\frac{1}{8}$ inches and can be cut from a $2\frac{1}{4}$ inch standard brass gear. The teeth of this quadrant mesh with a small brass spur gear, which is attached to the end of a horizontal shaft that passes through the small steel bearing fixed to the main carriage of the gun. At the opposite end of this shaft is a small steel wheel which has handles fixed to its periphery. A glance at the elevation end plan of the gun will make this feature clear. It will be seen that by turning this handle the gun can either be elevated or lowered. At the extreme of its elevation, the barrel of the gun is about 45 degrees.

The gun is held at any elevation by means of a set screw, which passes through a slotted member which has a radius of $1\frac{11}{16}$ inches. This particular piece is shown in the detail drawing (Fig. 165) in the lower right hand corner. It has a hole drilled in it at one end $\frac{3}{16}$ inch in diameter

through which the screw passes to hold it to the inside of the main frame. The piece should be free to move, as this is necessary to compensate for the movement of the barrel of the gun. The set screw passes through the slot screws into the side of the brass cradle. At the bottom of the brass cradle, a circular recess is cut with a radius of $\frac{5}{16}$ inch. A recoil cylinder is cut from a solid piece of brass stock $\frac{5}{18}$ inch in diameter with a $\frac{1}{16}$ inch wall. A cap is made for this cylinder, and it is merely held in place by means of a good fit. There is no objection, however, to threading this so it can be screwed into place. The plunger is a brass rod threaded at one end to receive a circular brass piece $\frac{1}{2}$ inch in diameter and $\frac{1}{4}$ inch wide. At the opposite end it is threaded $\frac{5}{8}$ inch of its length to receive two small nuts with knurled edges. This particular part of the piston passes through a hole in the end opposite to that which carries the cap, and one of the screws is used to adjust the tension on the spring, while the other is placed on the shaft after the gun has been put in the carriage, this shaft passing through a hole in a small bracket or yoke fixed underneath the forward part of the breech housing. The barrel can be removed from its carriage by merely taking off this screw and sliding it out.

The recoil spring is wound from eighteen gauge spring wire, so that it will fit in the recoil chamber.

The bearings of the gun are made of cold-rolled stock cut from a solid piece. These rest in a semi-circular recess in the gun carriage. They are held in place with special machine screws provided with hexagonal heads. The bearing for the side on which the quadrant is attached is made $\frac{1}{8}$ inch wide to compensate for this piece. The bearing on the opposite side is made $\frac{5}{15}$ inch wide. With the addition of a small brass cover, which springs over the bracket on the inside of the gun, which holds the vertical bearing for the range spur gear, the gun is finished with the exception of the breech housing.

The breech mechanism (Fig. 167) will now be described and this is really more difficult to do on paper than to follow in the actual construction. The mechanism has been reduced to its simplest form, all unnecessary parts having been suppressed. The first thing to do will be to cut a recess on the inside of the breech housing. This recess is cut to a depth of about $\frac{1}{8}$ inch and takes the shape shown by the dotted line in the detail drawing of the breech housing (Fig. 164). This recess should really be cut before the breech housing has been shrunk on the barrel as this will

facilitate working with a small chisel, by means of which this recess is cut. A $5/16$ inch hole is then drilled as shown at *A* in the drawing. The crank of this crankshaft is on the inside of the breech housing and rests in the recess previously cut. The projecting part of the crank on the inside engages with a groove slotted diagonally across the side of the breech block. This is shown at *B*. The outside end of the small crankshaft also has a cam arrangement, through the center of which passes the operating level which also acts as a set screw, the hole being drilled into the crankshaft, into which the threaded end of the lever passes. The collar or cam is shown clearly in the drawing at *C* and presents but an ordinary lathe job, the regular portion being shaped with a hacksaw and file. It will be seen that by actuating the crankshaft by means of a lever, the breech will be caused to move downward uncovering the breech of the gun. No extracting mechanism is included since this would lead to complications in construction.

The breech block is sawed into shape from a piece of cold-rolled stock, and if the builder has access to a shaper the job can be done much more easily, beside giving a more accurate result than would otherwise be possible. The dimension and

shape of the breech block is shown at *B* in the drawing. A back cover plate is cut and held in place on the breech block with filister head machine screws. The holes in the block are counter-sunk so that the heads of the machine screws will be flush with the surface. The shaper can also be used to advantage in producing this back cover plate, although this need not discourage the mechanic who cannot use such a machine. The groove in the back can be ground out roughly with a $\frac{3}{8}$ inch abrasive wheel, after which it can be finished up with a file.

The back plate and the breech block is shown in the drawing at *D* (Fig. 164). A hole through which the firing pin passes before it strikes the center of the shell is drilled in the center of the breech block, $\frac{1}{2}$ inch down from the top.

The firing pin is shown at *E* in the drawing (Fig. 164). This is filed into shape from a piece of cold-rolled steel stock. A square hole is cut in the firing pin, and a shaft passes through this to the outer end of which is fastened a small handle, shown at *F*. The shaft is also shown in detail here. The handle acts as a set screw on the shaft for the eccentric arrangement. The spring for the firing pin is very heavy and is bent into the shape shown at *G*. Before this spring is bent, it

will be necessary to anneal it somewhat and then harden it after it is in its final shape. This spring is interposed between the back of the breech block and the firing pin, the projecting portions of the spring fits in the notch, which is filed in the back of the firing pin. Reference to both of these members on the drawing will make this clear. While the spring is soft a hole is drilled in the bottom by means of which it is screwed to the breech block on the inside.

By actuating the small lever upon the shaft on which the firing pin is placed, the spring is compressed between the back of the firing pin and the breech block. After the spring has been forced back to this position, it is held in place by a small catch, shown at *H* in the drawing (Fig. 165). This is placed just forward of the lower part of the firing pin at the bottom of the breech block, and is held in place by a small shaft. The forward movement of this lever holds the firing pin in a cocked position by catching in the little notch shown in the drawing of the firing pin. Pulling this small lever backward releases the firing pin and it flies forward with a pressure of 7 lbs., which is necessary to fire a .25 Winchester shell. When the breech block is moved downward at the time the shell is to be ejected, the cam arrange-

ment on the outside of the crankshaft automatically cocks the gun so that it will be ready to fire when the breech block is returned to firing position. This it does by means of a little cam arrangement on the shaft of the firing pin, which forces the lever forward, thereby compressing the firing pin. At this time, it will be necessary to push the little lever forward on the bottom of the breech which will lock the firing pin in a cocked position.

By careful study of the drawings and photographs, these details can be readily understood and assembled intelligently by the constructor.

The gun sight is composed of two parts, the forward and after sight. The forward sight is a small ball $1/16$ inch in diameter and is fastened on top of the gun cradle directly in line with the after-sight which was copied from a Hotchkiss gun. It is situated on the top of the breech housing and has a slide with a small carriage. It travels $1/4$ inch and is operated by a lead screw. A V is cut on the top of the carriage and when the V is in line with the ball of the forward sight the apparent range is then found.

INDEX

A

Advanced Lathe Work, 128
Aluminum, How to Spin, 185
Amateur Lathe, Rugged, 32
Angle-plate Used with Face-plate, 141
Annealing Metals, 179, 184
Apron Clutch, 50
Apron Handle, 50
Arm-rest, 118
Ash Tray, How Handled, 187
Assembling of Gun Parts, 233
Attachments and Their Use, 54

B

Back-center, Revolving, 177
Back Gears, 25, 48, 49
Bar, Boring, 134
Barnes, Lathe, 23
Beads, or Convex Cuts, 172
Bearing Metal for Lathe, 215
Bearings, 22, 26, 47, 198, 201, 213
Bearings, Headstock, 47
Beds, Lathe, 20, 22, 29, 32, 193, 207, 210
Bench Lathe Countershafts, 40, 41
Bench Lathe Motors, 41
Bench Lathe Turret, 66
Bench Lathes, 26, 27, 29, 32, 192
Bent Thread Tool, 156
Blocks, Form, 187, 189
Boring a Small Cylinder, 139
Boring and How it is Done, 132

Boring Bar, 134
Boring Table, Flat, 30
Boring Tool, 133, 134
Boring Tool, Grinding, 134
Brass, How to Drill, 123
Brass, Negative Rake for, 112
Brass Pin, Turning a, 105
Brass, Threading, 156
Building a Metal Turning Lathe, 192
Building a Wood Turning Lathe, 208
Bushings, Making, 126

C

Calipers, 88
Care of the Lathe, 174
Care of Tools, 175
Carriage, 50
Carriage, Lathe, Speed of, 49
Cast-iron, Cutting, 135
Cast-iron, Threading, 156
Catalogues of Lathes, 17
Centering Drill, 109
Center, Live, 46
Center of Stock, Finding, 107
Center Rests, 54
Center, Revolving, Simple, 190
Center, Screw, for Wood Turning, 159
Center, Spur, for Wood Turning, 159
Chaser, Hand, Use of, 146
Chaser, Internal, 150
Chasers, Thread Cutting, 146

Choosing a Lathe, 17
 Chucks, 25, 50, 61, 97, 118, 125,
 128, 129
 Chucks and How to Use Them,
 128
 Chucks, Compression, 50, 61, 97
 Clearance in Drills, 120
 Collar, Micrometer, 52
 Compound Slide Rest, 28
 Compression Chuck, 61, 125
 Concave Cuts in Wood, 171
 Cone, 45
 Cone Bearings, 22
 Cone Pulley, 21, 193, 210
 Construction, Features of, 21
 Convex Cuts, or Beads, 172
 Copper Cup, Spinning a, 180
 Copper, Lubricant for, 183
 Countershaft, Mounting, 35
 Countershaft, Operation of, 36
 Countershaft Speeds, 38
 Countershafts for Bench Lathes,
 40, 41
 Counter-weight, Adjustable, 142
 Cross Cutting, How Done, 52
 Cross Feed, 53
 Cross Feeds, Automatic, 50
 Cup, Copper, Spinning a, 180
 Cup, More Elaborate, 189
 Cup, Turning a, 133
 Cutters, Gear, 61
 Cutters, Milling, 57, 58
 Cutting Action of Lathe, 103
 Cutting Gears, 62
 Cutting Sheet Metal, 143
 Cylinder, Boring a Small, 139

D

D-Bit, Use of, 220
 Disc Grinder for Small Lathe,
 125

Dividers, Spring, 99
 Dogs, Lathe, 110
 Drill, Centering, 109
 Drill Chuck, 118
 Drill Gauge, 98
 Drill-grinding Gauge, 122
 Drill, Names of Parts, 121
 Drill Pad, 120
 Drill Press, Lathe Used as, 118
 Drill, Re-grinding a, 121, 123
 Drilling Brass, 123
 Drilling, Directions for, 120
 Drilling Holes Crosswise, 120
 Drilling Steel, 123
 Drills, Clearance in, 120
 Drills, Re-grinding, 121
 Driving Pulley, 37
 Driving the Lathe, 34
 Drummond Lathe, English, 29

E

Eccentric Turning on Face-
 plate, 139
 Electric Motor Power, 38
 Enclosed Gears, 29

F

Face-plate and Its Use, 136
 Face-plate, Eccentric Turning
 on, 139
 Face-plate for Wood Turning,
 168
 Facing Off a Pulley, 137
 Facing Tool and Its Use, 114
 Feed Handle, 51
 Feeds, Cross, Automatic, 50
 Filing Attachment, 76
 Finishing Wood in the Lathe,
 167
 Fluting Reamers, 63
 Form Block for Metal Spinning,
 187, 189

- G**
- Gas Engine Power, 38
 Gauge, Depth, 92
 Gauge, Drill, 98
 Gauge, Drill-grinding, 122
 Gauge, Thread, 100
 Gauge, Thread-tool, 154
 Gauges, Snap, 101
 Gear Cutters, 61
 Gear, Idling, 151
 Gears, Back, 25, 48, 49
 Gears, Cutting, 62
 Gears, Enclosed, 29
 Gears, How Meshed, 49, 64
 Gluing Wood to Size and Shape, 169
 Goodell-Pratt Lathe, 26
 Gouge Tool, 162
 Grease, Getting Rid of, 34
 Grinder, Disc, for Small Lathe, 125
 Grinders, Tool Post, Electric, 54
 Grinding Attachments, 68
 Groover for Metal Spinning, 180
 Grooves, Cutting Semi-circular, 167
 Gun Design, 218
 Gun, naval, model Rapid-fire, 217
- H**
- Hand Chaser, Use of, 146
 Hand Turning Procedure, 115
 Hand Turning Tools, 117
 Hangers, Shaft, 36
 Headstock, 22, 45, 49, 193, 196, 201, 208
 Headstock Bearings, 47
 Headstock Motor, 31
 Heat Treatment of Metals, 179, 184
 Heavy Turning, 25
- Holes Drilled Crosswise through Round Stock, 120
 Hollow Spindle, 21
 Hook Tool and Its Use, 118
 Huhn Lathe, 32
- I**
- Idling Gear, 151
 Index Head, 82, 85
 Index Head, Improvised, 77
 Index Plates, 61, 62, 152, 153
 Inside Turning, 118
- J**
- Jig Saw Attachment, Home-made, 67
- K**
- Key-ways, Cutting, 85
- L**
- Lathe, Barnes, 23
 Lathe Beds, 20, 22, 29, 32, 193, 207, 210
 Lathe, Care of the, 174
 Lathe, Choosing a, 17
 Lathe, Cutting Action of, 103
 Lathe-dogs and Their Use, 110
 Lathe, Driving the, 34
 Lathe, English Drummond, 29
 Lathe, Goodell-Pratt, 26
 Lathe, Huhn, 32
 Lathe, Metal Turning, Building a, 192
 Lathe, Millers Falls, 19
 Lathe, Mounting and Leveling the, 35
 Lathe, Oiling the, 47, 50, 52, 174
 Lathe, Rugged Amateur, 32
 Lathe, Rivett Precision, 27
 Lathe, Seneca Falls, 20

- Lathe, Setting Up the, 34
 Lathe, Simple Type, 19
 Lathe, Stark Precision, 26
 Lathe, the, and Its Parts, 45
 Lathe, Unpacking the, 34
 Lathe, Wood Turning, 157
 Lathe, Wood Turning, Building
 a, 208
 Lathe, Wood Turning, Patterns
 for, 208
 Lathe Work, Advanced, 128
 Lathes, Bench, 26, 27, 29, 32,
 192
 Lathes, Catalogues of, 17
 Lathes, Features of Construc-
 tion, 21, 157, 192, 208
 Lathes, Metal Turning, 19-33,
 45, 192
 Lathes, Price of, 17
 Lathes, Screw-cutting, 23, 28, 31
 Lathes, Wood Turning, 19, 157
 Lead Screws, 23, 49, 64
 Lead Screw Speeds, 31
 Lighting of the Lathe, 39
 Line Shaft, 36, 39
 Line Shaft Horse Power, 38
 Live Center, 46
 Live Spindle, 46
 Lubricant for Copper, 183
 Lubricants for Brass and Zinc,
 188
- M
- Machining of Gun Parts, 219
 Mandrels and Their Use, 132
 Measuring Tools and Their Use,
 86
 Meshing of Gears, 49
 Metal Spinning, 176
 Metal Spinning, Speed for, 176
 Metal Spinning, Tools for, 180
 Metals Suitable for Spinning, 178
- Metal Turning, a Lesson in, 103
 Metal Turning Lathe, Building
 a, 192
 Metal Turning Lathes, 19-33,
 45, 192
 Micrometer Collar, 52
 Micrometer Reading, 96
 Micrometers, 94
 Micrometer Scale, Reading the,
 95
 Millers Falls Lathe, 19
 Milling Attachments, 56
 Milling Cutters, 57
 Milling, Vise for, 58
 Motor in Headstock, 31
 Motors for Bench Lathes, 41
 Motors, Starting Box for, 38
 Mounting and Leveling the
 Lathe, 35
 Mounting Irregular Wooden
 Pieces, 169
 Mounting the Countershaft, 35
 Mounting Work to be Bored, 136
- N
- Nose of the Lathe, 47
- O
- Oiling the Lathe, 47, 50, 52, 174
- P
- Pad, Drill, 120
 Parting Tool, 162
 Parting Tool and Its Use, 115
 Parting Tool, How Used, 183
 Parts, Lathe, 45
 Patterns for Wood Turning
 Lathe, 208
 Pitch of Screw, Finding, 147
 Planishing Tool, 180
 Plates, Index, 61, 62, 152

- Polishing Work in the Lathe, 173
 Positioning Work for Turning, 110
 Post, Tool, 51
 Power, Electric Motor, 38
 Power, Gas Engines, 38
 Power, Line Shaft Horse Power, 38
 Precision Bench Lathe, 26
 Precision Lathes, 23, 25, 33
 Price of Lathes, 17
 Pulley, Cone, 21
 Pulley, Driving, 37
 Pulley, Facing Off a, 137
 Pulley, Turning a, 131
- R
- Rack, 50
 Raising-up Tool, 180
 Rake, Negative and Positive, 111, 117
 Reamers, Fluting, 63
 Reamer, Use of Large, 144
 Rest, Arm, 118
 Rest, Slide, 50
 Rests, Center, 54
 Revolving Center, Simple, 190
 Rivett Precision Lathe, 27
 Roughing Cuts in Wood Turning, 165
 Roughing Tool and Its Use, 111
 Round-Nose Tool, 180
 Round Point Tool, 162
- S
- Sawing Attachments, 67, 70
 Saws, 6-inch coping, 76
 Scale, Compound Rest, 51
 Scale, Milling Attachment, 59, 60
 Scale, the, 86
 Scraping Tools, 165
 Screw Center for Wood Turning, 159
 Screw Cutting, 146
 Screw Cutting Attachments, 64
 Screw-cutting Lathes, 23, 28, 31
 Screw, Finding Pitch of, 147
 Screw, Master, 65
 Screws, Lead, 23, 49, 64
 Seneca Falls Lathe, 20
 Setting up the Lathe, 34
 Shaft Hangers, 36
 Shaft, Line, 36, 39
 Sharpening Tools, 105, 163, 165
 Sheet Metal, Cutting, 143
 Sheet Metal Gauge, 178
 Simple Type Lathe, 19
 Skew Chisel, Handling the, 166
 Skew Tools, 162
 Slide Rest, 50
 Slide Rest, Compound, 28
 Snap Gauges, 101
 Spear Point Tool, 162
 Speed for Brass Turning, 113
 Speed for Metal Spinning, 176
 Speed of Lathe Carriage, 49
 Speed of Milling Cutter, 58
 Speed of Wood Turning Lathe, 158
 Speed Reduction in Threading, 156
 Speeds, 21, 25, 31, 32, 38, 45, 159
 Speed Used in Spinning, 191
 Spindle, Hollow, 21
 Spindle, Live, 46
 Spindle, Tailstock, 26
 Spinning Aluminum, 185
 Spinning Metal, 176
 Spinning, Speed Used in, 191
 Spinning Tool, How Used, 183
 Spinning Zinc, 185

- Spur Center for Wood Turning, 159
- Square and Scale Combined, 87
- Squaring Holes, 85
- Square Point Tool, 162
- Stark Precision Lathe, 26
- Starting Box for Motors, 38
- Steel, How to Drill, 123
- Steel, Mild, Threading, 156
- Steel, Positive Rake for, 117
- T
- Table, Boring, Flat, 30
- Tailstock, 23, 53
- Tailstock, Off-set, 29
- Tailstock Spindle, 26, 193
- Taper Turning, Long, 53
- Tapers, Turning, 29
- Tee-rest as Used in Wood Turning, 160
- Tee-rest for Metal Spinning, 176
- Tee-rest, Use of, 116, 118
- Templates as Used in Wood Turning, 172
- Thread Cutting Chasers, 146
- Thread Cutting on Screw-cutting Lathe, 150
- Thread Cutting, Operation of, 155
- Thread Cutting Tool, How Ground, 154
- Thread Cutting without Attachment, 123
- Thread Gauge, 130
- Thread Tool, Bent, 156
- Thread Tool Gauge, 154
- Threading Brass, 156
- Threading Cast-iron, 156
- Threading Mild Steel, 156
- Threading, Speed Reduction in, 156
- Threads, Internal, Cutting, 150
- Thread, U. S. Standard, 147
- Tongue Tool, 180
- Tool Post, 51
- Tool Post Grinders, 54
- Tools, Care of, 175
- Tools for Metal Spinning, 180
- Tools, Hand Turning, 117
- Tools, How to Hold, 161
- Tools, Lathe, and Their Use, 103
- Tools, Measuring, 86
- Tools, Sharpening, 105, 163, 165
- Tools, Wood Turning, 162
- Tray, Ash, 187
- Turning a Small Brass Pin, 105
- Turning, Hand, Procedure, 115
- Turning, Heavy, 25
- Turning, Inside, 118
- Turning, Metal, Lesson in, 103
- Turning, Taper, 53
- Turning Tapers, 29
- Turning, Wood, 157
- Turret for Bench Lathe, 66
- U
- Unpacking the Lathe, 34
- V
- Vernier, Micrometer, 97
- Vise for Milling Work, 58
- W
- Wood Turning, 157
- Wood Turning Lathe, Building a, 208
- Wood Turning Lathes, 18, 157
- Wood Turning Tools, 162
- Woods Used in Turning, 167
- Z
- Zinc, How to Spin, 185

1922

CATALOGUE
of **LATEST and BEST**

Practical
Mechanical
Automobile
BOOKS

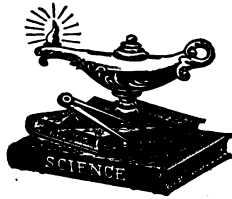

PRACTICAL BOOKS FOR PRACTICAL MEN

Any of these books will be sent prepaid
to any part of the world on receipt of
price. Remit by Draft, Postal Order,
Express Order or Registered Letter.

Published and For Sale by
THE NORMAN W. HENLEY
PUBLISHING CO.

2 West 45th Street, New York, U. S. A.

INDEX TO SUBJECTS

<p>Accidents 27</p> <p>Air Brake 25</p> <p>Arithmetic15, 29, 37</p> <p>Automobiles...3, 4, 5, 6, 7</p> <p>Automobile Charts 7</p> <p>Aviation 8</p> <p>Batteries 19</p> <p>Bevel Gears 22</p> <p>Brazing and Soldering.. 9</p> <p>Cams 22</p> <p>Carburetors 5</p> <p>Car Charts 9</p> <p>Charts7, 8, 9, 10</p> <p>Chemistry 10</p> <p>Coal 27</p> <p>Coke 10</p> <p>Compressed Air 10</p> <p>Concrete11, 12, 13</p> <p>Cosmetics 34</p> <p>Dictionaries14, 19</p> <p>Dies—Metal Work 13</p> <p>Drawing—Sketching Paper14, 15</p> <p>Dynamo15, 16</p> <p>Electric Bells 16</p> <p>Electricity, 15, 16, 17, 18, 19, 20</p> <p>Electroplating 20</p> <p>Ford Automobile 6</p> <p>Gas and Gasoline Engines 21, 22</p> <p>Gearing and Cams 22</p> <p>Hydraulics 22</p> <p>Ice and Refrigeration... 23</p> <p>Inventions—Patents 23</p> <p>Knots 23</p> <p>Lathe Work 24</p> <p>Link Motion 26</p> <p>Liquid Air 25</p> <p>Locomotive Engineering, 25, 26, 27, 28</p> <p>Machinery and Machine Shop Practice 28, 29, 30, 31</p>	<p>Manual Training 32</p> <p>Marine Engineering 32</p> <p>Mechanical Movements . 30</p> <p>Metal Work Dies 13</p> <p>Mining 32</p> <p>Model Making 33</p> <p>Motor Boats 33</p> <p>Motorcycles 33</p> <p>Motor Truck 4</p> <p>Paper, Drawing..... 14</p> <p>Patents and Inventions.. 23</p> <p>Pattern Making 34</p> <p>Perfumery 34</p> <p>Plumbing34, 35</p> <p>Radio16, 18, 19</p> <p>Recipe Book35, 40</p> <p>Refrigeration and Ice... 23</p> <p>Repairing Automobiles... 6</p> <p>Rubber 36</p> <p>Saws 36</p> <p>Screw Cutting 36</p> <p>Sheet Metal Work 13</p> <p>Smoke Prevention 27</p> <p>Soldering 9</p> <p>Starting Systems 5</p> <p>Steam Engineering...36, 37</p> <p>Steam Heating and Ven- tilating 38</p> <p>Steel 38</p> <p>Storage Batteries 19</p> <p>Switchboards 17</p> <p>Tapers 24</p> <p>Telephone 20</p> <p>Thread Cutting 29</p> <p>Tool Making 31</p> <p>Tractor6, 39</p> <p>Ventilation 38</p> <p>Waterproofing 13</p> <p>Welding5, 39</p> <p>Wiring17, 18, 20</p> <p>Wireless Telegraphy, 15, 16, 17, 18, 19, 20</p>
---	---

Any of these books will be sent prepaid to any part of the world, on receipt of price.

REMIT by Draft, Postal Money Order, Express Money Order, or by Registered Mail.

**YOUR LIBRARY IS NOT COMPLETE UNLESS
YOU HAVE IN IT, FOR REFERENCE, A COPY
OF HENLEY'S 20TH CENTURY RECIPE BOOK**

(See Page 40 for Full Description)

AUTOMOBILES

The Modern Gasoline Automobile, Its Design, Construction, Operation.

By VICTOR W. PAGÉ, M.S.A.E. This is the most complete, practical, and up-to-date treatise on gasoline automobiles and their component parts ever published. In the new revised and much enlarged edition, all phases of automobile construction, operation and maintenance are fully and completely described and in language anyone can understand. Every part of all types of automobiles, from light cyclecars to heavy motor trucks and tractors, are described in a thorough manner; not only the automobile, but every item of its equipment, accessories, tools needed, supplies and spare parts necessary for its upkeep, are fully discussed. It is clearly and concisely written by an expert familiar with every branch of the automobile industry and the originator of the practical system of self-education on technical subjects; it is a liberal education in the automobile art, useful to all who motor for either business or pleasure. Anyone reading the incomparable treatise is in touch with all improvements that have been made in motor car construction. All latest developments, such as high speed aluminum motors and multiple valve and sleeve valve engines, are considered in detail. The latest ignition, carburetor and lubrication practice is outlined. New forms of change speed gears, and final power transmission systems, and all latest chassis improvements, are shown and described. This book is used as a text in all leading automobile schools, and is conceded to be the standard treatise.

This book is not too technical for the layman nor too elementary for the more expert. It is an incomparable work of reference for home or school, 6 x 9. Cloth, 1,032 pages, nearly 1,000 illustrations, 12 folding plates. New Edition published. **Price, \$4.00**

Hints and Tips for Automobilists.

By VICTOR W. PAGÉ. The book is ideal for the busy man or woman who wants to know about car operation and upkeep because of the economies possible when an automobile is intelligently operated. It contains many money-saving hints and a brief simple exposition of location and remedy of roadside troubles apt to occur under ordinary operating conditions. **Price, 75 cents**

Questions and Answers Relating to Modern Automobile Construction, Driving and Repair.

By VICTOR W. PAGÉ. A self-educator on automobiling, without an equal. This practical treatise consists of a series of thirty-seven lessons, covering with over 2,020 questions and their answers—the automobile, its construction, operation and repair. The subject matter is absolutely correct and explained in simple language. If you can't answer all of the following questions, you need this work. The answers to these and 2,000 more are to be found in its pages.

Give the names of all important parts of an automobile and describe their functions. Describe action of latest types of kerosene carburetors. What is the difference between a "double" ignition system and a "dual" ignition system. Name parts of an induction coil. How are valves timed? What is an electric motor starter and how does it work? What are advantages of worm drive gearing? Name all important types of ball and roller bearings. What is a "three-quarter" floating axle?—etc., etc. Answers every question asked relating to the modern automobile. A popular work at a popular price. 5¼ x 7½. Cloth, 701 pages, 387 illustrations, 3 folding plates. New Edition just published. **Price, \$2.50**

How to Run an Automobile.

By VICTOR W. PAGÉ. This treatise gives concise instructions for starting and running all makes of gasoline automobiles, how to care for them, and gives distinctive features of control. Describes every step for shifting gears, controlling engine, etc. Among the chapters contained are: I. Automobile Parts and Their Functions. II. General Starting and Driving Instructions. III. Typical Control Systems—Care of Automobiles. Thoroughly illustrated. 178 pages, 72 illustrations. **Price, \$1.50**

The Modern Motor Truck, Its Design, Construction, Operation and Repair.

By VICTOR W. PAGÉ. Just off the press and treats on all types of motor trucks and industrial tractors and trailers. It considers all types of trucks, gasoline and electric and all varieties of truck bodies. This book is written in language everyone can understand and is not in any sense of the word a technical treatise. It is a practical volume that will make special appeal to the truck driver who seeks to better his position and to the mechanic charged with the repair and upkeep of trucks. The factory or business executive who wants to obtain a complete working knowledge of truck operation problems will find this book a reference work of great value. The truck salesman or automobile dealer will find that this work contains information that means money to them. All garage and service station men should have a copy of this book for reference because truck construction differs from passenger car design in many important respects. Anyone who reads this book is in touch with all the practical features that have been tested out in real service. Just Issued. Cloth, 6 x 9, 800 pages, 750 illustrations. **Price, \$5.00**

Gasoline and Kerosene Carburetors, Construction, Installation and Adjustment.

By VICTOR W. PAGÉ. All leading types of carburetors are described in detail, special attention being given to the forms devised to use the cheaper fuels such as kerosene. Carburetion troubles, fuel system troubles, carburetor repairs and installation, electric primers and economizers, hot spot manifolds and all modern carburetor developments are considered in a thorough manner. Methods of adjusting all types of carburetors are fully discussed as well as suggestions for securing maximum fuel economy and obtaining highest engine power. 250 pages, 89 illustrations. **Price, \$2.00**

Automobile Starting, Lighting and Ignition Systems.

By VICTOR W. PAGÉ. A practical treatise on latest automobile starting, lighting and ignition system practice. This practical volume has been written with special reference to the requirements of the reader desiring easily understood explanatory matter relating to all types of automobile electrical systems. It can be understood by anyone, even without electrical knowledge, because elementary electrical principles are considered before any attempt is made to discuss features of the various systems. These basic principles are clearly stated and illustrated with simple diagrams. All the leading systems of starting, lighting and ignition have been described and illustrated with the cooperation of the experts employed by the manufacturers. Over 200 wiring diagrams are shown in both technical and nontechnical forms. Complete data is given for locating troubles in all systems, the various steps being considered in a logical way for those without expert electrical knowledge. All ignition systems receive full consideration, starting with the simplest battery and coil forms found on early cars to the modern short-contact timer and magneto methods used with the latest eight and twelve-cylinder motors. Full directions are given for making all repairs and complete instructions for locating troubles with meters. This book is unusually complete, as it also includes descriptions of various accessories operated by electric current, such as electrical gear shifts, brake actuation, signaling devices, vulcanizers, etc. This is the standard book on this subject. It is used for instruction purposes in every automobile school and college in this country. Over 800 pages, 492 specially made engravings and wiring diagrams. New Edition, Revised and Enlarged. **Price, \$3.00**

Automobile Welding with the Oxy-Acetylene Flame.

By M. KEITH DUNHAM. Explains in a simple manner apparatus to be used, its care, and how to construct necessary shop equipment. Proceeds then to the actual welding of all automobile parts, in a manner understandable by everyone. *Gives principles never to be forgotten.* This book is of utmost value, since the perplexing problems arising when metal is heated to a melting point are fully explained and the proper methods to overcome them shown. 167 pages, fully illustrated. **Price, \$1.50**

Automobile Repairing Made Easy.

By VICTOR W. PAGÉ. A thoroughly practical book containing complete directions for making repairs to all parts of the motor car mechanism. Written in a thorough but non-technical manner. Gives plans for workshop construction, suggestions for equipment, power needed, machinery and tools necessary to carry on business successfully. Tells how to overhaul and repair all parts of all automobiles. The information given is founded on practical experience, everything is explained so simply that motorists and students can acquire a full working knowledge of automobile repairing. Other works dealing with repairing cover only certain parts of the car—this work starts with the engine, then considers carburetion, ignition, cooling and lubrication systems. The clutch, change speed gearing and transmission system are considered in detail. Contains instructions for repairing all types of axles, steering gears and other chassis parts. Many tables, short cuts in figuring and rules of practice are given for the mechanic. Explains fully valve and magneto timing, "tuning" engines, systematic location of trouble, repair of ball and roller bearing, shop kinks, first aid to injured and a multitude of subjects of interest to all in the garage and repair business. This book also contains Special Instructions on Electric Starting, Lighting and Ignition Systems, Tire Repairing and Rebuilding, Autogenous Welding, Brazing and Soldering, Heat Treatment of Steel, Latest Timing Practice, Eight and Twelve-Cylinder Motors, etc., etc. You will never "Get Stuck" on a Job if you own this book. 1,000 specially made engravings on 500 plates. 1,056 pages (5½ x 8). New Edition. **Price, \$4.00**

The Model T Ford Car, Its Construction, Operation and Repair, Including the Fordson Farm Tractor, F. A. Lighting and Starting System, Ford Motor Truck.

By VICTOR W. PAGÉ. This is the most complete and practical instruction book ever published on the Ford car and Fordson tractor. All parts of the Ford Model T car and Fordson tractor are described and illustrated in a comprehensive manner. The construction is fully treated and operating principle made clear to everyone. Complete instructions for driving and repairing are given. To the New Revised Edition matter has been added on the Ford Truck and Tractor Conversion Sets and Genuine Fordson Tractor. All parts are described. All repair processes illustrated and fully explained. Written so all can understand—no theory, no guesswork. New revised and enlarged Edition just published. 153 illustrations, 410 pages, 2 large folding plates. **Price, \$2.00**

Automobilist's Pocket Companion and Expense Record.

By VICTOR W. PAGÉ. This book is not only valuable as a convenient cost record, but contains much information of value to motorists. Includes a condensed digest of auto laws of all States. A collection of practical facts for the everyday motorist. Convenient pocket size. **Price, \$1.50**

Automobile Charts

By VICTOR W. PAGE, M.S.A.E.

UNIFORM SIZE—24" x 38"—PRICE 35 CENTS EACH

Location of Gasoline Engine Troubles Made Easy.

This chart shows clearly all parts of a typical four-cylinder gasoline engine of the four-cycle type. It simplifies location of all engine troubles. No details omitted. (24 x 38.) Price, 35 cents

Location of Carburetion Troubles Made Easy.

It shows clearly how to find carburetion troubles and names all defects liable to exist in the various parts. Instructions are given for carburetor adjustment, vacuum feed tank troubles, pressure feed system, etc. (24 x 38.) Price, 35 cents

Location of Ignition System Troubles Made Easy.

In this chart all parts of a typical double ignition system using battery and magneto current are shown, and suggestions are given for readily finding ignition troubles and eliminating them when found. Includes latest Delco, Connecticut and other systems. (24 x 38.) Price, 35 cents

Location of Cooling and Lubricating Troubles.

This is a combination chart showing all components of the approved form of water cooling group as well as a modern engine lubrication system. It shows all points where defects exist that may result in engine overheating, both in cooling and oiling systems. (24 x 38.) Price, 35 cents

Lubrication of the Motor Car Chassis.

This chart presents the plan view of a typical six-cylinder chassis of standard design and outlines all important bearing points requiring lubrication, and is a valuable guide to the correct lubrication of any modern car. A practical chart for all interested in motor car maintenance. (24 x 38.) Price, 35 cents

While each of the above five charts are complete, the set covers all maintenance instructions for the entire automobile.

Location of Starting and Lighting System Faults.

The most complete chart yet devised, showing all parts of the modern automobile starting, lighting and ignition systems, giving instructions for systematic location of all faults in wiring, lamps, motor or generator, switches and all other units. Invaluable to motorists, chauffeurs and repairmen. Size 24 x 38 inches. Price, 35 cents

Location of Ford Engine Troubles Made Easy.

An enlarged and revised chart showing clear sectional views depicting all portions of the Ford power plant and auxiliary groups. It outlines clearly all parts of the engine, fuel supply systems, ignition group and cooling system, that are apt to give trouble, detailing all derangements that are liable to make an engine lose power, start hard, or work irregularly. This chart simplifies location of all engine faults, and includes instructions for locating Ford electric starter troubles. Size 25 x 38 inches. Price, 35 cents

Location of Motorcycle Troubles Made Easy.

This chart simplifies location of all power-plant troubles and will prove of value to all who have to do with the operation, repair or sale of motorcycles. No details omitted. Size 20 x 30 inches. Price, 35 cents

AVIATION

A B C of Aviation.

By CAPT. V. W. PAGÉ. This book describes the basic principles of aviation, tells how a balloon or dirigible is made and why it floats in the air. Describes how an airplane flies. It shows in detail the different parts of an airplane, what they are and what they do. Describes all types of airplanes and how they differ in construction; as well as detailing the advantages and disadvantages of different types of aircraft. It includes a complete dictionary of aviation terms and clear drawings of leading airplanes. The reader will find simple instructions for unpacking, setting up and rigging airplanes. A full description of airplane control principles is given and methods of flying are discussed at length.

This book answers every question one can ask about modern aircraft, their construction and operation. 275 pages, 130 specially made illustrations with 7 plates. **Price, \$2.50**

Aviation Engines—Design; Construction; Repair.

By LIEUT. VICTOR W. PAGÉ, Aviation Section, S.C.U.S.R. The matter is logically arranged; all descriptive matter is simply expressed and copiously illustrated, so that anyone can understand airplane engine operation and repair even if without previous mechanical training. This work is invaluable for anyone desiring to become an aviator or aviation mechanic. 576 pages, 253 illustrations. **Price, \$3.00**

Aviation Chart.

By LIEUT. VICTOR W. PAGÉ. A large chart outlining all parts of a typical airplane power plant, showing the points where trouble is apt to occur and suggesting remedies for the common defects. Intended especially for aviators and aviation mechanics on school and field duty.

Price, 35 cents

Applied Aerodynamics.

By G. P. THOMPSON. This is a scientific and mathematical treatise that has a special appeal to the student and engineer who are seeking exact information on the aerodynamics of heavier-than-air craft and data on airplane design testing. This book gives an up-to-date presentation of the existing state of Aeronautical Science. In addition to a very full discussion of the qualities which determine the speed and rate of climb of an aeroplane and the method by which they can be calculated, special attention is paid to stability—a problem now fairly well understood, and to controllability—our knowledge of which is at present in a much more elementary state. Attention is directed to the numerous directions in which further information is required, especially in the form of full-scale experiments. 312 pages (7 x 10). Illustrated with over 142 Diagrams and Graphic Charts. **Price, \$12.50**

Glossary of Aviation Terms — English-French; French-English.

A complete glossary of practically all terms used in aviation, having lists in both French and English with equivalents in either language compiled by VICTOR W. PAGÉ and PAUL MONTARIOL. **Price, \$1.00**

BRAZING AND SOLDERING

Brazing and Soldering.

By JAMES F. HOBART. The only book that shows you just how to handle any job of brazing or soldering that comes along; it tells you what mixture to use, how to make a furnace if you need one. Full of valuable kinks. The fifth edition of this book has just been published, and to it much new matter and a large number of tested formulas for all kinds of solders and fluxes have been added. **35 cents**

Soldering and Brazing.

By RAYMOND FRANCIS YATES. This treatise gives all the necessary "kinks" that will enable one to accomplish successful soldering. If a mechanic has not succeeded in his soldering, this book may tell him just what he needs to produce good work—something that he may heretofore have forgotten. **Price, 75 cents**

CHARTS

Modern Submarine Chart—With 200 Parts Numbered and Named.

A cross-section view, showing clearly and distinctly all the interior of a submarine of the latest type. No details omitted—everything is accurate and to scale. This chart is really an encyclopedia of a submarine. **Price, 35 cents**

Box Car Chart.

A chart showing the anatomy of a box car, having every part of the car numbered and its proper name given in a reference list. **Price, 35 cents**

Gondola Car Chart.

A chart showing the anatomy of a gondola car, having every part of the car numbered and its proper reference name given in a reference list. **Price, 35 cents**

Passenger Car Chart.

A chart showing the anatomy of a passenger car, having every part of the car numbered and its proper name given in a reference list. **Price, 35 cents**

Steel Hopper Bottom Coal Car.

A chart showing the anatomy of a steel hopper bottom coal car, having every part of the car numbered and its proper name given in a reference list. **Price, 35 cents**

Tractive Power Chart.

A chart whereby you can find the tractive power or drawbar pull of any locomotive without making a figure. Shows what cylinders are equal, how driving wheels and steam pressure affect the power. What sized engine you need to exert a given drawbar pull or anything you desire in this line. **Price, 50 cents**

Horse-power Chart.

Shows the horse-power of any stationary engine without calculation. No matter what the cylinder diameter or stroke, the steam pressure or cut-off, the revolutions, or whether condensing or non-condensing, it's all there. Easy to use, accurate and saves time and calculations. Especially useful to engineers and designers. **Price, 50 cents**

Boiler Room Chart.

By GEORGE L. FOWLER. A chart—size 14 x 28 inches—showing in isometric perspective the mechanisms belonging in a modern boiler room. This chart is really a dictionary of the boiler room—the names of more than 200 parts being given. **Price, 35 cents**

CHEMISTRY

How to Make and Use a Small Chemical Laboratory.

By RAYMOND FRANCIS YATES. The treatise covers all of the essentials of elementary chemistry. The law of definite proportions, solutions, crystalloids, colloids, electrolysis, etc., are explained. The second part of the book is devoted to chemical and electro-chemical experiments. Only those experiments that will tend to broaden the reader's knowledge of chemistry in general have been chosen. **Price, 75 cents**

COKE

Coke—Modern Coking Practice, Including Analysis of Materials and Products.

By J. E. CHRISTOPHER and T. H. BYROM. This, the standard work on the subject, has just been revised and is now issued in two volumes. It is a practical work for those engaged in Coke manufacture and the recovery of By-products. Fully illustrated with folding plates. Among the chapters contained in Volume I are: Introduction; Classification of Fuels; Impurities of Coals; Coal Washing; Sampling and Valuation of Coals, etc.; Chlorific Power of Fuels; History of Coke Manufacture; Developments in Coke Oven Design; Recent Types of Coke Ovens; Mechanical Appliances at Coke Ovens; Chemical and Physical Examination of Coke. Volume II covers By-products. Each volume is fully illustrated, with folding plates. **Price, \$3.00 per volume**

COMPRESSED AIR

Compressed Air in All Its Applications.

By GARDNER D. HISCOX. This is the most complete book on the subject of air that has ever been issued, and its thirty-five chapters include about every phase of the subject one can think of. It may be called an encyclopedia of compressed air. It is written by an expert, who, in its 665 pages, has dealt with the subject in a comprehensive manner, no phase of it being omitted. Over 500 illustrations. Fifth Edition, revised and enlarged. Cloth bound. **Price, \$6.00**

CONCRETE

Concrete Wall Forms.

By A. A. HOUGHTON. A new automatic wall clamp, is illustrated with working drawings. Other types of wall forms, clamps, separators, etc., are also illustrated and explained.

Price, 75 cents

Concrete Floors and Sidewalks.

By A. A. HOUGHTON. The molds for molding squares, hexagonal and many other styles of mosaic floor and sidewalk blocks are fully illustrated and explained.

Price, 75 cents

Practical Concrete Silo Construction.

By A. A. HOUGHTON. Complete working drawings and specifications are given for several styles of concrete silos, with illustrations of molds for monolithic and block silos. The tables, data, and information presented in this book are of the utmost value in planning and constructing all forms of concrete silos.

Price, 75 cents

Molding Concrete Bath Tubs, Aquariums and Natatoriums.

By A. A. HOUGHTON. Simple molds and instruction are given for molding different styles of concrete bath tubs, swimming pools, etc.

Price, 75 cents

Molding Concrete Chimneys, Slate and Roof Tiles.

By A. A. HOUGHTON. The manufacture of all types of concrete slate and roof tile is fully treated. Valuable data on all forms of reinforced concrete roofs are contained within its pages. The construction of concrete chimneys by block and monolithic systems is fully illustrated and described. A number of ornamental designs of chimney construction with molds are shown in this valuable treatise.

Price, 75 cents

Molding and Curing Ornamental Concrete.

By A. A. HOUGHTON. The proper proportions of cement and aggregates for various finishes, also the methods of thoroughly mixing and placing in the molds, are fully treated. An exhaustive treatise on this subject that every concrete worker will find of daily use and value.

Price, 75 cents

Concrete Monuments, Mausoleums and Burial Vaults.

By A. A. HOUGHTON. The molding of concrete monuments to imitate the most expensive cut stone is explained in this treatise, with working drawings of easily built molds. Cutting inscriptions and designs is also fully treated.

Price, 75 cents

Concrete Bridges, Culverts and Sewers.

By A. A. HOUGHTON. A number of ornamental concrete bridges with illustrations of molds are given. A collapsible center of core for bridges, culverts and sewers is fully illustrated with detailed instructions for building.

Price, 75 cents

Constructing Concrete Porches.

By A. A. HOUGHTON. A number of designs with working drawings of molds are fully explained so any one can easily construct different styles of ornamental concrete porches without the purchase of expensive molds.

Price, 75 cents

Molding Concrete Flower Pots, Boxes, Jardinieres, Etc.

By A. A. HOUGHTON. The molds for producing many original designs of flower pots, urns, flower boxes, jardinieres, etc., are fully illustrated and explained, so the worker can easily construct and operate same.

Price, 75 cents

Molding Concrete Fountains and Lawn Ornaments.

By A. A. HOUGHTON. The molding of a number of designs of lawn seats, curbing, hitching posts, pergolas, sun dials and other forms of ornamental concrete, for the ornamentation of lawns and gardens, is fully illustrated and described.

Price, 75 cents

Concrete on the Farm and in the Shop.

By H. COLVIN CAMPBELL. Among the subjects treated are: Principles of reinforcing; methods of protecting concrete so as to insure proper hardening; home-made mixers; mixing by hand and machine; form construction, described and illustrated by drawings and photographs; construction of concrete walls and fences; concrete fence posts; concrete gate posts; corner posts; clothes line posts; grape arbor posts; tanks; troughs; cisterns; hog wallows; feeding floors and barnyard pavements; foundations; well curbs and platforms; indoor floors; sidewalks; steps; concrete hotbeds and cold frames; concrete slab roofs; walls for buildings; repairing leaks in tanks and cisterns; and all topics associated with these subjects as bearing upon securing the best results from concrete are dwelt upon at sufficient length in plain every-day English so that the inexperienced person desiring to undertake a piece of concrete construction can, by following the directions set forth in this book, secure 100 per cent success every time. 150 pages, 51 illustrations.

Price, \$1.00

Concrete From Sand Molds.

By A. A. HOUGHTON. A practical work treating on a process which has heretofore been held as a trade secret by the few who possessed it, and which will successfully mold every and any class of ornamental concrete work. The process of molding concrete with sand molds is of the utmost practical value, possessing the manifold advantages of a low cost of molds, the ease and rapidity of operation, perfect details to all ornamental designs, density and increased strength of the concrete, perfect curing of the work without attention and the easy removal of the molds regardless of any undercutting the design may have. 192 pages. Fully illustrated. Cloth.

Price, \$2.00

Ornamental Concrete Without Molds.

By A. A. HOUGHTON. The process for making ornamental concrete without molds has long been held as a secret; and now, for the first time, this process is given to the public. The book reveals the secret and is the only book published which explains a simple, practical method whereby the concrete worker is enabled, by employing wood and metal templates of different designs, to mold or model in concrete any cornice, archivolt, column, pedestal, base cap, urn or pier in a monolithic form—right upon the job. These may be molded in units or blocks, and then built up to suit the specifications demanded. This work is fully illustrated, with detailed engravings. Cloth. **Price, \$2.00**

Popular Handbook for Cement and Concrete Users.

By MYRON H. LEWIS. Everything of value to the concrete user is contained, including kinds of cement employed in construction, concrete architecture, inspection and testing, waterproofing, coloring and painting, rules tables, working and cost data. The book comprises thirty-three chapters. A valuable addition to the library of every cement and concrete user. Cloth, 430 pages, 126 illustrations. **Price, \$3.00**

Waterproofing Concrete.

By MYRON H. LEWIS. Modern methods of waterproofing concrete and other structures. A condensed statement of the principles, rules and precautions to be observed in waterproofing and damp-proofing structures and structural materials. Paper binding. Illustrated. Second Edition. **Price, 75 cents**

DIES—METAL WORK

Dies; Their Construction and Use for the Modern Working of Sheet Metals.

By J. V. WOODWORTH. A new book by a practical man, for those who wish to know the latest practice in the working of sheet metals. It shows how dies are designed, made and used, and those who are engaged in this line of work can secure many valuable suggestions. Sixth revised edition. 525 Illustrations, 394 pages. Cloth. **Price, \$3.50**

Punches, Dies and Tools for Manufacturing in Presses.

By J. V. WOODWORTH. An encyclopedia of die-making, punch-making, die-sinking, sheet-metal working, and making of special tools, subpresses, devices and mechanical combinations for punching, cutting, bending, forming, piercing, drawing, compressing, and assembling sheet-metal parts and also articles of other materials in machine tools. This is a distinct work from the author's book entitled "Dies; Their Construction and Use." 500 pages, 700 engravings. Second edition. Cloth. **Price, \$4.50**

DICTIONARIES

Standard Electrical Dictionary.

By PROF. T. O'CONNOR SLOANE. Just issued an entirely new edition brought up to date and greatly enlarged—as a reference book this work is beyond comparison, as it contains over 700 pages, nearly 500 illustrations, and definitions of about 6,000 distinct words, terms and phrases. The definitions are terse and concise and include every term used in electrical science. 767 pages, 477 illustrations. (See page 19 for fuller description.) **Price, \$5.00**

DRAWING—SKETCHING PAPER

A Course in Mechanical Drawing.

By LOUIS ROUILLION. The author has written a most practical book on the subject of Mechanical Drafting. It fully explains the art of Drawing, Lettering and Dimensioning. It is, by far, the most practical book ever published on this subject, for use in day and evening schools, and more especially adapted for the teacher and for self instruction. Fifteenth edition, revised and enlarged. Fully illustrated. Oblong. **Price, \$1.50**

Linear Perspective Self-Taught.

By HERMAN T. C. KRAUS. This work gives the theory and practice of linear perspective, as used in architectural engineering and mechanical drawings. The arrangement of the book is good; the plate is on the left hand, while the descriptive text follows on the opposite page, so as to be readily referred to. A self-explanatory linear perspective chart is included in the second revised edition. Cloth. **Price, \$3.00**

Self-Taught Mechanical Drawing and Elementary Machine Design.

By F. L. SYLVESTER, M.E., Draftsman, with additions by Erik Oberg, associate editor of "Machinery." A practical elementary treatise on Mechanical Drawing and Machine Design, comprising the first principles of geometric and mechanical drawing, workshop mathematics, mechanics, strength of materials and the calculation and design of machine details, compiled for the use of practical mechanics and young draftsmen. 330 pages, 215 engravings. Cloth. **Price, \$2.50**

A New Sketching Paper.

A new specially ruled paper to enable you to make sketches or drawings in isometric perspective without any figuring or fussing. It is being used for shop details as well as for assembly drawings, as it makes one sketch do the work of three, and no workman can help seeing just what is wanted. In three sizes of pads. Pads of 40 sheets, 6 x 9 inches, **Price, 40c.**; 9 x 12 inches, **Price, 75c.**; 12 by 18 inches, **Price, \$1.50.**

Practical Perspective.

By RICHARDS and COLVIN. Shows just how to make all kinds of mechanical drawings in the only practical perspective isometric. Makes everything plain so that any mechanic can understand a sketch or drawing in this way. Saves time in the drawing room and mistakes in the shops. Contains practical examples of various classes of work. Third edition. Limp cloth. **Price, 75 cents**

ELECTRICITY

Arithmetic of Electricity.

By PROF. T. O'CONNOR SLOANE. A practical treatise on electrical calculations of all kinds reduced to a series of rules, all of the simplest forms, and involving only ordinary arithmetic; each rule illustrated by one or more practical problems with detailed solution of each one. This book is classed among the most useful works published on the science of electricity, covering as it does the mathematics of electricity in a manner that will attract the attention of those who are not familiar with algebraical formulas. 200 pages. New Revised and Enlarged Edition. **Price, \$1.50**

Commutator Construction.

By WILLIAM BAXTER, JR. The business end of dynamo or motor of the direct-current type is the commutator. This book goes into the designing, building and maintenance of commutators, shows how to locate troubles and how to remedy them; everyone who fusses with dynamos needs this. Fourth edition. **Price, 35 cents**

Construction of a Transatlantic Wireless Receiving Set.

By L. G. PACENT and T. S. CURTIS. A work for the Radio student who desires to construct and operate apparatus that will permit of the reception of messages from the large stations in Europe with an aerial of amateur proportions. 36 pages. 23 illustrations. Cloth. **Price, 35 cents**

Dynamo Building for Amateurs, or How to Construct a Fifty Watt Dynamo.

By ARTHUR J. WEED. A practical treatise showing in detail the construction of a small dynamo or motor, the entire machine work of which can be done on a small foot lathe. Dimensioned working drawings are given for each piece of machine work, and each operation is clearly described. This machine, when used as a dynamo, has an output of fifty watts; when used as a motor it will drive a small drill press or lathe. It can be used to drive a sewing machine on any and all ordinary work. The book is illustrated with more than sixty original engravings showing the actual construction of the different parts. **Price, \$1.00**

Design Data for Radio Transmitters and Receivers.

By **B. M. SLEEPER**. Far from being a collection of formulas, Design Data takes up in proper sequence the problems encountered in planning all types of receiving sets for short, medium and long wave work, and spark coil, transformer and vacuum tube transmitters operating on 200 meters. Tables have been worked out so that values can be found without the use of mathematics. Radio experimenters will find here information which will enable them to have the most modern and efficient equipment. **Price, 75 cents**

Dynamos and Electric Motors and All About Them.

By **EDWARD TREVERT**. This volume gives practical directions for building a two H. P. Dynamo of the Edison type capable of lighting about fifty mazda lamps of the 20-watt size. In addition, it gives directions for building two small electric motors suitable for running sewing machines. The concluding chapter describes the construction of a simple bichromate battery adapted for running electric motors. 96 pages. Fully illustrated with detail drawings. Cloth. **Price, \$1.00**

Electric Bells.

By **M. B. SLEEPER**. A complete treatise for the practical worker in installing, operating and testing bell circuits, burglar alarms, thermostats and other apparatus used with electric bells. Both the electrician and the experimenter will find in this book new material which is essential in their work. Tools, bells, batteries, unusual circuits, burglar alarms, annunciators, systems, thermostats, circuit breakers, time alarms, and other apparatus used in bell circuits are described from the standpoints of their application, construction, and repair. The detailed instructions for building the apparatus will appeal to the experimenter particularly. The practical worker will find the chapters on Wiring Calculation of Wire Sizes and Magnet Windings, Upkeep of Systems and the Location of Faults of the greatest value in their work. 124 pages. Fully illustrated. **Price, 75 cents**

Experimental High Frequency Apparatus, How to Make and Use It.

By **THOMAS STANLEY CURTIS**. This book tells you how to build simply high-frequency coils for experimental purposes in the home, school laboratory, or on the small lecture platform. The book is really a supplement to the same author's "High Frequency Apparatus." The experimental side only is covered in this volume, which is intended for those who want to build small coils giving up to an eighteen-inch spark. The apparatus is simple, cheap and perfectly safe, and with it some truly startling experiments may be performed. 69 pages, illustrated. **Price, 50 cents**

Electrician's Handy Book.

By PROF. T. O'CONNOR SLOANE. This work has just been revised and much enlarged. It is intended for the practical electrician who has to make things go. The entire field of electricity is covered within its pages. It is a work of the most modern practice, written in a clear, comprehensive manner, and covers the subject thoroughly, beginning at the A B C of the subject, and gradually takes you to the more advanced branches of the science. It teaches you just what you should know about electricity. A practical work for the practical man. Contains forty-eight chapters.

The publishers consider themselves fortunate in having secured the services of such a well and favorably known writer as Prof. Sloane, who has with the greatest care completed a master work in concise form on this all-important subject. 600 engravings, 824 pages, handsomely bound in cloth. New Revised Edition. **Price, \$4.00**

Electricity Simplified.

By PROF. T. O'CONNOR SLOANE. The object of "Electricity Simplified" is to make the subject as plain as possible and to show what the modern conception of electricity is; to show how two plates of different metals immersed in acid can send a message around the globe; to explain how a bundle of copper wire rotated by a steam engine can be the agent in lighting our streets; to tell what the volt, ohm and ampere are, and what high and low tension mean; and to answer the questions that perpetually arise in the mind in this age of electricity. 218 pages. Illustrated. Fifteenth edition. **Price, \$1.50**

Electric Wiring, Diagrams and Switchboards.

By NEWTON HARRISON, with additions by THOMAS POPPE. This is the only complete work issued showing and telling you what you should know about direct and alternating current wiring. The work is free from advanced technicalities and mathematics, arithmetic being used throughout. It is in every respect a handy, well-written, instructive, comprehensive volume on wiring for the wireman, foreman, contractor or electrician. Third revised edition. 315 pages, 130 illustrations. **Price, \$2.50**

Experimental Wireless Stations.

By P. E. EDELMAN. The theory, design, construction and operation is fully treated, including Wireless Telephony, Vacuum Tube, and quenched spark systems. The new enlarged 1920 edition is just issued and is strictly up to date, correct and complete. This book tells how to make apparatus to not only hear all telephoned radio messages, but also how to make simple equipment that works for transmission over reasonably long distances. Then there is a host of new information included. The first and only book to give you all the recent important radio improvements, some of which have never before been published. 392 pages. 24 chapters. 167 illustrations. **Price, \$3.00**

Electric Toy Making, Dynamo Building and Electric Motor Construction.

This work treats of the making at home of electrical toys, electrical apparatus, motors, dynamos and instruments in general and is designed to bring within the reach of young and old the manufacture of genuine and useful electrical appliances. 210 pages, cloth. Fully illustrated. Twentieth edition, enlarged. **Price, \$1.50**

High Frequency Apparatus, Its Construction and Practical Application.

By THOMAS STANLEY CURTIS. The most comprehensive and thorough work on this interesting subject ever produced. The book is essentially practical in its treatment and it constitutes an accurate record of the researches of its author over a period of several years, during which time dozens of coils were built and experimented with. New revised and enlarged edition. Fully illustrated. 269 pages. **Price, \$3.00**

House Wiring.

By THOMAS W. POPPE. Describing and illustrating up-to-date methods of installing electric light wiring. Contains just the information needed for successful wiring of a building. Fully illustrated with diagrams and plans. It solves all wiring problems and contains nothing that conflicts with the rulings of the National Board of Fire Underwriters. 1920 edition, revised and enlarged. Including Direct Current Motor Connections—Diagrams of series wound motor—and Motor Wiring. 200 pages, fully illustrated, flexible cloth. **Price, \$1.00**

How to Become a Successful Electrician.

By PROF. T. O'CONNOR SLOANE. An interesting book from cover to cover. Telling in simplest language the surest and easiest way to become a successful electrician. The studies to be followed, methods of work, field of operation and the requirements of the successful electrician are pointed out and fully explained. 202 pages. Illustrated. Eighteenth revised edition. Cloth. **Price, \$1.50**

Radio Time Signal Receiver.

By AUSTIN C. LESCOUBOURA. This new book, "A Radio Time Signal Receiver," tells you how to build a simple outfit designed expressly for the beginner. You can build the outfits in your own workshop and install them for jewelers either on a one-payment or a rental basis. The apparatus is of such simple design that it may be made by the average amateur mechanic possessing a few ordinary tools. 42 pages. Paper. **Price, 35 cents**

Radio Hook-Ups.

In this book the best circuits for different instruments and various purposes have been carefully selected and grouped together. All the best circuits for damped and undamped wave receiving sets, buzzer, spark coil and transformer sending equipment, as well as vacuum tube telegraph and telephone transmitters, wavemeters, vacuum tube measuring instruments, audibility meters, etc., are shown in this book.

Price, 75 cents

Standard Electrical Dictionary.

By PROF. T. O'CONNOR SLOANE. Just issued an entirely new edition brought up to date and greatly enlarged—as a reference book this work is beyond comparison, as it contains over 700 pages, nearly 500 illustrations, and definitions of about 6,000 distinct words, terms and phrases. The definitions are terse and concise and include every term used in electrical science.

In its arrangement and typography the book is very convenient. The word or term defined is printed in black faced type which readily catches the eye, while the body of the page is in smaller but distinct type. The definitions are well worded, and so as to be understood by the non-technical reader. The general plan is to give an exact, concise definition, and then amplify and explain in a more popular way. Synonyms are also given, and references to other words and phrases are made. This work is absolutely indispensable to all in any way interested in electrical science, from the higher electrical expert to the everyday electrical workman. In fact, it should be in the possession of all who desire to keep abreast with the progress of this branch of science. New enlarged edition. 767 pages. 477 illustrations.

Price, \$5.00

Storage Batteries Simplified.

By VICTOR W. PAGÉ, M.S.A.E. This is the most thorough and authoritative treatise ever published on this subject. It is written in easily understandable, non-technical language so that anyone may grasp the basic principles of storage battery action as well as their practical industrial applications. All electric and gasoline automobiles use storage batteries. Every automobile repairman, dealer or salesman should have a good knowledge of maintenance and repair of these important elements of the motor car mechanism. This book not only tells how to charge, care for and rebuild storage batteries but also outlines all the industrial uses. Learn how they run street cars, locomotives and factory trucks. Get an understanding of the important functions they perform in submarine boats, isolated lighting plants, railway switch and signal systems, marine applications, etc. This book tells how they are used in central station standby service, for starting automobile motors and in ignition systems. Every practical use of the modern storage battery is outlined in this treatise. 208 pages, fully illustrated.

Price, \$2.00

Telephone Construction, Installation, Wiring, Operation and Maintenance.

By **W. H. RADCLIFFE** and **H. C. CUSHING**. This book gives the principles of construction and operation of both the Bell and Independent instruments; approved methods of installing and wiring them; the means of protecting them from lightning and abnormal currents; their connection together for operation as series or bridging stations; and rules for their inspection and maintenance. Line wiring and the wiring and operation of special telephone systems are also treated. 224 pages, 132 illustrations. Second revised edition. **Price, \$1.50**

Wireless Telegraphy and Telephony Simply Explained.

By **ALFRED P. MORGAN**. This is undoubtedly one of the most complete and comprehensive treatises on the subject ever published, and a close study of its pages will enable one to master all the details of the wireless transmission of messages. The author has filled a long-felt want and has succeeded in furnishing a lucid, comprehensible explanation in simple language of the theory and practice of wireless telegraphy and telephony. Fourth edition. 154 pages, 156 engravings. **Price, \$1.50**

Wiring a House.

By **HERBERT PRATT**. Shows a house already built; tells just how to start about wiring it; where to begin; what wire to use; how to run it according to insurance rules; in fact, just the information you need. Directions apply equally to a shop. Fourth edition. **Price, 35 cents**

ELECTROPLATING

The Modern Electroplater.

By **KENNETH M. COGGESHALL**. This is the most complete and practical book on electroplating and allied processes that has been published as a text for the student or professional plater. It is written in simple language and explains all details of electroplating in a concise yet complete manner. Full instructions are given for the preparation and finishing of the work and formulæ and complete directions are included for making all kinds of plating solutions, many of these having been trade secrets until published in this instruction manual. Anyone interested in practical plating and metal finishing will find this book a valuable guide and complete manual of the art. 142 illustrations. 276 pages. **Price, \$3.00**

GAS AND GASOLINE ENGINES

Gas, Gasoline and Oil Engines.

By GARDNER D. HISCOX. Revised by VICTOR W. PAGÉ. Every user of a gas engine needs this book. Simple, instructive and right up to date. The only complete work on the subject. Tells all about internal combustion engineering, treating exhaustively on the design, construction and practical application of all forms of gas, gasoline, kerosene and crude petroleum-oil engines. Describes minutely all auxiliary systems, such as lubrication, carburetion and ignition. Considers the theory and management of all forms of explosive motors for stationary and marine work, automobiles, aeroplanes and motorcycles. Includes also Producer Gas and Its Production. Invaluable instructions for all students, gas-engine owners, gas-engineers, patent experts, designers, mechanics, draftsmen and all having to do with the modern power. Illustrated by over 400 engravings, many specially made from engineering drawings, all in correct proportion. 640 octavo pages and 435 engravings. **Price, \$3.00**

Gasoline Engines: Their Operation, Use and Care.

By A. HYATT VERRILL. A comprehensive, simple and practical work, treating of gasoline engines for stationary, marine or vehicle use; their construction, design, management, care, operation, repair, installation and troubles. A complete glossary of technical terms and an alphabetically arranged table of troubles and symptoms form a most valuable and unique feature of the book. $5\frac{1}{4} \times 7\frac{1}{2}$. Cloth. 275 pages, 152 illustrations. **Price, \$2.00**

Gas Engine Construction.

Or How to Build a Half-Horse-power Gas Engine. By PARSELL and WEED. A practical treatise describing the theory and principles of the action of gas engines of various types, and the design and construction of a half-horse-power gas engine, with illustrations of the work in actual progress, together with dimensioned working drawings giving clearly the sizes of the various details. 300 pages. Third edition. Cloth. **Price, \$3.00**

The Gasoline Engine on the Farm: Its Operation, Repair and Uses.

By XENO W. PUTNAM. A useful and practical treatise on the modern gasoline and kerosene engine, its construction, management, repair and the many uses to which it can be applied in present-day farm life. It considers all the various household, shop and field uses of this up-to-date motor and includes chapters on engine installation, power transmission and the best arrangement of the power plant in reference to the work. $5\frac{1}{4} \times 7\frac{1}{2}$. Cloth. 527 pages, 179 illustrations. **Price, \$3.00**

How to Run and Install Two- and Four-Cycle Marine, Gasoline Engines.

By C. VON CULIN. The object of this little book is to furnish a pocket instructor for the beginner, the busy man who uses an engine for pleasure or profit, but who does not have the time or inclination for a technical book, but simply to thoroughly understand how to properly operate, install and care for his own engine. Pocket size. Paper binding.

Price, 25 cents

GEARING AND CAMS

Bevel Gear Tables.

By D. AG. ENGSTROM. No one who has to do with bevel gears in any way should be without this book. The designer and draftsman will find it a great convenience, while to the machinist who turns up the blanks or cuts the teeth it is invaluable, as all needed dimensions are given and no fancy figuring need be done. Third edition. Cloth. **Price, \$1.50**

Change Gear Devices.

By OSCAR E. FERRIGO. A book for every designer, draftsman and mechanic who is interested in feed changes for any kind of machines. This shows what has been done and how. Gives plans, patents and all information that you need. Saves hunting through patent records and reinventing old ideas. A standard work of reference. Third edition. **Price, \$1.50**

Drafting of Cams.

By LOUIS ROUILLION. The laying out of cams is a serious problem unless you know how to go at it right. This puts you on the right road for practically any kind of cam you are likely to run up against. Third edition.

Price, 35 cents

HYDRAULICS

Hydraulic Engineering.

By GARDNER D. HISCOX. A treatise on the properties, power, and resources of water for all purposes. Including the measurements of streams; the flow of water in pipes or conduits; the horse-power of falling water; turbine and impact water-wheels; wave-motors, centrifugal, reciprocating and air-lift pumps. With 300 figures and diagrams and 36 practical tables. 320 pages.

Price, \$4.50

ICE AND REFRIGERATION

Pocketbook of Refrigeration and Ice Making.

By A. J. WALLIS-TAYLOR. This is one of the latest and most comprehensive reference books published on the subject of refrigeration and cold storage. It explains the properties and refrigerating effect of the different fluids in use, the management of refrigerating machinery and the construction and insulation of cold rooms with their required pipe surface for different degrees of cold; freezing mixtures and non-freezing brines, temperatures of cold rooms for all kinds of provisions, cold storage charges for all classes of goods, ice making and storage of ice, data and memoranda for constant reference by refrigerating engineers, with nearly one hundred tables containing valuable references to every fact and condition required in the installment and operation of a refrigerating plant. New edition just published. **Price, \$2.00**

INVENTION—PATENTS

Inventor's Manual, How to Make a Patent Pay.

This is a book designed as a guide to inventors in perfecting their inventions, taking out their patents, and disposing of them. It is not in any sense a Patent Solicitor's circular nor a Patent Broker's advertisement. No advertisements of any description appear in the work. It is a book containing a quarter of a century's experience of a successful inventor, together with notes based upon the experience of many other inventors. Revised and enlarged second edition. Nearly 150 pages. Illustrated. **Price, \$1.50**

KNOTS

Knots, Splices and Rope Work.

By A. HYATT VERRILL. This is a practical book giving complete and simple directions for making all the most useful and ornamental knots in common use, with chapters on Splicing, Pointing, Seizing, Serving, etc. This book is fully illustrated with 154 original engravings, which show how each knot, tie or splice is formed, and its appearance when finished. The book will be found of the greatest value to campers, yachtsmen, travelers or Boy Scouts; in fact, to anyone having occasion to use or handle rope or knots for any purpose. The book is thoroughly reliable and practical, and is not only a guide but a teacher. It is the standard work on the subject. Second edition revised. 104 pages, 154 original engravings. **Price, \$1.00**

LATHE WORK

Lathe Work for Beginners.

By **RAYMOND F. YATES.** A book for those interested in lathe work which opens up a new world for the amateur worker in wood and metal. It will prove a valuable aid also to the young machinist or apprentice who intends to make lathe work his occupation. It foresees all his questions, and its answers go straight to the heart of his difficulty. This book shows the reader how to set up his lathe, explains the various tools and the correct way of using them, and makes plain the different lathe attachments and their applications. The lessons range from the turning of a brass cup to the completion of a model rapid-fire gun, and milling, gear-cutting, thread-cutting, sawing and grinding are set forth with refreshing simplicity. Among the chapters contained are: I Choosing a Lathe. II Setting up and Driving the Lathe. III The Lathe and Its Parts. IV Lathe Attachments and Their Use. V Measuring Tools and Their Use. VI A Lesson in Metal Turning. VII Advanced Lathe Work. VIII Screw Cutting. IX Wood Turning. X Metal Spinning. XI Building an Amateurs Metal Turning Lathe. XII Building a Simple Wood Turning Lathe. XIII A Model Rapid-Fire Naval Gun. 167 illustrations. **\$2.50**

The Lathe—Its Design, Construction and Operation, With Practical Examples of Lathe Work.

By **OSCAR E. PERRIGO.** A new revised edition, and the only complete American work on the subject. Lathe history and the relations of the lathe to manufacturing are given; also a description of the various devices for feeds and thread cutting mechanisms from early efforts in this direction to the present time. Lathe design is thoroughly discussed, including back gearing, driving cones, thread-cutting gears, and all the essential elements of the modern lathe. The classification of lathes is taken up, giving the essential differences of the several types of lathes, including, as is usually understood, engine lathes, bench lathes, speed lathes, forge lathes, gap lathes, pulley lathes, forming lathes, multiple-spindle lathes, rapid-reduction lathes, precision lathes, turret lathes, special lathes, electrically-driven lathes, etc. In addition to the complete exposition on construction and design, much practical matter on lathe installation, care and operation has been incorporated in the enlarged new edition. All kinds of lathe attachments for drilling, milling, etc., are described and complete instructions are given to enable the novice machinist to grasp the art of lathe operation as well as the principles involved in design. A number of difficult machining operations are described at length and illustrated. The new edition has 469 pages and 341 illustrations. **Price, \$3.00**

Turning and Boring Tapers.

By **FRED H. COLVIN.** There are two ways to turn tapers: the right way and one other. This treatise has to do with the right way; it tells you how to start the work properly, how to set the lathe, what tools to use and how to use them, and forty and one other little things that you should follow. **Fourth edition. Price, 35 cents**

LIQUID AIR

Liquid Air and the Liquefaction of Gases.

By T. O'CONNOR SLOANE. The third revised edition of this book has just been issued. Much new material is added to it; and the all important uses of liquid air and gas processes in modern industry, in the production especially of nitrogen compounds, are described. The book gives the history of the theory, discovery and manufacture of Liquid Air, and contains an illustrated description of all the experiments that have excited the wonder of audiences all over the country. It shows how liquid air, like water, is carried hundreds of miles and is handled in open buckets. It tells what may be expected from it in the near future. A book that renders simple one of the most perplexing chemical problems of the century. Startling developments illustrated by actual experiments. It is not only a work of scientific interest and authority, but is intended for the general reader, being written in a popular style—easily understood by everyone. 394 pages, fully illustrated. New Edition. Price, \$3.00

LOCOMOTIVE ENGINEERING

Air-Brake Catechism.

By ROBERT H. BLACKALL. This book is a standard text book. It is the only practical and complete work published. Treats on the equipment manufactured by the Westinghouse Air Brake Company, including the E-T Locomotive Brake Equipment, the K (Quick Service) Triple Valve for freight service; the L High Speed Triple Valve; the P-C Passenger Brake Equipment, and the Cross Compound Pump. The operation of all parts of the apparatus is explained in detail and a practical way of locating their peculiarities and remedying their defects is given. Endorsed and used by air-brake instructors and examiners on nearly every railroad in the United States. Twenty-seventh edition. 411 pages, fully illustrated with folding plates and diagrams. New edition. Price, \$2.50

Westinghouse E. T. Air-Brake Instruction Pocketbook Catechism.

By WM. W. WOOD, Air-Brake Instructor. A practical work containing examination questions and answers on the E. T. Equipment. Covering what the E. T. Brake is. How it should be operated. What to do when defective. Not a question can be asked of the engineman up for promotion on either the No. 5 or the No. 6 E. T. equipment that is not asked and answered in the book. If you want to thoroughly understand the E. T. equipment get a copy of this book. It covers every detail. Makes air-brake troubles and examinations easy. Fully illustrated with colored plates, showing various pressures. Some of these plates are printed in 16 different colors. This is the standard Book on the E. T. Air-Brake. Cloth. Revised and enlarged edition. \$2.50

Link Motions, Valves and Valve Setting.

By FRED H. COLVIN, Associate Editor of "American Machinist." A handy book that clears up the mysteries of valve setting. Shows the different valve gears in use, how they work, and why. Piston and slide valves of different types are illustrated and explained. A book that every railroad man in the motive-power department ought to have. Fully illustrated. New revised edition recently published.

Price, 75 cents

Train Rule Examinations Made Easy.

By G. E. COLLINGWOOD. This is the only practical work on train rules in print. Every detail is covered, and puzzling points are explained in simple, comprehensive language, making it a practical treatise for the train dispatcher, engineman, train man and all others who have to do with the movements of trains. Contains complete and reliable information of the Standard Code of Train Rules for single track. Shows signals in colors, as used on the different roads. Explains fully the practical application of train orders, giving a clear and definite understanding of all orders which may be used. Second edition revised. 234 pages. Fully illustrated, with train signals in colors.

Price, \$1.50

Locomotive Breakdowns and Their Remedies.

By GEO. L. FOWLER. Revised by Wm. W. Wood, Air-Brake Instructor. Pocket edition. It is out of the question to try and tell you about every subject that is covered in this pocket edition of Locomotive Breakdowns. Just imagine all the common troubles that an engineer may expect to happen some time, and then add all of the unexpected ones, troubles that could occur, but that you had never thought about, and you will find that they are all treated with the very best methods of repair. Walschaert Locomotive Valve Gear Troubles, Electric Headlight Troubles, as well as Questions and Answers on the Air Brake, are all included. Eighth edition. 294 pages. Fully illustrated.

Price, \$1.50

Practical Instructor and Reference Book for Locomotive Firemen and Engineers.

By CHAS. F. LOCKHART. An entirely new book on the locomotive. It appeals to every railroad man, as it tells him how things are done and the right way to do them. Written by a man who has had years of practical experience in locomotive shops and on the road firing and running. The information given in this book cannot be found in any other similar treatise. Eight hundred and fifty-one questions with their answers are included, which will prove specially helpful to those preparing for examination. 362 pages, 88 illustrations. Cloth.

Price, \$2.50

Diary of a Round-House Foreman.

By T. S. REILLY. This is the greatest book of railroad experiences ever published. Containing a fund of information and suggestions along the line of handling men, organizing, etc., that one cannot afford to miss. 176 pages.

\$1.25

Locomotive Boiler Construction.

By **FRANK A. KLEINHANS**. The only book showing how locomotive boilers are built in modern shops. Shows all types of boilers used; gives details of construction; practical facts, such as life of riveting punches and dies, work done per day, allowance for bending and flanging sheets and other data that means dollars to any railroad man. Second edition. 451 pages, 334 illustrations. Six folding plates. Cloth.

Price, \$3.50

Prevention of Railroad Accidents, or Safety in Railroadng.

By **GEORGE BRADSHAW**. This book is a heart-to-heart talk with railroad employees, dealing with facts, not theories, and showing the men in the ranks from every-day experience, how accidents occur and how they may be avoided. The book is illustrated with seventy original photographs and drawings showing the safe and unsafe methods of work. No visionary schemes, no ideal pictures. Just plain facts and practical suggestions are given. Every railroad employee who reads the book is a better and safer man to have in railroad service. It gives just the information which will be the means of preventing many injuries and deaths. All railroad employees should procure a copy, read it, and do their part in preventing accidents. 169 pages. Pocket size. Fully illustrated.

Price, 50 cents

Combustion of Coal and the Prevention of Smoke.

By **WM. M. BARR**. To be a success a fireman must be "Light on Coal." He must keep his fire in good condition, and prevent, as far as possible, the smoke nuisance. To do this, he should know how coal burns, how smoke is formed and the proper burning of fuel to obtain the best results. He can learn this, and more too, from Barr's "Combustion of Coal." It is an absolute authority on all questions relating to the firing of a locomotive. Fifth edition. Nearly 350 pages, fully illustrated.

Price, \$1.50

Walschaert Locomotive Valve Gear.

By **WM. W. WOOD**. If you would thoroughly understand the Walschaert Valve Gear, you should possess a copy of this book. The author divides the subject into four divisions, as follows: I. Analysis of the gear. II. Designing and erection of the gear. III. Advantages of the gear. IV. Questions and answers relating to the Walschaert Valve Gear. This book is specially valuable to those preparing for promotion. Third 1920 edition, revised and enlarged. 245 pages, fully illustrated. Cloth.

Price, \$2.50

Locomotive Engine Running and Management.

By ANGUS SINCLAIR, M.E., formerly Editor "Railway and Locomotive Engineering." Shows how to manage a locomotive, describes its parts and gives instructions for the care, and repairs of locomotives and their connections. CONTENTS:—Engineers and Their Duties. How Engineers Are Made. Inspection of the Locomotive. Getting Ready for the Road. Running a Fast Freight Train. Getting Up the Hill. Finishing the Trip. Hard-Steaming Engines. Shortness of Water. Boilers and Fireboxes. Accidents. Connecting-Rods, Side-Rods and Wedges. Valve Motion. Setting the Valves. The Westinghouse Air-Brake. Tractive Power and Train Resistance. Draft Appliances. Combustion. Steam and Motive-Power. Sight-Feed. Lubricators. Examination of Firemen for Promotion. Revised Twenty-Third Edition, 436 pages, illustrated. Price, \$3.00

Locomotives, Simple, Compound, and Electric.

By H. C. REAGAN, Locomotive Engineer. Describes the design, construction, operation, and repair of every type of locomotive. Very fully illustrated. CONTENTS:—Locomotive Boiler. Front End. Steam Cylinders and Connection. Frames, Driving-Boxes, and Spring Rigging. Rods and Connections. Valve Gearing. Compound Locomotive. Indicator-Cards. Superheaters. Injectors, Brakes and Brake Rigging. Liquid Fuel. Electric Locomotives. Apparatus Essential to the Operation of Electric Locomotives, Electric Control Systems. Typical Electric Engines. Fifth Edition, 932 pages. Price, \$3.50

Practical Locomotive Running and Management.

By W. GEO. KNIGHT. A practical book for the railroad man, specially helpful to those preparing for examination. The new second revised edition of this work deals with the principles of locomotive engineering in a practical manner, and explains fully and clearly those subjects that are usually difficult to understand by men who actually operate and maintain locomotives. The book is profusely illustrated and includes many reproductions of drawings and models used by the author as an instructor for the purposes of making clear the principles that underlie the construction and operation of the various parts of the locomotive engine. The simplicity in which these hard problems are treated has made the work very popular. Those preparing for an examination for locomotive engineer or fireman will find this volume most helpful. 541 Pages, 169 illustrations. Price, \$4.00

MACHINE SHOP PRACTICE

Complete Practical Machinist.

By JOSHUA ROSE. The new, twentieth revised and enlarged edition is now ready. This is one of the best-known books on machine-shop work, and written for the practical workman in the language of the workshop. It gives full, practical instructions on the use of all kinds of metal-working tools, both hand and machine, and tells how the work should be properly done. It covers lathe work, vise work, drills and drilling, taps and dies, hardening and tempering, the making and use of tools, tool grinding, marking out work, machine tools, etc. No machinist's library is complete without this volume. 547 pages, 432 illustrations. Price, \$3.00

Abrasives and Abrasive Wheels.

By FRED B. JACOBS. A new book for everyone interested in abrasives or grinding. A careful reading of the book will not only make mechanics better able to use abrasives intelligently, but it will also tell the shop superintendent of many short cuts and efficiency-increasing kinks. The economic advantage in using large grinding wheels are fully explained, together with many other things that will tend to give the superintendent or workman a keen insight into abrasive engineering. 340 pages, 174 illustrations. This is an indispensable book for every machinist. **Price, \$3.00**

Machine Shop Arithmetic.

By COLVIN-CHENEY. Most popular book for shop men. Shows how all shop problems are worked out and "why." Includes change gears for cutting any threads; drills, taps; metric system of measurements and threads. Used by all classes of mechanics and for instruction in Y. M. C. A. and other schools. Seventh edition. 131 pages. **Price, 75 cents**

"Shop Kinks."

By ROBERT GRIMSHAW. This shows special methods of doing work of various kinds, and releasing cost of production. Has hints and kinks from some of the largest shops in this country and Europe. You are almost sure to find some that apply to your work, and in such a way as to save time and trouble. 393 pages. Fifth edition. Illustrated. Cloth. **Price, \$3.00**

Home Mechanic's Workshop Companion.

By ANDREW JACKSON, JR. This treatise includes a compilation of useful suggestions that cannot fail to interest the handy man, and while it is not intended for mechanical experts or scientists, it will prove to be a veritable store of information for anyone who desires to rig up a small shop where odd jobs can be carried on. **Price, 75 cents**

Threads and Thread Cutting.

By COLVIN and STABEL. This clears up many of the mysteries of thread cutting, such as double and triple threads, internal threads, catching threads, use of hobs, etc. Contains a lot of useful hints and several tables. Third edition. **35 cents**

Shop Practice for Home Mechanics.

By RAYMOND FRANCIS YATES. A thoroughly practical and helpful book prepared especially for those who have had little or no experience in shop work. The introduction is given over to an elementary explanation of the fundamentals of mechanical science. This is followed by several chapters on the use of small tools and mechanical measuring instruments. Elementary and more advanced lathe work is treated in detail and directions given for the construction of a number of useful shop appliances. Drilling and reaming, heat treatment of tool steel, special lathe operations, pattern making, grinding, and grinding operations, home foundry work, etc., make up the rest of the volume. The book omits nothing that will be of use to those who use tools or to those who wish to learn the use of tools. The great number of clear engravings add much to the text matter and to the value of the volume as a visual instructor. Size 6 x 9. 320 pages. 309 engravings. New Edition. **Price, \$3.00**

THE WHOLE FIELD OF MECHANICAL MOVEMENTS IS COVERED BY HISCOX'S TWO BOOKS.

We publish two books by Gardner D. Hiscox that will keep you from "inventing" things that have been done before and suggest ways of doing things that you have not thought of before. Many a man spends time and money pondering over some mechanical problem, only to learn, after he has solved the problem, that the same thing has been accomplished and put in practice by others long before. Time and money spent in an effort to accomplish what has already been accomplished are time and money lost. The whole field of mechanics, every known mechanical movement, and practically every device is covered by these two books. If the thing you want has been invented, it is illustrated in them. If it hasn't been invented, then you'll find in them the nearest things to what you want, some movement or device that will apply in your case, perhaps; or which will give you a key from which to work. *No book or set of books ever published is of more real value to the inventor, draftsman or practical mechanic than these two volumes.*
Each book sold separately.

Mechanical Movements, Powers and Devices.

By GARDNER D. HISCOX. This is a collection of 1,890 engravings of different mechanical motions and appliances, accompanied by appropriate text, making it a book of great value to the inventor, the draftsman, and to all readers with mechanical tastes. The book is divided into eighteen sections or chapters, in which the subject-matter is classified under the following heads: Mechanical Powers; Transmission of Power; Measurement of Power; Steam Power; Air Power Appliances; Electric Power and Construction; Navigation and Roads; Gearing; Motion and Devices; Controlling Motion; Horological; Mining; Mill and Factory Appliances; Construction and Devices; Drafting Devices; Miscellaneous Devices, etc. Fifteenth edition. 409 octavo pages.

Price, \$4.00

Mechanical Appliances, Mechanical Movements and Novelties of Construction.

By GARDNER D. HISCOX. This is a supplementary volume to the one upon mechanical movements. Unlike the first volume, which is more elementary in character, this volume contains illustrations and descriptions of many combinations of motions and of mechanical devices and appliances found in different lines of machinery, each device being shown by a line drawing with a description showing its working parts and the method of operation. From the multitude of devices described and illustrated might be mentioned, in passing, such items as conveyors and elevators, Prony brakes, thermometers, various types of boilers, solar engines, oil-fuel burners, condensers, evaporators, Corliss and other valve gears, governors, gas engines, water motors of various descriptions, air ships, motors and dynamos, automobiles and motor bicycles, railway lock signals, car couplers, link and gear motions, ball bearings, breech block mechanism for heavy guns, and a large accumulation of others of equal importance. 1,000 specially made engravings. 396 octavo pages. Fourth revised edition. **Price, \$4.00**

MACHINE SHOP PRACTICE

Modern Machine Shop Construction, Equipment and Management.

By OSCAR E. PERRIGO. The only work published that describes the Modern Machine Shop or Manufacturing Plant from the time the grass is growing on the site intended for it until the finished product is shipped. Just the book needed by those contemplating the erection of modern shop buildings, the rebuilding and reorganization of old ones or the introduction of Modern Shop Methods, Time and Cost Systems. It is a book written and illustrated by a practical shop man for practical shop men who are too busy to read theories and want facts. It is the most complete all-around book of its kind ever published. Second edition. 384 pages, 219 original and specially-made illustrations. **Price, \$5.00**

Machine Shop Tools and Shop Practice.

By W. H. VANDERVOORT. A work of 555 pages and 673 illustrations, describing in every detail the construction, operation and manipulation of both hand and machine tools. Includes chapters on filing, fitting, and scraping surfaces; on drills, reamers, taps, and dies; the lathe and its tools; planers, shapers, and their tools; milling machines and cutters; gear cutters and gear cutting; drilling machines and drill work; grinding machines and their work; hardening and tempering; gearing, belting, and transmission machinery; useful data and tables. Seventh edition. Cloth. **Price, \$4.50**

American Tool Making and Interchangeable Manufacturing.

By J. V. WOODWORTH. In its 500-odd pages the one subject only, Tool Making, and whatever relates thereto, is dealt with. The work stands without a rival. It is a complete practical treatise on the art of American Tool Making and system of interchangeable manufacturing as carried on to-day in the United States. In it are described and illustrated all of the different types and classes of small tools, fixtures, devices and special appliances which are in general use in all machine-manufacturing and metal-working establishments where economy, capacity and interchangeability in the production of machined metal parts are imperative. The science of jig making is exhaustively discussed, and particular attention is paid to drill jigs, boring, profiling and milling fixtures and other devices in which the parts to be machined are located and fastened within the contrivances. All of the tools, fixtures and devices illustrated and described have been or are used for the actual production of work, such as parts of drill presses, lathes, patented machinery, typewriters, electrical apparatus, mechanical appliances, brass goods, composition parts, mold products, sheet metal articles, drop forgings, jewelry, watches, medals, coins, etc. Third edition. 535 pages and 601 specially made engravings. **Price, \$4.50**

MARINE ENGINEERING

The Naval Architect's and Shipbuilder's Pocket-book.

of Formulae, Rules, and Tables, and Marine Engineer's and Surveyor's Handy Book of Reference. By CLEMENT MACKROW and LLOYD WOOLLARD. The eleventh revised and enlarged edition of this most comprehensive work has just been issued. It is absolutely indispensable to all engaged in the Shipbuilding Industry, as it condenses into a compact form all data and formulae that are ordinarily required. The book is completely up to date, including among other subjects a section on Aeronautics. 750 pages, limp leather binding.

Price, \$6.00 net

Marine Engines and Boilers, Their Design and Construction. The Standard Book.

By DR. G. BAUER, LESLIE S. ROBERTSON and S. BRYAN DONKIN. In the words of Dr. Bauer, the present work owes its origin to an oft felt want of a condensed treatise embodying the theoretical and practical rules used in designing marine engines and boilers. The work is clearly written, thoroughly systematic, theoretically sound; while the character of the plans, drawings, tables and statistics is without reproach. The illustrations are careful reproductions from actual working drawings, with some well-executed photographic views of completed engines and boilers. 744 pages, 550 illustrations, and numerous tables.

Price, \$10.00 net

MANUAL TRAINING

Economics of Manual Training.

By LOUIS ROUILLION. The only book that gives just the information needed by all interested in manual training, regarding buildings, equipment and supplies. Shows exactly what is needed for all grades of the work from the Kindergarten to the High and Normal School. Gives itemized lists of everything needed and tells just what it ought to cost. Also shows where to buy supplies. Illustrated. Second edition. Cloth.

Price, \$2.00

MINING

Prospector's Field-Book and Guide.

By H. S. OSBORN. New 1920 edition, revised and enlarged by M. W. von Bernewitz. The last edition of this volume was published in 1910. It and the previous seven editions were suitable for those times. The new ninth edition will be found suitable for the present time. While the old-time prospector will always be an important factor, the knowledge of and search for the common and rarer minerals is bringing out men who are trained to some degree. In the field they need a handy and suggestive pocket-book containing hints on prospecting—where to search and how to test—couched in simple terms. 375 pages. 57 illustrations. New edition.

Price, \$3.00

MODEL MAKING

Model Making.

By **RAYMOND FRANCIS YATES**. A new book for the mechanic and model maker. This is the first book of its kind to be published in this country, and all those interested in model engineering should have a copy. The first eight chapters are devoted to such subjects as Silver Soldering, Heat Treatment of Steel, Lathe Work, Pattern Making, Grinding, etc. The remaining twenty-four chapters describe the construction of various models such as rapid fire naval guns, speed boats, model steam engines, turbines, etc. 400 pages. 301 illustrations. **Price, \$3.00**

MOTOR BOATS

Motor Boats and Boat Motors.

By **V. W. PAGÉ** and **A. C. LEITCH**. All who are interested in motor boats will find this latest work a most comprehensive treatise on the design, construction, operation and repair of motor boats and their power plants. It is really two complete books in one cover, as it consists of two parts, each complete in itself. Part one deals with **THE HULL AND ITS FITTINGS**, part two considers **THE POWER PLANT AND ITS AUXILIARIES**. A valuable feature of this book is the complete set of dimensioned working drawings detailing the construction of five different types of boats ranging from a 16-foot shallow draft, tunnel stern general utility craft to a 25-foot cabin cruiser. It is a comprehensive work of reference for all interested in motor boating in any of its phases. 372 illustrations. 524 pages. New Edition.

Price, \$4.00

MOTORCYCLES

Motorcycles and Side Cars: Their Construction, Management and Repair.

By **VICTOR W. PAGÉ**. Describes fully all leading types of machines, their design, construction, maintenance, operation and repair. Shows all new improvements in motorcycle construction and gives the most complete instructions ever published for starting, driving and repairing all types of motorcycles. There is a complete exposition of modern starting methods and a full explanation of the operating principles and repair of the new automatic electric lighting systems. The care of the generator, storage battery, automatic cut-out and other parts is clearly expounded. All types of change speed gears and clutches are fully outlined, also full instructions for their use. A complete new chapter has been added on the thorough overhauling and repairing of motorcycle engines, all processes are fully described and illustrated. The reader is told what parts wear, how to detect depreciation and how to make all repairs and adjustments necessary to make the engine as good as new. 693 pages, 371 illustrations. New Revised and Enlarged Edition. **Price, \$3.00**

PATTERN MAKING

Practical Pattern Making.

By F. W. BARROWS. This book is a comprehensive and entirely practical treatise on the subject of pattern making, illustrating pattern work in both wood and metal, and with definite instructions on the use of plaster of paris in the trade. It gives specific and detailed descriptions of the materials used by pattern makers and describes the tools; both those for the bench and the more interesting machine tools; having complete chapters on the lathe, the circular saw and the band saw. It gives many examples of pattern work. Nearly 350 pages, 170 illustrations. Third, 1922, edition, revised and enlarged. **Price, \$2.50**

PERFUMERY

Perfumes and Cosmetics, Their Preparation and Manufacture.

By G. W. ASKINSON, Perfumer. A comprehensive treatise, in which there has been nothing omitted that could be of value to the perfumer or manufacturer of toilet preparations. Complete directions for making handkerchief perfumes, smelling-salts, sachets, fumigating pastils; preparations for the care of the skin, the mouth, the hair, cosmetics, hair dyes and other toilet articles are given, also a detailed description of aromatic substances; their nature, tests of purity, and wholesale manufacture, including a chapter on synthetic products, with formulas for their use. A book of general as well as professional interest, meeting the wants not only of the druggist and perfume manufacturer, but also of the general public. Fourth edition, much enlarged and brought up-to-date. 354 pages, illustrated. **Price, \$5.00**

PLUMBING

Plumbers, Steam Fitters, and Tinnerns Reference Book.

By H. G. RICHKY. This book should be in the hands of all connected with the Plumbing or Steam Heating Trades. It is a most comprehensive work and written by a man who understands the subject thoroughly and who has gathered in its pages just such matter as can be turned to when help is needed. Contains 529 pages, fully illustrated, pocket-book form. **Price, \$3.00**

Standard Practical Plumbing.

By R. M. STARBUCK. This is a complete treatise and covers the subject of Modern Plumbing in all its branches. It treats exhaustively on the skilled work of the plumber and the theory underlying plumbing devices and operations. It commends itself to anyone working in the plumbing trade. A large amount of space is devoted to a practical treatment of hot water supply, circulation and range boiler work. Another valuable feature is the special chapter on drawing for plumbers. The book has 406 pages, including 347 illustrations—100 of which are full page plates which were made expressly for this book and show the most modern American practice in plumbing construction. $6\frac{1}{2} \times 9\frac{1}{4}$. **Price, \$3.50**

Mechanical Drawing for Plumbers.

By R. M. STARBUCK. A concise, comprehensive and practical treatise on the subject of mechanical drawing in its various modern applications to the work of all who are in any way connected with the plumbing trade. Nothing will so help the plumber in estimating and in explaining work to customers and workmen as a knowledge of drawing, and to the workman it is of inestimable value if he is to rise above his position to positions of greater responsibility. 150 illustrations.

Price, \$2.00

Modern Plumbing Illustrated.

By R. M. STARBUCK. The author of this book, Mr. R. M. Starbuck, is one of the leading authorities on plumbing in the United States. The book represents the highest standard of plumbing work. A very comprehensive work, illustrating and describing the drainage and ventilation of dwellings, apartments and public buildings. The very latest and most approved methods in all branches of sanitary installation are given. The standard book for master plumbers, architects, builders, plumbing inspectors, boards of health, boards of plumbing examiners and for the property owner, as well as the workman and apprentice. It contains fifty-seven entirely new and large full pages of illustrations with descriptive text, all of which have been made specially for this work. These plates show all kinds of modern plumbing work. Each plate is accompanied by several pages of text, giving notes and practical suggestions, sizes of pipe, proper measurements for setting up work, etc. Suggestions on estimating plumbing construction are also included. 407 octavo pages, fully illustrated by 58 full-page plates of engravings.

Price, \$5.00

RECIPE BOOK

Henley's Twentieth Century Book of Recipes, Formulas and Processes.

Edited by GARDNER D. HISCOX. The most valuable technological formulae book published, including over 10,000 selected scientific, chemical, technological and practical recipes and processes. This book of 800 pages is the most complete book of recipes ever published, giving thousands of recipes for the manufacture of valuable articles for every-day use. Hints, helps, practical ideas and secret processes are revealed within its pages. It covers every branch of the useful arts and tells thousands of ways of making money and is just the book everyone should have at his command. The pages are filled with matters of intense interest and immeasurable practical value to the photographer, the perfumer, the painter the manufacturer of glues, pastes, cements and mucilages, the physician, the druggist, the electrician, the dentist, the engineer, the foundryman, the machinist, the potter, the tanner, the confectioner, the chiropodist, the manufacturer of chemical novelties and toilet preparations, the dyer, the electroplater, the enameler, the engraver, the provisioner, the glass worker, the gold-beater, the watchmaker, the jeweler, the ink manufacturer, the optician, the farmer, the dairyman, the paper maker, the metal worker, the soap maker, the veterinary surgeon, and the technologist in general. A book to which you may turn with confidence that you will find

what you are looking for. A mine of information up-to-date in every respect. Contains an immense number of formulas that every one ought to have that are not found in any other work. New 1921 edition. 807 octavo pages. Cloth binding. **Price, \$4.00**

RUBBER

Rubber Hand Stamps and the Manipulation of India Rubber.

By T. O'CONNOR SLOANE. This book gives full details of all points, treating in a concise and simple manner the elements of nearly everything it is necessary to understand for a commencement in any branch of the India rubber manufacture. The making of all kinds of rubber hand stamps, small articles of India rubber, U. S. Government composition, dating hand stamps, the manipulation of sheet rubber, toy balloons, India rubber solutions, cements, blackings, renovating varnish, and treatment for India rubber shoes, etc.; the hektograph stamp inks, and miscellaneous notes, with a short account of the discovery, collection and manufacture of India rubber are set forth in a manner designed to be readily understood, the explanation being plain and simple. Third edition. 175 pages, illustrated. **Price, \$1.50**

SAWS

Saw Filing and Management of Saws.

By ROBERT GRIMSHAW. A practical hand-book on filing, gumming, swaging, hammering and the brazing of band saws, the speed, work, and power to run circular saws, etc. A handy book for those who have charge of saws, or for those mechanics who do their own filing, as it deals with the proper shape and pitches of saw teeth of all kinds and gives many useful hints and rules for gumming, setting, and filing, and is a practical aid to those who use saws for any purpose. Fourth edition, revised and enlarged. Illustrated. **Price, \$1.50**

SCREW CUTTING

Threads and Thread Cutting.

By COLVIN and STABLE. This clears up many of the mysteries of thread cutting, such as double and triple threads, internal threads, catching threads, use of hobs, etc. Contains a lot of useful hints and several tables. Third edition.

Price, 35 cents

STEAM ENGINEERING

American Stationary Engineering.

By W. E. CRANE. A new book by a well-known author. Begins at the boiler room and takes in the whole power plant. Contains the result of years of practical experience in all sorts of engine rooms and gives exact information that cannot be found elsewhere. It's plain enough for practical men and yet of value to those high in the profession. Has a complete examination for a license. Third edition revised and enlarged. 311 pages, 131 illustrations. Cloth. **Price, \$2.50**

Steam Engine Troubles.

By H. HAMKENS. It is safe to say that no book has ever been published which gives the practical engineer such valuable and comprehensive information on steam engine design and troubles. There are descriptions of cylinders, valves, pistons, frames, pillow blocks and other bearings, connecting rods, wristplates, dashpots, reachrods, valve gears, governors, piping, throttle and emergency valves, safety stops, flywheels, oilers, etc. If there is any trouble with these parts, the book gives you the reasons and tell how to remedy them. New Edition. 284 pages, 276 illustrations.

Price, \$2.50

Modern Steam Engineering in Theory and Practice.

By GARDNER D. HISCOX. This is a complete and practical work issued for stationary engineers and firemen dealing with the care and management of boilers, engines, pumps, superheated steam, refrigerating machinery, dynamos, motors, elevators, air compressors, and all other branches with which the modern engineer must be familiar. Nearly 200 questions with their answers on steam and electrical engineering, likely to be asked by the examining board, are included. Fourth edition. 487 pages, 405 engravings. Cloth.

Price, \$3.50

Steam Engineer's Arithmetic.

By COLVIN-CHENEY. A practical pocket book for the steam engineer. Shows how to work the problems of the engine room and shows "why." Tells how to figure horse-power of engines and boilers; area of boilers; has tables of areas and circumferences; steam tables; has a dictionary of engineering terms. Puts you onto all of the little kinks in figuring whatever there is to figure around a power plant. Tells you about the heat unit; absolute zero; adiabatic expansion; duty of engines; factor of safety; and 1,001 other things; and everything is plain and simple—not the hardest way to figure, but the easiest. Second edition.

Price, 75 cents

Steam Engine Catechism.

By ROBERT GRIMSHAW. This volume of 413 pages is not only a catechism on the question and answer principle, but it contains formulas and worked-out answers for all the steam problems that appertain to the operation and management of the steam engine. Sixteenth edition.

Price, \$2.00

Engine Runner's Catechism.

By ROBERT GRIMSHAW. Tells how to erect, adjust and run the principal steam engines in use in the United States. The work is of a handy size for the pocket. To young engineers this catechism will be of great value, especially to those who may be preparing to go forward to be examined for certificates of competency; and to engineers generally it will be of no little service, as they will find in this volume more really practical and useful information than is to be found anywhere else within a like compass. 387 pages. Seventh edition.

Price, \$2.00

STEAM HEATING and VENTILATING

Practical Steam, Hot-Water Heating and Ventilation.

By A. G. KING. This book has been prepared for the use of all engaged in the business of steam, hot-water heating and ventilation. Tells how to get heating contracts, how to install heating and ventilating apparatus, the best business methods to be used, with "Tricks of the Trade" for shop use. Rules and data for estimating radiation and cost and such tables and information as make it an indispensable work for everyone interested in steam, hot-water heating and ventilation. It describes all the principal systems of steam, hot-water, vacuum, vapor and vacuum-vapor heating, together with the new accelerated systems of hot-water circulation, including chapters on up-to-date methods of ventilation and the fan or blower system of heating and ventilation. Third edition. 402 pages, 300 detailed engravings. **Price, \$3.50**

500 Plain Answers to Direct Questions on Steam, Hot-Water, Vapor and Vacuum Heating Practice.

By ALFRED G. KING. This work is arranged in question and answer form; it is intended as a guide and text-book for the younger inexperienced fitter and as a reference book for all fitters. All long and tedious discussions and descriptions formerly considered so important have been eliminated, and the theory and laws of heat and the various old and modern methods and appliances used for heating and ventilating are treated in a concise manner. This is the standard Question and Answer examination book on Steam and Hot Water Heating, etc. 214 pages, 127 illustrations. Octavo. Cloth. **Price, \$2.00**

STEEL

Hardening, Tempering, Annealing and Forging of Steel.

By J. V. WOODWORTH. A book containing special directions for the successful hardening and tempering of all steel tools. Milling cutters, taps, thread dies, reamers, both solid and shell, hollow mills, punches and dies, and all kinds of sheet-metal working tools, shear blades, saws, fine cutlery and metal-cutting tools of all descriptions, as well as for all implements of steel, both large and small, the simplest, and most satisfactory hardening and tempering processes are presented. 320 pages, 215 illustrations. Fifth revised edition. Cloth. **Price, \$3.00**

Steel: Its Selection, Annealing, Hardening and Tempering.

By E. R. MARKHAM. This work was formerly known as "The American Steel Worker." This is the standard work on hardening, tempering, and annealing steel of all kinds. This book tells how to select, and how to work, temper, harden, and anneal steel for everything on earth. It is the standard book on selecting hardening, and tempering all grades of steel. 400 pages. Very fully illustrated. Fourth edition. **Price, \$3.00**

TRACTORS

Modern Gas Tractor: Its Construction, Utility, Operation and Repair.

By VICTOR W. PAGÉ. An enlarged and revised edition that treats exclusively on the design and construction of farm tractors and tractor power plants, and gives complete instructions on their care, operation and repair. All types and sizes of gasoline, kerosene and oil tractors are described, and every phase of traction engineering practice fully covered. Invaluable to all desiring reliable information on gas motor propelled traction engines and their use. All new 1922 types of tractors are described and complete instructions are given for their use on the farm. Valuable information compiled by Government experts on laying out fields for tractor plowing and numerous practical suggestions for hitches so all types of agricultural machinery can be operated by tractors are outlined. Full instructions are also given for using kerosene and distillate as fuel. 600 pages, 300 illustrations, 3 folding plates. **Price, \$3.00**

WELDING

Oxy-Acetylene Welding and Cutting with a Treatise on Acetylene and Oxygen.

By P. F. WILLIS. The 6th revised and much enlarged edition of this book is just off the press. It is a very complete work, written in simple language, fully illustrated with engravings showing how to prepare the work, as well as the actual welding of it. Special chapters treating on Acetylene Oxygen Welding and Cutting, Torch Apparatus and Installation, Preparing for Welding, Welding of Different Metals, Welding of Sheet Metal and Pipe, Welding of Boilers, Welding of Various Pieces, Electric Welding, Automobile and miscellaneous welding are contained, as well as other valuable data. 250 pages. Fully illustrated. **Price, \$1.50**

Modern Welding Methods.

By VICTOR W. PAGÉ. It considers in detail oxy-acetylene welding, the Thermit process and all classes of electric arc and resistance welding. It shows all the apparatus needed and how to use it. It considers the production of welding gases, construction and operation of welding and cutting torches of all kinds. It details the latest approved methods of preparing work for welding. All forms of gas and electric welding machines are described and complete instructions are given for installing electric spot and butt welders. Cost data are given and all methods of doing the work economically are described. It includes instructions for forge and dip brazing and manufacture of hard solders and spelters. It shows and explains soft soldering processes and tells how to make solders for any use. Complete instructions are given for soldering aluminum and authoritative formulas for aluminum solders are included. 292 pages. 200 illustrations. New edition. **Price, \$3.00**

Automobile Welding with Oxy-Acetylene Flame.

By M. KEITH DUNHAM. (See page 5 for full description.) **Price, \$1.50**

**The Most Valuable Techno-Chemical Recipe
Book Ever Offered to the Public!**

Henley's Twentieth Century Book of RECIPES, FORMULAS AND PROCESSES

Price \$4.00

THIS book of 800 pages is the most complete Book of Recipes ever published, giving thousands of recipes for the manufacture of valuable articles for every-day use. Hints, Helps, Practical Ideas and Secret Processes are revealed within its pages. It covers every branch of the useful arts and tells thousands of ways of making money and is just the book everyone should have at his command.

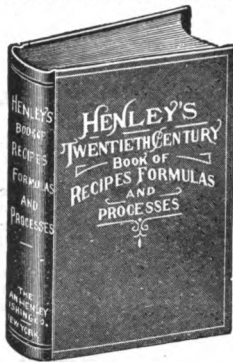

The pages are filled with matters of intense interest and immeasurable practical value to the Photographer, the Perfumer, the Painter, the Manufacturer of Glues, Pastes, Cements and Mucilages, the Physician, the Druggist, the Electrician, the Dentist, the Engineer, the Foundryman, the Machinist, the Potter, the Tanner, the Confectioner, the Chiropodist, the Manufacturer of Chemical Novelties and Toilet Preparations, the Dyer, the Electroplater, the

Enameler, the Engraver, the Provisioner, the Glass Worker, the Goldbeater, the Watchmaker and Jeweler, the Ink Manufacturer, the Optician, the Farmer, the Dairyman, the Paper Maker, the Metal Worker, the Soap Maker, the Veterinary Surgeon and the Technologist in general.

A book to which you may turn with confidence that you will find what you are looking for. A mine of information, up-to-date in every respect. Contains an immense number of formulas that everyone ought to have that are not found in any other work.

**10,000 Practical Formulas and Processes
The Best Way to Make Everything**

**ONE USEFUL RECIPE WILL BE WORTH MORE
THAN TEN TIMES THE PRICE OF THE BOOK**

(See page 35 for further description of the book.)

The borrower must return this item on or before the last date stamped below. If another user places a recall for this item, the borrower will be notified of the need for an earlier return.

Non-receipt of overdue notices does not exempt the borrower from overdue fines.

**Harvard College Widener Library
Cambridge, MA 02138 617-495-2413**

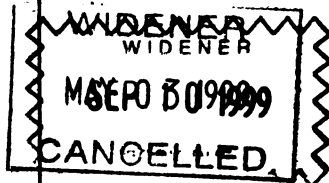

Please handle with care.
Thank you for helping to preserve
library collections at Harvard.

