

On the arrangement, care, and operation of wood-working ...

John Richards

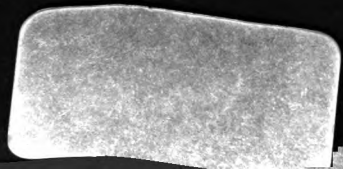
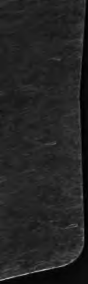

ON
THE ARRANGEMENT, CARE, AND OPERATION
OF
WOOD-WORKING FACTORIES
AND MACHINERY;

FORMING
A COMPLETE OPERATOR'S HANDBOOK.

BY J. RICHARDS,

MECHANICAL ENGINEER, AUTHOR OF 'A TREATISE ON WOOD-WORKING MACHINES.'



NEW YORK:
E. & F. N. SPON, 446, BROOME STREET.

LONDON:
48, CHARING CROSS.

1873.

186 . g . 65 .

*[Entered according to Act of Congress in the year 1873, by John Richards, in
the Office of the Librarian of Congress at Washington.]*

PREFACE.

IN the 'Treatise on the Construction and Operation of Wood-working Machines,' it was necessary to introduce a large number of expensive engravings, and to treat of many things not directly connected with the processes of wood conversion, but relating entirely to the construction of machines. This, while it added to the value of the work for engineers and machinists, at the same time extended its cost, and placed it beyond the means of machine operators and wood mechanics generally; besides, the plan of the work did not include the practical details of shop manipulation.

In view of this fact, and further to promote the development of wood manufacture, it has been considered expedient to supplement the 'Treatise on the Construction and Operation of Wood-working Machines,' with a shorter one, directed to their care and management, including the plans of arranging and equipping factories for wood work, and particularly the details with which the practical workman has to deal.

The work is mainly based upon American practice, which can hardly detract from its usefulness in other

countries. The wood interest is more extended in America than elsewhere, and we have every reason to assume, that with our present facilities of intercourse, wood conversion, like other manufacturing processes, will become analogous and uniform, as it progresses and improves.

J. RICHARDS.

10, JOHN STREET, ADELPHI, LONDON,
JAN., 1873.

INTRODUCTION.

At the present day it may be fairly claimed that machines have supplanted hand labour in working wood.

Year by year improvements have gone on, until bench work and hand skill have become comparatively unimportant elements in wood manufacture ; and, as Professor Willis remarked before the Society of Arts, 1852, “ nothing remains to be done by hand, but to put the component parts together.” None, except those who have learned their trades when and where machines were not used, can realize this change. You may tell the apprentice of to-day about going out through the snow to a board-pile, selecting your stuff, carrying it in, and after scraping off the snow in winter, or sweeping off the dust in summer, laying out the stuff with a chalk-line, and straight-edge, ripping out the job by hand, setting it about the stove to dry, and then dressing it up with a jack plane. You may tell him of mortising by hand, cutting tenons and shoulders, with a back-saw, and he will look at you with an incredulous stare. No wonder ; for this sort of thing has passed away, and with it, we are happy to say, some of the hardest labour that ever was dignified with the name of mechanical. It was mechanical, nevertheless, and called for the continual exercise of judgment and skill ; from the cutting out to the cleaning off, it was a kind of race between brains and muscle, in which brains some-

times conquered. Many a time, as older hand workmen will remember, would a small man, without that muscular strength that seemed to be the main element in his work, have earned his dollar or two dollars more at the end of the week than his stronger competitor, simply by his superior hand skill, superior judgment, and superior tools. But now machines do the work, and the main business of the operative is to take care of, guide, and direct them. The muscular work is gone; the brain work remains. We cannot quite say that our occupation is, like Othello's, gone, but it is greatly changed—from hand operation, it has become machine operation, and hence the need for this little work.

Machine operating is a trade—not an ordinary trade, but one of great intricacy, and unlike almost any other; it is one that cannot be completely learned even in a lifetime.

A man endowed with a strong natural capacity may, during a long and diversified experience, become a proficient and successful operator of wood machines, but the incessant changes and improvements that are going on in machines and processes, together with the arduous nature of his work, are more than enough to take up his time and his abilities. Month after month, and year after year, he sees that which he has to learn, grow and expand until he almost despairs of mastering it. He is not a mechanic with a trade in the usual sense; but is a mechanic of many trades. The duties discharged by a machine operator in America would be and are in Europe divided up into half-a-dozen different callings; there are for instance the sawyer, the filer, the planer, the jig sawyer, finisher, and others, involving a division of labour which would be very far from producing the results we have in our wood-working establishments in America, where

the machine operator must be a bench workman, understand all wood-machine operation, must be a machinist, not only one that can chip and file, but must know the theory of constructing and repairing machines; he must be a millwright, not an old time "whittler" who could pare for a week on half-a-dozen wooden cogs of a crown wheel, but a millwright who can lay out shafting, calculate speeds, build wooden drums and supports, and do it in a rapid and thorough manner; in short, be proficient in the most difficult of millwright work. Thus the wood workman, in escaping the muscular part of his calling, has only added to the mental part; but he has at the same time the assurance that the change dignifies his business, and leads to better pay, which has in all times and all places corresponded more to the mental than the physical part of man's labour.

Nearly every mechanical trade has its "Handbook," "Manual," or "Guide," based upon the practice of skilled men, and containing rules founded on experience, which have been of great use in giving information to workmen. To argue the merit of such books is superfluous. In every country the advancement of mechanic art has been largely if not mainly indebted to the dissemination of technical literature of this kind. A book relating to any branch of industry is, or ought to be, but the experience of some person, given with opinions and rules deduced from that experience, and is more valuable than oral instruction because more carefully given, can be often referred to, and used by a greater number of people. There has been in time past, and there is still, too much of a feeling that books cannot deal directly with practice, and relate to theory only; and further, that theory and practice are not only different elements in

mechanics, but in a measure antagonistic and opposed to each other. The further we go back, the more we find of this spirit, which has grown out of a variety of reasons, among which we will name the imperfection or impracticable character of certain books prepared by those who were only versed in theory, and did not understand practice as well. Again, want of knowledge and appreciation of the true relations between theory and practice; and the general want of both a knowledge of, and attention to principles, has led to the same result. We therefore, without fear of error, may claim that the popular estimate of text-books is in a degree wrong. We take up a book devoted to some art with which we are familiar, and find the author has made a blunder on some particular point which we understand better than he does, and at once conclude that the book is of no use; but read on, the author may make ten successive mistakes and then give some useful idea, that is new to the reader, and worth twenty times the cost of the book. Besides, the too common idea, especially with young mechanics, is to regard as wrong all that differs from their own opinions and practice. These things are mentioned as operating against the good that class text-books may do; but still the fact remains, that to such books we have been in the past indebted, and to them we must in the future look as a principal means of disseminating technical knowledge.

We have said that nearly all mechanical trades have been developed by, and have, their text-books. Can anyone tell why wood manufactures have had no such text-books? or rather, why wood working by machinery has had no books of any kind? This is the more remarkable in America, where the wood-working interest is so extensive, and where at least a quarter of a million of people are

concerned in wood manufactures. So long as the fact is assured, the reason is not important, except as it may tend to mend the matter in future.

We may say, that as changes and improvements in machines have been so rapid text-books could not do much good; that the art had no scientific base admitting rules that could be of general application; and that the operations were too diversified in different branches to be treated under a general head, with other excuses; but the fact still remains, without a sufficient reason, that wood manufactures have been greatly neglected, and that much that might have been done has not been done. In future, if the art is to keep up and maintain its place as one of the most important among American manufactures, it must, like metal work, textile fabrics, engineering, and other interests, have a literature consisting of text-books for operators and manufacturers, rules and formulas for constructors, and a general system to guide, in the arrangement of factories, the operation and care of machines and like matters.

As to how far a text-book, or rather a handbook, may be of general application in wood work is confessedly a question of difficulty, and this should be considered in any estimate placed upon what is written upon the subject; but there is still this argument in favour of having it relate to wood work in general, that the whole tendency of shop manipulation is to a uniformity of processes and machines, and the more of the work there is performed by machines, the stronger the analogy between different branches; and also, as machines approach nearer and nearer to a standard form of construction for the general purposes of planing, sawing, mortising, and so on, the more uniform will be these processes. In short, the machines used for such pur-

poses as joinery, cabinet making, carriage making, are becoming similar, except as to strength and capacity, which is not to be wondered at when we reflect that the one general principle throughout is cutting with sharp edges.

Hoping to contribute something to such a desirable end, this little treatise has been prepared. It is based directly upon American practice, which is peculiar, and could not be aided by text-books arranged for, and with reference to practice in, older countries, where labour is cheaper and the skill less; where hand labour yet maintains an important place, and will no doubt for a long time to come.

It must be remembered that "Handbooks," "Manuals," and text-books generally, are compilations to a great extent from more elaborate and scientific treatises relating to the same subject, and that authors have but little to do beyond condense, simplify, and arrange them. In the present case, however, it is different. One might look in vain to find anything to assist in the preparation of a treatise on wood manufacturing, if we except the writer's own Treatise on the Construction and Operation of Wood-working Machines.

The writer therefore sets out on this job with the expectation of having to furnish the material as well as to do the work. It will consist mainly of, and be founded on, his own experience, which he trusts has been extensive and successful enough, to afford much that will be useful to the reader.

We conclude this Introduction by further reminding the reader that in most mechanical trades a handbook would relate to processes alone; but for reasons already given, a book for machine operators in wood manufactures must be

more than this, or else fail to be of much use. It must to some extent treat of the construction of machines, the arrangement of wood manufactories, the power to drive them, the handling of material, of all that the machine hand has to deal with. As his calling is a combination of trades, so must this book relate to a diversity of subjects. There is but little fear of going outside of what an operator has to do and know, for it comprises nearly all that is carried on in wood-working shops except the accounts, and often includes a liberal share in that department. With this fact in view, we have but little fear of getting wide of the subject, and are quite confident that although we may discuss things which the Title would hardly reach, we shall not go beyond what either belongs to his business or is of interest to the operator of wood-working machinery.

THE OPERATOR'S HANDBOOK.

ARRANGEMENT OF WOOD-WORKING FACTORIES.

WOOD-WORKING establishments in America are divided mainly into those directed to the preparation of builders' material, the manufacture of furniture, and carriage work.

The first comprehend planing mills, door, sash, and blind factories, and moulding mills.

The second, all classes of furniture making, including chairs and turned work generally, with musical instrument cases.

The third, carriage work for railways and road traffic, with framing for agricultural implements, a class of work that is analogous and, as a rule, performed on the same kind of machines.

Outside these three general divisions there are turning shops, bending works, handle factories, tool factories, and similar establishments, in which the processes and machines are more or less special.

Wood manufacture, as a process unlike most others for the conversion of material, is confined to a single operation, that of cutting, which will be treated of under another head. The principles being nearly alike in the action of all the different wood machines, it follows that the shops are, or can be, very much on the same general plan for the several divisions of work which we have named. The machines and the material are nearly

the same for general woodwork; and if we leave out timber cutting, of which it is not proposed to say anything in the present work, rules that will apply to a planing mill, or furniture factory, will not be far wrong for a carriage shop, or a car shop.

An ordinary wood-working factory may be a plain rectangular building, not less than 48 feet wide inside; long enough and high enough to accommodate the requirements of the business. The writer in his experience has found 48 feet an advantageous width, and would recommend it never exceeding 60 feet; for beyond this the added width will not afford facilities in the same ratio, and will increase the proportionate cost of a building. A width of 50 feet to 60 feet will allow for what we will term four lines of machine work, two on each side, and a tramway or a wagon road in the centre.

The diagram given, Fig. 1, will serve as an example of this arrangement for a jobbing mill. The plan is not assumed as presenting anything new, but given rather for the opposite reason, because it is not new or ingenious.

The most important matter to be guarded against in making plans for a new mill, is that of intricate and original designs, seemingly presenting great advantages on paper, and apparently quite correct to an architect before building, but really quite wrong to a foreman or manager after the building is completed.

Fig. 1 is on a scale approximately as 1 to 400.

The plan here suggested is for a country jobbing mill 60 × 120 feet outside dimensions, having two cross lines of shafting, and equipped with machines requiring about 40-horse power.

The lower story should be 13 to 15 feet high in the clear, and the countershafts as far as possible overhead.

The arrangement of machines upon the floor is a matter that may be varied at pleasure, or to suit special kinds of

FIG. 1.

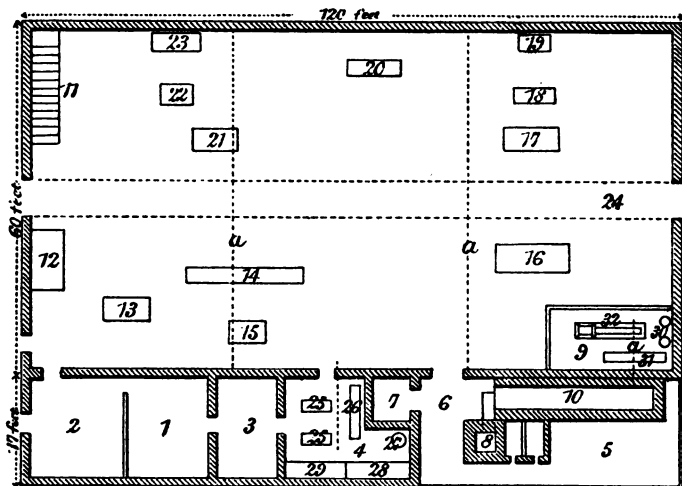

REFERENCES.

- | | |
|--|--|
| 1.—Office, 14 × 16 feet. | 17.—Matching planers for jobbing. |
| 2.—Counting room, 16 × 16 feet. | 18.—Large moulding machine. |
| 3.—Storeroom for oil, tools, and supplies, 10 × 16 feet. | 19.—Small moulding machine. |
| 4.—Repairing and tool-dressing room. | 20.—Slitting saw bench. |
| 5.—Boiler-shed. | 21.—General surfacing planer. |
| 6.—Firing room. | 22.—Splitting saw for siding. |
| 7.—Magazine for shavings. | 23.—Resawing machine. |
| 8.—Steam chimney. | 24.—Wagon passage, or tramway. |
| 9.—Engine-room. | 25.—Grindstones for planer-knives and tools. |
| 10.—Steam furnace. | 26.—Engine lathe for repairing. |
| 11.—Stairway. | 27.—Forge fire. |
| 12.—Hoisting platform. | 28.—Vice bench for machine fitting. |
| 13.—Cutting-off and jobbing saw-bench. | 29.—Saw-filing bench. |
| 14.—Jointing saw. | 30.—Pumps. |
| 15.—Jobbing saw. | 31.—Main driving pulley. |
| 16.—Large flooring machine. | 32.—Engine. |
| | <i>a a</i> .—Shafting. |

work; it cannot well be predicated upon an ideal plan, and can be remedied by changing, if wrong. The arrangement of the machines also depends upon their number and capacity. If in founding a mill the equipment is not complete, as is generally the case, there is no necessity for crowding and hampering machines to suit some general plan which may be carried out in future, when the mill is fully equipped; it is often more advantageous to set machines temporarily, moving them as occasion may require, and thus obtaining more room, and greater convenience for the time being.

The shafting is shown arranged in two lines, three are often better and more convenient. If three lines are used they will cost but little more than a single one running the other way of the building, and can have the advantage of being arranged to run at different speeds if required.

The last shaft, or the one farthest from the engine, can be driven at a higher speed than the other shafts to suit joiners' machines on an upper floor, an arrangement that is common in our mills; joiners' machines if belted from below will not require a line of shafting above, and a self-supporting roof can be used, so that the upper room will be clear of posts, adding greatly to both the appearance and convenience of the room.

The position of the posts in the lower story is not marked in Fig. 1, but they can be arranged on each side of the central passage at a distance apart that will best accommodate the handling of long stuff, which is an important thing to be considered about a mill floor.

In connection with the plan, Fig. 1, the following list of dimensions for machinery will be of use in making plans for mills, even when they may vary in capacity from the one assumed:—

Steam engine, 12 inches diameter, 20 to 24 inches stroke, with a speed of 75 revolutions a minute.

Boiler, if double flued, 44 inches diameter, 28 feet long; if multiflued, one-fourth less heating surface will do.

Grate surface, equal to 16 square feet.

Steam chimney, 60 feet high; area of flue, 500 square inches, fitted with air-tight slide damper.

Engine-driving pulley, 10 feet diameter, 18 inches space.

Line shafting, 3 inches diameter throughout, to make 250 revolutions a minute.

Line-shaft pulleys, with average diameter of 36 inches and 12 inches face.

Average speed of countershafting 750 revolutions a minute.

Hoisting platform, 10 × 6 feet.

As various dimensions will be hereafter considered under separate heads, these are only given to render the diagram more complete.

For furniture and carriage manufacture, and in any case where the lumber is short, or is reduced to short lengths, in working, the arrangement of machines must have reference rather to the course of the material through the shop as it is sawed, planed, bored, and mortised, than to providing room to handle it in.

In the case of a planing mill, a large share of the lumber worked is only dressed, or jointed and matched, and then again sent out; the trouble is to find room for the lumber among the machines, and to handle it; in other words, to get it into and out of the mill without interfering with other work. If flooring is regularly or continually made, or if surfacing is continually going on, it is useless to provide room within the main building for storing either the rough or finished stuff; it should be fed in through the

walls, and passed out of them as fast as worked, in such a manner as will not interfere with other operations going on at the same time.

A lumber-planing mill, where nothing but planing is done, requires a totally different arrangement from a mill where joiners' stuff and mouldings are made, or jobbing done.

The main building should be in such cases about 24 feet wide, with the machines placed side by side across the building, and have large doors opening opposite the feed end of each machine, as in Fig. 2.

The Figure is arranged on a scale of 1 to 200.

FIG. 2.

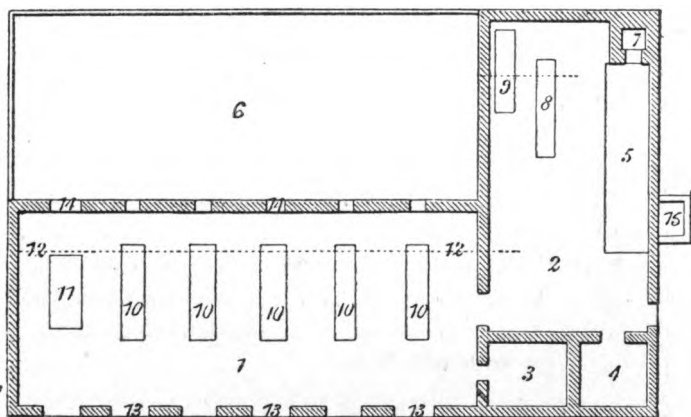

REFERENCES.

- | | |
|--|---|
| 1.—Is the main planing room. | 9.—Main driving pulley. |
| 2.—The engine-room. | 10.—Planing and matching machines. |
| 3.—Storeroom for oil, tools, and stores. | 11.—Surfacing machine. |
| 4.—Magazine for shavings. | 12.—Line shaft. |
| 5.—Boiler furnace. | 13.—Large doors hinged at the top to open inward. |
| 6.—Storing shed for worked lumber. | 14.—Portholes for planed stuff to pass through. |
| 7.—Steam chimney. | 15.—Ash-pit to the steam furnace. |
| 8.—Engine. | |

This plan in substance has been adopted in some of the larger mills about Chicago, and has many advantages to recommend it for a mill that is devoted to lumber dressing alone.

It affords a mill of great capacity with but a limited investment in the building, and the most economical arrangement of shafting and belts; besides, the plan is as safe from fire as it is possible to arrange one. The lumber is mainly handled out of doors, which gives unlimited room for storing, loading, and unloading it from wagons or railway trains.

The main mill-room and the engine-room should be thoroughly fireproof, with iron roof, and roof supports.

The walls should be 17 inches thick, and the overhead cross-beams not less than 15 feet above the floor, with the line shafting placed in pedestals, resting on top of the beams.

The line shafting should be 3 inches diameter, and make 250 revolutions a minute.

A mill of this capacity should manufacture at least 25,000 feet of matched stuff in a day, besides doing an equal amount of rough surfacing.

For general wood manufacture other than lumber dressing or car building, the plain rectangular form of building represented in Fig. 1 is as nearly correct as any that can be devised. The material and the machines are short, and a given amount of floor room, with convenient ingress and egress, is all that is required.

Upper floors are, with good hoisting apparatus, nearly as good as ground floors for most purposes, and the most economical buildings for furniture manufacturing are from four to six stories high.

To secure good lighting, cheap timber framing, and to avoid posts, wood-working buildings should be narrow and

long; or rather the width should be constant, and additional room secured by length.

A building for wood manufacturing can be 48 feet wide in the clear, with a single row of posts in the middle, if the girders are deep enough, say 16 × 12 inches, or if smaller they may be trussed, as shown in Fig. 3.

FIG. 3.

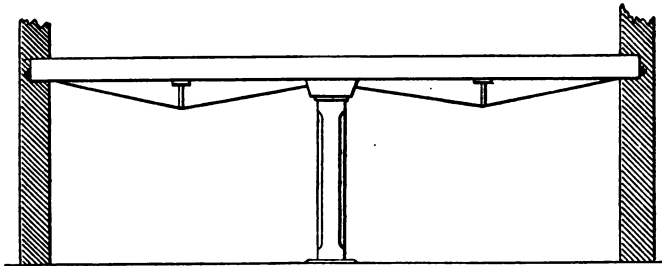

The truss rods are generally in the way of the belts, especially when the line shafting is placed, as it should be, across the building; and in nearly all cases it is both better and cheaper to provide strength in the girders without trussing them.

In the common plan of resting the joist on the top, the girders are themselves in the way of the belts, and often cause great inconvenience.

But few ever consider in building shops that this method of mounting joists *adds their depth to the height of the walls*; so that it is not only an inconvenient but a very expensive one. A building with three floors will require to be some three feet higher at least, to give the same clearance between the floors as when the joists are let in flush.

For factories, where there is overhead shafting, the joist

should be gained into the girders, and rest on string pieces also, as in Fig. 4.

FIG. 4.

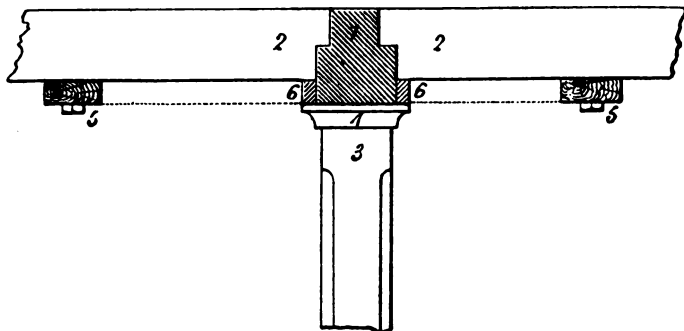

REFERENCES.

- 1.—Section across the girder.
- 2.—Joists.
- 3.—Post.
- 4.—Iron post cap, wide enough to receive the pieces 6, 6, which are bolted or spiked to the sides of the girder 1, to receive part of the strain and support the joists.

With bearing strips to help support the joists, the latter need not be gained into the girder far enough, nor deep enough, to weaken it. The bottom of a beam is its weakest part, in resisting transverse strain; and the gain, say $2\frac{1}{2}$ inches long and 6 inches deep in a girder 16×12 inches, does not affect its strength. The top receives only compressive strain, and is after notching generally stronger than the bottom side.

In Fig. 4, 5 5 are hanger-plates, which are thick enough to come flush with the bottom of the girders, as shown by the dotted lines. This arrangement of having the girders project below the joist to a depth equal to a 3 or 4 inch hanger-plate, is one that will find favour with any mechanic

who has had experience in erecting shafting beneath a floor, where the joist was laid on the top of the girders, and where all the plans for belts, and even the position of machines, had to be governed by the position of the girders. As here arranged, the whole ceiling is in effect a plane; a shaft or other overhead work can be set anywhere. If a hanger comes on the girders, it is evident that no hanger-plate is needed, so that there is really no inconvenience, but a decided advantage in having the girders project below the joist, to the difference of their depth, say from 3 to 4 inches.

Joist floors are the best floors for wood-manufacturing establishments of all kinds. A plank floor, resting on girder beams, is very strong in the sense of supporting a great load, and will do very well for machine shops, but is totally unfit to resist the jar and vibration of high-speed machines. A floor of this kind is elastic and springy, no matter how thick it may be, while a joist floor, well bridged, is stiff and unyielding; although it might be broken through in spots with heavy weights, or might yield more in supporting great loads.

To put the same planking upon joists, that is usually laid on beams, would give a floor that is stronger in nine cases out of ten. But the custom is to put a thin floor, generally a single one, on joists, and a double one consisting of heavy plank for the first course with $1\frac{1}{4}$ -inch matched boards, upon beams. Without questioning the necessity of the double floor in the case of beams, and admitting that a joist floor is strong enough without it, it is certainly but fair to assume a floor of equal strength in the two cases, when making comparisons between the plans.

A double floor is always best, a jointed one, say of $1\frac{1}{2}$ -inch thick lumber laid across the joist, and an inch

matched floor lengthwise the building, making $2\frac{1}{2}$ inches in all, is strong enough for ordinary upper floors that have only finishing machines to support.

Ground floors on which the heavy traffic comes cannot be made too strong. The weight of heavy machines requires good foundation supports to keep them level and to prevent vibration, but the piling of lumber which is quite as heavy, and falls first in one place and then another, is the main thing to provide against. The weight of a machine is constant at one place, and when it is once levelled up would remain so; but if two to five thousand feet of hard wood lumber is piled near it, unless the floor is very strong, the machine is listed over or twisted by depression of the floor.

When there is no basement room, and nothing to hinder the building of piers beneath a floor, there is no excuse for having it weak enough to yield, and it only requires proper consideration at the time of erecting the building.

STEAM POWER FOR WOOD-WORKING ESTABLISHMENTS.

Among other subjects which a foreman or wood-machine operator is expected to understand is that of steam power. The steam power is an integral part of the machinery of the establishment, and should not be conducted as a kind of separate department from the rest. If it is, as a natural consequence delays and derangements will be of frequent occurrence.

To keep an engine always running requires quick judgment and a fertility of expedients not often found with the class of engineers it is common to employ in wood-working mills.

In the United States the foremen and operators are, as a rule, well acquainted with steam power, and it often becomes a part of their duty to give suggestions and to make plans for furnaces, boilers, engines, and other details of the power department for wood shops.

It is therefore considered here quite in place to devote a short chapter to the subject directed to some of the peculiar points to be observed in making plans for steam power in wood-manufacturing establishments.

A wood-working factory, unlike a machine shop, has not the same facilities for repairing, and keeping fancy steam engines in order. The dust renders it almost impossible to keep them clean or bright, and the work is so irregular, and so heavy, that the expense of finishing is much better expended in more careful fitting.

The duty of a steam engine is not only more severe, but is more irregular than in almost any other business. As a rule, steam engines in wood-working establishments will be found working up to their full capacity, and require the packing and joints to be carefully kept in order. The duty is irregular in consequence of the sudden strain of starting planing machines, saws, and similar machines. The average duty is regular enough, so as to dispense with independent cut-off valves on the engine, which must always add to the complication, and liability to derangement and wear. A strong plain engine is what is required, without bright finish or ornament, but with well-fitted joints and large bearing surfaces made of the best material.

The piston, cross-head connecting rod, and main bearings, are the vital parts to be looked after. The cross-head bearings are continually deprived of their oil by the fine dust that will find its way to the engine-room, no matter what precautions are taken to prevent it; they

should have either fibrous packing, oil feeders, or be made of wood. Gibs of lignum vitæ will be found to wear well and be safe from danger of cutting the slides; besides, they can be replaced at any time without detention for repairs, or a trip to the machine shop.

An engine to drive wood machines requires a heavy balance wheel to ensure steady motion, it should have not less than 500 pounds of weight to each inch of diameter of the cylinder, and be as large in diameter as practicable.

The piston speed should for the same object be from 300 feet to 400 feet a minute.

The boiler and steam furnace are matters of greater importance than the engine. They generate the power, the engine merely transmits it to the work, a thing not always thought of.

In determining what variety of boiler to use, there are two leading conditions to be taken into account—the kind of water, and the kind of fuel to be used.

Wood refuse alone is not a severe fuel, but when mixed with bituminous coal it makes a very hot fire, which from its intensity and its irregularity may be considered destructive to a boiler; to obviate this the boiler must be kept clean and should be made of simple form, admitting of easy access to every part.

With hard lime water, which is commonly found throughout the middle States, this last-named condition becomes a necessity; no complicated multiflued or fire-box boiler can last long when there is much lime in the feed water; the advantage gained by the thinner metal in the tubes or by the fire-box is soon lost through incrustation, while the original cost, subsequent repairs, cost of cleaning, care, management, and risk, are all in favour of the plain cylinder boiler without flues, or with flues that can be

reached for the purpose of cleaning both internally and externally.

The irregularity of firing with wood fuel when a regulating damper is not used makes steam room desirable; this is seldom obtained in a multiflued boiler, where the contracted heating surface generally leads to a proportionately contracted steam space, and this, with the ordinary mode of firing, has the steam "up" and "down" continually, causing a derangement of the work, and having a most destructive effect upon the boiler itself from the intermittent strain upon the metal. The heating surface and steam room, or in other words the capacity of a boiler, should be one-third more for a wood manufactory where the cuttings and shavings are burned, than where coal is exclusively used for fuel.

Although in opposition to a popular prejudice, the writer recommends for most cases a plain cylinder boiler without flues of any kind, carefully set in a first-class furnace, and made long enough to gain the full effect of the fire. There is, however, not much use in recommending a thing which it is known will not be applied. There is a prejudice against cylinder boilers throughout most parts of the United States that prevents their use in a great many cases where they would give nearly as good a result as those with flues, and have other advantages which all must admit.

Following the general practice of the middle and western States we present some views respecting the construction of furnaces for double-flued cylinder boilers.

The plans set forth in the Figures which follow, have for general objects, a tight furnace, a cool place to fire, and a saving in first cost, with greater safety from fire. Such a furnace as is here represented requires better mason-work than ordinary furnaces, and should have a thorough

lining of fire-brick about the fire-bed. The whole amount of brickwork is greater than when an iron fire-front is used. As a modification of steam furnaces it may be considered adapted to wood-manufacturing establishments, because of its safety from fire and the avoidance of heat by the fireman; the latter, considering the attention and time that is needed to fire with shavings, is no small object.

Fig. 5 shows a longitudinal section through a furnace built with its end opposite to, and combined with, the stack, so that no breeching is needed, and the firing is effected from the side, as seen in the side elevation, Fig. 6, without exposure to the heat, and with more safety from danger of fire. The ash-pit opens on the opposite side of the furnace generally, outside the building, where there is no danger of the shavings catching fire while feeding the furnace or when the attendant is absent. A slide damper and the lever to work it are shown on the front of the stack, Fig. 6.

A cross-section through the furnace at

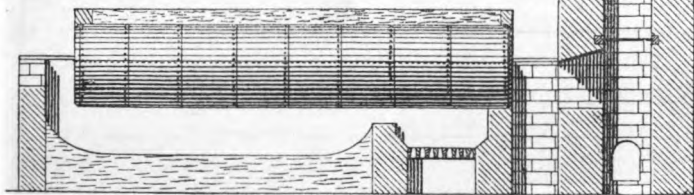

the bridge wall is shown at Fig. 7, with the covering over the boiler to retain the heat and to guard against danger from sparks. The filling, or covering, is of sand,

FIG. 5.

earth, or ashes, instead of mortar and brick, which is liable to crack, and allow sparks to escape, when the damper is shut, which is one of the most common sources of fire about wood factories where steam power is employed.

The following dimensions are for a furnace of this kind, arranged for about 40-horse power, and sufficient to drive a mill such as shown in Fig. 7.

- Boiler, 44 inches diameter, 28 feet long.
- Two flues, 16 inches diameter.
- Height of steam chimney, 60 to 75 feet.
- Area of flue in the chimney, 500 inches.
- Area of boiler flues, 400 inches.
- Area of throat at the bridge wall, 400 to 450 inches.
- Area of grate surface, 16 square feet.
- Area of the flue behind the bridge wall, 7 to 10 feet.
- Clearance on the sides of the boiler, $4\frac{1}{2}$ inches.
- Clearance at back end of the boiler, 14 inches.
- Size of fire-door, 15 × 30 inches.
- Depth of ash-pit, 24 inches.
- Width of ash-pit, 42 inches.
- Ash-door (air inlet), 700 to 800 inches.
- Thickness of furnace walls, single, 13 inches.
- Thickness of furnace walls, if double, 17 inches.
- Depth from boiler to grate, 18 to 22 inches.
- Clearance between boiler and chimney, 24 inches.
- The fire-room floor to be level with the grates.

FIG. 6.

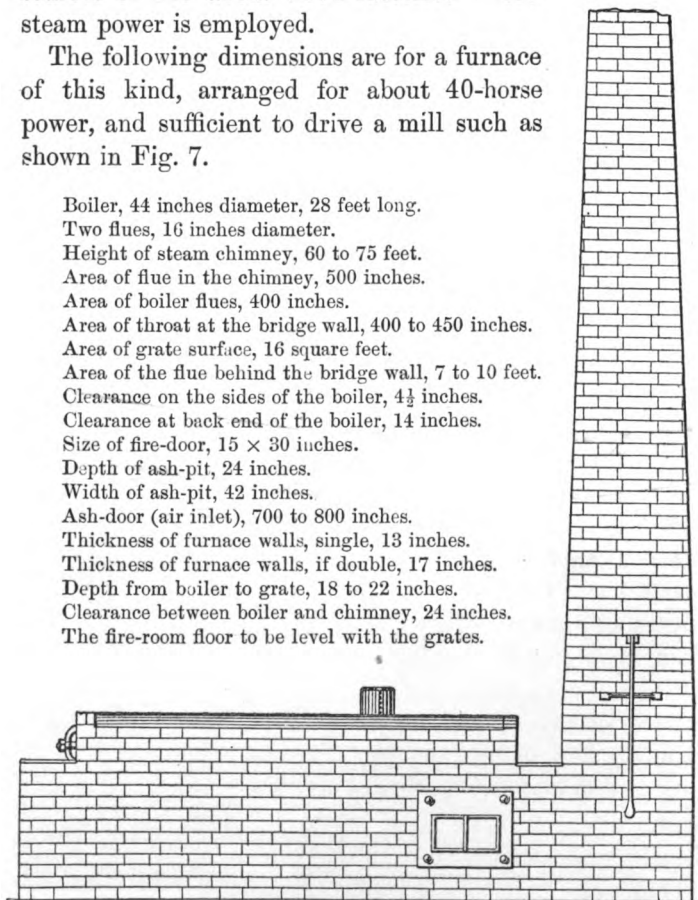

A covering of loose earth or sand, as shown in Fig. 7, has other advantages besides the safety which it ensures

from fire; it is cheap, easy to remove and renew, and a good non-conductor of heat. With a tight furnace covered in this manner, it is comparatively safe to erect drying rooms over a boiler, if the wood is kept at some distance above the furnace—say, 5 feet, or more.

The usual method of firing with wood shavings is wrong; there are seldom any means employed to regulate the fire or the quantity of steam generated, except by the amount of fuel that is fed to the furnace; a custom not only wrong, because of the waste of fuel it occasions, but because of the irregularity it causes in the pressure of the steam and the increased amount of labour required for firing. Without some means of controlling the fire there is, at intervals, an intense heat which generates more steam than is needed; the fuel is soon burnt out, and the cold air allowed to pass through the bare grates, until the heating effect of the fire is in part counteracted. When fresh fuel is added it at once burns up, or, as is often the case with a strong draught, nearly all the lighter shavings are drawn over the bridge wall before they are burned. An experiment for a single day in the use of a regulating damper will be sufficient to convince anyone of its advantages. The furnace should be kept full of fuel, no matter what its character, and the steam regulated by the draught, either with a slide damper operated by the fireman, or what is much better, with a steam damper that regulates the draught without any attention.

There are perhaps no simple contrivances that save so much labour and money, so uniformly perform their functions satisfactorily, are so much neglected and so

FIG. 7.

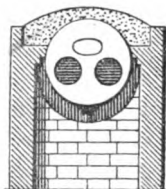

little known, as steam-damper regulators. No one who uses them would think of doing without them, and but few who do not have them ever think of their importance.

There is no case where steam dampers are not needed, but nowhere else are they so important as to regulate the fire in the steam furnaces of wood-working establishments, where the fuel is of a mixed and inflammable character and cannot be fed with sufficient regularity to keep the steam at a uniform pressure. The original patent on these damper regulators has expired, and they are now sold at a low price by various makers.

In arranging steam plant for wood manufactories provision should be made to guard against freezing in the winter. Carrying out and bringing in such bulky material as lumber always makes a shop cold, especially in the lower story where the steam power is placed, and nothing is more annoying than to be froze up. A little oversight in this way often leads to expensive delay, when a few dollars would have saved all if it had been considered in time.

Another very important matter in the arrangement of steam furnaces about wood mills is to have them convenient to fire. We may provide against heat by neither using a smoke breeching nor an iron fire front, but if the fireman has to stand and shovel in shavings through a small door breast high, only half has been done that can be accomplished to render the firing easy. The fire-doors should be level with the fire-room floor, so that the shavings and sawdust may be shoved into the furnace with a large scraper; the doorway should be not less than 30 inches wide, the doors well lined to keep them cool, and the whole floor in front of the furnace made of iron plates, so that the fuel may lie about the door without

danger of catching fire, and avoid the trouble of continually sweeping up, which would otherwise be necessary. There is not the least objection to arranging a furnace in this manner, in fact there is a decided gain in convenience of access to every part, except to the ash-pit, which is but a small matter.

SHAFTING FOR WOOD SHOPS.

If any machine operator of long experience, or, for that matter, of short experience, were asked what occasioned the greater number of accidents about wood shops and what caused most delays, he would be sure to reply, "The line shafting."

For a shaft to break by crystallization from bending—to be torn loose by winding belts—to have pulleys or couplings come loose, is a common cause of detention and expense. The couplings are mentioned last, although if ranked as to the amount of detention and trouble they cause, they should have been named first; but whether it be coupling, pulleys, hangers, or shafting, the trouble is generally with the main line.

If we go to a machinist who manufactures shafting, and inquire whether there is any special difficulty in the way of making it safe from derangement or accident, he will answer, "Certainly not."

Granting this, we have either a paradox, or very bad practice, and as a paradox is rare in mechanics, the latter is the safer conclusion.

Shafts for transmitting motion and power are the oldest of mechanical appliances, and should, as we would suppose, for this reason, be among the most perfect, but this is a

claim to which they can by no means pretend; and the great diversity of the plans for couplings, hangers, and bearings by different makers attests the fact that the manufacture of shafting is by no means a perfected art.

There are but few places where line shafting is so severely used as in wood shops; the usually small diameter, with the high speed, the wide belts, and the heavy duty that it generally has to perform, are all conditions that are more or less avoided in other manufacturing establishments.

Machines when suddenly started offer a resistance in proportion to the power employed in driving them, and measured by this rule there are but few machines in common use so heavy to start and causing so great a strain upon the shafting, as planing machines and circular saws. There are of course many that require as much power, but to include all conditions, such as the speed of the belts and the usual means of shifting them, with the sudden stopping which often occurs, there is hardly a parallel among manufacturing machinery. A planing machine or saw that consumes eight to ten horse power to drive it will have the belts shifted instantly from the loose to the tight pulley, and the only reason the shafting does not give way is that such machines are generally but weakly belted, and the belts slip until the machine gets into motion. The same thing in effect occurs in over-feeding saws, so that the shafting is continually subjected to a succession of torsional strains, that will soon search out the bad jobs in fitting couplings and pulleys.

In preparing plans for a wood-working mill, the shafting should, for reasons already given, go across the building whenever practicable. By belting from one line to the other at one side of the room the whole power is not trans-

mitted through the couplings, as in the case of one continuous shaft to drive all the machinery. The work is also divided more evenly throughout the several lines, and this does away with the supposed necessity of having the line shafting in sections of various diameters, which prevents the interchange of pulleys from one shaft to another, and often leads to expense and trouble.

The first section of shafting carrying the main driving pulley should have a diameter equal to one-fifth the width of the main driving belt, and be supported at each side of the main pulley; to make a rule, this section should not be more than twenty diameters long between bearings.

Fig. 8 shows a good arrangement of line shafting for a mill about 50 feet by 150 feet, with three cross lines of shafting.

FIG. 8.

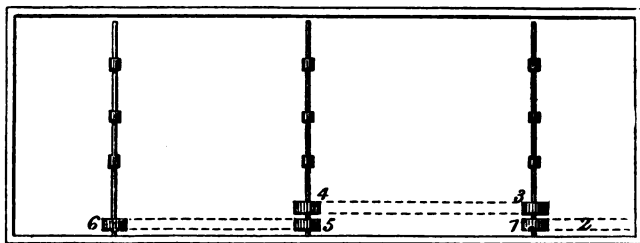

REFERENCES.

- 1.—The main driving pulley.
- 2.—Belt to the engine.
- 3 and 4.—Second driving pulleys.
- 5 and 6.—Third driving pulleys.

Having the first or driving sections 6 feet long, and four additional sections in each line 10 feet long, is a good arrangement for a mill of the dimensions given.

The advantages gained by this plan over that of having

a continuous line or a single line running the other way of the building are:—

First.—Only a part of the power is transmitted through the couplings.

Second.—The speed of the different lines can be varied and to some extent accommodate machines of different classes, which can be arranged with this view.

Third. — A part of the shafting can be stopped for repairs, or to put on belts or pulleys without stopping the whole; in other words, about two-thirds of the works may be kept going in such cases.

Fourth.—With this arrangement the shafting can be of a uniform diameter throughout, except the first or driving sections.

Fifth.—The machines stand lengthwise the building, and the course of the stuff is in this direction, as it should be, and as it must be, for it is no uncommon thing to find planing and other machines driven with quarter turn belting to accomplish this, when the shafting is placed the other way.

For wood shops, $2\frac{1}{2}$ -inch and 3-inch shafting are the best sizes; $2\frac{1}{2}$ -inch shafts are as small as any should be, and they should not, without some important reason, exceed 3 inches in diameter.

A line of $2\frac{1}{2}$ -inch shafting will run safely and well at 250 revolutions a minute, or a 3-inch line will run 200 revolutions a minute, if the bearings are properly made and it is kept in line.

Pulleys should be turned true and balanced—balanced perfectly, no matter what their speed.

The effect of an unbalanced pulley is as its speed, but it is never known where pulleys may have to be used in changing, and the only safe rule is to have every pulley

carefully balanced, no matter what the speed may be at which they run.

Pulleys should be as light as possible, both as a matter of economy and convenience. Our best makers are, however, making them light enough, so that a specification as to weight need hardly be given with an order for pulleys.

As to couplings, they should be adjustable or compressive, not keyed on, or wedged on, for only such a key should be used as will not keep a solid coupling on. Adjustable couplings are now very generally used for line shafting in America, and certainly there is no place where they are more needed than in our wood shops, where there is such a continual changing and adding of machines and pulleys, that the shaft has constantly to be disconnected for the purpose.

Hangers to support the line shafting in wood shops should always have their bearings pivoted, and adjustable vertically. The heavy loads of lumber that are piled on upper floors depress them between the posts, and a line shaft requires to be often levelled up. If the bearings have a vertical adjustment in the hanger frames, and are moved by screws, as they should be, it is a small matter to take a ladder, a level, and a wrench, and go along the line to level it. A hundred feet of shafting may be adjusted in this manner in an hour, if the larger belts are thrown off to relieve it from strain, and the shafting is straight and true. The operation is so simple and so generally understood that it need not be explained here.

Shafting is not liable to get out of line horizontally, unless from the strain of belts; it is, however, well to line up as often as twice a year, to be sure that all is right. It has been in times past a common thing to allow shafting to run as long as it would go, without adjusting, and

then stop the works for a day or two to line up; which is unnecessary and only a loss of time. A shaft may be levelled by almost anyone when the hangers are properly made, and can be done at noon, or after stopping in the evening, without interfering with the business at all.

FIG. 9.

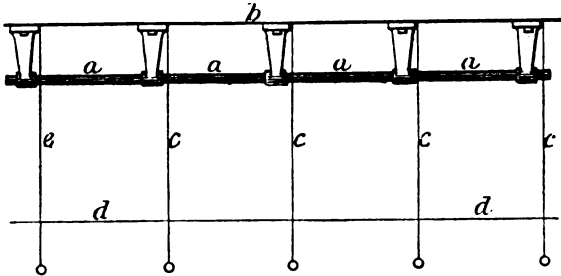

REFERENCES.

D.—The ceiling, to which the hangers are bolted.

a a a.—The line shaft.

c c c.—Plumb-lines resting against the shaft, near to the bearings.

d d.—A horizontal line stretched below the shaft.

FIG. 10.

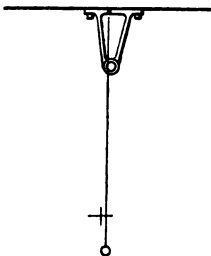

To line a shaft horizontally is but little more trouble if the bearings or hangers can be moved in that direction.

Suspended hangers should have the bolt-holes slotted for an inch or more of movement, and post hangers should have movable bearings that permit side adjustment.

Assuming that there is some means of moving the shaft horizontally, a good plan of adjusting it is by suspending a number of plumb-lines that will bear against one side of

the shaft, and reach down low enough to be sighted from the floor, as shown in Figs. 9, 10; or for greater accuracy a strong line may be stretched about 5 feet from the floor, as at *dd*, to gauge the plumb-lines from.

This lower line can at the beginning be set within about one-eighth of an inch of the two plumb-lines at the ends, and the rest can then be adjusted to the same position by moving the bearings; or the end bearings can be also adjusted, as the case may require.

A ball of strong packing thread, and half-a-dozen or more old screw nuts for the plumb-lines, make the outfit, and the job can be well executed, at but little expense and time, if the hangers are properly made, and erected so as to be adjusted without trouble.

This kind of work must be to a great extent a matter of judgment; anyone who depends upon special knowledge, or what he may have seen done and been instructed in, will not be so successful in millwrighting as he would be if he proceeds boldly, using his own judgment as to plans, and reasoning thoroughly about the work before beginning it.

There are many ways of adjusting line shafting; some of them tedious and expensive, and some useless. The one suggested is the most simple that can be given, and is accurate enough for all practical purposes.

ERECTING COUNTERSHAFTING.

If a machine operator or even a regular millwright were to be set at a job to test his judgment and abilities, there is perhaps no other that could be selected better than erecting a countershaft.

The ways of erecting, all of which may in the end produce the same result, are so various as to render it difficult to give rules that will be generally approved of. The advantages of the different plans can only be tested by the time required to do the work, assuming, of course, that it is to be properly done in all cases. It may require two, and often requires three, men a whole day to put up a countershaft; which in another case will be put up in two hours by one man, assisted only in holding and lifting.

In erecting a countershaft, what have first to be determined are the position of the machine it is to drive, and whether the belting is clear. When a line shaft is crowded with pulleys, it often requires great care to place the countershafts so that belts will not interfere with each other; it is no uncommon thing for a shaft to be put up, and then the discovery made that belts interfere with others on the opposite side of the line shaft.

Be careful in starting, that is the great point, not only in putting up shafts, but in all other mechanical operations that involve calculations and accurate measurements.

For example, let us suppose that a countershaft is to be erected, and go through the various operations, one at a time. Beginning with the hanger-plates, these should be of hard wood, long enough to reach from two to four joists, as the weight of the shaft and belting may require; their width should be from one and one-half to twice the width of the hanger base, and their thickness, as an approximate rule, one-fifth the drop of the hanger. When the joists are of hemlock, or harder wood, and three inches or more thick, almost any kind of shafting can be hung with safety on wood screws, or lag screws, as they are sometimes called, passing through the hanger-

plate, and screwed directly into the joist. These screws should be of good size, not less than $\frac{5}{8}$ inch diameter in any case, and long enough to pass into the joist a distance at least equal to the thickness of the hanger-plate. A plate three inches thick requires, with cast-iron washers, screws that are seven inches long; if one in each joist, $\frac{7}{8}$ inch diameter, if two in each joist, $\frac{3}{4}$ inch or $\frac{5}{8}$ inch will do for ordinary countershafts.

Having the hanger-plates ready, next mount the shaft in the hangers and invert them, to stand on a level floor, Fig. 11, and after settling the shaft to see that the bearings are not cramped, and that the hangers stand fair on their base, measure between the bolt holes accurately, or what is better, cut a short strip of wood to the length between the centres, marked *c* in the Figure.

FIG. 11.

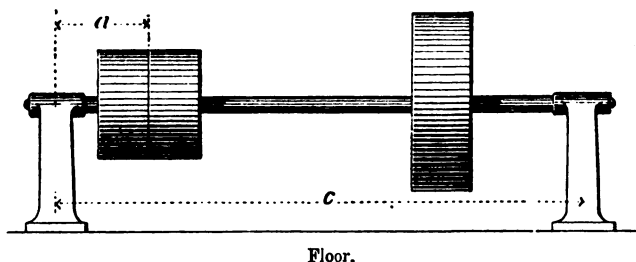

If the shaft is to be placed to suit some pulley on the line shaft, measure from the centre of the hanger next the loose pulley the distance to the centre between the tight and loose pulleys; this should also be marked on the stick, as the *base* for the position of the shaft, we will term it the driving belt line, it is the distance marked *a*, Fig. 11.

This belt line must then be determined and scribed on

the joist; it is easily found from a pulley, or by measuring from a wall or girder that crosses the line shaft at right angles.

Placing the measuring stick with this base mark, the centre between the pulleys, upon the belt line, next set out at each end for the wood screws or bolts that are to hold the hanger-plates, bore the hanger-plates and screw them up at one end, but not hard against the joist, leave a half-inch or more for packing, when levelling up; then set the plates at right angles across the joist, and mark the position of the joists so as to bore through the plates for the other screws, which can be done by swinging the plates around, and without taking them down. Again set the plates across the joist as accurately as possible by

FIG. 12.

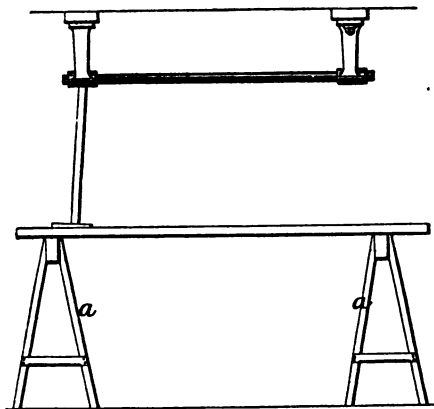

means of a carpenter's square, and mark the holes on the joist for the remaining wood screws. In screwing up the plates they can be brought level by furrowing down on their top, with pieces of wood split in two or notched to

accommodate the wood screws, placed between the plates and the joist. To mount the hangers, if they have pivot bearings, as all ought to have, bore through the hanger-plate for one bolt by measurement; no great accuracy is needed in this, unless the shaft has to come laterally to a particular line, which is seldom the case. Screw up one hanger with a through bolt, then remove the pulleys from the shaft, put it in the hangers, then prop the loose one, or both, if needed, with a brace resting on the floor or a stage, as shown at Fig. 12. For the next operation, procure a pole or strip of wood *c*, Fig. 13, long enough to

FIG. 13.

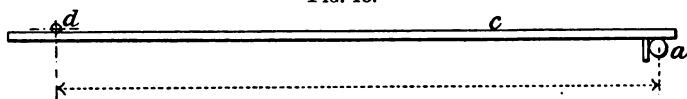

reach from the countershaft to the line shaft, cut a notch in the end, or drive a strong spike in the side, and let it rest on the line shaft, at *a*, and extend to the countershaft at *d*. By moving alternately from one end of the countershaft to the other, and driving the loose hanger to adjust it, a parallel is obtained, much truer than by lines and measurement, and in a tenth part of the time. The pole can be marked at the centres of the countershaft at each trial until the ends correspond. Then bore the three remaining holes for the hanger-bolts, put the pulleys on the shaft, and mount the whole in place. Level the shaft by using a plumb line alongside the pulleys, which, if they are at all true, will be found a more accurate plan than to use a spirit level on the shaft itself. The job is now finished, and there is a question as to which is the greater labour, to erect a shaft or to describe the operation. With a good pair of trestles at hand, and wood screws and hanger-plates ready, an ordinary counter-

shaft for belts from three to six inches wide should be put up in from one and one-half to three hours' time, by one man and an assistant. The time of erecting, and the accuracy with which a shaft can be set, as well as the facility with which it can be kept in line, depend greatly upon how the hangers are made. All bearings in wood-working establishments should be pivoted; the depression of floors, which must take place from piling stuff, is continually altering the bearings in a greater or less degree, and if they are rigid, the bearing is spoiled by the least change. Such nicety is not required at low speeds, but when shafts carrying heavy strained belts have a speed of 750 or more revolutions a minute, every precaution must be observed to have them run without heating. If the bearings are pivoted, and arranged to be adjusted vertically on the hanger, it is but little trouble to keep shafts level. The bolt holes in the hanger-plate if slotted to allow for horizontal adjustment, will answer for pendent hangers without having the bearings movable in the brackets.

The transverse strength of the brackets should be sufficient to break the belting, if not, there is always danger of the whole being torn down by the winding of belts; and as the belts are generally twice as strong as those used in other shops, the hangers should be the same.

SETTING MACHINES.

Setting machines belongs to the same class of work as erecting shafting, and is much the same thing—a matter of judgment, rather than one of acquired skill.

The only general rule that can be given, is to set them

level, with their shafts and spindles parallel to the line shaft. There are, however, many plans of doing this, and a word on the subject will not be amiss.

When a new shop is built, and the line shaft erected, or when its position is determined, and before it is erected, each floor of the building should be scribed with what we will term a machine line, that is, a base from which the engine, the line shaft, countershafts, and machines may be set, independent of each other, and yet with accuracy. To do this, take the centre line through the building both ways, and scribe it on the floors, not with a scribe awl alone, but with a wagon maker's scribing hook, that will cut a deep groove. After striking with a chalk line, tack down a straight edge, and score the lines with the scribing hook, so that they will remain as long as the floor lasts, or at least as long as machines are to be added. Plumb up or down, as the case may be, and scribe each floor in this way; whether machines are to be set on floors or not, there will sure to be some use for these base lines. If there are ground floors, scribe the lines on the walls, drive stakes, or put them on the ceiling; have them somewhere, in each story, and in each room. When these lines are once made, the setting of machines becomes a simple matter, for lines parallel to, or at right angles to, them are easy to lay out; and shafts or spindles can be set true by measurement as in Fig. 13, if they are first levelled.

The common practice when a shaft or machine is to be erected is to square it from something which has previously been set by something else, on the principle of measuring by succession, a practice no mechanic would think of in other cases.

If machines have iron frames and stand on masonry,

they can be fixed by running melted lead or brimstone under the feet after setting and levelling them. On earth floors, however, it is not necessary to build masonry for any except reciprocating machines. Stakes of locust, cedar, or mulberry wood, set in the earth from three feet to four feet deep, and then sawn off level on top, make almost as good a foundation for any machine as masonry. It is, however, exceptional to find machines set on the ground, a plan that has nothing to recommend it, for when attempted there has to be a floor over a great part of the room, that usually costs as much as a complete floor would, if it had been laid down at the beginning.

BELTING FOR WOOD MACHINERY.

Rules that apply to belts in general are applicable to those used in wood-working establishments, yet there are some conditions to be taken into account that are peculiar and exceptional. The belting is *dry* in all cases, and often has shavings or sawdust passing under the surfaces, preventing contact on the pulleys, and so reducing the tractile power. Besides, the belting moves at such high speeds that it prevents contact on the pulleys, especially when of small diameter.

For these reasons, the belting should be much wider than would be needed to transmit an equal amount of power in other establishments.

Belts to drive wood machines require to be at least one-third wider than for metal-cutting or other machines where the belts can be kept soft or moist. Even twice the width will not be too much in some cases.

For main belts, india-rubbre is preferable to leather.

It has advantages in driving capacity, in running true, and, if well made, it is more durable; its merits are, as a rule, not understood, although it has been in use for the last twenty years. The ordinary gum belting of commerce may not be as durable as leather; both the webbing and the gum may be of poor quality; but if an order is sent to a first-class house for a good gum belt, heavy enough for its work, there is no leather belt that will equal it. The tractile power in a wood shop, where the surfaces must run dry, is at least one-third greater than that of leather belts, and the tension can be proportionately less, or the belt so much narrower to do the same work. The best plan, however, is to keep the width and avoid tension, which, if too great, is apt to break the belt joints and heat the bearings of the shafts.

For joining gum belting there is no better plan than with malleable iron hooks. Clamps, with plates on the back, and other contrivances of a similar kind, make the joint too rigid, and also make a disagreeable noise in passing over metal pulleys. Cement joints that are generally recommended by the manufacturers of this belting cannot well be made by those unskilled in the matter, and are not necessary except for heavy driving belts.

What is wanted is a smooth joint, quickly and cheaply made, and one that will not pull out; such a joint can be made with hooks. A belt, 12 inches wide, can in this way be put together in a good workmanlike manner in ten minutes, and the joint will stand for a long time under any strain that a belt ought to bear, whether it be of gum or leather.

To make the joint, first cut the belt square; then lay out the lines for the holes, so that when the ends of the belt are placed together the distance between them will be a

little more than the length at *a*, Fig. 14. Punch the holes, then lap the ends, as in Fig. 15, and drive the hooks by keeping a bar of iron, a hammer, or some other weighty piece beneath the belt. After the points of the hooks are through the belt at both ends, the joint can be butted together by bending the belt backward from the joint until the ends will pass, and then straightening it. To

FIG. 14.

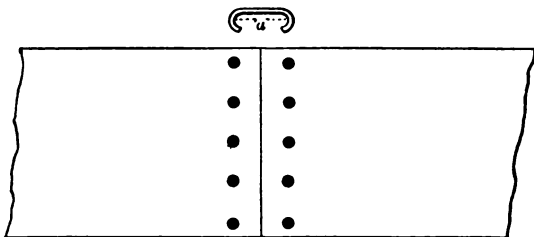

FIG. 15.

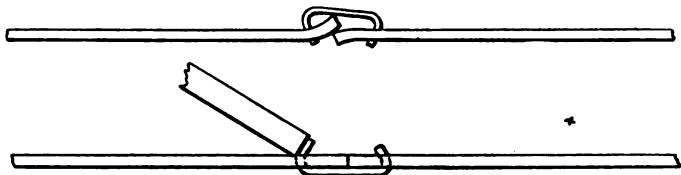

FIG. 15a.

clinch the hooks use an anvil bar, Fig. 15a, closing first one end and then the other with a light hammer, so that the belt will be firmly clamped, *but not cut*, with the hooks. In this last operation lies the secret of making these hook joints successfully; if the hooks are closed properly they will not tear out the holes like lacing, but will pull the belt asunder at the holes, proving the joint to be

as strong as any other portion of the belt, less the weakening effect of the holes. If the hooks are hammered down too hard they cut into the belt and weaken it. After the joint is closed the hooks may be bent to conform to the curvature of the pulleys they run over. If one is large and the other small, the hooks should be bent to fit a curve between them in size, or, if different, to fit the smaller pulley.

That belt hooks have not become more popular is owing to the careless manner in which they have been used. A belt may be fastened in almost any manner with lacing, and hold for a time; but it is not so with hooks; they must be put in carefully to stand. Properly done, they make one of the best joints, and if improperly done, perhaps the very worst.

The size of the hooks must be adapted to the thickness and width of the belting; the distance from the joint to the holes should be at least equal to three thicknesses of the belt.

The width of driving belts and their length should be such, that when at angles lower than 30 degrees they will do their work without tension on the slack side. By no tension, is meant that the belt should be loose enough to run in a curve. Main driving belts are here alluded to, and particular stress is laid on this matter, for no good result can be attained with a heavy belt that is not capable of doing its work mainly by its weight.

Speaking of weight, it may be remarked that in making comparisons of cost between leather and india-rubber belting, the weight should be taken into account. As a rule, single leather belts wider than 6 to 8 inches are not to be compared in weight to gum belts, and gum belts of two and three ply, with heavy cotton webbing, correspond to double

leather belts, which are usually double the price. A leather belt wider than 8 inches should always be double, no matter what its purpose, unless it is to run at a very high speed on small pulleys, which need never occur if machinery is properly arranged. A single leather belt will not keep straight; and speaking of the ordinary belting of commerce, the wider it is, the greater the tendency to become crooked and irregular.

For the extreme high speeds sometimes necessary in wood machines, belts of cotton webbing can be used with advantage. Heavy saddler's webbing coated with beeswax makes a belt that is very light, and has a high tractile power. When used the pulleys must be true and smooth, and the belts kept clear of flanges, or anything that will produce a rubbing action, as this soon destroys them.

In the change from round belts, once almost exclusively used, to flat ones, we have no doubt gone too far; a round belt is in many cases much cheaper and better. Such belts are extensively used in England and on the Continent, but are rarely seen on American machines. For the first movers to drive the feed works of planers and other machines, they are better than flat belts, especially when cones are used for graduating the speed, and when they have to run through shavings or sawdust.

In the treatment of belts for wood machines nearly all that can be done is to keep them soft; a coat of castor-oil now and then laid on with a brush is a good plan for softening them. Tallow is as good, but more difficult to apply. For gum belts no surface coating can be so good as the india-rubber itself, which is soluble in, and infused by animal oils; as they do not need softening they should be left alone, as the safest plan.

HANDLING MATERIAL.

What proportion of the labour of a wood-working establishment is directed to moving and handling material, cannot be stated, but that it is a fair share of the whole anyone must admit. Handling material is one of those things which cannot be done to any extent by power; and in machine operations, the greater part of the labour is usually handling the stuff. There can be little information given about handling long lumber, but the following suggestions in regard to short stuff or work in process will enable the operator to get along without so much handling, and carrying the stuff from place to place.

In arranging machines, always set them so as to leave truck-room between and around them; no matter how crowded the room, this should be done; the floor-room that will be saved by piling stuff on trucks will more than make up for room lost in the passages.

In furniture and chair shops, carriage shops, turning shops, door, sash and blind shops, and in nearly all of our wood-working factories, the material can be kept on trucks instead of on the floor, with two important advantages gained; it may at any time be moved from place to place, and can readily be reached without stooping to the floor.

We may also mention the system, order, saving from bruises, and the facility for counting pieces, as objects gained by the truck system, which is suggested.

The trucks for machine rooms should be made of uniform size for each story; there is no use in depending upon a particular truck being kept for a special use; the rule is, to take the first one at hand, and there is but little use in having different sizes. These trucks can be built as shown

in Figs. 16, 17, for upper floors, where the stuff is cut out and in process, and for anything except heavy loads of lumber, which require a truck that is lower in height and much stronger. The main frame should be of hard wood,

FIG. 16.

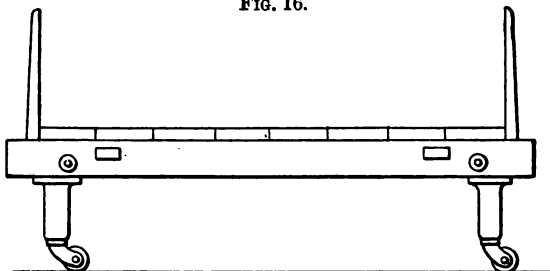
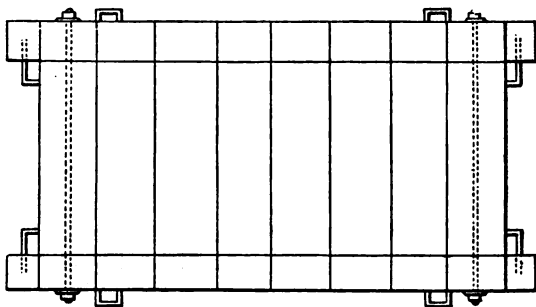

FIG. 17.



about 4×4 inches, the cross rails set in $3\frac{1}{2}$ inches from the end, with tenons to keep them in place. Two through-bolts $\frac{5}{8}$ in. diameter along the inside of the cross rails hold the frame firmly together, and yet allow it to spring in passing over blocks or uneven floors.

The common mistake in making trucks is in having them too rigid; they will not last long or work well, unless

made to yield at the corners. The planking across the top can be nailed to the side rails; it should be $1\frac{1}{4}$ or $1\frac{1}{2}$ in. thick, of white wood—sycamore, or some other tough wood, that will stand bruising, and will not split; even pine is better than ash or oak. The standards should be arranged to go either at the ends or on the sides, as shown in the plan, Fig. 17. Figs. 18 and 19 show a complete set of irons for a truck 4 feet to 5 feet long and 2 feet to 3 feet

FIG. 18.

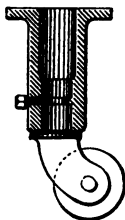
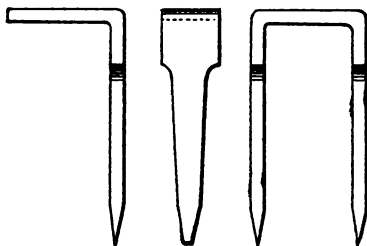

FIG. 19.



wide, consisting of four cast-iron brackets with a flange at the top to be fastened with wood screws; the swivel piece may be cast of malleable iron; the small screw is to keep the swivel from falling out when the truck is lifted; the roller can be of cast iron; the staples are for the sides and ends of the truck, as in Fig. 17; these staples should be forged from iron about $1\frac{1}{2} \times \frac{3}{8}$ in., and large enough to receive a tenon $2\frac{1}{2} \times 1\frac{1}{2}$ in.

With from six to twelve of these trucks on a floor, or at least one for each machine, half the handling, and nearly all the carrying, is saved. In working stuff, two are needed at each machine, so that the pieces can be taken from one and placed on another as they are worked.

When material is to be moved from story to story, the trucks can be run upon the platform of the hoist, and with their loads raised or lowered to where they are wanted. A boy with one of these trucks will move a thousand pounds the length or width of the shop, and up or down through several stories, at the same cost that a single load can be carried by a porter, to say nothing of the damage by having the stuff thrown down upon the floor, and the loss of time required to gather it up again. This system of roller trucks is to some extent in use; but it is exceptional, and rarely ever carried out so as to realize the greatest advantage from it.

A system half carried out is as no system at all, one or two trucks in a large shop are only an annoyance; the men lose more time during a year in searching or waiting for them, and in disputing about them, than a dozen additional new ones would cost.

To say that a wood-working establishment which has more than one story should have a power hoist, is to state what everyone knows, but not a thing which everyone has estimated the advantages of. The question of saving and earnings will be considered farther on, and here we will only say, have a hoist whenever there is work for it to do. A wood platform or cage, with a wire rope and winding drum driven by belts and a tangent wheel, is a cheap and simple plan for such hoists; the gearing is now furnished by different makers like any other machines, self-contained and ready to erect, including the cage and guides if wanted. Be sure to have a reliable safety catch to prevent falling, and avoid all ingenious triggers and self-acting apparatus that can be dispensed with. Put up a caution notice with directions for operating the machinery at each hatch, and leave the rest to the judgment and good sense of the work-

men. There is no machinery so dangerous as that which pretends to dispense with care and caution on the part of the operator; and the greater number of accidents with hoists come from that class known as the absolute safety. Accidents rarely happen with the old outside chain hoist, although it is without question very dangerous; the reason is that we watch it and run no risks.

In connection with the arrangement of a mill at Fig. 1, a tramway through the centre of the building is mentioned. This plan is a good one, and the best and cheapest in a large mill or car shop; but in furniture factories, chair factories, door and sash shops, and jobbing mills, caster trucks such as those just described for machine rooms, only stronger, are even more convenient than the tramway.

The general means of moving material may be said to consist in tramways for horizontal movement in straight lines, hoists for vertical movement, and caster trucks for distributing in irregular lines; however, in any but the largest mills, and for any but long and heavy lumber, the horizontal movement and the distributing can be combined, and the fixed tramway dispensed with. In such cases the trucks to be used in connection with cutting out saws, planing machines, and for first floor purposes generally, should be framed of stuff about 5×5 inches, and be correspondingly heavy in all their parts; they should be from six to eight feet long, with three wheels instead of four, the two forward wheels on a fixed axis, and the rear one swivelled. Such trucks should be strong enough to carry at least $2\frac{1}{2}$ tons, and their wheels six to eight inches diameter, with from $2\frac{1}{2}$ to $3\frac{1}{2}$ inches face. There is nothing peculiar about their construction that calls for diagrams to explain.

By laying a cheap plank floor from the mill room to, or through, the board yard, such trucks can be run out and loaded at any distance from the shop, and men will prefer to push in a thousand feet of stuff in this way to carrying two boards that will not weigh 50 lbs. each.

This simple matter of trucks is dwelt upon because it is perhaps the most neglected of all things about wood shops. We exhaust our ingenuity in devising machines to work stuff at a rapid rate, but make no provision to bring the stuff to or from the machines; and with the exception of the large lumber mills along the north-western Lake coast, and the very largest mills in cities, it is unusual to find any means of handling material that at all compares with the completeness in other details.

Of tramways little need be said; all know what they are for, and how they are made. The difference from trucks is that they can be used in one line only, and that the cars require less power to move them than trucks with casters. In many cases it may be expedient to have both, a tramway and trucks, but whether both, or even additional means of handling, are required, be sure and provide whatever will save carrying stuff or throwing it upon the floors.

CLEARING WOOD SHOPS.

Clearing shops of cuttings, shavings, and sawdust to a certain extent belongs to the same branch as moving and handling material, and the same rules will apply in many respects.

There is, however, this difference, that from recent improvements it is probable that the driving power will in future be used to clear shops, while we can hardly

hope to have it handle the lumber. There is at this time, in fact, no need of saying anything about plans for clearing shops except by pneumatic fans, for they are in general use, and we may safely say, where they are not in use they should be or will be. These pneumatic conductors are now so well known that it will not be necessary to go into a description of their general arrangement, which the reader is presumed to be familiar with. The writer having been personally concerned in the introduction of this system in England and the continent of Europe, and having built pneumatic apparatus, that have been in constant operation since 1862, has no fears in recommending the system as practical and economical, apart from its convenience and its sanitary advantages in getting rid of the fine dust so prejudicial to health, and one of the most objectionable features of operating wood machines.

The fans must be plain, strong machines, large enough to perform their work easily; the vanes strong enough to break up sticks that may pass into the fan. The bearings should be *outside* the casing and pipes; a common plan is to have one bearing inside the induction pipe, where the oil is at once absorbed, and there is a continual danger of fire from the bearing heating. Fans made for ordinary blowing purposes are not fitted for this use. We give at Figs. 20 and 21, side and front elevations of the fans used in England.

The casing is cast in one piece $\frac{1}{2}$ in. thick; the vanes are of forged or malleable iron; the shaft is $1\frac{1}{4}$ in. diameter of steel running in brass bearings outside the casing.

The size of the fans for clearing wood shops must depend upon the number of inlets, openings, or, as we will call them, leaks into the induction pipes. A blower 20 in. diameter and 5-inch vanes, would clear the largest mill, so far as conducting the shavings and dust, but could

not maintain a current strong enough, after supplying the inlets, to lift the shavings. For this reason, it is easy to see the importance of having the collecting hoods fit

Fig. 21.

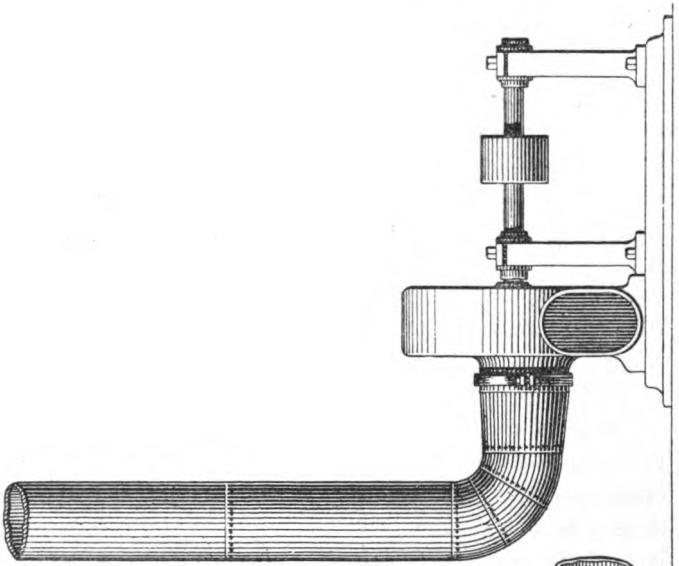
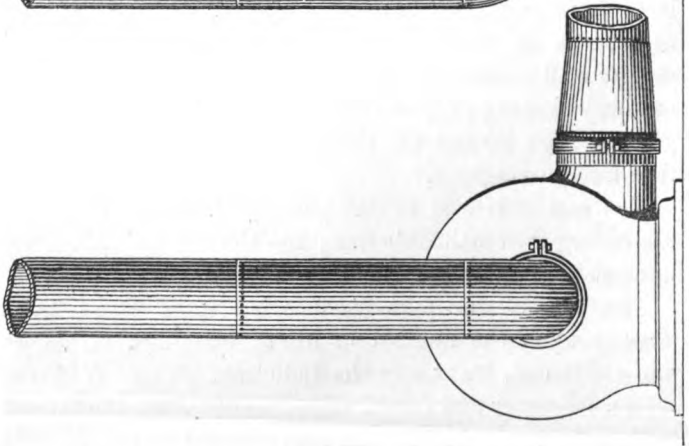

Fig. 20.



well, and avoiding all possible leaks into the pipes. The writer is at the present time engaged in experiments to test the practicability of exhausting the air from the magazine by fans so as to induce currents in the collecting pipes and avoid the necessity of passing the shavings through the fan. It is almost impossible to give any rule for the size of pipes without assuming some special premises to base such dimensions on. We will, however, say that starting with 5 inches diameter for the smallest size for a main pipe, there should be added at least 10 inches of sectional area for each machine that is connected, except surfacing or dimension planing machines, which will need twice as much.

Galvanized or zinc-coated sheet iron from 18 to 24 gauge, is a good material for conducting-pipes.

The elbows should be made with a radius of 10 inches or more on the short side, and everything avoided in the arrangement of the pipes that will endanger their choking. When machines are not in use, it is well to close off the induction pipes with a ball of paper or waste; dampers or valves can be made in the pipes for this purpose, but if constructed so that they will not obstruct the pipe when it is in use, they are expensive, and unnecessary except for floor pipes, noticed farther on.

It is often desirable to have the fine dust separated from the shavings and sawdust; even if they are only to be used for fuel, and the magazine or shavings room should be arranged to allow the dust to pass off at the top, as in Fig. 22.

The magazines should be fireproof throughout, and extend above the building to such a height that the dust will not be carried through the windows after it has escaped at the top. As it is often expensive to carry the brickwork high enough to effect this object, a

sheet-iron flue or uptake can be used, as shown in Fig. 22. The sectional area of this flue when used should be

FIG. 22.

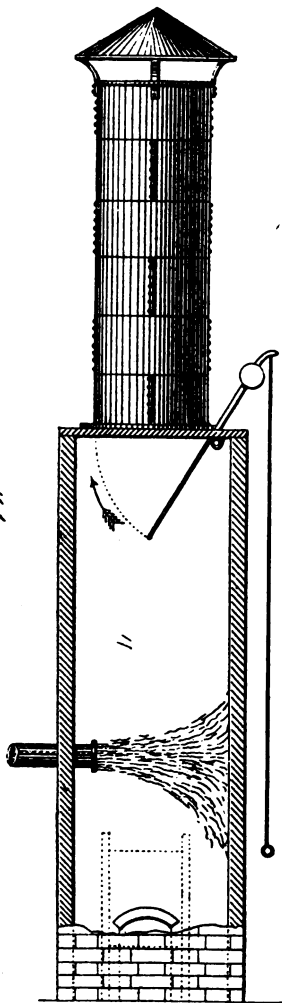

from ten to fifteen times as large as the pipe leading into the magazine, otherwise the current will be strong enough to not only carry off the fine dust but the lighter shavings from the benches.

There should be a swing trap-door at the bottom of the uptake, or at the top of the brickwork if an iron flue is not used, that can be instantly closed from the outside if the shavings in the magazine should catch fire. This trap can be pivoted on a shaft to extend out through the brickwork, and be operated by a lever on the outside.

The discharging door below should be closed by means of a sliding iron plate, counterweighted and working in grooves, so that it will rest on the shavings when the magazine is full, or partially full, prevent the dust from escaping, and at the same time prevent any circulation of air in the case of fire.

Inlets or openings, to take

off sweepings, should be provided at suitable places for clearing the floors. If opening downward the orifices should be at least as small as the pipe, and never made in a hopper form, as they will soon be clogged with blocks or sticks.

FIG. 23.

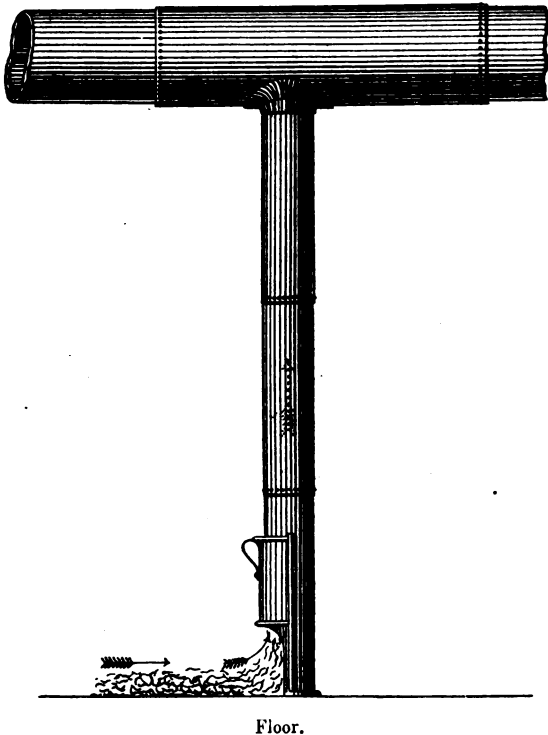

A better plan for these floor openings for sweepings, is to bring down a pipe from the main overhead, cutting it away at one side, Fig. 23, and closing the aperture with a slide door when not in use; this plan is much

better for many reasons than inlets cut vertically through the floors. The pipe can come down alongside a post or the wall, not interfering with the room; arranged in this way there is but little danger of its choking, or having lost tools, nails, or blocks, get into it. For conducting sawdust alone small tin pipes, 2 to 3 inches diameter, will do.

In erecting a set of pipes and apparatus of this kind to clear a shop, the person in charge should avail himself of any examples that may be in the vicinity, if they are good and have been successful; it is quite a new thing, although extensively applied, and there is a great deal yet to be learned by experience.

The danger of fire from this apparatus, once much apprehended, was owing to the use of wooden conducting pipes, pockets and corners, where fine dust would accumulate, and then explode by a spark communicated from a hot bearing, lucifer matches being dropped among the shavings, or by sparks from the fan striking grit or nails. The inflammable and explosive nature of wood dust is but little understood and not generally known, but few are aware that it is a fulminate like gunpowder. Any dust of combustible material, or even that of cast iron, when floating in, and thickly distributed in the air, explodes or burns up with great force. To prove this, let anyone hold a candle beneath a girder or beam in a wood shop and sweep off the fine dust from its top so as to fall on the light, and they will be convinced of its explosive nature. This is no doubt the origin of nearly all the fires that have been attributed to pneumatic apparatus; as soon as caught, the fire was by means of the wooden pipes immediately carried throughout the whole building, or as far as the air currents extended.

PRECAUTIONS AGAINST FIRE.

Besides what has been said upon the danger of wood dust in the last article, we will add a word about other sources of fire, one of the evils that wood manufacturers have particularly to contend with. Insurance rates for wood shops are, in America, from three to five times as high as in machine shops and other places, where, if the wood shops were carefully managed, the risk would be equally great. Everyone who has any charge in a wood shop should continually study the *possible sources of fire*. As accidents do not often happen when they are expected, so fires do not come from sources that are foreseen. Fires are generally mysterious, we rarely know just how they occur, yet there is no want of sources for them, and considering the little care that is exercised in most shops to guard against fires, the only wonder is they do not all burn down as fast as built. There is no desire to exaggerate this matter, but to state it in a positive way. The sources of fire about wood shops are generally bearings, smoking, matches, stoves, sparks from the furnace, lightning, and incendiarism, and also the want of means to put out incipient fires, for such want is certainly to be set down among the causes of destructive fires. To consider these several sources;—bearings need not be made so as to take fire; there should be no wood about them, no accumulation of shavings, or of oil and sawdust; smoking, we need hardly say, should not be allowed on the premises; matches are not very dangerous and can be carefully used; stoves are not often needed in shops where there is steam power, and when they are used, can be made comparatively safe by setting them on an elevated iron platform; sparks from the furnace can only be a

E

source of danger when there is great negligence in the plan of its construction or in its care; and finally, there is but little danger from any or all of these sources in a clean orderly shop. Disposing of the matter in this way, it may be said that it is quite easy to avoid danger from fire. There are none of the things enumerated but what are easily guarded against if taken in time and fully considered. To understand sources of fire is quite another thing, however, from merely thinking of them and being aware of their existence; they must be considered on scientific principles, like everything else connected with technical matters, and when understood must be attended to thoroughly, promptly, and persistently. It is not an easy thing to fire a shop when there is no accumulation of shavings, and a hard thing to guard against fire when there is such accumulation. The floors should be kept clean, no matter what it costs to keep them so; and if the business will not otherwise afford it, pay the insurance policy to a porter to sweep up and watch for fire. The chances are that you will save more in ten years than by insuring. On every floor and in each room there should be kept in some convenient place a number of wooden pails filled with water, not to be used to fill up the grindstone troughs, nor to wash up with, but marked "fire," and to be let alone unless needed for that purpose. It is but little trouble to keep them filled, and some cheap chemicals, say a few drops of carbolic acid, will keep the water pure in the summer during hot weather. Fifty pails of this kind, that will cost fifteen dollars, are worth more in a wood shop than a dozen chemical annihilators, steam pumps, or other contrivances which men cannot use when excited. A watchman, no matter how stupid he may be, understands a water pail,

and will not fail to use it if he can get it, but would not under excitement be able even to turn a stop-cock, or sound an alarm signal if a fire should occur. The responsibility of these precautions against fire rests mainly with the managers and operators, proprietors do not always understand them, and if they did, cannot watch them. We would therefore urge a carefulness about fires, a thorough study of all that may originate them, and the surest means of arresting them, as one of the first and highest qualifications of a competent machine operator and wood workman.

Dirty shops and want of system are the common sources of fires; the opposite, clean shops and perfect system, are the great safeguards against them. A clean shop guards against exposure, and system detects and anticipates the various ways in which fire may be kindled.

The pneumatic fan arrangement for clearing, alluded to before, will no doubt add much to the safety from fire, by keeping out the shavings and generally encouraging order and cleanliness.

SPEED OF WOOD MACHINES.

The speed at which machines should run to give the best result, is a question that operators should understand. It is a matter which they are expected as a rule to control, even when they do not direct the original arrangement for speeds. To prove that the proper speed of machines is an intricate, or at least an undetermined matter, we need only refer to the diversity of opinion among mechanics, and the want of any opinion at all with a great many who have not studied the matter. This is not stated in

a fault-finding spirit, but to show that it is no easy matter to tell how fast saws, cutter spindles, boring and mortising or other tools, should run.

If the speed of a machine could be premised from that needed for the cutting edges alone, we should have a general rule to apply, but the limit of speed is more frequently taken from the conditions of the spindles and bearings, than from the cutting action. Cutter-heads more than 4 inches diameter can generally be moved as fast as the edges need to run to give a good result, say within 5000 revolutions a minute, or 5000 feet of movement with the edges; but when the cutter-heads are smaller, the spindles are not diminished in the same ratio, and the speed must be slower. Always consider the cutter movement as the base in estimating speeds, instead of the number of revolutions made by the spindle. A cutter on a 3-inch head, making 4000 revolutions a minute, is only moving as fast as one on a 6-inch head at 2000 revolutions; yet it is quite common, and a habit hard to avoid, to consider all spindles as wanting a common speed of from 3000 to 5000 revolutions a minute, without considering the movement of the edges.

Perhaps as good a rule as can be used is to assume a 4-inch cutter-head to make 4000 revolutions a minute, as a base or unit of speed; this makes approximately 4000 feet a minute of cutting movement; then add 500 feet a minute for each inch of diameter that is added to the cutter-head; this makes, with 10 inches diameter, a speed of 7000 feet a minute, and for 16 inches diameter 10,000 feet a minute, which could then become a constant as a maximum speed for all larger diameters. This, it must be remembered, is assumed for strong cutter-heads of forged or malleable iron, steel, or brass,

and not cast iron, which should never be used for high speeds.

Reversing the rule, from 4 inches diameter, with 4000 feet of cutting movement; deduct 750 feet of the movement for each inch of diameter that the heads are reduced; this, at one inch, brings the cutting speed to 1750 feet a minute with 7000 revolutions of the spindle, about a practical limit. From this we have the following Table, which can be used for reference:—

SPEED OF WOOD MACHINES.

Diameter of Cutter-head.	Feet of Cutting Movement a minute.	Approximate Number of Revolutions a minute.	Average Speed of Bearing Surfaces a minute in feet.	Ratio of Movement in the Bearings.
inches.				
1	1,750	7000	875	8
2	2,500	5000	937	9
3	3,250	4333	1083	10
4	4,000	4000	1125	11
5	4,500	3600	1125	11
6	5,000	3333	1145	11
7	5,500	3142	1277	13
8	6,000	3000	1406	14
9	6,500	2880	1444	14
10	7,000	2880	1445	14
11	7,500	2706	1450	14
12	8,000	2666	1465	15
13	8,500	2615	1525	15
14	9,000	2576	1541	15
15	9,500	2533	1551	15
16	10,000	2500	1512	15
17	10,000	2352	1470	15
18	10,000	2222	1417	14
19	10,000	2105	1382	14
20	10,000	2000	1370	14
24	10,000	1666	1250	13
30	10,000	1333	1083	11
36	10,000	1111	987	10
40	10,000	1000	1000	10

NOTE.—These estimates, except the size of the cutter-heads, are approximate only, to give round numbers.

The speed of the line shafting should in all cases be as great as the bearings will stand with safety; 200 to 250 revolutions for 3-inch shafts, and 250 to 300 revolutions a minute for 2½-inch shafts, make a good rule, to be modified of course by the kind of bearings used. Countershafts, as a rule, can run three times as fast. 36-inch pulleys, on the line shaft, with 12-inch tight and loose pulleys on the countershafts, is a good arrangement for such shafts as drive cutter spindles.

Speeds should, as far as possible, be arranged to start from line-shaft pulleys of a uniform diameter, so that machines can be exchanged, or moved from one place to another, without taking down the line shaft each time to put on a new pulley. There is something strange in the fact that machine builders pay no attention to this matter; even machine tools that have nearly a constant velocity, and require nearly a constant amount of power, are arranged to be driven with pulleys varying from 6 to 24 inches diameter. Most builders, however, are willing to modify their countershafts to suit speeds and pulleys, if a special order is given, so that the fault rests mainly with those who purchase the machines.

The cylinders of planing machines being strong and safe, and the rate of feed needed as great as possible, they can be run at a speed one-fourth greater than that given in the Table.

Boring machines to operate screw-bits should run from 1000 to 2000 revolutions a minute, according to the kind of wood or the size of the bits used.

For all reciprocating machines there is a general rule that applies, which is to run them as fast as they will stand; or, in other words, their work always requires

more speed than it is possible to give them. This is certainly not a very comprehensive rule, but another rule, infinitely better, is to "use them only when they cannot be avoided," no matter to what purpose they are directed. For ordinary reciprocating machines the following list of speeds is given, for which we trust the reader will not require any special data, but accept it on faith and as a matter of experience:—

	Revolutions a minute.
Resawing machines with one saw	250 to 300
Scroll saw with sash	300 „ 400
Jig saws with spring tension	500 „ 800
„ unstrained saws	800 „1500
Mortising machines with movable table	300 „ 450
„ „ chisel-feed	250 „ 350
„ heavy, for car work	200 „ 300

Circular saws can be run at least a fourth faster than other cutting tools, which can, for ordinary cases, be added to the estimates in the Table for rotary motion. The manner in which a circular saw is hammered has much to do with the speed at which it can be run, and often when a saw becomes limber and "runs," it is the fault of the hammering instead of the speed. When slack on the periphery it will not stand speed, and becomes weaker and bends more readily when in motion than when it is still; on the contrary, if it is properly hammered a little tight, as it is termed, on the periphery, it becomes more rigid when in motion up to a certain limit. The theory of this is that the steel is elastic, and is stretched by the centrifugal strain in proportion to the speed, which is greatest at the teeth and diminishes to the centre.

If saws indicate a tendency to spring and a want of rigidity, have them re-hammered by an experienced smith,

before changing the speed to remedy it. Cutting wood is a little like cutting iron; hard wood cannot be cut at so high a speed as soft wood. Anyone who has had experience in working boxwood, cocoa, rosewood, or *lignum vitæ*, will have noticed that a high speed soon destroys the edges by overheating, especially with boring tools, or turning tools that act continuously. The use of these hard varieties of wood is, however, so exceptional in America, that the matter need not be discussed here, further than to say that a moulding or a planing machine that is to run mainly upon walnut, ash, oak, or any of the native hard woods, will give a better result if speeded one-fourth slower than for pine or other soft woods.

POWER NEEDED TO DRIVE MACHINES.

The article on speeds for machines was commenced by informing the reader that no positive rules could be given. The present one, for stronger reasons, should perhaps be commenced in the same way. The power is something, however, which some one must understand, and which all must be more or less conversant with. It is one of the first considerations in making plans for a mill, or for wood manufacture of any kind. It may seem arbitrary, in dealing with a new subject like the operation of wood machines, to make a list of and set down the power needed to drive each machine. It is, however, all that can be done in the absence of those careful experiments that have fixed the measure of power

for other duties almost as diversified and irregular. In our American shops from two to four times as much wood is planed off as in Europe. The lumber is cut to size whilst green, and then seasoned, so that it takes about an eighth of an inch to dress boards, to say nothing of irregular sawing. Foreign planing machines are driven with belts one-fourth the width of the cutters, while American machines have, or ought to have, twice as much width of belt; and, of course, consume power in proportion. As a general rule, for ordinary planing, with flat cutters the belts should be one-half the width of the cutters, running on pulleys whose diameter equals the cutter-heads, or is in the same proportion; that is, if the pulleys are half the diameter of the cutter-head, the belt should be as wide as the cutter, and so on. This is for top cutters that bring the stuff parallel; for bottom cutters, and for all other flat cutters that work on gauged stuff, one-third less will do.

Assuming a rule for belts would seem to be the same thing as establishing an estimate for the power required to run machines, and it would be in most cases, but not for wood machines. The high speed diminishes pulley contact, and the dust and shavings keep the belts dry, diminishing their tractile force; besides, they must be loose, to prevent the bearings from heating, so that if we were to reckon up the amount of power to drive a 24-inch double surfacing planer, according to the accepted standard for measuring the power of belts, it would in most mills leave nothing for the rest of the machines. Experience has, however, demonstrated certain widths as sufficient, and appended is a list of machines with an estimate in horse power as a unit. To determine the size of an engine to drive wood

machines, 3 in. of piston area to each horse power will be found sufficient, if other conditions are correct.

POWER NEEDED TO DRIVE MACHINES.

	No. of H.P.
30-inch surfacing planer, one side	8
30 " " two sides	10
24 " " one side	6
24 " " two sides	8
14 " planing and matching machine	6
14 " " " with bottom cylinder	7
8 " moulding machine, four sides	5
6 " " " " " " " " " " " "	3
4 " sash moulding machine, three sides	2
Circular saws for each inch of diameter above the table ..	1
Mortising machine for light work to $\frac{3}{4}$ inch	1½
" " heavy work to 2 inches	3
Rotary mortising machine for chair work	1
" " framing	3
Tenoning machine for joiner and cabinet work	2
" " framing	4
Jig saw for fret work	1
Band saw to 1-inch blades	3
Shaping machine, two spindles	2
Wood-turning lathe	1
Blower for clearing shavings, &c.	1 to 2
Boring machines	1 to 2

For grindstones, emery wheels, buffing wheels, hoisting machines, and other details, add one horse power for each ten men employed; the resistance of shafting, when of unusual length, must also be taken into account.

In all estimates of the power needed to operate machines, it must be remembered that the power used is generally as the amount of material that is passed through the machines, so that the aggregate must be based upon the length of time, or the constancy with which the machines are run. There must, of course, be enough provided to drive all the machines at one time, and to their fullest capacity, but in making estimates for rented power where it is employed at intervals, or when but a part of the

machines run at one time, the amount used is quite different from what the Table would indicate.

The power needed and the power consumed in wood shops are two quite different things. The old saying that time is money, is equally and more obviously true if rendered, power is money. It is an element of cost, just like oil, tools, or lumber. Power is, however, a less tangible thing, and because it is not seen and handled, is too often allowed to waste and escape under the notice of those who are rigidly careful in other matters. How common it is in going into a shop to hear the belts screeching on the pulleys, belts running half on the tight pulley when it is standing, or sometimes a machine blocked to keep it from starting, with the belts dragging on the pulleys. All this means waste of coal and waste of money, not by loss of power alone, but by the destruction of belts. If a belt is allowed to rub on a tight pulley, or any other fixed object, it is at once heated and stretched, and, as it stretches on one side, the tendency is to draw it more on to this object; if on the edges of tight pulleys, which is most common, its driving power is impaired to the extent that it is rubbed or stretched on its edges; as no contact takes place when it is shifted. Whenever a heated bearing is suspected, the rule is to hunt it up at once and correct it; the same thing should be done with the screeching of belts; whenever heard, look it out, and change the shafting until it runs true. A belt always runs to the nearest end of a shaft, as towards the line *a*, Fig. 24, which is just the opposite way from what is generally supposed. The old theory that a belt always runs to the highest part may be true, and is undoubtedly true with reference to the convexity of the face of pulleys, but does

not apply to pulleys that are set diagonally to the line of the belt. In Fig. 24 it is easy to see that the pulley 1,

FIG. 24.

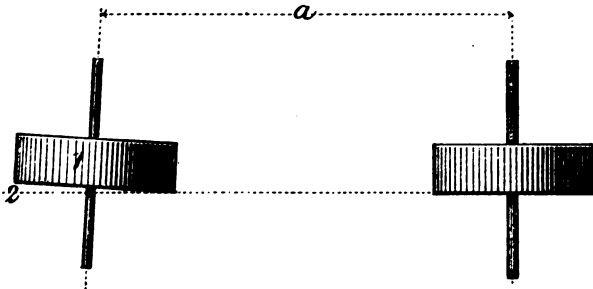

standing in the position shown, will wind the belt spirally, like the thread of a screw, whose pitch is equal to the space seen at 2, between the dotted line and the edge of the pulley, or, in other words, the amount that the pulley is out of truth.

The other edge, which may be called the high one, has its influence on the belt, but it is trifling when compared to the spiral winding action which carries the belt to one side just as positively as a shifter would.

STOPPING AND STARTING MACHINES.

The resistance offered by a machine in starting, is as the inertia of the parts before they are in motion, or as their momentum after they are in motion, and as momentum is as the weight multiplied into the velocity, wood machines, by reason of their great speed, are heavy

to start; especially planing and moulding machines that have heavy cutter-heads. Shifting pulleys, or tight and loose pulleys as they are generally called, are used almost exclusively in our wood shops, and are no doubt the best means there are of stopping and starting, except the idle tension pulley, which can be used only in particular cases. We should perhaps also except the plan of using an independent shaft, shown Fig. 25, in which 1 is the

FIG. 25.

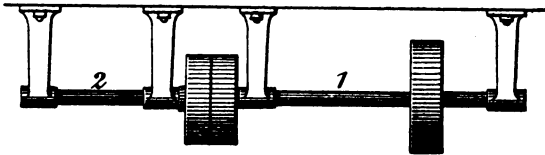

countershaft, and 2 an idle shaft carrying the stopping pulley. This, although a good device, is difficult to erect and keep in line, besides being too expensive to come into general use. Its merits, however, aside from these objections, will at once be conceded.

In a large mill in Cincinnati, Ohio, the shifting pulleys are all arranged on this plan, and it is claimed that the extra expense of first cost is more than made up by avoiding the detention incident to having the pulleys run loose on the shaft.

It is to be hoped that some modification of the friction clutch will be made that has the needed qualities of endurance and power, to take the place of shifting pulleys, for high speeds; it however lacks now much of the simplicity and capacity for wear, that would fit it for the purpose about wood-working establishments.

Shifting pulleys do very well at low speeds when the

shafts are not larger than 2 inches in diameter, and the motion is not more than 500 revolutions a minute, but at the high speeds which are necessary with wood machines, they are a great source of trouble and annoyance, and should be made with great care, and carefully looked after for a time when first started.

In making plans for, or in giving orders for wood machines, the loose pulleys should have special attention. The holes should be bored and reamed to standard sizes, so that a pulley may be exchanged from one shaft to another, or replaced at any time without the trouble of making a special fit.

Before erecting a countershaft or starting a machine that has loose pulleys, always see to the fit, the character of the hole, and that they are clean and well oiled at the start.

The fit should be loose, not too loose, but so as to be felt in shaking the pulley; the hole will show on its sides, from the rubbing of the mandril used in turning, whether it is true or not. A little time spent in looking after these things before starting, often saves detention and accident afterwards, and as the operator has the care, and generally the responsibility of loose pulleys sticking, or cutting, it is important that he should understand the cause of the difficulty and how to correct it. It is true the machinist who builds wood machines should assume the responsibility and always fit the work properly, but if he does not, it is the operator's business to shift the responsibility to whom it belongs.

Loose pulleys will give trouble now and then, no matter how well they are fitted, and in erecting new works, or in purchasing new machines, they should be carefully looked after.

At the risk of recommending a plan that seems to be theoretically incorrect, it is suggested that for high-speed loose pulleys, there should be an oil groove cut in the hub, as shown in Fig. 26—a deep narrow groove parallel to the shaft, and tapering from the ends to the middle, as

FIG. 26.

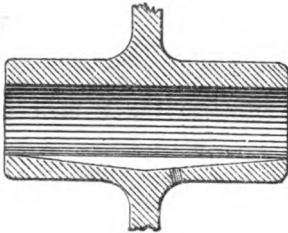
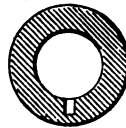

FIG. 27.



shown in the sections, Figs. 26, 27. Such grooves would be supposed to cause an unequal wear in the hole because of the surface cut away at one side, but it will not be found so in practice.

A better, although more expensive plan, is to have grooves cut through the hub, as in Fig. 28; these can be filled with brass antifriction metal, or what is equally good, pear wood. The grooves break what is termed the continuity of the bearing, a principle generally recognized as a safeguard against abrasion or cutting.

FIG. 28.

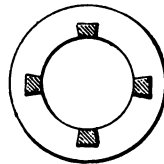

The proportion of the hubs has much to do with the performance of loose pulleys. A too common custom is to make the hubs on the light and loose pulleys, of equal length, losing a large amount of bearing surface that might with advan-

tage be added to the loose pulley, and is not needed on the fast. Fig. 29 is the proper plan of arranging the hubs of shifting pulleys, especially for wood machinery,

FIG. 29.

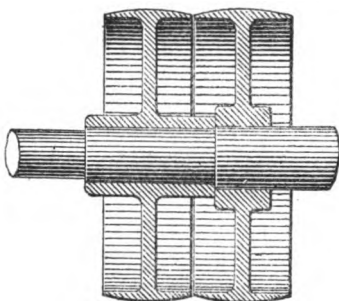

where high speed and wood dust are to be contended with. The hubs of loose pulleys to 3 inches face should project $\frac{1}{2}$ in. on each side of the rim, and for faces of greater width, 1 inch on each side.

Loose pulleys running on studs or fixed shafts cannot be oiled by means

of oil holes drilled in the hub; when a shaft is in motion and the pulley is stopped the oil is drawn in rapidly, but when both are still the case is quite different, and the oil-ways should be made through the shaft or stud instead of through the hub. This applies to the gearing about planing machines, and in all cases where gear wheels or pulleys run loose on a fixed axis. In ordering new machines, or in case of trouble with those in use, have the oil-ways changed to this plan, which is the only way to ensure thorough lubrication and prevent trouble.

While discussing mechanism for stopping, starting, and shifting belts, we will add some remarks about shifters.

A man may be tastefully dressed throughout in a suit of the best, but his whole appearance is spoiled by a bad hat. A machine may be properly constructed, in good proportion, and set up in the best manner, and still present a bad appearance from the effect of an awkward belt shifter.

The rods and fingers or studs are now generally furnished with hangers for the smaller shafts; but there are always more or less of them to be made of wood; the custom seems to be to pick up any pieces found lying about the floor to make them from, without reference to size or proportion. This is especially true of wood shops, where there is every facility for making them in a proper manner.

Of course no special arrangement or dimensions need be followed in making shifter frames, yet there are proportions which should be observed within reason.

Fig. 30 shows a wooden shifter frame, constructed of hard wood; the pendants 2, 2 should be from $2\frac{1}{4}$ to $2\frac{3}{4}$ inches

FIG. 30.

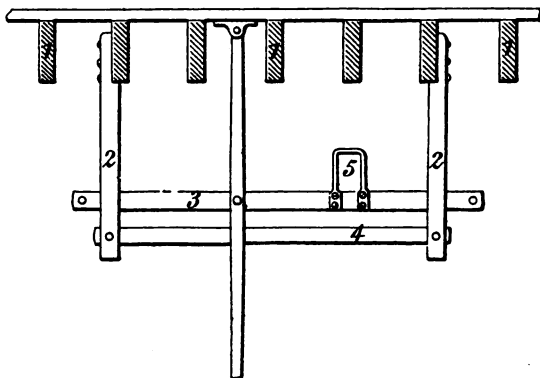

square; the shifter rail 3, $\frac{7}{8}$ by $2\frac{1}{2}$ inches; the friction rail 4, $\frac{7}{8}$ by 2 inches; and the lever $\frac{3}{4}$ in. thick by $2\frac{1}{2}$ inches wide at the extreme, tapering to $1\frac{1}{4}$ in. wide at the lower end, and to $1\frac{1}{2}$ in. wide at the top end. The rail 4 is to connect and stiffen the pendants 2, 2, and to hold the shifter when it is set over, by the friction against the

F

lever; this can be regulated by a piece of leather between them, or by having the rail sprung so as to bear against the lever.

The eye that the belt runs through at 5 can be made of round iron $\frac{1}{2}$ in. or $\frac{5}{8}$ in. diameter, flattened at the ends, and drilled to receive two wood screws in each side.

In building a new place, or when machines are being added, a good plan is to prepare a number of pieces for shifter rails and pendants, which can be shaped and mortised ready for use when wanted, and cost much less than if improvised each time they are needed.

Idle or tension pulleys, or more properly brake pulleys, are perhaps the best means of stopping and starting machines or shafts in any case when the belts are in a position that allows their use. In wood shops any belt that runs at an angle higher than 45 degrees can, as a rule, be operated by a brake pulley; which is not only a very effectual means of stopping and starting, but has the important advantage of regulating the tension of the belt to suit the character of the work, and also increases its lap and tractile power.

Wood shops are especially instanced because a belt at any other than a very high angle cannot be operated in this way unless the surfaces are sufficiently dry and smooth to allow them to slip on the still pulley. As the belts of a wood shop are usually in this condition because of the dust, brake pulleys can be used with advantage in a great many cases, particularly on the larger belts, and when the driving pulley is below. This latter case allows the belt to stop with the top pulley; but if the angle is as high as 60 degrees, Figs. 31 and 32, the driving pulley can be above, and the belt will run loosely around the

bottom pulley without injury if it is not too heavy and there are flanges or guides to keep it on when running loose. In Fig. 31, 1 is the driving pulley, 2 the brake pulley, and 3 the driven pulley. The brake pulley must always be placed on the slack side of the belt, where the bottom pulley is the driver, or as in Fig. 32, where the top pulley is the driving one.

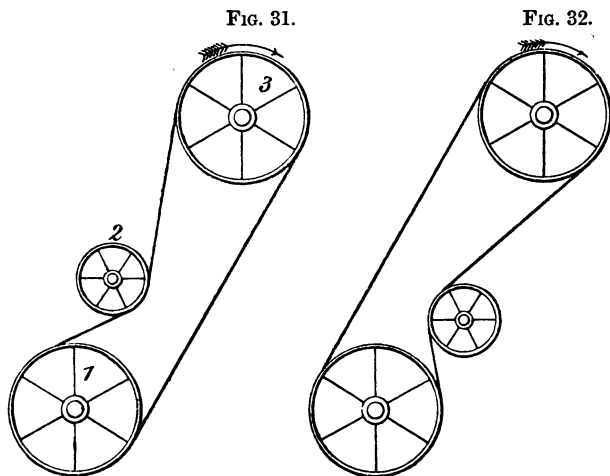

Besides the advantages of regulating the tension and increasing contact, brake pulleys can be used to guide the belt by changing their axes, a very important matter in the case of large driving belts; they also require but one-half the room and width needed for shifting pulleys.

Brake pulleys for small belts should be made as in Fig. 33, the centre laid up out of wood, with a flange of cast iron at each end, fitted on the spindle, and fastened to the wood by means of wood screws. The shaft can be square when it is fitted through the wood, which prevents

it from turning in the pulley, and obviates the necessity of keys in the end flanges; as there is no end thrust on

FIG. 33.

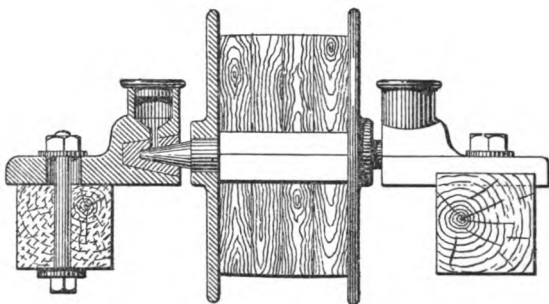

the shaft it can have point bearings. The bearing is arranged for antifricition metal, with a tallow cup on the top, which is the only lubrication needed. If the bearings have to be oiled in the usual manner, the belt is sure to become greased by the waste oil thrown from the flanges.

By letting these bearings into the brake frame, Fig. 33, and having the bolt holes slotted, they are easily moved for adjustment; and if keys are placed on each side of them, they can be set to change the axis of the pulley so as to guide the belt.

Positive clutches are not fit for wood machines, there are no motions that need be so positive as to require them; besides, if made as they should be, they are much more expensive than either shifting belts or brake pulleys.

A great trouble with wood machines is the abrupt manner in which they are started; a belt to drive a planing machine 8 inches wide, moving at 2000 feet a minute, is usually shifted at once to the fast pulley,

causing a shock to the pulleys and shafting, which if it were not for the slipping of the belt would soon destroy the whole arrangement.

This can be guarded against by shifting the belts gradually, but cannot be left to the judgment of those who work on the machines unless they are specially instructed, and even then will generally be forgotten or disregarded. Many machine builders in England arrange shifters to work with screws, so that they cannot be used abruptly, a plan that pays well for the trouble, when there are shifting pulleys which run at a high speed and when the shifter can be attached directly to the machine.

ACCIDENTS FROM WOOD MACHINES.

A machine operator who has not carefully studied the many sources of danger and accident to which he is continually exposed, has neglected a study, the neglect of which may cost him a limb or his life at any time. There is always more or less danger from sources that cannot be foreseen, and therefore cannot be provided against, without running risks from dangers that are understood.

Accidents in wood shops occur generally from carelessness, and a failure to correct some irregularity or risk that was well known, such as cuts by saws or other tools in motion—winding belts, bolts or cutters flying off, or winding the clothing—none of which seem to offer much risk, and yet are dangerous enough, if estimated from the number of accidents from these causes. It is rare to find a man who has been engaged for any length of time in operating wood-cutting machines who has not

lost fingers, or does not bear scars that attest the danger of his calling.

There is perhaps less real risk with wood-cutting machinery than many other kinds, if people were equally careful in working with it. One is not apt to go near a train of wheels, or a large belt that is in motion, without a feeling of dread; they convey a sense of danger; but a circular saw looks harmless when running, almost as though it could be handled without injury, and unless a high-speed machine makes a great noise, it does not seem to convey any sense of peril.

With one exception, circular saws are perhaps the most dangerous among wood tools. The hands in many varieties of work must of necessity be exposed to injury, and nothing but continual attention and care will prevent accidents. The mind must be kept on the work, and never for a single instant wander away to other matters.

The writer, during a long experience with a large number of sawyers under his charge, noticed that a man who was absent-minded was sure to be cut, and that by carefully observing the disposition and peculiarities of the workmen, there could be men selected for the saws who ran but little risk. Whenever a man was detected day dreaming, or engrossed in thought, he was removed from the saws and given a job with less risk; the result was, that accidents became rare, although the work was of a dangerous character, consisting mainly of what is termed blocking and cropping, where some twelve saws were at work.

Accidents in sawing are generally from cuts where the hands are jerked into the saw, and from pieces coming over the saw from behind. In the first case the accident generally occurs from the piece suddenly parting in the

line of the kerf, either through a split or a hidden cut on the under side that allows the piece to spring forward so quickly that the hands cannot be checked, or by the piece unexpectedly rolling over towards the saw when the cut is being made on one side. These are cases when a careful sawyer may be cut; but there are a hundred other ways in which accidents may occur, even by people deliberately placing their hands upon a saw without knowing it to be in motion, a circumstance which has often happened.

In block sawing, cutting short stuff, the sawyer should use a stick for pushing the pieces, placing his left hand to keep them against the fence, and keeping the stick in his right to push them through. A little practice soon makes this a convenient plan, and one that would be generally followed if it were not that in most American saw benches we have not only to push the stuff through but at the same time hold it down to keep it from rising behind the saw, a matter to be noticed farther on. If the stuff has no tendency to rise behind, there is no excuse for placing the hands near enough to the saw to be in danger, no matter what the character of the work.

In sawing from the side of a piece that is liable to roll over, no other precaution can be taken except close attention and an estimate of the danger beforehand. The best rule is to be ready to let go if anything happens, and it may be remarked that in this as in all other cases where accidents may or do happen, people are seldom hurt from a cause that has been previously considered and is watched for. Pieces coming over the saw is a danger that is more apparent, gives some warning, and is generally dreaded and watched for by the sawyer, especially if he has seen or experienced such accidents. Many who have worked

about saws for years do not know the force with which a piece will be thrown from a sharp saw that has hooked teeth.

If a piece of stuff—say, 10 feet long—is taken behind a ripping saw, and the end dropped on the top, so that its whole length will pass over the top, it will attain a velocity equal to that of the periphery of the saw, a fact that is easily proved by examining the marks of the teeth toward the last end, the pitch of which will equal that of the teeth on the saw. An accident of this kind will sometimes happen from a green or wet piece closing on the saw behind; but it is quite rare, and with this exception there is no need of such a thing ever happening. In nineteen cases out of twenty the fault is in the gauge or fence, which for some unaccountable reason seems in America to be arranged with a special view to throwing the stuff over the saw; and considering the ingenuity and the intelligence which mark shop manipulation in other matters, there is no parallel for it.

Fig. 34 shows the usual plan of arranging saw gauges in England and most other countries.

FIG. 34.

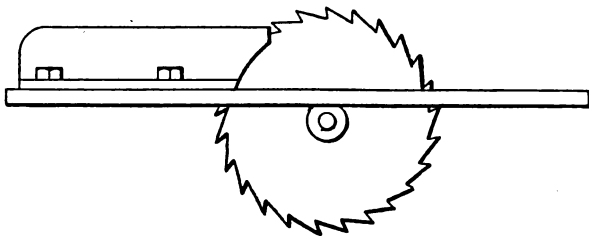

We often see saw benches from 8 to 10 feet long with a mandril in the centre, where no one can reach the saw

from the end, and the work is done with the greatest inconvenience; the gauges not only extend past the saw, but are often longer behind than they are in front, an arrangement that is never heard or thought of in any other country.

It is evident that if a gauge extends behind the saw it cannot be set parallel to the plate, but must, in order to free the stuff, stand at an angle; and as the constant tendency is to keep it parallel, the result is that the pieces are lifted behind and thrown over. This matter will be further considered under its proper head, and is alluded to here only in connection with the danger it occasions.

Many fatal accidents occur from flying pieces, which, from saws of average diameter, usually strike the sawyer in the breast or about the waist, often causing instant death—sometimes scarcely leaving a scar. Three fatal accidents of this kind happened within as many years with men personally known to the writer, which is mentioned to explain the emphatic disapproval of long saw gauges. A thick plank hinged so as to hang directly above the saw, heavy enough to stop any piece coming over, makes a safeguard against such accidents, but it hides the rear of the saw from view, and is not needed if other precautions are attended to.

Circular saws were mentioned as second among the dangerous machines of a wood shop. The irregular moulding or shaping machine should be placed first.

Safety shields of various kinds have been devised, most of which protect the hands, but are in the way, and can generally be found hanging on the wall somewhere in the vicinity of the machines. No safety device that impedes or increases the labour will ever be used in this or any other case, and the safest plan is to carefully consider how

accidents may happen and what precautions will hinder them without interfering with the work.

In shaping, the danger is from having the piece snatched by the cutters, either by a splinter raising or when the angle of the cutters is such as to cause them to catch, both of which can be in a measure guarded against by having the angle of the edges very obtuse, which suits the nature of the work besides promoting safety.

A great share of the work performed on shaping machines, especially such as is extensively duplicated, can be moulded on formers fitted with clamps to hold the piece as in Fig. 35. This arrangement fully protects the hands, besides making better and faster work.

FIG. 35.

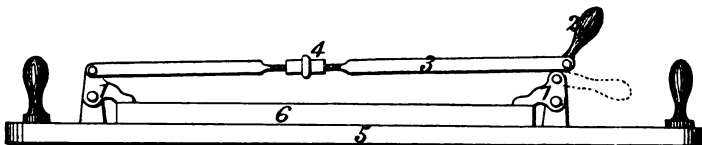

The holder shown at Fig. 35 is adapted to milling or shaping chair-stuff, hames, billet frames, or other work, when there are a number of pieces of the same pattern to be moulded; 5 is the pattern and main frame on which the clamping jaws are mounted, 6 is the piece to be moulded. The jaws 1, 1 are operated by the tension rod 3 and the handle 2, which locks the jaws when thrown down in the position shown by the dotted lines, making a toggle-joint, which is the only safe fastening when there is jar and concussion. The amount of force used in clamping is regulated by the swivel screw at 4, which can also to a limited degree be used to adjust the jaws for pieces of varying thickness.

This form of clamp is the only one that is safe to use on a shaping machine. Screws, spurs, or wedges—in fact, anything except the toggle-joint—may give way at any time, and lead to accident. The tension rod on the top equalizes the strain on the bar 5, which would be bent by any clamping device that acted independently at each end. There is also the advantage of clamping both ends instantly at the same time and with equal force.

The safety of operating shaping machines depends much upon the form of the cutters; if they have an obtuse angle and stand in a radial position, there is but little tendency to snatch the piece, and the cutting will be effected as easily and much smoother than when standing in an acute position; the angle of cutters will, however, be noticed under another head.

Accidents often occur from winding belts, and are always dangerous, either from the chances of being drawn in by the belt or from pulling down the shafting. Three cases out of every four are caused by the belts becoming fast between pulleys set too near together, an easy thing to guard against, and yet a most common fault.

Pulleys on a line shaft, that are separated only an inch or two, are danger traps, that may at any time cost a life or lead to destructive accidents. There should always be a space between, at least one-third more than the width of the belts, and as much wider as practicable. Belts running too near together are also a source of danger; if one belt breaks it is apt to be overrun by the other, and both of them wound about the shaft; and as the supports for shafting are often not strong enough to part the belts, the whole is likely to be thrown down if the heavier belts are wound.

There is always danger in throwing on belts when the

pulleys are in motion. It would be of little use arguing against the practice when it will have no influence to prevent it; what is better will be to give such instruction as is possible to lessen danger.

Do not attempt to throw on large belts until practised with small belts, at low speeds, and experiment until these can be thrown on without failure and without danger. There is nothing about a shop that is learned so blindly as this; no one can, as a rule, tell how to put on a belt, or even offer a suggestion, except it be to keep your hands out, or to get on the right side of the pulley. It is learned by accident, as we may say; and yet there is one little thing which, if understood, will save nearly all the experiment, and at the same time the danger, for the danger does not come from the throwing on of a belt so much as the failure in doing so. *Move the hand as fast as the pulley goes*; that is the whole art. Watch persons trying to throw on a belt, and it will be seen that the only difference between the skilled and the unskilled rests in this thing, of moving the hand with the pulley. The one will throw it on instantly, apparently without effort, and without a thought of failure; the other will try several times, and then, from desperation, attempt to force it on, and burn the hand from friction, or do something worse in the way of accident. Now the difference, if noted, will be found to consist in the fact, that in the successful attempts the hand was moved as fast as the pulley, and in the others it was not. There are of course other conditions to be observed, but this is the essential one.

If the belt is long and horizontal, the centre, or bight, as the sailors call it, should be held up, and the slack should be mainly on the taking-on side; this provides in a measure for overcoming the inertia of the belt, and the

machinery to be started, the chief difficulty where there is much speed.

Large belts, unless very long, should never be thrown on while the pulleys are in motion, but drawn together with clamps and joined. If they have to be thrown on, stop the pulleys, lash the belt to the face of the pulley, and turn by hand or slowly with the power until the pulley has made a half turn, and the belt is on, when the lashing can be removed.

Accidents from winding the clothing are of great frequency in wood shops, but unless from the line shafting, are less serious than in other places. The high speed is a safeguard in such accidents, as the body cannot be drawn in and revolved about a spindle or shaft that is running at a high speed; the greater danger is from slow shafts, making from one to three hundred revolutions a minute. Set screws are generally at the bottom of the matter, and boring spindles the most common source of accidents.

It was remarked before that there is no use in recommending a thing when you know the advice will not be followed. If it was not for this, we should feel like entering a general protest against all exposed set screws. Many of our best machinists avoid them wherever they can, and in some shops they are not allowed on the machines about which the men work, and where there is danger; but this is exceptional, and the rule in wood machinery of the present time is to find them not only in chucks to hold bits, but even in collars on the ends of shafts to keep the loose pulleys on. This last is nothing but a relic of old times, an unmechanical and most dangerous plan of keeping loose work on a shaft, at a place where belts are to be thrown on and off or oiling done. A nut on the end of the shaft is neater, more mechanical, and certainly safer.

Machine operators have usually under their charge unskilled hands, often boys, who have had no previous experience, and there is great responsibility resting on them in this matter of accidents; the novice is at their mercy, uninstructed and uncautioned, he is liable to meet with accidents that will cost him a finger, a limb, or his life. The dangers of machinery are to him just like secret traps set for his destruction, and the old or master operator is to be considered his guardian to take him safely through by warning him of the danger. We feel it quite unnecessary to appeal to the sympathy of the operators in this matter. Such accidents as we have alluded to rarely happen from any cause but oversight and want of caution; and wood workmen, as a class, have but little of that foolish jealousy that in some other trades leaves the young apprentice to learn of danger as he best can.

Operators and managers in any place where the work is under their charge, should go along the line shafting and look for projecting screws, keys, or bolt-heads, see that there are no belt traps between pulleys, and that there is free access to oil bearings without going into dangerous places. If such things are found, have them corrected; if proprietors will not do it, quit them, and seek employment with those of more humanity, system, and good sense; the change will be an advantage in the end. If exposed set screws are found on machines, have them countersunk, or if on the ends of spindles or shafts, have them replaced with nuts. Examine saw gauges and all machines for sources of danger, caution apprentices, and explain clearly the nature of possible accidents, and but little danger need be apprehended. Some foremen are continually having accidents with their machinery, and

others rarely ever have; the difference is mainly from things that have been pointed out, and millowners in placing their machinery in charge of anyone should inquire what accidents he has had, just as much as how much experience he has had in his business.

Accidents from flying cutters, or bolts thrown from cutter-heads in motion, are of rare occurrence. To one who knows nothing of the thing practically, the chances would seem equal, for cutters to fly off or to stay on, when their weight, work, and speed are taken into account. They do not come off very often, however, and when they do there are rarely any accidents from them. This is for two reasons; there is an instinct of danger from cutters that always keeps the operator on his guard; and anything that flies from a revolving cutter-head always goes *precisely in the plane of rotation*, which it is easy to avoid, and if the fact is realized, the operator keeps out of this plane when in the vicinity of high-speed spindles. As this statement comprehends nearly all that can be said as a caution, we will next notice the fastening of the cutters, where the danger generally has its origin.

Cutters are generally held by screws that pass through and clamp them to the head or block. These screws have two purposes to serve; to clamp the cutter on the head so firmly that the friction will keep it from sliding end-wise; and to hold it against the centrifugal strain and the strain of cutting, which is transverse to the face of the cutter, and from the centre of the head. Now making due allowance for the tenacity of good bolts, and the strength they are supposed to have in such cases, there is a point of straining where the screw is ready to break, without adding the further strain of the centrifugal and the cutting forces, and the great danger is rather in over-

straining than in understraining them. The inexperienced generally, with a feeling of greater security in having the cutters tight, will screw them down as firmly as they can, and as the amount of this strain is usually governed by the length of the wrench, it is easy to see the importance of watching the matter especially with moulding machines, where the cutters are too often held by bolts, not only too small, but of low grade iron.

Cutter-screws and bolts should be made of the very best refined iron, not from Swedish, Norwegian, or any of the fine imported iron which is too soft, but from the best rivet rods. It is not amiss to keep a few rods of this iron of $\frac{1}{2}$ in., $\frac{5}{8}$ in., and $\frac{3}{4}$ in. diameter, which can be sent out to have cutter-bolts made from; it will ensure their quality and add but a trifle to their cost. Steel is not safe for such bolts, and should never be used; if it is perfectly annealed and soft, it is of course stronger than iron, but there can never be any assurance of this, besides it will not stand blows and rough usage so well as iron.

REPAIRS OF MACHINERY.

The repairing about a wood-manufacturing establishment, including the renewal of cutters, tools, belts, or saws, that are regularly worn out, and the breakages from accident, if footed up at the end of each year, would in most cases equal, and in not a few exceed, the clear earnings. To lose a contract for a thousand dollars' worth of work on which there is a probable profit of ten per cent., is to lose the chances of one hundred dollars of earnings, but to lose by accident one hundred dollars for repairs is that much

money taken from the actual earnings already made. Its loss is a matter of certainty, and if we could only realize on all occasions, as we should, that one dollar of this kind of expense represents ten dollars' worth of work done in the shop, the repair bills would be materially reduced.

It was remarked at the beginning that an operator of wood machinery should be a machinist. Good operators are generally able to do ordinary repairs, and prefer doing them without sending them out to be bungled in a second-class machine shop.

There is no intention here of suggesting radical changes in existing practice and customs that are not wise and expedient, but it is confidently recommended that any woodwork shop employing fifty or more men should have an engine lathe and a portable forge for doing their own repairs. The engineer as a rule has time to work these tools, and will find many things to do on them in the course of a year, that would otherwise either remain undone or have to be sent out, and appear in a long bill for repairs.

An engine lathe suitable for general purposes in a wood shop of 16" to 20" swing, to turn 6 to 8 feet in length, can with the necessary equipment of tools be procured for from 450 dollars to 600 dollars.

The tools and appliances wanted will be as follows;—

Centre and following rests, furnished with lathe.

One 12" to 16" independent jaw chuck.

One set of chuck drills, $\frac{1}{2}$ " to 1" by eighths, to 2" by fourths.

One set of twist drills, $\frac{1}{8}$ " to $\frac{3}{4}$ " by $\frac{1}{16}$ ths, $\frac{3}{4}$ " to 1 $\frac{1}{4}$ " by eighths.

A set of V thread taps from $\frac{3}{8}$ " by $\frac{1}{16}$ ths to $\frac{3}{4}$ ", and by eighths from $\frac{3}{4}$ " to 1 $\frac{1}{4}$ ", with wrenches to turn them.

Two chucks for drills fitted to the lathe.

Six each, 4", 6", and 8", clamp bolts, $\frac{5}{8}$ " diameter.

Lathe dogs from $\frac{1}{2}$ to 2" by $\frac{1}{4}$ ths, from 2" to 4" by $\frac{1}{2}$ inch.

Lathe tools as follows;—

Four diamond tools, right and left.

Two side tools, right and left.

Four square tools, $\frac{1}{8}$ ", $\frac{3}{16}$ ", $\frac{1}{4}$ ", and $\frac{3}{8}$ " wide.

Two V tools for threads, one bent and one straight.

One inside thread tool 3" long.

Three boring tools, 3", 5", and 7" long.

One round nose tool,

making in all 17 pieces. These tools should be ordered with and come with the lathe, so that they will fit the tool post; and besides have the advantage of being properly made and tempered by the lathe manufacturer, who is presumed to understand just how they ought to be after their purpose has been explained.

A portable forge from 30 to 36 inches diameter, with a sufficient outfit of tongs, and a cast-iron anvil, will cost from 60 to 80 dollars. If the whole machine shop investment is valued at 750 dollars including the shafting, the interest of this would at ten per cent. a year be 75 dollars, as an investment, a sum that will generally be saved in making countershafts, pulleys, or other fittings, to say nothing of repairing. The lathe and tools, if taken care of, will be worth nearly what they cost at any time. We will next consider what may be gained by this auxiliary machine shop in repairs, and doing such fitting as comes within its capacity.

First—There is the saving in cost, notwithstanding the argument of machinists to the contrary. The labour, which is the expensive element in machine fitting, is often performed by the engineer, or some one else, in conjunction with other duties.

Second—The work is done when it is needed, or, what is better, and in most cases practicable, before it is needed; one job done at the right time is as good as two jobs done

at the wrong time; this may be among "Franklin's maxims;" if not, it ought to be.

Third—The work is done in the manner required, and this is the main point of all. In regular machine fitting there are drawings to work from, and there is no trouble in conveying to the workmen a knowledge of what is wanted; besides, the work is of a regular nature, and suggests its requirements; but the repairs of a wood-working establishment are very different. We have only to ask a machinist who has such repairs to do, to learn the reputation they have as a branch of work.

Fourth—The time otherwise lost running after the repairs when done outside. This item is placed last, at the risk of having fault found with the arrangement, for there is no one who has had to look after the repairs of a wood-working establishment, especially when they are at a distance, who would not name this item first. It is unreasonable to expect a machinist to do a thing at once, or even at a definite time, when he has no opportunity of making plans in advance; or to expect him to serve several at the same time; and it often costs more trouble and time to attend to repairs than they are worth.

A wood workman generally, from the nature of his business, knows something about metal fitting and machine work; on the contrary, it is rare that a machinist knows anything of wood cutting; hence, without drawings, it is almost impossible to convey an idea of what is wanted, except by immediately directing the workman, which is generally an equal and more distasteful duty than doing the work oneself.

With an outfit for repairing such as has been described, a wood-working factory may, by purchasing castings for hangers, pulleys, and bearings, when wanted, fit all shafts

except the main line, which, for reasons already given, should be bought from a first-class house that is regularly in the business.

Spindles, and shafts of all kinds that go on wooden frames, can be made; cutters, when of solid steel, can be cut off from the bar, bevelled, drilled, slotted, and tempered. Pulleys of all kinds within the swing of the lathe can be bored and turned. In short, nearly all operations that appear in the expense account of machine-shop bills will be saved. It leads also to a kind of self-sustaining spirit in the works, and this to a community of interest, that is always a characteristic of successful business.

It must however be remembered that this plan of doing their own machine work is not recommended for small shops; or, rather, it is not recommended as a paying investment, unless the tools can be kept at work a reasonable portion of the time.

A separate room, where the wood-dust cannot get in, is needed for this iron work. To put iron tools into the same room with wood tools is to make a failure of the experiment; the small tools are mislaid, the whole covered with dust, and the spirit of the thing lost. A room need not add much to the expense, because such a place is needed, whether there are iron tools or not, and the little space required for a lathe and forge does not much increase its size. Grindstones, saw filing vices, oil, and stores, can all be kept in the machine room, and in most cases one man can repair, file saws, grind cutters, and give out stores besides doing such new machine work as is needed and the tools will perform.

For the assistance of those who are not practically skilled in the use of an engine lathe, it is thought best to append some instructions and hints, which may be of use.

An engine lathe will perform nearly all the operations of machine fitting, except planing, and even this can be done to some extent on a lathe that has a strong screw and gearing. For drilling, have a stem pad, like Fig. 36, to go into the poppet spindle, and a number of wood blocks, of different dimensions, to build up under the work when drilling. Keep these blocks at hand, and do not have to go into the shop to search for new ones each time they are wanted.

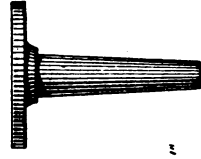
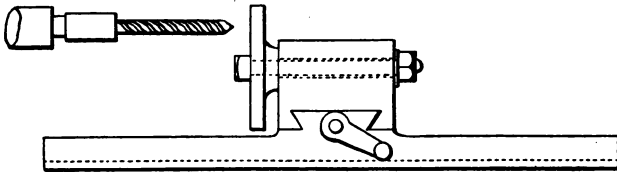

FIG. 36.

When two or more holes have to be drilled exactly parallel, take out the tool post, and bolt the piece to the tool block, as in Fig. 37; it can then be moved across the lathe by the tool screw to bore any number of holes

FIG. 37.



in a true line, or the piece can be turned on the bolt to bring different points to the drill. Do not use the turning feed in drilling, but move the carriage by means of the tail screw.

If a key way is to be cut in a pulley or wheel, first bore it, and then lock the lathe with the back gearing; put a thin slotting tool in the post, and by operating the slide by hand it can be planed out perfectly true, and in less time than it could be chipped. The tools for this purpose should

be narrow, not over an eighth of an inch wide, and the work done at several operations, Fig. 38. If the key is

FIG. 38.



wide the pieces between can be cut out with a chisel at a few blows, or cut out on the lathe by using a stiffer tool. To cut key ways in shafting, drill a hole at the end where the key way stops, mount the shaft between the centres, lock the lathe, dog the

piece to keep it from turning, and proceed by hand movement, as in the other case, using a narrow stiff tool. Never use the turning or screw-feed in any of these operations, or it may be found necessary to go out for repairs, notwithstanding your own machine shop.

In making steel spindles, do not try to anneal them; cut them off in the lathe by removing the tail stock if the bar is too long, catching the end in the chuck and running it in the centre rest, which is a better plan than to heat it, and will, if we count the squaring up of the ends, be less work than to do it at the forge, which requires two men instead of one. The same rule applies to shafting generally, a bar of any length can be put in a lathe in this manner and cut into pieces as long as the same lathe will turn. Have a breast drill for the purpose, and drill all the centres; never depend upon a punched centre for work of any kind. The breast drill will be found handy for many other purposes, such as drilling oil holes about machines without taking the work down, and for small holes generally.

Bolts and screws are now articles of merchandise, like nails, and can be bought of any diameter or length from several firms who make a specialty of their manufacture; odd screws can be made in the lathe. Left-hand nuts for saw mandrils, and cases where but a special nut is used, can be chased on the lathe.

Tempering tools that are not liable to spring is easily learned, and as the wood workman has the advantage of experimenting with the edges which he hardens, the chances are that with a little practice he can do it better than a smith. Tempering should be learned by everyone who uses tools, no matter of what kind. As a process it has but little more to do with forging than with any other branch of work, and is a question of judgment rather than skill. Slow regular heating, both before hardening and in drawing or tempering, is the main thing to ensure success. As to the proper shades and degrees of temper, they must be seen to be understood. If a piece of steel is hardened and then polished and reheated on a piece of hot iron, these shades of colour can be learned in one or two experiments. The first shade, pale-straw colour, is right for nearly all wood tools.

MOULDING BEARINGS.

Another kind of repair about our American woodwork shops is moulding bearings of alloy—making Babbitt metal bearings as it is generally termed, though for what reason it would be hard to say. The patent of Babbitt related to a mode of constructing bearings, and not to an alloy from which they were formed. We have to use some general name for the bearings and metal, however, and Babbitt is perhaps as good as any other; but when we make a verb of it, and to speak of Babbitting bearings, the matter has gone too far, and it is better certainly to call it moulding them.

Moulding bearings is one of the regular repair jobs about wood shops in America; and while almost anyone

can run a bearing of some kind, it requires both experience and judgment to do it correctly; that is to say, that the shaft shall not be sprung by the heat on one side, and that the bearing will be of the proper diameter when moulded, with the metal solid and smooth. To this we may add, pouring without spilling the metal, burning the hands, or having what is too well understood as a blow-up. In fitting new machines that have moulded bearings, the metal should always be poured on mandrils prepared for the purpose, and not on the shafts themselves; but in re-moulding them for a wood shop it is impossible to have templates for this purpose, because of the various diameters and lengths of the spindles, and the bearings have to be moulded on the shafts that are to run in them. This operation requires the greatest care to prevent springing the spindles, which will sometimes happen, no matter what precautions may be taken to prevent it. With short bearings, or those that run at a speed of less than 1000 revolutions a minute, there is little difficulty; but in the case of saw mandrils, planing and moulding spindles, shaping spindles, and so on, the bearings will sometimes heat in the most mysterious manner after being recast, and just when they are expected to perform well.

Whenever it is practicable, both sides of the bearings should be poured or moulded at one time, and not at two operations, as is commonly the case; it requires no more risk or trouble, and is sooner done, with much less risk of springing the shaft. To mould them in this manner the shaft or spindle should be first levelled up and set square or parallel with the planed surfaces on the frame or top of the machine by placing pieces of brass or wood beneath it, the packing then fitted, as shown in Fig. 39, with openings to allow the melted metal to run from the top to the

bottom, also some vent holes towards the ends to allow the gas and air to escape. This packing can be of paste-board, wood, or of several layers of paper, to be removed for adjustment; soft pine is perhaps the best kind of packing, and is always at hand. After the packing is fitted the cap can be screwed down firmly and the ends luted with clay, if there are

FIG. 39.

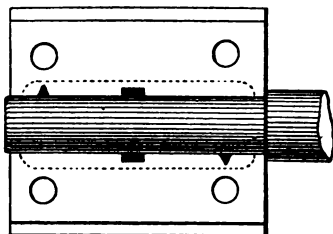

apertures large enough for the metal to escape. If the weather is cold, or in any case, it is best to heat the cap before putting it on; it will soon communicate its heat to the rest of the bearing and the shaft, which should be turned round so as to be warmed evenly.

In luting the ends with clay, do not paste them air-tight; it is a mistake that often leads to a failure. Carry the clay up to the top of the cap, leaving a free opening or gate for the gas to escape. Bearings that are to be remoulded will, unless burnt out, always contain grease enough to create a quantity of gas when the hot metal is poured in, and unless it has free means of escaping, the bearing will be blown, and imperfectly filled.

After the bearing has been moulded the gates can be broken off and the cap loosened by driving it endwise, or by wedging it up with a chisel: the harder kinds of metal are easily separated in this manner, and the softer should not be used for high speeds.

In melting the metal, be careful not to overheat it, and to have it at the proper temperature when poured. If it is too hot the shrinkage is in proportion, and as this is the

great trouble about moulding such bearings, the metal should be poured at as low a heat as it will run freely. A good plan is to thrust a pine stick into the metal after it melts, and as soon as it will burn the stick or cause it to smoke, it is hot enough, in fact, hotter than it need be, and should, when there are free gates to pour through, be allowed to stand to cool for a time after this test. Pour quickly and carefully, but without hurrying, and be sure that there is not something forgotten that may interrupt.

After the bearing has been poured and trimmed, the next thing is to fit it. We are well aware that this proposition will be a new one to most wood-machine operators, for bearings are generally moulded and then started without fitting; yet there is no risk in asserting that without fitting three out of every four will heat at the beginning.

It is evident that if the metal shrinks, as it must do, the bearing will be too small, unless the metal is so firmly fastened in the box as to prevent it from closing on the shaft. Even if it did not shrink, the bearing would be too close a fit to run cool, so that it must of necessity be fitted. To do this use a round-ended scraper, made by grinding a half-round file into shape, or by a scraper, specially prepared. A half-round file with its edges ground sharp is as good for the purpose as any tool that can be made; those not accustomed to scraping can do better by using the sides instead of the end. First scrape the sides of the bearing, which are always too close; then put the mandril in its place, and by turning it round it will mark the spots where it touches, which can be scraped off until it has a full bearing throughout. The cap can then be fitted in the same manner, and unless the shaft is sprung or otherwise imperfect there will be no heating.

No bearing about wood machines that runs at a high speed, whether it be brass, composition, or iron, can run

well without being fitted by scraping. It would seem that when they are moulded directly on the shaft it would ensure a fit, but a little observation and a practical experiment will prove the contrary.

Bearings that do not run at high speed, for countershafts or line shafting, can be made by winding a layer of paper about the shaft before casting them ; it not only provides for the shrinkage and brings the size right, but being a good non-conductor of heat, it prevents the metal from being chilled on the shaft, and will always ensure a sound smooth surface. A sheet of writing paper can be wound around the shaft and tied with a string outside the bearing, or a long strip of paper that is cut parallel and straight can be wound spirally on the bearing and held by the lips at the ends or tied with a cord as before. There is no fear of having the bearings too large by this plan ; it is the opposite fault that is to be guarded against. The fit will not be so good as one that is scraped, but will do very well, except for high speeds.

As to the material for moulded bearings, there is no plan so good as to send to a responsible house which prepares these alloys and purchase the metal, explaining its purpose and leaving its composition to the manufacturer.

In attempting to mix the metal there is generally more lost by oxidation and other waste than the profit of the regular smelter amounts to ; besides, the composition is rarely right, and seldom well mixed.

For slow bearings, pure zinc or worn-out printer's type does well, but with all that run at high speeds the best metal is none too good.

We may add on the general subject of the material for bearings in wood machines, in which every wood manufacturer is interested, that moulded bearings made from alloys are only to be considered as an expedient for cheap

fitting, good enough in many places where there is no considerable pressure, but if there was wanting any proof to show that they are not best for wood machines, it would be found in the fact that they have to be continually renewed. The dust from wood machines which cannot be avoided gets into the bearings and clings with great tenacity to the soft metal, and the spindles are continually going out of line from the wear that must of necessity take place. Brass bearings about 6 parts copper to 1 of tin, or harder, are the best for high-speed spindles, and if properly fitted and taken care of, will last as long as the machine itself. After the most careful experiments with moulded bearings by some of the European builders of wood machines, they were discarded for brass bearings.

These opinions on moulded bearings are given with a full knowledge of their extended use in many branches of machine manufacture, and the good results obtained in locomotive building and in marine engine work, but the conditions of high-speed wood machines require something else, unless operated by the highest skill and by those who understand how to renew them in a proper manner. We have moulded bearings, however, on nearly all wood machines, and shall no doubt always have them for the cheaper class of machines, so that whether right or wrong, they must be taken care of.

LUBRICATING WOOD MACHINERY.

Considering the quantity of oil that is used in wood-working establishments, its cost, and the great difference between its careless and its economical use makes it a subject worth marked attention. There can only be a certain quantity of oil utilized, no matter how much is

poured on or wasted, and there is little risk in the assertion, that where a pint is needed, four pints are wasted. This waste leads to the use of cheap oil to reduce the expense, and the general result is that if the cheap oil used carelessly was represented in good oil used carefully, it would be equal to the difference between sperm oil of the finest grade, compared with the poorest paraffine oils.

Lubricating is, with most kinds of machinery, a question of economy, rather than of efficiency. At slow speeds, except when there is great pressure, almost any kind of oil will do for lubrication; but in the case of high speed, as in wood-cutting machines, the very practicability of their operation depends upon efficient lubrication.

It is not proposed to consider the character of lubricants here: they are all grease, or ought to be, and their lubricating power, or endurance, is directly as the amount of grease they contain, and as the amount of other matter they do not contain. It is to be regretted that, among the many exhaustive researches that have been made in scientific matters, but little, if anything, has been done to explain and fix standards for lubricating oils. Every manufacturer is annoyed by the persistent visits of the agents of paraffine oil dealers, who have some Latin, Greek, or Choctaw name for their compounds, which are represented as having some peculiar power of lubricating from their chemical nature. The fact is, in plain terms, that their worth is as the amount of grease they contain; and as the market value of grease is nearly always constant, the different grades of oil can be considered as representing it in various states of dilution.

Next to the quality of the oil the most important matter is how to apply it economically to the bearings.

Constant lubricating can be considered as divided into

the two general plans;—circulating the oil in bearings, using it over and over again, and feeding it to the bearing as it is worn out or used up and then allowing it to run off. The first plan includes what are generally termed self-oiling bearings, constructed with cells or oil-chambers, beneath the shaft from which the oil is fed up with wicks, or in some cases through small holes, by capillary attraction, and after circulating through the bearing runs off into the oil-cell to be again fed up, until it is worn out. We have just passed through a mania for self-oiling bearings, which have been applied on all parts of wood machines, and we are now settling down to a more common-sense view of the matter, by looking for the best means of supplying oil to the bearings as it is required, or as it is worn out. To pour it on a bearing at intervals from a can, is simply to waste three-fourths of all that is used, even if done with ordinary care, and this plan is not to be considered except in cases where no other can be applied; so that the choice rests between circulating oil-cells, and the oil-feeders placed on the top of the bearing.

The difference between the two plans may be stated as follows;—with oil-cells the oil is circulated, or used over repeatedly; the cells and the wicks are generally inaccessible and out of sight; the arrangement cannot be applied to bearings at pleasure, but must be specially constructed when they are made; and more important than all, the workmen, as a rule, have but little confidence in a thing they cannot see, and oil bearings as often with their cans as though there were no oil-cells.

With the glass oil-feeders that are now used, the oil is fed to the bearing as it is needed; the supply of oil can at all times be seen; the feeders can be applied to almost any bearing, no matter what its construction.

There is, however, this objection to the last plan, that the oil will be fed and wasted when the machine, or bearing, is not running—a difficulty that we are not likely to get over without adding complication.

This waste is, however, more than compensated in the fact that the workmen have confidence in these feeders, and will take care of and rely upon them to oil the bearings, which is not the case with the concealed oil-cells. One of the most prominent of engineering firms has by careful experiments determined that a given quantity of oil will last a longer time and give a better result, if fed to the bearing from the top and when worn out allowed to run off; and considering the facility with which these oilers can be applied with the certainty of their action, we have no fear in recommending them for wood machines.

The wicks should be of wire wound round with textile material, ordinary wicking for instance, which can, by closing it together or stretching it on the wire, be made to feed more or less as required.

All the bearings of wood machines that run at a high speed should have tallow-cups, no matter what other means are used to lubricate them; they cost nothing, and are equivalent to placing a sentinel, or safeguard, over the bearing to protect it from accident in case the ordinary means of oiling should fail.

FIG. 40.

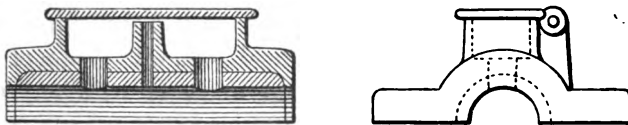
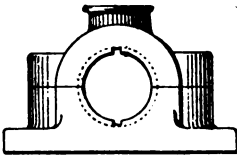

Fig. 40 shows a common box-cap with a tallow-cup as they should be arranged whenever there is room above

the bearing. The oiling is effected through the centre hole in the boss, while the cavity around it is to be packed with tallow. If the bearing heats, the tallow is melted, and runs through the holes seen at each end. These holes should be as large as the size of the shaft will admit, so that the tallow can remain at all times in contact with the shaft.

Tallow alone is too hard, it requires too much heat to melt it, except in warm weather, and should be mixed with lard, when necessary, to give the proper consistency.

FIG. 41.



For bearings that run at the highest speed a good plan is to cut a narrow groove along the top and bottom, as seen in Fig. 41, which, if filled with felt, or soft wood, retains and distributes the oil over the surface, and forms a lodging place for dust or grit that may get into the bearing.

THE CARE OF BEARINGS.

The care of bearings can hardly be considered as belonging to repairing machinery, and it is thought best to notice it as a separate matter.

To take care of the bearings of a high-speed wood machine, is one of the most intricate and difficult things which the operator has to do, and even after years of experience he can seldom tell at once, or with any certainty, the cause of a bearing heating.

When a bearing becomes hot, a machine stops; if on the engine or line shafts, all the machines stop; so that

it is an important matter to know how to treat it. To remove the cause is of course the best plan, and the first thing to be done; but the cause is sometimes not so easy to determine. Aside from becoming dry for the want of lubrication, the cause of heating may be want of truth in the shaft, either from not being round or from being sprung. It may be for the want of a fit, and lack of surface, from being too tight, or from over-pressure—that is, too much pressure for the amount of surface.

Among all these the question is first to tell with which the trouble lies; and next, how to apply a remedy in the soonest and surest manner. When a bearing heats, if the shaft is small, and can be freed from gearing and belts, first try to shake it with a lever, or otherwise, to see if it is loose enough; if so, next screw down the cap until it binds a little, and then turn the shaft by hand, watching carefully whether it binds at one place more than another; the least irregularity can be discerned in this way, and indicates that the bearing is not round, and needs turning. If the shaft is crooked, it is detected by holding a point against it while running—a matter that anyone understands.

If none of these things appear, next take the shaft out and examine the bearing; see where the shaft bears, whether at one end only, or on a line through the bottom, or on the sides. Examine the cap to see whether it shifts, so as to bind on the sides. This want of surface is the most common cause of heating with the bearings of new machinery, and, perhaps, the most common in bearings that have been remoulded; if out of truth, scrape off the points where the shaft bears until it touches throughout, as explained previously. Use good oil in starting, and if necessary cool the bearing for a time with water.

Never place any faith in compounds of plumbago, salt,

soap, or anything of the kind; they may have claims as lubricants, but it is generally a waste of time to try to conquer a hot bearing by any other plan than to correct the mechanical defect, which lies at the bottom.

THE PRINCIPLES OF WOOD CUTTING.

It was intended to confine this treatise as much as possible to practical shop matters, and not to include the principles of machine construction or of machine action; but it is evident that a mechanic qualified to take care of, to set, arrange, and adjust, or to devise ways and means of working with cutters, should proceed upon general principles and understand the theory of their action. Therefore the following brief article on the subject, from the writer's 'Treatise on the Construction and Operation of Wood-cutting Machines,' may be read with advantage.

“Cutting wood consists of two distinct operations; cross cutting the fibre, and splitting it off parallel to its lamination or grain.

“The two operations are in all cases combined; for to remove the wood both must be performed, and to go intelligently about the construction of machines and cutters, this principle must never be lost sight of. The greatest amount of power and the best edges are required to cross cut the fibre. To illustrate by a familiar example;—To cross cut a block 12 inches square requires a considerable amount of effort and time, but a single blow will serve to split it in two, parallel to the fibre.

“This principle exists throughout the whole range of wood cutting with the same general conditions in all cases;

a boring auger furnishes another example, different from the one given as an operation, but the same in principle.

“In boring, the main power is needed to cross cut the fibre with the ‘spurs’ or ‘jaws’ while the wood is split off and raised from the bottom of the hole without much effort; the spurs require frequent sharpening, must have thin edges, and are soon worn away; while the opposite is true of the radial or splitting edges, which may be blunt or dull, and yet work well enough and without much power.

“Another principle to be observed is that the cross cutting or cross severing of the fibre must precede the splitting process; the cross-cutting edges must act first and project beyond the splitting edges. There are no exceptions to this rule, which is from necessity carried out in most cases; yet it is not unfrequent to find tools working on the contrary principle, tearing instead of cutting away the wood.

“In some cases the wood is cross cut at such short intervals or lengths, that no splitting edges are needed, yet the operation is the same. A splitting saw is an example of this kind; each tooth cuts away its shaving, transverse to, or across the fibre, which is split off in the act of cross cutting without requiring separate edges. The cross-cut saw is an example of the same kind, although apparently different; the different shaped teeth that are required arise from the manner in which they are applied. With the ripping or slitting saw the plate is parallel to the fibre, and with the cross-cut saw it is transverse to the fibre; the cutting edges in both cases have nearly the same relation to and act in the same manner on the fibres or grain of the wood; in short, the difference between cross cutting and ripping saw teeth comes from the rotation being with or across the grain, and not from a difference in the operation of cutting.

“The line of the edge is parallel to the plate in cross cutting, and transverse to the plate in slitting. As before remarked all operations in wood cutting are the same in principle, and can be resolved into some such simple propositions as follow;—

“First.—Wood cutting consists in two operations or processes; cross cutting and splitting.

“Second.—Tools for wood cutting must have independent edges directed to these two operations, unless the wood is cross cut into short lengths, as in the case of saws.

“Third.—The cross-cutting edges must project beyond those for splitting, and act first, as in grooving and tenoning heads.

“Fourth.—Cross-cutting edges will, if applied at ‘an angle to the fibre,’ act with less power and be more durable.

“Fifth.—Splitting-edges act best when parallel to the fibre, but ‘at an angle to the direction of their movement.’

“Sixth.—Cutters for perforating, or end tools, as we will call them, should be arranged to have their action balanced across the centre whenever practicable, to prevent jar and vibration.”

These propositions comprehend the whole system of cutter action, and as all wood manufacture is by cutting, they may also be said to comprehend all that is done in working wood.

We shall not attempt to show their application to planing, moulding, rabbeting, sawing, grooving, shaping and other cutters, the reader can observe this himself, and thus will acquire, if he has not already done so, a general idea of principles, that will guide him in making, setting, and arranging cutters for all kinds of work, without fear of making mistakes and without having to try whether

this plan or that plan will work. It will also furnish a clue to the proper form of saw teeth, shearing knives, and other details, about which there is a great diversity of opinion.

THE ANGLE OF WOOD CUTTERS.

While the operators of wood machines are not expected to construct their own cutter-heads, it is expected that they will furnish plans and instructions to others as to how they should be made, and as the angles at which the cutters act is an important matter in the making of machines, it deserves some notice here.

The views given on the subject and the examples shown are not based upon theoretical inference so much as upon practical experiment. There are some very obscure conditions connected with the action of wood cutters; if they moved as slowly as metal-cutting tools we could observe and note the process of their action, but when in motion they are practically invisible, and nothing can be determined except by comparative experiments.

A general object among wood workmen seems to be to get as low or acute an angle for cutters as possible, regardless of the particular uses to which they are applied, and then to prevent slivering, or pulling out the wood, by means of caps. There are, of course, exceptions to this rule, especially with small cutter-heads, as in the case of shaping machines, but exceptions are generally necessary from the form of constructing the cutter-head rather than the result of any plans that have reference to the work. Never trouble with nor attempt to use caps on the cutters of power machines; they are expensive, inefficient to perform the intended purpose, and besides unnecessary.

Any kind of wood, including boxwood, rosewood, soft wood or green wood of all descriptions can be worked without caps, or chip breakers, as they are sometimes called, simply by giving the edges a proper angle, and attending to other conditions to be noted.

In planing veneers by hand it has long been demonstrated that the plane iron requires a much higher angle than for other work. It is also known that scraping tools with blunt edges are the only tools that can be used in turning hard woods or ivory; in fact with all hand tools the principle of varying angles adapted to the work seems to be well known and generally applied, but when we come to power tools we find planers and moulding machines made with their cutters at a constant angle, usually as acute as possible.

In determining the angle of cutters the following propositions are laid down;—

1st. In cutting clean pine for surfacing, matching, or moulding, the angle of the cutters can be as low as practicable to clear a good washer and holding bolt with a standard head.

2nd. An acute angle requires a thin edge, and a thin edge cannot at the same time be a hard one, nor, for that reason, a sharp one, except in working soft clean lumber.

3rd. An edge may be hard, and kept sharp, as the angle is obtuse and the bevel short.

4th. In cutting thin shavings the operation is altogether cross cutting, and a sharp edge is more important than a thin one.

5th. As the angle of cutters becomes more obtuse, or higher, the shape of the edge approaches nearer to having the same profile as the work, and the cutters for moulded forms are cheaper and more easily made and kept in order than if at a low angle.

From these propositions we can deduce the following rules, which are recommended to operators when they have occasion to determine the angle and bevel of wood cutters;—

For planing soft wood the angle at Fig. 42, of 40 degrees, is suitable.

FIG. 42.

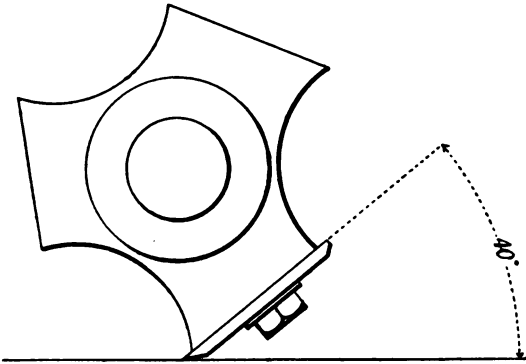
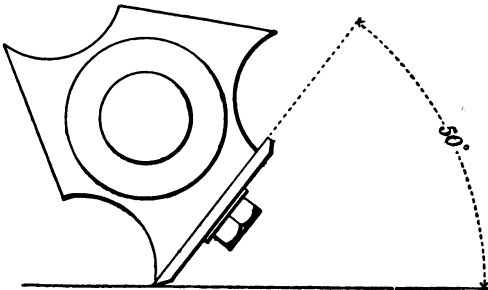

FIG. 43.



For mixed work, partly soft and partly hard wood, the angle at Fig. 43 is preferable; it is a mean to comprehend the two kinds of wood.

For working hard wood alone, such as oak, ash, walnut, cherry, or mahogany, the angle Fig. 44 is best, while

FIG. 44.

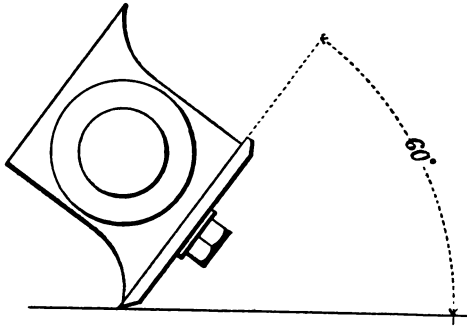

for the very hardest varieties, such as boxwood, rosewood, banyan, cocoa, and ebony, working crotch or cross-grained wood, or at an angle against the grain, the cutters should be set as in Fig. 45.

FIG. 45.

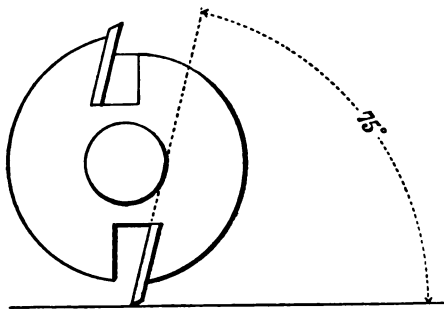

It is becoming of late years a common thing for planer men to grind a short bevel on the under side of the knives for working hard or cross-grained lumber, which is sub-

stantially the same thing as changing the angle of the cutters and making the bevel shorter. It is an excellent plan, as it would be impossible to change the cylinders when a machine has a variety of work to do, but by having some extra knives ground at different bevels it becomes an easy matter to change them, and one that will pay well for the trouble, especially if the knives are tempered harder as the bevel becomes more obtuse.

It will be found in practice that a set of knives that are hardened to a very pale straw colour, and with a bevel ground on the face side, just enough to keep the edge from breaking out, will run twice as long and do smoother work on walnut, ash, or oak wood, and will not pull out the stuff where it is knotty or cross-grained.

It has also become a common practice in some parts of the country to turn the matcher cutters of flooring machines *upside down*, that is, to turn the grinding bevel to the lumber; this is an effort in the same direction; a slow change from the necessities of practice, instead of from inference, as it might be. This way of getting an obtuse angle is going a little farther than is recommended here, but to halve the matter by grinding on both sides will be found an advantage in matching hard wood, including yellow pine. The plan is an old one. The Knowles matching heads, introduced about 1850, had this idea fully carried out by having the bevel on the inside of the cutters; they were always considered as being capable of working any kind of lumber without tearing, and without clips or pressure pads, yet for some strange reason the plan was not carried out in the common matcher heads, probably from their being too expensive. We will notice one more fact bearing on this matter, that of machines for making wave mouldings; such mouldings are cut smooth,

and in part at an acute angle against the grain. These mouldings are not as a rule torn or spoiled in working, yet the whole secret of their manufacture, often a matter of curiosity, is nothing more than to set the cutters at right angles to the face of the moulding. The feed movement is given to the wood, and the reciprocating motion to the cutters, which act as scrapers.

SHARPENING CUTTERS AND SAWS.

If the cost of sharpening cutters and saws in a wood-working factory were added to the profits, it would make a great difference in the earnings. We have no idea of the cost until we keep an account of the time—the detention of machines, wear of files, and grinding machinery, and the wear of the cutters themselves due to grinding and sharpening.

Corundum or emery wheels are now generally used for dressing both saws and cutters, and their introduction during the last five years has been one of the principal improvements that has taken place in wood manufacture. The saving of both time and files, and the more accurate grinding that can be done on cutters, amounts to a saving of onetwentieth of the whole labour account for machine work, when these wheels are properly and fully applied.

Saws are now sharpened with such wheels, in cases when they can be removed from their mandrils; and there is no doubt that lumber mills could be fitted with a portable grinding apparatus, that could be adjusted to the teeth in such a manner as to sharpen the saws sooner and better than with files.

Fd. Arbey, a prominent builder of wood machines in France, fits his planing machines with grinding wheels that are traversed parallel to the cylinder, and produces with the arrangement edges that can in no other way be made so true and straight; they are absolutely perfect. We may grind planer knives tolerably straight with a common slide and a stone, using a straight-edge; but when they are set, the chances are that they cannot be got true on the cylinder; but with this self-contained grinding apparatus the edges are ground precisely parallel to the axis of the cylinder, besides avoiding the inaccuracy and loss of time needed to remove and reset them. Often the machines have to be stopped during the time of grinding, and the chances are that the detention will be less than what would be required to remove and reset the knives without grinding them. The attention of wood manufacturers is invited to this thing as one that may effect a great saving and convenience.

It was remarked at the beginning that the main wear upon cutters was from grinding. This should have read by improper grinding.

Two-thirds at least of the wear of flat or straight cutters come from careless grinding, or over-grinding. To grind a cutter up to its edge makes a waste of from $\frac{1}{4}$ to $\frac{1}{2}$ of an inch of its length in all cases. The ground edge is not fit to work with, and after grinding it is necessary to whet a new bevel for a working edge before using it, and the cutter is then just in the condition it would have been if the grinding had been stopped short of the edge, leaving what we will term a whetting bevel. This is especially true of moulding cutters with an irregular profile at their edges, which should from the nature of their work, if there were no other reasons, have a compound bevel.

Fig. 46 shows a cutter with a compound or double bevel, and Fig. 47 one with a single bevel.

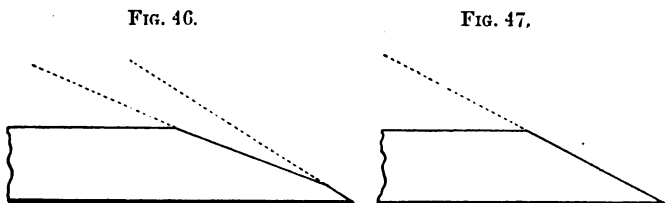

Now that the cutter shown at Fig. 46 is as stiff and strong as the one at Fig. 47 no one will dispute, and that the first is more easily whet and ground is obvious.

The art of taking care of cutters consists in whetting the edges as the wear requires it, and never grinding to the edge, or near enough to weaken it. If a cutter is not straight, joint it the first thing, then grind the whetting bevel very carefully, and afterwards the grinding bevel, which should never come nearer than $\frac{1}{16}$ of an inch from the cutting edge.

For planer-knives, have a coarse grain, soft stone, of the kind known as machine stone, not less than 40 inches in diameter when new; have a tight water box and hood, and in grinding use a heavy stream of water; the stone should be strongly belted, and instead of rubbing for an hour to make an *edge* on a fine hard stone, you will in ten minutes finish the knife, and have fifty minutes saved to devote to some more agreeable work. Grinding flat cutters is not—or at least should not be—making an edge; it is *removing the surplus material used to support the edge*.

For moulding irons, emery wheels are best. They should, however, for this purpose be specially arranged by having not less than five wheels on a spindle, arranged so

that they can be shifted to different positions, or taken off and put on instantly, as may be required.

The machines manufactured and sold in the market for ordinary grinding purposes are not fitted for use in wood shops, and it is better to have them specially made, as in Fig. 48, than to purchase the ordinary machines used for general grinding. There will, no doubt, in time be modifications for moulding cutters; but there are none now in general use that are convenient.

The wheels can be moulded on the flanges, as seen in the section at the centre, the emery being from 2 to 3 inches deep, which is as much as can be worn out in any case; manufacturers of wheels will furnish the disks, or they can be prepared and sent to their works to have the rims moulded on them.

FIG. 48.

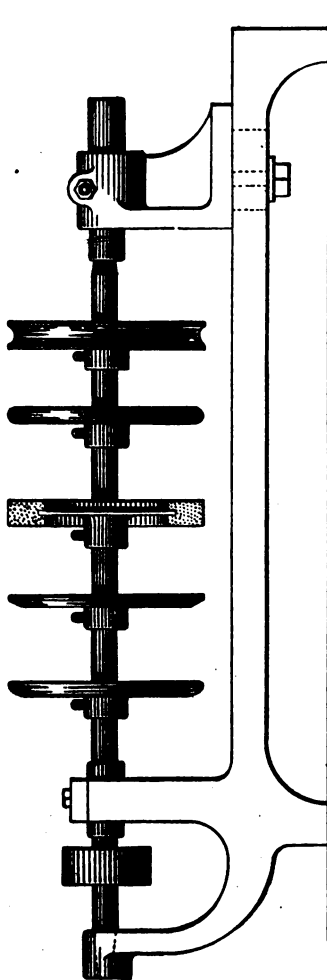

In preparing the disks, or centre plates, have at least two sets, so that one can be sent to have the rims renewed while the others are in use.

Fig. 49 represents a wet-stone machine for grinding moulding irons, used in the large mills in England. It is

FIG. 49.

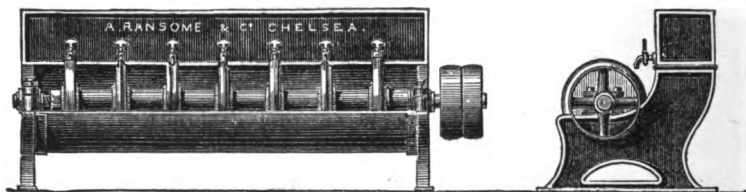

well adapted to the purpose, and with the proper kind of stones will last a long time, and preserve the shape on the periphery. There is no doubt, however, of the emery wheels being best, after the men have learned to use them. At first, the stones will have the preference, as the use of the wheels requires some special knowledge and skill, while grinding with stones is well and generally understood.

For working flooring and other kinds of planing, thin flexible cutters made from the best sheet cast steel, from 14 to 12 gauge in thickness, will be found a cheap and effective kind of knife; they are now regularly made to any pattern by saw makers and tempered to a hard filing temper, so that they can be sharpened on the cylinder without taking them off. To hold them there should be used a stiff steel cap, $\frac{5}{16}$ to $\frac{3}{8}$ in. thick, slightly concave on its under side, and made without having the bolt holes slotted. In many cases thin knives of this kind are used by placing old cutters on the back, instead of having proper caps made, a plan that is apt to lead to a

bad result. Their use is no experiment, and when adopted, if at all, it should be done, like everything else, under fair conditions and not with a view to experiment only. The successful working of these thin cutters depends upon their being held firmly, and in any case where they have failed to work satisfactorily, it will generally be found that the fault was in the caps, unless it was from the bad quality of the steel. Sheet cast steel from the best makers is by no means an inferior article for such cutters if carefully worked and not overheated in tempering. What will answer for a saw will not do for cutters that have sharp edges, not that a saw is not better if made from fine steel, but the edges are more obtuse and not so liable to break.

These flexible cutters were patented first by Godeau in France, subsequently by Gedge in England, and perhaps several times in America, so that the plan is well patented, if that is to be regarded as a recommendation. In sharpening these cutters, fine float mill saw files of the best quality should be used. As a rule it is an expensive plan to sharpen tempered steel tools with files, but in this case the cutter is so thin, and there is so little to file away, that when the time of taking off and resetting solid cutters is considered, there is a great saving of cost by the use of these thin ones, although sharpened with files. The edge must of course be finished with a stone to make it smooth.

A good rule, or we may say a good improvement, about wood shops, can be effected by abandoning hard fine stones for grinding tools of any kind, except moulding bits. They are used under the false impression that they are to make edges, but are really a machine to remove and cut away metal, like a lathe or planing machine, with the difference that they will cut hardened steel, which

the others will not; and until the grindstone comes to be considered in this light, it must be expected that a great waste of time and a great waste of tools will take place. In grinding, get a large stone of the kind before described, arrange so as to use plenty of water, without making a slop about the stone; have the belts strong enough to overcome any amount of pressure in grinding, and the result will be that from being a slow, tedious job, grinding will be but a trifle, and be done to a great deal more satisfaction by the workmen.

For sharpening small tools, such as auger bits, mortise chisels, or others that have angular corners, have a neat case, containing about a dozen of good files with various sections, triangular, square, round, half-round, knife edge, flat, and so on, set in not to rub together, each one to have its own handle; in the same case should be kept several slips of Washita stone, ground to various forms on their edges, to finish with.

Wood workmen having every facility to prepare lockers and cases, generally verify the old proverb in being without them. In a machine shop there are, as a rule, places to keep tools and stores; the planers, lathes, and drills have their lockers; but in our wood shops the tools generally lie around loose, and are only found, when wanted, after a good hunt, provided the article has not gone out in the shavings and into the furnace. In the matter of files alluded to, how much neater and more economical it is to have a case to keep them in, than to have them lying on the benches, to be used for purposes not intended, and spoiled; one-half the number will do if taken care of, and the whole time of hunting for them be saved, to say nothing of doing without them just when they are most needed.

To go into a wood shop and find a job bench containing three or four files with the tips broken off, a cob handle to be used between them, a monkey wrench without a handle, or without a screw, a lot of nails, old bolts, paint pots, and other junk piled upon it, at once indicates the character of the establishment; and as what the manager does generally determines what the men do, he can be set down as responsible for the whole. We cannot therefore too earnestly recommend order and system in all things, especially in such appliances as relate to tool dressing, which is the odd department in a wood shop, and an important one if measured by its expenses, all of which go to the wrong side of the accounts.

SAWS AND SAWING MACHINERY.

CIRCULAR SAWS.

Circular sawing machines, or saw benches as they are generally called, are in America for the most part made by the wood manufacturers themselves, with wooden frames and wooden tops, both for slitting and for cross cutting.

In speaking of saws, therefore, we shall consider the manner of constructing the machines as well as how to run them, because they are generally of home manufacture, but more especially because the matter is one that deserves more consideration than it has heretofore received. They are, as a class of machines, less perfectly made than almost any other in use, which is only to be accounted for in the fact that we regard them as a kind of rough blocking-out machine, and perhaps because they are so familiar that we do not trouble to investigate them.

Considering the great number of saws that are used, and that they are the principal and first machines in most

kinds of wood manufacture, it is strange that we do not make as much progress in their improvement as in other machines, or as their relative importance would seem to claim. Nothing is more common in wood shops than to find slitting benches six to eight feet long, with a mandril in the centre, and a guard extending nearly the whole length of the top. Even prominent makers are continually building machines arranged in this way. A bench of this length with a guard extending past the plate cannot work properly or do true work; and if it would, no one could reach it to operate with any convenience. The rear end of a bench is needed to support the timber after it has passed out of reach, but the front end next the sawyer should never be so long but that the saw can be easily reached, say from 20 to 24 inches beyond the teeth of the smallest saws used.

The gauges should never extend much, if any, beyond the front teeth, as shown in Fig. 34, and described before; there is no need of framing an argument in this matter, it is too plain to need discussion.

With carriage saws, such as are used for jointing floor boards or slitting very long stuff, when the operator has to walk along the side of the bench, the saw may, of course, stand at any part of the bench; the centre of the slide would be the proper place, and a guard behind the saw may be needed, but not an extension of the one in front; it should be a separate one, that can be set on a different line to prevent crowding the piece on the saw, and so that both gauges may be set parallel to the saw plate. The rear guard should only be used when indispensable, which means almost the same thing as not at all.

Circular saws in America, except for timber cutting, are generally without guides to support them, and without packing boxes to keep the saw oiled and clear of gum.

The result is that the saws have to be at least one-third thicker in order to be rigid enough for their work, consuming power, and wasting kerf in proportion. This needs thorough reform, and all benches

where the top is not arranged to adjust for grooving should have guides and packing boxes. Fig. 50 is a section through a set of guides for the front, and Fig. 51, a section through a packing box for the rear, adapted to an ordinary ripping saw bench.

The front half of the table *a*

should be loose on the frame, and arranged to slide back to remove the saw. If made of wood it can be held flush with hard wood dowels or cross cleats on the bottom, and when together be held by iron dowels or screws passing down through from the top. The front guides, Fig. 50, should be of hard wood, with the end to the saw, the bolt-holes slotted so as to set them up for wear. The packing or oiling boxes at Fig. 51 are arranged the same way, so that the lower bars can be kept up against the plate. The chambers are filled by winding packing of hemp or cotton about a square strip of wood, until it will fill the cavity, and then soaking in oil before putting it in. Holes can be made to oil the pack-

FIG. 50.

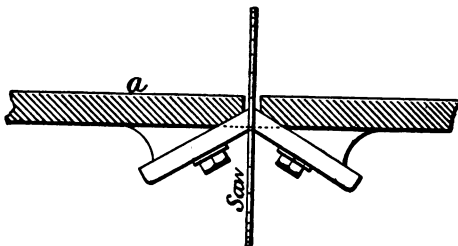
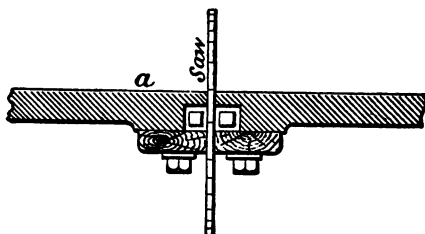

FIG. 51.



ing regularly, and the effect will be found quite different from throwing oil on the plate—a most wasteful and yet common custom.

The advantages derived from supporting the saw both at the back and front are obvious, and the experiment will satisfy anyone of its utility. In England all ripping saws are arranged for a packing, consisting generally of nothing more than a groove along the side of the plate, into which a bar of wood wound with packing can be pressed. This, of course, does for the front of the saw, but not so well behind, and is inconvenient in taking out the hand plates with which benches in that country are usually fitted.

In addition to what has already been said about saw gauges, it is as well to observe that the greater their ingenuity and complication, the less their utility; a rule that holds good in most other things. The guides and packing boxes beneath the top are out of the way, out of danger, and require no special attention; but the gauges, with everything about the top of a bench, must be strong and simple.

As it will often be necessary to make, or to have made, saw mandrils for different purposes, we give the following Table of dimensions, which can be referred to for proportions;—

For Saws to the diam. of	Diam. of Mandril.	Length over Bearings.	Diam. of Pulley.	Face of Pulley.	Length of Bearing.	Diam. of Collars.	Diam. of Hole in Saw.	Number of Revolutions a Minute.	Size of Nut.
"	"	"	"	"	"	"	"		"
10	1 $\frac{1}{8}$	18	5	4	4 $\frac{1}{2}$	2 $\frac{1}{2}$	1	3000	$\frac{7}{8}$
15	1 $\frac{1}{4}$	20	6	5	5	3	1 $\frac{1}{2}$	2700	1
20	1 $\frac{3}{8}$	24	8	7	5 $\frac{1}{2}$	3 $\frac{1}{2}$	1 $\frac{3}{4}$	2400	1 $\frac{1}{8}$
25	1 $\frac{1}{2}$	27	10	8	6	4	1 $\frac{3}{8}$	2100	1 $\frac{1}{4}$
30	1 $\frac{3}{4}$	31	12	9	7	4 $\frac{1}{2}$	1 $\frac{5}{8}$	1800	1 $\frac{3}{8}$
36	2	36	14	10	8	5	1 $\frac{7}{8}$	1500	1 $\frac{1}{2}$

These proportions exceed those of common practice, especially in belt power, but are none too large to give a good result. Saw mandrils, instead of being as light as they can be to do their work, should be as strong as possible, to stand the speed, and there can be no reason for making them less, except a trifling saving in first cost, which in this, as in many other cases, turns out losing in the second cost.

The saw collars should be of wrought iron, welded on; the pulleys, when on the end, put on with a nut and a taper fit, without keys, which are not necessary.

The form of teeth for ripping saws, would require lengthy notice to comprehend all the various plans in practice, and would be of but little use; most operators, although they may not keep the teeth of saws to a proper shape, know what that shape should be. The proper form is easily determined, from the principles already laid down, as well as from the nature of the work, and the whole can be summed up in a sentence—have the points as thin, and at an angle as acute, as they will stand.

In setting saws the custom is to bend the teeth: a great many set differently, but bending is the most common practice, so common indeed, that it is a bold assertion to say that it is wrong, or that another plan is better. Yet to bend a saw tooth, is not to set it, in a technical sense, and hardly in any other sense, for it soon comes out in working. A tooth in being set over must have a sharp blow on the inside to stretch the steel, and hold it in position, and as it is the easiest and truest plan to set saws of any kind with a hammer, there is no reason why it should not be practised.

For setting circular saws, a frame, as shown in Fig. 52, is convenient. It consists of a rail, say 8 × 5 inches, of

FIG. 52.

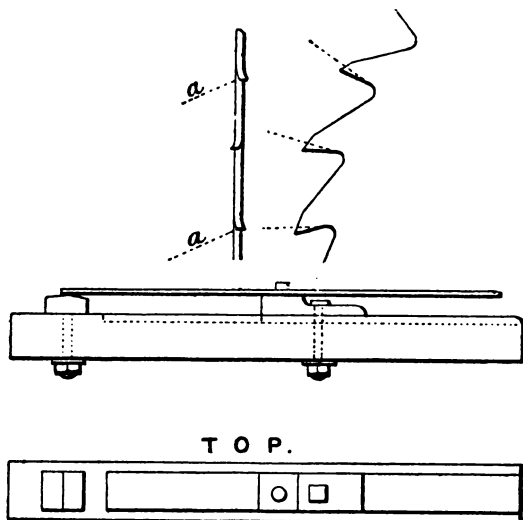

hard wood, with a sliding block on top, fitted with wood studs of various sizes to fit the holes in the saws; on one end is placed a steel laid anvil, to weigh from 15 lbs. to 30 lbs., with its face bevelled off to, say, ten degrees each way from the centre. The saw being placed on the stud, is moved out or in upon the anvil until the teeth come over the centre; the anvil is turned until its corner or apex comes across the tooth, in the position shown by the dotted lines, with the tooth standing over from $\frac{1}{16}$ to $\frac{1}{8}$ inch as the amount of set needed and the size of the tooth may require. The tooth is then struck a quick sharp blow with a light hammer, at an angle as shown by the line *a*, or several blows, until the bottom of

the tooth is set over as shown. This forms a kind of curved scraper edge on the outside, which keeps the side of the tooth clear of the wood, scrapes the surfaces smooth, and will stay there until filed away in sharpening. The teeth will be a little bruised after setting, but this bruising does no harm and is removed in a single filing.

All kinds of circular saws can be set on the same device. It is cheap to make, always in order, and easily understood. The teeth of cross-cutting saws require setting at a different angle, but can be set in the same manner. Finally, on the subject of circular saws, they are too much regarded as a kind of blocking-out machine, to divide stuff into pieces that are afterwards to be brought to dimensions. This comes from the fact that the great object in the United States has hitherto been to save labour, and not, as in Europe, to save material. If a man in sawing has, from the imperfection of his machine, to allow an eighth of an inch on each piece for bad sawing, and his saw cuts out one-third more kerf than is necessary, he soon saws up his wages in waste, especially with the more valuable kinds of lumber.

A sawing machine for slitting should be the most carefully and accurately constructed in all regards; the lumber should and can be cut down to the size, leaving just enough to dress it smooth. The frames and tops, more than any other machine, need to be made of iron, so as to withstand rough use, dampness, and wear. These are not theoretical propositions, but deductions from the practice in countries where lumber is saved, a distinction that cannot long exist at the prices that lumber has now reached in the States.

Cut-off saws, like ripping saws, are often built in the shops, with wooden framing, which is much better than in

the case of slitting benches. They are divided into two kinds, those in which the saw is fed through the lumber, and those that have carriages for moving the stuff, the first for lumber that is long and unwieldy, and the second for shorter and lighter work. The carriage cut-off saw is best whenever the lumber is easier to move than the saw, and the swing or travelling saw in the opposite case, a rule easy to remember and easily understood.

The carriage saw has an advantage in its greater simplicity, and the consequent durability, of its mechanism. The plans of construction are endless, and no suggestions of use can be given here, except that the carriages should be kept square by means of a rack on each end, gearing into pinions on a shaft extending along under the carriage ; this admits of its being mounted on rollers, which could not well be used without the squaring shaft.

BAND SAWS.

Among the improvements in wood-working machinery none have been so rapidly and generally adopted in America as band saws. From having, as we may say, none in use nine years ago (1864), we now find them in nearly every shop of any size, and in some cases not only doing scroll cutting, but used for straight lines. In at least one large establishment in New York city no circular saws are used except for cross cutting— all other sawing, coarse and fine, being done on the band saws. As a matter of interest to the reader rather than to convey any useful information, we will mention that although it has so rapidly gone into use in the nine years past, the machine was invented in 1808 by William

Newberry, of London, England, — not only invented, but built in a good practical working form, as drawings and descriptions yet in existence fully attest. Considering its present importance and extended use, it is hard to realize or believe that a machine of the kind should lie dormant for more than sixty years after its invention.

What the future of the band saw may be is hard to foretell; but judged upon general principles that govern the operation of all sawing, there is a probability of its supplanting every other method. Consisting of a thinner blade than can otherwise be used, capable of any degree of tension, and moving at a higher speed than it is possible to run other saws, its advantages are too obvious to warrant any other conclusion. Besides, it cuts square through the lumber, and, as a very important advantage, is operated by rotary shafts and wheels running at a moderate speed. There is, in fact, nothing to prevent its use for every kind of sawing, unless it be from difficult conditions of operation, which have not thus far arisen.

The fear of breaking blades, or the inability to manufacture them, seems to have been for forty years or more what deterred people from using the machines. This trouble has been overcome, and band saws of good quality will do as much cutting as other saws, measured by their value or cost. Joining the blades, from being regarded as the next thing to impossible, has become so simple a matter as to be performed in every shop, and almost by any person.

To first speak of the blades, they should have a high spring temper; if harder, they become more liable to fracture, are difficult to sharpen, and will be broken in

setting. A saw that has not a good lively temper is comparatively worthless.

It is quite impossible after a saw is finished to tell whether it is properly tempered throughout; if an inch even of its length has not been tempered, or is drawn by polishing or grinding, it is as bad as though the whole saw was wrong, for such spots cannot be found, and if they were found, there would be no remedy but to cut them out. We must therefore trust mainly to the skill and good faith of the saw makers, and should patronize those who have been longest and most successfully engaged in their manufacture.

In selecting saws, a good plan to test the temper, if the saw is not joined, is to roll up the ends, and see if it will spring back straight or remain bent. If it spring back nearly to its first shape, the temper is good. The texture or grain of the steel, which is the only clue to quality, can be determined by breaking a short piece from the end of the blade. By unrolling the blade on the floor, it can be tested as to straightness. The ends, if laid together, will show if it is parallel and of the same width throughout.

The processes of joining now in use can be divided into brazing and soldering, the distinction relating mainly to how the joining is done rather than to any difference in its nature. In what is termed soldering, the melting or heating is effected with hot irons, and in brazing the saw itself is put into the fire.

Brass, spelter, German silver, and other alloys can be used, for joining, any of which make a joint that, if well made, will be as strong as other parts of the blade, that is, will stand an equal tension, for the tendency to fracture is greatest alongside the joints, where the union takes

place between the tempered steel and the portion that is annealed in making the joint.

For solder joints the silver solder of jewellers is convenient; it is strong and melts at a low heat. The most convenient form is to have it rolled in thin strips, so that pieces the size of the lap can be cut off and laid between. To make joints of this kind there is required a strong heavy pair of wrought-iron tongs and some kind of a frame to hold the saw straight, leaving the joint free at the ends to be clasped with the tongs.

FIG. 53.



Fig. 53 shows a pair of tongs and scarfing frame for soldering, adapted for blades to 2 inches wide.

The saw should be scarfed or tapered at the ends for a length corresponding to one or two teeth, as the pitch may determine. This scarfing must be done true and level, or the joint will not be a close one.

Next cleanse the joint with acid, to remove grease; put the solder between, and clasp the saw with the tongs, which should have a full red heat. As soon as the solder runs, remove the tongs and apply a wet sponge or cloth to restore the temper in part. The joint can then be filed parallel by using a wire gauge or pair of calipers to determine the thickness, being careful to file the proper amount from each side.

This last is in fact the most difficult part of the operation, and requires great care to have the saw parallel and straight, without making it thinner at the joint than at other places.

Fig. 54 shows a forge for brazing band saws, which, aside from the original cost of the outfit, is the cheapest

FIG. 54.

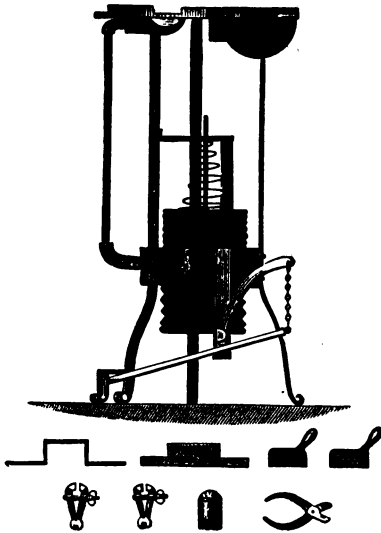

process, and certainly the best plan of joining narrow blades. The fire is of charcoal, about $2\frac{1}{2}$ inches square; the degree of heat is accurately regulated by the treadle, which is operated by the foot.

The saw is first scarfed, as in the other case, the joint then wound with brass wire, fluxed with borax, and placed in the fire until the brass melts and runs into the joint; the saw is then to be quickly removed from the

fire and placed upon a kind of anvil, and the joint quickly pressed together while the brass is in a melted state. The detached pieces shown below are details of the forge, for concentrating the fire, holding the saw, and other purposes.

One of the main points in operating band saws is to avoid bending the blades edgewise, which is more easily and frequently done than would be imagined. The wheels require to be so adjusted that the saw will only touch, and not bear against the back guides when not cutting; and as different saws and different positions of the guides as to height will vary this back thrust, it requires constant attention from the sawyer.

The amount of back pressure is easily determined by placing a piece of wood behind the saw while it is running and pressing it forward, noting the amount of force it requires, and then setting the wheels until it bears lightly on the back.

This edge strain, as we will call it, is generally provided for by an adjustment of the axis of the top wheel, which every machine should have.

Different forms of teeth, the pitch, angle, and manner of setting, are questions of much importance with large saws that run with power feed; but for scroll cutting, slitting, and with narrow blades generally, the matter of teeth has not such importance—a fact that is sufficiently proved by the great diversity of both opinion and practice met with.

For hand slitting saws from 2 to $2\frac{1}{2}$ inches are better than if wider. The perfection of manufacture and the truth of the blades is apt to be as their width, and beyond $2\frac{1}{2}$ inches wide the steel is not, as a rule, so good, or the saws so true and straight; besides, the tension needed for $2\frac{1}{2}$ -inch blades is as much as an ordinary machine with shafts $2\frac{1}{2}$ inches diameter will stand. There is a general tendency to use wide saws for straight lines, but the experience of the oldest and best makers, such as Perin, of Paris, leads them to recommend narrow blades.

The firm mentioned rarely make blades exceeding 3 inches in width, unless to special order, and as we can hardly hope to wear out more than an inch or two of width in filing, it is difficult to imagine any use for the width beyond what will allow of this wear. For slitting, the bench and gauge can be of the common form, the bottom guide attached to the table and the top one carried on an adjustable bracket; the speed can be from 5000 to

8000 feet a minute, the wheels not less than 4 feet in diameter, either of wrought iron or of cast iron, bound with wrought-iron bands, to prevent danger. Plain cast-iron wheels are not suitable for any machine, even to run at a low speed; for if strong enough to be safe, they must at the same time be heavy, which, for top wheels, throws a great strain upon the blades in starting the machine, and also in sawing causes the top wheel to overrun the bottom one when the saw first enters the wood.

RESAWING MACHINES.

Resawing lumber, the main business in the wood shops of other countries, is but a small affair in American mills.

Most planing mills have a resawing machine of some kind, but it is only used to split thin boards and cut lumber that is too thin to be sawed in the forest mills and safely transported. In America lumber is nearly all forest sawn, and comes to the manufacturer cut to size, as near as can be, allowing for warping, shrinking, and irregularity; not cut first into deals or fitches for transportation, and then sawed again to sizes, as in Europe. For this reason resawing machines are not so important, nor so well understood in America.

If we were to argue the merits of the two plans of lumber traffic, it would be a difficult matter to defend our own, or to show any reason for so great a waste as it occasions. No doubt one of the strongest reasons for the present system is the prejudice against resawing machinery. In considering resawing, it must be remembered that a single blade splitting lumber of one to two inches thick, is a different thing from a gang mill with

from six to twelve saws cutting flitches or deals, and to manufacture thin boards cheaply, the gang saw must be used.

Thin saws and slow feed are the rule for English machines; the amount cut must be increased by the number of blades, instead of crowding and forcing one saw to do three times as much as it should; our American system is the reverse of all this; we try to, and do, force a single blade through from 2000 to 3000 feet of lumber in a day,—a thing incredible to people who have not seen it, and the result is, as might be expected, bad sawing, and a great waste of both lumber and power.

It is not expected to give any useful information about resawing mills such as we have in use; they must soon pass away under a new lumber system, which enhanced prices are bringing about, and gang saws will no doubt be used for general resawing, and the band saw or circular saw for single lines.

Resawing deep stuff that is crooked, seasoned and dry, when fed by rollers, is the most difficult of all sawing, and will be the hardest kind to do with band saws, as it is with all other saws; yet experiments thus far go to confirm its future success, and when it is considered that in cases where resawing has been done successfully with band saws, the machines have in most cases been small and poorly made, it assures the practicability of the thing under more favourable conditions.

A band saw for resawing American lumber should never exceed $3\frac{1}{2}$ inches wide, nor be less than 40 feet long, the wheels 6 feet or more in diameter; the speed of the saw from 5000 to 8000 feet a minute. The teeth require a coarse pitch, with a deep throat, but of some form to ensure great stiffness, otherwise set cannot be kept in them.

For general resawing purposes, there is no saw better than a compact iron-framed reciprocating machine, to carry from one to ten saws. What may be lost in speed while working but one saw, will be gained when a gang can be used; which would soon be a great share of the time when the system of resawing was once begun. The blades for such machines need not exceed 14 gauge, and in most cases be thinner.

Looking, as we may, to a change in our resawing machinery, which is at this time open to that fatal objection of being too slow, there is no need for devoting any space here to the care and operation of the ordinary resawing mill, nor to gang machines before we have them.

JIG SAWS.

With respect to jig saws, the band saw and duplicating machines have driven the most of them out of use, and it is to be sincerely hoped that further improvements will do so entirely. What may be said of jig sawing need not consume much space here. For ordinary wood work a spring-strained fret saw to do the inside, or perforated work, is all that is needed.

To set up a jig saw, select the strongest place in the building, over a girder, if on an upper floor; if on a ground floor, set it either on masonry or piles set in the earth from three to four feet deep. If the saw is on an upper floor, use a counter-balance equal to three-fourths the weight of the reciprocating parts; this throws the vibration on a horizontal plane, in which direction a floor is the strongest of all foundations. If set on an earth foundation, use no counter-balance, leaving the vibration

to fall vertically, and be resisted by the foundation. Never drive jig saws at the highest possible speed; the wear and tear of the machinery will more than balance what is gained in the speed of sawing.

In selecting men to run jig saws, or any saw for irregular lines, two things must be considered—ingenuity and skill to take care of the machine, and the faculty of following lines. Without practical experience, and reasoning from inference alone, we should conclude that almost anyone could run a jig saw; but that it requires a peculiar faculty is to the experienced a well-known fact. A ship caulker, a chipper, or a carpenter, in striking a chisel or in driving nails, cannot tell, or hardly knows, how the blows of the mallet or hammer are directed to the head of the chisels or the nails: in chipping and caulking, the blows are continually varying from one angle to another, apparently without effort or care. The same faculty that guides the hammer and mallet, whatever it may be called, is needed in jig sawing. The sawyer who has this faculty scarcely knows how he follows the lines; he appears to do so without effort, and depends, in a large degree, upon natural instead of acquired skill. Occasionally men, who have great trouble in learning other work, make good sawyers; some men cannot learn to turn, others learn with great facility, and a manager who would get the largest amount of work done in the best manner, and in a way most congenial to the men themselves, must watch these peculiarities, as they will be sure to appear among workmen.

Saws for scroll work cut at all angles of the grain, and should have what the nature of the work would suggest, an intermediate form of teeth; not pointed, as for cross cutting, or square, as for slitting; but a mean

between, and always in the hook form. A narrow blade is not capable of withstanding back thrust, and should, consequently, be so filed that the tendency will be to lead into the wood instead of crowding back. A triangular file gives a good shape for the teeth of web saws, if they are not too deep, and the pitch not less than one-fourth of an inch. Float files are not so good for filing web saws as the double cut, known as Stubbs' files, these, although they cost nearly twice as much, are the cheapest in the end, because of the longer time they will last. In selecting web saws, always examine how they have been ground by the saw makers; if they have been hand scotched, as it is termed, by the grinders, and the bevel is irregular, they will work badly; machine grinding is the only plan for producing a true blade, when it is narrow, and bevelled back from the teeth.

PLANING MACHINERY.

After sawing comes planing, and as sawing, except cutting out, is in America mainly done at the forest mills, planing is the leading operation in most varieties of wood manufacture.

To operate planing machines intelligently and with the best result, one must understand the general principles of their operation, to which we will first call attention.

Under the general name of planers are classed, first, carriage machines, in which the lumber is moved in true lines throughout its length by guides, known as dimension planers, traversing planers, Daniel's planers.

Second, machines that reduce lumber to a uniform thickness, or thickness and width at the same time, the

stuff being fed by rolls and moved continuously between stationary guides and the cutters, such machines known as surfacing machines, matching machines, and moulding machines.

Third, surface planers, that cut away a constant amount of wood, gauged from the surface that is planed; in other words, machines that have fixed pressure bars, both in front and behind the cylinders. The under cylinder of a double surfacing machine, or bottom cylinders generally, are examples of surface planing.

These three classes of machines and their operations are different in principle, and give totally different results, yet the distinction hardly is recognized or understood. Everyone knows the difference in the machines, and can tell what kind of machine is best for a certain class of work; but generally, from facts gathered by experience, instead of a comprehensive knowledge of the principles of wood planing. There is, to be sure, nothing intricate in this difference between carriage, parallel, and surface planing, yet it is no uncommon thing to meet operators who have not studied the matter.

CARRIAGE PLANING.

All planing in straight lines has to be performed by means of carriages on which the lumber is moved, unless the pieces to be planed have two straight sides to guide them. A carriage is nothing more than a means of supplying for the time these two straight sides; for when the piece to be planed is fastened to the carriage, the two are to be considered as one body, guided in two directions, vertically and horizontally, by the track beneath,

which supplies the straight sides the lumber itself lacks. To make it more plain we can say that the lumber is not gauged from and by the side opposite to the one being planed, as in matching or moulding machines, but from an artificial face, which has been attached to the piece to guide it, consisting of the platen or table and the guides on which the table moves. This is the only means of planing true, and we can hardly hope to see any great change from the present plans for planing out of wind. The fault is, it is so slow that continual experiments are being made to do work on roller feeding machines, only to be done on carriage machines.

This want of speed must be met in some way, and is best remedied by using cross cylinders instead of traversing heads. The Daniels' planing machine, as it is called in America, was invented in 1802, by Bramah, and has ever since held its place as the standard machine for planing out of wind. It is no doubt best for some special kinds of work, but is too frequently used; three-fourths of the planing performed on this machine can be as well or better accomplished, and from two to three times as fast, with a cross cylinder. The Daniels' planer, from the nature of things, must be slow in its action; the length of cutting edge that can be brought to act in a given time is the exponent of a planer's capacity, and when we consider that in machines where the plane of rotation is parallel to the face of the wood the length of edge that can be used is no more than the depth of the cut, the wonder is that they perform so much.

A Daniels' planer with two cutters will, in ordinary work, use only *a half inch of edge* when taking a cut of one-fourth inch deep; a cross cylinder will, if it has

three cutters 20 inches long, represent *five feet of edge*, or 120 times as much as the other machine. The work performed of course is not in this ratio, but the actual cutting capacity is.

The result in working is, that while a 24-inch cylinder may plane 1000 feet of surface without sharpening the cutters, a traverse head will not plane *ten feet* without the edges being equally dull, but as they cut across the wood it can be bruised off with edges that would not cut at all if working parallel to the grain.

The secret of faster planing, we can safely conclude, is not in continuous feed with rollers, which can never make true work, but in increasing the capacity of carriage machines. With a traversing cutter-head the feed is only from 10 to 15 feet a minute; with a cylinder it can be from 40 to 60 feet a minute on a good strong machine. By cutting two sides at once, which is entirely practical on most kinds of lumber, and presuming that the same time is required in running back, the relative capacity is as one to five in favour of the cylinder, which ought certainly to be satisfactory.

In the arrangement of a wood-working establishment for purposes which require that a part of the planing be true, and out of wind, there is seldom any absolute need of a traverse planing machine, and unless there is such a need for one, it is best to do without it.

The beating down action of the cylinder, often presented as an argument against the use of dimension planers on thin lumber, is in practice not so serious matter as it is generally thought to be. A cylinder that has its cutters sharp, and set at a proper angle, will plane almost any kind of stuff without springing it or beating it down.

Both in England and France they manage very well to do all kinds of planing on dimension planers, not only framing, but flexible stuff, which in America is always planed on roller machines.

There is no question that in the United States too great a share of the planing is on roller machines; the little time saved in planing, is generally lost in putting the work together, especially in cabinet work, and similar branches; and this tendency to roller feeding machines is only because of their more speedy performance.

PARALLEL PLANERS.

This class includes nine-tenths of all the planers in use in this country, including moulding machines, which do not differ at all in principle from what we term planers, except in capacity, and the arrangements required for profile planing. We use the term parallel, because it describes the function of the machines, which is to reduce stuff to a uniform thickness, straightening it in some degree to be sure, but not effectually. Such machines are adapted to but one class of work, stuff that *can be bent or sprung into a straight line*, as it passes through the machine, and keeping this in view, it is easy to determine what work should be done by parallel planing machines. The presumption is that any kind of stuff that will bend in passing through the machine can be afterwards sprung straight in putting it together. Flooring, ceiling, mouldings,—in fact, every kind of stuff that is flexible enough, can, and should be, planed on parallel planing machines, which will plane two to four sides at the same time.

A four-side machine, as it is called, although it planes

all the sides of a piece, does not do so under the same conditions on each side. Two of the sides are surface planed,—that is, gauged from the surface that runs against the gauges and the bed; the other two are planed parallel, gauged from the opposite side to the one being cut.

The lumber is guided by its rough surface before coming in contact with the cutters, and will change the position of its irregularities as it passes through the machine, but will retain them all. By this is meant that a bend in a piece too stiff to be straightened by the rolls and pressure bars, will not be in the same place after planing as before, but advanced to a distance equal to that between the rolls or pressure-bar and the cutters. For this reason, among others, we cannot plane lumber either square or straight on a parallel planer. The top and bottom cylinder will work parallel, and the vertical spindles may work parallel; but as they cannot cut at opposite points at the same time, the piece may change its position between the horizontal and vertical cutters, and be correspondingly out of square. Everyone knows this in practice, and the discussion of it here is not expected to impart any special information as to how the operation may be changed or improved, but to assist in explaining the general principles, which must be understood in order to dictate or suggest the construction of machines, and also to determine proper plans of doing work.

When a piece has two straight sides, and is to be dressed all over, or one straight side, and be dressed on two, the work can, of course, be sooner and better done on a parallel machine; so that when machines of both kinds are at hand, as is usually the case, the lumber can,

after planing two sides on the carriage machines, go to the parallel machines to be finished, effecting a saving of time, and increasing the general capacity of the machinery. In furniture making, for instance, if there is a lot of table-tops to plane, the best side can first be planed on the traverse or carriage machine, and the stuff be then run through the parallel machines, which saves time, and produces true work.

Surfacing machines, as they are called, with an endless chain bed, are commonly used for rough surfacing in America, and if properly built in a durable manner, they do very well for the rougher class of work. Two changes are needed in them, which wood workmen ought to demand, and when ordering such machines make it a specification. The bed and the lumber line should be fixed, and the cylinder adjusted instead; there is nothing more annoying than to have the line of the stuff changing, especially in surfacing, when the stuff should be run out of the way by the feed; besides, it is a most unmechanical arrangement to move three-fourths of the working parts of a machine in order to have the other fourth fixed.

The other point alluded to is the chains, which should be stronger and better made. The running slats should be chilled on the bottom side, and the fixed bars, or bed, covered with tempered steel—not soft steel, but hard steel. Without this there is no safety in operating these machines, especially on heavy stuff that requires a strong pressure to feed. Surfacing pine-boards gives no test of one of these machines; stiff timber framing, such as car timber, put through one for a few hours is better.

In starting a new machine of this kind, great care is needed for a day or two at the beginning; the chain and bearing bars have not then come to a fit, and are not

smooth and polished. The chain—or rather, the bed—should be frequently oiled, or plumbago used with the oil, which can be dropped between the slats while the chain is in motion. Another fault that is often met with in these machines, is for the chain bed to be narrower than the cylinder and the rated capacity of the machine. This is merely one of those subterfuges too often adopted to convey an erroneous impression of the capacity of machines; the Daniels' planer is, for instance, generally rated as planing to the whole diameter of the cutter-head, whereas, as anyone knows, such machines should have their cutter-heads at least one-fourth larger in diameter than their rated width.

Of what we have termed surface planers there need be nothing said. With the exception of the scraping planer of B. D. Whitney, there are no machines of this class in general use. They relate, as the name indicates, to preparing surfaces; and with the progress that is at this time being made in polishing machines for wood, we are not likely to see a more extended use of planers of this kind, that have rotary cutters.

ABRASIVE, OR POLISHING MACHINES.

Sand-paper is almost as old as the art of wood working and wood cutting; yet while we have called in the natural forces and employ machines to effect the cutting, the polishing is mainly by hand. Power-polishing machines are, it is true, in common use for some purposes, such as finishing spokes for wheels, and oval turned work generally. Buffing wheels for chair stuff are also in common use; but the question is, why stop here? espe-

cially as the application of these power-polishing appliances has been mainly to cylindrical or irregular surfaces, and is successful; why not to plane surfaces as well? The truth is, power-polishing has not been looked into so closely or so carefully as it might have been, or this hand-rubbing process would be exceptional. Abrasive cutting, we will term it, need not be confined to smoothing merely; it is unquestionably cheaper to reduce wood with cutters when there is any considerable amount to be cut away; but in smoothing off doors, blinds, and other work that is framed with the stuff at angles, this grinding process is the cheapest one for flushing the shoulders, and finishing work after it is put together. It combines the two operations of planing off and sand-papering in one, and is at this time applied with great success in many of the largest mills in various parts of the country. It is regretted that the state of the art just at this time is such that there is nothing to warrant any more than a brief notice of it, to call attention to its importance, and to the probable saving which it will effect. There is no use in writing about undeveloped machinery in America. It may do in Europe to give plans, drawings or dissertations on a machine one or two years old; but in America the whole thing may pass away and be supplanted with something else while the description is in the press.

The pneumatic fans now in general use remove the dust, which has no doubt been one of the main causes why polishing machines have not been more used.

Experiments thus far have given the best result by moving the grinding surfaces in a plane parallel to the surface of the wood, like a traversing planer.

Barker's machine, working on this plan, is at present extensively and successfully used for cleaning off doors

and other joiner work, and in the preparation of plane surfaces generally, either for painting or varnishing. The endurance of the sand-paper, measured by the amount of surface gone over, is about as five to one contrasted with hand work, and when estimated by the wood cut away, not less than as ten to one; that is, a superficial foot of paper will cut away ten times as much wood, if properly used in a machine, as it would in ordinary hand use on the same class of work. It is not assumed that the paper will do this much more cutting under the same conditions, and with equal care in both cases, but including the waste of paper in hand use, which generally exceeds what is utilized.

Every wood workshop, no matter what the business may be, if the work is to be painted or varnished, can use a set of buffing wheels to advantage. They do not cost much, occupy but little room, and can be run by the helpers at odd times when there is nothing else to do. It will not cost one cent a foot to buff lumber, and even fence pickets will look well enough to pay for the expense.

To build a buffing machine, construct a frame about 4 x 6 feet outside dimensions, of framing from 4 to 5 inches square, as shown in Figs. 55 and 56.

Three wheels are better than two even if but two kinds of paper are required; the two wheels, with the same grade, if laid with

FIG. 55.

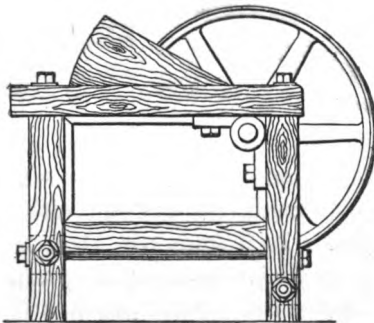

the kind of paper used for general purposes, will be worn, as soon as the other, and it will save a large share of the time needed to renew the paper. The wheels should be from 30 to 40 inches in diameter, with a face of 8 to 10 inches; they may be made entirely of wood, but an iron pulley with lagging is not only best but cheapest. The frame should be open on the front, Fig. 56, so as to allow of free access with crooked pieces, and be convenient for the operator. The shaft should be not less than 2 inches diameter, mounted as shown, to protect the bearings and loose pulleys, as much as possible, from the sand.

FIG. 56.

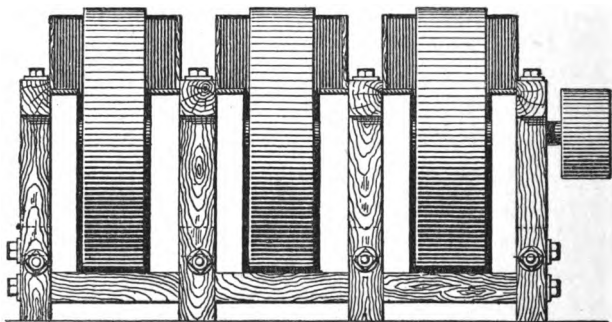

To prepare the wheels, procure pulleys of 30 to 36 inches diameter with 8 inches face, the rims heavy and turned true inside and out, with two rows of screw-holes, drilled $\frac{3}{4}$ inch from the edge, 2 inches apart, to receive $1\frac{1}{2}$ -inch No. 16 wood screws; the holes well countersunk on the inside. First put on a layer of lag pieces, either 2 or 4 inches wide, to match the screw-holes, making the joints carefully, gluing and screwing each one as it is put on; turn the wheel off true in its place on the machine,

and put on a layer or two of felt or heavy cloth, to make a cushion for the paper; next prepare a strip of strong canvas two inches wider than the face of the wheel, and long enough to go around it, or half around it, as the case may be, notch the edges, as at Fig. 57, so that they will lap over the ends of the pulley, to be fastened with tacks. After

FIG. 57.

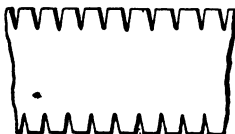

putting on the canvas, a good plan is to add a layer of plain manilla paper without sand, and after it dries, lay the sand-paper on the outside, using thick strong glue;

let the wheels dry thoroughly before using them, and when worn smooth, put a new layer on top of the former one, and continue until the wheel becomes uneven and irregular, then by drawing the tacks that hold the canvas, and cutting the paper across opposite the joint, the whole covering is stripped off, leaving the felt or cloth cushions intact. The canvas can then be placed in water until the sand-paper is soaked off, and again put on the wheel to begin another set of coverings.

It should have been mentioned that the felt covering can be nailed on with small copper tacks, and that in applying the canvas, a strip of paper rubbed with beeswax laid under the joints in the canvas will prevent adhesion from any glue that may go through.

The whole body of the machine frame may be encased to confine the dust, and exhausted by the induction fan, hoods being placed at the back of the wheels to gather the dust, as seen in Fig. 56.

In building a machine of this kind it is well to add a common pulley at the end opposite the driving pulleys, to operate sand or wax belts, for polishing perforated work or

such pieces as cannot be applied on the wheels; this extra pulley and an idle pulley set on the floor, with a few canvas belts, comprises the arrangement, which is often of great convenience, especially in chair and cabinet work.

JOBGING AND SHAPING MACHINES.

The term shaping, as applied in wood manufacture, comprehends all work in irregular lines; a better distinction would be to call all operations shaping, when the stuff is fed by hand. This would include the many improvised plans of doing special work, that cost so little, and save so much, nearly all of which are performed by hand feed.

Speaking of hand feed, it is apparent that in the great race for automatic machinery, wood manufacturers have gone far beyond the true limit in the use of power feed, and have applied power feed in many cases when the work could be fed to the cutters by hand, and advantages gained both in the quality and cost of the work.

To feed lumber to cutters at a uniform speed, regardless of the state of the edges, the grain of the wood, or knots, is a most unnatural plan, and can only be considered as adapted to the coarser kinds of work; besides, to secure the smoothest and best work, the wood should pass over the top of the cutter-heads, as in hand-feeding machines, and not beneath them. This last proposition would seem to be but a question of relative position between the cutter-head and the wood, but it is something quite different. When material is passed over the cutters, the amount cut away is usually gauged from the

side acted upon, and the machine becomes a surface planer instead of a parallel planer, as explained in another place.

Hand feed, contrasted with power feed, must not therefore be regarded as meaning two ways of performing the same thing, but as two classes of planing, involving different principles. This distinction is, however, not the most important one between a power-feeding and a hand-feeding machine. The main difference practically is that when arranged with feeding mechanism, a machine is adapted only to some standard kind of work, such as parallel planing, moulding, or grooving, will receive stuff only within certain dimensions, and must be set and adjusted every time the dimensions of the lumber are changed. Besides, in such machines the feed is uniform, regardless of the varying amount that is cut away, the nature of the wood, or the starting, which should be done slowly.

A machine that is arranged to be fed by hand is the opposite of all this; it will receive stuff of any size, will cut away any amount of wood, because the feed can be graduated to suit, and is convertible into a general shaping and jobbing machine, applicable to almost anything within the whole range of wood cutting.

There is nothing about wood manufacture that needs to be more carefully studied than this matter of machine adaptation; a successful business is always marked by more or less original practice and an adaptation of means to ends, that we may class under a general head of ways and means of doing odd jobs.

Ten years ago it was most unusual to find a hand-feeding machine in an American wood shop; whenever the power-feeding machines failed to do what was re-

quired, the next resort was hand labour; but of late years, from experience and necessity, there has been a return to first principles, by the use of hand-feeding machines for jobbing, and they are to be found at this time in most large establishments.

A singular thing about their use, and one that argues how little the principles of wood cutting are studied, is that such machines have been sold mainly upon trial, and only bought after they had demonstrated their utility. Manufacturers had no confidence in a machine, the merit of which was predicated upon theoretical grounds, and appeared like a discarded thing of the past.

One reason of this is to be found in the common impression that a hand-feeding machine requires a man's time to run it, and that a power-feeding machine does not, a mistake which is easily seen when considered; in fact, in many cases, hand feed requires no more attention, and is the faster plan of the two, as bench sawing will serve to illustrate.

Hand-feed machines have been mainly introduced under the name of universal machines, and a common impression exists that their value is due to a combination of several functions, such as planing, boring, and sawing; but a careful investigation of their use will prove their value to be in the adaptability gained by dispensing with the power-feeding mechanism.

A planing, moulding, and general jobbing machine, arranged as in Fig. 58, with an overhung spindle to receive various cutter-heads, having a compound table in two parts with independent adjustment, is one of the most useful of hand-feed machines. The tables *a, a* are mounted on movable brackets, *c, c*, which are raised or lowered to suit the diameter of the cutter-heads, and the

amount of wood to be cut away. The rear table is adjusted to meet the face after it is planed, and varies from

FIG. 58.

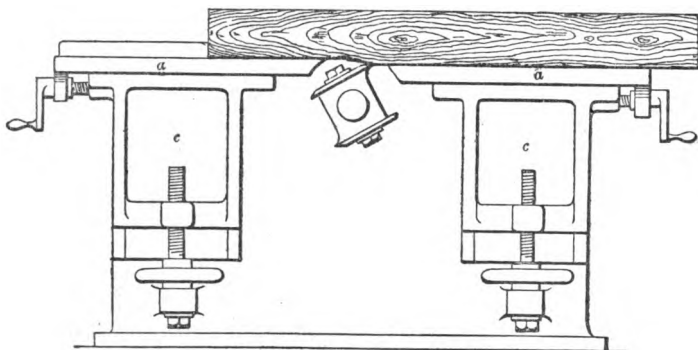

the line of the front one, as the depth of the cut. The figure merely conveys an idea of the general functions of a machine which can be applied to a hundred uses, and will generally have something to do in the way of shaping, moulding, grooving, matching, raising panels, rebating, or other work.

Such a machine corresponds very nearly to the original plans for wood-planing machines; a machine for moulding and planing very nearly in this form was introduced in America in 1835, but soon gave way to power-feeding improvements, which were capable of performing all that was needed at that day, and when modern work demands hand-feed machines, it is hard to realize that we must go back to the discarded machines of forty years ago.

Shaping machines, with two vertical spindles, have now become standard machines in American shops; and we often hear the true remark that they "will do almost anything." When we come to consider why they have

such a range of adaptation, it will be found substantially in the principles that have been already pointed out—hand fed, surface and gauging.

This machine, although comprehended in the British patent of Bentham, 1793, and that of Boyd, 1822, was, like many others, a long time in being developed, which only proves that wood-machine improvement is not a question of ingenuity in machine making but a sequence of improvements in wood conversion.

Whenever a process is invented by the wood-machine operators, we soon have machines to perform it, and there is no greater mistake than to ascribe the progress of wood manufacture to machine improvement; it is just the opposite, machine progress comes almost entirely from improvements in shop manipulation, and from the wood workmen themselves. This matter is mentioned with a view to directing the attention of operators to processes instead of machines; they must invent plans of performing work, after which it is easy to adapt machines to the purpose. In the case of the jobbing machine alluded to, for instance, if we have the premises or principles to begin with, and know what kind of work can be done in a special manner by a machine, it is then an easy matter to generate the necessary mechanism. To illustrate this matter of processes further: if there is a set of lagging to make for a drum or pulley; in some shops it will be worked out by hand with cove planes, involving no little time and cost, besides making a poor job. In another shop, the lags or staves will be run across the top of a circular saw, and cut out true in a few minutes' time. This last is what is meant by expedients to facilitate and perfect machine work. A machine like the one shown at Fig. 58 is of very simple construction; but an ingenious workman who

understands its operation will soon prepare a set of guides, gauges, and stops to do all kinds of jobs, even to working curved lines; and this outfit requires more ingenuity to invent than the machine proper.

Since the introduction of emery wheels for grinding cutters, the objections to those of solid steel are overcome, and a solid steel cutter, hardened throughout, is sooner ground in this way, than an iron one steel laid; and when it is considered that those of solid steel may be one-third thinner and yet as rigid, it becomes an argument in their favour. It is not recommended, however, that the extra thickness be omitted when they are made of solid steel, because shaping cutters are nearly always made too thin. When there is the least spring in them they are liable to break, snatch the piece from the workman, or, what is worse, take his hand into the cutters with it.

When a number of these cutters are needed for shaping machines, and when they are held by angular grooves at the ends in the usual manner, it will be found a good plan to procure several bars of the best cast steel, $\frac{1}{4} \times 1$ in., $\frac{1}{4} \times 1\frac{1}{4}$ in., $\frac{5}{16} \times 1\frac{1}{2}$ in., $\frac{5}{16} \times 1\frac{3}{4}$ in., $\frac{3}{8} \times 2$ in., and $\frac{3}{8} \times 2\frac{1}{2}$ in., in such proportion as the nature of the work may require; cut these bars up into lengths of about 2 feet each, and send them to a machine shop to have their edges jointed and bevelled by a planing machine. This will cost but a trifle, and ensure the uniform width of the cutters, without which no machine can work well, as the spindle is bent to meet any variation of width between the cutters forming pairs.

The cutters can be cut from the bars, shaped and tempered as needed. If there is a very irregular outline to make, it saves time to drill holes, and break out a part of the steel in the deepest places, or it can be cut out

at a forge fire without deranging the shape of the cutter, if care is used. When there is much grinding and it is to be done on emery wheels, harden the cutter before it is ground; but do not draw the temper until after it is shaped, it will then be clean and bright, to show the shades of temper. If solid steel cutters of any depth, say more than $3\frac{1}{2}$ inches, are used, it is best to slot them in the centre, and put a block between with clamping screws, as in Fig. 59. It may not be needed

FIG. 59.

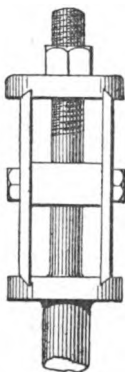

with ordinary work, but always where there is danger of splinters raising, or pieces pulling out, that may break solid steel cutters.

It is safest in shaping to keep the material as much as possible between your person and the cutters. This is the natural position; but when fulcrum pins are employed to hold the forms against the cutter-heads, the operator can in many cases be shielded behind the piece, or stand exposed as he may choose.

In arranging shaping machines, always drive them at as high a speed as the spindles and bearings will stand. The small diameter of the heads requires this to attain anything like a standard speed with the cutting edges, besides, it ensures greater safety to the operator; the weight and inertia of a piece will often prevent it from catching at a high speed, when it would be drawn in at a slow one. A set of spindles properly fitted should run at least 4500 revolutions a minute, which with heads $2\frac{1}{2}$ inches diameter gives a cutting movement of less than 3000 feet a minute, much slower than with most other machines.

The step-bearings for these machines should be as long and nearly as large in diameter as the top bearings, and arranged to be flooded with oil. Small tempered steel points will always give trouble, and have long ago, for all kinds of machinery, been abandoned by the best makers.

Have no balance wheels on the spindles, they only add useless weight on the steps, which have enough to carry without them. The need for them on the spindles of shaping machines is about the same as on the grindstone shaft, and they can be as well dispensed with in one case as the other.

Set the countershaft 10 feet from the spindles when there is room, or if nearer have the pulleys on it smaller in proportion; they should not in any case exceed five times the diameters of those on the spindles, unless set 10 feet or more distant.

MORTISING.

It was remarked of jig saws that they should only be used when no other machine could be employed for the work. It will not be far wrong, and for similar reasons, to say the same in reference to reciprocating mortising machines.

In no other country except America have reciprocating machines been applied to all kinds of mortising, and there is nothing strange in the reaction we now see going on by the return to rotary machines for car building and other heavy work. It is hard to tell which deserves the greater credit, the ingenuity and care that has kept the reciprocating machines in working order, or the forbearance that suffers their jar, rattle, and derangement. All recipro-

cating machines, no matter what their character, if run at a high speed are open to serious objections—from wear, breaking, jar, and vibration—but when we add a kind of duty that consists in heavy blows, like mortising, it amounts to a culmination of these troubles, and explains why the mortiser in a wood shop is generally out of order and requires more repairs than all the rest of the machines.

As before remarked, it is not our intention to treat of the principles of machine construction further than to give useful hints as to the care and operation of machines, but there is nothing that will teach the care and operation of machines so well as to understand the principles and the general theory of their action. It must also be admitted that as engineers and machinists as a rule know but little of wood-working machines, improvements and changes must be suggested mainly by wood workmen themselves.

We therefore suggest a thorough investigation of this mortising question to see whether the reciprocating mortising machine has not been applied to many kinds of work which could have been as well or better done by rotary machines. All the mortising in France, and the greater part in England, is performed by rotary machines, that cut clean true mortises without vibration or noise, the question arises, suppose it takes a little longer to cut a mortise, it is but a small part of the operation in making up work, there are no breakdowns to hinder and derange other things, the work is better done, the tools are not half so expensive, and finally is it not worth a great deal to get rid of the clashing and banging of a reciprocating machine, as a matter of order and comfort about the works? But

even this argument need not be used alone, for some car builders from careful statistics prove that rotary mortising machines effect a saving of time in the end, from the better facilities they afford in presenting and handling long or heavy lumber.

There is perhaps no question about the claims of reciprocating machines for light work, and for chisels to $\frac{3}{4}$ in. wide, or for pieces that are not too heavy to be fed to the chisel. In these machines there is none of the very objectional mechanism needed for a chisel bar feed, and the machines are quite simple throughout. The reciprocating parts can be light and the crank shaft can be placed in the base of the machine, to avoid overhead connections and prevent jar upon a building.

Machines of this kind are suitable for joiner work, cabinet work, and the lighter kinds of mortising generally, except for chairs; all other mortising should be done on rotary machines.

In making comparisons between reciprocating and rotary mortising machines we have to consider—first, the time required to perform the work; second, the character of the work when done; third, the skill needed to perform it; fourth, cost of tools and repairs of machinery, including detention by its derangement; or, briefly, time, quality, skill, and repairs.

To first consider time, it must in the case of reciprocating machines include the cleaning out of mortises after they are beat down, as it is termed, and unless the operator is specially skilled in the proper form of chisels, this cleaning out often equals the mortising. With rotary machines the mortises are clear, but require in most cases squaring at the ends, a work hardly fair to balance against

the cleaning out in the other case, for it requires less time and no more skill. If a mortise is made in soft wood and without boring, it will be made in less time on a high speed reciprocating machine, but if there has to be a hole bored for starting, the mortise will be soonest made by a rotary machine, which amounts practically to the former proposition, that small mortises in light work are soonest made by the reciprocating machines, and heavy work by rotary machines. Presuming that rotary machines had been as long and generally used in America as those with reciprocal motion, the test of time would perhaps be in their favour, taking the general range of work to judge from.

The question of quality need hardly be considered, mortises made by either plan are good enough.

In the matter of skill all is in favour of the rotary machine; those with reciprocating motion need not only as much care and skill to keep up the cutting tools, but a great deal more to keep up the machines, which are with the best care usually out of order. They are besides laborious to work, not only in the exertion needed to feed, but the jarring communicated to the foot is disagreeable, and often injurious in heavy work.

Of repairs, breakage, and detention, they are as the difference between reciprocating and rotary motion which expresses all that could be said.

In the selection of machines and the arrangement of shops let this matter be carefully canvassed, and whenever there are any doubts as to the plan of mortising to be adopted decide in favour of rotary machines, for heavy work at least. They will not only perform the work, but do it well, and when not needed for mortising can be used

for boring, recessing, gaining, or other work at times when a reciprocating machine would be idle. For the lighter class of work when a movable table machine can be used, the reciprocating machine is best, and will probably remain so, but whenever the work requires a machine with chisel bar feed, the case is different. Rotary machines are not used in America at this time, except a large size for car builders, but soon would be, if introduced, and many improvements be added in adapting them to general purposes. The length and position of the mortises being gauged by stops in the rotary mortising machine, it is possible that with some convenient system of gauges, no laying out would be needed on any kind of work. This is one of the advantages that has called the attention of car builders to these machines, and which is no small matter when we consider both the time and the mistakes saved; a stop system is necessarily a check system at the same time, and prevents mistakes. Speaking of there being but few rotary mortising machines in use in this country, we must except what are generally called chair mortisers, a kind of rotary machine that deserves a more extended use than it has at this time. The rule has been to use these machines on round or crooked stuff which could not be held firm enough to withstand the blows of reciprocating machines; they never fail to do all that is required, and do it well, without much repairing or attention. These machines are made in Ohio, and other places in the West, in a simple, compact form, and at a low price; those made in New England for chairwork are more complicated and slow to operate, having generally vertical spindles, cutting downward, so that the chips remain in the mortise, and in some cases the vibratory

motion has to be stopped when pieces are put into the machine. The spindles of these machines should stand either horizontally or vertically beneath the work, and run at a speed of 6000 to 7500 revolutions a minute, the vibratory motion may be from 200 to 400 a minute; the cutters or bits should be made from Stubbs' steel, drawn polished rods of the finest grade and used without tempering. The spindles should be bored deep enough to receive from 8 to 12 inches of the rods, so that there will be no waste except the wear, and that the cutter may be set out more or less, as the depth of the mortises may require.

The bits should be held by a conical split thimble fitting into the end of the spindle; set screws are unfit for the purpose; they are often in the way when mortising on angles, and are liable to catch in the clothing.

The chuck-end of a spindle is shown in section, Fig. 60,

FIG. 60.

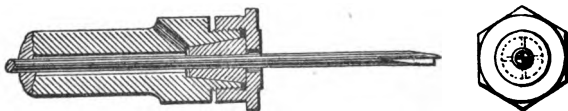

a good device for any kind of rotary tools, where the torsional strain is not too great to be sustained by friction alone.

The chisels for reciprocating mortise machines have much to do with their performance; a chisel that is true and of a form that loosens the chips and throws the greater part of them out of the mortise, works easy, does not lift the piece on the up-stroke, or jar the machine.

Chisels should be tapered slightly on their sides and backs, and the only plan to get them true is to plane or

mill them from the shank after it is turned; this is easily done, and is the cheapest plan after the chuck or holder has been prepared.

Fig. 61 is a chuck for planing or milling these chisels, consisting of a revolving shell or holder, *a*, with a socket

FIG. 61.

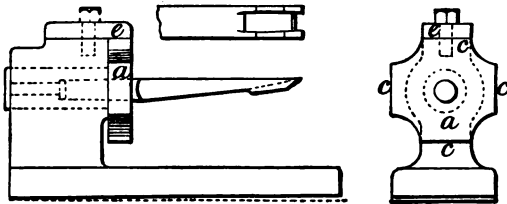

to receive the chisel shank, and four stops, *c*. The base of the chuck is planed to the taper needed on the sides and back of the chisels, and arranged to fit on a planing or milling machine. To set the chisel the clamp-piece *e* is loosened, the chuck revolved one-fourth, and then again fastened.

Mortising chisels should have a filing temper deep blue or tinged with violet colour, and be made of the best steel only. To sharpen them a thin emery wheel can be used for the throat instead of files, in which case, however, the temper should be no harder than described, or they will be liable to break. The jaws or ribs at the sides of the chisels are generally made too thin; it is as well for all chisels more than $\frac{3}{8}$ in. wide to have lips one-fourth the width of the chisel. Their purpose is to divide the chip into three parts and loosen it in the mortise, and the central part, or throat, aside from inconvenience of sharpening, need be no wider than the jaws themselves.

TENONING.

Machines for cutting tenons are so well understood, and have been so little changed in a long time, that they are perhaps the most successfully built and operated of all wood machines. Those with a fixed table and the cutting movement given to the spindles are slowly coming into use for the heavier class of work, especially when the tenons are double. With this exception, the American tenoning machines have remained about the same for twenty years past. Improvements have been made in the cutters, the machines have been improved in strength and workmanship, and by the change from wood to iron framing, the manner of adjusting the heads has also been improved and simplified; but for light work an old machine is as good as a new one, which can be said of but few other machines. There are some things, notwithstanding these facts, that need improvement, which any experienced wood workman will appreciate when pointed out. The shoulders of the tenon, for instance, are squared from opposite sides of the piece by reversing it, when it is tenoned at both ends, and it must be both parallel and straight to bring true work; it amounts to the same thing as using the try square on two different sides of a piece in scribing shoulders, which would not be thought of by a bench workman. For this we have the remedy of tenoning both ends at the same time, which not only evades this trouble of squaring the shoulders, but saves a great share of the time and labour. It also ensures accurate and uniform lengths between shoulders, a matter of no small importance in tenoning. This plan of tenoning both ends at one operation has gone into practice in Chicago, where it has met with great suc-

cess, and deserves to be generally adopted in door and sash work.

Some of the joiners' shops in Sweden and Norway employ the same plan, and machines of this kind have been made in England.

Another improvement is needed in the carriages. They are made to run on slides, and to move them backward and forward is the main labour in operating a tenoning machine; it is not only hard work, but consumes time, and hinders the operator from holding the stuff, which is nearly all he can perform with his hands. The carriages should in all cases move on rollers, no matter how small the machine; it is of course more important for heavy work, and on the larger machines, but in any case it allows the operator to feel the action of the cutters more sensitively, and saves time. The argument has been in this matter, that a carriage, if mounted on rollers, could not be kept true and square. Without discussing the subject from a mechanical point of view, it is suggested that a maker who cannot produce a tenoning carriage to move true and square on rollers had better leave the work to be done by those who can. The old wooden carriages are so light, and slide so easily in doing light work, that they do very well without roller bearings; but, as now made of iron, a carriage strong enough to stand the rough use to which it is subjected, is too heavy to move on slides. Carriages when mounted in this way start heavy and bring the wood in contact with the cutters in an abrupt manner that shivers the corners in starting. The pressure needed to move the carriage is so great that the cutting is not felt, and, as remarked before, the main work in operating is to move the carriage backward and forward.

Tenoning cutters, with all others that act transversely to the grain, should be as thin, and stand at an angle as acute as possible. The tenons depend for accuracy upon the edges being straight and true, which requires precision in grinding and sharpening them, or rather in jointing them, which should be done when on the head at first, and then a gauge prepared that will indicate the true angle for the edges: most makers send out such gauges with their machines, but they nearly always need a readjustment by the operator, who can test them by careful experiments which the machinist has not facilities to do.

WOOD TURNING.

The 'Turners' Companion,' with other treatises on the subject, generally relate to fancy engine turning for ornamentation, and are intended mainly for amateurs, or at least do not apply to what is needed in a wood-working establishment.

What is said here will therefore be directed to other matters that are of more interest to the practical workman, and while there may not be much said that is new, it will it is hoped contain suggestions that will be of use.

Turning is an extensive and important branch of wood work, one that has to be performed in nearly all wood shops, and, more or less, on all kinds of work. Every wood workman should learn plain hand turning; not elaborate pieces, but such things as are met with in general wood work. In joinery, circular work such as circle top frames, round corners, and columns, have to be turned. In cabinet work, although turning is not so great a share as in former times, it is yet a large part of the whole.

Pattern makers learn to turn from necessity, and the time spent in this way is more than compensated in the aid it gives in learning bench work.

The art of turning in wood and ivory has always been considered an amusement, and there is nothing in the whole range of industrial processes more fascinating than to shape pieces in a lathe; some of the pleasure is to be ascribed to the fact that turning is performed without much exertion, and consists rather in directing the tools than propelling them; yet the rapid change of form that is made at will, and the nice skill needed in some of the finer varieties of work, makes it a most agreeable labour, even to those who are continually engaged at it. The hand lathe is chief among turning machines; for centuries it was applied to all manner of turning in both wood and iron, without any attempt to guide or direct the cutting tools by mechanism, but of late years, from a turning lathe we have changed to turning "machinery," and so many auxiliaries have been added, that the lathe can now be considered but little more than a device to rotate the piece. In wood turning, all the coarser kinds, and even fine work when there are many pieces of one kind to be made, are machine turned. Nothing connected with wood cutting has been followed more persistently than automatic turning, and nothing has met with more failure. A strange fact running through all experiments made thus far, is that they have been successful or unsuccessful as they have corresponded to the action of hand tools. Except in America but little has been attempted in automatic turning machinery; in the older countries labour is too cheap, and less turning in wood is done.

Hand lathes for wood turning require to be made with more care in some respects than any machine used in

wood work ; they should run true and steady, as a matter of convenience, and of necessity as well, for no turner can do good work on a bad lathe, or one that is not in order. The cones should be of cherry or mahogany, the wood thoroughly seasoned, and laid up so that the joints will run true. Nothing looks worse, nor more unworkmanlike, than to have the joints in a set of lathe cones to run in a zigzag course ; besides, it is just as easy to have them true, by planing up and sawing out the different layers, and then gluing them up on the spindle, using the small cone, which should be of iron, and screwed on the spindle, to clamp them. The cones should be for a common hand lathe five in number, rising from 4 to 12 inches diameter. The spindle should have long bearings of hard brass at each end. There is something strange in the fact that while bearings for other spindles are made from three to four diameters in length, lathe bearings are as a rule but half as long ; and still more strange that lathe spindles should have a small point bearing at the end any more than the spindles of other machines. The end thrust is great, it is true, and must be resisted, but in other cases a little point would not be thought of ; a series of shallow collars has been determined in engineering practice generally, as the best means of resisting end thrusts, and why not in a lathe ?

Without going into construction of lathes any further than to offer suggestions to those who purchase and use them, we will say, that if turners would note the weak points and faults in hand lathes, and dictate their construction in such particulars as need improvement, we should soon have them more perfect.

The shear, or lathe frame, which is seldom furnished with the lathe, can be made of wood, and is for some pur-

poses better than if made of iron. An iron shear is cold in winter, generally too narrow on top, and injures the tools, which are sure to come in contact with it. For pattern work, and the heaviest kind of wood turning, an iron shear is for some reasons best, because of keeping the heads in line, and the weight preventing vibration from pieces that are out of balance.

A wooden shear should be made of dry pine, the sides not less than 5×10 inches— 6×12 is better—the top covered with an inch board of ash or oak, fastened with wood screws, so that it can be taken off and replaced when worn; this preserves the shear frame, and makes a hard surface for the heads to slide upon. Lathe shears should in setting be braced, or blocked and bolted, to a wall whenever practicable, especially when there is more than one lathe to stand on a single frame, otherwise one lathe will disturb another in starting rough stuff that is out of balance.

A wood turner needs a good and complete set of tools. It is not pretended that there is anything new in the suggestion, but there never was one more needed; there is no accounting for the want and the imperfection of tools that can be seen with nine out of every ten wood lathes in use. A man may at bench work manage to get along without tools of the best temper, or those properly ground, but no one can turn with satisfaction, or with success, without both, because turning depends upon a sharp keen edge, and in most cases a true bevel, *which forms a rest for the edge of the tools*. The finest steel only will hold an edge, and even then not on all kinds of wood, so that scraping tools have to be resorted to. Except for light work, the scraping tools—cutting off, or square tools—and nearly all except flat chisels and gouges, can be made from bars of

steel, and used without wooden handles ; if made from $\frac{1}{2}$ -in. or $\frac{3}{4}$ -in. square bar, and the sharp corners ground off, they are convenient for pattern turning at least, and much safer than with detachable handles. Tools made in this way should be longer than handled tools ; for pattern turning they may be from 16 to 20 inches long without inconvenience. For all kinds of light turning, those with handles are of course more convenient.

Tool handles and other fancy articles should be polished in the lathe before taking them out, by first putting on a light coat of linseed oil with a brush, and then using shellac varnish, applied with a woollen rubber, made by doubling heavy cloth to make two to four thicknesses, and, when doubled, about 3 inches square. Apply the varnish to the cloth, then hold it on the work, pressing hard enough to heat and dry it ; the varnish must be thick, and the operation, to be successful, done rapidly.

It may be said that polished work, tool handles, for instance, cannot be performed by automatic lathes ; such work cannot be made smooth enough to receive the polish, and the polishing if required would have to be at any rate a second and independent process.

No rules of much value can be given to aid a beginner in learning to turn, for turning is an operation consisting almost entirely in hand skill. One thing, however, may be suggested—cut, instead of scrape, with the tools. The beginner at once discovers that his tools will not catch when scraping or dragging on the wood and adopts scraping from a sense of danger ; he may at the same time discover that if used in this way the edges of the tools are at once destroyed, but little is accomplished, and the surfaces produced are very rough.

Machine or automatic lathes, as they may be called,

consist of four classes ;—First, gauge lathes, with a slide rest and tool carriage, after the manner of an engine lathe, for metal working. Second, lathes with rotary cutting tools, that have a compound motion of the wood and the cutters, both revolving. Third, excentric lathes for turning elliptical or other irregular forms. Fourth, chuck lathes, hollow mandrils, or rod machines.

The gauge lathe was invented by Bentham, described in his patent of 1793, and has possibly, under some modification, been in use ever since. What is known as the Alcott slide, to be used in connection with an ordinary hand lathe, is but a modification of this machine. The principle of operation consists in a following rest, in front of which is a roughing gouge, to reduce the piece so that it will fit the rest ; behind this rest other tools follow, one to three in number, as the work may require, the rest supporting the piece. The following or finishing tools are generally mounted upon pivoted falls, which slide on patterns, that raise and lower the cutters to give the required shape to the piece. This produces duplicate pieces very rapidly, but if the profile is in any degree irregular the work is too rough for any but the rougher uses. By tumbling the pieces in a cylinder with leather scrap, after they are thoroughly dried they can be made smooth enough for painted work, but not to varnish or polish. Gauge lathes have been helped out of this difficulty of making rough work by shearing knives, that come down diagonally behind, and follow the rest, cutting off a light shaving with a thin tangential edge, corresponding to the action of a hand chisel that leaves the piece true and smooth. This device has been extensively and successfully used, and manufacturers need have no fear in adopting it for any work to which it can be applied.

If a gauge lathe is to be used, have a good one. It was a long time being discovered that a gauge lathe for wood turning required to be as accurately, and even more carefully made, than an engine lathe for machine fitting. Such lathes require to be made in the most thorough manner, and will cost a large price from any responsible maker. If the amount and character of the work does not justify the outlay for a first-class gauge lathe, it is better to do the work by hand, or with an Alcott slide, than to buy a cheap one.

The spindle bearings of gauge lathes should be made of the hardest brass, set into accurately planed seats, so that they may be adjusted or renewed without trouble. Centres project 6 to 10 inches from the ends of the spindles, have sharp points, and the head and tail points must come together precisely, and keep there, that is, the lathe must keep in line; this must be the test of a gauge lathe, and is one that would condemn nine-tenths of all the engine lathes in use.

Of second class, of lathes with rotary tools are but little used; the cutters and the wood both running in circles, and cutting intermittently, make rough work; it is difficult enough to produce smooth surfaces with either the wood tangential to the cutters, or the cutters tangential to the wood, without having two circles to meet. There has been a limited use of these lathes for turning hubs and other coarse work, but nothing to merit a further notice here. We suggest to wood manufacturers that whenever they find this compound rotary motion of both the tools and the piece in a machine to do cylindrical turning, to buy some other; it is a subversion of the true principles of wood cutting, and as such should be employed only when it is unavoidable.

Excentric lathes for oval turning are among those machines which require special knowledge to manage. The Blanchard lathe, if driven at its utmost speed, may turn from five to seven hundred small spokes a day, the surface so rough that the grinding and polishing becomes a more important matter than the turning. We do not want to find fault with a machine so long and so successfully used as the Blanchard lathe, but will suggest that if instead of turning six hundred spokes on one machine, the same man were to turn three hundred each, on two machines, and turn them smooth, a great gain would be made. The investment in machinery would be something more, but this is a small matter, to be rated as the interest on the money, and is balanced by a small daily gain in either the quantity or quality of the work performed. What we contend for is, that these excentric lathes should be better made, do their work more smoothly, and if necessary keep up the quantity turned by increasing the number of machines. In excentric turning the rough character of the work is due in a great measure to the cutting being done across the grain, and to the very inferior quality of the cutters used; these are, as a rule, made from saw-plate steel, tempered to a blue only, so as to be filed, and the edges break or bend as soon as they touch any bark or grit. The plan of filing answers for rough work, and plate-steel is good enough for cutters, but it should be of the finest quality, carefully tempered, and the inside which forms the edge polished.

The best lathes for excentric turning are those which have the reciprocating movement in the cutter-head, a principle which is followed in all cases except for spoke turning, and in what is called the Handle Lathe. The fact is that no durable and substantial machine can be

made that has its spindles and driving gearing vibrating on a swing frame. The lathes used for turning gun stocks in the armories are the best in use, and are in all cases made with the spindles to run in fixed supports. Spoke-turning machines that have their cutters arranged to act lengthwise the piece, parallel to the fibre, do smoother work, and admit of several pieces being worked at the same time. This plan is one employed in machines of foreign manufacture, and has certainly been successful enough to prevent the introduction of the Blanchard lathe in Europe. It is therefore suggested to manufacturers that in fitting up new works, or in increasing old ones, that this subject of elliptical turning be more carefully considered, and investigations made as to the relative cost of grinding and polishing, compared with the turning, also the cost of turning by different machines.

The cost of turning is the wages paid for operating the machine, with its wear and repairs added; for polishing, it is the cost of the labour, the wear of belts, cost of glue, sand, and the time of laying the belts. A little gained by fast turning may be easily lost in finishing, and it is quite unfair to rate the capacity of a machine by the number of pieces that may be turned out, regardless of the manner in which it is done.

With handle lathes the cutting is generally done in saws, which stand the bark better than cutters, and do not spring the piece so much. A cutter-head with six or eight cutters to do the same amount of work as a saw that has from 24 to 32 teeth, must displace four times as much wood at each cut, and the shock and strain upon the piece is nearly in the same proportion. The straighter kinds of handles, such as sledge, pick, hammer, and hatchet handles, can be turned much faster with cutters than with

saws, because of the edges being broader, and the feed proportionately faster; but axe handles, or any handle that has short turns or angles, can be best turned with saws. The true plan is to have each lathe supplied with both saws and cutter-heads, so that they can be changed to suit the kind of work being done.

Chuck turning relates to parallel rods like dowel pins, chair braces, or fence pickets. As machines, chuck lathes are simple, efficient and labour-saving, cost but little, and should be used whenever there is anything for them to do. The principle of their operation is the same as the hand gauging tool shown at Fig. 62, a little device that should be among the tools on every hand lathe.

FIG. 62.

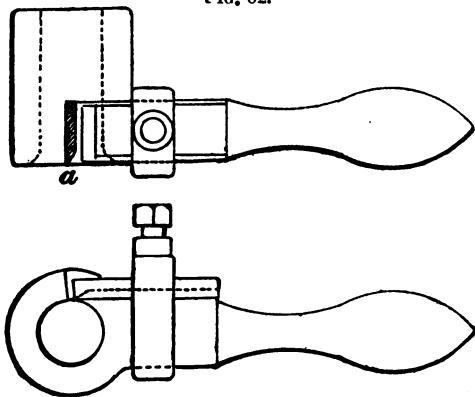

This gauge tool is used in turning any kind of parallel stuff, dowel pins, wooden screws, gauge stems, in fact anything that is in whole or in part straight. Cabinet turning, such as nulling, cottage spindles, or other pieces that are turned straight before being moulded, can be sized much quicker and more accurately with a gauge tool than with chisels.

The tools are made of cast iron, are inexpensive, and easy to operate. One stirrup and cutter will do for several sizes by exchanging. The only fitting in making gauge tools is to bore them to the size wanted and cut away the throat. In using them the handle runs on the rest, and should be held down firmly; some of the first experiments may be failures, until there is some skill acquired in setting the cutter. The tool will either go perfectly straight, which is its natural and most easy course, or it will not go at all. Although but little known they have been in successful use for years, and are especially needed in turning the stems of wooden screws, and other pieces that have to be accurate.

PATENTS ON WOOD MACHINES.

It is thought that, among other things, a short article on the subject of inventions and patents would not only be of interest, but probably of use. All engaged in wood manufacture—proprietors, managers, and workmen—are at some time either afflicted with a patent mania themselves, or brought in contact with it in others, and the little that has been written or is known of the history of wood machinery, together with its recent rapid development, has been not only favourable to invention, but also to deception and mistakes. If anyone before investing in, or becoming interested in, inventions, or in applying for patents on wood-working machinery, would look over the statistics of the past, and see how little has been derived from invention, or even from the monopoly of manufacture, by patents on wood machines, he would need no other caution to deter him from what will, in nine cases

out of ten, result in a loss of time and money. Even in the case of the few master patents, on principles, we use the word advisedly, such as Woodworth's patent on planers, or Blanchard's patent on excentric lathes, but little, if anything, has been gained to the patentees. The greater share of the revenue was consumed in litigation, to defend against infringement, a consequence that is natural, and will always occur in any attempt to monopolize the manufacture of a machine after it becomes popular. There is something about public sentiment in the United States that rebels against patent monopoly and favours attempts to evade patents, which renders it difficult to introduce patents, and still more difficult to defend them against infringement if they are really useful.

Leaving out the considerations already named, which ought to be quite enough to save at least the greater share of what is each year lost in wood machinery patents, there is one other too often lost sight of, the difficulty and expense of ascertaining the novelty of improvements. Foreign patents or foreign practice become legal evidence against the novelty of inventions in our courts, and it is only in late years that we have had facilities for acquiring and using such evidence or acquainting ourselves with what exists and what has been done abroad. Our Patent Office, with all the good features of its system, and the examination it gives to cases, does not dare to give any validity to a patent, or to confer a single right that is indefeasible or not conditional; it simply gives the inventor power to prosecute others for infringement, and actual damages on condition of being the true and original inventor, as against his opponent and everyone else. The writer has spent no little time and money in securing patents on wood-cutting machines, most of which

he has found to be anticipated by other and older inventors, and without having in any case realized as much as the same amount of effort would have earned if it had been applied to other business.

What it is intended to notice here, is not so much the policy of patenting improvements, as the founding of business schemes with patent monopoly as a base, or constituting a part of the capital. Any failure of a manufacturing business is felt far and wide, both as a loss of capital and an injury to the reputation of the branch of work to which it belongs; and in establishing a business, as in building a house, there is required a good foundation, which in manufacturing should be a demand and market for the product, skill to produce it at as low or a lower cost than others, and capital to do the business upon.

The estimates of a market should be based upon a careful review of existing facts and probable future changes, how far the articles to be made are a luxury or a staple of necessity, and how others have or are succeeding in the same line.

In the matter of skill, depend upon mechanical ability, experience, shop system, and good manipulation; if patents are to be a consideration, balance them against some other intangible consideration, but not against money, credit, machines, or material. If a patent earns anything, it is easy to set it off to a separate account, but never safe to use the money until it is earned, which is done when a patent represents manufacturing capital.

In the matter of capital, no matter what the amount, let it consist in cash or actual assets; there was a time in wood manufacturing when it was comparatively safe to borrow money for one or two years and invest it in lumber

and machines, but that time has gone by; competition is now so great, and our establishments have grown so large, that the manufacturer with a small or a borrowed capital has but little chance against the one who has a large capital and owns it. In making special and new articles of manufacture, or in districts not connected with our great cities by rail or water communication, or when the business is carried on to meet a local demand, these rules may not apply: they are safe premises, however, to reason from in starting a new business.

PURCHASING MACHINERY.

There is no knowledge more important to a wood manufacturer than what kind of machines he should purchase to be used in his business.

Operators generally understand the subject better than proprietors, and machines are usually bought upon their judgment and advice; only so far, however, as a choice between the machines of different makers, for it is very seldom that they can get just what is wanted, no matter how well they may understand what is needed for the work.

Wood machines are made in America at this time like boots and shoes, or shovels and hatchets. You do not, as in most other countries, prepare a specification of what you want, as to capacity, belt power, adjustments, and so on, but must take what is made for the general market. That this is not right need not be argued, and that it is as much the fault of the purchaser as it is of the maker is also true.

Purchasers are too apt to barter and beat down the price to the lowest point, and then go to another maker to see if he will furnish machines for less, just as though it was a circular saw, a roll of belting, or a barrel of oil that was wanted. This not only degrades the business of machine manufacturing, and provokes competition and bad work, but it leads to a state of affairs that allows almost anyone to engage in machine making without the engineering knowledge and skill that is needed.

This is not the way to construct and sell machines that will earn the most money. They should, whenever practicable, be specially adapted to the work to be performed, by makers who not only understand the nature of the work, and the principles of machines, but have proper facilities for designing and modifying them, without enhancing their cost. In most cases a man who is to run a machine upon some special work knows how it should be made and arranged for that work, and he should have it arranged accordingly. If a machinist applied to has not the skill or the engineering knowledge to modify the machine, go to one who has such knowledge, and the chances are that what is saved at such a shop by skill and system will fully make up for the extra cost of the changes needed. This commercial system of machine manufacture has, among other troubles, led to a kind of conditional sale system; machines are bought, and what is stranger, furnished, on trial. The purchaser is afraid to trust his own judgment, the maker is not to be depended upon, the manager or the operators have no choice except between the stereotype machines in the market, and the builder is allowed to send a machine on trial, or rather, to send one with a guarantee of its working.

The way to reform this, which all must admit as a

wrong system, is for the machine operators to educate themselves in the principles of constructing as well as operating wood machinery; to study the theory of the action of cutting edges, the proportion and composition of bearings, the diameter and length of spindles, the size of pulleys and width of belts, speeds, and everything pertaining to wood manufacture.

They must not depend upon machinists, who as a rule know nothing of wood work, to do this. It is altogether a different thing from making lathes and planer drills for metal work; tools which machinists understand and continually use in their own business. Wood machines are not only peculiar and difficult to build, but are also peculiar to operate. A machinist is expected to run a lathe or planer, to drill, or do vice work, but on the contrary it is only a few wood workmen who can run the different machines found in a wood shop, so that it is unreasonable to expect a machinist, without specifications, to fill an order satisfactorily for a machine which even the operator may not understand.

In ordering machines, therefore, take time to investigate their adaptation to what you want to do; if the work is of a regular character the public reputation of a machine may be trusted, but it is due to the dignity of any shop to at least attempt to improve their manipulation by modifying machines whenever useful improvement suggests itself. In the matter of shafting, belts, and steam power, we have already offered suggestions to aid in their selection.

SUPPLYING MATERIAL.

"A penny saved is a penny earned," is a maxim as old as it is true; applied to the purchase of lumber and wood supply for an establishment it means that a dollar saved in the manner of supplying material, can be added to the profits account.

As to purchasing sawed lumber, it is only a commercial question of quality and value, but other plans of procuring material, without its passing through what is called the lumber market, are open to some suggestions for those who are within reach of timber.

A great many, in manufacturing articles from wood, never think of anything but to purchase sawed lumber and recut it, often into small pieces, when they had just as well cut their stuff from round timber, saving thereby a great share of the cost, and at the same time securing better material. As a rule, 200 feet of lumber will cost as much as one cord of timber; a cord of timber, 128 cubic feet, is as a solid equal to something over 1500 feet of sawed stuff board measure; allowing one-half for saw-kerf and waste, it would make when sawed 766 feet of lumber. A good sawyer, with an efficient machine, will cut up four cords of logs 8 feet long into framing pieces or turning stuff in a day; the waste, after furnishing fuel to drive the saw, is generally worth enough to pay for the sawing, and something over; as one-half is allowed for waste it should certainly make a cord of firewood, worth as much as a cord of round timber.

This would give 766 feet of prepared stuff at the same price that would have been paid for 200 feet of lumber, with the difference that what has been cut from timber

is cut to dimensions, while the other would be in planks or boards, and subject to a much greater waste in reworking than the stuff sawed by hand.

Leaving all nice calculations out, we may safely assume that when a cord of round or split timber costs as much as 200 feet of lumber, the stuff saved from the timber will, when cut out, not cost more than one-half as much as an equal quantity of merchantable lumber, and that if any considerable part of the lumber used in a manufacturing establishment could be produced in this way, it alone would make a large profit.

As to the question of quality, or worth, which is the same thing; timber that is cut to be sold by the cord is usually of smaller size and a younger growth than what is taken for saw-mill logs, and is for that reason sounder and brighter than the older growth. If it is split before sawing it must be reasonably straight grained, and is sawed nearly with the grain; being in short lengths of 8 feet or less, the lumber in any case is much straighter in grain than if it had been cut at a regular lumber mill, where the logs would have been twice as long. In other words, the lumber from a crooked tree is straight or cross grained as the lengths into which it is cross-cut before slitting.

It might be said in reference to this system, that round timber cannot be obtained; however, there are but few places in the United States, except in large cities, or the prairie countries, where such timber cannot be procured, by simply letting its want be known. The farmers during the winter are glad to haul in, or deliver such stuff on the railways, canals, or rivers, and only too glad to avoid the saw-log business, which is by no means a favourite one. Many of the largest wood manufacturing establishments

have already adopted this system, so far as they can, and have continued it successfully for years; it is not expected, of course, that we are giving them information, but a great many never think of it.

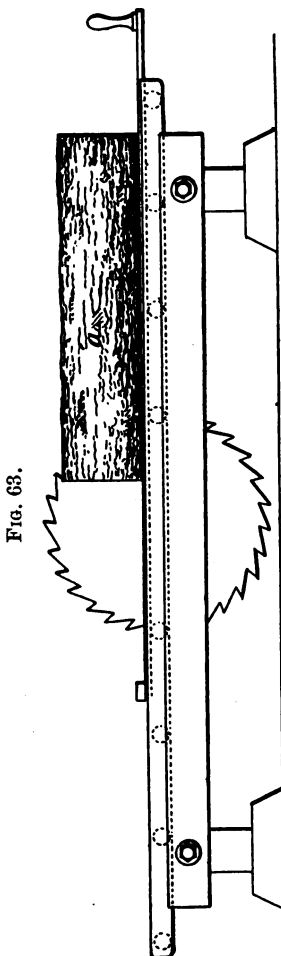
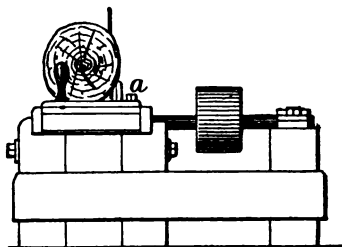

FIG. 64.



For this kind of sawing there is needed a saw framed and arranged as in Figs. 63 and 64, the general dimensions as follows;—

- Length of main frame, 14 feet.
- Height of main frame, 24 inches.
- Length of running board or table, 13 feet.
- Length of bearing rails, 16 feet.
- Diameter of saw, 36 to 40 inches.
- Diameter of mandril, $2\frac{1}{2}$ inches.
- Length of mandril, 42 inches.
- Size of pulley, 12 inches diameter, 8 inches face.
- Speed of the saw, 1200 revolutions per minute.
- Power required from 10 H.P.

The table is merely a hard wood board, interposed between the timber and the rollers, split throughout its length, but held together by the cross cleats on

the ends; the angle irons seen on the end view, at *a*, are used to gauge the stuff; other plans can be used, which may be more convenient; one is to have swinging gauges fixed to the main frame outside the moving table, so that they will swing round out of the way when the timber is moved; another is to have lines scored on the table, indicating inches or smaller divisions if needed. In sizing stuff that is to be squared after it is cut into deals, a number of pieces can be piled on top of each other and cut at one time to save time and walking. Six cords of timber have been cut into pieces for hoe handles, rake handles, and general turning lumber, in a day, on one of these saws.

Table legs, bedstead and chair stuff, with the greater share of the lumber used in furniture manufacture, can be prepared in this way, either to size, or in deals to be recut after seasoning.

HINTS ON BENCH WORK.

It requires some temerity to write about bench operations in wood work; a hand art almost as old as the world, or at least as old as civilization, ought by this time to be perfect, and it would, no doubt, have been perfected long ago, so far as hand skill is concerned, if it were not continually modified by the influence of machines, so that bench work, like other things, must progress and improve.

If a reason was wanting, there is another which would serve for the introduction of this article—it will instruct apprentices. In most trades there are inferior branches with which an apprentice may begin, and then become gradually skilled in his art by changing to those more difficult as he learns, but this is hardly true of bench work

in wood manufacture. An apprentice may clean the shop, rip out stuff, sand-paper, and knock about at the beginning, but as soon as he goes to the bench he has at once to begin some of the most difficult things that he will ever have to perform, which are to dress up stuff, make joints, and keep a set of planes in order. It is therefore expected that this part of the book will not be without its use, although somewhat disconnected from the general subject of wood-machine operation.

BENCHES FOR WOOD WORK.

Long custom has established certain forms of benches for different kinds of wood work, and while almost any kind of wood work may be done on almost any kind of bench, there are in this, as in most old customs, some good reasons at the bottom. The cabinet maker wants a tail-screw, the carriage maker a standing or high vice, and the pattern maker the back tray, while the carpenter does not care much what his bench may be, so long as it is long and wide.

Since the general introduction of machinery to do the planing, benches have been made higher than when work was done by hand, an improvement that prevents stooping. Thirty-two inches high was once a limit, but now benches 36 inches high are often more convenient than if lower. In any case they should be as high as possible.

The main part of a bench is the top, and next the vice. For carriage work the vice is the main part; there is, however, no harm in having both as good as can be. The tops should never be made of a whole plank; they are much better if made of scantling, bored at intervals of

12 inches for dowels, and the whole drawn together with $\frac{5}{8}$ -inch bolts. One of the bolts can pass through the standing leg of the vice, which should always be gained into and come flush with the top of the bench, and not mortised into the under side, in this way it generally splits the top; besides, the top will not stand the wear opposite the vice jaw. When a tail-screw is to be used the top cannot well be made throughout of scantling; a wider piece will be needed on the front side, to frame the tail-vice in, but it should be as narrow as possible, and the rest of the top in pieces. Always make benches large enough, the constant tendency is to have them too small, especially with cabinet makers, who often own their benches, and move them like a tool chest to wherever they are engaged; this has no doubt been a reason for the small size that cabinet makers' benches are generally made. A tray at the back is the common plan, and at the risk of violating the maxim laid down at the beginning about old custom, we must say it is wrong. No one wants to hunt small tools out of a tray; it is never deep enough for the stuff on the bench to clear plane handles, is always full of dirt and shavings, and at best can be considered as nothing more than a plan to save width. If the stuff being worked is wide enough to cover a tray, the tray is of no use; if it is not, there is still no need of the tray, six inches more of width added to the top will be found more convenient for any kind of work, from carving to wagon making. A flush top is easier kept clean and clear, but if it must be divided into a working top and a tool compartment, raise the tool platform *above* the bench, either by laying on a pine board 8 inches wide, or, if the bench is less than 30 inches wide, raise this board up 6 inches from the bench, like a shelf,

leaving room so that planes will go under it, or, what is better, leave a place clear at the front for planes. This will be found more convenient for small tools, and more orderly than a tray. A cabinet bench, to be convenient, should not be less than 30 inches wide, and 8 feet long, the centre of the main vice 20 inches from the end, the top $3\frac{1}{2}$ to 4 inches thick for the whole of its width, for it nearly always costs more to fit up a backboard than the extra lumber is worth, if the tops are made of uniform thickness throughout: these sizes are nearly twice as large as such benches are usually made. The amount that a man may earn on a bench does not often lead to affluence, even when all conditions are favourable, and to render this amount as large as possible, after skill, the next most important thing is order and good tools, neither of which can be had without bench room.

A vice jaw for wood work, except wagon and carriage making, should be from 8 to 10 inches wide, 3 to $3\frac{1}{2}$ inches thick, of seasoned hard wood, set at a sufficient angle to prevent it from twisting when long pieces are set in vertically. The standing leg should be the same size, and, as before said, gained into the top depth, not full depth, but from $1\frac{1}{2}$ to 2 in.

Benches for pattern making require to be wider, longer, and higher. A good plan for pattern benches is to make them continuous along one or more sides of the building. The tops need not be more than 3 inches thick: if covered with pine, it prevents bruising the work, and is easier to true up. Such benches should be 32 to 34 inches high, 34 inches wide, and if in sections, at least 10 feet long. The vice should be strong, of the same proportions before given. The screw will be more convenient if of a coarse pitch, so as to act quickly. The square thread screws, coming into

use, are well adapted to pattern makers, vices, or for any work that requires much use of the vice. Always have the screw and slide bar arranged so that the vice can be drawn out or closed up to any distance, without helping the bottom along with the hands; this can be done by putting a bearing over the top of the screw inside the nut behind the standing leg, and by having a well-fitting collar key, and also a good running bar at the bottom. It is better to spend a little time in fitting a vice properly, than to stoop or sit down to pull out the vice jaw at the bottom each time it is changed for different sizes of stuff.

Wagon and carriage makers mainly use parallel iron vices, which are so much better for the purpose that there is no need of describing how wooden vices should be made.

BENCH TOOLS FOR WOOD WORK.

It was remarked in the Introduction that we sometimes see a man without much physical strength, and apparently without exertion, do more work than a strong one who labours harder. No fact is better known to wood workmen than this, but the lesson it teaches is generally neglected, and the matter regarded as a kind of mysterious dispensation, over which there is no control. There is no greater mistake; workmen may have peculiar faculties mentally that enable them to succeed better than others when their work is very diversified and intricate, but so far as bench work is concerned, nearly all the difference can be traced to the tools used; a fast workman generally has plenty of them, kept in order, and in the right place. Hand skill is of course requisite, but hand skill is a result of good tools, and the same spirit that promotes

order ensures speed. A man may do good work with poor tools, and if well skilled may do a day's work with poor tools, but such a man takes no pride in his business, and could do proportionally more, and with greater ease, if he had better tools.

It is almost impossible to speak intelligently or specifically about tools without assuming some special kind of work to govern the matter, but as this would exceed the brief limits assigned to the subject here, we will endeavour to treat it in a general way.

The first and leading tools are bench planes, a set of which should consist of one 26-inch jointer $2\frac{3}{4}$ -inch iron, one 24-inch jointer $2\frac{3}{4}$ -inch iron, one 22-inch fore-plane $2\frac{1}{2}$ -inch iron, one jack plane $2\frac{1}{2}$ -inch iron, all double irons; one jack plane 2-inch single iron, one handle smooth plane $2\frac{1}{4}$ -inch iron, one common smooth plane 2-inch iron, one block plane 2-inch single iron—nine planes in all, as a set of bench planes. To these standard planes may be added a panel, plough, and right and left rebate planes. Other planes, such as hollows and rounds, match and moulding planes, are usually shop tools, to be used in common.

For chisels an outfit should consist of a set of firmer-chisels, from $\frac{1}{8}$ th to 2 in.; two long firmer-chisels for paring, $1\frac{1}{4}$ and $1\frac{3}{4}$ in.; two socket chisels for heavy work, $\frac{3}{4}$ and $1\frac{1}{2}$ in.; bench gouges, from $\frac{1}{2}$ to 2 in.; and a 1-in. blunt scraping chisel. All should be in order, handled, and kept in racks at the back of the bench, within easy reach. For saws there will be needed one rip and one cross-cut hand saw, one panel saw, one each 12 and 8 inch back saws, with others of a special character, such as a ramp saw, bow saw, and dovetail saw.

Planes, chisels, and saws, are the main tools in bench work, and should be of the best quality.

For the convenience of apprentices who desire to select a set of tools, the following list is appended; it may contain many more than are needed, but will be none the less useful for reference;—

Planes, as before.	One 24-inch single fold slide-rule.
Chisels and gouges, as before.	Oil-stone, slip, and oil-can.
Hand, back, and other saws, as before.	One pair 4-inch spring dividers.
3, 5, and 7 inch try-squares.	One pair 8-inch steel compasses.
One carpenter's steel square.	One wooden brace, with full set of bits.
Bench and tack hammers.	One set auger-bits, from $\frac{1}{4}$ to 1 inch.
One wood mallet.	
One 5-inch hand-axe.	Two spoke-shaves, 2 $\frac{1}{2}$ and 3 inch.

To these may be added a number of little things which, although hardly to be included in a list of bench tools, will often be wanted, such as a chalk-line and spool, bench brush, strap block, sand-paper block, wood straight-edges, plumb-line, spirit level, or bench hooks, which can be supplied as needed, but should be owned by the workman, and kept at the bench, each in its proper place.

When a man learns bench work, he should do so thoroughly. He should study and observe the various modes of performing work which he sees around him, and estimate their advantages. The fact that bench work is mainly done by the piece in wood shops would be, as one would think, a sufficient incentive for workmen to study it carefully, with a view to increase their earnings, but strange to say the facts do not permit such a conclusion.

Twenty-five cents a day saved or made by having a good bench and a complete set of tools, amount to 75 dollars a year, almost enough to pay for an outfit of tools, to say nothing of the greater satisfaction with which the work can be executed.

In using bench planes it is a good plan to learn to

plane with one hand as much as possible, especially with jack planes.

To keep both hands on a plane makes one of two things necessary, either to walk along and carry the body with the plane at each stroke; or else to plane by short strokes, making a kind of chipping operation. A man can stand in one position and plane the length of a piece 4 feet long, with one hand, and propel the plane with just as much force, and when he has learned it, with more force than if he used both hands. If a brace pin is used in the side of the bench, he can, in roughing out with a jack plane, do twice as much in a given time as he could by grasping the plane in both hands and moving his body with it. Granting this proposition, which will be fully proved by an experiment and following it until learned, is it not strange that we rarely see planes used in one hand?

Another thing connected with dressing up stuff which may save time and labour, is the use of the try square. Supposing that a piece is being jointed or squared in the vice, the custom in trying is to remove the plane, put the square on the piece with the blade on the top, and then stoop down to look under the blade, generally low enough to bring the eye level with the piece. This can be done with half the trouble and with more accuracy by placing the head of the square on the top of the piece, as in Fig. 65, and looking down along the blade at the side.

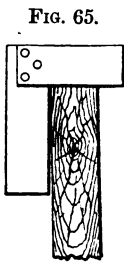

To do this the plane need not be removed from the piece, the body is kept erect, and in the case of a thin board instead of having but its thickness to gauge from, there is the whole length of the square blade to be sighted. At first it will seem awkward to use a square in this manner,

and difficult to have it balance on the top of the stuff, but after a little practice it becomes natural and easy, even on the thinnest pieces, and it would be equally awkward to return to the old method.

These two examples are cited as preliminary to saying that very old practice may be capable of improvement. In fact the tendency is to move in a particular groove, to hold to old habits, and the tenacity with which they are retained is generally as the length of time they have been practised; so strong has this influence been in opposing improvement and progress that we are justified in accepting any old custom with a certain degree of distrust, not of its being wrong in the main, for anything long practised by intelligent people is generally right, but this statement must be qualified by adding, so far as it goes. The very confidence that causes us to cling to old usages is but a recognition of the truth of the proposition.

In America this conservatism is but weak compared to older countries, and in this fact is found one of the strongest reasons for the progress made in improving hand manipulation and industry of all kinds. Rapid changes may sometimes lead to errors which a greater respect for old customs would have enabled us to avoid, but upon the whole the gain is vastly greater than the loss.

It is therefore contended that because bench practice in wood work is old, it is no reason why it cannot be improved, especially as it has been greatly modified and changed by the introduction of machinery.

THE END.

INDEX.

- ACCIDENTS**, causes of, 69.
— from winding clothing, 77.
— from flying cutters, 79.
— from set screws, 77.
— from saws, 71.
— from winding belts, 75.
— from wood machines, 69.
— in sawing, to guard against, 71.
— precautions against, 78.
Arrangement of machines, 4.
— of shafting, diagram of, 21.
- BAND saw blades**, 121, 122.
— saw blades, joining, 122, 123.
— saws, brazing forge for, 124.
— saws, edge strain of, 124, 125.
— saws, for recutting, 127.
— saws, for resawing, the construction of, 127.
— saws, on the use of, 121.
— saws, the width of, 125.
— saws, the teeth of, 125.
— saws, the speed of, 125, 126.
- Bearings**, brass, 92.
— how to fit, 90.
— how to examine, 97.
— metal for, 91.
— moulded, 87.
— to melt the metal for, 89.
— to mould, 88.
— the cause of heating, 97.
— the care of, 96.
- Belt joints**, diagrams of, 84.
Belts for wood machines, proportions of, 32.
— for cutters, width of, 57.
— hook joints for, 84.
— how to throw on, 76.
— injury by rubbing, 59.
— main, material for, 33.
— of leather and india-rubber, 38.
— of webbing for high speeds, 36.
— plans of joining, 33.
— round and flat, 36.
— single and double, 86.
— tractile power of, 32.
- Belts**, treatment of, 36.
— tension of, 35.
— to make run true, 59.
— danger of throwing on, 76.
— weight of, 35.
Belting for wood machinery, 32.
Benches for wood work, 178.
— for cabinet work, 180.
— for pattern making, 180.
— tool racks for, 179.
Bench tools for wood work, 181.
— tools, a list of, 182.
Bench work, 177.
— work, how to save, 183, 184.
- Boilers for wood manufactories**, 13.
— manner of covering, 16.
- Boring bits**, speed of, 54.
- CEILINGS**, flush, convenience of, 10.
- Circular saws**, danger from, 71.
— gauges for, 73.
— pieces thrown from, 72.
— rigidity of, 55.
— speed of, 55.
- Clearing wood shops**, 42.
- Countershaft**, diagram of, 27.
- Countershafts**, bearings for, 30.
— erecting, 25.
— hanger-plates for, 26.
— laying out the position of, 28.
— speed of, 54.
— to set parallel, 29.
- Couplings for shafting**, 23.
- Cutter-bolts**, overstraining, 80.
— material for, 80.
- Cutter-heads**, diagrams of, 103, 104.
- Cutters**, angle of, for hard wood, 103.
— bevels for, 108.
— bolts for, 79.
— of scraping machines, 106.
— of solid steel, 147.
— of thin steel, 110, 111.
— the angle of, 101.
— the bevel of, 105.
- Cutting parallel to and across the fibre**, 99.

- Cutting, propositions relating to, 100.
 — saws, as an example of, 99.
 — wood, the principle of, 98.
- DAMPER regulators, steam, 17.
 Difficulties of text-books, v.
 Division of labour in Europe, iv.
- EFFECT of machines on labour, v.
- FACTORIES, general arrangement of, 2.
 Feeding furnaces, manner of, 18.
 Fire, precautions against, 49.
 — rooms, arrangement of, 18.
 — sources of, 49.
 — to guard against, 50.
 Firing, irregularity of, 14.
 — the manner of, 17.
 Floors, supports for, 11.
 — sheathing for, 10.
 — with beams and joists, 10.
 Furnace, cross section of, 17.
 — elevation of, 16.
 — longitudinal section of, 15.
 Furnaces for wood factories, 15.
 — general dimensions for, 16.
- GAUGE lathes, character of, 164.
 Girders for wood factories, 8.
 — supports for, 9.
 Grinding cutters, the object of, 111.
 — hard stones for, 108.
 Grindstones, arrangement of, 112.
 — for cutters, 108.
- HANDBOOKS, how prepared, viii.
 Hand-feeding machines, 143, 144.
 Hand labour supplanted by machines, iii.
 Handling material, 37.
 Hanger-plates, mode of fastening, 27.
 Hangers for line shafts, 23.
 — strength of, 30.
 Hard wood, speed of cutting, 56.
 Height of factories, affected by the floor framing, 8.
 Hoisting machinery, 40.
 — machines, danger of, 41.
 Hook-belt joints, manner of making, 34.
- JOBBER mill, arrangement of, 3.
 — diagram of, 3.
 Joiners' stuff, mill for, 6.
- LATHES, excentric, cost of turning by, 167.
 — excentric, 165.
 — excentric, the arrangement of, 165.
 — for gauge turning, 163.
 — for rod turning, 167.
 — shears for, 161.
 — the construction of, 159, 160.
 — tools for, 161.
 — with finishing cutters, 163.
 — with rotary tools, 164.
 Lime feed water for boilers, 13.
 Line shafting, arrangement of, 4.
 Lubricating compounds, 97.
 — tallow, cups for, 95.
 — wood machines, 92.
 Lumber from round timber, 174, 175.
 — machine, dimensions of, 176.
 — machine to prepare, 176.
 — supplying, 174.
 — to procure, 175.
- MACHINE lines in buildings, 31.
 — lines, manner of making, 31.
 — operating as a trade, iv.
 Machines, foundations for, 32.
 — how manufactured, 171.
 — levelling and fixing, 32.
 — purchasing, 171.
 — resistance of in starting, 20, 60.
 — setting, 30.
 — stopping and starting, 60.
 Magazines for shavings, 45.
 Main driving pulleys, diameter of, 54.
 Material, moving, means of, 41.
 — room for moving, 37.
 — trucks for moving, 37.
 Measurements, by succession, 31.
 Mortising, 149.
 — bits, chuck for, 154.
 — chisels, to prepare, 155.
 — machines for joiner work, 151.
 — machines, reciprocating, 149, 150.
 — machines, rotary, 150, 151.

- Mortising machines, rotary, for chair work, 153.
 — plans for compared, 151, 152.
- OIL, means of applying, 94.
 — feeders, wicks for, 95.
 — paraffine, 93.
 — waste of, 93.
- On hand-feeding, 143.
- PATENTS, 168.
 — as capital, 170.
 — on thin cutters, 111.
 — the scope of, 169.
 — value of, 169.
- Planers, carriage, 131.
 Planer carriages, objects of, 131.
 — for surfacing, 136.
 — parallel, 134.
 — parallel, the principles of, 134, 135.
 — scraping, 137.
 — traversing, 132.
 — used in Europe, 134.
 — with chain feed, 136.
- Planing and jobbing mill, difference between, 5.
 — cylinders, speed of, 54.
 — machines, classification of, 130.
 — machines, starting, 136.
 — mill, arrangement of, 7.
 — mill, diagram of, 6.
 — mill, general dimensions for details, 6.
 — the amount of edge used in, 132.
 — the speed of, 133.
 — to increase the speed of, 132, 133.
- Pneumatic apparatus, danger of fire from, 48.
 — conductors for wood shops, 43.
 — fans, construction of, 43.
 — fans, diagrams of, 44.
 — pipes for sweepings, 47.
 — pipes, hoods for, 45.
 — pipes, material for, 45.
- Polishing, as a process, 138.
 — Barker's machine for, 139.
 — machine, drawings for, 142.
 — wheels, how to construct, 139.
- Posts, position of, 4.
- Power for grinding, and other details, 58.
 — needed for American wood machines, 57.
 — required, table for, 58.
 — to drive machines, 56.
 — value of, 59.
 — waste of, 59.
- Processes, nature of, in wood work, 1.
- Pulleys, arrangement of, on line shafts, 75.
 — balancing, 22.
 — for line shafting, 22.
 — loose, fit of, 62.
 — loose, means of oiling, 64.
 — loose, oil ways for, 63.
 — loose, packing for, 63.
 — shifting, 61.
 — shifting, arrangement of, 64.
 — shifting, with idle shaft, 61.
- QUALIFICATIONS of an operator, v.
- REPAIRING, an economical plan for, 82.
 — instructions for, 85.
 — outfit for, 81.
 — room for, 84.
 — the difficulty of understanding, 83.
 — tools for, 81.
 — wood machinery, 80.
 Repairs, cost of, 80.
- SAW benches, arrangement of, 114.
 — benches, for jointing, 114.
 — mandrils, dimensions for, 116.
 — mandrils, manner of fitting, 117.
- Saws, circular, 113.
 — circular, guides for, 114.
 — counter-balances for, 128.
 — cross-cutting carriages for, 120.
 — for cross-cutting, 120.
 — form of teeth for, 117.
 — for recutting, 128.
 — for scroll cutting, 128.
 — gauges for, 114.
 — guides, drawings of, 115.
 — how to set, 117.
 — jig, to set up, 128.
 — jig, foundations for, 128.
 — jig, men to operate, 129.
 — on the use of, 119.

- Saws, packing for, 115.**
 — reciprocating, 128.
 — scroll, sharpening, 130.
 — scroll, the teeth of, 129.
 — setting machine for, 118.
Shafting, advantages of several cross lines, 22.
 — arrangement of, 20.
 — dimensions for, 21.
 — for wood shops, 19.
 — how to level, 23.
 — imperfection of, 19.
 — severe duty of, in wood shops, 20.
 — to line horizontally, 24.
Shaping cutters, how to prepare, 147.
 — deep cutters for, 148.
 — hand feed for, 142.
 — machines, cutters for, 75.
 — machines, danger of, 73.
 — machines, guards for, 73.
 — machines, holding clamp for, 74.
 — machines, origin of, 146.
 — machines, speed of, 148.
 — machines with two spindles, 145.
 — spindles, bearings of, 149.
 — the meaning of, 142.
Sharpening tools, 106.
 — moulding cutters, 109.
 — emery wheels for, 106-109.
 — planing knives, device for, 107.
 — tools for, 112.
 — bench tools for, 112.
Shavings magazine, diagram of, 46.
Shifters for belts, 65.
 — for belts, arrangement of, 65.
Shops, system in, 113.
Speed of line shafting, 54.
 — of reciprocating machines, 55.
 — of cutting edges, 52.
 — diversity of opinions of, 51.
 — rules for, 52.
 — tables for, 53.
 — of wood machines, 51.
Starting machines, shock of, 68.
Steam engines, details of, 13.
 — requirements of, 12.
 — power for wood factories, 11.
TEMPERING tools, 87.
Tenoning, 156.
 — machines, old and new, 156.
 — machines, the carriages of, 157.
Tension pulleys, 66.
 — pulleys, advantages of, 67.
 — pulleys, construction of, 68.
 — pulleys, diagrams of, 68.
Text-books for wood-machine operators, ix.
 — how far useful, vii.
 — the reason they are wanting, vii.
 — their importance, v.
Tools, taking care of, 112.
Tramways for wood shops, 41, 42.
Trucks, advantages of, 40.
 — construction of, 38.
 — details of, and dimensions for, 39.
 — diagrams for, 38.
Try square, how to use, 184.
Turned work, to polish, 162.
Turning, 158.
Turning, gauge tool for, 167.
 — hand lathes for, 159.
 — the importance of, 158.
UNIVERSAL machines, 144, 145.
WATER pipes, freezing of, 18.
Wood-dust, inflammable nature of, 48.
Wood machines, analogy between, vii.
 — machines, danger from, 70.
 — machines, how improved, 146.
 — machines, improvements in, 146.
 — work, divisions of, 1.
 — work has no text-books, vi.
 — in America, extent of, vi.

Just Published, in crown 4to, cloth, gilt, \$6 or 25s.

A TREATISE
ON
THE CONSTRUCTION AND OPERATION
OF
WOOD-WORKING MACHINES:

CONTAINING

A HISTORY OF THE ORIGIN AND PROGRESS OF THE
MANUFACTURE OF WOOD-CUTTING MACHINERY
SINCE THE YEAR 1790.

Illustrated by numerous Plates and Engravings,

SHOWING

THE MODERN PRACTICE OF PROMINENT ENGINEERS IN
ENGLAND, FRANCE, AND AMERICA.

BY J. RICHARDS,

MECHANICAL ENGINEER.

NEW YORK:

E. & F. N. SPON, 446, BROOME STREET.

LONDON:

48, CHARING CROSS.

The attention of Engineers, Builders, and Wood Manufacturers, is called to this work as one that cannot fail to be of advantage in their business.

Although wood conversion is an extended and impor-

tant interest, both in Home and Foreign manufactures, and although immediately connected with general engineering matters, such as ship-building, bridge-building, and railway equipment, it has thus far remained without such text-books as have contributed so much to the development of other branches of industry.

The application of machinery to wood conversion is the subject of special interest at this time, because of the increased cost of skilled labour, a condition that must be mainly met by a more thorough and extended application of machines in the various branches of wood work.

The Treatise is directed to this object, and contains explanations of the principles that govern wood-cutting, with full instructions as to the best manner of constructing and operating wood-working machines, their care and management, with other useful information that cannot fail to be worth many times the cost of the book to those engaged or connected with wood manufacture, the equipment of railways, or supplying engineering plant.

The work includes an interesting history of the leading facts connected with the origin and progress of machines for wood conversion in Europe and America; with dissertations on the various operations of sawing, planing, shaping, boring and turning wood, based upon the experience of a practical engineer who has for twenty years been engaged in designing, constructing, and operating standard and special machines for wood manufacture.

It contains twenty-five folding plates, and nearly one hundred full-page illustrations of English, French, and American Wood-working Machines in modern use, selected from the designs of prominent engineers. The engravings are finely executed, consisting mainly of true elevations.

Extracts from Notices of the Work by leading Scientific Journals.

“With the exception of a very few imperfect articles in encyclopædias, two or three papers read before scientific societies, and the description of special machines contained in patent specifications and in the pages of technical journals, such as our own, the subject has been left untouched; and until the appearance of the book now before us, there was, so far as we are aware, none that could be referred to for information as to how wood machines should be constructed and managed. Under these circumstances, Mr. RICHARDS' Treatise is doubly welcome; it is welcome in the first place, because it supplies a want, and in the next place because it supplies it well. . . . Mr. RICHARDS devotes two sections of his work to a consideration of wood-working machinery generally, and to an explanation of the principles that govern wood-cutting; these explanations being accompanied by data concerning hand-power operations and the performance of the same work by machines. . . . It contains information that will be appreciated by a large circle of readers besides those specially interested in the construction of wood-working machinery.”—*Engineering*, Nov. 8, 1872.

“One of the few technical works of originality and merit that have recently appeared. The plan adopted by the author is to notice in a general way the leading operations of wood conversion, with the construction and operation of machines in modern use; introducing such rules and treating of such laws as have been fixed by practice and experience, and have come within the knowledge of the writer within an extended experience in designing and constructing both standard and special machines for wood work. . . . The illustrations form an important feature of the work. . . . The descriptive letter-press and the vast amount of information about the various kinds of wood work will make this work indispensable to all who are either makers or users of wood-working machines.”—*Mechanic's Magazine*, Nov. 16, 1872.

“It is a full and intelligent account from the pen of a practical engineer, of the construction and operation of these useful implements, which are every day becoming more of necessity

where there is a strain on the ordinary powers of production. A closing word is due to the illustrations, which are as copious as they are well executed."—*British Trade Journal*, Nov. 1, 1872.

"Its publication supplies a want, and the execution of the work is for the most part all that could be desired. The author has his subject well in hand, and his practical experience is well seconded by his literary ability. The book is carefully printed, and the illustrations well engraved."—*Building News*, Nov. 15, 1872.

"If Mr. RICHARDS' work were one of many on the same subject, it would possess an intrinsic value as an exposition of the opinions of a man practically engaged in the construction of the machines of which he treats; as it is the only work of the kind yet published, it cannot fail to be of very great interest to those engaged in similar pursuits, and to those who employ and superintend the operation of wood-working machines. . . . The work contains one hundred and sixteen excellent engravings, which are mainly shaded elevations."—*English Mechanic and World of Science*, Dec. 13, 1872.

"Mr. RICHARDS has written on a subject with which he has a thoroughly practical acquaintance, and he has succeeded in producing a treatise which should certainly be in the hands of all users of wood-working machinery, and which, moreover, will be of much interest to engineers generally. In conclusion we should state that the work is illustrated by no less than one hundred and seventeen well-engraved plates, showing examples of every class of wood-working machinery by the leading makers in this country, in America, and on the Continent, while it is admirably printed, and its general get-up reflects credit on all concerned in its production."—*Engineering*, Dec. 20, 1872. *Second notice.*

"The work contains all the information which those who are particularly interested in wood-working machines are likely to require. . . . If it had not been for pressure on our space, we had intended to give a detailed account of the book; but no abstract would do justice to the valuable information which Mr. RICHARDS furnishes. . . . All builders who possess machinery of this kind, or who intend to purchase some, ought to study attentively this book."—*The Architect*, Dec. 28, 1872.

LIST OF SUBJECTS TREATED OF.



History of Wood-working Machines since 1790.
 Engineering Progress in Machine Construction.
 Invention as an Element in Engineering.
 The Past and the Future of Machine making.
 On Wood-cutting Machines in general.
 The Relation between Hand and Power Operations in Woodwork and
 the Principles that govern them.
 American and English Wood Machines.
 French Wood Machines.
 Machine Labour-saving.
 Combination in Wood Machines.
 Framing of Machines.
 Patterns for Castings.
 Bearings for Shafts and Spindles.
 Sizes, Proportions, and manner of Constructing.
 Shafting for Wood Manufactures.
 Rotary Balancing.
 Resawing Machinery.
 Band Saws and Band Sawing.
 Band Sawing Machinery.
 Jig Saws.
 Slitting and Cross-cut Saws.
 Cutting and Cutters.
 Planing Machinery.
 Mortising Machinery.
 Turning Machinery.
 Shaping Machinery.
 Boring Machinery.
 Dovetailing Machinery.
 Cutting Machines with Direct Action.
 Pneumatic Conductors for Clearing Wood Shops.
 Belt Contact and other matters connected with High Speeds.
 Machine Operating.

