

KING'S SERIES IN WOODWORK AND CARPENTRY

HANDBOOK

IN

WOODWORK AND CARPENTRY

FOR TEACHERS AND NORMAL SCHOOLS

BY

CHARLES A. KING

DIRECTOR OF MANUAL TRAINING

EASTERN HIGH SCHOOL, BAY CITY, MICHIGAN



NEW YORK ·· CINCINNATI ·· CHICAGO
AMERICAN BOOK COMPANY

KING'S SERIES IN WOODWORK AND CARPENTRY

ELEMENTS OF WOODWORK

ELEMENTS OF CONSTRUCTION

CONSTRUCTIVE CARPENTRY

INSIDE FINISHING

HANDBOOK FOR TEACHERS

**COPYRIGHT, 1911, BY
CHARLES A. KING.**

ENTERED AT STATIONERS' HALL, LONDON.

W. P. I

PREFACE TO THE SERIES

THIS series consists of five volumes, four of which are intended as textbooks for pupils in manual-training, industrial, trade, technical, or normal schools. The fifth book of the series, the "Handbook in Woodwork and Carpentry," is for the use of teachers and of normal students who expect to teach the subjects treated in the other four volumes.

Of the pupils' volumes, the first two, "Elements of Woodwork" and "Elements of Construction," are adapted to the needs of students in manual-training schools, or in any institution in which elementary woodwork is taught, whether as purely educational handwork, or as preparatory to a high, or trade, school course in carpentry or vocational training.

The volumes "Constructive Carpentry" and "Inside Finishing" are planned with special reference to the students of technical, industrial, or trade schools, who have passed through the work of the first two volumes, or their equivalent. The subjects treated are those which will be of greatest value to both the prospective and the finished workman.

For the many teachers who are obliged to follow a required course, but who are allowed to introduce supplementary or optional models under certain conditions, and for others who have more liberty and are able to make such changes as they see fit, this series will be found perfectly adaptable, regardless of the grades taught. To accomplish this, the material has been arranged by topics, which may be used by the teacher irrespective of the sequence, as each topic has to the greatest extent possible been treated independently.

The author is indebted to Dr. George A. Hubbell, Ph.D., now President of the Lincoln Memorial University, for encouragement and advice in preparing for and planning the series, and to George R. Swain, Principal of the Eastern High School of Bay City, Michigan, for valuable aid in revising the manuscript.

Acknowledgment is due various educational and trade periodicals, and the publications of the United States Departments of Education and of Forestry, for the helpful suggestions that the author has gleaned from their pages.

CHARLES A. KING.

BAY CITY, MICHIGAN.

PREFACE TO HANDBOOK FOR TEACHERS AND NORMAL SCHOOLS

THE matter contained in this volume is arranged with special reference to its value to the teacher of manual training, woodwork, or carpentry, and to the normal student preparing to teach these subjects. To the latter, it offers many suggestions for the discussion of equipment and courses, and of conditions that exist in the classroom. It gives also a preview of some of the obstacles met in leading pupils in the way of manual righteousness, and suggests methods of surmounting these obstacles.

The contents of Chapters I and II, although separated into manual training and carpentry, may be applied to the teaching of either subject or both. A few items mentioned in Chapter II, however, may be omitted in teaching a class in educational manual training, as they apply entirely to carpentry or joinery. It would be unwise, for example, to spend time upon the steel square, estimating, or extended practice in sawfiling, as these are subjects for the prospective workman.

While the Suggestive Courses are courses in woodwork, the hints and discussions may be easily adapted to the teaching of any branch of handwork, since classroom conditions vary no more in the different branches of manual training than in the different branches of academic studies.

The sketches of models are intended to be only suggestive as to dimensions and degree of difficulty, leaving it to the student to work out details and to make any changes that his taste may dictate.

In the courses are included some of the standard models which have been in use in manual-training schools for years, but many of the models have been designed and worked out in the classroom in preparation for this particular work.



TABLE OF CONTENTS

	PAGE
CHAPTER I. TEACHING HINTS: MANUAL TRAINING. — Exercises in the joints; Value of large models; Sequence of tools; New tools; Importance of the model; Individual work; Selection of models; Working drawings; Stock cutting	1
CHAPTER II. TEACHING HINTS: CARPENTRY AND JOINERY. — Relation of Chapters I and II; Theory; Joints and exercises; Construction; The blackboard; Treatment of facts; Written exercises; Position; Shingling; Arithmetic; The steel square; Advanced class; Use of tools; Tendencies to be guarded against; Smoothing and sandpapering; Sawfiling; Gluing; Estimating	10
CHAPTER III. EQUIPMENT AND SUPPLIES. — The equipment; Economical equipment; Comparison of tools; Care of equipment; Supplies; Lists of equipment	21
CHAPTER IV. SUGGESTIVE COURSES. — Grading of exercises; Time necessary for completion; Use of outlined courses; Research and written exercises; Tests and examinations; References to other volumes; Suggestive courses in manual training; Suggestive trade courses in carpentry	40
CHAPTER V. SPECIAL TEACHING HINTS AND SUGGESTIVE DESIGNS. — New subjects; Stock cutting; Making the model; Tendencies to be corrected; Suggestive designs:—	
1. Plant label	11. Rule
2. Key tag	12. Plant stand. — Octagonal
3. Wedge	13. Tool rack
4. Flower stick	14. Bench hook
5. Sandpaper block	15. Cutting board
6. Pencil sharpener	16. Sand shovel
7. Silk winder	17. Dish drainer
8. Fishline winder	18. Coat hanger
9. Hatrack	19. Key rack
10. Table mat	20. Blotting pad

	PAGE
21. Bracket shelf	
22. Pen tray	
23. Plant stand — Halved	
24. Bird house	
25. Glove box	
26. Rod towel rack	
27. Corner shelf	
28. Wall pocket	
29. Sleeve board	
30. Cart	
31. Towel roller	
32. Knife box	
33. Paper knife	
34. Picture frame	
35. Folding towel rack	
36. Letter box	
37. Foot rest	
38. Toilet case	
39. Drawing board	
40. T square	
41. Dovetailed bookrack	
42. Plate rack	
43. Screen frame	
44. Bookcase	
45. Table	
46. Detail of table	56
CHAPTER VI. ANSWERS TO ARITHMETIC QUESTIONS IN "ELEMENTS OF	
CONSTRUCTION" AND IN "INSIDE FINISHING"	
	120
INDEX	127

HANDBOOK FOR TEACHERS IN WOODWORK AND CARPENTRY

CHAPTER I

TEACHING HINTS. — MANUAL TRAINING

Exercises in the joints. — Students in the sixth, seventh, eighth, and ninth grades of manual-training work do not need to follow the exercises in the joints given in "Elements of Construction" so closely as does the student of carpentry. The manual-training student should, however, learn the principles of construction of the joints, together with something of their application and use, and the reasons why one particular type of joint is better adapted to certain uses than are others. He should also master the tool processes required in making a model containing the form of construction illustrated by an exercise, before he undertakes to make the model itself.

This method is far better than to allow a student to destroy what would be a valuable model, or to finish it by means of less accurate work than the exercises in the involved joints would make possible. As he gains skill, the student will of course be able to dispense more and more with this preliminary work.

In many schools, the students make models of increasing difficulty, but much of the work so done is of little value except as an exercise. In some instances, the model

may be named and may be a useful article, but often it requires quite a stretch of imagination to believe that the time spent upon some particular piece of carefully finished work has been spent in the best possible way. The author is convinced by his own work among the students of the above grades, that the time spent in drill and in making a few *simple* exercises is better invested, provided a definite result is accomplished, the application of which is apparent in making a practicable piece of construction.

Value of large models. — Work upon large models not only interests students more than does work upon small ones, but promotes concentration, a more thoughtful study of details, and care in the use of tools. Judgment also may be developed better by working upon large models than upon many of those used commonly in the grades; this work requires, however, more oversight and a broader knowledge upon the part of the teacher.

Sequence of tools. — Why any one sequence of tools or exercises should be strenuously insisted upon, the author has never been able to discover. There is bound to be a certain amount of awkwardness in beginning to use any new type of tool, which is overcome as the student gains experience and confidence in himself in the use of tools in general. There is no occult reason, for instance, why the use of the *jack plane* should precede that of the *bitbrace*, or *vice versa*, since the beginning and learning processes have to be passed through in either case, and neither depends upon the other.

The amount of skill necessary to use the *jack plane* well is unquestionably greater than that necessary to do as good work in boring a hole, but as a rule the *jack plane*

is one of the first tools used. This sequence is as it should be, because the jack plane ordinarily will be used more than the bitbrace; this is not, however, a psychological reason, but one depending solely upon the exigencies of the work. If "logical sequence" were followed, the bitbrace should be used first; but this would require that a series of abstract models be made, and in general the devotees of logical sequence are radical upon the question of making anything that cannot be given a name, whether or not it will ever be used.

The *block plane* is one of the hardest tools to use effectively, but in the courses in which sequence is considered of so much importance, it comes, like the jack plane, quite near the beginning of the work, — and for the same reason, that the work requires it; if logical sequence were carried out, both these tools should come after the bitbrace, the hammer, and a number of other tools that are easier to use than are the planes. The block plane causes more trouble than do most other tools, because of the splitting off of the corners when planing across end wood. This difficulty is overcome by some teachers by block-planing in a bench hook, which acts as a jack board or shooting board, by which the splitting off of chips is prevented and the work planed square at the same time, regardless of the amount of skill possessed by the student.

Although this process is entirely mechanical, many teachers who apply methods of this sort at every opportunity wax enthusiastic over the advantages of the possession of skill, and the beauties of making the hand perform the desires of the brain.

The writer is satisfied that more is gained by teaching the most direct methods of obtaining results, than by teaching

those that make unnecessary labor simply for the sake of practice, which seems the only reason for the existence of certain methods followed by some teachers. The student will learn *incidentally* to use tools in all necessary ways and under all conditions, the important considerations being that he should (1) comprehend the importance of accuracy, (2) acquire the ability to control the tool, and (3) understand the principle upon which it operates. These in general may be as well taught while using the tool in one way as in another; after the student has attained a reasonable degree of proficiency, the tool may be used for any purpose within its scope.

Some of the school methods of using tools and of obtaining results are not, unfortunately, those employed by mechanics, who by their years of experience learn to use tools intuitively and in the easiest and most effective manner. To this statement, teachers who believe that there is some occult principle involved in the particular methods and sequence in the use of tools that they practice, and in the course of models that they follow, will probably find objection, but the writer contends that there is nothing educational in teaching a method that is wrong, — and some methods taught will certainly not stand comparison with those of mechanics in grace and ease of motion, efficiency, or speed. The best results may not be obtained at first, but in a short time, if correct methods of work are instilled into the pupils from the beginning, there will be better progress.

New tools. — If, in the course of making a new model, a new tool is to be used, or a new process performed, it should be made the occasion of practice before being applied to the model in hand. The size and the combina-

tion of constructive elements should be the basis of the progression, rather than the inventing of models that demand the use of tools in a certain sequence. After the student has learned to use the commonest tools well, he will have little trouble with the tools that are used only occasionally.

Importance of the model. — This must not be construed as meaning that the model is the important thing. It is of little importance, except as it may indicate the care, thought, and progress of the student who performs the work. The model should be considered by the teacher simply *as the means of interesting the pupil*, and of giving him an incentive to perform the processes that involve the use of certain tools. The student, however, looks upon the model as the chief end of the work, — a conception, which, unfortunately, seems prevalent among nearly all those also who are not directly connected with school work, despite all that has been written and said upon the end and aim of manual training since its inception.

Individual work. — It is not the plan of "Elements of Woodwork" to lay out a course or a series of models for the use of students from their earliest ventures into manual training, as no course can be planned which is the best for all students. A student with natural aptitude for tool work will complete easily a model that another of the same class may not be able to make at all; thus the naturally skillful student loses the opportunity for advancement and development.

Many teachers have not the inclination, and others have not the technical knowledge, to do well the individual work that is necessary if each student's work is planned so that he can work to the best advantage. To do indi-

vidual work so that each student may receive the best results, even though the student is naturally "handy" and likes to work with tools, requires that the teacher shall have a broader knowledge than can be acquired by a short course at a teachers' training school. The instruction of a poorly prepared teacher, if he departs from the course with which he is familiar, results almost invariably in work which is not built upon correct principles of construction. It is not reasonable to expect, as a rule, that a teacher can secure from his class better work than he can do himself; thus the results are false ideas of construction and poor and inaccurate methods.

Again, in many schools where the teachers realize their dependence upon one particular series of models, there is an ironbound course through which all students are required to go, model after model, in the same sequence, regardless of the different degrees of natural ability that must exist. In consequence, the development of the individual student's natural abilities is but little assisted, and the opportunity of promoting his originality and initiative is too often ignored entirely. This statement may seem severe in its reflections upon some teachers, and it is so, intentionally; but it applies only to those who are deliberately managing their classes to make their work easier, regardless of the effect upon their students, and who could do better if they chose to take the trouble, and to those who, with a slight smattering of knowledge, try to teach manual training because positions in this work are obtained with less difficulty, and often are better paid, than are those in the ordinary branches of academic work. The statement does *not* apply, however, to teachers who are in the employ of a school board whose only ideal of

manual training is that the students shall make something that will please the eye of the board, and of the occasional visitor, in order to prove that their school system is up to date, and who require the teacher to handle with a meager equipment, and in rooms poorly lighted and ventilated, a class so large that it is impossible to conduct it properly. The teacher of manual training who has to work under these conditions is obliged to follow a more or less rigid course, since the students must be handled as a whole to the greatest extent possible.

To do acceptable individual work in the grades, a teacher should not have more than twenty in one class; in high schools, and in technical and industrial schools, where the students are older and, in most cases, have had elementary work, the classes may be larger, a competent teacher being able to handle as many as thirty with satisfactory results. In a large class students may be divided into squads, each of which works upon a model suited to its ability, thereby making it possible to do more nearly individual work. In order to arrange the squads to best advantage, time, judgment, and a thorough knowledge of each pupil's capacity is, of course, necessary.

Selection of models. — A well-equipped manual-training room should have blueprints or drawings of a large number of different designs and models, suitable for the various grades taught, as a reserve upon which to call when the original ideas of the students are not forthcoming or are too elaborate to answer the purpose.

Many suggestions for models may be procured from published bulletins of various schools, and from stores dealing in supplies for manual-training schools, though much skill is necessary upon the part of the teacher to

obtain original ideas from the students, based upon the suggestions secured from these sources.

To assist in the development of original ideas, *the teacher should persuade the student to design continually*; not only for his own work, but to stimulate his creative faculties. The teacher should suggest only, aiding the student to keep within the bounds of difficulty, and always insisting upon the utmost simplicity of design and construction. The model the student selects should be one that he will feel is worthy of his best energies, but not so difficult that it cannot be made well, nor so intricate or large that he will become tired of it before its completion.

In the ability to advise in the selection of work for his pupils, and in discriminating between individuals, lie the most important qualifications of the manual-training teacher; and the most difficult part of this aspect of his work is selecting that which will bring out the various forms or shapes, and which will include the use of different tools to furnish change of exercise for the muscles in the several positions in which tools must be used. There should be frequent alternations of straight and curved lines, that the student may learn to know and to detect *true form* and the laws that govern it, and that he may receive such training of the eye as will enable him to detect any deviation from the desired form.

Working drawings. — Before beginning work upon a model, each student should make a working drawing of it, not only to familiarize himself with the details, but that he may receive a drill in making working drawings and working from them, which will be of great practical use to him, and that he may learn the value of drawing as a means of expression.

If the student originates a design, he may need help in putting all that is necessary upon paper, but if he is working from a model already made, he should be required to work with as little assistance as possible.

Stock cutting. — A stock list should be made out for every model, each student working from the plan that he has drawn. After the stock list has been made out, and passed upon by the teacher, the student should lay out the pieces as they are to be cut from the board, but the cutting should not begin until the teacher has approved of the method of getting out the pieces; otherwise much valuable material may be wasted.

Many teachers prepare the pieces from which the models are to be made, before the class meets. This method has economy to recommend it, both of material and of the time spent in cutting the stock in class, but with much of the work, these advantages will not compensate for the loss of the drill received by the student in planning the most economical way of cutting his own material.

CHAPTER II

TEACHING HINTS. — CARPENTRY AND JOINERY

It will be noticed that the third volume of the series, "Constructive Carpentry," deals with the working of rough lumber, or construction. It is a quite prevalent belief that because rough lumber is handled, the work must necessarily be rough, and therefore require little skill. On the contrary, the utmost skill, and the greatest knowledge, is required in the framing of a building, as a framer should understand all parts of a structure, and have knowledge of as many different kinds of work as possible.

Relation of Chapters I and II. — The subjects discussed in the previous chapter may be applied with equal force to the teaching of carpentry, since the future workman will pass over much the same ground in his elementary work as does the student of manual training.

Theory. — Every student in carpentry should be required to look up in the various books and periodicals to which he has access, the theoretical aspects of each topic outlined in the textbook. These books of reference should be listed by the teacher, who should familiarize himself with the matter in them and catalogue the parts that he needs, before assigning subjects to the students for study.

Joints and exercises. — In "Elements of Construction" the exercises in joints form an important part of the work

laid out for the student who intends to complete the course in carpentry, since they illustrate the different forms of construction. The teacher should see that each pupil acquires a thorough knowledge of the principles and the uses of each tool, and at intervals should assign a written exercise reviewing the work passed over.

It is not necessary that every student should work out every problem, but each member of the class should solve different ones according to his ability and needs. The construction and use of each tool should, however, be illustrated to the whole class, and its accompanying exercises explained in such a way that each student may be able to give an intelligent demonstration of the same. The joints and the use of the tools involved, should also be made the subjects of written exercises, the writing of which will aid the student in expressing himself intelligently.

Besides making the joints, one or more supplementary models should be made which will include as far as possible the principles of construction illustrated by the preceding exercises. As in the manual-training classes, the student should design his own supplementary models, assisted by the teacher.

If the teacher thinks it advisable, the exercises may be entirely dispensed with in the work of individuals who have a high degree of natural aptitude in the use of tools, and the supplementary work may be substituted. The extent to which this may be done depends much upon the teacher's judgment and tact, since the students generally do not enjoy the exercises so much as the work to which they lead, and unless the teacher feels that the reasons for this sort of discrimination are exceedingly well founded and apparent, a great difference should not be made. As the class in

carpentry in an industrial school consists often of students of a wide range of ages, the above difference in the work frequently may be carried out with profit to the individuals.

Construction. — At the proper place in the course, the students should build a *flight of stairs*, making them one quarter or one half size. This model flight should contain all the section posts, and the different sections should be constructed by various methods.

In teaching *the construction of a frame building*, a model should be built upon a small scale, as in stair building, several students working upon it. One as large as practicable may be built the first time, and the same material used by successive classes; the next house may be made somewhat smaller in its dimensions, if desired, but if the same material is used in different parts of the house, some of the longer pieces will have to be made new each time, and as there is always a demand for small pieces in a manual-training class, there will not be much waste. Another satisfactory method is to require each student to build a small house, using the scale of 3" to 1', which allows a 2" × 4" piece to be $\frac{1}{2}$ " × 1", and in measuring the lengths of pieces, the scale of 1" to 1'. This is also good practice for the student in working from one scale to another.

The house built should contain all the problems used in building a house with square angles, — a house with an ell or addition upon the side or back joined to the main house with a valley in the roof, and hips upon the corners of the main house, as described in Topic 53 E, "Constructive Carpentry," will contain the most essential framing problems that the carpenter has to solve.

The blackboard. — Abundance of blackboard space is an essential part of the equipment of a room in which

carpentry, and in fact any form of tool work, is taught; and it should be used freely in demonstrations by means of diagrams, since the students should become familiar with methods of sketching and with working from sketches, and also should acquire facility in explaining their own thoughts graphically, as this is an important part of the training of a workman.

Treatment of facts. — Facts in manual training, as in any other subject, should be impressed upon the student by comparisons, frequent reviews, tests, and examinations. Skill in the use of the *gauge*, *ripsaw*, *cutting-off saw*, and the *planes* should be acquired by continuous drill upon waste pieces of wood. After control of the planes has been gained, the student should be required to put his smoothing plane in order and to smooth a piece of hard, cross-grained wood to a surface, planing either way of the grain. This will impress upon him the fact that although a piece of wood may be ever so knurly or crossgrained, it is possible to plane it perfectly smooth, if the work is done skillfully.

The teacher should require the students to locate, upon buildings within easy reach of the school, different forms of construction, such as finish and details, and should explain these forms to the class by diagrams, making the exercise the basis of instruction upon various applications of the same principle.

As little as possible should be told the students; instead, by drawing out what they have previously learned, and by applying it, the teacher should make them find answers to their own questions.

Written exercises. — The course in carpentry should be so arranged that the written exercises may be required

at times which will not interfere seriously with similar duties of the students in other departments of the school, and at regular stated periods, in order that the student may plan for a definite amount of work to be done each week. The teacher should be careful not to load the students intermittently, as that has a bad effect upon all of their school work. Frequent short written exercises, submitted weekly, are better than long tedious essays, which the average student will slight to the greatest extent possible. The material included under the different topics will offer numerous suggestions for outside reading and research, which the teacher may require of the student.

Each student should have a notebook devoted entirely to carpentry, in which should be placed all notes, written exercises, and such information as may be gathered from discussions in the class room. Sketches of details of construction should be neatly drawn. These notebooks should be kept in the schoolroom, and frequently examined by the teacher and corrected by the pupils.

Position. — The teacher should insist upon each student's maintaining a proper position while at work at the bench, as bad habits acquired at this time are apt to be lasting, with the result that there are many round-shouldered or otherwise deformed workmen. The student should acquire the habit of bending from the hips instead of from the shoulders; this will assist in preserving an erect carriage, while if the other habit is acquired, he will be permanently round-shouldered and hollow-chested before middle age.

The majority of the students will sit down if there is the slightest excuse for so doing; the teacher should prevent this, as it is a great incentive to laziness and to careless

habits of work. Drawing and certain kinds of small work may sometimes be performed more advantageously in a sitting position, but aside from drawing there is little work in this series which the student can do as well while sitting.

Students generally are apt to assume awkward positions of the feet when first attempting bench work, but if the teacher sees to it that this habit is remedied, the student will in a short time naturally take the position in which he can work to the best advantage.

Shingling. — In teaching shingling, it is necessary to have a model roof upon which to work; this should include at least two hips, a valley, and a gable, in order to illustrate the different methods of shingling the various parts of a roof.

Arithmetic. — The questions in arithmetic should be divided into lessons of convenient length, and assigned to students at regular stated intervals; they should be so planned as not to conflict with their regular work in mathematics. In the solution of these problems, the shortest and most practical methods should be used, the student being allowed to use his own methods, provided they are sound and can be demonstrated, even though they may not be found in the textbook in use in the school.

In practical work the workman falls into short cuts of doing any arithmetic that may be necessary, though of course the methods he uses have to be sound in order to give correct results; it is to develop *facility in using figures in the most economical way*, therefore, that these questions in arithmetic are given.

The phraseology in stating the questions is that used by carpenters in speaking of their work; the explanatory

notes accompanying the questions and the glossary in "Constructive Carpentry" will be found of assistance.

If necessary, square and cube root may be taught from any good textbook; in fractions, however, the student should have had, before entering the work, sufficient instruction to give him a good working knowledge of this subject, the questions being intended simply to familiarize him with the daily problems of the carpenter. The use of tables of circumferences and areas of circles also should be taught, but as these are published in so many manufacturers' catalogues and in other easily accessible places, they are not made a part of this series. Formulas may be taught by the use of algebraic symbols, which are not at all difficult to master, as any student having the above-mentioned knowledge of arithmetic, and knowing how to work square root, can by a little application solve the formulas given in this book, and also those published in trade papers.

The steel square. — This part of the work requires the closest application and the most comprehensive knowledge of construction. A thorough drill in the use of the steel square should be given in the different problems, which will demand the construction of model roofs, working to the scale of 1" to 1', as previously described. Applying this method, a roof 18' × 30' would be 18" × 30" at the outside of the plate, which is a convenient size for this purpose.

There are other ways of obtaining pitches, angles, and lengths of rafters, easier in some instances than those taught in this series, and many carpenters have a rule for each separate pitch; but this is confusing to a class, therefore the formulas given in "Constructive Carpentry" are adaptable to roofs of all pitches and dimensions.

Advanced class. — The teacher of the advanced class should take his students to visit buildings in various stages of construction, and should repeat the visit periodically as the work progresses, requiring the students to hand in written exercises treating of the foundations, framing, finishing, painting, heating, etc. The pupils should notice also the progress of the building in a given time, the number of men employed, the peculiarities of construction or arrangement, and any feature which is out of the ordinary, or which is intended to adapt the building to some special purpose.

The class may all write upon the same subject, or each one may take a special part. When the papers are read before the class, encourage criticism and discussion.

Use of tools. — As soon as the class begins upon its first work, the use of each tool, its construction, and any new process or materials should be made the subject of a short talk and demonstration; this, in fact, should be the program when any new tool is used for the first time, using the topics in "Elements of Woodwork" or "Elements of Construction" as the basis of such an exercise. The teacher should also guide the pupils to further research upon the subject of tools. The methods of using and adjusting tools for different woods and for the various kinds of work should be discussed fully, each student being required to follow the teacher step by step with his own tools, as far as it is practicable to do so.

Tendencies to be guarded against. — The teacher will save himself much trouble, and insure better work upon the part of the class, if he insists upon the use of the knife in marking all places where a close fit is desired. Most students will use the pencil in places where only a knife

should be used; consequently, it is wise to take the pencils away from all the students when they are doing work which requires accuracy, as it is the most peaceable way to prevent their use. It takes time, and often involves as well the destruction of considerable work, before the class realizes that there is but one point which is accurate, and that the slightest deviation from that point results in poor work. The indiscriminate use of the pencil also should be prevented, or it will in many places cause a decided blemish. Many students will not hesitate to draw their pencils across the surface of a nicely smoothed and sandpapered piece of wood, but are surprised to discover that perhaps they may have to work half an hour to resmooth the wood and remove the results of the thoughtlessness of a second. The best way is to bar the use of the lead pencil as much as possible.

Another peculiar characteristic of students in general, is that they will not use a plane, if a rasp, sandpaper, spokeshave, or any other tool can be made to answer. The majority will at first prefer to work with a piece of sandpaper for half an hour, when a couple of minutes' work with a smoothing plane followed by sandpaper will accomplish the desired result in a much easier and more satisfactory manner. Therefore the teacher should watch to see that the plane is used and all necessary cutting done, and should inspect the work carefully, before the scraper or sandpaper is allowed to touch it, as the surface of a piece of wood filled with the grit from sandpaper will quickly dull the edge of any tool that touches it afterward.

Smoothing and sandpapering. — Sandpaper should be torn into pieces of convenient size, say about one eighth of a sheet, and kept by the teacher, who should give it out

as it is needed, requiring that all worn pieces should be returned to him. In this way the teacher may keep track of the entire supply, and be sure that none is used before the work is ready for it. After the class has learned the danger of using sandpaper indiscriminately, such vigilance will be unnecessary.

Most students in working upon a model that cannot be smoothed after it is put together, will need to be watched carefully, or the model will have to be taken apart before it can be smoothed. The best results are obtained by an ironbound rule that two pieces shall not be fastened together until the teacher has said that they are ready. Do not hesitate to require that an entire model shall be destroyed in order to enforce a matter of this sort; this may have to be done once in a while, but rarely twice with members of the same class.

Saw filing. — Saw filing should extend throughout the entire course after the first lessons, and as much opportunity as possible should be given for each student to obtain experience, as a sufficient degree of skill can be acquired only by careful practice. The students should be encouraged to bring saws from home, or those of their neighbors, since where all the students use the same equipment of saws, it is hardly fair that these should be kept in order by any one but an expert.

Gluing. — Set apart one place in the shop for gluing. Keep handscrews and clamps there, and insist that all gluing shall be done in that place, otherwise glue will be dropped and smeared in all parts of the shop. Do not allow glue to be used so near the end of the class period that the work cannot be done properly, as some students will get the glue on, and, if the bell rings, will go off and leave it,

thus destroying the work, if the teacher does not discover it in time to correct the matter.

Estimating. — The teacher should select a small, simple house for the students to estimate upon. He should either secure a copy of the original plans, make a set himself, or have the students make a set as part of their mechanical drawing work. These plans should be used in taking off quantities.

If possible, a copy of the original stock bill and estimates should be secured, as they may be used for comparison with the work of the students. If this is not possible, the teacher should make a stock bill and estimate the cost, using the data given in "Inside Finishing," Chapter VII, and the local prices.

A careful study and review of this work is essential, all the class working upon the same house.

Estimating of small details, cases, or any convenient pieces of work should be practiced through the entire course in carpentry.

CHAPTER III

EQUIPMENT AND SUPPLIES

The equipment. — The equipment for the woodwork, or carpenter's, shop consists of *a complete set of the usual cutting tools for each boy*, which he should be required to keep in order and at all times ready for use or inspection. This method of equipping a shop requires that each bench should have a set of drawers or a closet in which the tools of each student may be kept under lock and key.

Aside from the cutting tools, are the *try-square, rule, hammer, etc.*, which need no special care. In some schools these are included in each student's equipment, but in others there is one set of these for each bench, which is used by all the students who use the bench, the edge tools being kept guardedly for each individual student.

Besides the bench equipment, there should be a set of tools for general use, which should include all *the different sizes of bits, chisels, etc.*, and other tools which will be used only occasionally. These should be kept in racks which they will just fill, so that the teacher may with a glance detect a vacant space, and hold the class until the missing tool is in its place.

Economical equipment. — In schools where it is necessary to use economy in purchasing the equipment, there may be a set of tools for each bench, which will be used by all the classes. This method of equipping a shop should

be avoided if it is possible, as it is far better that each student should have his own tools, for which he may be held responsible, which is practicable to but a limited extent, if all classes use the same equipment.

Comparisons of tools. — We will discuss here the reasons why certain forms of tools have been recommended instead of others.

The *iron planes* are listed because they are easier to adjust and to use. A wooden plane is heavy and clumsy, and for young students especially unsuitable, as their hands are not large enough to grasp and to control it properly. Another advantage of iron planes is that they are kept in order more easily, as the face holds its shape under conditions which would cause enough change to the face of a wooden plane to require its rejointing. An iron plane also lies down, or "hugs the wood" closer than does a wooden plane, and is for that reason preferred by many. Equally as good work may be done with one type of plane as with the other.

The *knuckle-joint block plane* is better designed than are some other forms, because the lever that keeps the iron in place is more positive in its action, and holds the iron more firmly. If the plane falls from the bench, or is dropped, the grip, or the top of the cap lever, is not so apt to break as if it were of one piece of light cast iron.

If some manufacturer should make a form of *gauge* which had no graduations upon it, he would find a ready sale for it among manual-training schools, because unless the scratcher is exactly opposite the beginning of the graduations, the entire rule is inaccurate. However accurately the point may be placed originally, it will be out of place after the gauge has been in use a short time and different

students have endeavored to satisfy their curiosity regarding its construction.

The form of *bitbrace* in which the jaws are tightened by a thumb-screw instead of by a grip nut is best adapted to the use of manual-training classes, for the reason that the only part to be lost is the screw that sets up the jaws. In the common form of brace, — that which grips the bit by the tightening of a grip nut which forces the jaws together until the bit is held firmly, — there are three parts, which are apt to be lost by the attempts of the students to study the tool's construction. Bitbraces of small swing should be selected, as they are better adapted to the small bits that are generally used in manual-training classes, though there should be two or more braces of the larger sizes for occasional use.

In purchasing *try-squares*, secure, if possible, those upon which there are no graduations, because the average student will use his try-square as a rule, which is awkward, especially after the tool has been in use a considerable time, when it is much more difficult to read the marks than when it is new, and at all times it is more difficult than to read a rule.

A 24" *straight rule* is better than a folding rule for several reasons; the chief of which is, perhaps, that it is not easy for the student to drop a straight rule into his pocket and carry it off. Neither is there the temptation with a straight rule, that there is with a four- or two-fold rule, to see how far it can be bent without breaking, nor is it so apt to be broken by falling open on the floor and being stepped upon.

The type of *auger bit* known as the "Jennings" is perhaps the most satisfactory for the use of manual-training

schools, as the shape of its worm, its cutters, and the smoothness of the finish of the twist, in the best makes, all aid in making it smooth-running and clean-cutting. The cheaper grades of the tool are not satisfactory in finish or in ease of working, nor will they stand boring more than a very few holes in oak or in other hard woods.

The *bell-faced claw hammer* is more satisfactory than the older flat-faced pattern. Its face being slightly convex, it is not so apt to bruise the wood badly if the nail is missed, and in outside finishing and in common work the nail may be driven a little below the surface of the wood without the use of a nail set. In general, the older pattern has not the long neck of the bell-faced hammer, which extends upon the handle far enough to be valuable in strengthening the connection between them, and which allows a much greater strain upon the handle in pulling a nail than if the neck were not a part of the head. More skill is required in using a bell-faced hammer than one of the flat-faced type.

For a manual-training class, the divisions of the edges of the *steel square* are not important, as the use of the tool will be that of a large try-square, but if the class is studying roof construction, it will be of great advantage if the squares have the *octagon, brace, and lumber measures* on them, and still more advantageous if *one edge is divided into 12ths of an inch* which will be used as a scale of 1" to 1', in laying out the angles and lengths of rafters, braces, and other parts of a building.

Countersinks that may be taken apart and sharpened are preferred by most workmen. The teacher should be careful that the students do not use a wooden countersink upon metal, as it will be destroyed. The *lightning counter-*

sink is made to stand any metal but tempered steel, and works well upon wood.

The *turning* or *frame saws* are to be preferred to the compass saws for cutting curves, because they are not nearly so liable to catch in the wood and break. They can be turned around a very much smaller curve than can the compass saw, though of course they are not so efficient for some purposes.

In regard to the 10'' and 12'' *handscrews*, often it would be better for a great deal of the work if smaller handscrews could be used, but they would soon be broken, as the students almost invariably apply all the strength that they can, which breaks the screws or jaws if they become cramped.

The size of *cabinet scrapers* mentioned will be found generally satisfactory. If much larger, the scraper will be clumsy, and if more than $\frac{1}{2}$ '' smaller, the tool will be too small to be grasped easily.

In selecting a *workbench*, it is well to bear in mind that if there is iron in its top, the edges of the tools frequently will come in contact with it. Benches for the use of manual-training classes have been designed with a piece of iron at the head of the bench, extending across the entire width of the top. This is part of a device to hold a piece of wood between a "dog," which fits into holes in this iron, and the jaws of the vise, either the whole or a part of which may be elevated to hold the other edge of the piece that is to be clamped between them. While this is a very good idea, as it furnishes an efficient substitute for a tail screw, it is not a success for the use of students, as many of them have not the judgment necessary to perform their work and at the same time keep the edges of their tools away from the iron. It seems unavoidable that the

iron jaws of the modern quick-action vises should be there, hence all that can be done is to guard against allowing the edges of the tools to come in contact with them; however, as the vises are upon the edge of the bench, this is not so difficult to prevent.

In ordering an equipment, it is wise to include in the order a few of the small adjusting screws and other parts that are likely to become lost or broken; for instance, the screws of wing compasses, bevels, saw handles, throat and adjusting screws, and levers of block planes; also knobs, handles, and their screws, for the iron bench planes, shoes for gauges, cutters, caps, and set screws for spokeshaves, chisel handles, etc.

In selecting tools, it is well to be sure that they are uniform in design, for if there are several different styles of tools, the problem of keeping them in repair becomes more serious.

Care of equipment. — Usually the teacher himself is obliged to keep the tools in order at first, if more than one class uses them, as it takes time for the new student to realize that nothing is gained, and a great deal lost, by working with dull tools. Each beginner will have to be watched carefully until he discovers that it is to his advantage to keep his tools in order, and will voluntarily take time to sharpen them.

While the class as a whole should see the demonstration of tool sharpening, it will be necessary in most cases to give individual instruction, otherwise the tools will rarely be in condition to do satisfactory work. Unless the teacher constantly guards against it, the older classes will be obliged to do most of the sharpening, as the members of the beginning class will not do it unless they are made to.

At all events, the equipment should be kept continually in the highest state of efficiency.

Teachers of the languages and of mathematics and sciences spend much of their time outside of school in correcting papers, and generally think that the teacher of manual training has much more leisure time than they have; but if the latter keeps ahead of his work, and sees that his tools are in perfect condition, there will be little reason to envy him on this score.

In the care of tools it is well to have stated times for giving the entire equipment a thorough overhauling in order to be sure that the adjusting mechanism is working as it should, and that the cutters are ground and sharpened properly. The frequency of these times depends upon the faculty of the teacher to impart to his pupils the inclination and the ability to care for their own tools. If a school has been equipped upon the basis of the strictest economy, and all classes have to use the same edge tools, it is not wise to depend upon the students to keep all the tools in good order. Unless the teacher gives them his personal attention frequently, the temptation to use tools that have been sharpened by others will prove irresistible to many students. This is discouraging to a boy who would naturally keep his tools in good order, and he himself is apt to fall into the same bad habit. Of course this may be prevented to a certain extent, but unless there is an individual equipment of cutting tools for each student, the teacher may be sure that there is more or less of this borrowing being done all the time, and he should be careful, in his endeavors to prevent it, not to develop a system of "nagging."

It is the custom of some teachers to send all tools that

need grinding, and saws that need filing, to a shop where the work is done by an expert. One reason for doing this is that the teacher does not have the time to do it as it should be done. Another reason is, that unless the grindstone is run by power, it will need some one to turn it, and even with power, the grinding of tools on a grindstone is tedious work at best. Despite the fact that there is a strong prejudice against using an emery wheel for the purpose of grinding edge tools, it is the usual method in furniture and other woodworking shops, as the work may be done in much less time. It is true that the temper of a tool may be started, but the fact that edge tools are being sharpened continually in this way is proof that it is simply a matter of skill. Therefore, the writer recommends the use of a 6" or 8" *emery wheel*, which may be driven by a small motor if there is no other power in the shop.

While the manual-training teacher need not be ashamed to admit that he does not know how to file a saw properly, since he will find plenty of good company among journeymen woodworkers, many of whom habitually send their saws to a saw filer, *every teacher of woodwork, however, should be an expert in grinding, whetting, or oilstoning, in fitting a cap iron to a plane cutter, and in doing any of the adjusting necessary to keep his entire outfit in perfect condition.* Moreover, he should be able to do it in the time which the average teacher ordinarily can give to that part of his work.

If there is but one equipment of edge tools to be used by all classes, it will be difficult to know of all losses and breakages of tools, unless the teacher makes an inspection of tools before each class leaves the room, which is impracticable on account of the time required, and at the same

time unsatisfactory, because, even then, the source of the damage can rarely be located with certainty.

Constant care is necessary to insure that the benches and other fittings are not defaced, either carelessly or deliberately, as the possession of a sharp tool is, to most boys, a temptation to use it, and a few will be apt to cut the first piece of wood that they see, without much regard for the ethics of their action.

Supplies. — There is but one exact way of estimating the material necessary to provide for the work of a class during a specified time, and that is to plan a series of models, and require each student to make them one after the other. It is then an easy matter to calculate how many reproductions of a certain model will be made, and the dimensions and the amount of material necessary to make them, allowing 20 or 25 per cent more than is actually necessary for pieces destroyed and for waste. This method, which has definiteness to recommend it, is used entirely by some teachers, but there is one important objection against it, — it restricts individual work, which will prevent the progressive teacher from using it to more than a limited extent.

A teacher should plan his courses so that the first few models will be made by all his students, but as soon as a moderate degree of facility has been gained in the use of the more essential tools, the individual work should commence. The material for these models may be calculated fairly accurately, and by selecting a course of problems from this book, a satisfactory variety may be obtained which will require material of certain dimensions kept in stock by almost any lumber dealer.

The models herein described are planned with special

reference to individual work, and if a supply of boards of the required kinds and thicknesses is ordered, it will be possible to cut the dimensions desired. The width and the length of the boards may be in a general way estimated, so that they may be cut with the least possible waste.

The different kinds and thicknesses of boards necessary to do any of the work in the courses hereafter described, except that in the trade courses, are as follows:—

Poplar, pine, or basswood, $\frac{1}{4}$ " , $\frac{1}{2}$ " , $\frac{5}{8}$ " , $\frac{7}{8}$ " ; $1\frac{3}{8}$ " , for towel roller.

Black gum, $\frac{7}{8}$ " ; cherry may be substituted for gumwood, if desired.

Cherry, $\frac{1}{4}$ " , $\frac{1}{2}$ " , $\frac{7}{8}$ " .

Maple, $\frac{1}{4}$ " .

Oak, $\frac{1}{2}$ " , $\frac{5}{8}$ " , $\frac{7}{8}$ " ; $1\frac{1}{8}$ " , for table top and rails; $1\frac{1}{4}$ " for feet for screen frame; $3'' \times 3''$ for table legs.

In giving an order, poplar, pine, and basswood may be ordered as substitutes for each other, the poplar in general giving the best results, as it takes a better finish than either of the other woods. The material for the larger models — the plate rack, screen frame, etc. — may be furnished by the boys themselves, so that the teacher need not include this material in his estimate. As a matter of fact, if individual work is the rule, generally there will be but two or three of either of the large models made by any class, as it will be found that the mass of the students will work to better advantage upon the smaller models, or that they will want to make some model not included in these courses, in which case it is wise to allow each student to furnish his own material.

It is a matter of principle with some teachers and schools not to allow the pupils to pay for any material that they may use. There are various reasons advanced to uphold

this policy, but the writer has heard none which he feels has as much weight as the reasons which may be advanced for requiring the student to pay for the material that he uses in making a large piece of work. This does not mean that there should be a penurious administration of the financial side of manual training, but that *the student who makes a model in which the material may cost any considerable amount, or which may have a real intrinsic value, should pay for the material of which it is made.* This is not for the purpose of saving expense to the school, although that is the natural result, but for the benefit derived by the student in receiving tangible evidence of the purchasing value of money, — frequently the first real experience of the sort which some of the pupils may have. The average student will feel very differently toward economizing the material which he has bought and paid for, at some mill, than he will if he has obtained the same pieces from the lumber rack of the manual-training department, especially if, through carelessness, he destroys a piece and has to purchase another.

The writer has noticed frequently that a boy who was actually indifferent while at work upon the routine work at the beginning of the course, becomes alert and interested as soon as he has selected a model, and has bought and paid for the material of which it is to be made. There is rarely any need of cautioning a boy who has purchased his own material, in regard to the necessity of laying out his work carefully in order to avoid the possibility of cutting the material to waste.

The foregoing does not mean that small models and exercises, in which the value of the stock used is nominal, should be paid for by the student.

In ordering, the teacher should use judgment in selecting the grades of lumber; for instance, the best grade of a certain kind of lumber may cost ten cents per foot, and another grade of the same kind of wood may cost but six cents. The difference may be due to extra large dimensions, or to the presence of a few blemishes, which may be cut around. As there are so many opportunities for using small pieces in a manual-training shop, most of the pieces from which blemishes have been cut may be used for other purposes.

It is a true saying that the best is the cheapest, but like many other generalities, it does not apply in every case, as the majority of people find it necessary to be governed in their purchases by considerations of economy as well as by those of quality. In the above instance, it will be cheaper to buy the six cent lumber, as there will be nothing like the difference in the cost of the boards cut to waste. Although quartered oak costs about twice as much as plain oak, the latter, by many teachers, is never considered. Much of the work of a manual-training school, however, may be done quite as satisfactorily with plain as with quartered oak.

The teacher should not feel obliged to use the exact kinds of wood specified in the various courses, but should give the preference to the kinds most easily obtained in his locality, if they are suitable.

Both *hot and cold glue* should be purchased. Though there is no doubt that the former holds better than the latter, there is not enough difference to justify the statement that cold glue is worthless, which has been made by different writers upon the subject. A good grade of hot glue should be used if the best results are desired, but still,

on account of its always being ready for use, cold glue may be used advantageously in many places where the strength of the joint does not depend entirely upon the glue.

In purchasing *volatile, liquid finishing materials*, it is best not to order too large quantities at a time; several small orders at different times will insure fresh goods, and thus greater efficiency. Since these liquids deteriorate rapidly if the can or bottle is left open (which is certain to happen if the students handle it without the closest supervision), it is a good plan for the teacher to keep the large cans away from the students, and to supervise personally the pouring into smaller receptacles of a sufficient amount for the use of each class, taking care that any residue is returned to its can and the brushes thoroughly cleaned before the class is dismissed.

There are many ready-mixed stains and wax finishes upon the market, and these are in general better for the use of manual-training classes than any which can be mixed, as they are sold in convenient form and for every conceivable purpose.

In purchasing *shellac*, care should be taken to secure a satisfactory article. Certain manufacturers, in putting up shellac, use some adulterant, which prevents its hardening properly. This can be known only by testing. Pure shellac and alcohol, spread thinly, will set perfectly in a few minutes, but the kind above mentioned will require a longer time to set; in fact, finger marks will be left upon it the next day, unless handled carefully, and it will be very little harder a year after its application.

Pure shellac and alcohol, which should be specified in ordering, has an appearance similar to coffee and cream, while the objectionable kind has a peculiar oily appearance.

After an opportunity for one comparison in appearance and in behavior under a brush, the difference will be evident.

The most reliable shellac is that which is cut by the teacher himself. This may be done by dissolving gum shellac in alcohol. Break up gum shellac into fine pieces, or use flake shellac; put the pieces into a jug or glass jar, and cover them with alcohol; set this away, and shake it occasionally. Grain alcohol, or the best grade of wood alcohol, may be used; either will give satisfactory results. Fresh gum shellac should be secured for this purpose, or it will not cut properly. Test a small sample before purchasing, unless it is guaranteed.

A suitable *brush for stains and filling* may be bought at a very low price, as it makes little difference if the work is not done so smoothly as shellacking, for the spreading of which an expensive brush is necessary, which should be well taken care of, if the best results are desired. A teacher can make six of each kind of brush last three or four years by giving his personal attention to caring for them; on the other hand, a gross of each may be destroyed in the same time if he leaves their care entirely to his students.

Some little care should be exercised in the selection of the supply of *screws and nails*. The assortment of nails should include some of every size from 3d. fine to 20d. common, and from half inch to 10d. finish. Likewise, screws suitable for the needs of the course should be ordered, and, in addition, one or two dozen each of several larger sizes, and a few boxes of assorted smaller screws. There should also be a small assortment of screw hooks and eyes, carpet tacks, and similar articles, as the manual-train-

ing teacher frequently is called upon to accommodate others, and there is often a demand for various kinds of odds and ends in doing jobs around the shop.

Lists of equipment. — The following outfit is suitable for the benches of a school where the individual equipment is to be purchased, and is for the use of twenty-four students at one time.

Individual Outfit for Twenty-four Students

24 benches, fitted with drawers, racks, and closets for tools.

24 outfits of tools, each consisting of: —

1-15" iron jack plane.	1-1" socket firmer chisel.
1-7" iron knuckle-joint block plane.	1 gauge.
1-1" socket firmer chisel.	1-12" backsaw.
1-1/2" socket firmer chisel.	1-20" cutting-off saw.
1-3/4" socket firmer chisel.	1-24" ripsaw.

NOTE. For mature students of carpentry, instead of the two last-mentioned saws, a 22" panel saw, a 26" ripsaw, and a 26" cutting-off saw should be provided in addition to the backsaw.

1-8" swing bitbrace.	1 bench brush.
1-12 oz. bell-faced claw hammer.	1 bench hook.
1-2 1/2" hickory mallet.	1-24" straight rule.
1-6" screw driver.	1-1" auger bit.
1-6" bevel.	1-3/8" auger bit.
1-6" try-square.	1-1/2" auger bit.
1 pr. 6" wing dividers.	1-3/4" auger bit.
1-8" x 2" x 1" oilstone.	1-1" auger bit.
1 self-righting oil can.	

The above is a satisfactory equipment for students taking the carpenter's trade course, and for most of the work the students may be called upon to do if the school is part of an institution in which they are expected to aid in keeping the buildings in repair.

For a manual-training school, some of the tools above mentioned will be found unnecessary for the individual equipment, but they should be a part of the general or rack equipment of the shop. In such a school, in which a satisfactory but an economical outfit is desired, the following list of tools will be found suitable.

Outfit of Common Tools for Each Bench

1-20" cutting-off saw.	1 bench brush.
1-24" ripsaw.	1 bench hook.
1-12" backsaw.	1-6" screw driver.
1-24" straight rule.	1 oilstone.
1 gauge.	1 self-righting oil can.
1-6" try-square.	1 bitbrace. 8" swing.
1-12 oz. hammer.	

Individual Outfit of Edge Tools

1-15" iron jack plane.
1-7" iron knuckle-joint block plane.
1 each, $\frac{1}{4}$ ", $\frac{1}{2}$ ", $\frac{3}{4}$ ", 1" socket firmer chisels.
1 each, $\frac{1}{4}$ ", $\frac{3}{8}$ ", $\frac{1}{2}$ ", $\frac{3}{4}$ ", 1" auger bits.

General or Rack Equipment

(These tools are suitable to accompany either of the above described bench outfits.)

3-24" iron jointers.	2-12" try-squares.
8-10" iron smoothing planes.	6 framing squares.

NOTE. Edges of framing squares should be divided into 4ths, 8ths, 12ths, 16ths. (For manual training, two will be enough.)

6-4" screw drivers.	2-12" bevels.
4-8" screw drivers.	8-6" bevels. (Omit for carpentry.)
2-12" screw drivers.	8-6" wing dividers. (Omit for carpentry.)
12 hickory mallets, 2 $\frac{1}{2}$ " face.	
6 gauges.	2-10" wing dividers.

1-12" wing divider.	1 glass cutter.
6 slip stones. Assorted sizes and shapes.	1- $\frac{1}{12}$ " department tool stamp.
3-26" cutting-off saws. 8 points.	1 set $\frac{5}{16}$ " steel letters.
2 sets auger bits.	1 set $\frac{5}{16}$ " steel figures.
1 doz. each, # 3, 4, 5, 6, 7, German bits.	1-30" level.
1 each, 3" and 2" expansion bits.	1-12" iron level.
6 wooden countersinks.	3 doz. nail sets. Cup point. Assorted, mostly small.
6 lightning countersinks.	1 doz. peg-awl hafts.
1 set socket firmer chisels. $\frac{1}{8}$ " to 2".	6 doz. awls for above hafts.
6-18" turn-saw frames. (Omit for carpentry.)	1-10" swing, ratchet brace.
Blades for above saws.	1 doz. 3 $\frac{1}{2}$ " x 5" cabinet scrapers.
6-16" compass saws.	1 doz. iron spokeshaves.
6 clamps; to open 3' 6".	1 doz. sloyd knives.
6-14" hand screws.	1 hack-saw frame.
1 doz. 12" hand screws.	1 doz. hack-saw blades.
1 doz. 10" hand screws.	2-10" drawshaves.
1 doz. each, 6" and 4" slim taper files.	1 iron routing plane.
1 doz. 12" half round cabinet files.	1-9" iron rabbet plane.
1 doz. flat bastard mill files; single cut.	1- $\frac{1}{4}$ " wood bead plane.
6 bit files.	1 set $\frac{7}{8}$ " match planes.
1 each, 8" and 12" monkey wrenches.	1 set $\frac{1}{2}$ " match planes.
3-6" button pliers.	1 iron tongue and groove plane.
1 each, 8" and 10" button pliers.	1 breast drill.
3-6" end-cutting nippers.	2 doz. twist drills, assorted from $\frac{1}{8}$ " to $\frac{1}{2}$ ".
	3 each, $\frac{1}{4}$ ", $\frac{3}{8}$ ", $\frac{1}{2}$ ", $\frac{3}{4}$ ", 1", 1 $\frac{1}{4}$ ", gouges.
	3 each, $\frac{1}{4}$ ", $\frac{1}{2}$ ", $\frac{3}{4}$ ", 1", center bits.
	24 drawing kits.
	24 pencil compasses.
	2-3" hatchets.
	1 grindstone.

In a school where strictest economy is necessary, the equipment of tools on the following page will be found sufficient for a class of twenty-four boys to do all the work planned in these courses.

Many teachers prefer an equipment similar to the following, there being fewer tools to care for and to keep in order, as it eventually falls upon the teacher to see that all the tools are in the best possible condition for a new class.

Economical Bench Equipment for Twenty-four Pupils

24 benches.	24 bench brushes.
24-15" iron jack planes.	24-6" try-squares.
24-7" iron knuckle-joint block planes.	24-12" backsaws.
24-1" socket firmer chisels.	24 bench hooks.
24 gauges.	24 drawing kits.
24-24" straight rules.	24 pencil compasses.

General Tools for Rack Equipment

6-20" cutting-off saws. 10 points.	2 doz. assorted twist drills, $\frac{1}{8}$ " to $\frac{1}{2}$ ". For bitbrace.
6-24" ripsaws. 6 points.	1- $\frac{1}{4}$ " wood bead plane.
4-10" iron smoothing planes.	1- $\frac{7}{8}$ " dado plane.
1-24" iron jointer.	1-9" iron rabbett plane.
1-12" try-square.	1-10" drawshave.
1 framing square. (6, for the Carpenter's course.)	6 sloyd knives.
12-12 oz. hammers.	6 iron spokeshaves.
3-4" screw drivers.	6-3 $\frac{1}{2}$ " x 5" cabinet scrapers.
6-6" screw drivers.	6 peg-awl hafts.
2-8" screw drivers.	3 doz. awls for above hafts.
1-12" screw driver.	1 doz. nail sets. Cup pointed.
3 oilstones.	Small size.
3 self-righting oil cans.	1-18" level.
4-6" wing dividers.	1- $\frac{1}{4}$ " steel department stamp.
6-8" swing bitbraces.	1 set $\frac{1}{4}$ " figures.
2-6" swing bitbraces.	1 glass cutter.
1-10" ratchet bitbrace.	2-6" button pliers.
1 set auger bits.	2-6" end-cutting nippers.
6 each, $\frac{1}{4}$ ", $\frac{3}{8}$ ", $\frac{1}{2}$ ", $\frac{3}{4}$ ", 1", auger bits.	1-8" monkey wrench.
6 each, # 3, 4, 5, 6, 7, German bits.	$\frac{1}{2}$ doz. 8" flat bastard mill files.
	Single cut.

- | | |
|---|---|
| 1 doz. 12" half round cabinet files. | 6 each, $\frac{1}{8}$ ", $\frac{1}{4}$ ", $\frac{3}{8}$ ", $\frac{1}{2}$ ", $\frac{3}{4}$ ", socket |
| 1 doz. 4" slim taper files. | firmer chisels. |
| 1 doz. 6" slim taper files. | 3 wooden countersinks. |
| 4 clamps. To open 3' 6". | 1 lightning countersinks. |
| 3-14" hand screws. | 2 slip stones. |
| 6-12" hand screws. | 3 each, $\frac{1}{8}$ ", $\frac{1}{4}$ ", 1", 1 $\frac{1}{4}$ ", gouges. |
| 6-10" hand screws. | 2 each, $\frac{1}{8}$ ", $\frac{1}{4}$ ", $\frac{3}{8}$ ", 1", center bits. |
| 3-18" turning saw frames with | 6-6" bevels. |
| blades. (Omit for carpentry.) | 1-3" hatchet. |
| 3-16" compass saws. | 8-2 $\frac{1}{2}$ " hickory mallets. |
| 1 set socket firmer chisels, $\frac{1}{8}$ " to 2". | 1 grindstone. |

CHAPTER IV

SUGGESTIVE COURSES

Grading of exercises. — In preparing the following courses, it has been the intention to suggest a series of models which will lead the student from the simple to the complex in gradual steps. For reasons that have been previously discussed, the writer realizes the futility of endeavoring to arrange a course which may be completed by a series of exercises as perfectly graded as is possible for instance, in piano practice. He has therefore been governed by the size and the importance of the models, and by the difficulties involved in combining the various forms of construction, rather than by the questionable basis of one tool being more difficult to use than another.

Time necessary for completion. — In regard to the time necessary to complete the various courses, there is a wide difference in the amount of work that may be accomplished by different classes. These courses are planned to give ample work for the exceptionally capable student; consequently the conscientious teacher need not feel that he is doing less than he should, if his class does not accomplish all that is laid out.

Use of outlined courses. — It is not expected that the outlines will be followed implicitly, as no course can be devised which is the best for each one of any class, but they should each be considered simply as an *indication of the grade of work* that the average student should be able

to perform at each step in his progress. They may also be used by the teacher in selecting work for his classes, and as a basis for comparison when a new model is being considered, in this way aiding the teacher to decide whether a certain model that some student may wish to make is suitable for that particular student to undertake at that time.

In fact, the courses are, in general, adapted to the more mature student of the normal schools, and, in connection with the rest of this handbook are intended primarily for the use of prospective teachers of manual training in preparing for their future work.

Some of the sketches illustrating the models of the courses, instead of being working or scaled drawings, are made in perspective, the student being given only enough to suggest the size. It is desirable that the student should not follow the design closely; therefore the details are suggestive only, and each student should be required to design the details of every model that he makes, being guided by the teacher.

To reiterate and to emphasize previous statements, the courses should by no means prevent the teacher from departing from them as individual cases may make it advisable, or from substituting others that he may deem better suited to his special work. The models mentioned are suggestive only of the approximate degree of difficulty that should govern the selection of the work of the average student.

A regular course to be followed under all conditions seriously hinders the development of many students, who should be encouraged, instead, to design their own work to the greatest extent possible. If necessary, models made by the teacher or by other students may be used as

motives or suggestions, and each student required to make a working drawing of the model, changing or improving the design, instead of making a simple copy, and constructing his own model from the drawing.

The use of the *arithmetic* given in "Elements of Construction" may, in the manual-training classes, be optional with the teacher.

Research and written exercises. — In using "Elementary Woodwork" and "Elements of Construction" as the basis of the work of classes in the carpenter's trade courses, research and written exercises should be required upon topics and exercises which treat of construction, the allied trades, and the use, strength, and durability of materials. An entire chapter upon tools, materials, or other subjects generally, should not be assigned for study at one time, as, in most cases, if the proper amount of research is devoted to the subject and it is written up as it should be, there will be too much work for one assignment. Each teacher will have to decide for himself the matter which should be discussed and the time which may be allowed for it.

Tests and examinations. — Periodic verbal or written tests should be given, reviewing the work performed since the preceding test; there should also be an examination at the end of the term or semester, covering the more important points of theory and practice.

The written exercises should, if possible, be arranged so that they will come at frequent intervals, during the whole term, and should be kept as nearly as possible parallel with the bench exercises. Class exercises may be performed by as many students as can work together to advantage, or by as few as the teacher may desire.

References to other volumes. — In the following outlines of suggestive courses, special care has been exercised to use no unfamiliar term, and to mention no subject nor process which is not fully described in one of the volumes of the series. These volumes are indicated by the use of letters; for instance, the work of the manual-training classes, and of the first year of the trade classes, is taken from "Elements of Woodwork" and from "Elements of Construction," the former being indicated by the letter W, and the latter by the letter C. The work of the second year trade classes is taken from "Constructive Carpentry," which is indicated by the letters CC, and from "Inside Finishing," to which reference is made by the letters IF. These letters indicate the book, and the accompanying number indicates the topic in which the item mentioned will be found. If no letters appear, the sketch will be found in this volume.

Suggestive Courses in Manual Training

I. SEVENTH AND EIGHTH GRADES

1. Time required: two fifty-minute periods per week for four semesters of nineteen weeks each. Arithmetic optional. (C)

	BENCH WORK	TOPICS FOR WRITTEN WORK	BENCH WORK
SEMESTER 1	Wedge. Fig. 3. Flower stick. Fig. 4. Pencil sharpener. Fig. 6. Rule. Fig. 11. Bench hook. Fig. 14. C, 81. Cutting board. Fig. 15.	W,* 1 to 7. W, 27 to 64. C,† 39 to 46.	Sleeve board. Fig. 29. Paper knife. Fig. 33. Folding towel rack. Fig. 35. Foot rest. Fig. 37. C, 83.
SEMESTER 2	Coat hanger. Fig. 18. C, 82. Keyboard, cherry, carved. Fig. 19. Necktie box. Fig. 25. Corner shelf. Fig. 27.	W, 8 to 13. W, 14 to 26. W, 65 to 68. W, 69 to 76. C, 81, A.	Drawing board. Fig. 39. C, 86. Dovetailed bookrack. Fig. 41. C, 92. Plate rack. Fig. 42.
SEMESTER 3			
SEMESTER 4			

NOTE.— In this and in the following courses, the teacher should use his judgment in distributing the talks upon theory throughout the course, reviewing and introducing matter not found in this series, wherever it seems best.

* W = "Elements of Woodwork." † C = "Elements of Construction."

2. Time required: two fifty-minutes periods per week for six terms of thirteen weeks each. Arithmetic optional. (C)

	BENCH WORK	TOPICS FOR WRITTEN WORK	BENCH WORK
TERM 1	Wedge. Fig. 3. Flower stick. Fig. 4. Rule. Fig. 11. Tool rack. Fig. 13.	W, 1 to 7. W, 27 to 64. C, 39 to 46.	Wall pocket. Fig. 28. Sleeve board. Fig. 29.
TERM 2	Cutting board. Fig. 15. Coat hanger. Fig. 18. C, 82. Keyboard, cherry, carved. Fig. 19.	W, 8 to 13. W, 65 to 68. W, 69 to 76.	Paper knife. Fig. 33. Drawing board. Fig. 39. C, 86. T square. Fig. 40. C, 87.
TERM 3	Plant stand. Fig. 23. Glove or necktie box. Fig. 25. Rod towel rack. Fig. 26.	W, 14 to 26. C, 81, A.	Dovetailed bookrack. Fig. 41. C, 92. Plate rack. Fig. 43.
		TERM 4	
		TERM 5	
		TERM 6	

II. EIGHTH AND NINTH GRADES

1. Time required: two fifty-minute periods for four semesters of nineteen weeks each. Arithmetic optional. (C)

	BENCH WORK	TOPICS FOR WRITTEN WORK		BENCH WORK
SEMESTER 1	<p>Wedge. Fig. 3. Flower stick. Fig. 4. Pencil sharpener. Fig. 6. Rule. Fig. 11. Tool rack. Fig. 13. Cutting board. Fig. 15. Dish drainer. Fig. 17.</p>	<p>W, 1 to 7. W, 27 to 64. C, 39 to 46.</p>	SEMESTER 4	<p>Toilet case. Fig. 38. Screen frame. Fig. 43.</p>
SEMESTER 2	<p>Coat hanger. Fig. 18. C, 82. Keyboard, cherry, carved. Fig. 19. Bracket shelf. Fig. 21. Necktie box. Fig. 25.</p>	<p>W, 8 to 13. W, 65 to 68. W, 69 to 76. C, 81, A.</p>		
SEMESTER 3	<p>Towel roller. Fig. 31. Picture frame. Fig. 34. Folding towel rack. Fig. 35.</p>	<p>W, 14 to 28.</p>		

2. Time required: two fifty-minute periods per week for six terms of thirteen weeks each. Arithmetic optional. (C)

TERM 1	BENCH WORK	TOPICS FOR WRITTEN WORK	TERM 4	BENCH WORK
	Wedge. Fig. 3. Flower stick. Fig. 4. Pencil sharpener, cherry. Fig. 6. Rule. Fig. 11. Tool rack. Fig. 13.	W, 1 to 7. W, 27 to 64. C, 39 to 46.		Towel roller. Fig. 31. Knife box. Fig. 32.
TERM 2	Cutting board. Fig. 15. Dish drainer. Fig. 17. Coat hanger. Fig. 18. C, 82. Cherry keyboard. Fig. 19.	W, 8 to 13. W, 65 to 68. W, 69 to 76. C, 81, A.	TERM 5	Foot rest. Fig. 37. C, 83. Drawing board. Fig. 39. C, 86.
TERM 3	Glove box. Fig. 25. Corner shelf. Fig. 27. Sleeve board. Fig. 29.	W, 14 to 26.	TERM 6	Dovetailed bookrack. Fig. 41. C, 92. Plate rack. Fig. 42.

III. SEVENTH, EIGHTH, AND NINTH GRADES

1. Time required: two fifty-minute periods per week for six semesters of nineteen weeks each. Arithmetic optional. (C)

SEMESTER 1	BENCH WORK	TOPICS FOR WRITTEN WORK	SEMESTER 4	BENCH WORK
	Plant label. Fig. 1. Wedge. Fig. 3. Flower stick. Fig. 4. Pencil sharpener. Fig. 6. Rule. Fig. 11. Bench hook. Fig. 14. C, 81.	W, 1 to 7. W, 27 to 64. C, 39 to 46.		Knife box. Fig. 32. Paper knife, carved. Fig. 33. Foot rest. Fig. 37. C, 83.
SEMESTER 2	Dish drainer. Fig. 17. Coat hanger. Fig. 18. C, 82. Keyboard. Fig. 19. Bracket shelf. Fig. 21.	W, 8 to 13. W, 65 to 68. W, 69 to 76. C, 81, A.	SEMESTER 5	Drawing board. Fig. 39. C, 86. T square. Fig. 40. C, 87. Dovetailed bookrack. Fig. 41. C, 92.
SEMESTER 3	Pen tray. Fig. 22. Plant stand. Fig. 23. Glove box. Fig. 25. Towel rack, rod. Fig. 26.	W, 14 to 26.	SEMESTER 6	Plate rack. Fig. 42. Screen frame. Fig. 43.

2. Time required: two fifty-minute periods per week for nine terms of thirteen weeks each. Arithmetic optional. (C)

TERM 1	BENCH WORK	TOPICS FOR WRITTEN WORK	TERM 6	BENCH WORK
TERM 2	Plant label. Fig. 1. Flower stick. Fig. 4. Pencil sharpener. Fig. 6. Rule. Fig. 11. Bench hook. Fig. 14. C, 81. Cutting board. Fig. 15. Coat hanger. Fig. 18. C, 82.	W, 1 to 7. W, 27 to 64. C, 39 to 46.	TERM 7	Folding towel rack. Fig. 35. Letter box. Fig. 36. Foot rest. Fig. 37. Drawing board. Fig. 39. C, 86. T square. Fig. 40. C, 89.
TERM 3	Keyboard, carved. Fig. 19. Bracket shelf. Fig. 21. Glove or necktie box. Fig. 25.	W, 8 to 13. W, 14 to 26. W, 69 to 76.	TERM 8	Screen frame. Fig. 40. Dovetailed bookrack. Fig. 41. C, 92.
TERM 4	Rod towel rack. Fig. 26. Wall pocket. Fig. 28. Sleeve board. Fig. 29.	C, 81, A	TERM 9	Table. Fig. 45.
TERM 5	Knife box. Fig. 32. Paper knife. Fig. 33. Picture frame. Fig. 34.			

IV. SIXTH, SEVENTH, EIGHTH, AND NINTH GRADES

1. Time required: two fifty-minute periods per week for eight semesters of nineteen weeks each. Arithmetic optional. (C)

	DENCH WORK	TOPICS FOR WRITTEN WORK		BENCH WORK
SEMESTER 1	Plant label. Fig. 1. Key tag. Fig. 2. Flower stick. Fig. 4. Silk winder. Fig. 5. Pencil sharpener. Fig. 6. Fishline winder. Fig. 8.	W, 1 to 7. W, 27 to 64.	SEMESTER 5	Rod towel rack. Fig. 26. Wall pocket. Fig. 28. Sleeve board. Fig. 29.
SEMESTER 2	Hatrack. Fig. 9. Table mat. Fig. 10. Plant stand. Fig. 12. Tool rack. Fig. 13. Bench hook. Fig. 14. C, 81.	W, 8 to 13. W, 65 to 68.	SEMESTER 6	Knife box. Fig. 32. Paper knife. Fig. 33. Folding towel rack. Fig. 35.
SEMESTER 3	Cutting board. Fig. 15. Sand shovel. Fig. 15. Dish drainer. Fig. 17. Coat hanger. Fig. 18. C, 82.	W, 14 to 26. W, 69 to 76. REVIEW: W, 27 to 64.	SEMESTER 7	Drawing board. Fig. 39. C, 86. T square. Fig. 40. C, 87. Dovetailed bookrack. (Single end.) Fig. 41. C, 96.
SEM. 4	Blotting pad. Fig. 20 Bracket shelf. Fig. 21. Glove box. Fig. 25.	C, 81, A.	SEM. 8	Plate rack. Fig. 42. Screen frame. Fig. 43.

2. Time required: two fifty-minute periods per week, for twelve terms of thirteen weeks each. Arithmetic optional. (C)

TERM	BENCH WORK	TOPICS FOR WRITTEN WORK	TERM	BENCH WORK
TERM 1	Plant label. Fig. 1. Key tag. Fig. 2. Flower stick. Fig. 4. Silk winder. Fig. 5.	W, 1 to 7. W, 27 to 64.	TERM 7	Wall pocket. Fig. 28. Sleeve board. Fig. 29.
TERM 2	Pencil sharpener. Fig. 6. Fishline winder. Fig. 8. Hatrack. Fig. 9. Table mat. Fig. 10.	W, 8 to 13. W, 39 to 26.	TERM 8	Towel roller. Fig. 31. Knife box. Fig. 32.
TERM 3	Plant stand. Fig. 12. Tool rack. Fig. 13. Bench hook. Fig. 14. C, 81. Cutting board. Fig. 15.	W, 14 to 26. W, 65 to 68.	TERM 9	Paper knife. Fig. 33. Letter box. Fig. 36.
TERM 4	Sand shovel. Fig. 16. Coat hanger. Fig. 18. C, 82. Key rack. Fig. 19.	W, 27 to 64. W, 69 to 76. C, 81, A.	TERM 10	Foot rest. Fig. 37. C, 83. Drawing board. Fig. 39. C, 86. T square. Fig. 40. C, 87.
TERM 5	Blotting pad. Fig. 20. Bracket shelf. Fig. 21. Pen tray. Fig. 22. Plant stand. Fig. 23.		TERM 11	Dovetailed bookrack. Fig. 41. C, 92. Screen frame. Fig. 43.
TERM 6	Glove box. Fig. 25. Rod towel rack. Fig. 26. Corner shelf. Fig. 27.		TERM 12	Bookcase. Fig. 44.

Suggestive Trade Courses in Carpentry

FIRST COURSE

Time required: thirty fifty-minute periods per week for twenty-four weeks.

The work as planned for six terms of thirteen weeks, requiring ten fifty-minute periods each week, is adaptable to six school months of four weeks, working six fifty-minute periods per day, which allows the entire work to be completed in six months. In this case, each term's work as planned should be done in one school month of four weeks, of thirty fifty-minute periods per week.

It is well, in this course, to work six full hours per day, which will give five hours per week more than is required to equalize the time between the courses of six terms of twelve weeks, as described, and the time under this arrangement.

This extra time may be employed advantageously by doing additional work upon supplementary models, in drilling upon the problems of carpenter's geometry, or in visiting work under construction.

The average student will not receive as much from this course as he will from one of the courses that cover a longer period, as he loses the opportunity of doing work in other departments of the school which he is attending.

NOTE.—The teacher will find that in this, and the following courses, much time will be saved if a supply of pieces of a suitable size to make the exercises is sawed to a width upon a circular saw. Care should be used that the students do not become possessed of the idea that these exercises are worthless and that they may be made carelessly. The teacher should be particularly watchful to be sure that the students' methods of work upon these are correct, as it is to prevent experimenting upon important work that the exercises are used. To strengthen the impression that the teacher himself considers them of the greatest importance, the best of them should be kept upon exhibition in a prominent place.

SECOND COURSE

Time required : ten fifty-minute periods per week, for six terms of thirteen weeks each.

	BENCH WORK	TOPICS FOR WRITTEN WORK	TOOL WORK
TERM 1	Bench hook. Fig. 14. C, 81. Coat hanger. Fig. 18. C, 82. Theory, with drill. C, 1 to 37 (or W, 27 to 63). W, 69 to 76. C, 39 to 46. Theory only. W, 1 to 7. Arithmetic. Examinations and tests. Reviews and "question class." * Note-books and essays.	C, 47 to 59.	CC, † 17 to 25. Theory and drill. CC, 31 to 46. Theory only. CC, 1 to 16; 26 to 28; 70 to 80. Arithmetic, etc., as in Term 1. Visiting construction work.
TERM 2	Foot rest. Fig. 37. C, 83. Tool box. C, 84. Glove box. Fig. 25. Theory, with drill. W, 65 to 68. W, 64. Theory only. W, 8 to 13. Arithmetic, etc., as in Term 1.	C, 60 to 70.	IF, †† 30 to 36. CC, 47 to 69. Theory, with drill. IF, 11 to 25; 81 to 85. Theory only. CC, 29, 30; 86 to 91. Arithmetic, etc., as in Term 1. Visiting construction work.
TERM 3	Bookshelf. C 85. Drawing board. Fig. 39. C, 86. T square. Fig. 40. C, 87. Threefold screen. C, 88. Theory and drill in above topics. Theory only. W, 14 to 26. Arithmetic, etc., as in Term 1.	C, 71 to 80.	IF, 37 to 39, 41, 42. Theory, with drill. IF, 45 to 48; 50 to 55. Theory only. IF, 1 to 10; 26 to 29; 40, 43, 44, 49; 58 to 73. Arithmetic, etc., as in Term 1. Visiting construction work.

* The teacher should require each pupil to bring to class, at stated times, questions relating to some feature of building construction; these should be discussed before the entire class. The students should be encouraged to demonstrate and illustrate upon the blackboard as far as possible anything that they may have observed in their visits to buildings under construction. An open discussion of this sort never fails to be profitable.

†† IF = "Inside Finishing."

THIRD COURSE

Time required : ten fifty-minute periods per week, for four semesters of nineteen weeks each.

	BENCH WORK	TOPICS FOR WRITTEN WORK		TOOL WORK	TOPICS FOR WRITTEN WORK
SEMESTER 1	<p>Bench hook. Fig. 14. C, 81. Coat hanger. Fig. 18. C, 82. Foot rest. Fig. 37. C, 83. Glove box. Fig. 25. Theory, with drill.</p> <p>Theory only. Arithmetic. Examinations and tests. Reviews and question class. Notebooks and essays.</p>	<p>C, 47 to 64.</p> <p>{ C, 1 to 37; C, 39 to 46; W, 65 to 68; W, 69 to 76. W, 1 to 7.</p>	3	<p>Theory, with drill. CC, 31 to 46. Theory only. CC, 1 to 16; 26 to 28; 29, 30; 70 to 80; 86 to 91. IF, 81 to 85. Arithmetic, etc., as in Semester 1. Visiting work in process of construction.</p>	<p>CC, 17 to 25; 47 to 69.</p>
SEMESTER 2	<p>Tool box. C, 84. Bookshelf. C, 85. Table. C, 89. Magazine stand. C, 93. Theory, with drill. Theory only. Arithmetic, etc., as in Semester 1.</p>	<p>C, 65 to 80.</p> <p>W, 64. { W, 8 to 13; W, 14 to 26.</p>	4	<p>Theory, with drill. IF, 11 to 25; 45 to 48; 50 to 55. Theory only. IF, 1 to 10; 26 to 29; 40, 43, 44, 49; 58 to 73. Arithmetic, etc., as in Semester 1. Visiting work in process of construction.</p>	<p>IF, 30 to 36; 37 to 39; 41, 42.</p>

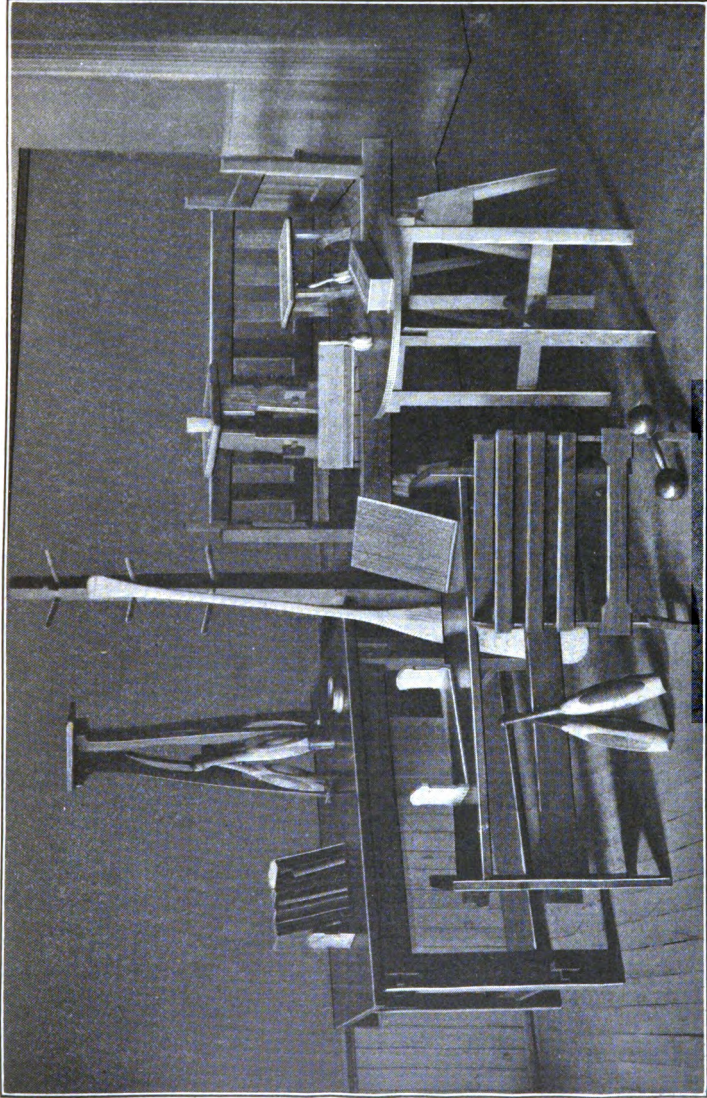

**WORK OF HIGH SCHOOL STUDENTS
BAY CITY, MICHIGAN**

CHAPTER V

SPECIAL TEACHING HINTS AND SUGGESTIVE DESIGNS

New subjects. — The models hereafter described indicate the *approximate progression of difficulty* rather than the exact sequence of work that should be followed. Each teacher, far better than any one else, should be able to select the models best suited to the needs of his own classes; therefore the subjects for description and demonstration should be decided when the model is selected, and should include, except as review may seem necessary, only the new tools and materials or processes introduced.

It will not be wise to go through the entire list of new subjects at the beginning of the work upon the model. If taken up at this time, very little of it will be fixed sufficiently in the minds of the students to be of value to them when they reach the different stages of the work. A short talk at the beginning of the work each day, as a new tool is taken up, will produce better results.

Stock cutting. — The materials for the first few models of any course should be prepared by the teacher before the class arrives. After it is evident that the students have learned the necessity for making an allowance for working and for cutting, as well as to minimize waste and blemishes, they should be allowed to cut from the board, having first made sure that there are no scraps from which

the desired pieces may be cut. The teacher should watch this part of the work very carefully, as within it lies the greatest possibilities of economy or waste. In order that the students may be given a broader experience in stock cutting than is possible in cutting only one or two pieces at a time, they may get out the stock from which several models of the same kind are to be made, taking turns in doing this, that all the class may have the benefit of the exercise. This may be carried out successfully by allowing the advanced students to prepare the stock for the work of the beginning classes.

In general, the material required for the following models may be cut from the regular stock thicknesses. This saves a great deal of time, and there is no real benefit gained by requiring that the student should plane everything to its three dimensions. Usually material that has been cared for properly during the time it has been seasoning will be as fair, or "out of wind," as it is possible for any student or workman to make it; but if its face is not true, which may be proven by the method indicated in "Elements of Woodwork," 30 D, or in "Elements of Construction," 4 D, it should be made so by using the jack plane sharpened carefully and set to cut very fine, after which the piece should be gauged to an even thickness and planed to the gauge marks. This will result in a piece a little thinner than actually required, and if this difference is so great as to destroy the piece for its purpose, it should be discarded. Many young teachers regard the dimensions given upon a drawing as immutable, and they will repeatedly discard material that is a trifle smaller than called for, or will cut stock badly to waste in order to secure

the desired size. There are certain dimensions that cannot be changed after the work is planned, and others that need not be observed so carefully; in making the distinction, the teacher has an opportunity to give a demonstration of the necessity for exercising economy and judgment.

In commercial work it is generally the custom to get out all the material called for by the stock list, or all that will be required to finish the work to a certain stage. In school work this custom cannot be followed so closely as in practical life since, if a large article, or a model requiring a number of pieces, is being made, the work is apt to be in progress for several months before the last piece will be needed. If all the material were cut at once, some of it certainly would be lost or appropriated by another student, unless the teacher assumed the unnecessary burden of giving his personal attention to seeing that all the pieces of the different models under construction were accurately accounted for at each lesson, or of keeping them under lock and key.

Making the model. — When the actual work upon the model has commenced, the teacher should be continually upon the alert to prevent the students from cutting off too much wood, thereby making the model undersize; the tendency to do this will be more apparent upon the parts of the work in which the tools work the easiest, as, for instance, in planing the sides and the edges. It is obviously more difficult to obtain a square and true end than to obtain equally good results upon side and edge wood. The use of the bench hook as a jack board or shooting board (see page 3) should not be encouraged; it is a method of

obtaining results rarely used by workmen, though much used in the manual-training work of the grades, but the methods described in "Elements of Woodwork," 44 B, or in "Elements of Construction," 18 B, have stood the test of many generations. A mechanic sometimes will use the jack board if he has many ends to block plane; say, for instance, in making mitered picture frames. "Any fool," as a workman once said, "can make a joint with a jack board." It should be the aim of the teacher to develop the skill which will permit the student to make a good joint by his own unassisted efforts, as a workman has to do.

The difficulty of making a good joint upon end wood is not due entirely to the fact that it is more difficult to cut end wood than side wood, but largely to the fact that the average student persists in cutting a shaving about four times as thick as he should, and in continuing his exertions after the plane is badly in need of sharpening. As Solomon said, "If the iron be blunt, and he do not whet the edge, then must he put to more strength; but wisdom is profitable to direct." (Eccl. x. 10.) After the students have obtained a reasonable degree of skill in the use of their tools, as satisfactory results may be obtained upon end as upon side wood, if the tools are properly sharpened and adjusted.

Tendencies to be corrected.— If there is one thing more than another, in teaching tool work, in which the novice should be guided and watched, it is in *the use of sandpaper*, largely because it seems the simplest thing in the world to rub a piece of sandpaper over a piece of wood. The average student has an irresistible tendency to use sandpaper for any and all purposes, and no amount of

reasoning or instruction will change this tendency until by experience he learns that he injures more work than he improves, and that the use of sandpaper before all the cutting is done results in dulling the edge tools which are used after it. It is the custom of some teachers, during this stage of the class work, to keep a supply of sandpaper torn to a convenient size, say one eighth of a sheet, and to give a piece to each student as he needs it, requiring that each piece shall be returned to him after it is used. This prevents stray pieces from being used without the teacher's knowledge.

Never allow a student to sandpaper across the grain. In sandpapering a flat surface, no matter how small, always use a block; the smaller the surface, the more need of a block.

The teacher should guard against the tendency of the students to use *the spokeshave* for every conceivable purpose. Its use should be kept within its legitimate field, that of truing curved surfaces, and never used for making a cylinder, nor in any other place where a plane may be used as well.

Files and rasps, in respect to the disposition of the students to use them for other than their legitimate uses, belong in the same category as do sandpaper and spokeshaves. Very few students have the moral stamina to resist the temptation to use a rasp or a file in place of the block-plane, if the latter does not work easily. The best way to prevent the use of these tools in places where others should be used is to keep them out of the way. The spokeshave, contrary to the custom of many teachers, should not be a part of the regular bench equipment,

but a part of the rack or general equipment, in which place the teacher may easily prevent its wrong use.

SUGGESTIVE DESIGNS

As has already been stated, the students should not be allowed to use the following designs for the purpose of copying them, but only as suggestions; they are intended simply as the basis from which the students may develop their own designs.

References to the four volumes of the series are made, as in the "Suggestive Courses for Study," by letters (see page 43).

Fig. 1. Plant Label.

*New subjects:*¹ Ripsaw and cutting-off saw (will be used only in rough cutting the material). Back-saw. Gauge. Knife (cutting and whittling). Rule. Try-square. Jack plane. Block plane.

Wood: Poplar (whitewood), pine, or basswood. Its native area, method of growth, and manipulation. (See W., Chaps. 1, 2.)

Preparatory.

- A. Make working drawing.
- B. From material dressed two sides to desired thickness, cut a piece $\frac{1}{2}$ " longer and $\frac{1}{4}$ " wider than required dimensions.

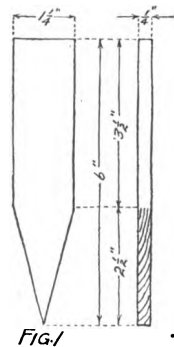

Exercises.

1. A. Prove best or face side (broad surface) to make sure it is out of wind.

¹ The items under this heading are intended for discussion and demonstration on the part of the teacher, and for drill on the part of the students. Each teacher should decide for himself whether the sequence of the subjects is best suited to his needs, and if not, should rearrange it accordingly.

- B. Mark the figure "1" on face side, near the face, or best edge, and plane edge straight and square with face side; use jack plane.
 - C. Unless it is necessary to plane the face side to make the piece out of wind (which will rarely be the case on a model of this size), do not plane the face side until all the edges are done.
2. A. Mark the figure "2" on the face side near the best end (at right angles with the grain).
 - B. Mark with knife and try-square the line to which the end will be cut off.
 - C. Cut off with backsaw; leave a very little for block-planing.
 - D. Block-plane exactly to line, and test with try-square to be sure that the end is square with both the face side and the edge.
3. Measure desired length from end 2, and square across the face side with a pencil.
4. A. Mark the figure "4" near the other edge (the back edge) on the face side.
 - B. Mark the required distance with the gauge. (Drill on waste piece.)
 - C. With the jack plane, plane edge 4 down to the required line, and straight and square with the face side.
5. Point the label, being sure that the point is on the center line, and that the obtuse angles are exactly opposite each other. The point should not be brought to a feather edge, as it will be broken easily in handling, and it will be very difficult to work to an exact length; leave the point something less than $\frac{1}{8}$ " across it. Do not measure it, but be guided by the eye.
6. Plane both sides.
7. A. This model should not be sandpapered, as a small piece is difficult to hold for sandpapering.
 - B. This model may be used also as a whittling exercise.
 - C. Inspect for defects and remedy them.

Fig. 2. Key Tag.

New subjects: Bits; auger, center. Spokeshave. Chisel used for paring. Compasses.

Wood: Same as in Fig. 1.

Preparatory: Same as in Fig. 1.

Exercises.

1, 2, 3, 4. Same as in Fig. 1.

5. With compasses, mark round end on face side.

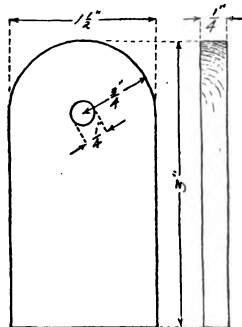

FIG 2

6. Bore $\frac{1}{4}$ " hole at center of round end. Use auger or center bit. To do this without splitting the piece, place it in the vise, face side up, and slightly compressed at right angles with the grain. Do not bore entirely through from face side, as the pit is apt to tear the wood badly when it comes through the back; turn piece over when the center is definitely marked on the back and bore from that side.

7. Plane sides.

8. Do not use sandpaper.

9. Inspect for defects and remedy them.

Fig. 3. Wedge.

New subject: Bevel square.

Wood: Same as in Fig. 1.

Preparatory.

A. Make working drawing.

B. Prepare piece 3" longer than required, so that there will be sufficient wood to grasp while at work upon the model, which will be too small to be handled easily. Get piece out of $\frac{1}{2}$ " stock $\frac{1}{4}$ " wider than required.

C. Mark face side.

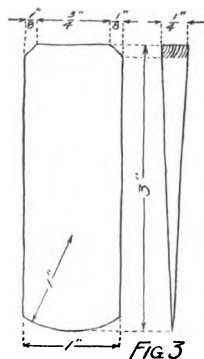

FIG 3

Exercises.

1. Plane both edges straight and square with face side. Do not block-plane either end.

2. Hold in vise and plane to a wedge, which may be cut off to one of required dimensions. Make point of wedge on the center line of the edge by planing from both sides.

3. Round thin edge of wedge. Do not make a feather edge; see Fig. 1, Ex. 5.

4. A. Measure from round end the desired length; mark with knife.
B. Transfer to all four sides.
C. Lay out bevel corners with light knife lines. Set bevel to angle of 45° by setting the tongue of the bevel to the same figures upon both sides of the angle of a steel or framing square. See C., Topic 58 D.
D. Cut off with backsaw to length. Leave marks on the wood.
5. Bevel corners to required angle, which has been described in Ex. 4, above. Cut down on the bench hook with the knife.
6. A. Block plane butt edge of wedge to knife marks, or trim with knife if preferred.
B. Omit sandpapering.
7. Inspect for defects and remedy them.

Fig. 4. Flower Stick.

Wood: Same as in Fig. 1.

Preparatory.

- A. Make working drawing.
- B. Cut piece from material at least $\frac{1}{8}$ " larger in square, and $\frac{1}{2}$ " longer than required dimensions.

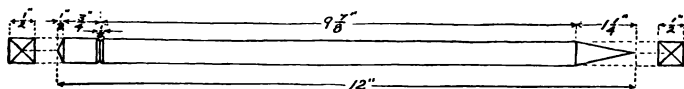

FIG. 4

Exercises.

1. A. Plane one side straight and true, and mark it for the face, or "1."
B. Plane one adjoining side square with it, and mark it "2."
C. With a gauge sharpened to make a fine line, gauge from this side across the face, and mark the line which indicates the face corner of the other side.
D. Plane the third side to this line, and square with the face; mark it "3."
E. Using the gauge without changing the set of it, mark the edges of side "4" upon sides 2 and 3.
F. Plane side 4 to these marks.
2. A. Mark and finish top end.

- B. Lay out decorative notches with fine knife lines, and with the utmost accuracy cut to them with a sharp knife or a chisel.
3. Point stick according to dimensions. Be sure that the students do not cut off this end until this stage has been reached. Leave point as described in Ex. 5, Fig. 1.
4. Omit sandpapering.
5. Inspect for defects and remedy them.

Fig. 5. Sandpaper Block.

New subject: Sandpaper; its manufacture; its use and abuse; its effect upon edge tools.

Wood: Same as in Fig. 1.

Preparatory: Same as in Fig. 1.

Exercises.

- 1, 2. Same as in Fig. 1.
3. A. Measure desired length from end 2, and mark with knife, working from face edge or edge 1. Mark this end "3." The edge parallel to edge 1 should be marked "4."
- B. Square across edges 1 and 4 from this mark, and connect the lines across the back side (the poorer broad surface), using the knife for all lines.
- C. With the backsaw, cut off the wood beyond mark 3, as near the mark as possible, and leave the mark on the wood.
- D. Finish to the knife mark with the block plane.
4. A. With a fine gauge, mark upon the face the required distance of edge 4 from edge 1.
- B. With the jack plane, work edge 4 down to mark, and square with face side.
- C. Plane sides.
- D. Inspect for defects and remedy them.
5. A. Cut or tear a sheet of No. 1 sandpaper into eight equal parts.

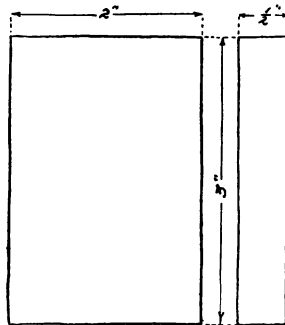

FIG. 5

- B. Fold it, not tack it, around a block of wood about 2" × 3" and sandpaper all six faces with it. Be sure that the corners of the model are not rounded off, but that they are perfectly square, and that true edges and sides are maintained.

Fig. 6. Pencil Sharpener.

New subjects: Hand screws (See W., Topics 59, 66, and C., Topic 33).

Glue (See W., Topic 65). Gluing (See W., Topic 66).

Gluing with a caul. Shellac (See W., Topic 71).

Wood: Cherry, or any hard-grained wood.

Preparatory: Same as in Fig. 1.

Exercises.

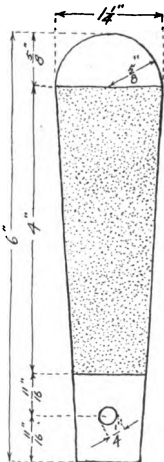

FIG 6

1. With a sharp lead pencil, draw a line the length of the piece in the center of the face side.
2. A. Lay off on the center line the distance between the wide and the narrow points of the model.
B. Lay off from these points, one half of the wide and narrow dimensions each side of the center line.
C. Draw semicircle, and straight lines indicating taper.
D. Plane to taper lines.
E. Round the end.
F. Plane sides.
3. Same as Ex. 5, Fig. 5.
4. A. Cut a piece of sandpaper the desired length, and about $\frac{1}{2}$ " wider than the widest part of the wood.
B. Glue it in place. Use a caul, which is a piece of wood for the purpose of pressing the sandpaper close to the piece to which it is to be glued; hold it there by the pressure of a hand screw until the glue has hardened. The caul should be somewhat larger than the piece of sandpaper.
C. After the glue has become hard, trim the sandpaper flush with the sides of the piece of wood to which it is glued.
D. Inspect for defects and remedy them.
5. A. Finish model with white shellac, spread very thin.

- B. After the first coat is hard, sandpaper it lightly with 00 sandpaper.
- C. Apply second coat of thin shellac.
- D. After second coat is hard, rub it with 00 sandpaper and with boiled or sweet oil.
- E. Polish with a soft cloth. (In rubbing finish with sandpaper, do not rub it with a block; use a felt pad, or the hand. Otherwise the sandpaper will cut through the finish.)

Fig. 7. Silk Winder.

New subjects: Grain of hard wood; comparison with other woods; method of growth; area of growth. Files and rasps; their use and abuse.

Wood: Cherry, or any close-grained hard wood.

Preparatory.

- A. Make working drawing.
- B. From material dressed two sides to the required thickness, cut piece $\frac{1}{4}$ " wider, and $2\frac{1}{2}$ " longer than desired dimensions (to allow wood enough to grasp).

Exercises.

- 1, 2. Same as Ex. 1 and 2, Fig. 1.
- 3. Same as Ex. 4, Fig. 1.
- 4. A. With a sharp knife, mark length on end 3, but do not cut it off.
- B. Lay out notches upon all four sides, using the bevel set to angle of 45° .
- C. Cut notches on three sides, with backsaw, which should run very lightly, and just clear marks.
- D. With a sharp chisel, pare very lightly to marks.
- E. Finish with a fine file, keeping inside angles and all corners clean and sharp.
- 5. A. Cut end 3 with a backsaw, making notches as in Ex. 4 B above
- B. Plane sides.

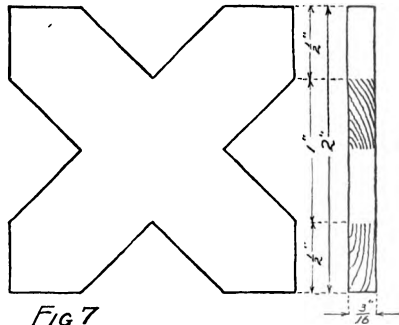

FIG 7

6. Same as Ex. 5, Fig. 5.
7. Inspect for defects and remedy them.
8. Same as Ex. 5, Fig. 6.

Fig. 8. Fishline Winder.

Wood: Either hard or soft.

Preparatory.

- A. Make working drawing.
- B. From material dressed two sides to the desired thickness, cut piece $\frac{1}{2}$ " longer and $\frac{1}{8}$ " wider than required.

Exercises.

- 1, 2. Same as in Fig. 1.
- 3, 4. Same as in Fig. 5.
5. A. Locate center of $\frac{1}{8}$ " holes.
B. Place piece in vise as in Fig. 2, Ex. 6.
C. Bore holes with center or auger bit. If a "Forstner" bit is available, it should be used instead of either of the others, as it is less liable to split the wood. (This bit is not suitable for the general use of a class, as it is very easily dulled, and it is almost impossible to sharpen it.) If this bit is used, B may be omitted, as the model should be held with a hand screw closely against another piece, so that the bit may bore through without tearing the wood of the back side.
6. Finish the holes in the ends of the model, and cut out the waist, or the middle of the edges. Use a sharp knife.
7. Plane sides first.
8. Sandpaper the model.
9. Inspect for defects and remedy them.
10. Shellac the model. Two coats rubbed down with oil. (Exercises 8 and 10 may be omitted if desired.)

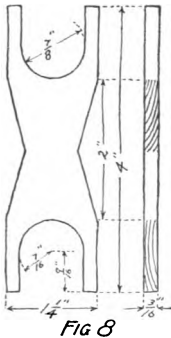

Fig. 9. Hatrack.

New subjects: Bradawl. Studding in plaster partitions. Wood stains (See C. C., Topic 24 B.) Chamfering.

Wood : Any wood desired.

Preparatory : Same as in Fig. 1.

Exercises.

1, 2. Same as in Fig. 1.

3, 4. Same as in Fig. 5.

5. A. Make pencil lines upon face, edges, and ends, indicating the angles of the chamfer. Do not use a gauge for this purpose, as the scratches will show after the chamfer has been made.

B. Chamfer ends first, using the block plane.

C. Chamfer the edges, using the jack plane.

6. A. Mark location of hooks. If a screw hook similar to the one shown in the illustration is used, mark the location of the screw. If a hook which is fastened on with screws is preferred, mark the location of the screw holes.

B. Bore holes with suitable bradawl.

C. Locate and bore $\frac{1}{4}$ " holes through which the rack will be fastened to the wall. These need not come under the hook, as shown in in the illustration, unless desired, but they should be placed 16" to centers, as that distance will allow the screws to enter the studs of a plaster partition.

7. A. Plane sides of model.

B. Sandpaper model.

8. Inspect for defects and remedy them.

9. The model may be either stained or finished in the natural wood. If the former, it may receive either a wax or a shellac finish. If oak or other hard, open-grained wood is used, it may be filled if desired.

See W., Topic 69.

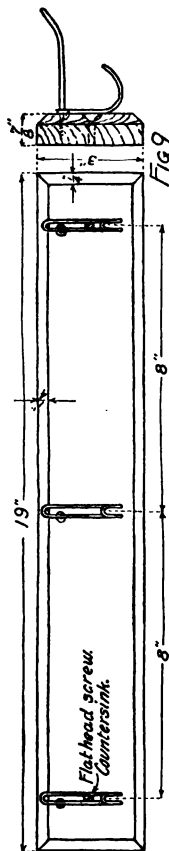

Fig. 10. Table Mat.

New subjects : Frame saw. Compass saw. Direction of grain to obtain maximum strength. Different forms of bitbraces.

Wood : Poplar, or oak.

Preparatory.

A. Make working drawing.

B. Cut piece about $\frac{1}{8}$ " larger each way than required dimensions.

Exercises.

1. A. Locate the center by diagonals, without planing the edges.
 - B. Draw circle of required diameter.
 - C. Before sawing, space off on the diagonals the centers of the holes as indicated.
2. A. Place piece in vise to prevent splitting while boring holes. See Ex. 6, Fig. 2. Be sure that sufficient pressure is not exerted to split the piece by buckling.
 - B. Bore the holes as indicated. (If the line of centers of these holes is parallel with the grain, the piece will be apt to split.)

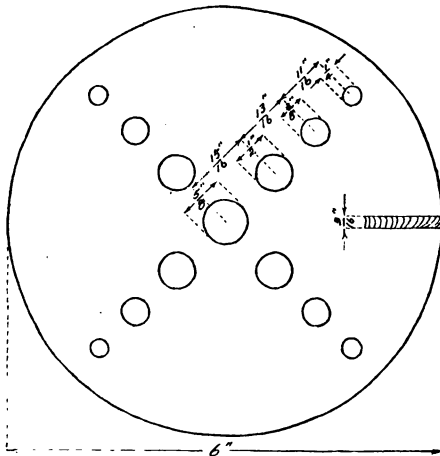

Fig 10

3. With the compass saw, or preferably with the frame saw, cut the circle, about $\frac{1}{8}$ " outside of the line. Place the piece in the vise, the flat surfaces parallel with the vise jaws, the grain running at angle of about 45° with the surface of the bench. This will minimize the danger of splitting while sawing, which will be almost cer-

tain to happen if the grain is parallel with the bench top. If the grain stands vertically, the same result will be attained. The saw must run very lightly, or the piece will be apt to split, regardless of all precautions.

4. Finish edge to exact dimensions by spokeshave and wood file. Be sure that the contour of a perfect circle is maintained.

5. Smooth both sides with jack plane. The model will be found a somewhat awkward shape to hold ; to make neat work possible, a form may be made by making two pins somewhat smaller than the outside hole, and setting them in a piece of scrap wood large enough to support the entire model in such a way that two of the holes will fit over them. Allow the pins to project above the scrap piece a little less than the thickness of the model. Place the model over these pins, and plane both sides in the usual way.
6. Sandpaper both sides and edges. Maintain correct corners.
7. Inspect for defects and remedy them.
8. Stain and finish to taste.

Fig. II. Rule.

Wood: Maple, or any close-grained hard wood.

Preparatory: Same as in Fig. 1.

Exercises.

- 1, 2. Same as in Fig. 1.
- 3, 4. Same as in Fig. 5, except that in planing the edges, especial care must be used that they are perfectly straight. It is better to be guided entirely by the eye in this, but if necessary, a steel straight-edge may be used for the final test. In work requiring such a degree of accuracy as this, the tools should be in perfect order, and so adjusted that they will take the thinnest possible shaving.

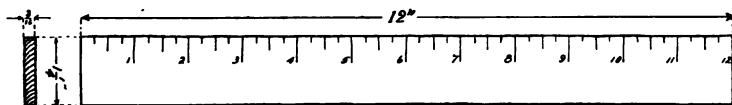

FIG. II.

5. In making the graduations, do not allow the students to lay out one inch at a time. Instead, lay out all the inch graduations at once, then the half inch, then the quarter inch, and eighths if desired. Insist upon absolute accuracy.
6. If the wood is straight grained, the rule may be planed upon both sides. If this cannot be done well, the students may sandpaper the sides to a smooth surface. If care is used in selecting the wood for this model, this may be done satisfactorily.

7. Finish with two coats of shellac, rubbed down in oil. See Fig. 6, Ex. 5.
8. If a set of $\frac{1}{8}$ " sharp steel figures is available, the inches may be marked before the rule is shellacked; otherwise the figures should be made very carefully with black drawing ink after the model has been rubbed with oil and polished.

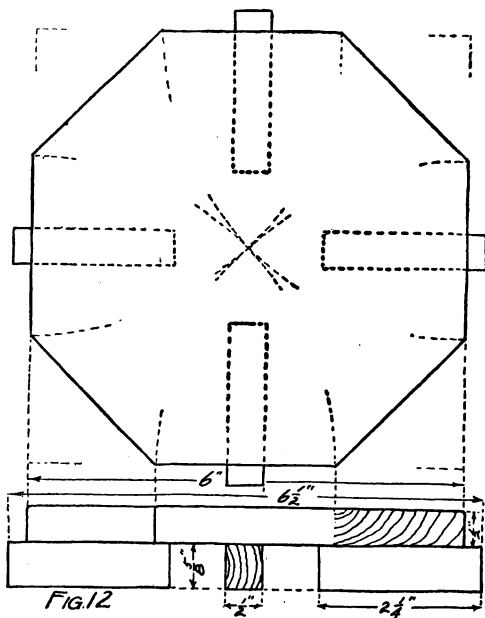

Fig. 12. Plant Stand.
Octagonal.

New subjects: Laying out an octagon. Nailing. Nails. Hammer.

Wood: Poplar.

Preparatory.

- A. Make working drawing.
- B. From $\frac{1}{2}$ " poplar, cut rough square $\frac{1}{4}$ " larger than required.

C. Make the piece for the foot long enough for all four pieces.

Exercises.

1. A. Plane edge 1. See Fig. 1.
- B. Lay out square accurately with a pencil.
- C. Draw diagonals from corner to corner across the face of the square, and set the compasses at one half of their length, measuring from either corner to the center. With the corners as centers, draw arcs as indicated; their intersection with the edges of the square will give the angles of an octagon.
- D. Connect these points across the angle.

2. A. With block plane, make ends 2 and 3 square with face edge and side, planing toward edge 4, as the chips will be cut off. See Fig. 1.
- B. Cut off corners diagonally with the grain, and complete the octagon.
3. Plane both sides.
4. Sandpaper both sides and edges.
5. A. Plane four sides of the piece prepared for the feet.
- B. Cut them to length. Place them together, and block-plane each end of the four at once.
- C. Sandpaper the feet.
6. A. Nail the feet in their places, locating them accurately. Use 1" brads.
- B. Set the nails.
7. Inspect carefully for defects, and remedy them as far as possible.
8. A. Shellac one coat.
- B. Color putty to match.
- C. Proceed with sandpaper and second coat in the usual way.

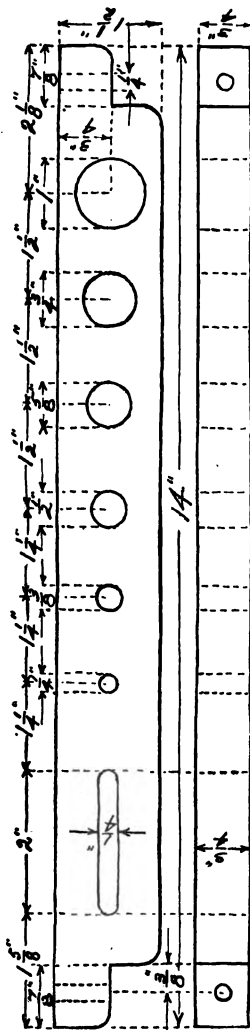

FIG. 13

Fig. 13. Tool Rack.

Wood: Pine, poplar, or basswood.

Preparatory: Same as in Fig. 1.

Exercises.

- 1, 2. Same as in Fig. 1.
- 3, 4. Same as in Fig. 5.
5. Space and bore holes, as indicated.
6. Cut ends to shape indicated, and bore holes for screws.
7. Sandpaper.
8. Inspect for defects.
9. Shellac finish if desired, or model may be left unfinished.

Fig. 14. Bench Hook. See C., Topic 81.

New subjects: Relation of dimensions to grain. German bits. Countersink. Screwdriver.

Wood: Basswood.

Preparatory.

A. Make working drawing.

B. Cut one piece $\frac{1}{2}$ " wider and $2\frac{1}{2}$ " longer than required to include all three pieces.

Exercises.

1, 2. Same as in Fig. 1.

3, 4. Same as in Fig. 5.

5. Cut from each end of above piece, one piece 3" long, or $\frac{1}{2}$ " longer than

required for short pieces.

6. Cut one of above pieces to the width of the narrower short piece. Cut out a blemish,

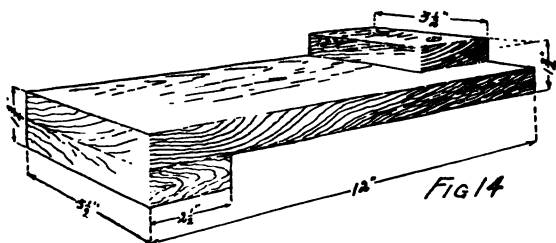

if there is one that can be removed in this way.

7. A. Smooth the largest piece of the three upon both sides, but do not sandpaper.
- B. Mark with the exact location of the blocks of each end on opposite sides. The distance between the vertical faces of the short pieces should come in the middle of the length of the large piece, leaving an indefinite distance at each end.
8. A. Bore and countersink screw holes in small pieces. Make the holes large enough to allow the screws to slip through easily.
- B. Hold the different pieces in their permanent positions by means of hand screws, and drive screws into the large piece to mark the holes there.
- C. Remove pieces.
9. A. Spread glue thinly on the bottom of one of the small pieces. Do not use enough glue to squeeze out, or it will make unnecessary work in cleaning it off.

- B. Place screws in holes as in Ex. 8, A and B, and turn them in. If the screws do not bring the pieces to a joint, apply hand screws until the glue sets. Be sure that the piece is exactly in its position. Repeat the operation with the other piece.
10. Consider the three pieces as one and treat them as in Exs. 1, 2, 3, 4, above, except that the vertical distance between the two short pieces should be the basis of the extreme length. This model should be neither sandpapered nor finished. Enough of these models should be made to keep the shop supplied with bench hooks.

Fig. 15. Cutting Board.

New subject: The ellipse.

Wood: Poplar.

Preparatory.

- A. Make working drawing.
- B. The teacher may make a pasteboard pattern a little larger than the required model, which will do to mark for rough cutting,

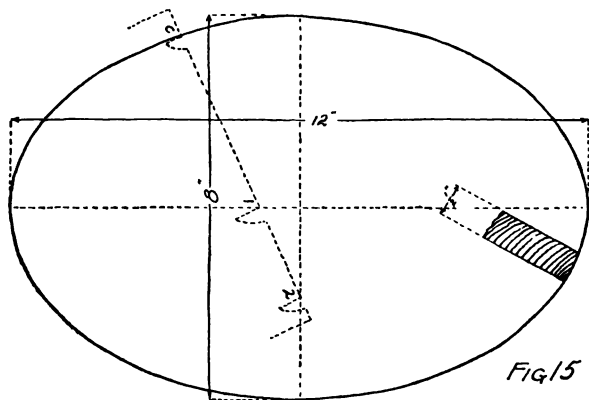

but the students should lay out the ellipse to exactly the right dimensions. This model should be cut from a board which is good on both sides, as both sides will be used.

Exercises.

1. Lay out the ellipse by trammel method, as follows: lay out or cut

notches from C (or the corner of a piece of card or thin wood) the distance $C-1$, which is equal to one half of the minor axis of the ellipse, and the distance $C-2$, which is equal to one half of the major axis. Place 1 on the major axis, and 2 on the minor axis, and C will indicate a point upon the circumference of the ellipse. Each time the positions of 1 and 2 are changed upon the axes, C locates another point on the circumference. These points should be close enough together to allow a freehand line to be drawn through them, which will be the desired form of the ellipse.

2. A. Saw to about $\frac{1}{8}$ " larger than desired.
- B. Finish to exact size and shape with spokeshave and wood file.
Make the edges square before they are rounded; otherwise they will be apt to have irregularities.
- C. Round the edges.
3. Plane and sandpaper both sides and edges.
4. Inspect for defects.
5. Shellac finish if desired, but it is unnecessary.

Fig. 16. Sand Shovel.

New subjects: Clinch nails. Stock lists. Three planes of projection.

See C., Chap. 4.

Wood: Poplar, oak, or maple.

Preparatory.

- A. Make working drawing.
- B. Make stock list.
- C. Cut blade of shovel from poplar, $\frac{1}{2}$ " longer and $\frac{1}{4}$ " wider than required.
- D. Cut back cleat of shovel from $\frac{1}{2}$ " poplar, making allowance for working.
- E. Cut the handle from $\frac{3}{8}$ " hard wood, 1" longer than necessary.

Exercises.

1. A. Apply Ex. 1, 2 of Fig. 1, and Ex. 3, 4 of Fig. 5, to the blade of the shovel. Do not taper it.
- B. Plane and sandpaper the best side only.
2. Make back cleat of required dimensions, not cutting it to length.
3. A. Using 1" tinned trunk, clout, or clinch nails, fasten the blade

to the cleat. Bore holes with a bradawl to insure that the nail will not split either piece of wood. Allow the ends of the cleat to project beyond the edges of the blade. Clinch the nails neatly on the top of the cleat, and be sure that no nail comes in the middle of the cleat, as it will interfere with fitting the handle.

B. Cut the ends of the cleat off flush with the edge of the blade, and touch lightly with the block plane.

C. Bevel the ends of the cleats.

4. Lay the blade under side up on the bench, holding the cleat against the edge, and taper it down to $\frac{1}{2}$ " at the thin edge. Use

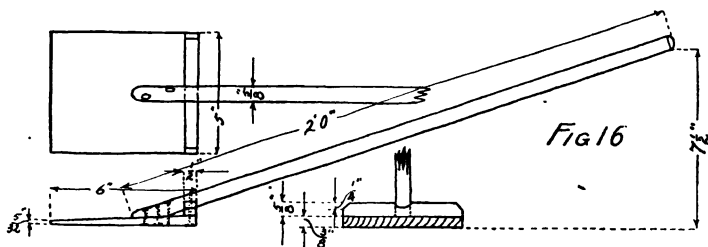

the jack plane, and guard against planing the heads of the clinch nails, which should be set a little under the surface of the wood.

5. A. Using the jack plane, square the handle to the required dimensions, leaving the piece the full length.
 B. Plane the corners until the piece is an accurate octagon the entire length.
 C. Plane each one of the eight corners off, and make the stick round. Set the plane to cut very fine in doing this, and in finishing it, the block plane may be used if very light touches are necessary, and if the cut does not tear the wood.
 Guard against the use of the spokeshave for this purpose, as it will result in making the piece too small. Do not depend upon sandpaper to round the handle, as it will not do it.
 D. Sandpaper the handle.
6. A. Cut the end of the handle to fit the angle of the blade.
 B. Make a notch in the cleat, which will fit the handle.

- C. Sandpaper the back end of blade and cleat, after they have been planed flush with a block plane.
7. A. With 1" and 1½" clinch nails, fasten the blade to the handle.
 B. Fasten the cleat and the blade to the handle with 1½" or 1¾" clinch nails.
 C. Bore holes carefully with a bradawl or small German bit.
 In making this model, the utmost care will be necessary in guarding against splitting the wood, especially in the handle.
8. Sandpaper the bottom and the edges of the blade.
9. A. Cut the handle to required length.
 B. Round the end of the handle, and sandpaper it.
10. Inspect for blemishes, and correct them.
 A model of this nature need not be finished.

Fig. 17. Dish Drainer.

New subject: Driving nails to give maximum grip.

Wood: Poplar.

Preparatory.

- A. Make working drawing.
 B. Make stock list.
 C. Get out slats ½" longer and ⅛" wider than required.

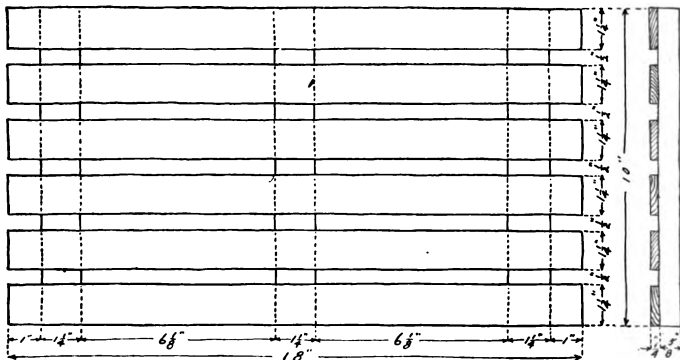

FIG 17

- D. Cut cleats with the same allowance for working.
 As a matter of economy, the slats for as many of these as will

be made should be ripped upon a circular saw at the mill, because it will be almost impossible to split these by hand without allowing the saw to catch, which will generally result in splitting the board and destroying stock.

Exercises.

1. Plane one edge of all cleats.
2. Place them together, planed edge all one way, and block plane one end.
3. Keep them all together, saw to length, and block plane the other end.
4. A. With a gauge, mark to width, one at a time.
B. Plane to gauge mark, one at a time. (It is not necessary that these edges should be planed perfectly square.)
5. Plane both sides and sandpaper.
6. A. Make cleats to desired size.
B. Plane and sandpaper.
7. A. Nail slats on the cleats, using $\frac{7}{8}$ " brads. Drive them slanting.
B. Set the nails a little below the surface; hold against a piece of flat iron to clinch the nails, if they are driven through.
C. Inspect for defects.
Finishing unnecessary.

Fig. 18. Coat Hanger. See C., Topic 82.

New subject: Laying out curves by points.

Wood: Poplar.

Preparatory: Same as in Fig. 1.

Exercises.

1. Same as Exs. 1, 2 of Fig. 1 and Exs. 3, 4 of Fig. 5.
2. A. Lay out points as indicated, by intersection of lines.
B. Draw curve; with elbow resting on bench and forearm as radius, a pencil held in the fingers will approximate the correct curve.
3. With compass, or with frame saw, cut to curved lines, allowing about $\frac{1}{8}$ " for working. Keep the saw square with the face of the piece, and use the try-square frequently to insure accuracy.
4. With spokeshave, make inside of curve true and square with sides.
5. With spokeshave, round the top to given dimensions; be sure that the corners of the curved edges are clean and sharp, and that no lumps are visible.

6. Plane the sides, and sandpaper the model all around. In this lies a fruitful source of trouble, as the majority of the students

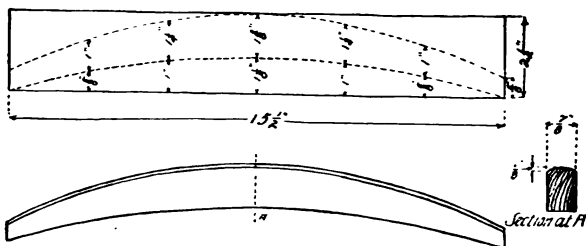

FIG 18

will round the corners, thus destroying the character and the grace of the curves.

7. Inspect for defects.
 8. Finish in the natural wood, with two coats of shellac rubbed in oil. (The teacher should guard against the tendency to make the model too small, which is more apparent in this than in many other models.)

Fig. 19. Key Rack.

New subject: Wood carving.

Wood: Poplar.

Preparatory. As in Fig. 1.

Exercises.

1. Same as Exs. 1, 2 of Fig. 1 and Ex. 4 of Fig. 5.
2. Plane smooth, but do not sandpaper.

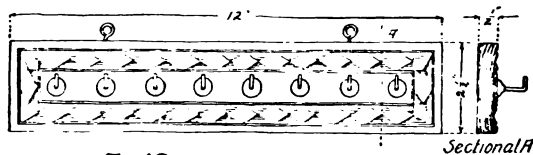

FIG 19

3. Draw simple design for carving. (The teacher should be sure that the carving tools are in perfect condition, as these, above others, require the attention of an expert.)

4. Drill in carving upon a piece of waste wood, making the design to be carved. Be careful that the cuts are not too deep ; ordinarily a cut $\frac{1}{8}$ " deep is sufficient for this kind of carving. Use a No. 11 veining gouge, a No. 2 skew chisel, and a chip carving knife for this work.
5. Locate holes for screw hooks and screw eyes and bore them with a bradawl.
6. Sandpaper. Use a block and keep the sandpaper well under control, so as not to destroy the sharp edges of the carving. Under no condition allow the sandpaper to touch a cut made by a carving tool.
7. Inspect for defects.
8. Stain and finish to suit the taste.

Fig. 20. Blotting Pad.

Wood: Cherry.

Preparatory.

- A. Make working drawing.
- B. Make stock list.
- C. Cut both pad and top of required thickness, making an allowance for working.

Exercises.

1. A. Lay out pad, or under piece with rough edges, and work one half of it to desired shape. Work from one straight edge.
- B. Cut to length, and make other half symmetrical.
2. Plane to required width. Bore holes for round-headed brass screws.
3. Make top to fit pad.
4. With a suitable gouge, cut the finger holes in the sides. If students are below the seventh grade, this model may be made of soft wood.
5. Inspect for defects.
6. Stain, and shellac or wax to suit taste.

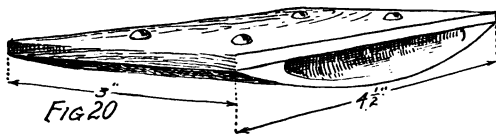
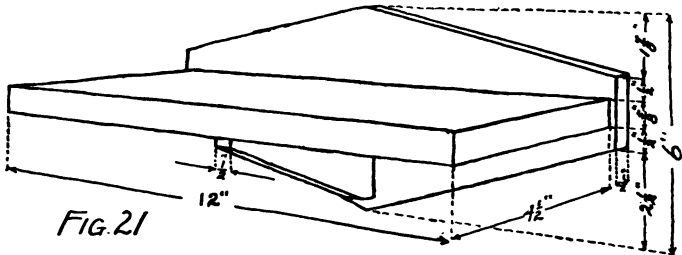

Fig. 21. Bracket Shelf.*Wood:* Poplar.*Preparatory.*

- A. Make working drawing.
- B. Make stock list.
- C. Cut the shelf and back $\frac{1}{4}$ " wider and $\frac{1}{2}$ " longer than desired.
- D. Cut bracket by pattern, for the sake of economy.

*Exercises.*

1. Same as Exs. 1, 2 of Fig. 1 and Exs. 3, 4 of Fig. 5, applied to the shelf only.
2. Lay out back with pencil and work carefully to lines.
3. Plane and sandpaper the shelf and the back.
4. Using $1\frac{1}{4}$ " brads, nail the shelf to the back, being sure that they are square with each other.
5. Make bracket in accordance with original design.
6. A. Fit bracket to both shelf and back. Fit the end wood first.
B. Plane and sandpaper it.
Fasten in place with brads, and with glue used sparingly.
- C. Set nails.
7. A. Stain.
B. Putty nail holes.
C. Inspect for defects.
D. Shellac or wax finish.

Fig. 22. Pen Tray.*New subjects:* Inside and outside gouges.*Wood:* Cherry, or gumwood.

Preparatory: Same as in Fig. 1.

Exercises.

1. Same as Exs. 1, 2 of Fig. 1 and Exs. 3, 4 of Fig. 5.
2. Plane top and bottom.
3. Lay out recess in tray.
4. With an outside gouge of somewhat smaller curve than that required, cut the recess. Be sure that the edge of the recess is clean and true.

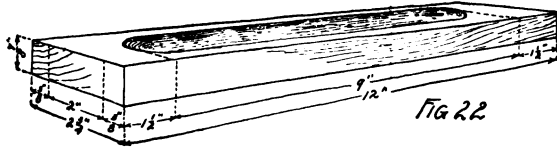

5. Sandpaper recess and top of piece. Be sure that the sharp corners and true edges are preserved.
6. Inspect for defects.
7. Finish with shellac, rubbed in oil.

Fig. 23. Plant Stand.
Halved.

New subject: The halved or lock joint.

Wood: Poplar.

Preparatory: Cut two pieces as required, making allowance for working.

Exercises.

1. Make pieces of form and dimension required.
2. Mark the cuts for the lock joint. Be sure that they are made small enough to insure a tight fit, but not small enough to bruise the wood in pressing the joint together.

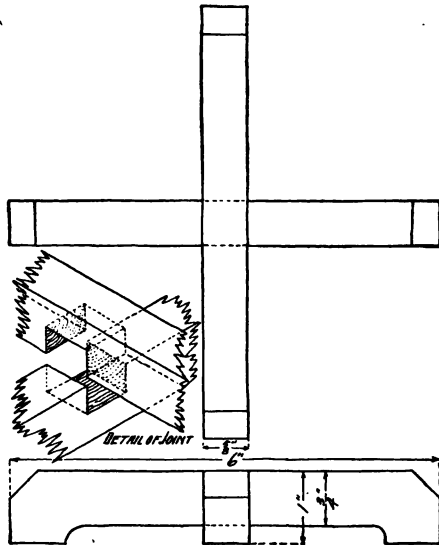

In doing this, do not measure with a rule to obtain the marks, but mark directly from the pieces which are to come together.

Use the gauge for the depth mark. Square down for sides of the cut

3. A. Make the cuts with the backsaw. Be sure to cut inside of the lines, but leave the lines on the wood.
- B. If too tight, do not chisel by guess, but make an accurate knife mark to receive the edge of the chisel in making the cut.
- C. Inspect for defects.
4. Stain or shellac to suit taste.

Fig. 24. Bird House.

New subjects: Use of steel square in laying out gable. Paint; its composition and uses.

Wood: Pine, or poplar.

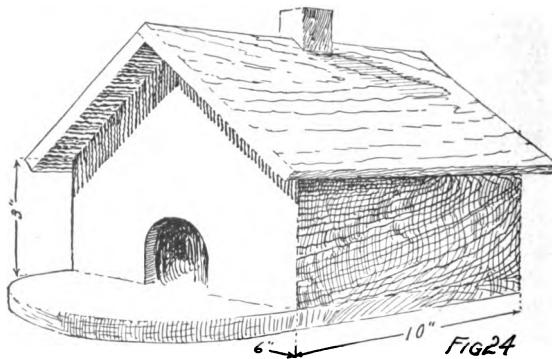

Preparatory.

- A. Make working drawing.
- B. Make stock list.
- C. Cut all pieces, making allowance for working.

Exercises.

1. Cut the ends with half pitch gable; make edges square. Grain to stand vertically.
2. A. Cut door in one end.
B. Plane outside of end.
3. A. Make sides of desired dimensions.

- B. Plane the outsides.
4. A. Nail sides to ends.
B. Bevel upper edges to same pitch as the roof.
C. Plane the bottom of the ends and sides flush.
D. Sandpaper ends and sides.
5. A. Make bottom of the desired size.
B. Fit the ends and sides of the house to the bottom.
C. Nail the bottom on to the ends and sides of the house with $1\frac{1}{2}$ " brads.
6. A. Cut both roof pieces to desired size. Plane outsides.
B. Nail the narrow roof board in its place.
C. Be sure that the tops of the gable and the top edge of the roof board are exactly in line, or the other piece will not fit closely.
D. Nail the wide roof board in its place.
E. Smooth joint at ridge of roof, and sandpaper both roof boards and their edges.
7. Make and fit chimney, and nail to its place.
8. Inspect for imperfect work, and correct defects.
9. Paint the house with two coats to suit.

Fig. 25. Glove Box.

New subject: Use of the miter box.

Wood: Poplar.

Preparatory.

- A. Make working drawing.
- B. Make stock list.
- C. Cut all pieces, making usual allowance for working. Cut the top from a piece of straight-grained, soft wood, which will make the carving easier. The triangular pieces that hold the top in place should not be cut until the work is ready for them.

Exercises.

1. A. Work pieces of the rim to required size by usual method.
B. Plane and sandpaper both sides of each piece.
2. Nail the pieces together; the ends between the sides. Use $\frac{3}{8}$ " brads, and place the poorest side inside of the box.
3. Finish the outside of the ends with sandpaper. Be careful not to

rack the box in doing this. Do not sandpaper the top or bottom edges of the rim.

4. A. Make the bottom of the box $\frac{5}{8}$ " longer and $\frac{5}{8}$ " wider than the rim of the box. Measure from the rim itself; do not take the dimensions from the stock list.

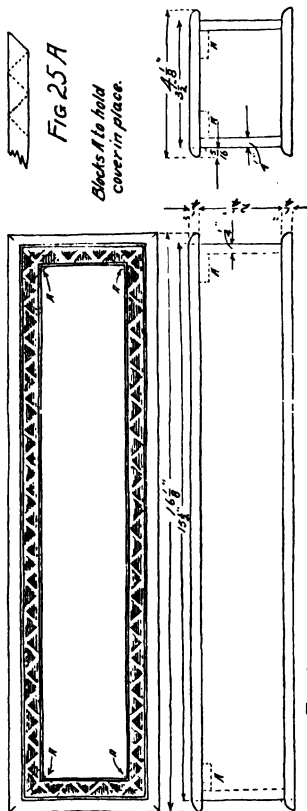

- B. The top, or the best side, should receive a quarter round on all edges. Be sure that the round is true, and that it does not extend on far enough to prevent the rim from fitting the bottom perfectly.

- C. Plane and sandpaper the bottom.
 D. Fit the rim to the bottom of the box. It is important that there should be a perfect joint upon the outside, to insure which, see C., Topic 84 C.
 E. Be sure that the rim of the box is square, and nail the bottom to it with $\frac{3}{4}$ " brads.

5. A. The dimensions of the top should be ascertained in the same way as those of the bottom.

- B. Round all edges to make a thumb molding, or round them under so that they suggest the form of the thumb when held with the ball up. Insist upon the correct contour of the curves of both the top and bottom.

C. Plane both sides of the top. Do not sandpaper.

6. Select a simple design for carving. Draw it carefully with a hard pencil, and with tools in good order, proceed to cut the design.
 7. See Ex. 6, Fig. 19.

8. A. Cut triangular pieces from a piece $\frac{3}{4}$ " wide. Make the cuts as indicated in Fig. 25 A. Sandpaper them.
 - B. Find their exact location by laying the top bottom-side up on the bench ; place the rim in its place upon the top while in this position. Mark the two sides of the angle of each corner with a sharp knife. Remove the rim, and measure the thickness of the rim in from these marks.
 - C. Fasten the triangular blocks in their places, using glue very sparingly.
9. Plane top of rim to fit the under side of the cover.
 10. Inspect for defects.
 11. Stain, color putty, shellac, or wax to suit taste.

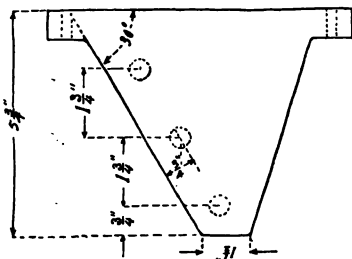

Fig. 26. Rod Towel Rack.

Wood: Poplar, or oak.

Preparatory.

- A. Make working drawing.
- B. Make stock list.
- C. Cut out ends. To do this economically, an approximate pattern should be made.
- D. Get out squares for the rods, $\frac{1}{8}$ " larger than required.

Exercises.

1. Lay out the exact size and shape of the ends, and work to the lines. Keep the edges square with the sides.
2. A. Locate and bore holes for rods, boring right and left, and only halfway through the ends.

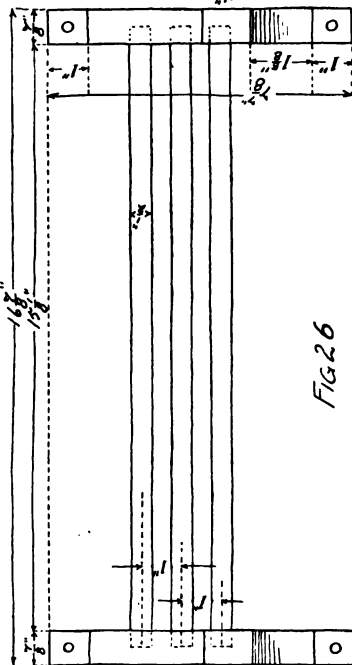

FIG 26

- B. Bore the holes in the ends to receive the screws.
3. A. Plane the rods to the required size. See Fig. 16, Ex. 5, B and C.
- B. Cut them to required length. Be sure that the rods are no smaller than they should be.
4. Plane and sandpaper the ends.
5. With a small stick, cover the sides of the holes sparingly with glue.
6. Put all the rods in at once; be sure that the ends are square with them, both vertically and horizontally, when the rack is put away for the glue to set.
7. Examine for defects, and remedy them.
8. Stain and finish to suit taste.

Fig. 27. Corner Shelf.

Wood: Poplar.

Preparatory.

- A. Make working drawing.
- B. Make stock list.
- C. Select a board of the desired thickness, and of a width at least equal to the radius of the arc of the front of the shelf.
- D. With a steel square, mark the two back edges of the shelf, so that the grain will be parallel with the chord of the front arc. Hold the square as though cutting an angle of 45° , its angle indicating the center of the front arc.
- E. Cut one piece of a size which will include the two back pieces with allowance for working.

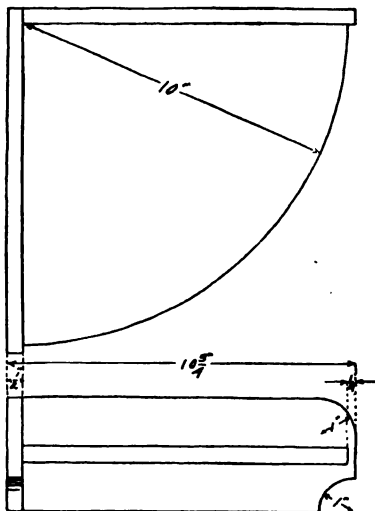

Fig 27

Exercises.

1. A. With compasses, draw the curve of the front of the shelf, and saw $\frac{1}{8}$ " larger.
- B. With the spokeshave, work the edge of the shelf to correct line.

2. Plane the back edges of the shelf square with each other and with the face side.
3. A. Plane both top and bottom sides of the shelf.
B. With the spokeshave, take a few light shavings from each of the corners of the front edge.
C. Sandpaper these corners to the form shown in the sketch.
4. A. Make backs of required dimensions.
B. Plane and sandpaper.
5. Nail backs in place. Set nails.
6. Remedy defects.
7. Stain, color putty for nail holes, and finish to suit taste.

Fig. 28. Wall Pocket.

Wood: Poplar.

Preparatory: Same as in Fig. 1. Apply to each piece.

- A. Make stock list.
- B. Cut pieces for carvings first.

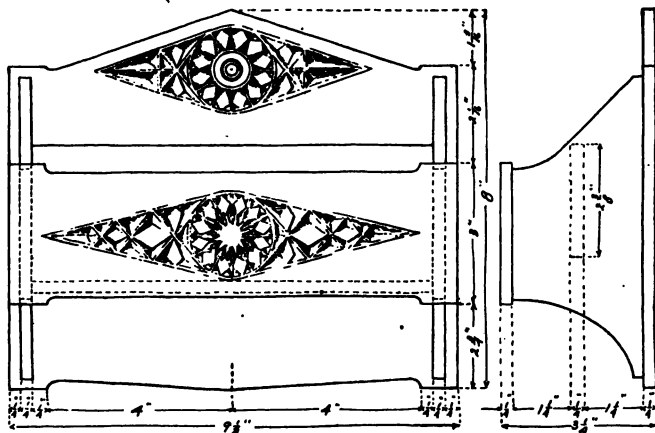

FIG 28

Exercises.

1. A. Work all pieces to required dimensions and form, designing original details where possible.

2. Plane pieces which are to be carved.
3. Draw simple design for carving, and proceed to cut both pieces.
4. A. Plane and sandpaper the end, partition, and bottom pieces.
B. Sandpaper carved front and back.
5. Nail together with $\frac{3}{8}$ " brads. Set nails.
6. Remedy defects.
7. Stain and finish. Color putty for nail holes.

Fig. 29. Sleeve Board.

New subjects: Wedged pin. Scribing (See C. C. Topic 79). Scraper.

Wood: Oak and poplar.

Preparatory.

- A. Make working drawing.
- B. Make stock list.
- C. Cut all pieces as needed. Make allowance for working.

Exercises.

1. A. Make base of required dimensions.
B. Bore holes for pins of standards.
C. With a round file, make the holes a little longer on the under side of the bottom, to allow the wedge to expand the pin.
D. Plane top and bottom sides of the base.
2. Make standards, with pins which fit the holes of the base closely. Do not cut the tops of the standards off. Leave pins a little longer than required. The standards should be long enough to allow several attempts at fitting the shoulder, if necessary.
3. A. Place the pins of the standards in their holes, and see if the shoulders fit the back perfectly; if they do not, proceed as follows:—
B. "Scribing." Push the pin into the hole until the shoulder stops against the back.
C. Lay a scraper, or piece of wood a little thicker than the greatest opening of the joint, upon the bottom close to the standard.
D. Make a knife mark around the standard, being guided by the thickness of the piece described in C above. See Fig. 29 A.
E. With a sharp chisel, cut exactly to these marks, being sure that the wood of the inside of the shoulder is shorter than at the surface. If this is done accurately, a perfect joint will result.
F. Repeat this process with the other standard.

G. Mark the center of the holes in the standards which are to receive the skeins of the axle. Bore them partially through.

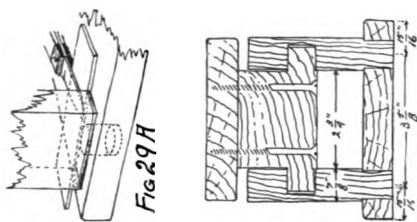

H. Make the tops of the standards of the desired form.

I. With the backsaw, make a cut the entire length of the pin of each standard, in the center of the pin, and at right angles with the width of the standard. This is to receive the wedge.

J. Plane, scrape, and sandpaper the standards.

4. A. Make the axle of oak. The shoulders and skeins must fit the standards. These must be held in place temporarily while the axle is being fitted.

B. Plane, scrape, and sandpaper.

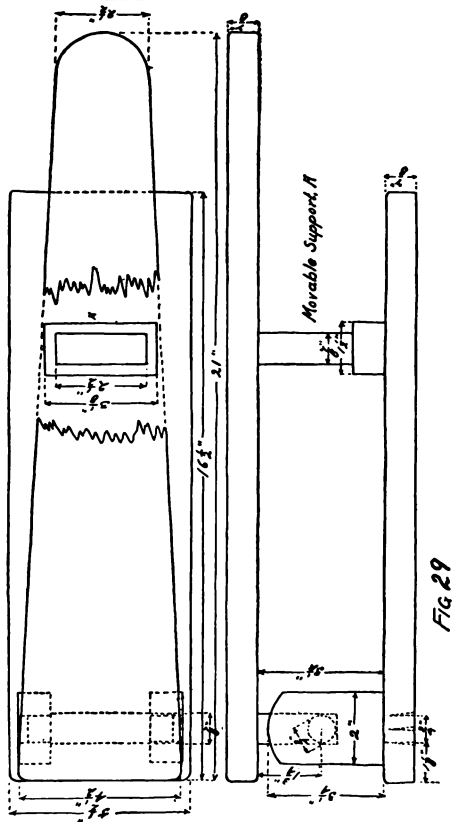

5. A. Make sleeve board of the required size and form.
B. Plane and sandpaper.
C. Fasten the axle to the sleeve board by the method indicated.
6. Scrape and sandpaper the top side of the bottom, and round the top corner.
7. A. Enter the skeins of the axle in the standards, and put the pins of the standards through the holes in the base.
B. Fasten the standards permanently by wedges, which will force the pins to fill the elongated holes. Use glue sparingly. A wedge used for this purpose must be placed at right angles with the grain surrounding the hole which contains the pin. Generally it should be of the same kind of wood.
8. Plane the ends of the pins flush with the underside of the bottom. It is unnecessary to do anything more to this side.
9. Make the two pieces for the support of poplar.
10. Remedy defects.
11. Shellac all but the poplar sleeve board, which will be covered with cloth before it is used.

Fig. 30. Cart.

Wood: Poplar, maple, or oak.

Preparatory.

- A. Make working drawing.
- B. Make stock list.
- C. Cut a piece $\frac{1}{4}$ " wider than height of rim, and long enough to include the four pieces.
- D. Cut bottom $\frac{1}{2}$ " longer and $\frac{1}{4}$ " wider than desired.
- E. Get out pieces for the wheels $\frac{1}{2}$ " larger than required.
- F. Hard wood for the axle, $\frac{1}{8}$ " wider and $\frac{1}{2}$ " longer than required.
- G. Maple or oak for tongue, $\frac{1}{8}$ " larger in square, and 1" longer than required.
- H. Make piece for cross handle long enough to grasp while working it down to dimensions.

Exercises.

1. Same as Exs. 1, 2, 3, and 4 in Fig. 1, applied to each piece of the rim.
2. Plane these pieces on both sides. The poorer side will go inside of

the box, and should be sandpapered before the rim is nailed together. Guard against sandpapering the ends of either piece.

3. A. Nail the rim together, the short ends between the sides.
Use four $1\frac{1}{2}$ " brads to each corner.
- B. Plane the bottom of the rim perfectly straight to fit the bottom of the body. See C., Topic 84 C.

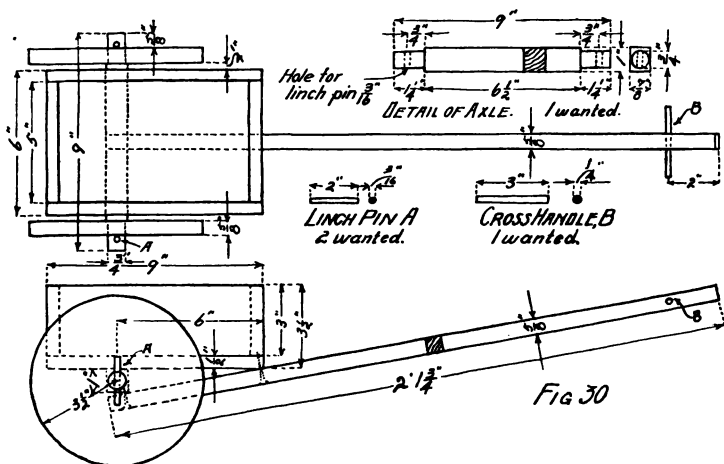

4. A. Plane one edge of the bottom straight.
- B. Plane and sandpaper the best side.
- C. Nail planed edge to the bottom, the best side on the inside of the body. The grain should extend lengthwise.
- D. Be sure that the rim is square, and nail the bottom all around.
5. A. Plane the edges of the bottom flush with the rim.
- B. Make the ends of the rim and the ends of the sides flush.
6. A. Mark the wheels to the exact size; in sawing, leave $\frac{1}{8}$ " for working.
- B. Bore holes for skein; be sure that they are square with the sides of the wheel.
- C. Smooth edge line with spokeshave and wood file.
- D. Plane and sandpaper the sides of the wheels, but not the edges.

7. Work the axle to required dimensions. Be especially careful that the skeins are made accurately. This will be the most difficult part of the work.
8. Fasten the axle to the box by means of screws through the bottom.
9. A. Work the tongue to required dimensions.
B. Fit it to the axle and body.
C. Bore the hole for the cross handle.
D. Make the handle round, and cut to length. Fasten it in place.
10. A. Remove wheels from the body.
B. Plane the top of the rim, and sandpaper it.
C. Sandpaper the outside of the rim.
D. Fasten the tongue in its place.
11. Put on the wheels. Make and fit the linchpin.
12. Remedy defects.
13. Smooth sharp and ragged corners by touching them lightly with sandpaper.
14. Finish with shellac, if any finish is desired.
This model sometimes is made in the lower grades by using $\frac{1}{2}$ " and $\frac{1}{4}$ " material.

Fig. 31. Towel Roller.

Wood: Poplar.

Preparatory.

- A. Make working drawing.
- B. Make stock list.
- C. Cut piece for the back, one piece for the two brackets, and one for the roller, $\frac{1}{8}$ " larger than required.

Exercises.

1. Make the back of desired shape and size.
2. A. Make brackets of size indicated, but of original detail.
B. Bore holes in the brackets to make them right and left. Cut the groove in the right-hand bracket, which allows the roller to enter.
C. Bore screw holes in the back for the brackets.
D. Fasten the brackets on temporarily.
3. A. Remove brackets from the back.

- B. Plane both sides of the back.
- C. Draw design for carving.
- D. Put tools in order and cut the design.
- 4. A. Sandpaper the face side of the back, and both sides of the brackets.
- B. Fasten brackets on permanently. Use glue sparingly.
- 5. A. Work roller to the required size, and perfectly round. Use smoothing or block plane to finish it. Cut to exact length.
- B. Mark size of pin on end to fit holes in bracket.

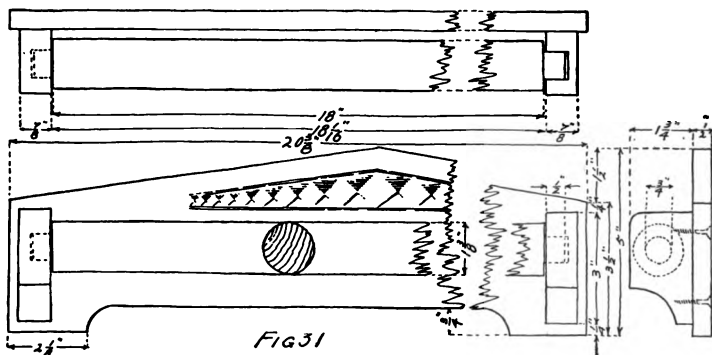

- C. Locate shoulders. Wind a piece of straight-edged paper around the roller, the straight edge just touching the point which indicates the shoulder. Mark around the roller by the edge of the paper. Cut the shoulder with a backsaw, as far as the pin described in B. Finish the pin with a knife or with a sharp chisel.
- 6. Remedy defects.
- 7. Sandpaper the roller.
- 8. Stain, shellac, or wax to suit taste.

Fig. 32. Knife Box.

New subjects: Squaring by diagonals (See W., Topic 88 E.). Grooving or housing.

Wood: Pine, or poplar.

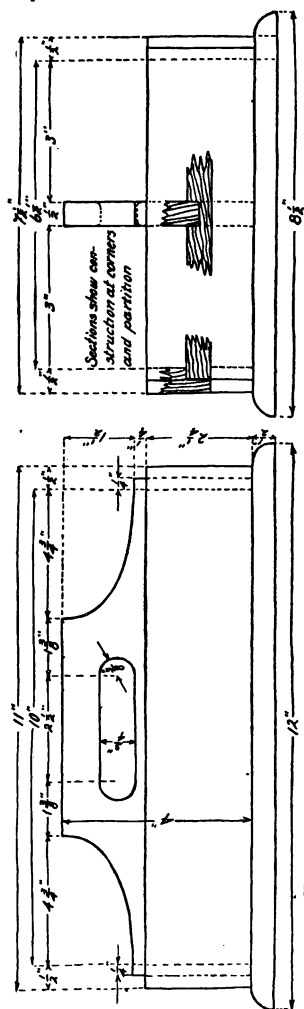

Preparatory: After the working drawing and stock list have been made, cut all pieces as in Fig. 1.

Exercises.

1. Work sides and ends to required dimensions.
2. Make halved cuts at ends of sides to receive the ends.
3. Cut grooves in the center of the insides of the ends to receive the ends of the handle or partition. To insure a good fit, these grooves should be made a little smaller, not a measurable distance, but enough smaller to make it necessary to use a little force to push the partition into its place. Mark by the piece which is to fit in, remembering that it will be a little thinner after it has been planed on both sides.
4. A. Plane these pieces on both sides and sandpaper the insides.
B. Nail them together, using 1" and 1 1/4" brads. Nail the corners both ways. Be sure that the grooves are on the inside, and that the box is square when this part of the work is completed. Square by diagonals, and tack on a small piece to hold it square. See W., Topic 34 B.
5. A. Make the bottom 1" longer and 1" wider than the rim of the box.

B. Plane the edge to a quarter round. Maintain a good full curve.

See Fig. 25, Ex. 4 B.

C. Plane and sandpaper.

6. Plane the bottom of the rim to fit the bottom of the box.

7. Nail the bottom to the rim of the box.

8. Plane the top of the rim, and sandpaper it.
Remove the ragged edges by touching it lightly with sandpaper.

9. A. Cut the partition to just the right length to fill the grooves prepared for it.

B. Make original design for the handle.

C. Plane sides and sandpaper.

D. Finish edges accurately to desired form.

E. Fasten in place with glue and 1" brads.

Use glue sparingly.

10. Remedy defects.

11. Stain and finish as desired. Color putty for the nail holes.

Fig. 33. Paper Knife.

Wood: Maple.

Preparatory: Same as in Fig. 1.

Exercises.

1. Plane to exact width. Both edges straight and square.

2. A. Draw the shape of the knife.

B. Bore holes in handle; cut out between them.

C. Shape the outside of the knife to lines.

3. With a sharp knife, or outside gouge of the same curve, cut the curve at the end of the handle where it joins the blade. Guard against cutting too deep.

4. With rasp and smoothing plane, work the blade down to the required thickness, finishing one side first, but not making the edge sharp. Be sure that the contour of the ends of the handle is accurately preserved.

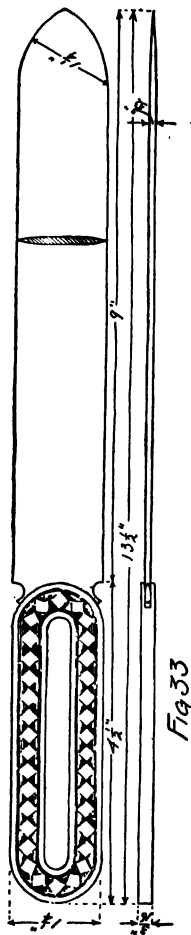

5. Secure a piece of pasteboard, or thin wood, of a thickness equal to the amount of wood cut away in Ex. 4. Place this under the blade to give it stiffness, while the other side of the blade is being worked down to make it of the proper thickness. Make both sides of the blade free of inequalities.
6. A. Work the blade down to a sharp edge, which must be in the center of the thickness of the blade.
B. Plane and scrape the handle, and the blade if necessary.
7. With a hard, sharp pencil, lay out a simple design for carving. One or both sides may be carved. Make shallow cuts, as the figures will have to be small.
8. Remedy defects.
9. Finish with two coats of shellac, and oil. Natural color.

Fig. 34. Picture Frame.

New subject: Cutting a rabbet.

Wood: Cherry, or poplar.

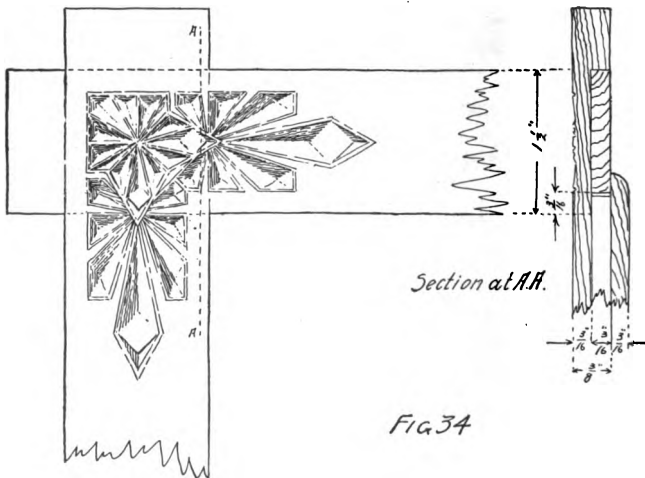

Preparatory: Decide size of frame. Preparatory of Fig. 1, applied to all pieces.

Exercises.

1. Work the pieces of the frame to required size.
2. Make lock joints. See C., Topic 61.
3. Cut rabbets in back of opening.
4. A. Smooth and sandpaper the edges, being careful not to touch the wood at the joint.
B. Glue together. Use the glue sparingly.
Be sure that the face of the frame is out of wind when the frame is set away for the glue to harden.
5. A. With a smoothing plane, plane the face and the back.
B. Scrape the face and the back, and make both ready for the sandpaper. In both of the above, smooth the back first, as that will minimize the danger of scratching the face.
6. With a hard pencil, draw a simple carving design.
7. See that tools are perfectly sharp, and cut design.
8. Make the back to required dimensions.
9. Sandpaper frame, and plane and sandpaper the back.
10. Remedy defects.
11. Finish as desired.
12. Fasten the back on temporarily with small brads.

Fig. 35. Folding Towel Rack.

Wood: Poplar.

Preparatory: Same as in Fig. 1, applied to all pieces. Make stock list. The brackets should be included in one piece.

Exercises.

1. Make and finish back of size and shape required. Be sure that the chamfer is the same on all sides.
2. Bore holes in the back for the pins of the bracket.
3. A. Lay out a shoulder and pin on each end of the piece prepared for the brackets, or standards.
B. Cut each shoulder, and fit it to the back. Brackets fitted to back by the same method used in Fig. 28, Exs. 2 and 3, omitting F, G, H, and I of Ex. 3.
4. A. Make the brackets of the required shape and size.
B. Bore the holes for the pin which supports the arms, about $\frac{1}{4}$ "

deep. Be sure that the holes are made in the sides of the bracket that face each other.

5. Make the arms of the required size and shape, so that when they are in their places, there will be no play.
6. Bore the holes in the arms for the pin upon which they swing. These should be bored with the utmost accuracy, so that the arm will swing horizontally. Finish top of standard or bracket.
7. Make the pin upon which the arm swings to pass just through

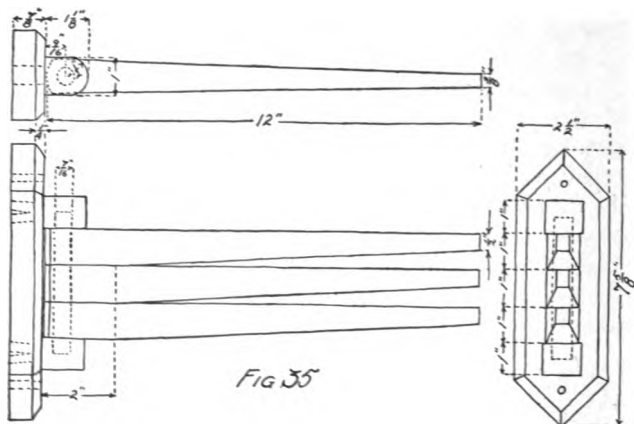

Fig 35

the hole, not a tight fit, but loose enough to allow the arm to move.

8. See Fig. 28, Ex. 1 C.
9. Plane and sandpaper everything except the back and the edges of the back.
10. A. Pass the pin through the arms and into the holes made to receive them in the brackets or standards.
B. See Fig. 28, Ex. 7 B.
11. A. See Fig. 28, Ex. 8.
B. Sandpaper the edges and the chamfer.
C. Inspect for defects and remedy.
12. Stain and finish as desired.

Fig. 36. Letter Box.

New subjects: Cutting in hinges. Hinges.

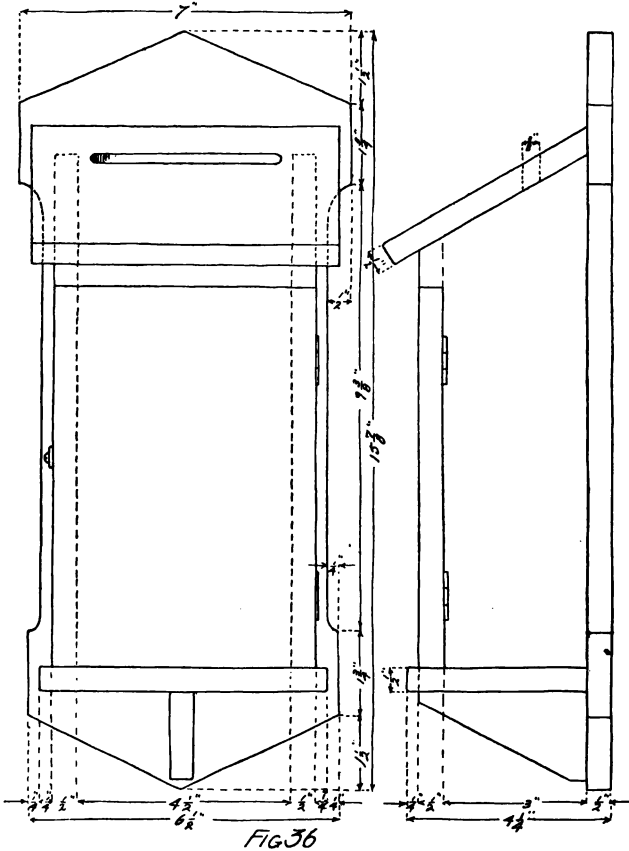

Wood: Poplar, or oak.

Preparatory: Same as in Fig. 1, applied to all pieces. Make stock list.

Exercises.

1. Make all pieces of the required shape and size. Original designs preferred.

Do not bevel the top of the header, or the piece which is above the door.

2. A. Plane and sandpaper all pieces.
B. Fasten them in their places with $1\frac{1}{2}$ " brads, and with glue used sparingly. Hold sides in place while nailing through the back into them.
3. After the header is in place, bevel the top to the same pitch as the top of the sides.
4. A. Make the top of size and shape required.
B. Bevel the top edge to fit the back.
C. Nail it in its place. Be sure that the nails through the back into the top are not long enough to interfere in cutting the letter hole.
D. Cut the letter hole. Nail through the back into the top.
5. A. Make bracket of required size, and of original design.
B. Fasten it in its place with glue and nails.
6. A. Make the door to fit closely between the bottom and header.
B. Cut the thickness of the hinges in the edges of the sides. This gives more wood in the door to receive the screws. If the door does not swing exactly in its place, the hinges may be moved a little by placing the screw to one side of the hole in one side of the hinge, so that it will push the hinge in the direction desired.
7. Inspect for defects, and remedy.
8. Stain and finish as desired.

Fig. 37. Foot Rest. See C, Topic 83.

Wood: Oak, ash, or elm. Poplar or basswood top, if it is not upholstered.

Preparatory: Same as in Fig. 1, applied to each piece as it is wanted.

Exercises.

1. A. Make each piece of required dimensions.
B. Do not block-plane either end of the legs.
C. Plane all sides of each piece.
2. A. Cut the notches for the halved and locked joints.
Measure directly from the pieces which are to make the joint, not from dimensions taken by the rule.
B. With a sharp gauge, make the depth cuts of all pieces. Take

out $\frac{1}{4}$ " from each piece which is to form the joint. (The workman always tries to make all marks that are alike with one setting of the gauge. This is, in general, the method which should be followed.)

These marks should be made a trifle smaller than actually desired, to insure a close fit, but not so close that the pieces will be bruised in bringing the joint together.

3. Scrape and sandpaper all the pieces, and glue them together.

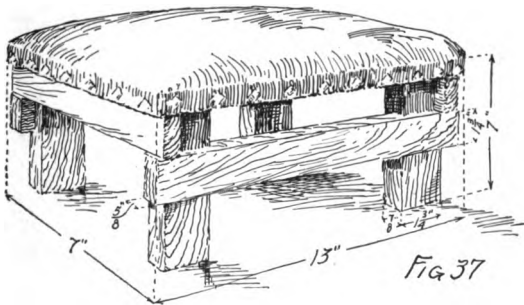

4. If an upholstered top is desired, the top board may be of any wood, which may be nailed to the end rails. If a top of the same wood as the rest is wanted, it may be fastened by screws through the end rails, or by one of the methods of doweling explained in C, Topic 69 C.
5. Remedy defects.
6. Stain and finish as desired.
7. If the top is to be upholstered, the filling of the cushion should be put in place and held there by a coarse cover, before the model is finished, after which the leather or cloth may be fitted and fastened by ornamental upholstery nails.

Fig. 38. Toilet Case.

New subjects: Moldings. Bead plane. Clamps.

Wood: Poplar, elm, or butternut.

Preparatory: Same as in Fig. 1, applied to cutting each piece as it is wanted.

Exercises.

1. A. Mark face side, and plane one edge of the stiles square with it. Leave ends longer than required.

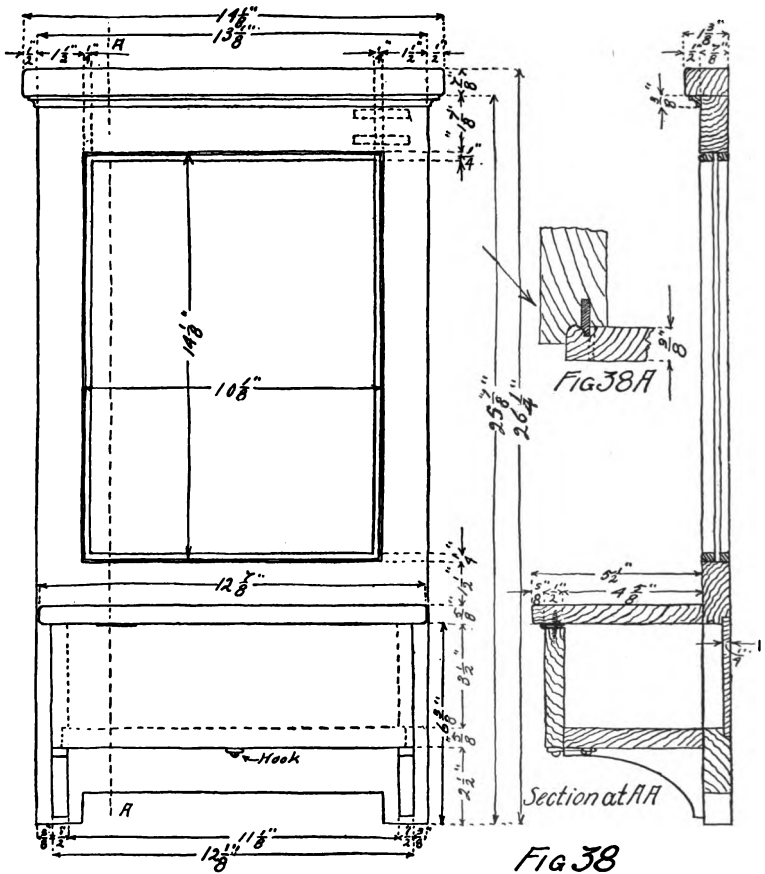

- B. Mark face side and plane one edge of the top rail, and one edge each of the middle and bottom rails.

- C. Mark with knife, cut, and block-plane one end of each rail to make a square joint against one of the stiles.
- D. Mark with a knife, cut, and block-plane the three rails to exact length required, so that the other end of them will make a square joint against the other stile.
- E. Plane the other edge of the middle and bottom rails.
- F. Make the joints of the frame with two $\frac{3}{8}$ " dowels. See C, Topic 69 A.

Allow the stiles to project indefinitely beyond the top and bottom rails, being sure that enough is allowed at the bottom for the piece that projects below.

- 2. Glue frame together. Keep faces of rails and stiles flush by using hand screws. Hold together by clamps until the glue has set.
- 3. A. Plane the face and the back of frame roughly, to remove glue.
B. Plane the edges.
C. Cut the top ends of the stile off flush with the top of the top rail, and square it to receive the cap.
D. Cut bottom of the stiles off to the required length and block plane.
E. Cut the rabbet in the middle and bottom rails, and the stiles to receive the back of the brush case.
F. Smooth the face of the frame. Sandpaper. See W, Topic 68 D.
- 4. A. Make the top shelf of given dimensions. Plane and sandpaper.
B. Fasten it to the back with screws. Be sure that it is square with the face of the back.
- 5. A. Make the bottom shelf of the given dimensions.
B. Plane and sandpaper it.
- 6. A. Make the brackets of the given dimensions, and from original design.
B. Fit them to the back and top shelf. The top of the brackets should be grooved into the under side of the top shelf, if the best job is desired, but it will be satisfactory to some if the shelf rests squarely upon the top of the brackets, and is nailed with $1\frac{1}{2}$ " brads. However, if the brackets are fitted squarely against the top shelf, the workmanlike way to fasten them is to make a doweled joint, by one of the methods explained in C, Topic 69 C.

- C. Cut the grooves in the brackets for the bottom shelves.
- D. Fasten the brackets and the lower shelf together with glue and a hand screw, and to the frame with screws through the back. The joint with the top shelf should be made at the same time.
7. A. With a $\frac{1}{4}$ " bead plane, make the glass beads, and plane them all to a uniform width and thickness. Cut the beads with a bead plane, as shown in Fig. 38 A. Saw them, as indicated, plane, and sandpaper. (Drill upon a scrap in the use of the bead plane. The pressure should be exerted lightly in the direction indicated by the arrow.)
B. Miter glass beads in the frame, flush with the face, and nail it with $\frac{3}{4}$ " brads.
8. A. Make the cap of the desired dimensions.
B. Plane and sandpaper.
C. Nail it in place, or fasten it by dowels if preferred.
9. Miter a small molding under it. (May be secured at any mill.)
10. Cut the back to the required size, and nail it in its place.
11. Make the flap of suitable size to fit its opening closely.
12. Cut in the hinges. Use the gauge to obtain the depth of the cut for the thickness of the hinge, which should all be cut out of the flap.
13. Smooth and sandpaper the flap.
14. Put the hinges in the flap so that a little more than half of the round of the hinge will project beyond its face.
15. A. By careful measurement with the dividers or compasses, find the centers of the screw in the underside of the top.
B. By manipulating the screw holes to one side or the other of the center line, the hinge may be pushed in or out or endways, to make the flap hang just as it should.
16. Cut strips to hold the mirror in from the back, or cut a backboard of $\frac{1}{4}$ " material to cover the entire back. This latter is preferable, though not shown on the sketch.
17. Inspect carefully, and remedy defects.
18. Stain and finish as desired.
19. Secure a suitable flat hook, and place on the under edge of the flap.

Fig. 39. Drawing Board. See C, Topic 86.

New subjects: Gluing a wide board. Warping of a wide board. Its effect minimized. Traverse planing.

Wood: Pine and maple, or oak.

Preparatory.

- A. Make working drawing.
- B. Make stock list.

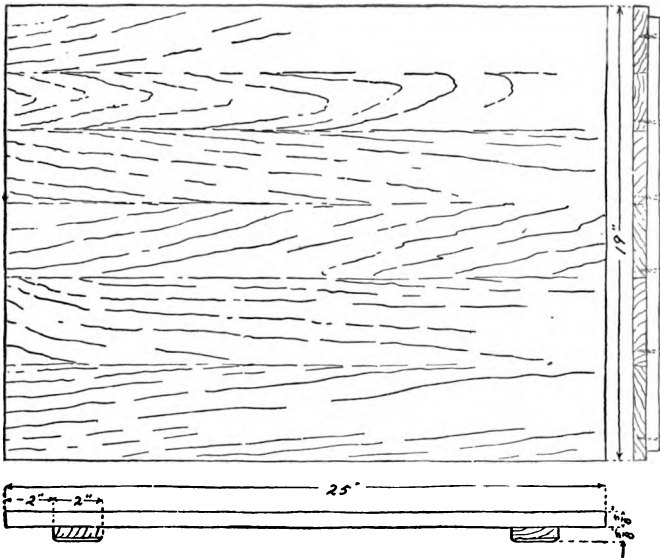

FIG 39

C. Cut pieces for the board, not over $3\frac{1}{2}$ " wide, which will make the desired width after jointing and finishing.

D. Cut cleat from maple or oak.

Exercises.

1. Joint the pieces together. Read carefully C, Topic 86 A. See also C, Topic 54.

Use $\frac{1}{4}$ " dowels. Mark for them by the method shown in C, Fig. 110.

2. A. Glue the board together. Put the glue in the dowel holes, not on the dowels, and along the entire length of both sides of the joint. Use clamps to bring the joints up, and hold them while the glue is setting.
B. If the board is not perfectly straight across its face when the clamps are on, make it straight with hand screws and straight-edges.
3. A. Scrape off the surplus glue from each side of the board, and traverse plane the back side; that is, plane it crossways diagonally to straighten it. Plane it lengthways to make it smooth.
B. Joint one edge of the board, and cut it roughly to the desired size.
4. A. In the cleats, bore holes of a size that will allow a 1" No. 9 screw to slip through without catching. These holes should be placed so that the screws will not enter a joint in the board.
B. The holes should be elongated upon the side of the cleat which comes next to the board, to allow the board to shrink and swell, and still hold it straight.
Do not glue the cleat to the board.
5. A. Traverse plane the top.
B. Plane it lengthways. Make it perfectly straight and smooth.
6. A. Joint the edges perfectly straight, and make the board exactly square.
B. Prove it by measuring the diagonals.
C. Sandpaper crossways, diagonally, and lengthways.
7. Remedy defects.
8. Shellac finish, if any finish is desired.

Fig. 40. T Square. See C, Topic 87.

New subject: Making a straight edge. See C, Topic 50.

Wood: Maple, or mahogany.

Preparatory: Same as in Fig. 1, applied to each piece.

Exercises.

1. Make the head of required shape and size. Be sure that the edge is perfectly straight and square.
2. Make the tongue straight and parallel. See C, Topic 50.

3. A. Plane, scrape, and sandpaper the head and the tongue.
- B. Bore a $\frac{3}{8}$ " hole in the tongue. See Fig. 2, Ex. 6.

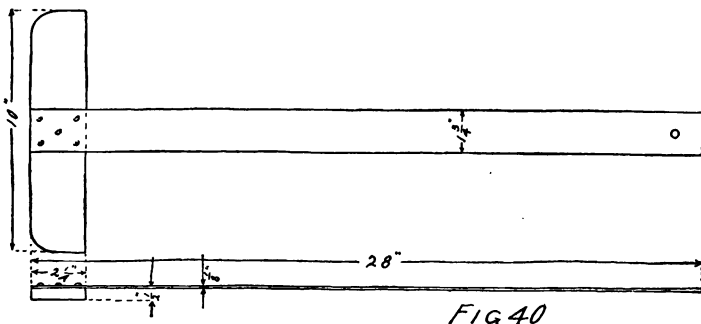

4. A. Glue the tongue to the head at an exact right angle. While the glue is setting, hold it in place with a hand screw, which must bear evenly over all the joint.
 - B. After the glue has set, put five $\frac{3}{8}$ " No. 3 flathead bright screws through the tongue into the head.
 - C. Remedy defects.
 5. Finish with two coats of shellac, rubbed in oil.
- A more elaborate piece of work may be made by gluing a narrow strip of ebony or white holly on the working edge of the head, and on each edge of the tongue.

Fig. 41. Dovetailed Bookrack. See C, Topic 92.

New subject: Dovetailing.

Wood: Oak, or poplar.

Preparatory.

- A. Make working drawing. Cut a piece long enough to include all three pieces, with a working allowance of 3".

Exercises.

1. A. Plane one edge straight, and both ends square with the face side and edge.
- B. From each end cut one piece $\frac{1}{4}$ " longer than is required for the end of the book rack. This allows for the possibility that the first attempt at dovetailing may not be successful.

2. Block-plane each end of the remaining piece square with the face side and edge. This is long enough to allow the student to make one unsuccessful attempt at dovetailing upon each end, and still keep his work up to size. It should be a matter of pride to the student to finish this model as much larger than required as possible, as it is an evidence of skillful work.

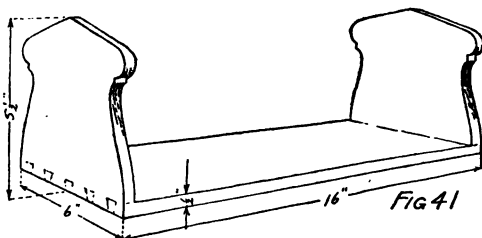

3. See C, Topic 78. Remember that all ends to be joined should be squared and gauged at once. The back edges of the pieces have not been planed yet to their exact dimensions; consequently, in laying out the dovetails, the line to which the pieces are to be dressed must be marked, and the dovetails planned to be the same distance from each edge, after the model is finished. Do not try the pieces together more than is necessary, as it makes the joints loose.
4. After the joints are satisfactorily completed, cut the ends to conform to an original design, and plane the bottom to width.
5. A. Plane and sandpaper the inside of the ends and the bottom, being careful that as little as possible is taken off of the pins of the latter, as this tends to make the joint loose. The plane cut should begin at the bottom of the pins.
6. Using glue sparingly, so that it will not squeeze out on the inside, put the pieces together; use a hammer very judiciously upon a piece of scrap wood, to prevent bruising and to minimize the danger of splitting the end.
Be sure that the ends stand perfectly square with the bottom.
7. After the glue is set, plane (scrape, if oak is used) and sandpaper the outside of the bookrack. Be sure that the plane is carried from the ends on to the piece, instead of the reverse, or the wood will be broken off the same as in injudicious block-planing.
8. A. Smooth edges of the bottom and the ends,

- B. Inspect for blemishes, and correct them.
 9. Stain and finish as desired.

Fig. 42. Plate Rack.

New subjects: Wedged construction. Router plane.

Wood: Oak, elm, or cherry.

Preparatory: Same as in Fig. 1, applied to all pieces.

Exercises.

1. A. Work ends to desired shape. Do not plane the ends.
- B. Select the best sides for the outsides, and lay out carefully the exact location of the grooves which are to receive the shelves. Be sure that the grooves are a little smaller than the thickness of the shelves. Mark with a knife.
- C. Locate the mortises through which the tenons of the shelves

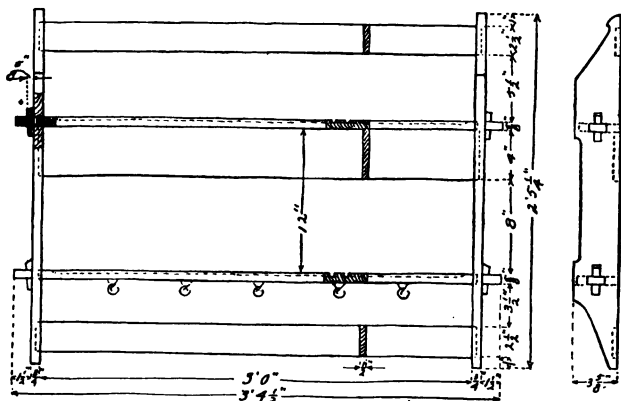

FIG 42

are to pass, and from the lines denoting the grooves, square across the edges of the piece to the outside. Knife lines should now be made across the top and bottom of the mortise, but not across the rest of the outside of the end, as they will show when the piece is finished. The top and bottom of the mortises on the outside of the end must be exactly square with the corresponding lines of the grooves on the inside.

- D. Cut the mortises nearly through from the outside, beginning by boring with a bit about $\frac{1}{8}$ " less in diameter than the thickness of the shelf. Be sure that the wood in the mortises is cut away so that the tenons which extend through will bear only upon the inside and outside of the ends. See C, Topic 90 A.
- E. Cut the grooves in the inside of the end $\frac{1}{4}$ " deep. Do not allow them to extend within $\frac{1}{2}$ " of the front edge of either piece.
- Use a router plane to insure accurate depth to each groove.
- F. Cut the rabbets to receive the backboards in the inside corners of the ends.
2. A. Cut shelves to the required width and length, including tenons.
B. Block-plane the ends square with the edge and sides.
C. Mark sides of the tenons on the ends of the shelves by laying their ends against the mortises in the ends of the rack into which they are to fit with the front edges of the shelves in their exact relation with the front edge of the ends. Number the shelves and mortises so that the pieces may be returned to the places for which they are fitted. Mark with a knife, and saw a little outside of the marks, to allow for smoothing the edges of the tenons.
3. A. Lay the shelves together with edges and ends flush.
B. Hold them with hand screws.
C. Measure the required distance between the insides of the ends of the plate rack, and lay it off equidistant from the ends of the shelves.
D. Make the knife line by a try-square across the front edges of the shelves as they are held in one bunch. This is important, as it is necessary that all the shelves should be exactly the same length between the lines which indicate the shoulders, or the visible part of the connection between the shelf and the end.
E. With a backsaw, make the cut for the shoulder, square with the face edge, and to a depth of $\frac{1}{2}$ " from it. See C, Fig. 139.
F. Take off the hand screws. Measure about $\frac{7}{32}$ " beyond the shoulder of each end of each shelf, from which point make

a line from the front to the back of the shelf. This line, where it does not cross a tenon, indicates the end of the shelf that rests against the bottom of the groove.

- G. Cut carefully to this line with a saw, and no more finishing will be needed.
4. A. Plane shelves and ends.
B. Cut grooves in shelves between the ends. Use a gouge for this purpose.
5. A. Mark holes in the tenons for wedges.
B. Make the outside of the holes in the tenons of the same slant as the wedge that it is to receive; the inside of the holes, or the side nearest the base of the tenons, should be about $\frac{1}{8}$ " inside of the ends when they are in place. See section. This is to allow the force of the wedge to pull the shoulder of the shelf against the end, to assist which, the part of the shelf which enters the groove is $\frac{1}{4}$ " less than the depth of the groove.
C. Make the wedges about three times as long as they should be, so that they may be fitted, and afterward cut off to their correct length.
6. Fit the tenons to the mortises for which they have been cut. If they are too tight, take a little from the mortise, being very careful that no more is taken off than will allow the tenon to come through snugly.
7. Plane, scrape, and sandpaper all pieces.
8. A. Set up case permanently. Use glue on the shoulders only.
B. Hold joints together with clamps until wedges are fitted.
C. After the wedges are fitted, they should be cut off so that they will project about $\frac{1}{8}$ " above and below the shelf.
D. Sandpaper wedges.
E. Place a little glue on the end of the rack where the wedge will cover it, — not enough to squeeze out, — and drive the wedge into its permanent place.
9. Fit back rails, smooth, scrape, and sandpaper, and nail them in their places from the back.
10. Examine for defects and remedy them.
11. Stain and finish as desired. If it is thought best to fill this model, see W, Topic 69.

Fig. 43. Screen Frame.*New subject:* Mortise joint.*Wood:* Oak.*Preparatory.*

Same as in Fig. 1.

Exercises.

1. Make stiles and rails of size required ; use straight stock.
2. A. Lay stiles side by side, inside edges up and faces together.
Mark the ends of mortises with sharp pencil.

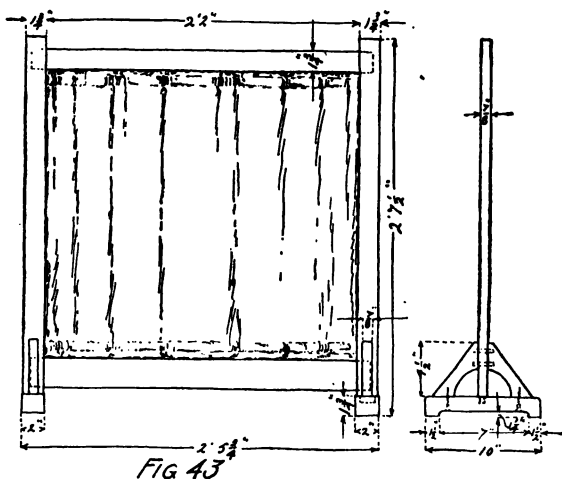

- B. Lay rails edge to edge, face side up, and measure length between shoulders, which should be equidistant from the ends of the piece. Square all around the piece with sharp knife.
3. A. Working from the face side with a mortise gauge, mark the two edges and the end of the tenon.
B. Without changing the set of the gauge, lay out the sides of the mortises on the stiles.
(If a single gauge instead of a mortise gauge is used, make the first scratch on all tenons and mortises without changing

the set. Then change for the second cut, and make it all around.)

Be sure that no scratches are carried beyond the shoulders of the rails nor the ends of the mortise, or they will show on the finished work.

- C. Cut mortises and tenons as in C, Topic 65.
4. 1" above the bottom mortise, and the same distance below the top mortise, bore a $\frac{3}{8}$ " hole to receive a brass curtain rod or a dowel.
 5. Cut a tenon $\frac{1}{2}$ " thick, $1\frac{1}{2}$ " wide, and $\frac{1}{2}$ " long upon the end of each stile.
 6. A. Glue the frame together; be sure that it is out of wind when it is stood away for the glue to set, or it will be permanently twisted.
 - B. Plane, scrape, and sandpaper both sides of the frame.
 7. A. Make the feet of the size and shape required.
 - B. Cut the mortise to receive the tenon of the frame stiles.
 - C. Plane, scrape, and sandpaper.
 - D. Glue the foot to the frame. Be sure that each is square with the stile to which it is glued.
 8. A. Make braces to original design.
 - B. Fit them to their places.
 - C. Mark for, and bore $\frac{3}{8}$ " holes for dowels for the frame, and corresponding holes in the braces.
 - D. Bore holes in the feet for screws, which hold the bottom of the braces. Plane, scrape, and sandpaper.
 - E. If a straight angle is used like the sketch, glue angle blocks on them to receive the hand screw which will hold them in place while the glue is setting. See C, Topic 70.
 - F. After the glue on the angle blocks has set, fit dowels. Use glue on the joints sparingly, and hold in place by screws through the feet, and by hand screws at the top.
 - G. After the glue has set, remove hand screws and take off angles carefully, or the brace will be damaged.
 - H. Clean off the glue, and inspect for blemishes.
 9. Stain and finish to suit taste.

The opening may be filled with a solid panel, covered with cloth, or by a silk curtain, if preferred.

Fig. 44. Bookcase.*Wood: Oak.*

Preparatory: Make working drawing and stock list. Cut all pieces to required dimensions, making allowance for working.

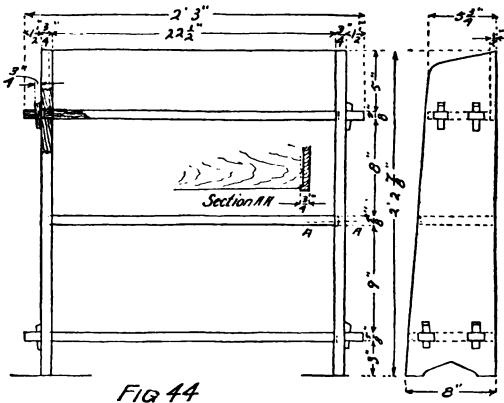
*Exercises.*

1. A. Make ends of desired shape and size. Do not waste time in block-planing bottom of ends, as they rest on the floor.
- B. Same as Ex. 1 B of Fig. 42.

Complete the model by the same exercises and progression as described in Fig. 42. The only important adaptations necessary will be in Ex. 1 E, in which the grooves should be made $\frac{5}{8}$ " deep. In Ex. 3 F, $\frac{7}{8}$ " should be made $\frac{1}{4}$ ".

Ex. 3 G should read: cut from the front and back edges to the tenons with a saw, and cut out the space between the tenons with a frame or turning saw. Begin this cut with a hole made by an auger bit large enough to start the saw.

Fig. 45. Table. Fig. 46. Detail.

New subject: Draw boring. See W, Topic 65 C.

Wood: Oak.

Preparatory: Make working drawing and stock list. Cut necessary pieces, making usual allowance for working.

In cutting the material for the top, $1\frac{1}{8}$ " boards may be used, or thicker material, if desired.

The appearance of thickness may be secured without the expense or the weight of using the thicker stock, as follows: Cut the material for the top from $\frac{3}{8}$ " stock, and glue it in the ordinary way, making a doweled glue joint. Cut the top to its required size roughly, and straighten the under side across the ends by traverse planing. Glue pieces

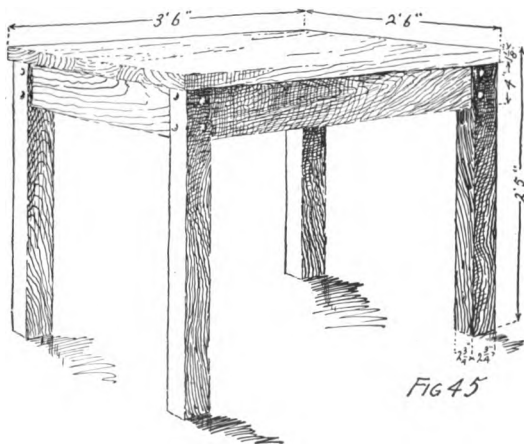

about 5" wide and as long as the top on the under side of the top, flush with the edges. Cut pieces 5" long, and enough in width to fill in between these edge pieces, and glue them flush with the end of the top. The whole may now be treated as though the entire top were glued of thick material.

Exercises.

1. A. The legs and rails should be made of solid oak. Allow a tenon of about $2\frac{1}{4}$ " on the end of each rail to enter the legs.
- B. Cut shoulders and tenons on the ends of each rail, marking them by the mortise gauge.

- C. Set the head of the mortise gauge back, the amount of sinkage required between the face of the legs and the face of the rails, and mark the tenons on the legs. In doing this, be careful that the best sides of the legs are kept on the outside.
2. A. Cut the tenons with a rip saw, and the shoulders with a backsaw.
 - B. Miter the ends of the tenons so they will clear each other in the mortise.
3. A. With a rip saw, make a cut to the lines of the mortises of each side of each leg, making the cut upon the inside of the lines, to maintain the size of the mortise.
 - B. Trim out the corners, bottom, and sides of the mortise, working

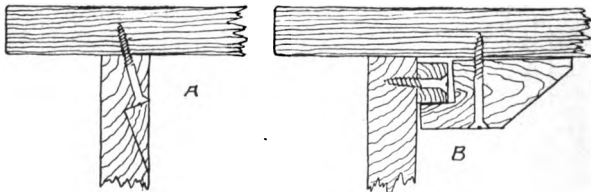

Fig 46

carefully to the lines.

- C. Fit the rails in their places. Mark all joints for future identification.
4. A. Draw bore the joint. See W, Topic 65 C.
 - B. Make the pins of required length, and round the top over carefully. If it is desired to save a little work, the draw boring may be done from the inside, in which case the ends of the pins will not show on the outside.
5. Plane, scrape, and sandpaper all pieces; leave no sharp or ragged corners. The corners of the legs should be rounded quite perceptibly.
6. A. Glue end rails and legs together. Pin them.
 - B. Glue side rails and legs together, and drive the pins in their places. Drive the pins so that their rounded tops will just project beyond the surface of the leg, if the pegs are driven from the outside.

7. A. Place the boards of the top together and match the figure of grain. If possible, the grain of the boards should run in the direction easiest planed from that side. This is not so important as it is that the figure should match well.
- B. Joint edges. See C, Topic 54 and Topic 69 A, for instructions in jointing and doweling. The dowels should be placed not more than 15" to centers.
- C. Glue the top, using clamps. Put the glue in the dowel holes and along the whole length of the joint. See W, Topic 66.
- D. Cut top to approximate size. (If piece is to be glued on to make the top appear thicker, refer to preparatory instructions of this model.)
- E. Make top of required dimensions.
- F. Joint the tops of the legs and rails straight and true.
- G. Straighten under side of the top, and fit it and the legs and rails to each other.
8. Fasten the top on by method indicated in C, Fig. 46, A or B. The latter method is to be preferred, as it allows the top to shrink and swell without danger of opening the joints.
9. A. Traverse plane the top. Take a very light shaving.
- B. Plane lengthways with jack plane.
- C. Traverse lightly with jointer if necessary, and make the top straight in all directions.
- D. Smooth with finely adjusted smoothing plane.
- E. Scrape with a sharp scraper; remove all grain marks, and be careful not to dig a hole which can be felt in passing the hand over the top.
- F. Sandpaper lengthways. Do this very thoroughly, being sure that the sandpaper does not slip off of the corners.
- G. Give the corners a perceptible round; do this accurately, or it will look worse than if it were not done at all.
10. Inspect for defects, and remedy them.
11. Stain and finish as desired.

CHAPTER VI

ANSWERS TO ARITHMETIC QUESTIONS

I. Elements of Construction, Chapter V

- | | | |
|--|---|------------------------------|
| 4. $\frac{7}{16}$ " | 6. N. side, 20'. S. side, 79' 6". E. and W. sides, 17' 7 $\frac{1}{2}$ ". | |
| 5. 22 $\frac{1}{2}$ " | 22. 349' nearly. | 37. 20 sq. yd. |
| 7. 7349.38 sq. ft. | 23. 970'. | 38. 375'. |
| 13. $\frac{5}{8}$. | 24. 14" \times 28" glass. | 39. 55 $\frac{2}{7}$ cu. yd. |
| 14. 17 pieces. | 25. 5" to each piece. | 40. \$6.91. |
| 17. 231 cu. in. | 26. 1505.56". | 41. \$17.44. |
| 18. 1 gal. | 31. 2976" B. M. | 44. 1485". |
| 19. 14' B. M. | 34. 2160 cu. in. | 45. 308'. |
| 20. 250'. | 35. 1 bu. | 46. 8 lb. weights. |
| 21. 50,244". | 36. 280' B. M. | 47. \$10. |
| | 48. A received \$6.89. B received \$5.51. | |
| | 50. The latter two are the cheaper. Saved \$.62. | |
| 51. 45'. | 53. 67 $\frac{1}{2}$ '. | 59. 10. |
| 52. \$66.82. | 58. 10 ϕ . | 60. 14.546'. |
| | 61. 2 ends 18" long \times 12 $\frac{1}{2}$ " wide \times $\frac{7}{8}$ " thick,
2 sides 25 $\frac{1}{2}$ " long \times 12 $\frac{1}{2}$ " wide \times $\frac{7}{8}$ " thick,
1 top 19 $\frac{3}{4}$ " long \times 25 $\frac{1}{2}$ " wide \times $\frac{7}{8}$ " thick,
1 bottom 19 $\frac{3}{4}$ " long \times 25 $\frac{1}{2}$ " wide \times $\frac{7}{8}$ " thick. | |
| 62. 150'. | 64. A's pay should be raised to 11 ϕ per hour. | |
| 63. —. | 65. B's pay should be cut down to 7.3 ϕ per hour. | |
| 66. 18'. | 70. 14 ϕ per hour. | 74. 8.87'. |
| 67. 26,124.2 lb. | 71. 7'. | 75. \$97.60. |
| 68. 74 $\frac{3}{4}$ '. | 72. Neither; a catch question. | 76. 402'. \$18.76. |
| 69. Lost, \$1.31 $\frac{3}{4}$. | 73. 1512 cu. ft. | 77. Made \$16.66. |
| 78. The journeyman mechanic would be 15 ϕ per hour the cheaper. | | |
| | 79. 2 sides 6' 2" long \times 12" wide \times 1" thick,
2 ends 2' 0" long \times 12" wide \times 1" thick,
1 top 2' 2" long \times 6' 2" wide \times 1" thick,
1 bottom 2' 2" long \times 6' 2" wide \times 1" thick. | |

80. $49\frac{1}{8}'$. 82. $25\frac{1}{3}'$. 84. $4''$. 86. $2470'$. 88. $10\frac{1}{2}'$.
 81. $10\frac{1}{2}'$. 83. $49''$. 85. Four 7-lb. weights. 87. $13\frac{1}{3}'$. 89. $37\frac{1}{3}'$.
 90. \$7.15. 91. B receives \$2.00. C receives \$1.60.
 92. 26 rafters. 93. $416'$. 94. $20.11'$. 95. $38'$.
 96. His duty as foreman requires that he should report the case, also the protection of his own reputation. A's financial loss is $\frac{1}{3}$ of the money paid for the labor.
 97. $24\frac{1}{2}'$. 98. $11\frac{1}{4}'$. 99. $17\frac{1}{2}'$. 100. $15'$. 101. 14,000 shingles.
 102. $125'$. 103. \$1.35. 104. Nothing; a catch question.
 105. 1946 people. 106. $21\frac{1}{3}'$. 112. 31.36 lb.
 106. $14'$. 110. 30 days. 113. \$24.62.
 107. $10\frac{1}{4}'$. 111. 7840 shingles. 114. $17.21'$.
 118. A receives \$4.80. B receives \$4.20. 119. $900'$.
 120. 24 double periods. 121. 640 ft. of rails. 2560 ft. of boards.
 122. 675 people. 126. B paid 7¢ per hour.
 123. 209,350 lb. 127. \$7.20. 128. 2516.
 129. 2 stiles $6' 8'' \times 4'' \times 1\frac{1}{2}''$,
 1 top rail $2' 0'' \times 4'' \times 1\frac{1}{8}''$,
 1 middle rail $2' 0'' \times 5'' \times 1\frac{1}{8}''$,
 1 bottom rail $2' 0'' \times 7'' \times 1\frac{1}{8}''$.
 130. 8.89'. 135. A. 139. 142.6 cu. yd.
 131. $88\frac{3}{4}$ cu. yd. 136. 10ϕ . 140. 50 rafters $2 \times 6 \times 14'$ long.
 132. \$11.11. 137. $36'$. 141. \$38.22.
 133. 6336 laths. 138. $17\frac{5}{8}'$. 142. 38 lb.
 143. \$13.047. 144. 25 students @ 8¢ per hour.
 145. 10 pieces $1''$. 1 piece $\frac{3}{4}''$ left.
 146. 9.197'. 149. $12'' \times 24''$ glass.
 147. A $\frac{2}{3}$, B $\frac{1}{3}$ of the work. 150. Four 6-lb. weights.
 148. $425'$. 151. 1512 tiles.
 154. \$7.24. 155. A received 80¢. B received 64¢. 156. $4'$.
 157. $1320'$ long. 160. $16' 3''$ nearly. 163. $840'$. 166. $1\frac{1}{8}''$.
 158. 108,000'. 161. $154'$. 164. 7500'. 167. $\frac{5}{8}''$.
 159. 99.03 lb. 162. $7'$. 165. $1''$. 168. $\frac{3}{8}''$.
 169. B's work causes a loss of 20¢.
 170. \$200. 175. $2''$. 180. Yes.
 171. \$20.16. 176. 9762 laths. 181. $204\frac{3}{4}'$.
 172. 790'. 177. $41''$. 182. $12\frac{1}{2}$ hr.
 173. \$35.55. 178. $10'$. 183. $5' 6\frac{1}{4}''$.
 174. 42.68 lb. 179. $12\frac{1}{2}\phi$ per hour. 184. $640'$.
 185. 16,128'. Nine 14×30 4 lt. windows.
 186. 355 cu. yd. 187. \$44,375. 188. $42'$ B. M.

189. $10' 6''$. 196. \$28.50. 203. 13ϕ per hour.
 190. \$38.52. 197. A, 10ϕ per hour. 204. $8\frac{3}{8}\phi$ per hour.
 191. 8ϕ per hour. 198. 47 layers. 205. 10ϕ per hour.
 192. 18ϕ per hour. 199. 96 6-lb. weights. 206. \$340.
 193. 144'. 200. \$27.30. 207. \$12,000.
 194. \$1.40. 201. The last. 4ϕ . 208. $3' 7\frac{3}{4}''$ nearly.
 195. \$14.74. 202. 8ϕ per hour. 209. 71.69 cu. ft.
 210. $6' \times 6'$. 211. A receives \$1.46. B receives \$1.34. C receives \$1.10.
 212. \$7.50. 214. $14\frac{3}{8}$ hours. 216. \$25.60.
 213. \$9.16 $\frac{2}{3}$. 215. 8ϕ per hour. 217. $8\frac{1}{3}\phi$ per hour.
 218. A receives 8ϕ per hour. B receives 12ϕ per hour.
 219. 2000'. 220. \$128. 221. $\frac{1}{2}$ of the work. 222. $9\frac{1}{2}'$. 223. \$5.33.
 224. A should receive \$13.33. B should receive \$6.67.
 225. A should receive \$5. B should receive \$4.17. C should receive
 \$2.50. D should receive \$8.33.
 226. A's time is 20ϕ cheaper. 227. \$32.12.
 229. $10' 4''$. 234. $\frac{1}{27}$. 239. 11 hr.
 230. 12ϕ per hour. 235. $\frac{1}{32}$. 240. $\frac{3}{8}\phi$ per hour.
 231. 8ϕ . 236. $\frac{7}{18}$. 241. \$8.00.
 232. $\frac{5}{8}$ of a foot. 237. $101' 8\frac{1}{8}''$. 242. $\frac{2}{11}$ profit.
 233. $\frac{4}{12}$ of a foot. 238. \$6.20. 243. \$54.02.
 244. \$10,000. \$20,000. \$13,333. \$21,666.67. \$15,000.
 245. 2 tops $4' \times 3' \times \frac{7}{8}''$,
 12 legs $20\frac{1}{8}'' \times 2' \times 3''$,
 6 rails $3' 8'' \times 5'' \times 1''$,
 6 rails $2' 8'' \times 5'' \times 1''$.
 246. $83'$. 247. B $8\frac{1}{3}\phi$ per hour. C. $6\frac{1}{3}\phi$ per hour.
 248. B's table cost 16ϕ more. C's table cost 36ϕ more.
 249. A's table brings 16ϕ profit. B's table, cost = price. C's table, causes
 20ϕ loss.
 250. $6' 6''$ in sight. 252. \$2610. 254. \$1.15. 256. 4ϕ .
 251. \$25.19. 253. \$105.55. 255. 10ϕ . 257. \$2.49.
 258. $2\frac{1}{2}$ hr. 259. $6\frac{3}{4}$ hr.
 260. 2 sides $2' 6\frac{3}{4}'' \times 7\frac{1}{2}'' \times \frac{7}{8}''$,
 2 ends $1' 3\frac{1}{2}'' \times 7\frac{1}{2}'' \times \frac{7}{8}''$,
 1 top $1' 5\frac{1}{4}'' \times 2' 6\frac{3}{4}'' \times \frac{7}{8}''$,
 1 top $1' 5\frac{1}{4}'' \times 2' 6\frac{3}{4}'' \times \frac{7}{8}''$.
 261. $12\frac{1}{6}'$. 265. \$10.29. 272. \$45.
 262. \$3.60. 266. $4\frac{1}{4}$ hr. 273. 5ϕ .
 263. \$32.40. 269. \$1.05.
 264. $8''$. 271. \$945.

274. A receives 10¢ per hour. B receives 5¢ per hour. C receives 10¢ per hour.
275. \$3220.67. 276. $14\frac{2}{16}$ ". 277. 11.85 hr.
278. B receives 7¢ per hour. C receives $7\frac{1}{2}$ ¢ per hour. D receives 6¢ per hour.
279. 75¢. 280. 10 hr. 281. $15\frac{1}{4}$ ¢ per hour. 282. $5\frac{5}{11}$ da. 283. 24 da.
284. A does $\frac{3}{5}$ per day. B does $\frac{3}{5}$ per day.
285. A's share, \$12. E's share, \$8.
286. 68.25 hr. 288. 12'. 291. 825'. 298. \$5.25.
287. 708.6 lb. 290. 1960'. 292. $17\frac{1}{2}$ lb.
294. 3 stiles $18'' \times 3'' \times \frac{3}{8}''$,
 2 rails $42'' \times 3'' \times \frac{3}{8}''$,
 3 muntins $12'' \times 3'' \times \frac{3}{8}''$,
 4 panels $13'' \times 9\frac{1}{2}'' \times \frac{1}{2}''$.
295. 37.825 da. work. 298. \$8.125. 302. 800'. 305. \$4.80.
296. 20 men. 299. 56'. 303. \$4.80.
297. \$8.40. 300. 424'. 304. \$1.70.

II. Inside Finishing, Chapter VIII

1. 22%. 5. \$3. 10. 70%. 15. 10% loss.
2. 1.8%. 6. 10%. 11. $\frac{2}{3}$ loss. 16. 7.2¢ per hour.
3. \$15.66. 7. $92\frac{1}{2}$ ¢. 13. \$286.87 $\frac{1}{2}$.
4. Ratio, $\frac{1}{2}$. 8. 10%. 14. $9\frac{2}{3}$ hr.
17. A's pay reduced 20%. B's pay raised $33\frac{1}{2}$ %.
18. 25.2 da. 20. \$122.50. 22. \$129.41. 25. 41.52+%
19. \$1.20. 21. \$1.26 $\frac{2}{3}$. 24. \$35.00.
27. 12¢ per hour. 28. A lays 977'+. B lays 1220'+.
29. A receives \$16.50. B receives \$7.35. C receives \$3.15.
30. \$42. 34. 40 and 50. 39. .02 $\frac{2}{7}$ %.
31. 6 students. 35. $30\frac{2}{3}$, $46\frac{1}{3}$, $69\frac{3}{10}$, $99\frac{1}{6}$. 41. 39 squares.
32. 32,233 sq. ft. 37. $6\frac{1}{4}$ %.
33. $13\frac{1}{2}$ da. 38. $22\frac{2}{9}$ %.
42. A receives \$2.88. B receives \$2.40. C receives \$1.92. D receives \$1.44.
43. \$146.65. 49. \$16.666. 54. 29%.
44. 20%. 50. \$73.33. 55. 18,937 sq. ft.
46. 864 sq. ft. 51. \$133. 58. \$31.54.
47. $53\frac{2}{3}$ hr. 52. $14\frac{2}{3}$ %.
48. 720 sq. ft. 53. 22 men. 59. $11\frac{1}{2}$ hr.
60. 20%.

61. 3.70 da. 63. \$58.80.
62. 86%. 64. 751.68 sq. ft.
65. A receives \$10.40. Others receive \$29.60.
67. Made 11.7%. 92. \$26.50. 116. $78\frac{1}{2}\%$.
68. $37\frac{1}{2}\%$. 93. \$390. 117. 10% loss.
69. 35.34 sq. ft. 94. 98.46%. 120. $58\frac{2}{3}\%$.
70. 30% waste. 95. 92.3%. 122. 7¢ per hour.
71. A is 4.6% cheaper. 96. $7\frac{9}{10}\%$. 123. 2484'.
72. $16\frac{2}{3}\%$. 97. 140 sq. ft. 124. A is $9\frac{1}{2}\%$ cheaper.
73. 1800 lb. 98. $10' \times 14'$. 126. 48%.
74. 19.23 cu. ft. 99. 20 sq. ft. 127. 3.7%.
75. 170%. 100. \$300. 128. $30\frac{3}{5}\%$ left.
76. $787\frac{1}{2}$ sq. ft. 102. \$22.50. 129. 1452.77'.
78. 2325 bricks. 103. \$345.60. 130. $\frac{2}{3}\%$.
79. 12 ft. high. 104. 7.9%. 132. $19\frac{1}{17}\%$.
80. 15,129 bricks. 105. $14\frac{1}{2}$ sq. ft. 133. $66\frac{2}{3}\%$.
81. \$50.00. 106. $14' \times 10' 3''+$. 134. 28.8%.
82. $33\frac{1}{2}\%$. 107. 1293 cu. ft. 135. 13.3%.
83. $29\frac{1}{2}$ sq. ft. 108. 5240 bricks. 136. 11.25%.
84. $47' 6''$. 109. $1.50+$ sq. ft. 138. \$137.73 profit.
85. 821.275 sq. ft. 110. 1580 sq. in. 139. 18.5% nearly.
87. 24 hr. 111. $25.75+$ sq. ft. 140. $120\frac{1}{4}'$.
88. $3\frac{2}{3}\%$. 112. 98 T. 141. $38\frac{1}{11}\%$ profit.
89. $11\frac{8}{13}\%$ gain. 113. $653\frac{1}{2}$ sq. ft. 142. \$36.60.
90. $44\frac{1}{2}\%$. 114. \$17.77. 143. 4; 8; 12.
91. $28\frac{1}{4}\%$. 115. 1.29% loss. 144. 9; 81; 400; 625.
145. 216; 512; 1728; 5832; 27,000.
146. 27; 144; 512; 1728; 5832; 27,000.
147. 36; 9; 25; 6400. 150. 2; 3; 7; 9.
148. 27; 125; 729; 5265. 151. 2; 2; 3 orders.
149. 5; $12\frac{1}{2}$; 18; $24\frac{1}{2}$; 40. 152. 1; 1; 1; 1 order.
153. 2; 3; 4; 5; 7; 9; 10.
154. 25; $27.71+$; $72.66+$; $113.872+$; $438.88+$.
155. $3.1+$; $4.79+$; 18 nearly. 70.14.
156. 10'. 157. 40'. 158. 20'. 159. 20.60' nearly. 160. $7\frac{6}{15}''$ rise.
161. Either $7\frac{1}{15}''$ or $7\frac{1}{4}''$ rise.
162. $6\frac{3}{4}''$. 165. $12' 6''$ long. 168. 60'.
163. $12' 6''$ long. 166. 40.31'. 169. 33.3'.
164. $11\frac{1}{2}''$ wide. 167. 26.49 square. 170. 63.5'.
171. $7\frac{1}{3}''$ or $7\frac{5}{7}''$ rise; $10\frac{5}{13}''$ or $9\frac{9}{14}''$ run.
172. $11\frac{5}{13}''$ or $10\frac{9}{14}''$ wide.

173. 27'' fall. 177. 415.475''. 181. 3450 sq. ft.
 174. $\frac{1}{7}$ '' pitch. 178. 14.6'. 182. 5875.2 gal.
 175. $6\frac{2}{3}$ '' fall. 179. 165.13 sq. ft. 183. 3331.374 gal.
 176. 72.256''. 180. 25 circles. 184. 1396.115 sq. ft.
 185. a. 2; b. 2; c. 25; d. 20; e. 20; f. 3; g. 4; h. 4; i. 10; j. 4; k. 2; l. 5; m. 7; n. 7; o. 4; p. 13; q. 5; r. 6; s. 4; t. 46; u. 2; v. 3; w. 33.
 186. a. 77; b. 18; c. 144; d. 30; e. 60; f. 288; g. 126; h. 48; i. 40; j. 48; k. 55; l. 16; m. 90; n. 21.
 187. a. 3; b. 8; c. 4; d. 7; e. 5; f. 3; g. 4.
 188. a. 36; b. 54; c. 120; d. 3; e. 3; f. 5; g. 8.
 189. 118,400'. 198. 38.485 sq. ft. 207. 38' \times 50'.
 190. 810 cu. ft. 199. 20' diameter. 208. 62' 8''.
 191. 200 sq. ft. 200. 49.48 sq. ft. 209. 40'.
 192. 192 sq. ft. 201. 2.513'. 210. 80.061.
 193. $812\frac{1}{2}$ sq. ft. 202. 20,106.24 sq. ft. 211. 10'.
 194. 120.83 sq. ft. 203. 472 pupils. 212. 90 T.
 195. 2122 sq. ft. 204. 482,348.76 cu. ft. 213. 19 sq. ft. nearly.
 196. 28.27 ft. 205. 12,058.02 sq. ft. 214. 27' \times 34'.
 197. 12' 6''. 206. 1253.64. 215. $16\frac{2}{3}$ ft.
 216. 6'' \times 8'' will have 4 sq. in. more area.
 217. 48 sq. in. 237. There will be no ridge. 257. 12' $7\frac{3}{4}$ ''.
 218. 6' $4\frac{3}{8}$ '' 238. 3' long. 258. $4\frac{1}{2}$ ''.
 219. 12' 7''+. 239. 3' $4\frac{3}{8}$ '' long. 259. 12' 4''.
 220. $\frac{3}{8}$ '' 240. $\frac{7}{12}$ '' shorter. 260. 16'.
 221. 16.97''. 241. 14' $\frac{7}{8}$ '' long. 261. 13' 11''.
 222. 7.14' nearly. 242. 14'' rise. 262. 14' $5\frac{1}{2}$ ''.
 223. 9' $5\frac{1}{4}$ '' nearly. 243. $31\frac{1}{16}$ '' long. 263. 15' 7''.
 224. 12.07 ft. nearly. 244. 20' 10'' long. 264. 15' $5\frac{7}{8}$ ''.
 225. 10' $3\frac{1}{2}$ ''+. 245. 21' $9\frac{1}{2}$ '' long. 265. 15' $4\frac{1}{2}$ ''.
 226. 13' $7\frac{1}{2}$ ''+. 246. 19' 6'' long. 266. 15' $7\frac{1}{2}$ ''.
 227. 14' rise. 247. 28 $\frac{1}{2}$ '' long. 267. 1 $\frac{1}{2}$ '' shorter.
 228. 16,720 shingles. 248. $1\frac{7}{8}$ '' shorter. 268. 2' 10'' shorter.
 229. \$44.10. 249. 12' long. 269. 2' $5\frac{1}{2}$ '' shorter.
 230. \$13.60. 250. 18' long. 270. $14\frac{7}{8}$ '' shorter.
 231. 20' 6''. 251. 24' long. 271. 10' 5''.
 232. 42 rafters. 252. 3' long. 272. 10' $10\frac{1}{2}$ ''.
 233. 17 ft. 253. 4' long. 273. $4\frac{3}{8}$ '' shorter.
 234. 16' run, 10' 8'' rise. 254. 6' long. 274. \$2289.
 235. 20'. 255. 14' 5'' long. 275. \$55.
 236. 16' 3''. 256. 15' $7\frac{1}{2}$ '' 276. \$81.
 277. 45 bu. lime; 157 $\frac{1}{2}$ bu. sand.

	278. \$107.79.		279. 73 bu. lime ; 292 bu. sand.	
280. 146 studs.	287. 13,685'.	294. \$45.33.	301. \$2533.	
281. \$1.92.	288. \$26.08.	295. \$7.	302. \$14.76.	
282. 2104'.	289. \$45.00.	296. \$9.62.	303. 45 gal.	
283. 2314'.	290. \$27.00.	297. \$34.10.	304. \$126.	
284. 400 sq. ft.	291. \$14.06.	298. \$66.88.	305. 16 $\frac{1}{2}$ gal.	
285. 427 sq. ft.	292. \$50.75.	299. \$93.94.	306. \$16.75.	
286. 12,820'.	293. \$56.70.	300. \$9.33.	307. \$30.70.	

INDEX

- Accuracy, importance of, 4, 18.
Adjusting mechanism, overhauling of, 27.
Adjusting parts, ordering of, 26.
Administration, of finances, 31.
Advanced class, work of, 17; preparing of stock by, 57.
Alcohol and shellac, 33.
Algebraic symbols, in formulas, 16.
Allowance for working and cutting, 56.
Arithmetic, questions in, how to assign, 15; use of, in manual-training classes, 42.
Auger bit, described, 23; for equipment, 35-38.
Awls, for hafts, *see* Equipment lists, 37, 38.
- Backsaw, for equipment, 35, 36, 38; new subject (fig. 1), 61.
Basswood, for models, 30, 61.
Bastard mill files, flat, for equipment, 37, 38.
Bead plane, for equipment, 37, 38; new subject (fig. 38), 103.
Beginning classes, cutting of stock for, 57.
Bench, position at, 14; selection of, 25; equipment for, 21, 35, 36, 37; work, *see* Suggestive Courses, 44-54.
Bench hook, use of, 3, 58; for equipment, 35, 36, 38; how to make, 74.
Bevel, for equipment, 35, 36, 39.
Bevel square, new subject (fig. 3), 63.
Bird house, how to make, 84.
Bit, auger, described, 23; for equipment, 35-38; new subject (fig. 2), 62.
Bit files, for equipment, 37.
Bitbrace, use of, 2, 3; description of, 23; for equipment, 35, 36, 38; different forms of, new subject (fig. 10), 69.
- Bits, center, for equipment, 37, 39; new subject (fig. 2), 62.
Bits, expansion, for equipment, 37.
Bits for general use, 21.
Bits, German, for equipment, 37, 38; new subject (fig. 14), 74.
Blackboard, use of, 12.
Black gum, for models, 30.
Blades, for turn-saw frames, 37; hack-saw, 37.
Blemishes, in lumber, 32, 56.
Block plane, use of, 3; new subject (fig. 1), 61; iron knucklejoint, for equipment, 22, 35, 36, 38.
Blotting pad, how to make, 81.
Blueprints, 7.
Boards, kinds and thicknesses of, 30.
Bookcase, how to make, 116.
Bookrack, dovetailed, how to make, 109.
Borrowing, of tools, 27.
Bracket shelf, how to make, 82.
Bradawl, new subject (fig. 9), 68.
Breast drill, for equipment, 37.
Brush, for stains and filling, described, 34; for equipment, 35, 36, 38.
Button pliers, for equipment, 37, 38.
- Cabinet files, for equipment, 37, 39.
Cabinet scrapers, description of, 25; for equipment, 37, 38.
Cap iron, 28.
Carpentry, teaching hints on, 10-20; course, equipment for, 35; suggestive trade courses in, 52-54.
Carpet tacks, 34.
Cart, how to make, 92.
Carving, wood, new subject (fig. 19), 80.
Caul, gluing with, new subject (fig. 6), 66.
Center bits, for equipment, 37, 39.
Chamfering, new subject (fig. 9), 68.

- Cherry, for models, 30.
 Chisel, for paring, new subject (fig. 2), 62.
 Chisels, for equipment, 21, 35, 36, 37, 38, 39.
 Circles, areas of, 16.
 Clamps, for equipment, 37, 39; new subject (fig. 38), 103.
 Class, size of, 7; in construction, advanced, 17.
 Clinch nails, new subject (fig. 16), 76.
 Coat hanger, how to make, 79.
 Commercial work, material for, 58.
 Comparison of tools, 22-26.
 Compass saws, for equipment, 37, 39; new subject (fig. 10), 69.
 Compasses, new subject (fig. 2), 62.
 Construction, in carpentry, 12, 13; advanced class in, 17; wedged, new subject (fig. 42), 110.
 Corner shelf, how to make, 88.
 Countersinks, described, 24; for equipment, 37, 39; new subject (fig. 10), 74.
 Course, one, for all students, 6, 41.
 Courses, planning of, 29; time necessary for completion of, 40; use of, outlined, 40; in manual training, 44-51; in carpentry, 52-54.
 Criticism, in class, 17.
 Crossgrained wood, planing of, 13.
 Cube root, 16.
 Curves, laying out of, new subject (fig. 18), 79.
 Cutting board, how to make, 75.
 Cutting-off saw, use of, 13; for equipment, 35, 36, 37, 38; new subject (fig. 1), 61.
 Dado plane, for equipment, 38.
 Defacement of tools, 29.
 Demonstration of tools, 11, 17.
 Design, simplicity of, 8; original, 6, 8, 9, 42.
 Designs, suggestive, 61-119.
 Diagonals, squaring by, new subject (fig. 32), 95.
 Diagrams, blackboard, 13.
 Dimensions, how they should be regarded, 57.
 Direct method, advantage of, 4.
 Discussion, class, 17.
 Dish drainer, how to make, 78.
 "Dog," used on workbench, 25.
 Dovetailed bookrack, how to make, 109.
 Draw boring, new subject (fig. 45), 116.
 Drawing board, how to make, 106.
 Drawing kits, for equipment, 37, 38.
 Drawings, working, 8, 42; perspective, 41.
 Drawshaves, for equipment, 37, 38.
 Drill, class, 2, 9, 13.
 Economy, in cutting material, 9, 57; in using figures, 15; in purchasing material, 32.
 Edge tools, for individual student, 21; effect of sandpaper upon, new subject (fig. 5), 65.
 Ellipse, new subject (fig. 15), 75.
 Emery wheel, use of, 28.
 End wood, making joint upon, 59.
 Equipment, complete, for carpenter's shop, 21; economical, 21; care of, 26; lists of, 35-39.
 Estimating, how to teach, 20.
 Examinations, 42.
 Exercises, in the joints, 1, 10; written, 11, 13, 17, 42; grading of, 40.
 Expansion bits, for equipment, 37.
 Facts, treatment of, 13.
 Figures, steel, for equipment, 37, 38.
 Files, for equipment, 37, 38, 39; use of, 60; new subject (fig. 7), 67.
 Filling, brushes for, 34.
 Finishing materials, liquid, 33.
 Fishline winder, how to make, 68.
 Flower stick, how to make, 64.
 Foot rest, how to make, 102.
 Form, true, how to know, 8.
 Formulas, use of algebraic symbols in, 16.
 Fractions, 16.
 Frame building, construction of, 12.
 Frame saw, new subject (fig. 10), 69; *see also*, 25.
 Framing squares, for equipment, 36, 38.

- Gable, laying out of, new subject (fig. 24), 84.
- Gauge, use of, 13; description of, 22; for equipment, 35, 36, 38; new subject (fig. 1), 61.
- German bits, for equipment, 37, 38; new subject (fig. 14), 74.
- Glass cutter, for equipment, 37, 38.
- Glove box, how to make, 85.
- Glue, hot and cold, 32; new subject (fig. 6), 66.
- Gluing, special place for, 19; new subject (fig. 6), 66; (fig. 39), 106.
- Gouges, for equipment, 37, 39; inside and outside, new subject (fig. 22), 82.
- Grading of exercises, 40.
- Graduations, on gauge, 22; on try-squares, 23.
- Grain, sandpapering across, 60; of hard wood, new subject (fig. 7), 67; direction of, new subject (fig. 10), 69; relation of dimensions to, new subject (fig. 14), 74.
- Grinding of tools, 28.
- Grindstone, for equipment, 37, 39.
- Grip of nails, new subject (fig. 17), 78.
- Gripnut, in bitbrace, 23.
- Grooving, new subject (fig. 32), 95.
- Hack-saw frame, for equipment, 37.
- Hafts, peg-awl, for equipment, 37, 38.
- Hammer, for equipment, 21, 35, 36, 38; bell-faced claw, description of, 24.
- Handscrews, use of, in gluing, 19; description of, 25; for equipment, 37, 39; new subject (fig. 6), 66.
- Hard wood, grain of, new subject (fig. 7), 67.
- Hatchets, for equipment, 37, 39.
- Hatrack, how to make, 68.
- Hinges, new subject (fig. 36), 101.
- Housing, new subject (fig. 32), 95.
- Incentive, model as, 5.
- Individual equipment of tools, 35, 36.
- Individual work, how to provide for, 5, 8, 11, 29, 30, 31, 41.
- Iron jointers, for equipment, 36, 38.
- Iron planes, 22; *see also* Equipment, lists of, 35-39.
- Iron tongue and groove plane, for equipment, 37.
- Jack board, use of bench hook as, 3, 58; use of, in block planing, 59.
- Jack plane, use of, 2, 57; for equipment, 35, 36, 38; new subject (fig. 1), 61.
- "Jennings" auger bit, 23.
- Joint, how to make, 59.
- Dovetail** (fig. 41), 109.
- Doweled (fig. 37), 193.
- Draw bored (fig. 45), 116.
- Draw wedged (fig. 42), 110.
- Glued (fig. 39), 106.
- Halved (fig. 23), 83, (fig. 37), 102.
- Housed (fig. 32), 95.
- Mitered (fig. 38), 105.
- Mortise and tenon (fig. 43), 113.
- Notched (fig. 16), 77.
- Joints, exercises in, 1, 11.
- Key rack, how to make, 80.
- Key tag, how to make, 62.
- Knife box, how to make, 95.
- Knife, paper, how to make, 97.
- Knife, use of, in marking, 17; new subject (fig. 1), 61.
- Knives, sloyd, for equipment, 37, 38.
- Laziness, how to prevent, 14.
- Letter box, how to make, 101.
- Letters, steel, for equipment, 37.
- Level, for equipment, 37, 38.
- Lines, straight and curved, alternations of, 8.
- List, stock, for each model, 9; new subject (fig. 16), 76.
- Lists of equipment, 35-39.
- Lumber, grades of, 32.
- Mallet, for equipment, 35, 36, 39.
- Manual training, suggestive courses in, 44-51.
- Maple, for models, 30.
- Marking, use of knife in, 17.
- Match planes, for equipment, 37.
- Material, purchase of, 30, 31.

- Miter box, use of, new subject (fig. 25), 85.
- Model, preliminary work upon, 1, 4, 8; importance of the, 5; stock cutting for, 9; smoothing of, 19; making the, 58.
- Models, value of large, 2; sequence of, 6; selection of, 7, 41, 56; supplementary, 11; material for, 29; value of small, 30; use of, in suggestive courses, 41; cutting stock for, 57; undersize, 58.
- Moldings, new subject (fig. 38), 103.
- Monkey wrench, for equipment, 37, 38.
- Mortise joint, new subject (fig. 43), 113.
- Mortises (fig. 42), 113.
- Nail sets, for equipment, 37, 38.
- Nails, purchase of, 34; clinch, new subject (fig. 16), 76; maximum grip of, new subject (fig. 17), 78.
- New subjects, 56; *see also* figs. 1-46.
- New tools, 5.
- Nippers, end-cutting, for equipment, 37, 38.
- Notebook, carpentry, 14.
- Oak, for models, 30; plain, 32; quartered, 32.
- Octagon plant stand, 73.
- Oil can, for equipment, 35, 36, 38.
- Oilstone, for equipment, 35, 36, 38.
- Oilstoning, 28.
- Originality of design, 6, 8, 9, 42.
- "Out of wind," 57.
- Paint, new subject (fig. 24), 84.
- Paper knife, how to make, 97.
- Pen tray, how to make, 82.
- Pencil, indiscriminate use of, 17, 18.
- Pencil compasses, for equipment, 37, 38.
- Pencil sharpener, how to make, 66.
- Perspective drawings, 41.
- Phraseology, in arithmetic, 15.
- Picture frame, how to make, 98.
- Picture frames, mitered, 59.
- Pine, for models, 30; new subject (fig. 1), 61.
- Pitches, of roofs, 16.
- Plane, block, 3, 61 (new subject, fig. 1).
- Dado, for equipment, 38.
- Iron, description of, 22; for equipment, 32, 35, 36, 38.
- Jack, 2, 57, 61 (new subject, fig. 1); for equipment, 35, 36, 38.
- Router, new subject (fig. 42), 110.
- Smoothing, 13, 18.
- Wood bead, for equipment, 37, 38.
- Wooden, 22.
- Planes of projection, new subject (fig. 16), 76.
- Planing, traverse, new subject (fig. 38), 106.
- Plant label, how to make, 61.
- Plant stand, how to make: octagonal, 73; halved, 83.
- Plate rack, how to make, 110.
- Poplar, for models, 30.
- Position, at bench, 14.
- Preliminary work, on models, 1; *see also* figs. 1-45.
- Principles, of tools, 4, 11.
- Projection, three planes of new subject (fig. 16), 76.
- Rabbet, cutting a, new subject (fig. 34), 98.
- Rabbet plane, iron, for equipment, 37, 38.
- Racks, equipment for, 21, 36, 38.
- Rasps, use of, 18, 60; new subject (fig. 7), 67.
- Ratchet brace, for equipment, 37, 38.
- Reference books, use of, 10.
- References to other volumes, explained, 43.
- Research, upon tools, 17; in carpentry course, 42.
- Review, 11.
- Ripsaw, use of, 13; for equipment 35, 36, 38; new subject (fig. 1), 61.
- Roofs, shingling of, 15; construction of, 16.
- Router plane, new subject (fig. 42), 110.
- Routing plane, for equipment, 37.
- Rule, for equipment, 21, 35, 36, 38; straight, 23; folding, 23; new subject (fig. 1), 61; how to make, 71.

- Sand shovel, how to make, 76.
- Sandpaper, use of, 18, 59; new subject (fig. 5), 69.
- Sandpaper block, use of, 60; how to make, 65.
- Saw, back, for equipment, 35, 36, 38; new subject (fig. 1), 61.
- Compass, for cutting curves, 25; for equipment, 37, 39; new subject (fig. 10), 69.
- Cutting-off, use of, 13; for equipment, 35, 36, 37, 38; new subject (fig. 1), 61.
- Frame, new subject (fig. 10), 69.
- Rip, use of, 13; for equipment, 35, 36, 38; new subject (fig. 1), 61.
- Turning (or frame), description of, 25; for equipment, 37, 39; new subject (fig. 10), 69.
- Saw filing, 19.
- Scale, use of, in construction, 12.
- Scraper, use of, 18; new subject (fig. 29), 90.
- Scrapers, cabinet, 25.
- Scratcher, on gauge, 22.
- Screen frame, how to make, 113.
- Screwdriver, for equipment, 35, 36, 38; new subject (fig. 14), 74.
- Screws, miscellaneous, for equipment, 26; purchase of, 34.
- Scribing, new subject (fig. 29), 90.
- Selection of models, 7, 41, 56.
- Sequence, of tools, 2; of work, 56.
- Sharpening of tools, 26.
- Shelf, bracket, how to make, 82; corner, 88.
- Shellac, how to purchase, 33, 34; new subject (fig. 6), 66.
- Shingling, 15.
- Shooting board, 3, 58.
- Silk winder, how to make, 67.
- Sketches, blackboard, 13; *see also* "Drawings."
- Sleeve board, how to make, 90.
- Slip stones, for equipment, 37, 39.
- Smoothing and sandpapering, 18.
- Smoothing plane, use of, 18; for equipment, 36, 38.
- Spokeshave, use of, 18, 60; for equipment, 37, 38; new subject (fig. 2), 62.
- Square root, 16.
- Squaring by diagonals, new subject (fig. 32), 95.
- Stains, how to purchase, 33, 34; new subject (fig. 9), 68.
- Stairs, flight of, 12.
- Stamp, steel department, for equipment, 37, 38.
- Steel square, use of, 16; divisions of, 24; in laying out of gable, new subject (fig. 24), 84.
- Stock bill, making of, 20.
- Stock cutting, 9, 56.
- Stock lists, new subject (fig. 16), 76.
- Straight edge, new subject (fig. 40), 108.
- Studding, in plaster partitions, new subject (fig. 9), 68.
- Subjects, new, for description and demonstration, 56.
- Suggestions, for models, 7, 8, 41, 42.
- Supplies, estimating for, 29.
- T square, how to make, 108.
- Table, how to make, 116.
- Table mat, how to make, 69.
- Tables of circumferences and areas, 16.
- Tacks, carpet, 34.
- Taper files, for equipment, 37, 39.
- Teacher, in relation to class, 6; his care of tools, 27.
- Teaching hints, special, 56-61.
- Tendencies to be guarded against, 17, 59.
- Tenons (fig. 42), 113.
- Tests and examinations, 42.
- Theory, in study of carpentry, 10; and practice, 42; talks upon, 44, note.
- Thumb-screw, in bitbrace, 23.
- Time for completion of courses, 40; *see also* "Suggestive Courses," 44-54.
- Toilet case, how to make, 103.
- Tool rack, how to make, 72.
- Tool work, *see* "Courses in Carpentry," 52-54.
- Tools, sequence of, 2; new, 4; construction and use of, 11, 17; comparison of, 22; sharpening of, 26; losses and breakages of, 28; lists of, for equipment, 35-39.

- Towel rack, how to make: rod, 87; folding, 99.
- Towel roller, how to make, 54.
- Traverse planing, new subject (fig. 39), 106.
- Try-square, description of, 23; for equipment, 21, 35, 36, 38; new subject (fig. 1), 61.
- Turn-saw frames, for equipment, 37, 39.
- Twist drills, for equipment, 37, 38.
- Undersize models, 58.
- Vises, on workbench, 26.
- Wall pocket, how to make, 89.
- Warping, new subject (fig. 39), 106.
- Waste, allowance for, in supplies, 29; in stock cutting, 31, 56.
- Wax finishes, 33.
- Wedge, how to make, 63.
- Weged construction, new subject (fig. 42), 110.
- Wedged pin, new subject (fig. 29), 90.
- Whetting, 28.
- Whittling, new subject (fig. 1), 61.
- Wind, out of, 57.
- Wing dividers, for equipment, 35, 36, 37, 38.
- Wood carving, new subject (fig. 19), 80.
- Wood, hard, new subject (fig. 7), 67; kinds of, *see* Cherry, Oak, etc.
- Wood stains, new subject (fig. 9), 68.
- Work, individual, 5, 8, 11, 29, 30, 31, 41.
- Workbench, for equipment, 25.
- Working drawings, 8, 42.
- Written exercises, 11, 13, 17, 42.
- Written work, topics for, *see* "Suggestive Courses," 44-54.

