

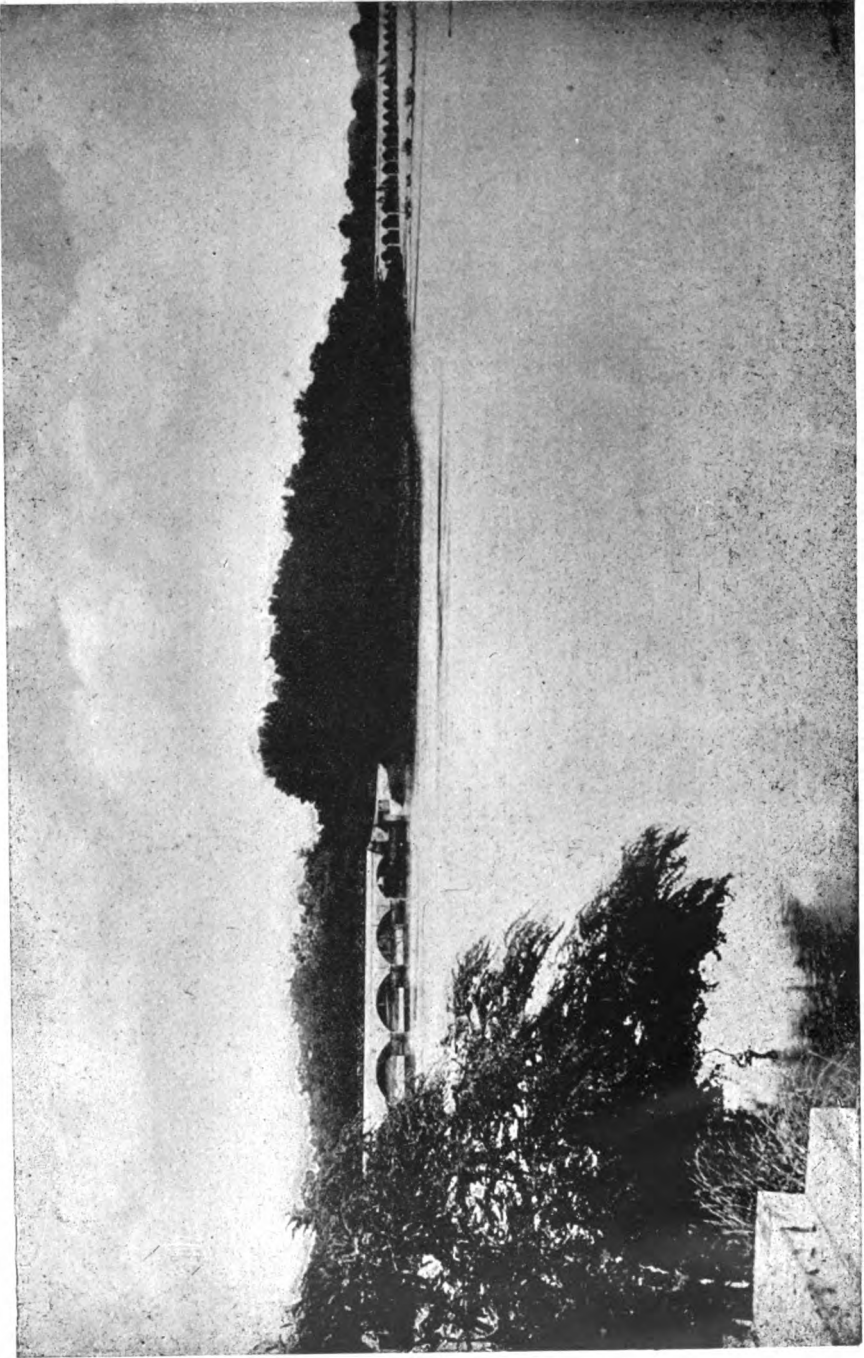

*Frontispiece.*



**Plate I. Upper Anicut across the Cauvery.**



# COLLEGE OF ENGINEERING MANUAL.

---

## IRRIGATION WORKS

BY

B. O. REYNOLDS,

*Instructor in Civil Engineering, College of Engineering.*



---

MADRAS:

PRINTED BY THE SUPERINTENDENT, GOVERNMENT PRESS.

1906.



**DEDICATED**  
BY PERMISSION TO  
**HIS EXCELLENCY LORD AMPHILL, G.C.S.I., G.O.I.E.,**  
**GOVERNOR OF MADRAS.**



## PREFACE.

---

WHEN the original College text-book on Engineering went out of print, it was decided that it should be re-written in the form of several manuals. The first to be undertaken was one on Hydraulics which was published in 1887. A Manual of Building Materials and Construction was issued in 1894.

The want of a Manual on Irrigation Works was felt by the College, and in 1896 a small work, adapted for the most part from Mullins' "Irrigation Manual" by permission of the Government, and with the late General Mullins' consent, was published.

Experience showed, however, that this work required revision and amplification to fit it for College requirements, and it has accordingly been re-written. The present publication does not aim at being a comprehensive treatise on irrigation, it is merely a manual compiled for the use of students.

I have to acknowledge the courtesy of Mr. R. B. Buckley in granting permission to make use of his book "Irrigation Works in India and Egypt," to Mr. Herbert M. Wilson in regard to extracts from his "Manual of Irrigation Engineering," to Mr. James D. Schuyler for leave to reproduce several illustrations from his book on "Reservoirs for Irrigation, Water Power and Domestic Supply," and to Messrs. Ransomes and Rapier for the notes on Stoney's sluices.

I also express my gratitude to His Excellency Lord Amphill, Governor of Madras, for graciously accepting the dedication of this work.

MADRAS,  
*January 1906.*

B. O. R.





# CONTENTS.

## CHAPTER I.

### MEANING OF IRRIGATION, NECESSITY FOR IRRIGATION, DIFFERENT MODES OF IRRIGATION.

ART.	PAGE
1. Meaning of irrigation ... ..	1
2. Necessity for irrigation ... ..	1
3. Value of irrigation ... ..	1
4. Different modes of irrigation ... ..	2
5. Sources of irrigation water... ..	2
6. Water for irrigation drawn from rivers ... ..	2
7. Inundation and perennial canals ... ..	2
8. Parts of a canal system ... ..	4
9. Tanks collecting rainfall for irrigation ... ..	4
10. Reservoir dams for storing up irrigation water ... ..	5
11. Masonry Reservoir dam with flood discharge sluices ... ..	5
12. Preparation of irrigation projects ... ..	6

## CHAPTER II.

### RAINFALL, RUN-OFF, FLOOD DISCHARGES, FLOOD LEVELS AND THEIR REGISTRATION, EVAPORATION, ABSORPTION, SILTING.

13. Rainfall ... ..	7
14. Rainfall registers ... ..	7
15. Ganging rainfall ... ..	7
16. Run-off... ..	8
17. Catchment basin ... ..	8
18. Maximum discharge of catchment basin ... ..	8
19. Formulae for maximum run-off ... ..	9
20. Tables for representative areas ... ..	10
21. Flood discharges ... ..	13
22. Flood levels and their registration ... ..	13
23. River embankments ... ..	14
24. Ganging river discharges ... ..	14
25. Evaporation ... ..	14
26. Leakage and absorption ... ..	15
27. Amount of losses in reservoirs and canals ... ..	16
28. Prevention of percolation ... ..	16
29. Silt ... ..	17

## CHAPTER III.

### CANALS, CHANNELS AND DISTRIBUTARIES.

30. Classes of canals ... ..	19
31. Irrigation canals ... ..	19
32. Navigation canals ... ..	19
33. Combined irrigation and navigation canals ... ..	19
34. The Alignment of canals ... ..	20
35. Canals and channels ... ..	21
36. Purposes for which designed ... ..	21
37. Data for design ... ..	21
38. Levels ... ..	22
39. Dimensions of main channels ... ..	23
40. Typical sections of Indian canals ... ..	24

ART.	PAGE
41. Irrigation channels ... ..	26
42. Distributaries ... ..	28
43. Limiting velocity of water ... ..	28
44. Details of channel ... ..	29
45. Best form of channel ... ..	30
46. Details of full cross section .. ..	31
47. Height of channel banks ... ..	32
48. Width of top of channel banks ... ..	32
49. Mile and intermediate stones or posts ... ..	32
50. Cattle crossings ... ..	33

## CHAPTER IV.

## HEAD-WORKS AND ANICUTS OR DIVERSION WEIRS.

51. Head-works ... ..	36
52. Anicuts or weirs ... ..	37
53. Component parts of anicuts ... ..	38
54. Crest wall ... ..	38
55. Horizontal masonry apron ... ..	40
56. Retaining wall ... ..	41
57. Sloping aprons of masonry or concrete ... ..	41
58. Sloping aprons of rough stone ... ..	42
59. Outer rough stone apron ... ..	43
60. Water cushions ... ..	43
61. Apron and groynes above crest wall ... ..	44
62. Principal types of anicuts ... ..	44
63. Sunkesala weir ... ..	44
64. Jutoor weir ... ..	46
65. Srivaikuntam anicut ... ..	48
66. Gódvári anicut .. ..	49
67. Third type of anicut ... ..	53
68. The Kistna anicut ... ..	53
69. Soane weir ... ..	54
70. Lawrence weir ... ..	56
71. Movable iron weirs, French type ... ..	57
72. Goulburn masonry and iron drop-gate weir ... ..	58
73. Open and closed weirs ... ..	60

## CHAPTER V.

## SCOURING-SLUICES, OPEN WEIRS.

74. Scouring sluices ... ..	62
75. Construction of under-sluices ... ..	64
76. Scouring sluice shutters and movable dams ... ..	65
77. Fouracres' shutters on Soane weir ... ..	66
78. Stoney's sluices ... ..	69
79. Examples of Stoney's sluices—The Belleek sluices ... ..	71
80. The Weaver sluices ... ..	71
81. The Assuán sluices ... ..	72
82. Smart's shutter ... ..	72
83. Example of Smart's shutter ... ..	72

## CHAPTER VI.

REGULATORS, HEAD SLUICES, ESCAPES, CANAL WEIRS OR FALLS  
AND BRIDGES.

84. Regulators or head sluices ... ..	75
85. Position of head sluice ... ..	75
86. Construction of regulator ... ..	77

CONTENTS.

ix

Art.	PAGE
87. Head sluices	78
88. Data for design	78
89. Details of Design—Plans	81
90. Head sluices of distributaries	81
91. Escapes	81
92. Location and characteristics of escapes	85
93. Design of escapes	87
94. Canal weirs or falls	88
95. Notched crest fall	92
96. Formulæ for notch falls	93
97. Determination of profile for notch falls	93
98. Bridges and culverts	94
99. Data for design	95
100. Details of design	95

CHAPTER VII.

CROSS DRAINAGE WORKS, INLETS AND ESCAPES, SUPER-PASSAGES,  
AQUEDUCTS, SYPHONS.

101. Drainage works	97
102. Drainage cuts, or diversions	97
103. Inlet dams	99
104. Level-crossings	99
105. Super-passages	100
106. Aqueducts	102
107. Gunnáram aqueduct	108
108. Iron aqueducts	107
109. Siphons	108
110. Examples of inverted siphons	109

CHAPTER VIII.

NAVIGATION, LOCKS, LOCK WEIRS, TOW-PATHS, FENDER  
PILES, BRIDGES.

111. Canals for navigation only	114
112. Irrigation canals adapted for navigation	114
113. Limiting velocity of water	115
114. Navigation in the dry season	115
115. Lock weirs	116
116. Locks	116
117. Design of lock	119
118. Tidal canals	119
119. Site plans for locks, and lock-weirs	119
120. Fender piles	126
121. Bridges	126
122. Tow-paths	129

CHAPTER IX.

DUTY OF WATER.

123. Duty of water	130
124. Units of measure for water duty and flow	130
125. Measurement of water duty	131
126. Quantity of water required and used per acre for rice crops	132
127. Actual water supply of canals and channels	132
128. Comparisons of water supply and area irrigated	133
129. Classes of storage works	136

## CHAPTER X.

STORAGE WORKS, RESERVOIRS, TANKS, EARTHWORKS,  
SURPLUS ESCAPES, SLUICES.

ART.	PAGE
130. Preliminary investigation ... ..	136
131. Examples of reservoir sites—The Sweet-water site ... ..	136
132. Tinto Basin dam, Arizona ... ..	137
133. Designs ... ..	137
134. Earthen dams or embankments ... ..	137
135. Foundations of earthen dams ... ..	137
136. Masonry cores and puddle walls ... ..	138
137. Masonry cores ... ..	138
138. Homogeneous earthen embankment ... ..	139
139. Tanks ... ..	140
140. Grouping of tanks ... ..	140
141. Repair and improvement of tanks ... ..	140
142. Supply from catchment basins ... ..	141
143. Methods of computing areas of water sheds, etc. ... ..	142
144. Capacity for storage ... ..	143
145. Irrigating duty of water ... ..	143
146. Tank bunds ... ..	144
147. Puddle walls ... ..	145
148. Puddle faces ... ..	147
149. Scour holes ... ..	149
150. Revetments and substitutes therefor ... ..	149
151. Surplus weirs or means of disposing of surplus water ... ..	152
152. Designs of weirs ... ..	152
153. Sluices for the distribution of water ... ..	159
154. Regulation of vent by shutter ... ..	161
155. Regulation by plugs ... ..	161
156. Closing of breaches in tank bunds ... ..	163

## CHAPTER XI.

## MASONRY DAMS.

157. Masonry dams ... ..	173
158. Stability of masonry dams ... ..	174
159. Practical formula ... ..	176
160. Theoretical profile ... ..	177
161. Limiting or maximum pressure on the masonry at the base or any point of a dam. ... ..	177
162. Examples of limiting pressure ... ..	178
163. General form of dam ... ..	178
164. Design of curved dams ... ..	179
165. Details of construction ... ..	180
166. Examples of dams—the Periyár Dam ... ..	181
167. The Tansa Dam ... ..	183
168. The Poona or Lake Fife Dam ... ..	184
169. The Bhatgur Dam ... ..	184
170. The Betwa Dam ... ..	185
171. The Beetaloo Dam ... ..	186
172. The Geelong Dam ... ..	186
173. The Quaker Bridge Dam ... ..	186
174. Sweet-water Dam ... ..	187
175. Bear Valley Dam ... ..	187
176. Pacoima Submerged Dam ... ..	187
177. The Zola Dam ... ..	189
178. The Furens Dam ... ..	190
179. The Ban Dam ... ..	191
180. The Bousey Dam ... ..	192
181. The Alicante Dam ... ..	194
182. The Puentes Dam ... ..	195

ART.	PAGE
183. The Vyrnwy Dam' ... ..	195
184. Masonry reservoir dam with flood discharge sluices ... ..	196
185. The Assiout Dam ... ..	198

CHAPTER XII.

SOURCES OF WATER-SUPPLY, WELLS, WATER LIFTS.

186. Sources of water-supply ... ..	199
187. Sources of earth waters ... ..	199
188. Wells ... ..	199
189. Capacity of common wells ... ..	200
190. Artesian wells ... ..	200
191. Examples of artesian wells ... ..	201
192. Size of well ... ..	201
193. Lift irrigation ... ..	201
194. Motive power and pumps ... ..	202
195. Choice of pumping machines ... ..	202
196. Mechanical methods of irrigation ... ..	203
197. Hydraulic rams ... ..	208
198. Other forms of motors for pumping water ... ..	209
199. Lift pumps ... ..	209
200. Force pumps ... ..	209
201. Centrifugal pumps ... ..	210
202. Pulsometer pumps ... ..	210
203. Length of suction pipes ... ..	211
204. Steam engines ... ..	211
205. Oil Engines ... ..	212

CHAPTER XIII.

WATER-SUPPLY OF TOWNS.

206. Quality of water ... ..	213
207. Taking samples of water ... ..	213
208. Purification of water ... ..	213
209. Filtration ... ..	214
210. Quantity of water required per head ... ..	215
211. Variation of demand ... ..	215
212. Intermittent and constant supply ... ..	216
213. Classification of water-works ... ..	216
214. Settling reservoirs ... ..	217
215. Design of settling reservoirs ... ..	217
216. Position of inlets and outlets ... ..	218
217. Filter beds ... ..	219
218. Drainage arrangements ... ..	221
219. Filter head ... ..	222
220. Rate of filtering speed allowable ... ..	223
221. Area and number of filter beds ... ..	223
222. The sand bed ... ..	224
223. Other systems of purification ... ..	226
224. Service reservoirs ... ..	226
225. Position of settling and other reservoirs ... ..	227
226. Distribution systems ... ..	227
227. Determination of the sizes of pipes ... ..	229
228. Pipes for water-works ... ..	229





# IRRIGATION WORKS.

## CHAPTER I.

### MEANING OF IRRIGATION—NECESSITY FOR IRRIGATION—DIFFERENT MODES OF IRRIGATION.

**1. Meaning of Irrigation.**—Irrigation is a method of producing or increasing fertility in soils by an artificial supply of water. In dry weather you take a watering-pot and sprinkle such plants and flowers as you consider most valuable, or perhaps with a hose or water-cart moisten more or less your garden. This is irrigation pure and simple. The only difference between this form and that more generally implied by the word irrigation as used in India is that in the latter case the application of water to crops becomes a business by itself, and it is the duty of the Engineer to design and introduce methods whereby water may be applied in the easiest, least expensive and most certain manner. This is by aid of the action of gravity, and irrigation by natural flow is the result. Channels are constructed which lead the water from the source of supply, be it well, reservoir or stream; and they are so aligned and graded that the water shall flow through these and from them into minor channels, and from these again be led by ploughed furrows through the fields.

**2. The Necessity for Irrigation.**—The rainfall in some parts may be utterly insufficient in every season to mature the crops; this is the case, for instance, in Sindh and in parts of the Punjab, where the rainfall for the year averages from 2 to 4 inches only, and in the whole basin of the Nile in Africa, where the rainfall, on large tracts, is practically nothing at all. Or the rainfall may be amply sufficient in total quantity, but badly distributed with reference to the seasons or to the requirements of the crops. This is the case in Southern India and in the Madras Presidency particularly, where the rain, though the total amount ranges from 40 to 60 inches in the year, generally falls in short periods and it is not uncommon to have bursts of 12 inches in twenty-four hours. And even in parts of the Himalayas, where the rainfall varies from 50 to as much as 100 inches, crops grown on the terraces in the mountains are matured in the dry season by artificial irrigation.

**3. Value of Irrigation.**—Of the incalculable benefits derived by a country from irrigation, not the least important are increase of revenue and protection from famine.

Irrigation works are consequently classed as *Productive* or *Protective* according as they conspicuously fulfil one or other of these great functions. In a productive work the revenue not only pays the cost of maintenance but, in addition, a percentage on the capital expended.



This percentage is a profit to the State, that is to the community. In the case of a protective work the revenue is generally insufficient to yield a profit ; but the construction of the work is undertaken to protect the inhabitants of the district from scarcity and famine.

The full advantage of irrigation works cannot, however, be estimated by their direct results. Works are indirectly profitable in improving the condition of the people, in promoting trade, and in developing the resources of the country.

**4. Different Modes of Irrigation.**—Irrigation works may be divided into two great classes, viz., gravity and lift irrigation. Gravity works include all those by which the water is conducted to the land by the aid of natural flow. They include—

- (1) Canals, which may be either perennial or inundation canals.
- (2) Storage works.
- (3) Artesian well supplies.

Lift irrigation includes those forms of irrigation in which the water does not reach the land by natural flow, but is transported to it by pumping or other means of lifting. Lift irrigation is divided into classes according to the form of power used.

**5. Sources of Irrigation Water.**—The water required for irrigation may be obtained from underground where it is often met with at a moderate depth by sinking wells to the water-bearing strata. The water is drawn up, either by manual, animal or other power.

Where the rainfall is heavy, but of short duration, it may be collected in tanks ; and the flow of streams, which fail in the dry season, may be stored in reservoirs, formed by dams placed across the valleys of streams at suitable sites.

The most abundant supply, however, of water for irrigation is derived from large rivers, by means of canals.

**6. Water for Irrigation drawn from Rivers.**—Water may be drawn from rivers during their floods by means of inundation canals, leading the water at a somewhat high level from the river to the lands at the sides, the influx being sometimes regulated by sluice-gates, and ceasing directly the river falls. Water is also obtained for irrigation from the upper parts of rivers, having a perennial flow, by canals which, being given a suitable fall, convey the water for long distances to irrigate arid plains at a considerable distance from any natural water-course ; and shorter canals are constructed branching off lower down on such rivers, to irrigate lower lands away from the river. Canals, moreover, starting from the head of a delta, where the water is backed up by a weir during the dry season, supply water for irrigation to the low-lying lands situated between the branches of the river traversing the delta. In the first case the irrigation is intermittent, only taking place when the river is in flood, and depending for its extent on the height of the flood ; whilst the last two methods are intended to furnish a perennial irrigation, discharging a constant supply of water throughout the dry season.

**7. Inundation and Perennial Canals.**—The leading of water from rivers and streams to irrigate adjacent lands was probably practised even before the time when the construction of tanks was undertaken.

The most primitive system was that of making comparatively shallow cuts, through the river bank, or through the ridge which separates the river from the low-lying surrounding country, into which the water flowed when the level of the river was raised by the regular floods which occur annually in most tropical streams. The canals made on this system are called, in India, inundation canals. The chief inundation canals of India are found in the basin of the Indus and of its five tributaries. Inundation canals give, at best, a precarious system of irrigation; if the floods of the rivers, from which the canals are drawn, are regular, and the duration of the flood is sufficient, the cultivation is secure, provided that the canals have been cleared of the silt deposits of the previous year; but when the floods are low, or only remain for a short time at their full height, it is impossible to pass the necessary volume of water on to the fields, or even to give any water at all to many of them.

A very large proportion of the area now under irrigation in India is commanded by perennial canals taken from the large rivers. It is impossible to draw any very distinct line between inundation and perennial canals. There are some canals which are perennial, in the sense that the water does flow in them all the year round and yet the discharge is so small during the dry season of the year, as compared with that of the flood season, that they would more probably be classed with inundation canals, although the term is usually only applied to channels with an intermittent discharge. The extra depth to which such canals are cut may be sufficient to take in water when the river is at its lowest, but the real object of it often is to increase the discharge in the season of inundation. A perennial canal may be only an inundation canal cut to a sufficient depth; but usually it has head works in or across the river from which it is taken. The construction of perennial canals in India was probably first undertaken in Madras, where, as has already been stated, there are numerous examples of channels leading a constant supply of water from streams. In some cases, and notably in that of the channels taking off from the Grand Anicut in the Tanjore District, these canals drew their supply from permanent weirs or anicuts, but in many cases a dam or *corumbo* was constructed across the river every year as the flood fell, to retain the water at a sufficient height to compel it to flow into the canals. The *corumbos* were often made of sand and brushwood only, and completely closed the channel of the river, diverting the entire supply into the canal. The Grand Anicut is said to have been constructed several centuries ago.

The earliest examples of successful perennial canals are to be found in the delta system of Madras; of these the Cauvery or Coleroon works are the most ancient, both as regards the original portion constructed by the natives, and with reference to the improvements of them which were commenced in 1836.

The area of irrigation dependent on this anicut system, before any improvements were effected, was 669,000 acres; now it is rather more than one million acres; about 18 lakhs of rupees only have been spent on the improvements. This irrigation system is the largest delta system, and it is the most profitable of all the works in India. There are six or seven somewhat similar delta systems in Madras, of these the Gódávári system is a fine example. At the head of the delta of the Gódávári the deep bed of the river is only some 8 or 10 feet below the highest

parts of the delta which require irrigation, so that it was easy to command the whole area by means of a weir which was constructed across the river at Dowlaishweram, where the total width from bank to bank is  $3\frac{1}{2}$  miles, but where four islands reduced the actual length of weir to about  $2\frac{1}{2}$  miles. The river at the head of the delta bifurcates into two streams, which divide the area under command into three sections, each of which is watered by a canal taking off the river above the anicut. In the eastern section the main canal soon bifurcates, one branch following the high bank of the river, and the other flowing along the foot of the hilly ground bordering the delta at this part, both these branches throw off many other channels to irrigate the lower land lying between them. In the same way the canal in the central section of the delta throws off branches along the high banks of the river, which command the country between them, while one of them in its lower reaches crosses a branch of the river by an aqueduct of 49 arches. In the western section the main canal divides into several branches, one of which, as in the eastern section, follows the margin of the delta, and another follows the river bank. The main lines of canal in this system are constructed for navigation as well as for the supply of water. The area irrigated is nearly 700,000 acres.

**8. Parts of a Canal System.**—A canal system consists essentially of the following parts:—

- (1) Source of supply.
- (2) Lands to be irrigated.
- (3) Main canal and branches.
- (4) Head and regulating works.
- (5) Control and drainage works.
- (6) Distributaries.

The principal works of this system are the main canals and distributaries. Between different canal systems the greatest points of difference are found in the head works and in the first few miles of the diversion line, where numerous difficulties are frequently encountered, calling for variations in the form and construction of drainage works and canal banks.

**9. Tanks collecting Rainfall for Irrigation.**—One of the earliest systems of irrigation in India, in those districts where the rainfall is generally copious, but unsuitably distributed during the season, was by surface tanks. They are found to some extent in all parts of India, but are to be counted by thousands in Madras, where millions of acres of rice crops are irrigated from them. These tanks vary in size from a few acres to nine or ten square miles of water surface. They are usually formed by throwing earthen embankments across small local drainages, often with a catchment area of only two or three square miles, or by a series of such embankments thrown across the valleys leading from larger catchments. The floods are impounded in this series of tanks and utilized subsequently for irrigation; the surplus from one tank flowing by escape channels to that below. In years of very heavy rainfall these local tanks are occasionally breached, and the supply store lost, and in years of deficient rainfall many fail to fill at all. In Madras, where there are some 60,000 tanks, the majority are provided with

masonry works for draining off the water or for regulating the discharge. The Madras tanks also depend mainly on local rainfall, but they are sometimes fed from rivers or streams by means of channels taking off from weirs constructed in the beds of the rivers. In a return given by the Madras Government it appears that there are 1,129 weirs across rivers or streams in Madras, each connected with a series of tanks, or with a single one. These weirs are exclusive of those connected with the larger irrigation works. The dependence on local rainfall renders the irrigation from these tanks to a certain extent precarious, but the area ordinarily irrigated from works of this kind in Madras exceeds  $3\frac{1}{2}$  million acres. In some cases the embankments, which, with one or two exceptions, are all made of earth, are built in gorges; thus the embankment of the Cumbum tank in the Guntúr district which is over 100 feet high, is little more than 300 feet long, but the water surface of the reservoir is about 8 square miles: while another example, the Chembarambakam tank, about 14 miles from Madras, has an embankment 3 miles long which sustains a minimum depth of only 20 feet or so; it has a waterspread of 8.95 square miles and a capacity of 103 millions of cubic yards. In Mysore the Miggar tank has an earthen embankment 84 feet high and 1,000 feet long. In the north these surface tanks, in almost all cases, depend on their local catchment, but in Madras tanks are sometimes grouped together and fed from rivers. Plate I shows one of these systems in the Salem district which has been greatly improved since 1883 by the construction of a weir across the river Ponnar, and of a system of supply channels and sluices.

#### 10. Reservoir Dams for Storing up Irrigation Water.—

Large volumes of water can be stored up for irrigation by erecting an earthen or masonry dam across the lower part of the valley of a stream or river. The dam arrests the flow of water during floods till the water has filled the reservoir space above the dam, the volume of water thus stored up depending upon the height of the dam and the configuration of the valley above. A narrow part of the valley is generally selected which widens out higher up, so that a comparatively short dam across a gorge retains a large volume of water. A waste weir is provided, over which the surplus water flows away harmlessly into the channel below when the reservoir has been filled. The water in these reservoirs being deep, is much less exposed to loss from evaporation than in shallow tanks.

Several reservoirs have been formed by earthen and masonry dams in the hilly districts of the province of Bombay for irrigating tracts having a small rainfall, as being the only method available on account of the variable flow of the rivers in those regions. Earthen dams are ordinarily used for moderate heights, and in places where compact rock is not reached at a moderate depth below the surface; and masonry dams are adopted for considerable heights, where a rock foundation can be obtained.

**11. Masonry Reservoir Dam with Flood Discharge Sluices.**—Reservoir dams for storing up water for irrigation or water-supply are commonly constructed across the narrow, mountainous gorge of a small river or stream, whose waters during floods gradually fill the reservoir thus formed above the dam; and the moderate volume of

surplus water in wet years passes over the waste weirs. When, however, a dam is constructed across the channel of a large river, such as the Nile, to store up a portion of the flow towards the close of the flood season as designed to be accomplished by the masonry dam at Assuân, provision has to be made for the discharge of the maximum flood through numerous openings near the bottom of the dam. These are only closed when the flood has begun to abate, and the river, having fallen considerably, is carrying along comparatively little silt.

**12. Preparation of Irrigation Projects.**—In considering proposals for constructing irrigation works, whatever the circumstances may be, there are certain points on which information is required. These are—

- (1) The average rainfall of the country and its character.
- (2) The irrigation duty of the drainage from a square mile of country or other definite area.
- (3) The yield or quantity of water derivable from that definite area.
- (4) The average rates of assessment, for wet lands and dry lands, respectively, per acre in the neighbourhood.
- (5) Special circumstances regarding the site of the proposed work.

## CHAPTER II.

### RAINFALL, RUN-OFF, FLOOD DISCHARGES, FLOOD LEVELS AND THEIR REGISTRATION, EVAPORATION, ABSORPTION, SILTING.

**13. Rainfall.**—Rainfall is the source of all water used for irrigation purposes and therefore a knowledge of its amount, character, seasons or periods, and of the effects produced by it, is of primary importance to all whose duty it is to design, carry out, improve, or maintain irrigation works.

The resulting discharge, or run-off, from rainfall has to be considered in two ways: first, the water to be utilized; second, the water to be otherwise disposed of; and in connection with every irrigation work these two points require to be concurrently taken into consideration.

**14. Rainfall Registers.**—Rainfall registers are the foundation of knowledge of the water resources of a country. It is essential therefore that they be kept in a convenient form at as many stations as possible; and indeed, wherever there is some one available, either permanently or temporarily, to measure and record the rainfall. All old registers should be preserved, abstracted, and used as data.

It should be remembered that an accurate record of the duration of all very heavy falls of rain is of much importance, and this should be impressed upon all in charge of rain-gauges. But even if the rainfall returns of any particular district are complete, there is often no little difficulty in deciding, first, the maximum discharges from the catchment in periods of maximum rainfall: and second, the amount of run-off or the proportion of the total rainfall which finds its way to the point of discharge along the outfall line of the country.

**15. Gauging Rainfall.**—A common form of rain-gauge is shown in Fig. 1. It consists of three parts, the collector A, the receiver B, and the overflow attachment C. A measuring rod graduated to inches and tenths is furnished with each gauge and is used in measuring the depth of water. The gauge should be placed in an open space, preferably over grass soil, and, to obtain a free exposure to the rain, should be at least 50 feet from any building or obstruction. It should be enclosed in a close-fitting box and sunk into the ground, to such a depth that the upper rim of the gauge shall be about one foot above the surface, and care should be taken to maintain it in a horizontal position. The sectional area of the receiver being only 0.1 of the area of the collector, the depth of water measured is ten times the true rainfall.

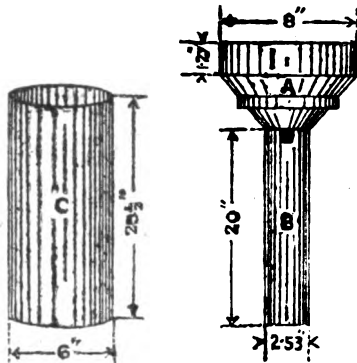

Fig. 1. Rain Gauge.

**16. Run-off.**—By “run-off” is meant the quantity of water which flows in a given time from the catchment basin of a stream. The run-off of a given catchment area may be expressed either as the number of cubic feet per second,\* of water flowing in the stream draining that area, or it may be expressed as the number of inches in depth of a sheet of water spread over the entire catchment. The latter expression indicates directly the percentage of rainfall in inches which runs off.

**17. Catchment Basin.**—The ground or country over which the rain falls, and then drains off into one line of outfall or water-course, is called the catchment basin; the boundary line of this basin is the watershed.

Every irrigation work is dependent for its supply of water upon the run-off or discharge, due to rainfall, from a basin of greater or less extent, varying, in Madras, from the 115,570 square miles of the Gódávári basin above the anicut, to the fraction of a square mile supplying a small tank.

The run-off or discharge of a catchment basin may be stored in tanks or reservoirs, in which case the proportion of the whole discharge intercepted may be large or small; or it may be utilized by means of irrigation canals or channels, with or without the aid of an anicut or weir, to raise the water-level in the water-course, which may be the immediate source of supply.

**18. Maximum Discharge of Catchment Basin.**—Upon a right estimate of the greatest quantity of water liable to be discharged from a catchment basin will depend the safety of any work which may exist, or which it may be proposed to construct, to utilize a part of the water for irrigation purposes.

As run-off bears a relation to rainfall, it would appear that, knowing the amount of rainfall and the area of the catchment basin, the amount of run-off, or discharge, can be readily ascertained. This is not exactly the case, however, as the amount of run-off is affected by many varying climatic and topographic factors. Many formulæ, none of

\* The abbreviation now adopted in the Public Works Department for “cubic feet per second” is “cusecs.”

which give perfectly satisfactory results, have been proposed for obtaining the relation between run-off and rainfall. The run-off will be affected by the depth of the soil, the amount of vegetation, the steepness of the slopes, and the geologic structure.

Another difficulty in determining the run-off from any given catchment basin is due to the ever-varying circumstances under which heavy rain-storms occur.

While, however, an absolutely correct determination of this quantity is not possible, it is, nevertheless, quite practicable, if a right use be made of available data, to form a fairly accurate estimate of the maximum quantity of water which may have to be disposed of, and then by allowing a reasonable margin for errors in the estimate, the requisite safety may be secured.

**19. Formulæ for Maximum Run-off.**—Several formulæ for ascertaining the maximum discharge from a given catchment basin have been obtained both empirically from known measurements and by theoretic processes.

In India the formulæ which have been in general use are the following:—

1. Ryves' formula— $Q = CM^{\frac{2}{3}}$
2. Dickens' formula— $Q = CM^{\frac{2}{3}}$

in which  $M$  represents the area of the catchment basin in square miles,  $C$  is a co-efficient depending for its value upon rainfall, soil, slope of ground forming the basin, etc., and  $Q$  is the resulting discharge, which is usually taken in units of cubic feet a second. By plotting a curve derived from the flood discharges of some American streams it was found that the resulting equation became,  $Q = 200 M^{\frac{5}{6}}$ .

The first of these formulæ assumes that the discharge from catchment basins of different areas varies as the cubic root of the square of the area, while in the second the variation is supposed to be as the fourth root of the cube of the area. The general result is, in the former case, a much more rapid diminution of proportionate discharge as the area increases, than in the latter case. The data for deciding as to which is the more generally applicable formula for Southern India do not as yet exist, and either may be usefully employed if it be borne in mind that, while these formulæ may be confidently used for the practical settlement of questions connected with the design of works, when the conditions of their applicability have been determined on adequate data, yet they are otherwise to be relied on only as a guide to the reasonableness, or the reverse, of the conclusions independently arrived at.

The following additional caution should, however, not be lost sight of. No such formula can be strictly applicable, with the same co-efficient, to areas of various sizes, even in the same part of the country and within the influence of the same intensity of rainfall, unless, as has been already pointed out, the other circumstances, such as the slope of the ground, description of the soil, etc., be approximately similar.

The chief difficulty will be found in the selection of a suitable co-efficient. For the comparatively limited areas in the coast districts,



where the country is flat, and the drainage takes a longer time to run-off, 400 to 500 have been found to be suitable co-efficients for use with Ryves' formula; and 675 is a suitable co-efficient for limited areas near the hills, though occasionally in hilly tracts, liable to heavy storms, a much higher co-efficient is necessary.

**20. Tables for Representative Areas.**—The following tables (see pages 11 and 12) giving for the two formulæ, with different co-efficients, the corresponding depth in inches draining off certain representative areas, and the discharges in cubic feet a second, will be useful in determining from recorded rainfall, from recorded discharges, or from the two combined, what co-efficients would be likely to be suitable to different localities.

The use of these tables may be explained by one or two examples.

Suppose the greatest recorded rainfall within, or near, a catchment basin under investigation to have been 11 inches in 24 hours. The nearest rainfall to this, in the line of 5 square miles (the standard area) is 10·86 inches under co-efficient 500 for Ryves' formula, and about midway between 400 and 500 for Dickens' formula. Were no other data available, either formula with the co-efficient indicated might be used to obtain the approximate discharge. Were the area of the basin 500 square miles, the resulting discharges obtained would be—

		C. ft. per second.	
By Ryves' formula	.. ..	31,500	}
By Dickens' formula	.. ..	47,500	
			a very material difference.

Suppose, however, that for a part of the basin to be dealt with, say, for 250 square miles, there should be recorded a maximum discharge (over an anicut suppose) of 20,000 cubic feet a second, and that the rainfall at the time at which this occurred were the highest on record, viz., 11 inches. These data would indicate Ryves' formula to be applicable, with the co-efficient 500; whereas, if the discharge had been about 28,000 cubic feet a second, Dickens' formula with the co-efficient 450, would be more likely to give a correct approximation to the flood discharge of the larger basin.

Again, suppose that the recorded rainfall connected with an ascertained flood discharge of 16,000 cubic feet a second from a basin of 250 square miles were 8·70 inches, and that subsequently (or previously) a heavier fall of 11 inches occurred; then the co-efficient 400 with Ryves' formula would be the one deduced from the smaller rainfall, and for the greater rainfall a co-efficient of 500 would be indicated as suitable for adoption.

In all such enquiries it is necessary to ascertain not only the actual maximum rainfall, but also the amount of rainfall preceding such maximum fall, and the duration of both, but especially of the latter, otherwise a serious mistake might be made in deducing from the discharge due to any one rainfall what that due to a maximum fall would be. A rainfall of 6 or 8 inches in six or eight hours, after several days of moderate but soaking rain, may produce a greater discharge than one of 12 inches in 24 hours after dry weather.

Areas in square miles.	D. = C.M. <sup>3</sup> .										D. = C.M. <sup>3</sup> .										
	Co-efficients.										Co-efficients.										
	200.	300.	400.	500.	600.	700.	800.	200.	300.	400.	500.	600.	700.	800.	200.	300.	400.	500.	600.	700.	800.
	Discharges in thousands of cubic feet a second.																				
1	0.200	0.300	0.400	0.500	0.600	0.700	0.800	0.200	0.300	0.400	0.500	0.600	0.700	0.800	0.200	0.300	0.400	0.500	0.600	0.700	0.800
5	0.584	0.876	1.168	1.400	1.752	2.044	2.336	0.688	1.002	1.336	1.670	2.004	2.338	2.672	0.688	1.002	1.336	1.670	2.004	2.338	2.672
10	0.928	1.392	1.856	2.320	2.784	3.248	3.712	1.124	1.686	2.248	2.810	3.372	3.934	4.496	1.124	1.686	2.248	2.810	3.372	3.934	4.496
25	1.710	2.565	3.420	4.275	5.130	5.985	6.840	2.236	3.354	4.472	5.590	6.708	7.826	8.944	2.236	3.354	4.472	5.590	6.708	7.826	8.944
50	2.714	4.071	5.428	6.785	8.142	9.499	10.86	3.760	5.650	7.520	9.400	11.28	13.16	15.04	3.760	5.650	7.520	9.400	11.28	13.16	15.04
100	4.308	6.462	8.616	10.77	12.92	15.08	17.23	6.324	9.486	12.65	15.81	18.97	22.14	25.30	6.324	9.486	12.65	15.81	18.97	22.14	25.30
250	7.936	11.91	15.88	19.84	23.81	27.79	31.76	12.57	18.86	25.15	31.43	37.72	44.01	50.30	12.57	18.86	25.15	31.43	37.72	44.01	50.30
500	12.60	18.90	25.20	31.50	37.80	44.10	50.40	21.15	31.72	42.29	52.86	63.44	74.01	84.58	21.15	31.72	42.29	52.86	63.44	74.01	84.58
1,000	20.00	30.00	40.00	50.00	60.00	70.00	80.00	35.57	53.35	71.13	88.91	106.7	124.5	142.3	35.57	53.35	71.13	88.91	106.7	124.5	142.3
2,500	36.84	55.26	73.68	92.10	110.5	128.9	147.4	70.71	106.1	141.4	176.8	212.2	247.5	282.8	70.71	106.1	141.4	176.8	212.2	247.5	282.8
5,000	58.48	87.72	117.0	146.2	175.4	204.7	234.0	118.9	178.4	237.8	297.3	356.8	416.2	475.6	118.9	178.4	237.8	297.3	356.8	416.2	475.6
10,000	92.88	139.2	185.7	232.1	278.4	324.9	371.4	200.0	300.0	400.0	500.0	600.0	700.0	800.0	200.0	300.0	400.0	500.0	600.0	700.0	800.0
25,000	171.0	256.5	342.0	427.5	513.0	598.5	684.0	397.6	596.5	795.3	994.1	1,193	1,392	1,591	397.6	596.5	795.3	994.1	1,193	1,392	1,591
50,000	271.4	407.1	542.9	678.5	814.2	950.0	1,086	668.7	1,003	1,337	1,672	2,006	2,340	2,674	668.7	1,003	1,337	1,672	2,006	2,340	2,674

Areas in square miles.	D. = C.M. <sup>3</sup> .								D. = C.M. <sup>3</sup> .							
	Co-efficients.								Co-efficients.							
	200.	300.	400.	500.	600.	700.	800.	900.	200.	300.	400.	500.	600.	700.	800.	900.
	Discharges in inches from areas in 24 hours.															
1	7.43	11.45	14.87	18.59	22.30	26.02	29.74	7.43	11.15	14.87	18.59	22.30	26.03	29.74		
5	4.34	6.52	8.60	10.86	13.03	15.20	17.38	4.96	7.44	9.92	12.40	14.88	17.36	19.84		
10	3.35	5.03	6.71	8.39	10.06	11.74	13.42	4.18	6.27	8.36	10.45	12.54	14.63	16.72		
25	2.54	3.82	5.09	6.36	7.63	8.90	10.18	3.33	4.49	6.66	8.33	9.98	11.65	13.33		
50	2.02	3.03	4.04	5.05	6.06	7.07	8.08	2.79	4.15	5.50	6.99	8.38	9.78	11.18		
100	1.60	2.40	3.20	4.00	4.80	5.60	6.40	2.35	3.52	4.60	5.78	7.04	8.12	9.20		
250	1.18	1.77	2.36	2.95	3.54	4.13	4.72	1.87	2.81	3.75	4.69	5.62	6.56	7.50		
500	0.93	1.40	1.87	2.34	2.80	3.27	3.74	1.57	2.35	3.14	3.93	4.70	5.40	6.28		
1,000	0.74	1.11	1.48	1.85	2.22	2.59	2.96	1.32	1.98	2.64	3.30	3.96	4.62	5.28		
2,500	0.54	0.81	1.09	1.36	1.63	1.90	2.18	1.05	1.57	2.10	2.63	3.14	3.67	4.20		
5,000	0.43	0.65	0.87	1.09	1.30	1.52	1.74	0.88	1.32	1.76	2.21	2.64	3.08	3.52		
10,000	0.34	0.51	0.69	0.86	1.03	1.20	1.38	0.74	1.11	1.48	1.86	2.22	2.69	2.98		
25,000	0.25	0.38	0.51	0.64	0.76	0.89	1.02	0.59	0.88	1.18	1.47	1.76	2.06	2.36		
50,000	0.20	0.30	0.40	0.50	0.60	0.70	0.80	0.49	0.74	0.99	1.24	1.48	1.73	1.98		

## 21. Flood Discharges.—In estimating flood discharges—

1. Rely chiefly on calculations based upon ascertained flood levels, and on the rainfall to which the resulting discharges were due.

2. Study the rainfall register and see whether the highest recorded rainfall is likely to have been a maximum, and whether its occurrence was preceded by those conditions likely to make it produce the maximum effect.

3. Use Ryves' or Dickens' formula to check calculations otherwise made, and do not rely on the discharges that they indicate until the conditions of their applicability have been settled on adequate and satisfactory data.

4. Ascertain the co-efficient to be used with each formula for the different parts of the district, so that a ready means of settling approximately the requirements of anicuts, tanks, supply channels receiving land drainage, etc., as regards safety, may be available.

5. Make use of every opportunity of accumulating additional data. Such opportunities occur every, or nearly every, year, and in ten years data on which very valuable calculations can be based could be collected

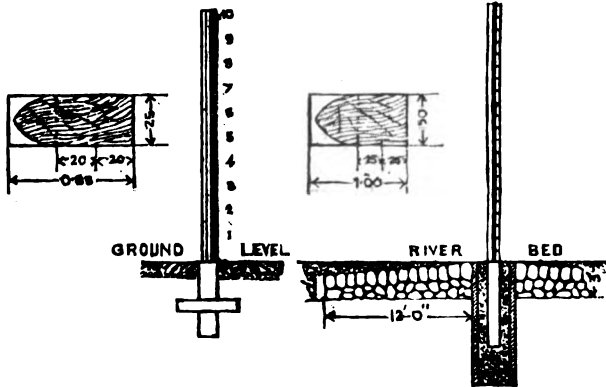

Fig. 2. River Gauge.

Fig. 3. River Gauge.

**22. Flood Levels and their Registration.**—Trustworthy calculations and deductions must be based on accurate data, and the careful ascertainment and record of flood levels are of much importance; where there are masonry works the actual maximum flood levels may be marked clearly and conspicuously, in most cases on a wing wall by a line showing the level to which the water rose, the value of this level, and the year of the flood, *e.g.*, *M.F.L. 1892—74.83*. When there are no masonry works at or near the point at which flood levels are required to be registered, gauge posts must be set up, and these will need to be specially designed to suit the circumstances, for when the depth of water is great, the selection of the position for the gauge will require care, and a secure foundation must be provided. Having settled the general arrangements, the form of the cross section may be as in Figs. 2 and 3.

**23. River Embankments.**—In considering flood levels as affecting anicuts it is requisite to determine the greatest height to which the water has risen, or may rise, at only one point on the river, but in the case of river embankments it is necessary to ascertain the maximum flood level throughout the whole of that part of the river's course which is, or is to be, embanked. Advantage should be taken of all masonry works, such as sluices, escapes, etc., forming part of an embankment; and the M.F.L. should be accurately marked as described in the preceding paragraph.

**24. Gauging River Discharges.**—The calculation of the discharge of a river may be made in two ways:—

1. At a weir or anicut. The water-levels above and below the anicut and the velocity with which the water approaches the anicut, together with the length of the latter are the data required.

2. By ascertaining the mean velocity of the water in the river and the sectional area of the waterway at the selected points.

The gauging of river discharges is dealt with in Chapter VIII of the College Manual of Hydraulics.

**25. Evaporation.**—In all tanks and channels there is a loss of water from evaporation, leakage and absorption into the soil. The rapidity with which water is converted into vapour is dependent upon the relative temperatures of the water and atmosphere and upon the amount of motion in the latter. It is least when the atmosphere is moist, the air quiet and the temperature of the water low. Evaporation is constantly taking place at a rate due to the temperature of the surface, and condensation is likewise going on from the vapours existing in the atmosphere, the difference between the two being the rate of evaporation. The total loss by evaporation is believed never to exceed 0·4 inches a day in the hottest and driest weather in India.

While several methods have been devised for measuring evaporation none of them are wholly satisfactory. A simple apparatus and one which is as successful as most of the more elaborate contrivances is that employed by the United States Geological Survey. It consists of a pan, Fig. 4, so placed that the contained water has the same temperature and exposure as that of the body of water the evaporation from which is to be measured. This evaporating pan is of galvanized iron 3 feet square and 10 inches deep, and is immersed in water, and kept from sinking by means of floats of wood or hollow metal. It should be placed in the canal, lake, or other mass of water, the evaporation of which it is intended to measure, in such a position as to be exposed to its average wind movements. The pan must be filled to within 3 or 4 inches of the top in order that the waves produced by the wind shall not cause the water to slop over, and it should float with its rim several inches above the surrounding surface, so that waves shall not enter the pan. The device for measuring the evaporation consists of a small brass scale hung in the centre of the pan. The graduations are on a series of inclined crossbars so proportioned that the vertical heights are greatly exaggerated, thus permitting a small rise or fall, say of a tenth of an inch, to cause the water surface to

advance or retreat on the scale 0.3 of an inch. By this device, multiplying the vertical scale by 3, it is possible to read to 0.01 of an inch.

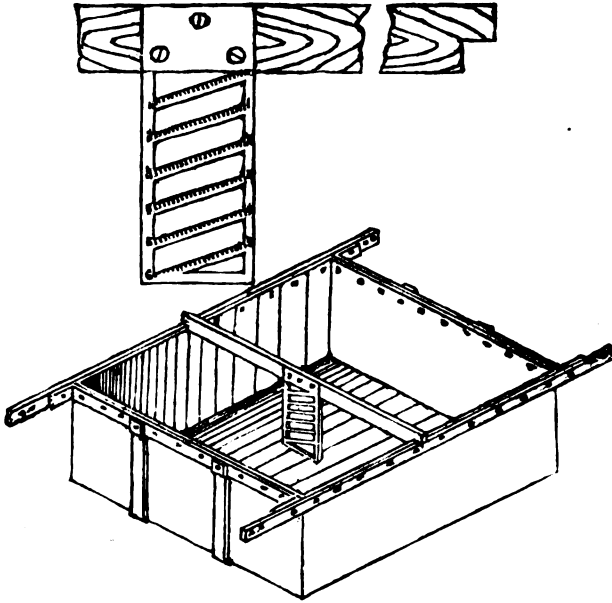

Fig. 4. Evaporating Pan.

**26. Leakage and Absorption.**—The loss from absorption varies greatly according to the nature of the bed of the reservoir, but it may be generally taken as not more than half the loss by evaporation during the year, although, in the earlier months of the period when the run-off of the catchment is being impounded, it would be much greater: the loss by leakage depends entirely on local circumstances and is generally small.

The quantity of water which is lost by absorption can be determined by no rule; it varies both with the nature of the soil on which a tank is constructed, or in which a canal is cut, and with the spring level in the sub-soil. The loss is greater in flowing water than in reservoirs. Mr. J. S. Beresford who studied the matter closely in the North-West Provinces, came to the following conclusions:—

1. The more extensive the absorbing medium the greater the losses from this cause, and hence loss by absorption is greater when a canal is in cutting than when it is in embankment.

2. If the extent of the absorbing medium be limited by a bed of clay placed under the reservoir or canal in which the percolation occurs, then the losses due to this cause are greatly diminished in quantity. The layer next the wetted perimeter limits the quantity absorbed, and the greater its area the more will it pass through to the

still greater area of the next layer; hence percolation varies as the wetted perimeter.

3. Under ordinary conditions the loss by absorption between the head of a distributary and any point  $L$  miles from the head can be approximately ascertained by the formula—

$$\text{Loss} = AL^x$$

where  $A$  is the loss actually ascertained by experiment in the first mile, and  $x$  the power to which  $L$  is raised, varies from  $\frac{5}{8}$  to  $\frac{6}{7}$ .

4. There is more waste by absorption in village chaunels than in all other parts of an irrigation system.

The loss by absorption is much greater, as a rule, in new canals than in old ones, as the porous surface of an absorbent soil becomes blocked by the silt which is deposited on it and drawn into the interstices of the ground. This is of course more particularly the case when the water of the canal is much charged with silt, and will not occur when the canal carries clear water.

**27. Amount of Losses in Reservoirs and Canals.**—This amount is difficult to ascertain and varies greatly with soil and climate. If the bottom of the reservoir is composed of sandy soil, the losses from percolation and evaporation combined will be about double those from the latter alone. If the bottom of the reservoir be of a clayey material, or if the reservoir be old and the percolation limited by the sediment deposited on its bottom, this loss may be but little more than that of evaporation alone.

On a moderate-sized canal in India the total losses have been found to amount to about one cubic foot per second ("cusec") per linear mile. In new canals these losses are greatest. If the soil is sandy, the losses on new canals may amount for long lines to from 40 to 60 per cent. of the volume entering the head. In shorter canals the percentage of loss will be proportionately decreased, though they will rarely fall below 30 per cent. in new canals of moderate length. As the canal increases in age the silt carried in suspension will be deposited on its banks and bottom, thus filling up the interstices and diminishing the loss. In old canals with lengths varying between 30 to 40 miles the loss may be as low as 12 per cent. in favourable soil, though in general for canals of average length the loss will be about 20 to 25 per cent. of the volume entering the head. On the Ganges canal the length of which is several hundred miles, the losses in some years have been as high as 70 per cent. Experiments made on Indian canals show that the loss by evaporation alone on medium-sized canals is about 5 per cent. of the probable discharge, showing that the greater portion of the total loss is from percolation.

**28. Prevention of Percolation.**—An excellent method for the reduction of the loss by percolation is that recommended by Mr. J. S. Beresford, who advises that pulverized dry clay be thrown into the canals near their head-gates. This will be carried long distances and deposited on the sides and bottom of the canal, forming a silt berm.

The losses by absorption are greatly increased by giving the canal a bad cross-section. Thus depressions along the line of a new canal are often utilized to cheapen construction by building up a bank on the

lower side only, thus allowing the water to spread and consequently increasing the absorption. The least possible wetted perimeter and the least surface exposed to the atmosphere will cause the least loss from this cause.

**29. Silt.**—The silt which is borne in suspension in the waters of rivers, consists of organic and mineral matter, which, while it is often a source of advantage to the fields, is, not unfrequently, the cause of much trouble in the channels of irrigation works. It is desirable in all cases to pass forward to the fields as much fertilizing material as possible, but it is also desirable to prevent the deposition of silt in the channels, where it impedes, and sometimes completely chokes the discharge.

It is well known that for ages the fertility of Egypt has been preserved by the silt laden waters of the Nile. Every year the Nile deposits its load of rich slime on the land, and, in consequence of this, the soil retains the fertility for which it has been famous since the earliest years of history. Such muddy water furnishes not only moisture to bring the crop to perfection, but it also brings manure to the land, and thus prevents it from being exhausted. The silt annually deposited is merely manure, which is consumed in bringing the crops to maturity.

Of all water used for irrigation, river water is, generally speaking, by far the best. The water is led direct from the rivers by canals to the fields. It deposits in the channel only the coarser parts of the silt it has brought down from the higher levels and forests, much of which is only sand. A large quantity of its most fertilizing silt is, however, conveyed to the land. So complete is the effect of this fertilization, that lands so supplied will continue to bear one or two grain crops for hundreds of years without other manure. Thus the district of Tanjore is believed to produce as large crops now as it did ages ago.

Silt varies enormously in its nature, according, generally speaking, to the velocity of the river which carries it and to the character of the catchment area of the river. Thus in the canals taking off the Ravi, the Jumna, and the Ganges, near the points where these streams first debouch from the hills, and where the fall of the beds is from 10 to 19 feet in a mile, and the velocities are as great as from 10 to 15 feet a second, the matter which is occasionally swept down to impede and sometimes to block the channels consist mainly of shingle and boulders. Lower down the courses of these same rivers and other similar ones, shingle and boulders give place to coarse sand mixed with mud, carried by velocities of perhaps 5 to 8 feet a second, at surface slopes of 1 to 2 feet a mile: and nearer the sea, where, as in the case of the Nile in Egypt or the Ganges in Bengal, the surface slope of the floods is from 5 inches to as little as 3 inches a mile, the silt consists of the finest sand mixed with a large proportion of mud, borne by a stream flowing with a velocity of only 2 or 3 feet a second. This silt when deposited is a soft slimy mud of a highly fertilizing nature.

Experiments were made on the Ganges near the head of the Ganges canal where the velocity is great (probably 10 to 12 feet a second), with the result that the maximum amount of silt found was  $\frac{1}{15}$  by weight of the water, but this appears to have been an extreme example and a somewhat doubtful one, an average of four examples in August and September giving only  $\frac{1}{75}$ . The Ganges at this point is fed mainly by



the melting of the snows in the Himalayas, and the water is consequently comparatively free from silt; but in its lower reaches, after receiving the drainage of a large tract of country, the water is heavily charged with material in suspension. Experiments have shown that the water in the Ganges canal at Boorkee, some 18 miles from the point where the canal draws its supply from the river, is, at times of full supply, sometimes far more heavily charged with silt than the water in the river, the proportion of silt being as high as  $\frac{1}{3}$ . This circumstance is interesting as confirming the fact that water which is not fully charged with silt, will pick up silt from the bed of a canal, even although its velocity in the canal is far less than it was in the river from which it was drawn.

Different rivers are more or less fertilizing according as they pass through different rocky strata. Thus the Kistna river, which passes through a lime-stone country, has a delta which has been found to produce crops 50 per cent. larger than the delta of the Gódávári which passes chiefly through a granite country. In Midnapore the rainfall is sometimes as much as ten inches in twenty-four hours, but the cultivators are not satisfied with this. In order to gain the advantage of the manure in the river water, they drain off the rain water as quickly as possible and admit the former. Long experience has proved to them that they get better crops by irrigating with the silt-laden water of the river than by the rain water.

The water of the Indus is preferred to well water, owing to the fertilizing silt it contains.

General Scott Moncrieff, R.E., states that the price paid for the water of the Po in Italy was three times the amount paid for the water of the Dora Baltea, the extra value of the water of the Po being due to the fact of its alluvial silt being highly fertilizing, while that of the Dora Baltea is not. He also refers to the marked difference between the fields irrigated with the silt-bearing waters of the Durance canals in France, and those of the clear, cold Sorgues, so much so that cultivators prefer to pay for the former ten or twelve times the price demanded for the latter.

One of the most important points to be considered before an irrigation work of any kind is undertaken is the amount and quality of the silt in the source from which the water is to be obtained. In the case of canals taking off rivers of high velocity, and which probably carry but little fertilizing matter, but a good deal—at certain times—of sand or even of shingle, the problem is to design the head-works so as to exclude to the utmost the coarser materials lest they materially diminish the discharge of the canals. In the case of rivers with a more moderate velocity, the problem is how to arrange matters so that the heavier particles, which float in the lower strata of the river and which are sometimes swept along the bed of it more than actually held in suspension in its waters, may be excluded, and the lighter fertilizing atoms may not only be taken into the canal but may be carried along it and its branches and finally deposited on the fields. Again, in rivers with still lower velocities, the problem is rather how to design the canals so as to carry to the fields all the silt which can be obtained.

## CHAPTER III.

## CANALS, CHANNELS AND DISTRIBUTARIES.

**30. Classes of Canals.**—Canals are divided into three great classes—

- 1st.—Those for Irrigation alone.
- 2nd.—Those for Navigation only.
- 3rd.—Those for Irrigation and Navigation combined.

**31. Irrigation Canals.**—The conditions required to successfully design and carry out one of the first class are:—That it should be carried at as high a level as possible so that there may be sufficient fall from it to irrigate the land for a considerable distance, on one or both sides of it, and also that it should be a running stream, fed by a continuous supply from the parent river, in order to compensate for the water consumed in irrigation.

**32. Navigation Canals.**—The requisite conditions for a canal for navigation alone, are, in many respects, contrary to those required for a canal for irrigation alone. The former should be, as much as possible, a still-water canal, so that navigation may be equally easy in both directions; and, as no water is consumed except by evaporation and absorption, and at points of transfer at locks, the required quantity of fresh supply is comparatively small, and the canal is thus most economically constructed at a low level.

**33. Combined Irrigation and Navigation Canals.**—It has been found impracticable to combine irrigation and navigation economically in the same canal, and to make it a good working machine for the two purposes.

In a canal intended for navigation only, a still-water channel is the most suitable, and the lower its velocity is, the less obstruction will it cause to boats proceeding upstream.

In an irrigation canal, on the contrary, the greater the velocity of the water, so long as it does not damage the works, the more economical and better machine it is.

The cross-section of the channel can be diminished in proportion to the increase in velocity of the water, and consequently all the works, such as head works, embankments, cuttings, bridges, aqueducts, falls or drops, etc., can be diminished in size and expense. In addition, locks to pass the falls would be required for navigation.

Mean velocities exceeding 4 feet per second cause waves, which injure the banks in the greater number of canals, especially in sandy loam.

An irrigation canal requires, for average soil, a velocity of at least  $2\frac{1}{2}$  feet per second. It follows, therefore, that when forcing its way against the current at the rate of 4 feet per second a boat is actually making headway only at the rate of  $1\frac{1}{2}$  feet per second, and any attempt at higher velocities would injure the banks, so that, irrespective of the loss of power the banks could not stand if there was quick navigation.

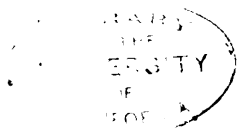

It therefore appears evident that for economical working and the safety of the banks, an almost still-water canal is required.

Indian experience has fixed about  $1\frac{1}{2}$  feet per second as the maximum velocity which ought to be allowed in a navigable canal. The small slope would increase the number of falls required to overcome the greater surface slope of the country, and in addition, the greater cost of all the other works would make the cost of a navigable canal almost double that of the channel required for irrigation alone. Again, in a navigable channel, a certain minimum depth and width, for the passage of canal boats, must be allowed everywhere; and the amount of water required for this minimum must be allowed over and above the quantity required for irrigation.

The canal of Bernegardo, in Italy, is a notable example of the great difficulty of combining navigation and irrigation in the same channel. It is with difficulty, and only by the strictest measures, that the supply for navigation is secured during the summer, on account of the urgent demand for the water for irrigation. When boats are passing, the whole of the irrigation outlets, between each pair of locks, are necessarily closed, and, with the supply accumulated in the channel by this means, the passage is effected, though with great inconvenience, and with the stoppage of irrigation from this reach of the canal during the time of the boat's transit.

In his report on the Sutlej canal, Major Crofton, R.E., gives some of the items which cause an increase of cost for navigation. They are, the necessity of providing for a navigable communication throughout, which involves, besides lockage at the overfalls, increase of excavation in the form of tow-paths, and considerable additions to every bridge to give towing passages on either side, as well as extra height to afford headway for laden boats. Navigation appears to be satisfactorily combined with irrigation on the Madras canals, and here again, the small declivities and low velocities come into their aid. In a report by Sir A. Cotton, on some of the Gódávári channels, he mentions a mile an hour (or 1.47 feet per second) as the maximum velocity which ought to be allowed in the current of a navigable channel. Were this to be taken as the basis of the calculations for the Sutlej canal the cost of the works in excavation, and falls, to overcome the superfluous slope, would be well nigh doubled. The latest information on the subject of navigable canals, in India, is strongly in support of the above. In the Revenue Report of the Irrigation Department of the Punjab, India, for 1889-90, it is stated with reference to the Sirhind, or Sutlej canal, that: "On this, as on the other irrigation canals of Upper India, the cost of providing navigation is not likely to prove remunerative." This is conclusive.

**34. The Alignment of Canals.**—The first point of importance in the alignment of the channels of an irrigation system is that all of them should, as far as may be possible, run on the watershed. In that position they both avoid interference with drainage and hold command the requirements of the Engineer, and, in almost all cases, the alignment of a main canal has to be determined by a balance of many considerations. One of the most weighty of these, of course, is the best position for the head-works: if there are several possible sites for these, the alignment of the canal in its upper reaches is primarily determined by the

cost of the head-works and of the different routes which are possible. The highest site for the head-works may involve less depth of cutting in the canal, but a longer channel : or it may necessitate crossing heavy torrents or drainages which can be avoided by a lower head : or, it may require that the canal should be carried through an unculturable country for a long distance before the fertile land is reached. The first reach of any canal drawn from a river is always unprofitable in itself, as it is necessarily in cutting, and little or no irrigation from it is possible. The problem to be solved in connection with it is the cheapest route by which it can be constructed, so as to deliver the water on the surface of the ground at a point where the canal can be carried along a main watershed of the tract to be irrigated. There are, of course, cases, such as that of a canal leading from a reservoir in hilly ground, or of one on the upper margin of a deltaic tract, in which the alignment of the canal must necessarily follow a contour—or very nearly follow it—along the foot of the hilly ground. In such a case the alignment may be said to be marked out by nature : but in most other cases there is room for much skill and judgment in selecting the line for the first few miles of any system.

**35. Canals and Channels.**—The term “Canals” is usually applied to the larger channels for the conveyance of water, otherwise the terms “Canals” and “Channels” are used indifferently.

**36. Purposes for which designed.**—Canals or channels are designed to carry water for—

- (1) Irrigation only, or for irrigation and navigation combined ;
- (2) Irrigation without the intervention of tanks or reservoirs, commonly called direct irrigation ;
- (3) Irrigation partly direct, and partly indirect ; or through tanks only ;
- (4) Navigation only.
- (5) Water-supply of Towns.

The conditions, therefore, are very variable, and the design and arrangement have to be varied to suit them. Moreover, the conditions are in most cases constantly changing, as the quantity of water to be conveyed is diminished by the successive off-takes.

**37. Data for Design.**—The information needed to enable a channel to be properly designed includes the following data :—

- (1) Levels.
- (2) Quantity of water to be carried.
- (3) Limiting velocity of current, as dependent upon the nature of the soil.
- (4) Limiting velocity and minimum depth in the case of navigable canals.
- (5) Extent and circumstances of the cross drainage, and disposal of surplus generally.
- (6) Maximum water-level, and, in connection therewith, the minimum height of the channel banks.
- (7) Normal height of channel banks where no cross-drainage has to be taken into account.

**38. Levels.**—The levels required are, first, the general levels of the whole area of country or ground to be dealt with, so as to show its fall and the configuration of the ground. Usually there are two main

**LINES OF LEVELS FOR DETERMINING COURSE OF CHANNELS**

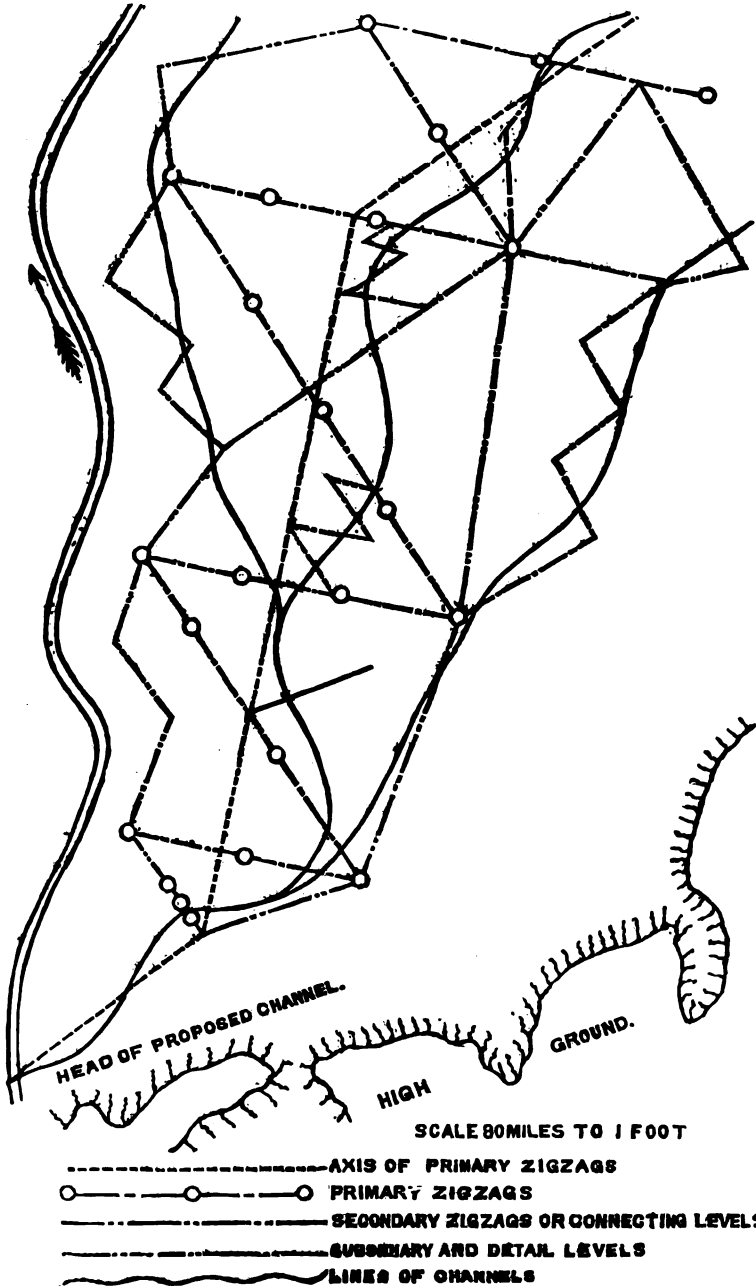

Fig. 5.

lines of inclination, the one in the direction in which the river flows, the other transversely to the axis of the river, and this latter slope may be either towards the river or, as in the case of delta or deltaic formations, away therefrom.

It is generally advisable to take the levels in the first instance on lines of from 6 to 9 miles in length, forming zigzags, the axis of which may be more or less parallel to that of the river, and the individual lines at right angles to the river from 30 to 45 degrees to each other, so as to make the salients from 4 to 5 miles apart. According to the extent of country to be examined, one, two, or more sets of such zigzags may be required. Fig. 5.

Such levels may require to be supplemented by lines joining the salients, or by intermediate levels to show particular features of the ground.

The data thus supplied will enable the best approximate line for the main channel, and also for such branches as may be required, to be laid down. A suitable distance apart for the back and fore staves in these general levels will usually be 600 feet, or 300 feet on either side of the levelling instrument.

In the next place, having settled the best apparent line for a channel, levels should be run along that line with readings at intervals of about 200 feet, and a longitudinal section of the ground plotted therefrom; also cross-sections of the ground should be taken at every station, or at every second or third station, depending upon whether the ground is more or less uniform in its slopes and general features, extending to from one to two or three hundred feet on either side of the longitudinal section, and at right angles thereto. These data will suffice for fixing the line of channel and plotting its cross section in due course.

Longitudinal and cross sections of every stream and water-course crossed by the line of the channel should be taken and plotted on a suitable scale, on one or more sheets of paper, bearing the same plan number as the longitudinal section, so as to establish their connection therewith, and these sections should be numbered consecutively from the upper to the lower end of the longitudinal section. The longitudinal sections of the water-courses should extend to a somewhat greater distance, on either side of the line for the channel, than the cross sections of the ground; and the cross-sections of each stream should be at least three in number, viz., one on the selected line for the channel, and one at either end of the longitudinal section, the limit of information being such as will allow the best point for taking the channel across the stream to be settled. The area of the catchment basin, or extent of country above the line of channel drained by each stream should be ascertained, and noted on the sheet of sections relating thereto, as also on the channel survey and longitudinal section.

**39. Dimensions of Main Channels.**—The dimensions of a main canal are primarily determined by the "duty" of water during a period of pressure, and consequently by the quantity of water which it is necessary to pass on to the land in a short period of maximum demand. Mistakes have not infrequently occurred by working on "duties" based on the whole irrigating season instead of on this period. It will be shown later how greatly "duties" vary, and any particular case must be treated accordingly. As a general rule, main

canals irrigating monsoon crops should be capable of carrying a maximum discharge of one cubic foot per second for every 66 acres of that crop which it is intended to irrigate, and they should be capable of carrying one cubic foot for each 100 acres of dry weather crops. The extent of land which can be irrigated may be determined either by the quantity of water available in the source of supply, or, when that quantity is abundant, by the area which can be commanded by the system. In some cases it is held to be desirable to irrigate only a portion of the area which is commanded, while, in others, no restriction is imposed. Thus, in the Madras works, and in Orissa, water is thrown widely over the largest area possible, but in the North-West Provinces it is generally considered desirable to restrict the area irrigated to a certain proportion (varying from 40 to 80 per cent.) of the culturable area, and in the Punjab a smaller proportion is sometimes taken. On the Sirhind canal, for instance, only one-fourth or even one-fifth of the culturable areas is allowed to receive water. This restriction is partly due to the desire to spread the available supply of water to as many parts of the district as possible for the benefit of the people, and partly because the light soil of Upper India is liable to become water-logged, and the spring level unduly raised, if irrigation is spread over all the area commanded. This evil is not feared in less permeable soils; in Egypt, for example, the whole face of the culturable land may be said to be covered with water during a portion of the year.

The dimensions of a main canal—indeed of all channels—are usually determined by the necessities of the monsoon irrigation, for it is during that crop that the largest quantities of water are, in most cases, required. It is rarely wise, in those cases where the average supply available is greatly in excess of the minimum supply, to base the capacity of a canal on the former quantity, but rather to provide a discharging power only moderately in excess of the minimum. For, although the minimum may occur only at comparatively long intervals, it is, at the same time, when that minimum does occur that it is most desirable to be able to fully irrigate the area on which cultivation from the canal is practised. If the discharge of the canal, and, consequently, the area dependent on irrigation, is based on the average available supply, it is inevitable that, in a bad year, the canal must fail to fulfil the anticipations of cultivators who have sown crops to the extent which the average supply may justify.

**40. Typical Sections of Indian Canals.**—Typical sections of Indian canals are shown in Figs. 6, 7, 8. The particular form of cross-section suitable to any particular case can only be determined by a system of trial and error, but the calculations may be greatly facilitated by the use of tables such as Jackson's 'Canal and culvert tables.'

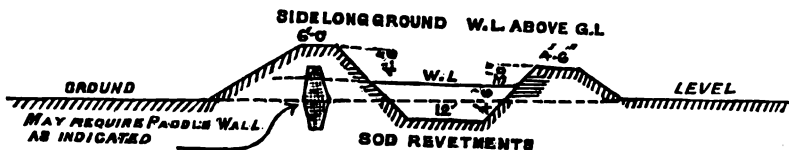

Fig. 6.

## WITH BERMS - W.L. BELOW G.L.

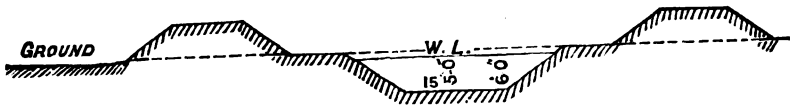

Fig. 7.

## WITHOUT BERMS - W.L. BELOW G.L.



Fig. 8.

Where a canal is in deep cutting, as in Figs. 6, 7, 8 and especially in light soils, it is necessary to make a system of drains on the inner berms, or else the slopes will gutter badly: the drains on the ground level can be either led out through the spoil bank on to the fields or into the canal. In the latter case it is necessary to make paved masonry ducts leading down the slopes into the canal. In Fig. 6 the case is shown where a canal is in embankment, and the cutting is insufficient to form the bank above ground level. In such cases it is sometimes made up by cutting silt traps below the canal bed. This is a good plan where there is much silt, but, if that is not the case, it is not a good plan, as there would be considerably increased loss of water by absorption, especially in porous soils. Under those circumstances side borrow-pits are better.

When a canal is carried on side-long ground, one bank is sufficient to form the canal; many of the canals leading from the larger Bombay tanks are made in this way. Where the slope of the ground is steep, this method is suitable, and, indeed unavoidable; but where the slope is gentle, the width of the canal at the water-line is necessarily great, and there is much loss of water from absorption and evaporation. Considerable lengths of the Kurnool canal in the Madras Presidency are made with only one bank, and in parts the side bank is as much as

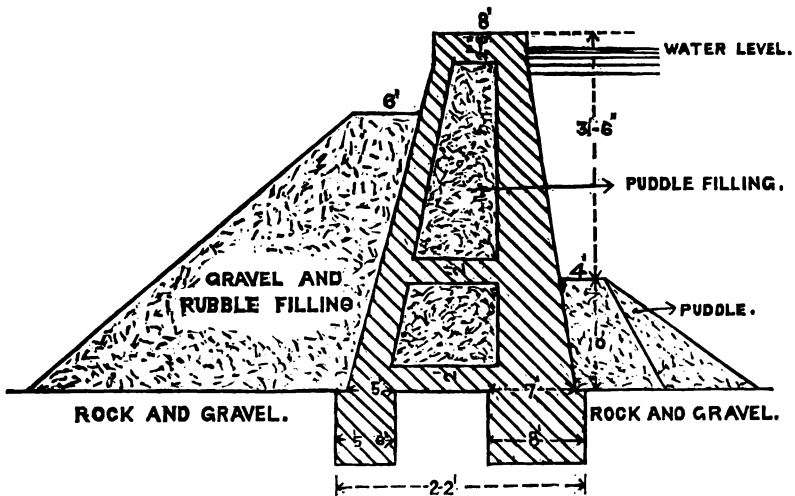

Fig. 9.



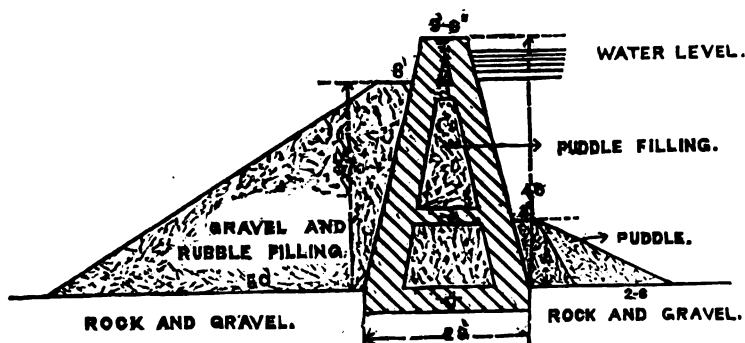

Fig. 10.

50 feet in height: there are some miles of banks more than 35 feet in height. In most cases the banks are made of earth only; in others of dry rubble walls, with a puddle core between them, faced on the water side with a gravel slope covered with puddle and rubble pitching. Figs. 9 and 10.

Branch canals and distributaries may be designed on the same general principles as main canals: that is, that they shall be capable of carrying the discharge which is necessary during the period of maximum demand.

**41. Irrigation Channels.**—There are but very few rivers in Madras, which have, throughout the irrigation season, such a supply as would suffice to keep channels running full: consequently, except in these few cases, in which the usual allowance of water is one cubic foot a second for every 60 to 70 acres, it becomes necessary to carry more water than would otherwise be requisite, when available, and to store it either in the fields themselves or in tanks. The proportion of the whole supply, which must be stored to ensure successful cultivation, manifestly depends upon the circumstances of the river freshes at the point of off-take; and this, again, is dependent not only upon the natural character of those freshes, but also on the extent to which water may be drawn off above the place selected for the head of a new channel, or at which the head of an existing channel, which it is intended to improve, is situated. Reliable information as to the frequency, extent, and duration of the freshes is therefore essential to the proper designing of a channel; and this is obtainable either from the records of weirs or channels higher up or lower down the river, or from gauges established for the purpose at or near the site of the channel head under investigation. From the data thus obtained, the time within which a given quantity of water must be conveyed will be deducible, and the quantity of water per second which the channel should carry will then be known; *e.g.*:—

Area to be supplied .. .. .	1,000 acres.
Normal quantity of water required .. .. .	16 c. ft. per second.

Month in which river is lowest during the season (September) in which the river contains sufficient water during six small freshes lasting three days each:

Average supply during the intervals .. .. .	5 c. ft. per second.
Required capacity of channel will be —	
$18x = 30 \times 16 - 12 \times 5 = 420$	
And $x = \frac{420}{6} = 23.33$ cubic feet per second.	

It may be assumed that storage in the fields themselves must be limited to cases in which the freshes during the season occur at intervals of not more than a week, and in which the quantity equivalent to a ten days' supply can be distributed over between six and seven days, when a discharge of one and-a-half times the normal will suffice for the channel. For any great interval between freshes tank-storage will be needed, and the normal full quantity of storage required (for a 5 months' crop) may be taken to be 216,000 cubic feet per acre, while that required in any particular case will depend upon the quantities receivable from the tank catchment or from the river, and in the intervals between such accessions. The ordinary rule for the storage capacity required will be, taking  $z$  as the interval in days between the freshes, and  $S$  as the store in cubic feet:

$$S = \frac{\frac{2}{3} z \times 86 \times 400 \times \text{acres}}{60} = 2,160 z \times \text{acres} \times \text{number of seconds in one day.}$$

And the capacity of the channel, if  $T$  be the duration in days of the freshes,  $Q$  the normal discharge, and  $Q_1$  the required discharge, will be—

$$Q_1 = \frac{Q(t+z)}{t}; \text{ e.g., area to be supplied} = 1,000 \text{ acres;}$$

$$\text{Interval between freshes} = z \quad \dots \quad = 30 \text{ days;}$$

$$\text{Duration of freshes} = t \quad \dots \quad = 10 \text{ "}$$

$$\text{Normal supply} = Q \quad \dots \quad = 16 \text{ c. ft. per second;}$$

$$S = \frac{45 \times 86 \times 400 \times 1,000}{60} = 45 \times 1.44 \text{ millions,}$$

$$= 64.80 \text{ millions of cubic feet;}$$

$$Q_1 = \frac{16(10+30)}{10} = 64 \text{ cubic feet a second;}$$

or, in this case, the capacity of the channel would need to be four times that requisite were the source of supply a stream with never less than the quantity of water required. It has been mentioned above that the normal supply for direct irrigation is, in the case of large canals, 1 cubic foot a second for every sixty or seventy acres. This is a good and sufficient average for large areas, but when the latter are small, the demand for water for preparing the land, and occasionally at other times during the season, is liable to be much in excess of the above allowance; and it is desirable therefore as regards small channels and distributaries, to base the discharge which they should be capable of conveying as a maximum, and whenever circumstances may render such an increase necessary, upon a sliding scale proportioned to the areas. The following scale may be taken as a guide, the normal area which can be supplied by one cubic foot a second being taken as 66 acres:—

Area under channel— Acres.	Above 6,000.	5,000 to 6,000.	4,000 to 5,000.	3,000 to 4,000.	2,000 to 3,000.	1,000 to 2,000.	500 to 1,000.	250 to 500.	100 to 250.	Under 100.
Number of acres to be supplied by 1 cubic foot a second.	66	63	59	55	50	44	40	35	30	25

*Example.*—The maximum discharge which a channel should be able to carry for the irrigation of 1,537 acres would be  $\frac{1537}{44} = 34.93$  cubic feet a second, and 35 cubic feet would be a proper provision. The table should be used, not arbitrarily, but as a general guide, otherwise a channel for 100 acres would be arranged to carry 4 cubic feet a second, and 1 for 144 acres only 3.80 cubic feet. About 4 cubic feet would be proper in both cases.

The table is not intended to apply to the supply channels of tanks. The carrying capacity of such channels is determined by the quantity of water to be conveyed in a given time to the tanks.

When from the sandy nature of the soil of the area to be irrigated or from other exceptional circumstances, the normal duty of one cubic foot a second requires to be reduced below 66 acres for large areas, the proportionate duty for small areas should be reduced accordingly.

When circumstances admit of the maximum discharge being obtained by carrying an increased depth of water in a channel, this will be a more convenient and economical arrangement; and it is possible whenever there is sufficient head to spare at the head sluice. When this is not the case, an increase to the width of channel appropriate to the average or ordinary supply, will be necessary.

**42. Distributaries.**—The variation in the discharge of a distributary introduces some new difficulties in the grading and section of the channel; it is generally better to grade the channel, so that the surface of water, when running in low supply may be on the average about one foot above ground level. Slopes of distributaries are usually cut at 1 to 1, but where there is silt in the water the sides generally silt up to slopes of about  $\frac{1}{2}$  or  $\frac{3}{4}$  to 1, so that it is best to base all calculations of discharge on these reduced slopes. These silt berms are a great protection against percolation and absorption, and they should never be cut away unless the discharge of a distributary is injuriously affected by them.

In the Punjab the Government not only constructs the larger distributaries, but the minor channels are made from them into each village, so that the villagers never have to construct their own channels beyond the boundaries of their own ground. A "minor" is defined as a channel carrying less than 10 cubic feet a second: if a larger discharge has to be carried the channel is classed as a branch distributary. These channels in Bengal and in the North-West Provinces have generally been constructed by the villagers themselves, or at the expense of the villagers who have rights of ownership in them. In Madras, where rice is mainly cultivated, small village channels are rarely made, and the irrigation is affected by wide-spread flow from field to field. Under this system villages which are near the distributaries are well protected, but, in a time of pressure, those which are far from distributaries, and can only obtain water through intervening villages, are in a very unfavourable position.

**43. Limiting Velocity of Water.**—In determining the velocity of flow which can be allowed, consideration has to be given to the question of silt deposit, of the scour of the banks, and, if the canal is to be navigable, of the impediment to traffic. It is usually considered in India that a higher velocity than 2 feet per second,  $1\frac{1}{2}$

miles an hour, is undesirable in a navigable canal, and a velocity of  $2\frac{1}{2}$  feet a second is a marked impediment to boats towed by men or animals. If the canal is not to be navigable, the most economical velocity, as regards the size of the channels, is, of course, the highest one which the soil will stand. On the other hand, a low velocity, with, consequently, a low surface slope, will shorten the length of the upper reach of the canal, and bring the water more quickly on to the surface of the ground. But low surface slopes and low velocities mean larger channels, and, if the river carries silt, larger silt deposits in the canal head. Here all the matters concerning silt which have been discussed in chapter require consideration. As a general rule the highest velocity which the soil can stand without erosion will be found the most suitable; with the proviso that it is advantageous, in almost all cases, to increase rather than to diminish the velocity of the water as it advances from the larger to the smaller channels of the system, for this tends to carry forward to the fields the matters in suspension, which are almost always beneficial.

In irrigation channels it is necessary to limit the velocity of water in order to prevent the erosion of the bed and sides and the consequent alteration of the capacity of the channel, in addition to the greater or less damage which might result. Various authorities have given particulars of the substances which water at different velocities is capable of moving or carrying off, but it is more than doubtful whether such information is of any practical value, if only for this reason that the substances experimented on were in a state of disintegration. It appears also that velocity alone is not a complete index of the action and power of water, and that volume is an important factor; for, if this be small, an effective attack or commencement of erosion may be impracticable, whereas with the same velocity and larger volume great effect may be produced. Small volumes, moreover, soon become saturated as it were with suspended matter, when the velocity is in excess of that which the soil can effectually resist, and such matter occasions a decrease of velocity. This result was very remarkably shown in the channels used for the silting process on the Nilgiris: not only was the water, though running in channels having gradients as high as 1 in 2 to 2 in 3, incapable of causing further erosion, but it actually plastered the channels with clay. Ordinarily for small channels running not more than 3 feet deep, suitable velocities will be—

- In alluvial soil 2 feet a second,
- In hard red soils  $2\frac{1}{2}$  feet a second,
- In compact gravelly soils 3 feet a second ;

but the best guide will generally be the fall, velocity, and condition of the river and of the streams in the neighbourhood, as also of artificial channels if there be any. From these it can be ascertained what velocity is in excess of the resistance of the soil and to what extent, and a fair approximation to a proper limit will be obtained.

**44. Details of Channel.**—The settlement of the details of the channel will depend further upon the fall or gradient which may be conveniently adopted so as to deliver the water on to the lands, or into the tank to be supplied. The fall will always be less than the fall of the country, because at its head the channel bed will be below the

surface of the ground, and generally considerably below that surface, while sooner or later it will be at, or slightly below, that level. Special considerations apart, it is desirable to bring the bed of the channel as speedily as possible to that level at which the cutting will just suffice to form the banks to the height deemed necessary. This desired level may be secured, when the character of the country is non-deltaic, by carrying the channel approximately parallel to the river until the bed reaches the proper depth below ground, and then on a falling contour while in deltaic country the channel would be aligned to recede from the river until the desired depth below surface had been reached, and would then be contoured as before.

The quantity of water to be carried, otherwise called the discharge, the limiting velocity, and the fall having been settled, the determination of the other details has to be made. The next point is the gradient of the side slopes, which may vary from  $\frac{1}{2}$  to 1 in stiff clayey soils, to  $1\frac{1}{2}$  to 1, or even 2 to 1 in sandy soils. The steeper the side slopes, provided they be stable, the less the excavation, and the cheaper the channel will be, but it is not advisable to adopt steeper slopes than would be likely to stand, and when the cutting is in excess of 9 to 12 feet in depth, the selection of suitable side slopes becomes a matter of considerable importance. In the next place, the deeper the water, the smaller and less expensive will be the channel, so the velocity should be fixed as high as may be deemed quite safe.

**45. Best Form of Channel.**—The best or most economical form of rectilinear sided channel is the half-square, or one with vertical sides equal, up to water-level, to half the bottom width, but this form Fig. 11, is applicable only to rock or rocky soil so compact as to stand against all causes of disintegration. The best trapezoidal form is a semi-hexagon, Fig. 12, in which the width at water surface is double the bottom width, and equal to the sum of the side slopes: the ratio, however, of the latter is only 0.58 to 1, and the soil must be more than ordinarily compact to stand at this slope. For any given area,  $A$ , of waterway required, the bottom width is equal to  $\sqrt{\frac{A}{1.299}}$  and for any given bottom breadth  $b$ ,  $A = .866 b (b + \frac{b}{2}) = 1.299 b^2$ .

For any other trapezoidal form of channel, if  $w$  be the mean width of waterway,  $d$  the depth of water,  $b$  the bottom breadth,  $A$  the area of waterway, and  $n$  the ratio of base of slope to  $d$  the height of slope (Fig. 13).

$$w = b + nd; \quad A = wd. = d(b + nd); \quad b = \frac{A - nd^2}{d}$$

#### HALF SQUARE.

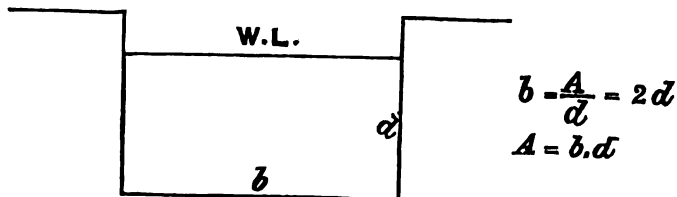

Fig. 11.

## SEMI HEXAGON.

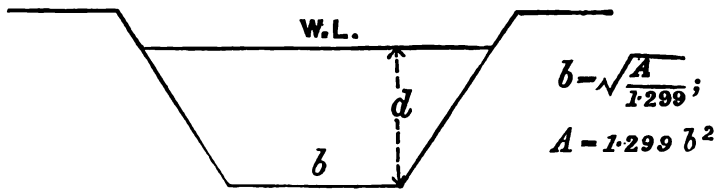

Fig. 12.

## TRAPEZOIDAL.

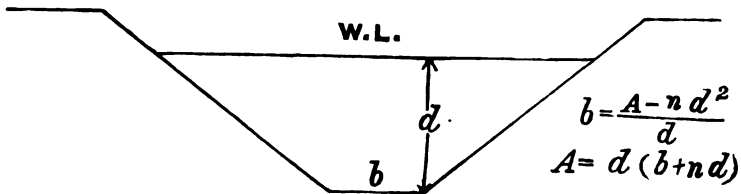

Fig. 13.

**46. Details of Full Cross Section.**—So far the details of the waterway only of the channel have been under consideration, and it remains to complete the cross section.

In the interests of economy, the side slopes above the water-level should be as steep as the nature of the soil will allow, because not only will the first cost be the smaller, but the expense of maintenance will be diminished the less the area of slope exposed to rainfall. In cutting, the soil above water-level will stand at an equal or smaller slope than below water-level; but when the ground surface is below water-level, and the former has to be raised artificially to complete the waterway of the channel, some care will be needed to make this supplemental portion of the side slope stable, if the slope in cutting be at all steep. It will usually be best whenever the side slopes below are steeper than 1 or  $1\frac{1}{4}$  to 1 to form a revetment of turf sods, and to consolidate the made soil thoroughly in layers the thickness of the sods, carrying up the two descriptions of work equally. With flatter slopes the sods may be dispensed with entirely, or laid flat on the slope, if the earthwork be properly consolidated. The slope should be carried up to 6 inches, as a minimum, above water-level.

The next thing is to settle whether a berm should be provided between the top of the channel side slope and the toe of the inner slope of the embankment to be formed with the soil from the cutting, with or without any additional material from side cuttings. As a rule, in the case of small channels, when the top of the bank will not be more than 9 feet above the channel bed, and the side slopes not steeper than 1 to 1,

berms may, with advantage, be dispensed with, so as to reduce the area of ground the drainage of which has to run into the channel. When, however, the cutting is deep, berms are generally necessary, and need to be carefully laid out with a slope of about 1 in 15 away from the edge of the channel, and the drainage of these, and of the inside faces of the banks, should be specially arranged for, either by carrying it under the banks at a higher level than M.W.L. in the channel, or by conducting it into the latter at suitable intervals. It is of the greatest importance that, from the first, all guttering of the side slopes, the formation of pot holes, etc., by drainage water, should be prevented, for, if once allowed to commence, very great trouble and considerable expense may have to be incurred to put matters right, and the efficiency of the channel may be materially affected.

**47. Height of Channel Banks.**—For channels, or reaches of channels, which receive no drainage, the margin to be allowed above full supply or maximum water-level, if there be any difference, need not exceed 2 feet, and should never be less than 1 foot. Half the depth of water, subject to the above limits, will be a suitable guide to the margin. When in cutting, a smaller margin than when in embankment will generally suffice.

For canals the margins to be allowed are—

1. When the discharge is 750 cubic feet a second, or more, 3 feet.

2. When the discharge is less than 750 cubic feet a second,  $2\frac{1}{2}$  feet.

When the berms are wide and below full supply level, it is often necessary to provide inside banks to confine the water to the proper waterway, and, for such banks, which are also useful as towpaths, a margin of 18 inches will be ample if the main banks in rear be retained.

When channels receive drainage, the margins must be allowed above the maximum water-level at which the surplus works may be designed to dispose of the drainage, which level will regulate and fix the maximum in the channel.

**48. Width of Top of Channel Banks.**—The top width of channel banks should be sufficient to admit of an easy passage for the purposes of inspection. Four and-a-half feet may be taken as a suitable width for small channels, and, except for these, 6 feet will be more suitable. For such widths, at least, in the case of wider banks formed by depositing spoil, the surface should be made and kept in good order, with a slight transverse slope towards the outside. The banks of canals should be from 6 to 9 feet in width.

**49. Mile, and Intermediate Stones or Posts.**—On every canal, and on every channel, there should be milestones or, where stone is exceptionally costly, posts; and, between these, smaller stones or posts which need not project more than 3 or 4 inches above the ground-level. These intermediate stones should not be farther apart than one-eighth of a mile and it is better to place them at half that interval, so as to have a bench-mark at every 330 feet. When a channel is about to be newly made, the stones should be set up immediately after the centre line has been finally settled and lockspitted, and when there is a berm above water-level, the stones should be placed on the berm near the toe of the bank: otherwise the ground near the toe of the outer slope of the bank

will be a suitable position. Unless the artificial bank be an old one, and thoroughly consolidated, these stones should not be placed thereon, even when the alternative position on the outside of the bank may seem to be somewhat inconvenient. Care should be taken to fix the stones so as to obviate all risk of disturbance. In some soils all that is necessary is to place a sufficient length below ground and to tamp the filling-in thoroughly; in other soils the hole may be made 2 feet square and then filled in with gravel well wetted and tamped, while in some soils, *e.g.*, black cotton or whitish sandy loam, nothing but a bed of concrete will render the stones secure.

Suitable patterns of mile, and intermediate stones are shown in Figs. 14 and 15. It is not necessary to dress the stones, except at the table for the figures and for the seat of the levelling staff, while as regards the part below ground some irregularity is an advantage.

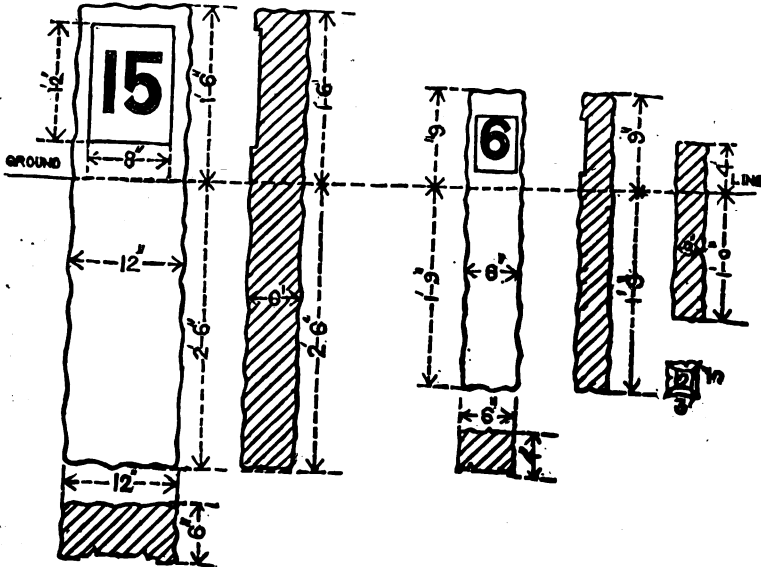

Fig. 14.

Fig. 15.

**50. Cattle Crossings.**—Whenever it is necessary, owing to the absence of bridges, to allow cattle to cross canals or important channels, it is requisite that the places where such crossing is to be permitted should be selected, and that proper arrangements for facilitating the traffic and preventing injury to the channels should be made. The simplest cases are those in which the soil is good, the water so shallow as to be fordable, and the water-level below that of the ground: then nothing more is required than the removal of the banks for a length of from 20 to 30 feet, according to the number of cattle to be accommodated, the soil removed being placed on either side of the approach to help to direct the cattle to the crossing: the flattening of the side slopes of the channel to not less than 4 to 1, and the laying down of some gravel or small stone from the top of one slope across the channel to the top of the opposite slope.



CANAL CATTLE CROSSING

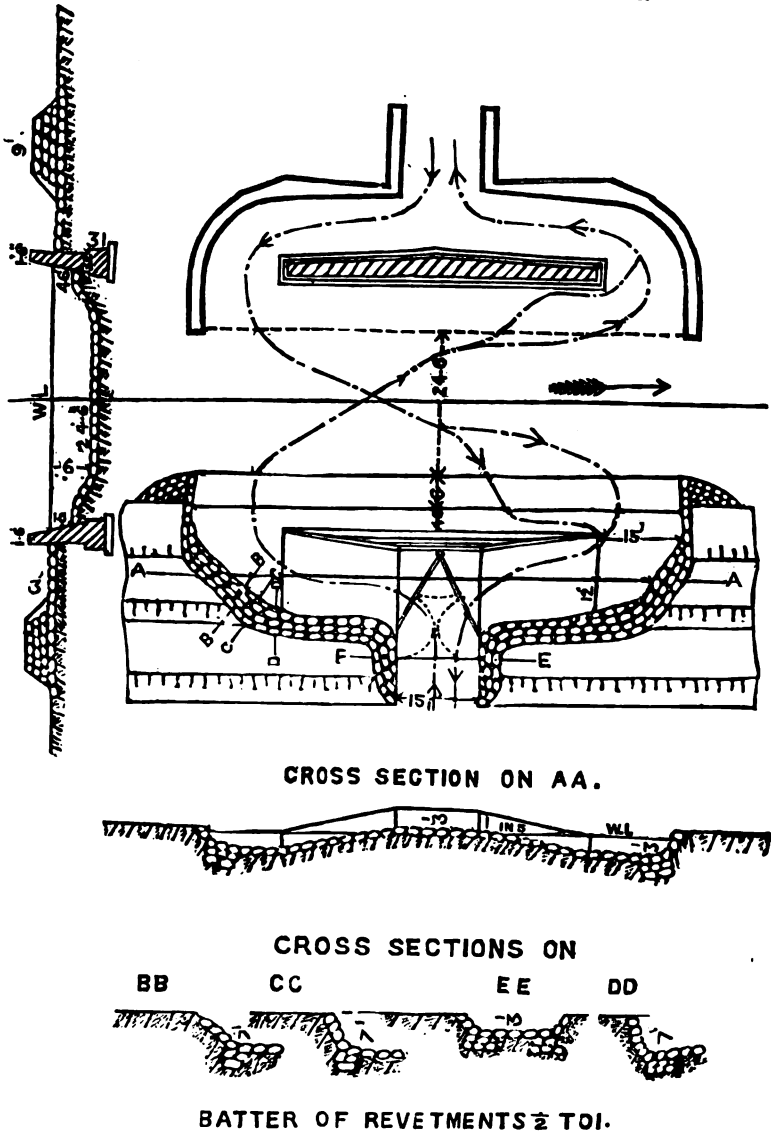

Fig. 16.

When the depth of water is so considerable that the cattle must swim, the difficulty is not great if the current be but slight; the width of the crossing has to be increased from 40 to 50 feet, and that is all. (Fig. 16.)

If, however, the current be strong, the difficulty of laying out an efficient crossing, and of getting it worked properly, is great, for the cattle will land on the one side some distance below the point of departure on the other side, this distance varying with the strength of the current and the width of the canal. It follows that either the width of the crossing must extend over this full distance, and that the cattle must be made to start from the upper end of the ramp on the off-take side, which is a matter of difficulty; or the crossing may consist of a double ramp on each side, parallel to the axis of the canal, the one part pointing up and the other down-stream, and the lower ends of each pair of ramps being sufficiently far apart to ensure the cattle, starting from the up-stream ramp on one side, landing at or above the down-stream ramp on the other side.

The approaches to cattle crossings should always be fenced, and in selecting and forming the fencing it should be remembered that the fences require to be very strong. The best and cheapest form of fence, when once established, is the common aloe planted on a bank 2 or 2½ feet high and 2 feet wide at the top; the lines of aloes should be carried in continuation up the slopes of the canal banks, and across the berms. On navigation canals special provision will usually have to be made by means of a light foot-bridge, stilts or swing gates, or otherwise, for the passage of the towline and the men. In some cases the ordinary Y fork, used by the natives to allow of the passage of men through field fences, will meet all requirements, especially on non-navigable canals.

---

## CHAPTER IV.

## HEAD-WORKS AND ANICUTS OR DIVERSION WEIRS.

**51. Head-works.**—One of the most important matters to be settled in connection with any irrigation project is the proper site and the nature of the head-works. These consist of—

- (1) The weir or anicut across the river.
- (2) The under-slucices in the anicut.
- (3) The regulator or head sluice, at the head of the canal for its control, and, if the canal is to be navigable.
- (4) The head-lock from the river to the canal.

Sometimes to these are added river training or regulating works for the protection of the banks of the river above and below the anicut.

The selection of the site of the head-works is often a matter of considerable difficulty. The problem is generally to find the best site on a given river in order to command as large an area as possible.

The ideal spot for the head-works of an irrigation system would be the place where the river emerges from the hills. At such a point the slope of the country and of the stream is steep, making it possible to conduct a canal thence to the irrigable lands with the shortest diversion line. Moreover, the width of the channel of the stream is generally contracted, and it flows through firm soil or rock, thus permitting a reduction in the length of the weir and in the cost of its construction and maintenance. As one of the principal objects of the diversion weir is to raise the level of the water and force the water into the canal head, one of the controlling factors in determining the site of the head-works is the height of the weir. This again is dependent on the effect of various weir heights on the location and the cost of the remainder of the head-works and of the diversion canal; also on the flood discharges, amount of sediment carried by the stream, the foundation, the depth of water in the canal, and other factors.

It may, however, be taken that the most suitable position, as a rule, for head-works of a canal system of irrigation is on a portion of the river where the channel is straight, the velocity uniform and the sectional area of the stream fairly constant. A narrow gorge of a river appears to have the advantage of cheapness, but it may be the most expensive on account of the greater velocity and greater depth of water which produce a stronger frictional action on the works, and necessitate heavier materials and stronger work. Again, when the volume of flood water occurring in the stream is great, it is sometimes necessary to locate the head-works at a point where the width between banks is greatest, in order that the depth of water flowing over the weir may be reduced to a minimum and danger of its destruction reduced accordingly. While such a site may be the most permanent, it is also usually most costly for construction. The site of the head-works should be such that the most permanent weir can be constructed at the least cost, and yet the

works should be so situated that the diverting canal can be conducted thence to the irrigable lands at a minimum cost. The placing of the head-works high up on the stream is usually antagonistic to the last object, since it generally results in heavy rock cutting and difficult construction until the canal gets away from the river banks.

In the case of irrigation projects in deltaic tracts there is usually but little option in theselection of a site for the head-works; if the areas lying between the various branches are to be irrigated, the anicut must necessarily be at the point where the branches leave the main stream.

Too careful attention cannot be given to an examination of the stream at the point of diversion. Soundings and borings should be made to ascertain the depth of water and character of the foundation. The velocity of the stream and its flood heights should be studied, as should the material of which the banks are composed. Where possible, a straight reach in the river should be chosen for the site of the head-works in order that the stream shall have a direct sweep past them, thus reducing to a minimum the deposition of silt in front of the regulating gates. If possible, a point should also be chosen where the velocity in the river will not exceed that in the canal, so that the deposition of silt shall be further reduced.

It should be borne in mind that the head-works of a canal are the most vital portions of its mechanism, and that through them the permanency of the supply in the canal is maintained, and any injury to them means paralysis to the entire system.

**52. Anicuts or Weirs.**—Anicuts, or weirs, are dams built across rivers to divert water into canals or channels. Their height, form and arrangement depend upon the level at which the water should be turned into the channel, the nature of the river bed, and that of materials available. Weirs are also used to raise the water-level in a river, or canal, and so increase the depth, or diminish the current, for navigation purposes.

It is not, in all cases, necessary to construct a permanent weir, as it may be possible to divert the water from the river to the canal by means of temporary spurs, constructed right across the river when very low, or thrown out for some distance into it when it is not necessary, or possible, to draw off the entire discharge. But this method is generally only practicable when the river is a shallow one and the banks low, as otherwise the canal would have to be in very deep cutting; and it can only be employed where the bed of the stream is narrow and either in boulders or rock; in broad rivers with sandy beds the annual cost of the spurs would be very great and it would be impossible to construct them in time to ensure a constant supply.

At the head of the Ganges and the Jumna canals there are no permanent diversion works, the water being turned into the canal head by means of temporary structures of boulders, or by means of training the water of the river so that it shall flow directly against the canal head.

There are several well-known dangers which threaten all river weirs. There is, first, the danger of the weir being breached by the actual force of the current sweeping the material of the structure away.

A second danger to which river weirs are exposed is that of being breached by water flowing below them and undermining the foundation.

A third danger is that a weir may be out-flanked by the water in the river. This is most likely to occur in rivers with friable banks and especially when the course of the river above the weir is not straight and shows signs of change.

A fourth danger to which weirs across large rivers are subject, is that of parallel currents. These currents generally threaten the front face of a weir; they tend to undermine the foundations and thus breach the weir.

Another of the dangers which threaten some river weirs, and which may be a serious one, is that of a retrogression of levels in the bed of the river below the weir. In certain portions of a river course, after it has emerged as a torrent from the hills, the velocity of the water is too great for the soil, and an action is continually going on which generally deepens the level of the bed, and reduces the surface slope, until the velocity is suitable to the soil in which the river flows. If a weir be constructed across a river in which this action is in progress, it stops it at and above weir by forming a bar to further cutting of the bed at that point. But the cutting action below the weir is not checked, and the bed of the stream is gradually cut away, it may be at a slow rate, but still by degrees the head on the weir is increased and the toe of the apron of the weir is attacked.

**53. Component parts of Anicuts.**—Anicuts of modern design consist of (1) a crest or body wall to retain the water at the desired level; (2) horizontal aprons of masonry, concrete, or uncemented stone with a retaining wall at the lower edge, and, in case of rough stone aprons of considerable width, with intermediate bind walls parallel to the crest wall; (3) an outer or lower apron, usually horizontal or nearly so, beyond the retaining wall; (4) an apron, with or without groynes, on the up-stream side of the crest wall to protect its foundations from scour; and sometimes (5) hanging or trailing groynes, projecting from, and at right angles to, the outer edge of the lower or outer apron, to direct the course of the water down-stream. It is usual also to provide (6) a set of under-slucices to prevent the silting up of the river bed at the head of the off-take channel; and if there be such a channel on each side of the river, under-slucices are required at each end of the weir. In cases in which the construction of a permanent anicut, of sufficient height for irrigation or navigation purposes, would involve an undue or dangerous raising of the flood level, a greater or smaller extent of the length of the weir is made movable, so as to leave the water-way at such parts unobstructed when the river is in fresh; (7) wing walls to connect the weir with the river banks, and, when the latter are not above the maximum flood level, with flood banks, or with the channel head-slucices.

**54. Crest Wall.**—This wall needs to be securely founded, and so constructed that no material leakage may take place near the level of the surface of the river-bed, if this be of deep sand; and no leakage at all, if the wall be founded on rock or on clay.

The simplest form of weir is that required when the bed of the river consists of solid, or nearly solid rock, of sufficient hardness to withstand

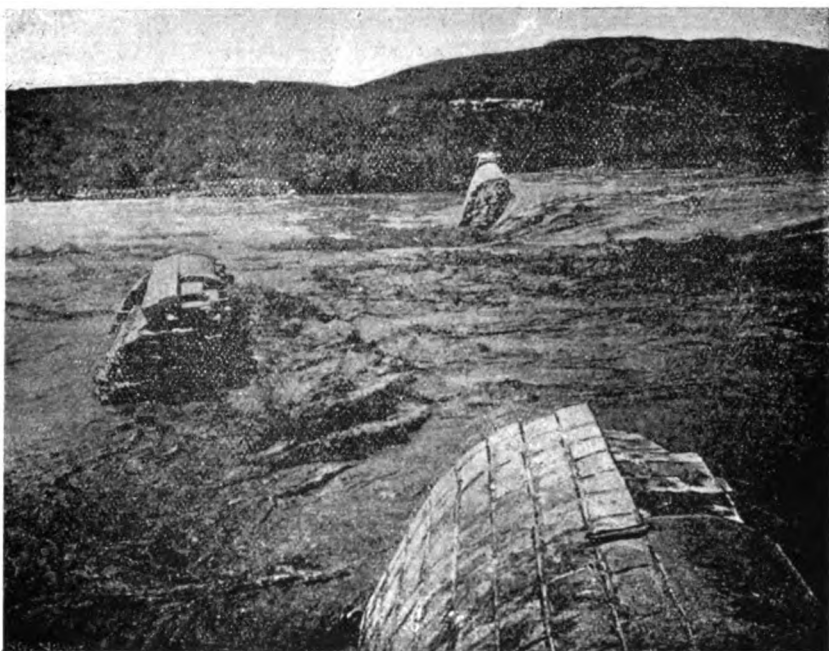

**Plate II (a).** Austin Dam, Texas. View taken during flood a few minutes after the break.

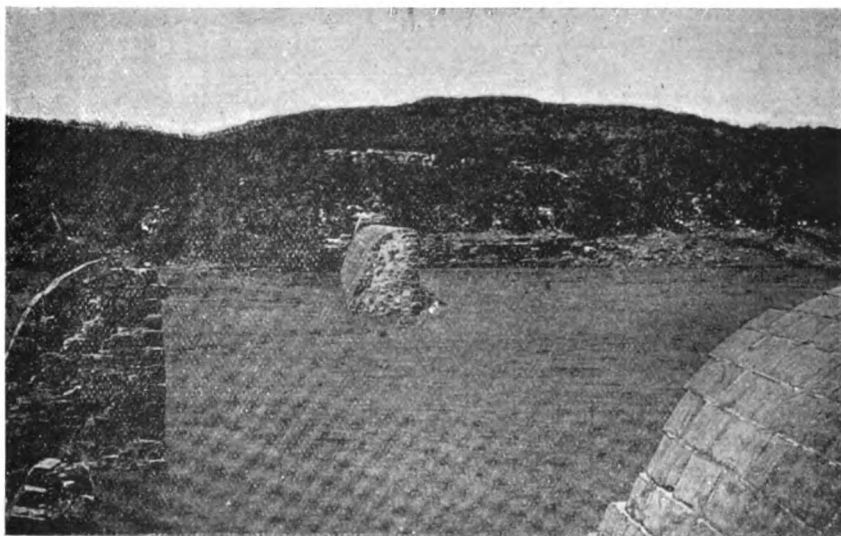

**Plate II (b).** Austin Dam, Texas, after subsidence of flood of April 7, 1900. Showing section of masonry moved bodily down stream.



ANICUT CREST WALLS

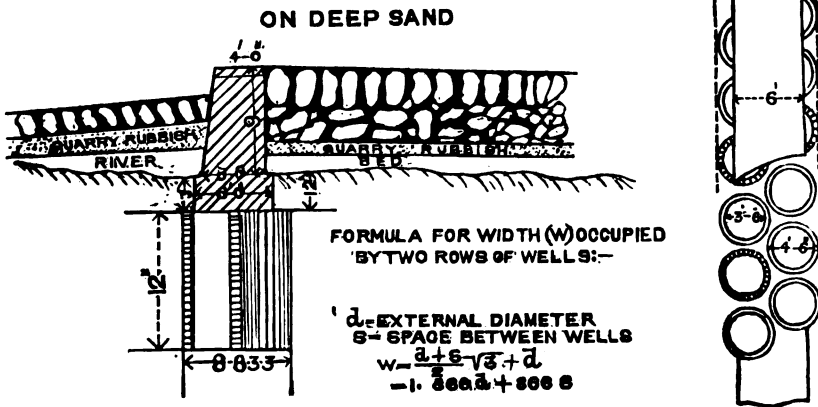
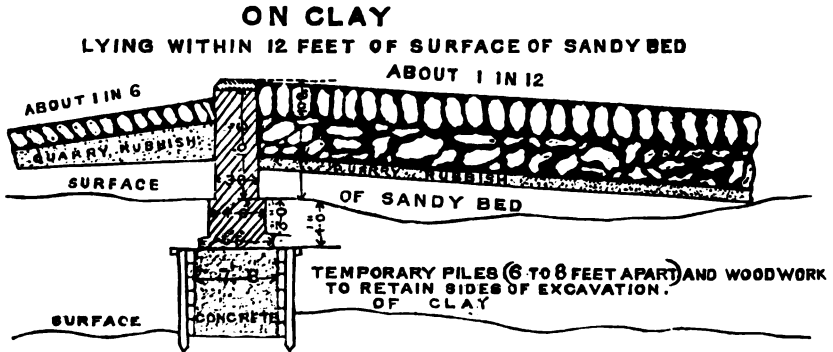
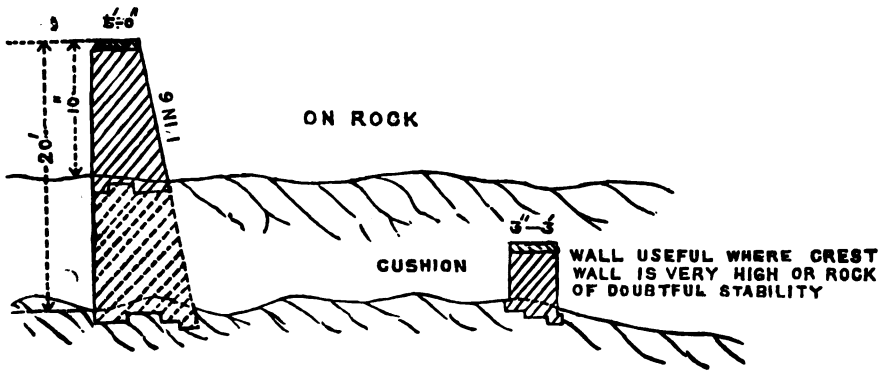

Fig. 17.



the action and impact of the water. Then the details to be settled are the thickness of the top of the wall, which should be sufficient to prevent the coping being easily displaced by floating logs or débris; and the consequent thickness of the base of the wall, which is usually fixed by giving a batter of from 1 in 6 to 1 in 4 to the rear face, and the width of the wall at base is then dependent upon the height at each part. The mean thickness should not be less than one-third of the height, *e.g.*, for a height of 20 feet, a top width of 5 feet, and batter of 1 in 6, would give the least mean thickness allowable, and a batter of 1 in 5 would be preferable generally, as giving not too strong a wall for the height named. On the other hand, for a height of 10 feet, a wall so arranged would have a mean thickness of 6 feet, or three-fifths of the height; consequently, when the rocky bed of a river is of very variable level, it will be economically advantageous to strengthen the crest wall, where high, by offsets on the front face, and to reduce the batter of the rear face. The rock should always be benched or dressed level for the full width of the wall-base: the length of each bench at this level may vary from a foot upwards according to circumstances.

If the river-bed be sandy, and if the depth of the sand be not more than 12 feet, with clay or impervious soil below, it is desirable to put in concrete foundations laid at  $1\frac{1}{2}$  feet, as a minimum, below the surface of the impervious soil. With deeper sand than 12 feet, it will be more economical, and it will save time, which is often of great importance, to found this wall on wells. In that case, the crest wall would consist of three parts, *viz.*, wells from not less than 12 feet to 3 feet below the surface of the river-bed, masonry foundations above the wells to the latter level, and the crest wall proper above that level. The form of the crest wall will differ somewhat, with horizontal and sloping aprons respectively. For the former it should be of the same thickness as for a wall founded on rock, and it should have a batter on the rear or downstream face. With a sloping apron the top width will be fixed as may be convenient for use as a foot-path, etc., and both faces may be vertical. Fig. 17.

The level of the crest of the wall should always be somewhat higher than the full-supply level in the offtake channel; the exact amount of difference will depend upon the relation between the area of water-way of the vents of the head-sluice and that of the channel supplied. It is but seldom necessary to make the anicut crest higher than 1 foot above such full-supply level, and often much less will suffice.

The dimensions of the coping stones are dependent upon the character of the river, the velocity of the water, and the liability to logs or trees being brought down by floods. Generally, the length of the stones should be of the full width of the crest, when this does not exceed 5 feet; the width should be not less than a foot, and the depth of the course not less than 8 inches. At anicuts across large rivers, coping stones of 10 cubic feet are none too large. The upstream top edge of the stones should be rounded, or bevelled at an angle of 45 degrees with not less than 4-inch sides to the bevel, to lessen the risk of trees being fixed by their branches on the crest.

**55. Horizontal Masonry Apron.**—The proper width of the first apron, if horizontal, is dependent upon the depth of water passing over the anicut before the tail water rises to the crest level, and upon the

velocity of the water, or, as it is called, the velocity of approach. The latter is convertible into head or depth, and the greatest distance from the crest wall at which the water can strike the apron is ascertainable by the equation  $x = 2 \sqrt{(d + h) H}$ , in which  $x$  is the horizontal distance on the apron,  $d$  the depth of water on the crest,  $h$  the head due to velocity of approach, and  $H$  the height of the crest wall above the horizontal apron. In practice the width of this apron should be not less than double the distance so found, and not less than twice  $d + h + H$ .

The thickness of this apron must be sufficient to stand the impact of the water. Two feet may be taken as the minimum thickness for small depths of water and weirs of low elevation, and  $2 + \frac{(d + h) H}{30}$  will be an approximation to the proper thickness, generally with  $4\frac{1}{2}$  feet as the limit, which is a sufficient thickness in any case in which this form of weir would be suitable. The surface of the apron should be made of material able to withstand the cutting action of the water with the sand, gravel, etc., with which it is mixed when a river is in considerable fresh. Hard stone is the only really suitable material, and it should usually be one foot thick with the vertical faces dressed so as to make thin joints. It is best to lay the stone with its length parallel to the crest wall. Concrete is the most suitable material for the apron below the surface stone.

**56. Retaining Wall.**—The retaining wall to the apron is a very important part of the work. It should be substantial, and should be founded at a level considerably below the foundations of the crest wall in sandy beds, or whenever there is not a bed of compact or tenacious soil to make it unnecessary to go lower. In the absence of such soil, well foundations will generally be essential. The top of the retaining wall should be at, or somewhat below, the level of the deep bed of the river. It is a great mistake to place it higher, as a retrogression of level in the river-bed is a nearly invariable result of building a weir.

**57. Sloping Aprons of Masonry or Concrete.**—General Mullins considered that sloping masonry aprons should be curved (Fig. 18) and that such curve would discharge the water at the foot of the fall in a horizontal direction, and with a velocity closely approximating to that of water falling vertically from an equal height. They would get rid of impact, and the curved apron could be efficiently constructed with concrete whenever, as is very generally the case in Southern India, stone or nodular lime of excellent quality is obtainable.

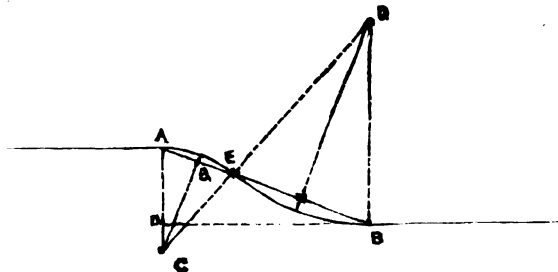

Fig. 18. Ogee curve.

This form is termed an ogee curve and may perhaps be best understood from the accompanying diagram Fig. 18. Bisect AE, and from the point of bisection at A draw a perpendicular cutting the perpendicular let fall from A at C. Join CE and prolong this line until it cuts the perpendicular projected on B at D. From the points C and D as centres, draw the curves of the ogee.

$$bB = \frac{5Ab}{2}; \quad AE = \frac{AB}{3}$$

This opinion, however, does not appear to have been proved by actual experience. On the Ganges canals nearly all the falls were originally built on what is called the "Ogee" shape, with the idea of delivering the water at the foot of the fall without any shock on the floor. The crests of these falls were at the upper canal bed level, and were usually of the full width of the canal and sometimes even wider; when a large discharge was passing down the canal the effect was to increase the velocity in it, and to decrease the depth of water for a considerable distance above the fall, so that the velocity of approach at the weir crest was great. The velocity increased of course as the water ran down the "Ogee" and the friction on the slope was enormous; the shock on the floor was reduced, but the friction did as much damage as the shock would have caused, and the velocity was so great that a standing wave was created below the fall, and the washing of the banks was considerable. These ogee falls have given endless trouble; they were constructed in brick and the lower slopes were constantly torn up: ashlar was substituted in some cases at considerable expense.

**58. Sloping Aprons of Rough Stone.**—The usual gradient for anicut aprons of uncemented stone is 1 in 8 or 1 in 9. The lower portion, *i.e.*, the part below the surface stone, may be composed of stone of all sizes, with a proportion of quarry rubbish. It should nowhere be less than 3 feet in depth below the surface stones, and usually, from the subsidence of the stone put in during the first season, it will be thicker. In estimating, the allowance for this part of the work between the crest and retaining walls should not be less than for an average thickness of  $4\frac{1}{2}$  feet. The surface should be formed with large stones of from  $1\frac{1}{2}$  to 2 tons weight, and should be packed with the length of the stone, which should not be less than  $2\frac{1}{2}$  feet, at right angles to the slope. The rougher the actual surface the better, as then the velocity with which the water will pass to the outer apron beyond the retaining wall will be the lower, and the action of the current on this outer apron, and on the river bed beyond it will be reduced to a minimum. The gradient of the upper part of the slope may be made steeper, and of the lower part flatter than the average, but it is not desirable to allow a steeper slope than 1 in 6 for the former.

When the horizontal width of the slope exceeds 40 feet it will be desirable to insert a bind wall half-way between the crest and retaining walls. Its function is to limit the area of disturbance of the surface stones, should any of these get displaced. It should not be less than 3 feet in thickness, and a depth of 4 to 5 feet below the surface of the slope will usually suffice. If the width of this apron exceeds 75 feet, two bind walls, at intervals of 25 feet, will be needed; and generally,

such walls should be inserted at from 20 to 30 feet intervals, whatever may be the total width of the sloping apron. The retaining wall at the toe of both sloping masonry or concrete, and sloping rough stone aprons, should be constructed in the manner indicated for an anicut with a horizontal masonry apron.

**59. Outer Rough Stone Apron.**—The object of this apron is the full and complete protection of the retaining wall, and, both as regards depth and width, the dimensions allowed must be ample for this purpose. The size of stone to be provided or prescribed will depend upon the velocity of the water. This at anicuts with a vertical fall will be but little more than the natural velocity of the river, and consequently with anicuts of this type, the needful width and the size of stone for this apron are the least. The minimum width admissible may be taken to be 24 feet, and generally it will be proper, subject to this limit, to make the widths not less than for—

Anicuts with vertical fall	..	..	..	2	( d + h + H )
"    "    sloping masonry aprons	..		..	3	( d + h + H )
"    "    "    rough stone aprons	..		..	2½	( d + h + H )

Three feet may be taken as the minimum thickness and 6 feet as the maximum. The surface stone for one-third of the width from the retaining wall should not be smaller than about 4 cubic feet. In the first instance the best way to form this apron is to clear away the bed of the river to 3 feet below the top of the retaining wall for two-thirds of the full width of the apron, and to throw in a bank of stone with its top about 3 feet higher than the wall, the highest line being at 5 or 6 feet from the wall with a rough slope towards the outer edge. The first fresh will cause considerable settlement and widening, and in the second season the material can be adjusted to the normal level and dimensions.

**60. Water-cushions.**—The principle involved in the water-cushion is that which nature has laid down for herself on all natural falls, namely, that of having a deep enough cistern below the fall to take up the shock of the falling water and reduce its velocity to the normal. It has been noticed below cataracts and falls, for instance, that they erode a cistern the depth of which bears a certain relation to the height of the fall. The method of constructing a water-cushion is not to excavate such a cistern below the weir, but to create a corresponding depth by building a subsidiary weir below the upper weir. This subsidiary weir backs the water up against the lower toe of the main weir to the required depth, at the same time practically reducing the height of the subsidiary weir.

It is difficult to find any set rule for determining the depth of water-cushion for a given height of fall. From observations of several natural water-falls it has been discovered that the height of fall is to the depth of the water-cushion as from 5 or 7 to 1. In an experimental fall constructed on the Bari Doab canal in India it was found that, with a height of fall to a depth of water-cushion as 3 to 4, the water had no injurious effect on the bottom of the well. On canals where the height of fall is not great it is considered that the depth of the water-cushion may be approximately determined from the formula  $D = c \sqrt{h^3} \sqrt{d}$ ,

in which  $D$  represents the depth of the water-cushion below the crest of the retaining wall;  $c$  is a co-efficient, the value of which is dependent on the material which is used for the floor of the cushion and varies between .75 for compact stone and 1.25 for moderately hard brick;  $h$  is the height of the fall, and  $d$  is the maximum depth of water which passes over the crest of the weir. The breadth of the floor or the bottom of the cistern of the water-cushion parallel to the stream channel is dependent on the section of the weir and will not exceed  $8d$  and should not be less than  $6d$ . A rule laid down for determining the dimensions of water-cushions and their cisterns on the smaller canals in India is that the depth of the cistern at the foot of the weir shall equal one-third of the height of the fall *plus* the depth of the water. Thus on a fall 4 feet deep on a canal carrying 5 feet of water the cistern depth will equal  $\frac{1}{3}(4 + 5) = 3$  feet. The minimum cistern length is equal to three times the depth from the drop-wall to the reverse slope of the cistern, which latter will be 1 in 5. The width of the cistern must be twice the mean depth of the water in the channel.

**61. Apron and Groynes above Crest Wall.**—Usually it is necessary to protect the crest wall on the up-stream side from scour along the face. The best way of doing this is to throw in a bank of stone, which may be of moderate size, up to 2 cubic feet, and quarry rubbish. At the junction with the wall the bank may be from 3 to 5 feet below the crest level, and it should slope at about 1 in 5 to the river bed. Such a bank will ordinarily be a sufficient protection against currents induced by the action of the under-sluiques, but when the river current is made, by the formation of sand banks or otherwise, to approach the anicut at an angle (other than a right angle) a greater development of this protection than that above indicated may be required.

The use of groynes above an anicut is sometimes attended with risk, unless great care be taken to prevent their being breached, and with the formation of holes on the off-side. Their action is similar to that of small weirs, and consequently it is necessary to provide them with a small apron on the side against which the current sets, and with much wider aprons at the nose or salient and on the off-side. They should when used be kept as low as possible, and their action should be carefully watched.

At the outer up-stream wings of under-sluiques groynes are necessary in all cases when the bed of the river is sandy, and they need to be of considerable length, say, twice the length of the set of sluiques from abutment to abutment, as a minimum. The current will necessarily be rapid, and the groynes themselves should be substantial and the aprons wide and about 3 feet thick. The groynes should be founded at about 3 feet below the under-sluique sills.

## 62. Principal types of Anicuts—

- (1) That in which the water passing the crest is dropped at once, or by steps, on to a horizontal apron or on to rock.
- (2) That in which the water is lowered by means of a curved apron to the level of the river bed.

- (3) That in which the water runs down an inclined plane with a uniform slope; or down a series of two or more planes, the slopes of which decrease from top to bottom.

**63. Sunkesala Weir.**—An example of a weir on a rocky bed, and where the water passing the crest is dropped at once on to rock is the one across the Tungabhadra at Sunkesala in Kurnool. The weir forms the head-work of the Kurnool canal, which was constructed by the Madras Irrigation and Canal Company in 1866–70. It has a total length of 4,500 feet clear overfall; the average height of it is 18 feet, but it varies from 6 feet to 26 feet in different parts of the river bed. The more lofty parts of the weir have the section as shown in Fig. 19. In these parts the wall is of solid gneiss rubble masonry faced with limestone ashlar; the up-stream side of the wall has a batter of 1 in 4, the down-

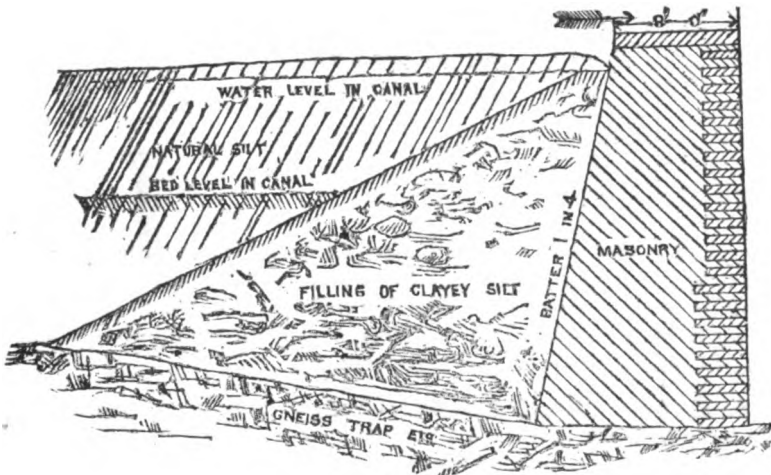

Fig. 19. Sunkesala Weir.

stream face being vertical. The lower parts of the weir have the same width of crest, but both faces of the weir wall are stepped to a batter of 1 in 8; and in these parts the wall is either of rubble masonry, or of gravel concrete with gneiss rubble facing. The whole length of the weir is coped with limestone 12 inches thick, every alternate stone being 8 feet long and weighing about  $1\frac{1}{2}$  tons. The rock of gneiss and trap, on which the weir is built, appeared perfectly hard and sound at the time the weir was erected, but it was subsequently found that the force of the scour was sufficient to dig out several deep holes in the rock and these have had to be built up with masonry in cement.

**64. Jutoor Weir.**—The Jutoor weir, Fig. 20, on the Kurnool canal is built across the Kali river, which has a bed of soft shale. The weir is 6 feet broad on the crest, has a batter of 1 in 4 on the up-stream side and is vertical on the down-stream side. Below the weir an ashlar floor of limestone is laid to protect the shale from the scour of

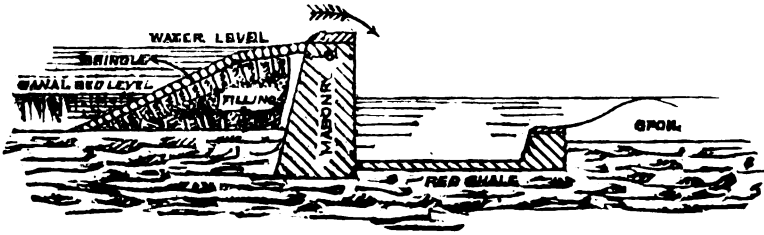

Fig. 20. Jutoor Weir.

the overfall. The floor, which is recessed below the river bed, ends in a dwarf wall, so that a water cushion is formed which aids in the protection of the floor. Experience has shown that in this case the length of the floor is insufficient. The weir is protected on the up-stream side by a bank of broken shale reveted with shingle.

**65. Srivaikuntam Anicut.**—Figs. 21 and 22 show the sections of an anicut built across the Tambraparni river in Srivaikuntam. This anicut is 1,380 feet in length between wing walls;— its crest is 6 feet above the average level of the deep bed of the river, and has a width of  $7\frac{1}{2}$  feet; there is a front slope of  $\frac{1}{2}$  to 1, and in rear a perpendicular fall on to a cut-stone apron 24 feet wide and  $4\frac{1}{2}$  feet in depth; beyond there is a rough stone apron of the same depth and 36 feet in width, protected by a retaining wall. The foundations of the body of the work and of the cut-stone apron in rear are of brick in mortar, laid on wells sunk  $10\frac{1}{2}$  feet in the sand, and raised  $4\frac{1}{2}$  feet above the wells, including the cut-stone covering; the retaining wall is built of stone in mortar, also resting on a line of wells sunk to the same depth of  $10\frac{1}{2}$  feet. The body of the anicut is of brick in mortar, faced throughout with cut-stone, and is furnished with a set of under-sluiques at each extremity of the work to let off sand and surplus water. Each set of sluiques consists of nine vents of 4 feet width each, lined with cut-stone. It was originally intended to have three more similar sets of sluiques at equal distances throughout the work, but, with the Kistna anicut, as an example, the intermediate sluiques were dispensed with.

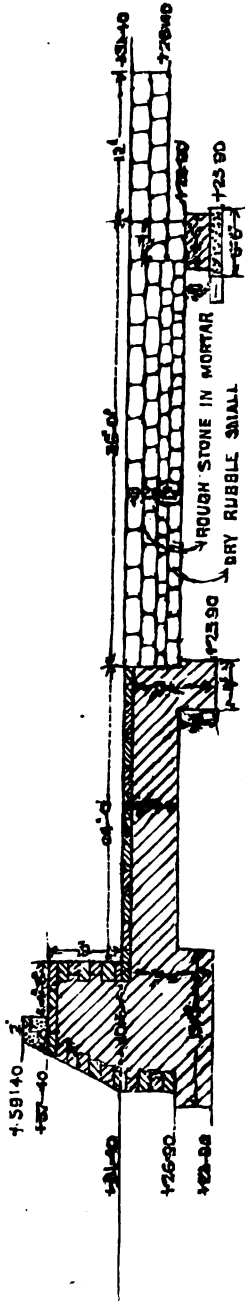

Fig. 21. Cross Section of Srivaikuntam Anicut.

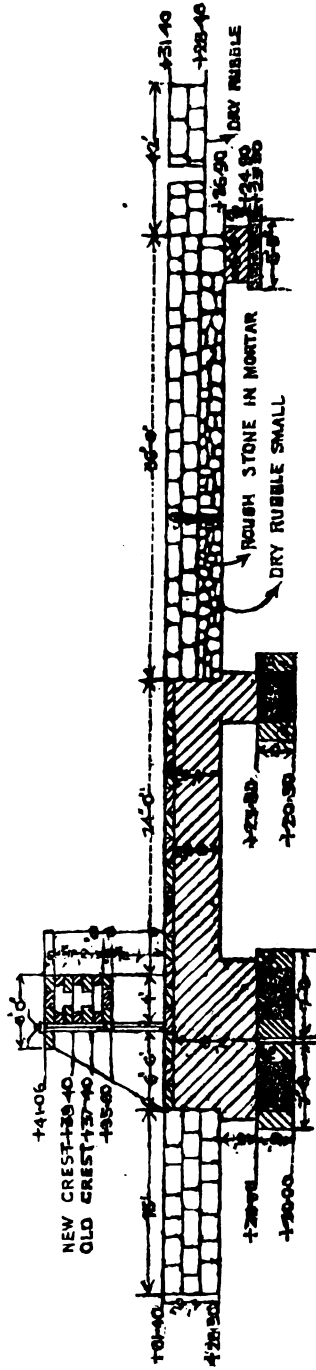

Fig. 22. Cross Section through Sluice, Srivaikuntam Anicut.



Other examples of this type of weir, which was the one usually adopted by the Natives for the numerous weirs constructed by them in Southern India, will be found across the Coleroon, the Vellár in South Arcot, the Pálár and the Poiney in North Arcot, the Korttalaiyár and other rivers. Examples of this form of anicut adapted to different circumstances are shown in Figs. 23 and 24.

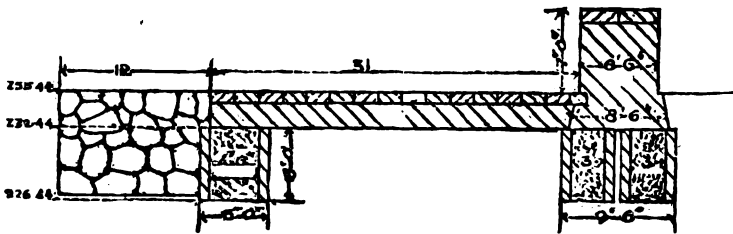

Fig. 23. Coleroon Anicut.

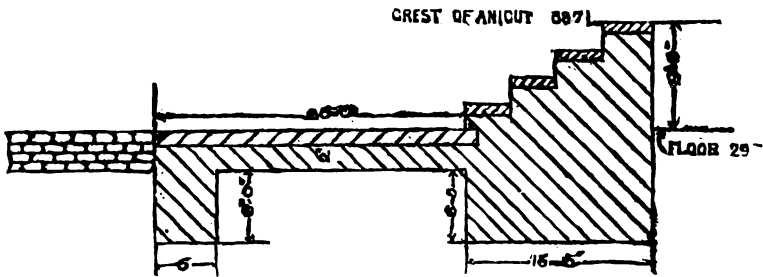

Fig. 24. Shatiatope Anicut.



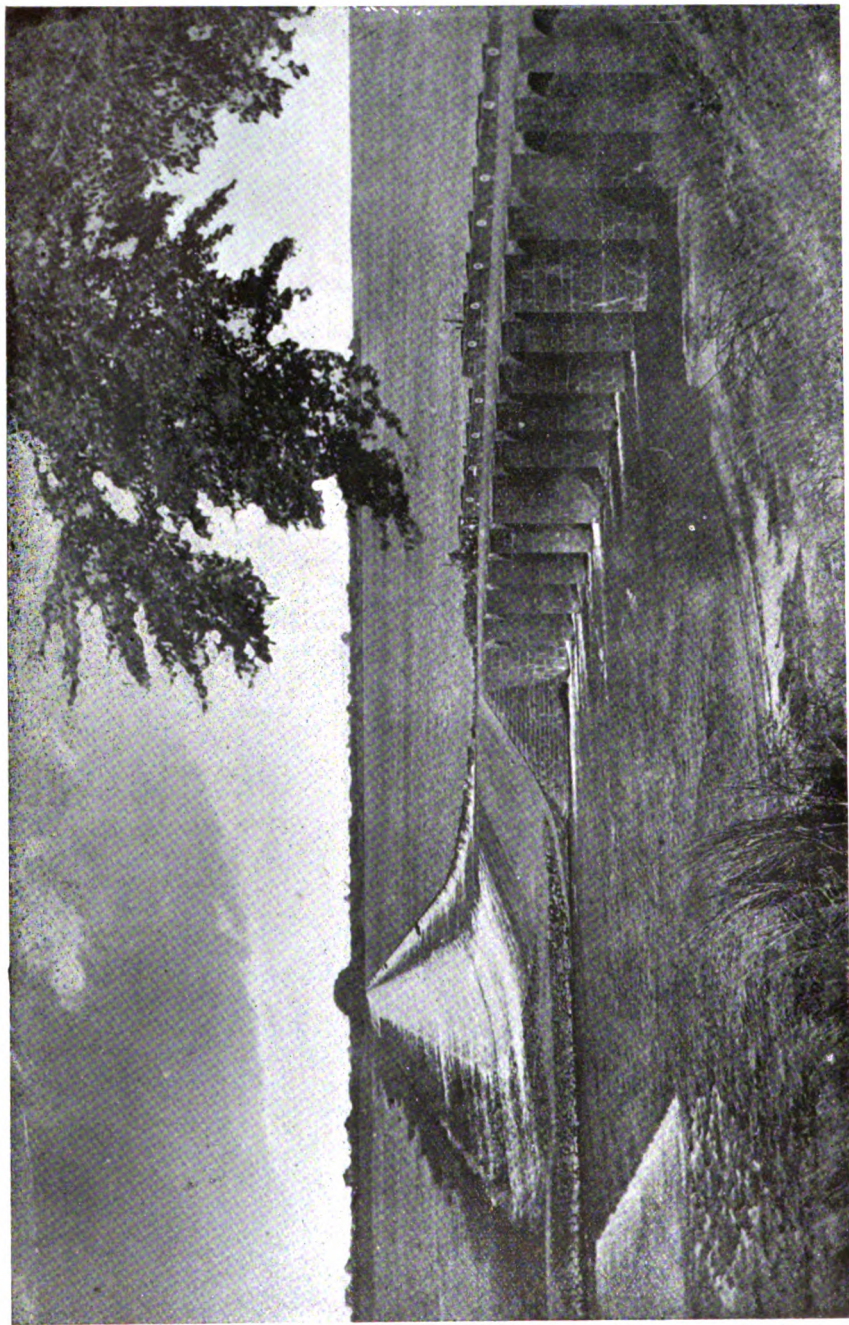

Plate III. Godavari Anicut at Dowlaisheram.

**66. Gódávári Anicut.**—The Gódávári anicut is an excellent example of the second type on a large scale. It is well suited to the conditions met with and has, as regards both first cost, and expense of maintenance, been found to be economical. The general arrangement of the cross section is found in Fig. 25.

At the time when this work was undertaken, there was no weir in existence across a river of the width and capacity of the Gódávári. This river issues from the hills at a distance of about 60 miles from the sea; between that point and the coast the fall of its bed is very irregular, it varies from 3 feet to as little as  $4\frac{1}{2}$  inches in a mile, the average fall being between 5 inches and 6 inches. The rise of the floods at the point where the river issues into the plains is as much as 38 feet, and at the site of the weir the rise is 27 feet or 28 feet. The bed of the river is of pure sand. The Gódávári weir is built in four sections, the united length of which is nearly 12,000 feet; three islands in the bed of the river divide these sections from each other. Across these islands earthen embankments are constructed aggregating more than 6,000 feet in length. These connect the four separate portions of the weir.

The original idea for the weir contemplated a vertical drop wall with an ashlar floor below, but this design was abandoned in favour of that shown in consequence of the difficulty in obtaining skilled workmen to execute it. The main wall of the weir is founded on circular wells which are 6 feet in diameter, and are sunk 6 feet in the bed of the river. The main wall itself is only 4 feet thick at the base, and 3 feet at the top. Over this there is a solid masonry flooring, 47 feet in width, of which 19 feet are horizontal, and 28 feet sloping and slightly curved in section. This floor terminates in another row of wells similar to those under the main wall. The masonry floor consists of 4 feet of masonry covered with cutstone strongly clamped together. Below the lower row of wells there is an apron of rough stone pitching which varies in width, but is generally about 70 feet or 80 feet. The body of the first section of the weir, between the two rows of wells, rests on a core of sand which was thrown into place wetted and rammed. The second section is very similar to the first, with the exception that the front wall is founded on a mass of rough stone which extends under the body of the weir in the place occupied by sand in the first section. The apron is strengthened by a bind wall of masonry, 4 feet by 3 feet, which is carried longitudinally through the length of this section of the weir. The third and fourth sections are generally similar to the first one, but the fourth section is rather stronger, the masonry is a few inches thicker and the front slope is protected by a rough stone apron about 6 feet or 7 feet wide, which is carried along its entire length.

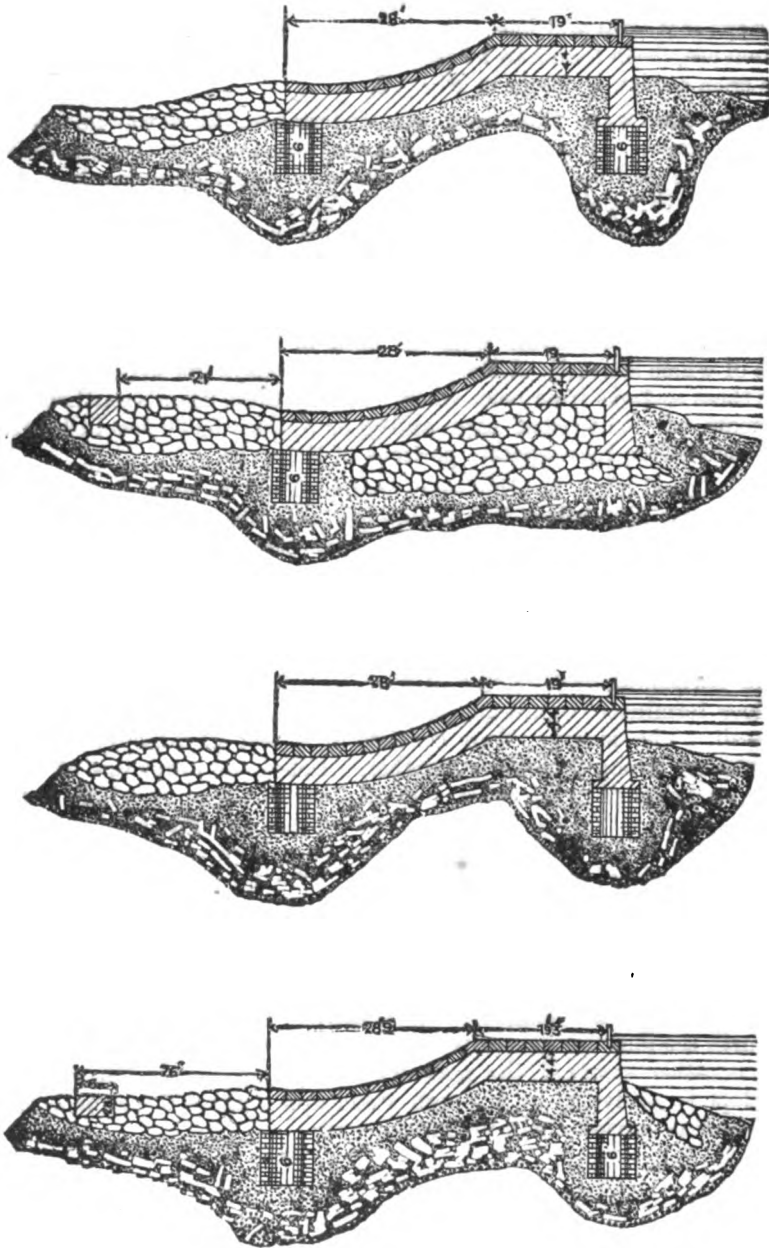

Fig. 25. Cross Sections of Gódávari Anicut.

SECTION OF ANICUT ACROSS THE PENNER AT NELLORE.

1853

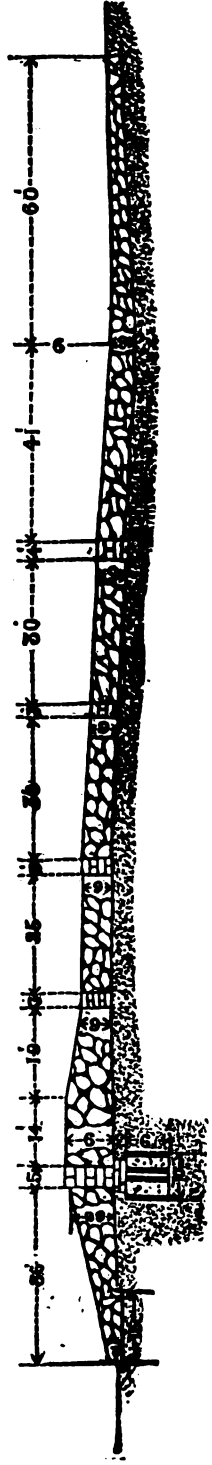

Fig. 26.

SECTION OF ANICUT ACROSS THE PENNER AT SANGAM.

1852

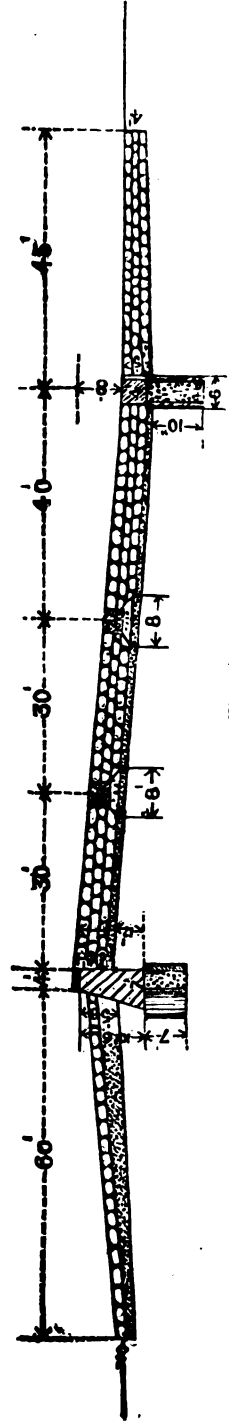

Fig. 27.

SECTION OF ANICUT ACROSS THE PENNER AT ADIMAPALLI

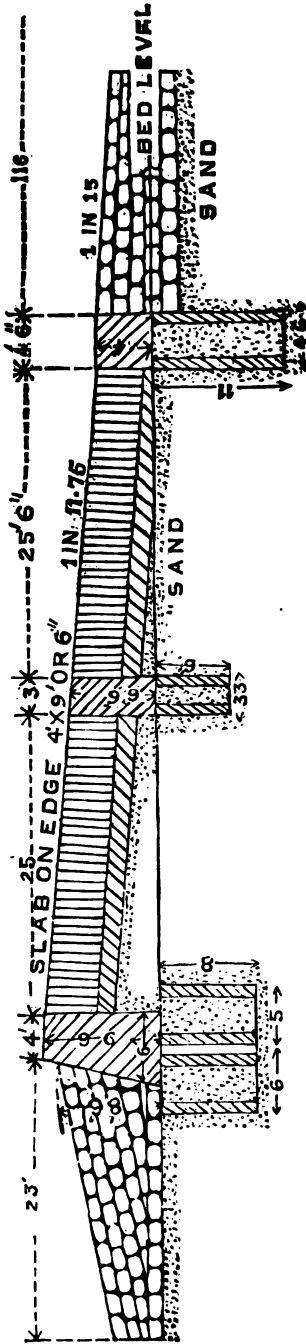

Fig. 28.

SECTION OF ANICUT ACROSS PALAR

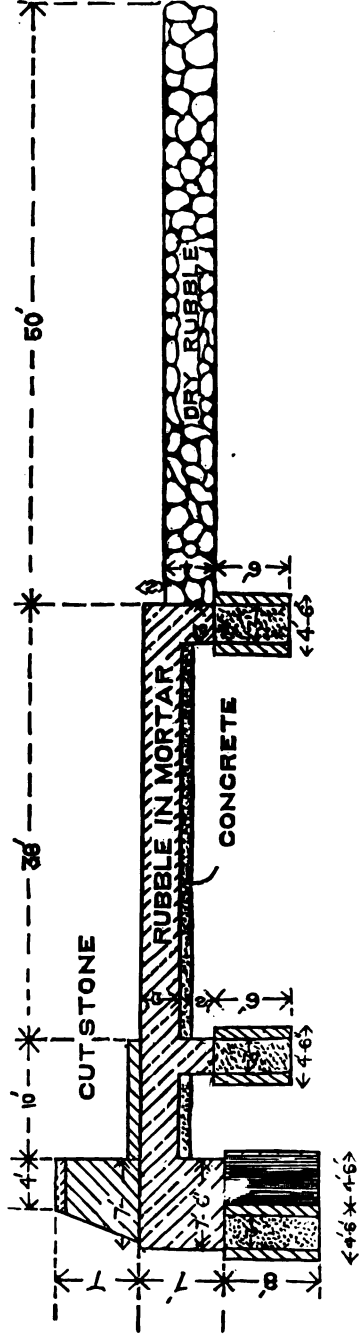

Fig. 29.







Plate IV. Anicut across Kistna River at Bezwada.

**67. Third Type of Anicut.**—The third type of anicut is that generally constructed in Indian rivers, where the banks and bed are of sand, gravel, or other unstable material.

These weirs generally rest on shallow foundations of masonry, in such manner that they practically float on the sandy beds of the streams. The foundation of such a weir is generally of one or more rows of wells sunk to a depth of from 6 to 10 feet in the bed of the river, the wells and the spaces between the rows of wells being filled in with concrete, thus forming a masonry wall across the channel. A well or block is a cylindrical or rectangular hollow brick structure which is built upon a hard cutting edge like a caisson, and from the interior of which the sand is excavated as it sinks. After it has reached a suitable depth it is filled with concrete, the whole depending for its stability on the friction against its sides. This form of construction is illustrated in Figs. 26, 27, 28 and 29 which exhibit several different types of such works.

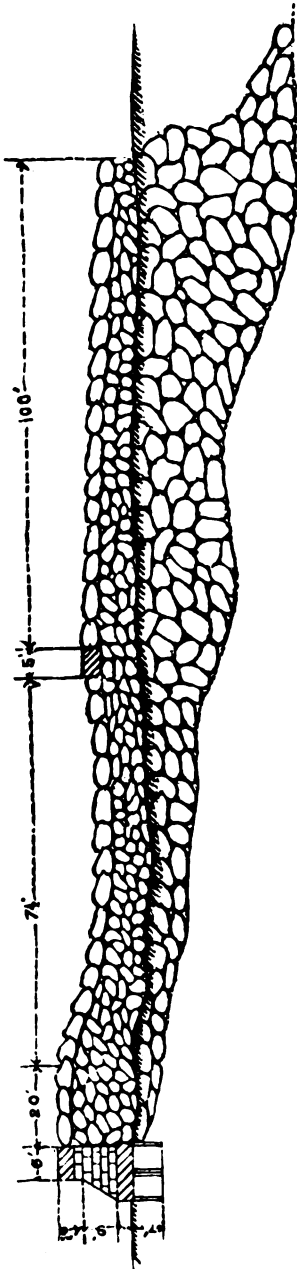

Fig. 30. Section of the Kistna Anicut.

**68. The Kistna Anicut.**—The weir across the river Kistna is one of the most remarkable of this class. Plate IV and Fig. 30. It was built in 1854–55. The body of the weir itself is about 3,000 feet long, but the entire length of the weir, including the under-slucices and piers, is nearly 4,000 feet. The crest of the weir is 16 feet above the summer level of the river, and from 20 to 25 feet above the deepest parts of the original bed as it was before the weir was constructed.

The river Kistna above and below the site of the weir is from  $1\frac{1}{4}$  to  $1\frac{1}{2}$  miles in width, but it narrows at the point where the anicut is built to the dimensions given. A spur of sandstone runs down to the bank of the river at each side of the anicut. The fall of the bed of the river above the anicut is about 13 inches a mile, below it the slope is about 11 inches

a mile. The ordinary greatest rise of the river, at this spot, before the

anicut was built was 35 feet, and in extraordinary freshes as much as 38 feet has been recorded. The velocity of the river in freshes was as great as 10 feet a second before the construction of the anicut; the velocity over it now is said to attain 16 feet a second at which times there is a depth of as much as 20 feet over the crest.

The construction of an anicut at this point presented many difficulties, but they were successfully overcome. The bed of the river was very uneven on the line of the weir; the floods scoured out deep holes, sometimes on one side of the river, sometimes on the other. It was at one time intended to have filled up all the inequalities of the bed with stone, but sand was used for this purpose instead. In the bank of sand, thus thrown up in the deep parts of the river, wells were sunk to a depth of 7 feet below the summer level. On the top of the wells a heavy course of ashlar masonry 3 feet thick was laid. Above this a massive wall of rubble masonry,  $13\frac{1}{2}$  feet high, 12 feet base, and 6 feet top, coped with ashlar, was built. Behind this wall a mass of rough stone of all sizes, up to 5 and even 6 tons in weight, was deposited. At 100 feet back from the main wall another one was constructed, the top of the wall was 6 feet below the crest of the weir; between the two walls the surface of the weir is packed with the largest stones placed on end, the interstices of these stones are filled as far as possible by quarry rubbish jammed well into them. Behind this second wall the apron of the weir is continued for about another 100 feet with large stones.

This anicut obstructs from three-sevenths to one-half of the former water-way of the river at the site where it is built, and although the action on the weir is consequently great, very little has been needed in the way of repairs since the work was first completed in 1855. Some stone has been added year by year, and, on one occasion, a short length of the body-wall was washed away. The cost of the yearly repairs has averaged about  $1\frac{1}{4}$  per cent. on the original cost.

**69. Soane Weir.**—The weir at the head of the Soane canals, which is typical of this class of structure, consists of three parallel lines of masonry running across the entire width of the stream, and varying from  $2\frac{1}{2}$  to 5 feet in thickness. The main wall, which is the upper of the three and the axis of the weir, is 5 feet wide and 8 feet high, and all three lines of walls are founded on wells sunk from 6 to 8 feet in the sandy bed of the river. Between these walls is a simple dry-stone packing raised to a level with their crests, thus forming an even upper surface. The up-stream slope is 3 to 1, and the down-stream slope 12 to 1, the total length of this lower slope being 104 feet, while the total height of the weir including its foundation is 19.3 feet. The Soane weir has a total length across stream of 12,480 feet, of which 1,494 feet consist of open weir disposed in three sets of scouring sluices, Fig. 31, one in the centre and one adjacent to either bank and in front of the regulating gates at the heads of the canals.

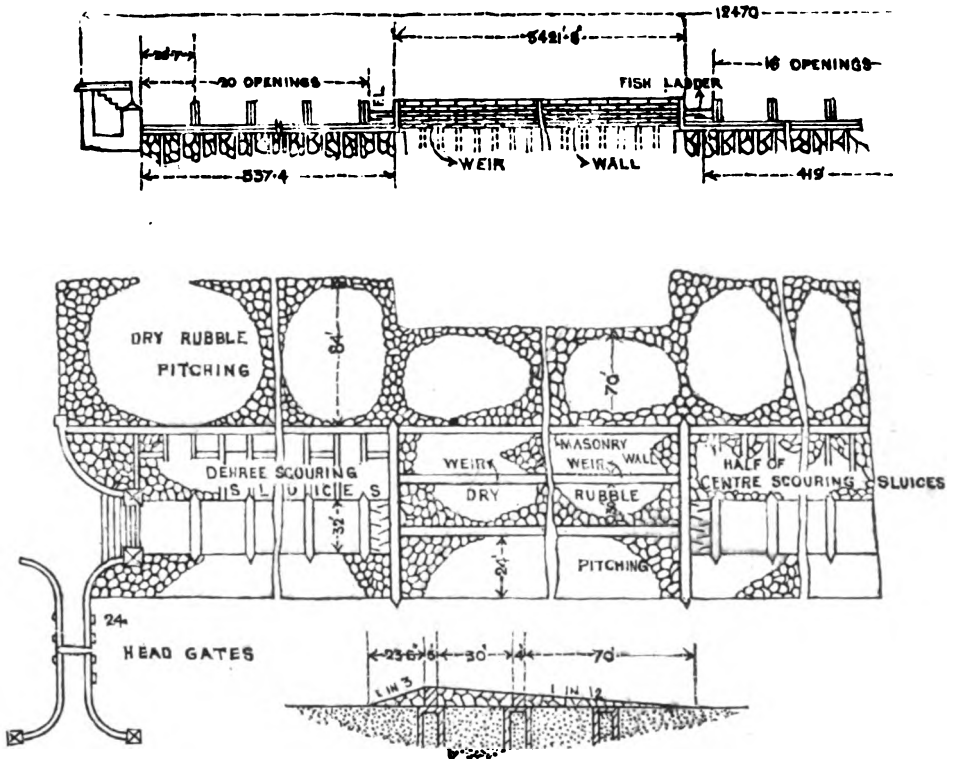

Fig. 31. The Soane Weir.

The third type of anicut has been adopted for the Kistna at Bezwada, and for the weirs across the Pennar at Nellore, Sangam, and Adimappalli. It is suitable where stone is cheap and abundant, and it is not necessary that this material should be specially adapted for masonry work.

These are the three types of weir generally in use in India, but in America, Europe and Australia, where much attention has lately been paid to irrigation works, many other types of weir are in use. Among others the following may be noticed.

**70. Lawrence Weir.**—The weir across the Merrimac river at Lawrence, Massachusetts, appears to have an unnecessarily heavy cross section, Fig. 32. It is 33 feet in maximum height, its extreme breadth at the base being 35 feet. The down-stream face has a batter of 1 in 12, and the structure is surmounted by a coping stone which is level for 3 feet and then slopes downwards up-stream with a batter of 1 in 6 for 12 feet, beyond which the weir is stepped off with a batter of 1 to 1 to within about 10 feet of its base, which latter portion is vertical. It is

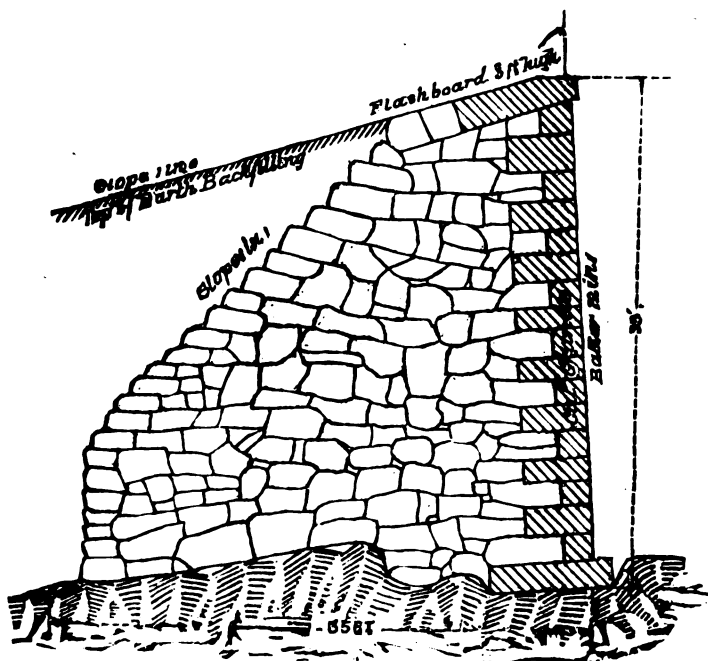

Fig. 32. Lawrence Weir.

composed of rubble masonry founded on firm rock, the front of the dam resting against the edge of a trench excavated in the rock. The face and coping of the weir are of dressed ashlar, headers and stretchers being dovetailed together, and the coping stones are dowelled to each other and the next face stone below. The body of the weir is of rough rubble in cement and is backed up to a level with the top coping by an earth filling having a slope of 6 to 1. The level of the water may be raised by means of planks, 16 feet in length, to a height of 3 feet.

**71. Moveable Iron Weirs, French Type.**—The weirs on the river Seine in France differ materially from the open Indian weirs. They consist of a series of iron frames of trapezoidal cross section, on which rests a temporary footway, and on their upper side is placed a rolling curtain shutter, or gate, which can be dropped so as to obstruct the passage of water across the entire channel-way of the stream, or can

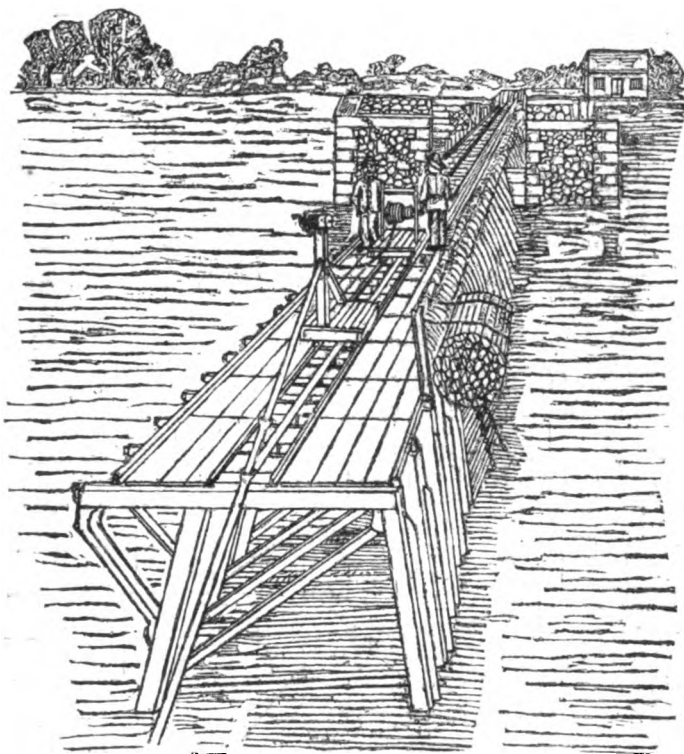

Fig. 33. Moveable Weir.

be raised to such a height as to permit the water to flow under them. In times of flood the curtains can be completely raised and removed on a temporary track to the river banks, the floor and track can then be taken up, leaving nothing but the slight iron frames, which scarcely impede the discharge of the river and permit abundant passage-way of the floods over, around, and through them, Fig. 33.

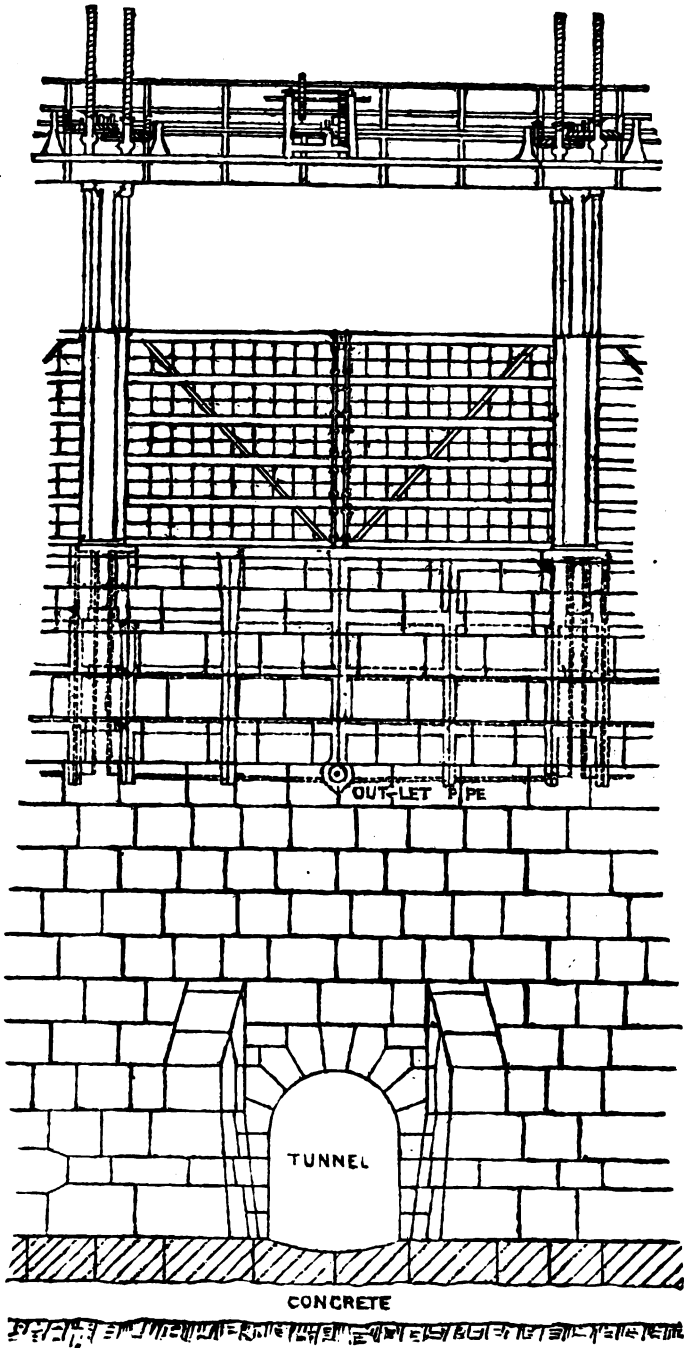

Fig. 34. Goulburn Masonry Weir. Down stream Elevation.

**72. Goulburn Masonry and Iron Drop-gate Weir.**—One of the most modern and interesting weirs which has recently been designed for the diversion of storage water is at the head of the Goulburn Irrigation system in Australia. This weir is a clear overfall weir for its

whole length, and at each of its abutments there leads a main line of canal. In addition to acting as a diversion weir this structure is intended to act as a storage dam for a small portion of its height, its available storage capacity being about  $43\frac{1}{2}$  million cubic feet, though it is expected that this can be filled up several times in a season. On the crest of the masonry structure are built up iron pillars between which are slide lifting gates which can be raised and lowered by hydraulic power, these add thus to the diversion height of the weir and furnish storage capacity equivalent to this height. The highest flood known in the river was estimated to discharge 50,000 cusecs, and the waste-way capacity furnished between the crest of the masonry work and the soffit of the overhead bridge is capable of passing a larger volume than this.

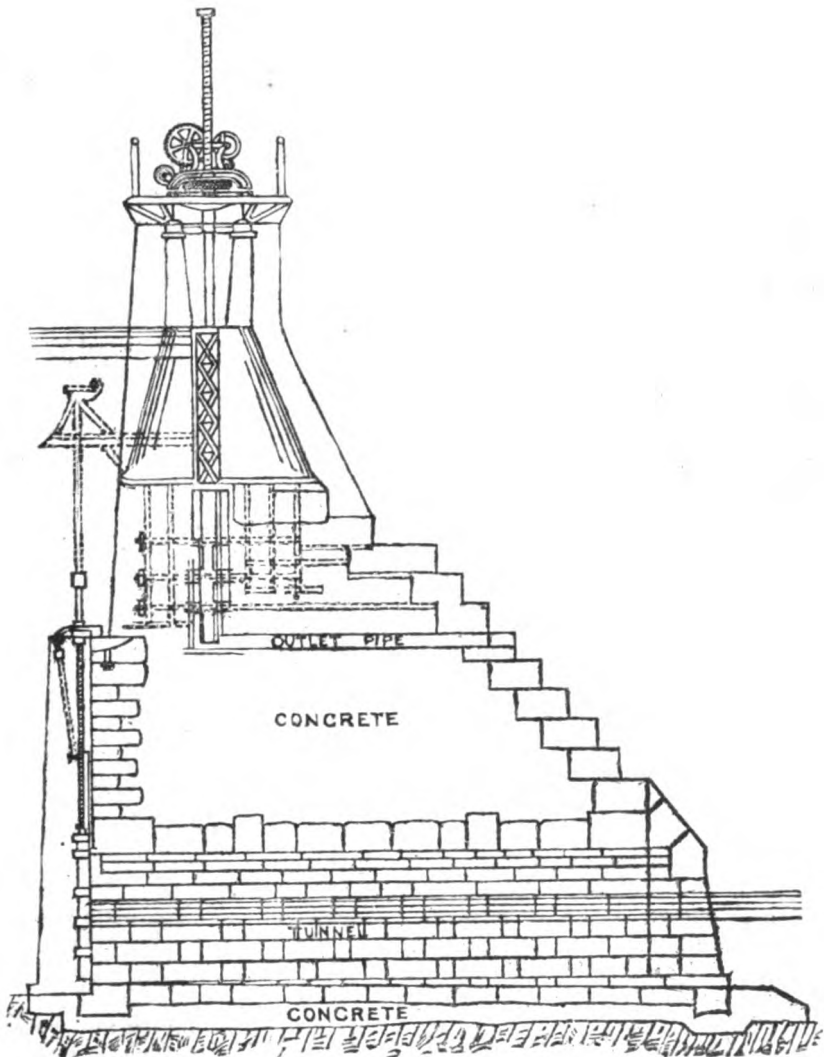

Fig. 35. Section of Goulburn Weir.



The Goulburn weir is founded on alternate beds of sand-stone, slate, and pipe clay, standing almost vertically on edge.

This weir is of sufficient height to raise the summer level of the river about 45 feet, or to a total of 50 feet above the river bed. It is 695 feet in length, exclusive of the canal regulators at either end, which have a further length of masonry work of 230 feet. The body of the work is of combined concrete masonry, composed of broken stone, sharp grit, and Portland cement backed with stepped granite. In the portion of the weir across the natural water-way of the river are six temporary tunnels, Fig. 34, each with a sectional area of 44 square feet, which were designed to carry the ordinary flow of the stream during the process of construction, about 3,750 cusecs and which were filled in with masonry after the completion of the work. The water-way in the upper portion of the weir above the masonry crest is supplied by 21 flood-gates, each having a clear opening of 20 feet horizontally and 10 feet vertically. These are lowered into chambers or recesses in the body of the structure, Fig. 35, and can be so adjusted as to maintain the water-level in front of the canal off-takes at the normal full supply level. The chambers are lined with skeletons of cast iron ribs between strong cement mortar, and the wall in front of each chamber, that takes the pressure of water, is strengthened by a series of rings of wrought iron, built into the concrete, which are strong enough to take the entire thrust, so that should the concrete become fissured from any cause the skeleton would still take the pressure, the masonry merely acting in detail. The gates are framed with wrought iron T beams filled with cast-iron plates, and weigh 7 tons each. They are worked by screw gearing actuated by three 30½-inch Leffel turbines, which can be worked either together or separately. The available head for working them varies from 3 to 13 feet, according to the volume of water in the river, and they give from 3 to 27 horse-power. Hand-gearing is provided for each gate in case of emergency.

**73. Open and Closed Weirs.**—Diversion weirs may again be classified as open or closed. A close weir is one in which the barrier which it forms is solid across nearly the entire width of the channel, the flood waters passing over its crest. Such weirs have usually a short open portion in front of the regulator known as the "scouring sluice", the object of which is to maintain a swift current past the regulator entrance, and thus prevent the deposit of silt at that point. An open weir is one in which scouring sluices or openings are provided throughout a large portion of its length and for the full height of the weir.

The advantage of the closed weir is that it is self-acting, and if well designed and constructed requires little expense for repairs or maintenance. It is a substantial structure, well able to withstand the shocks of floating timber and drift; but it interferes with the normal regimen of the river, causing deposit of silt, and perhaps changing the channel of the stream. Open, or scouring sluice weirs interfere little with the normal action of the stream, and the scour produced by opening the gates prevents the deposit of silt, while their first cost is generally less than that of closed weirs.

The closed weir consists of an apron properly founded and carried across the entire width of the river flush with the level of its bed, and protected from erosive action by curtain walls up and down stream. On a portion of this is constructed the superstructure, which may consist of

To face page 60.

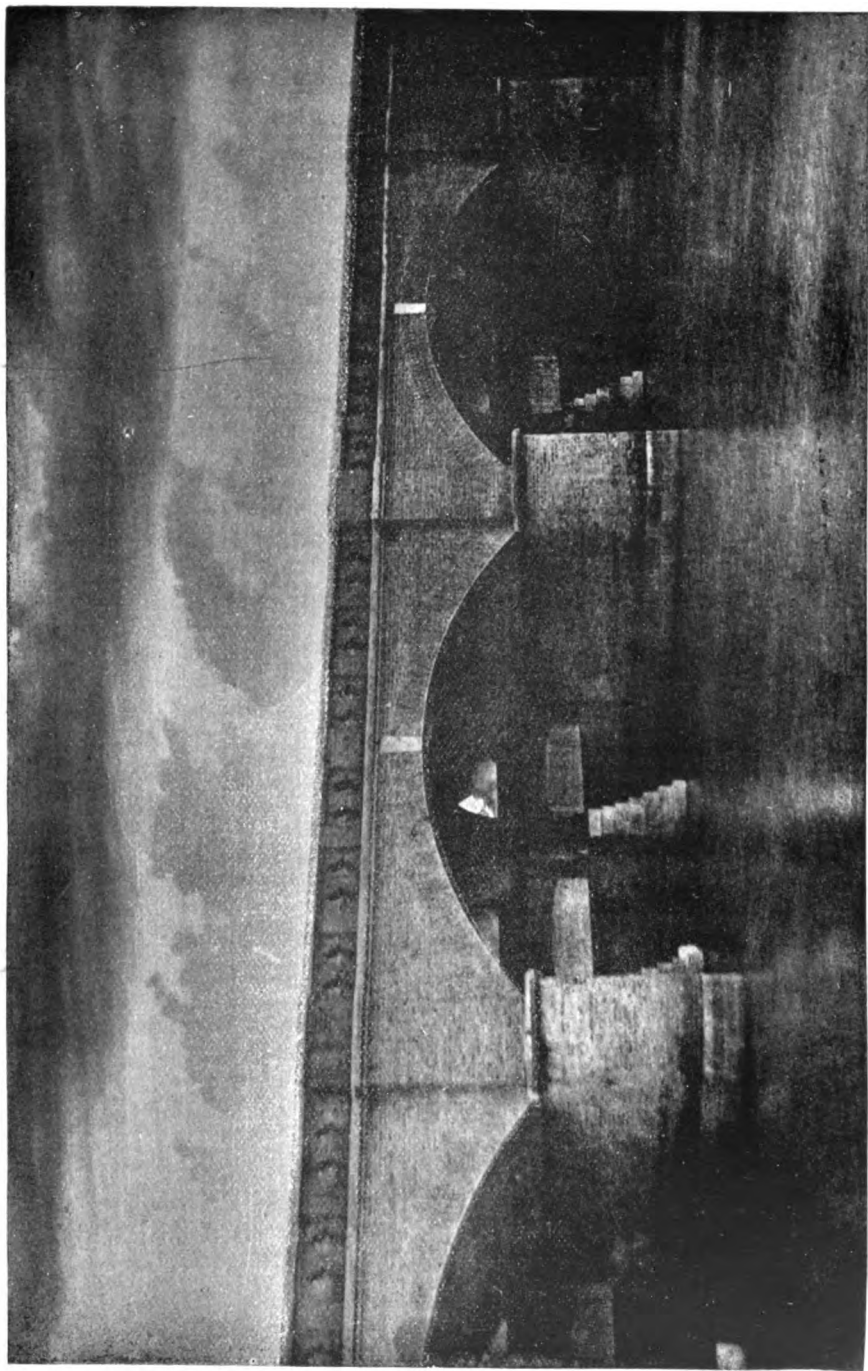

Plate V. Grand Anicut, Cauvery.



a solid wall or in part of upright piers, the interstices between which are closed by some temporary arrangement. This portion of the weir is called the scouring sluice. The apron of the weir should have a thickness equal to one-half, and a breadth equal to three times, the height of the weir above the stream bed. During floods the water backed against the weir acts as a water-cushion to protect the apron, and as the flood rises the height of the fall over the weir crest diminishes, so that with a heavy flood over an ordinary weir its effect as an obstruction almost disappears.

An open weir consists of a series of piers of wood, iron or masonry, set at regular intervals across the stream bed and resting on a masonry or concrete floor. This floor is carried across the channel flush with the river bed, and is protected from erosive action by curtain walls up and down stream. The piers are grooved for the reception of shutters or gates, so that by raising or lowering these the afflux height of the river can be controlled. The distance between the piers varies according to the style of the gate used. If the river is subject to sudden floods these gates may be so constructed as to drop automatically when the water rises to a sufficient height to top them. It is sometimes necessary to construct open weirs in such manner that they shall offer the least obstruction to the water-way of the stream. This is necessary in weirs like the Nile "barrage" below Cairo, Egypt, or in some of the weirs on the Seine, in France, in order that in time of flood the height of the water may not be appreciably increased above the fixed diversion height. Should the height be increased in such cases the water would back up, flooding and destroying valuable property in the towns above. Under such circumstances open weirs are sometimes so constructed that they can be entirely removed, piers and all, leaving absolutely no obstruction to the channel of the stream, and in fact increasing its discharging capacity, owing to the smoothness which they give to its bed and banks.

## CHAPTER V.

## SCOURING-SLUICES—OPEN WEIRS.

**74. Scouring-sluices.**—Scouring or under sluices are placed in the bottom of nearly every well-constructed weir or dam, at the end immediately adjacent to the regulator head. The object of these is to remove, by the erosive action of the water, any sediment which may be deposited in front of the regulator. If the flow in the stream is sufficiently great to permit it, these scouring-sluices are kept constantly open and they perform their functions by keeping the water in motion past the regulating head and thus preventing the silt from settling. If sufficient water cannot be spared to leave the scouring-sluices constantly open, they are opened during flood and high waters, and by creating a swift current are effectual in removing silt which has been deposited at other times.

The scouring effect of sluices constructed in the body of the weir is produced by two classes of contrivances; namely, by open scouring-sluices and by under-sluices. The open scouring-sluice is practically identical with the open weir, as the latter consists of scouring-sluices carried across the entire width of the channel. Where the weir forms a solid barrier to the channel and is only open for a short portion of its length adjacent to the canal head, the open portion is spoken of as a scouring-sluice. The waterway of a scouring-sluice is open for the entire height of the weir from its crest to the bed of the stream.

Under-sluices are generally constructed where the weir is of considerable height and the amount of silt carried in suspension is relatively small. In these the opening does not extend as high as the crest of the weir, nor does the sill of the sluiceway necessarily reach to the level of the stream-bed. It is chiefly essential that its sill shall be as low as the sill of the regulator head. Under-sluices are more commonly employed in the higher structures, such as weirs and dams which close storage reservoirs.

Scouring-sluices are practically open portions of a weir and consist of a foundation, flooring, and superstructure. The floor must be deep and well constructed and carried for a short distance upstream from the weir axis, and for a considerable distance below it. On it are built piers, grooved for the reception of planks or gates, so that the sluice may be closed or opened at will.

It is nearly always necessary to have a set of scouring-sluices below the offtake of a canal, in order to prevent the accumulation of silt, immediately in front of the head-sluice, and it used to be held desirable to have an additional set in the centre of long weirs; it is now, however, considered that central sluices are not of much practical value. There can be no doubt that the weirs of the future will be of the open type, raised little, if any, above the bed of the stream and fitted with moveable shutters on the crest; and, since it is necessary that some kind of bridge should be erected over them, from which to work the lifting gear of the shutters, it follows that these weirs practically become regulators.

To face page 62.

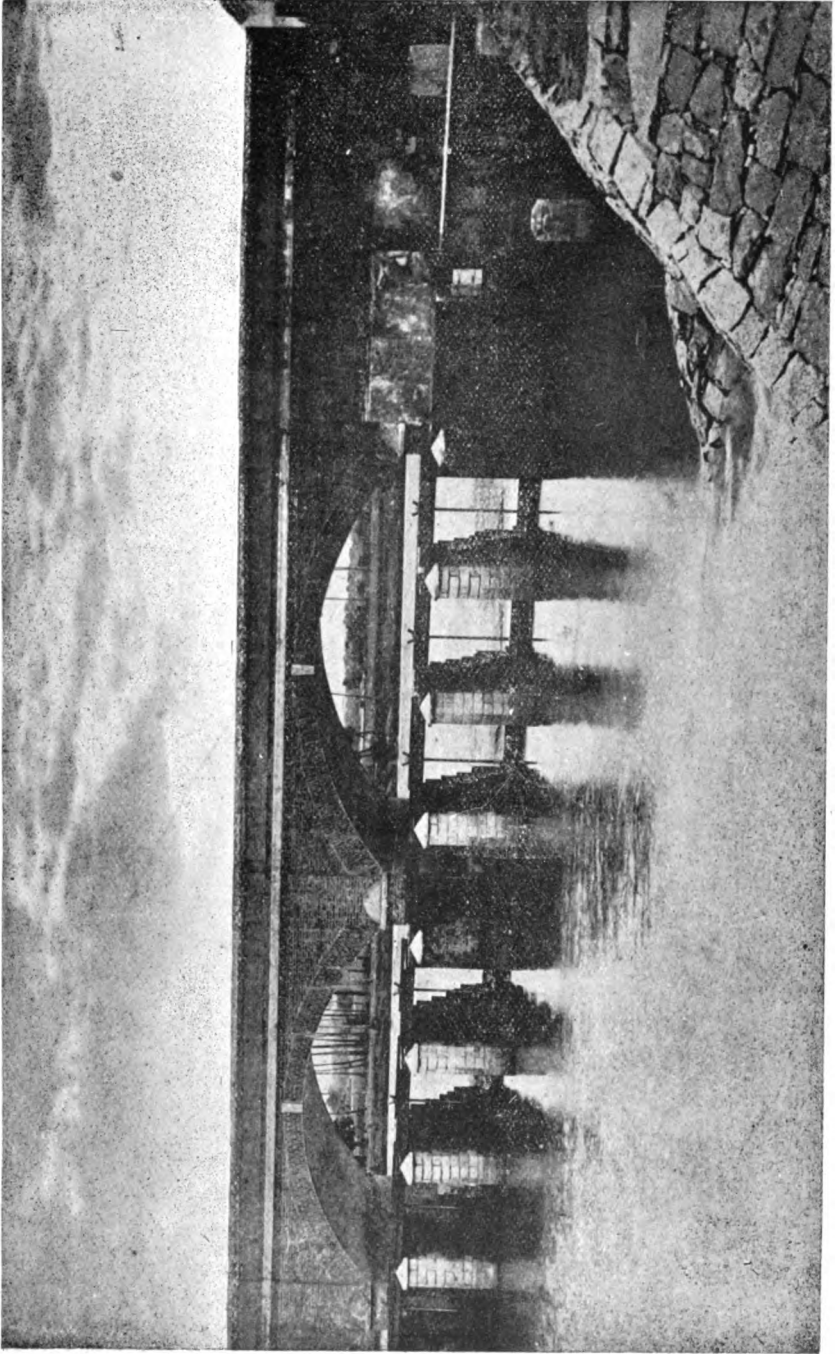

Plate VI. Under-slucices, Grand Anicut, Cauvery River.



ELEVATION

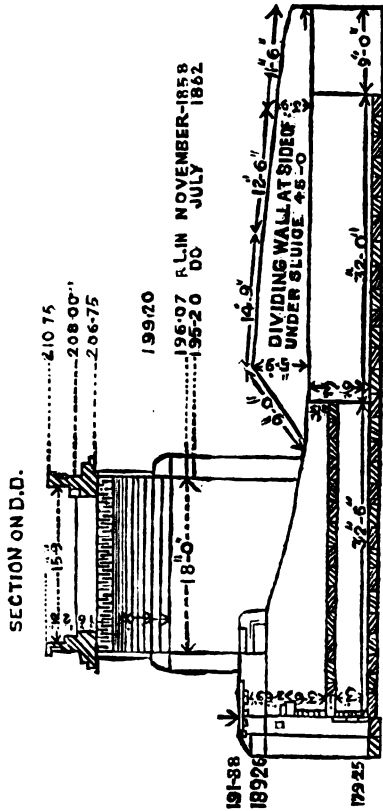
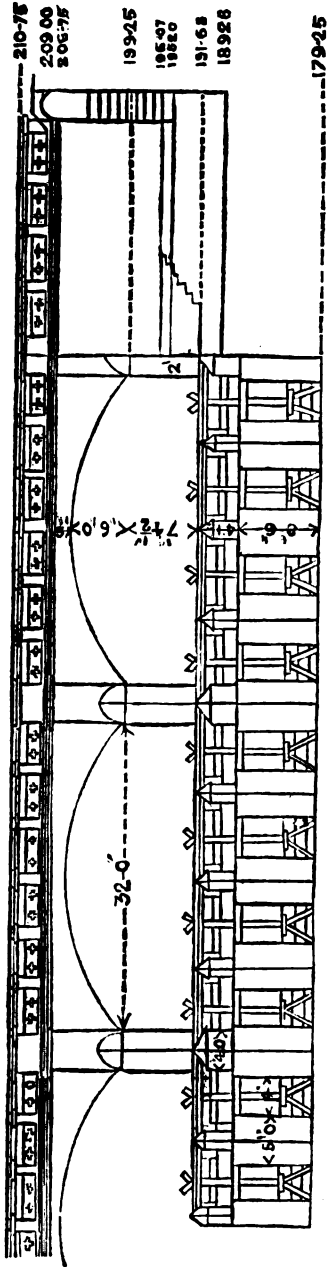

Fig. 36. Under Sluices of Grand Anicut.



In almost every case, except perhaps for very broad rivers, the shutters will be of the lifting type; falling shutters, while useful for broad rivers, have the serious objection that once they fall the flood-water must drop nearly or quite to the level of the floor of the weir before they can be raised again, while with lifting shutters the water can be held up to any convenient height and all excess safely passed.

Such being the case, the openings of the weir become scouring-sluides, and by judicious lifting and closing of the shutters the river-bed above the weir can be kept clear of silt. In some few cases, where the head-sluides occupy a considerable breadth, as at the Grand Anicut across the Cauvery, it may be necessary to provide some means of increasing the scour immediately in front of the head-sluides and this can be done by under-sluides below the floor of some of the openings in the weir nearest the sluides (Plate VI and Fig. 36). The sills of the under-sluides being considerably below level of river-bed will naturally induce a heavy scour and the under-sluides must be strongly built and manipulated with care and judgment.

**75. Construction of Under-sluides.**—The construction of under-sluides needs care as the velocity of the water passing through them is at times very considerable; and, moreover, the meeting of the current through them, with the less rapid current of the water passing over the weir, is liable to induce whirlpools, and the formation of scour holes. The wings and front aprons of the masonry should be of a length and width respectively of about three times the height of the weir above the sluice sill, which latter should be placed at the level of the deep bed of the river. The apron should be completed by a retaining wall founded at the same level as the crest wall. On the upstream side of the retaining wall a rough-stone apron should be provided of about the same width as the masonry apron, and this should extend from the groyne connected with the outer wing to the wing of the weir.

On the lower side, the wing wall on the weir side should conform to the slope of the apron of the weir, if it have a sloping apron, and should be a wall sloping from the weir crest to the retaining wall, if the whole apron be horizontal and at one level; while, if in steps, it should slope to the edge of the first step, and thereafter conform to the section of the apron; it will thus act as a lateral retaining wall to the apron of the weir. The width of the masonry apron on this (the lower) side should be the same as that of the weir apron, *i.e.*, to the line of its retaining wall, if the weir apron be of masonry, horizontal or sloping, and to four or five times the height of the weir, if its apron be a slope of rough stone. A retaining wall of the same depth as that of the weir should be built at the edge, and the rough-stone apron beyond should be of large stone, extending to the outside line of the outer apron of the weir, and laid to as great a depth, below the surface of the floor, as the excavation of the sand, for this purpose, can be conveniently carried. A reserve of stone should be provided to be thrown in as soon as any settlement or disturbance becomes apparent. Generally additional material will have to be placed in this apron, from time to time, for four or five years. One or more bind walls may, with advantage, be inserted, to check displacement, after the freshes of one or two seasons have consolidated the stone, and made further material settlement improbable.

To face page 64.

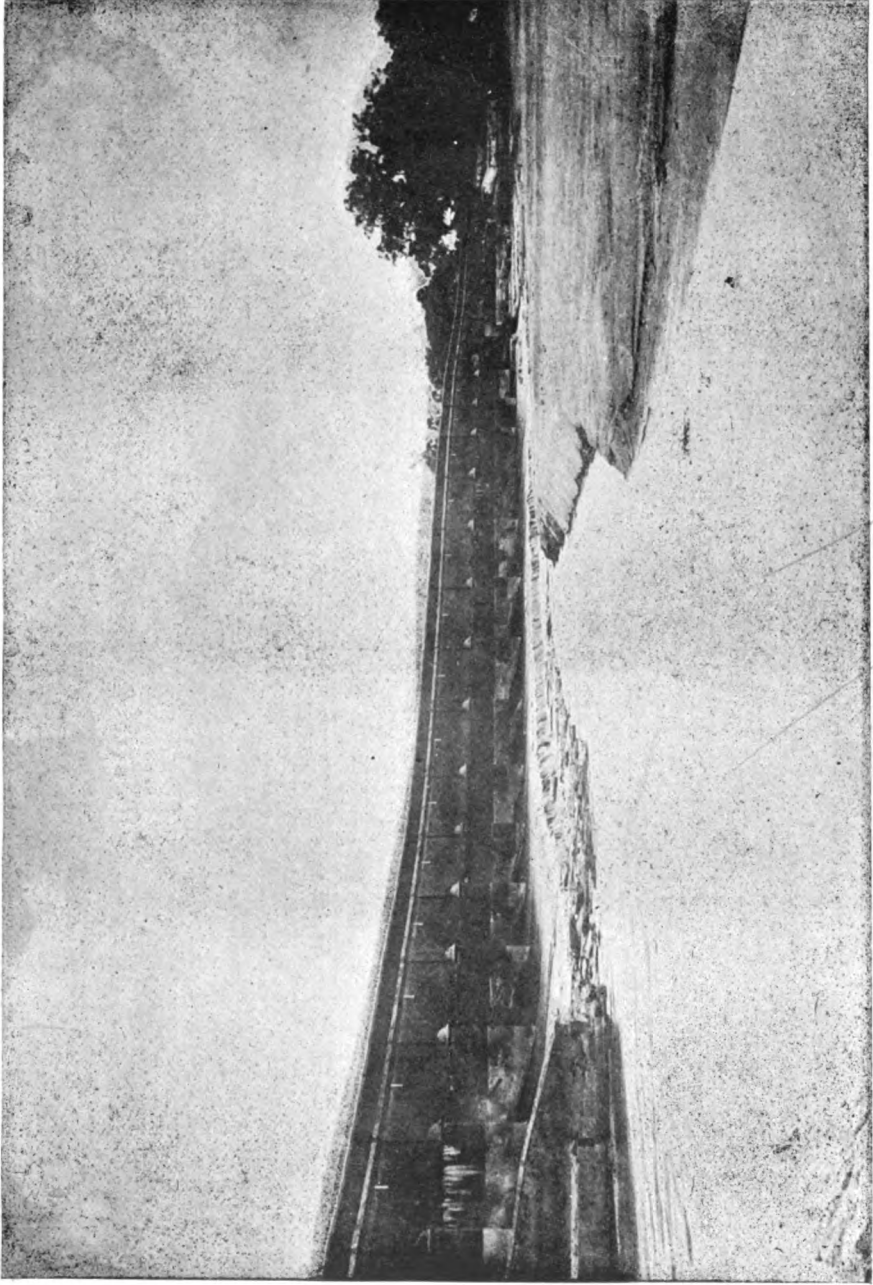

Plate VII. Rear View, Grand Anicut, Cauvery River.

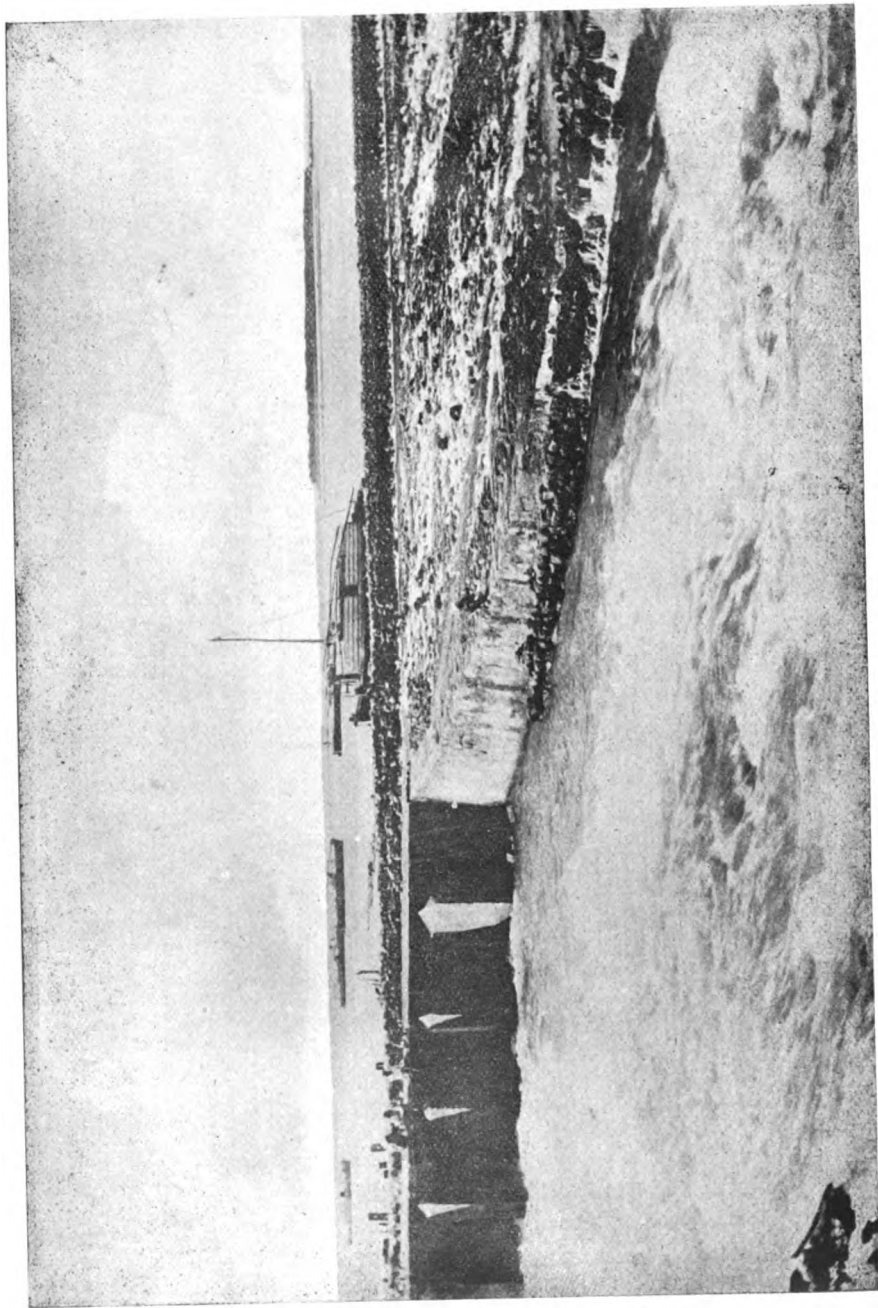

Plate VIII. Kistna Anicut. Under-slucices at Sitanagaram.

**76. Scouring-sluice Shutters and Moveable Dams.**—The old works on the Gódávári, Kistna, Cauvery and other rivers had sluices with vents only 6 feet wide, and of a height equal to about only half that of the flood. In these works the scouring-sluices were closed in the dry season, either by baulks of timber dropped one after another into the grooves in the piers, or by gates, sliding in vertical grooves, which gates were raised and lowered from above by screw-gearing working on long rods attached to the gates. This system necessitating the construction of a masonry superstructure above the level of the highest floods, was found to oppose great resistance to the free flow of flood water, and also to stop floating debris in the river, so that the sluices not unfrequently became choked with trees and brushwood.

As these earlier works were inefficient, steps were taken to increase both the size and number of the openings with the result that, as already stated, the anicut or solid barrier across a river has become, under most conditions, a thing of the past, and nearly all new works will be constructed on the open weir principle, while many existing works either have been or are being converted to the same class.

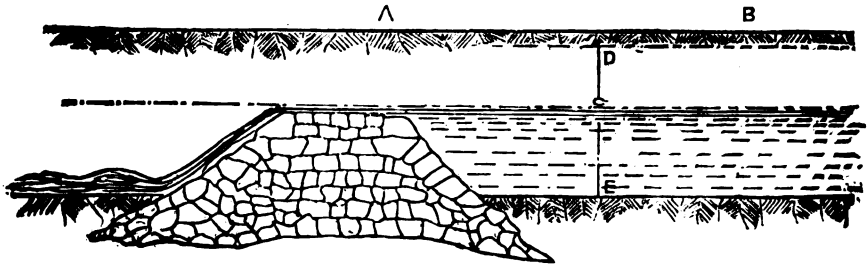

Fig. 37.

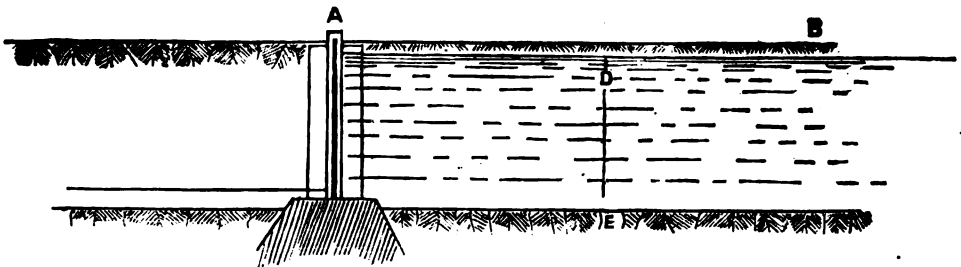

Fig. 38

Suppose it is required to impound the water, in the stream indicated in Figs. 37 and 38 from the point A. The level of the bank at B represents the maximum height to which the water can be permitted to rise at any time without flooding the adjacent lands. It is obvious that a weir cannot be built to the height B. As all the water must pass over the weir, inundation of the land can only be avoided in time of flood by keeping the crest of the weir below the point B by a distance equal to the maximum rise of the river above the normal level. The greater the rise which must be provided for the lower must the crest of the weir be made. If the distance CD represents the rise of the stream in time of flood, then the crest of the weir must be kept this depth below the

point B, and the height CE represents all the head and all the storage that can be provided by the construction of a weir. But, if, on the other hand, the stream be controlled by a properly-constructed sluice-gate, as indicated in the second figure, or by a barrier of sluices in a stream too wide for one, then the head available for distribution becomes the full height DE, because it is not necessary to provide any margin for the passage of flood-water over the sluice. The shutter being raised clear from the bottom according to the volume of the flood, permits the flood-water to flow freely along the bottom. The theoretical advantages of a sluice over a weir, have, of course, been long recognized, but engineers were formerly loth to adopt sluices because of the defects which were inseparable from the older forms. The most important of these were the large amount of power required to open the sluice owing to the friction between the shutter and its bearings. The first attempts to improve matters were made by cutting down the crests of existing weirs and fitting them with automatic shutters. The shutters held up the water till a certain height was reached and then fell. The impounded flood-water was released and all that remained to be done was to raise the shutters and leave them up till such time as the water again rose sufficiently high to cause them to fall. The method of working these shutters will be understood from the following paragraph.

**77. Fouracres' Shutters on Soane Weir.**—Figs. 39, 40 and 42 give three different views of the shutters of the Soane weir in different

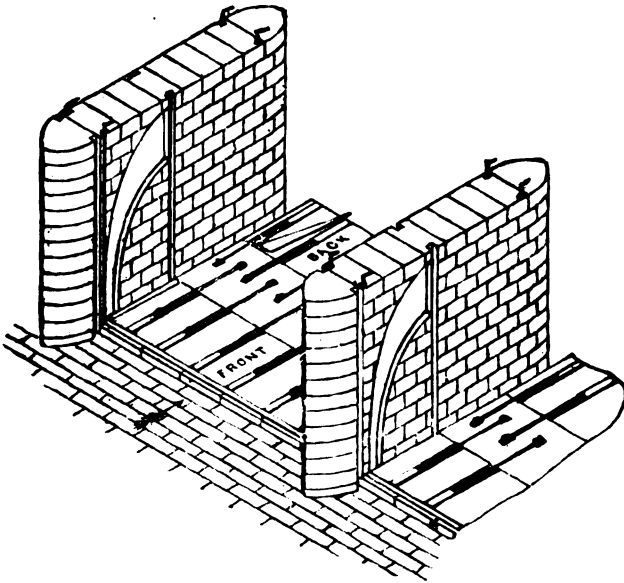

Fig. 39. Fouracres' Shutter Open.

positions. Fig. 39 shows the sluice open, with both shutters lying on the floor, the flood being supposed to be running freely between the piers, which are 8 feet in height, 6 feet thick and 32 feet in length. When it becomes necessary to close the sluice and shut off the

water flowing through it, a clutch worked by a handle from the top of the pier is turned, and frees the shutter from the floor, and it then floats partially up from its own buoyancy, when the stream, impinging

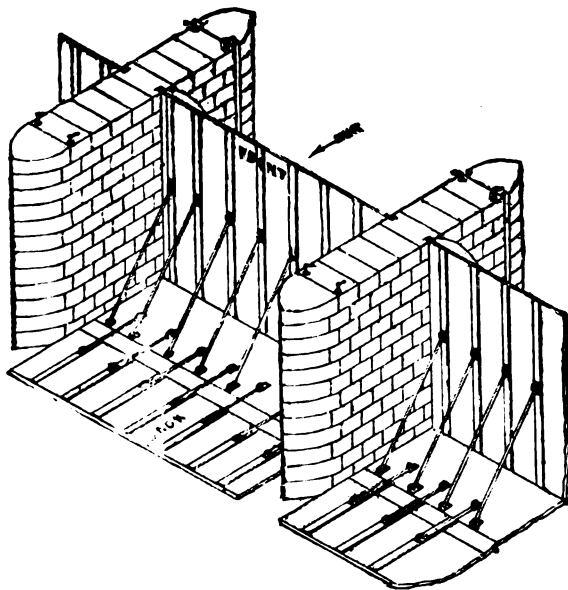

Fig. 40. Upper Shutter, Lifted.

upon it raises it to an upright position; with great force Fig. 40. But if a shutter, 20 feet long and 8 feet in height, were allowed to come up with such velocity, it would either carry away the piers or would be carried away itself. To destroy this sudden shock six hydraulic rams or buffers are fixed on the down-stream side of the upper shutters. These rams which are simply pipes with a large plunger inside, also act as struts for the shutters when in an upright position. Fig. 41.

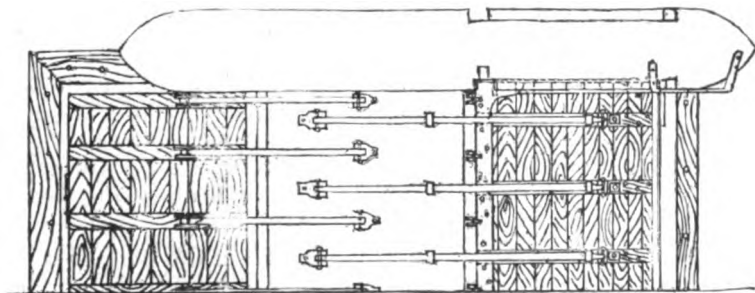

Fig. 41. Arrangement of rams.

The pipes fill with water when the shutter is lying down, and as soon as it commences to rise, the water has to be forced out of them by the plunger in its descent and, as only a small orifice is provided for the escape of the water, the ascent of the shutter, forced up by the stream, is slow and gentle instead of being violent. The orifices in the pipes are covered with India-rubber discs to prevent them being filled with sand or silt.

The water is now effectually shut off, as shown in Fig. 40; but without other means being taken it would be impossible to open the sluice again, as the shutter could not be lifted against the force of the stream. The back shutter is therefore provided as shown in the same

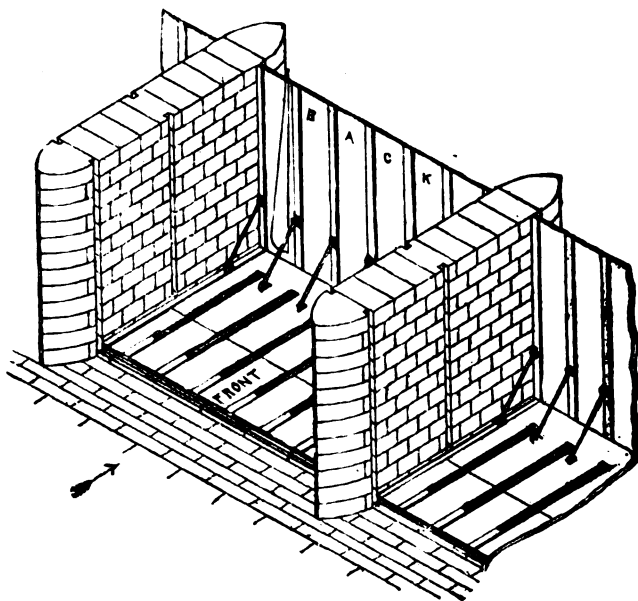

Fig. 42. Rear Shutter Lifted.

view. This back shutter is so arranged as to be lifted by hand and placed upright, ties being placed to support it, as shown in Fig. 42. The water is then allowed to fill the space between the two shutters, and the upper one can then be lowered to the floor again, but the lower one is held up by ties which are hinged to it at one-third of its height, and by this means it is balanced and resists the pressure on it till the water reaches its top edge, when it loses equilibrium and falls over, thus opening the sluice again.

The sluices can be left to fall of themselves if the river rises in the night; or, if required, they can be made fast by a clutch on the pier-head as shown in Figs. 39 and 40.

Falling shutters have been tried in Madras, but they were found to be very troublesome to manage and were the cause of a great loss of water, they leaked considerably when up, and after a flood they could not be raised until the water was comparatively low and the process of raising them was difficult and slow and somewhat dangerous for the lascars employed. Attention was again turned to the design of suitable sluices and the most satisfactory arrangement was that of the late Mr. Stoney.

**78. Stoney's Sluices.**—As already stated the theoretical advantages of a sluice over a weir had been long recognized, but the use of sluices had not been adopted because of the defects which were inseparable from the older forms. These defects were principally the amount of power required to operate the sluice and the risk of the sluice becoming jammed. In any form of sluice where the gate worked between or against fixed guides directly, excessive leakage could only be avoided by making the guides and valves a tight fit. The power required to operate such a sluice under pressure was found to be not less than six-tenths of the total load, and might be more; whilst, in some instances such sluices were never opened because of the uncertainty as to whether they could be closed again when required. It was the late Mr. Stoney's experience of these difficulties when in charge of the head-works of the Madras Irrigation canal, that led him to make a special study of sluice construction, and to initiate a series of experiments which resulted in the form of sluice with which his name is associated. The problem may be briefly stated.

To construct a sluice which shall be—

1. Water-tight.
2. Easily operated under all conditions.
3. Always to be depended upon to open or close when required.

The final solution of the problem, as found by Mr. Stoney, is marked by great simplicity. In the Stoney sluice the valve, or door, hangs freely between abutments as indicated in Fig. 43. Each jamb is rebated or recessed, as shown, but instead of the door being made to fit tightly against this face, as in the common sluice, a series of anti-friction rollers is interposed between. The contact between the two faces, when the sluice is being worked is therefore not a sliding contact, which means excessive friction but is a rolling contact. The rollers are not fixed to either face, but are simply mounted in a hanging frame so arranged that it may travel up and down with the door, the rollers revolving easily on the faces during the operation. The load on the door does not pass through the axles of the rollers: friction and wear and tear thus being reduced to a minimum. Ease of movement is in nearly all cases further secured by the addition of counterbalances to the shutters.

The requisite tightness of the door is secured in an equally simple manner. In the angle formed by the edge of the sluice and the face of the jamb, a turned bar is hung freely as shown. The pressure of the water forces this "Staunching rod" into the angle against both the sluice and the jamb, a perfectly water-tight joint being thus secured. The freedom of movement and ease of manipulation thus obtained may



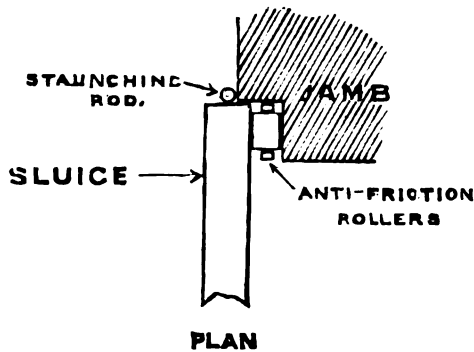
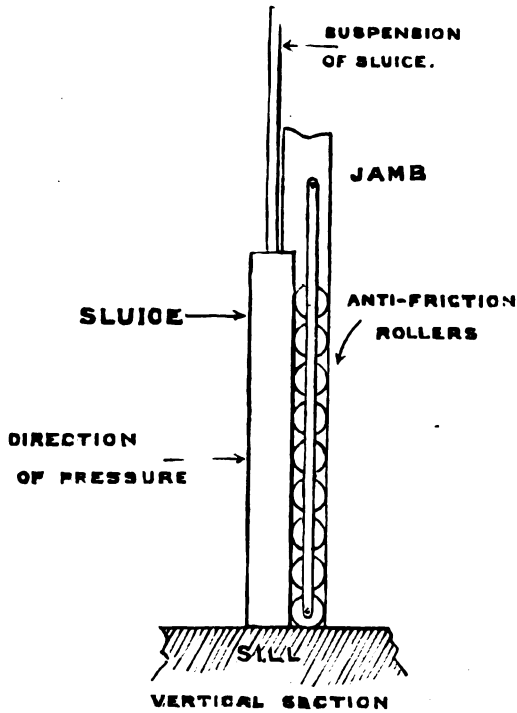

Fig. 43. Stoney's Sluice.

be realized from the fact that one of these patent sluices, 30 feet wide, with a head of 26 feet of water against it, is easily opened and shut by the hand-power of a stout boy.

This freedom of movement means also certainty of control, permitting the nicest adjustment of the sluice at any moment to any desired change in the rate of discharge or in the head of water to be maintained.

To face page 70.

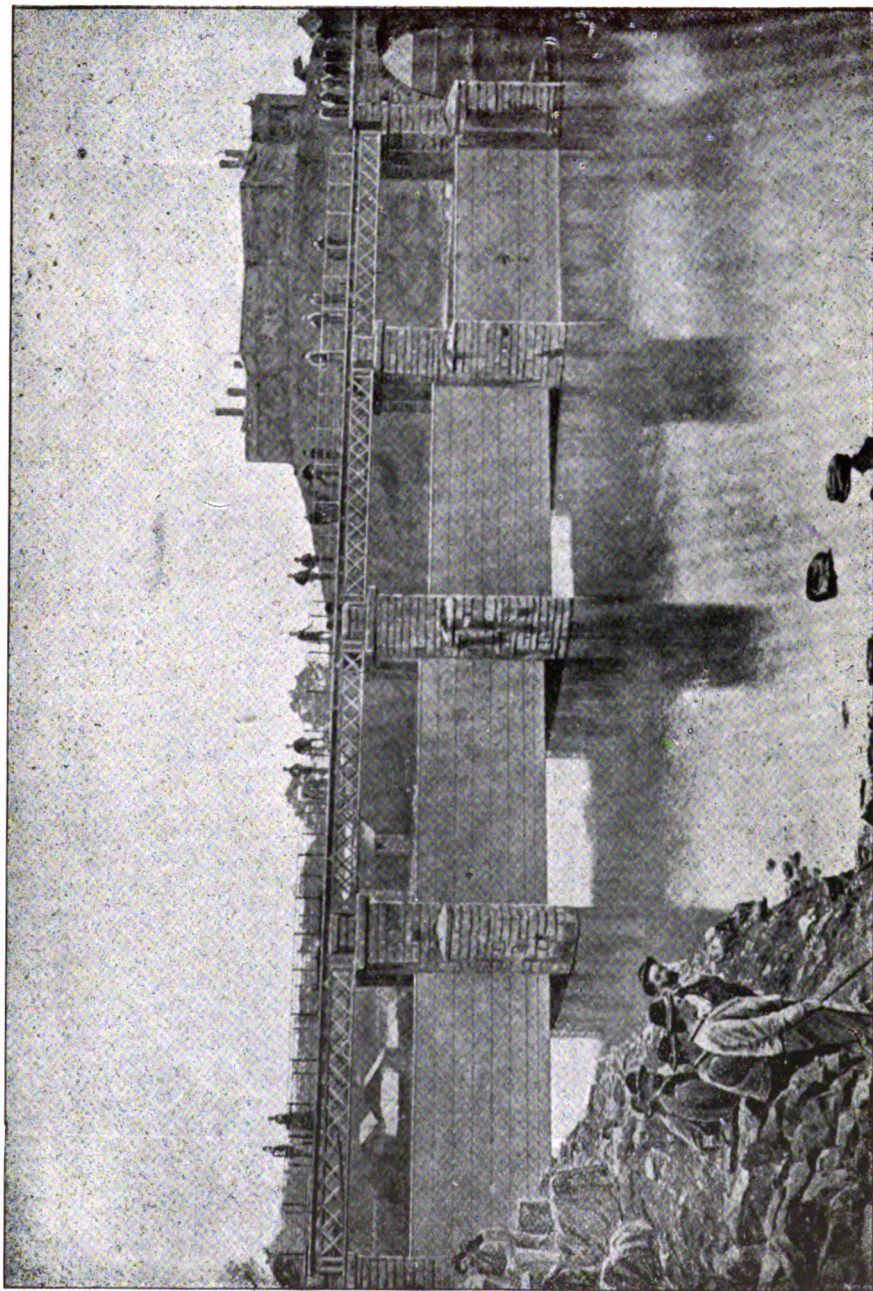

Plate IX. The Belleek, Sluices, Lough Erne, Ireland.

To face page 71.

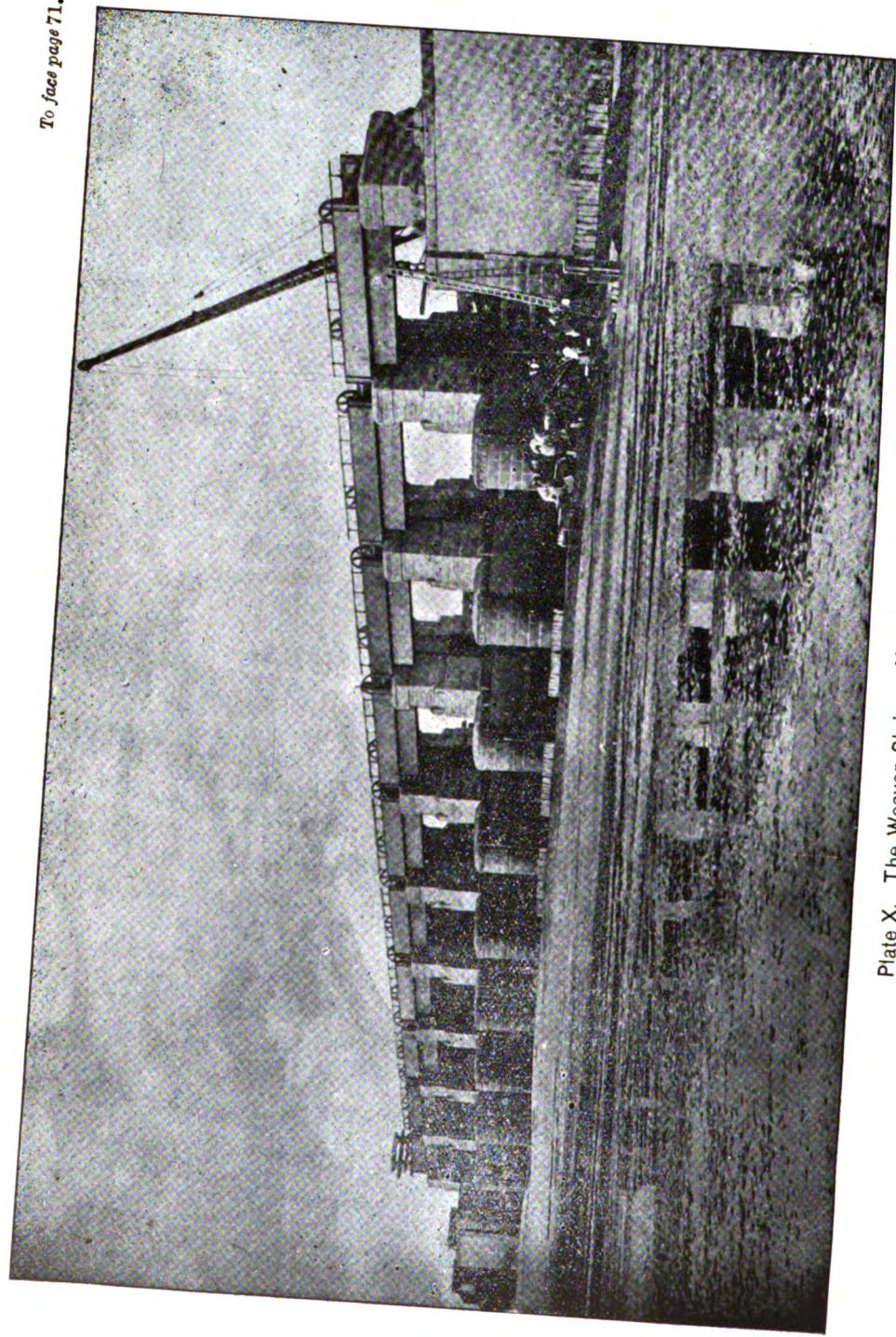

Plate X. The Weaver Sluices, Manchester Ship Canal.

**79. Examples of Stoney's Sluices—The Belleek Sluices.**—These sluices furnish an important example, on a large scale, of the value of the Stoney sluice in maintaining water-powers and preventing floods. Plate IX.

Lough Erne, properly speaking, consists of two lakes united by a short river. The total length of the lakes and the connecting river is over 42 miles, while the water-surface at water-level represents an area of about 40,000 acres. The lakes drain a most important agricultural district many hundreds of square miles in extent. The outlet from the lakes is by way of a short river to the town of Belleek. Formerly the waters were held up by a barrier of rock in the bed of the stream, forming a natural weir.

The country has a heavy rainfall and was formerly always subject to floods which, owing to the outlet being limited by the natural weir at Belleek, would yearly rise more than 10 feet above the normal summer level, flooding nearly 20,000 acres of valuable land. In one year the lands adjoining the lakes remained under water during the entire summer months, resulting in a loss of over £40,000. It became necessary, therefore, for the public authorities to take steps to avoid the recurrence of these yearly disasters.

Mr. James Price, M.I.C.E., the Engineer placed in charge of the works, after carefully investigating all known methods of water-control by personally visiting works in various parts of the world, finally decided upon adopting the Stoney system and the work shown in the Plate were consequently erected.

The sluices are four in number, each having a clear opening of 29 feet and a height of 14 feet 6 inches above the sill. The weight of each gate is over 12 tons, and works against a water-pressure of 85 tons.

The sluices have been in continual use since first erected, and have never failed to give perfect control over the heaviest flood-waters. The lakes, instead of rising 10 or 11 feet in the rainy season, with disastrous results to the adjoining country, have never varied more than 7 or 8 inches since the sluices were put up. The flooding of the country has been avoided, the navigation and all water rights preserved, and the beauty of the lakes maintained.

**80. The Weaver Sluices.**—Before the construction of the As-suân dam, these were the largest sluices made. The sluices are situated at Weaver Point on the Manchester Ship canal and their function is to control the discharge of the waters of the river Weaver into the estuary of the Mersey, after they have served their purpose in the Ship canal. Plate X.

The following are the details of the sluices—

Span of each gate	..	..	..	..	..	30 feet.
Depth of sluice	..	..	..	..	..	18 "
Lift of sluices	..	..	..	..	..	15 "
Pressure against each gate	..	..	..	..	..	120 tons.
Combined width of waterway	..	..	..	..	..	300 feet.

In Plate XI is an illustration of the hand gear used for controlling the Weaver sluices. In order to raise a shutter, the attendant simply

releases a small friction break on the hand gear, and the shutter which is counterbalanced, comes up rapidly of itself easing off to repose when equal balance is reached. While such an operation would be impossible with a shutter of the old type of construction its feasibility under the Stoney system will be readily understood when the fact is grasped that the friction to be overcome is in the new type of shutter only one four-hundredth part of what it would be in the old. Hence the striking feature of the gate on the Weaver Dam, where one man, by means of a hand gear, closed a sluice against the pressure and flowing current, notwithstanding that the shutter, as it becomes more immersed, is gaining buoyance and is finally two tons lighter than the counterbalance by the time it reaches the sill.

**81. The Assuán Sluices.**—There can be no doubt that the invention of the Stoney sluice played a most important part in enabling the storage and control of water at Assuán to become an accomplished fact for we have it on the authority of Sir W. Willcocks, K.C.M.G., to whom the credit for the original conception of this great undertaking is due, that he considered the Stoney system of sluices was the only one which could deal with the problems at Assuán. Plate XII.

The sluices in the dam are built at various levels. Sixty-five are designed to work with a maximum head of 61 feet; the sluices also vary in size, 120 being 22 feet 11 inches high by 6 feet 6½ inches wide and the remainder 11 feet 5½ inches high by the same width. The sluices are unbalanced, that is, have no counter-weights, and are operated by crab winches from the top of the dam. Two men work the sluices notwithstanding that the weight of the heaviest is 14 tons.

These, of course, are only a few instances of the case with which large works can be brought under complete control by means of Stoney sluices, but from them it will be readily seen how important a part these sluices must play in all future undertakings of any magnitude.

**82. Smart's Shutter.**—About 1891 proposals were made to cut down some of the weirs in the Cauvery delta and fit them with Stoney's shutters, but the cost of the shutters was considered prohibitive. Colonel Smart, R.E., the late Chief Engineer for Irrigation, who was then on special duty, was of opinion that ordinary shutters working on rollers attached to the shutters would do as well, provided counterbalances and powerful lifting gear were used. He designed a shutter, which while less efficient than Stoney's was suited to the purpose required and was considerably cheaper. This shutter was tried and adopted. As will be seen from the example of Smart's shutter shown in Fig. 44 the essential difference between the two types is that while in the Stoney form the rollers are free and supported in a hanging frame which moves up and down with the shutter, in Smart's form they are fixed to the shutter itself.

**83. Example of Smart's Shutter.**—Fig. 44 shows the shutter used at the Grand Anicut in the Cauvery delta. Its total length is 32 feet and its height 5 feet. The shutter consists essentially of two bow-string girders connected by vertical braces and faced with ½ inch iron plate. The rollers are bushed with *lignum vitae* with 1½ inch gunmetal pins. They are attached to the shutter by spring plates, which allow for

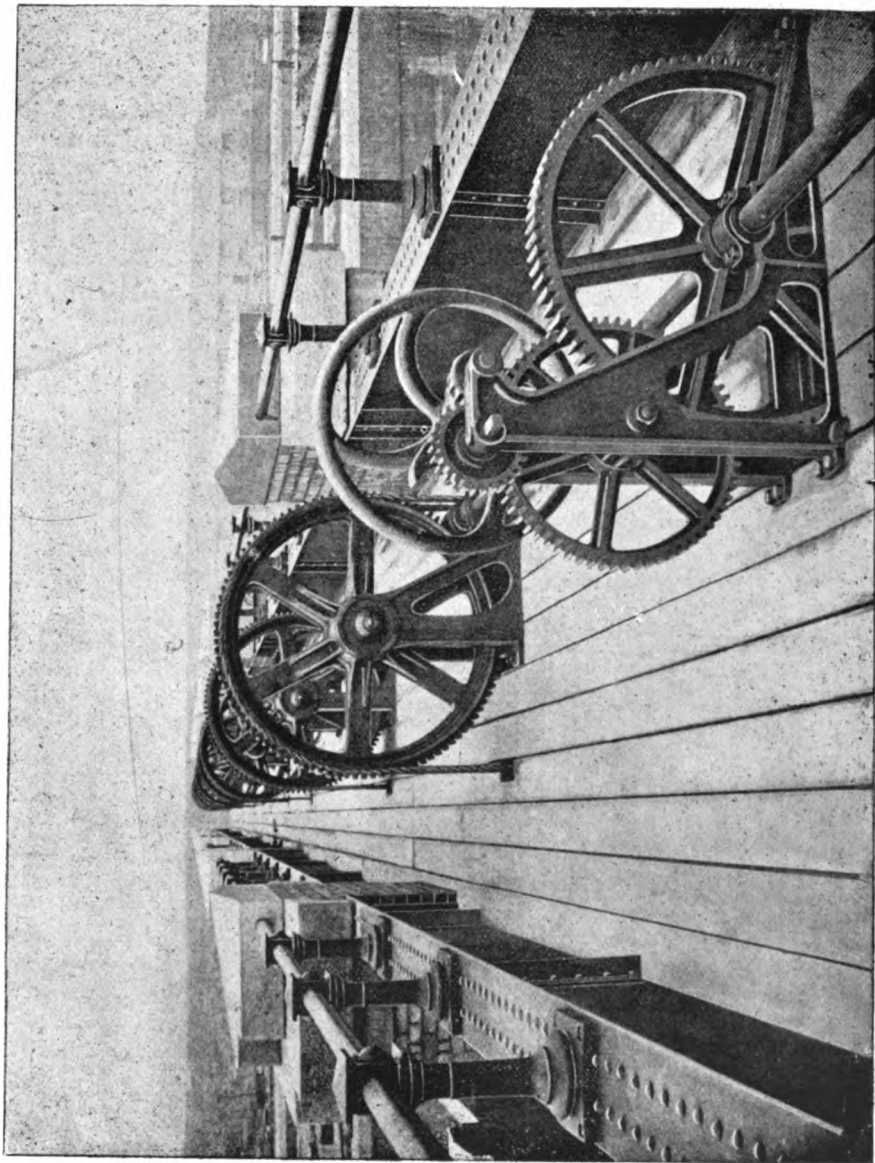

Plate XI. Hand Gear for Controlling Weaver Sluces.

1000  
1000  
1000  
1000

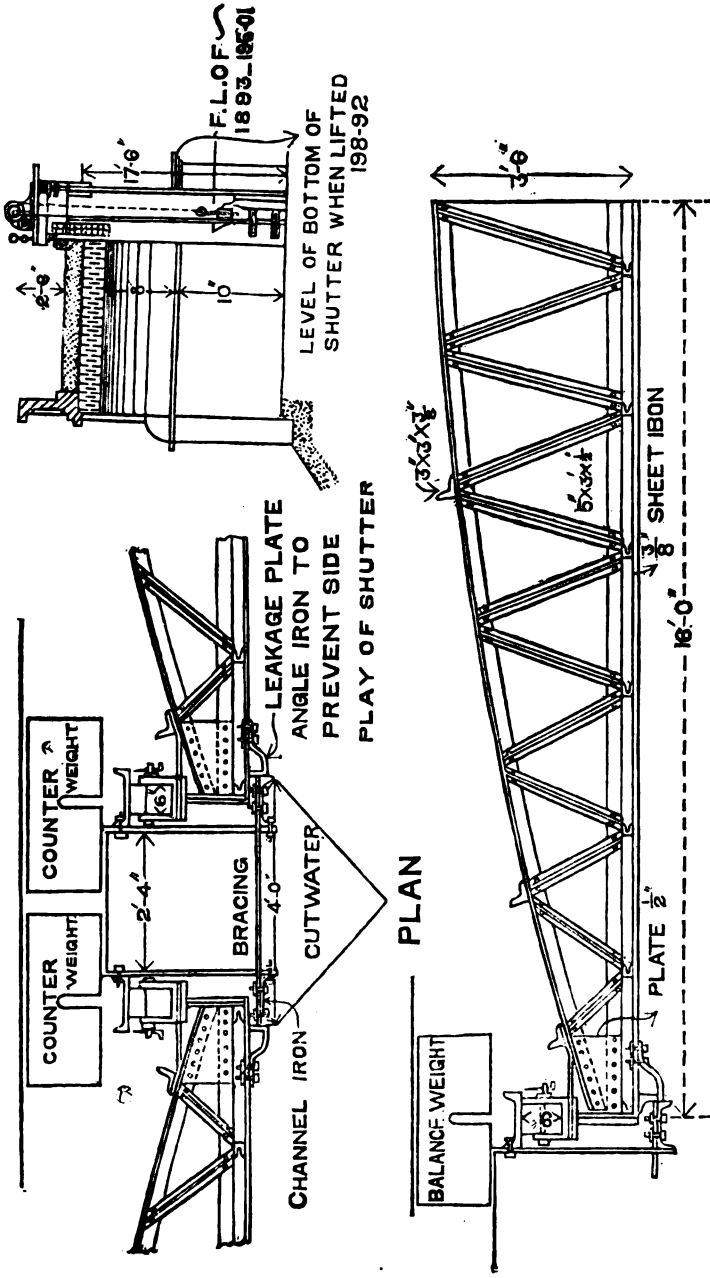

Fig. 44. Smart's Shutter at Grand Anicut.



deflection and so ensure the true bearing of the rollers on the roller path. Leakage is prevented by a leakage plate which presses against an angle iron fixed to the side of the pier and these plates together prevent side play of the shutter. The shutters are counterbalanced and lifted by means of chains worked by powerful lifting gear somewhat similar to that of the Weaver sluices.

---





Plate XIII. Godavari Head-sluiices, Centre Delta.

## CHAPTER VI.

## REGULATORS, HEAD SLUICES, ESCAPES, CANAL WEIRS OR FALLS AND BRIDGES.

**84. Regulators or Head-sluices.**—The masonry work at the point where a canal takes off from a river is called the regulator or head-sluice. The regulator controls the admission of water to the canal, allows it to enter if required, or prevents its entrance and causes it to pass down-stream over or through the weir. There are on most canals other regulators at various points of the system—most frequently in connection with escapes—which control the discharge of the chief branches.

Recent experiments emphasize the importance of supplying channels as far as possible with top water. This has been to some extent recognized in this Presidency, and the sluices at the heads of the principal canals have been fitted, as far as was feasible in dealing with old works, with shutters arranged in tiers, but the principle does not appear to have been carried far enough. Even in recent works the tops of the vents are only about the level of full supply. In future designs it will be well to carry the vents up to ordinary high flood level with shutters in tiers, the openings in each tier being made large enough to pass full supply with a moderate head. This will necessitate a large departure from the designs now generally adopted. Piers will have to be made more massive and floors stronger and broader.

The determining of the level of the sill of the head-sluice requires careful consideration. In 1897 Colonel Smart, R.E., proposed a rule that the heads of channels should not be less than 6 feet above the sills of under-sluices, but Mr. Hughes, the then Chief Engineer for Irrigation, considered that the rule was not one which could be made of general application. In his opinion all that was needed was that the sill should be above the level to which the approach channel would be likely to silt.

**85. Position of Head-sluice.**—The position of head-sluices has to be considered in connection with the general design of head works. There is no justification for the prevalent idea that the only good position for a head-sluice is close to the flank of a weir and at right angles to it. The essential thing is that there should be means of keeping the bed in front of the head-sluice scoured to a certain desired level.

Many Engineers think that it is radically wrong to put a head-sluice close to the flank of a weir and that it would be better to place it a good way up-stream; distances of a quarter or a third of a mile have been suggested. In regard to this it is of importance to remember that scouring sluices, unless there is a well-defined approach channel, have but a very local effect, and if a head-sluice is placed beyond where a scour can be maintained, it may stand a very good chance of being blocked by sand shoals. On the other hand the increased disturbance of the water, as it approaches the weir, must not only increase the silt

in suspension but must also cause an increase in the roll of the sand along the bed. It has been suggested that in such cases a remedy for the evil might be obtained by constructing the head works as shown in Fig. 45, which is adapted from Buckley's Irrigation Works.

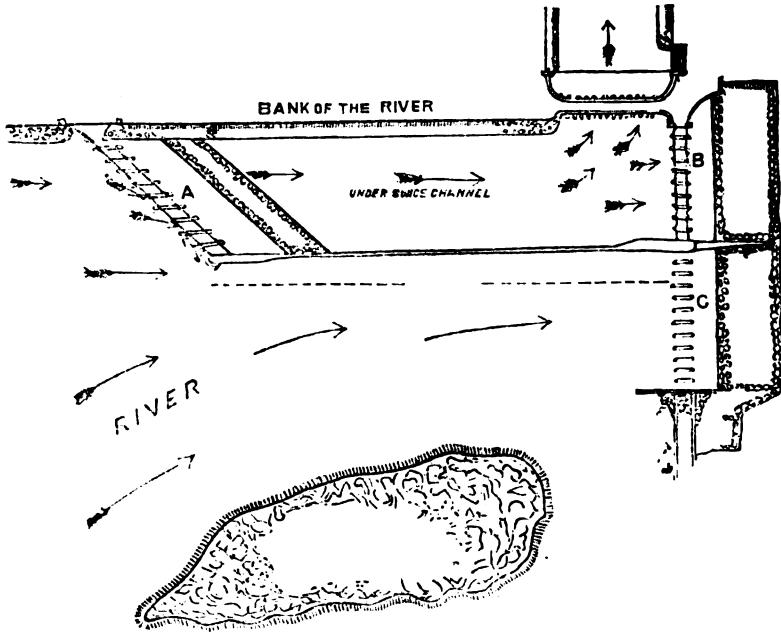

Fig. 45.

The under-sluiçes B and C together would have a capacity rather greater than that considered necessary to keep a good channel open to the head-sluice, but the under-sluice B would have its floor 5 feet lower than the floor of C and of the head-sluice. The under-sluice B would be fitted with draw-gates in tiers, so that the discharge, even in floods, could be regulated through it. Between B and C there would be a wall carried above high flood level, running up-stream, parallel with the main current, which would divide the under-sluice channel A B from the main body of the river. At the upper end of this wall the under-sluice A would be built with its floor at the same level as that of under-sluice C (or slightly above it, according to the slope of the bed of the river). This sluice A would have draw-shutters, but they would only close a portion, say 4 feet, of the lower portion of the vent. The action of this arrangement would be this: under-sluice C would be open during all the flood season, and the "draw" from them would keep a channel open through the deposits above the weir. The shutters of under-sluice A would usually be kept down, so that the moving sand on the bed would be checked at that point, and diverted towards C: at the point A, the velocity in the stream would be less than it is immediately in front of the under-sluiçes where the head-sluice is usually placed, and the rolling sand could be more easily checked. The water at A would be drawn from the surface above the



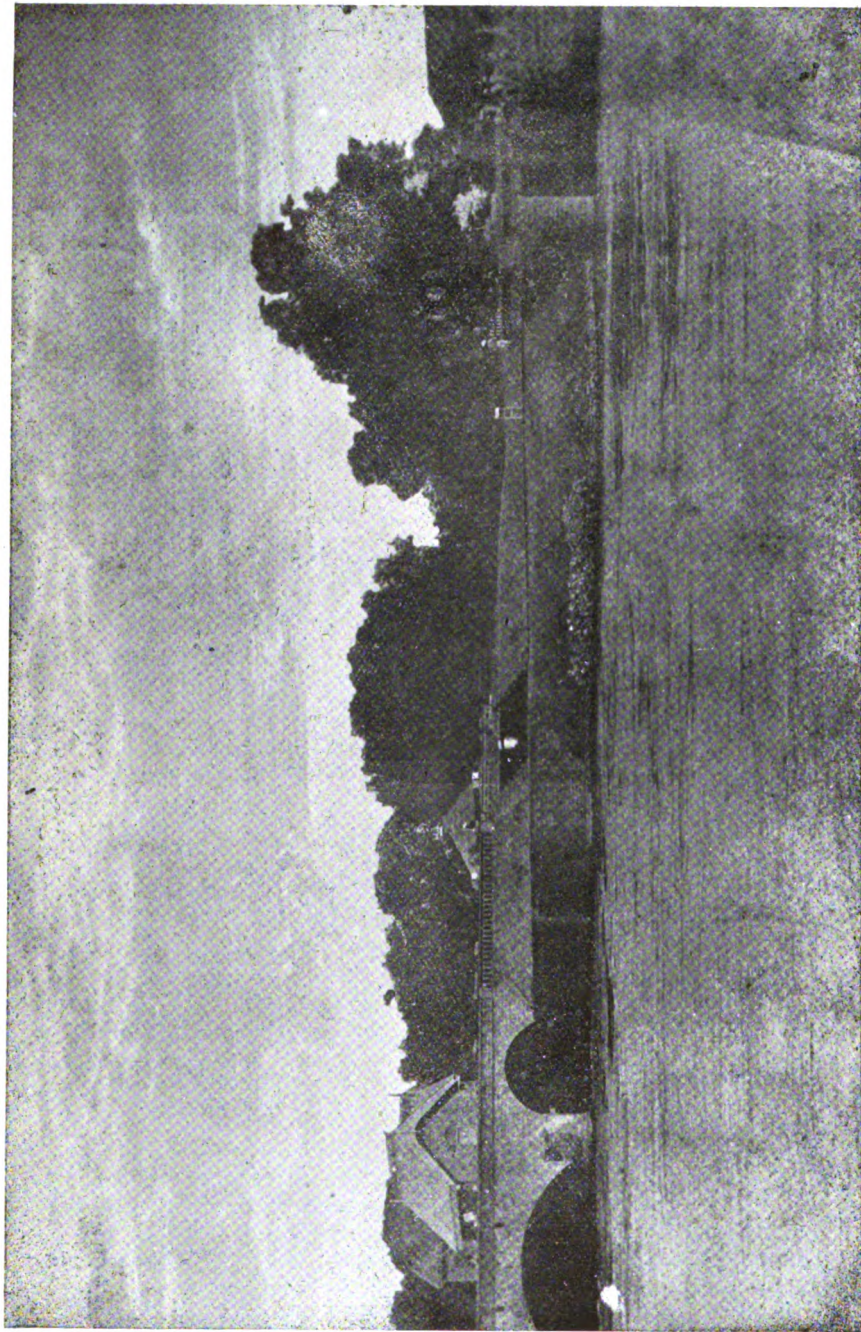

Plate XIV. Godavari Head-slucies, Dowlaisheram. Rear View.

row of shutters. In the under-sluice channel A B, the velocity would be regulated by the manipulation of the shutters in B, so that it was only moderately in excess of that in the canal. The result would be that a considerable portion of the heavier sand would be deposited in the under-sluice channel between A and B, which, under present circumstances, is deposited in the canal. In time the under-sluice channel A B would become silted sufficiently to impede the discharge of the canal. Then the shutters of both A and B would be completely raised, and a strong stream would be sent through the under-sluice channel, which would scour out the deposit or a good deal of it; at this time the canal would, if possible, be closed. The velocity in the under-sluice channel would be considerably augmented by the drop in the floor-level of the under-sluice B, and the height of the head-sluice floor above bed of the under-sluice channel opposite it would impede the progress of sand into the canal. It might be that it would not always be possible to scour out all the sand deposited in the under-sluice channel A B, especially if it were of a coarse nature; in that case it might be necessary to dredge some portion of it out; the dredged material could be easily discharged into the river and the heavy expense incurred by discharging with a long lead would be avoided. The plan would be an expensive one in first cost.

**86. Construction of Regulator.**—The regulator should be so constructed that the amount of water admitted to the canal may be easily controlled whatever may be the water level in the river. This can only be done by having gates of such dimensions that they can be quickly opened or closed as desired. Accordingly, when the canal is large and its width great, the regulator should be divided into several openings, each closed by a separate and independent gate. The sluice should have a flooring of concrete or masonry to protect the bottom against the erosive action of the water, and side or wing walls of masonry to protect the banks. The various openings will be separated by piers of wood, iron, or masonry and the amount of obstruction which they offer to the channel should be a minimum, in order that the total width or length of the regulator shall be as small as possible while giving the required amount of water-way. For convenience in operation it is customary to surmount the regulator by arches of masonry or a flooring of wood, so as to give an overhead bridge from which the gates may be worked. Lastly, the height of the regulating gates and of the bridge surmounting them must exceed the greatest height to which the floods may attain, in order that they shall not top the regulator and destroy the canal. The regulator must be substantially constructed to withstand the pressure of great floods, and a drift fender should, if necessary, be built immediately in front of, or at a little distance in advance of, the gates.

Regulators within a system of canals are generally situated either at the point of bifurcation of a main canal, or across the channel immediately below an escape; in the former case the regulator is required in order to divide the discharge between the branches in the required proportions, and in the latter case to regulate the discharge of the canal by compelling the surplus water to flow off through the escape instead of down the canal.



**87. Head-slucices.**—All channels should be provided with head-slucices for the regulation of the supply, and the means of regulation should be adapted to the circumstances. The difference of design between the head-slucices or regulators, of main channels, which have to exclude river floods as well as pass the channel supply, and the small slucices at the heads of single village channels, is evidently very great, and the variation in design will correspond to the varying conditions. In all cases, however, the waterway of the sluice will be based on—

- (1) The quantity of water to be admitted to the channel below.
- (2) The head available, or, in other words, the difference of water-level above and below the sluice.

In order that the quantity of water at any time under supply to a channel may be known, there should be gauges placed above and below the sluice to show the exact difference of water-level; and further, the exact area of open vent should be readily ascertainable, to secure which information a gauge rod can be attached to the shutter to indicate how much of the height of the vent is uncovered or open.

Small shutters, working under small heads, can be lifted or lowered by hand. When the vents are large, or the head of water is great, mechanical appliances, of which the screw is usually the best and most convenient, are required.

**88. Data for Design.**—In order to determine the height of the work it will be necessary to ascertain, as accurately as possible, the maximum water-level above the sluice. In order that the supply required may be admitted through the regulator or sluice, (1) the area to be irrigated; (2) the quantity of water required; (3) the time within which this supply has to be afforded, whenever the supply is not fairly constant during the irrigation season; (4) the head available, or the difference of water-level above the sluice and the water level (maximum) below the sluice; (5) the velocity of discharge, which will be found from the preceding factor by the formula  $V=c\sqrt{2gh}$  in feet a second, must all be determined.

When there is no anicut or weir, the sum of the widths of the vents should generally be equal to the mean normal width of the river channel to be supplied; as, except when the river or stream is in considerable fresh, there will be no material difference between the water-levels above and below the sluice.

The circumstances of the site should be shown by: a cross section of the channel at the site selected, and an average or normal cross section—if the channel be a new one the latter section will suffice—and on them, or it, should be marked the M.W.L. above the sluice, and the ordinary and maximum water-levels below the work; a site plan showing the river or channel of supply for a sufficient distance to indicate its direction; the position of the anicut (if there be one), with its wing; the alignment of the river embankment (if any); and the alignment of the special flood banks should any be required; also the channel itself for about one-fourth of a mile below the place where the sluice is to be built, or for a distance fully sufficient to show its normal direction, as well as any curves which may be needed at, or near, the head; also information as to soil and subsoil.



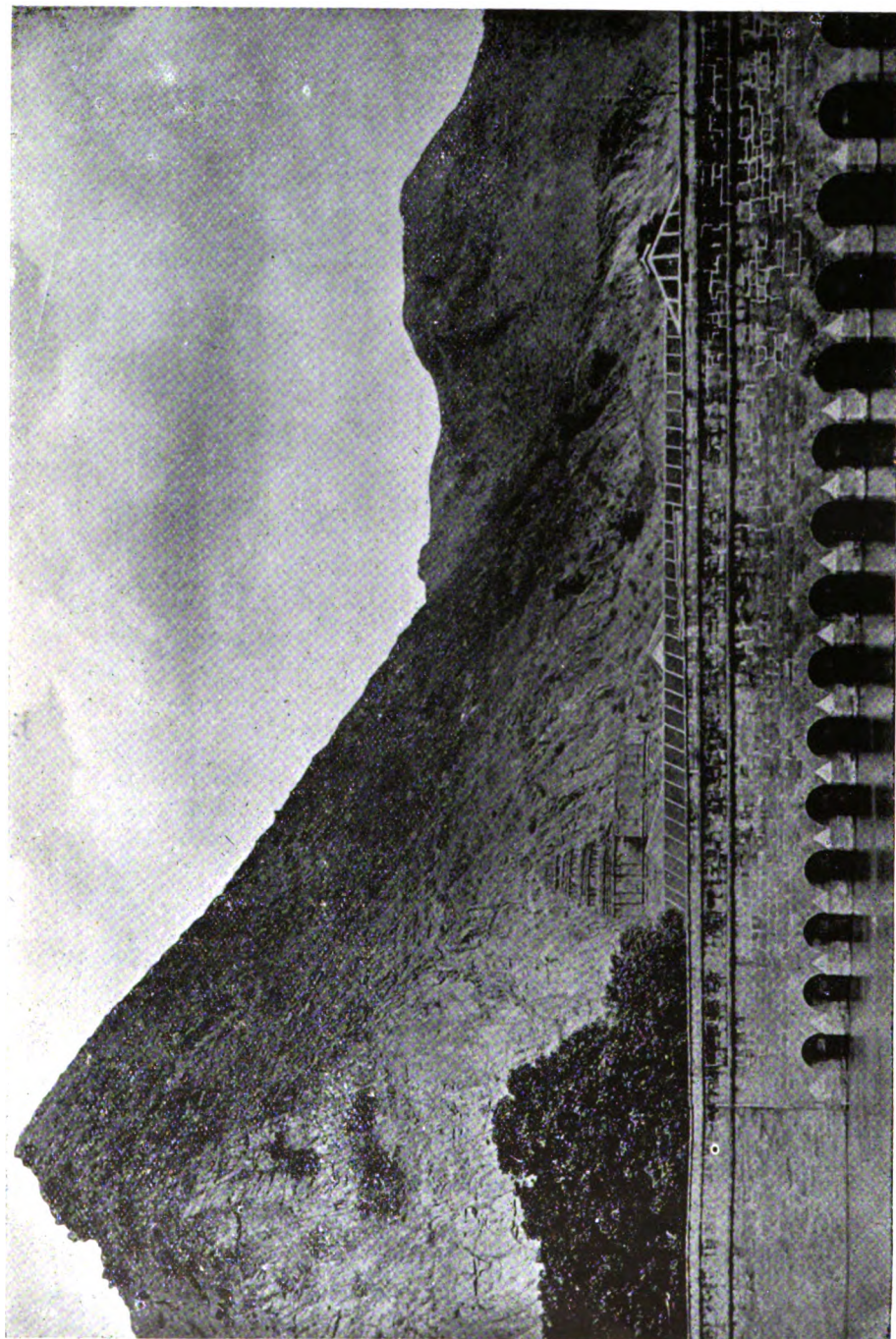

Plate XV. Old Head-sluiices at Bezwada, Kistna River.



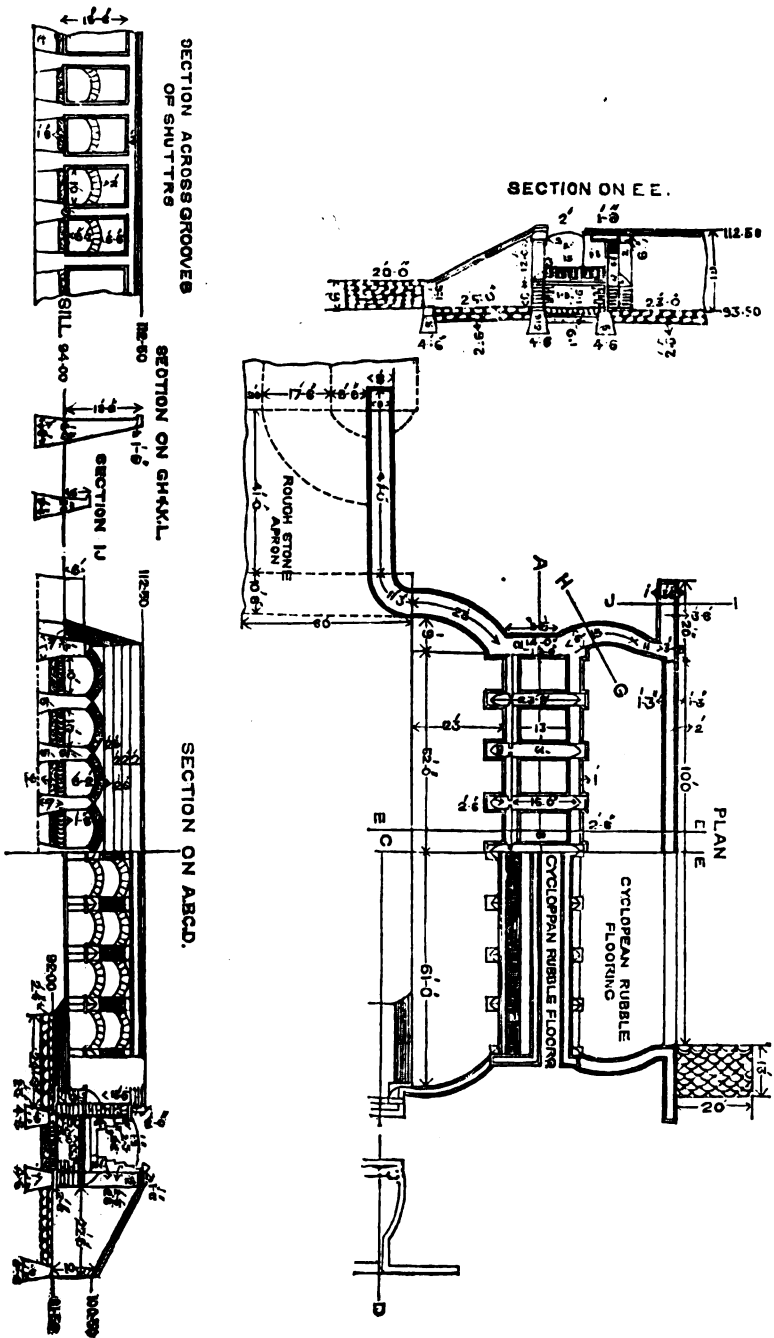

Fig. 46. Head Sluice, Periyar System.

**89. Details of Design—Plans.**—The details of the design should be exhibited by—

- (1) A half top plan, on which all the earthwork slopes should be plotted.
- (2) If well foundations be necessary, a half plan of the wells with the outline of the base of the walls to be placed thereon.
- (3) A half front elevation and half longitudinal section.
- (4) A cross section, on which the M.W.L. above, and ordinary F.S.L. and M.W.L. in the channel below the sluice should be shown.
- (5) A rear elevation, which, though not always necessary, is usually desirable, especially when the slopes in connection with the rear wing returns are to be revetted, as is generally requisite.
- (6) Cross sections of the front and rear wings, and of their returns.
- (7) The width between the ends of the rear wings is nearly always greater than the normal bottom width of the channel, and often greater than the mean width of the latter. It is needful, therefore, that the way in which the channel is to be restored to its normal arrangements, should be noted. In many cases a diminution of 1 foot on each side for every 50 feet in length would be suitable as a maximum; and, supposing the width between the wings to be 6 feet greater than the normal bottom width, the distance at which the latter could be regained would be 150 feet, and on the plan would be marked (with or without breaks) the converging lines of the toe of the side slopes, terminating in parallel lines the normal bottom width apart.

**90. Head-sluices of Distributaries.**—The same general principles apply to the head-sluices of distributaries, though these are for the most part small works. Care should be taken to give due consideration to the effect of the variations in the water-level of the channel of supply, so that the vent may be of a size capable of passing the required supply of water with a small head, or when, from the low state of the channel of supply, it may be necessary to distribute by turns.

The sill, platform, roadway, and water-service-levels, above and below the sluice, should be clearly marked on the plans, as also the acreage to be supplied, and the ordinary and maximum discharge provided for, with the head required in each case.

**91. Escapes.**—There are several causes which render it necessary to have means of discharging water from a canal into a river or into a channel leading to a river. In the first place it not infrequently occurs that a heavy fall of rain puts an immediate check to, or perhaps will completely stop, all irrigation within a few hours. The cultivators close the outlets leading to their little channels, and the heads of distributaries have to be closed or the banks will burst, the closing of the distributaries makes it necessary to reduce the discharge of the canal, or the same result would follow; but this cannot always be done

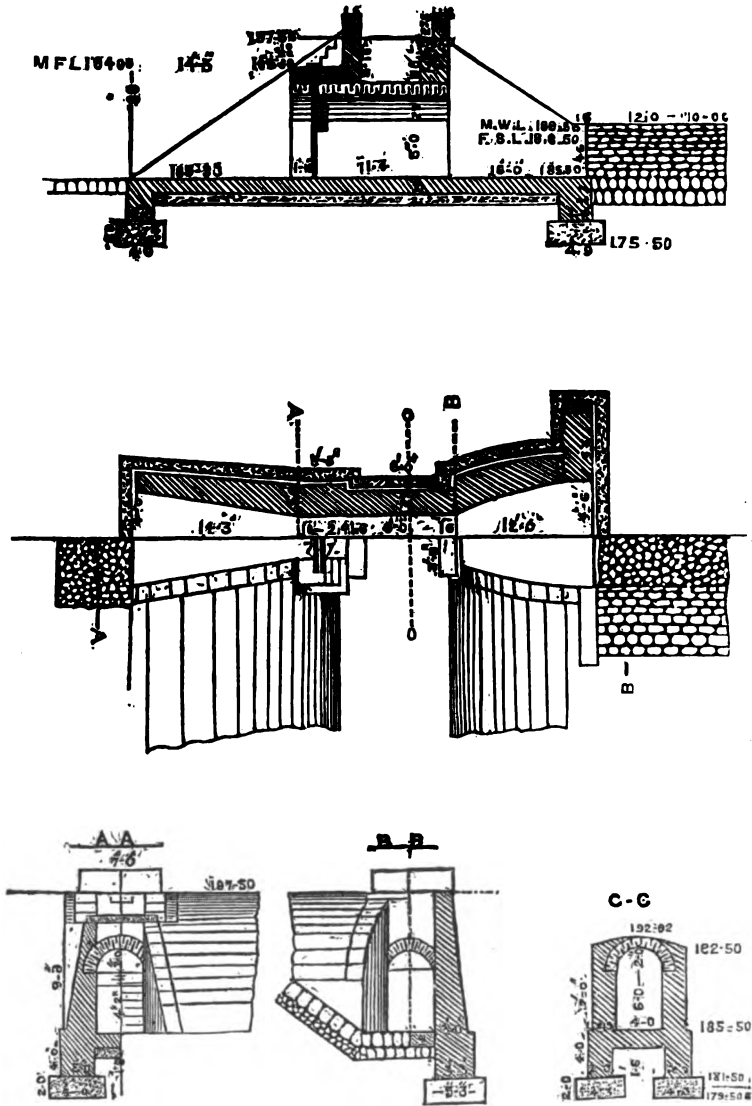

Fig. 48. Head Sluice of Distributary.

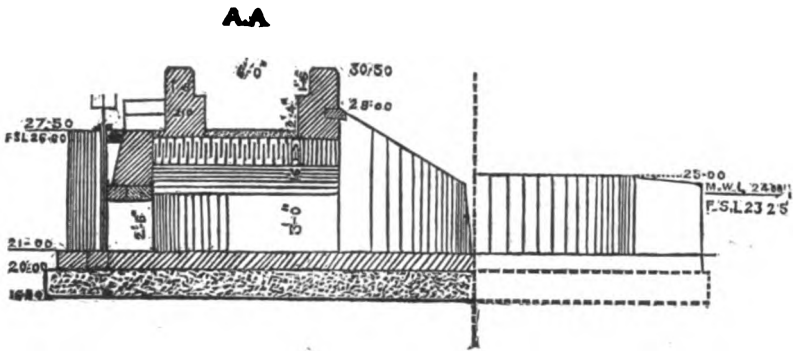
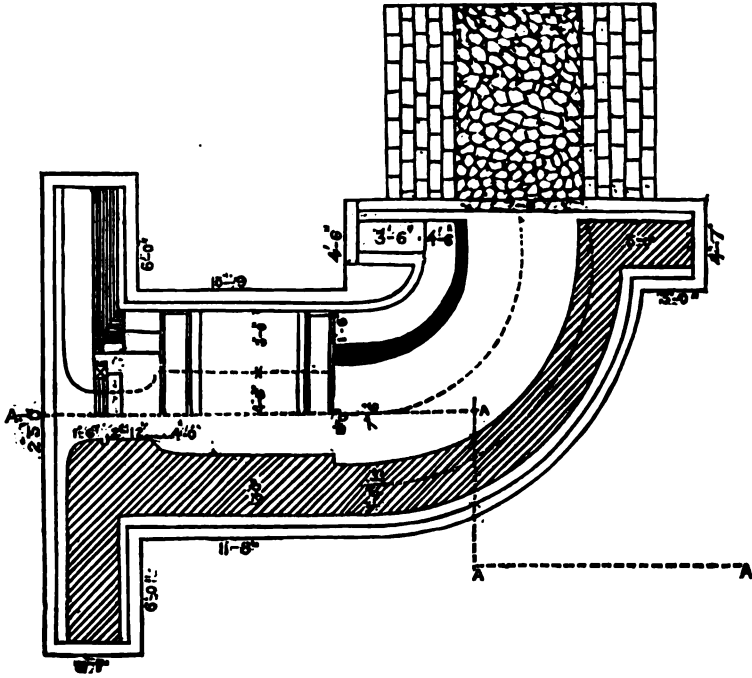

Fig. 40. Head Sluice for a Parallel Channel.



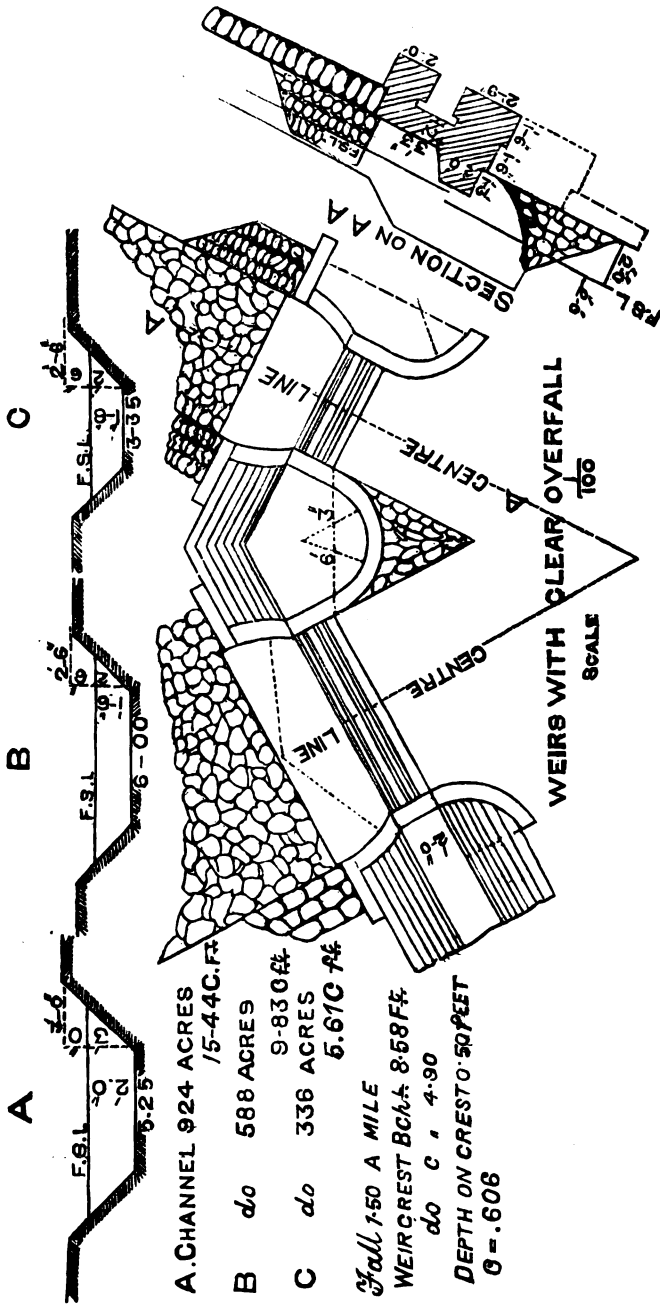

Fig. 50. Regulating Weirs of Distributaries.



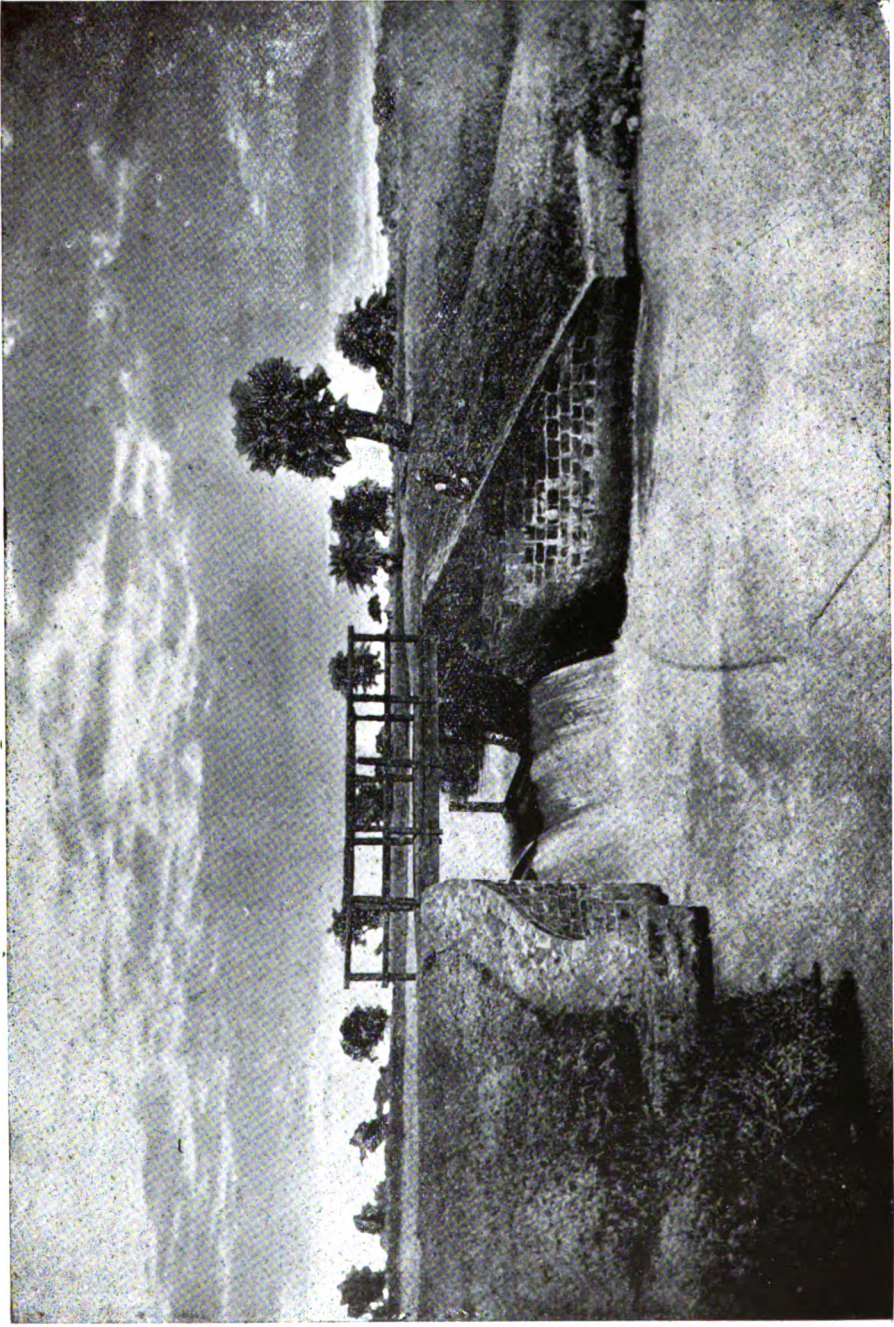

Plate XVI. Typical Escape, Madras.

in time to prevent a larger discharge passing down than the channels are able to pass forward, or, if it is possible to carry on the discharge, it must be escaped from the canal system somewhere, if the cultivators will not utilize it on the fields. Escapes are in some cases necessary to carry off from the canal drainage water which may have been admitted into it through inlets; and they are of service when any accident to a masonry work or breach of the canal renders it necessary to reduce the discharge immediately. In Southern India escapes are usually termed surplus-sluiques.

Escapes should be provided at intervals along the entire canal line, the lengths of the intervals depending on the topography of the country, the danger from floods or inlet drainage, and the dimensions of the canal. In America it is customary to place them at intervals of 10 to 20 miles apart, but no rule can be laid down as it depends on the cross drainage. The Nizampatam canal in the Kistna Delta has no escape in its whole length of 31 miles, while the Commamur Canal in the same system has escapes probably averaging one per mile. Where the regulator head is placed back from the river a short distance, an escape should be provided immediately above the regulator head for the discharge of surplus water and in order that the channel may be kept free from silt. The first or main escape on a canal should always be constructed at a distance not greater than half a mile from the regulator, in order that in case of accidents to the canal the water may immediately be drawn off.

**92. Location and Characteristics of Escapes.**—Escapes should be located above weak points, as embankments, aqueducts, etc., in order that the canal may be quickly emptied in case of accidents. Their position should be so chosen that the surplus channels through which they discharge shall be of the shortest possible length. These must have sufficient waterway to carry off the whole body of water which may reach them from both directions, so that, if necessary, the canal below the escape may be laid bare for repairs while it is still in operation above.

As already pointed out the greatest danger from injury to canals is during local rains, when the irrigator ceases to use the water, thus leaving the canal supply full, while its volume is increased by flood, or drainage water. Hence it is essential that, where a drainage inlet enters the canal, an escape should be placed opposite it for the discharge of the surplus water with a regulator below in the case of important cross drainages. During floods the escape acts in relieving the canal of surplus water as though the head regulator of the canal had been brought so much nearer the point of application. It is usual to construct the lower side walls of aqueducts with their crest at F.S.L. thus practically converting them into escapes for surplus water; this practice is economical but is far from being a good method unless the surplus discharge is light and great care is taken. The water falling from the aqueduct may damage its foundations while the escape does not add to the security of the structure in which it is placed, as it does not shut off the water above it.

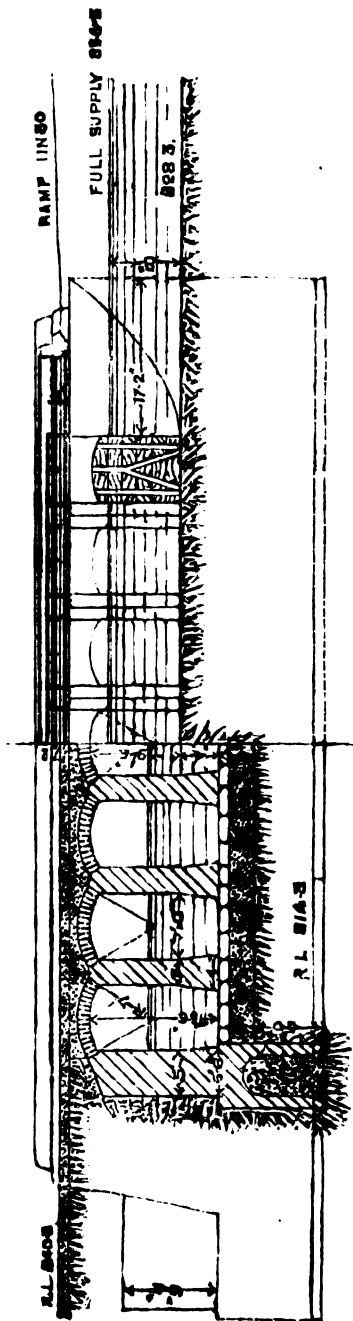

Fig. 51. The Indri Escape.

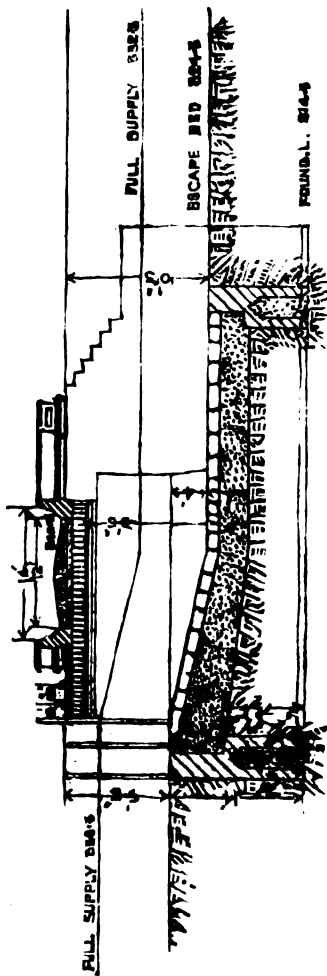

Fig. 52. Indri Escape. Cross section.

**93. Design of Escapes.**—Escapes sometimes take the form of head-sluiques with drawgates, as in the Indri escape Figs. 51 and 52, where

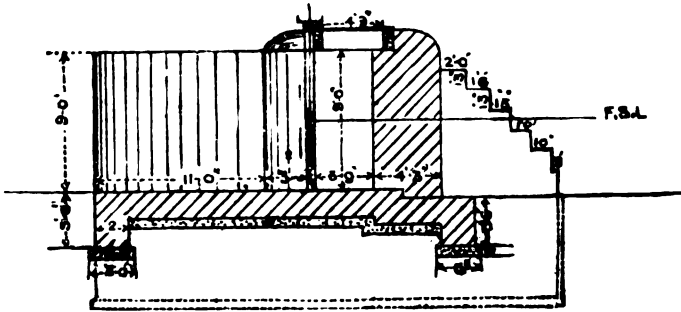

Fig. 53. Madras Type of Escape.

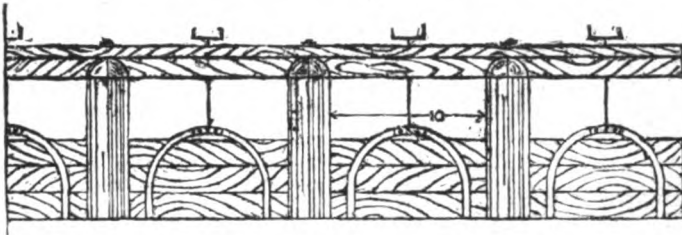

Fig. 54. Shutters of Madras Escape.

the gates completely close the opening when they are down. In some cases as in Fig. 54, which is typical of the escapes—or surplus sluices as they are called in Madras—the gates are worked in the same way as the previous example, by screws, but they do not close the vents, the crests of the gates, when down, are at full supply level, and a moderate amount

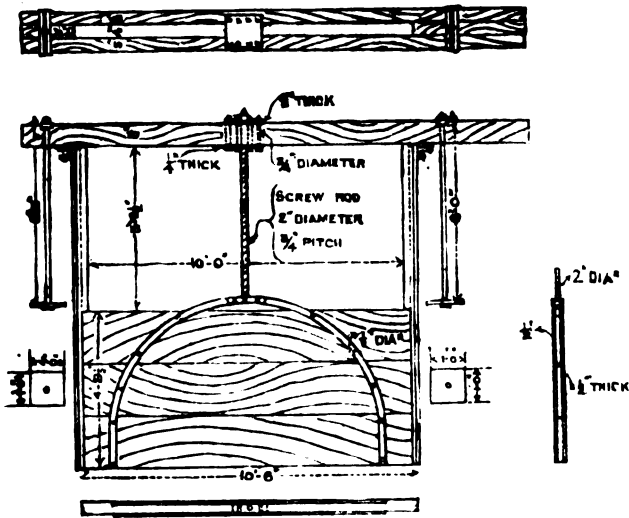

Fig. 55. Details of Shutter.

of surplus water can be permitted to flow over the top of them when the water in the canal rises.

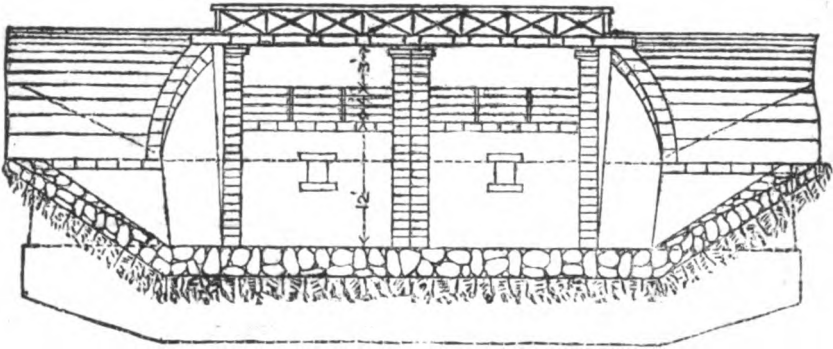

Fig. 56. Rear Elevation of Fall on Midnapore Canal.

In other cases, an escape in the form of a canal weir such as shown in Fig. 56 and Fig. 57 is used, in which the planks above the weir crest can be removed at pleasure; this form of escape is most suitable when the canal is in embankment.

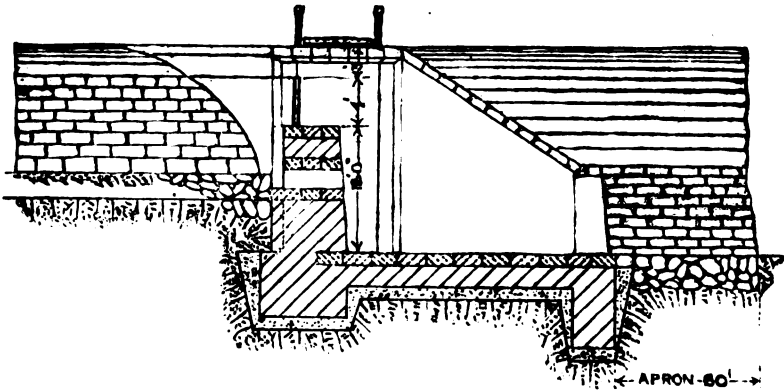

Fig. 57. Cross section of Fall on Midnapore Canal.

When an escape is constructed simply for scouring purposes, the drawgate system is preferable to one worked with planks or baulks, and it is desirable to have a drop in the floor of the work, and a free discharge for the water in the escape channel below, so that the flow may not be impeded. When escapes are in the form of free overfalls, and indeed in other cases too when the channel below the escape runs dry, it is essential that the floor below the outlet should be very strong, or that a good water cushion should be provided, as escapes are occasionally opened suddenly, and a very heavy action on the floor follows.

**94. Canal Weirs or Falls.**—Canal weirs or falls are required at intervals on any canal in which the slope of the bed is less than that of the country in which it runs; for, as the bed gains on the surface of the ground, the water level becomes raised above it till a point is reached at which it is desirable to drop the water over a weir or fall and to

commence a new reach of the canal. In canals, which are designed for navigation as well as irrigation, a lock has to be constructed at each fall.

There are two general methods of compensating for slope : one is by the introduction of vertical drops or falls, and the other by the use of inclined rapids or, as they are termed in America, chutes. In design the fall may be of two general types : (1) it may have a clear vertical drop on a concrete masonry apron ; (2) the water may plunge into a water-cushion.

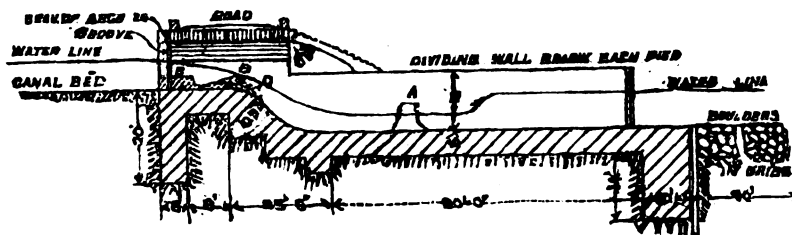

Fig. 58. Canal Fall, Upper India.

Figs. 58 to 61 show some of the various forms of canal falls which have been adopted ; the earliest ones in Upper India were those on the Bari Doab Canal. In the upper reaches rapids were generally adopted,

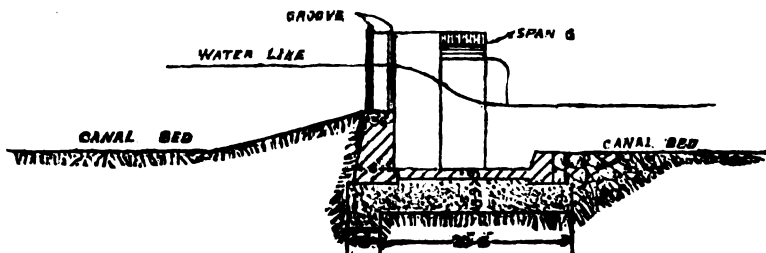

Fig. 59. Canal Fall, Upper India.

and in the lower reaches, where boulders were not so readily obtainable, vertical falls, Fig. 59, were generally used, and a cistern was sunk

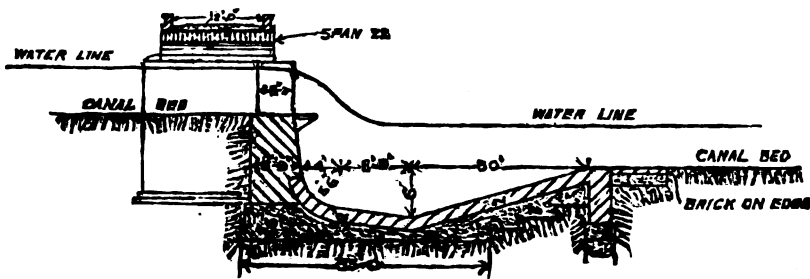

Fig. 60. Canal Fall, Upper India.



below the level of the lower canal bed to form a cushion of water to resist the shock of the falling stream. On many of the canal falls in Upper India it used to be the practice to fix gratings, as shown in Fig. 61 just at the level of the weir crest, sloping up to the surface of the stream; the gratings were composed of timber beams, 4 to 5 inches thick, spaced 6 or 8 inches apart; lying in the direction of the current so that the water was divided into a number of filaments. They still survive in some of the old weirs on the Ganges and Bari Doab Canals, but the principle is not now considered a good one. On the Ganges

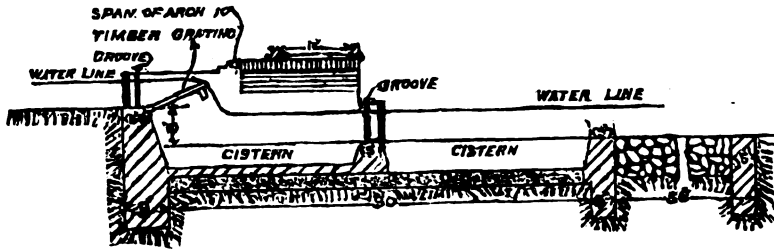

Fig. 61. Canal Fall with grating.

Canals nearly all the falls were originally built on what is called the "Ogee" shape, but they proved a complete failure.

In Southern India the practice always has been in favour of maintaining a steady velocity in the canal up to the fall by raising the crest and reducing the width of it to that which was necessary for the purpose. This plan causes a somewhat greater drop than would be the case if the crest were at the canal bed level, and the width of it equal to, or even greater than, that of the canal; but the velocity of approach is less and the action on the floor is moderate. Fig. 62 shows a typical Madras fall, with a depressed floor or cistern below, but in many cases, the floor is at the level of the canal bed below the falls.

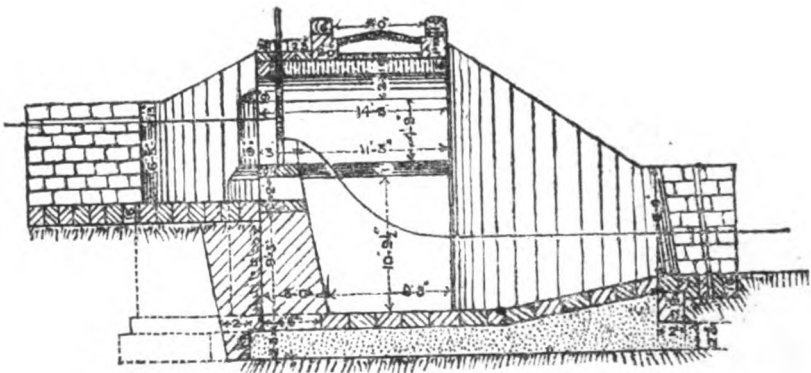

Fig. 62. Canal Fall, Madras.

The Madras type has been generally followed in Bengal, but the arrangement of the screw shutter shown in the figure has not been

followed. Figs. 56 and 57 show rear elevation and cross section of a canal fall on the Midnapore canals ; those in Orissa on the Sone are of the same description.

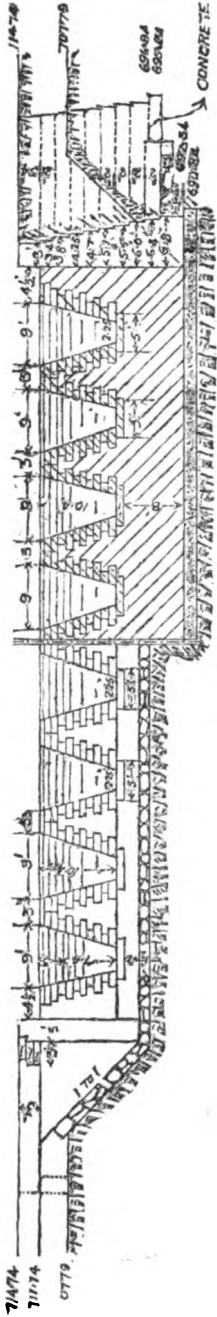

Fig. 63. Notched Canal Fall.

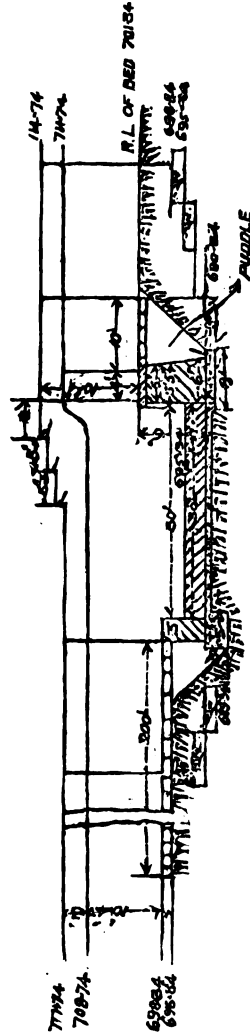

Fig. 64. Cross section, Notched Canal Fall.

**95. Notched Crest Fall.**—Fig. 63 is a typical design of the notch falls which have been constructed on the Chenab Canal in the Punjab. The breast wall of the fall is cut into a number of notches of which the bases are at the canal bed level, the crest of the breast wall being above F.S.L.; at the foot of each notch there is a lip projecting beyond the lower face of the breast wall, which has a great influence in spreading the stream and determining the form of the lower face of the falling water. The notches in the wall are all alike and they are so designed that they discharge at any given level the same amount of water approximately as the canal above carries at that level, so that there is no increase in velocity (except for a few feet close to the notch) in the canal as the water approaches the fall, but a uniform flow and a uniform depth is maintained. These notches work excellently. The water flows from them in a fanlike shape, and meets the water surface below with a steady flow which contrasts most favourably with the violent ebullitions which accompany all other clear overfalls, and there is no vestige of the standing wave which is produced in falls which permit of a greatly increased horizontal velocity. The action on the canal banks below these falls is very small although the wings are of very moderate length. Mr. R. B. Buckley states that there is no question of the superiority of this over all other forms of fall where it can be adopted. The form of the basin below the fall is practically that of a shallow water cushion, it being widened to check the ebullition of the water and reduce it to a steady forward velocity. One objection to this form of fall is the depth of foundation required, which adds considerably to the difficulty of construction except where the soil is very firm. In many cases it may prove cheaper to protect the lower level by mere strength of additional material than by the construction of a deep water cushion. A simple notched fall for a channel is shown in Figs. 65 and 66.

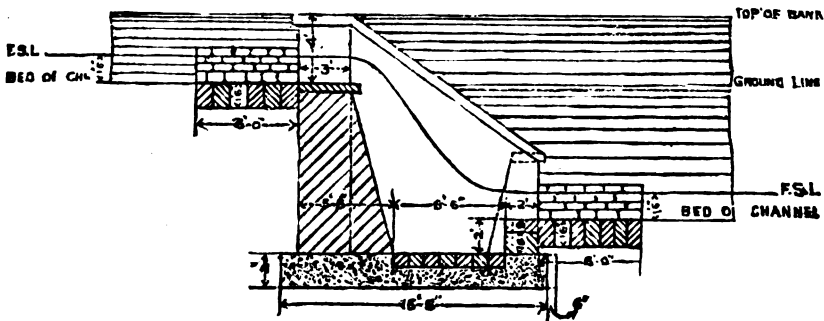

Fig. 65. Eight-foot Channel Fall.

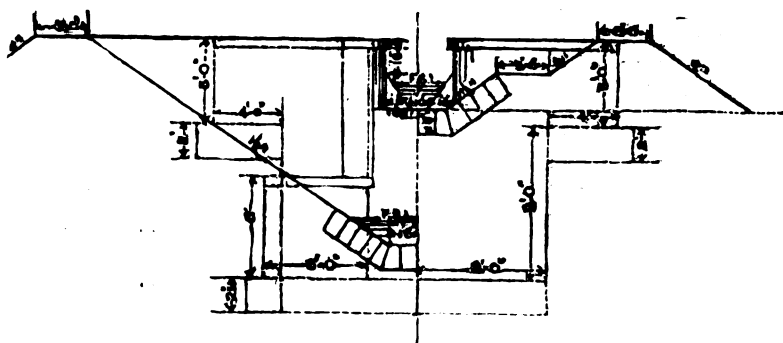

Fig. 66. Elevation of 8-foot Fall.

**96. Formulæ for Notch Falls.**—A trapezoidal notch in the breast wall of a canal fall should be such that it will carry the ordinary low supply at the level at which that supply runs in the canal, and will also carry the maximum supply at the levels due to that supply. The discharges of a trapezoidal notch at levels intermediate to these will vary from the discharge of the canal at those levels to a certain extent but not sufficiently to cause any practical difficulties.

Let  $d$  = the depth of water in the channel measured 10 feet above the plane of the notches.

$Q$  = the discharge of each notch.

$c$  = the coefficient of discharge. This may be taken as 0.67.

$V$  = velocity of approach in feet per second.

$h_a$  = head due to velocity of approach =  $0.0155 V^2$ .

$b$  = width of bottom of notch.

$n$  = ratio of side slope, *i.e.*, the co-tangent of the angle made by the side of the notch with the horizontal. Hence width of notch at any height  $d = b + 2nd$ .

Then to find the discharge of a notch—

$$Q = 5.35 c \left\{ lb \left[ (d + h_a)^{\frac{5}{2}} - h_a^{\frac{5}{2}} \right] - 2n \left[ d h_a^{\frac{3}{2}} - \frac{2}{5} \{ (d + h_a)^{\frac{5}{2}} - h_a^{\frac{5}{2}} \} \right] \right\} \dots \text{I.}$$

If the velocity of approach be neglected, this becomes—

$$Q = 5.35 c \left\{ lb d^{\frac{5}{2}} + \frac{2}{5} \times 2nd^{\frac{5}{2}} \right\} \dots \dots \dots \text{II.}$$

**97. Determination of Profile for Notch Falls.**—When the profile of the notch is undetermined, the equations given above contain two unknown quantities, *viz.*,  $b$  and  $n$ .

Let  $d_1$  = the value of  $d$  at ordinary low supply level in the canal.

$d_2$  = the value of  $d$  at maximum level in the canal.

$Q_1$  } = { the discharge required through the notch at these depths  
 $Q_2$  } = {  $d_1$  and  $d_2$  respectively.

$c$  = the coefficient which may be taken as constant for both  $d_1$  and  $d_2$ .

$V_1$  and  $V_2$  = the respective velocities of approach.

$h_{a1}$  and  $h_{a2}$  = corresponding heads due to those velocities.

Then

$$\frac{Q_1}{5.35c} = lb \left\{ (d_1 + h_{a1})^{\frac{5}{2}} - h_{a1}^{\frac{5}{2}} \right\} - 2n \left\{ d_1 h_{a1}^{\frac{3}{2}} - \frac{2}{5} \left[ (d_1 + h_{a1})^{\frac{5}{2}} - h_{a1}^{\frac{5}{2}} \right] \right\}$$

and similarly

$$\frac{Q_2}{5.35c} = lb \left\{ (d_2 + h_{a2})^{\frac{5}{2}} - h_{a2}^{\frac{5}{2}} \right\} - 2n \left\{ d_2 h_{a2}^{\frac{3}{2}} - \frac{2}{5} \left[ (d_2 + h_{a2})^{\frac{5}{2}} - h_{a2}^{\frac{5}{2}} \right] \right\}$$

Let  $\frac{Q_1}{5.35c} = A_1$  and  $\frac{Q_2}{5.35c} = A_2$ .

$(d_1 + ha_1)^{\frac{3}{2}} - ha_1^{\frac{3}{2}} = B_1$  and  $(d_2 + ha_2)^{\frac{3}{2}} - ha_2^{\frac{3}{2}} = B_2$ .

$d_1 ha_1^{\frac{3}{2}} - \frac{2}{3} [(d_1 + ha_1)^{\frac{3}{2}} - ha_1^{\frac{3}{2}}] = C_1$ .

and  $d_2 ha_2^{\frac{3}{2}} - \frac{2}{3} [(d_2 + ha_2)^{\frac{3}{2}} - ha_2^{\frac{3}{2}}] = C_2$ .

Then  $A_1 = lb B_1 - 2 n C_1$ .

$A_2 = lb B_2 - 2 n C_2$ .

Whence  $n = \frac{1}{2} \frac{A_1 B_2 - A_2 B_1}{C_2 B_1 - C_1 B_2} \dots \dots \dots$  III

and  $lb = \frac{A_1 + 2 n C_1}{B_1} \dots \dots \dots$  IV.

When the velocity of approach is neglected, the same formula will be used, but the coefficients  $B_1, B_2$ , and  $C_1, C_2$ , will be altered thus:—

$B_1 = d_1^{\frac{3}{2}}; B_2 = d_2^{\frac{3}{2}}; C_1 = \frac{2}{3} d_1^{\frac{3}{2}}; C_2 = \frac{2}{3} d_2^{\frac{3}{2}}$ .

*Example.*—It is required to find  $n$  and  $lb$  for a canal fall with six notches from the following data:—

Bed width of canal = 84 feet; side slopes  $1\frac{1}{2}$  to 1.

Depth of ordinary supply = 4.6 feet.

Depth of maximum supply = 6.0 feet.

Inclination of bed = 1.0 in 6666.6.

The fall is a clear overfall.

Then in the formulæ given above

$d_1 = 4.6$  and  $d_2 = 6.0$ .

The discharges and velocities of approach calculated by the ordinary formulæ for discharges in open channels are:—

$Q$  (when  $d_1 = 4.6$ ) = 802 cusecs  $V_1 = 1.92$  feet.

$Q$  (when  $d_2 = 6.0$ ) = 1275.7 cusecs  $V_2 = 2.29$  feet.

Since there are six notches in the fall

$Q_1 = 133.6$  and  $Q_2 = 212.6$ .

$ha_1 = 0.0155 V_1^2 = 0.0155 (1.92)^2 = 0.06$  nearly.

$ha_2 = 0.0155 V_2^2 = 0.0155 (2.29)^2 = 0.08$  nearly.

Then  $A_1 = \frac{133.6}{5.35 \times 0.67} = 37.27$ .

$A_2 = \frac{212.6}{5.35 \times 0.67} = 59.31$ .

and  $B_1 = (4.6 + 0.06)^{\frac{3}{2}} - (0.06)^{\frac{3}{2}} = 10.06$ .

$B_2 = (6.0 + 0.08)^{\frac{3}{2}} - (0.08)^{\frac{3}{2}} = 14.99$ .

and  $C_1 = 4.6 \times (0.06)^{\frac{3}{2}} - \frac{2}{3} [(4.6 + 0.06)^{\frac{3}{2}} - (0.06)^{\frac{3}{2}}] = (-18.75)$ .

$C_2 = 6.0 \times (0.08)^{\frac{3}{2}} - \frac{2}{3} [(6.0 + 0.08)^{\frac{3}{2}} - (0.08)^{\frac{3}{2}}] = (-36.46)$ .

Then from equation III—

$n = \frac{1}{2} \frac{(37.27 \times 14.99) - (59.31 \times 10.06)}{(18.75 \times 14.99) - (36.46 \times 10.06)} = 0.2215$

and from equation IV—

$lb = \frac{37.27 - (0.443 \times 18.75)}{10.06} = 2.88$ .

**98. Bridges and Culverts.**—As a rule, bridges or culverts should be provided not only for regular made roads, but for all village tracks on which there is cart traffic. When the normal full supply depth in a

channel exceeds 2 feet, such means of carrying wheeled traffic across channels are a necessity. Should village tracks be unnecessarily numerous, it will be sufficient to provide such accommodation in the way of bridges as will obviate any great or material lengthening of the distance to be traversed by the traffic between villages, or between a village and the lands beyond a channel thereto belonging.

When a channel runs close to a village, a bridge at, or about the nearest point to the latter is desirable, as the traffic after crossing the channel, can diverge in any required direction.

Culverts under a channel can, when the width and headway are sufficient, be made to afford facilities for traffic, if care be taken to provide suitable approaches, and to prevent accumulations of water and mud. Attention should, therefore, be given to these matters whenever a culvert may be made to serve the double purpose of passing drainage and the traffic of the country.

**99. Data for Design.**—The design of bridges and culverts is affected by many considerations, of which the following are those needing special attention: (1) the cross section of the channel; (2) the depth of water, whether fixed or variable; on this will depend the level of the springing of arched bridges, and of the tops of the abutment walls of girder or platform bridges; (3) ground level; (4) road normal level; (5) nature of soil and sub-soil; (6) velocity of water; (7) gradient required for road approaches when the normal level of the road is below the intended level of centre of length of bridge.

**100. Details of Design.**—The span, or sum of the spans, of a bridge should, as a rule, be equal to the mean width of a normal or average section of the channel. Spans of 15 to 20 feet are economical when by their adoption a single span will suffice, and it is but seldom that larger spans across irrigation channels could be adopted without increase of expense. The depth of cutting, as also the road (normal) level, will materially affect the desirable level for the roadway, and consequently the width of span most suitable to the particular circumstances. The cost of approaches is often an important item, which may directly affect the selection of the dimensions of the openings.

Ordinarily arched bridges are cheaper than those with iron girders, but for small spans of not more than about 9 feet old railway metals, when available, make good girders at a very moderate cost. A 24-foot rail will cover two such spans. Segmental arches are the simplest and, therefore, ordinarily the best. Curves struck from five or more centres may be used when an approximation to the semi-ellipse is desired, but three-centre curves need a high rise and are usually unsightly.

The level of the springing of arched bridges should generally be not less than 6 inches above O.W.L. (ordinary water level) and not more than 6 inches below M.W.L. in a channel. The underside of girders should be at least 6 inches above M.W.L. The margins to be allowed will generally be greater, but the above minima will be suitable, when to enlarge them would unduly enhance the cost of the approaches.

The length of the wings will depend on the level of the roadway at their ends, and the point to which the slope along the wings can be conveniently or safely allowed to extend, with the level of the base of the slope at this point. Some of the cases commonly met with are; when a berm has to be left at the top of the channel side slope, in which case,

the side slope of the approach will end at the outer line of the berm ; when the approach slope has to be formed so as to be a prolongation of the channel side slope, at the same or a different inclination ; when the difference of level of the ground on the two sides of a channel is material, and causes difference in the heights of the approaches at the ends of the wings, with consequent different lengths of wings ; when the axes of the road and channel are not at right angles, and the wings at the same end are therefore of different lengths. High approaches should have substantial side ridging, from a foot to 15 inches in height, as a protection ; this side ridging, as normal road level is approached, may diminish to the ordinary height of from 4 to 6 inches.

The width of the roadway is dependent upon the class of road, and, in some degree, upon the length of the bridge, for a short narrow bridge may do very well where a long bridge of the same width would be inconvenient. The minimum width of roadway, between the parapets and above the wheel guards, suited for cart traffic is 7 feet, and this width is applicable only to short bridges or culverts, with low parapets, on tracks between villages. A width of 9 feet is sufficient for short bridges on which carts will not need to pass, while 13 feet is the smallest width which will allow carts to pass each other safely. Except in the immediate vicinity of large towns, a width of 18 feet is sufficient for even long bridges.

The gradients of the approaches should not be steeper in any case than 1 in 16. At bridges on made roads 1 in 20 will be a suitable gradient, and at large bridges with long approaches 1 in 30 will be convenient. The point to be borne in mind in this connection is, that the gradient should not be so steep as to prejudice the traffic or to involve undue exertion on the draught cattle. On mere tracks, carts are necessarily lightly laden, and a somewhat steep gradient is unobjectionable ; but on made roads, heavy loads may be taken and then steep gradients, except of small length, would be very inconvenient.

The depth, spread, and description of foundations (*i.e.*, whether on wells or otherwise), will depend upon the nature of the soil. With small spans, instead of laying separate foundations for each abutment and pier, it is preferable to put down an all-over bed of concrete, which will ensure better and more reliable work, especially when a flooring with retaining walls may be necessary.

The description and extent of the flooring, retaining walls, etc. (if any), will depend upon the nature of the soil, and the maximum velocity of the water, whether augmented by contraction of waterway or not.

Finally bridge designs should be prepared so as to secure the accommodation required at a minimum cost for bridge and approaches together.

## CHAPTER VII.

CROSS DRAINAGE WORKS—INLETS AND ESCAPES—  
SUPERPASSAGES—AQUEDUCTS—SYPHONS.

**101. Drainage Works.**—An irrigation canal is best placed, of course, when it runs on the crest of a ridge, and when the drainage of the neighbouring country flows from it on either side. Such an ideal position, however, is rarely attained by any canal during the whole of its course, except perhaps in some cases in deltaic systems; and when the line of a canal is carried round the sides of hills or along sloping ground great difficulties are sometimes experienced in passing side drainage. The cost of the work necessitated by cross drainages is often considerable, and in some cases,—as in the Ganges and Sirhind Canals—it may exceed the cost of the head works themselves. Cross drainages, when the volume of water concerned is small, may be admitted into a canal by an inlet dam and absorbed in it, but when the volume is too large to be treated in this manner, the discharge of the cross drainage may be passed in one of the following ways:—

- (1) Through the canal by inlets and escapes.
- (2) Over it by superpassages.
- (3) Under it by aqueducts, syphons or culverts.

The system to be adopted depends mainly upon the relative levels of the beds of the canal and drainage, and partly on the relative cost of the different systems. When the bed of the drainage is at the same level as that of the canal, or slightly above it, it is generally cheaper to pass the discharge through the canal by means of an inlet on one bank and an escape on the other, than to carry it under the canal in a syphon. If the bed of the drainage is above that of the canal, a superpassage is generally cheaper, and more secure, than a syphon. If the bed of the drainage is below that of the canal, it is generally better—and of course, essential, if the canal is navigable,—to carry the drainage under the canal, by means of a syphon or aqueduct, than to carry the canal under the drainage.

**102. Drainage Cuts or Diversions.**—Much may be done in the way of disposing of drainages by drainage cuts or diversions, that is by altering their course so as to make them flow clear of the canal. An instructive example of dealing with drainage in this way is the case of the Chuhi torrent on the Bari Doab Canal. This torrent had two outlets, one running into the Beas and the other into the Ravi river just above the canal crossing. The latter was embanked close to the bifurcation by boulder dams and spurs of the same material, and by these means the water was forced down the Beas and the expense of crossing the canal was saved.



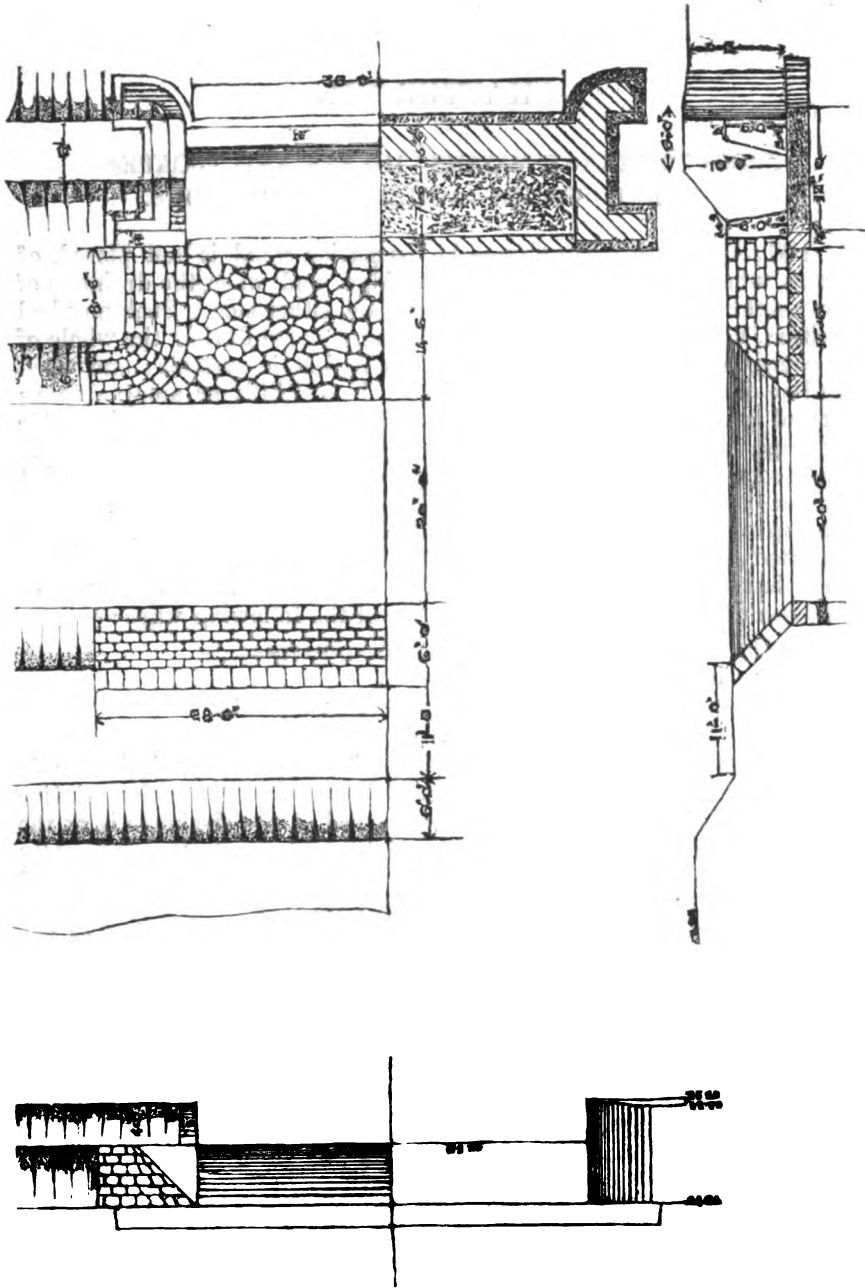

Fig. 67. Drainage Inlet.

On the Betwa Canal is another interesting diversion cut. The first six miles of this line are protected by a drainage channel, 15 feet wide at bottom and 6 feet deep, which runs parallel to the canal and intercepts the minor drainage from small streams; this it discharges into the Betwa river above the point of diversion of the canal.

**103. Inlet Dams.**—When the drainage encountered is intermittent, and its volume is small relatively to that of the canal, much expensive construction may be saved by admitting the water directly into, and permitting it to be absorbed by, the canal. If the volume of the drainage is small, the inlet dam may be nothing more than a retaining wall of loose stone packed dry, and in this case the bed and banks of the canal above and opposite should be revetted with dry stone packing to protect them from erosion, Fig. 67. In the case of drainage torrents more substantial works than this will be required, and it may be necessary to build a masonry inlet dam and perhaps to build a portion of the canal channel of masonry revetting the opposite bank with loose stone.

**104. Level Crossings.**—When the discharge of the drainage channel is large and it is encountered at the same level as the canal, it may be passed through the latter by means of inlets and escapes. The discharge capacity of the escape must be ample to pass the greatest flood volume likely to enter and a regulator should be placed in the canal immediately below the escape in order that only the proper amount of water may be permitted to pass down the canal.

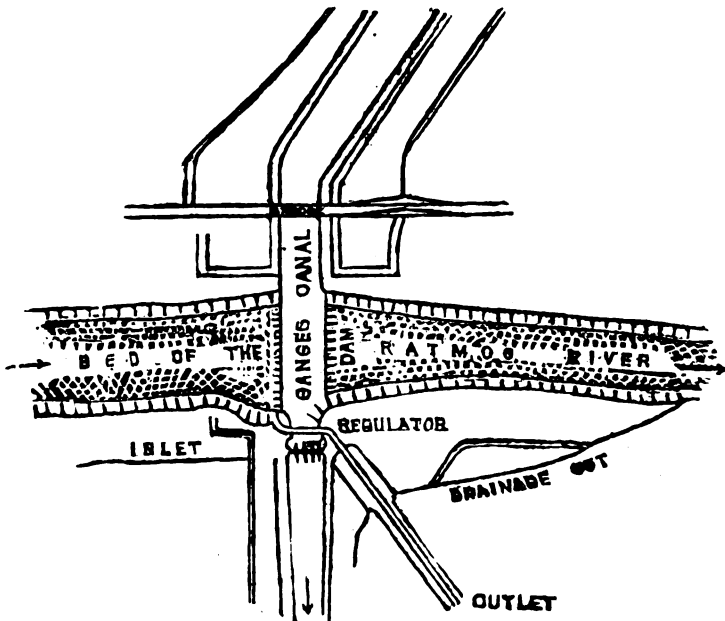

Fig. 68. Rutmoo Crossing.

The most interesting example of a level crossing is that of the Rutmoo torrent on the Ganges canal. The Rutmoo torrent, which crosses the Ganges Canal at a point where the bed of the torrent and that of the canal are at about the same level, carries some 35,000 cubic feet a second, and has a bed slope, near the canal, of 8 feet a mile. There is an inlet and an escape opposite each other in the banks of the canal, and a regulating bridge in the canal itself below the crossing, so that when there is a flood in the Rutmoo, the discharge of the canal can be regulated at will, and is not affected by the discharge of the torrent (Fig. 68). The inlet and escape consist essentially of a floor at canal bed level with piers dividing the opening into bays which can be closed with shutters. The intention originally was to close up the vents in the inlet to prevent water standing in the bed of the Rutmoo, and arrangements were made for draining off the leakage; but in practice this is not done, and the canal water remains impounded in the depressed channel of the stream when there is no discharge in the torrent, so that the inlet sluices might have been omitted altogether. The outlet, which consists of 47 sluices, is fitted with falling gates, hinged at the lower edge, which can easily be dropped when a sudden flood comes down the Rutmoo, and there are grooves for horizontal planks in front of the falling gates.

**105. Superpassages.**—Where the bed of the canal is at a lower level than that of the drainage channel, a superpassage is employed to carry the latter over the canal. A superpassage is practically an aqueduct, though there are some elements entering into its design which are different from those affecting aqueducts. The volumes of streams which are to be carried in superpassages are variable, at times they may be dry, while at others their flood discharge may be enormous. No provision has to be made for passing flood waters under the structure, since the discharge of the canal beneath it is fixed. On the other hand, the waterway of the superpassage must be made amply large to carry the greatest flood which may occur in the drainage channel, and much care must be taken in joining the superpassage to the stream bed, above and below, to prevent injury by the violent action of the flood waters.

A superpassage possesses the great advantage of keeping the canal completely free from any influx of flood water from the drainage channel, which is always more or less heavily charged with silt. It has the additional recommendation of not requiring the maintenance of a large establishment every rainy season, as in the case of a level crossing, where the regulating apparatus must be worked by manual labour. And, lastly, the canal supply can thus be kept up without interruption, there being no necessity to shut it off at the crossing to keep the flood water out of the canal.

There are two fine examples of superpassages a few miles below the head works of the Upper Ganges Canal, by which the Puttri and Rampur torrents are carried across the canal. The discharge of the former amounts in time of flood to as much as 15,000 cubic feet per second. The Rampur superpassage is built of masonry founded on wells and its flooring, which is given a steep slope in order that the velocity shall prevent its filling with sediment, is 3 feet in thickness above the crown of the arches, and is bordered by parapets 7 feet wide and 4 feet high. The flooring and parapet continue inland from

the body of the work a distance of 100 feet on each side, the latter splaying outwards so as to form wings to keep the water within bounds. The superpassage is 300 feet long and provides a waterway 195 feet wide and 6 feet deep.

Another example is the Seesooan superpassage across the Sutelj Canal (Fig. 69). Taking the catchment basin of the Seesooan as having an area of 24 square miles, this with a maximum rainfall of half an inch an hour, gives a maximum discharge of 7,752 cubic feet per

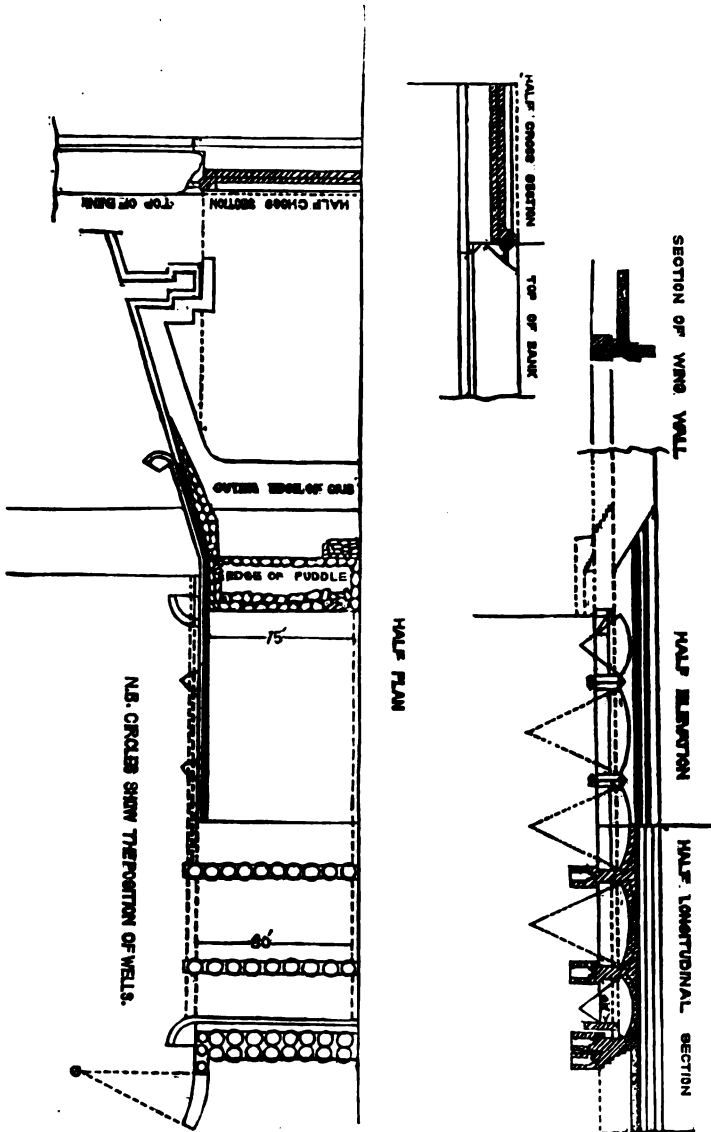

Fig. 69. The Seesooan Superpassage.

second, agreeing very closely with the discharge calculated from the area of the section at the canal crossing, with the velocity due to a fall of 1 in 791. To carry this discharge the water channel is 150 feet wide with vertical sides  $6\frac{1}{2}$  feet deep and fall of 1 in 794. The difference of level between the beds of the canal and drainage channel is 21.93 feet which is disposed of thus—

	FEET.
Depth of water in canal .. .. .	7.00
Headway up to soffit of arch (for navigation) ..	10.00
Thickness of arch .. .. .	3.00
Brick on edge flooring .. .. .	1.93
Total ..	21.93

The canal channel is spanned by three central arches of 45 feet span each and two at the sides, of 32 feet each; tow paths of  $7\frac{1}{2}$  feet wide in the clear, are carried under each side arch, leaving an aggregate waterway of 184 feet. The mean waterway of the earthen channel of the canal is only 177 feet. The addition is made to this work, in consideration of the expense of increasing its dimensions, should the canal be required to carry a larger supply hereafter. The waterway for the drainage above the canal consists of one channel, 150 feet wide at bottom, with side walls 10 feet in height, 5 feet thick at the base, 4 feet at the top; the flooring over the arches was designed to be of asphalt or some substance impervious to water, the upper surface being covered with some hard material, probably a layer of kunkur slabs. The backing of the abutments was to be of puddled clay, covered with a flooring of kunkur, slag or boulders packed in cribs.

**106. Aqueducts.**—Aqueducts, usually called Flumes in America, are used to carry a canal over a river or other obstruction. Care must be taken to study the discharge of the stream crossed in order that the waterway under the aqueduct may be ample to pass the greatest flood which may possibly occur. Another point needing care is that, as already explained in the case of superpassages, the junction of the aqueduct with the earthen embankments at its ends should be made watertight.

For want of ample provision for flood water the Kali Nuddee aqueduct across the Lower Ganges Canal was destroyed on January 17th, 1885, causing great loss, not only on account of the cost of reconstruction, but also on account of the stoppage of irrigation. In this case the waterway under the aqueduct was calculated to carry 30,000 cubic feet per second, while the flood which destroyed it amounted to 135,000 cubic feet per second in volume. The present structure, which is of similar design to the one destroyed, is perhaps the most magnificent aqueduct ever built, and consists of 15 masonry spans of 60 feet each, divided by abutment piers into three sets of 5 spans each; the whole work is founded on wells sunk 50 feet below the bed of the stream. The circular wells are 20 feet in diameter under the piers and left (canal) wings, 13 feet in diameter under the river wings, and 12 feet in diameter under the abutments, abutment piers, and right (canal) land wings. The river wing walls run back well beyond the ends of the land wings, to protect the flank of the work. The main arches are 4.15 feet

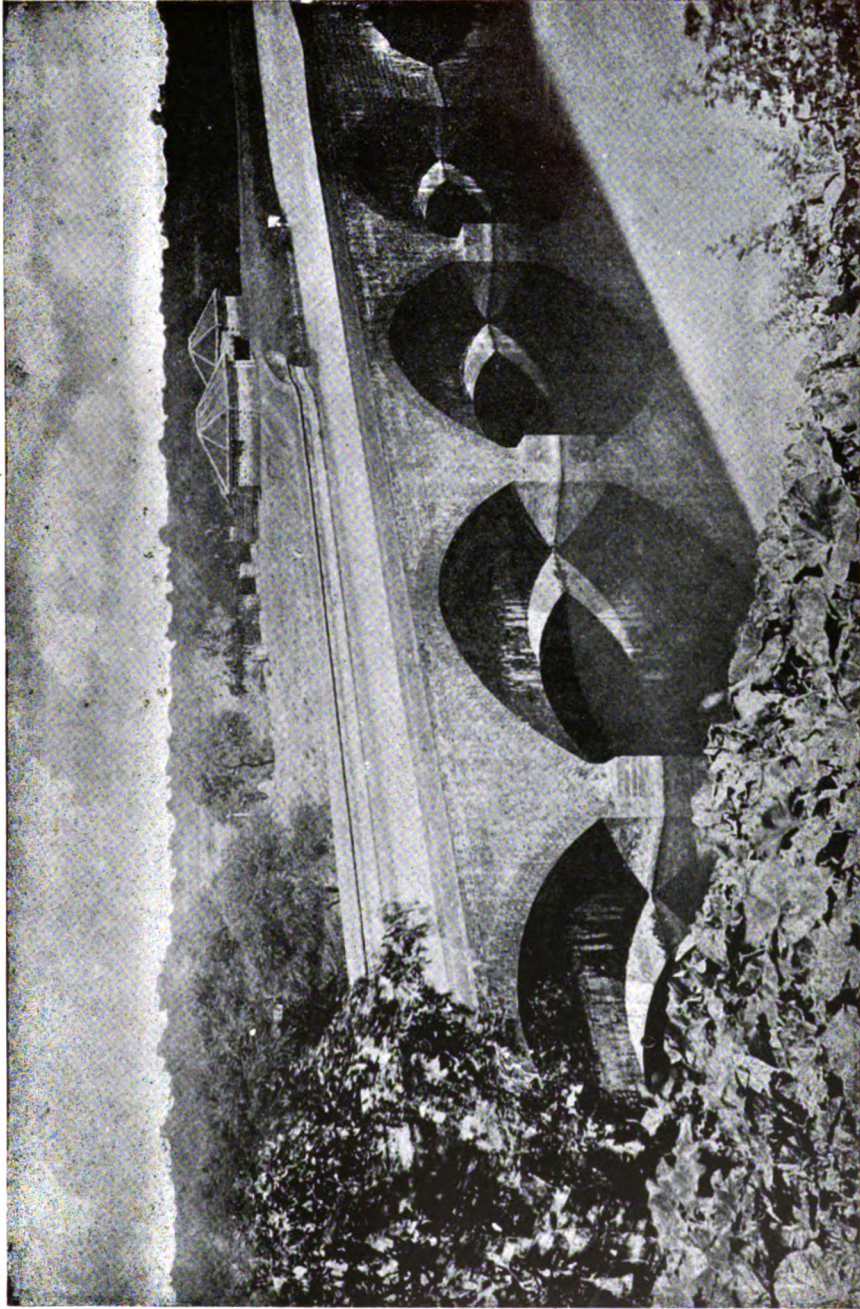
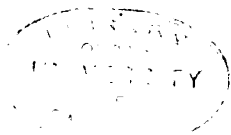

Plate XVII. Mundamur Aqueduct, Kistna Delta System.



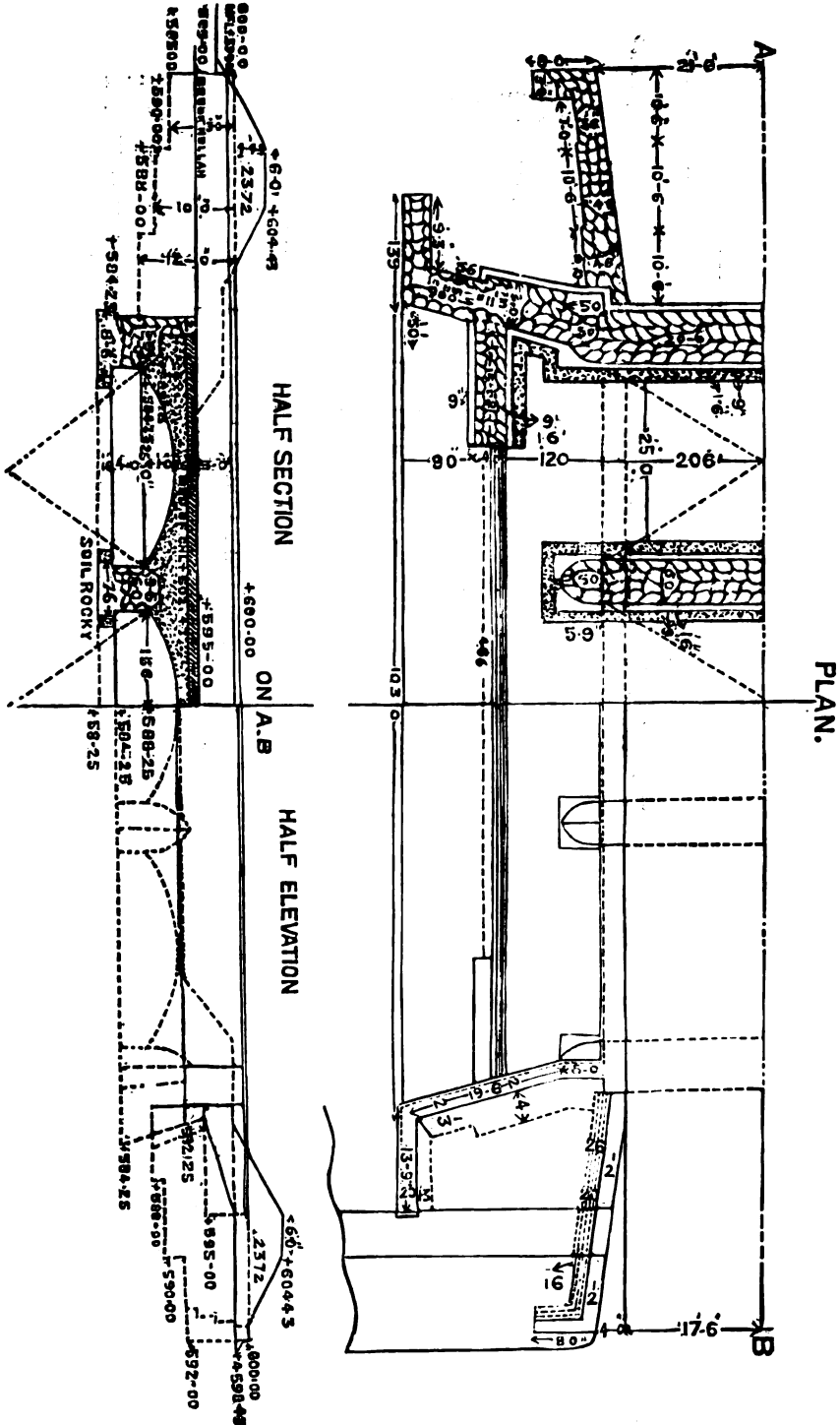
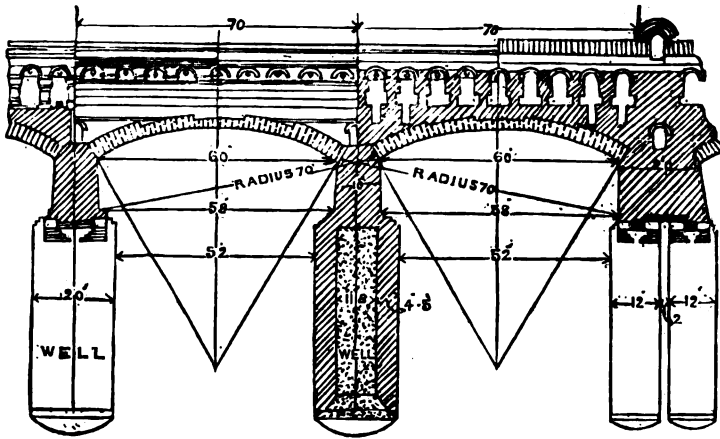

Fig. 70. Superpassage in the Periyar Systems.







ELEVATION AND CROSS SECTION

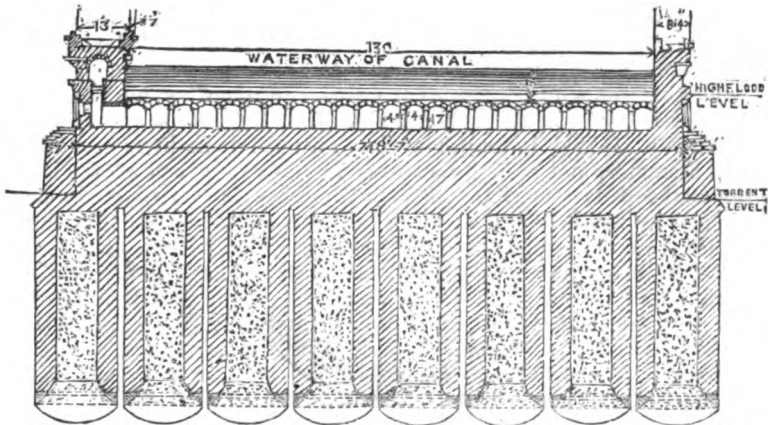

Fig. 72. The Kali Nuddee Aqueduct.

flat in cement over the spandril arches, and the entire canal floor is covered with a layer of fine cement concrete, and the sides of the channel are plastered with cement in order to make them perfectly watertight. The width of the channel across the aqueduct is only 130 feet, which causes a velocity of 4 feet a second at times of maximum supply: the bed and sides of the earthen channel, where it is contracted above and below the aqueduct, are strongly revetted with rubble to enable them to withstand the velocity.

Another great structure of this kind is the Solani aqueduct above the Ganges Canal. This consists of an earthen embankment  $2\frac{1}{2}$  miles in length across the Solani valley, its greatest height being 24 feet.

This embankment is 350 feet wide at the base and 290 feet wide at the top, and on this the canal banks are formed, the width of the banks being 30 feet on top and the bed width of the canal 150 feet. The aqueduct is 920 feet in length with a clear water space between piers of 750 feet, disposed in 15 spans of 50 feet each. The breadth of each arch parallel to the channel of the river is 192 feet, and its thickness 5 feet. The greatest height of the aqueduct above the river bed is 38 feet, and the walls of the waterway are 3 feet thick and 12 feet deep. This structure is founded on masonry piers resting on wells sunk 20 feet in the river bed.

**107. Gunnaram Aqueduct.**—Colonel Baird Smith, a distinguished officer of the Bengal Engineers, who saw the aqueduct early in 1853, has the following description of, and remarks about, it in his 'Irrigation in the Madras Provinces' and a plan of the work as it then was, taken from that book, will be found in the Atlas volume of this 'History':—

"The passage of the branch is effected by means of the Gunnaram aqueduct, a work most creditable to the professional character of Lieutenant Haig of the Madras Engineers, the officer by whom it was constructed. It will be convenient to give a short description of it here. The total length of the aqueduct, between abutments, is 2,248 feet, divided into 49 arches of 40 feet waterway each at the springing of the arches, and 48 piers of 6 feet in thickness at the same points, with an external batter of 6 inches on each side. The abutments on both sides are segments of circles, having radii of 35 feet terminating in return walls, binding the work into the embankments of the channels, 15 feet in length each. These and the piers rest on wells 5½ feet in diameter, and sunk 8 feet deep in the sandy bed of the stream. Over the well-tops is a flooring which, in 25 arches, is composed of concrete, strengthened by five bond-walls of bricks, 2 feet in breadth. The flooring is 1 foot thick and is supported by five rows of wells, 4 feet in diameter, and sunk 3 feet in the sand beneath, the heads being secured by the bonds first alluded to, which run through the whole length of the flooring. The total height of the piers from the floor to the springing line of the arches is 11½ feet, the rise of the arches 7 feet, their thickness throughout 2½ feet; the height of the parapets above the line of the crown of the arches is 6 feet, and they are surmounted by light wooden railings 3½ feet in height. The top of each parapet is made to carry a foot pathway 6 feet in breadth for purposes of cross communication. The spandrels are not filled in\*; there is no flooring to the aqueduct channel between the parapets, which are 2 feet thick at top and 3 at bottom, with spandrel walls 1 foot thick and of lengths variable according to their position. The water thus flows over an exceedingly rough bed, and when I saw the work, there were several awkward rapids at different points of its length. There is a fall of 2 feet from the eastern to the western end, which is nearly at the rate of 5 feet per mile, causing great rapidity of current. The breadth of the channel varies a little, ranging from 22 to 24 feet. Loose-stone aprons protect the foundations in front and rear, and they will be extended as occasion requires. The architectural design is perfectly plain and hard; in fact the elevation is merely that of a wall with a series of holes through it, and its appearance is even heavier than there was any occasion for making it. The whole structure is of brick in excellent cement, the bricks being unusually large or 18 inches by 6 inches by 3 inches.

---

\* These were filled with concrete in May 1885.

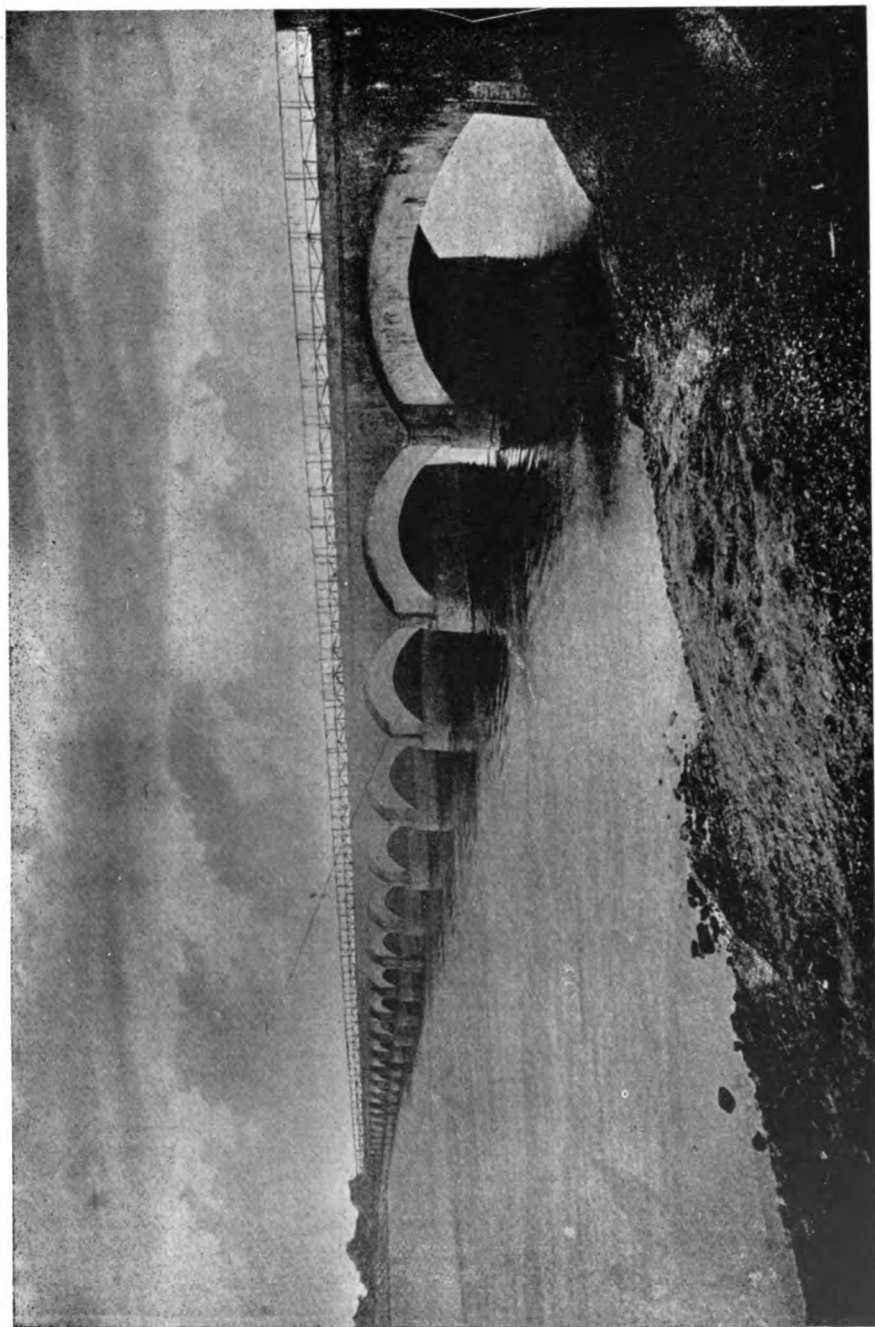

Plate XVIII. Gunnaram Aqueduct across a branch of the Godavari.

1000

From the commencement of preparation of materials for the work till the completion of all its 49 arches, only four months elapsed and in another four months, it was ready to have water passed over it. In any part of the world this would have been a noteworthy achievement; in an out-of-the-way part of the Madras Presidency where machinery was almost unobtainable and most of the skilled labour required had to be trained as the work went on, it was an extraordinary feat.<sup>57</sup>

**108. Iron Aqueducts.**—But few of these have been constructed, though it is probable that they will continue to grow in favour. The chief difficulty encountered in constructing long aqueducts of iron has been the expansion and contraction of the metal, though this in fact has proved to be an imaginary rather than a real danger. In practice, it has been found that the metal of the structure has approximately the same temperature as that of the water, and as this is somewhat uniform but little change takes place in the dimensions of the aqueduct. On the Corinne branch of the Bear River canal in Utah is a simple iron aqueduct resting on iron trestles (Fig. 73). The floor of this is 37 feet above the

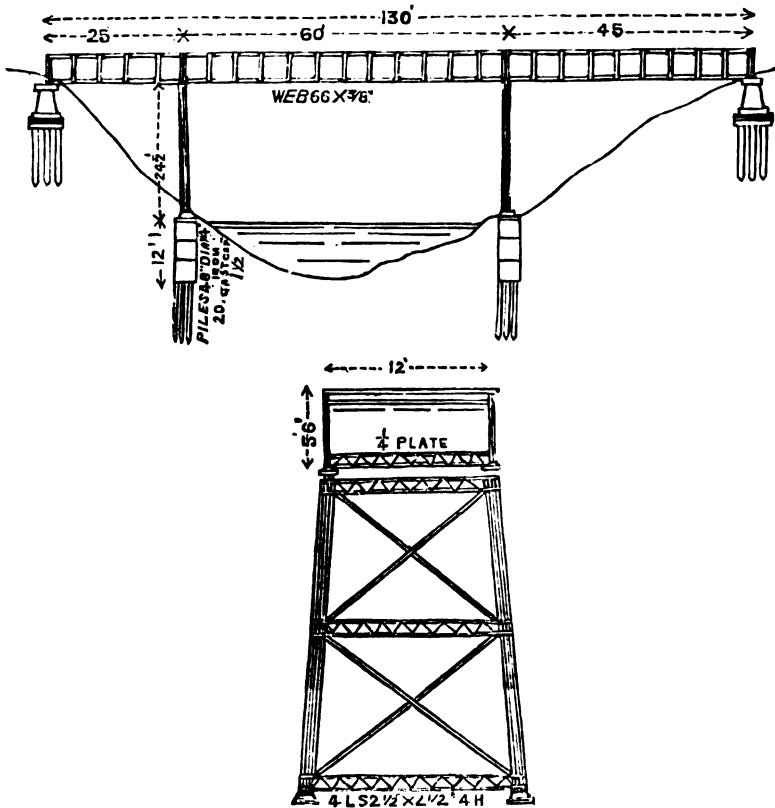

Fig. 73. Bear River Aqueduct.

bed of the stream, and its length is 130 feet disposed in three bays, the centre span of which is 60 feet long, the other two being respectively 25 and 45 feet long. This aqueduct is essentially a plate girder bridge resting on iron columns and founded on iron cylinders filled with concrete and resting on piles. The plate girders forming the sides of

the aqueduct are  $5\frac{1}{2}$  feet in depth, the available depth of water being 4 feet. The sides of the girder are braced by vertical angle irons riveted to it every 5 feet apart, while the top is cross-braced by similar angle irons. These angle irons vary between 3 and 4 inches in width, while the web of the sides of the aqueduct consists of  $\frac{3}{8}$  inch iron.

On the Henares canal in Spain is an iron aqueduct over the Manjanar torrent. This aqueduct is 70 feet long, with a clear span of 62 feet. Its waterway is 10.17 feet wide, its capacity being 177 feet per second. The sides are composed of box girders 6.2 feet deep (Fig. 74) and

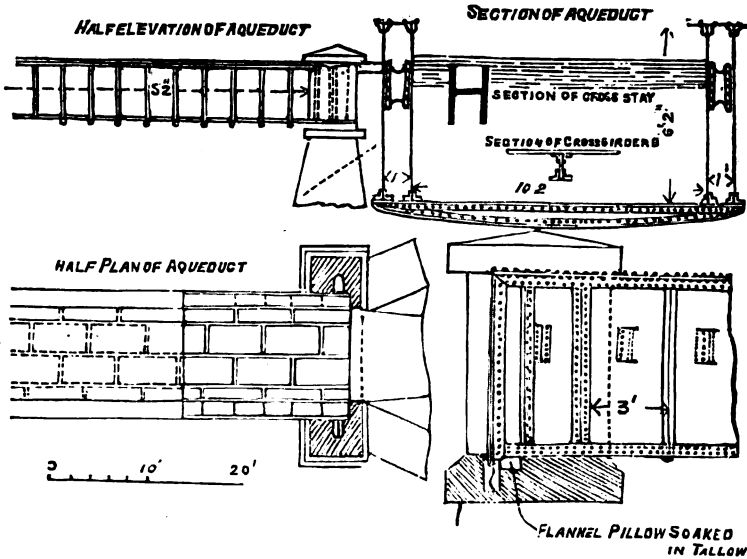

Fig. 74. Manjanar Aqueduct.

each girder is calculated to bear 200 tons or the entire structure to carry 400 tons. To prevent leakage the ends of the aqueduct rest on stone templates, and 4 inches from each end is a pillow composed of long strips of felt carpet, 9 inches wide and soaked in tallow, which is let into the stone below the aqueduct. This presses on it with its full weight, thus making a water-tight joint. In addition to this lead flushing is revetted to the aqueduct and let into a recess of the stone abutment. This recess is 12 inches deep and 4 inches wide, and around it is poured, hot, a mixture of tar, pitch and sand, which allows slight play during its expansion and contraction and yet is water-tight.

**109. Syphons.**—Where the canal is not used for purposes of navigation and encounters drainage at a relatively low level, the most convenient and usual form of crossing is by means of inverted syphons. The ordinary method of using these is to carry the water of the canal in the syphons under the stream, though sometimes the stream is carried in the syphon under the canal. It must be remembered that the syphon is under pressure, and it is usual to give it such a head, or fall of water surface, from its inlet to its outlet, that it has a high velocity and, therefore the velocity of the water passing through it has sufficient scouring force to prevent the deposition of silt and debris. If the water passing through the syphon has not sufficient velocity to keep it clear,

not only of the silt held in suspension, but also of the material rolled along its bed, it will, in time, get partly or entirely choked, and the water being thus dammed, will cause floods, and very likely break the canal banks and do material damage.

As a matter of economy it is, of course, advantageous to restrict the waterway of a syphon as much as possible, and it is often desirable to do the same thing in order that a high velocity may be obtained.

The capacity of the barrels of a syphon is usually designed so that the maximum discharge can be passed at a velocity varying from 5 feet to 8 feet a second, provided that the circumstances permit of a sufficient head being placed on the syphon to produce such a velocity. In syphons with a vertical drop, such as that in (Fig. 75), which was designed for a velocity of rather more than 8 feet a second, the flow of the water approaching the syphon is checked by the vertical drop, and it is necessary to allow ample head to produce the required velocity in the syphon. In most cases a head of at least 30 inches would be required to produce an 8-foot velocity, and it is often difficult to obtain this without going to considerable expense, either in embanking the channel above the syphon or in excavating it below it, and in flat shallow drainages it may be impossible to do either. In the latter case there is no alternative but to increase the waterway of the barrels to such a point that they will be capable of carrying the discharge with the velocity due to the head which can be obtained. In all cases of shallow drainages of slight surface slope, shallow and wide vents are preferable to narrow ones of the same waterway, in order that a wide entrance and exit over the lip of the syphon may be obtained for the water entering it and leaving it. Figs. 76 and 77 show a typical section of the syphons constructed on the Chenab canal in the Punjab, which are very suitable for cases of this kind.

**110. Examples of Inverted Syphons.**—An interesting structure of this kind, which is practically a syphon aqueduct, since the waters of the stream are carried under those of the canal, is that carrying the Kas torrent under the Soane canal, Fig. 78. This work is built of the most substantial masonry, the area of the superstructure being contracted and given a slightly increased fall to carry the waters of the canal, while the waters of the torrent flow over a masonry floor which is depressed a few feet. The Kas Nullah, which drains an area of 57 square miles, of which the greater part is in hilly ground, is subject to sudden floods and the discharge was estimated to be equal to a run-off of 6 inches in 24 hours, or 161 cubic feet per second per square mile, but experience has shown the discharge is not as great. This work, and most others of this class, are subject to the disadvantage that the syphon is liable to be filled up by detritus washed into it during a flood. The result of this may be disastrous. In the case of the Kas syphon the accumulations in it have been partially cleared out every year.

In all works of this class it is necessary to consider the upward pressure on the covering of the syphon vents due to the head upon them under the most unfavourable conditions, which occur, of course, when there is no water in the upper channel. It may be that the canal will never be dry at the time when a flood occurs in the drainage, but it is usually better to provide for such a case. In the Kas syphon the



cover stones of the vents are anchored down to the foundation by wrought iron bolts.

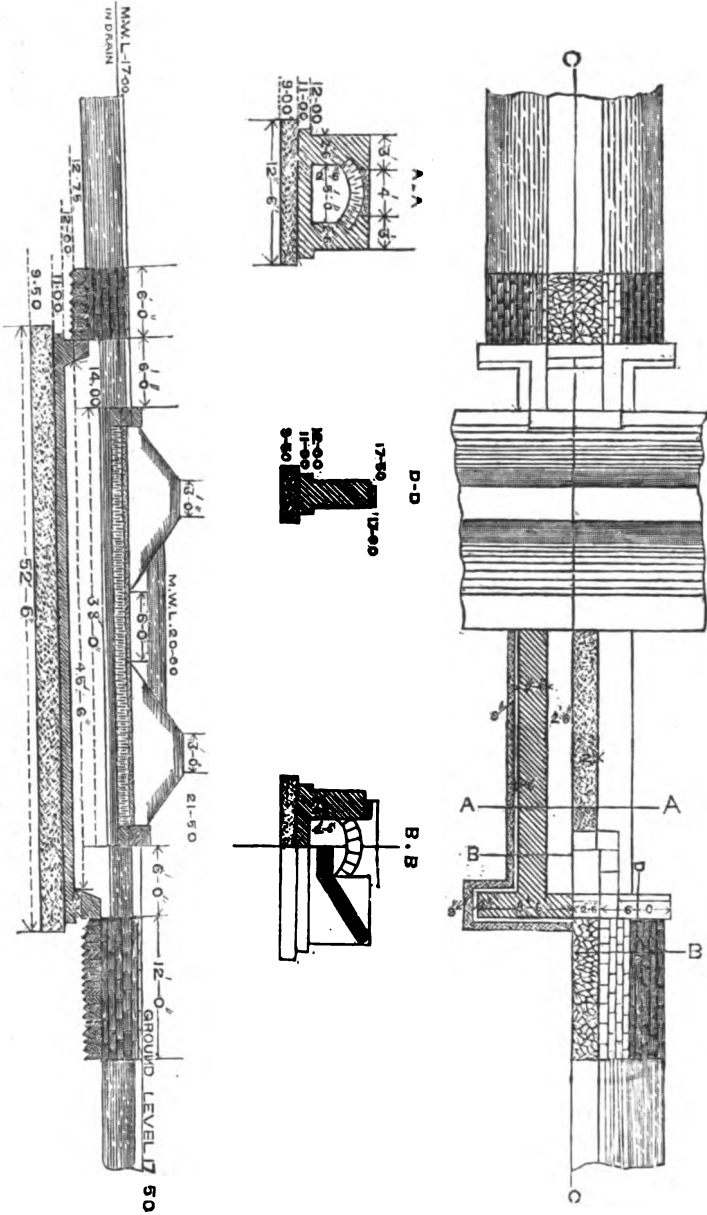

Fig. 75. Syphon.

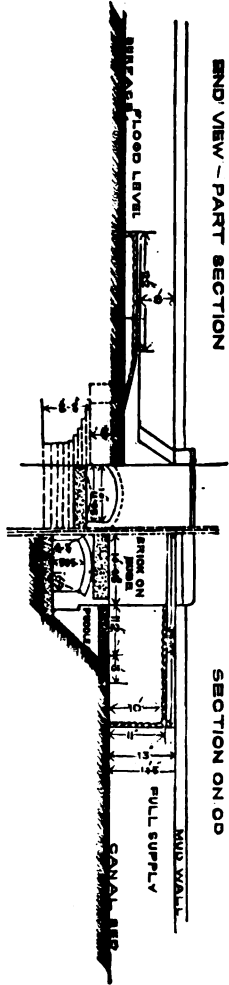

Fig. 76.

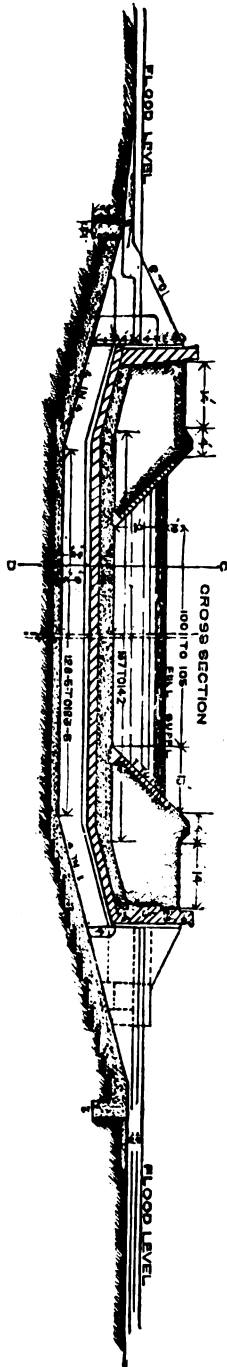

Fig. 77.

Typical Section of Syphons on the Chenab Canal.

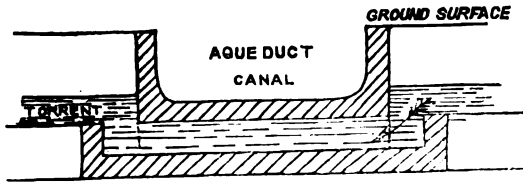
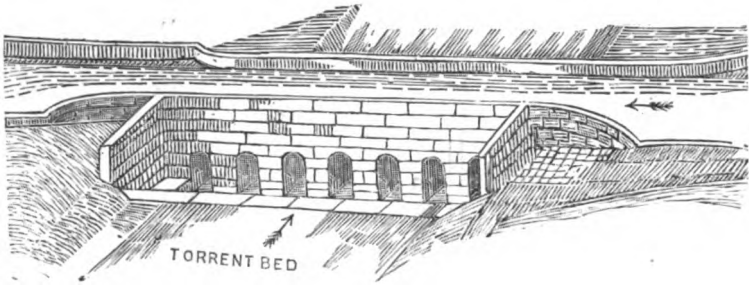

Fig. 78. Syphon Aqueduct on the Soane Canal.

The most magnificent masonry syphon ever built is that carrying the waters of the Cavour canal under the Sesia river in Italy, Fig. 79. Its total length is 878 feet and it consists of elliptical shaped

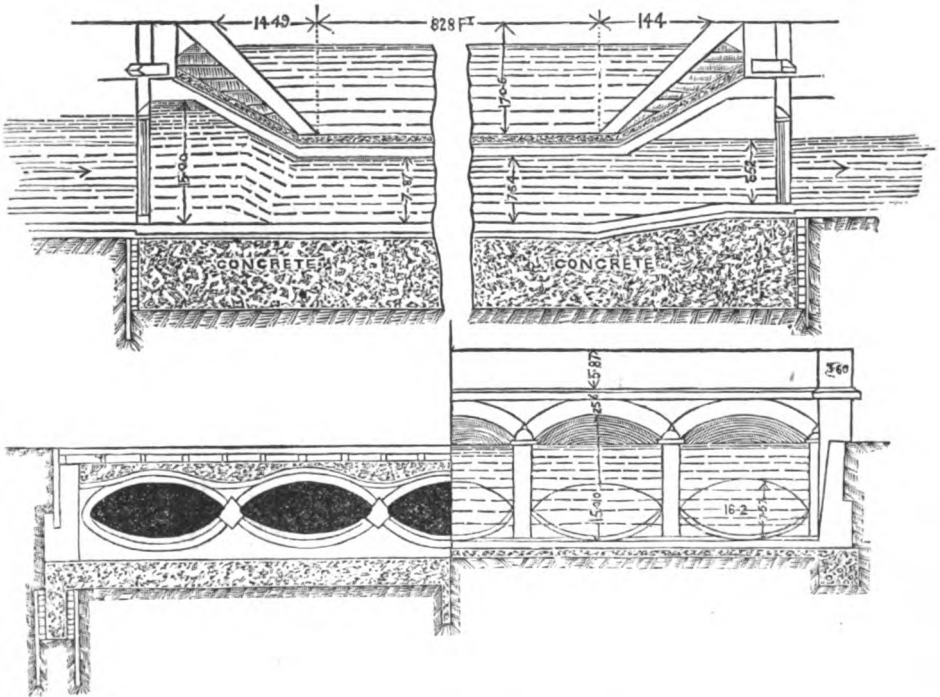

Fig. 79. Sesia Syphon, Cavour Canal.

orifices or culverts, the horizontal diameter at the entrance of each is 16.2 feet and the vertical diameter 7.8 feet at the entrance, and 7 feet 6 inches at the exit, the amount of depression of the water surface in the canal being  $7\frac{1}{2}$  feet. The area of the 5 culverts at the entrance is about 483 square feet, and the canal was designed to carry 3,883 cubic feet per second. This would give a mean velocity, at the entrance, of about 8 feet per second, and, with a supply of 3,000 cubic feet per second, it would give a mean velocity of about 6 feet per second, and, with these velocities, it is found that no silting of the culverts takes place. The syphon consists of a substantial concrete floor or foundation  $11\frac{1}{2}$  feet in thickness under the river bed, its roof forming the floor of the river channel and being about 5 feet in thickness.

Another large syphon is that on the Sirhind canal where it crosses the Hurrion torrent. The total length of this is 212 feet, and it consists of two openings each 4 feet high by 15 feet wide. The water drops from the canal almost vertically into a well, the floor of which is on a level with the floor of the syphon, while at its exit it is raised again to the level of the outlet canal up an incline built in steps.

## CHAPTER VIII.

NAVIGATION—LOCKS—LOCK-WEIRS—TOWPATHS,  
FENDER PILES—BRIDGES.

**111. Canals for Navigation only.**—There are three large canal systems in India which have been constructed solely for the purpose of navigation; these are the Circular and Eastern canal and the Orissa canal in Bengal, and the Buckingham canal in Madras. These systems are not used in any way for irrigation, and could not be so used, as the water in them is generally brackish. The canals are in immediate contact with the tidal creeks and rivers connected with the Bay of Bengal: indeed the greater portion of the Eastern and Circular canal, which connects Calcutta and Barrisaul in Eastern Bengal, consists of natural tidal channels which have been artificially improved, and which are maintained in a fairly efficient state in order to bear to Calcutta the products of the eastern and northern districts. The Orissa canal and the Buckingham canal are both coast lines; the latter was undertaken primarily as a protective work after the famine of 1877-78, in order to connect the Gôdâvari and Kistna deltas with the southern districts of the province. Of these three navigable systems, the Calcutta and Eastern canal, which was partially in operation at the end of the eighteenth century, has always paid well, but the others are not financially successful at present.

**112. Irrigation Canals adapted for Navigation.**—Of the large canal systems in the Upper Provinces of India and in Madras, which were primarily constructed for irrigation, twelve are also adapted, in certain portions of their channels for navigation also. None of the canals in Bombay or Sind have been constructed so as to be available for navigation, although small boats are sometimes used on parts of them. The mileage of irrigation canals which are also navigable are

Province.	Mileage of irrigation canals.	Mileage which is navigable.
Bengal ...	710	(a) 467
North-West Provinces.	1,420	(b) 512
Punjab ...	4,058	(c) 432
Madras ...	3,143	(d) 970

(a) The Orissa, Sone and Midnapore canals.

(b) The Ganges, Lower Ganges and Agra canals.

(c) The Western Jumna and Sirhind canals.

(d) The Gôdâvari, Kistna and Kurnool canals.

shown in the marginal statement. It has been maintained that it is desirable, if not necessary, to make the trunk lines of an irrigation system navigable, in order that an easy and cheap means of carriage may be available for exporting the surplus grains and other products which irrigation produces; it has also been argued that the expense of the additional works is not large, while the convenience to the people and to the officers in charge of the canals is very great. It is, however, by no means easy to estimate correctly the difference in cost between an irrigation canal of a given capacity, and one of the same capacity which is suitable for navigation; the difference, is by no means

To face page 114.

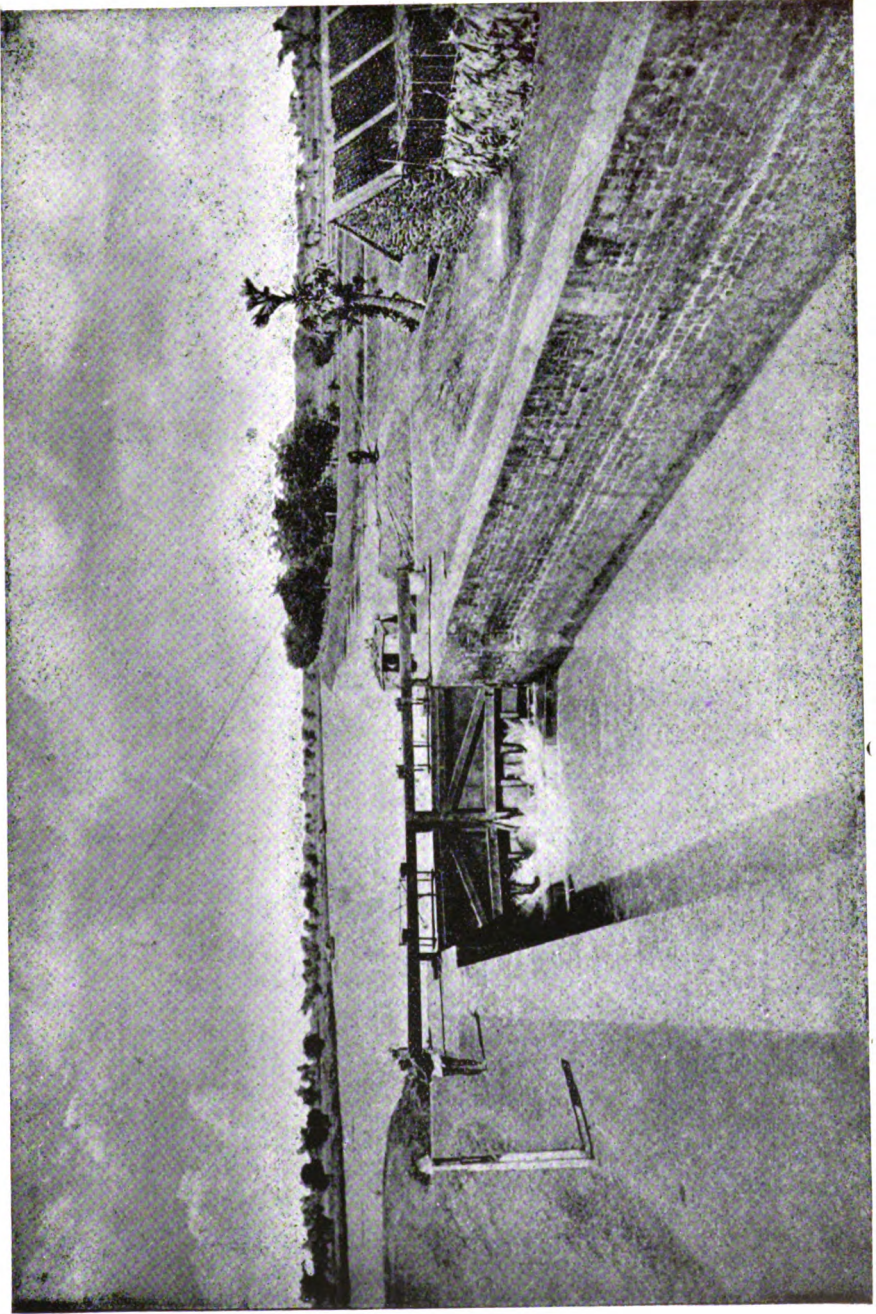

Plate XIX. Lock, Godavari Delta System.



represented by the cost of the locks which have to be added at the canal falls. One of the chief reasons, no doubt, why water carriage has not been successful in India is because canals primarily designed for irrigation do not connect centres of trade, but run on lines suitable for irrigating the land; another reason of the small receipts is probably to be found in the fact that in a highly cultivated district large numbers of draught cattle are required for ploughing which, at odd times, are available for carting the surplus crops to market at a very nominal cost to the owners.

**113. Limiting Velocity of Water.**—Considered in connection with navigation only, the smaller the velocity of the water in a canal, the better it will be for traffic, but, in fresh water canals, there is usually the conveyance of water for irrigation to be provided for, and in deciding what velocity may be allowed, the character of the water-supply needs to be taken into consideration, lest on the one hand, by adopting a very low velocity, the water be robbed of much fertilizing material, and, on the other hand, the cost of the periodical clearances of silt be unduly enhanced.

It has been found from experience that a mean velocity of 1.50 to 1.75 feet a second does not materially add to the cost of transport, and these velocities have accordingly been adopted in the Madras Presidency for the more important, and for the secondary lines of transport respectively; though at times, especially in the main canals, higher velocities, when the water level is above that of normal full supply level prevail. With, then, the ordinary full depth of water, it is desirable to limit the velocity, as above shown: but in any particular case, the primary object of the canal should be allowed due weight, and if this be irrigation, its efficiency must be secured, even though navigation be thereby rendered less convenient than could be wished.

**114. Navigation in the Dry Season.**—Canals which carry any considerable quantity of water for irrigation have an appreciable surface fall, and, in order that, when the irrigation is over, and the supply of water runs short, navigation should still be conveniently practicable, it is necessary to arrange for getting rid of this surface fall to any desired extent by holding up the water-level at the lower end of each reach, so as to secure a minimum depth of water at the upper end of the reach. This minimum should not in any case be less than 4 feet, while, in reaches in which the fall between the upper and lower ends is small, the minimum may conveniently be fixed higher. It has to be remembered that though 4 feet of water will keep any boat used in inland navigation clear of the bottom, a greater depth is highly desirable, seeing that the greater the sectional area of the waterway, in proportion to the immersed sectional area of the boat, the less will be the traction power required to obtain any given speed, and this holds good for even the low speeds of not more than  $2\frac{1}{2}$  miles an hour, at which cargo boats are run; while for the faster passenger boats, and still more for steam-launches the importance of ample waterway is very great. Even on the larger of the Delta canals—the main canals when running full excepted—a speed of more than 6 or 7 miles an hour with the current, and of 5 miles an hour against the current, is, owing to the cumulative resistance offered by the water, unattainable with a steam-launch capable of going 10 or 11 miles an hour in the open river. Except in



deep and wide canals steam navigation must not be expected to secure such rapidity of transit as the steamers may be constructed to obtain, but even for ordinary traffic plenty of water is essential to the efficiency of a canal for navigation.

**115. Lock-Weirs.**—It is evident that when the fall of the country is in excess of that of the canal it will be necessary, in order to prevent the canal from rising much above ground level, to drop the water at longer or shorter intervals, by means of fall or drop weirs; these on navigable canals are termed lock-weirs, as they are usually built in connection with locks. They differ from ordinary weirs chiefly in the fact that they must be bridged: the required length of crest, when in excess of about 9 feet, being divided by piers into convenient lengths, and regulating shutters, worked by screw gear, being provided to maintain the proper water level in the upper reach, whatever the quantity of water passing down may be. Whenever practicable the axis of the lock-weir bridge and that of the lock bridge should be in the same straight line.

**116. Locks.**—Locks are required to pass boats from one reach to another in both directions. They were formerly built of many different sizes, but from about the year 1870 the dimensions have been fixed at, for first-class canals, chambers 150 by 20 feet; and for second-class canals, 105 by 15 feet chambers, the lengths being measured on the centre line from the face of the drop wall to the mitre-posts of the lower gates when closed.

Locks are closed by a pair of gates, meeting at an angle pointing up stream and abutting against a sill, at each end of the lock chamber, into which boats are admitted from the upper or lower reach, and in which, when both pairs of gates are shut, they are lowered or raised to the extent of the difference of level between the reaches, by letting out water from the chamber into the reach below, or by introducing water from the upper reach into the chamber for boats proceeding up the canal.

Locks should be capable of being filled or emptied in three minutes. The best arrangement for this purpose is that of side culverts, the openings or waterways in which are regulated by shutters worked with a rack and pinion. A vent 3 feet square is a convenient sized opening, and meets the usual requirements, but in each case the proper dimensions to secure the filling or emptying of the lock in three minutes should be worked out, and, if found to be slightly less than the above, those dimensions can be adopted as suitable.

Screws should not be used to work the shutters as they do not open the vent quickly enough. Brockman's single and double purchase rack and pinion are excellent and inexpensive, and are well suited, the former for the upper, and the latter for the lower culverts. Bollards fixed a short distance from the lock walls, or eye bolt rings fixed in the side walls at top are desirable for keeping boats in position while the lock is being filled or emptied.

At all locks at which there is night traffic, a lamp post and a good lamp should be fixed in such a position as will warn boatmen that they are nearing the lock, and serve also to light the lock itself. When there is a bridge over the tail bay, the parapet on the lock or upstream side, on the centre line, is the best position for the lamp.

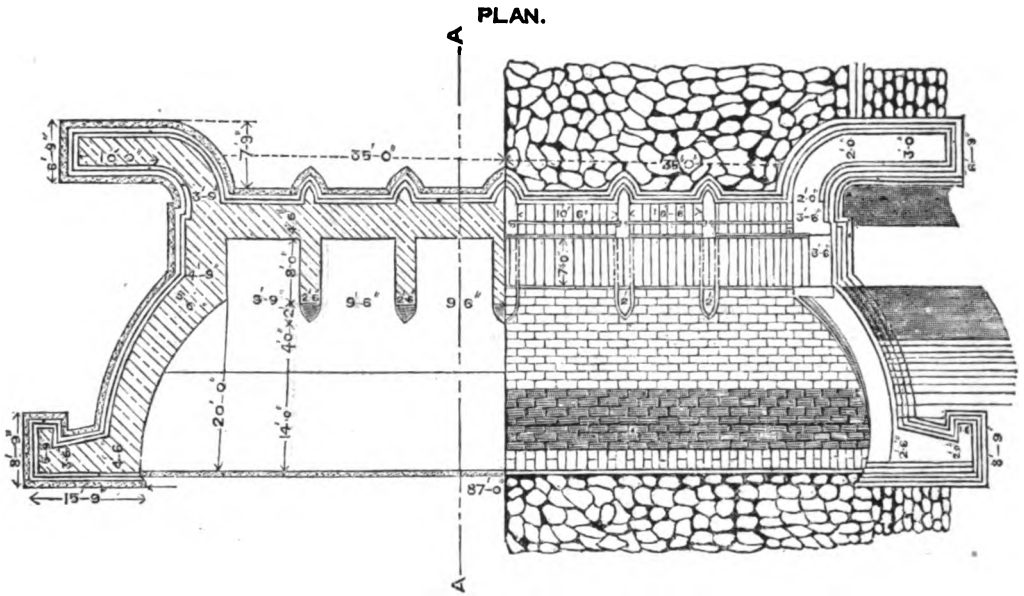

**SECTION ON A.A.**

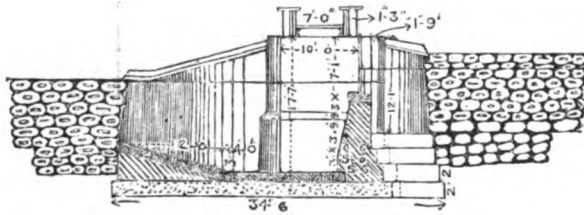

Fig. 80. Lock Weir. Godavari System.

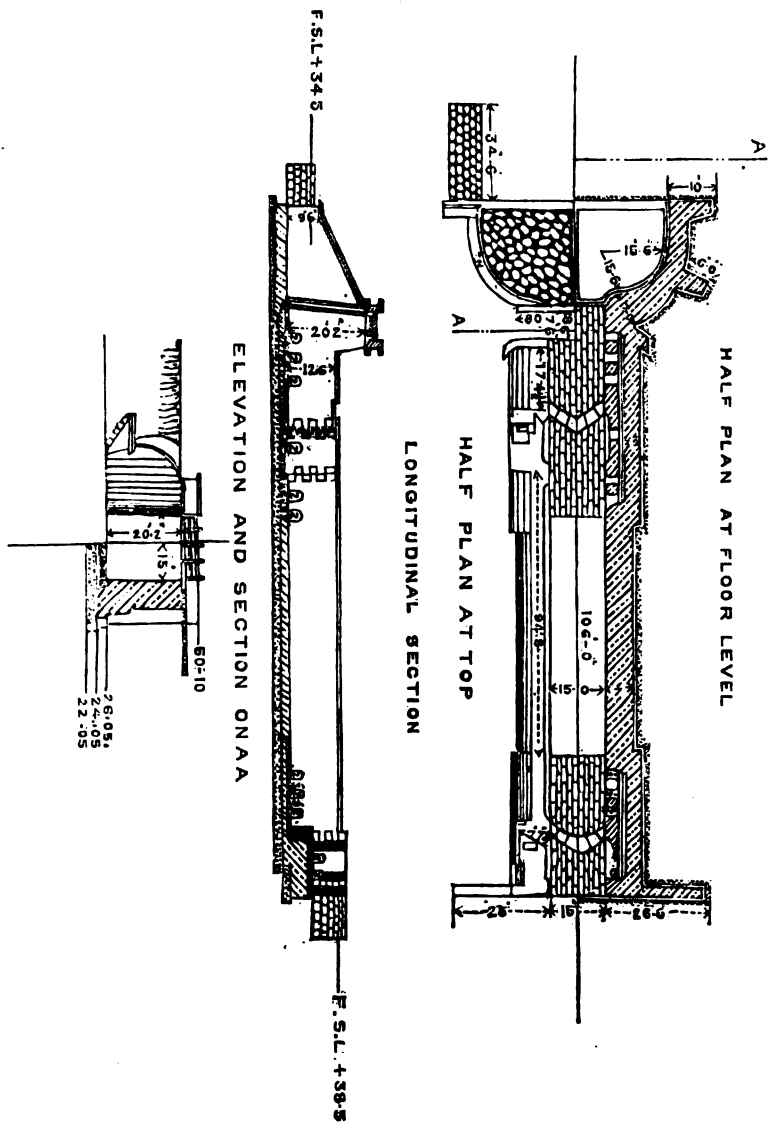

Fig. 81. Chopella Lock. Godavari System.

As a rule, a bridge should be provided over the tail bay. Gang boards should be provided at both the upper and lower gates for the convenience of the lock establishment, and of the boat crews, to prevent the gate balance beams being used for crossing, a practice attended with considerable risk.

**117. Design of Lock.**—With regard to the design of the lock itself, this will vary for every difference in the height of the walls, the thickness of certain parts of which will depend upon that height. Figs. 81 and 82 show the designs of locks which have been recently constructed in the Madras Presidency, and which include the improvements which have been from time to time found to be desirable. In Fig. 83 will be found details of gates and gang boards.

The gates of tidal locks require to be protected with copper sheathing up to a few inches above high water of spring tides, and all fastenings up to the same level should be of copper.

**118. Tidal Canals.**—Tidal canals are connected with the several rivers across the lines of which they are carried. Unless then the canals be excavated to a depth sufficient to secure the normal depth of water at low tide, an arrangement which would generally involve much difficulty and expense, it is necessary to provide locks at the junctions, so as to maintain the water in each reach at, or nearly at, high tide level. Further, as the admission of flood water to a canal, when the rivers are in fresh, would lead to the deposition of much silt, it is requisite that the means of excluding flood water should be provided: extra, or flood gates, with their salients towards the river,—and, therefore, opening the opposite way to the other gates—enable this to be done. The tops of such gates, and the side walls behind the gates for a sufficient length to admit of a proper connection with the flood banks, should be of the same height as the latter, and in all cases several feet above M.F.L. in the rivers, the margin to be allowed being determined by the degree of the completeness and reliability of the evidence as to M.F.L. A design for a lock of this description is given in Fig. 84.

**119. Site Plans for Locks and Lock-Weirs.**—Site plans are specially requisite when locks and lock-weirs have to be constructed. The arrangements need careful consideration, so as, on the one hand, to avoid material alteration from the normal in the velocity of the water in the approach and tail channels of the weir, and to secure an equal discharge over each part of the latter; and, on the other hand, to keep the length of these channels as small as may be consistent with efficiency. Fig. 85 shows one system of placing the lock and lock-weir at a point where a drop occurs in the canal bed. In that case the channel carrying the irrigation supply is diverted to the weir, and the lock is located on the direct line of the canal; this is the system usually followed in Southern India and in Bengal. On the Ganges canal exactly the opposite procedure was adopted as shown in Fig. 86 the lock being placed in the loop and the main canal being carried straight through on its true alignment over the fall. This system is preferable in those cases where the discharge is very large, but a lock channel of so great a length is open to serious objection where there is much silt in the water, for, in that case, it rapidly fills up with deposit. On the Sirhind canals the locks and falls, Fig. 87, are built together as is usually done in France; this system keeps the lock

SECTION AND ELEVATION ON G. G.

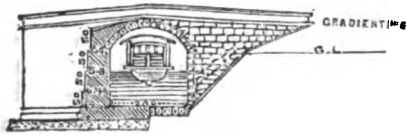

SECTION ON C. C.

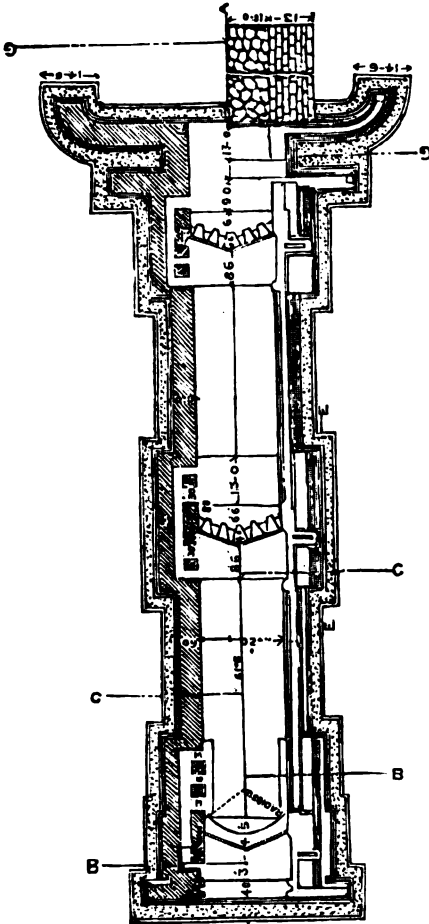

SECTION B. B.

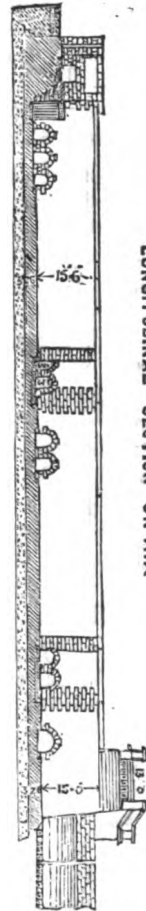

LONGITUDINAL SECTION ON A. A.

SECTION ON E. E.



Fig. 82. Double Lift Lock. Buckingham Canal System.

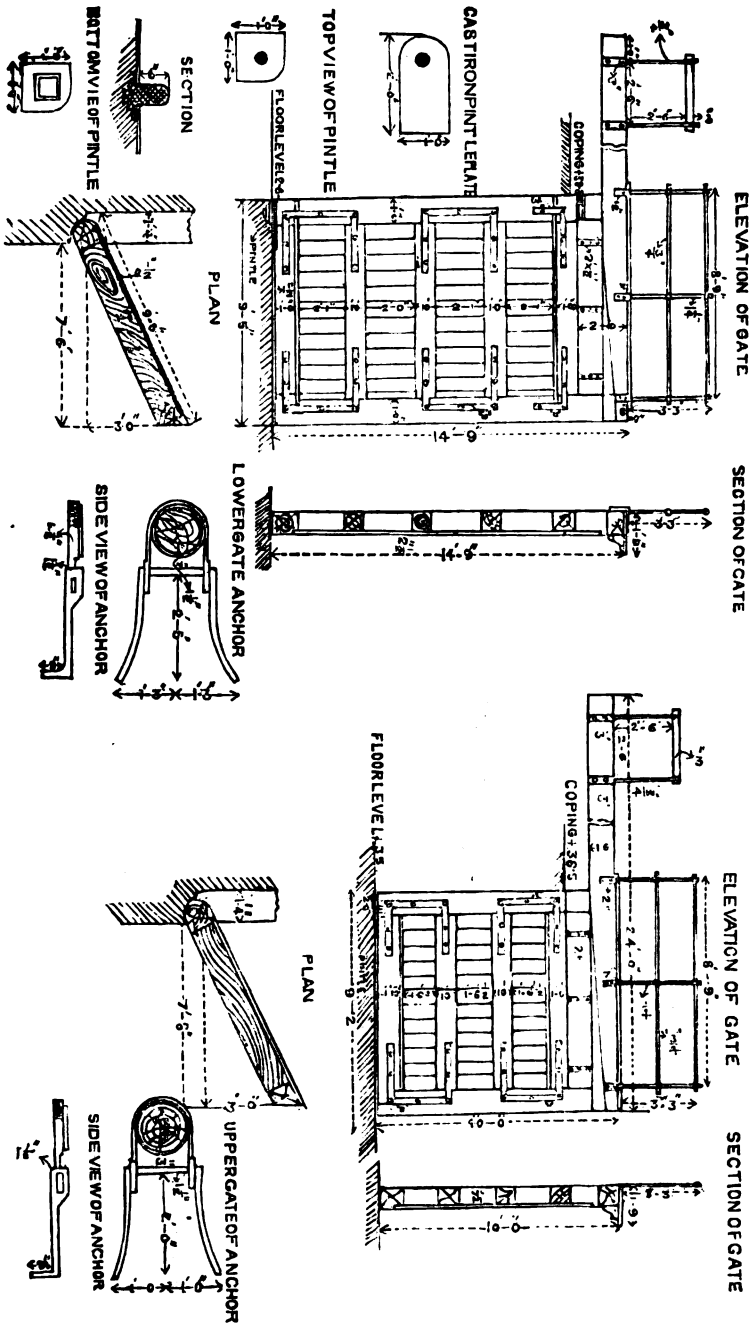

Fig. 83. Details of Lock Gates.

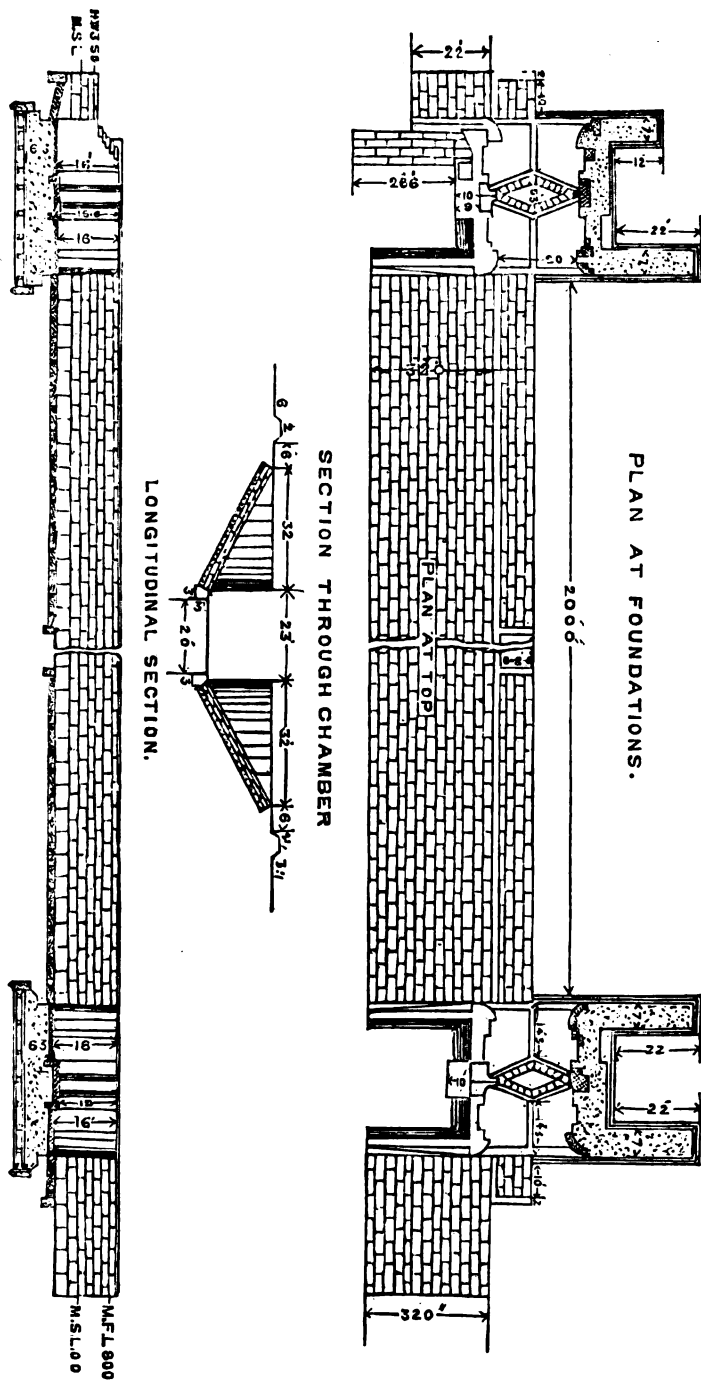

Fig. 84. Adyar Lock. Buckingham Canal System.

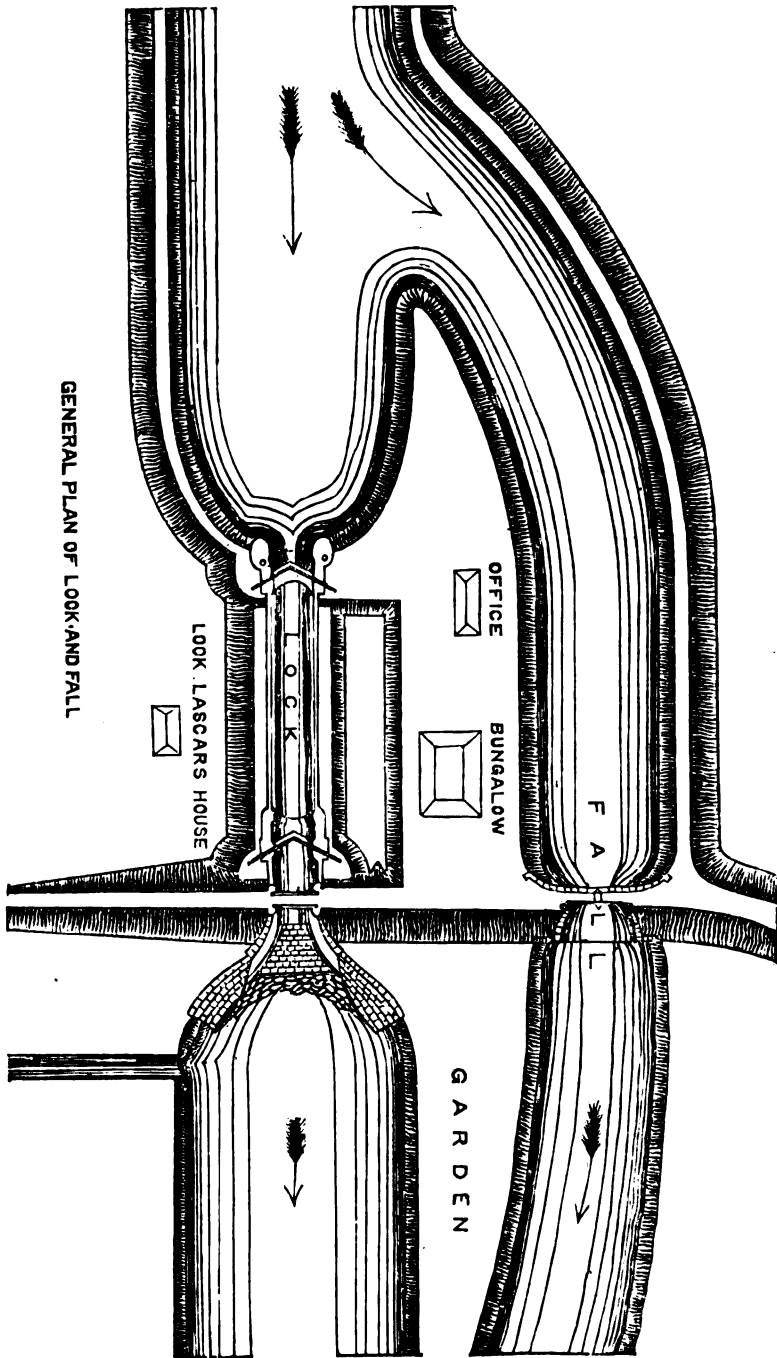

Fig. 85. General Site Plan of Lock on Midnapore Canal,



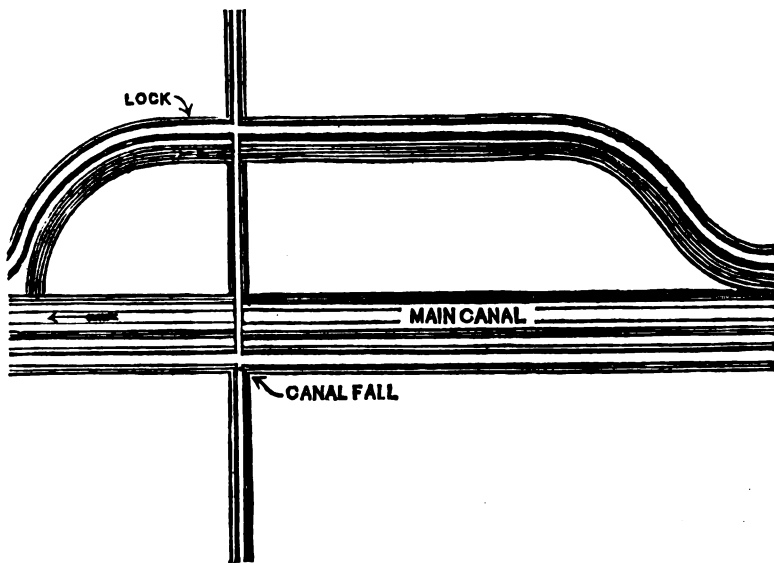

Fig. 86. Site Plan of Lock and Fall on Ganjes Canal.

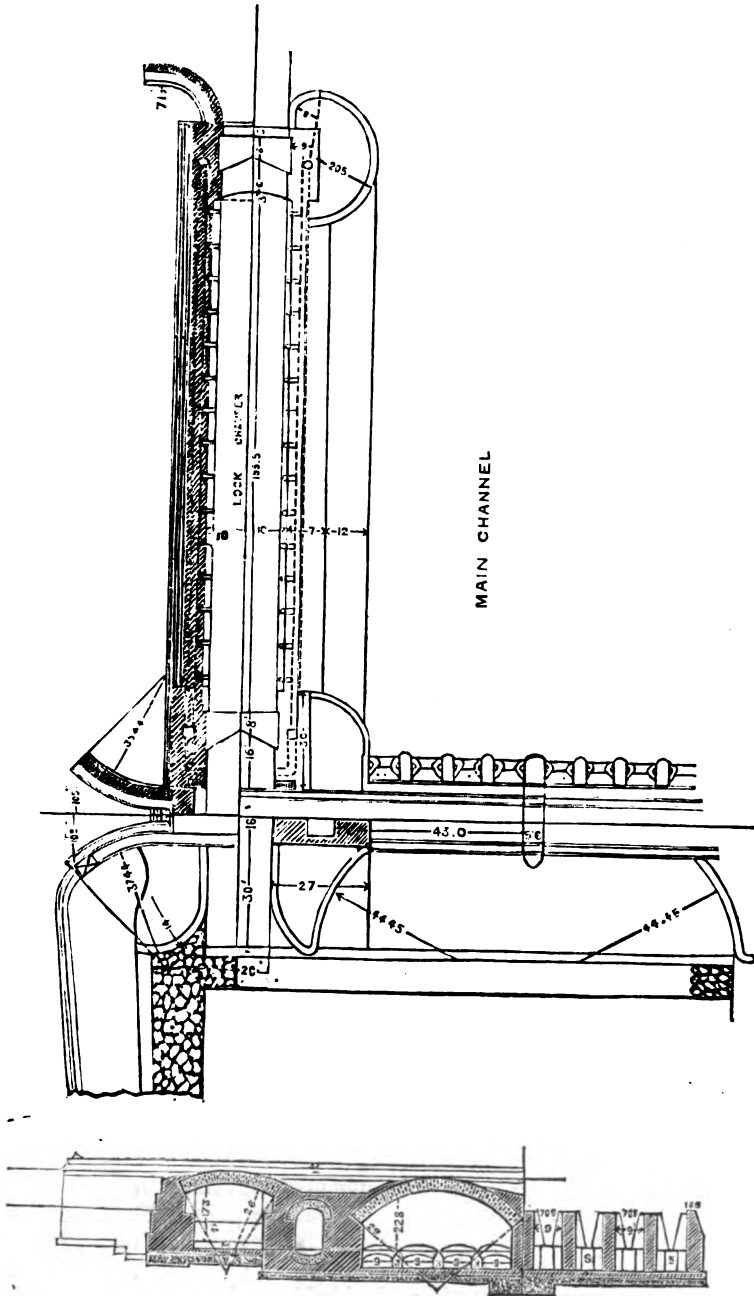

Fig. 87. Bhawani Regulator with Lock and Fall on Sirhind Canal.

channel clear of silt, but it is objectionable, especially where there are large unwieldy boats to deal with, on account of the difficulty in getting the vessels into the lock; the stream to the weir producing a current across the mouth of the lock, boats cannot easily be kept in their proper course, but are liable either to be drawn into the weir channel or to run with some shock against the lock walls.

**120. Fender Piles.**—When a lock-weir, surplus weir, or large head sluice is placed in the bank of a canal, and a considerable local current is thereby induced, a line of fender piles, connected by stout beams or wales, fixed at from 1 foot to 18 inches above normal F.S.L. should be provided across the whole front of the weir or sluice, to prevent boats being carried by the current against the work. The piles should be well strutted, and should be fixed on the line that the water would occupy were there no break in the line of the side slope of the canal. Were the piles placed farther back than this line the boats would be liable to be drawn more or less out of their proper course, and would then run against the barrier with increased force. Details of a suitable arrangement are shown in Fig. 88. It will often be found convenient to make a gangway along the top of the piles, so as to carry the tow-rope along this line rather than over the weir, or sluice-bridge.

**121. Bridges.**—Bridges on navigation canals should have ample headway; and the towpaths should be carried under them on both sides of the canal. The following are the rules regulating the dimensions and height of bridges:—

First-class lines of navigation—

(1) For bridges of more than one opening, the minimum span to be 30 feet, or 25 feet exclusive of a 5-foot towpath. If there be but one opening, the minimum span to be 40 feet, or 30 feet exclusive of two towpaths of 5 feet each.

(2) In arched bridges the clear headway under the arch or arches should be a rectangle 12 feet wide, and not less than 11 feet above F.S.L. or spring tide level, Fig. 89. In girder bridges the minimum headway admissible is 11 feet for the whole width of the canal. An additional foot of headway is very desirable, when it can be secured without undue expense, Fig. 89.

(3) The waterway should not be contracted so as to produce a velocity of more than 1.50 feet a second. It follows, that if the velocity in the canal be at that rate, the waterway at a bridge must not be less than that of the canal.

Second-class lines of navigation—

(1) For bridges of more than one opening, the minimum span to be  $27\frac{1}{2}$  feet, or 23 feet exclusive of a  $4\frac{1}{2}$ -foot towpath. For a bridge of a single opening the minimum span to be 33 feet, or 24 feet exclusive of two towpaths of  $4\frac{1}{2}$  feet each.

(2) The clear headway in arched bridges should give a rectangle 10 feet wide, and not less than  $9\frac{1}{2}$  feet above F.S.L. or spring tide level, Fig. 90. In girder bridges the minimum headway will be  $9\frac{1}{2}$  feet throughout, and should be greater when economically feasible.

(3) The waterway at a bridge should not be contracted so as to produce a velocity of more than 1.75 feet a second.

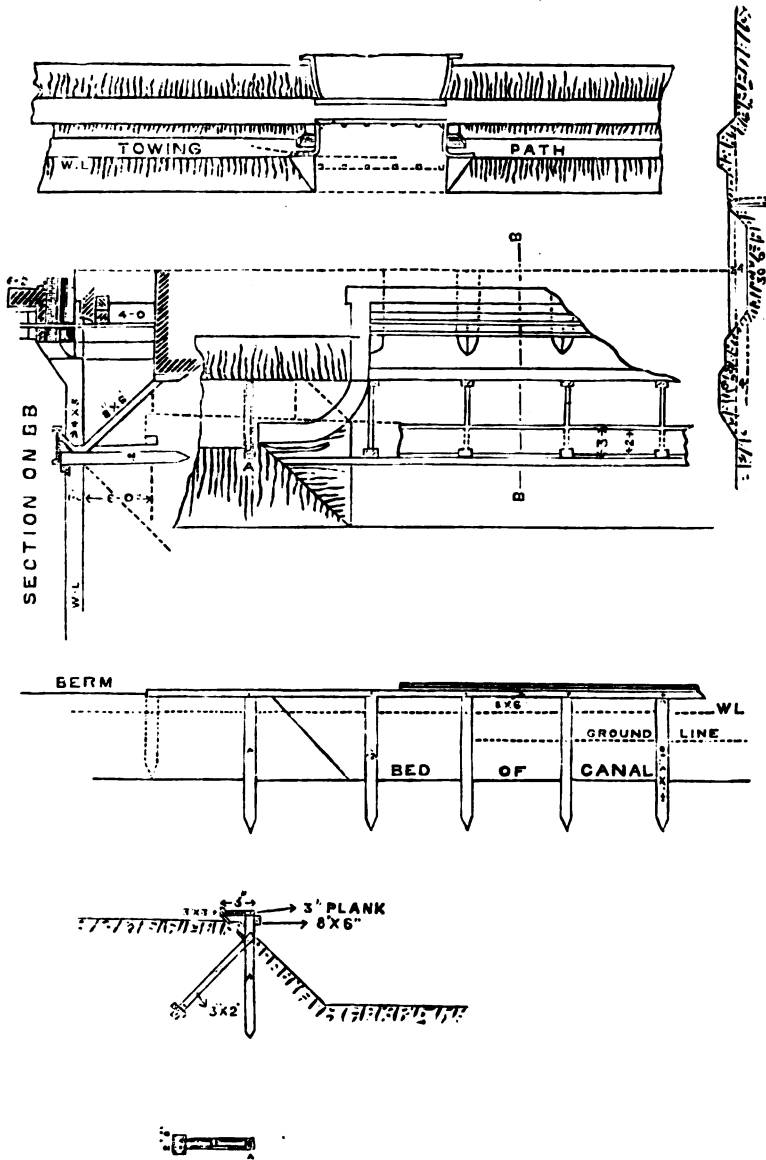
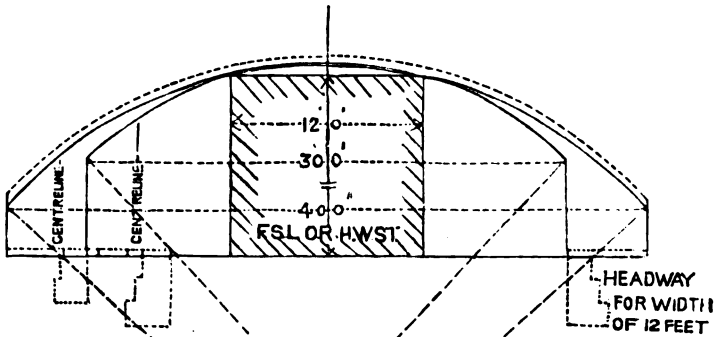

Fig. 88. Fender Piles.

FIRST CLASS CANALS



SINGLE SPAN 40 FEET  
2 OR MORE SPANS 30 FEET

TOW PATHS 5 WIDE ON 1<sup>st</sup> CLASS CANALS

DO 4 1/2 DO 2 MP DO

N.B. THE CHAIN LINE ARCHES SHOW THE ARRANGEMENTS REQUIRED TO SECURE 5 FEET HEADWAY ON CENTRE LINE OF TOW PATH WITH THE LATTER AT 8 INCHES ABOVE F.S.L. THESE BEING THE MINIMA ALLOWABLE

SECOND CLASS CANALS

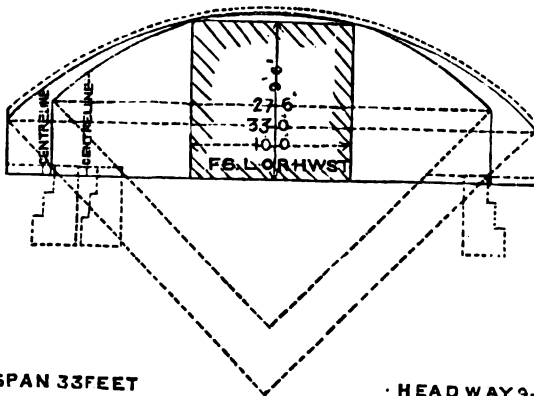

SINGLE SPAN 33 FEET  
2 OR MORE SPANS, 27'-6"

HEADWAY 9'-6" FOR WIDTH OF 10 FEET

Figs. 89 and 90. Minimum Spans and Headways of Bridges on Navigable Canals.

**122. Towpaths.**—Towpaths should, whenever practicable, be close alongside the waterway, and at a level of about 12 to 18 inches above normal F.S.L. or, when water is held up, at 12 inches above still water level. Much of the convenience and economy of navigation depends upon the towpaths being close to the work, and they should be kept in good order, with a smooth upper surface. When creeks or heads of channels, etc., cross their line, foot bridges should be provided. Towpaths under canal bridges should be laid out so that the rub of the towline against the corners of the abutments may be made as light as possible; it cannot be altogether avoided, but it may be reduced from being a material obstruction to a slight inconvenience. The abutment corners should be protected by either vertical rollers, Fig. 91,

#### DETAILS OF ROLLER

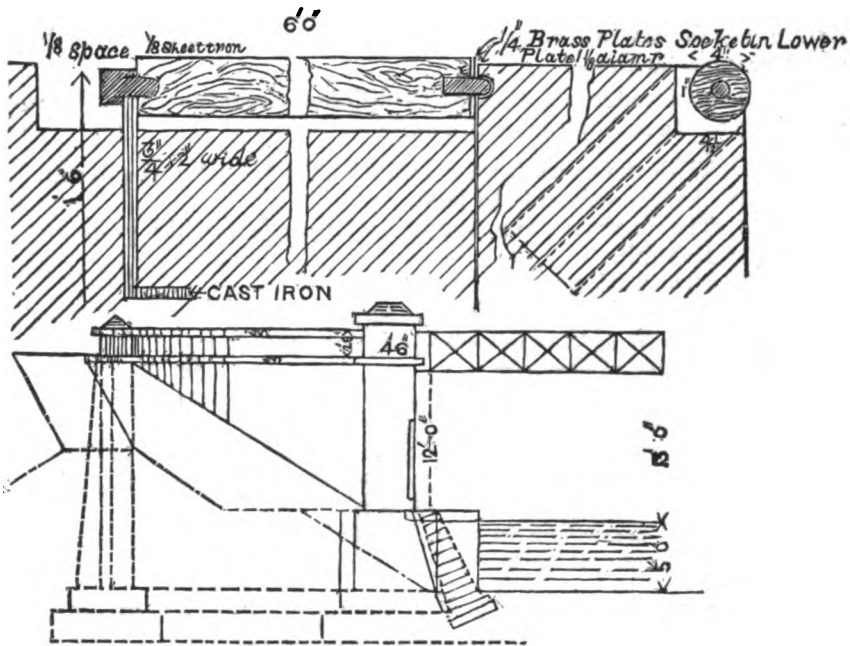

Fig. 91. Towpath Roller.

or a sheet iron plate, otherwise the towrope will cut into and disfigure the masonry.

## CHAPTER IX.

## DUTY OF WATER.

**123. Duty of Water.**—The duty of water may be defined as the ratio between a given quantity of water and the area of crop which it will mature. In order to determine what amount of water is sufficient to irrigate a given area of land it is first necessary to, at least, approximately determine its duty for the specific case under consideration. On the duty of water depends the financial success of every irrigation enterprise, for as water becomes scarce its value increases. In order to estimate the cost of irrigation in projecting works, it is essential to know how much water the land will require. In order to ascertain the dimensions of canals and reservoirs for the irrigation of given areas the duty of water must be known.

The duty of water is influenced by different circumstances and varies according to the following conditions:—

- (1) With the character and conditions of the soil and sub-soil.
- (2) Configuration of the land.
- (3) The depth of water line below the surface of the ground.
- (4) Rainfall.
- (5) Evaporation and temperature.
- (6) The method of application employed.
- (7) Length of time the land has been irrigated.
- (8) Nature of the crop.
- (9) The quantity of fertilizing matter in the water.
- (10) The experience of the irrigators.
- (11) The method of payment for the water, whether by the rate per acre irrigated or by payment for the actual quantity of water used.

Payment according to the quantity of water used is the best method of making the irrigators use the water with economy.

**124. Units of measure for Water Duty and Flow.**—In India it is usual to take one cubic foot per second as the unit of quantity, and the whole period during which a crop requires water to bring it to maturity as the time during which the flow of one cubic foot per second continues. For bodies of standing water as in reservoirs, the standard unit is the "cubic foot" and the capacity is expressed in millions of cubic feet. In America, however, the cubic foot is thought to be too small a unit to handle conveniently when considering large volumes of water, and there the unit adopted is the "acre-foot" which is the amount of water which will cover one acre of land one foot in depth, that is, 43,560 cubic feet. This seems to be a very convenient unit as it bears a direct relation to the unit used in defining areas cultivated. Hence the capacity of a tank or reservoir in acre-feet expresses a direct ratio to the number of acres which it will irrigate, or its duty per acre-foot.

In considering running streams, as rivers or canals, the expression of volume must be coupled with a factor representing the rate of movement. The time unit usually employed by irrigation Engineers is the second, and the unit of measurement of flowing water is the cubic foot per second, or the "second-foot," as it is called for brevity. Thus, the number of second-feet flowing in a canal is the number of cubic feet which pass a given point in a second of time. The period of time during which water is applied to the land for irrigation from the time of the first watering until after the last watering of the season is usually known as the "irrigating period." This is generally divided into several "service periods," by which is meant the time during which water is permitted to flow on the land for any given watering.

Each method of expressing duty is readily convertible into the other, providing the irrigating period be known. The following simple formulæ are given by Mr. R. B. Buckley for use in making such conversions:—

$D$  = duty of water in second-feet;

$B$  = irrigating period per second-foot;

$V$  = cubic feet of water required to mature one acre of crop.

$S$  = total depth in inches of volume used if evenly distributed over area irrigated;

$Q$  = discharge in second-feet required to irrigate a given area ( $A$ ), with a given duty ( $D$ ), and irrigating period ( $B$ ).

$$V = \frac{B}{D} \times 86,400$$

$$S = \frac{B}{D} \times 23.8$$

$$Q = \frac{A}{D} = \frac{AS}{23.8B}$$

**125. Measurement of Water Duty.**—The duty of water varies primarily with the crop. Rice needs more water than indigo, indigo more than wheat. It varies even more largely with the soil: sandy land—especially if the crop is rice—will take two or three times the water that clay soil will need. It varies with the season: if the rainfall is scanty, the more need for water. It varies with the condition of the channels: flat shallow channels necessarily give smaller duties than steeper and deeper ones. It varies with the distance the water has to be carried in the channels, owing to the loss on the road. And it varies in no small degree with the skill with which the distribution of water is managed, not only by the cultivators, but by the canal officers.

In considering the duty of water care should be taken to show whether it is reckoned on the quantity of water entering the head of the canal or the quantity applied to the land, since the losses by seepage, evaporation, etc., in the passage of water through the canal are considerable. Thus, if in a long line of canal, the duty at the head is estimated at 150 acres per second-foot, and the losses by seepage and evaporation are 33½ per cent., the duty would be reduced to 100 acres at the point of application. Careful measurements made on various canals in India show the loss of water between their heads and the heads of the distributaries to vary from 20 to 40 per cent. Where duty on discharge at canal head was 53 acres, that on its discharge utilized was 72 acres, while the duty on the distributaries on their discharge at outlet was 104 acres per second foot.



**126. Quantity of Water required and used per Acre for the Cultivation of Rice Crops.**—Statistical information on these subjects based, as regards the quantity of water required, on specially conducted experiments, and, for the quantity used, on carefully maintained records, extending over a sufficiently long period, and embracing different descriptions of soil, variations of rainfall, and other local circumstances is essential to the successful designing of irrigation projects, and to their efficient and economical management when completed and brought into use.

There has been, for a very long period, a generally accepted rough estimate of the quantity of water usually needed by rice crops, after these have been sown or transplanted, on soils of an ordinarily retentive character, such as are the paddy fields of a large part of the irrigated tracts of country; and this quantity was formerly expressed as 2 cubic yards per acre per hour, or, according to the present notation, 0.015 of a cubic foot a second per acre, equivalent to 1/2 cubic foot a second for 66 2/3 acres; and this estimate is perhaps, as an average, as accurate as any such general estimate could be reasonably expected to be. A reason why such an average may be applicable to soils varying very considerably in composition is the circumstance that, in the preparation of the land, for sowing or transplanting, the ground is ploughed up under, or with a very large quantity of water, and is brought to the consistency of semi-liquid mud; as a consequence, all but very sandy soils become more or less puddled, and are very much less absorbent than they would be in their natural state.

It is, however, certain that there are very material differences in the quantities of water really required during the time that a crop is under cultivation, on different soils; and, without considering soils too much in detail, it is very desirable that definite information should be obtained on this subject as regards the several classes of land adopted in the Revenue Settlement Department, for the purpose of fixing assessments.

The following figures taken from the Administration Report of the Irrigation Branch of the Madras Public Works Department for 1901-1902 will show how the duty of water varies:—

Name of Canal.	Acres irrigated per cubic foot per second.		
	Discharge at head.		
Gódávari Delta System .. .. .	108	30	
Kistna .. .. .	193	80	
Pennéru River Canals Systems .. .. .	173	30	
Kurnool-Cuddapah Canals .. .. .	69	49	
Cauvery Delta System .. .. .	54	37	
Srivaikuntam Anicut System .. .. .	64	56	

**127. Actual Water Supply of Canals and Channels.**—The water supply in channels is ascertainable in several ways. It can be readily calculated at head sluices from the head, or difference of level of the water above and below a sluice, and the area of waterway open; or it can be deduced from the depth of water in the channel itself, in connection with the dimensions and fall of the channel. When the supply of a channel is regulated by a head sluice, the former means will be the more convenient, but in some cases the distribution on division

of the supply is effected by dividing dams, and the difference of level of the water above and below such dams is often so small as to be incapable of being estimated with sufficient accuracy from the readings of ordinary gauges, to admit of a reliable calculation of the discharge over them. It will then be better to estimate the supply from the depth in the channels. When, moreover, as is the case on navigable and other canals and channels, the supply of a reach is passed over a lock, or other weir, the quantity of water can be determined from the formula for weirs. To enable the supply to be conveniently ascertained from the depths, or water-level in a channel, either tables may be framed to show the discharge at all depths up to full, or maximum, supply-level or, as will be easier and better, a curve representing graphically such discharges may be plotted, and then the supply corresponding to any depth can be at once read off. For the delta canals, daily water reports are forwarded to the Divisional Engineer, and contain detailed information as to the actual circumstances of the water supply at all points where there are conservancy establishments to read the gauges. Similar information is available for the heads of all main channels supplied by anicuts on which conservancy establishments are maintained, and also for the principal branch channels as often as the regulation has to be adjusted. With works differing so greatly in character and arrangement as do the principal systems of irrigation in different parts of Madras, it will not be practicable to exhibit the same extent of information for all, but the variation will be rather as to detail than otherwise; and, while in the Gódávári and Kistna deltas, the supply of each day will be ascertainable, elsewhere the intervals between successive observations and record will generally be much longer, and consequently the resulting information less accurate, though still of much value.

The next thing to be done is to show, for comparison with the water supply, the area under irrigation. This will be capable of being done with greater completeness and accuracy for some systems than for others, and most so for the Gódávári and Kistna deltas. Everywhere, however, whatever may be the defects in the information received during the progress of the irrigation, the actual extent of irrigation under each principal channel for the whole season will, in due course, be accurately known, together with particulars of the extent to which the area under any channel has suffered from an insufficient or, it may be, sometimes, from a too abundant supply.

**128. Comparisons of Water Supply and Area Irrigated.—** These are manifestly essential to the proper and efficient management of channels. It is better to be able to make such comparisons frequently, and to apply such corrections, or make such changes as the facts elicited indicate to be necessary, for the immediate benefit of the crops then on the land; but even when this cannot be done as promptly as is desirable, the general comparison for the season will enable the responsible officers to detect and remedy some or many defects, which would otherwise not come under notice.

When channels have surplus works, which are regulated from time to time, according to circumstances, the quantity of water passed to waste or it may be into other irrigation channels, should be duly taken into account.

In the Delta of the Cauvery, the rivers take the place of and perform the functions ordinarily belonging to canals and main channels. In recent years, regulating works provided with shutters have been built at the heads of several of the principal effluents and it is now practicable, wherever such works exist, to calculate approximately, and with fair accuracy, what the water supply of each river at any given time, and therefore throughout the season, may amount to. Certain rules, moreover, have been drawn up to guide the conservancy establishments in the distribution of the supply whatever the depth of water above the regulating works may be. The very large areas irrigated will if compared with the supply, rainfall, etc., afford information of great value as to the average quantity of water needed for effective irrigation, while, from the detailed records, light will be thrown on the question as to the variations in quantity supplied, which may be experienced without serious prejudice to the crops. The Cauvery, for several weeks in the interval between the cessation of the south-west and the setting-in of the north-east monsoon, is liable to be very short of water, and the quantity at such times available is so inadequate to the large area under rice crops that, were it not that such crops can remain without serious injury for considerable periods with little or no water, and then progress when the water becomes again abundant, a very large proportion of the crop would fail. The Cauvery delta is, therefore, from its special circumstances able to afford evidence on this point, which will be very useful in dealing with smaller systems existing, or proposed, for which the water supply may be similarly more or less liable to material fluctuations during the irrigation season.

It is the opinion of most officers interested in the question that the quantity of water supplied can be largely reduced. While there is no direct proof of this, there are many circumstances which tend to confirm it. The following are quoted by Mr. H. E. Clerk in his "Preliminary Report on the Investigation of Protective Irrigation Works in the Madras Presidency." Firstly, in 1899-1900, a year of exceptionally scanty supply in the Gódvári, the irrigated area was the largest on record, the duty as worked out having increased by nearly 50 per cent. It is no doubt a fact that there are circumstances which tend to reduce this calculated duty, but even when they are allowed for, it is probable that a very much smaller supply per acre was used in that year than in any previous year.

Secondly, the following facts supplied by the Deputy Collector on special duty on the Kurnool Canal. In 1896 owing to the large demand for water for dry crops there was a short supply in the Kurnool-Cuddapah Canal. The standing paddy at the lower end of the canal was 2 or 3 months old and received no water for a period between 10 and 14 days; much less was expected on this area, but when water was passed on to it the crops revived and on being harvested, to every one's surprise, yielded an outturn 25 per cent greater than what was usual when unlimited water was supplied.

For every system of irrigation, then, a sustained endeavour should be made to ascertain as completely as possible what quantity of water is admitted at its head; how it is distributed, what part of it is run to waste at surplus works, and whether on account of the artificial supply needed being reduced by rainfall or otherwise; what proportion the

area effectively irrigated bears to the water supply in different parts of the system, and in different systems.

Improvements in the management of irrigation works must, as far as water supply is concerned, be based on knowledge thus obtained, and the subject is one of great interest, besides being of great practical utility.

---

## CHAPTER X.

STORAGE WORKS—RESERVOIRS—TANKS—EARTHWORKS—  
SURPLUS ESCAPES—SLUICES.

**129. Classes of Storage Works.**—A storage work is any variety of natural or artificial impounding reservoir or tank for the saving of surplus or flood waters. Storage works are employed to insure a constant supply of water during every season regardless of the amount of rainfall. They may be broadly classed as reservoirs and tanks; the former term being applied to works where large volumes of water are impounded by earthen or masonry dams constructed across the natural drainage lines flowing in a valley; and the latter to smaller and shallower works formed in natural depressions of the ground or by low earthen bunds placed between ridges.

**130. Preliminary Investigation.**—Every part of the country is divided into a number of principal and minor valleys, or drainage areas; the former being those of considerable rivers, the latter those of tributaries. The first thing to be done is to obtain a good general idea of the country to be investigated. The Atlas sheets will be of considerable assistance, and the Revenue survey maps will, when available, show the character of particular tracts, and the extent of cultivation within them.

The conditions on which sites will usually be considered to be apparently favourable will be: (1) a valley with a moderate longitudinal slope; (2) moderate transverse slopes on either side of the axis of the valley; (3) a moderate length of dam, with suitable abutments at either end; (4) a probably moderate depth of water and consequently height of embankment; (5) suitable material for the formation of a bund or dam; (6) facilities for the disposal of surplus, preferentially at detached saddles with a rocky soil or sub-soil; (7) land below the site available for irrigation, and to which water could be easily conducted; (8) the absence of much or valuable cultivation, and of many small, or any important villages, within the probable area of the waterspread.

**131. Examples of Reservoir Sites—The Sweetwater Site.**—Captain H. M. Chittenden, U.S.A., who was deputed to examine sites and report on the practicability and desirability of constructing reservoirs and other hydraulic works in the States of Wyoming and Colorado says of the Sweetwater dam-site: "It stands almost without exception as the most favourable site for a masonry dam in the world." The accompanying photograph, Plate XX corroborates this statement. A gap in the ridge at one side of the dam limits the height to 100 feet, and affords a natural escape of any desired capacity.

The proposed site is situated on the Sweetwater River at a point known as the Devil's Gate, about 65 miles north of the town of Rawlins, Wyoming. The river here cuts through a granite ridge with a remarkably narrow gorge, only about 35 feet wide at the water surface,

*To face page 136.*

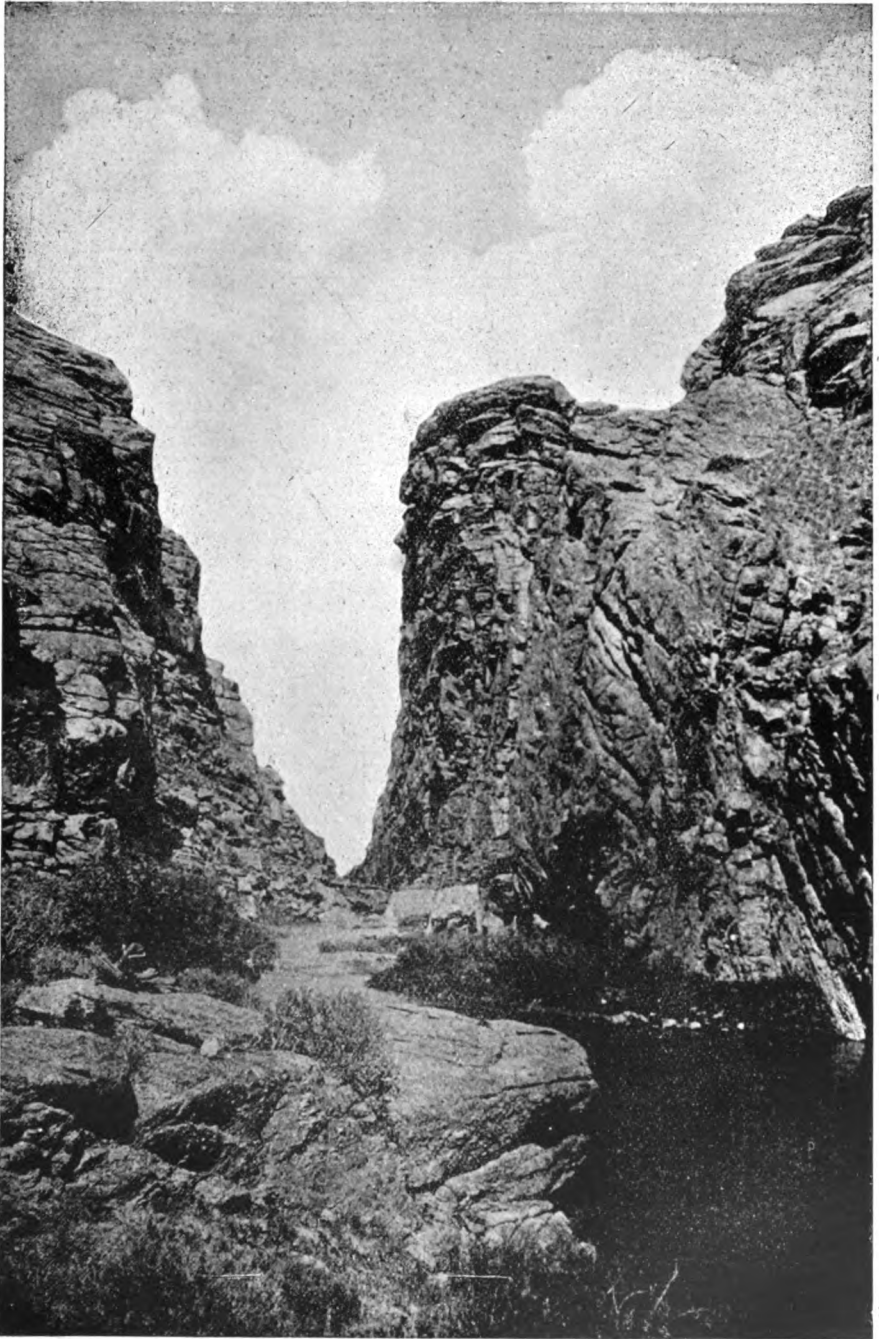

Plate XX. Sweetwater Reservoir Site.

To face page 137.

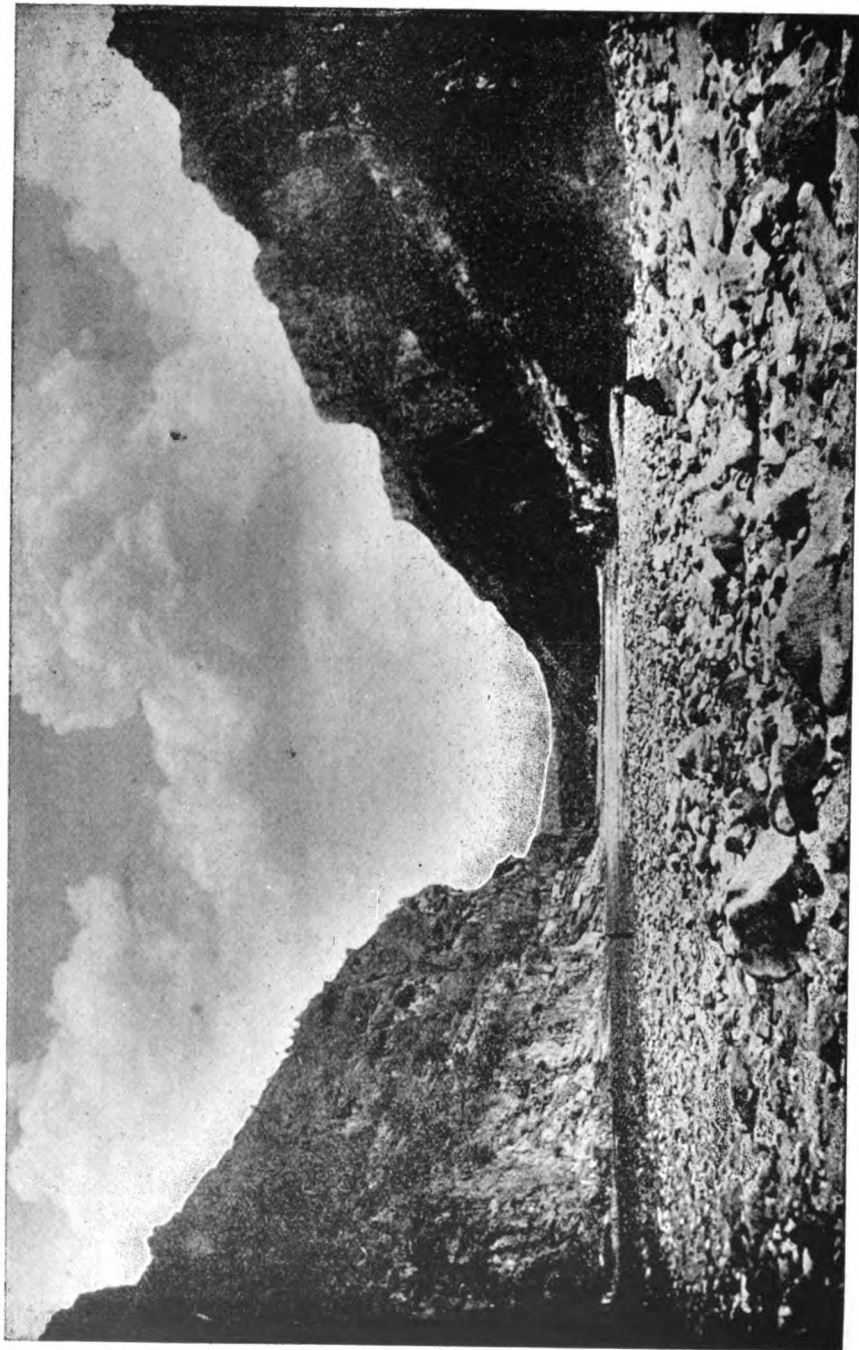

Plate XXI. Tonto Reservoir Site.

330 feet deep, and 400 feet wide on top. The top length of the dam at the 100-foot level will be but 150 feet. Here it is proposed to build a masonry dam about 100 feet high, which will form a reservoir 13 miles long, covering an area of 10,578 acres and having a storage capacity of about 14,216 millions of cubic feet. The available supply for storage is about 4,348 millions of cubic feet annually.

The profile of the dam proposed is of heavy dimensions, the base width being 94 feet, and the thickness at crest 25 feet; yet with these dimensions the entire cubic contents of the dam are but 21,534 cubic yards. The proposed outlet is by a tunnel 1,000 feet long in the solid rock around the base of the dam.

**132. Tonto Basin Dam, Arizona.**—Of all the reservoir projects for irrigation storage in the State of Arizona in America, the most extensive is that of building a high masonry dam on Salt River and converting the great Tonto Valley into an enormous reservoir, covering 14,200 acres and impounding over 43,400 millions of cubic feet of water, Plate XXI. The dam proposed will be 200 feet above the ordinary low-water level of the stream. The extreme height of the dam above foundations will be 250 feet, and its length on the top will be 647 feet, measured on the arc of its curvature upstream, which is to be on a radius of 818.5 feet.

**133. Designs.**—The design for a reservoir will include: (1) the dam; (2) the surplus weirs, or arrangements for disposing of surplus; (3) the sluices; (4) the distributaries.

**134. Earthen Dams or Embankments.**—The choice of the material of which the dam should be constructed, whether it shall be earth, masonry, or loose rock, is dependent largely upon the character of the foundations and cost of carriage of materials. Earthen dams, when well constructed, are as substantial as those of masonry, and in many cases they are more so. In countries subject to earthquakes, or where the rock foundation is not thoroughly homogeneous, earthen dams are preferable to those of masonry. They are usually cheaper, and where no facilities exist for the transport of material, they are much cheaper. Provided a substantial escape of sufficient capacity to carry the greatest possible flood be provided, an earthen dam is generally to be preferred in mild, damp climates. In warm, dry climates they are liable to dry and crack. For reservoirs over 100 feet in depth masonry dams are to be preferred, as earthen dams are nearly as expensive.

As already stated the choice between the two depends largely on the foundation, a substantial masonry dam cannot be founded on loose gravel or soil; an earthen dam, on the contrary, should rarely be founded on rock, owing to the difficulty of making a water-tight joint between it and the earth.

**135. Foundations of Earthen Dams.**—The foundation of an earthen dam should be examined with great care. The best material on which to found it is sandy or gravelly clay, fine sand or loam. The first thing to be done in preparing the site of the dam is to clean off all soil, removing it to a depth equal to that penetrated by the roots of the grasses, bushes and trees. If firm and impervious, the soil may be scored by longitudinal trenches, which will give the proper adhesion between the foundation and the embankment, and prevent the slipping



of the latter. If a puddle wall or masonry core is to be built into the dam, the foundation for this should be sunk to a suitable depth to secure its permanence. If the dam is to be constructed without a central core and the foundation material exposed is not impervious, a trench should be dug and filled with some puddle material as clayey gravel, or gravelly loam, moistened and worked in layers.

**136. Masonry Cores and Puddle Walls.**—There is still a wide difference of opinion among engineers as to the best type of earthen dam. Occasionally in England and in America earthen dams have been constructed entirely of earth, the front or water face being covered with a deep layer of some puddle material. This practice, however, is falling into disuse, and engineers now rarely trust to a puddle face alone for protection against leakage.

The masonry core is in great favour with many engineers, both in Europe, America and India. A centre core of puddled earth is liable to rupture from the settlement of the embankment. Both are practically impervious to leakage. In building them they must be carried sufficiently deep to reach some impervious stratum, and far enough into the side walls of the valley to prevent the passing around their ends of seepage water which would travel along their impervious faces.

The earthen dam with masonry core is probably the most popular at present, especially for very high dams and those with which other masonry structures combine, as masonry surplus weirs, or extensions of the dam, for then a safe bond can be made between the core wall and the adjoining masonry work. Magnificent examples of such works have recently been built in America for the water-supply of the cities of Boston and New York.

Engineers in India favour the earthen dam built up in layers, each carefully rammed or trodden by the feet of the work-people in such a manner that the whole dam is a dry puddle wall. This character of construction has all the advantages of imperviousness to leakage if the work is well done, while it is free from the disadvantages possessed by dams with central cores, namely, a smooth surface along which water may travel, and liability to rupture in the wall. This liability to rupture is, however, very slight. Still an earthen dam, built in layers in the manner described, is one of the simplest and cheapest to construct and may be so built as to be practically indestructible. With such a form of dam a trench is usually excavated in the centre of the foundation and filled with puddle material to prevent leakage under and around the dam, and the material used may be so placed that the finer and least pervious constituents shall be in front, and the heavier and coarser materials in rear of the dam. Such a form of construction practically converts the dam into one having an impervious face of great thickness.

**137. Masonry Cores.**—The masonry core should be brought up to a level with the crest of the surplus weir, and in very high dams it would be advisable to raise it to M.W.L. It should be as thin as possible in order to reduce its cost, yet as some movement may take place in the embankment owing to settlement, it should be heavy enough to be self-supporting. A safe and usual rule is to give it a top breadth of 4 or 5 feet and to increase its thickness towards the bottom at the rate of about 1 foot in 10. This centre wall may be composed

of the best hydraulic masonry, preferably of concrete composed of sharp broken stone, mixed with clean sharp sand and Portland cement. Concrete, however, is not essential; rubble in cement is equally good, and ordinarily quite as convenient and satisfactory. An excellent example of a masonry core or centre wall, for an earthen dam is shown in Fig. 92.

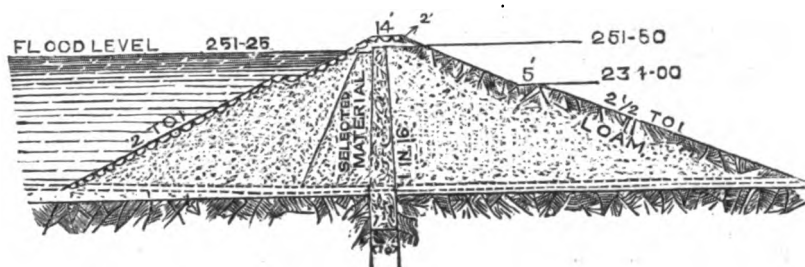

Fig. 92. Earthen Dam with Masonry Core.

**138. Homogeneous Earthen Embankment.**—This type of dam is considered by many engineers as the most safe and efficient as well as economical. If enough impervious material cannot be had to build the whole structure up homogeneously in layers, the up-stream third or half should be built of the best material available, the poorest and heaviest being put on the lower side, and the two classes of material should be well worked into one another so as to obtain perfect bonding. The earth should be disposed in layers the full width of the embankment and from 6 to 15 inches in thickness; each layer being well consolidated by ramming or preferably by being well trampled by the feet of the work-people. In building a dam up in layers in this way the layers should be so disposed that the outer edges or extremities of each layer should be higher than its centre by from 2 to 4 feet.

The ideal material of which to construct an earthen dam is such a mixture of gravel, sand and clay that all the larger interstices between the particles of the former shall be filled by the sand and that all the minute openings in this material shall be filled by the still finer particles of clay. This would give such a composition that the water would pass through it with the greatest amount of resistance, and the bank would be practically impervious. In practice, with proper care in mixing the materials so as to thoroughly incorporate them, the following proportions should be used:—

	CUBIC YARD.					
Coarse gravel	..	..	..	..	..	1.00
Fine gravel	..	..	..	..	..	0.35
Sand	..	..	..	..	..	0.15
Clay	..	..	..	..	..	0.20

Giving a total of about 1.70 cubic yards, which when well mixed and consolidated will be reduced to about  $1\frac{1}{4}$  cubic yards in bulk. These proportions can rarely be obtained, but no effort should be spared in order to approach them as nearly as possible in order to produce the best combination of materials. If judgment be used in choosing materials, dirty gravel, or that possessing a large amount of soil and

sandy matter may often be found which will give nearly the proportions above specified.

**139. Tanks.**—Tanks used or intended for irrigation are divisible into two principal divisions, viz. (1) isolated tanks, and (2) connected tanks forming groups. Isolated tanks are those which neither receive water from, nor discharge water into, other tanks. In the Madras Presidency they are a comparatively small and unimportant class. On the other hand, groups of tanks are very numerous, and the number of tanks in a group is often large.

Tanks are further distinguished by their source of supply as rainfed and river-fed tanks. The former are supplied exclusively from the catchment basins in which they are situated; the latter receive more or less water from such catchment basins, but are also in part supplied from streams or rivers draining other, and generally more extensive areas than those lying above the tanks.

**140. Grouping of Tanks.**—Figure 93 shows the arrangement of a group of tanks. The sub-groups should be taken in their order from left to right looking up the basin from the terminal tank, *e.g.*, 1 is the terminal tank giving its name to the group; 2, 6, 11, are the terminal tanks of sub-groups.

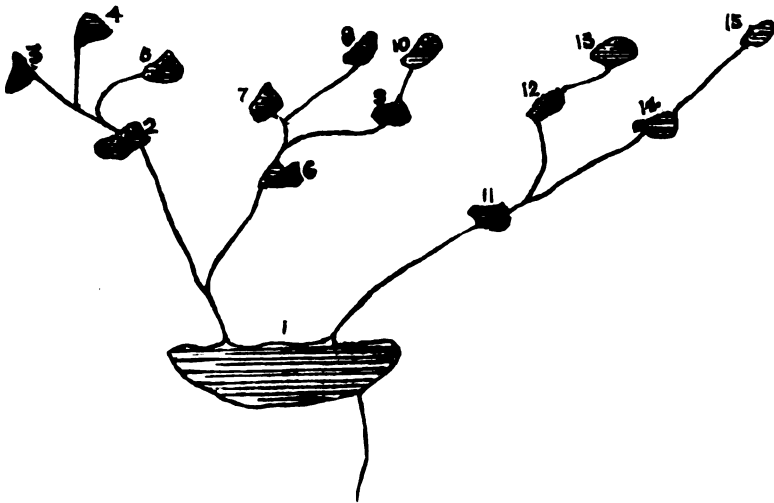

Fig. 93. Grouping of Tanks.

In the case of river-fed tanks the sub-groups are named from the supply channel; and if the channel has direct irrigation under it it will also be numbered.

**141. Repair and Improvement of Tanks.**—Every tank should be placed and maintained in a state to insure its safety and its efficiency for the duty it has to perform.

Its safety depends upon—(1) the bund or dam being high enough, thick enough, water-tight, and capable of resisting the action of the water on its inner face or slope; (2) the sufficiency of the weirs for the

discharge of surplus or flood water; (3) the suitability and sufficiency of the sluices for the supply of the field channels.

The two levels which are of primary importance in settling the details of all tanks are the full-tank level (F.T.L.) and the maximum level (M.W.L.) to which the water may be allowed to rise for the discharge of surplus. On the former level depends the capacity of the tank and its efficiency as an irrigating work. In a large number of cases the F.T.L. cannot be raised without submerging private property, and in this place, therefore, the improvements referred to will be understood to include only such as are necessary to make a tank safe and efficient, without providing for an increase of capacity, which subject will be separately dealt with.

As a necessary preliminary to the determination of the work to be done to a tank, a line of levels along the bund, with cross sections at moderate intervals, varying from 100 to 250 feet according to the regularity or irregularity of the earthworks, should be taken. On the longitudinal section should be shown the lengths and crest levels of the surplus weirs, the levels of the sills of the sluices, the height to which each part of the revetment (if any) extends, the present height of the top of the bund, the ground levels inside and outside the bund, the F.T.L., the M.W.L., and the intended levels of the top of the revetment and the top of the bund when these have been determined.

The proper existing F.T.L. should be carefully ascertained. More or less reliable evidence is to be found in the water-marks on the sluices, revetments, and upright stones of calingulahs, and these can be compared with the accounts given by the village officers; while, in surveyed districts, the waterspread of the tank, as shown on the village map, will be an additional guide. A variation of a few inches only being a matter of material importance, the settlement of the proper F.T.L. should invariably be made with great care, and the evidence on which it may be determined should be fully explained in the field book in which the levels may be recorded.

The next matter to be considered is the M.W.L. Upon this depends the greater part of the general arrangements, and in settling it there are several points to be taken into account. When facilities exist for the provision of long surplus weirs; when the bund is long, and low with reference to F.T.L.; and when it is not of special importance in connection with the safety of tanks lying further down the catchment basin or valley, to make the tank as far as possible an effective flood moderator, a small difference between F.T.L. and M.W.L. is generally desirable. The difference may then be conveniently fixed at 2 or  $2\frac{1}{2}$  feet, and it should but seldom exceed 3 feet, while very rarely will the circumstances necessitate a greater difference than 4 feet.

**142. Supply from Catchment Basins.**—The formula employed is  $Q = cM^{\frac{3}{2}}$ ,  $Q$  being the discharge in c.f.s.,  $M$  the drainage area in square miles, and  $c$ , a constant depending on the nature of the ground and other local considerations.

Where, however, a portion of the area  $M$  is occupied by other tanks, the co-efficient should be as high for that portion as for the free area which drains directly into the tanks concerned, inasmuch as the tanks above operate to some extent as regulators and moderators of the discharge.

In such a case it is desirable to employ the following formula :  $Q = CM^{\frac{2}{3}} - cm^{\frac{2}{3}}$  where  $M$  is the whole drainage area and  $m$  the portion of it which is occupied by the tanks above, the difference between  $M$  and  $m$  being the ' free area ' or area draining directly into the tanks under consideration ;  $c$  is one-fifth of  $C$ .

As stated above the co-efficient  $C$  must depend on local circumstances. For the Chingleput district it is 500. The same co-efficient is used in the Madura district except in the Cumbum valley where  $c = 600$  and on the Pulney Hills where it ranges as high as 1,000.

When a tank obtains part of its supply from a river or stream and when the supply channel has a head-sluice and does not receive any material accession of water from land drainage crossed by it in its course, the determination of the supply will easily be made.

**143. Method of Computing Areas of Watersheds, etc.—** The following method of calculating areas has been largely used and found to give fairly accurate results.

It is based upon the well-known principle, that if a line  $A, B$  (Figure 94) be drawn in any convenient position across a figure whose area is to be calculated, and divided into any number of equal parts, lines at right angles to the main line being drawn across the figure, the area of the figure is approximately equal to the sum of the lengths of the cross lines multiplied by the distance between them ; the risk of error diminishing as the number of cross lines increases.

To draw the lines for every figure whose area requires to be calculated is tedious and not always desirable where finished drawings are concerned, but by having a piece of tracing cloth or paper with

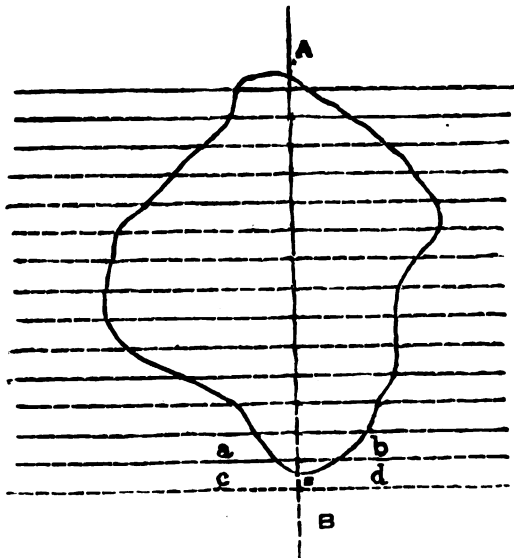

Fig. 94. Method of computing areas.

lines ruled across it at uniform intervals, it can be laid on any figure and the area of the latter can be calculated without the necessity of ruling lines on the figure itself.

The most convenient distance apart for the cross lines is a quarter of an inch, which will be found close enough in almost all cases. The total length of the cross lines, in inches, divided by 4, gives the area in square inches which can be reduced by a simple multiplication to any unit required according to the scale of the plan.

Where the object is very regular the length of every second cross line only need be taken, if saving of time be an object. In this case of course the area is the sum of the length divided by 2.

In applying the ruled tracing paper to the figure, the following points should be attended to. First one cross line should be made to fall upon a point at the upper end of the figure. If the lower end of the circumference of the figure falls upon another cross line, no further correction is necessary: but if not a deduction must be made according to the distance at which it comes from the last cross line. Thus in the sketch shown in Figure 94 one cross line is made to fall upon the point A. If the point B be half way between  $ab$  and  $cd$ ; one-fourth the length of  $ab$  should be deducted from the total. If two-thirds from  $ab$  one-sixth should be deducted, or in general terms, whatever the proportion which the distance of B from the line  $cd$  bears to the distance between the lines, half that proportion of  $ab$  should be deducted from the total. The eye is capable of judging with quite sufficient accuracy of the amount of correction to be made on this account, which moreover is always small as compared with the total area.

**144. Capacity for Storage.**—The capacity of a tank for storage purposes is the quantity of water it is capable of holding between the level of the sill of the lowest sluice and full supply level (F.T.L.).

This capacity can be determined by running a contour at the level of sill of lowest sluice and another at F.T.L. with a sufficient number of cross sections between the two contours to admit of the laying down of contours at intervals of 1 foot (vertical). The cross sections should be taken in two sets, which should be at right angles to each other, *e.g.*, one set in a north and south direction, and the other set east and west. A convenient distance apart for cross sections is 500 feet, the squares then formed would measure a quarter of a million square feet each.

An approximate method is to ascertain the area of waterspread of tank at F.T.L. and to multiply this by one-third of difference between F.T.L. and level of sill of lowest sluice.

**145. Irrigating Duty of Water.**—The 'duty' of water may be defined as the area of crop which can be matured by a given quantity of water. This of course varies primarily with the crop. Sugar-cane needs more water than rice, rice than indigo. It varies even more largely with the soil; sandy soil—especially if the crop is rice—will take two or three times more water than clay soil will need. It also varies with the season; if the rainfall is scanty, more water is needed. It also varies with the condition of the channels; flat shallow channels necessarily give smaller results than steeper and deeper ones owing to their greater absorption and evaporation.

In Madras, where the irrigation is almost entirely confined to rice, it is the general rule that the duty of water in large channels may be taken as 86 acres to the cubic foot.

In Tank Restoration works the discharge to be allowed through tank sluices is taken at 0.015 c.f.s. per acre.

**146. Tank Bunds.**—Earthen embankments of great height need to be founded with at least as much care as those of masonry. The surface soil should, in all cases, be removed and the nature of the strata below should be carefully examined by borings to see that the soil is homogeneous, sufficiently impermeable to water, and capable of bearing the pressure which will be brought upon it.

The height of the bund above M.W.L. should be sufficient to provide against error in estimating the maximum quantity of water to be disposed of. It should never be less than the difference between F.T.L and M.W.L., or, in other words, the height of the bund above F.T.L should not be less than double that difference. The direction of the prevailing winds, at the time of the year when the tank may be expected to be full needs also to be taken into account. If these blow directly on to the bund, this may need to be made specially high, at any rate along those parts where the water is deep, and where, therefore, the waves are likely to be high. Something, too, will depend upon the slope and description of the revetment, *i.e.*, whether this may have a smooth or rough surface, and be flat or steep, for with a smooth flat revetment the waves will run much higher up the slope than when it is steep and rough.

Every bund should be in itself quite water-tight, and when the soil of which it is made does not secure freedom from leakage, the insertion of a core wall of puddle is the only effective remedy. Not unfrequently moreover, the soil on which a bund stands is more or less porous, and then not only must the puddle wall be carried down to a sufficient depth below original ground surface, but provision must be made for carrying off any water which may pass under the wall, so as effectually to prevent soakage into the base of the rear part of the bund, and the instability which saturation would be liable to produce. For the effective closing of breaches, puddle walls will generally be necessary, even when the soil may be fairly good.

The top width of a bund should not be less than 4 feet anywhere, and while that width will suffice for the ends of the bunds of comparatively shallow tanks, the width at the deeper parts of these should be 6 feet; 9 to 12 feet will be proper top widths for the bunds of large tanks, and for very large reservoirs, one-fourth of the depth of water is the prescribed minimum for the deeper parts, and 8 feet that at the ends.

The top of the bunds, of which the front slope is revetted, should always slope towards the rear edge, so that rainfall may flow off down the rear slope, and not on to the revetment with the risk of washing out the backing of the latter: 1 in 6 for earth, and 1 in 20 for gravel, will be suitable gradients for this top slope.

It is desirable to gravel the tops of bunds, after they have been brought to their full height and section and have become fairly consolidated, whenever gravel is procurable at a moderate cost.

The gradient of the interior or front slope of a bund will depend upon the description of protection against wash to be provided. Revetted slopes range from  $\frac{1}{2}$  to  $1\frac{1}{2}$  to 1; for shingled slopes 2 or  $2\frac{1}{2}$  to 1 are suitable; for earth slopes to be planted with nanel grass, a steeper slope than 2 to 1 would, in the absence of a foreshore at not more than

6 feet below F.T.L., make the width of the belt of grass too small to be effective as a breakwater. Mere turfing is useless below M.W.L.; but turf revotment, *i.e.*, sod walls built up at 1 to 1, may be an efficient substitute for stone or shingle in situations where these are not procurable within a reasonable distance or cost.

The gradient of the exterior or rear slope will vary in different localities, according to the nature of the soil, from  $1\frac{1}{2}$  to 1, which is the steepest allowable, to 3 to 1, which is the flattest necessary.  $1\frac{1}{2}$  to 1 and 2 to 1 are the usual gradients. When good soil is available for dressing the rear slope to a depth of about 6 inches, root grass should be dibbled in; otherwise a coating of gravel will be the most suitable protection. Turfing with sods laid flat on the slope is seldom worth the cost, and should not be done unless there be conservancy establishment attached to the tank.

SECTION OF COMPLETED BUND

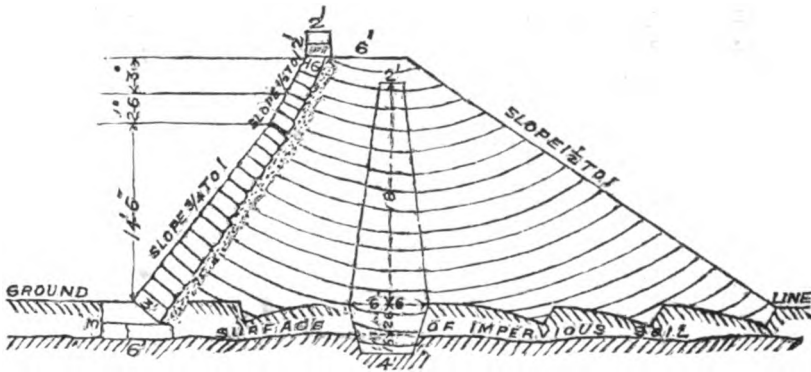

Fig. 95. Section of bund with puddle wall.

**147. Puddle Walls.**—In Southern India at any rate whatever may be the practice elsewhere, the best position for a puddle wall is at or about the centre of the embankment. It is of primary importance that the wall should not get cracked during the considerable periods in each year that tanks are either dry or the water in them at a low level, and the greater the thickness of earth on either side of the wall, the greater the probability that it will be kept in water-tight condition. The positions shown in Figs. 95, 96 and 97, are appropriate. The most suitable material for puddle walls is clay of the description used for tile-making. It must be well tempered, and puddle should not be made too wet: if a little drier than that for table-made bricks it will do well. Any excess of moisture, beyond that needed to allow of the entire wall being worked into a homogeneous mass, would increase the risks arising from settlements, disturbance from lateral pressure, etc. The top width of a puddle wall, whatever its height, should be 2 feet. The top level should be 1 foot above M.W.L. as a rule; but never higher than 2 feet below the level of the top of the bund. The wall should have batters (equal) on the two faces. If the puddle be very good, batters of 1 in 8 will suffice to secure adequate thickness throughout: otherwise they should be 1 in 6. The thickness of the wall at base, *i.e.*, at ground level, will be



$2 + \frac{2h}{b}$  in which  $h$  is the height from ground to top of wall, and  $b$  is the batter, e.g., height of 20 feet, batter 8 to 1; the thickness of base 7 feet. The figures fully explain the manner of construction. The special precautions needed are the prevention of any of the soil used in forming the bund from being thrown over the puddle; if accidentally any soil be so thrown it must be completely washed off; the prevention of the drying of the upper surface of the wall while under construction by covering it with 2 or 3 inches of water when work is suspended either at midday or in the evening—*vide* Fig. 96, or the removal of all dried puddle before any more is added; the battered faces of the wall

TOP OF PUDDLE WALL WHEN LEAVING OFF WORK FOR THE DAY. SHOWING AT (A) THE RAISED SIDES TO RETAIN WATER AT THE TOP, (B) THE WAY IN WHICH THE JOINTS BETWEEN SUCCESSIVE LAYERS OF PUDDLE SHOULD BE MADE, AND (C) THE WAY IN WHICH THE EARTHWORK SHOULD BE MADE UP

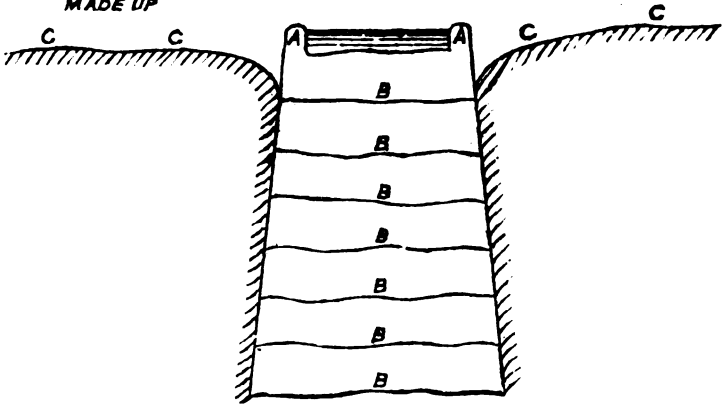
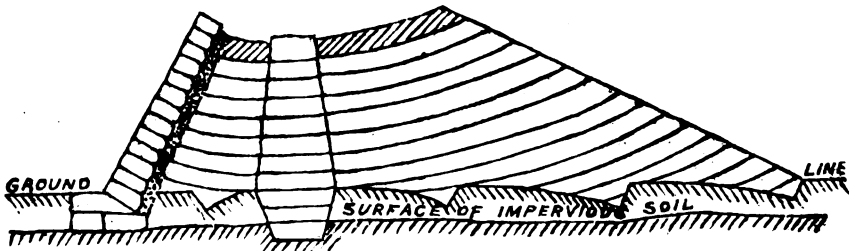

Fig. 96. Puddle wall.

should be prevented from drying by making up the earthwork as shown in Figs. 96 and 97, this work being well watered and rammed.

SECTION OF BUND IN PROGRESS



THE CROSS HATCHED PART SHOWS THE WORK LAST DONE AND ANOTHER FOOT OF PUDDLE WALL WOULD NOW BE ADDED

Fig. 97. Puddle wall.

The foundation of the wall must be carried down to an adequate depth below ground surface, viz., to 1 foot at least into clay or impervious soil; to 4 feet into more or less pervious soils. The cross-section of the foundation trench will be as wide at top as the base of the puddle wall, and somewhat narrower at the bottom, being cut with batters or side slopes of 1 in 3 or 1 in 4.

When puddle walls have to be founded in gravelly soil, on shale, stratified or decomposed rock, all of which are more or less pervious to water, provision must be made for carrying off any water which may pass under the foundations of the puddle wall, by means of a longitudinal drain, placed close to the base of the wall in rear, and transverse drains therefrom at intervals, which will vary accordingly to the extent of sub-soil leakage to be carried off. Fig. 99 indicates the arrangement.

In some cases an additional longitudinal drain, half-way between that against the puddle wall and the toe of the rear slope, may be found necessary or desirable. All drains under the bund should be filled with small stone about 4 inches in diameter, and irregular in shape. Turf sods should be laid over the stone at the top, and at the sides also so far as these may be above ground-level. When the fall of the ground in rear of the bund is considerable, *i.e.*, not less than 1 in 50, the cross-drains should be cut to their full intended depth into the ground; when the fall is too slight for this, they may be, at their upper ends, partially or wholly above ground level. The longitudinal drains and the transverse drains must be at the same level where their directions cross or intersect.

When puddle walls are constructed, or inserted, at special parts of bunds, whether breaches, leaky places, or otherwise, care must be taken that the ends of the puddle wall are carried into sound non-porous soil, and a good joint made.

**148. Puddle Faces.**—As before stated a puddle face is rarely employed. Where it has been used it consists generally of a covering on the whole inner face of a layer of puddle of 8 or 10 feet in thickness at the base and 2 or 3 feet in thickness near the top and on the whole is placed a layer of ordinary soil and gravel backing in which the revetment is laid. One of the most serious objections to puddle facing is its liability to slip if the water is drawn off from the reservoir so quickly as not to give it time to dry, for this is a slow process with so close-grained a material as a puddle of clay. Fig. 98 shows a modern dam with puddle facing.

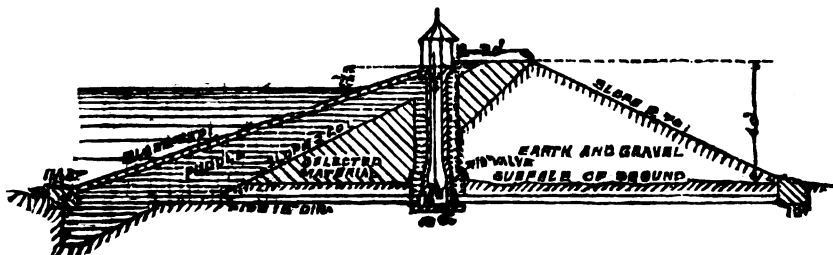
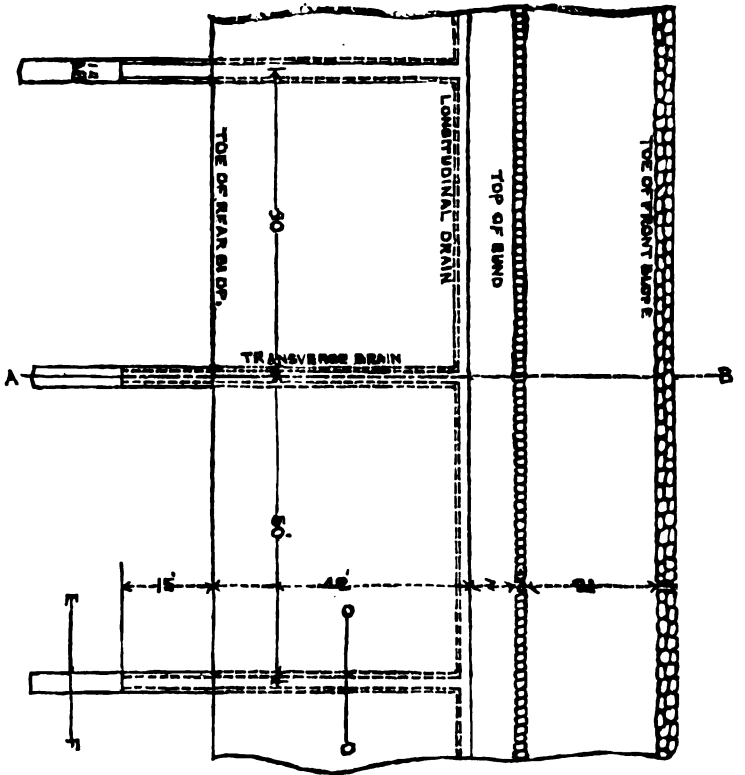

Fig. 98. Earthen bund with puddle face.



SECTION THRO: A.B

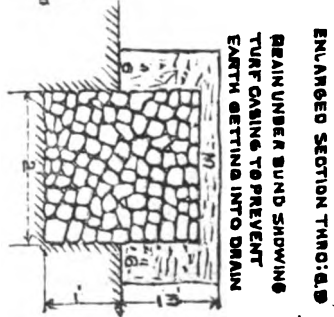
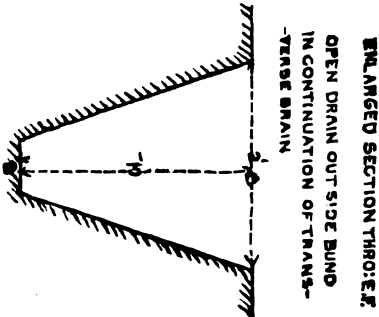
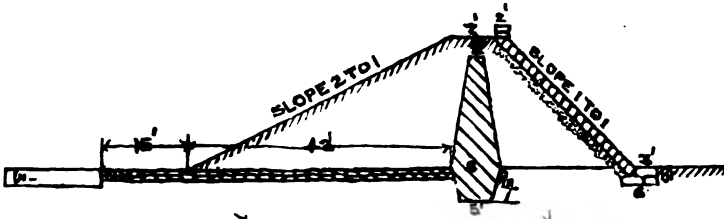

Fig. 99. Drainage of Tank Bunds.

**149. Scour-holes.**—Scour to a considerable depth below normal ground level is often the result of a breach in the bund of a tank, and this scour may extend beyond the line of the rear toe of the bund, *i.e.*, of the line where the plane of the rear slope intersects ground level. Scour-holes must always be unwatered and all soft mud removed before the filling in of a breach is commenced. Extended scour in front of the inner slope of a bund need not generally be filled in, but such scour in rear of a bund should always be carefully filled up to ground level and thoroughly consolidated, unless a cut can be made from the bottom of the hole so as to drain it completely, and this alternative is seldom feasible.

**150. Revetments and Substitutes therefor.**—The most satisfactory protection to the waterside of an embankment or dam would be a masonry wall of a section similar to that used for quay walls, escarp and counterscarp walls, etc. The cost would, however, generally be too great, and the next best arrangement is a facing or revetment of uncemented stone, with a backing of small stone and gravel. This backing is of much importance, and should never be omitted when constructing revetments. The description of revetment, or, in other words, the disposition of the stone, should depend upon the character of the latter. Stone of regular shape, and of a length equal to the thickness of the revetment may be built in steps: that which is more or less irregular, but of good length, will answer well, if laid with the length at right angles to the slope. For pitching, the irregularity of the stone is not only unobjectionable, but it is desirable that the exposed surface should be as rough as possible. For shingling any small stone will do.

In the case of the more regular revetments, a thickness at M.W.L. of  $1\frac{1}{2}$  feet will suffice for ordinary tanks, and somewhat less at the top: the thickness at other parts will depend upon the form of section and the illustrative diagrams will show what is necessary in each case.

With regard to pitching, which is always laid on a flat slope with the length of the stone either at right angles to the slope or pointed somewhat downwards, *i.e.*, nearer to the horizontal, a good arrangement

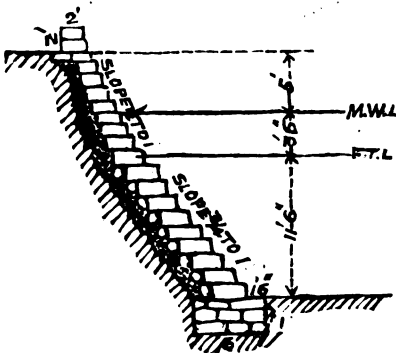

Fig. 100.

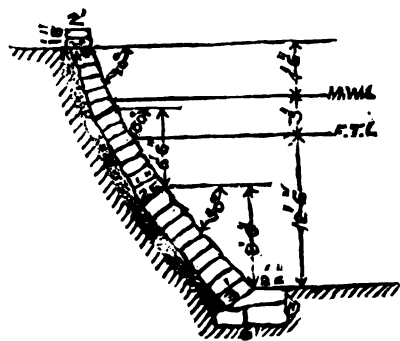

Fig. 10

Different forms of Revetments.

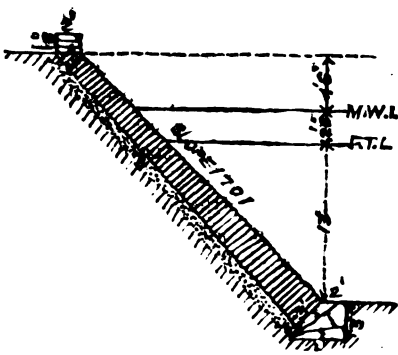

Fig. 102.

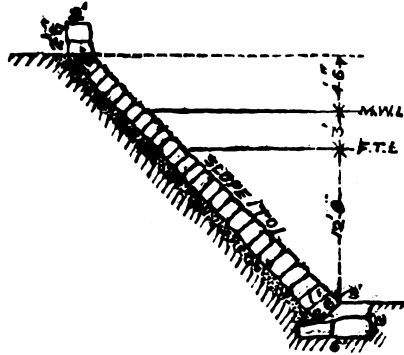

Fig. 103.

Different forms of Revetments.

is to lay down a course of the longest stones available at the foot of the slope, then to pack a height (or width) of 3 feet measured on the slope with stone of the minimum length admissible (probably 1 foot), then another course of long stones, and so on. The whole surface should be rough and the front edge of the long stones should project 3 or 4 inches beyond the rest of the work. Every care should be taken to bed each stone securely in the backing and to pack the stone as tightly as possible.

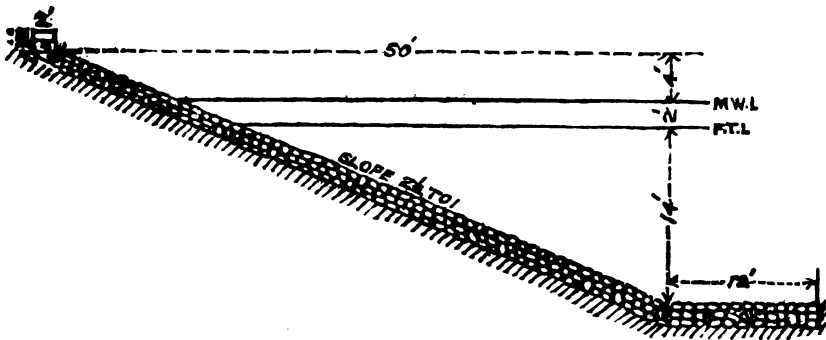

Fig. 104. Slope of bund shingled.

For shingling slopes the stone has to be merely laid down on the slope, commencing from the bottom, and spread evenly, with the depth or thickness prescribed, which depth will depend on the character of the waves, the action of which is to be resisted.

In some parts of the country suitable stone is either not to be found at all, or the distance from which it has to be carted is so considerable as to render the cost of stone revetments prohibitive. On the other hand, the water slopes of bunds will not stand without protection, and the extensive foreshores, which have been formed at all old unrevetted tanks by the continual washing down of the material put into the bunds, are evidence that it would be hopeless to expect them to stand.

The best substitutes are—

(1) *Nanel* facing, or, as it is called in Tanjore, *durbah* revetment with also a plantation of nanel grass 12 or 15 feet wide, or as much wider as circumstances will allow. This is a very efficient protection when the soil is suited to nanel, and the latter is procurable. Nanel will not grow in sour soil, and it must not be submerged for long, but if the upper ends of the leaves be always above water it will thrive. It should therefore be generally confined to parts of the slope and foreshore which are not more than 6 feet below F.T.L. This revetment is made with rolls of grass about the size of small fascines, say, 5 or 6 inches in diameter, and to prepare these, young and supple grass is laid on the ground, covering an area of 6 or 7 feet by 9 or 10 feet, the latter being the intended length of the fascine, and the former the length of the grass; some more grass is laid transversely upon the first layer, the surface is sprinkled with earth, and the whole is rolled up in the direction of the grass of the underlayer, and tied so as to form a roll about 6 inches in diameter with 3 or 4 feet of the grass projecting. These rolls are then used as a revetment at a slope of 1 to 1, or from that to  $1\frac{1}{2}$  to 1, the free ends of the grass being laid in the earthwork, which should be carried up concurrently with the revetment (*vide* Fig. 105); if kept well watered until established, the grass will grow strongly and will withstand a strong current or wash.

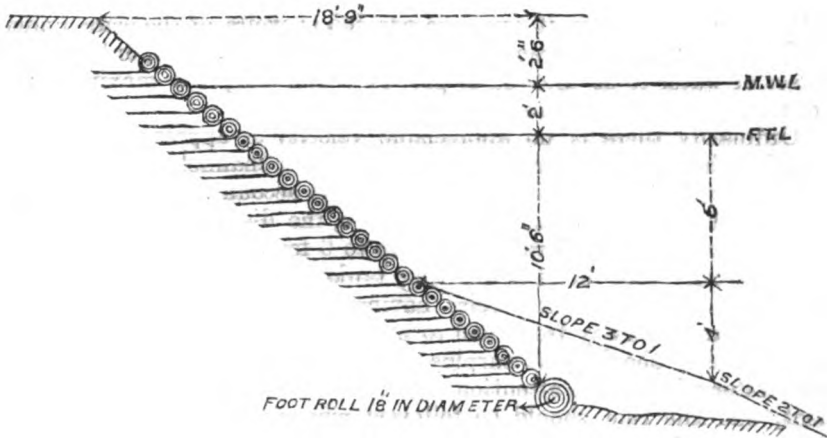

Fig. 106. Nanel or Durbah Revetment.

(2) A plantation of nanel grass 15 or 30 feet wide, without a nanel revetment.

(3) Plantations of tank or *kaskas* grass, which, though very inferior to nanel, will grow where the latter would have no chance.

(4) Various kinds of long local grasses.

(5) Three or four lines, parallel to the bund, of *neer-nochy* trees, to act as a partial breakwater.

(6) Turf sod revetments: these, if well built, with sods cut on good tenacious soil, will stand a moderate wash, but this arrangement is inferior to those numbered 1, 2 and 3, though probably better than 4 and 5.

**151. Surplus Weirs, or Means of Disposing of Flood Water.**—The water to be got rid of may be the drainage of the catchment basin only, or this augmented by water brought in by a supply channel. Whatever the sources whence the water may come, it is necessary to calculate, or ascertain, as accurately as possible, what the maximum quantity will be, and then to provide ample means of getting rid of it.

In those districts in which the improvement of tanks has made good progress, the data already obtained for dealing with other tanks are quite sufficient, if rightly used, to enable a reasonably close approximation to the requirements as regards surplus to be made: otherwise the methods indicated in chapter II will have to be employed for this purpose.

Having settled what is the quantity of water to be got rid of, and the difference between F.T.L. and M.W.L. having been fixed, the length of surplus weir required is readily ascertainable either from tables, or by calculation with the formula for weirs.

This formula is—

$$Q = c l h \sqrt{2gh}$$

$$= c l \times 8 \sqrt{h^3}$$

which, with  $c = .6075$ —a value applicable to very many tank weirs—becomes  $Q = 3.35 l \sqrt{h^3}$ . In this formula  $Q$  is the discharge in cubic feet a second;  $c$  a co-efficient the value of which varies with the form of the weir, but seldom if ever exceeds .65 at weirs of the class under consideration;  $h$  the difference between F.T.L. and M.W.L., or the depth in feet of water to be allowed to pass over the weir, as a maximum;  $g$  a constant representing the force of gravity.

Ordinarily there is no appreciable velocity of approach to a tank weir, but should the water reach the latter by a channel, or cut, it may be necessary to take velocity of approach into account.

Table 1 gives, with various values of  $c$ , the discharge, for 1 foot in length of crest, with all values of  $h$  up to 6 feet.

The work to be done at existing tanks is usually the conversion of the old calingulah into weirs having their crests at F.T.L., and with a clear waterway from end to end above that level. The rule is that all tanks should have surplus works capable of disposing of all flood water without the attention of villagers or conservancy establishment, and this rule should be followed whenever practicable. There are cases in which—either from there being insufficient room at those positions at which alone the discharge of surplus can be arranged for without injury to the cultivation, or from the very rapid rise of the ground at the ends of the tank, or for other weighty reasons—it is necessary to discharge surplus at a level lower than that of the full tank, and works that provide for doing this cannot well be made self-acting: consequently whether such works be of the type of the old native calingulah, or sluices, the safety of the tank would then depend in a great measure upon the care and judgment of those whose duty it might be to regulate their moveable parts.

**152. Designs of Weirs.**—The simpler forms of weirs are applicable to positions in which (1) ground-level and F.T.L. coincide, or differ by only 1 or 2 feet; (2) the depth of water, or the difference

between F.T.L. and M.W.L. is moderate; (3) the soil is hard; and (4) the fall of the surplus channel is small.

In considering (under the Tank Restoration Scheme) how the safety of the great numbers of small tanks could be ensured, and taking into account the small amount of revenue derived from them, which rendered desirable the utmost economy, it was arranged to provide for the discharge of surplus by either (1) levelling (to F.T.L.) a sufficient length of ground at one or both ends of the bund, and leaving this waterway without any protection if the soil were fairly hard; (2) where stone was plentiful and cheap, laying down a mere pavement, or strip, of stone about 6 feet wide, the upper surface of the stone being flush with F.T.L.; or (3) where stone was not cheap, and the ground too soft to stand the flow of water, levelling the ground for twice the length ordinarily required, and planting a belt of tank grass, which would both protect the ground, and reduce to about one-half the velocity of the water. These expedients were suitable to the class of tanks to which they were to be applied, but most of these tanks have ceased to be in charge of the Public Works Department, and for tanks classed as Imperial, surplus works of more permanent and reliable character are required. While, therefore, any one of the above arrangements may be adopted temporarily, pending the sanction and construction of permanent works, the latter should be provided as speedily as the means available will allow.

Of the simpler forms of permanent weirs, examples will be found in Figs. 106 to 111.

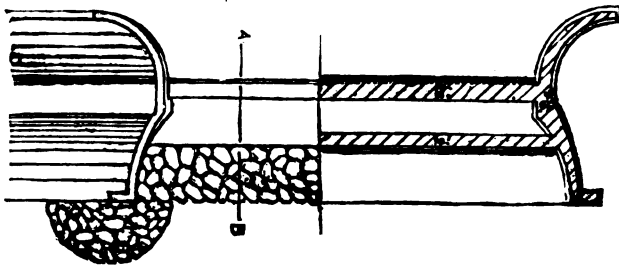

Fig. 106. Weir with vertical drop.

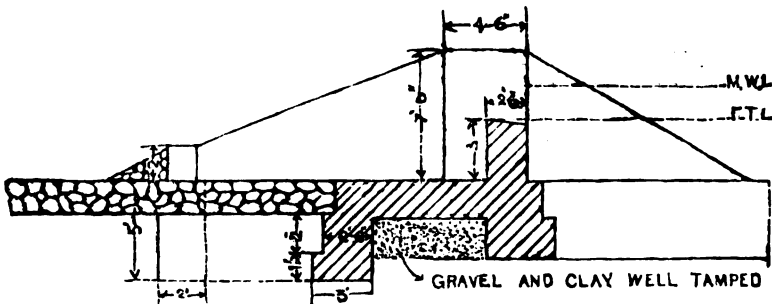

Fig. 107. Cross-section of weir with vertical drop.



When the surplus water has to be dropped several feet, the design of a weir is necessarily less simple, and its cost much greater. The form to

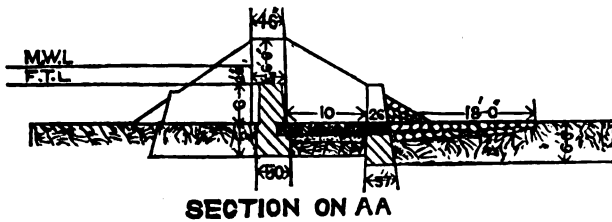
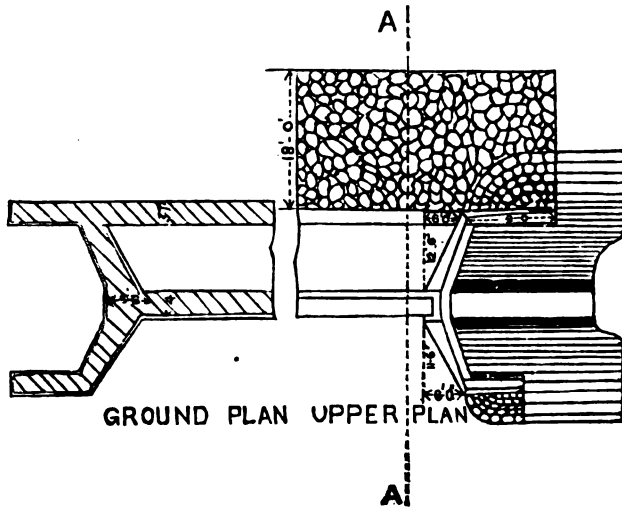

Fig. 108. Weir with Vertical Drop.

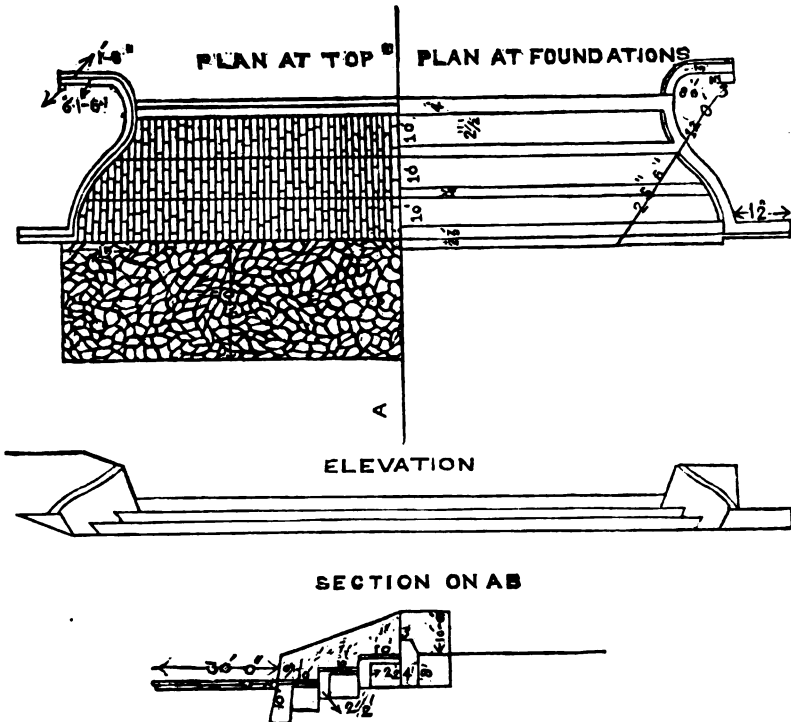

Fig. 109. Tank Surplus Weir.

be adopted will depend in a great measure upon the description of building material available. One cardinal point should be borne in mind, viz., that economy will be best secured by dropping the water down to the required level as rapidly as possible, or, in other words, within as short a distance of the crest wall as practicable. For weirs of this class, examples are given in Figs. 106, 107, 108 & 109.

For weirs with water-cushions (Fig. 110) the depth of the latter may be determined from the formula  $D = c\sqrt{h^3d}$ , in which  $D$  represents the depth of the cushion below the top of the retaining wall;  $c$  is a co-efficient, the value of which is dependent upon the description of material used for the floor of the cushion, and varies between 0.75 and

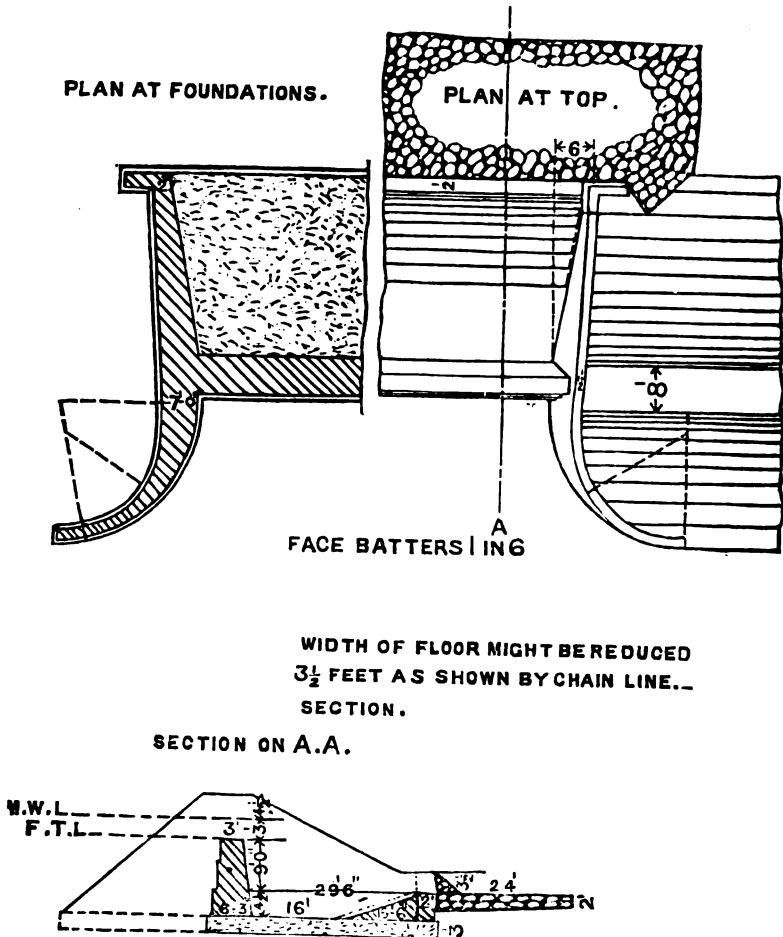

Fig. 110. Surplus Weir with Water Cushion.

1.25, the former for compact stone, and the latter for moderately hard brick;  $h$  is the height of the drop, and  $d$  is the maximum depth of water to pass over the weir crest. The width of the floor of the cushion will depend somewhat on the section of the bund; it need not exceed  $8\sqrt{d}$ , and should not be less than  $6\sqrt{d}$ .

For weirs with a vertical drop, and a horizontal apron on the same level as the retaining wall (Figs. 106 & 108), this masonry apron should be formed of fairly regular blocks of stone, or, in its absence, of Portland cement concrete, the width being from six to eight times  $\sqrt{d}$ , and the thickness or depth of the stone one-fifth to one-fourth of  $h + d$ . The stonework should be laid or bedded on concrete (ordinary), the thickness of which will vary with the compactness or otherwise of the soil, but should not be less than 1 foot. The depth of the foundations of the retaining wall, and of the returns of the rear wings, should be considerable, and a rough stone outer apron of ample width and thickness should be provided to protect these foundations.

Weirs with curved sloping aprons have not proved a success as already explained in paragraph 57.

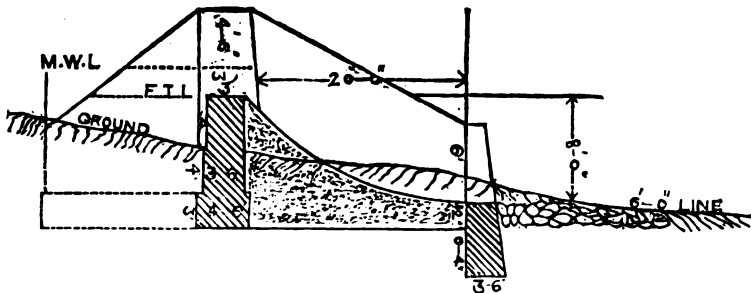
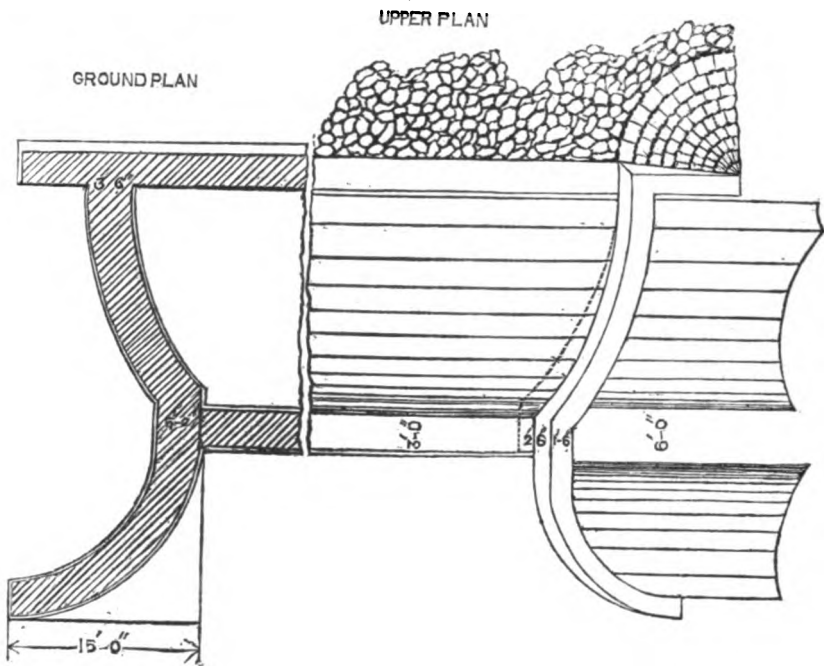

Fig. 111. Weir with curved apron.

The design of tank surplus weirs and escapes of all kinds other than the mere levelling of a certain extent of ground to allow surplus water to pass over, must be prepared with reference to the site the work is to occupy, and to the discharge which the work has to provide for. The circumstances of the site must, therefore, be fully ascertained and clearly shown. They are—

(1) The cross-section of the bund to which each wing is to be attached. Frequently, in the case of long weirs, the section of the bund at one end differs materially from that at the other. Should this be the case, two sections of the actual bund, if no alteration be needed, or of the intended bund, if it is to be improved, are necessary.

(2) The nature of the surface soil and sub-soil.

(3) The level of the ground on the tank side of the weir. If this is below the weir crest-level for a distance of  $1\frac{1}{2}$  times the length of the weir measured at right angles to the end nearest the termination of the bund, no further information need be given beyond the assurance that the approach to the weir is unobstructed.

(4) The level of the ground along the line to be occupied by the crest wall, with cross-sections at intervals of not more than 50 feet, if the variation of the ground be of any importance.

(5) The levels along the line of the surplus channel, or line of outfall, below the weir. Information on this point is absolutely necessary, first, to show that the design is suitable and that there is no serious risk of the work being undermined by retrogression of levels, and in this connection the nature of the soil and sub-soil are often of great importance; second, to indicate what the conditions of discharge are, and whether a high or low co-efficient should be made use of. Items 1 and 4 can be shown on the cross and longitudinal sections. Item 2 is to be noted on the plan. Item 3 is to be stated in a note or shown by one or more sections. Item 5 by a longitudinal section with such cross-sections as may be found necessary.

(6) It is further requisite, in the case of new or additional surplus works which are not to be placed on the line of customary outfall of surplus, that the direction in which the surplus will go and its possible effect on cultivated lands over or through which it may pass should be inquired into and the facts noted in the report on the work.

The dimensions and arrangements of the work have to be considered and shown with reference to the discharge to be provided for and the circumstances of the site. The following particulars should, therefore, be noted on the plan:—

- (1) Maximum flood discharge——cubic feet a second.
- (2) F.T.L. and M.W.L.

The latter will be indicated by lines on the cross-section of the weir, and the levels of these lines should be marked thereon.

The arrangements of the design should be shown by—

(1) A part-plan of the work with all the horizontal dimensions marked thereon. If the wings differ owing, as is often the case, to

varying ground levels, to the presence of rock, or otherwise, both ends of the work will need to be shown in plan. The earthwork slopes in connection with one or both wings, as the case may be, should be accurately plotted.

(2) A cross-section of the weir with elevation of one wing.

(3) Such cross-sections of the wing walls as may be necessary to make the intended arrangements perfectly clear.

(4) Tank surplus weirs are not often founded on wells, but when wells are required, a plan of the wells under one wing and a part of the weir proper is always necessary, together with the outlines of the bases of all walls to be placed on the wells.

(5) Site plans should always be prepared and on them should be shown the details of subsidiary works. They may conveniently be combined with the information regarding circumstances of site, items 3, 5 and possibly 6.

**153. Sluices for the Distribution of Water.**—Every tank should have a sufficient number of sluices to supply both adequately and conveniently all the land to be irrigated. Each sluice should be able to supply the maximum quantity of water required for the lands under it; and the level of its sill should be such as to admit of the irrigation being carried on until the crop or crops are fully matured.

The design of a tank sluice must be suited to the actual or intended cross-section of the bund, the slopes of which must be completely retained in position by the masonry. The first thing necessary, therefore, to a proper design is a cross-section of the bund, and this section should show the interior slope of the bund or the ground inside the tank as far as the level of the sluice sill, or to 15 feet beyond the ends of the front wings, if there be a long leading channel. A cross-section of this channel, if there be one, taken just beyond the line of the end of the front wings, and carried to, say, 20 feet on either side of the centre line, is also necessary. This section may be shown on the front elevation of the sluice, and similarly the cross-section of the bund may be plotted on the longitudinal section of the sluice.

The design of the sluice and the arrangements for water regulation must be suited to the discharge required. On the design, therefore, should be recorded the following particulars:—

(1) Area to be irrigated——acres.  
 (2) Discharge required——cubic feet per second.  
 (3) Water-level at which full discharge required will be secured:—

- (a) Through plug holes or other high level orifices.  
 (b) Through lower vent——feet above sill.

(4) Areas of orifices (in square feet and decimals of a foot).

The following are the particulars or details of the design required:—

(1) Plan, which may be either a full plan at floor level and a full top-plan, or half of each. When the foundations are on wells, at least a half plan of the wells with the outline of the base of the masonry foundations to be placed on the wells, will be necessary.

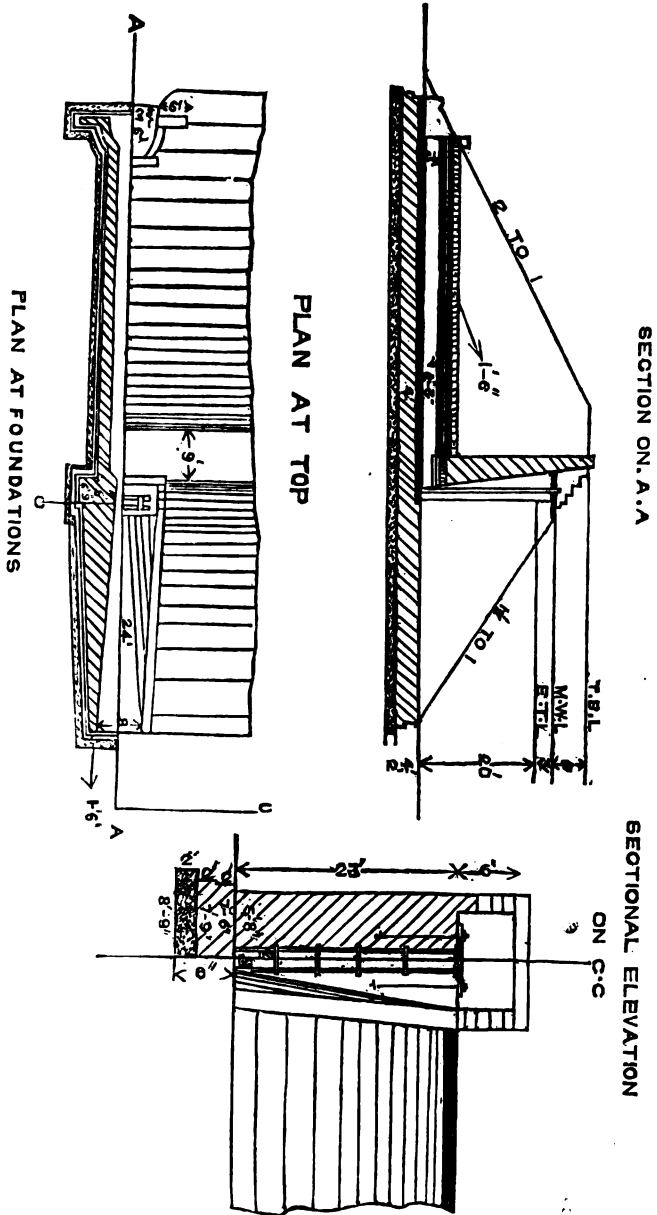

Fig. 112. Tank Sluice with Arched Tunnel.

(2) Longitudinal section. On this F.T.L. and M.W.L. should be shown by lines, and the height of these lines above sill should be indicated by their levels thus:—

M.W.L., 43·95.

F.T.L., 41·95.

Sluice sill, 30·21.

(3) Front elevation.

(4) Cross-section of front wings at junction with head-wall; or at the junction of splayed wings with parallel wings.

(5) Cross-section of front wing returns.

(6) Rear elevation.

(7) Cross-section of rear wing with junction of tail-wall.

(8) Cross-section of rear wing return.

(9) Details of regulating arrangements.

1, 4 and 9 are essential.

5 to 8 are left optional unless circumstances render their exhibition necessary.

Designs of tank sluices are shown in Figures 112, 113, 114, and 115.

**154. Regulation of Vent by Shutter.**—The regulation of the discharge of irrigation water at a sluice is best effected by means of a shutter. The following precautions are necessary:—(1) The area of the cross section of waterway of the sluice tunnel, or culvert, must be much greater than that of the sluice vent, so as to limit the maximum velocity in the culvert to 15 feet a second, supposing the tank to be full and the sluice vent fully opened, *e.g.*, if the vent be  $2\frac{1}{2}$  feet by 2 feet, and the depth on sill 20 feet,  $V = 5.6 \sqrt{19} = 24.416$ ,  $Q = 122.08$  cubic feet,  $\frac{122.08}{15} = 8.14$ ; and, as the depth of water in the culvert should not

exceed 2 feet, its width should be about  $4\frac{1}{2}$  feet, and the height of the side walls to springing of arch, or to covering stones, 3 feet; (2) the floor and the sides of the culvert should be lined with cutstone if the limiting velocity be 15 feet a second: if cutstone be expensive, and it be desired to substitute flooring tiles or Portland cement concrete for the floor, and brickwork for the side walls, the limiting velocity should not exceed 10 feet a second, and the proper width of the culvert, in the example above given, would be then a little over 6 feet; (3) the gear for working the shutter should be a screw having a pitch of  $\frac{1}{3}$ rd or  $\frac{1}{4}$ th its diameter, and care must be taken, by providing cross bars with collars at moderate intervals, to prevent the bending of the spear when forcing down the shutter.

An example of a sluice of this kind is given in Fig. 112.

**155. Regulation by Plugs.**—Plugs, though by no means so satisfactory as a shutter, were formerly much in vogue, and as many tanks are still fitted with them, the tables of discharge which follow may be found useful. To secure convenient and fairly accurate regulation, it is necessary that (1) the holes should be of a suitable size and sufficient in number; (2) proper plugs should be provided, and a well-cut seat made for the shoulder of the plug; (3) the plugs should be regulated from a platform always accessible; (4) it should be known what the discharge is at any given time, and with the tank water at



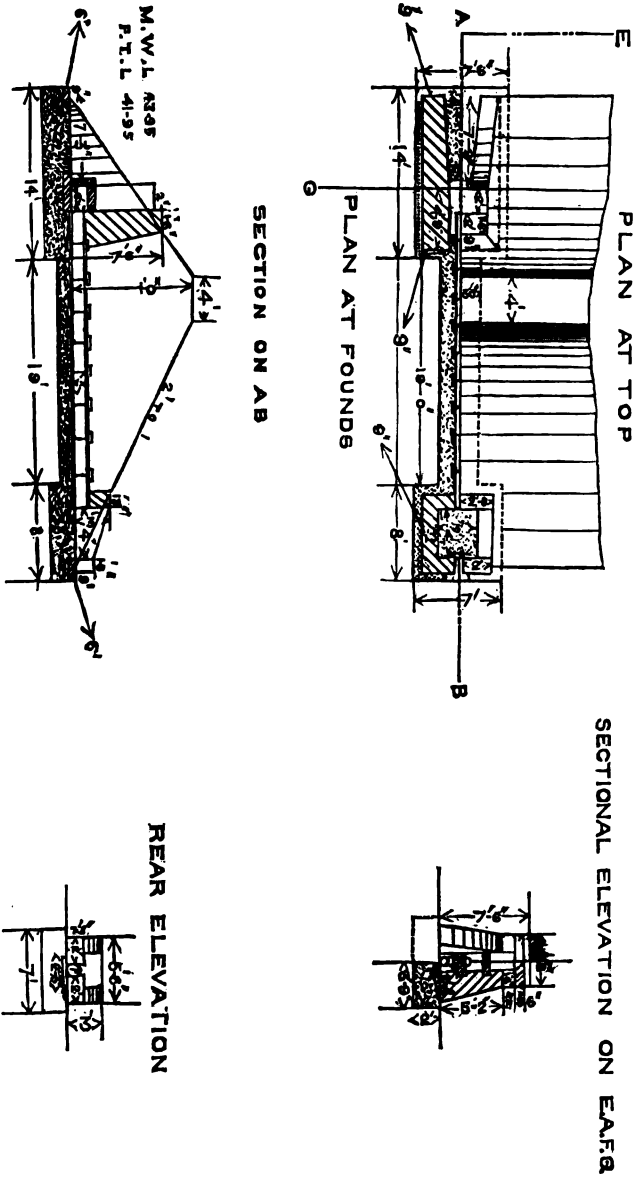

Fig. 113. Tank Sluice. Earthenware Pipe.

any given level: and that the way to secure any required discharge should be readily ascertainable.

Again, although 2 cubic yards per acre per hour, or 1 cubic foot a second for 66 acres, is usually adequate as an average supply, this quantity, when much of the land is being prepared for cultivation, will be by no means enough. It is desirable, therefore, that the plug holes should be capable of discharging much more water at times, and this can be provided for by allowing one or two large, or several smaller plug holes, so as to admit of the discharge being varied according to circumstances.

**156. Closing of Breaches in Tank Bunds.**—The manner of carrying out earthworks generally to bunds of tanks has been indicated in article 146, while puddle walls are treated of in article 147, and scour holes in article 149. There are, however, several important points which need particular care and attention when dealing with the repairs of breaches. These are:—

(1) All water should be cleared out of the bottom of the breach, and all soft mud removed, otherwise there cannot be a good foundation, which is the first essential.

(2) All loose soil should be removed from the ends of the bund on either side of the breach.

(3) The new work must be properly bonded into, or united with, the old bund, and to this end a cut must be made at, or from 2 to 3 feet in rear of, the centre line of the top of the bund into the latter, on either side of the breach, from top to bottom, the distance to which these cuts should be carried horizontally, and their width, depending on the depth of water to be retained. About half the depth of water, with 5 feet as a minimum, will suffice for the horizontal distance, and one-fourth the depth, with a minimum of 4 feet, for the width. These cuts will have vertical, or nearly vertical, faces, and must therefore be shored up with planks and struts, so arranged as to allow of the removal of the planks, course by course, before the filling in of each successive foot of the new work.

(4) Except in the case of shallow tanks, having good water-tight soil available, it will be necessary to insert a puddle wall with foundations carried well below the bottom of the scour at the breach. The position and dimensions of this wall should be fixed as indicated in article 19, and drains should be provided, if necessary, as therein described.

(5) The filling in should be carried up regularly over the whole area of the breach. The soil should be thrown down evenly over all this area, commencing on the outer lines, or at the front and rear toes of the slopes (after the scour-hole has been filled in) and working towards the centre, or towards the puddle wall, if there be one, taking special care that the filling in of the cuts at either end keeps pace exactly with the rest of the work. Every layer of 5 or 6 inches of soil should be thoroughly consolidated with rammers.

(6) When all the soil is not good, selected soil should be used for the front half of the bund, or the part between the puddle wall and the front slope, while sandy or gravelly soil will do well for the part in rear of the puddle wall, or of the centre line of the bund.

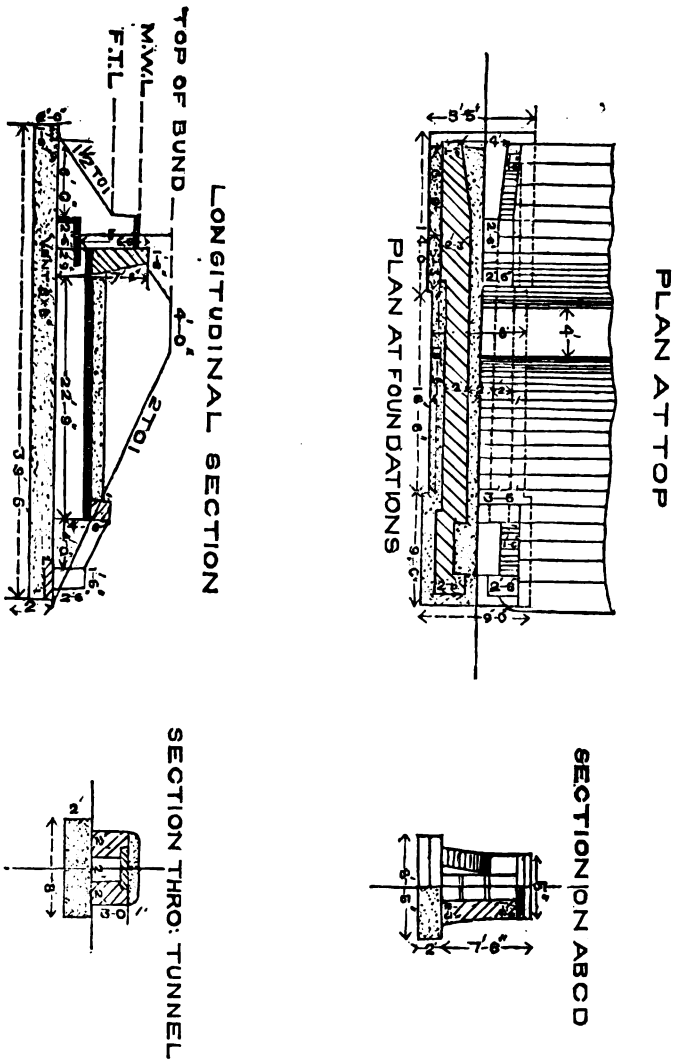

Fig. 114. Tank Sluice. Stone slabs.

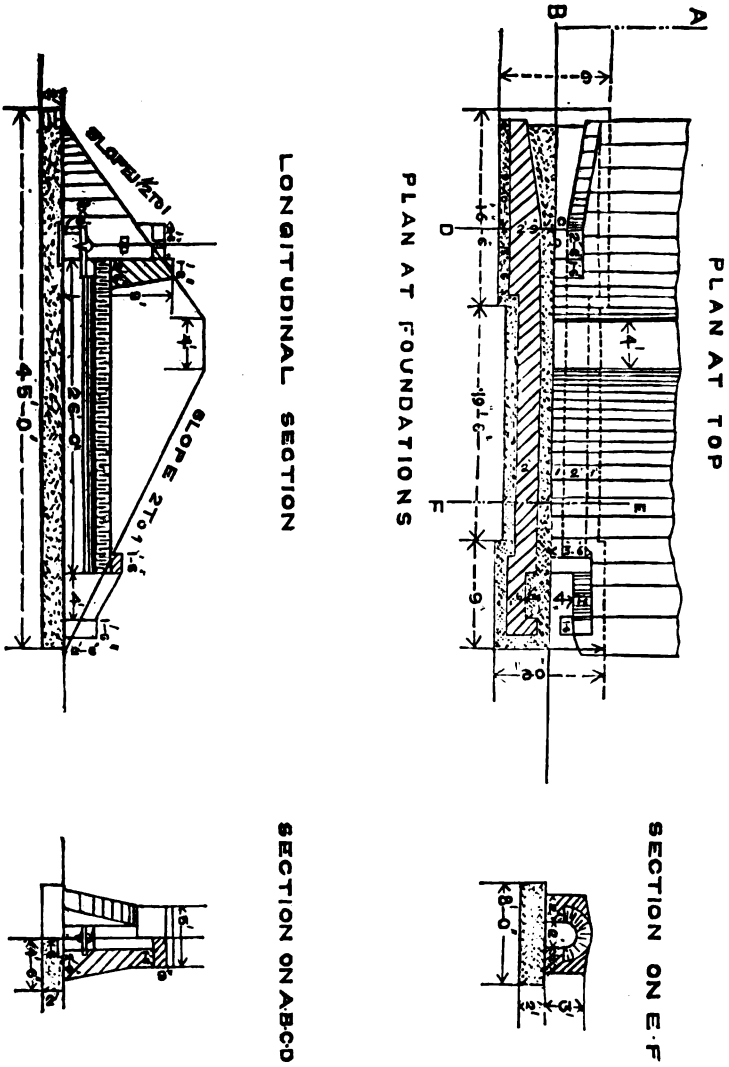

Fig. 115. Tank Sluice. Arched Tunnel with Plug.

(7) The work should be properly laid out, and sections put up as guides to the workpeople, and, during the progress of the filling in, the earthwork at the faces should always be from 6 to 12 inches higher than at the middle line.

(8) The slopes of the new earthwork should be made sufficiently flat; it costs far less to make a stable bund in the first instance than to stop and repair slips, which are inevitable if the slopes be made too steep. Three to one for the rear, and two to one for the inner or front face, if the latter be unrevetted, are usually as steep as can be relied on to stand; and, if the soil be bad, somewhat flatter slopes may be advisable.

(9) The reconstruction of revetments can, with proper consolidation of the earthwork, be carried on simultaneously with the filling in of the breach; the slope to be given should correspond with that of the old bund on either side, if this be fairly suitable. With regard to backing and other details, instructions will be found in article 150.

(10) The tops of bunds at newly filled-in breaches should be made up to about one-sixteenth of their height, from the bottom of the scour, above the old part of the bund, to allow for settlement, and should be gravelled so that rain water may not soak into them and cause unequal settlement or slips, and, where unrevetted, the slopes should be turfed.

## Discharges of ordinary Tank Escapes.

$$Q = c \times 5.35 h \sqrt{h} \times l.$$





Section of escapes.	C = .687.	C = .625.	C = .562.	C = .5.	C = .437.	C = .375.
	Board with beveled edge.					
Head in feet.	$Q = \frac{3}{8} h \sqrt{h}.$	$Q = \frac{1}{3} h \sqrt{h}.$	$Q = \frac{2}{3} h \sqrt{h}.$	$Q = \frac{1}{3} h \sqrt{h}.$	$Q = \frac{2}{3} h \sqrt{h}.$	$Q = \frac{1}{2} h \sqrt{h}.$
h.						
0.25	0.444	0.417	0.375	0.333	0.292	0.250
0.50	1.256	1.178	1.060	0.943	0.824	0.706
0.75	2.300	2.157	1.941	1.725	1.510	1.294
1.00	3.555	3.333	3.000	2.666	2.333	2.000
1.25	4.969	4.658	4.192	3.727	3.260	2.795
1.50	6.532	6.124	5.512	4.899	4.288	3.676
1.75	8.232	7.718	6.946	6.174	5.402	4.630
2.00	10.066	9.428	8.485	7.542	6.599	5.656
2.25	12.000	11.250	10.125	9.000	7.875	6.750
2.50	14.056	13.176	11.859	10.542	9.225	7.908
2.75	16.215	15.201	13.681	12.161	10.641	9.121
3.00	18.475	17.320	15.588	13.856	12.124	10.392
3.25	20.832	19.530	17.577	15.624	13.671	11.718
3.50	23.283	21.826	19.644	17.462	15.280	13.098
3.75	25.821	24.206	21.786	19.366	16.946	14.526
4.00	28.444	26.666	24.000	21.333	18.666	16.000
4.25	31.152	29.204	26.281	23.364	20.444	17.524
4.50	33.941	31.820	28.638	25.466	22.274	19.092
4.75	36.809	34.507	31.057	27.607	24.157	20.707
5.00	39.751	37.263	33.542	29.816	26.080	22.364
5.25	42.761	40.096	36.087	32.077	28.068	24.069
5.50	45.861	42.994	38.695	34.396	30.087	25.738
5.75	49.023	45.959	41.363	36.767	32.171	27.575
6.00	52.255	48.989	44.080	39.191	34.282	29.395

TABLE II.

Table of Plug-hole discharges, with Plugs coned at 1 in 4.

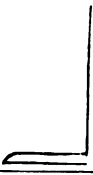
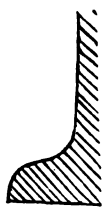
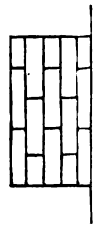
Diameter of plug-hole 4 inches, and of plug  $\frac{3}{4}$  and  $\frac{1}{2}$  inches at upper and lower ends. Discharges in cubic feet a second, and acreages, with normal supply of 54 cubic feet an hour (0.15 cubic feet a second) per acre, for which the discharges will suffice.

$$V = 0.7 \sqrt{2g} z = 5.614 \sqrt{h}; Q = AV.$$

Heads in feet.	Inches of lift of plugs.												Remarks.		
	2 inches.		4 inches.		6 inches.		8 inches.		10 inches.		12 inches.			16 inches (clear).	
	Discharges.	Supply for acres.	Discharges.	Supply for acres.	Discharges.	Supply for acres.	Discharges.	Supply for acres.	Discharges.	Supply for acres.	Discharges.	Supply for acres.		Discharges.	Supply for acres.
0.5	0.100	6.65	0.167	11.17	0.224	14.93	0.270	18.02	0.305	20.37	0.330	22.00	0.346	23.07	
1.	0.141	9.41	0.237	15.79	0.317	21.13	0.382	25.49	0.432	28.80	0.466	31.07	0.490	32.7	
1.5	0.173	11.53	0.290	19.33	0.388	26.9	0.468	31.21	0.529	35.27	0.571	38.07	0.601	40.07	
2.	0.200	13.31	0.335	22.33	0.448	29.9	0.541	36.04	0.611	40.73	0.660	44.00	0.692	46.13	
2.5	0.223	14.88	0.374	24.97	0.502	33.5	0.604	40.29	0.683	45.54	0.738	49.20	0.774	51.60	
3.	0.244	16.30	0.410	27.35	0.550	36.67	0.682	44.14	0.748	49.89	0.808	53.87	0.849	56.60	
3.5	0.264	17.61	0.443	29.54	0.593	39.53	0.715	47.68	0.808	53.89	0.873	58.20	0.917	61.13	
4.	0.282	18.82	0.474	31.57	0.634	42.3	0.764	50.67	0.864	57.61	0.933	62.20	0.980	65.33	
4.5	0.299	19.96	0.502	33.49	0.673	44.9	0.811	54.06	0.916	61.10	0.990	66.00	1.040	69.33	
5.	0.316	21.04	0.530	35.31	0.709	47.3	0.855	56.99	0.966	64.41	1.043	69.53	1.095	73.00	
5.5	0.331	22.07	0.555	37.03	0.743	49.53	0.896	59.79	1.013	67.55	1.094	72.93	1.148	76.58	
6.	0.346	23.05	0.580	38.67	0.776	51.73	0.936	62.43	1.058	70.55	1.142	76.17	1.200	80.00	
6.5	0.360	23.99	0.604	40.25	0.809	53.92	0.975	64.97	1.101	73.43	1.180	79.29	1.249	83.27	
7.	0.373	24.90	0.627	41.77	0.839	56.95	1.011	67.43	1.143	76.20	1.234	82.28	1.296	86.41	
7.5	0.387	25.77	0.649	43.24	0.869	57.91	1.047	69.79	1.183	78.88	1.277	85.17	1.343	89.45	
8.	0.399	26.63	0.670	44.65	0.897	59.81	1.081	72.08	1.222	81.47	1.319	87.96	1.386	92.38	
8.5	0.411	27.40	0.690	46.03	0.925	61.65	1.114	74.30	1.260	83.97	1.360	90.67	1.428	95.22	
9.	0.423	28.23	0.710	47.37	0.952	63.45	1.147	76.45	1.296	86.41	1.399	93.29	1.470	97.98	

TABLE III.

Table of Plug-hole discharges, with Plugs coned at 1 in 4.

Diameter of plug-hole, 6 inches. Diameter of plug, 5 1/2 and 1 1/2 inches at upper and lower ends. Perpendicular length of plug below shoulder 18 inches. Discharges in cubic feet a second; and acreages, with normal supply of 54 cubic feet an hour (0.15 cubic feet a second) per acre, for which the discharges will suffice.

$$V = 0.7 \sqrt{2gh} = 5.614 \sqrt{h}; Q = AV.$$

Heads in feet.	Inches of lift of plugs.												Remarks.								
	2 inches.		4 inches.		6 inches.		8 inches.		10 inches.		12 inches.			14 inches.		16 inches.		18 inches.		24 inches (clear).	
	Discharges, acres.	Supply for acres.	Discharges, acres.	Supply for acres.	Discharges, acres.	Supply for acres.	Discharges, acres.	Supply for acres.	Discharges, acres.	Supply for acres.	Discharges, acres.	Supply for acres.		Discharges, acres.	Supply for acres.	Discharges, acres.	Supply for acres.	Discharges, acres.	Supply for acres.	Discharges, acres.	Supply for acres.
0.5	0.154	10.06	0.265	17.96	0.365	24.54	0.457	30.27	0.533	35.55	0.600	40.57	0.657	45.34	0.705	49.89	0.753	54.24	0.779	51.76	
1	0.218	14.51	0.375	24.97	0.516	34.42	0.642	42.84	0.751	50.24	0.840	56.61	0.920	61.97	0.993	66.31	1.044	69.63	1.102	73.49	
1.5	0.267	17.77	0.450	30.83	0.632	42.13	0.787	52.56	0.923	61.53	1.040	69.83	1.139	75.90	1.218	81.21	1.279	85.28	1.350	90.00	
2	0.308	20.22	0.530	38.32	0.730	48.07	0.909	60.58	1.068	71.04	1.201	80.08	1.315	87.55	1.407	93.78	1.477	98.47	1.559	103.98	
2.5	0.344	22.95	0.592	39.49	0.816	54.42	1.016	67.73	1.191	79.43	1.343	88.80	1.470	97.99	1.573	104.85	1.631	110.08	1.743	116.19	
3	0.377	25.14	0.649	43.26	0.904	59.61	1.113	71.10	1.305	87.01	1.471	98.04	1.610	107.54	1.723	114.55	1.809	120.00	1.909	127.28	
3.5	0.407	27.15	0.701	46.72	1.008	64.30	1.232	80.14	1.410	93.96	1.568	105.90	1.739	115.04	1.881	124.98	1.984	130.26	2.093	137.48	
4	0.435	28.03	0.749	49.36	1.082	68.83	1.283	83.97	1.493	100.47	1.661	113.81	1.839	123.05	1.985	133.62	2.089	139.36	2.205	146.97	
4.5	0.462	30.79	0.795	52.38	1.169	73.01	1.365	89.87	1.591	109.57	1.780	120.65	1.972	133.47	2.110	144.67	2.216	150.89	2.338	158.59	
5	0.487	32.45	0.838	55.84	1.264	76.96	1.457	93.76	1.686	115.33	1.890	129.67	2.079	138.98	2.232	148.23	2.335	155.70	2.466	164.32	
5.5	0.511	34.04	0.878	58.97	1.211	80.71	1.507	100.46	1.767	117.82	1.991	132.73	2.189	145.34	2.333	153.51	2.449	163.29	2.585	173.84	
6	0.533	35.56	0.918	61.17	1.264	84.30	1.574	104.92	1.846	123.08	2.068	136.65	2.270	151.31	2.436	163.43	2.468	170.45	2.700	187.01	
6.5	0.557	37.00	0.955	63.67	1.316	87.74	1.638	109.21	1.921	130.00	2.165	144.32	2.317	158.00	2.503	170.66	2.463	177.56	2.810	197.38	
7	0.578	38.40	1.000	66.07	1.366	91.06	1.700	113.53	1.994	135.91	2.246	150.70	2.460	163.97	2.632	178.44	2.465	184.43	3.016	204.43	
7.5	0.596	39.75	1.058	68.36	1.414	94.25	1.760	117.31	2.064	139.58	2.325	155.02	2.546	168.72	2.724	181.60	2.460	190.69	3.019	201.25	
8	0.616	41.05	1.060	70.64	1.460	97.34	1.817	121.16	2.131	142.09	2.402	160.10	2.629	175.29	2.813	187.66	2.364	196.94	3.118	207.85	
8.5	0.635	42.31	1.092	72.81	1.508	100.34	1.873	124.89	2.197	146.40	2.475	163.03	2.710	180.98	2.900	193.33	2.045	205.00	3.214	214.23	
9	0.655	43.54	1.124	74.92	1.549	103.25	1.928	128.51	2.261	150.71	2.547	165.92	2.789	185.92	2.984	198.93	2.153	208.89	3.307	220.48	
9.5	0.671	44.73	1.165	76.97	1.591	106.08	1.980	132.05	2.323	154.94	2.618	174.47	2.866	190.96	3.066	204.36	2.219	214.61	3.388	226.60	
10	0.688	45.90	1.186	78.97	1.632	108.83	2.032	135.46	2.385	158.96	2.688	179.00	2.946	195.98	3.146	209.60	2.303	220.19	3.466	232.39	
10.5	0.705	47.03	1.214	80.93	1.673	111.52	2.082	138.80	2.442	163.78	2.751	183.42	3.012	200.92	3.223	214.87	2.384	225.62	3.572	238.13	
11	0.722	48.11	1.242	82.85	1.712	114.15	2.131	142.07	2.499	166.62	2.816	187.74	3.083	205.56	3.299	219.93	2.464	230.38	3.666	243.73	
11.5	0.738	49.22	1.270	84.69	1.751	116.71	2.179	145.26	2.556	170.36	2.879	191.94	3.150	210.17	3.373	224.97	2.542	235.12	3.758	249.31	
12	0.754	50.28	1.298	86.51	1.788	118.22	2.226	148.38	2.610	173.02	2.941	196.09	3.220	214.08	3.446	229.71	2.618	240.20	3.819	254.97	



TABLE IV.

Table of Plug-hole discharges, with Plugs coned at 1 in 4.

Diameter of plug-hole, 8 inches. Diameter of plug, 7½ inches at upper, and 2½ inches at lower, end. Perpendicular length of plug, below shoulder, 21 inches. Discharges in cubic feet a second; and screages, with normal supply of 54 cubic foot an hour (0.15 cubic feet a second) per acre, for which the discharges will suffice.

$$V = 0.7 \sqrt{2gh} = 5.614 \sqrt{h}; Q = AV.$$

Heads in feet.	2 inches.		4 inches.		6 inches.		8 inches.		10 inches.		12 inches.		14 inches.		16 inches.		18 inches.		20 inches.		21 inches.		28 inches (clear).		Remarks.
	Discharges.	Supply for acres.	Discharges.	Supply for acres.	Discharges.	Supply for acres.	Discharges.	Supply for acres.	Discharges.	Supply for acres.	Discharges.	Supply for acres.	Discharges.	Supply for acres.	Discharges.	Supply for acres.	Discharges.	Supply for acres.	Discharges.	Supply for acres.	Discharges.	Supply for acres.	Discharges.	Supply for acres.	
0.5	0.248	16.51	0.359	29.61	0.540	38.00	0.670	44.96	0.787	52.47	0.887	59.81	0.965	66.31	1.081	72.08	1.157	77.13	1.222	81.46	1.260	83.36	1.386	92.38	The discharges for intermediate heads can be obtained by interpolation.
1	0.350	23.35	0.565	37.68	0.764	50.96	0.947	65.15	1.116	74.38	1.269	84.59	1.407	93.77	1.529	101.94	1.636	109.08	1.728	115.21	1.768	117.85	1.960	130.64	A fair approximation to discharges for intermediate heads can also be found by interpolation.
1.5	0.429	28.59	0.691	46.10	0.935	62.35	1.160	77.35	1.336	91.10	1.554	103.60	1.723	114.85	1.873	124.83	1.994	133.59	2.116	141.10	2.168	144.38	2.400	160.01	
2	0.495	33.92	0.798	53.23	1.080	71.99	1.340	89.31	1.578	105.14	1.794	119.62	1.969	132.61	2.162	144.16	2.314	154.27	2.444	162.93	2.444	162.93	2.771	184.76	
2.5	0.554	38.92	0.893	59.51	1.207	80.49	1.498	99.85	1.764	117.61	2.006	133.74	2.224	148.27	2.418	161.18	2.587	172.47	2.732	182.16	2.796	186.39	3.068	206.57	
3	0.607	40.43	0.978	65.19	1.323	88.17	1.641	109.38	1.932	128.58	2.198	146.51	2.426	162.42	2.648	176.56	2.834	188.94	2.993	199.54	3.063	204.18	3.394	226.28	
3.5	0.655	43.68	1.056	70.41	1.429	95.24	1.772	118.15	2.087	139.15	2.374	155.25	2.631	175.43	2.861	190.71	3.061	204.08	3.223	215.53	3.308	220.54	3.606	244.41	
4	0.700	46.70	1.129	75.27	1.527	101.81	1.895	126.31	2.251	148.76	2.534	169.14	2.813	187.55	3.058	203.88	3.272	218.17	3.456	230.41	3.537	235.77	3.919	261.26	
4.5	0.743	49.53	1.198	79.84	1.620	107.90	2.010	133.97	2.367	157.78	2.662	179.44	2.984	198.92	3.244	216.24	3.471	231.40	3.666	244.39	3.751	250.07	4.157	277.14	
5	0.783	52.21	1.262	84.16	1.707	113.83	2.118	141.21	2.495	166.32	2.837	189.14	3.145	209.68	3.419	227.94	3.659	243.92	3.864	257.61	3.954	263.09	4.382	292.13	
5.5	0.821	54.75	1.324	88.27	1.791	119.38	2.222	148.11	2.617	174.44	2.976	198.37	3.299	219.92	3.586	239.07	3.838	255.54	4.053	270.18	4.147	276.47	4.566	306.26	
6	0.858	57.19	1.383	92.19	1.870	124.69	2.330	154.69	2.733	182.16	3.108	207.19	3.445	230.70	3.745	246.70	4.001	267.10	4.233	282.20	4.331	288.76	4.800	320.01	
6.5	0.895	59.52	1.441	95.95	1.947	129.78	2.415	161.01	2.844	189.63	3.235	215.65	3.586	250.89	4.172	278.11	4.406	293.72	4.508	300.55	4.606	300.55	4.960	333.08	
7	0.932	61.74	1.494	99.58	2.020	134.98	2.506	167.66	2.952	196.76	3.337	225.50	3.721	248.10	4.046	269.70	4.329	308.01	4.572	304.81	4.678	311.06	5.185	345.65	
7.5	0.969	63.94	1.546	103.07	2.091	139.41	2.594	172.36	3.055	203.70	3.425	231.65	3.852	256.11	4.188	279.17	4.481	308.73	4.733	315.17	4.843	322.84	5.367	357.78	
8	0.991	66.04	1.597	106.43	2.160	143.98	2.679	178.62	3.156	210.38	3.509	239.25	3.978	265.23	4.325	288.39	4.628	308.53	4.888	325.85	5.001	333.43	5.543	369.52	
8.5	1.021	68.07	1.646	109.79	2.226	148.41	2.762	184.12	3.255	216.85	3.609	246.61	4.101	273.39	4.458	297.20	4.770	318.03	5.038	335.88	5.155	343.69	5.713	380.89	
9	1.051	70.04	1.694	112.91	2.291	152.72	2.842	189.46	3.347	223.14	3.706	253.76	4.220	281.00	4.585	305.81	4.909	327.23	5.184	345.63	5.305	353.68	5.759	391.93	
9.5	1.079	71.96	1.740	116.04	2.354	156.90	2.926	194.63	3.439	229.95	3.811	260.71	4.335	289.03	4.713	314.18	5.043	334.29	5.296	355.06	5.450	363.35	6.040	402.47	
10	1.107	73.83	1.785	119.02	2.413	160.98	3.006	199.71	3.528	236.21	4.012	267.49	4.448	296.54	4.833	322.36	5.174	334.95	5.465	364.31	5.592	372.79	6.197	413.13	
10.5	1.135	75.65	1.929	121.96	2.474	164.95	3.070	204.64	3.615	241.02	4.111	274.69	4.558	303.86	5.005	330.32	5.302	335.47	5.600	373.31	5.730	381.96	6.350	423.33	
11	1.162	77.44	1.972	124.88	2.532	168.83	3.142	209.46	3.700	246.69	4.203	280.54	4.665	311.01	5.071	338.06	5.427	361.79	5.781	382.10	5.925	390.68	6.469	433.30	
11.5	1.188	79.18	1.978	127.63	2.589	172.63	3.212	214.16	3.784	251.34	4.293	286.85	4.770	318.00	5.185	345.69	5.519	369.92	5.860	390.63	6.095	399.77	6.646	443.04	
12	1.213	80.88	1.956	130.38	2.645	176.34	3.282	218.77	3.865	257.06	4.385	293.02	4.873	324.84	5.297	353.12	5.608	377.87	5.986	399.09	6.126	408.37	6.788	452.68	
12.5	1.238	82.55	1.986	133.07	2.700	179.98	3.349	223.28	3.945	262.97	4.486	299.06	4.973	331.54	5.406	360.31	5.785	385.67	6.110	407.32	6.252	416.74	6.928	461.90	
13	1.263	84.18	1.956	135.70	2.753	183.54	3.416	227.70	4.023	268.18	4.575	303.98	5.072	338.10	5.518	367.51	5.600	393.39	6.231	415.58	6.376	425.04	7.066	471.00	
13.5	1.287	85.76	2.014	138.29	2.806	187.04	3.481	232.04	4.099	273.99	4.662	310.79	5.163	374.54	5.618	374.54	5.618	374.54	6.349	423.30	6.467	433.14	7.200	480.02	
14	1.310	87.38	2.072	140.86	2.857	190.47	3.544	236.50	4.175	279.31	4.747	313.65	5.250	381.92	5.732	381.92	5.732	381.92	6.466	431.05	6.610	441.04	7.332	488.53	
14.5	1.334	88.90	2.130	143.39	2.908	193.84	3.607	240.48	4.248	283.23	4.831	322.10	5.356	397.08	5.823	388.17	6.231	415.37	6.580	438.69	6.753	448.90	7.462	497.38	
15	1.366	90.42	2.186	145.77	2.967	197.16	3.669	244.59	4.321	288.07	4.914	327.00	5.448	393.18	5.922	394.80	6.357	422.47	6.683	446.19	6.849	456.57	7.590	505.98	

TABLE V.

Table of Plug-hole discharges, with Plugs coned at 1 in 4.

Diameter of plug-hole, 10 inches. Diameter of plug, 9½ inches at upper, and 4½ inches at lower, end. Perpendicular length of plug, below shoulder, 21 inches. Discharges in cubic feet a second; and acreages, with normal supply of 5.4 cubic feet an hour (0.15 cubic feet a second) per acre, for which the discharges will suffice.

$$V = 0.7 \sqrt{2gh} = 5.614 \sqrt{h}; Q = AV.$$

Heads in feet.	Inches of lift of plugs.												Remarks.												
	2 inches.		4 inches.		6 inches.		8 inches.		10 inches.		12 inches.			14 inches.		16 inches.		18 inches.		20 inches.		21 inches.		31 inches (clear).	
	Supply for acres.	Discharges.	Supply for acres.	Discharges.	Supply for acres.	Discharges.	Supply for acres.	Discharges.	Supply for acres.	Discharges.	Supply for acres.	Discharges.		Supply for acres.	Discharges.	Supply for acres.	Discharges.	Supply for acres.	Discharges.	Supply for acres.	Discharges.	Supply for acres.	Discharges.	Supply for acres.	Discharges.
0.5	0.313	20.83	6.508	33.84	0.691	46.10	0.845	57.05	1.027	68.47	1.176	78.58	1.319	87.95	1.449	96.62	1.568	104.56	1.677	111.78	1.727	116.11	2.165	144.34	
1.	0.542	29.47	0.718	47.65	0.978	65.19	1.253	81.62	1.463	96.83	1.745	111.12	1.966	124.39	2.050	136.64	2.218	147.87	2.371	158.07	2.442	162.79	3.061	204.08	
1.5	0.541	36.00	0.879	58.61	1.198	79.35	1.468	99.55	1.779	118.60	2.041	136.10	2.285	162.35	2.510	187.35	2.716	181.16	2.904	198.60	2.961	199.38	3.750	250.01	
2.	0.625	41.08	1.015	67.67	1.383	89.20	1.720	115.29	2.054	136.95	2.357	157.14	2.639	175.92	2.908	193.24	3.137	209.12	3.353	225.55	3.453	230.23	3.330	268.61	
2.5	0.699	46.60	1.135	75.06	1.546	103.08	1.934	129.90	2.297	153.11	2.636	175.76	2.930	196.68	3.241	216.07	3.507	233.96	3.749	249.94	3.861	257.46	4.341	322.76	
3.	0.766	51.05	1.245	82.68	1.694	112.92	2.118	141.20	2.516	167.72	2.897	192.47	3.232	215.45	3.550	236.67	3.842	256.11	4.107	273.79	4.250	281.97	5.303	353.56	
3.5	0.827	55.14	1.345	89.52	1.850	121.97	2.288	152.52	2.717	181.16	3.118	207.66	3.401	232.72	3.634	255.05	3.826	276.64	4.036	295.73	4.168	304.56	5.728	381.90	
4.	0.884	59.94	1.436	95.70	1.956	130.59	2.446	163.05	2.905	193.67	3.334	222.25	3.732	248.79	4.039	273.29	4.306	295.74	4.742	316.15	4.884	325.39	6.124	408.26	
4.5	0.938	62.52	1.523	101.51	2.074	138.30	2.594	172.94	3.081	205.42	3.536	235.73	3.958	263.98	4.348	289.86	4.705	315.97	5.030	335.32	5.180	345.34	6.465	433.05	
5.	0.988	65.90	1.605	107.00	2.187	145.78	2.731	182.30	3.248	216.53	3.727	248.46	4.172	278.15	4.583	305.54	4.960	330.64	5.302	353.46	5.460	364.02	6.847	456.45	
5.5	1.037	69.12	1.683	112.92	2.293	152.89	2.868	191.19	3.406	227.10	3.968	290.27	4.376	320.73	4.820	350.45	5.205	366.78	5.568	397.20	5.681	398.76	7.500	500.02	
6.	1.083	72.19	1.758	117.21	2.395	160.69	2.995	198.69	3.558	237.20	4.085	304.70	4.527	334.14	4.925	381.32	5.255	376.96	5.645	418.01	5.726	416.05	8.006	520.45	
6.5	1.127	75.17	1.830	122.00	2.493	168.21	3.118	207.82	3.703	246.88	4.250	293.51	4.757	317.14	5.245	365.37	5.555	376.96	5.975	435.23	6.037	430.71	8.101	540.08	
7.	1.170	77.94	1.899	126.60	2.587	174.49	3.235	215.89	3.843	256.20	4.371	307.11	4.937	329.11	5.283	381.22	5.568	391.22	6.073	461.90	6.141	450.71	8.101	540.08	
7.5	1.211	80.71	1.966	131.05	2.678	178.54	3.349	223.26	3.978	265.19	4.505	304.22	5.110	340.60	5.613	374.20	6.074	404.95	6.494	432.90	6.567	445.83	8.386	539.04	
8.	1.250	83.36	2.030	135.35	2.764	184.40	3.459	230.59	4.108	273.69	4.715	314.21	5.278	351.84	5.797	396.38	6.278	418.29	6.707	447.10	6.807	460.45	8.661	577.37	
8.5	1.289	85.92	2.093	139.51	2.851	190.07	3.565	237.68	4.235	282.32	4.860	323.98	5.440	362.66	5.976	398.37	6.467	431.16	6.913	460.86	7.119	474.62	8.927	593.14	
9.	1.326	88.41	2.153	143.66	2.933	195.68	3.669	244.57	4.358	290.50	5.001	333.37	5.598	373.18	6.149	409.02	6.654	443.50	7.113	474.22	7.392	498.38	9.186	613.39	
9.5	1.363	90.84	2.212	147.49	3.014	200.194	3.769	251.29	4.477	298.46	5.138	342.51	5.731	383.40	6.317	416.92	6.856	455.78	7.308	487.22	7.627	501.77	9.458	632.17	
10.	1.398	93.20	2.270	151.32	3.092	206.16	3.867	257.80	4.588	306.22	5.271	351.49	5.900	393.36	6.481	432.09	7.014	467.60	7.468	499.87	7.792	514.60	9.683	646.52	
10.5	1.432	95.50	2.326	155.06	3.169	211.25	3.963	264.17	4.707	313.78	5.401	360.08	6.028	405.08	6.641	449.77	7.197	470.14	7.683	519.22	7.913	529.73	9.923	661.46	
11.	1.466	97.75	2.381	158.71	3.245	216.28	4.056	270.39	4.831	321.16	5.526	368.68	6.158	412.56	6.798	458.17	7.356	478.42	7.864	524.27	8.069	539.10	10.155	677.05	
11.5	1.499	99.94	2.436	162.27	3.316	221.09	4.147	276.46	4.926	328.59	5.653	376.14	6.281	421.91	6.981	463.37	7.523	491.46	8.041	536.06	8.281	552.07	10.384	693.24	
12.	1.531	102.00	2.494	165.78	3.389	225.84	4.256	282.41	5.032	335.45	5.774	384.94	6.464	430.91	7.100	473.24	7.683	501.29	8.214	547.58	8.459	563.94	10.607	707.13	
12.5	1.563	104.20	2.558	169.15	3.457	230.50	4.364	288.25	5.135	342.36	5.893	392.68	6.597	439.79	7.246	483.10	7.842	512.71	8.383	558.88	8.633	575.67	10.826	721.17	
13.	1.594	106.36	2.626	172.53	3.529	235.06	4.469	293.94	5.237	349.14	6.010	400.68	6.736	448.50	7.390	492.66	7.997	523.14	8.549	589.94	8.804	598.08	11.040	736.01	
13.5	1.624	108.28	2.697	175.82	3.595	239.54	4.463	299.54	5.337	355.70	6.124	408.39	6.866	457.08	7.511	502.05	8.149	534.39	8.719	599.84	8.972	608.13	11.250	750.03	
14.	1.653	110.22	2.766	179.06	3.659	243.94	4.567	305.04	5.453	362.32	6.237	415.79	7.002	465.45	7.639	511.26	8.296	545.27	8.872	611.45	9.145	617.45	11.457	763.78	
14.5	1.683	112.22	2.833	182.25	3.724	248.25	4.667	310.44	5.581	368.74	6.347	423.16	7.127	473.67	7.766	520.31	8.446	553.01	9.029	621.83	9.299	619.81	11.660	777.31	
15.	1.712	114.14	2.750	185.33	3.787	252.50	4.786	315.04	5.635	371.64	6.456	430.93	7.247	481.77	7.883	529.30	8.599	562.09	9.185	612.22	9.359	630.94	11.859	790.66	

The discharges for intermediate heads can be obtained by interpolation. A fair approximation to discharge for intermediate heads can also be found by interpolation.

TABLE VI.

Table for the Reduction of Rainfall and Evaporation measured in Inches to the Equivalents in Cubic Feet per Acre and per Million Square Feet of Area.

A			B			C			D		
Depth, inches.	Cubic feet per acre.	Cubic feet per million square feet.	Depth, inches.	Cubic feet per acre.	Cubic feet per million square feet.	Depth, inches.	Cubic feet per acre.	Cubic feet per million square feet.	Depth, inches.	Cubic feet per acre.	Cubic feet per million square feet.
1	2	3	4	5	6	7	8	9	10	11	12
1	3,630	83,333	0'1	363	8,333	0'01	36'3	833	0'001	3'63	83
2	7,260	166,666	0'2	726	16,666	0'02	72'6	1,666	0'002	7'26	166
3	10,890	250,000	0'3	1,089	25,000	0'03	108'9	2,500	0'003	10'89	250
4	14,520	333,333	0'4	1,452	33,333	0'04	145'2	3,333	0'004	14'52	333
5	18,150	416,666	0'5	1,815	41,666	0'05	181'5	4,166	0'005	18'15	416
6	21,780	500,000	0'6	2,178	50,000	0'06	217'8	5,000	0'006	21'78	500
7	25,410	583,333	0'7	2,541	58,333	0'07	254'1	5,833	0'007	25'41	583
8	29,040	666,666	0'8	2,904	66,666	0'08	290'4	6,626	0'008	29'04	666
9	32,670	750,000	0'9	3,267	75,000	0'09	326'7	7,500	0'009	32'67	750
10	36,300	833,333	...	...	...	...	...	...	...	...	...

Example 1.—Required the number of cubic feet per acre corresponding to 1'237 inches of rain:—

Under A for	1 inch,	column 2,	cubic feet	...	...	3,630'00
" B "	0'2	" 5	"	...	...	726'00
" C "	0'03	" 8	"	...	...	108'90
" D "	0'007	" 11	"	...	...	25'41

Total cubic feet ... 4,490'31

Example 2.—A tank has a waterspread, at a certain time, of 93'45 millions of square feet, and a rainfall of 4'35 inches then occurs. Required the quantity of water received by the tank from the rainfall over that area of waterspread.

The number of cubic feet equivalent to 4'35 inches of rainfall on one million square feet is—

From the table, column 3	...	...	...	...	383,333
" "	" 6	...	...	...	25,000
" "	" 9	...	...	...	4,166

362,500

and  $93'45 \times 3625 = 33'876$  millions of cubic feet.

Example 3.—At X Tank, during the period 17th July to 18th December of the irrigation season, the loss by evaporation was as shown in the following tabular statement:—

Dates of record of evaporation and waterspread.	Evaporation depth, inches.	Areas of waterspread.		Loss of evaporation.	
		Actual on dates, millions of square feet.	Mean millions of square feet.	Cubic feet per million square feet.	Millions of cubic feet.
17th July ... ..	10'38	76'080	68'803	891,666	60'739
31st August ... ..	6'21	61'748	57'439	517,500	29'725
30th September ... ..	5'673	53'131	48'637	472,700	22'993
31st October ... ..	2'741	44'144	39'651	228,416	9'057
30th November ... ..	1'216	35'158	26'355	101,333	2'671
13th December ... ..		17'552			
					125'185

## CHAPTER XI.

## MASONRY DAMS.

**157. Masonry Dams.**—Having settled upon a site that meets in every respect the requirements demanded—which embrace the utilization of every source of supply, and the adaptation of such sources to the required object—the next point to be studied is the one of locating the dam and herein are involved a few matters that call for special consideration. It is of course understood that an impounding reservoir cannot be constructed unless there be an impervious bed under it at a reasonable depth. It is often found that where two streams meet, a contraction of the valley occurs a little lower down, and the best site for the erection of a dam is where a valley widens out into a flat area bounded by steep sides, there generally being a contraction of the valley in close proximity.

The quality, condition, and class of rock; inclination, permeability and direction of strata; whether in closing the valley the strata will pass obliquely under the dam at right angles or parallel with it are all matters requiring consideration. Observation will also have to be made as to whether any portion of the district has ever been subjected to the disturbing influence of volcanic eruption or earthquake shocks. The solidity of the rock upon which the dam is to be founded is also of great importance, whilst faults or small fissures filled with clay will inevitably lead to an immense amount of excavation. It is usual, therefore, to test the ground by boring, or, preferably, by sinking shafts along the line where the proposed dam is to be built. In this way the condition of the rock, the depth of the loose sub-soil, and the discovery of any springs of water, which cause great trouble and danger in the foundations, will be at once ascertained. Too little attention is often paid to these details, with the result that as much masonry has to be placed below the surface of the ground as there is in the superstructure, with a corresponding enormous increase upon the original estimate of the work.

The fall of the water-course in which the dam is to be erected has a direct relationship to its height, a rapid course requiring a greater height of dam to give a large impounding space.

Having located the ultimate position of the dam, we can next proceed, by the aid of carefully surveyed contour lines, which have been previously set out on the ground at every 3 or 4 feet height, to calculate at various heights the capacity obtained, the required capacity indicating the necessary height of the dam.

At a point near where the various water-courses upon which we depend for supply touch the water when the reservoir is full, wells should be built of dry stone or otherwise for the purpose of retaining the silt which will be brought down by heavy rainfalls. In this way a great quantity of detritus will be checked from being swept into and depositing on the bottom of the reservoir, and so reducing its capacity. Each silt deposit can be conveniently cleaned out, during dry weather, at small expense. As the bulk of the silt will be brought

down during heavy storms, allowance may be made for passing off the water by a by-wash when the reservoir is full; this also relieves any undue strain upon the wall from a sudden rise of the surface of the water, and further insures that the overflow provided is under all circumstances ample.

**158. Stability of Masonry Dams.**—For a masonry dam to be perfectly stable the following conditions must be complied with:—

1. No part of the masonry must be in tension.
2. No part of the structure must be under more than a certain pressure from the super-incumbent weight.
3. It must by friction alone resist any tendency to slide on its base.
4. It must by its own weight alone be able to resist all tendency to overturn by water pressure or the pressure of uneven winds, etc.
5. There must be such a width given to the top as to counteract the effects of expansion and contraction.

If the line of pressure falls outside the centre third of the profile, the structure is exposed to tension. The line of pressure—sometimes called the line of resistance—should therefore fall within the centre third, for if the requirement as to tension be fulfilled we have conditions 2 to 4 complied with. The line of pressure is a line intersecting each joint of a structure at the point of application of the resultant of all the forces acting on that joint.

To compute the best section that fulfils the above requirements without any important excess of material beyond what is necessary, is a very complicated problem, but with care it can be greatly simplified. The system that has been generally adopted is to make a number of trial profiles and to adopt the one that gives the required lines. Mr. W. B. Coventry remarks in his memoir on the "Design and Stability of Masonry Dams": Owing to the indeterminate nature of the problem, it seems impossible to construct a general formula for calculating the dimensions of a dam, and the method usually followed consists in assuming an approximate profile, and then testing its stability by a graphic resolution of forces. If found defective, the profile is altered, and the graphic process repeated until a sufficiently exact result is obtained!

A correct profile may undoubtedly be found by making a number of trials; but it is extremely laborious, and may involve a long period of unsatisfactory work, yet an approximate profile may be obtained by the application of a very simple formula giving polygonal outlines of inelegant form, but sufficiently accurate to bear upon it the ultimate design.

The ultimate profile should adhere to the theoretical profile, but there are a few factors which the formula does not take into account—these, when allowed for, can be incorporated in the design of outline.

The top width of a dam is a matter of judgment, and it is this width, which cannot be calculated theoretically, that will assist the designer, to produce a graceful form.

The great heat of tropical and semi-tropical climes during the day has a very decided expanding influence upon the masonry, and the case may be cited of a masonry dam that is cracked in two places from the

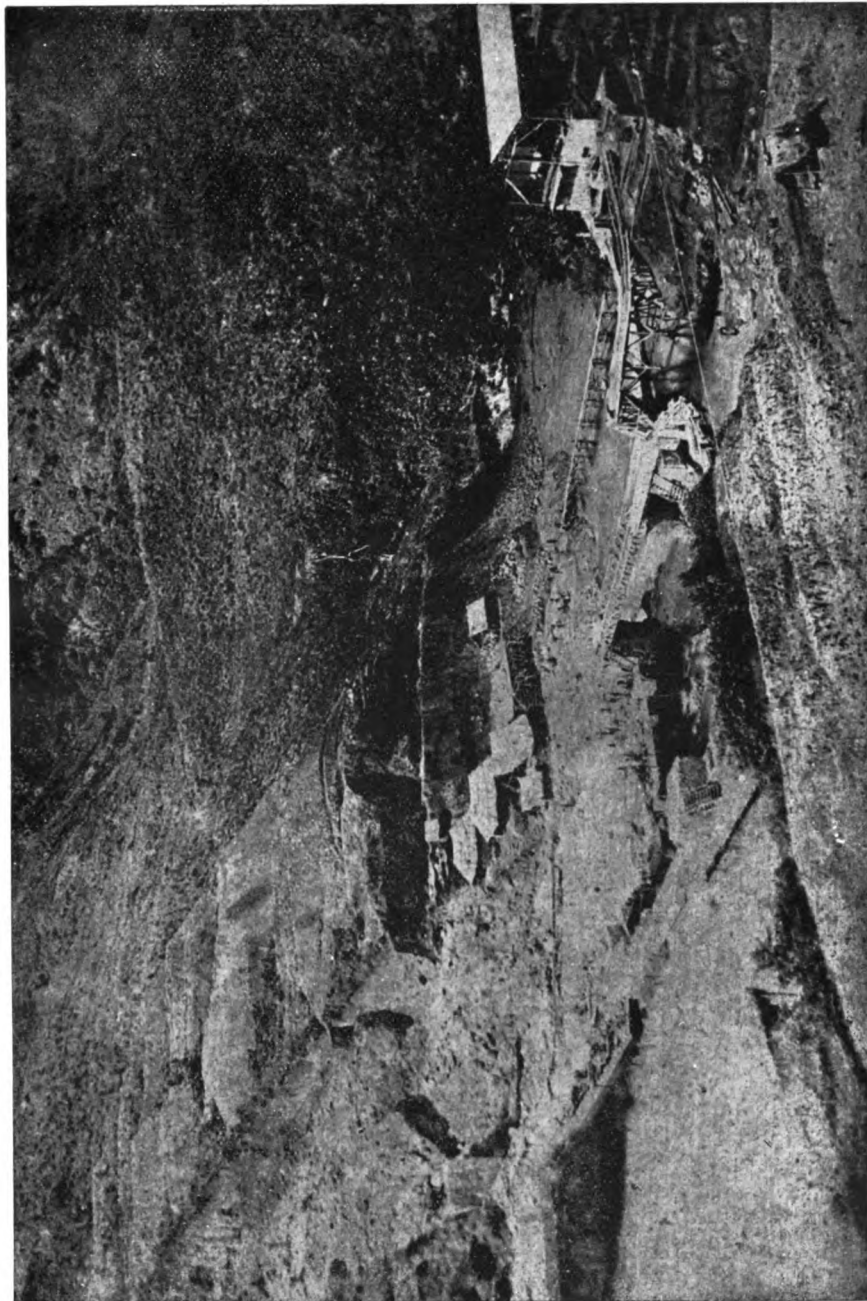

Plate XXII. Periyar in flood during construction of Dam.



top downwards for a depth of 8 to 12 feet, and passes a stream of water during the winter, while in the summer months it is perfectly water-tight; the top width, however, is only 6 feet 6 inches, instead of being 8 feet 3 inches, in which case these cracks would not have taken place.

High masonry dams being usually required to close deep gorges and valleys have consequently less length of top to depth than low masonry dams, which may impound the same quantity of water, but, being in flat and low-lying country, will be of excessive length to depth; by taking  $\sqrt{H} + 2$  feet (where H equals height) for width of top, a wide top in proportion to height is obtained for low dams and a gradually decreasing width to height in high dams.

It is necessary, then, that a theoretical profile should embrace and allow for the above in all cases, which the following very simple formula does; and that the width at quarter height from the top shall be dependent upon beauty of outline rather than strict mathematical rule. By a slight modification of Sir Guildford Molesworth's formula Mr. Courtney obtains one which is applicable to both high and low dams; whilst the method employed in obtaining the offset to the inner face is very simple, and results in a very close approximation to Rankine's theoretical profile, as well as the practical or ultimate profile obtained for the inner face of the Quaker Bridge Dam, built for the supply of water for New York, which has a maximum height of upwards of 250 feet, Fig. 116.

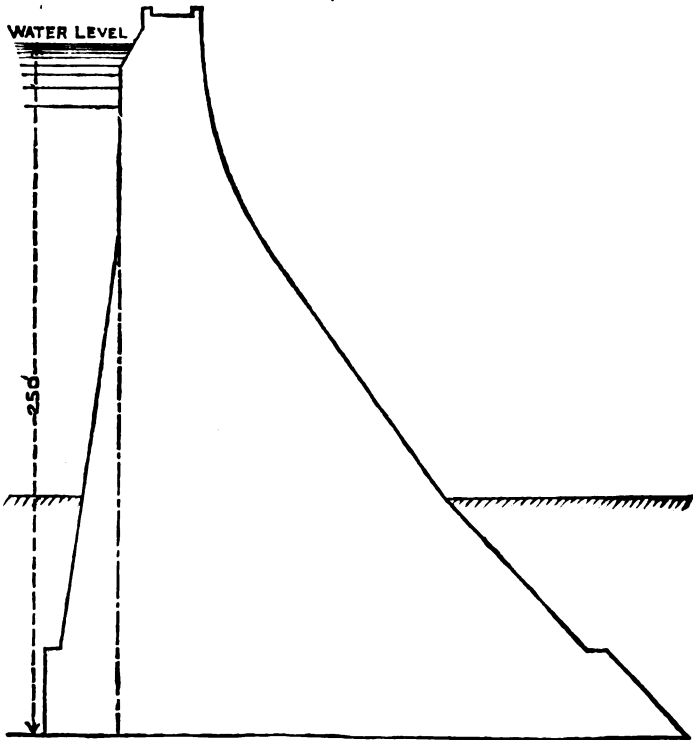

Fig. 116. Quaker Bridge Dam.



**159. Practical Formula.**—The following formula (Courtney's) may therefore be adopted in ascertaining any theoretical profile and will meet rigidly the requirements of stability which can be afterwards ascertained by the graphic system and by calculation as a check if desired :—

Where (Fig. 119)  $b = \sqrt{H} + 2$

$$a = \frac{H}{4} \times 0.72$$

$$y = \sqrt{\left( \frac{0.05 \times x^2}{\lambda + (0.03 \times x)} \right)} = 0.6x \text{ as a minimum.}$$

$$z = \frac{f}{25} \text{ for 100 feet depth or}$$

$$= \left( \frac{0.09 \times x}{\lambda} \right)^4 \text{ approximately for all depths.}$$

In which the notation is :—

$H$  = height of dam in feet.

$x$  = depth in feet of an imaginary horizontal plane from the surface of the water.

$b$  = width of the top of the dam.

$a$  =  $F$  at a depth of  $\frac{1}{4} H$ .

A vertical line being dropped from the top of the upstream face of the dam then :—

$y$  = the ordinate, in feet, from that vertical line to the outer or downstream face of the dam at any depth  $x$ .

$z$  = the ordinate, in feet, from that vertical line to the inner or upstream face.

$\lambda$  = limit of pressure, in tons, per square foot.

$f$  =  $H - \frac{1}{4} H$ .

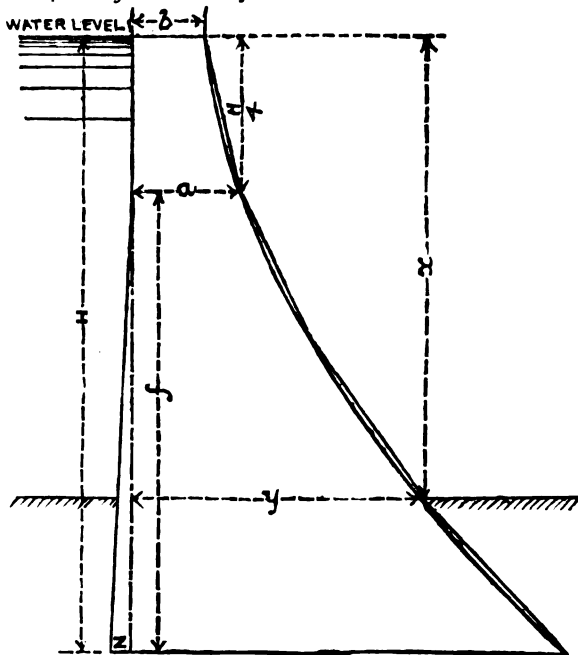

Fig. 117. Theoretical Profile of Dam.

**160. Theoretical Profile.**—Having drawn out our theoretical profile by dividing it into four sections, we can proceed to design upon this outline the ultimate form which the wall shall assume, being guided by the width at  $\frac{H}{4}$ , this width being, by the method adopted, dependent upon an outline that combines rigidity and elegance of form. This is obtained by applying a curve that will start tangentially with any point at the outer face at about half the total height of the dam, passing through the point given for the quarter height and meeting the top edge; from the half height to the base another curve will be drawn in that, closer, with the calculated width at the half height, three-quarter height, and the base. These two curves, encroach somewhat upon the trapezium, given by the formula on each section; but if the total height be divided into more than four planes the curved lines will approximate more closely to the polygonal lines of the outer face. We have, after completing this operation, an ultimate or practical profile, upon which may be based the diagram of forces, in order to ascertain the lines of resistance with the reservoir full and empty. The density of the material of the dam must be taken into consideration in fixing the limiting pressure; though the latter is, of course, directly governed by the capability of the materials used to resist crushing.

**161. Limiting or Maximum Pressure on the Masonry at the base or any point of a Dam.**—The proportions of stone to mortar in a well-built dam will be two-thirds stone to one-third mortar; the stone employed should not have a less specific gravity than 2.5; the cubic metre will therefore weigh 2,500 kilogrammes. A mortar composed of one cement to three of sand,—sand being washed after passing through a one-eighth inch square hole sieve, and the weight of the cement being equal to 90 pounds per struck cubic foot—will have a specific gravity of 2.02 when fresh, but the immediate evaporation, and the drying which takes place afterwards, result in giving 1.99.

The density of the masonry can therefore be ascertained as follows:—

	Kilos per cub. metre.	Lb. per cub. ft.
$\frac{2}{3}$ of stone at 2,500 kilogrammes per cub. metre .. .. .	1,666	104.04
$\frac{1}{3}$ of mortar at 1,900 kilogrammes per cub. metre .. .. .	663	41.04
Total weight ..	<u>2,329</u>	<u>145.44</u>

The density can, therefore, be taken at 145 lb. per cubic foot, which will ensure a perfectly sound monolith. With especially sound and heavy stone, and increasing the proportion of cement, the density will rise to 150 lb. per cubic foot, or even 155 lb. For high masonry dams of over 100 feet no material should be used which will result in a less density than 145 lb. per cubic foot; for dams of 50 feet or less a poorer class of stone may be employed, and the masonry might have a density of not more than 130 lb. per cubic foot and be perfectly safe. The higher the density adopted the safer the work will be as it necessitates good material.

The next point that requires consideration is the limit of pressure on the masonry at the base of the wall. It must be noticed that in buildings of this kind the mortar plays a considerable part, and on its resistance the work depends. The crushing force on an eminently hydraulic mortar composed of one of cement to three of sand, when placed under the condition in which it is found in masonry, will not be less than 130 tons per square foot after ageing. Taking one-tenth of the crushing force as the limit of pressure we have 13 tons per square foot. By adhering to the rule that the lines of resistance shall fall within the middle third, with the density of the material taken as 150 lb. per cubic foot, the pressure on the outer base of the wall will not be more than 6.35 tons per square foot at 100 feet depth, 8.11 tons at 150 feet, and 10.47 tons at 200 feet. There is no chance, therefore, of the combined masonry and water pressures exceeding this limit, while for dams of 200 feet depth a stronger mortar would probably be used than one to three and thereby resist a greater crushing force.

**162. Examples of Limiting Pressure.**—General Mullins quotes the following examples of maximum pressure in dams: "For the Furens dam this pressure was taken as 6 kilogrammes per square centimetre or 5.488 tons per square foot, and the maximum, as executed, is estimated at 6.30 kilogrammes or 5.722 tons. For the dam of Ban, a later work, the pressure limit is 7.30 kilogrammes or 6.672 tons. For the Periyár dam this maximum pressure has been taken as 18,000 lb. or 8.035 tons per square foot. At the Almanza dam in Spain, the height of which is 134.48 feet, the maximum pressure is as much as 12.805 tons to the square foot, but this dam is, in profile, very different from the designs of modern works of this description.

As already stated the safe limit depends generally on the power of resistance of the cementing material to crushing. In Southern India lime of an excellent quality is fairly abundant, some of which is naturally hydraulic, while the richer or fat limes can be made so by suitable admixture of baked clay. Experiments to determine the resistance of the mortar to crushing must be undertaken.

Having determined the density and ascertained the limit of pressure to be applied at the base and drawn out the profile according to the formula the next step is to calculate the areas, weight, and centres of gravity of the four sections into which the profile is divided, and ascertain the direction and intensity of the resultant on each plane respectively.

**163. General Form of Dam.**—It has been considered with reference to the form of a dam on plan, that it is desirable, when the circumstances of the site afford facilities for its construction on a curved axis, convex on the front or water face, to adopt this arrangement, as by so doing the sides of the valley not only support the weight of the superimposed material, but also act as abutments and absorb a portion of the horizontal thrust due to the pressure of the water and that in a very narrow valley, or where the width of the bed of the river is considerably less than the height of the dam, this horizontal thrust may, by suitable arrangements, be transferred altogether to the sides, and the safe width for the base be thereby reduced materially with a corresponding economy of construction.

A dam of the pure arched type relies solely on the arched form for stability, in which case the pressure of the water is transmitted laterally to the abutments. If our knowledge of the laws governing masonry arches were more complete, the arched or curved dam would probably be the best type since it will contain the least amount of material. As it is, we know something of the laws governing such true masonry arches as those supporting bridges. In these the two extremities of the arch are raised at their springing on some firm abutment and the whole is keyed together at the centre; but in a masonry dam of arched form not only is the arch supposed to transmit the pressure laterally to the abutments at the sides, but as the dam rests on the bottom of the valley it is sustained again at that point, so that it cannot act as a true arch. For this reason it is not considered safe to build a dam depending purely on the arched form, and such few dams as have been constructed on this principle have been given somewhat of the gravity cross section, increasing downwards in width, so that they presumably resist the pressure both by gravity and arch action. The three best existing types of such works are the Zola dam in France and the Bear Valley and Sweet-water dams in California.

That a masonry dam constructed across a narrow valley can resist the water pressure by transmitting it to its abutments is proved by the dams above cited. The question then arises, can the profile be reduced from what would be required if the dam were straight? Krantz asserts that a dam curved in plan and convex upstream with a radius of 65 feet or less will transfer the pressure to its abutments. Dams, however, of even greater radius than this do transfer the pressure to the abutments. The radius of the Zola dam is 158 feet and its length on top is 205 feet. The length of the Bear Valley dam, which depends wholly on its arched form for its stability, is 230 feet, the radius at the top being 335 feet and at the bottom 226 feet. The Sweet-water dam is 380 feet in length on top, its radius at the same point being 222 feet. M. Delocre says that a curved dam will act as an arch if its thickness does not exceed one-third of the radius of its upstream or convex side. M. Pelletrew fixes the limiting value of the thickness at one-half of this radius. When a dam acts as an arch it only transmits the water pressure to the sides of the valley; its own weight must still be borne by the foundations.

**164. Design of Curved Dams.**—Wegmann gives the following formula for calculating the thrust in curved dams of circular plan:—

$$t = pr$$

in which  $t$  = the uniform thrust in the circular rings of any plane of the masonry;

$p$  = the pressure per unit of length of this section of the ring;

$r$  = the radius of the rings of the outer surface.

Arch action can only take place by the elastic yield of the masonry; but little is known of the elasticity of brick, stone, etc., and nothing of the elasticity of masonry; hence it is impossible to determine the amount of the arch action.

The chief disadvantage of the curved dam is the increased length over a straight plan, and the consequent increase in the amount and cost of the material to within certain limits of top length and radius.

Though the cross section of a curved dam may unquestionably, be somewhat reduced, it would be unsafe to reduce it as much as has been done in the case of the Bear Valley and Zola dams, though these have withstood securely the pressures brought against them. It might be reduced to the dimensions of the Sweet-water dam, thus saving largely in the amount of material employed. All the more conservative writers, as Wegmann, Rankine, and Krantz, recommend that the design of the profile be made sufficiently strong to enable the wall to resist water pressure simply by its weight, and to curve the plan as an additional safeguard whenever the nature of the site makes it advisable. An additional advantage of the curved form is that the pressure of the water on the back of the arch is perpendicular to the upstream face, and is decomposed into two components, one perpendicular to the span of the arch and the other parallel to it. The first is resisted by the gravity and arch stability, and the second thrusts the upstream face into compression, which has a tendency to close all vertical cracks and to consolidate the masonry transversely.

**165. Details of Construction.**—The founding of masonry dams on sound rock, both at bottom and sides of a valley, is essential. No site without such facilities for securing absolute stability and impermeability is suitable for a great dam.

All decomposed rock, and all detached or doubtful blocks or masses must be removed, and a thorough sound seat secured for the dam from end to end. Cracks or seams are liable to occur in all great masses of rock, and wherever these are found, they should be stopped with cement, and not only those traceable at the actual seat of the dam, but also any that may occur for a considerable distance on the upstream side of the toe of the inner face. Irregularities of surface and level at the seat are not only unobjectionable, but desirable and the nearer this surface approaches to that of random rubble when the stones are set with their angles sticking up, or to a series of rough pyramids, the better. It is desirable that there should be 4 or 5 longitudinal trenches or depressions from 10 to 15 feet wide, and 4 or 6 feet deep, traversing the rock on which the base of the dam is to be laid, to provide a good joint between the rock and the masonry. One of these trenches should be at, but within, the toe of each face. Such trenches will be longitudinally at more or less different levels every few feet, as determined by the surface level of the perfectly sound rock; and the bottom and side surfaces of the trenches should be left as rough as the blasting may make them.

The materials to be made use of are limited to stone, lime, and sand, and the mode of their use to rubble-masonry and concrete. These latter are about equally good, and the selection should depend upon the character of the rock available, of the stone therefrom obtainable from its reduction or quarrying, and upon the greater or less abundance of labour capable of executing random rubble work in the way required. Such work has to be carried out in horizontal courses, and, to use the description of the French Engineers, the platform of each course should present the appearance of a field bristling with projecting stones, so as to secure a bond in every direction; none of the stone should be larger than can be easily carried and handled by one man. If concrete be used, the roughness of surface cannot of course be the same in degree,





Plate XXIII. Foundations, Periyar Dam.

but it should be similar on the smaller scale proportioned to the smaller size of the stone. The lime used must be naturally, or must be made artificially, decidedly hydraulic. The time, within which the mortar must be relied on to set hard, will depend on the circumstances of the site, and upon the period therefore that may be expected to elapse, after the completion of any given height of the dam, before water will be permanently retained to that level. If there be no means of keeping down the water level below the lower part of the dam for the time being, and if, as may be the case, the water be liable to rise to this level within a very short time of, or immediately after the execution of a section of the height, it will be necessary to take care that the mortar is eminently hydraulic, and that the quantity of water used in its preparation is just what is necessary for the formation of hydrate of lime, and no more.

The more hydraulic the lime may be, the greater the necessity for preventing the desiccation, or premature drying of the mortar in each successive layer of rubble masonry or concrete. Though an excess of water in the preparation of the mortar would be highly prejudicial, rapid desiccation after it has been placed in the work would be even more so, and in the climate and temperature of Southern India the surface of freshly executed hydraulic masonry must be kept artificially moist in some completely effective manner. Even a very short time after hydraulic mortar has been put into a work, it will have set sufficiently not to absorb any more water placed upon it, than that which a very thin layer of the surface may need for its transformation. Wet sand, grass, or straw, may be used to cover up fresh work if more convenient than water, but moisture must be maintained continuously on the horizontal surface of the work so long as this remains uncovered by the succeeding course, and on the front and rear faces for at least ten or twelve times the period required for the firm setting of the mortar.

The sand must be clean and sharp: sand suitable for ordinary hydraulic construction work will do, but special care must be taken to make it perfectly free from earth or dirt of any kind.

**166. Examples of Dams—the Periyár Dam.**—A concrete dam faced with rubble masonry, 176 feet high, and retaining a head of water, with the reservoir full, of 162 feet, was constructed across the valley of the Periyár river in 1888-96, with the object of diverting the flow of the river from its own valley in the rainy district of Travancore, on the western side of the Ghâts, by means of a tunnel through the narrow dividing ridge, into the valley of the Vaigai, for irrigating the dry district of Madura on the eastern side of the mountain range which intercepts the rain coming from the Arabian Sea during the South-West Monsoon. The dam forms a reservoir with an area, when full, of 6,405 acres, from which the water can be drawn down 31 feet to the level of the sill of the diversion, affording a volume of 252 million cubic yards for supplementing the discharge from the river at its low stage, when it has a flow varying from 15 million up to 450 million cubic yards in a month. The dam accordingly in this case, enabling the flow of the river to be utilized for irrigation, so that the upper layer of water impounded in the reservoir forms only an auxiliary supply,



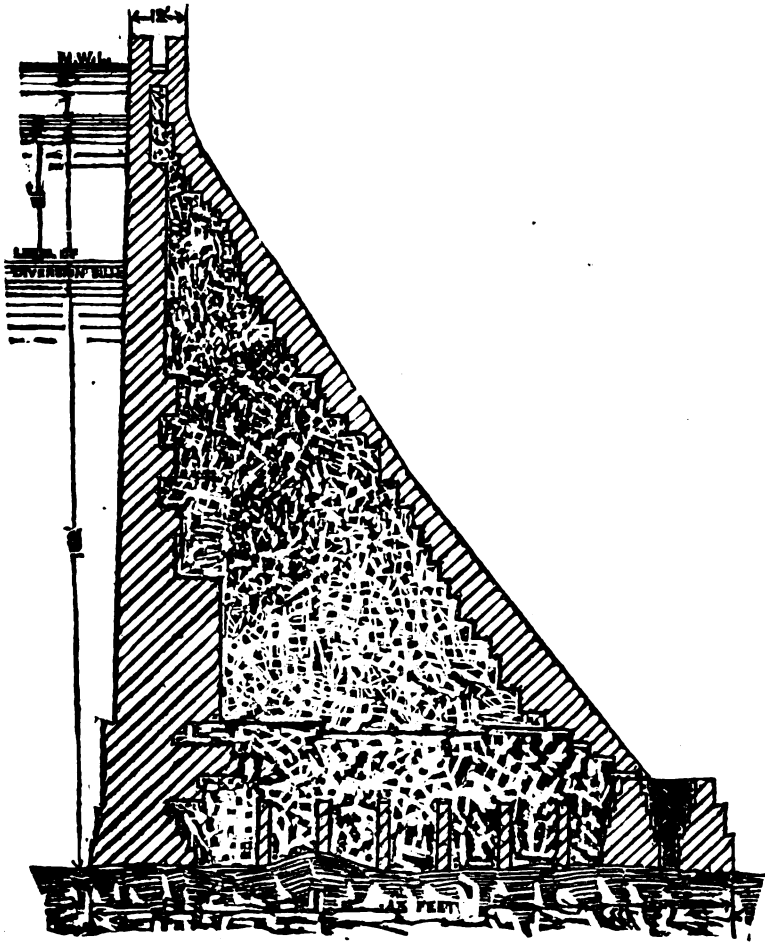
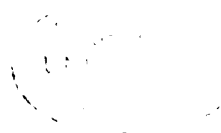

Fig. 118. The Periyár Dam.

will permanently maintain a depth of water in the reservoir of 131 feet; but though this depth is more than four times the depth of the layer which can be utilized, the volume of water retained in the reservoir is 12 million cubic yards less than that available for drawing off, owing to the notable decrease of every reservoir in area towards the bottom. The water is led from the reservoir in an open cutting, 21 feet wide, to the tunnel, rather over a mile in length, which pierces the rocky ridge, separating the river basins. The tunnel, having a sectional area of 90 square feet, has been given a fall of 1 in 75 for discharging the flow of the Periyár into a tributary of the Vaigai. From this tributary it is directed by a weir into the distributing channels for irrigation. A waste-weir, 420 feet long, has been formed across a depression on the right bank of the Periyár valley, Plate XXII but separated from the dam by a ridge of rock, with its crest 162 feet



To face page 183.

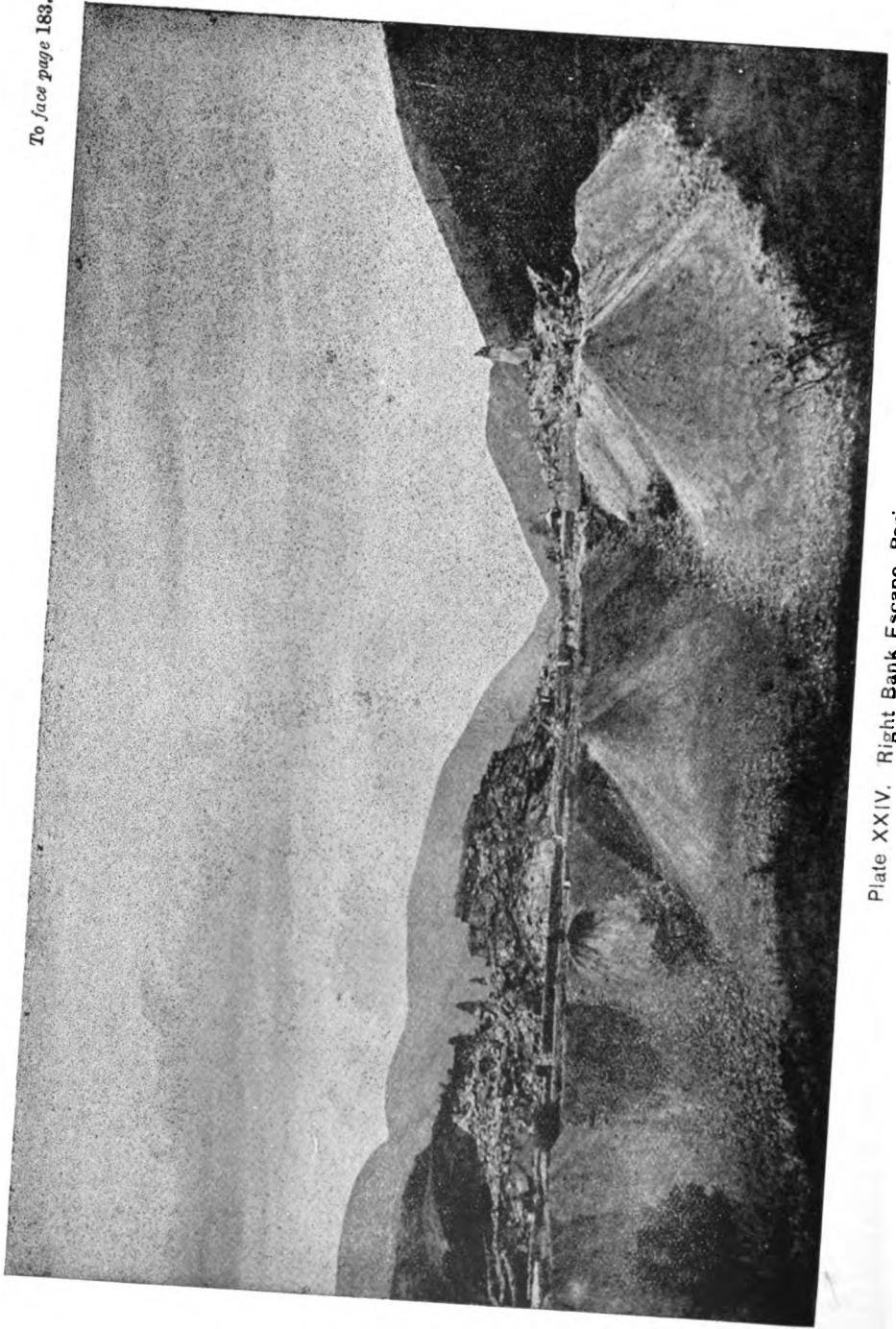

Plate XXIV. Right Bank Escape, Periyar.

above the bottom of the reservoir, and 14 feet below the top of the solid dam, over which the surplus waters are discharged during a high flood.

**167. The Tansa Dam.**—This great dam forming a reservoir for the supply of Bombay, was begun in 1886, and completed in April 1891. The work was done by contract and cost 31 lakhs of rupees. It is straight in plan, the alignment consisting of two tangents, and it has a total length of 8,800 feet, the maximum height being 118 feet. For a length of 1,650 feet the dam is depressed three feet to serve as a waste-weir. The thickness of the masonry at the base is 96.5 feet and the entire section is made of sufficient dimensions for an ultimate height of 135 feet, to which it may be raised in future when its length will be 9,350 feet on top.

The dam consists of uncoursed rubble masonry throughout, all the stones being small enough to be carried by two men. The stone is a hard trap rock, quarried on the spot. The cement was burned at the site of the dam from nodules of hydraulic lime-stone. From 9,000 to 12,000 men were employed on this dam during the working season of each year, from May to October, but during monsoons all work was suspended.

The volume of masonry in the work is 408,520 cubic yards. The excavation was carried to a considerable depth in places, and necessitated the removal of 251,127 cubic yards for the foundations.

The reservoir covers an area of 5,120 acres and impounds 2,720 million cubic feet above the level of the outlets which are placed 25 feet

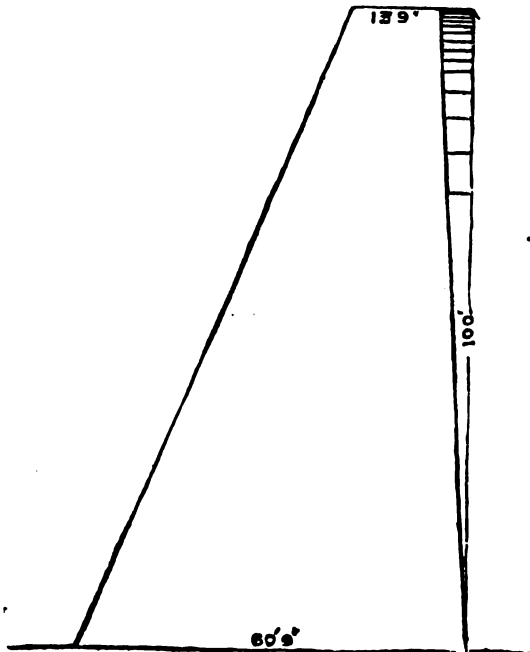

Fig. 119. The Poona or Lake Fife Dam.

below the crest of the waste-weir, or 89 feet above the river-bed. The loss by evaporation reduces the available supply to 6,858,000 cubic feet, although of course many times this quantity could be drawn from the lake if the outlets were near the bottom. The area of the watershed is 52.5 square miles, on which the rainfall is from 150 to 200 inches annually, and the estimated annual run off is 1,164 millions cubic feet.

**168. The Poona or Lake Fife Dam.**—This was one of the first masonry dams built in India by the British Government for irrigation storage, and was begun in 1868. It is made of uncoursed rubble masonry, founded on solid bed-rock, and is straight in plan, having a top length of 5,136 (nearly a mile), of which 1,453 feet is utilized as a waste-way. Its maximum height above foundation is 108 feet, and above the river-level 98 feet.

It is considered that the design of the dam does not exhibit any great professional skill. The upstream batter is 1 in 20 and the downstream slope 1 in 2, unchanged from top to bottom, the top width being 13 feet 9 inches, and the base 60 feet 9 inches. The alignment of the dam is in several tangents with different top width for each, according to its height, the points of junction being backed up by heavy buttresses of masonry. When completed the dam showed signs of weakness and was strengthened by an embankment of earth, 60 feet wide at top, 30 feet high, piled up against the lower side.

The water is drawn from the reservoir 59 feet above the river-bed, and there is therefore available but 29 feet of the total depth of the reservoir. The amount available above this level is 3,280 million cubic feet. The lake is 14 miles long and covers an area of 3,681 acres.

**169. The Bhatgur Dam.**—There are no masonry structures in the United States or Europe which surpass in size those of India, which have been constructed for irrigation purposes by the British Government, in the attempt to render the great population self-supporting and check the frightful famines by which it has been periodically devastated.

The Bhatgur dam, constructed on the Yelwand River, about 40 miles south of Poona, is one of the most notable of these great structures. Its length on top is 4,067 feet, its extreme height above foundations is 127 feet, and it forms a reservoir 15 miles in length, having a capacity of 5,480 million cubic feet. The extreme bottom width of the dam is 74 feet, and the crest is 12 feet wide, forming a roadway. The alignment of the dam curves in an irregular way across the valley, so as to follow the outcrop of bed-rock on which it is founded. The section of the dam was designed after a formula similar to that deduced by M. Bouvier, and all the calculations were worked out by Mr. A. Hill, M.I.C.E., who was afterwards assistant on the construction of the Tansa dam. The curve adopted for the lower face was a catenary, but the wall was actually built in a series of batters.

The three primary conditions of the design were—

- 1st.—The intensity of the vertical pressure was nowhere to exceed 120 lb. per square inch (8.64 tons per square foot);
- 2nd.—The resultant pressures were to fall within the middle third of the section; and

*3rd.*—The average weight of the masonry was assumed at 160 lb. per cubic foot. The use of concrete was only permitted where the pressure was calculated not to exceed 60 lb. per square inch, which gave a factor of safety of between 6 and 7.

The dam was designed and built by Mr. J. E. Whiting, M.I.C.E.

Waste-weirs at each end of the dam have a total length of 810 feet, and can carry 8 feet depth of water. The roadway is carried over these weirs on a series of 10-foot arches. Additional flood-discharge is given by twenty under-sluzes, 4 × 8 feet in size (of which fifteen are located 60 feet below the crest), having a total capacity of 20,000 second-feet. These sluzes are lined with cutstone, and closed by iron gates, operated from the top of the dam. The overflow wasteway is closed by a novel series of automatic gates that open in flood and rise up into position as the flood recedes, permitting the full storage of the additional 8 feet depth to be utilized. The gates are nicely balanced by counterweights that occupy pockets in the masonry. As the water rises to the top of the gate it fills these pockets, reducing the weight of the counterpoises, and the gate, being then heavier, will descend below the crest of the weir. When the level of the flood is reduced so that it no longer enters the pockets, the latter are emptied by small holes in the bottom, and the counterpoises overcome the weight of the gates, lifting them into place again.

The reservoir is used to supply the Nira Canal, which heads 19 miles below. This canal is 129 miles long, 23 feet wide, 7.5 feet deep, and carries 470 second-feet, supplying 300 square miles of land. The water is diverted to it by a masonry diverting-dam, known as the Vir weir, which is of itself an important structure, being 2,340 feet long, 43.5 feet high, constructed of concrete faced with rubble masonry. Its top width is 9 feet. Maximum floods of 158,000 second-feet pass over its crest to a depth of 8 feet, coming from a watershed of 700 square miles. A secondary dam, forming a water-cushion, is located 2,800 feet downstream. This is 615 feet long, 24 feet high, built of masonry founded on bed-rock, and carries a roadway over its crest. During maximum floods the water is 32 feet deep in the cushion when the water is 8 feet deep over the main dam.

The works were finished in 1890-91.

**170. The Betwa Dam.**—This masonry structure forms a diversion weir for turning the water of the Betwa River into a large irrigation-canal, and also serves for storage to the extent of 1,600 million cubic feet, which is the capacity of the reservoir above the canal flow, although not all available.

The total length of the dam is 3,296 feet, and its maximum height is 50 feet. It has an extremely heavy profile, being 15 feet thick at top and 61.5 feet at base. At its highest part the down-stream face is vertical and a large block of masonry 15 feet thick reinforces the dam at its lower toe. It consists of rubble masonry laid in native hydraulic lime, with a coping of ashlar, 18 inches thick, laid in Portland cement mortar.

In plan the dam is divided into three sections, of different lengths, by two islands, and is irregular in alignment.

The canal floor is placed 21·5 feet below the crest of the dam. A masonry subsidiary weir, 12 feet wide on top, 18 feet high, to form a water cushion for the overflow of the dam, was built 1,400 feet below, across the main channel, and a second subsidiary weir, 200 feet below the main weir, was made, to check the right-bank channel at the same level. The main dam and subsidiary weirs cost 5 lakhs of rupees, not including the regulating and flushing sluices, which cost Rs. 31,000. The main canal is 19 miles long, and with its branches supplies 150,000 acres. The dam is located 10 miles west of the town of Poona, on the Mutha River.

The canal on the right bank is 23 feet wide, 8 feet deep, and 99·5 miles long, drawing 412 second-feet from the reservoir and distributing it over 147,000 acres of land to be irrigated. At the town of Poona a drop of 2·8 feet is utilized for power by an under-shot wheel, to pump water to supply the town. The left bank canal is 14·5 miles long and carries 38 second-feet. The sluices from the reservoir are each 2 feet square, closed by iron gates operated by capstan and screw from the top of the dam. Ten of these supply the larger canal, and three discharge into the small one. Eight additional circular sluices, 30 inches in diameter, supply water to natives for mill-power and discharge into the larger canal.

**171. The Beetaloo Dam.**—Like the Periyár dam in India and the San Mateo dam in California, this structure is composed entirely of concrete, of which about 60,000 cubic yards were used.

The dam was built in 1888-90, to form a reservoir of 126 million cubic feet capacity for irrigation and domestic water-supply.

The dam is 580 feet long on top, curved in plan, with a radius of 1,414 feet, and designed after Professor Rankine's logarithmic profile type. The maximum height is 110 feet, the base width being the same as the height. The thickness at top is 14 feet. The spillway is 200 feet long, 5 feet deep. The cost was 17½ lakhs of rupees.

Water is distributed entirely by pipes under pressure, some 255 miles of pipe from 2 to 18 inches diameter being required.

The dam was designed and built by Mr. J. C. B. Moncrieff, M.I.C.E., Chief Engineer.

**172. The Geelong Dam.**—This structure is also constructed wholly of concrete, made of broken sandstone and Portland cement, in the proportion of 1 of cement to 7½ of aggregates.

The dam is 60 feet high, 39 feet thick at base, and 2·5 feet on crest. It is curved in plan on a radius of 300 feet from the water-face at crest. The coping is formed of heavy bluestone of large size cut and set in cement. The work was carried up evenly in courses a few inches thick, and thoroughly rammed. The surface of the finished concrete was wetted and coated with cement grout before adding a fresh layer to it.

The dam forms a reservoir for the supply of the city of Geelong in the State of Victoria, Australia. Water is drawn from it by two 24-inch pipes passing through the masonry, one of which is used for scouring purposes. The dam leaked slightly at the outset, but this leakage quickly disappeared.

**173. The Quaker Bridge Dam.**—The great dam for increasing the water-supply of New York is 730 feet long, 290 feet maximum





To face page 187.

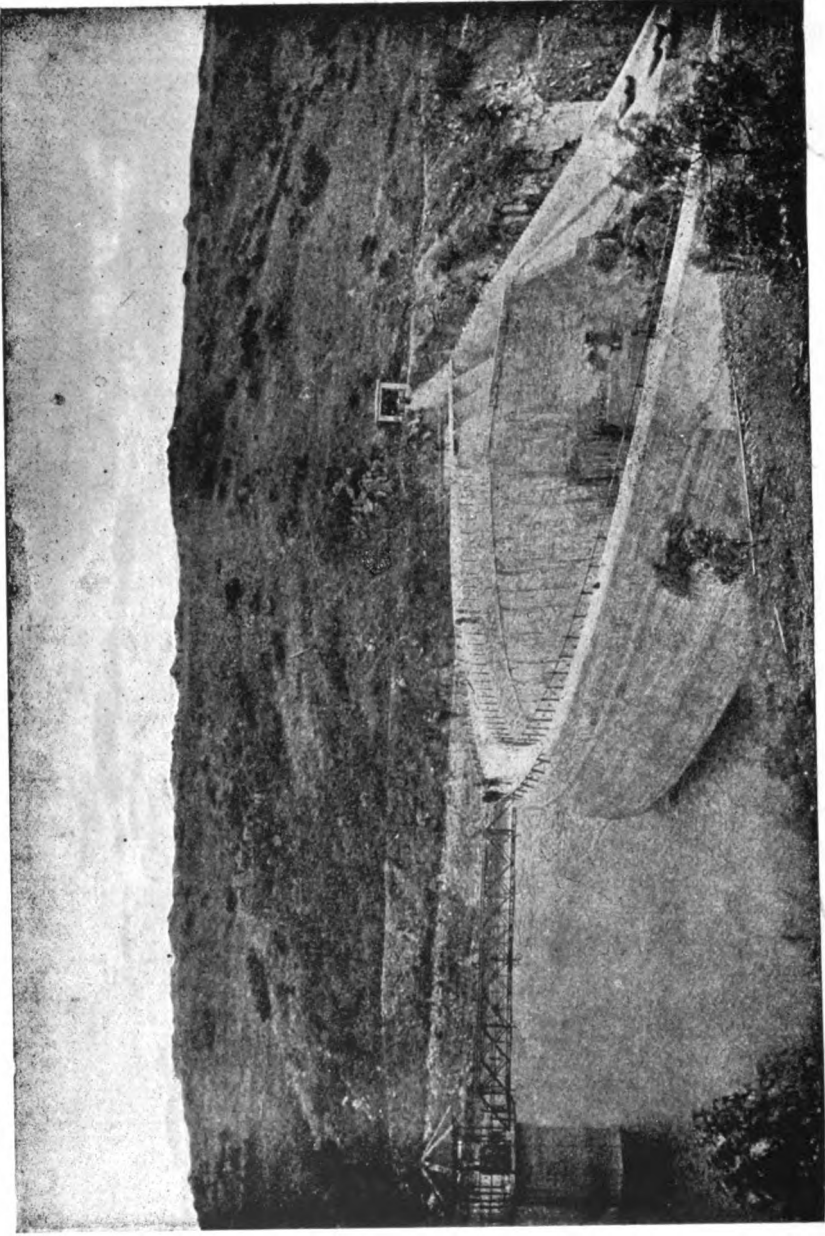

Plate XXV. The Sweetwater Dam.

height. It has a base width of 185 feet and crest width of 18 feet exclusive of the parapets protecting the roadway. The watershed area above the dam is 360.4 square miles and the reservoir when full will submerge an area of 3,360 acres. The original estimate of the volume of masonry of all kinds was about 579,000 cubic yards and is of rubble in cement.

The dam proper is joined to the left bank by an earthen embankment about 530 feet long, 245 feet in extreme height above its foundation and 120 feet above ground surface. Its top is 30 feet wide and stands about 20 feet above high water. The main dam is connected with the earthen dam by heavy masonry wing walls and masonry core wall. In continuation of the main dam a masonry overflow weir of heavy cross-section and 1,020 feet in length is constructed.

**174. Sweet-water Dam.**—This dam is slighter in cross-section than theory would require and depends to a certain extent on its curved plan for its stability. As shown in Plate XXV, it is 90 feet in maximum height, 380 feet long, 12 feet wide on top and 46 feet wide at the base. The radius of its curvature being great, this adds considerably to its stability. The structure is built throughout of large uncoursed rubble masonry, the greatest care having been used in every detail of construction. At its southern end are a set of seven escape-ways 40 feet in aggregate width, so arranged that the water issuing through them drops first into a series of water cushions, and is then led off by a directing wall so as to clear the dam. Near its base is a discharge sluice, operated from a water tower in the reservoir.

**175. Bear Valley Dam.**—The most notable curved dam is the Bear Valley dam in California, the cross-section of which is unusually light, as it depends chiefly on its curved plan for its stability, Plate XXVI. It is but 3.2 feet in width on top, and 8.5 at a depth of 48 feet below the crest. At this point an offset of 2 feet is made on each side, and its width thence increases to 20 feet at its base, which is at a point 64 feet below its crest. The structure is about 300 feet in length on top, and in plan it is curved with a 335-foot radius. It is built throughout of uncoursed rubble granite masonry, and depends almost wholly on its curved plan and excellence of its construction for its stability, since the lines of pressure with the reservoir full fall from 13 to 15 feet outside of its base.

**176. Pacoima Submerged Dam.**—One of the most novel and interesting masonry dams erected for impounding water in California, where so many novelties and experimental works have been carried out, is a slender little reservoir wall built across Pacoima Creek in the San Fernando Valley, 20 miles north of Los Angeles, for the purpose of forming an underground reservoir, whose storage capacity consists solely of the voids in the gravel bed filling the valley of the stream.

The creek drains a watershed whose area is 30.5 square miles above the point where it issues from the mountains. Here it flows over exposed bed-rock, and the normal summer flow, which diminishes gradually from about 2 cubic feet per second to less than one-tenth of that quantity is entirely diverted by a pipe-line and used below for irrigation. The dam in question is located  $2\frac{1}{4}$  miles further down where the channel of the stream is contracted to a width of 550 feet by a ledge of sandstone which

crosses it at about right angles. Between the dam and the mouth of the canyon is a continuous bed of gravel, in places half a mile wide, which, though lying on a heavy grade, constitutes the storage-reservoir. The dam was constructed by excavating a straight trench, 6 feet wide, from side to side of the channel, down to and into the sandstone bed-rock. In the centre of the trench a wall of rubble masonry was laid, 3 feet wide at base, 2 feet at surface, using the cobbles excavated from the trench, and a mortar of Portland cement and sand. The mistake was made of not filling the entire width of the trench with concrete, thoroughly rammed between the side walls, which would probably have insured satisfactory water-tightness. As it was, the space each side of the wall was refilled with gravel, and the wall was not thick enough or sufficiently well pointed to be entirely water-tight. The general height of the wall is 40 feet, the maximum being 52 feet. Plan, profile, and section of the dam are shown in Figs. 120 and 121. Two gathering wells are provided in the line of the wall, each 4 feet inside diameter, reaching from bottom to top.

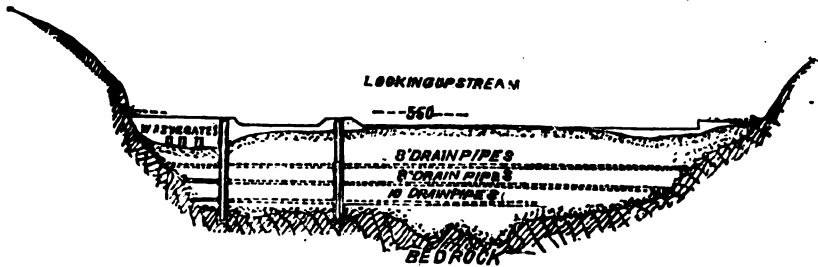

Fig. 120 Profile Paoima Submerged Dam.

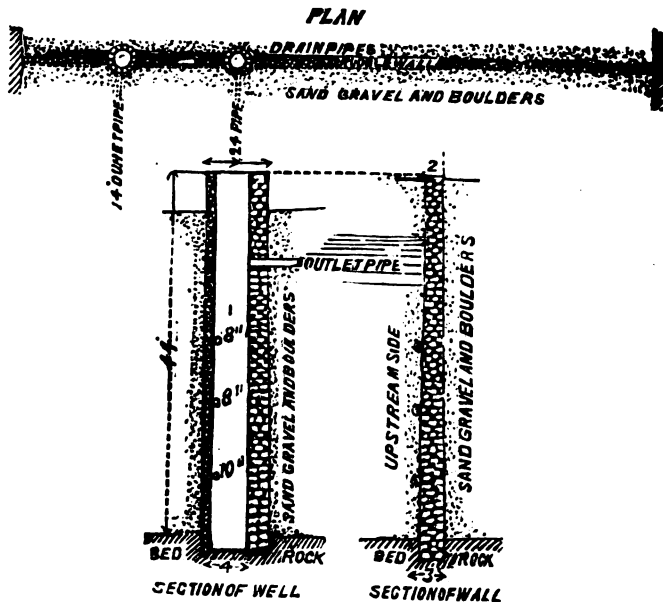

Fig. 121. Sections of Paoima Submerged Dam.

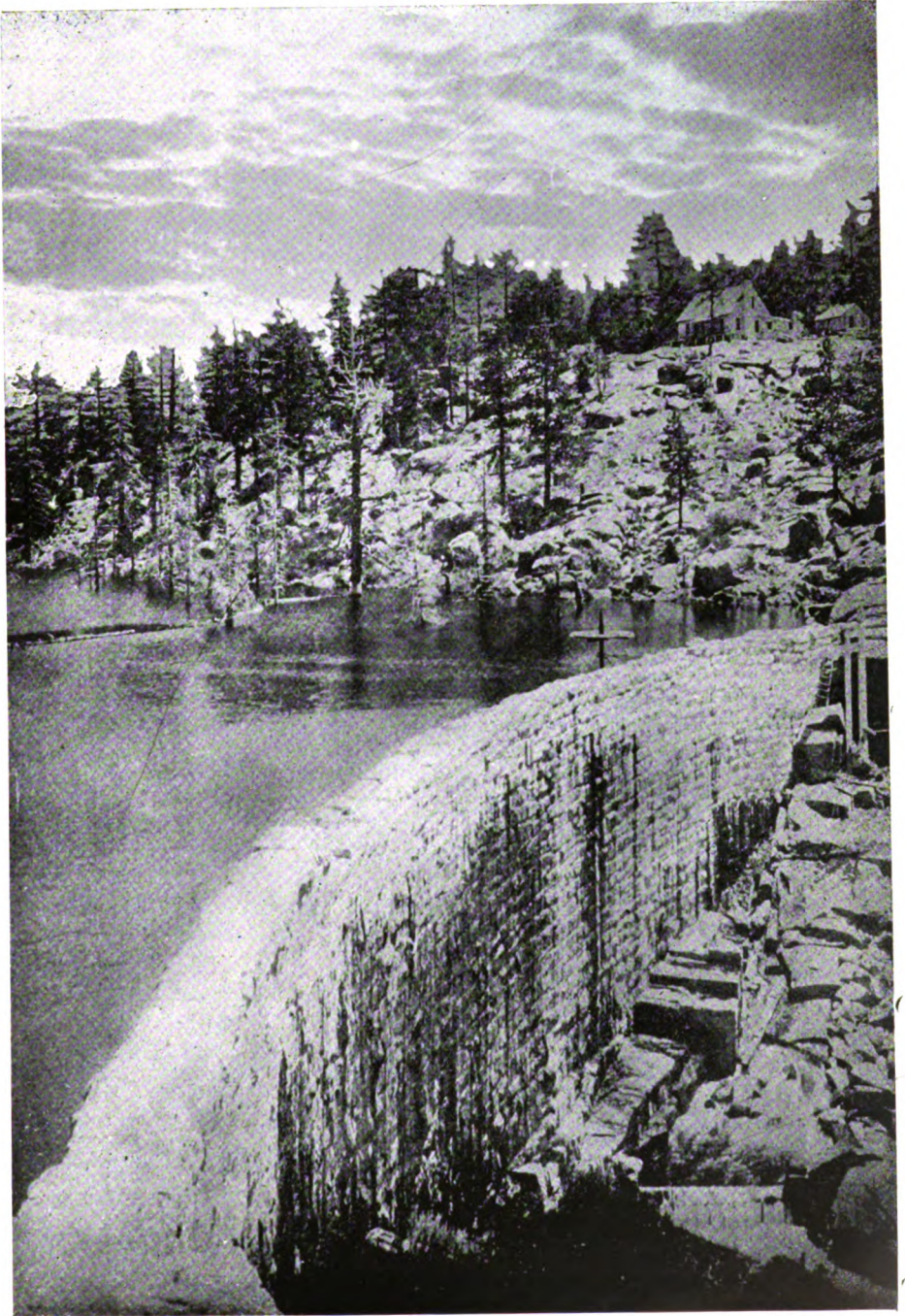

Plate XXVI. The Bear Valley Dam.

To face page 189.

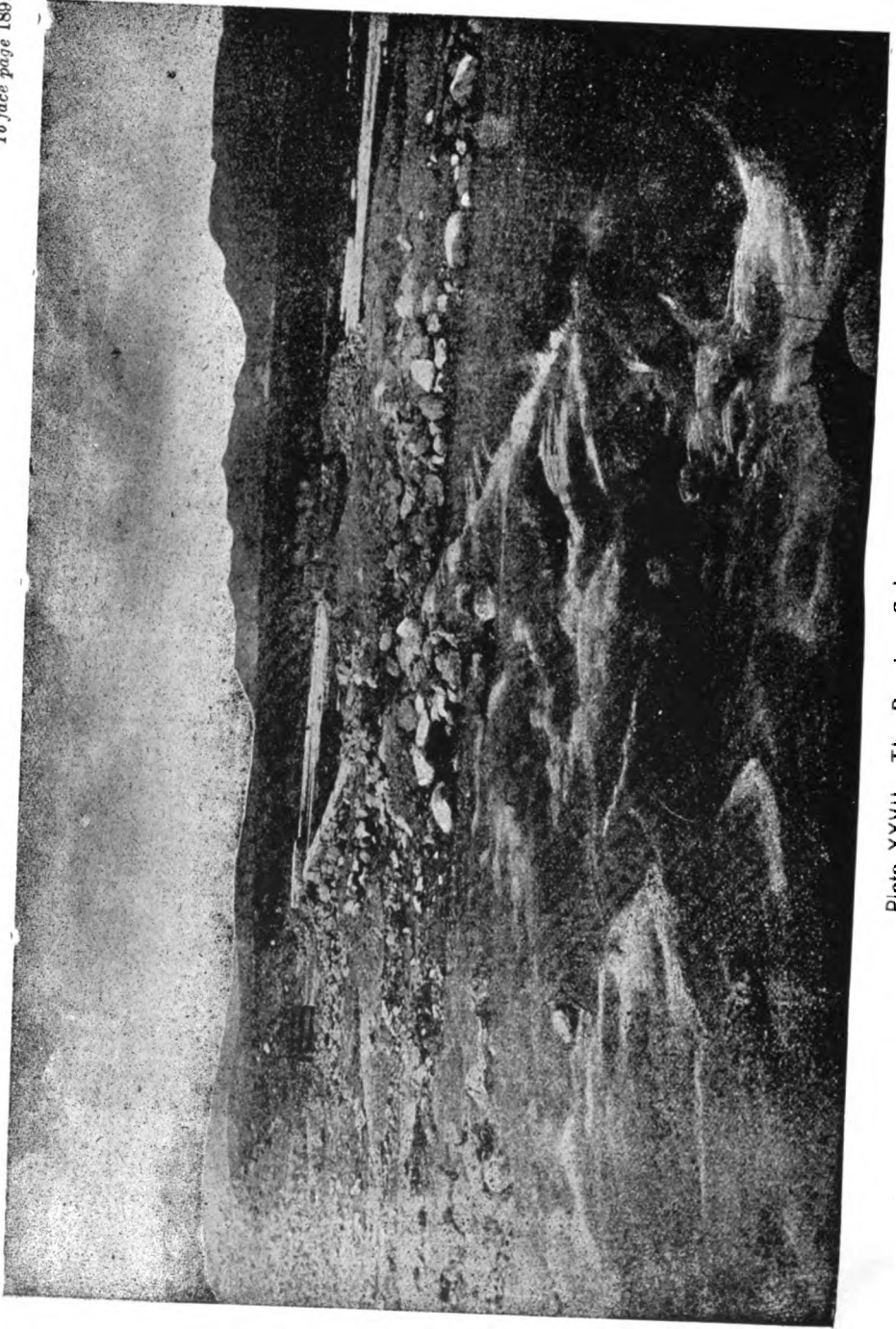

Plate XXVII. The Pacoima Submerged Dam.

Three lines of drain pipes, 8 and 10 inches diameter and made of asphalt concrete, laid with open joints, are placed inside the dam leading to the wells, the function of which is to gather the water and feed it to the wells. Outlet-pipes 14 inches diameter, one from each well, lead to either side of the valley. These are placed 13 feet below the top of dam and connect with a main leading to the pipe distributing system supplying the irrigated lands. When the reservoir is drained down to the level of these outlets further draft is made by pumping, which is required for about 100 days during late summer and fall.

The cost of the dam is given at Rs. 1,50,000, and the volume of masonry was about 2,000 cubic yards. It is a piece of amateur work, built without engineering advice, but it serves a useful purpose, though not at all commensurate to its cost. It is, however, a type of dam that may be applicable to other localities more naturally favorable than this.

The dimensions and capacity of this novel reservoir cannot be clearly determined, but its surface area is approximately 300 acres, its mean depth probably 15 to 20 feet, and its capacity equivalent to the volume of voids in the gravel, or 58 to 65 million cubic feet.

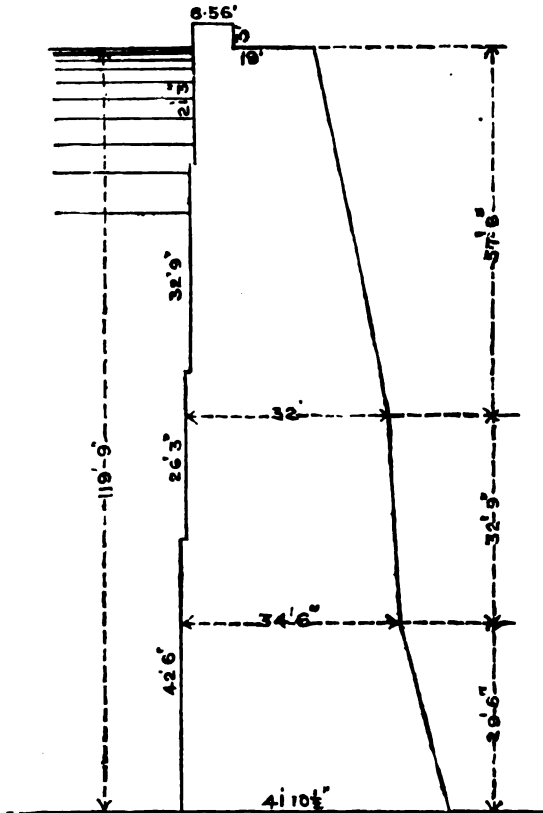

Fig. 122. The Zola Dam.

**177. The Zola Dam**—designed by the father of the noted novelist, is one of the few dams depending solely upon their arched form for their stability. It is 119.7 feet high, 48.8 feet thick at base,

19 feet thick at top, and 205 feet long on the crest, which is surmounted by a parapet 4 feet high. The gorge has a width of but 23 feet at the base of the dam. The radius of the arch is 158 feet at the crown. The water-face has three steps or offsets from the vertical and the profile is quite erratic and irregular. It forms a reservoir for supplying the city of Aix with water, and was built about the year 1843. It is made of rubble masonry, founded on rock.

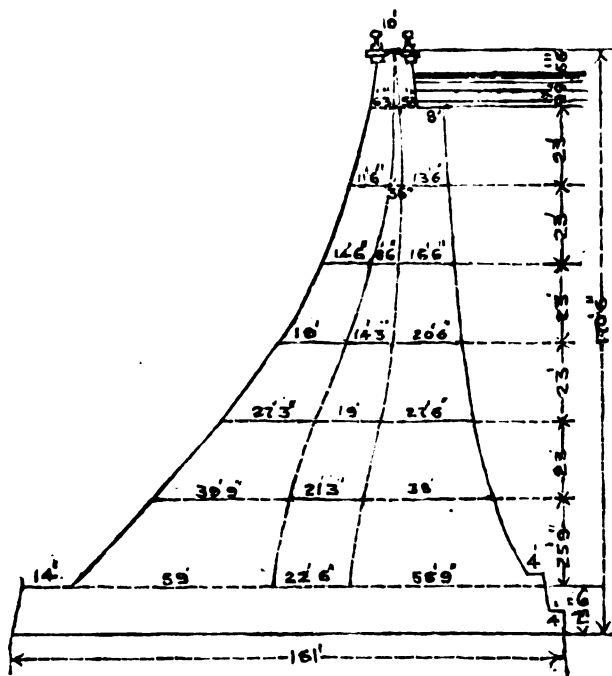

Fig. 123. The Furens Dam.

**178. The Furens Dam.**—Among many engineers this famous dam is recognized as a model of correct form, profile, and dimensions, whose outlines conform closely to what are accepted as certainly safe and well-balanced proportions throughout, even though the volume of material may be slightly excessive. It was built by the French Government in 1862 to 1866 for the purpose of controlling the floods of the Furens River and protecting the town of St. Etienne from inundations.

The dam is 183.7 feet in extreme height on the down-stream side, 170.6 feet in height on the up-stream side, and carrying a maximum depth of 164 feet of water. Its base thickness is 165.8 feet, and it is 16.4 feet thick at a depth of 21 feet below the top. The crest is 12.4 feet wide, and is used as a carriage-road; the top length is 326 feet. The dam was four years in building, construction being limited to six months each season owing to the altitude and to the severity of the winter weather. Each year, while building, the water was allowed to flow over the top of the finished masonry, and when completed no leakage was visible further than a few damp spots on the lower side with full reservoir.

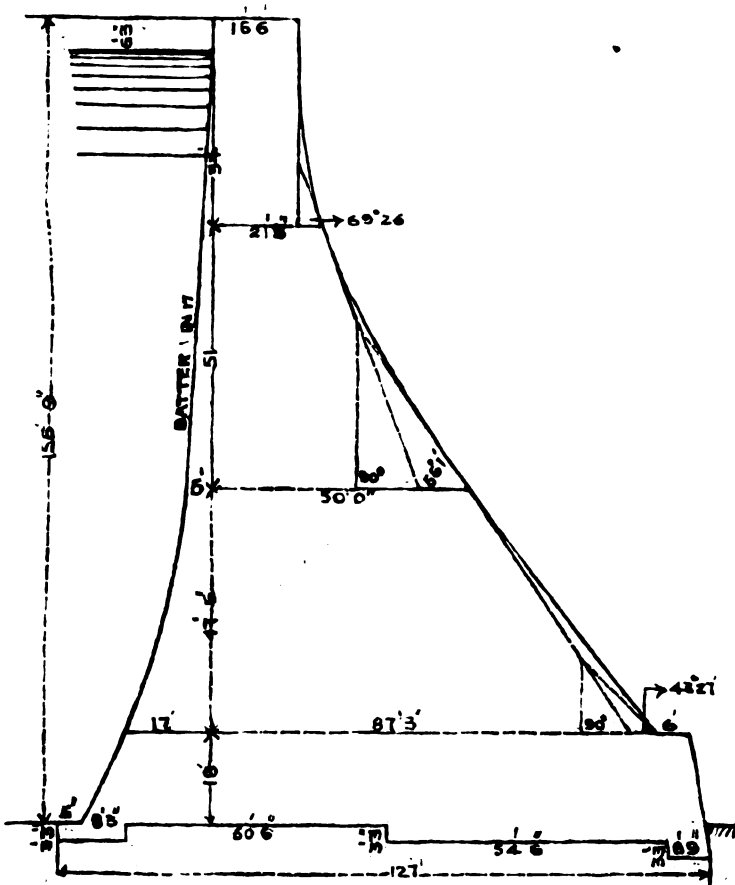

Fig. 124. The Ban Dam.

**179. The Ban Dam.**—Next to the Furens dam in height the reservoir wall constructed in 1867 to 1870, near the city of St. Chammond, was built upon the same general principles as the Furens dam, except that a greater maximum pressure was permitted upon the masonry, the computed extreme being 8.18 tons per square foot. Its extreme height is 157 feet, length 512 feet, base thickness 127 feet, top width 16.4 feet. The wall is battered or curved on both sides, there being no vertical faces. In plan it is curved convex upstream. It is composed of rubble masonry founded on rock. It is used for the supply of the city of St. Chammond—



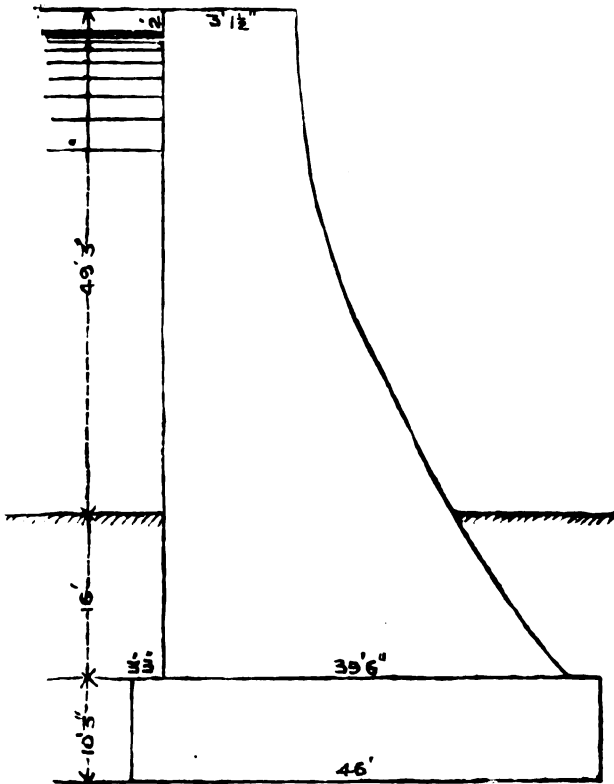

Fig. 125. The Bousey Dam.

**180. The Bousey Dam.**—The failure of this structure, April, 27, 1895, with the loss of one hundred and fifty lives and the destruction of much property has particularly emphasized the value of several features of masonry dams which may be regarded as essential in the design of all such works—

- 1st.—That they may be founded on impermeable bed-rock and the possibility of upward pressure from water passing through fissures be avoided.
- 2nd.—That they shall have a profile of such dimensions as to permit of no tension in the masonry.
- 3rd.—That the masonry shall be practically impervious to water.
- 4th.—That it be curved in plan to avoid temperature cracks and movements as the result of expansion and contraction of the masonry.

The Bousey was lacking in all of these essential features, and its failure was not surprising in the light of all the facts that have been published regarding it.

It was built in 1878 to 1881, near Epinal, France, across the small stream of Avière to form a storage-reservoir of 1,875,000,000 gallons for supplying the summit level of the Eastern Canal, which here crosses the Vosges Mountains in connecting the rivers Moselle and

Saoné, this canal being a connecting link in interior navigation between the Mediterranean and the North Sea.

The reservoir was fed by an aqueduct from the Moselle River. The reservoir covered an area of 247 acres. The general dimensions of the dam are as follows :—

	FEET.
Length on top .. .. .	1,700
Height above river-bed .. .. .	49
Height above foundations .. .. .	72
Width on top .. .. .	13
Width 36 feet below water-level .. .. .	18

The wall was vertical on the water-face from top to bottom.

The masonry was founded on red sandstone, which in places was fissured and quite permeable, with springs which gave trouble in constructing the foundations. The foundation was not excavated to solid, impermeable rock under the entire dam, but an attempt was made to remedy this deficiency by building what was called a "guard-wall", 6·5 feet thick, on the upper side of the dam extending down below the foundations through the imperfect rock for the purpose of cutting off leakage underneath. This was carried up to the river-bed and lapped against the main wall. The dam was completed in 1880, and the following year water was admitted. When it had reached about  $\frac{1}{4}$  the height, 33 feet below the top, enormous leakage, amounting, it is said, to 2 cubic feet per second, appeared on the lower side of the dams partly due to two vertical fissures or expansion-cracks in the wall. On March, 14, 1884, when the water had risen to within 10·4 feet of the top the pressure was sufficient to bulge the wall forward for 444 feet, forming a curve convex down-stream, the extreme movement being from 1 to 3 feet according to different authorities. Four additional fissures then appeared, and the leakage increased to about 8,000,000 gallons per day. These cracks opened in winter and closed in summer. The water was kept behind the dam and the following year allowed to rise to within 2 feet of the top, after which it was drawn off, when it was discovered that for 97 feet the dam had been shoved forward, separating from the guard-wall, and numerous cracks were found on the inner face. Extensive repairs were then undertaken. The joint between the main wall and the guard-wall was covered with masonry and surrounded by a bank of puddle, 10 feet thick, while a heavy, inclined buttress-wall was built at the lower toe, deep into the bed-rock and toothed into the masonry of the dam to prevent tendency to slide on its base. This abutment was nearly 20 feet in height and its base was 84·3 feet below the top of the dam, making the total thickness of base 71·6 feet. Notwithstanding all this work the dam was fatally weak at a point near the river-bed level, where the line of resistance falls considerably outside the middle third, and the final break occurred at a point about 33 feet below the top, where the fracture was almost horizontal longitudinally, and 594 feet of the central part of the dam was overturned. The break was level transversely for about 12 feet and then dipped towards the outer face. The repairs finished in 1889 were presumed to have made the dam safe, and the break did not occur for six years afterwards, during which time the action of temperature-changes is

presumed to have produced the weakness resulting in the final catastrophe. An interesting account of the failure of the dam was published in *Engineering News*, May, 16 and 23, 1895. The lesson taught by it will be serviceable to Engineers the world over.

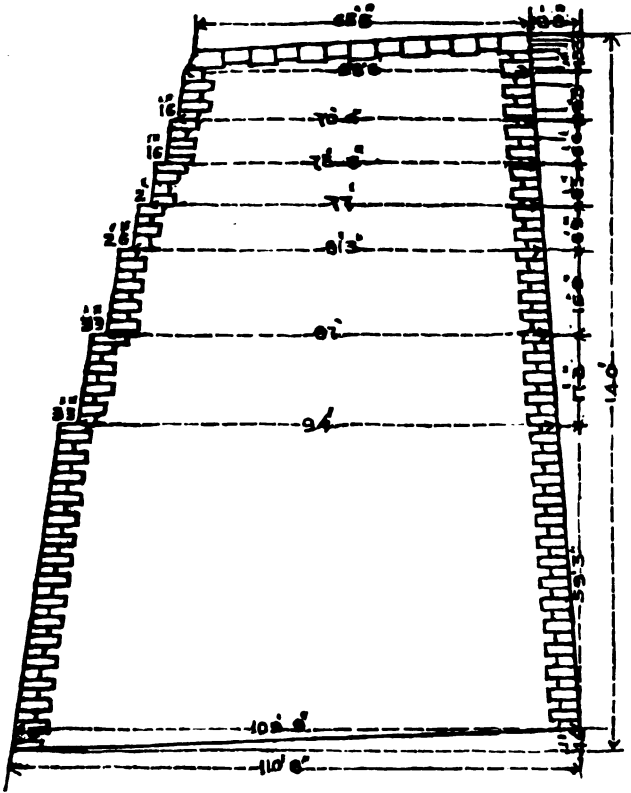

Fig. 126. The Alicante Dam.

**181. The Alicante Dam.**—This structure, erected in a narrow gorge on the river Monegre, in 1579 to 1594, is the highest dam in Spain, and is used for irrigation of the plains of Alicante. The height is 134.5 feet, the base width being 110.5 feet, and the crest 65.6 feet. The gorge is remarkably narrow, being but 30 feet at bottom and 190 feet on the top of the dam. The dam is curved in plan, with a radius of 351.37 feet on the up-stream face at crest, which has a batter of 3 to 41. The dam is built of rubble masonry, faced with cutstone. It is supposed to have been designed by Herreras, the famous architect of the Escorial palace.

The reservoir formed by the dam is small for so large a structure, having a length of but 5,900 feet and a capacity of 975,000,000 gallons.

The stream carries such a large volume of silt that it is necessary to scour out the sediment by a device called a scouring-gallery. The scouring is done every four years. The gallery is a culvert through the

centre of the dam at the bottom, 5.9 feet wide, 8.86 feet high at the upper end, and enlarged below. The mouth is closed by a timber bulk-head, which is cut out from below when the scouring is to be done. The sediment forms to a great depth above the mouth of the culvert, and has to be started to move by punching a hole through it with a heavy iron bar.

The sediment which is not swept out by the velocity of the current shoveled into the stream by workmen.

**182. The Puentes Dam.**—This structure is noted because it was of unusual height and massiveness, and yet failed by reason of its having been founded on piles driven into a bed of alluvial soil and sand instead of bed-rock. It was erected in 1785 to 1791, on the Guadalantin River, at the junction of three tributary streams, and stood successfully for eleven years, during which time the depth of water never exceeded 82 feet, but in 1802 a flood occurred which accumulated a depth of 154 feet in the reservoir, and produced sufficient pressure to force water through the earth foundation. The reservoir was emptied in an hour, the pile foundation was washed, and a breach in a masonry, 56 feet wide, 108 feet high, was created, destroying the dam and leaving a bridge arching over the cavity. The extreme height of the dam was 164 feet, and its crest-length was 925 feet; its thickness at base was 145.3 feet and at top 35.72 feet. The extreme pressure on the masonry was computed by M. Ayrnard at 8.12 tons per square foot. It was built of rubble masonry, with cutstone facings, and was polygonal in plan, with convexity up-stream. Water was taken from it through two culverts, one near the base and the other 100 feet from the top. These were 5.4 feet wide, 6.4 feet high, and connected with masonry wells having small inlet-openings from the reservoir. A scouring sluice, 22 feet wide, 24.7 feet high, was also provided through the dam, divided by a pier into two openings at its mouth to shorten the span of the timbers that closed it. At the time of the break the mud deposited in the reservoir was 44 feet deep.

The disaster caused the loss of 608 lives and the destruction of 809 houses. The property lost was estimated at \$1,045,000.

The dam is reported to have been recently restored, and was doubtless extended to bed-rock for its foundation.

**183. The Vyrnwy Dam.**—Since July, 14, 1892, the city of Liverpool, England, has been chiefly supplied by water from a large storage-reservoir, having a surface area of 1,120 acres, in the mountains of Wales, 77 miles distant, formed by a monumental dam of masonry erected across the Vyrnwy valley, in 1882 to 1889. The dam has a top length of 1,172 feet, is straight in plan, and has a maximum height of 161 feet from foundation to parapet. It is used as an overflow weir over its entire length, and its profile was designed to offer additional resistance over that presented by water-pressure alone. An elevated roadway is carried across the dam on piers and arches, above the level of flood-water, which adds greatly to the architectural effect and ornamentation of the imposing mass of masonry. The great wall is composed of cutstone. The base width of the dam is 117.75 feet. The back-water level below the dam is 45 feet above its base.

The total volume of masonry in the dam is 260,000 cubic yards, which was laid with such extraordinary care that its average cost was nearly

Rs. 30 per cubic yard in a country where materials and labour are of the cheapest.

The base of the dam is founded on a hard slate rock, and one end of the masonry is built into the solid wall of bed-rock on the side of the valley. At the other end, however, the rock was so deeply overlaid with a deposit of boulder clay that the masonry was connected with this material by puddle-wall of clay recessed into the masonry.

The general dimensions of the dam are as follows:—

	FEET.
Total length on top .. .. .	1,172
Maximum height on top of roadway parapet ..	161
Height, river-bed to parapet .. .. .	101
Height, river-bed to overflow level .. .. .	84
Greatest width of base .. .. .	120
Batter of water-face .. .. .	1 to 7·27

The reservoir formed by the dam covers a surface area of 1,121 acres, and impounds 12,131,000,000 Imperial gallons, or 44,690 acre-feet. This gives a mean depth of 39·87 feet, or 47·5 per cent. of the maximum. The watershed area is 29 square miles; upon which minimum recorded rainfall is 49·63 inches, and the maximum 118·51 inches.

The average cost of the dam per acre-foot of storage capacity formed by it was

The dam was planned and constructed by George F. Deacon, Chief Engineer, Liverpool Water-works. Messrs. Thomas Hawkesley and J. F. Bateman were Consulting Engineers.

Tests made by Kirkaldy of large blocks of the concrete and masonry taken from the dam showed a compressive strength of 300 tons per square foot, while the maximum strains to be borne by it are but 9 tons per square foot, an excess of strength which has been considerably criticised.

**184. Masonry Reservoir Dam with Flood Discharge Sluices.**—Reservoir dams for storing up water for irrigation or water-supply are commonly constructed across the narrow, mountainous gorge of a small river or stream, whose waters during floods gradually fill the reservoir thus formed above the dam; and the moderate volume of surplus water in wet years passes over the waste-weirs. When, however, a dam is constructed across the channel of a large river, such as the Nile, to store up a portion of the flow towards the close of the flood season, as designed, to be accomplished by the masonry dam at Assuân, provision has to be made for the discharge of the maximum flood through numerous openings near the bottom of the dam, which are only closed when the flood has begun to abate, and the river, having fallen considerably, is carrying along comparatively little silt. The Assuân dam stretches across the Nile at the first cataract, and is to retain a maximum head of water of 65½ feet, rising itself 10 feet above the highest water-level of the reservoir. It is pierced by one hundred and forty under-sluices, 23 feet high and 6 feet wide, and forty upper-sluices of the same width but only half the height. The sixty-five lowest sluices, situated in the deeper channels, have their sills about 3½ feet above the lowest water-level on the down-stream side of the dam, and the other under-sluices are built at a uniform level, with their sills about 16 feet higher up. The sluices, separated by piers 16½ feet wide,

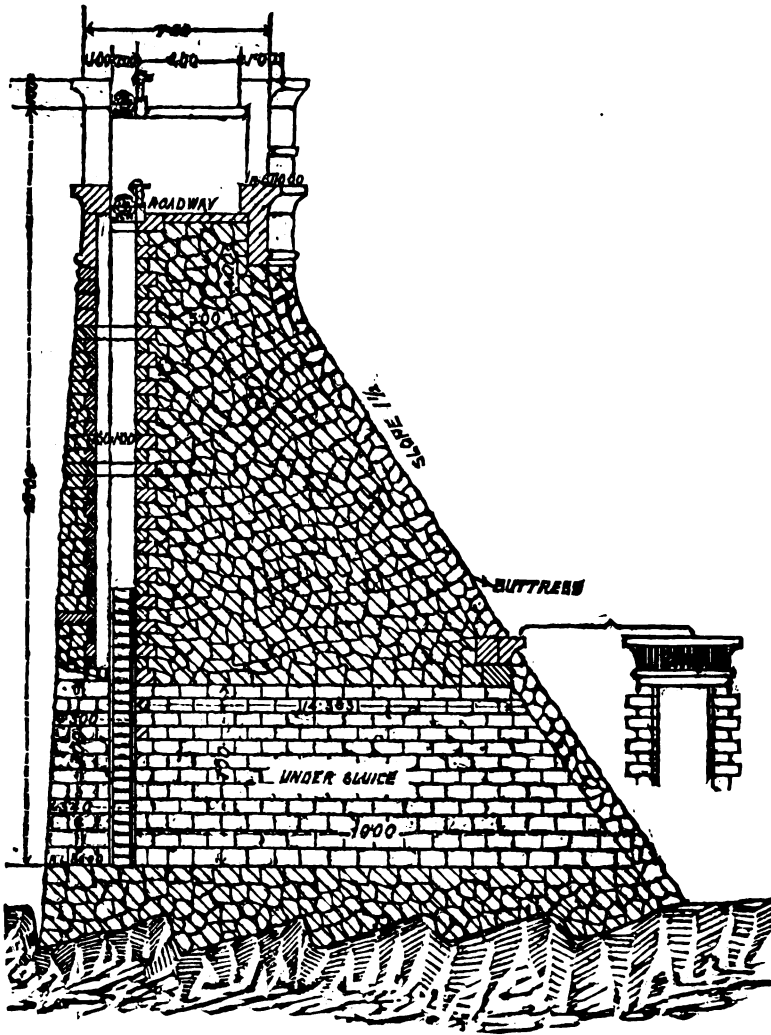

Fig. 127. The Nile Dam at Assuán.

are arranged in groups of ten; whilst there is a thickness of 33 feet of masonry between groups. All the under-sluices are closed by lifting gates sliding on free rollers. The foundations have been carried down into the solid granite rock forming the bed of the river; and the total length of the dam at top is 6,398 feet. The navigation of the river is provided for at the dam, by a channel excavated along the left bank, with locks for surmounting the fall of the dam. The volume of water retained by the Assuán dam, available for increasing the flow of the Nile below the dam during its lowest stage, after deducting the estimated loss from evaporation of a depth of  $3\frac{1}{4}$  feet over the whole surface of the reservoir, will amount to 1,295 million cubic yards.

It is most important that sufficient water should be stored to ensure the flow of the Nile at Assuân never being less than 500 cubic metres (654 cubic yards) per second at the canal heads for distribution, so that all the lands in Upper Egypt, intended to be under perennial irrigation, may receive with certainty the requisite supply of water throughout the summer, even in years when the discharge of the Nile falls very low; for a failure of water ruins the summer crops, causing great loss to the cultivators, and leading to the lands being left uncultivated.

**185. The Assiout Dam.**—In connection with the utilization of water stored in the great Assuân reservoir a diverting-weir is being erected across the Nile, below the head of the Ibrahimia Canal.

This dam is also of masonry, and will have a total length of 3,930 feet, and a maximum height of 48 feet. The dam will have one hundred and twenty sluices, each 16·4 feet wide, with piers 6·56 feet wide between them. The navigation-lock will be 262 feet long, 52·5 feet wide, capable of passing the largest steamers that ply on the Nile. It is located about 200 miles above Cairo.

The loss of water from evaporation and seepage in the Assuân reservoir, and in traversing the distance of 330 miles to Assiout, is estimated at about 21·5 per cent., leaving about 32,000 million cubic feet as the nett amount available for irrigation.

---

## CHAPTER XII.

## SOURCES OF WATER-SUPPLY—WELLS—WATERLIFTS.

**186. Sources of Water-supply.**—In addition to the collection of rain-water as it falls, water may be obtained in considerable quantities from streams and rivers fed by the rainfall flowing off the basins which they drain, or from springs which constitute the outlet of rain which has percolated through permeable strata: and it can also be raised from wells sunk down so as to tap underground supplies contained in the water-bearing strata resting on impermeable beds.

**187. Sources of Earth Waters.**—The water which enters the soil by percolation either from rain or from canals, reservoirs, or tank finds its way through the soil to some lower level, where favourable geologic structure enables it to again reach the surface. This seepage water may move slowly through the particles of sub-soil, its motion being rather that due to absorption or capillary attraction than to direct percolation; or it may enter some seam between two formations from which it may find an exit perhaps at some great distance through a spring or artesian well. The flow of water by percolation is limited not only by the degree of porosity of the strata, but also by their inclination. Yet comparatively impervious rocks frequently furnish abundant supplies which are the result of capillary attraction.

**188. Wells.**—The wells sunk for the purpose of procuring a supply from the underground waters contained in permeable strata are of two kinds, namely, shallow wells sunk nearly to the bottom of a superficial permeable stratum, and deep wells sunk through an upper, impermeable stratum, some distance down into an underlying, water-bearing permeable stratum. In each case the wells tap the underground flow, or subterranean reservoirs of water derived from the rainfall, which find a natural outlet in the form of springs at the outcrop of the strata, or are sometimes permanently retained in the lower portions of the permeable strata from the absence of any outlet at a low enough level to drain off the waters during dry weather. Wells and springs usually derive their water-supplies from shallow formations as gravels, sands and marls. Their temperature is the same as that of the surface of the soil, while their flow is affected by precipitation of recent occurrence and by evaporation from the surface of the ground.

Gravitation tends to draw the water towards the centre of the earth, and it percolates in that direction until intercepted by some impervious stratum along which it finds its way. If the water fills a pervious stratum so surrounded by impervious strata that it is prevented from escaping, and the hydrostatic pressure due to the inclination of the beds is sufficient to bring the water to the surface the conditions are favorable for the production of an artesian well. All that is necessary is to pierce the upper confining stratum by boring, when the water will escape. Generally artesian supplies exist in the newer sandstones and other equally porous rocks. Waters are frequently gathered into such strata from distant catchment basins. Where such a water-bearing stratum approaches the surface in a broad plain it forms an extensive artesian basin.



Shallow wells afford access to the rain-water percolating through a permeable surface stratum, whose downward flow is arrested by an underlying impermeable stratum, such as that of sand or gravel overlying a bed of clay. Moderate supplies of water are readily obtainable in this manner at small cost; but, if the water is used for domestic purposes, great caution is needed to avoid contamination from surface impurities being carried down into the well through the shallow stratum.

Deep wells are not open to the same objection: for the upper impervious strata shut off, for the most part, the surface impurities; and the thickness of the strata which have to be traversed before the water drawn into the well is reached protects the water to a great extent by filtration from organic impurities. These wells, when very deep, are usually constructed by sinking an ordinary brick-lined well for the upper portion and then carrying down a steel tube considerably further by boring to the requisite depth; but in many instances wells have been bored and lined with tubes throughout and this is a more economical method of construction.

**189. Capacity of Common Wells.**—It is to India that we must look in order to gain an idea of the extent to which wells furnish irrigation water. In the Central Provinces 120,000 acres are irrigated from wells. In Madras 2,000,000 acres are irrigated from 400,000 wells. In the North-West Provinces 360,000 acres are irrigated from wells. Some of these wells are sunk to depths as great as from 80 to 100 feet, in some cases through hard rock, and are capable in ordinary seasons of irrigating from 1 to 4 acres each. These wells may really be said to supplement irrigation from canals and reservoirs, for after the waters of the latter have been used and have soaked into the soil they are caught by the well and used again for irrigation. In this way irrigation water may be used over several times; by pumping it from wells it may find its way by seepage back to the streams from which it may again be diverted.

**190. Artesian Wells.**—Artesian wells are those wells in which, when carried down by a boring in a valley to a water-bearing stratum enclosed between two impermeable strata, the water rises above the surface of the ground, the name being derived from the French province of Artois, in which the earlier artesian wells in Europe were bored in the twelfth century, though traces of more ancient borings have been found in Asia and Africa. The overflow of the water from artesian wells is due to the confined permeable stratum rising at the side so much higher than its level where the boring is made, that the plane of saturation is higher than the top of the well; and, consequently when the super-incumbent, impervious stratum is pierced at a lower level, the water is forced up the aperture by hydrostatic pressure, Fig. 128.

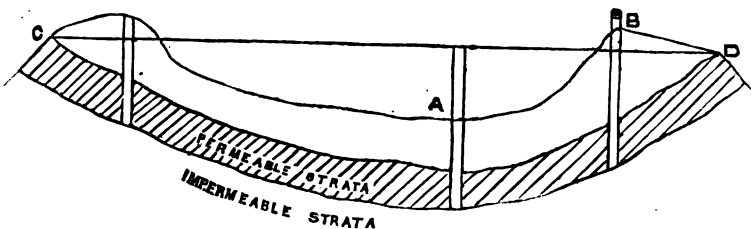

Fig. 128. Artesian Well,

Deep wells do not always overflow. The condition of overflow depends on whether the pressure is sufficiently great to force the water above the surface in which case they are known as artesian wells. Frequently the water will reach within a few feet of the surface when an ordinary well or shaft can be excavated and the water pumped to the desired height. In many other cases the pressure is so great that the water spouts forth from the well to great heights. In an artesian area of considerable extent the various wells seriously influence each other. In some districts in North America it has been found that, after a certain number of wells have been sunk, each additional well affects its neighbours by diminishing their discharge. There thus comes a point in the sinking of the wells when the number which can be utilized in any given area or basin is limited.

**191. Examples of Artesian Wells.**—Some great wells have been sunk in different parts of the world. The celebrated Grinnel well in Paris commenced with a 20-inch bore and is gradually reduced to an 8-inch bore at the bottom. Its depth is 1,806 feet and its yield has been as great as 1.5 cubic feet per second. A well has recently been bored in West Virginia to the great depth of 4,500 feet but it is dry. At Sperenberg, near Berlin, is a well 4,170 feet deep, and at Schladabach, near Leipsic, is a well 5,740 feet in depth. In Louis is a well which reaches a depth of 3,850 feet, about 3,000 feet below sea level.

In America, where much attention has been paid to the boring of artesian wells, there were in 1890 no less than 8,097 such wells on farms in the arid region. Of these, 3,210 were in California, 2,524 in Utah, 596 in Colorado, and between 460 and 527 respectively in North Dakota and South Dakota, and 534 in Texas besides a few in each of the remaining states and territories. Of these wells 48½ per cent. were used in irrigating 51,896 acres at the average rate of 13.2 acres per well. Their average depth is 210 feet, average cost \$245, and average discharge 0.12 cubic feet per second.

Wells of this kind have been driven at Pondicherry and have proved a success. A trial at Madras proved a failure, while other trials in the vicinity of Madras have met with partial success.

**192. Size of Well.**—The volume of the well does not necessarily depend upon its size. A 6-inch well will not necessarily discharge twice as much as a 3-inch well—perhaps not as much. The amount of the flow depends directly upon the volume of the water-bearing strata and the pressure due to its initial head or source. Provided that this is sufficiently great, then the discharge of the well is dependent on its diameter. Other things being equal, a large well will cost more to drill, but will be more easily and cheaply cleaned and kept in operation than a smaller one which is apt to clog. Further, during and after drilling an accident may ruin a small well, while a larger one may be recased with diminished bore and still remain serviceable. For purposes of irrigation it may be said, generally, that a well less than 4 inches in diameter should not be drilled, and it is probable that one with a bottom bore greater than 8 inches will not be economical.

**193. Lift Irrigation.**—There are large volumes of water situated at such a low level that gravity will not carry it to the fields, and this water must be raised by pumping and other lifting devices. Pumping may be employed to utilize the water from wells or from streams

flowing at a lower level than the land to be irrigated or may be employed to raise water from low service canals to others at higher level.

When the gravity sources of supply have been entirely utilized large areas of land may still be brought under cultivation by the employment of pumps. The value of pumping for irrigation purposes has been recognized in the older European and Asiatic countries for ages, and a large proportion of the irrigation in Europe, China, Japan, India and Egypt is by means of lifting. In Oriental lands lifting is performed almost wholly by animal or man power, through various ancient devices operated chiefly by bullocks or men. In Italy a considerable amount of pumping is done by machinery, chiefly to raise water from existing low-level canals to high service canals. In America the value of pumping as a means of irrigation is scarcely yet appreciated. A few wind-mills and water-wheels are utilized for this purpose, and a small amount of lifting is done by steam power at present, but most American Engineers are agreed that the supply to be derived from these modes of lifting is sure to increase greatly in the near future.

**194. Motive Power and Pumps.**—Pumps are machines for elevating water, and consist of two principal parts: (1) The pumping or water-elevating mechanism, and (2) the motive power by which this is operated. Pumps may be divided into four general classes according to the principles on which they raise the water. These are—

- (1) Lift pumps.
- (2) Force or plunger pumps.
- (3) Rotary and centrifugal pumps.
- (4) Mechanical water-elevators.

Lift and force pumps may be combined and may be either reciprocating or rotary, in which latter case they come under class (3). All may be single or double acting—

The motive power may be—

- |                   |                                   |
|-------------------|-----------------------------------|
| (1) Animal-power. | (4) Hot-air, oil, or gas engines. |
| (2) Wind-power.   | (5) Steam engines.                |
| (3) Water-power.  |                                   |

**195. Choice of Pumping Machines.**—The pump and motive power which are to be employed in each particular case depend wholly on the services to be performed and on various local modifying conditions. The variety of pumps must be chosen according as greater or less volumes are to be elevated to greater or less heights. The motive power must be selected according to the pump chosen, the work to be done, and the fuel available, be this air, water or wood, coal or oil. Where means are limited and the area to be irrigated is but a few acres, the motive power chosen will usually be either animal or water. The first is cheapest of installation but least economical, and the second is next cheapest, where a sufficient water-supply is available for the operation of an ordinary midcurrent undershot wheel or hydraulic ram. Where the area is small but the means at the disposal of the irrigator less limited, animal power will usually be left out of consideration, and the choice rests between wind, water, hot-air, oil or steam pumping-engines. If the wind be reasonably steady and the facilities good for the construction of a storage tank, that power, though not less expensive to install than some others, is least expensive and troublesome to maintain and operate, yet not the most reliable. Where water is

abundant, it furnishes, through rams, water-wheels, turbines or water-engines, the next least expensive power to maintain and operate though not the cheapest to install. The class of water-motor selected will depend wholly upon the volume of motive power available and the height to which the water is to be raised. Hot-air engines and oil-engines furnish the most reliable power for pumping water, and are less difficult to operate than steam engines. Oil-engines are especially economical where coal or wood as fuel are expensive, though hot-air engines have a wide adaptability in the variety of fuel which they may utilize. Steam engines, where coal is cheap, furnish the most satisfactory motive power, but are generally not so economical to operate, especially where small areas are to be irrigated. For the pumping of large volumes, water and steam are the only competing motive powers.

The irrigation engineer, who proposes installing a pumping plant, should consider all the various circumstances which affect the case under consideration. He should carefully weigh the necessity for having a permanent and steady supply, the inaccessibility of the plant for repairs or replacement of broken parts, the relative cost and accessibility of different kinds of fuel or of water, and the degree of intelligence and skill possessed by those who are to operate the machine employed.

For these reasons, it is most desirable that Civil Engineers should have some knowledge of the principles of pumping machinery although it is not necessary that they should understand all details, this being a department of mechanical engineering. The makers of pumping machinery are certain to know more of the details of such machinery than most Civil Engineers and there is no doubt that the best results will be obtained if the Civil Engineer, when drawing up the specifications of the machinery required, confines himself to the general style of the engine, the work it has to do, the duty it is to develop per pound of fuel, and the position it is to occupy, and allow the makers to tender for the form of engine they prefer to make.

**196. Mechanical Methods of Irrigation.**—The old mechanical means employed for lifting water from wells, from streams and from

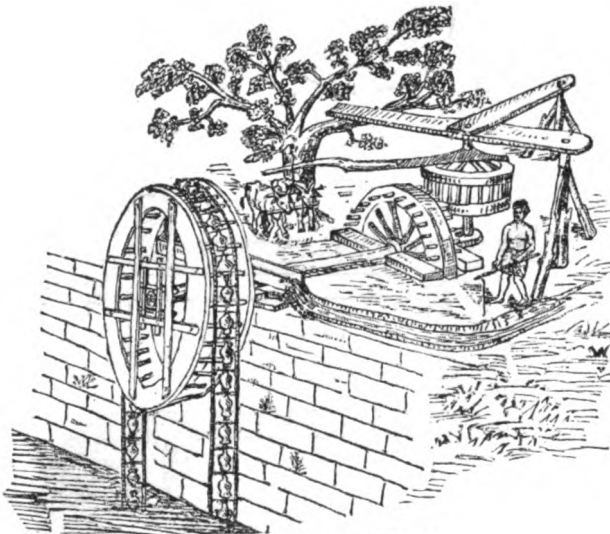

Fig. 129. The Persian Wheel.

low-lying depressions, are of various kinds; all of them with slight modifications are to be found both in Africa and in Asia. The Persian wheel, Fig. 129, which is found in various forms in Egypt and in Sindh and the Punjab consists of a series of earthenware pots revolving on a wheel with a horizontal axis; each pot delivers its contents into a trough, and then descends to the water to be filled again. In some cases the earthen jars are attached to endless ropes which revolve on the wheel, and sometimes they are attached to the circumference of the revolving wheel itself. These wheels are generally actuated by bullocks.

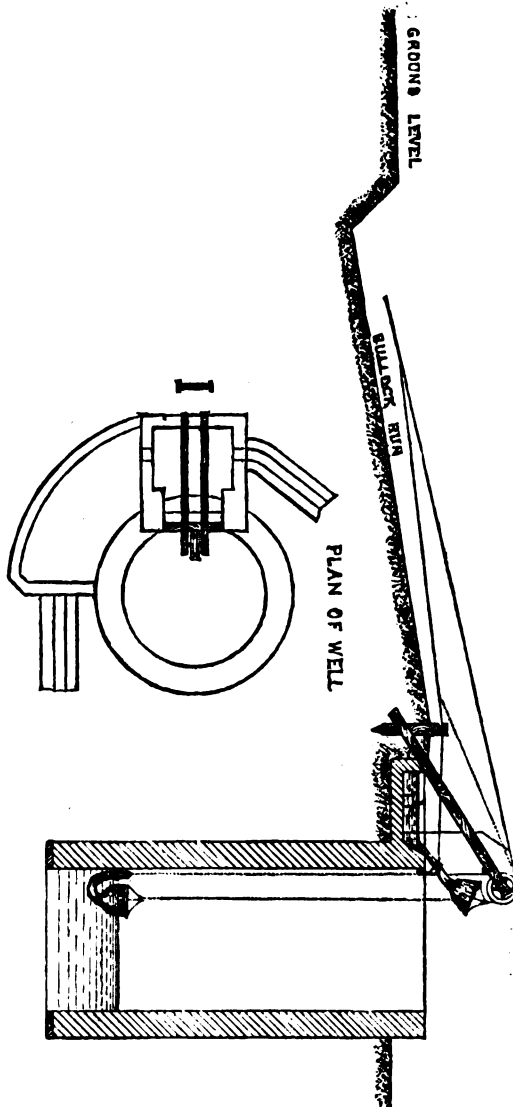

Fig. 130. The Mote.

Another system which is extensively used in India for the larger lifts is "the mote," Figs. 130 and 131. Two bullocks raise a leathern bag,

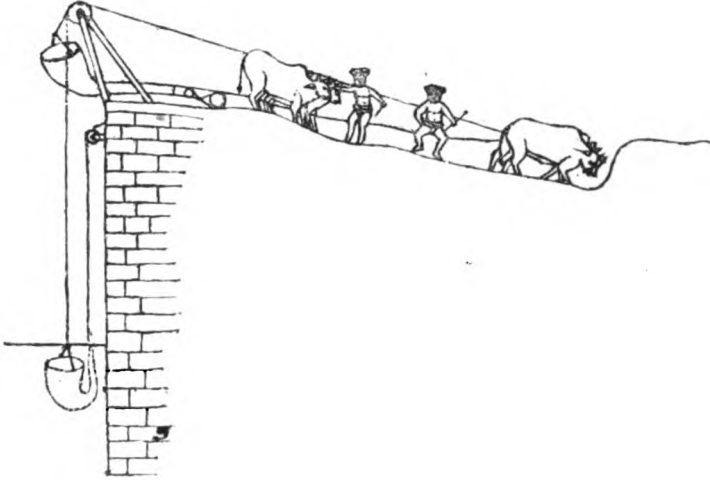

Fig. 131. The Mote.

and by an ingenious but rough contrivance the driver by manipulating the lower cord, lets the water escape from the lower end of the bag, when the bullocks have reached the end of their run and when the bag is at the top of the lift. Occasionally the mote is worked by two men, the driver, and another at the well head, who pulls the leathern bucket over the trough or channel into which the water runs.

For smaller lifts of 4 to 10 feet the appliance shown in Fig. 132 is often used. This arrangement is called a picottah in Southern India. It consists essentially of a bucket, which is of leather or iron, as the case may be, hung to a beam which can oscillate in a vertical plane: the short end of the pole is counterbalanced by a weight, usually a clod of earth, so that the bucket, when full, requires but little force to raise it. In some cases the clod of earth or other weight is replaced by a man or men who walk along the oscillating beam and thus throw their weight to one or the other side according as the bucket is being lowered or raised. The man working this contrivance stands at the edge of the well and uses his weight to depress the bucket into the water, when, with but little force, it rises to the point where the water is delivered.

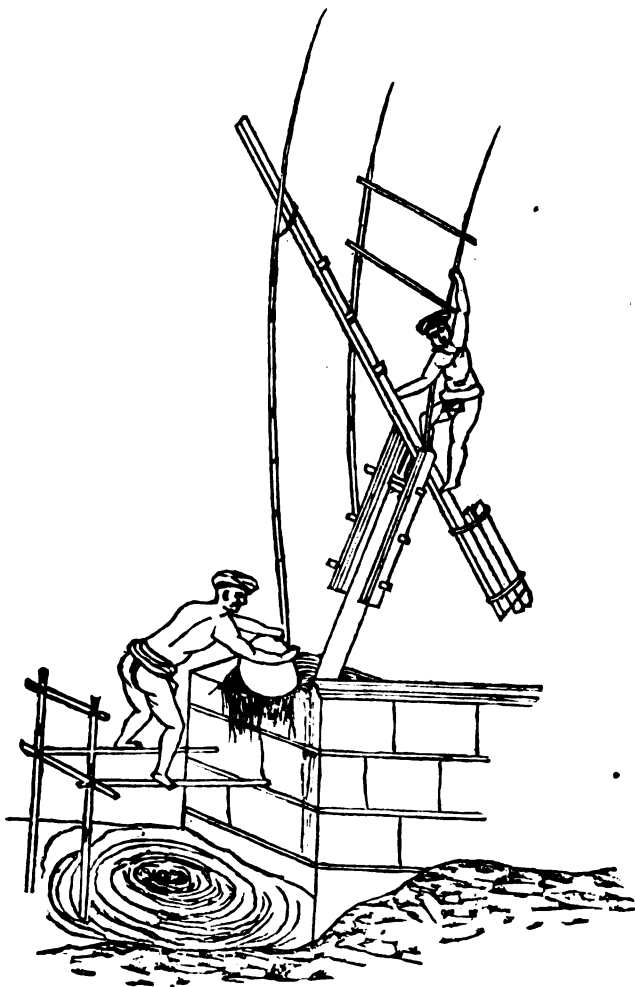

Fig. 132. The Picottah.

The basket scoop, Fig. 133, is used for smaller lifts of from 1 to 4 feet, and the "doon," Fig. 134, is common in Bengal for lifts of about 2 or 3 feet. The doon is an oscillating trough, usually half the stem of a tál tree hollowed out which oscillates on a fixed centre so that one end is

alternately depressed into the water, and raised above the level of delivery; the weight of water is equalised by a counterbalance, so that

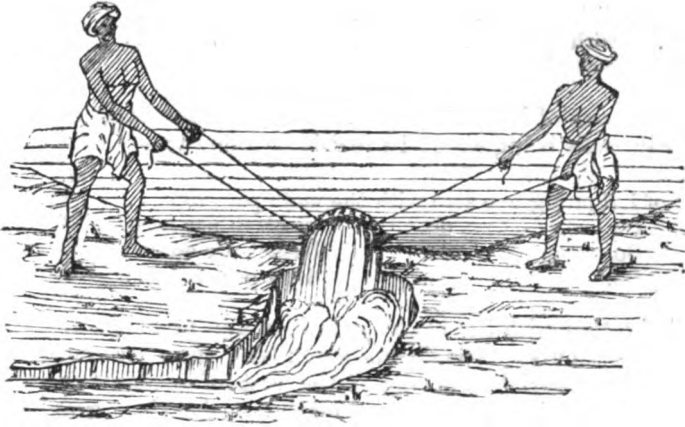

Fig. 133. The Basket Scoop.

the man, who stands over the water on a plank, can depress the end of the doon into the stream with his feet, and then, by stepping on to the plank and lifting slightly with his hands can slope the trough towards the point of delivery, and thus enable the water to run into the channel.

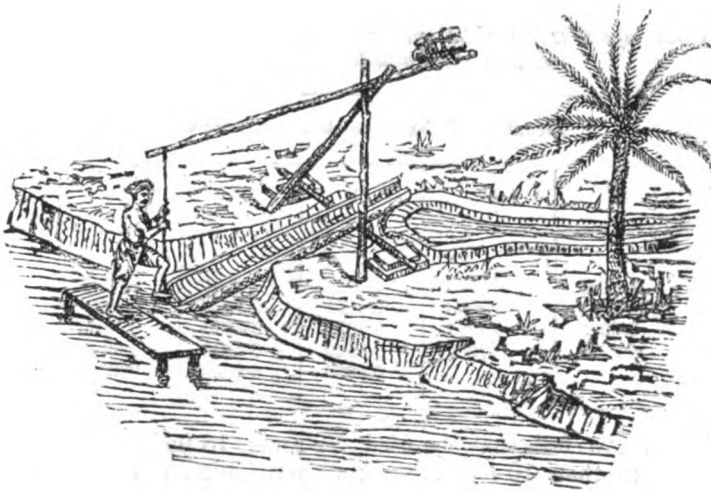

Fig. 134. The Doon.



Experiments made in Central India on these methods of raising water gave the following results:—

Description of method used.	Number of cubic feet of water raised one foot high in ten hours.
Bullock mote with two bullocks and one man .. .. .	79,200
Picottah with two men .. .. .	57,600
Do. with one man .. .. .	33,000
Basket scoop with two men .. .. .	20,178

As to the cost of irrigation by these different methods, the depth of the water in wells being about 15 feet is as follows:—

	RS.	A.	P.
Cost of irrigating one acre with the mote per crop ..	9	0	0
Do. do. picottah per crop.	13	0	0
Do. do. basket per crop..	6	8	6
Do. do. doon per crop ..	3	14	0

The irrigation with the basket and doon are probably from lifts of from 1 to 4 feet only. The figures given take into account the value and life of the material used, and of the cost of a man's labour. All these methods of raising water are more expensive than gravity irrigation, which in India, costs on an average Rs. 3 per acre; but, in some cases, irrigation from wells really costs the cultivator little or nothing, as he only employs himself and his bullocks at times when there is no other work on hand.

**197. Hydraulic Rams.**—The hydraulic ram may be used, where there is a sufficient fall, for raising by simple means a moderate amount of water. The principle on which it works is that a larger volume of water with a certain fall will, under certain conditions, lift a smaller volume to a higher level than its own. The amount of water that can be raised is one-seventh the quantity used discharged to a height equal to five times the fall, one-fourteenth the quantity used raised to ten times the height of the fall and so on; the following table is useful:—

*Percentage of water which will be delivered by a hydraulic ram under various heads and to various elevations.*

Work- ing head.	Elevation of discharge above delivery value at ram.					
	15	18	21	30	50	60
2	0·0724	0·0533	0·0402	0·0181	0·0063	...
5	0·2614	0·2068	0·1686	0·1020	0·0441	0·0307
10	0·6040	0·4877	0·4058	0·2614	0·1327	0·1020
15	0·9600	0·7809	0·6543	0·4303	0·2285	0·1800
20	...	...	0·9088	0·6040	0·3282	0·2614

High or low falls may be used for rams (18 inches to 10 feet), but heads of more than 10 feet are not recommended as the wear and tear on the ram is excessive. If any considerable quantity of water is

required, say, 4 cubic feet per minute, a fall of 8 to 10 feet is suitable and in such cases two rams working into one delivery pipe should be used in place of one. Hydraulic rams should be simply and strongly designed; all valves should be of gunmetal and all joints faced. The length of the supply pipe should be as short as possible. The largest quantity of water is delivered by a ram, when the working head is great and the delivery head low.

**198. Other Forms of Motors for Pumping Water.**—In not a few cases water-power is used for pumping water in large quantities for various purposes. It is evident that, where such power is available, there is a distinct advantage in using it. In the first place the machinery is very seldom of a complicated nature, and in the second, there is no difficulty regarding fuel as none is required. Wherever there is even a small fall, and it is necessary to raise only a comparatively small portion of the water, this portion can be raised to a height above the top of the fall, the height that it can be raised being inversely as the quantity that has to be raised in terms of the whole quantity of water. Neglecting friction, the height to which the water can be raised is expressed by the formula :

$$H = \frac{h \times Q}{q}$$

Where  $H$  = the height to which the water can be raised ;  
 $h$  = the head of water available for raising it ;  
 $Q$  = the total quantity of water } in the same terms.  
 $q$  = the quantity to be raised }

This is on the assumption that the pump is placed at the bottom of the fall. The quantity of water that can be raised to a given height can be found from the following formula, friction again being neglected, and the symbols having the same meaning as before :

$$q = \frac{Q \times h}{H}$$

Water-wheels of the *overshot* and *breast* types have probably been more used than any other kinds of motors for pumping water, and they have the advantage that, if of considerable size, they revolve slowly, or pumps can be connected with them by cranks and connecting rods.

Of late years *turbines* have been used to some extent which will probably be increased in the near future. The high velocity of most forms, however, involves gearing between the spindle and the pump. With any of the motors mentioned an efficiency of about two-thirds may be expected; that is to say, the water can be pumped to two-thirds the height got by the first of the two formulæ given, or two-thirds the quantity of the water obtained by the second formula can be pumped.

**199. Lift Pumps.**—The lift-pump is that generally employed for raising water from wells; it has as a feature a hollow bucket through which the water, after it has been forced up by the atmosphere during the forward state, passes as the bucket returns. Sometimes a forcing plunger is combined with a lifting bucket.

**200. Force Pumps.**—Force pumps have a solid bucket or plunger or piston which works in a barrel furnished with inlet and outlet valves, the water flowing through the inlet valve into the barrel as the plunger

leaves a vacuum behind it. These pumps may be double or single acting. Bucket-and-plunger pumps are those in which a forcing plunger is fixed above the bucket on the same rod, so that while there is only a single-action suction there is a double forcing or delivery.

**201. Centrifugal Pumps.**—This is a class of pump differing much from any of those just described. Pumping is performed by a rotating disc with radiating blades (bent to an effective curve) working inside a casing at a high speed. The high speed causes a vacuum and the water follows by pressure of the atmosphere to be once more displaced and thus passed into the delivery pipe. These pumps are suitable where large quantities of water have to be dealt with in a short time and where the lift is comparatively low; they can be made to lift and force a total of 80 or 100 feet or more; they are probably most economical when the lift is below 20 feet. These pumps may be driven by any rotative engine, or through gearing, or by an engine whose crank shaft is an extension of the pump spindle. Well-made centrifugal pumps under effective conditions give an efficiency which is often as high as seventy per cent. The quantity of water delivered by centrifugal pumps of various sizes and various lifts may be ascertained from the following table, in which the powers given are for discharging the minimum quantities when working average lifts:—

*Centrifugal Pumps. Table of deliveries with approximate horse powers.*

Bore of pump and diameter of suction and discharge pipes.	4"	5"	6"	7"	8"	9"	10"	12"
Gallons of water discharged per minute.	200 to 300	350 to 500	500 to 750	700 to 1,000	900 to 1,300	1,150 to 1,600	1,600 to 2,200	2,000 to 3,000
Approximate nominal horse power required for each foot of lift.	0·08	0·15	0·25	0·30	0·35	0·45	0·65	0·90
Bore of pump and diameter of suction and discharge pipes.	14"	15"	16"	18"	20"	22"	24"	
Gallons of water discharged per minute.	2,800 to 4,000	3,000 to 5,500	3,500 to 5,300	4,500 to 6,600	6,000 to 8,200	7,000 to 10,000	8,500 to 12,000	
Approximate nominal horse power required for each foot of lift.	1·2	1·3	1·5	1·8	2·0	3·0	3·0	

**202. Pulsometer Pumps.**—Another class of pump is the pulsometer. This consists of two chambers, steam being admitted to one of them forces up the water within it. The steam becoming condensed forms a vacuum into which the water from below ascends, while the upward forcing process is being performed in the second chamber, and thus by a succession of pulsations pumping is continuous. Pumps of this class are useful for many purposes with water works, as with so many branches of engineering, especially for temporary work or where

it is necessary frequently to change the position of the suction pipe, or even of the pump; but they are not to be recommended for constant work. They cannot lift more than 25 feet, but, with high steam pressure, they can force a considerable height. They moreover consume a large quantity of fuel in proportion to the work done.

**203. Length of Suction Pipes.**—Theoretically a pump can lift, or rather the atmosphere will balance, a column of water 34 feet high, but in practice very much less owing to imperfect vacuum. With very perfect construction and care, pumps may be made to draw 26 or even 28 feet, but it is always advisable to place the pump as near the water level as possible. It will of course be understood that when length of suction, or height of suction, is mentioned here, *vertical* height is referred to. Length horizontally is not nearly so detrimental, but it is to be avoided if possible, as it increases the weight of water that has to be set in motion and stopped at every stroke, or that, at any rate, has to have its velocity augmented and retarded. Especially when the vertical limit is nearly reached, every foot of horizontal length increases the trouble. For this reason pumping wells should, whenever possible, be immediately below the pumps. It is to be observed that the suction is to be measured from the surface of the water to be pumped, to the highest point of the inside of the pump-barrel, whether this be horizontal or vertical.

**204. Steam Engines.**—Steam engines for working pumps may be divided into direct and crank-shaft with fly-wheel engines. In direct-engines the piston-rod of the engine and the piston-rod of the pump, or the plunger, are continuous, and there is no crank-shaft or fly-wheel. Direct-engines are generally quite self-acting, and for this reason are very convenient. Up to their limit of capacity they pump just whatever quantity of water is demanded of them, and they have the further advantage of being compact. They are very uneconomical, simply pushing the water without any expansion of steam. Of late years, however, direct-engines have been greatly improved in the matter of economy, firstly by "compounding" and afterwards by the introduction of "high-duty gear." It is claimed for some of the most modern direct-engines, with high-duty gear, that they give the same or even higher duty as a fly-wheel engine of good design working at the same pressure.

The advantage of the crank-shaft form of engine is, of course, that the steam may be worked expansively. The disadvantage is to be found in the space occupied. A crank-shaft engine has nearly always at least two cylinders. With two pumps as well as two cylinders, as is commonly the case in all kinds of two cylinder engines, the delivery of the water is much more uniform; but there is a great advantage in what is known as the "three-throw" engine—that is to say, one in which there are three cylinders, each working a pump, preferably double acting, with three cranks at 180°. The delivery of water from such an engine is as nearly uniform as possible. Steam-pumping engines may also be divided into condensing and non-condensing engines. They are also further divided into simple, compound, triple expansion and quadruple expansion. The object of compounding is to permit of the use of a greater expansion of steam than can be utilized in the case of

simple engines, without excessive strain on the working parts and the framing or bed-plate.

**205. Oil Engines.**—For the purpose of well irrigation in India the oil-engine is eminently suitable, as for small powers, such as required by individual cultivators, it is much superior to the steam-engine. Being an internal combustion engine, and using oil or liquid fuel instead of steam as a motive power; this fuel being fed direct into the cylinder of the engine, the boiler necessary for a steam-engine is done away with. The oil-engine can also be started and be in full work in ten minutes; whereas in the steam-engine, the time necessary to heat up the water in the boiler until the required pressure is attained has to be spent before the engine will commence to work. The oil-engine has the advantage also of being more easily understood by the unskilled labourer, than is the steam-engine. The cost of working in the Madras Presidency according to Mr. Chatterton is about the same as for the steam-engine, if the oil-engine uses kerosine oil, but this cost can be reduced in the proportion of about eight to three by substituting liquid fuel for kerosine oil. The above comparison is drawn for an oil-engine of the ordinary type using about .8 lb of oil per horse-power hour: but oil-engines are now made using as low as .5 lb of liquid fuel per horse-power hour. The initial cost of installing one of these oil-engines is less than that of the steam-engine, except in the case of the Deisel engine when the amounts are about equal. Taking into consideration the lesser initial cost, the less time occupied in starting, the smaller cost of working when using liquid fuel, the less attention required when working, and the lesser likelihood of going wrong or breaking down in the hands of unskilled labourers, and considering that the oil-engine can be connected to all sorts of pumps with the same facility as the steam-engine; the oil-engine appears to be the form of motor most suited to the requirements of the Indian cultivator.

---

## CHAPTER XIII.

## WATER-SUPPLY OF TOWNS.

**206. Quality of Water.**—There are two things that have to be taken into consideration before a source of water is decided on for a town supply ; one is the quality of the water, the other is quantity. Every one knows that the quality of different waters varies greatly ; that some are pleasant to the taste and smell, and that some are not ; and, what is far more important, that some are perfectly wholesome, while others are liable to produce ill-health when habitually used, or even to spread epidemic diseases ; that some are good for washing and others are not ; that some are inferior to others for cooking and so on. It is necessary, therefore, for an engineer who is to report on a proposed source of water to have some knowledge of the cause of the difference in the qualities of water, although he need not have any deep knowledge of chemistry, far less be able to analyse the water himself. He will find it much more convenient, if he wants an opinion on water, to hand a sample to a professional chemist, getting, if possible, the latter's opinion on the results of both a chemical and a biological examination.

**207. Taking Samples of Water.**—If possible the chemist should draw his own samples of water, but this is often inconvenient. For this reason a word or two on the collection of samples may not be out of place here. Each sample should consist of about half a gallon, and should be collected in a clear glass bottle with a glass stopper. The bottle must be made scrupulously clean, and, before it is filled, it should be rinsed out two or three times with the water to be collected. Care should be taken not to stir up any mud on the banks of a stream, and, if the proposed source is a large river or lake, the water should be collected at some distance from the bank, from a boat, or in the case of a river, from a bridge, if possible. The mouth of the bottle should be entirely submerged while the water is being collected. The stopper should not be fastened down with any cementing material but merely tied with string. The sample of water should be handed over to the analyst as soon as possible after collection, as changes are liable to take place. If it has to be kept for any length of time, it should be kept in a cool place away from strong light.

**208. Purification of Water.**—Water is very liable to contain impurities both in suspension and in solution, composed of inorganic and organic matters. The heavier particles carried along by the current readily settle when brought to rest in a settling tank, or in an impounding reservoir ; whilst the finer and floating matter, with the exception, in some cases, of organic matter in an extremely fine state of division, can be removed from the water by straining it through fine wire gauze and by filtration. Calcium bicarbonate, generally found in solution

in spring and river waters is easily removable; and other inorganic salts usually existing in solution in much smaller quantities, which cannot be separated by any practical process, are harmless; but organic matter in a very fine state, or in solution, is difficult to deal with, and being very objectionable even in minute quantities, has led to special care being exercised in the selection of sources of supply, to avoid its introduction into the water as far as possible. Water collected in a reservoir from a hilly uninhabited watershed, spring water, and water from deep wells are usually adequately free from organic impurities; but river water, which sometimes constitutes the only available source of supply for towns situated in flat, alluvial plains, generally contains some organic matter.

**209. Filtration.**—It is the general practice to pass water destined for domestic supply, through filter-beds before discharging it into the service reservoirs, thereby removing the fine, light particles which do not separate by subsidence. This process of purification, which is essential for rendering most river waters suitable for supplying towns (more especially in unfavourable instances, such, for example, as the turbid river Hooghli, affording the only available supply for Calcutta), is usually advisable even for the comparatively pure waters collected in impounding reservoirs, owing to the possibility of their contamination at some point of their course, from the reservoir to the town, and the greater liability of the purest waters to be affected by pollution than waters already impregnated with mineral salts.

Before entering on a description of filter beds, it may be advisable to enunciate the principles upon which filtration depends. For a long time it was considered that the process of filtration consisted in passing the liquid through some porous substance, the interstices of which were too small to allow of the passage of the solid particles, the principle of the action being the same as that of a sieve, or in other words, as an entirely mechanical operation, for sifting out matters in suspension, the result usually being tested by the aid of the eye. Subsequently chemical analysis was resorted to, and this resulted in the reduction of the speed of filtration which is now generally 4 or 6 inches in depth of water per hour. The application of bacteriology to the testing of water gave, however, a clearer conception of the changes to which water is subjected in passing through sand filters and showed that, for the water from each particular source, there is a rate of filtration particularly applicable. If the sand of filters is of a fairly uniform grain, the volume of the interstices is about 33 per cent. Water abounds with micro-organisms and in some waters the bacteria of cholera, typhus, or tuberculosis may be present. It is therefore desirable to remove as many bacteria as possible before the water is available for domestic supply.

Sand, when closely packed, has interstices between the grains of  $\frac{1}{10}$ th of millimetre (0·00393 of an inch), whereas bacteria are of a size of from  $\frac{1}{800}$ th to  $\frac{1}{200}$ th of a millimetre (0·000065 to 0·000196 of an inch), so that they can easily pass through the channels among the sand grains. The longer the channels the slower the rate, and the greater the chances of arrestment, but economic considerations limit the depth of sand and flow of water so that the former is limited to from 2 to 3 feet and the latter to 4 inches per hour. Under such conditions sand filters

arrest the bacteria as shown by the following analysis of 1 kilogram of sand by Koch's process :—

	Colonies of bacteria capable of further development.				
	MILLIONS.				
At the surface .. .. .	..	..	..	..	734
At 4" below the surface..	..	..	..	..	190
At 8"    "       " .. .. .	..	..	..	..	150
At 12"   "       " .. .. .	..	..	..	..	92
At 24"   "       " .. .. .	..	..	..	..	60

The grains of sand examined were moreover found to be covered with a thin skin consisting in part of bacteria. The sand referred to had been some ten years in use, and it was thought that clean sand would give better results. Sand filtration is therefore a biological process.

**210. Quantity of Water required per Head.**—The volume of water required for supplying any town or district is usually reckoned in gallons per head per day of 24 hours, so that, having determined the quantity to be supplied per head, it is only necessary to multiply it by the population to be supplied in order to obtain the daily volume which has to be provided; whilst the future probable increase in the demand which has to be taken into consideration in selecting a source of supply depends upon the estimated growth of population during the period to be provided for in the scheme. The estimated supply per head, of course, varies with the habits of the people, and not only deals with purely domestic supply but also includes the watering of streets and roads, flushing the sewers and drains, water for stables and gardens, and special supplies for trade and manufacturing purposes, fountains and extinguishing fires, mainly determined by special conditions of each locality.

The actual consumption in different towns exhibits a very wide range depending not only upon the various requirements given above but also on the care taken in the administration and control of waste. Under these circumstances it is very difficult to estimate the quantity actually needed in dwelling houses and although attempts have been and are being made to estimate this quantity it is generally conceded that it is better to make use of past practice than to depend on such estimates.

Mr. J. A. Jones, the late Sanitary Engineer to the Madras Government, was of opinion that the amount of water supplied per head in Indian towns bore but a very small proportion to the amount used in England, and in his *Manual of Hygiene, Sanitation and Sanitary Engineering* he states that he is inclined to think that, though allowing for waste the amounts do not usually exceed 9 to 10 gallons per head, these figures are due (1) to imperfect distribution, (2) to a continued use of wells from which supplies had been obtained previous to the introduction of a pipe supply, (3) to prejudices against the use of pipe water. Finally he considers that 15 gallons per head per diem (allowing for increase in population) is none too ample a supply.

**211. Variation of Demand.**—The quantity determined as required per head is, of course, to be understood as being the mean



daily consumption during the whole year, but this consumption is by no means uniform. As is natural more water is consumed in hot weather than in cold. Then again, there is, of course, a great variation in the quantity of water used during the different parts of the twenty-four hours. Domestic consumption falls to nearly zero during some hours of the night, and is much above the mean during some hours of the day. Commonly the maximum consumption for any one whole month may rise to 10 or 20 per cent. above the mean monthly consumption taken for the whole year, and in some cases it may rise higher especially in India where local festivals are often attended by thousands of persons. Again during intensely hot and dry weather, the consumption may, for a few days, rise to 50 per cent. above the mean, and it is therefore necessary to provide for these contingencies in any scheme of water-supply.

In the Sanitary Engineers Department of the Madras Presidency it has been the practice to consider that one-half the total supply is used between 6 A.M. and 9 A.M. and 3 P.M. and 6 P.M., or in six hours. Some engineers consider eight hours as applicable to Indian conditions. It is, however, believed that the higher figure of demand is the one which should be adopted, especially in pumping schemes, because if the demand is less than anticipated, the cost of pumping will be reduced; whereas if an error is made in the other direction, the cost of pumping will be increased, and as this charge is a continuous one, the error may turn out to be very expensive.

**212. Intermittent and Constant Supply.**—Formerly, with the object of preventing waste, a cistern in each house adopted to its size was filled with water from the main, by turning on the water for a short period once or twice a day; and by this means the consumption was limited to the contents of the cistern between the periods of turning on the water; and the supply to be provided could be very closely estimated, and was only required at fixed periods. These open cisterns, however, were exposed to various sources of contamination, and were rarely cleaned out, and moreover water might not be available in case of emergency. Accordingly, though the old system is still in existence in several places, the constant system of supply is being generally adopted.

A constant supply is obtained by drawing the water through the service pipe direct from the main, so that the water is always obtainable fresh without being exposed to any pollution, and to any extent required.

In India where, as a rule, the pumps discharge directly into the mains (without the intervention of a service reservoir), the demand between 8 P.M. and 5 A.M. is sometimes too small to warrant pumping during that interval, and where there is a long and large main outside the town, falling towards it and holding a large supply of water, there is not much objection to this plan; otherwise, it is better to keep the pumps working, so that foul air, &c., may not be drawn into the pipes.

**213. Classification of Water works.**—Water-works are generally classified into gravitation works and pumping works. Under certain circumstances a town may receive its supply by a combination of both. In any system the following works will usually be necessary (1) a settling reservoir, (2) filter beds, (3) a service reservoir near the

town and (4) a distribution system. In a pumping system it will of course be necessary to add to the above, one or more pumping stations at the points where the water has to be lifted, and, if the water is pumped directly into the mains, the service reservoir will be omitted.

**214. Settling Reservoirs.**—When there is no impounding reservoir, and the water of a stream is liable to be turbid at times, it is generally advisable to have one or more settling reservoirs. These are simply reservoirs of moderate size, which can be emptied occasionally for cleaning, and which hold the water long enough to allow the grosser particles of suspended matter to settle. Since the object of settling reservoirs is really to spare fatigue to the filters, their area and number will of course depend principally on the state of the water when admitted to them. Water may hold in suspension very large quantities of matter; if this is of a heavy description the deposit will take place much more quickly than with material or matter of a lighter class. The proper area of a subsiding reservoir must, therefore, be determined with reference to the amount and specific gravity of the matter in suspension. The time taken to deposit such matters must be ascertained from experiment or by experience.

Settlement may be conducted either on the constant or alternating system. In the case of constant settlement water is continually flowing into a reservoir at one end, while it is constantly flows out at the other, the reservoir in fact being a canal with a very low velocity. In the alternating system two or more reservoirs are necessary, water being drawn off from one while it is admitted to another. The depth of settling reservoirs is from 8 to 15 feet; it is not always possible to arrange the levels of the filter-beds, so that the water can be drawn down to within a few feet of the bottom of the settling reservoirs. If it is possible to draw down only a few feet below the maximum water level, pumps should be provided for emptying. The two or three feet at the bottom are drawn off and run to waste only when the reservoir has to be cleaned out.

**215. Design of Settling Reservoirs.**—The best form for a settling reservoir is a rectangle with the length several times the breadth, and, where this can be divided, so that the water travels this length several times over, that form is still more efficient. Fig. 135. In

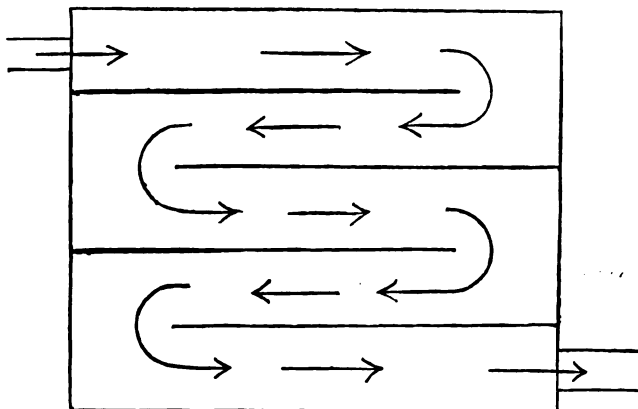

Fig. 135. Design of Settling Reservoir.

construction a circular form is the most economical, a square more so than a rectangle, but with two reservoirs close together this latter form for the outer boundary of two adjacent reservoirs can be advantageously adopted. In section the reservoir may have slopes of 2 to 1 or 3 to 1, and should be revetted, or lined with such material as will admit of the banks being cleaned. The floor should have a slope of 1 in 200 towards a drain for which a slope of 1 in 300 is sufficient.

**216. Position of Inlets and Outlets.**—The selection of the proper position for inlets and outlets of settling reservoirs needs attention. There are four relative positions—

- (1) Both inlet and outlet at top of reservoir. Fig. 136.

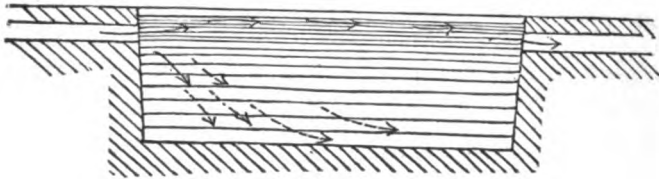

Fig. 136. Position of Inlets and Outlets.

- (2) Both inlet and outlet at bottom of reservoir. Fig. 137.

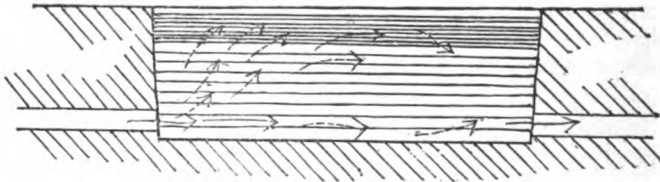

Fig. 137. Position of Inlets and Outlets.

- (3) Inlet at top and outlet at bottom. Fig. 138.

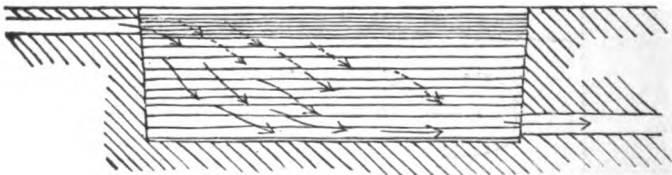

Fig. 138. Position of Inlets and Outlets.

(4) Inlet at bottom and outlet at top. Fig. 139.

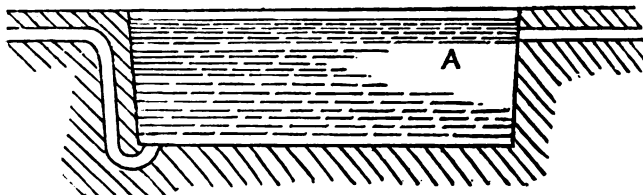

Fig. 139. Positions of Inlets and Outlets.

The best position is (4) because if the entering water is colder than that already in the reservoir, it will incline to remain at the bottom and force up the purer water, if it be warmer it will try to rise and take a more direct course to the outlet, but, having to pass through a larger body of water in this case, its temperature will soon be assimilated and that tendency cease. It is evident, however, in this case that, if the alternating system be adopted, a modification must be introduced since the water could only be drawn down for a very short distance from the top; a stand-pipe with valves at different levels or a floating pipe must be used.

The form of the inlet should be that of a bell-mouth, so that the entering water may have the least possible tendency to cause currents by its velocity merely, and the bell-mouth may with advantage turn upwards. A drain-pipe or scouring-pipe, and, in the case of any danger of over-filling, an overflow-pipe are necessary adjuncts of settling reservoirs.

**217. Filter Beds.**—Filter-beds are placed in shallow reservoirs, usually lined with brickwork, from the bottom of which drains lead the water to the purewater tank, from which the water is conveyed to the service reservoir. The filtering materials are laid in successive horizontal layers over the floor of the reservoir: and the top layer consists of sharp sand, which constitutes the actual filtering material. Below this sand comes a layer of coarse sand or fine gravel, then a layer of coarse gravel, and, lastly, about a foot of rubble at the bottom, or sometimes bricks laid loose and dry or tile drains.

The floor of a filter bed may be made to slope a little—say, 1 in 100 to 1 in 200, but this is by no means necessary as it is the hydrostatic pressure of the filtering head that forces the water along the drains. The drains unless discharging into an open channel must be ventilated, and these ventilators should be carried to ground level. The sides of a filter bed may be vertical or sloping. With sloping sides the mean area of the sand bed is the area of the filter to be considered in relation to the flow and in the determination of the size of the bed.

When filtering plant is first started, it is generally necessary to fill the filters cautiously from the upper side with unfiltered water, but once filtration has started, the beds should be filled from below with filtered water. There are several devices for regulating the filtering speed of filter-beds accurately, some of which also provide for filling the filter from below. One of these shown in Figs. 140 and 141. It

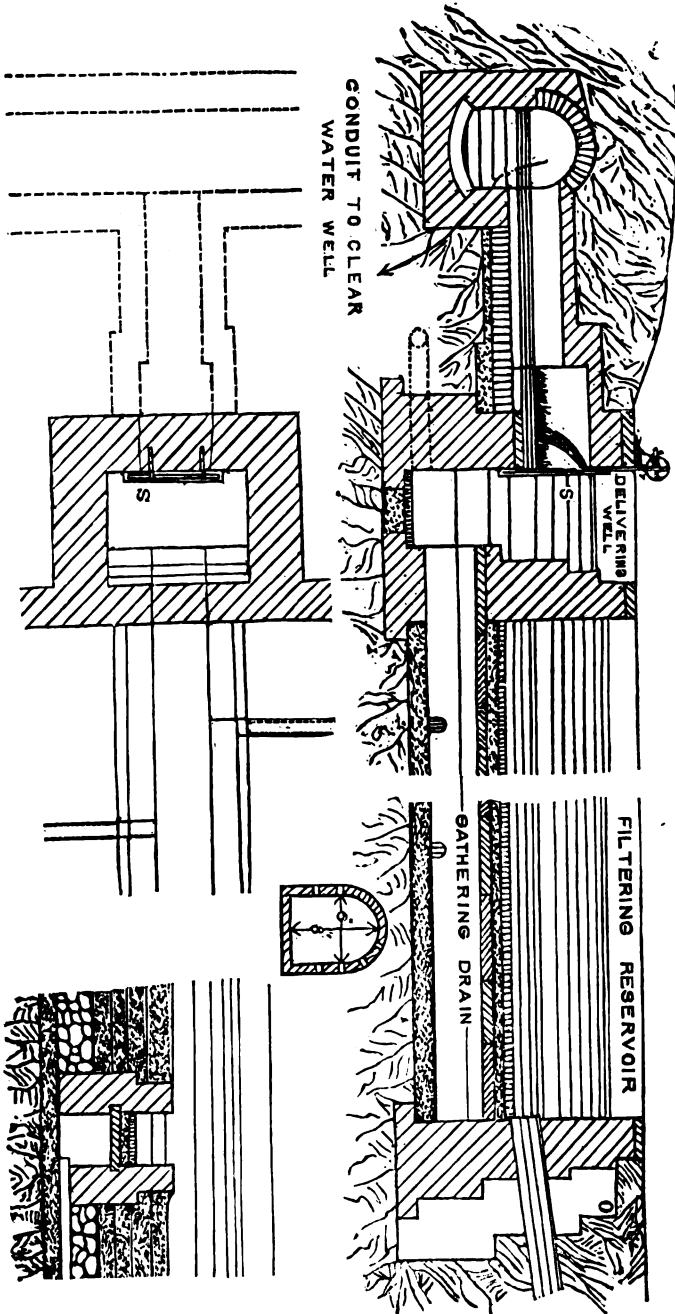

Figs. 140 and 141. Filter Beds.

is extremely simple. It consists merely of a sluice,  $s$ , that can be lowered so as to allow the water to flow over its top. By adjusting it from time to time, so as to keep the depth of water over its top constant, the flow of water remains constant. After the water has been drained off, and the filter has been cleaned, it may be filled up from below by entirely lowering the sluice when the water will back up the gathering drain from the conduit to the clear-water well, the water of course coming from the other filters.

**218. Drainage Arrangements.**—There is no difficulty in efficiently draining away the filtered water. The method commonly adopted, namely, that of filling the bottom of the filter with boulders, above which is broken stone, then gravel and then the sand and water is quite efficient, but the real requisite is an efficient method in itself in expensive and taking up the least possible depth. These requirements are met in the following two methods in which a bed of gravel, supporting the sand, is under-drained, in the one case by a set of drains, in the other by a cellular brick false floor laid on the real floor. In the former case the drains of whatever section will most naturally take the form shown in Fig. 142, that is to say, a main drain down the centre

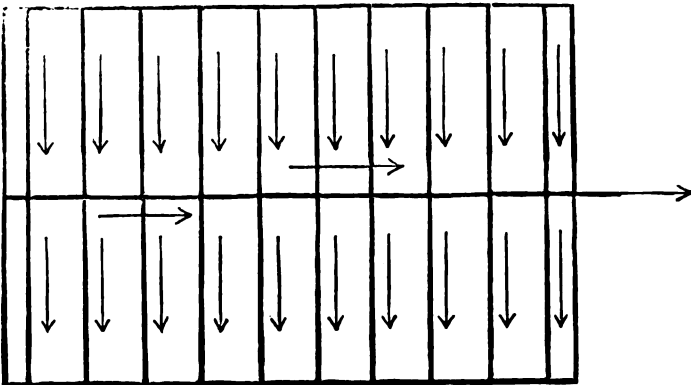

Fig. 142. Drainage arrangement of the Filter Bed.

of the filter-bed, with branches running into it at right angles from either side. The drains are sometimes made of brick, as shown in Fig. 143,

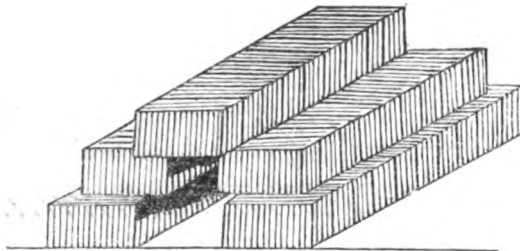

Fig. 143. Arrangement of Brick Drains.

but stone-ware pipes, such as are used for house drainage, are to be preferred. Whatever form of branch drain be adopted, there must be

at length 6 inches of gravel over the top of it. The cellular brick floor is most certainly the best method for draining a filter bed. The arrangement of the bricks is shown in Figs. 144 and 145. This method has the following advantages: (1) it gives perfectly uniform drainage over the whole of the filter-bed; (2) it takes up the least vertical space possible; and (3) it forms an arrangement most easily taken up for cleaning.

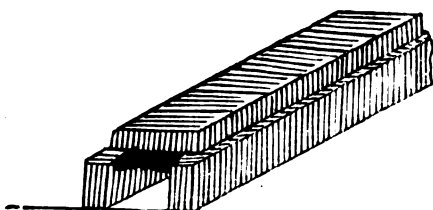

Fig. 144. Arrangement of Brick Drains.

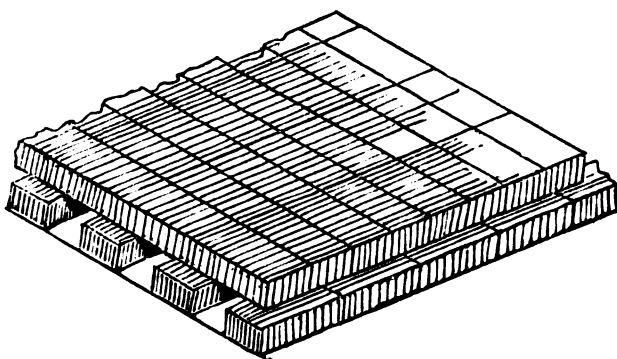

Fig. 154. Arrangement of Brick Drains.

**219. Filter Head.**—It should be noted that it is not an unusual error to suppose that the depth of water over the sand affects the rate of filtration; that rate depends upon the 'head' or difference of water level inside and outside the filter, and not on the depth of water over the sand Fig. 146. Some persons also consider that the latter depth has consider-

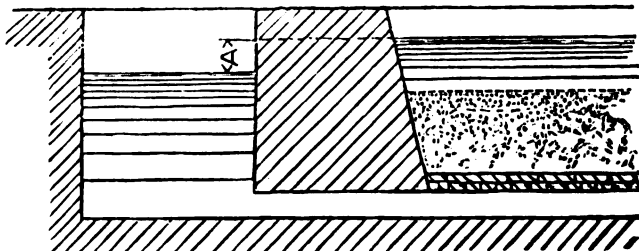

Fig. 146. Filter Head.

able effect on the temperature of the water; this however is not so; for instance, if filtration is proceeding at the rate of 4 inches per hour or 8 feet per day and there is only one foot of water on the sand it will be

exposed to the sun for 3 hours; if there be 3 feet of water there will be three times the quantity to be treated, but it will be exposed for 9 hours. It is evident therefore that, unless the depth can be made such that the rays of the sun cannot penetrate the lower layers, there is not much advantage in having a great depth. Engineers generally favour a depth of about 3 feet.

**220. Rate of Filtering Speed Allowable.**—By “filtering Speed” is meant the velocity with which the whole of the water in a filter-bed approaches the sand in a vertical direction. This velocity, multiplied by the area of the sand surface, gives the quantity filtered. Dr. Koch, it is believed, came to the conclusion that the filtering speed should not exceed  $7\frac{1}{2}$  feet in 24 hours; but there is still a considerable variation in practice. In London it has been found that a flow of  $2\frac{1}{2}$  to 3 gallons of water an hour for each square foot of area of filter-bed, has proved efficient for the purification of river water from the Thames, thus necessitating the provision of 16,500 to 14,000 square feet of filter-bed for each million gallons per day of supply. From this the size and number of filter-beds can be determined.

**221. Area and Number of Filter Beds.**—To provide for cleaning, one filter-bed, at least, must always be out of action and the filtering area required must be divided among two or more independent beds and then one additional bed must be provided as a surplus. The greater the number of equal divisions the less will be the surplus area to be provided, but, on the other hand, each division adds to the cost so that both convenience and finance are factors in controlling the design. The division may be approximately as follows:—

Popula- tion.	Number of gallons per head.	Gallons per diem.	Cubic feet per diem.	Actual filter area required.		Suggested number and size of filters.	
				SQ. YDS.	SQ. FEET.	NO.	SIZE.
5,000	7.5	37,500	8,000	84	756	3	20 × 20
	10.0	50,000	8,000	111	999	3	22 × 22
	15.0	75,000	12,000	166	1,494	3	28 × 28
7,500	7.5	56,250	9,000	125	1,125	3	24 × 24
	10.0	75,000	12,000	166	1,494	3	28 × 28
	15.0	112,500	18,000	250	2,250	3	34 × 34
10,000	7.5	75,000	12,000	166	1,494	3	28 × 28
	10.0	100,000	16,000	222	1,998	3	32 × 32
	15.0	150,000	24,000	333	2,997	3	38 × 38
15,000	7.5	112,500	18,000	250	2,250	3	34 × 34
	10.0	150,000	24,000	333	2,997	3	38 × 38
	15.0	225,000	36,000	500	4,500	4	38 × 38
20,000	7.5	150,000	24,000	333	2,997	3	38 × 38
	10.0	200,000	32,000	444	3,996	4	37 × 37
	15.0	300,000	48,000	666	5,994	4	45 × 45
30,000	7.5	225,000	36,000	500	4,500	4	38 × 38
	10.0	300,000	48,000	666	5,994	4	45 × 45
	15.0	450,000	72,000	1,000	9,000	4	55 × 55
40,000	7.5	300,000	48,000	666	5,994	4	45 × 45
	10.0	400,000	64,000	868	7,992	4	50 × 50
	15.0	600,000	96,000	1,332	11,988	4	65 × 65
50,000	7.5	375,000	60,000	840	7,560	4	50 × 50
	10.0	500,000	80,000	1,111	9,999	4	58 × 58
	15.0	750,000	120,000	1,666	14,994	4	70 × 70



**222. The Sand Bed.**—First, as to the sand itself. The very finest sand is not the best. The coarseness should be such that the separate grains are visible to the naked eye, and the sand should be fairly uniform in grain and sharp. Of course it should be clean, but if dirty only in the ordinary sense of the word when found, it is sufficient to wash it. The thickness given to the sand bed varies with different Engineers, but for various reasons, it would appear to be undesirable to have it less than  $2\frac{1}{2}$  feet and 3 feet may be said to be about the standard thickness. When a filter has been in action for some time the organic matter collected on the sand surface may die and in hot weather putrefy. It is a sign of advanced putrefaction when spongy matter floats on the surface of the water of filters, and it is then time to stop the filter and clean it. This is done by allowing the water to run away by the scour-pipes; after the water has been drawn down to a level of one foot below the surface of the sand, a sheet of sand of about half an inch in thickness should be removed. After removing the upper layer of sand it is advisable to stir up and loosen, with a fork or other pronged instrument, a depth of about 8 inches of the upper surface of the sand, and then to allow it to remain exposed to the atmosphere for some time. To replace the thin layer of sand removed at every single cleaning of this kind would involve too much labour; and it is customary to allow a foot or so of the thickness of the sand to be thus removed in parings before it is replaced.

Occasionally clean sand is so near at hand, and so readily and cheaply got, that the dirty sand may be thrown away altogether; but this is seldom the case, as, even if sand is as cheap as may be, it is seldom in such a condition that it is not improvable by washing and it takes little or no more trouble to wash the sand that has already been used than to wash new sand. Various contrivances have been invented for washing sand. One of the most popular is illustrated in Fig. 147. Dirty sand is shovelled into the upper part of this contrivance, water is turned on

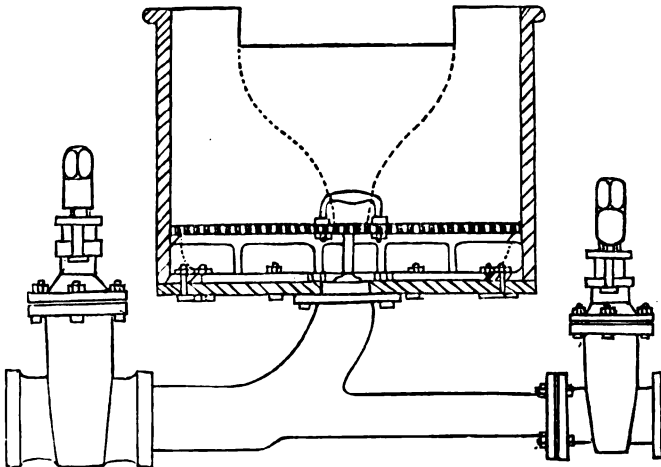

Fig. 147. Apparatus for washing sand.

from below, and is allowed to flow till that leaving the upper receptacle, at first thoroughly dirty, becomes quite clear, when the now purified sand is removed, and another lot treated. In Fig. 148 is shown a sand-washing apparatus known as "Walker's patent" the water being

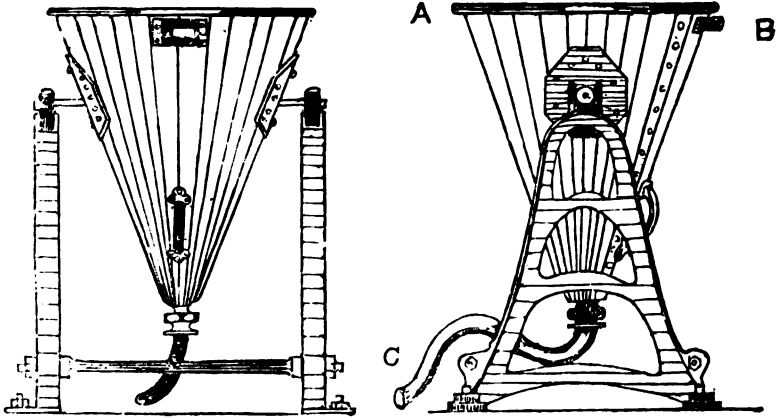

Fig. 148. Apparatus for washing sand.

introduced from below by rubber pipes, *c*, connected with a main, and, during the washing escapes by the spout, *B*. The rubber permits of the tipping of the vessel without making any disconnection at the main. When the water comes off clear it is an indication that the sand is clean, and the vessel is tipped over in the direction *A*, the sand being received

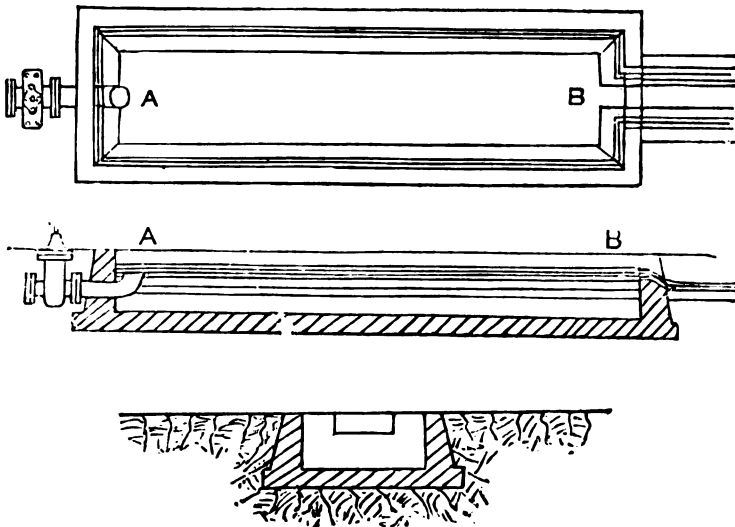

Fig. 149. "Canal" sand washer in plan and sections.

in a barrow or truck. These vessels are generally placed in "batteries" of such number as required. A third plan is to construct a narrow shallow canal as illustrated in Fig. 149. Water is allowed to flow continuously in at the end *A* and out at the end *B*, whilst dirty sand is continuously introduced at the outlet end and raked towards the inlet end. The rate of flow and raking of the sand should be so regulated that no sand is washed out at the end *B* and that no visible dirt is washed out of the sand for several feet before it reaches the end *A* where it is removed. A canal 30 feet long is sufficient for population up to 100,000. The water used for washing sand must, of course, be filtered water. Filter-beds, besides the ordinary cleansing described above, should at intervals, varying from six months to several years, according to the nature of the water, be emptied out and the whole of the materials constituting the filter-bed, right down to floor level, should be removed and thoroughly cleaned.

**223. Other Systems of Purification.**—There are systems of purification other than that of filtration referred to above, one of the chief systems being purification by what are known as revolving purifiers. These are large cylinders which are caused to revolve and are partly filled with spongy iron, or, preferably with cast iron borings. The water is introduced into the cylinders at one end and drawn off at the other after a contact of about  $3\frac{1}{2}$  minutes with the iron. It is stated that impure waters treated by these means will be found safer for dietetic purposes than even good deep well or spring water; because after treatment the water can be preserved in covered reservoirs, where as wells or springs may become contaminated.

**224. Service Reservoirs.**—The chief object of service reservoirs is to hold a reserve of water, so that they may compensate for the difference between the demand and supply. The size of the reservoir must be fixed by the relation between the maximum demand and the average supply. If we take it for granted that one-half the supply is required in six hours (from 6 A.M. to 9 A.M. and from 3 P.M. to 6 P.M.), we see that the demand is at times double the average. As in 6 hours only one quarter the supply would be received in the reservoir while one-half is demanded, it is evident that the reservoir must hold at least a quantity equal to one-fourth the average daily demand. It is desirable, however, to make it hold one-third and in some cases reservoirs have been designed to hold as much as two or three, and even more, days supply. There are advantages in having large storage capacity for storing clean water and particularly so in pumping systems, but the modern tendency is to do with the smallest size of storage reservoir that is compatible with efficiency. Service reservoirs are always, or nearly always, made with sides vertical or having a very slight internal batter. The bottom, as with settling reservoirs, may have a slight slope towards a cleaning drain. These reservoirs should be covered because of liability to be fouled by birds dropping matter into them, and in order to keep the water cool. The best form of roof is in most cases that of a series of brick or concrete arches supported on piers or columns and the arches should be covered with two or three feet of earth. Such a roof is practically impervious to heat, and forms an effectual covering.

**225. Position of Settling and Other Reservoirs.**—The best position for settling reservoirs, filter beds and service reservoirs requires notice; as a rule they should be as near the population to be supplied as possible; one reason is that the conduit between the source of supply and the reservoir requires to be of such capacity as will carry only the average hourly supply, whereas all pipes between the service reservoir and the town must be of sufficient size to discharge the maximum, or double the hourly, demand. This position cannot always be maintained, owing to a certain head on the pipes through the town being necessary, and these works may be required to be placed near the source at some intermediate position between it and the town. It may, in some cases, be advantageous to place the settling tanks and filter-beds near the source of supply and the service reservoir at an intermediate point. A study of the relative levels of the source of supply, of the town area, and of the intermediate ground will determine what the most economical arrangement will be. To prevent service or other reservoirs being filled above a fixed level, they should be furnished with self-closing valves or overflow pipes or both; the former are desirable when an economical use of water is a necessity.

**226. Distribution Systems.**—There are two systems of distribution which are applicable to India, the "dead-end" and the inter-lacing or "grid-iron" system. The two systems may, however, be combined. Figs. 150 and 151.

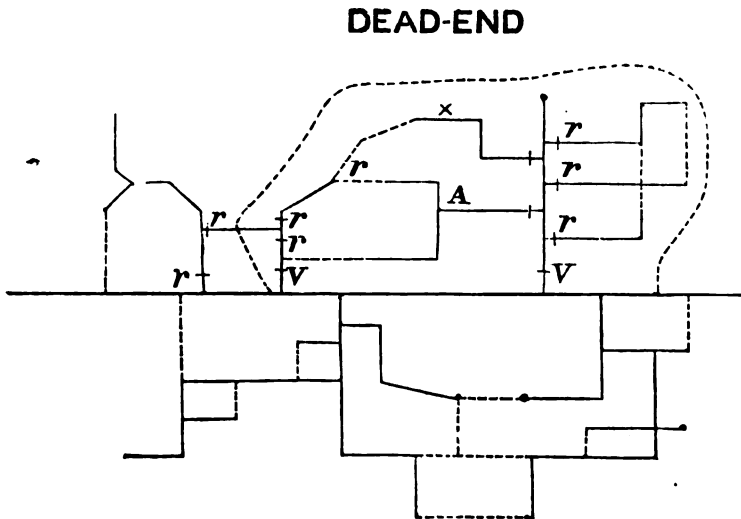

Fig. 150. Distribution system.

## GRID-IRON

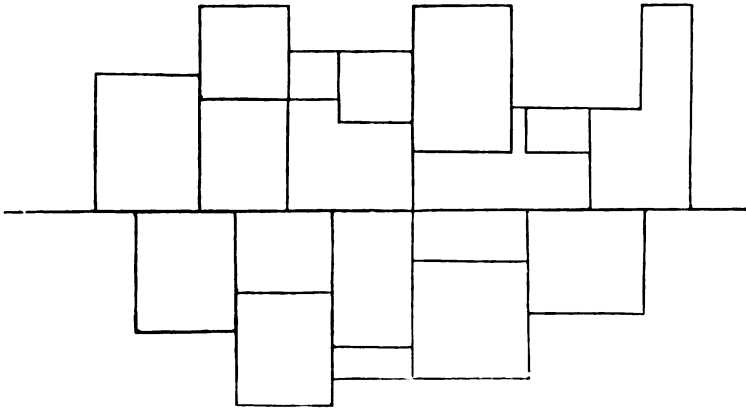

Fig. 151. Distribution system.

In the dead-end system the water, once it has left the main, cannot return again, and, if not drawn off the water must remain in the pipes and become stagnant and deteriorate in quality. This can be partly overcome by occasionally flushing out the pipes by hydrants or scour-valves at the dead-ends, but this involves waste of water and needs careful supervision to see that the precaution is not neglected. This system has the advantage of lending itself to an easy determination of the proper sizes of the pipes and also of requiring a lesser number of valves than the grid-iron system; but it has this disadvantage that the water is supplied from one direction only, and that therefore when anything goes wrong on the branch pipe, the whole district supplied by that branch may be temporarily deprived of its supply.

In the grid-iron system, the ends of the mains are junctioned into one another and when fully carried out the pipes should cross each other forming a complete network.

Except in the case of the largest towns in India it is probable that a combination of the two foregoing methods will be suitable. In this case the sizes of the mains are determined under the condition of water flowing from one size only and then the ends of all pipes are connected together by pipes of not less than 3 inches in diameter, so that stagnation is avoided, and a partial supply, at any rate, always available. Such a system requires, of course, a larger number of valves than in the dead-end system, unless very extensive districts are to be shut off from supply during any burst, repair, etc. The number of valves required depends greatly on the security and amount of convenience required.

In an irregularly built town with few definite main streets, it is a matter of judgment and experience as to how the pipes should be arranged. In India, where the major part of the supply is drawn from the street stand pipes, it is necessary to be guided by two factors; firstly, the distribution of the stand pipes ought to be averaged over the whole

town area, so that no person may be beyond a fixed distance from a stand pipe or fountain; secondly, the supply to each stand pipe or fountain should be in proportion to the population served by it, thus at fountains in densely-populated districts two, three or four taps may be required.

**227. Determination of the Sizes of Pipes.**—In working out the diameters of the large mains of a system, it is first of all necessary to divide the area to be supplied into a number of districts, and to discover the approximate population of each. It is usual to limit the flow of water through pipes to certain maximum velocities which should not be exceeded, and if these are determined, the maximum discharge allowable and the maximum hydraulic gradients at which such pipes should be laid are known. The diameters of the pipes should therefore be fixed not only with reference to the quantity they are required to carry, but also with reference to the maximum velocity permissible through them. The first thing to be done in the case of the smaller mains is to determine the minimum diameter of the pipe to be adopted. In some cases a minimum of three inches has been allowed, but it is now generally agreed that this diameter is too small. It is certainly too small in the case of waters that incline to produce incrustation rapidly. A better minimum would undoubtedly be four inches.

**228. Pipes for Water Works.**—The standard material used for water works at the present time is undoubtedly cast-iron, though under special circumstances pipes of other material may be used. Cast-iron pipes are connected together by flanged joints or spigot and faucet joints; the latter class of joint is sub-divided into "plain" and "turned and bored" joints.

Flanged pipes are not used to any extent on water works except in special positions. Flanged joints are ordinarily "faced," that is, their surfaces which come into contact are accurately planed. The joint is made water-tight by the insertion, between the flanges, of yarn and lead, India rubber, asbestos or soft lead rings; these are compressed when the joints are screwed up tight. Flanged pipes can be easily removed from a line of piping, but they do not allow for expansion and contraction, and the joints are expensive to make.

Spigot and faucet joints are therefore usual on water-supply mains. In turned and bored joints a portion of the outside of the spigot end of the pipe is accurately turned, and the inside of the faucet end similarly bored, so that when the end of one pipe is thrust into the opposite end of the other pipe the joint is water-tight. The remaining portion of the joints of turned and bored joints is sometimes filled with cement mortar. With plain spigot and faucet joints, lead is run into the joints after yarn has been well rammed home.

## INDEX.

	PAGE
ABSORPTION ... ..	16
Amount of, in reservoirs and canals	17
Greatest in village channels	16
ACRE-FOOT ... ..	130
Duty of water per	180
ALICANTE DAM ... ..	184
ALIGNMENT OF CANALS ... ..	21
ANICUTS OR WEIRS ... ..	37
Apron and Groynes above	44
Component parts of	38
Crest walls of	38
Coleroon	48
Gódvári	40
Goulbourn on drop gate	58
Horizontal masonry apron	39
Jutoor	46
Kistna	53
Kortelliar	48
Lawrence	56
Moveable iron, French type	57
Open and closed	60
Outer rough-stone apron	59
Palar	48
Poiney	48
Principal types of	44
Retaining walls	41
Second type of	49
Shatiatope	48
Sloping aprons of masonry or concrete	41
Rough Stone	42
Srivaikuntham	47
Sunkesala	45
Third type of	53
Water cushions of	43
APRONS—	
Above crest walls	44
Horizontal masonry	40
Outer Rough stone	48
Rough stone	42
Sloping	41
Water cushions	43
AQUEDUCTS ... ..	102
Drainage	100
Gunnáram	106
Iron	107
AREA IRRIGATED ... ..	133
Comparison of water-supply	133
AREAS OF WATER SHEDS ... ..	142
Methods of computing	142
ASSIOUT DAM ... ..	198
ASSUÁN DAM... ..	197
BAN DAM ... ..	191
BANKS—	
Height of channel	32
Top width of channel	32
BEAR VALLEY DAM ... ..	187
BERTALOO DAM ... ..	186
BELLECK SLUICES ... ..	71
BEST FORM OF IRRIGATION CHANNEL ... ..	81

	PAGE
BETWA DAM ... ..	185
BHATGUR DAM ... ..	184
BOUSEY DAM ... ..	193
BRIDGES ... ..	126
Canal ... ..	126
Head way of ... ..	126
Over irrigation canals ... ..	94
BRIDGES and CULVERTS ... ..	95
Data for design ... ..	95
Details of design ... ..	95
BUNDS OR EMBANKMENTS—	
Breaches in ... ..	163
Earthen ... ..	137
Foundations ... ..	137
Masonry cores ... ..	138
Preservation of slopes of ... ..	146
Puddle, walls ... ..	138
Revetments ... ..	149
Substitutes for ... ..	149
Scour holes ... ..	149
CANALS ... ..	19-21
Alignment of ... ..	21
Bridges ... ..	126
Classes of ... ..	20
Combined navigation and irrigation ... ..	20
Dimensions of main ... ..	23
Fender Piles ... ..	126
Inundation ... ..	3
Irrigation ... ..	20
Irrigation adapted for navigation ... ..	114
Limiting velocity of water ... ..	115
Losses in ... ..	14-16
Navigation ... ..	20 & 114
Navigation in dry season ... ..	115
Perennial ... ..	3
Tidal ... ..	119
Towpaths ... ..	129
Typical sections of Indian ... ..	25
CANAL FALLS ... ..	87
Madras type ... ..	87
Midnapore ... ..	88
Notched crest ... ..	92
Northern Indian ... ..	89
With grating ... ..	90
CANALS AND CHANNELS ... ..	22
Absorption in ... ..	15
Actual water-supply ... ..	132
Data for design ... ..	22
Evaporation ... ..	15
Leakage ... ..	15
Levels ... ..	23
Purposes for which designed ... ..	22
CANAL LOCKS ... ..	116
Design of ... ..	119
Site plans ... ..	119
Weirs ... ..	88
CANAL SYSTEMS ... ..	36
Ancients or weirs ... ..	37
Head works ... ..	36
Part of ... ..	4
CATCHMENT BASIN ... ..	8
Formulae for Discharge ... ..	9
Maximum discharge of ... ..	8
Run-off ... ..	8



	PAGE
<b>CATTLE CROSSINGS</b> ... .. .	84
<b>CAVOUR CANAL, INVERTED SYPHON UNDER RIVER SESIA</b> ... .. .	112
<b>CENTRIFUGAL PUMPS</b> .. .. .	210
<b>CHANNELS—</b>	
Absorption ... .. .	15
Best form of irrigation ... .. .	31
Cattle crossings ... .. .	84
Details of ... .. .	80-82
Dimensions of ... .. .	24
Distributaries ... .. .	29
Evaporation ... .. .	15
Height of banks ... .. .	32
Irrigation ... .. .	27
Limiting velocity of water ... .. .	29
Leakage ... .. .	15
Main dimensions of ... .. .	23
Mile and intermediate stones ... .. .	33
Width of bank ... .. .	32
<b>CORE WALLS, MASONRY</b> ... .. .	138
<b>CROSS DRAINAGE WORKS</b> ... .. .	97
Aqueducts ... .. .	102
Cuts ... .. .	97
Diversions ... .. .	97
Escapes ... .. .	97
Inlets and outlets ... .. .	99
Level crossings ... .. .	99
Superpassages ... .. .	100
Syphons ... .. .	108
Inverted ... .. .	109
<b>CROSSINGS, LEVEL</b> ... .. .	89
<b>CULVERTS AND BRIDGES</b> ... .. .	94
Data for Design ... .. .	95
Details of Design ... .. .	95
<b>CURVED DAM, DESIGN OF</b> ... .. .	199
<b>CUSEC—Abbreviation of cubic feet per second</b> ... .. .	11
<b>Cuts, DRAINAGE</b> ... .. .	97
<b>DAMS</b> ... .. .	174
Alicante ... .. .	194
Assiout ... .. .	198
Assuán ... .. .	197
Ban ... .. .	191
Bear Valley ... .. .	187
Beetaloo ... .. .	186
Betwa ... .. .	185
Bhatgur ... .. .	184
Bousey ... .. .	192
Design of curved ... .. .	179
Details of construction ... .. .	180
Earthen ... .. .	137
Examples of sites ... .. .	136
Limiting pressure ... .. .	178
For storing irrigation water ... .. .	6
Furens ... .. .	190
Geelong ... .. .	186
General form of ... .. .	178
Limiting pressure, on masonry ... .. .	178
Moveable ... .. .	65
Paicoma submerged ... .. .	187
Periyár ... .. .	181
Poona or lake Fife ... .. .	184
Practical formula ... .. .	176
Puentes ... .. .	195
Quaker bridge ... .. .	175-186
Stability of ... .. .	174
Submerged ... .. .	187

	PAGE
Sweetwater ... ..	187
Tansa ... ..	183
Theoretical profile ... ..	177
Tonto Basin ... ..	137
Vyrwy ... ..	195
With flood discharge sluices	196
Zola ... ..	189
<b>DIMENSIONS OF CHANNELS</b> ... ..	<b>24</b>
<b>DISCHARGES—</b>	
Flood ... ..	14
Gauging river ... ..	15
<b>DISTRIBUTARIES</b> ... ..	<b>29</b>
Head sluice of ... ..	81
<b>DIVERSION WEIRS</b> ... ..	<b>37</b>
<b>DRAINAGE WORKS</b> ... ..	<b>97</b>
Aqueducts ... ..	102
Cuts ... ..	97
Diversions ... ..	97
Inlets and outlets ... ..	99
Level crossings ... ..	99
Superpassages ... ..	100
Syphons ... ..	108
Inverted ... ..	109
<b>DUTY OF WATER</b> ... ..	<b>130</b>
Actual supply of canals and channels ... ..	132
Comparison of supply and areas irrigated ... ..	133
Measurement of ... ..	131
Quantity of water required for rice cultivation ... ..	132
Units of measurement ... ..	130
<b>EMBANKMENTS</b> ... ..	<b>137</b>
Earthen ... ..	137
River ... ..	15
<b>ENGINES FOR PUMPING—</b>	
Oil ... ..	212
Steam ... ..	211
<b>ESCAPES</b> ... ..	<b>81</b>
Characteristics of ... ..	85
Design ... ..	87
Indri ... ..	86
Location ... ..	85
Madras type ... ..	87
Shutters of ... ..	87
<b>EVAPORATION</b> ... ..	<b>15</b>
Apparatus for measuring ... ..	15
Losses in canals, channels and tanks ... ..	16
<b>FALLS, CANAL--</b>	
Madras type ... ..	87
Midnapore ... ..	88
Notched crest ... ..	92
Upper Indian ... ..	89
With grating ... ..	90
<b>FENDER PILES</b> ... ..	<b>126</b>
<b>FLOOD DISCHARGES</b> ... ..	<b>13</b>
<b>FLOOD LEVELS</b> ... ..	<b>14</b>
Registration of ... ..	14
<b>FORMULÆ—</b>	
Diokens ... ..	10
Discharge of tank weirs.	
Losses in channels.	
Maximum run-off ... ..	10
Notched fall ... ..	93
Byes ... ..	10
<b>FOUR ACRES SHUTTERS—</b>	

	PAGE
GANGES, RAIN ... ..	7
River ... ..	13
GEELONG DAM ... ..	186
HEAD SLUICES ... ..	75-78
Construction of ... ..	77
Data for design ... ..	78
Details of design ... ..	81
Distributaries ... ..	81
Position of ... ..	75
HEAD WORKS ... ..	36
INLET DAMS ... ..	99
INUNDATION CANALS ... ..	2
INVESTIGATION OF—	
Irrigation projects ... ..	6
Storage works ... ..	136
IRRIGATION—	
Area of, in Madras ... ..	3
Canals ... ..	20
Canals adapted for navigation ... ..	114
Channels ... ..	27
Different modes of ... ..	3
Lift ... ..	201
Meaning of ... ..	2
Necessity for ... ..	2
Projects, preparation of ... ..	7
Reservoir Dams for storing water ... ..	6
Tank, collecting rainfall ... ..	5
Value of ... ..	2
Water, drawn from rivers ... ..	3
Sources of ... ..	8
JUJOOB WEIR ... ..	46
KISTNA ANICUT ... ..	53
KORTELLIAR ANICUT ... ..	48
LAKE FIFE OR POONA DAM ... ..	184
LAWRENCE WEIR ... ..	56
LEAKAGE ... ..	16
Amount of, in reservoirs and canals ... ..	17
LEVELS—	
Canals ... ..	22
Channels ... ..	21
Flood, registration of ... ..	13
LIFT IRRIGATION ... ..	201
LIMITING VELOCITY OF WATER ... ..	29
LOCKS ... ..	116
Design of ... ..	119
In tidal canal ... ..	119
Site plans for ... ..	119
Weirs ... ..	116
LOSSES IN CANALS, CHANNELS AND TANKS ... ..	17
Formula for ... ..	16
MADRAS PRESIDENCY AVERAGE RAINFALL IN ... ..	2
Area of irrigation in ... ..	3
Tanks for irrigation in ... ..	4
MILE STONES ... ..	33
NAVIGATION—	
Canals ... ..	114
In dry season ... ..	115

	PAGE
Limiting velocity of water in canals ... ..	115
Irrigation canals adapted for ... ..	114
Indian canal systems ... ..	114
Locks ... ..	116
Lock weirs ... ..	116
Tidal canals ... ..	119
Fender piles ... ..	126
Bridges on navigation canals ... ..	126
Tow-paths ... ..	129
OPEN WEIRS ... ..	60
PACOIMA SUBMERGED DAM ... ..	187
PALÁR ANICUT ... ..	52
PARTS OF ANICUTS ... ..	38
PARTS OF CANAL SYSTEMS ... ..	4
PENNAR ANICUT ... ..	52
PERCOLATION ... ..	16
Prevention of ... ..	17
PERENNIAL CANALS ... ..	2
PERIYÁR DAM ... ..	181
PILES-FENDER ... ..	126
PIPES ... ..	229
Length of Suction ... ..	211
Size ... ..	229
Water works ... ..	229
POlNEY ANICUT ... ..	48
POONA OR LAKE FIFE DAM ... ..	184
PREPARATION OF IRRIGATION PROJECTS ... ..	6
PRODUCTIVE WORKS ... ..	2
PROTECTIVE WORKS ... ..	2
PUNTES DAM ... ..	195
PUMPS—	
And motive power ... ..	202
Centrifugal ... ..	210
Choice of ... ..	202
Force ... ..	209
Lift ... ..	209
Pulsometer ... ..	210
QUAKEE BRIDGE DAM ... ..	186
RAINFALL ... ..	8
Catchment basin ... ..	9
Gauging ... ..	8
Maximum discharge ... ..	9
Registers ... ..	8
Run-off ... ..	9
Tanks collecting—for Irrigation ... ..	5
RAIN GAUGES ... ..	7
REGISTRATION OF FLOOD LEVELS ... ..	13
REGULATORS ... ..	75
Construction of ... ..	77
Position of ... ..	75
RESERVOIRS ... ..	136
Losses in ... ..	16
RESERVOIR DAMS ... ..	137
Earthen ... ..	136
For storing irrigation water ... ..	6
Masonry ... ..	173
With flood discharge sluices ... ..	5 & 196
RETAINING WALLS OF ANICUTS ... ..	41
RICE—	
Quantity of water required for cultivation ... ..	132

	PAGE
<b>RIVERS—</b>	
Embankments ... ..	15
Gauging discharges ... ..	14
Water for irrigation ... ..	2
<b>RUN-OFF</b> ... ..	9
Formulae for ... ..	10
Tables of representative areas ... ..	11
<b>SCOURING SLUICES</b> ... ..	62
Shutters of ... ..	65
<b>SHATIATOPE ANICUT</b> ... ..	48
<b>SHUTTERS—</b>	
Fouracres ... ..	66
Madras escape ... ..	87
Scouring sluice ... ..	65
Sluice ... ..	69
Smart's ... ..	72
Stoney's ... ..	69
<b>SILT</b> ... ..	18
<b>SLUICES—</b>	
Assuán ... ..	72
Bellek ... ..	71
Construction ... ..	77
Head ... ..	75
Stoney's ... ..	69
Weaver ... ..	71
<b>SLUICES—HEAD</b> ... ..	78
Data for design ... ..	79
Details of design ... ..	81
Distributaries ... ..	81
Position of ... ..	75
Tank ... ..	159
<b>SOANE WEIR</b> ... ..	54
<b>SOURCES OF IRRIGATION WATER</b> ... ..	2
<b>SRIVAIKUNTHAM ANICUT</b> ... ..	47
<b>STORES-MILE AND INTERMEDIATE</b> ... ..	32
<b>STORAGE WORKS—</b>	
Classes of ... ..	136
Examination of site ... ..	136
Preliminary investigation ... ..	136
Sweet-water site ... ..	136
<b>SUNKESALA WEIR</b> ... ..	45
<b>SUPERPASSAGES</b> ... ..	100
<b>SWEET-WATER DAM</b> ... ..	187
<b>STPHONS</b> ... ..	108
Inverted ... ..	109
<b>TAKES</b> ... ..	140
Bunds ... ..	144
Capacity ... ..	143
Closing of breaches ... ..	163
Collecting rainfall for irrigation ... ..	4
Evaporation in ... ..	15
Grouping ... ..	140
Improvements ... ..	140
Irrigation duty of water ... ..	143
Leakage in ... ..	15
Means of disposing of flood water ... ..	153
Method of computing areas of water sheds ... ..	142
Puddle faces ... ..	147
Walls ... ..	145
Repairs ... ..	140
Revetments ... ..	149
Substitutes for ... ..	140
Sluices ... ..	159

	PAGE
Supplies from catchment basins ... ..	141
Surplus weirs ... ..	152
Weirs, designs of ... ..	152
<b>TANK WEIRS—</b>	
Curved ... ..	157
Designs of ... ..	152
Examples of ... ..	153
Formulse for discharge ... ..	152
Vertical drop ... ..	153
Water cushions ... ..	156
<b>TANK SLUICES—</b>	
Designs ... ..	159
Examples ... ..	162
Plug ... ..	165
Shutter ... ..	160
<b>TANSA DAM ... ..</b>	<b>183</b>
<b>TYPICAL SECTIONS OF INDIAN CANALS ... ..</b>	<b>25</b>
<b>UNDER SLUICES—</b>	
Construction of ... ..	64
<b>WATER—</b>	
Duty of ... ..	180
Measurement of ... ..	131
Units of measurement ... ..	130
<b>WATER CUSHIONS ... ..</b>	<b>48</b>
<b>WATER SUPPLY OF TOWNS ... ..</b>	<b>213</b>
Distribution systems ... ..	227
Dead end ... ..	227
Gridiron ... ..	228
Filter beds—	
Drainage arrangements ... ..	221
Number and area of ... ..	223
Filtration ... ..	214
Filter head ... ..	222
Rate of ... ..	223
Sand bed ... ..	224
Intermittent and constant supply ... ..	216
Purification ... ..	213
Quality ... ..	213
Quantity required per head of population ... ..	215
Taking samples ... ..	213
Variation of demand ... ..	215
Vyrnwy Dam ... ..	195
<b>WATER-WORKS—</b>	
Classification of ... ..	216
Pipes ... ..	229
Settling reservoirs ... ..	217
Design ... ..	217
Position of ... ..	227
Position of inlets and outlets ... ..	218
Service reservoirs ... ..	226
<b>WEAVER SLUICES ... ..</b>	<b>71</b>
<b>WEIRS OR ANICUTS—</b>	
Apron and groynes above ... ..	44
Component parts of ... ..	38
Crest wall of ... ..	38
Coleroon ... ..	48
Góddávari ... ..	40
Goulbourn iron drop gate ... ..	58
Horizontal masonry apron ... ..	39
Jutoor ... ..	46
Kistna ... ..	53
Kortelliar ... ..	48
Laurence ... ..	56
Moveable iron—French Type ... ..	57

	PAGE
Open and closed ... ..	60
Outer rough stone apron ... ..	59
Pálár ... ..	48
Poincy ... ..	48
Principal types of ... ..	44
Retaining walls ... ..	41
Second type of ... ..	49
Shatiatope ... ..	48
Sloping aprons of masonry or concrete ... ..	41
Rough Stone ... ..	42
Srivaikuntham ... ..	47
Sunkesala ... ..	45
Third type of ... ..	53
Water cushions of ... ..	43
WEIRS OR FALLS—	
Madras type ... ..	90
Midnapore ... ..	88
Notched crest ... ..	82
Northern Indian ... ..	89
With grating ... ..	90
WEIRS-LOCK ... ..	116
WELLS ... ..	199
Artesian ... ..	200
Examples of ... ..	201
Capacity ... ..	200
Size ... ..	201
WORKS—	
Classes of storage ... ..	136
Drainage ... ..	87
Head ... ..	86
Preliminary investigation of ... ..	136
ZOLA DAM ... ..	189



