

AGRICULTURAL ENGINEERING SERIES

E. B. McCORMICK, CONSULTING EDITOR

FARM MOTORS

McGraw-Hill Book Company

Publishers of Books for

Electrical World	The Engineering and Mining Journal
Engineering Record	Engineering News
Railway Age Gazette	American Machinist
Signal Engineer	American Engineer
Electric Railway Journal	Coal Age
Metallurgical and Chemical Engineering	Power

FARM MOTORS

STEAM AND GAS ENGINES, HYDRAULIC
AND ELECTRIC MOTORS, TRACTION
ENGINES, AUTOMOBILES, ANIMAL
MOTORS, WINDMILLS

BY

ANDREY A. POTTER

MEMBER AMERICAN SOCIETY OF MECHANICAL ENGINEERS, DEAN OF THE ENGINEERING
DIVISION AND PROFESSOR OF STEAM AND GAS ENGINEERING
IN THE KANSAS STATE AGRICULTURAL COLLEGE

SECOND EDITION

REVISED AND ENLARGED

McGRAW-HILL BOOK COMPANY, Inc.
239 WEST 39TH STREET. NEW YORK

LONDON: HILL PUBLISHING CO., LTD.
6 & 8 BOUVERIE ST., E. C.

1917

COPYRIGHT, 1913, 1917, BY THE
MCGRAW-HILL BOOK COMPANY, INC.

THE MAPLE PRESS YORK PA

215045
JAN -7 1918

6949 378

TH

P85

.2

PREFACE TO SECOND EDITION

The first edition of this book was published in 1913. It was new in its field and the experience since gained in teaching farm motors has led to the present revision.

In this edition the chapters on gas and oil engines and on traction engines were enlarged, the steam engine chapters were rewritten and new chapters were added on automobiles and on animal motors. All other chapters were revised.

In the preparation of this edition, the author is particularly indebted to President J. H. Waters and to his colleagues N. A. Crawford, W. A. Buck, E. V. Collins and F. A. Wirt of the Kansas State Agricultural College.

A. A. POTTER.

MANHATTAN, KANSAS,
April 10, 1917.

PREFACE

In preparing this book it has been the intention to include the fundamental principles governing the construction, working and management of motors which are suitable for farm use. The motors treated include steam engines, gas and oil engines, traction engines, automobiles, water motors, windmills and electric motors.

The method followed in each chapter was to give:

1. the fundamental principles underlying the particular motor,
2. the principal parts of the motor,
3. auxiliary parts,
4. uses to which the particular type of motor is adapted.
5. selection, erection and management of the different machines.

While this book was prepared primarily as a text-book for students in agricultural engineering, the subject matter is so presented that it will be of equal value to farmers and to operators of various kinds of engines and motors. Much practical information is included regarding steam, gas and electricity, and the text is illustrated with over 275 cuts.

Some space is devoted to the more refined methods used in engineering practice for improving the economy of various motors. While many of these methods are not used at the present time in connection with farm motors, it is the opinion of the author that a knowledge of the best engineering practice is not only of considerable educational value, but will lead to the more perfect manipulation of the simple farm motors.

The successful rural engineer of the near future will be the man that applies proven engineering to the machinery and constructions used on the farm.

The author is particularly indebted in the preparation of this book to Professors E. B. McCormick, M. R. Bowerman, R. A. Seaton, and W. W. Carlson, of the Kansas State Agricultural College; to Professors Allen and Bursley of the University of Michigan; and to Mr. S. Yesner of Boston, Mass.

A. A. POTTER.

MANHATTAN, KANSAS,
November, 1913.

CONTENTS

	PAGE
PREFACE	v

CHAPTER I

FARM MOTORS IN GENERAL.	1
Sources of energy—Principles governing the action of various mechanical motors—Animal motors—Comparison of various types of motors—Power used on farms—Comparative cost of power with various motors—Problems.	

CHAPTER II

FUNDAMENTAL PRINCIPLES AND DEFINITIONS	6
Matter—States of matter—Motion—Force and pressure—Work, energy and power—Horsepower—Indicated horsepower—Brake horsepower—Draw-bar horsepower—Nature of heat—Temperature—Thermometers—Units of heat—Mechanical equivalent of heat—Specific heat—Specific gravity—Problems.	

CHAPTER III

STEAM GENERATION AND STEAM BOILERS	16
Theory of steam generation—Fuels—Combustion—Commercial value of fuels—Principal parts of a steam power plant—Classification of boilers—Return tubular boiler—Vertical fire-tube boilers—Water-tube boilers—Grates for boiler furnaces—Piping for boilers—Pipe fittings—Valves—Safety valves—Steam gages—Water glass and gage cocks—Water column—Steam traps—Feed pumps and injectors—Feed-water heaters—Chimneys and draft-producing systems—Firing—Rating of boilers—Management of boilers—Problems.	

CHAPTER IV

STATIONARY STEAM ENGINES	42
Description of the steam engine—Action of the plain slide valve—Types of steam engine valve gears—Valve setting—Steam engine indicator cards—Losses in steam engines—Steam engine governors—Engine details—Lubricators—Steam separators—The steam locomotive or Buckeymobile—Steam turbines—Installation and care of steam engines—Problems.	

CHAPTER V

GAS AND OIL ENGINES 65

The internal-combustion engine—The gas engine cycle—Classification of gas engines—The four-stroke cycle—The two-stroke cycle engine—Comparison of two-stroke cycle and four-stroke cycle engines—Gas engine fuels—Gasoline and other distillates of crude petroleum—Alcohol as a fuel for gas engine use—Essential parts of a four-stroke cycle gas engine—Carburetors for gasoline engines—Carbureting kerosene and the heavier fuels—Cooling of gas engine cylinder walls—Gas engine ignition systems—Electric ignition systems for gas engines—The make-and-break system of ignition—The jump spark system of ignition—Ignition dynamos—Magnetos—Low-tension magnetos—High-tension magnetos—Timers—Automatic ignition for oil engines—Lubrication of gas and oil engines—Governing of gas engines—The gasoline engine on the farm—Selecting a gas engine—Installation of gas engines—Instructions for operating gas engines—Care of a gas engine—Problems.

CHAPTER VI

AUTOMOBILES 122

Types of automobiles—Essential parts of a gasoline automobile

- Automobile motors—Clutches—Transmission gears—The progressive sliding-gear transmission system—The selective sliding-gear transmission system—The planetary transmission system—The friction drive—Differentials for automobiles—Universal joint—Front and rear axles—Steering and control systems—Brakes—Wheels and tires—Carburetors and gasoline feed systems—Ignition—Automobile lubrication—Automobile starting systems—Automobile lighting and accessories—Management of automobiles—Gasoline motor cycles—Problems.

CHAPTER VII

TRACTION ENGINES 168

Fundamental parts of a traction engine—Steam traction engines—Boilers—Pumps—Feed-water heaters—Engine types—Reversing mechanisms for steam traction engines—Steering—Transmission systems and differentials—Gas traction engines—The gas traction engine motor—Carburetors for traction engines—Ignition for gas traction engines—Transmission systems and differentials—Type of traction—Uses of traction engines—Development of the gas traction engine—Economy of gas traction engines—Rating of traction engines—Operation and care of traction engines—Problems.

CHAPTER VIII

WATER MOTORS 211

Determining the power of streams—Types of water motors—Over-

CONTENTS

xi

PAGE

shot, undershot and breast wheels—Impulse water motors—Water turbines—The hydraulic ram—Problems.

CHAPTER IX

WINDMILLS	221
Types of windmills—Principal parts of a windmill—The wind-wheel—The rudder or vane—The governor—Windmill gearing—Windmill brake—Towers—Method of erecting windmills—Care of windmills—Power of windmills—Uses of windmills—Problems.	

CHAPTER X

ELECTRIC MOTORS, GENERATORS AND BATTERIES	236
Action of electricity—Units of electricity—Ohm's law—Incandescent lamps—Wires for conductors of electricity—Electrical batteries—Primary batteries—Storage batteries—The lead storage battery—The Edison storage battery—Methods of connecting batteries—The electric generator—Action of the electric generator—Direct and alternating currents—Principal parts of generators and motors—Classification of generators and motors—Series-wound generators—Series-wound motors—Shunt-wound generators—Shunt-wound motors—Compound-wound generators—Compound-wound motors—Various types of motors compared—Distribution of electric current—Electric meters—Fuses and circuit breakers—Switches and rheostats—Method of connecting motors—The electric motor on the farm—The farm electric light plant—Installation of electric motors and generators—Starting and stopping motors—Starting and stopping generators—Care of motors and generators—Problems.	

CHAPTER XI

ANIMAL MOTORS	272
The horse—Selection of a draft horse—Capacity and power of draft animals—Selection of feed for the horse—The mule—The ox—Cost of animal power—Problems.	

CHAPTER XII

MECHANICAL TRANSMISSION OF POWER	278
Belts—Leather belts—Rubber belts—Canvas belts—Care of belts—Method of lacing belts—Pulleys—Method of calculating sizes of pulleys—Quarter-turn belt—Chain drives—Rope transmission—Friction gearing—Toothed gearing—Shafting—Problems.	

INDEX	293
-----------------	-----

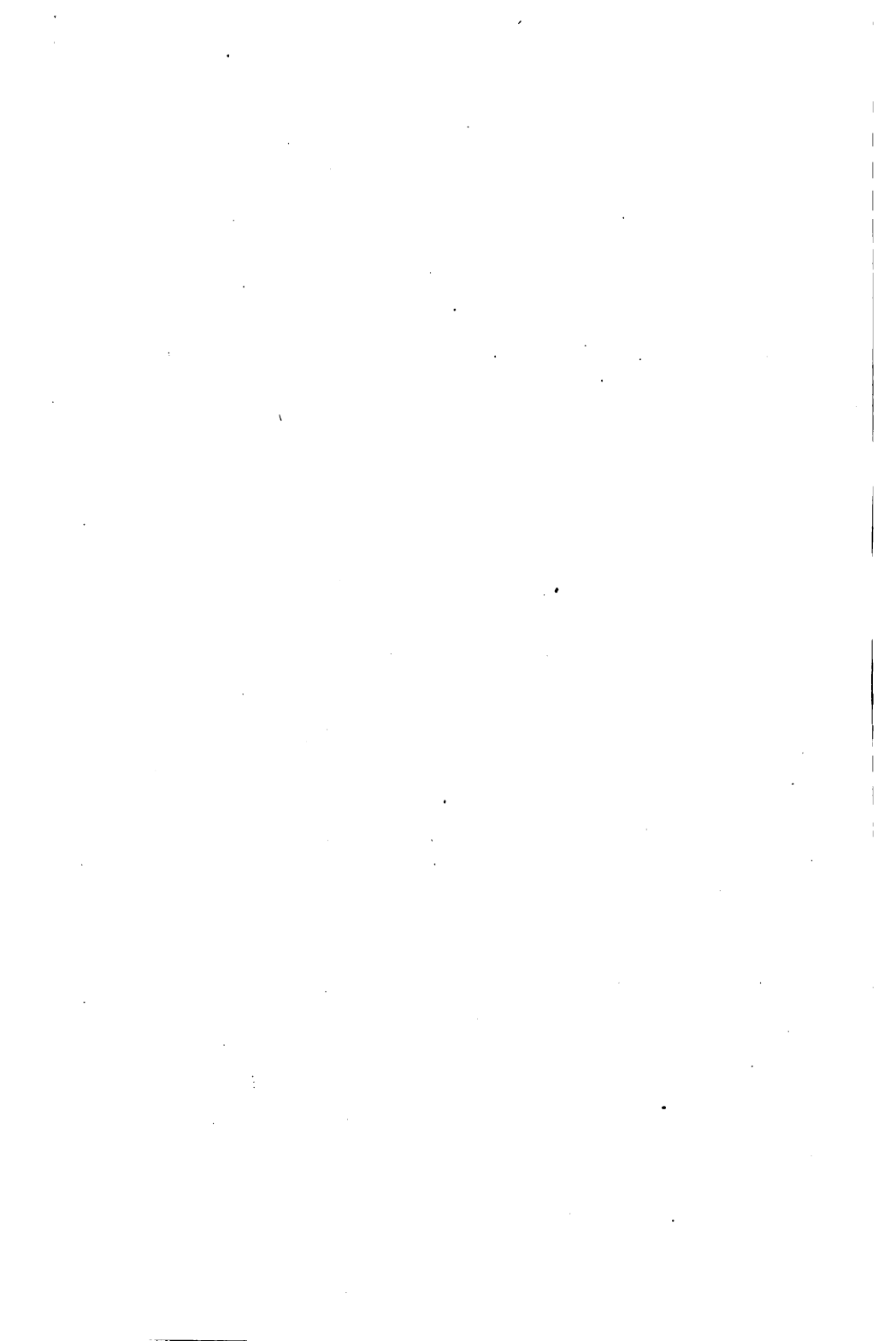

FARM MOTORS

CHAPTER I

FARM MOTORS IN GENERAL

A motor is an apparatus capable of doing work. Not considering animal motors, which include men, horses and other animals, the mechanical motors available for farm use are: heat engines, including steam, gas, oil, hot-air and solar engines; pressure engines such as waterwheels and water motors; windmills; electric motors.

Sources of Energy.—The principal source of all energy is the sun. It causes the growth of plants which furnish food for man and animals. The great coal deposits are only the result of the storing up of the sun's rays in plants in bygone days. These rays are also responsible for the raising of water from sea level to mountain top, thus giving it energy which can be utilized to turn waterwheels and made to do useful work.

On the other hand, while the sun's rays are the fundamental sources of all energy, they can be utilized directly by man only to a very limited extent. The secondary sources of energy are the wind, waterfalls, carbon in different forms, such as coal, petroleum, or gas, and chemicals used in electric batteries.

Principles Governing the Action of Various Mechanical Motors.—All mechanical motors do work by virtue of motion given to a piston, to blades on a wheel, or to an armature by some substance such as water, steam, gas, air, or electricity. The first requirement is that the above-mentioned substance, often called the working substance, be under considerable pressure.

This pressure in the case of the water motor or waterwheel is obtained by collecting water in dams and tanks, or by utilizing the kinetic energy of natural waterfalls. The total power available in water when in motion depends on the weight of water discharged in a given time, and on the head or distance through

which the water is allowed to fall. The head of water can be utilized by its weight or pressure acting directly on a piston or on blades or paddles on wheels.

Considering next the various forms of heat engines, work is accomplished by steam or gas under pressure, this pressure being obtained by utilizing the heat of some fuel or of the rays of the sun.

A motor utilizing the heat of the sun is called a solar motor or a solar engine. The action of this type of motor depends on the vaporization of water into steam by means of the rays of the sun, which are concentrated and intensified by means of reflecting surfaces.

In the case of the steam engine a fuel, like coal, oil, or gas, is burned in a furnace and its heat of combustion is utilized in changing water into steam, at high pressure, in a special vessel called a boiler. This high-pressure steam is then conveyed by pipes to the engine cylinder where its energy is expended in pushing a piston as in the case of the reciprocating engine. The sliding motion of the piston may be changed into rotary motion at the shaft by the interposition of a connecting rod and crank. Another method is to allow the high-pressure steam to escape through a nozzle, strike blades on a wheel and produce rotary motion direct, as in the case of the steam turbine.

In another type of heat engine, called a hot-air engine, air is heated in a cylinder by a fuel which is burned outside of the engine cylinder, and by its expansion drives a piston and thus does work.

In the case of gas and oil engines the fuel, which must be in a gaseous form as it enters the engine cylinder, is mixed with air in the proper proportions to form an explosive mixture. It is then compressed and ignited within the cylinder of the engine, the high pressures produced by the explosion pushing on a piston and doing work. These engines belong to a class called internal-combustion engines, and differ from the steam and hot-air engines, which are sometimes called external-combustion engines, in that the fuel with air is burned inside the engine cylinder, instead of in an auxiliary apparatus.

The windmill derives its high pressure for doing work from the moving atmosphere.

The electric motor converts electrical energy at high pressure into work; this electrical pressure or voltage is produced in an apparatus called an electrical dynamo, or generator.

Animal Motors.—The animal can be considered as a motor to which fuel is supplied in the form of food. This food furnishes energy required for the operation and maintenance of the various organs and processes within the animal body, as well as for the production of mechanical work. The animal body is, in fact, a combination of complex mechanisms, in every one of which heat is produced and work is performed.

Comparison of Various Types of Motors.—The solar motor is but little used on account of its high first cost and great bulk in relation to the small power developed.

In localities where the wind is abundant and little power is needed, the windmill is the most desirable and cheapest power. The greatest application of windmills is for the pumping of water for residences and farms, and for such other work as does not suffer from suspension during calm weather. Electric storage and lighting on a small scale from the power of a windmill has been tried in several places with fair success, but probably will not be adapted to any great extent on account of the high first cost of such an installation.

The water motor or water turbine is very economical if a plentiful supply of water can be had at a fairly high head, but its reliability is affected by drought, floods and ice in the water supply.

The hot-air engine, while not economical in fuel consumption, is well-adapted for pumping water in places where the cost of fuel is not an important item and where safety and simplicity of mechanism are essential. The hot-air engine, on account of its high cost, bulk and poor fuel economy, has been largely superseded by the oil engine, which uses gasoline or the heavier oils.

Of the other forms of heat engines, the internal-combustion engine, whether using gas or oil, is well-adapted for small and medium-sized powers, such as for farm use and irrigation work. The oil traction engine has also a very important field on the modern farm.

For the generation of electricity, and in large sizes, the steam engines or steam turbines will be found more suitable on account

of their lower first cost and great reliability. The steam engine is also used successfully on large traction engines.

If a source of electric current is available at a low price, the electric motor is very desirable, as it requires little care and can be bought in sizes to suit all requirements.

Of the animal motors, the horse is the most important. Unlike mechanical motors, the horse is self-feeding, self-reproducing and self-maintaining. For very short intervals, animal motors are capable of considerable overload capacity, but are expensive, require constant care and can work effectively only for short periods of time. With animal motors, the amount of power under the control of one man is much less than in the case of mechanical motors. The mechanical motor requires fuel only when actively at work, while the animal motor requires feed at regular intervals whether working or not.

Power Used on Farms.—About 25 million horses and mules are available for power purposes on the farms of the United States. This represents available animal power to the amount of about 16 million horsepower. The power available in mechanical farm motors will probably exceed 10 million horsepower. The total amount of power used on farms thus represents more than 25 million horsepower, or the power which is available on farms is about one-third greater than the total amount of power used by all the manufacturing industries of this country.

Comparative Cost of Power with Various Motors.—Varying character and prices of both feed for animal motors and fuel for mechanical motors will affect the cost of power in different localities. Ordinarily, the power produced by animal motors is more expensive than that developed by the use of mechanical motors. Experiments indicate that with the horse as a motor, the cost of power per horsepower per hour will vary from 5 to $6\frac{1}{2}$ cts. With stationary gasoline engines, the cost of power will vary from $1\frac{1}{2}$ to $2\frac{1}{2}$ cts. per horsepower per hour; with kerosene fuel, from $\frac{3}{4}$ to 1 ct.; with fuel oil, less than 1 ct. per horsepower per hour. With steam engines a horsepower per hour can usually be produced for about 1 ct.

Problems: Chapter I

1. What is a motor? Name four types of mechanical motors.
2. Name the principal source of all energy. Explain in detail.

3. What are the fundamental principles which govern the action of various mechanical motors? Illustrate how the principle is applied in the case of waterwheels, steam engines, gas engines, windmills, electric motors.

4. Compare various types of mechanical motors as to their adaptability for use on the farm.

5. Discuss the relative advantages and disadvantages of mechanical motors and of animal motors.

6. How does the power available on American farms compare with the power used in the manufacturing industries of this country?

CHAPTER II

FUNDAMENTAL PRINCIPLES AND DEFINITIONS

Before a study is made of any motor, the fundamental conceptions of physics regarding states of matter, work, power and heat are essential.

Matter.—Matter is that which occupies space and, when limited in amount, it is called a body. Matter in any form consists of a great many small particles, called molecules, the relative position of which determines the state in which a substance exists.

States of Matter.—Matter exists in the solid, liquid and gaseous states.

In the case of the solid the relative positions of the molecules are fixed. A solid having a certain shape or form, whether due to natural or artificial causes, will retain that form, unless and until it is made to change the same by some external cause.

In the liquid, the relative positions of the various molecules are not fixed. The shape or form of a liquid depends, therefore, on the solid walls surrounding it, a liquid assuming the form of any vessel in which it may be placed.

In the case of a gas the various molecules struggle to occupy greater space. A gas can be greatly compressed by an external force, and will expand to a considerable extent, if it is given perfect freedom.

Motion.—Motion means change of place. If a definite amount of matter, called a body, is removed from one place to another, motion is produced.

Force and Pressure.—Anything which produces or tends to produce, modifies or tends to modify motion is called force. Force is measured in pounds. Pressure is the intensity of force and is equal to the total force divided by the area over which it acts. For example, a force of 1,000 lb. acting on a body whose dimensions are 5 by 2 in., will produce a pressure or intensity of force equal to the force divided by the area of the body in square inches, or $\frac{1,000}{10} = 100$ lb. In English and American prac-

tice, pressure is always expressed in pounds per square inch. Thus when a steam gage on a boiler is registering 80 lb., this means that the steam is capable of transmitting a force of 80 lb. for every square inch on which it acts. If it is allowed to act on a 12-in. piston, the area of which is 113.1 sq. in., the total force exerted on the piston is 80 times 113.1 or 9,048 lb.

The pressure exerted by the atmosphere is called barometric pressure. The barometric pressure is 14.7 lb. per square inch at sea level and decreases as the altitude, or the height of the surface of the earth above sea level, increases. For each 2,000 ft. in elevation the pressure of the atmosphere is decreased by about 1 lb. The barometric pressure plus gage pressure equals absolute pressure.

Work, Energy and Power.—Work means force times distance through which it acts and is independent of time. If a body of 1 lb. is raised through a distance of 1 ft., the resulting work is 1 ft.-lb.

The capacity for doing work is called energy. Energy existing in a body at rest, as in the case of the raised weight, is called potential energy. Energy possessed by a body when in motion is called kinetic energy.

As an illustration, a cubic foot of water, weighing 62.5 lb. when at rest at a height of 100 ft., has potential energy of 6,250 ft.-lb. and this potential energy is changed into kinetic energy of work when the water is allowed to fall through that height. The water in the above example when allowed to fall through 10 ft. will be capable, on account of its kinetic energy, to do 625 ft.-lb. of work and will have a potential energy of 6,250 - 625, or 5,625 ft.-lb. when it comes again to rest.

Power takes into consideration the time required to do a certain amount of work and is defined as the rate of doing work. Thus if steam at a pressure of 100 lb. moves a piston 18 in. in diameter through a distance of 2 ft., the work done is 100 times 508.92 (the area of the piston in inches multiplied by the distance in feet) or 50,892 ft.-lb. The power of the engine, however, depends on the time that the steam requires to move the piston through the given distance and, if the motion is accomplished in 1 sec., the power of the engine is five times greater than if 5 sec. were required.

Horsepower.—If work is done at the rate of 33,000 ft.-lb. per minute, 1 hp. is said to be exerted. This means that an engine will have a capacity of 1 hp. if it can do 550 ft.-lb. of work in a second, 33,000 ft.-lb. of work in a minute, or 1,980,000 ft.-lb. of work in an hour. To determine the horsepower developed by any motor or engine, it is necessary to find the foot-pounds of work which the motor or engine is doing in a minute and divide this by 33,000. In the example of the previous paragraph if the piston passes through the distance of 2 ft. in $\frac{1}{50}$ min., the power of the engine in horsepower is

$$\frac{25,446 \times 2}{33,000 \times \frac{1}{50}} = 77.1$$

It is important to remember that power takes into consideration work and time. All animals, including man, are able to produce more power for a short period of time, while mechanical motors, whether driven by water, wind, steam, gas, or electricity can exert, with proper care, the power for which they are designed for an indefinite length of time.

Indicated Horsepower.—The term “indicated horsepower” (i.hp.) is applied to the rate of doing work by steam or by a gas in the cylinder of an engine, and is obtained by means of a special instrument, called an indicator. One form of this type of instrument, the Crosby, is shown in section in Fig. 1. It consists essentially of a cylinder(4), which is placed in direct communication with the engine cylinder, and in which moves a piston(8) compressing a spring above it and raising the arm (16). At the end of the arm is a pencil(23) which records graphically the pressure of the steam in the engine cylinder on the revolving drum(24). This drum(24) is covered with paper and receives its motion from the engine crosshead. From the diagram drawn on the drum of the indicator, the average unbalanced pressure is determined, and the horsepower is calculated from this and from dimensions and speed of the engine.

As an illustration: Given the average unbalanced pressure of the steam on a 12-in. piston, as obtained by means of an indicator, and called the mean effective pressure, 40 lb. per square inch; then the total pressure exerted by the steam is

$$\text{Total pressure} = 40 \times 113.1 = 4,524 \text{ lb.}$$

If the stroke of the piston is 13 in., the work done in foot-pounds per stroke is

$$4,524 \times \frac{13}{12} = 4,901$$

If the engine speed is 250 r.p.m., the work per minute will be, if the engine is single acting,

$$4,901 \times 250 = 1,225,250 \text{ ft.-lb.}$$

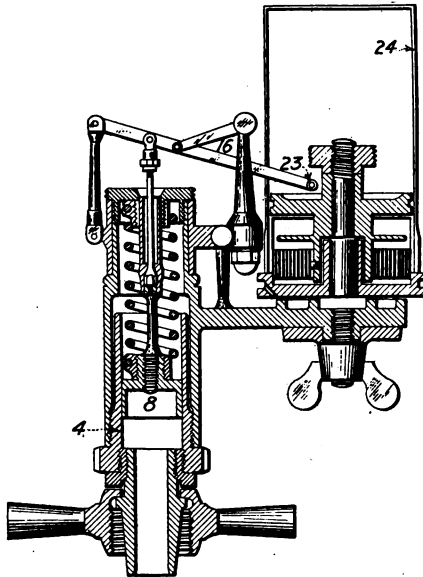

FIG. 1.—Steam engine indicator.

Since 33,000 ft.-lb. per minute is 1 hp., the power of the engine when single-acting is

$$\frac{1,225,250}{33,000} = 37.1 \text{ i.hp.}$$

As steam engines are usually double-acting, an indicator card would have to be taken of the crank end, the unbalanced or the mean effective pressure determined for that end and the indicated horsepower calculated by the above method, taking into consideration the size of the piston rod. The total indicated horsepower of the engine is the sum of that calculated for the two ends.

Brake Horsepower.—Brake horsepower represents the actual effective power which a motor or engine can deliver for the purpose of work at a shaft or a brake, or transmit to a belt for stationary work, such as threshing or the driving of machines. An instrument for the measurement of the brake horsepower of motors, and called a Prony brake, is shown in Fig. 2. This brake consists of two wooden blocks *BB* which fit around the pulley *P*

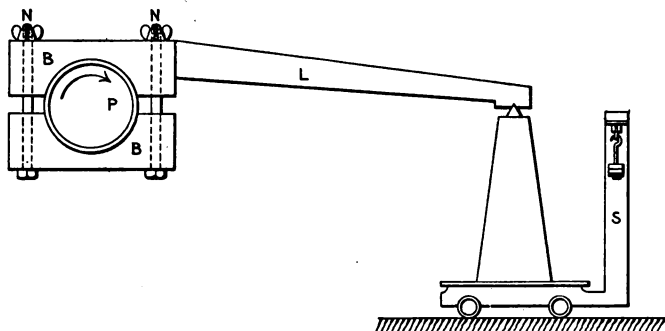

FIG. 2.—Prony brake.

and are tightened by means of the thumb nuts *NN*. A projection of one of the blocks, the lever *L*, rests on the platform scale *S*. When the brake is balanced, the power absorbed is measured by the weight as registered on the scales, multiplied by the distance it would pass through in that time if free to move. If *l* is the length of the brake arm in feet, *w* the weight as registered on the scales, in pounds, and *n* the revolutions per minute of the motor, the horsepower absorbed can be calculated by the formula

$$\text{Brake horsepower} = \frac{2\pi lwn}{33,000}$$

As an illustration, the scale reading of an engine running at 250 r.p.m. is 80 lb. If the length of the brake arm is $5\frac{1}{4}$ ft., calculate the brake horsepower developed.

$$\text{Brake horsepower} = \frac{2 \times 3.1416 \times 5.25 \times 80 \times 250}{33,000} = 20.00$$

Drawbar Horsepower.—The belt or the brake horsepower minus the power required to propel the weight of a traction engine

or power vehicle is called the drawbar horsepower. Ordinarily, a traction engine will require about 50 per cent. of the total power developed by its motor, to move the traction engine. This means that the drawbar horsepower, available for plowing or for pulling implements, is about one-half of the total power developed by the motor.

Nature of Heat.—Heat is a form of energy and not a material substance. The heat of a body depends on the vibratory motion of the particles or molecules of which the body is built up; the greater the rate of motion of these molecules the higher is the temperature of the body.

Temperature.—Temperature indicates the relative heats of bodies, or the relative rates of motion of the molecules in bodies. Temperature is not a measure of the amount or quantity of heat in a body. Thus a small and a large piece of metal may be heated to the same temperature, but the large piece would possess the greater quantity of heat. Temperature is an indication of the sensible heat of a substance, or the heat intensity which can be revealed to the senses of an observer.

Thermometers.—A thermometer is an instrument by means of which the temperature of a substance is measured. As usually constructed, it consists of a liquid such as mercury or alcohol inclosed in a bulb at one end of a thin glass tube, the temperature changes producing sufficient variations in the expansion of the liquid to be read off on a scale attached to, or graduated on, the glass tube.

Thermometers are graduated in three different ways, which are called the three thermometric scales, the type of scale depending on the number of graduations, or degrees ($^{\circ}$ denotes degree), between the melting-point of ice and the boiling-point of water.

The scale mostly used in English-speaking countries is the Fahrenheit (F.). In this case the melting-point of ice is taken at 32° and the boiling-point of water at 212° . Thus the Fahrenheit degree ($^{\circ}\text{F.}$) is $\frac{1}{180}$ of the interval between the two fixed points.

In scientific work the Centigrade scale is used in most countries. The Centigrade degree is $\frac{1}{100}$ of the temperature interval between the melting-point of ice and the boiling-point of water, these two fixed points being denoted 0°C. and 100°C. respectively.

Another scale, used only to a limited extent in certain countries of Europe is the Reaumur scale, which has the melting-point of ice at 0°R. and the boiling-point of water at 80°R.

The relations existing between the thermometric scales mostly used, *i.e.*, the Fahrenheit (F.) and the Centigrade (C.), can be expressed:

$$\text{degrees C.} = \frac{5}{9} (\text{degrees F.} - 32)$$

$$\text{degrees F.} = \frac{9}{5} \text{degrees C.} + 32$$

Example: Convert 15°C. to the Fahrenheit scale and 400°F. to the Centigrade scale.

$$\text{degrees F.} = \frac{9}{5} \times \text{degrees C.} + 32$$

$$= \frac{9}{5} \times 15 + 32$$

$$= 27 + 32 = 59^\circ\text{F.}$$

$$\text{degrees C.} = \frac{5}{9} (\text{degrees F.} - 32)$$

$$= \frac{5}{9} (400 - 32)$$

$$= 204^\circ\text{C.}$$

Table 1 can be used for converting Centigrade into Fahrenheit degrees and conversely.

Units of Heat.—Heat is measured in heat units. A heat unit is the amount of heat required to raise the temperature of 1 lb. of water 1°. The heat unit used in English-speaking countries is the British thermal unit (B.t.u.). The B.t.u. is defined as the amount of heat required to raise 1 lb. of water from 62°F. to 63°F.

When a certain illuminating gas is said to contain 600 B.t.u., this means that each cubic foot of the gas is capable of raising the temperature of 10 lb. of water through 60°F., or that it will raise the temperature of water so that the product of the weight of water and temperature rise (in °F.) is 600.

Mechanical Equivalent of Heat.—It has been proven experimentally that heat and work are mutually convertible. It requires 778 ft.-lb. of work to produce 1 B.t.u.; and similarly 1 B.t.u. will produce 778 ft.-lb. of work, if all the heat is converted into work. The number 778 is called the mechanical equivalent of heat. It is due to the fact that heat can be converted into work that the various heat engines, including the steam, gas and oil engines, are possible.

Specific Heat.—As the addition of the same quantity of heat will not produce the same temperature changes in equal weights

TABLE 1.—RELATION BETWEEN THE FAHRENHEIT AND CENTIGRADE THERMOMETRIC SCALES

Fahr.	Cent.	Fahr.	Cent.
-30	-34.4	210	98.9
-20	-28.9	212	100.0
-10	-23.3	220	104.4
0	-17.8	230	110.0
+10	-12.2	240	119.6
20	- 6.7	250	121.1
30	- 1.1	260	126.7
32	0.0	270	132.2
40	+ 4.4	280	137.8
50	10.0	290	143.3
60	15.6	300	148.9
70	21.1	310	154.4
80	26.7	320	160.0
90	32.2	330	165.6
100	37.8	340	171.1
110	43.3	350	176.7
120	48.9	360	182.2
130	54.4	370	187.8
140	60.0	380	193.3
150	65.6	390	198.9
160	71.1	400	204.4
170	76.7	410	210.0
180	82.2	420	215.6
190	87.8	430	221.1
200	93.3	440	226.7

of different substances, it is evident that the amount of heat which can be taken in or given out by any substance depends on the capacity of that substance for heat. The capacity of a substance for heat, or the resistance which a substance offers to a change in its temperature, is called its specific heat. The specific heat of water is taken as the standard and equal to one.

Specific Gravity.—By specific gravity is meant the relation existing between the weight of any substance and the weight of an equal volume or bulk of water. Thus the specific gravity of cast iron is about 7, which means that a cubic foot of iron is seven times heavier than a cubic foot of water. In Table 2 are given the specific heats and specific gravities of common substances.

TABLE 2.—SPECIFIC HEATS AND SPECIFIC GRAVITIES OF COMMON SUBSTANCES

Name of substance	Specific heat (average)	Specific gravity (average)
Solids		
Iron, cast.....	0.1298	7.2100
Iron, wrought.....	0.1138	7.7000
Steel.....	0.1170	7.8000
Lead.....	0.0314	11.4000
Copper.....	0.0951	8.9000
Glass.....	0.1700	2.6000
Ice.....	0.5040	0.9000
Stone.....	0.2100	2.7500
Brickwork, masonry.....	0.2000	2.0000
Liquids		
Water.....	1.0000	1.0000
Kerosene.....	0.4750	0.8100
Gasoline.....	0.5350	0.6900
Alcohol, ethyl.....	0.5500	0.7900
Alcohol, methyl.....	0.5900	0.8080
Ammonia.....	0.9500
Vegetable oil.....	0.4000	0.9000
Gases		
Air.....	0.2375	1.0000
Oxygen.....	0.2175	1.1052
Hydrogen.....	3.4090	0.0692
Nitrogen.....	0.2438	0.9701
Ammonia.....	0.5080	0.5889

Problems: Chapter II

1. Calculate the work done by a pump when lifting 100 gal. of water to a height of 125 ft.
2. The pressure of steam on the piston of an engine is 30 lb. per square inch. If the diameter of the piston is 18 in., its stroke 2 ft., how much work does the engine do per hour if its speed is 110 r.p.m.?
3. Calculate the horsepower of the engine in the above problem.
4. Why will two horses be able to draw a heavy load up a hill when a 40-hp. automobile will be unable to do so? Explain the reason in detail.
5. Calculate the horsepower of a traction engine required to draw a plow at the rate of 2 miles per hour if the pull on the drawbar is 15,000 lb.
6. Convert the following readings in degrees Centigrade to the Fahrenheit scale:

- 18, - 2, 15, 53, 78.

7. Convert the following readings of the Fahrenheit scale to degrees Centigrade:

– 20, 10, 60, 80, 220, 350.

8. A pound of gasoline will yield, when completely burned, 19,200 heat units; calculate the foot-pounds of energy contained.

9. Calculate the heat required to raise the temperature of 1 lb. of cast iron, of copper, of glass, of stone and of water through 100°F.

10. Calculate and compare the weights of a gallon of kerosene, of gasoline, of ethyl alcohol, of ammonia and of water.

11. Calculate the indicated horsepower of an engine having the following dimensions:

Diameter of cylinder.....	16 in.
Diameter of piston rod.....	2½ in.
Stroke.....	24 in.
Revolutions per minute.....	120
Mean effective pressure, head end.....	52.3
Mean effective pressure, crank end.....	52.0

12. A gasoline engine running at 300 r.p.m. is tested by means of a Prony brake. If the length of the brake arm is 42 in. and the net weight as registered on the platform scales is 35 lb., calculate the brake horsepower developed by the engine.

CHAPTER III

STEAM GENERATION AND STEAM BOILERS

Theory of Steam Generation.—If heat is added to ice, the effect will be to raise its temperature until the thermometer indicates 32°F. When this point is reached, a further addition of heat does not produce an increase in temperature until all the ice is changed into water, or in other words the ice melts. It has been found experimentally that 144 B.t.u. are required to change 1 lb. of ice into water. This quantity is called the latent heat of liquefaction of ice.

After the quantity of ice given, which for simplicity may be taken as 1 lb., has all been turned into water, it will be found that if more heat is added the temperature of the water will again increase, though not as rapidly as did that of the ice. While the addition of each British thermal unit increases the temperature of ice 2°F., in the case of water an increase of only about 1° will be noticed for each British thermal unit of heat added. This difference is due to the fact that the specific heat, or resistance offered by ice to a change in temperature is one-half that offered by water. That is, the specific heat of ice is 0.5.

If the water is heated in a vessel open to the atmosphere, its temperature will keep on going up until about 212°F., the boiling-point of water, when further addition of heat will not produce any temperature changes, but steam will issue from the vessel. It has been found that about 970 B.t.u. will be required to change 1 lb. of water at atmospheric pressure and at 212°F. into steam. The quantity of heat so supplied which changes the physical state of water from the liquid state to steam is called the latent heat of vaporization.

If the above operations are performed in a closed vessel, water will boil at a higher temperature than 212°F., since the steam driven off cannot escape and is compressed, raising the pressure and consequently the temperature. The latter is the condition in an ordinary steam boiler.

That the boiling-point of water depends on the pressure is well known. Thus in a place in Colorado where the altitude is 6,000 ft. above sea level and the barometric pressure is 12.6 lb. per square inch the boiling-point of water is about 204°F. as compared with 212°F. at sea level where the barometric pressure is 14.7 lb. per square inch.

As the pressure is increased to 60 lb. per square inch by the gage, it will be found that the boiling-point of water is 275°F. At 100 lb. per square inch water will boil at 317°F. and at 150 lb. the temperature will read 350.5°F. before steam will be formed.

Steam is spoken of as being in three conditions:

1. Wet.
2. Dry.
3. Superheated.

In the first case the steam carries with it a certain amount of water which has not been evaporated. The percentage of this water determines the condition of the steam; that is, if there is 3 per cent., by weight, of moisture, the steam is spoken of as being 97 per cent. dry. A stationary boiler, properly erected and operated and of suitable size, should generate steam that is 98 per cent. dry. If there is more than 3 per cent. moisture, there is every reason to believe that the boiler is improperly installed, inefficiently operated, or is too small for the work to be done.

In the second condition, that of dry steam, the vapor carries with it no water that has not been evaporated; that is, it is dry. Any loss of heat, however small, not accompanied by a corresponding reduction in pressure, will cause condensation, and wet steam will be the result. Steam, whether wet or dry, has a definite temperature corresponding to its pressure.

An increase in temperature not accompanied by an increase in pressure will cause the steam to acquire a condition that will permit a loss of heat at constant pressure without condensation necessarily following. This third condition is called superheat. The advantage of superheated steam lies in the fact that its temperature may be reduced by the amount of the superheat without causing condensation. This makes it possible to transmit the steam through mains and still have it dry and saturated at the time it reaches the engine cylinder. Superheated steam may be secured by passing saturated steam through coils of pipe

in the path of the hot flue gases from the boiler to the chimney. An apparatus for superheating steam is called a superheater.

The pressure of steam will remain constant if it is used as fast as it is generated. If an engine uses steam too rapidly the boiler pressure will drop and similarly if the fuel is burned at a constant rate and an insufficient amount of steam is used the pressure of the steam in the boiler will increase.

In Table 3 are given some of the most important properties of saturated steam, which include:

1. Pressure of steam in pounds per square inch absolute.

TABLE 3.—PROPERTIES OF SATURATED STEAM
English Units

Abs. pressure, pounds per sq. in.	Vaporization temperature, degrees F.	Heat of the liquid	Latent heat of evaporation	Total heat of steam	Specific volume, cubic feet per lb.	Density, pounds per cu. ft.	Abs. pressure, pounds per sq. in.
1	101.8	69.8	1,034.6	1,104.4	333.00	0.00300	1
2	126.1	94.1	1,021.4	1,115.5	173.30	0.00577	2
3	141.5	109.5	1,012.3	1,121.8	118.50	0.00845	3
4	153.0	120.9	1,005.6	1,126.5	90.50	0.01106	4
5	162.3	130.2	1,000.2	1,130.4	73.33	0.01364	5
6	170.1	138.0	995.7	1,133.7	61.89	0.01616	6
7	176.8	144.8	991.6	1,136.4	53.58	0.01867	7
8	182.9	150.8	988.0	1,138.8	47.27	0.02115	8
9	188.3	156.3	984.8	1,141.1	42.36	0.02361	9
10	193.2	161.2	981.7	1,142.9	38.38	0.02606	10
14.7	212.0	180.1	970.0	1,150.1	26.79	0.03733	14.7
20	228.0	196.2	959.7	1,155.9	20.08	0.04980	20
30	250.3	218.9	944.8	1,163.7	13.74	0.07280	30
40	267.3	236.2	933.0	1,169.2	10.49	0.09530	40
50	281.0	250.2	923.2	1,173.4	8.51	0.11750	50
60	292.7	262.2	914.6	1,176.8	7.17	0.13940	60
70	302.9	272.7	906.9	1,179.6	6.20	0.16120	70
80	312.0	282.1	900.1	1,182.2	5.47	0.18290	80
90	320.3	290.6	893.7	1,184.3	4.89	0.20450	90
100	327.8	298.4	887.8	1,186.2	4.430	0.22570	100
125	344.4	315.5	874.6	1,190.1	3.582	0.27920	125
150	358.5	330.1	863.1	1,193.2	3.013	0.33190	150
200	381.9	354.6	843.3	1,197.9	2.289	0.43700	200
250	401.1	374.7	826.6	1,201.3	1.848	0.54100	250
300	417.5	392.0	811.8	1,203.8	1.547	0.64700	300

2. Temperatures of steam in degrees Fahrenheit. This column of temperatures shows the vaporization temperature at each of the given pressures.

3. Heat of the liquid, or the heat required to bring up a pound of water from freezing-point to boiling-point.

4. The latent heat, or the heat required to vaporize a pound of water at the given pressure after boiling-point is reached.

5. The volume of 1 lb. of steam at the various pressures.

6. Density of steam in pounds per cubic foot.

Fuels.—The fuels most commonly used for steam generation are coal, wood, petroleum oils and natural gas. The combustible, or heat-producing, constituents of all fuels are carbon and hydrogen. A fuel containing much sulphur should be avoided for steam generation on account of the injurious sulphurous acid formed when the fuel is burned.

Wood is but little used for steam generation except in remote places, where timber is plentiful or in special cases where sawdust, shavings and pieces of wood are by-products of manufacturing operations. Wood burns rapidly and with a bright flame, but does not evolve much heat. When first cut, wood contains 30 to 50 per cent. of moisture, which can be reduced by drying to about 15 per cent. One pound of dry wood is equal in heat-producing value to $\frac{4}{10}$ lb. of soft coal. It is important that wood be dry, as each 10 per cent. of moisture reduces its heat-producing value as a fuel by about 12 per cent.

Coal is more extensively used as a fuel for steam generation than any other substance. All coals are derived from vegetable origin and are classified as follows:

1. Anthracite, or hard coal, consisting mainly of carbon. This coal is slow to ignite, burns with very little flame, produces and gives off very little smoke. Anthracite coal contains very little volatile matter and may contain none.

2. Semianthracite coal is softer and lighter than anthracite, and contains less carbon and from 7 to 12 per cent. volatile matter.

3. Semibituminous, which contains from 12 to 25 per cent. volatile matter and less fixed carbon than the semianthracite.

4. Bituminous, or soft, coal contains more than 20 per cent. of volatile matter and only about 50 per cent. of fixed carbon.

5. Lignite, which may be classified as soft coal arrested in the

process of formation. This coal contains a very large proportion of volatile matter and less than 50 per cent. fixed carbon. However, it has a good heating value and is usually a free burner, but owing to the high percentage of volatile matter it will not stand storage, but crumbles badly soon after exposure to air.

Other solid fuels used to some extent for steam generation are: Peat, which is an intermediate between wood and coal and found in bogs; sawdust, oak bark after it has been used in the process of tanning, bagasse or the refuse of cane sugar, and cotton stalks. Coke is also used to some extent, the advantage of this fuel as compared with coal being that coke will not ignite spontaneously, will not deteriorate or decompose when exposed to the atmosphere, and produces no smoke when burned. Coke is manufactured by burning coal in a limited air supply, the volatile hydrocarbons being driven off during the process.

Petroleum fuels, either in the form of crude petroleum or as the refuse left from its distillation, are used for making steam to a considerable extent in certain parts where the relative cost of oil is less than that of coal. It has been estimated that petroleum oils at 2 cts. per gallon are equally economical for steam making as coal at \$3 per ton. The advantages of oil as compared with solid fuels are ease of handling, cleanliness and absence of smoke after combustion.

Natural gas is used for steam generation where its cost is low. If the cost of natural gas is greater than 10 cts. per 1,000 cu. ft. it cannot compete with coal at \$3 a ton. Illuminating gas is too expensive for steam generation and cannot compete with other fuels.

Combustion.—Combustion is a chemical combination of the heat-producing constituents of a fuel with oxygen and is accompanied by the production of heat and light. The supply of oxygen for combustion is taken from the atmosphere, every pound of air consisting of 0.23 part by weight of oxygen and 0.77 part by weight of nitrogen.

It has been found that most coals require between 11 and 12 lb. of air for every pound of coal burned and that the heat developed during the combustion of 1 lb. of the various fuels is as follows:

TABLE 4.—HEAT DEVELOPED BY THE COMBUSTION OF VARIOUS FUELS

Name of fuel	Heat developed in B.t.u. per pound of fuel	Heat developed in B.t.u. per cubic foot of fuel
Anthracite coal.....	13,200 to 13,900	
Semibituminous coal.....	13,000 to 16,000	
Bituminous coal.....	12,000 to 15,000	
Lignite.....	8,500 to 11,400	
Peat (dry).....	8,000 to 11,000	
Wood.....	8,200 to 9,200	
Petroleum fuels.....	18,000 to 20,000	
Kerosene.....	18,550	
Gasoline.....	19,000	
Alcohol (100 per cent.).....	11,500	
Natural gas.....	900 to 1,000
Illuminating gas.....	600 to 700
Producer gas.....	100 to 150

Commercial Value of Fuels.—In the furnace of the actual boiler plant only 30 to 70 per cent. of the heat units contained in the given fuel is utilized for the generation of steam. The principal losses in the boiler furnace are due to incomplete combustion, infiltration of air through setting, and to the heat carried away in the flue gases. The methods to be employed in order to reduce these losses to a minimum will be discussed under boiler management.

STEAM BOILERS AND AUXILIARIES

Principal Parts of a Steam Power Plant.—The principal parts of a steam power plant are illustrated in Fig. 3, and include the following:

A furnace in which the fuel is burned. This consists of a chamber arranged with a grate(1), if coal or any other solid fuel is used, and with burners when the fuel is in the liquid or gaseous state. The furnace is connected through a flue or breeching (2) to a chimney. The function of a chimney is to produce sufficient draft, so that the fuel will have the proper amount of air for combustion; it also serves to carry off the obnoxious gases after the combustion process is completed. The flue leading to

the chimney is provided with a damper(3), so that the intensity of the draft can be regulated.

A boiler(4), which is a closed metallic vessel filled to about two-thirds of its volume with water. The heat developed by burning the fuel in the furnace is utilized in converting the water contained in the boiler into steam. The boiler(4) is arranged with a water column(5) to show the water level, with a safety valve(6) to prevent the pressure from rising too high, and with a gage(7) to indicate the steam pressure.

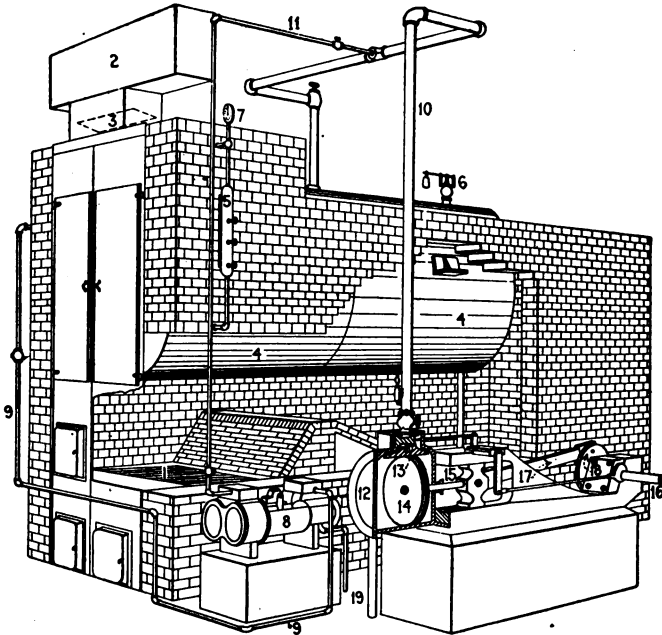

FIG. 3.—Steam power plant.

The function of a setting is to provide correct spaces for the furnace, combustion chamber and ashpit, to support the boiler shell, to prevent air from entering the furnace above the fuel bed, and to decrease the heat radiation to a minimum.

The feed pump(8) supplies the boiler with water through the feed pipe(9).

The steam lines(10) and(11) convey steam from the boiler to the engine and to the steam end of the pump respectively.

In the engine the energy of the steam is expended in doing work. The steam enters the engine cylinder(12) through the valve (13) and pushes on the piston(14). The sliding motion of the piston, which is transmitted to the piston rod(15), is changed into rotary motion at the shaft(16) by means of a connecting rod(17) and crank (18).

The exhaust pipe(19) conveys the used steam to the atmosphere, to the condenser, or to some use where its heat is abstracted, converting the steam back into water.

Classification of Boilers.—Boilers are divided into fire-tube and water-tube types. In the fire-tube the hot gases developed by the combustion of the fuel pass through the tubes, while in the water-tube boilers these gases pass around the tubes. Either type may be constructed as a vertical or as a horizontal boiler, depending on whether the axis of the shell is vertical or horizontal.

The fire-tube boiler may be externally or internally fired. In the externally fired boiler the furnace is in the brick setting entirely outside of the boiler shell, while in the internally fired types the furnace is in the boiler shell, no brick setting being necessary. For stationary work the externally fired boiler is most common, while the internally fired types are always used for locomotive and traction engine purposes and generally for marine use. Vertical fire-tube boilers are usually internally fired.

Return Tubular Boiler.—Boilers of this type are most commonly used in this country. The general appearance of a return tubular boiler is shown in Fig. 4. Fig 5 illustrates the details of the setting. The height of the boiler above the grate depends upon the fuel employed.

These boilers as seen from the cuts consist of a cylindrical shell closed at the end by two flat heads, and of numerous small tubes which extend the whole length of the shell. Two-thirds of the volume of the shell is filled with water, the remaining part being left for the disengagement of the steam from the water, and called the steam space. Sometimes, as shown in Fig. 6, a steam dome *D* is provided to increase the volume of the steam space. The coal burns upon the grates which, as shown in Fig. 5, rest upon the bridge-wall *W* and upon the front of the setting.

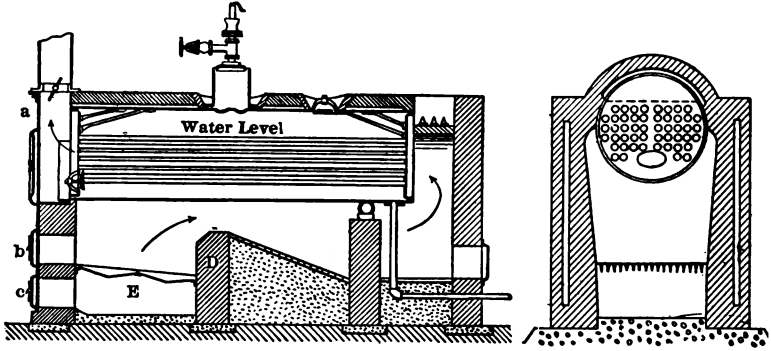

FIG. 4.—Return tubular boiler.

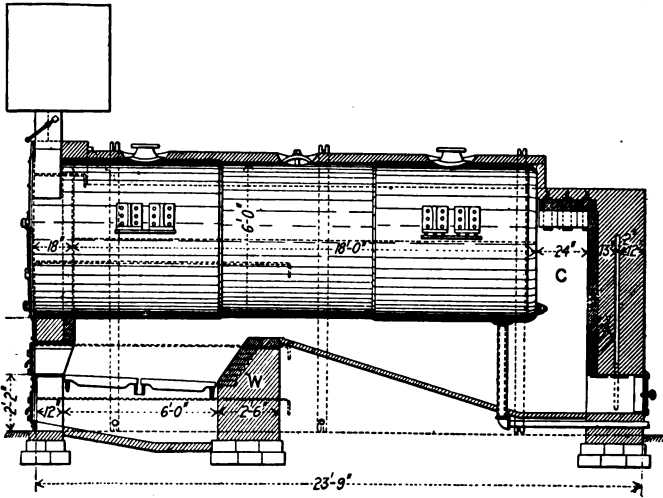

FIG. 5.—Details of boiler setting.

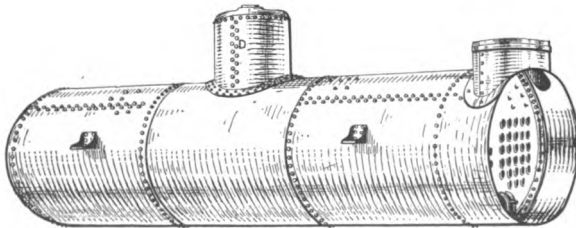

FIG. 6.—Boiler with dome.

The gases pass from the furnace under and along the boiler shell to the back connection or combustion chamber *C*, and from there to the front through the tubes and up the uptake to the breeching or flue which leads to the chimney.

Vertical Fire-tube Boilers.—Two forms of vertical boilers are shown in Figs. 7 and 8. In the form shown in Fig. 7 the tops

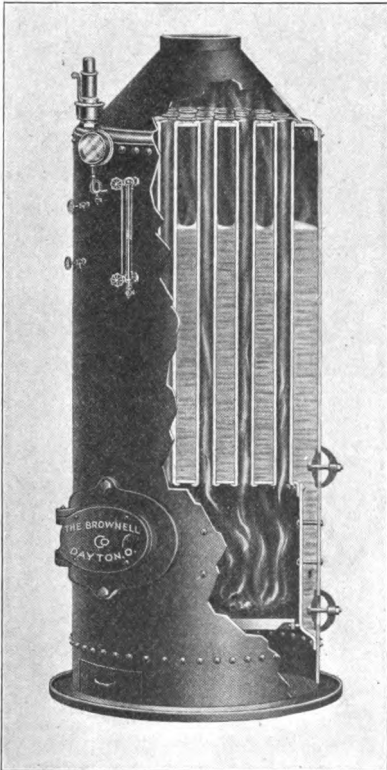

FIG. 7.—Vertical boiler.
Exposed tube type.

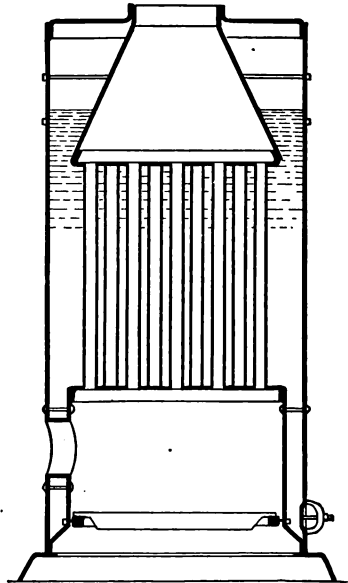

FIG. 8.—Vertical boiler.
Submerged tube type.

of the tubes are above the water line and may become overheated when the boiler is forced. To prevent injury from this cause, some forms of vertical boilers are constructed as shown in Fig. 8, the tops of the tubes being ended in a submerged tube-sheet which is kept below the water line.

The essential parts of all forms of vertical boilers are a cylin-

drical shell with a firebox and ashpit in the lower end. The tubes lead directly from the furnace to the upper head of the shell. The hot gases from the furnace pass through the tubes and out of the stack.

Vertical boilers occupy little floor space and require no setting or foundation. They can also be used as portable boilers.

Water-tube Boilers.—Water-tube boilers are used in large power plants on account of their adaptability to higher pressures and larger sizes, decreased danger from serious explosions, greater space economy, and rapidity of steam generation. For small power plants the fire-tube boiler is usually more suitable on account of its lower first cost. Also in a fire-tube boiler if a tube should break, the boiler can be repaired by plugging without interrupting service, which is not the case with most types of water-tube boilers. As far as economy is concerned, numerous tests show that either type when properly designed and operated will give the same economy.

There are many different types of water-tube boilers on the market, but the essential parts of all are tubes filled with water and one or more drums for the disengagement of the steam from the water.

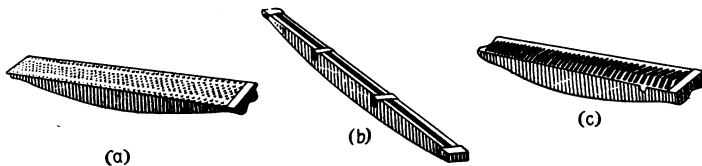

FIG. 9.—Grate bars.

Grates for Boiler Furnaces.—Grates are formed of cast-iron bars. Several forms of grate bars are illustrated in Figs. 9 and 10. Plain grates (b), Fig. 9, are best adapted for caking coals and are usually provided with iron bars cast in pairs and lugs at the side. The Tupper type of grate (c), Fig. 9, is more suitable for the burning of hard coal, which does not cake. The grates of a boiler furnace can be easily interchanged to suit the fuel burned. For most economical results some form of rocking and dumping grate, as shown in Fig. 10, should be used.

Piping for Boilers.—Pipes used for carrying steam are made of wrought iron or of steel. Wrought-iron pipe is superior to steel

pipe as far as durability is concerned, but is more expensive and more difficult to secure. Sizes of pipe are named by the inside diameter, while boiler tubes go by the outside diameter. Standard steam pipe is made in sizes of $\frac{1}{8}$, $\frac{1}{4}$, $\frac{3}{8}$, $\frac{1}{2}$, $\frac{3}{4}$, 1, $1\frac{1}{4}$, $1\frac{1}{2}$, 2, $2\frac{1}{2}$, 3, $3\frac{1}{2}$, 4, $4\frac{1}{2}$, 5, 6, 7, 8, 9, 10, 11 and 12 in. Sizes above 12 in. are named by the outside diameter.

The various grades of pipe are merchant, standard, extra heavy and double extra heavy. Merchant pipe is somewhat

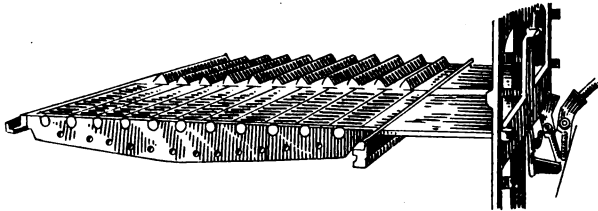

FIG. 10.—Dumping grate.

lighter than standard pipe and its manufacture is being discontinued. Extra heavy and double extra heavy have the same outside diameters as standard pipe, but the inside diameters are smaller, due to the greater thickness of the pipe.

Steam pipe lines should always be laid with a gradual inclination downward, so as to allow the condensation that occurs to flow in the direction in which the steam is moving. If this is not done water may accumulate, will be picked up by the steam and may cause much damage by water-hammer.

Pipe Fittings.—Fig. 11 illustrates several forms of pipe unions, which are used for uniting two lengths of pipe.

The elbow or ell shown in Fig. 12 is employed for connecting two pipes of the same size and at an angle to each other. If the pipes are of different diameters a reducing ell as shown in Fig. 13 should be used.

The tee shown in Fig. 14 is used for making a branch at right angles to a pipe line.

The cross shown in Fig. 15 is used when two branches must be made in opposite directions.

In order to reduce the size of a pipe line a bushing, Fig. 16, or a reducer, Fig. 17, can be used.

To close the end of a pipe a cap, Fig. 18, is used, while the plug

shown in Fig. 19 is used to close a pipe threaded on the inside or to close a fitting.

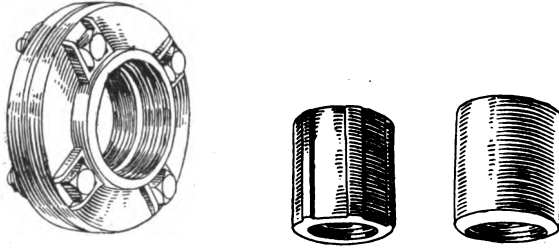

FIG. 11.—Pipe unions.

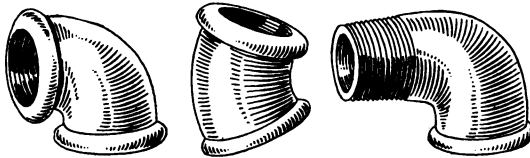

FIG. 12.—Ells.

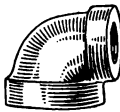

FIG. 13.—Reducing Ell.

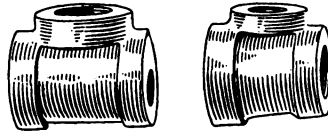

FIG. 14.—Tees.



FIG. 15.—Cross.

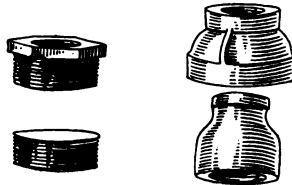

FIG. 16.—Bushing. FIG. 17.—Reducer.

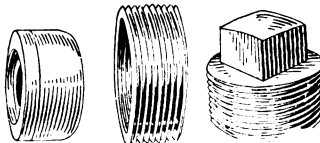

FIG. 18.—Cap. FIG. 19.—Plug.

Valves.—The function of a valve is to control and regulate the flow of water, steam, or gas in a pipe. In the globe valve in Fig.

20 the fluid usually enters at the right, passes under the valve and out at the left.

This method of installation places the pressure of the steam, or other fluid, against the disc in such a way that it tends to open the valve. The advantages claimed for this method are:

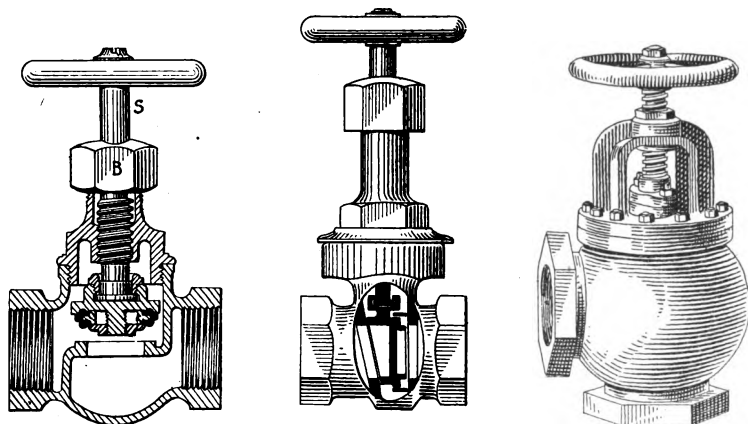

FIG. 20.—Globe valve. FIG. 21.—Gate valve. FIG. 22.—Angle valve

1. When the valve is closed the stem may be packed without cutting the steam pressure off the entire line.

2. The adjustment of the opening can be made more accurately against the steam pressure than with it.

3. The flow of steam tends to keep the valve seat free from scale and other dirt.

Those who favor the other method claim, as the principal advantage, that the pressure of the

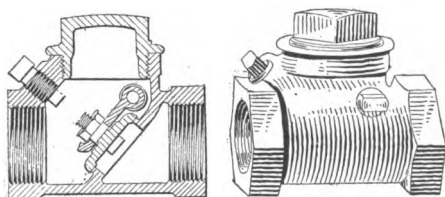

FIG. 23.—Check valve.

steam, when the valve is closed, tends to keep it in that position and that there is much less likelihood of the valve leaking. Both methods will be found in use, but it is probable that a large majority of the installations will be found to be in accordance with the first method.

A gate valve is shown in Fig. 21. This form of valve gives a

straight passage through the valve, and is preferable for most purposes to the globe valve.

Fig. 22 illustrates an angle valve which takes the place of an ordinary valve and ell.

The function of a check valve illustrated in Fig. 23 is to allow water or steam to pass in one direction but not in the other.

A boiler feed line should always be provided with a check valve and also with some form of globe or gate valve to enable the operator to examine and repair the check valve.

Safety Valves.—The function of a safety valve is to prevent the steam pressure from rising to a dangerous point. The two

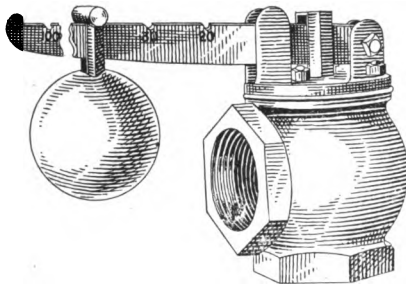

FIG. 24.—Lever safety valve.

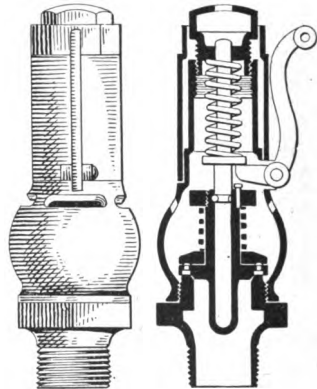

FIG. 25.—Pop safety valve.

common forms of safety valves are the lever safety valve and the spring or pop safety valve.

The lever safety valve shown in Fig. 24 consists of a valve disc which is held down on the valve seat by means of a weight acting through a lever, the steam pressing against the bottom of the disc. The lever is pivoted at one end to the valve casing and is marked at a number of points with the pressure at which the boiler will blow off if the weight is placed at that particular point.

The pop safety valve shown in Fig. 25 differs from the lever valve in that the valve disc is held on its seat and the steam pressure is resisted by a spring in place of a weight and lever. Pop safety valves can be adjusted to blow off at various pressures by tightening or loosening the spring pressure on the valve disc.

Steam Gages.—A steam gage indicates the pressure of the steam in a boiler. The most common form, shown in Fig. 26, consists of a curved spring tube closed at one end and filled

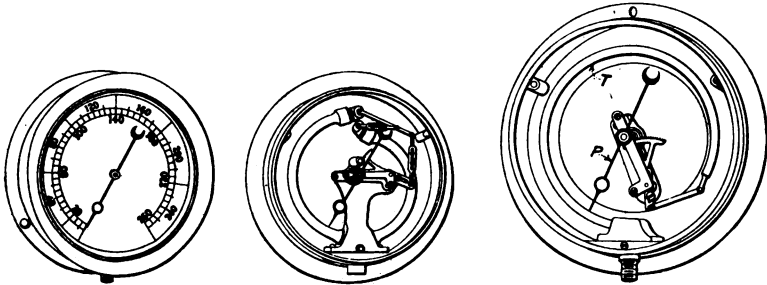

FIG. 26.—Steam gages.

with some liquid. One end of the tube is free, while the other is fastened to the fitting which is secured into the space where the pressure is to be measured. Pressure applied to the inside of the tube causes the free end to move. This motion is communicated by means of levers and small gears to the needle which moves over a graduated dial face, and records the pressure directly in pounds per square inch.

Water Glass and Gage Cocks.—The height of the water level in a boiler is indicated by a water glass, one end of which is connected to the steam space and the other end to the water space in the boiler. All boilers should also be provided with three gage cocks, one of which is set at the desired water level, one above it and one below. These are more reliable than the water glass and should be used for checking the glass.

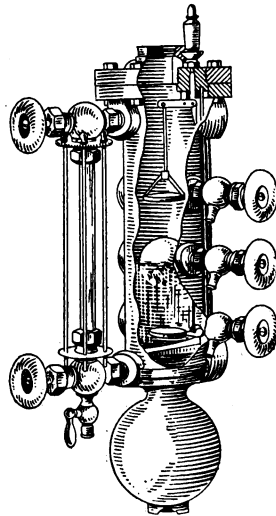

FIG. 27.—Water column.

Water Column.—The steam gage, water glass and gage cocks are usually fastened to a casting called a water column. One form of water column is shown in Fig. 27, this also being fitted

with a float and whistle to notify the operator should the water in the boiler become too low or too high. A fireman who takes proper care of the boilers in his charge will never allow the water to be at a height that will necessitate audible warning.

Steam Traps.—The object of a steam trap is to drain the water from pipe lines without allowing the steam to escape. One form

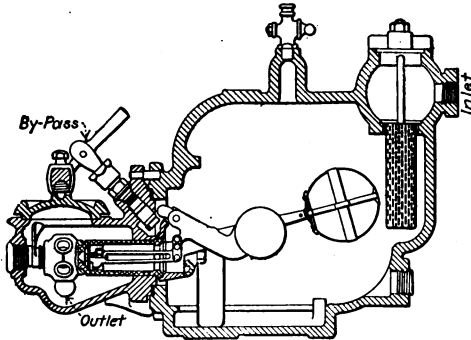

FIG. 28.—Steam trap.

of steam trap is shown in Fig. 28, the valve being controlled by a float when the water in the trap rises to a sufficient height.

Feed Pumps and Injectors.—Water is forced into steam boilers by pumps or injectors. A pump will handle water at any temperature,

while an injector can be used only when the water is cold. The injector is not as wasteful of steam as a pump and for feeding cold water to a boiler has the additional advantage, that it heats the water while feeding it to the boiler.

Feed pumps may be driven from the crosshead of an engine, as is often the case on traction engines. Such pumps are very simple, but can only supply water to the boiler when the engine is in operation.

Direct-acting steam pumps, driven by their own steam cylinders, are most commonly used for feeding stationary boilers, as they can be operated independently of the main engine and their speed can be regulated to suit the feed water demand of the boilers.

The details of construction of two forms of direct-acting pumps are shown in Figs. 29 and 30.

In the pump shown in Fig. 29, 1 is the steam cylinder and 2 is the water cylinder. The valve *E* is moved by the vibrating arm *F* and admits steam into the cylinder 1. If steam is admitted at the left of the piston *A*, the piston will be moved to the right, pushing the plunger *B*, driving the water through the

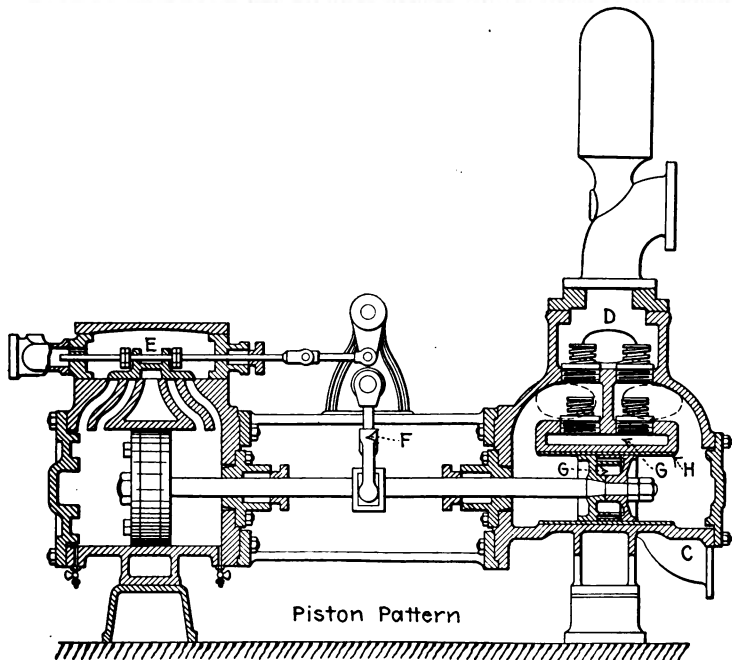
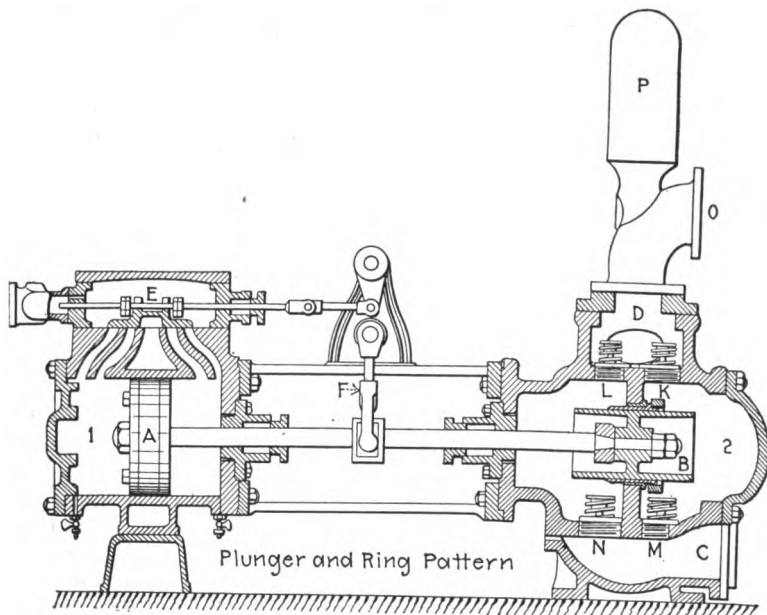

FIG. 29.—Boiler feed pumps.

water valve *K*, and into the feed line at *O*. While the plunger is moving to the right, a partial vacuum is formed at its left, which opens the valve *N* and draws the water from the supply at *C*. When the plunger *B* reaches the extreme position to the right, the vibrating arm *F* moves the valve *E* to the left, admitting steam which pushes the piston and plunger to the left, driving the water through the valve *L* and taking a new supply through *M*. The function of the air chamber *P* is to secure a

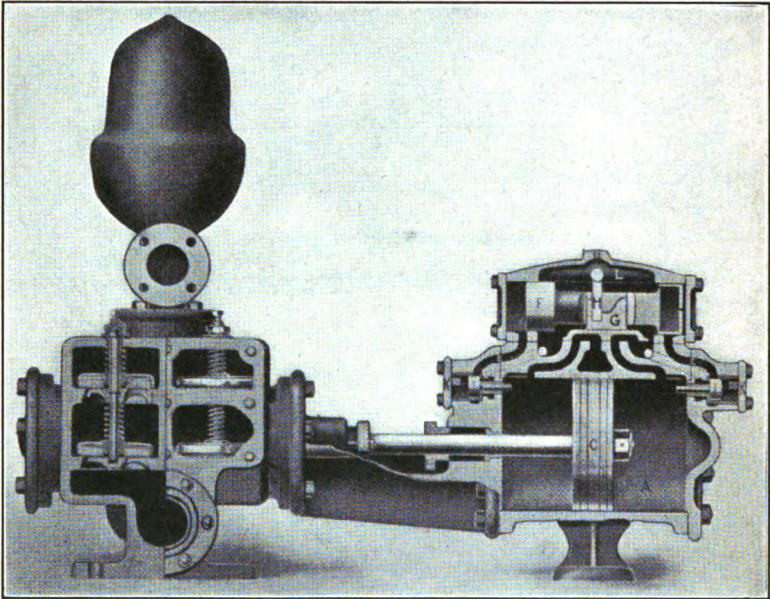

FIG. 30.—Boiler feed pump.

steady flow of water through the discharge *O* and to prevent shock in the piping.

The pump shown in Fig. 30 differs from the one just described in that the steam valve *G* is operated by the steam in the steam chest and not by a vibrating arm outside of the cylinder. The piston *C* is driven by steam admitted under the slide valve *G*, this valve being moved by a plunger *F*. This plunger *F* is hollow at the ends and the space between it and the head of the steam chest is filled with steam. Thus the plunger remains motionless until

the piston *C* strikes one of the valves *I*, exhausting the steam through the part *E* at one end. The water end is similar to that of the pump in Fig. 29.

Injectors are used very commonly for the feeding of portable and of small stationary boilers. In larger plants injectors are sometimes used in conjunction with pumps as an auxiliary method for feeding boilers.

The general construction of an injector is illustrated in Fig. 31. Steam from the boiler enters the injector nozzle at *A*, flows

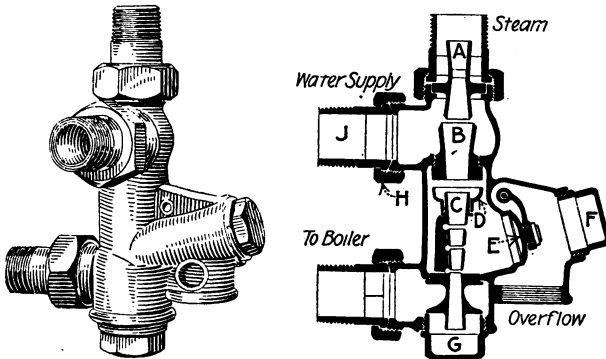

FIG. 31.—Injector.

through the combining tube *BC* and out to the atmosphere through the check valve *E* and overflow *F*. The steam in expanding through the nozzle *A* attains considerable velocity, and forms sufficient vacuum to cause the water to rise to the injector. The steam jet at a high velocity coming into contact with the water is condensed, gives up its heat to the water and imparts a momentum which is great enough to force the water into the boiler against a steam pressure equal to or greater than that of the steam entering the injector.

As soon as a vacuum is established in the injector, and the water begins to be delivered to the boiler, the check valve *E* at the overflow closes. Should the flow of feed water to the boiler be interrupted, due to air leaking into the injector or to some other cause, the overflow will open and the steam will escape to the atmosphere.

The method of connecting an injector to a vertical boiler is

illustrated in Fig. 32. To facilitate the taking down of an injector for inspection and repairs it should be connected up with unions.

Due to the fact that the vacuum in an injector is broken as the temperature of the water increases, injectors can only work when the feed water is 150°F. or cooler.

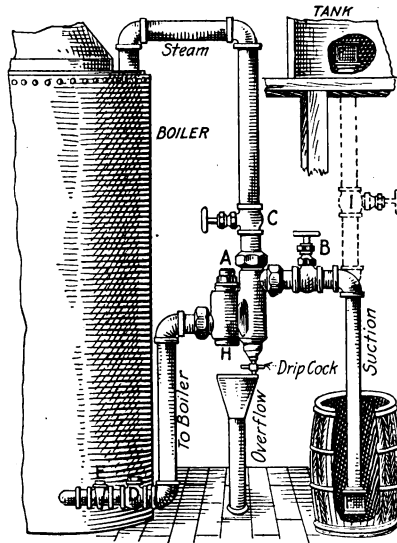

FIG. 32.—Method of connecting an injector.

Feed-water Heaters.—If cold water is fed to a boiler, the temperature at the place where the water is discharged will be different from that in the other parts of the boiler, and strains due to unequal expansion and contraction will be set up which will decrease the life of the boiler, besides impairing the tightness of the setting. With hot feed water, strains due to unequal expansion are prevented. Also for every 10° increase in the temperature of the feed water a gain of about 1 per cent. in the fuel economy can be expected. This also means that the capacity of a boiler plant can be increased by the installation of some apparatus, outside of the boiler, for the heating of feed water.

This increase in capacity can usually be accomplished at much less cost than by increasing the size of the boiler. Heating the feed water outside of the boiler serves also to purify the water before it enters the boiler.

Feed water can be heated by live steam, by exhaust steam, or by the waste chimney gases.

The heating of feed water by live steam is not recommended, as the advantage of this method lies mainly in the amelioration of unequal expansion.

Feed-water heaters which utilize the heat of exhaust steam from engines and pumps are most commonly used. Heaters may be constructed so that the exhaust steam and water come into direct contact and the steam gives up its heat by condensation. Such heaters are called open feed-water heaters. In this form water passes over trays upon which the impurities thrown out of the water by heating it are deposited, and can be easily removed.

If it is desired to prevent the steam and water from coming into contact with each other, some form of closed heater should be used. In the case of closed heaters the steam on one side of a tube heats the water on the other. Such heaters may be constructed so that either the steam or the water flows through the tubes.

Chimneys and Artificial Draft-producing Systems.—A chimney or stack is used to carry off the obnoxious gases formed during the process of combustion at such an elevation as will render them unobjectionable. Another very important function performed by a chimney is to produce a draft which will cause fresh air, carrying oxygen, to pass through the fuel bed, producing continuous combustion.

The draft produced by a chimney is due to the fact that the hot gases inside the chimney are lighter than the outside cold air. In the boiler plant the cold air is heated in passing through the fuel bed, rises through the chimney and is replaced by cold air entering under the grate.

The amount of draft produced by a chimney depends on its height; the taller the chimney, the greater is the draft produced, since the difference in weight between the column of the air inside and that of the air outside increases as the height of the chimney.

The intensity of chimney draft is measured in inches of water, which means that the draft is strong enough to support a column of water of the height given. The draft produced by chimneys is usually $\frac{1}{2}$ to $\frac{3}{4}$ in. of water.

Chimneys are made of brick, concrete, or steel. For small plants steel stacks are more desirable. A brick chimney unless carefully constructed may allow large quantities of air to leak in, which will interfere with the intensity of the draft. Steel stacks are also cheaper. Brick chimneys as usually constructed have two walls, with an air space between them. The inside wall should be lined with firebrick.

Draft produced by chimneys is called natural draft.

In some cases the draft produced by chimneys is insufficient and some artificial method has to be used.

Artificial draft may be produced by steam jets, as is common in locomotive and traction-engine practice. This system is uneconomical, and is used only in connection with land boilers to reduce the clinkering of certain grades of coal.

Firing.—To the average person firing consists merely of opening the furnace door and throwing fuel on the grate. It has been found that some system of firing must be adopted in order to produce economical combustion of coal.

The method to be adopted depends mainly on the kind of fuel.

The spreading method consists of distributing a small charge of coal in a thin layer over the entire grate. This system will give satisfactory results with anthracite coal and with some bituminous coals. With this method, if the fuel is fed in large quantities and at long intervals, incomplete combustion will result.

The alternate method consists of covering first one side of the grate with fresh fuel and then the other. The volatile gases that pass off from the fresh fuel on one side of the grate are burned with the hot air coming from the bright side of the fire. This system is best applied to a boiler with a broad furnace.

The coking method is best adapted for smoky and for the caking varieties of bituminous coal. In this method the coal is put in the front part of the furnace, and allowed to remain there until the volatile gases are driven off; it is then pushed back and spread over the hot part of the furnace, and a new charge is thrown in the front.

Either one of the three systems of firing explained will produce good results, if properly carried out and if the fire is kept bright and clean. Smoke indicates incomplete combustion and with

bituminous coal occurs if the volatile gases are allowed to pass off unburned. If the boiler is set too close to the grate, the volatile gases driven off from the coal are brought into contact with the comparatively cool surfaces of the boiler shell or tubes and smoke is produced.

In all cases the best results can be obtained by firing coal frequently and in small quantities. With mechanical stokers this can be accomplished and one man can attend to a large number of furnaces.

When using mechanical stokers inferior fuels can be burned without smoke, but for small power plants they are not practical on account of the initial high cost, large repair bills and cost of power for operating the stoker mechanism.

Rating of Boilers.—Boilers are usually rated in horsepower. The term horsepower in this connection is only a matter of convenience in rating boilers, and does not mean the rate of doing work, but is an arbitrary unit applying to the evaporation of a definite amount of water. The American Society of Mechanical Engineers has recommended that one boiler horsepower should mean the evaporation of 30 lb. of water per hour at 100°F. into steam at 70 lb. gage. This is equivalent to the evaporation of 34½ lb. of water from feed water at 212°F. into steam at 212°F.

Boiler manufacturers often rate boilers in square feet of heating surface. It has been found that each square foot of boiler heating surface can evaporate economically 3 to 3.4 lb. of water, so that a boiler horsepower can be produced by 10 to 12 sq. ft. of boiler heating surface.

Management of Boilers.—Before a boiler is started for the first time, its interior should be carefully cleaned, care being taken that no oily waste or foreign material is left inside the boiler. The various manholes and handholes are then closed and the boiler is filled to about two-thirds of its volume with water. The fire is started with wood, oily waste, or other rapidly burning materials, keeping the damper and ashpit door open. The fuel bed is then built up slowly.

While getting up the steam pressure, the water gage glass should be blown out to see that it is not choked, the gage cocks should be tried and all auxiliaries such as pumps, injectors, pressure gages, piping, etc., carefully examined. The safety valve

should be carefully examined and tried out before cutting the boiler into service.

When cutting a boiler into service with other boilers, its pressure should be the same as that of the other boilers. Steam valves should be opened and closed very slowly in order to prevent water-hammer and stresses from rapid temperature changes.

During the operation of a steam boiler the safety valve should be kept in perfect condition and tried daily by allowing the pressure to rise gradually until the valve begins to simmer. Each boiler should have its own safety valve and under no condition should a stop valve be placed between it and the boiler. The steam gage should be calibrated from time to time with a standard gage or still better by means of some form of dead-weight tester. It is best not to depend on the water gage glass entirely. Gage cocks are more reliable and should be used for checking the water level of a boiler.

In case of low water do not turn on the feed, but shut the damper, cover the fuel bed with ashes, or if that is not available, with green coal. In case of low water the safety valve should not be lifted until the boiler has cooled down, or an explosion may occur. Operating conditions, as regards the use of steam, should not be changed. If the engine is running allow it to continue, but do not open valve to reduce the pressure.

A boiler should be cleaned often and kept free from scale. If clean water is used a boiler may be run several months without fear of serious scale formation, but in most places boilers should be cleaned at least once each month. When preparing to clean a boiler allow it to cool down, and the water to remain in the shell until ready to commence cleaning.

In emergencies split tubes may be plugged with iron plugs without throwing the boiler out of service. Also if a tube becomes leaky in the tube-sheet this can be remedied by inserting a tapering sleeve slightly larger than the inside diameter of the tube.

A boiler should always be thoroughly inspected before it is started up. In the case of the locomotive type of traction engine boiler (Fig 159) the crown sheet should be given particular attention.

Problems: Chapter III

1. Sketch and explain the fundamental parts of a steam power plant.
2. Sketch and explain the use of the various kinds of pipe fittings.
3. Explain, using clear sketch, the construction and use of a steam gage.
4. Sketch and explain the action of some form of feed pump.
5. Sketch and explain the action of a steam injector.
6. Give three reasons for using feed-water heaters.
7. Explain the fundamentals of good firing.
8. Calculate the heat contained in 7 lb. of dry steam at 100 lb. absolute.
9. If the steam in the above problem contained 5 per cent. moisture, calculate heat contained in 1 lb.
10. Calculate the volume of 3 lb. of steam at atmospheric pressure, and also at a pressure of 150 lb. absolute.
11. If steam at a pressure of 125 lb. absolute has a temperature of 390°F., is it saturated?
12. Taking the weight of a gallon of water as $8\frac{1}{3}$ lb. and using the values given in Tables 2 and 4, compare the heat units contained in a gallon of gasoline and kerosene.
13. If a ton of ice melts (at a temperature of 32°F.) in 24 hr., how much heat will it abstract during that time from the surrounding substances?
14. Explain the meaning of boiler horsepower. Is there any relation between boiler horsepower and engine horsepower? Explain in detail.
15. Give directions for handling a boiler plant.
16. What should be done in case of low water?
17. What should the fireman do if he finds that the steam-pressure is excessive?
18. Give directions for firing bituminous coal.

CHAPTER IV

STATIONARY STEAM ENGINES

Description of the Steam Engine.—A steam engine is a motor which utilizes the energy of steam. It consists essentially of a piston and cylinder with valves to admit and exhaust steam, a governor for regulating the speed, some lubricating system for reducing friction, and stuffing boxes for preventing steam leakage.

In its simplest form, the steam hammer, the steam acting on the piston lifts weights against the force of gravity.

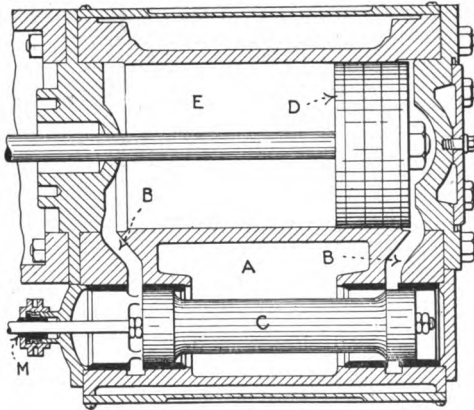

FIG. 33.—Engine cylinder and steam chest.

In the steam engine working as a motor continuous rotary motion of a shaft is essential. This is accomplished by the interposition of a mechanism consisting of a connecting rod and crank, which changes the to-and-fro or reciprocating motion of the piston into mechanical rotation at the shaft. A steam engine in which the reciprocating motion of the piston is changed into rotary motion at the crank is called a reciprocating steam engine to differentiate this form of motor from the steam turbine to be described later.

The various parts of a steam engine are illustrated in Figs. 33 and 34.

Steam from the boiler at high pressure enters the steam chest *A*, Fig. 33, and is admitted through the ports *BB* alternately to either end of the cylinder by the valve *C*. The same valve also releases and exhausts the steam used in pushing the piston *D*. *E* is the cylinder in which the steam is expanded. The motion of the piston *D*, Fig. 34, is transmitted through the piston

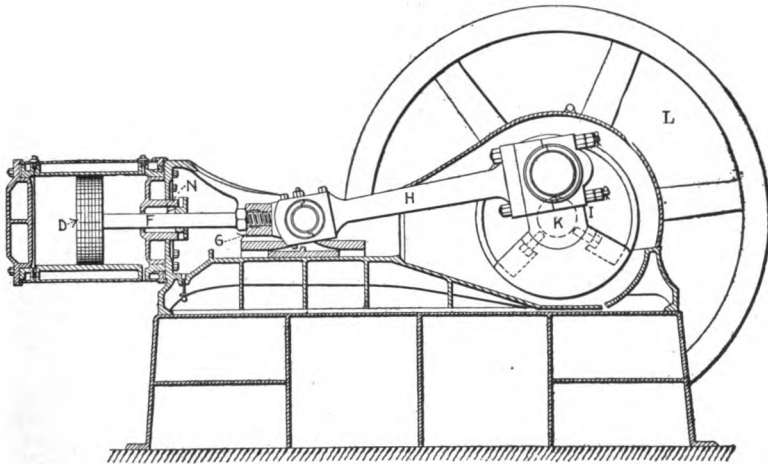

FIG. 34.—Steam engine.

rod *F* to the crosshead *G*, and through the connecting rod *H* to the crank *I* which is keyed to the shaft *K*.

The shaft is connected directly, or by means of intermediate connectors such as belts or chains, to the machines to be driven.

The shaft carries the flywheel *L*, the function of which is to make the rate of rotation as uniform as possible and to carry the engine over dead-center. The dead-center occurs when the crank and connecting rod are in a straight line at either end of the stroke, at which time the steam acting on the piston will not turn the crank. A flywheel is sometimes used as a driving pulley, as shown in Fig. 35.

The eccentric shown in Fig. 35 also rotates with the shaft. An eccentric is a crank of special form which imparts reciprocating motion to the valve through the eccentric rod and valve stem.

The eccentricity of the eccentric is the distance between the center of the eccentric and the center of the shaft. The travel of the valve is equal to the throw of the eccentric, or twice the eccentricity. Changing the eccentricity changes the travel of the valve.

Stuffing boxes which prevent the escape of steam around the rods are illustrated at *M* and *N* in Figs. 33 and 34.

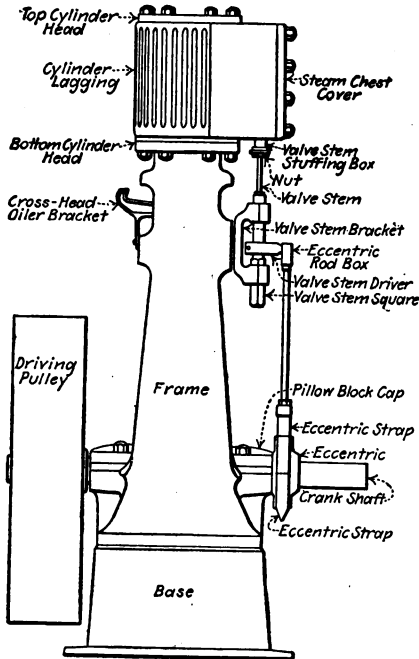

FIG. 35.—Vertical steam engine.

The size of a steam engine is given in terms of the cylinder diameter and length of stroke of the engine. Thus if an engine is called an 8-in. by 10-in. engine, this means that the diameter of its cylinder is 8 in. and its stroke or piston travel is 10 in.

Action of the Plain Slide Valve.—The action of the plain slide valve will now be taken up in detail, as a thorough knowledge of this type of valve will enable one to understand all other forms. Referring to Fig. 36, which shows a section of a cylinder with the slide valve in mid-position, *A* and *B* are the steam ports,

which lead to the two ends of the cylinder; *C* is the exhaust space. The steam ports are separated from the exhaust space by the two bridges *D* and *E*. *F* is the steam chest. *V* is a plain slide valve, commonly called a *D* slide valve. The amount *S*

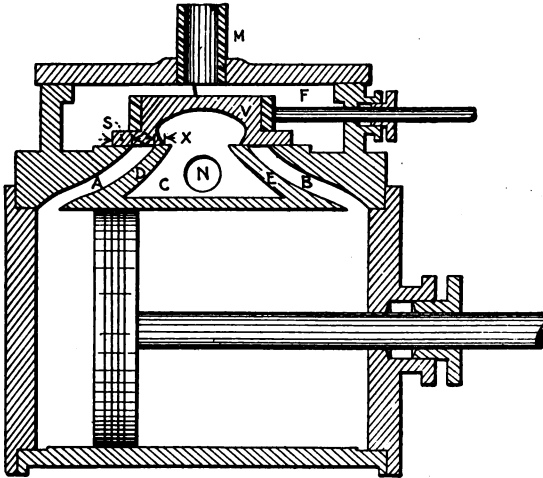

FIG. 36.—Engine cylinder and plain slide valve.

that the valve *V* overlaps the outside edge of the port, when in the middle of its stroke, is called the steam lap. Similarly the amount by which the valve overlaps the inside edge of the port

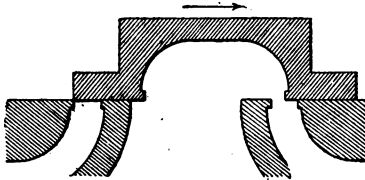

FIG. 37.—Admission.

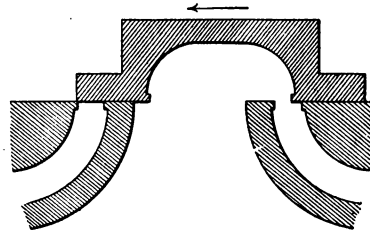

FIG. 38.—Cut-off.

when it is in mid-position is called the exhaust lap. *M* and *N* are the steam and exhaust pipes respectively.

The four valve events are: admission, cutoff, release and compression. Admission is that point at which the valve is beginning to uncover the port, as shown in Fig. 37. Cutoff occurs

(Fig. 38) when the valve covers the port, preventing further admission of steam. This is followed by the expansion of the steam until the cylinder is communicated with the exhaust opening, at which time release, as shown by Fig. 39, occurs. Compression occurs when communication between the cylinder and exhaust opening is interrupted (Fig. 40) and the steam remaining in the cylinder is slightly compressed by the piston. The valve is in

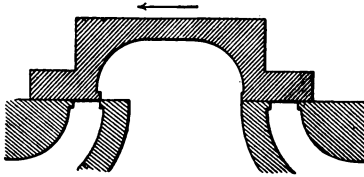

FIG. 39.—Release.

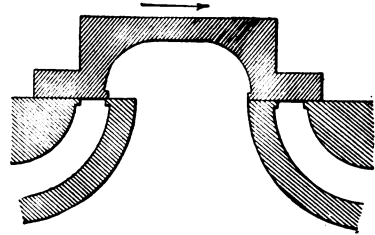

FIG. 40.—Compression.

the same position at cutoff as it is at admission, only it is traveling in the opposite direction. Similarly the positions of the valve are the same at release and compression.

By lead is meant the amount that the port is uncovered when the engine is on either dead-center. The object of lead is to supply full pressure steam to the piston as soon as it passes the dead-center.

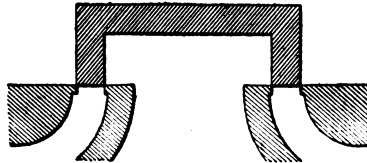

FIG. 41.—Valve without laps.

If a valve is constructed without laps, as shown in Fig. 41, steam would be admitted to the cylinder at one end or the other and exhausted at the opposite end, if the valve is moved slightly in either direction. This would mean that steam admission at one end would take place throughout the entire stroke of the piston and would be exhausted from the opposite end at the same time. It is evident that a valve without laps will have

no cutoff and steam will not be used expansively. To use steam without expansion is very uneconomical and is resorted to only in direct-acting steam pumps. For best economy a steam engine should be provided with a valve which cuts off at about one-third of the stroke.

Types of Steam-engine Valve Gears.—The simplest type of valve for steam engines is the single-slide valve, which controls

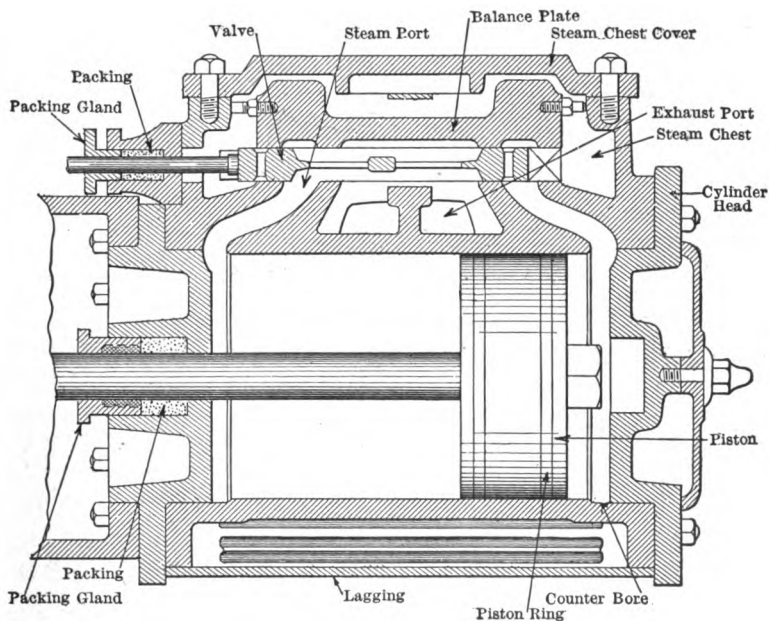

FIG. 42.—Balanced valve.

the admission and exhaust of steam alternately to each end of the cylinder. The form shown in Fig. 33 is called a piston valve. In the position shown it admits steam to the head of the cylinder, the end farthest away from crank, and at the same time exhausts the steam from the crank end of the cylinder.

Still a simpler type of valve, the plain slide valve, often used on portable and on traction engines, is shown in Fig. 36. The objection to this type of valve is that it is not balanced, and, either the friction of the valve on its seat is excessive, or the valve allows steam to leak into the exhaust space. This is remedied

by the piston valve shown in Fig. 33, which is perfectly balanced, or by some form of balanced slide valves, illustrated in Fig. 42, which works between the valve seat and a balance plate with an accurate mechanical fit.

Valve Setting.—The object of setting valves on an engine is to equalize as much as possible the work done on both ends of the piston. A valve may be set so that both ends have the same lead, or so that the point of cutoff is the same at both ends.

Before a valve can be set, the dead-centers for both ends of the engine must be accurately determined.

The method of setting an engine on dead-center can best be understood by referring to Fig. 43. *H* represents the engine

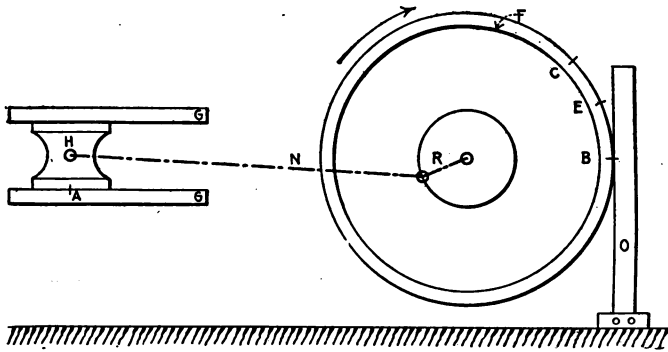

FIG. 43.—Valve setting.

crosshead which moves between the guides marked *G*, *N* is the connecting rod, *R* the crank, *F* the engine flywheel, and *O* a stationary object.

To set the engine on dead-center, turn the engine in the direction in which it is supposed to run, as shown by the arrow, until the crosshead is near the end of its head-end travel, and make a small scratch mark on the crosshead and guide, as at *A*. At the same time mark the edge of the flywheel and the stationary object opposite each other, as at *B*. Turn the engine past dead-center, in the same direction as shown by the arrow, until the mark on the crosshead and that on the guide again coincide at *A*, and mark the flywheel in line with the same point on the stationary object, obtaining the mark *C*. The distance between the two marks on the flywheel is now bisected at *E*. If the mark *E*

on the flywheel is now placed in line with the mark on the stationary object, the engine will be on the head-end dead-center. Similarly the crank-end dead-center can be found.

The stationary object may be a wooden board, or a tram may be used with one end resting on the engine bedplate and with the other end used for locating the marks *B*, *C*, and *E* on the flywheel.

If a valve is to be set for equal lead on both ends, set the engine on the dead-center by the method given above, remove the steam-chest cover, and measure the lead at that end. Move the engine forward to the other dead-center and measure the lead again. If the lead on the two ends is not the same, correct half the error by changing the length of the valve stem, and the other half by moving the eccentric.

To set an engine for equal cutoff, turn the engine until the valve cuts off at one end and mark the position of the crosshead on the guides. Then turn the engine until cutoff occurs on the opposite end and again mark this position of the crosshead on the guides. If the cutoff occurs earlier at one end than at the other, shorten the valve stem until the cutoff is equalized at both ends.

Steam-engine Indicator Cards.—In general the best method of setting valves is by means of a steam-engine indicator, explained in Chapter II and illustrated in Fig. 1. This form of instrument shows directly the action of the steam inside the engine cylinder, recording the actual pressure at each interval of the stroke.

An indicator card taken by means of an indicator is shown in Fig. 44. The events of stroke on the card are marked: admission *A*, cutoff *C*, release *R*, compression *K*. Fig. 45 shows indicator cards taken from two ends of a cylinder with a valve properly set, while Fig. 46 shows indicator cards taken from an engine where the valve is poorly set.

Losses in Steam Engines.—The main losses in a steam engine are:

1. Loss in pressure as the steam is transferred from the steam boiler to the engine cylinder due to the throttling action in the steam pipe and ports.

2. Leakage past piston and valve.

3. Losses due to the condensation of steam in the cylinder during part of the stroke.

4. Radiation losses which take place when the steam passes through the steam pipes from the boiler to the cylinder and also while the steam is in the cylinder.

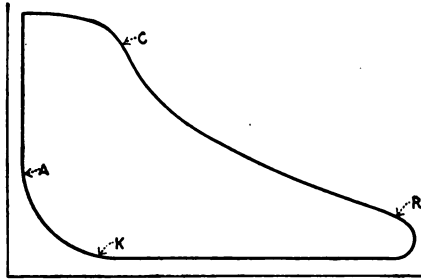

FIG. 44.—Steam-engine indicator card.

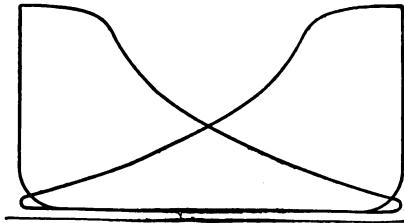

FIG. 45.—Indicator cards, valves properly set.

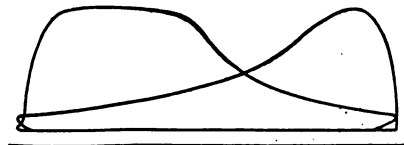

FIG. 46.—Indicator cards, valves improperly set.

5. Losses of heat in the exhaust steam.

6. Mechanical losses due to the friction of the moving parts.

Of the above losses those due to the heat carried away in the exhaust steam are greatest and are usually 75 per cent. or more of the heat supplied in the steam. Part of this heat can be used for such purposes as the heating of feed water before it enters the boiler, for heating buildings, or in employing the exhaust steam in connection with various manufacturing processes.

The other great loss is that due to the condensation of steam which takes place when the entering steam comes into contact with the cylinder walls which are at the temperature of the exhaust

steam. This loss can be reduced to a considerable extent by having the steam entering the cylinder as dry as possible. Another method for reducing this loss, which is used in connection with large engines, is to compound the engine.

By compounding is meant the subdivision of the expansion of the steam into two or more cylinders. The steam on leaving

the boiler enters the high-pressure cylinder, is partly expanded, and then enters one or more cylinders where its expansion is completed to the exhaust pressure. The range of pressures in each cylinder of a compound engine being less than is the case of a simple, or one-cylinder engine, the temperature difference between the incoming and the outgoing steam is less. This lower temperature range decreases the condensation of the steam in the cylinder. The gain in economy does not usually compensate for the increased first cost of compound engines as compared with simple engines in small sizes.

Radiation losses in the steam pipes leading from the boilers to the engines can be reduced to a minimum by covering the pipes. A good pipe covering will save the latent heat in the steam that would otherwise be lost, will keep the steam drier, and will pay for itself in a very short amount of time.

The cylinders of most steam engines are now jacketed with some good non-conductor of heat and this loss is very small.

Mechanical losses in steam engines can be reduced by proper lubrication. Oil can be applied to the various parts by separate sight-feed lubricators and grease cups. Another method is to connect an oil tank conveniently located with the various parts by adjustable sight-feed tubes, allowing different rates of feed to the various bearings. Still another method is to inclose some of the parts and make them self-oiling.

The losses due to leakage past the piston and valves are usually very small in well-designed engines. The various forms of balanced slide valves can be kept tight by means of balance plates.

Steam-engine Governors.—The function of a governor is to control the speed of rotation of a motor irrespective of the power which it develops. In the steam engine, the governor maintains a uniform speed of rotation either by varying the initial pressure of the steam supplied, or by changing the point of cutoff and hence the portion of the stroke during which steam is admitted.

Governors which regulate the speed of an engine by varying the initial pressure of the steam supplied to the engine are called throttling governors. This is the simplest form of governor and is used mainly on engines of the plain slide-valve type. In Fig. 47 is given a section of a throttling governor, showing details. This form of governor is attached to the steam pipe at *A* and is

connected to the engine cylinder at *B*, so that the steam must pass the valve *V* before entering the engine. The valve *V* is a balanced valve and is attached to a valve stem *S*, at the upper end of which are two balls *CC*. The valve stem and balls are driven from the engine shaft by a belt, which is connected to the pulley *P*, and which in turn runs the bevel gears *D* and *E*. As the speed of the engine is increased the centrifugal force makes the balls fly out, and in doing so they force down the valve stem *S*, thus reducing the area of the opening through the valve, and

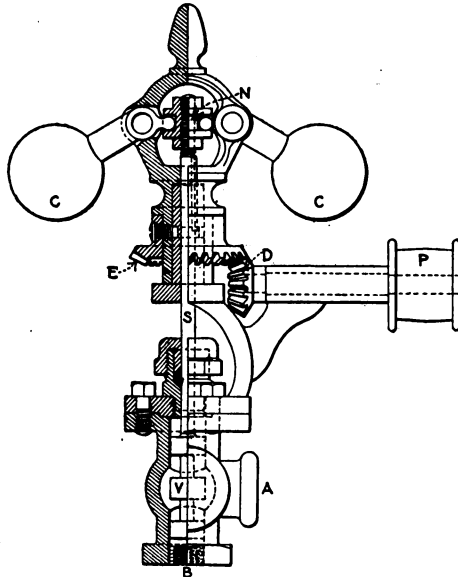

FIG. 47.—Steam-engine governor.

the steam to the engine is throttled. As soon as the engine begins to slow down, the balls drop, increasing the steam opening through the valve *V*. The speed at which the steam is throttled can be changed within certain limits by regulating the position of the balls by means of the nut *N*.

Most of the better engines are governed by varying the point of cutoff and hence the total volume of steam supplied to the cylinder.

In high-speed automatic engines this is accomplished by some

form of flywheel governor which is usually placed on the engine shaft, and which controls the point of cutoff by changing the position of the eccentric.

Engine Details.—The general construction of steam-engine cylinders can be seen from the previous illustrations. Steam-

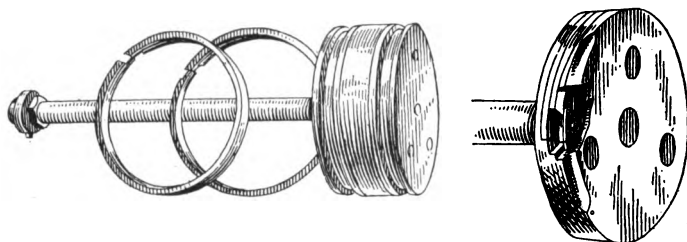

FIG. 48.—Piston.

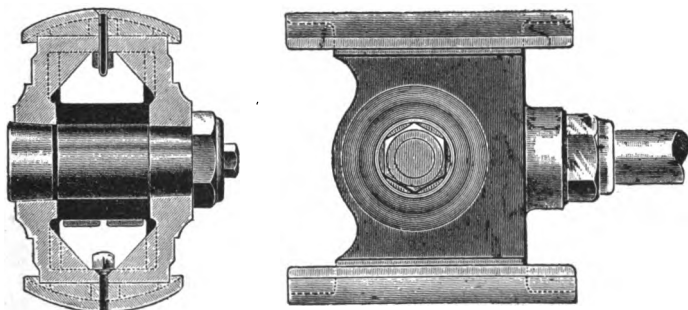

FIG. 49.—Cross-head.

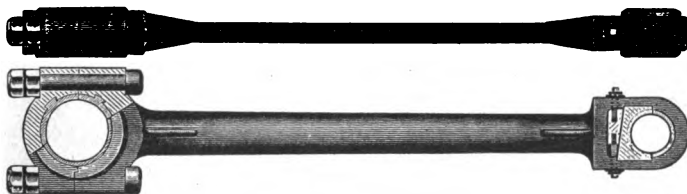

FIG. 50.—Connecting rod.

engine cylinders are made of cast iron. As the cylinder wears it has to be rebored so as to maintain true inside surfaces. The thickness of the cylinder walls not only should be strong enough to withstand safely the maximum steam pressure, but should allow for reboring. All steam-engine cylinders should be pro-

vided with drip cocks at each end in order to drain the cylinder and steam chest when starting.

A good piston should be steam-tight and at the same time should not produce too much friction when sliding inside the engine cylinder. The piston is usually constructed somewhat smaller than the inside diameter of the engine cylinder, and is made tight by the use of split cast-iron packing rings. In Fig. 48 is illustrated a piston with its packing rings.

The general construction of steam-engine crossheads is illus-

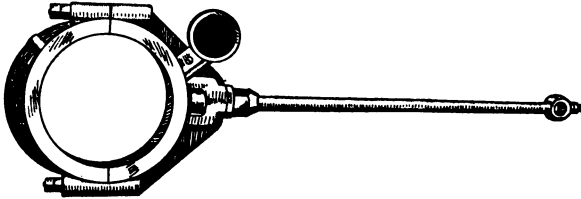

FIG. 51.—Eccentric rod and strap.

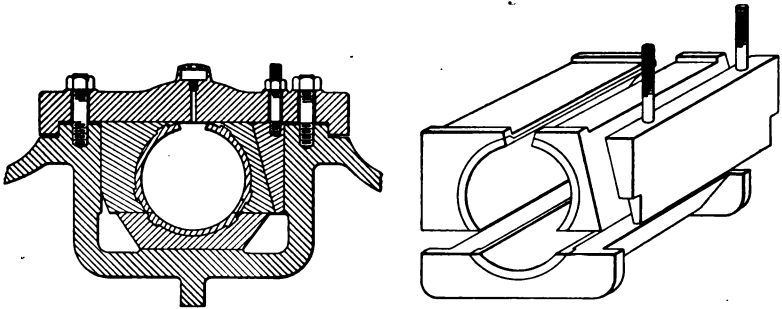

FIG. 52.—Main bearings.

trated in Fig. 49. All crossheads should be provided with shoes which can be adjusted for wear.

Fig. 50 shows a connecting rod. It is connected at one end with the crosshead and at the other with the crankpin. A connecting rod should be so constructed that the wear on its bearings can be taken up. This is usually accomplished by wedges and setscrews as illustrated.

Some engines have their cranks located between the two bearings of an engine, and are called center-crank engines. Engines which have the cranks located at the end of the shaft and on one side of the two bearings are called side-crank engines.

The eccentric is a special form of crank. It is usually set somewhat more than 90° ahead of the crank and gives motion to the valve or valves in the steam chest of the engine. The eccentric is a cast-iron disc through which the shaft passes and which gives motion to the valve. Fig. 51 shows an eccentric rod and strap.

The main bearings of steam engines are illustrated in Fig. 52. These bearings are usually made in three or four parts and can be adjusted for wear by means of wedges and setscrews fastened with locknuts.

Lubricators.—The subject of lubricating the moving parts of

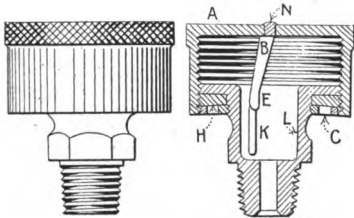

FIG. 53.—Grease cups.

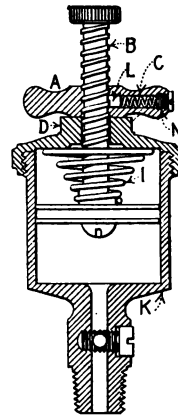

FIG. 54.—Automatic grease cup.

an engine was treated to some extent in connection with the discussion of mechanical losses in steam engines.

Bearings may be lubricated by grease cups illustrated by Figs. 53 and 54. The first type is used on stationary bearings, the grease being forced out by screwing the cap down by hand. The type illustrated in Fig. 54 is automatically operated, and is used for the lubrication of crankpins.

If oil is used, a plain oil cup, illustrated in Fig. 55, can be employed, or some form of sight-feed lubricator, as shown in Fig. 56. By means of the sight-feed types the flow of oil can be regulated and the drops of oil issuing from the lubricator can be seen.

For the lubrication of steam-engine cylinders some form of sight-feed automatic steam lubricator, as illustrated in Fig. 57, should be employed. This form of lubricator is used to introduce a heavy oil into the steam entering the cylinder. This oil is a

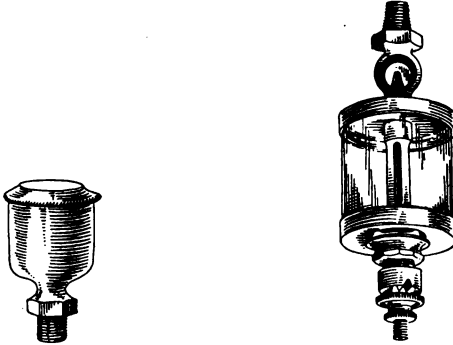

FIG. 55.—Plain oil cup. FIG. 56.—Sight-feed lubricator.

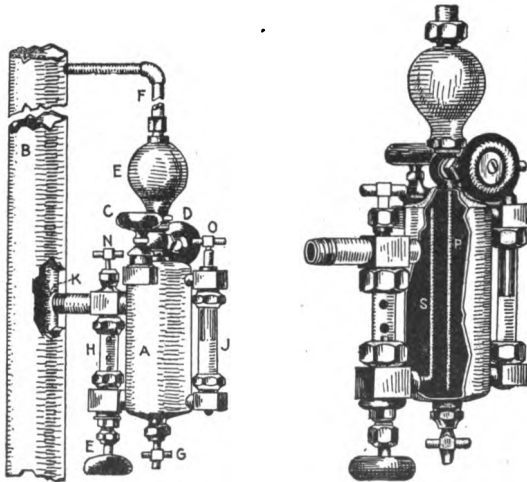

FIG. 57.—Sight-feed automatic lubricator.

specially refined heavy petroleum oil which will neither decompose, vaporize, or burn when exposed to the high temperature of steam. Steam from the pipe leading to the cylinder *B* is admitted through the pipe *F* to the condensing chamber *E*, where it is condensed and falls through the pipe *P* to the bottom of the chamber

A. The oil which is contained in chamber *A* rises to the top, is forced through the tube *S*, ascends in drops through the water in the gage glass *H*, and into the steam pipe *K* leading to the steam chest. The amount of oil fed is regulated by the needle valve *E*. *T* shows the amount of oil in the chamber *A*.

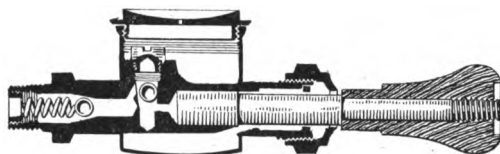

FIG. 58.—Hand oil pump.

In order to fill the chamber *A*, the valves on the pipes *F* and *H* are closed, the water is drained out through *G*, and the cap *D* is removed for receiving the oil.

Fig. 58 shows a hand oil pump which is sometimes used to admit oil into the cylinder of an engine when starting.

Steam Separators.—The function of a steam separator is to remove any water which may be contained in the steam before it enters the engine cylinder. A separator placed in the exhaust pipe of an engine will remove a large part of the oil, making the exhaust steam more suitable for heating, manufacturing purposes, or for use in steam boilers after condensation.

The importance of having the steam entering the engine cylinder as dry as possible was explained in an earlier part of this chapter. A good steam separator, if of sufficient size, will insure fairly dry steam and should be used in connection with all stationary steam engines.

Fig. 59 shows in section one form of steam separator. The wet steam enters at *A*, strikes the deflecting plates, its velocity is decreased and the entrained water, which is heavier than the steam, falls to the bottom and is removed at *C* by means of a trap. The dry steam passes out at *B*.

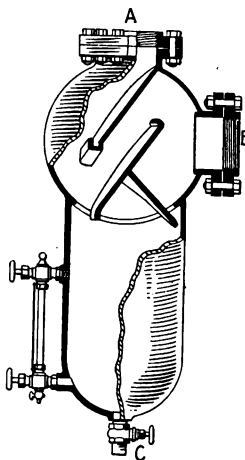

FIG. 59.—Steam separator.

The Steam Locomobile or Buckeymobile.—The locomobile, as built in Europe, and the Buckeymobile of the United States, is a self-contained power plant, which consists of a compound

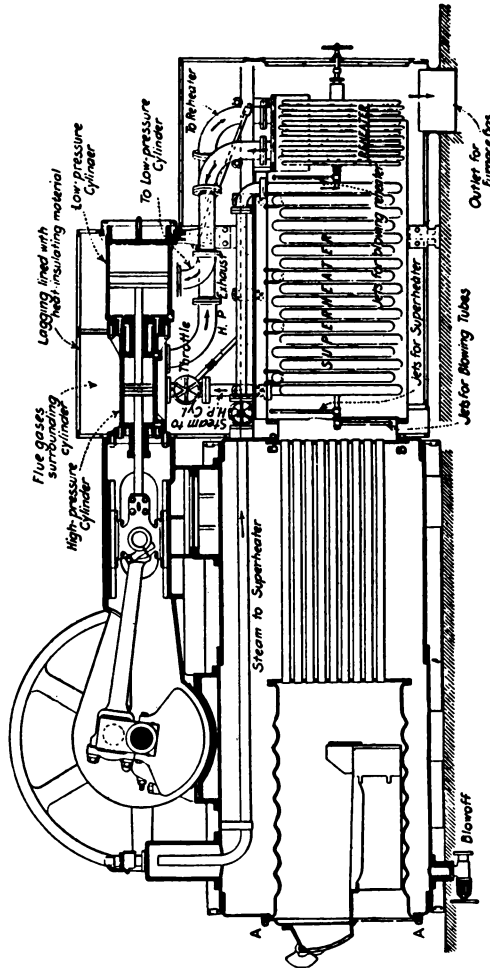

Fig. 60.—The steam locomobile or Buckeymobile.

steam engine mounted upon an internally fired boiler. An insulated sheet-metal smoke box incloses both engine cylinders, a superheater, all steam piping and valves, and a reheater which imparts heat to the steam as it passes from the high- to the low-

pressure cylinder. This arrangement utilizes the heat in the flue gases for superheating the steam before it enters the engine cylinder, for reheating the steam between the high- and the low-pressure cylinder, for reducing heat losses within the engine and for cutting down the radiation losses of the entire power plant.

The steam from the engine exhausts through a feed-water heater into a condenser, where it is condensed (converted into water) by direct contact with cold water or by contact with tubes through which cold water circulates.

Fig. 60 shows a longitudinal section of a Buckeymobile with the various parts named.

This form of power plant has found a large field of application in Europe on account of its compactness and good fuel economy. The Buckeymobile, in small sizes, will no doubt in time be used to a considerable extent in rural communities in connection with flour mills, for irrigation pumping plants and for electric light plants in small towns. The principle of this type of power plant should also find successful application in connection with steam traction engines.

Steam Turbines.—The steam turbine differs from the steam engine described, in that it produces rotary motion directly and without any reciprocating parts. It consists of a stationary part and one or more wheels with vanes which are rotated by steam striking the vanes. The elastic force of the steam, instead of acting on a piston, is exerted on the steam itself, producing a drop in pressure and a steam jet of high velocity.

The steam turbine is best adapted for the driving of electrical generators, centrifugal pumps and air compressors, cream separators and other machinery requiring a high-speed rotation.

In large sizes the steam turbine is somewhat more economical than the reciprocating steam engine and occupies considerably less space. The steam turbine requires no internal lubrication, and thus the exhaust steam can be used again in the boiler without requiring oil filtration. For large power plants the steam turbine has several other advantages.

The action of one form of steam turbine used for the driving of cream separators is illustrated in Fig. 61. *A*, *B*, *C* and *D* are stationary nozzles in which the steam is completely ex-

panded and strikes the vanes *V*, giving a direct rotary motion to the wheel *W* and also to the shaft *S*.

Installation and Care of Steam Engines.—Foundations for stationary steam engines are usually put in by the purchaser, the manufacturer furnishing complete drawings for that purpose. Drawings of a board template are also included. A template is

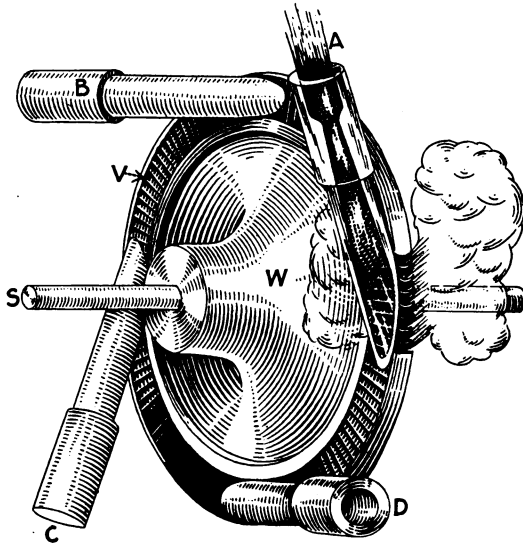

FIG. 61.—Steam turbine.

a wooden frame which is used in locating the foundation bolts and for holding them in position while building the foundation.

Before starting on the foundation a bed should be prepared for receiving it. The depth of bed depends on the soil. If the soil is rocky and firm, the foundation can be built without much difficulty. When the soil is very soft, piles may have to be driven. The ground for receiving the piles should be excavated to a depth of about 2 ft.

The wooden template is then constructed from the drawings, holes being bored for the insertion of foundation bolts.

Foundations may be built of masonry or of concrete. If of concrete the mixture should consist of 1 part of cement, 2 parts of sharp sand and 4 parts of crushed stone. The stone should be of

a size as will pass through a 2-in. ring. In starting on a concrete foundation, a wooden frame of the exact shape of the foundation is built. This template is then placed in position in the manner shown by Fig. 62, and the bolts are put in, the heads of the bolts being at the bottom in recesses of cast-iron anchor plates marked *P*. Often the foundation bolts are threaded at both ends and the anchor plates are held in place by square nuts. A piece of pipe should be placed around each bolt, so as to allow

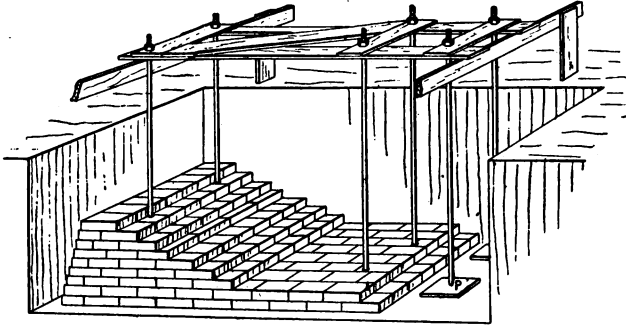

FIG. 62.—Foundation in the process of construction.

the bolts to be moved slightly to pass through the holes in the engine bedplate, in case an error should occur in the placing of the bolts, or in the location of the bolt holes in the engine bedplate.

With the frame, template and foundation bolts in place, the concrete can now be poured and tamped down. After the concrete has set, the template is removed and the foundation is made perfectly level. It is well to allow a concrete foundation to set several weeks before placing the full weight of the engine on it.

When the foundation is ready, the engine is placed in position and leveled by means of wedges. The nuts on the bolts are now screwed down and the engine is grouted in place by means of neat cement, this serving to fill any crevices and to give the engine a perfect bearing on the foundation.

After erecting the engine and all its auxiliaries, including pipes, valves, cocks and lubricators, all the parts should be carefully examined and cleaned, and a coating of oil should be applied to all rubbing surfaces, cylinder oil being used for the wearing parts in the valve chest and cylinder.

Before the engine is operated for the first time, it is well to loosen the nuts and bolts, adjust bearings, and turn the engine over slowly until an opportunity has been given for any inequalities due to tool and file marks to be partially eliminated, and also to prevent heating that might occur if there was an error in adjustment.

When the engine is ready to start, the boiler valve should be slowly opened to allow the piping to warm up, but leaving the drain cock in the steam pipe, above the steam chest, open to permit the escape of condensation. While the piping is being warmed up all the grease cups and lubricators are filled. Before opening the throttle valve, all cylinder and steam-chest drain cocks should be opened to expel water, and the flow of oil started through the various lubricators. The throttle valve is then opened gradually, and both ends of the engine warmed up. This can be accomplished in the case of a single-valve engine by turning the engine over slowly by hand to admit steam in turn to each end of the cylinder. In starting a Corliss engine the eccentric is unlocked from the pin on the wristplate and the wristplate is rocked by hand sufficiently to allow steam to pass through each set of valves. The drain cocks are closed soon after the throttle is wide open and the engine is gradually brought up to speed, provided steam is blowing through.

When stopping an engine, close the throttle valve. As soon as the engine stops, close the lubricators, wipe clean the various parts, examine all bearings and leave the engine in perfect condition ready to start.

The above instructions apply to non-condensing engines. If the engine is to be operated condensing, the circulating and air pumps should be started while the engine is warming up. The other directions apply with slight modifications to all types of steam engines.

In regard to daily operation, cleanliness is of great importance. No part of the engine should be allowed to become dirty and all parts must be kept free from rust. It is well to draw off all the oil from bearings quite frequently and to clean them with kerosene before refilling with fresh oil. In starting it is well to give the various parts plenty of oil, but the amount should be decreased as the engine warms up. An excess of oil should be avoided.

Competent engine operators usually make a practice of going over and cleaning every bearing, nut, and bolt, immediately on shutting down. This practice not only keeps the engine in first-class condition, as regards cleanliness, but enables the operator to detect the first indication of any defect that, if overlooked, might result seriously.

If a knock develops in a steam engine, it should be located and remedied at once. Knocking is usually due to lost motion in bearings, worn journals or crosshead shoes, water in the cylinder, loose piston, or to poor valve setting. Locating knocks in steam engines is to a great extent a matter of experience and no definite rules can be laid down which will meet all cases.

However, the beginner may, by careful attention to the machine, learn to trace out the location of a knock in a comparatively short time. He must, however, bear in mind that he cannot rely on his ear for locating it, as the sound produced by a knock is, in many cases, transmitted along the moving parts, and apparently comes from an entirely different point.

A knock, due to water in the cylinder, is usually sharp and crackling in its nature, while that in the case of a crank or a crosshead pin is more in the nature of a thud. If the knock should be due to looseness of the main bearings, the location may be detected by carefully watching the flywheel, while if the crossheads are loose in the guides the observer may be able to detect a motion crossways of the crosshead, but it is not likely that he can do this with accuracy in the case of a high-speed engine, and the crosshead should be tested when the engine is at rest. *In no case should any adjustment be made in bearings or moving parts of an engine unless the machine is at standstill or being turned by hand; never when under its own power.*

The heating of a bearing is always due to one of five causes:

1. Insufficient lubrication due to insufficient quantity of oil, wrong kind of oil, or lack of proper means to distribute the oil about the bearings.
2. The presence of dirt in the bearings.
3. Bearings out of alignment.
4. Bearings improperly adjusted; they may be either too tight or too loose.
5. Operation in a place where the temperature is excessive.

In case a bearing should run hot and it is very undesirable to shut down, it is oftentimes possible to keep going by a liberal application of cold water upon the entire heated surface or surfaces. It is sometimes possible to stop heating by changing from machine oil to cylinder oil which has a higher flash point.

Should a bearing, particularly a large one, be overheated to the extent that it is necessary to shut down the engine, do not shut down suddenly or allow the bearing to stand any length of time without attention. This is particularly important in the case of babbitted bearings, as the softer metal of the bearings will tend to become brazed to, or fused with, the harder metal of the shaft, and it may be necessary to put the engine through the shop before it can be used again.

In case of the necessity of shutting down for a hot bearing, first remove the load, then permit the engine to revolve slowly under its own steam until the bearing is sufficiently cool to permit the bare hand to rest on it.

The presence of water in the cylinder is always a source of danger, and care should be taken that the water of condensation is thoroughly drained from the cylinder when the engine is first started, at shutting down, and at regular intervals throughout the operation. An accumulation of water may readily result in the blowing out of a cylinder head with its resultant loss to property and possibly of life. There are several appliances now on the market which automatically safeguard the cylinder head by providing a weak point in the drain system which will relieve the excess pressure before the cylinder head gives way.

Problems: Chapter IV

1. Sketch and explain the action of the plain slide-valve engine.
2. Explain in detail how to set the valve of a steam engine.
3. Discuss the losses in steam engines.
4. Sketch and explain some form of steam-engine governor.
5. Sketch and explain construction and use of the common grease cup, the sight-feed type of lubricator and steam-engine cylinder sight-feed automatic lubricator.
6. Explain the fundamental details of the steam Buckeymobile.
7. Explain, with sketches, the action of a steam turbine.
8. Give directions for starting and stopping steam engines.
9. Give directions for the care of a steam engine.
10. Explain how to prevent the heating of bearings.

CHAPTER V

GAS AND OIL ENGINES

The Internal-combustion Engine.—The internal-combustion engine, commonly called a gas engine, differs from the steam engine, in that the transformation of the heat energy of the fuel into work takes place within the engine cylinder. The fuel may be gasoline, kerosene, crude petroleum, alcohol, illuminating gas, or some form of power gas.

In order to form an explosive mixture in the cylinder, air must be mixed in certain proportions with the fuel, and this can be accomplished only when the fuel is in the gaseous state, or is a mist of liquid fuel easily vaporized at ordinary temperatures. Thus the essential difference among internal-combustion engines using the various fuels is in the construction of the device for preparing the fuel before it enters the engine cylinder. If the fuel is a gas, only a stop valve is necessary between the source and the gas-engine admission valve. The devices for preparing liquid fuels depend on the character of the fuel, a heavy fuel requiring heat while a volatile fuel is easily vaporized at ordinary temperatures by being broken up into a fine mist. If the fuel is in the solid form, like coal, it must be converted into a gas by the use of a gas producer, to be described later, before it can be used in the gas-engine cylinder.

After the mixture is drawn into the cylinder, it is prepared by compressing and intimately mixing the fuel with the air at one end of the engine cylinder. This highly compressed combustible mixture of air and fuel is burned within the cylinder against the face of the piston. The heat liberated by the burning gases causes these gases to expand, the pressure within the cylinder is increased and the piston is driven out toward the other end of the cylinder. The motion of the piston is changed into rotary motion at the crankshaft through the interposition of the connecting rod and crank. The crankshaft can be connected directly to the machines to be driven or through mechanical connectors, such as belts and chains.

The internal-combustion engine, in small sizes, is much more economical than the steam power plant. The average small steam power plant converts less than 5 per cent. of the heat energy in the fuel into useful work. A small oil engine which develops a horsepower on 1 lb. of gasoline per hour converts nearly 15 per cent. of the heat energy available in the fuel into work.

The Gas-engine Cycle.—The series of events which are essential for carrying out the transformation of heat into work is called the cycle of an engine. The gas-engine cycle mostly used, the Otto cycle, comprises five events, which are:

1. The mixture of fuel and air must be drawn into the engine cylinder.
2. The mixture must be compressed.
3. The mixture must be ignited.
4. The ignited mixture expands doing work.
5. The cylinder must be cleaned of burned gases in order to receive a fresh mixture.

The above five events in the order explained are usually called: suction, compression, ignition, expansion, and exhaust.

There is another commercial gas-engine cycle, the Diesel, which is used in certain types of oil engines. The Diesel cycle also requires five events, and differs from the Otto cycle in that air without fuel is compressed in the engine cylinder to such a great pressure that the temperature resulting is sufficiently high to ignite the fuel automatically, as it is sprayed by an auxiliary pump into the engine cylinder.

The compression pressures carried in engines working on the Diesel cycle are about 500 lb. per square inch, while those carried in engines working on the Otto cycle and with the same fuels are 55 to 90 lb. per square inch.

Classification of Gas Engines.—Gas engines are divided into two classes, according to the number of piston strokes required to carry out the five events of the gas-engine cycle. To one class belong all engines which require four complete strokes of the piston, or two complete revolutions of the crankshaft to carry out the five events of the gas-engine cycle. These engines are called four-stroke cycle engines. The two-stroke cycle engine works on the same gas-engine cycle as the four-stroke cycle

engine, only the mechanism is modified so as to complete the five events in two strokes of the piston.

The Four-stroke Cycle.—The action of an internal-combustion engine working on the four-stroke Otto cycle is illustrated in Figs. 63 to 67.

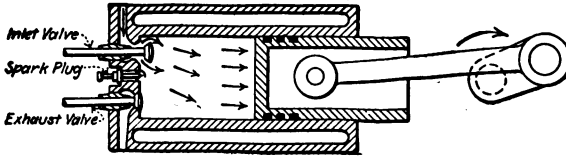

FIG. 63.—Suction.

1. Suction of the mixture of air and gas through the inlet valve takes place during the complete outward stroke of the piston, the exhaust valve being closed. This is shown in Fig. 63. This stroke of the piston is called the suction stroke.

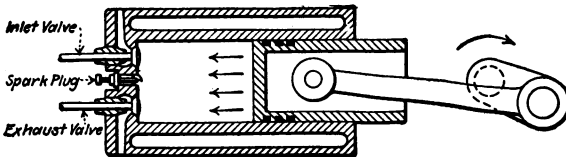

FIG. 64.—Compression.

2. On the return stroke of the piston, shown in Fig. 64, both the inlet and exhaust valves remain closed and the mixture is compressed between the piston and the closed end of the cylinder. This is called the compression stroke. Just before the compression

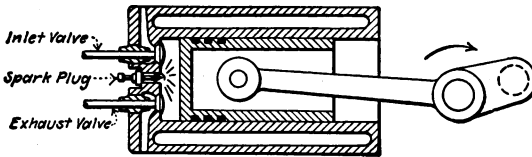

FIG. 65.—Ignition.

stroke of the piston is completed, the compressed mixture is ignited by a spark (Fig. 65) and rapid combustion, or explosion, takes place.

3. The increased pressure within the cylinder due to the rapid combustion of the mixture drives the piston on its second for-

ward stroke, which is the power stroke. This is shown in Fig. 66. This power stroke, or working stroke, is the only stroke in the cycle during which power is generated. Both valves remain

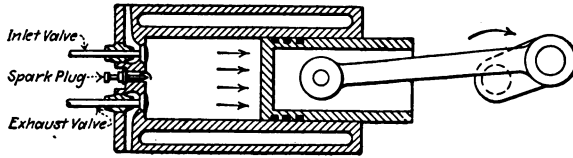

FIG. 66.—Expansion.

closed until the end of the power stroke, when the exhaust valve opens and provides communication between the cylinder and the atmosphere.

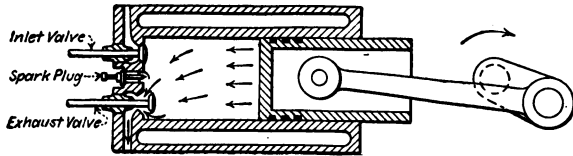

FIG. 67.—Exhaust.

4. The exhaust valve remains open during the fourth stroke called the exhaust stroke, Fig. 67, during which the burned gases are driven out from the cylinder by the return of the piston.

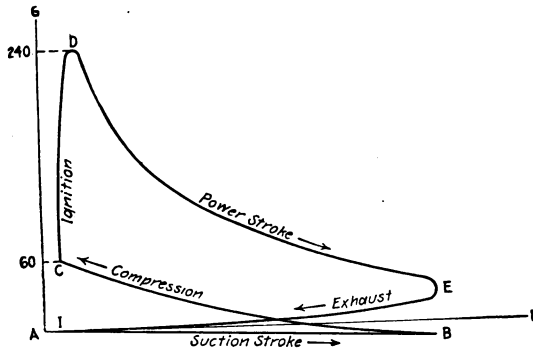

FIG. 68.—Gas-engine indicator card.

An indicator diagram, taken from a four-stroke cycle engine, using gasoline as fuel, is illustrated in Fig. 68. *IB* is the suction stroke, *BC* the compression stroke, *CD* shows the ignition event, *DE* is the power stroke and *EI* is the exhaust stroke. The

direction of motion of the piston during each stroke is illustrated in each case by arrows. Lines AF and AG were added to the indicator diagram; the first is the atmospheric line, while AG is the line of pressures. From Fig. 68 it will be noticed that part of the suction stroke occurs at a pressure lower than atmospheric. The reason for this is that a slight vacuum is created in the cylinder by the piston moving away from the cylinder head. This vacuum helps to draw or suck the mixture into the cylinder.

The engine working on the four-stroke cycle requires two complete revolutions of the crankshaft, or four strokes of the piston to produce one power stroke or working stroke. The other three are not only idle strokes, but power is required to move the piston through these strokes, and this has to be furnished by storing extra momentum in heavy flywheels. Several attempts were made from time to time to produce an internal-combustion engine by modifying the Otto or Diesel gas-engine cycles, so that the working stroke would occur more frequently. This has resulted in the so-called two-stroke cycle engine, to be explained in the next section, which completes the cycle in two strokes, requiring only one complete revolution of the crank.

The Two-stroke Cycle Engine.—The two-stroke cycle engine carries out the gas-engine cycle in two strokes by precompressing the mixture of fuel and air in a separate chamber, and by having the events of expansion, exhaust and admission occur during the same stroke of the piston. The precompression of the mixture is accomplished in some engines by having a tightly closed crank case, and in other types by closing the crank end of the cylinder, and providing a stuffing box for the piston rod. Large two-stroke cycle engines are usually made double-acting and an additional cylinder is provided for the precompression of the mixture.

The principle of the two-stroke cycle internal-combustion engine is illustrated in Fig. 69. On the upward stroke of the piston P , a partial vacuum is created in the crank case C , and the explosive mixture of fuel and air is drawn in through a valve at A . At the same time a mixture previously taken into the upper part of the cylinder W is compressed. Near the end of this compression stroke, the mixture is fired from a spark pro-

duced by the spark plug *S*. This produces an increase in pressure which drives the piston on its downward or working stroke. The piston descending compresses the mixture in the crank case to several pounds above atmospheric, the admission valve at *A* being closed as soon as the pressure in the crank case ex-

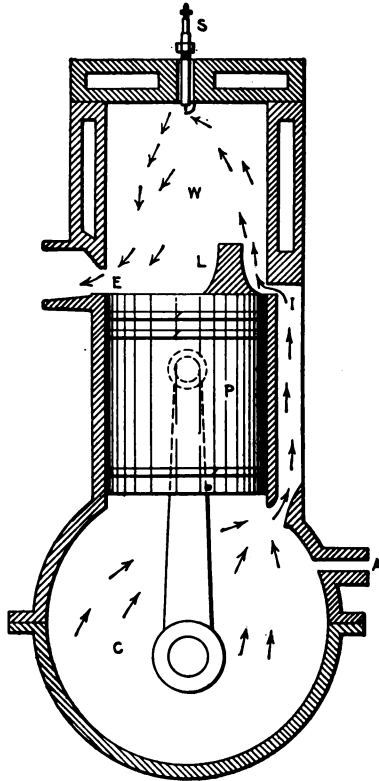

FIG. 69.—Two-stroke cycle engine.

ceeds atmospheric. When the piston is very near the end of its downward stroke, it uncovers the exhaust port at *E* and allows the burned gases to escape into the atmosphere. The piston continuing on its downward stroke next uncovers the port at *I*, allowing the slightly compressed mixture in the crank case *C* to rush into the working part of the cylinder *W*.

The distinctive feature of the two-stroke cycle engine is the

absence of valves. The transfer port *I* from the crank case *C* to the working part of the cylinder *W*, as well as the exhaust port *E*, are opened and closed by the piston.

Comparison of Two-stroke Cycle and Four-stroke Cycle Engines.—To offset the advantages resulting from fewer valves, less weight and greater frequency of working strokes, the two-stroke cycle engine is usually less economical in fuel consumption and not as reliable as the four-stroke cycle engine. As the inlet port *I* is opened while the exhaust of the gases takes place at *E*, there is always some chance that part of the fresh mixture will pass out through the exhaust port. Closing the exhaust port too soon will cause a decrease in power and efficiency, on account of the mixing of the inert burned gases with the fresh mixture. By carefully proportioning the size and location of the ports, and by providing the piston with a lip *L* (Fig. 69) to direct the incoming mixture toward the cylinder head, the above losses may be decreased. In any case the scavenging of the cylinder cannot be as complete in the two-stroke cycle as in the four-stroke cycle engine, where one full stroke of the piston is allowed for the removal of the exhaust gases. The four-stroke cycle engine also has the advantages of wider use and of longer period of development.

The two-stroke cycle engine can be made to run in either direction by a simple modification of the ignition timing mechanism. This feature, and its light weight, makes the two-stroke cycle engine especially adaptable for the propulsion of small boats. For stationary purposes, in small and medium sizes, and for the propulsion of traction engines, automobiles and other vehicles, the four-stroke cycle engine is usually to be preferred on account of its reliability and somewhat better fuel economy.

Gas-engine Fuels.—Fuels for internal-combustion engines may be classified as solid, liquid and gaseous. The value of a fuel for gas-engine use depends on the amount of heat liberated when the fuel is burned, on the cost of the fuel, and on the cost of preparing the fuel for use in the gas-engine cylinder.

As was explained in the earlier part of this chapter, the fuel entering the gas-engine cylinder must be in the form of a vapor or a gas. For this reason where a gaseous fuel can be obtained

at low cost, the complications of the engine mechanism are reduced. In or near the natural gas regions, no other gas-engine fuel is a competitor of the natural gas. Also in connection with certain industrial processes, certain gaseous fuels are obtained as byproducts and are utilized with good results in gas engines. Illuminating gas is usually too expensive for a gas-engine fuel.

Where solid fuels are cheap and petroleum oils are expensive, an artificial gas, suitable for gas engine use, can be generated in a gas producer. A gas producer consists essentially of a tall shell filled with coal, coke, or with some other solid fuel and supplied with a blast of air and steam. Due to the thickness of the fuel bed the combustion of the fuel is incomplete and a combustible gas is formed. The steam supplied with the blast enriches the gas and prevents the formation of clinker by keeping down the temperature of the fuel bed. Producer gas is not used at the present time as a fuel for farm motors, although experiments are being carried on with a gas producer as a possible power plant for gas traction engines.

As a portable engine for small powers, the internal-combustion engine using some liquid fuel has the greatest field of application. Such engines are especially suitable for intermittent work and are ideal for farm use.

The liquid fuels used in internal-combustion engines are gasoline, kerosene, crude petroleum, fuel oil and alcohol.

Gasoline and Other Distillates of Crude Petroleum.—Gasoline and kerosene are among the lighter distillates of crude petroleum. The so-called distillates are obtained by boiling or refining crude petroleum in large retorts or stills, and condensing the vapors which are driven off at various temperatures.

The vapors which are condensed into gasoline are driven off at temperatures of 140° to 160°F. The various grades of kerosene are the condensed vapors, driven off at temperatures of 250° to 400°F., and the heavy oils are driven off at still higher temperatures.

Of all petroleum distillates, gasoline is the most important fuel for small internal-combustion engines. The yield of gasoline, however, is very small in comparison with the heavier distillates. By refining American petroleum, an average of less than 15 per cent. of gasoline is obtained and usually about 50 per cent. of kerosene. This makes gasoline more expensive than other

petroleum fuels. However, as a fuel for small and portable engines it has the advantages of quick starting and greater reliability, which more than make up for the greater cost. Processes are now being perfected for extracting greater quantities of gasoline from crude petroleum, and there is little doubt that gasoline will remain for many years to come the most important fuel for small internal-combustion engines and for gasoline automobiles.

Gasoline has a flash point of 10° to 20° F. This means that it forms an inflammable vapor at that low temperature, provided a sufficient supply of air is present. For this reason care must be taken in the handling of gasoline. A good storage tank free from leaks and placed underground contributes greatly to the safety, as well as to the economical use of gasoline. When filling a gasoline storage tank or in handling gasoline, care must be taken not to have any unprotected flame nearby. In case gasoline takes fire at the engine or at the storage tank, it is best to extinguish it by means of wet sawdust. Sand or dirt will do in an emergency, but if it finds its way into the engine cylinder, it may cause considerable damage by cutting the rubbing surfaces.

Kerosene, which can be secured in greater quantities than gasoline, and which has a rather limited market, is the fuel next to gasoline, among the products of crude petroleum, for use in oil engines. This fuel is more difficult to vaporize at ordinary temperatures and presents a more difficult problem when used in oil engines than does gasoline.

The flash point of kerosene is 70° to 150° F., depending on the grade. As the flash point of oil is a measure of its safety, a kerosene of a lower flash point than 120° F. is dangerous for use as an illuminating oil in lamps. The lower the flash point of an oil the better it is for gas-engine use, as less heat is required to vaporize it ready for use in the engine cylinder.

Very light gasoline has a specific gravity of from 0.65 to 0.74.

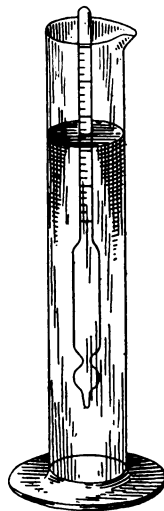

FIG. 70.—Hydrometer.

TABLE 5.—RELATION BETWEEN SPECIFIC GRAVITY, THE BAUMÉ HYDROMETER SCALE, AND THE WEIGHT PER GALLON

Specific gravity	Degrees Baumé	Pounds per gallon	Specific gravity	Degrees Baumé	Pounds per gallon
1.000	10	8.336	0.775	51	6.462
0.993	11	8.277	0.771	52	6.428
0.986	12	8.220	0.767	53	6.394
0.979	13	8.161	0.763	54	6.358
0.972	14	8.104	0.759	55	6.324
0.966	15	8.051	0.755	56	6.290
0.959	16	7.997	0.751	57	6.258
0.953	17	7.944	0.747	58	6.212
0.947	18	7.891	0.743	59	6.195
0.940	19	7.837	0.739	60	6.163
0.934	20	7.785	0.736	61	6.133
0.928	21	7.736	0.732	62	6.101
0.922	22	7.687	0.728	63	6.070
0.916	23	7.638	0.724	64	6.038
0.911	24	7.590	0.721	65	6.006
0.905	25	7.541	0.717	66	5.975
0.899	26	7.493	0.713	67	5.946
0.893	27	7.444	0.710	68	5.916
0.887	28	7.395	0.706	69	5.886
0.881	29	7.347	0.703	70	5.856
0.876	30	7.298	0.699	71	5.827
0.870	31	7.254	0.696	72	5.797
0.865	32	7.210	0.692	73	5.771
0.860	33	7.166	0.689	74	5.743
0.854	34	7.122	0.686	75	5.715
0.849	35	7.079	0.682	76	5.688
0.844	36	7.038	0.679	77	5.659
0.840	37	6.998	0.676	78	5.632
0.835	38	6.966	0.672	79	5.603
0.830	39	6.918	0.669	80	5.576
0.825	40	6.878	0.666	81	5.548
0.820	41	6.839	0.662	82	5.517
0.816	42	6.804	0.658	83	5.487
0.811	43	6.760	0.655	84	5.457
0.806	44	6.721	0.651	85	5.427
0.802	45	6.683	0.648	86	5.402
0.797	46	6.644	0.645	87	5.374
0.793	47	6.608	0.642	88	5.353
0.788	48	6.571	0.639	89	5.316
0.784	49	6.534	0.639	90	5.304
0.779	50	6.498			

The specific gravity of kerosene is 0.78 to 0.86, of crude oil 0.87 to 0.90, and of fuel oil 0.90 to 0.94. The specific gravity of petroleum fuels is usually given in degrees of the Baumé hydrometer. Commercial gasoline will test from 50° to 65°Bé. This means that when a hydrometer is placed in the gasoline (Fig. 70), it will sink to a depth as will indicate 50° to 65°, the lighter gasoline showing the greater value. The relations existing between the specific gravity of various liquid fuels, the degrees on the Baumé hydrometer, and the weight of a fuel in pounds per gallon are given in Table 5.

A study of Table 5 shows that the weight per gallon of the heavier oil is greater than that of the lighter oils. Since the calorific value per pound of the various petroleum fuels is very nearly the same (see Table 4, Chapter III), and liquid fuels are bought by the gallon, it is evident that the total heat in a gallon of kerosene or in that of the still heavier oil, is much greater than the heat in a gallon of gasoline. Kerosene for farm use has the further advantages over gasoline in that it can be obtained everywhere, is cheaper, can be used for illumination in lamps and is not so dangerous.

Any good gasoline engine can be easily changed into one suitable for kerosene fuel. Such engines are started on gasoline and changed over to kerosene as soon as the cylinder walls become hot. Several types of engines, to be described later, will start on kerosene and will also operate on crude petroleum and on fuel oil. The first cost of such engines is greater than that of a gasoline engine, and these are used mainly in sizes of 25 hp. and larger for the driving of pumps in irrigation plants, and also in connection with electric light plants for towns or cities.

The various types of gas tractors, to be described in another chapter, are usually started on gasoline and operate with kerosene or with solar oil, which is a heavier distillate than kerosene.

In general, an engine running on petroleum fuel other than gasoline is more difficult to start and requires greater care and more frequent cleaning of valves and pistons. For small engines gasoline has sufficient advantages to give it the preference to the cheaper petroleum fuels.

Alcohol as a Fuel for Gas-engine Use.—Alcohol as a fuel for gas-engine use has many advantages as compared with the

petroleum distillates. It is less dangerous than gasoline, its products of combustion are odorless, and it lends itself to greater compression pressures than do the various petroleum fuels. Experiments show that an engine designed to stand the compression pressures before ignition most suitable for alcohol will develop about 30 per cent. more power than a gasoline engine of the same size, stroke and speed. Alcohol, when used as a fuel in the ordinary gasoline engine, and with the common compression pressures for gasoline fuel, will show a much poorer economy than gasoline, or kerosene. Engines operating with alcohol fuel are difficult to start and the operation at variable loads is less certain than with gasoline fuel.

Several years ago, when the internal revenue tax was removed from alcohol, so denatured as to destroy its character as a beverage, it was expected that denatured alcohol would become a very important fuel for use in gas engines. Its price up to this date, however, has been so much higher than that of gasoline, the most expensive of petroleum fuels, that its use in gas engines is still out of the question. It is probable that, as the cost of the petroleum distillates increases, and processes are developed for producing denatured alcohol at a low price, the alcohol engine will come into prominence as a motor for farm use.

American denatured alcohol consists of 100 volumes of ethyl (grain) alcohol, mixed with 10 volumes of methyl (wood) alcohol and with 0.5 volume of benzol.

The specific gravity of denatured alcohol is about 0.795 and its calorific value is about two-thirds that of petroleum fuels. Alcohol requires less air for combustion than do petroleum fuels. Theoretically, the calorific value of a cubic foot of explosive mixtures of alcohol and of gasoline is about the same. Actual tests show that the fuel economy per horsepower is about the same for both fuels provided the compression pressures before ignition are best suited for the particular fuel used. In gasoline engines, a compression pressure of about 75 lb. is used, while the alcohol engine gives best results, as far as economy and capacity are concerned, when the compression pressure before ignition is 180 lb. per square inch.

Essential Parts of a Four-stroke Cycle Gas Engine.—The essential parts of a gas engine are illustrated in Fig. 71. The fuel

from the liquid fuel tank *T* is supplied to the mixing valve or carburetor through the fuel-regulating valve *G*. The air, through the air pipe *A*, enters the same carburetor and is thoroughly mixed with the fuel. The mixture of air and vaporized fuel enters the engine cylinder *C* through the inlet valve *V* as the piston *P* moves on the suction stroke. The mixture is then compressed, and ignited by an electric spark produced, at the spark plug *Z*, by current furnished from the battery *B*. The ignition of the mixture is followed by the power stroke. The reciprocating motion of the piston *P* is communicated, through the connecting rod *R*, to

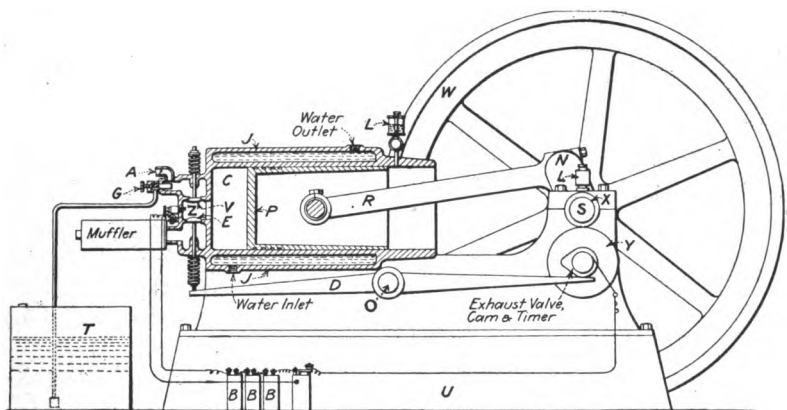

FIG. 71.—Parts of a four-stroke cycle gas engine.

the crank *N*, and is changed into rotary motion at the crankshaft *S*. The crankshaft *S*, while driving the machinery to which it is connected, also turns the valve gear shaft, sometimes called the two-to-one shaft, through the gears *X* and *Y*. The gear *Y* turns once for every two revolutions of the crank, and near the end of the power stroke opens the exhaust valve *E* through the rod *D* pivoted at *O*. In larger engines this valve gear shaft also opens and closes the admission valve *V* and operates the fuel pump and ignition system. As the temperatures resulting from the ignition of the explosive mixture is usually over 2,000°F., some method of cooling the walls of the cylinder must be used, in order to facilitate lubrication, to prevent the moving parts from being twisted out of shape and to avoid the ignition of the explosive mixture at the wrong time of the cycle. One method of cooling

gas engines is to jacket the cylinder *J*, that is, to construct a double-walled cylinder and circulate water between the two walls, through the jacket space. The base *U* supports the various parts of the engine; the flywheel *W* carries the engine through the idle strokes. Besides the above details, every gas engine is usually provided with lubricators *L* for the cylinder and bearings, and with a governor for keeping the speed constant at variable loads.

The majority of farm gas engines are of the single-acting type. This means the combustion (burning) of the fuel takes place at one end of the piston only.

The various parts of horizontal and vertical gasoline engines are illustrated and named in Figs. 72 and 73.

Carburetors for Gasoline Engines.—The function of a carburetor is to vaporize the gasoline, mix it with the correct proportion of air to form an explosive mixture and then deliver the mixture to the engine cylinder.

A mixture of fuel and air in the proper proportions is one of the most important factors essential to the economical and reliable operation of a gasoline engine. If too little air is present, or if the mixture is too rich, the fuel will not burn completely. This will result in loss of power, the exhaust from the engine will be darkened and odorous, and the unburned fuel may explode in the exhaust pipe, when it meets more air. If the mixture has too little gasoline, or is too lean, it will be slow-burning. In fact, it may still be burning when the inlet valve opens on the suction stroke, and the flame, flashing back through the inlet valve into the carburetor, may produce what is commonly called "back-firing." Faulty timing of valves, or a badly leaking valve, may also cause back-firing.

In some early forms of carburetors the air was passed over the surface of the gasoline on its way to the engine and became saturated with the fuel. In another type, called the bubbling carburetor, the air was made to bubble through the fuel. The objection to these types of carburetors is that the air combines with only the more volatile portion of the fuel, leaving the heavier constituents not vaporized.

The modern carburetors are of the spray or nozzle type, that is, the gasoline is injected into the entering air through a nozzle

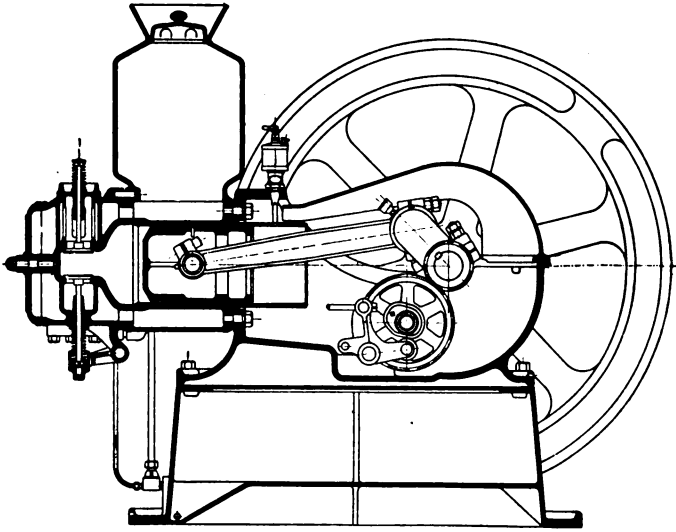

FIG. 72.—Hopper-cooled gasoline engine.

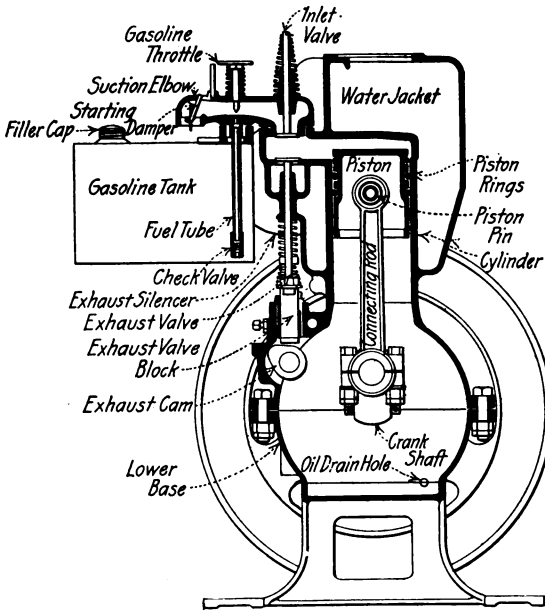

FIG. 73.—Vertical gasoline engine.

in the form of a finely divided spray. In the best forms of spray carburetors the fuel is delivered to the nozzle at constant pressure by maintaining the fuel at a constant level in the carburetor, either by means of an overflow pipe or by a float.

To the first type belong the mixer valves, or pump-feed carburetors, in which constant pressure is obtained by a pump and an overflow pipe keeping the height of the fuel at a constant level in a small reservoir. This type of carburetor is well suited for stationary and for semiportable engines. Pump-feed carburetors are also used to a limited extent on traction engines. This form of carburetor is well adapted for a fuel supply which is located in a tank underground and at a considerable distance.

For automobiles, boats, portable engines and for traction engines the float-feed type of carburetor is best-adapted. In this type of carburetor the gasoline is admitted to a float chamber, by gravity, from a tank placed above the carburetor. The gasoline flows out of the float chamber by a spray nozzle, the level of the fuel in the chamber being regulated by a copper or by a cork float which operates the gasoline valve. Most carburetors of the float-feed type are automatic in their action in that the quality of the mixture is regulated, by auxiliary air inlet valves, to suit the speed at which the motor is running.

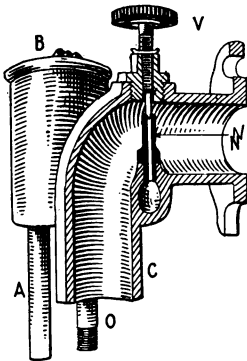

FIG. 74.—Pump-feed carburetor.

One form of mixer valve, or pump-feed carburetor, is illustrated in Fig. 74. A pump operated by the valve gear shaft of the engine forces the gasoline through the supply pipe *A* to the reservoir *B*. *O* is the overflow or return pipe which maintains the fuel at a constant level in the reservoir, and slightly below the point at which the needle valve *V* enters the gasoline nozzle *N*. When the piston of the engine starts on the suction stroke, a partial vacuum is created in the cylinder; the inlet valve is opened and a current of air is forced by the atmospheric pressure into the cylinder. This current of air enters through the air pipe *C*, attains a high velocity, and carries with it into the cylinder

a portion of the gasoline vapor. This is the reason why the air passage of a carburetor is so arranged, that the velocity of the air is increased as it passes around the gasoline spray nozzle. The greater the velocity of the air at the nozzle the more vapor

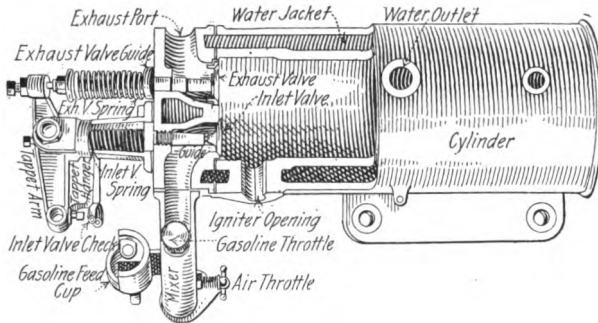

FIG. 75.—Pump-feed carburetor and engine cylinder.

is carried into the engine cylinder. When starting an engine by hand with this form of carburetor, a damper or throttle in the air pipe is closed, so that the velocity of the air is increased sufficiently to admit the fuel to the cylinder. The relative positions of the air throttle and mixer are illustrated in Fig. 75.

Another form of spray nozzle carburetors is illustrated in Fig. 76. Air enters at the lower opening *C*, gasoline flows in at (5), and the mixture of the air and fuel leaves the mixer valve at *B*. The amount of gasoline fed is regulated by adjusting the needle valve at *P*. When the engine piston moves on its outward stroke, the disc *F* is raised by suction, drawing in a charge of air, through the seat opening and past the gasoline port, into the mixing chamber above *F*. The lift and movement of the valve *F*, and consequently the quantity of the mixture to the cylinder, is regulated by the stem (6). The gasoline is supplied from a tank above the carburetor. This form of carbureter is much used for two-stroke cycle engines, as it facilitates easy starting,

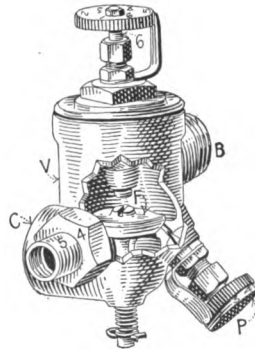

FIG. 76.—Gravity carburetor.

but is somewhat dangerous on account of the possibility of gasoline leakage.

In small stationary engines the form shown in Fig. 77 is often used. This carburetor consists essentially of a needle valve *N*, which regulates the fuel, and a check ball valve *B* which maintains the level of the fuel.

Automatic or float-feed carburetors are provided with two chambers, one a float chamber in which a constant level of the fuel is maintained by means of a float, the other a mixing chamber through which the air passes and mixes with the fuel. The float and mixing valves may be placed side by side, or the two chambers may be constructed concentric; that is, the float is placed around the spray nozzle.

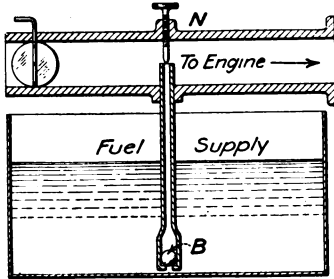

FIG. 77.—Suction-feed carburetor.

The concentric type keeps the fuel at the predetermined level much better than the carburetor with the chambers side by side.

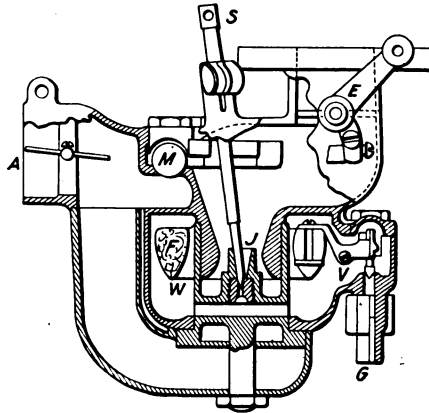

FIG. 78.—Kingston carburetor.

The concentric float-feed type of carburetor is illustrated in Fig. 78. *F* represents the float, which operates the float valve *V* and regulates the amount of gasoline entering the float chamber *W* through fuel inlet at *G*. The air inlet to the carburetor is

at *A*. *S* is the gasoline-adjusting screw which regulates the needle valve. The mixing chamber around the top of the spraying nozzle *J* is constructed so as to increase the velocity of the air at that point. This part is called the throat or Venturi tube of the carburetor. The amount of mixture which is allowed to pass to the engine cylinder is regulated by the throttle *E*. As the throttle *E* is opened and the speed of the motor increases, the velocity of the air at the Venturi passage becomes great and too much fuel is pulled in by the air. To overcome this, carburetors

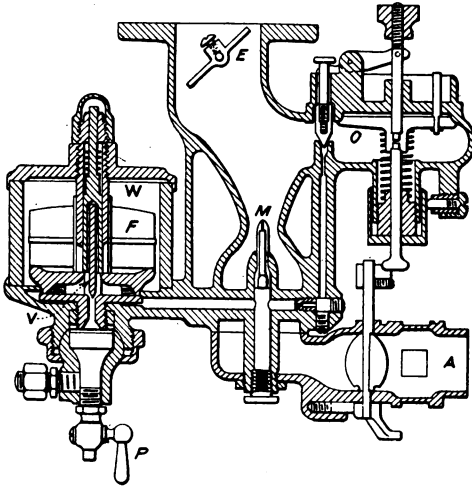

FIG. 79.—Stromberg carburetor.

of this type are arranged with auxiliary valves which are controlled by the balls *M*. These auxiliary valves admit more air as the speed of the motor increases, diluting the mixture before it is allowed to enter the engine cylinder.

A float-feed carburetor with the two chambers side by side is illustrated in Fig. 79. In the float chamber is placed a float *F* which operates the float valve *V* and regulates the amount of fuel entering the float chamber *W*. The main air inlet is at *A*. When the float chamber becomes filled with gasoline to a certain level, the float closes the needle valve *V*, and the flow of fuel is stopped. The fuel from the float chamber enters the mixing chamber *M*, at the right, and is picked up by the air entering at *A*. The mixture passes to the engine cylinder through the throttle *E*.

The auxiliary air valve *O* is operated by a spring and regulates the quality of the mixture in proportion to the speed of the

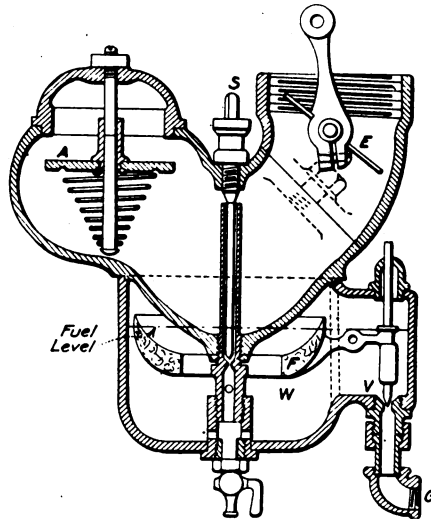

FIG. 80.—Bennett carburetor.

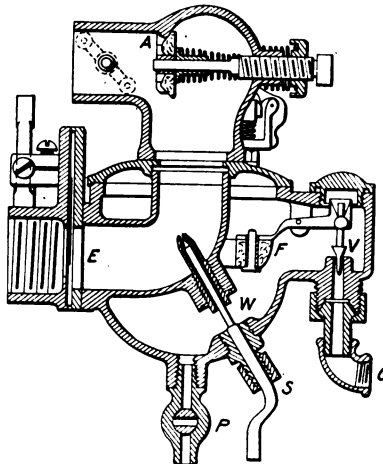

FIG. 81.—Schebler carburetor.

engine and in a manner similar to the ball valves in the carburetor of Fig. 78. In some forms of carburetors an enlarged main air inlet takes the place of the auxiliary valve. In others, the con-

nection to the throttle regulates the fuel needle valve, or the air inlet, to suit the speed of the engine and the load on the engine. Two other forms of float-feed carburetors are shown in Figs. 80 and 81. The parts of these carburetors are designated by the same letters as the similar parts in Figs. 78 and 79.

The concentric type of carburetor is usually preferred on account of the fact that the pressure on the spray nozzle can be kept more nearly constant in this type than in the carburetor where the float and mixing chambers are placed side by side.

Floats for carburetors are made either of cork or of metal. The hollow metal float is more expensive and is more liable to leak. Cork floats, when covered thoroughly with shellac, will not lose their buoyancy, but there is some danger that particles may become detached from the cork and clog the passages leading to the spray nozzle.

The carburetor float chamber is usually provided with a pet-cock at its lowest point (*P* in Fig. 79), for drawing off poorer grades of gasoline and also water.

In automobile practice, multiple-jet carburetors are sometimes used. The multiple-jet carburetor has two or more spray nozzles and this enables the engine to draw the correct proportion of fuel and air at high speeds.

The action of the carburetor, Fig. 80, is that of a multiple-jet type. In starting, this form operates as a surface carburetor, but the mixture becomes diluted as the engine speeds up.

Most float-feed carburetors are provided with some hand-operated method for priming the carburetor. This is accomplished by depressing the float, so that an excess of gasoline may be allowed to enter the mixing chamber. Another method is by throttling the air.

To overcome carburetor troubles on account of climatic conditions, or where low-grade gasoline is used, the carburetor should be jacketed by hot water. A hot-air connection to the carburetor will also overcome this difficulty. In automobiles in which the thermo-syphon system of water circulation is employed, exhaust gases from the engine are used for jacketing the carburetor, instead of hot water. Hot jackets are also advantageous in cold weather and prevent the use of rich mixtures and the consequent low fuel economy.

Carbureting Kerosene and the Heavier Fuels.—The various forms of carburetors described cannot be used for kerosene or for the heavier petroleum fuels, as these fuels are less volatile than gasoline at ordinary temperatures and pressures. The heavier the fuel the more heat is required to vaporize it.

A kerosene carburetor, used on some forms of traction engines, is

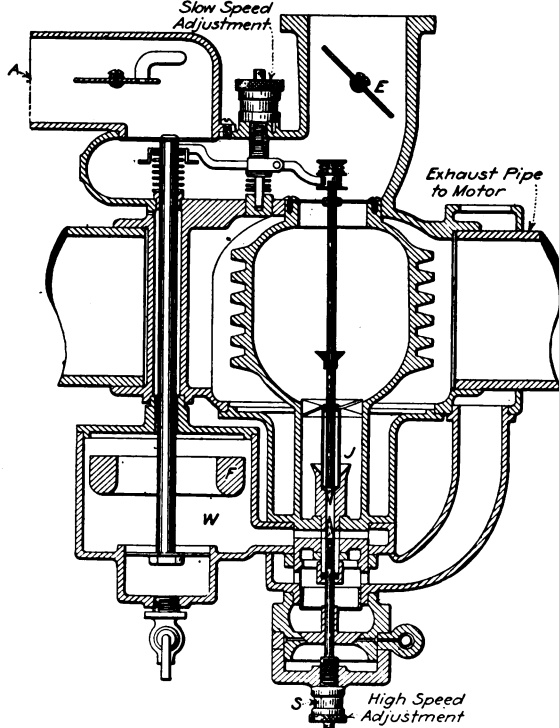

FIG. 82.—Kerosene carburetor.

illustrated in Fig. 82; the parts of this carburetor are designated by the same letters as similar parts in Fig. 78.

An ordinary gasoline engine will operate with kerosene fuel, if started on gasoline, but carbon deposits in the cylinder will necessitate frequent cleaning of the cylinder walls, piston and rings.

Some engines work very successfully with kerosene and the heavier distillates, if the fuel is vaporized by the heat secured from

exhaust gases in a coil located entirely outside the engine cylinder. It has been found that the injection of water with the fuel reduces the carbon deposits in the cylinder and improves the operation of the engine. Water injection increases the capacity of an oil engine when operating with the heavier petroleum fuels, but decreases the economy. The supply of injection water should be cut off at light loads and used at heavy loads in amounts sufficient to prevent preignition. Preignition is indicated by a metallic knock within the cylinder.

Oil engines for burning petroleum fuels heavier than 35°Bé. have been perfected. These engines are either of the Diesel or semi-Diesel types, and ignite the fuel automatically. The principle of construction of engines for heavy fuels will be explained in the section on "ignition."

Cooling of Gas-engine Cylinder Walls.—The necessity for cooling gas-engine cylinder walls was explained in an earlier part of this chapter. In smaller engines only the cylinder or cylinder and cylinder head must be cooled. In large engines it becomes necessary to cool also the piston and exhaust valve.

Three methods are used for cooling gas engines:

1. Air-cooling.
2. Water-cooling.
3. Oil-cooling.

An air-cooled gasoline engine is illustrated in Figs. 83 and 84. The cylinder is cast with webs, and air is circulated by means of a fan driven from the engine. In very small engines natural air circulation is used. The air-cooling system has not been found practical for stationary engines above 5 hp. Even for small engines there is no positive temperature control with this system of cooling. This often results in the decomposition of the cylinder oil and in carbon deposits on the piston and cylinder walls.

Cooling of cylinder walls by means of water is the most common method. In this case the cylinder barrel or the cylinder barrel and cylinder head are jacketed; that is, they are built with double walls and water is circulated through the space between the walls. One method of water-cooling was illustrated in connection with the hopper-cooled engine in Fig. 72. In this case the water is heated by contact with the hot cylinder walls, rises and is replaced by cooler water.

Another system of water-cooling is to place a galvanized-iron tank filled with water near the engine and connect the lower part of the cylinder jacket to the bottom of the tank and the upper part of the jacket at the top of the tank (Fig. 85). The cold water enters the jacket at the bottom, is heated, rises and

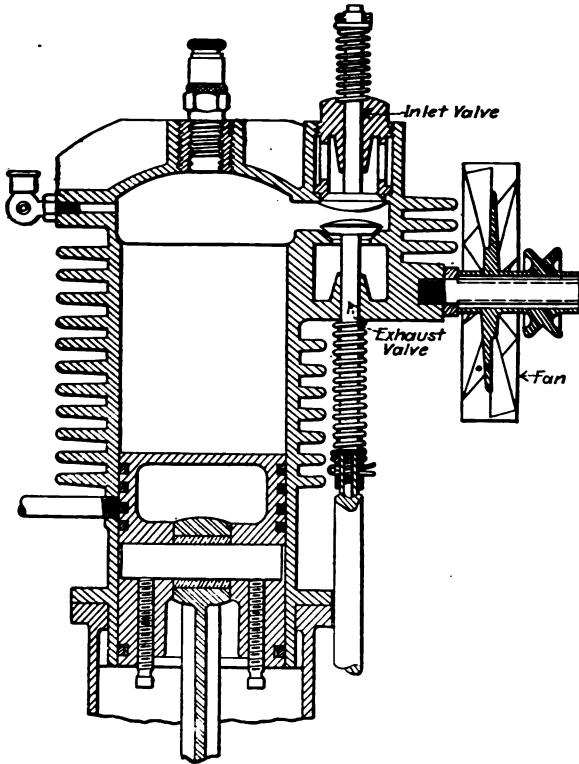

FIG. 83.—Air-cooled cylinder.

flows to the upper part of the tank, the water circulation being similar to that of the hopper-cooled engine.

In order to definitely control the temperature of the water jacket, the forced system of water circulation shown in Fig. 71 is preferable to the two described. This system is used when a constant source of water supply is available. The temperature in the jacket is usually maintained at about 150°.

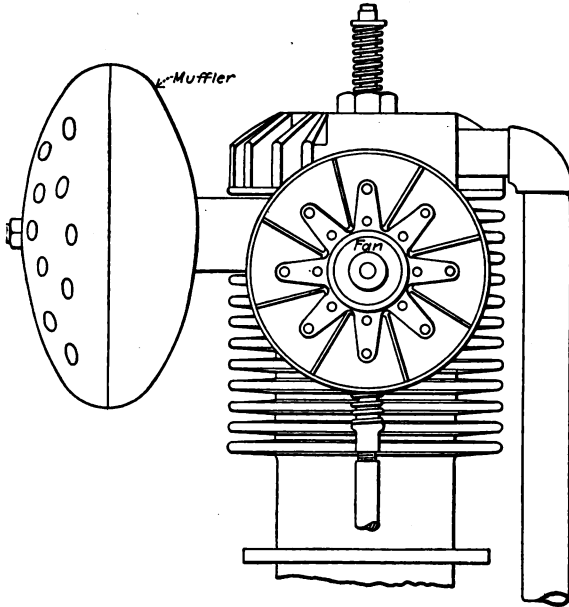

FIG. 84.—Air-cooled engine.

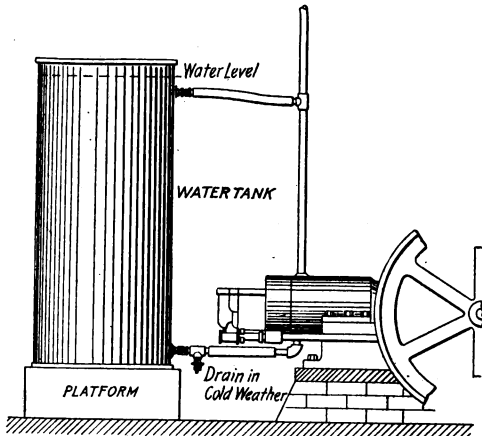

FIG. 85.—Gas-engine water-cooling system.

Another method of water-cooling by forced circulation, used quite extensively on small stationary and portable engines, is illustrated in Fig. 86. The water from the lower part of the tank *T* is forced by a pump through the jacket. The water enters the bottom of the jacket, and leaves from the top of the jacket by the pipe *P*. The water is then allowed to pass over the screen *S* and is cooled by evaporation before reëntering the tank. The advantage of this system is that the screen acts as a cooling tower

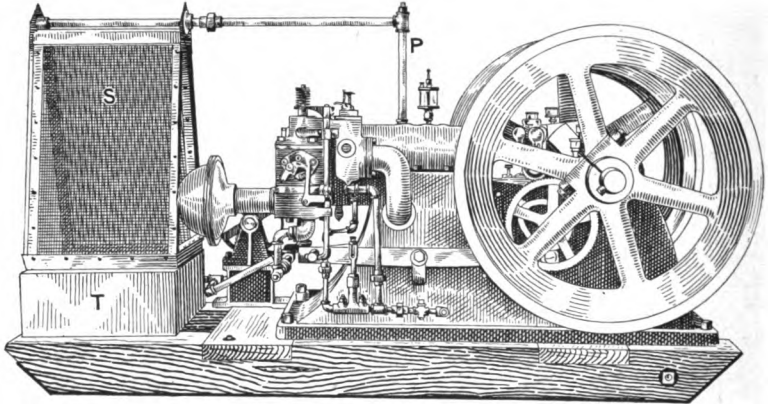

FIG. 86.—Gas-engine water-cooling system.

and reduces the weight of water which must be carried with the engine.

Automobiles and traction engines are provided with a cellular or tubular radiator for cooling the water from the cylinder jackets. The heated water passes through the radiator, where the rush of air to which it is exposed absorbs a portion of the heat and cools the water. A fan is arranged for inducing a cold current of air through the radiator.

Oil is being used for cooling gas-engine cylinders to a limited extent where the engines are exposed to low temperatures. The systems of oil-cooling are similar to water-cooling. In some cases natural circulation is employed, using hoppers or tanks, while in other types some form of forced cooling like the one illustrated in Fig. 71 is used. However, oil is not a satisfactory

cooling medium on account of its inability to take up heat as easily as water.

In some cases non-freezing mixtures composed of water, alcohol and glycerine have been used for cooling the cylinders of gas engines. Calcium chloride and common salt solutions have also been used to some extent for the cooling of engines. These mixtures will tend to prevent freezing and the consequent cracking of the jacket and cylinder walls during cold weather when the engine is not running.

When water is the cooling medium, the engine should be provided with a drain cock at the lowest point of the jacket, so that the jacket can be thoroughly drained in freezing weather.

Gas-engine Ignition Systems.—Ignition in all modern gas engines is accomplished either by an electric spark, or automatically by the high compression to which either the air or the mixture is subjected in the engine cylinder.

In some older makes of engines the hot-tube system of ignition is still employed, in which a tube, made of porcelain or of some nickel alloy, is open at one end to the cylinder and is closed at the other. The closed end of the tube is heated by a Bunsen burner. A portion of the explosive mixture is forced into the tube during the compression stroke of the piston, and is fired by the heat of the tube walls. Accurate timing of the point of ignition is quite impossible with the hot-tube system. The only points in favor of this system are the low first cost and cost of maintenance as compared with the electric system.

Electric Ignition Systems for Gas Engines.—Electric ignition for farm gas and oil engines has practically superseded every other form.

Electric ignition is produced by an electric spark or arc.

In one system the spark is similar to that produced when an electric circuit is broken by the opening of a switch, or when a wire connected to one pole of a battery is drawn across the other pole. This method is called the make-and-break system of ignition and is produced by contact and then quickly separating metallic points which are located within the clearance space of an engine cylinder.

In another system of electric ignition a current of high voltage (electrical pressure) is used which jumps across a small air gap. This system is called the jump-spark ignition system.

The electric current for producing the spark in the make-and-break system is usually obtained, from a primary battery of dry cells or of wet cells, from a storage battery, from a small low-voltage dynamo, or from a low-tension magneto. The electric pressure required is about 6 volts and can be produced by a battery of four to eight dry cells in series or by a storage battery of three or four cells in series.

The source of current for the jump-spark system may be, a battery of dry or of wet cells, a storage battery or a small dynamo.

Some form of magneto, as will be explained later, is often employed for this system of ignition.

Those not familiar with the fundamentals of electricity should study Chapter X before taking up electric ignition.

The Make-and-break System of Ignition.—The principle of the make-and-break system is illustrated in Fig. 87. *B* is a battery which supplies the electric current for ignition. *C* is an inductive spark coil, often called a

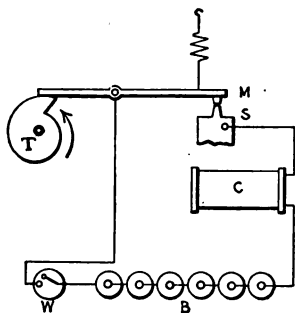

FIG. 87.—Make-and-break ignition system.

kick coil. It consists of a bundle of small soft iron wires, called the core, surrounded by a coil of many turns of insulated copper wire through which the current passes. On account of the inductive action of such a coil, the spark is greatly intensified, producing a strong arc with a small current from a battery of low voltage. *S* is a stationary electrode well-insulated from the engine and *M* is a movable electrode not insulated from the engine. Both electrodes are set in the combustion space of the cylinder. The contact points of the two electrodes are brought together by means of a cam *T* operated from the valve gear shaft of the engine. When the switch *W* is closed, current will flow through the circuit as soon as the contact points of the electrodes are brought together by the cam *T*. A sudden breaking of the contact, aided by a spring, causes a spark to pass between the points, which ignites the mixture. The more rapidly the electrodes are separated the better is the spark produced.

The contact between the two electrodes of the make-and-break

system can be made by sliding one contact point over the other, this being known as the wipe-spark igniter and is illustrated in Fig. 88. *A* is the movable and *B* is the stationary electrode.

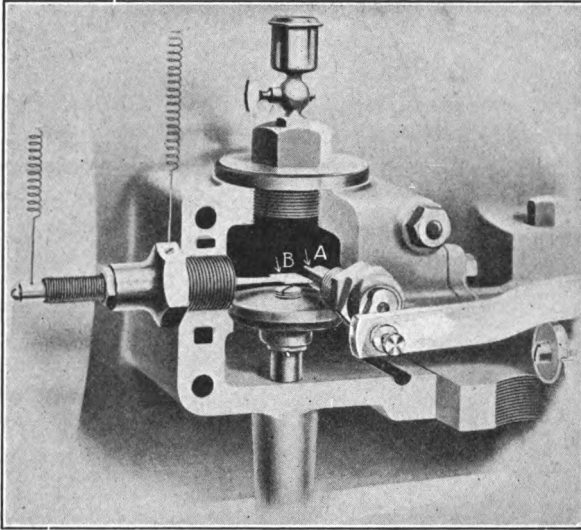

FIG. 88.—Wipe-spark igniter.

Another type, shown in Fig. 89, is called the hammer-break igniter. *S* is the stationary and *M* is the movable electrode.

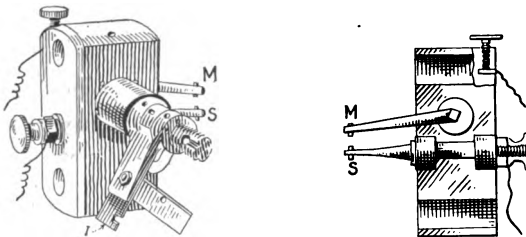

FIG. 89.—Hammer-break igniter.

The interrupter lever *I* is operated from a cam on the valve gear shaft until the two contact points *M* and *S*, which are located in the combustion space of the cylinder, are brought into contact. At the desired time, *I* is tripped and flies back, instantly break-

ing the contact and producing an arc between *M* and *S*. Another form of hammer make-and-break igniter is illustrated in Fig. 90, the contact points of which are designated *M* and *S*.

Wipe-spark igniters (Fig. 88) keep the contact points cleaner than hammer-break types (Figs. 89 and 90). The hammer-break igniter is more commonly used on account of the easier adjustment and less wear of the contact points.

To determine the point of ignition with the make-and-break system, the engine flywheel is turned over slowly until the igniter snaps. This is the point of ignition and should be marked on the flywheel and frame or on the piston and cylinder, so that the correct timing may be checked at any time.

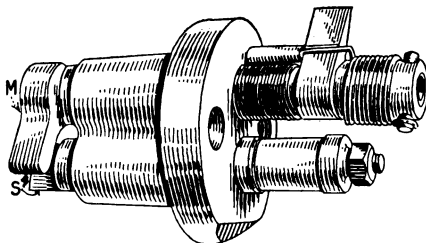

FIG. 90.—Hammer-break igniter.

To secure best results, the points of the igniter must be clean and free from carbon and corrosion, all connections must be tight, and the wires used for connecting electrodes with source of electricity must be of sufficient size to allow the current to flow freely.

The size of the inductance coil to be used in the make-and-break system depends upon the speed of the engine. For a high-speed engine, a short inductance coil should be employed, as the shorter the coil the quicker is the magnet brought to a saturated state. In the case of slow-speed engines, a larger coil can be used.

The Jump-spark System of Ignition.—The principle of the jump-spark system is illustrated in Fig. 91. *A* is a spark plug, the spark points *E* and *F* of which project into the cylinder. These spark points are stationary, insulated from each other, and separated by an air gap of about $\frac{1}{32}$ in. When the switch *W* is closed, the current from the battery *B* flows through the

timer T , which completes the circuit at the proper time through the induction coil I , and the induced high-voltage current produces a spark at the spark-plug gap, igniting the explosive mixture in the cylinder.

The induction coil I , Fig. 91, differs from the inductance coil used in connection with the make-and-break system of ignition, in that two layers of insulated wire are wound on the core C of the induction coil and only one layer in the case of an inductance coil. In an induction coil, one of the layers, called the primary P , consists of several turns of fairly large insulated copper wire. The other winding, the secondary S , consists of many turns of very fine insulated wire. The secondary is wound over the primary winding, but has no metallic contact with the primary. The current from the battery B enters the primary winding P of the induction coil and induces a high-voltage current in the secondary winding S .

R is the vibrator, sometimes called a trembler or an interrupter. The function of the vibrator R is to interrupt the primary circuit

with great rapidity; this action induces an alternating current in the secondary and a series of sparks at the air gap of the spark plug. In some types of induction coils, the vibrator is omitted and but one spark is produced at the spark plug.

K is known as an electric condenser. The condenser consists of alternate layers of tin foil and insulating material like paraffined paper. The condenser acts like an air chamber of a pump, in that it absorbs the excess of current at the primary winding, prevents sparking at the vibrator, and gives out this excess at the proper time to increase the intensity of the spark.

The condenser as well as the windings and the core of an induction coil are placed in a box made of wood, and the space between the parts is filled with an insulating material, usually paraffin or some similar wax mixture, in order to protect the

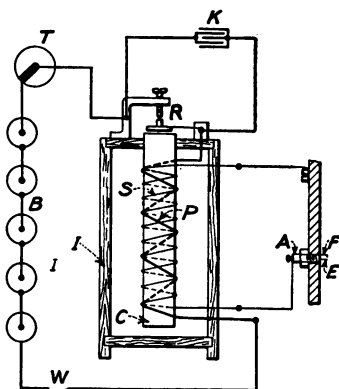

FIG. 91.—Jump-spark ignition system.

parts from moisture. A complete induction coil for a jump-spark system is shown in Fig. 92. Induction coils operate on about 6 volts.

Fig. 93 shows inductance coils suitable for make-and-break systems of ignition.

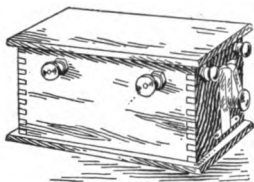

FIG. 92.—Induction coil.

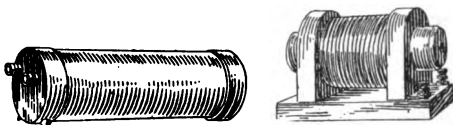

FIG. 93.—Inductance coils.

In automobile practice, where four or more cylinders are used, induction coils are made up in units, each unit supplying a spark to one cylinder. In some cases each coil has its own vibrator; in other types one vibrator, called a master vibrator, is so connected that it breaks the current for each induction coil in turn. The system with a master vibrator produces better timing of ignition, but an accident to the master vibrator interrupts the entire system.



FIG. 94.—Spark plug.

A spark plug used in connection with the jump-spark system of ignition is illustrated in Fig. 94. It consists essentially of two metallic points, well-insulated from each other. The central point is connected to the binding post which receives current from the secondary, or high-tension winding of the induction coil. The other point is not insulated from the thread, and completes the circuit

when the spark plug is in the engine cylinder.

Comparing the two systems of electric ignition, the jump-spark system is much more simple mechanically as it has no moving parts inside the cylinder. The make-and-break system is simpler electrically, requires less care in wiring, does not have to be insulated so carefully and the spark is more certain. It is difficult to lubricate the many mechanical parts of the make-and-break system. The make-and-break system is usually used on stationary slow-speed engines and to some extent on traction engines.

The jump-spark system is better adapted for high-speed and multiple-cylinder engines than is the make-and-break, and is used on automobiles, small stationary engines, marine engines and also on traction engines.

Ignition Dynamos.—An ignition dynamo is a miniature direct-current electric generator, built on the same plan as any large dynamo used for lighting (see Chapter X). It has electromagnets as field magnets and is usually of the iron-clad type. One form of ignition dynamo is shown in Fig. 95. In using an ignition dynamo the internal-combustion engine must be started on batteries, as the speed developed when turning the engine by hand is insufficient to produce a spark of sufficient intensity by the dynamo. As soon as the engine speeds up, the battery current is thrown off and the spark is supplied by the ignition dynamo. Most ignition dynamos will supply a spark of sufficient intensity for a make-and-break system of ignition without an inductance coil. A 5-volt and 3- to 5-amp. generator is suitable for make-and-break ignition. For jump-spark ignition a special induction coil must be used with the ignition dynamo.

Magnetos.—The magneto differs from the ignition dynamo in that its magnetic fields are permanent magnets. For this reason it is unnecessary to run the magneto for any length of time in order to build up its field. Magnetos can be operated in either direction and at any speed. Magnetos may be classed under two heads:

1. High-tension magnetos which generate sufficient voltage to jump the gap of a spark plug.
2. Low-tension magnetos which include all other types and are used in place of batteries or of batteries and inductance coil.

Low-tension Magnetos.—The low-tension magneto, shown in Fig. 96, is of the direct-current type and differs from the ignition dynamo (Fig. 95) in that the magneto field is a permanent magnet. This type of low-tension magneto can be used for charging a storage battery or for producing illumination on a very small scale. The direct current from the magneto (Fig. 96) is taken off by two brushes which press on the opposite sides of a commutator. This type of magneto is usually driven by a friction wheel or by a belt, and must be operated at high speeds.

Fig. 97 illustrates a low-tension alternating-current magneto. This type of magneto generates an alternating current of high frequency and can be used in connection with a vibrating in-

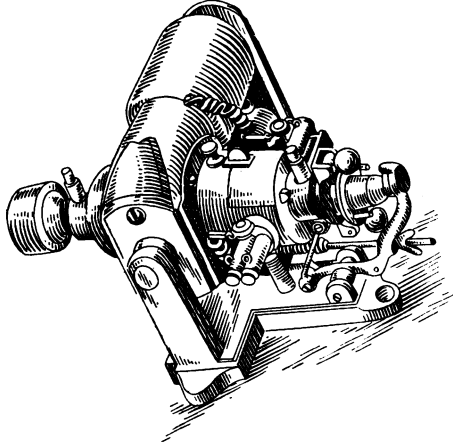

FIG. 95.—Ignition dynamo.

duction coil for jump-spark ignition systems. It is not necessary that this type of magneto be timed with the engine.

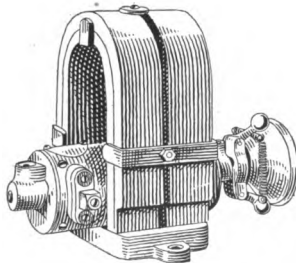

FIG. 96.—Low-tension direct-current magneto.

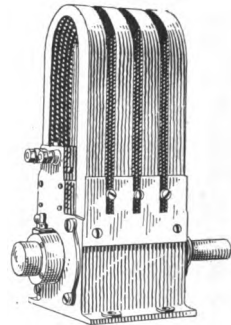

FIG. 97.—Low-tension alternating-current magneto.

The low-tension magneto (Fig. 98) also generates an alternating current, but differs from the low-tension magneto of Fig. 97 in that the alternating current is of low frequency. This type of

magneto is used mainly for the make-and-break system of ignition and takes the place of batteries and induction coil. The magneto of the type shown in Fig. 98 must be timed with the

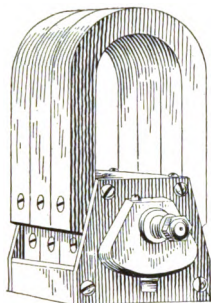

FIG. 98.—Low-tension low-frequency magneto.

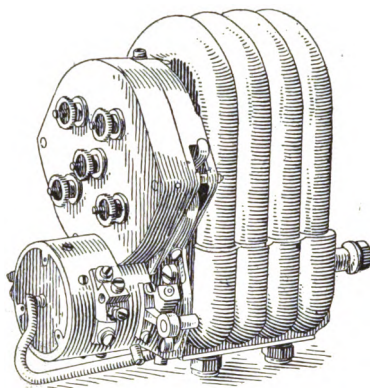

FIG. 99.—Magneto with circuit-breaker and distributor.

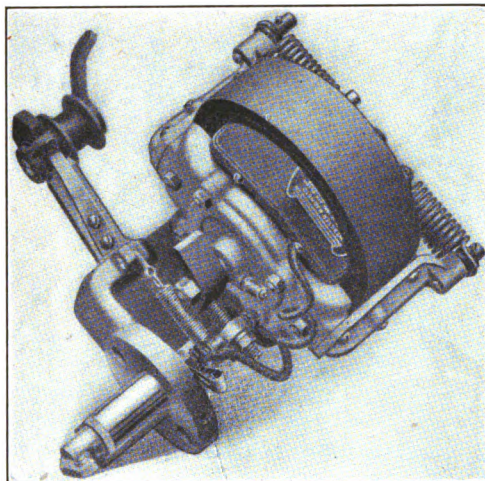

FIG. 100.—Oscillating magneto.

engine, as the current is produced only for a small portion of a revolution.

The magneto illustrated in Fig. 99 is also a low-tension alternating-current low-frequency magneto, but is equipped with a

circuit-breaker and distributor so that this form can be used for jump-spark system when connected with a non-vibrating induction coil. This type of low-tension magneto is often used in connection with the "dual system;" that is, with batteries for starting and magneto for operating.

Low-tension magnetos are sometimes built in the form of an oscillating magneto (Fig. 100). The oscillating magneto pro-

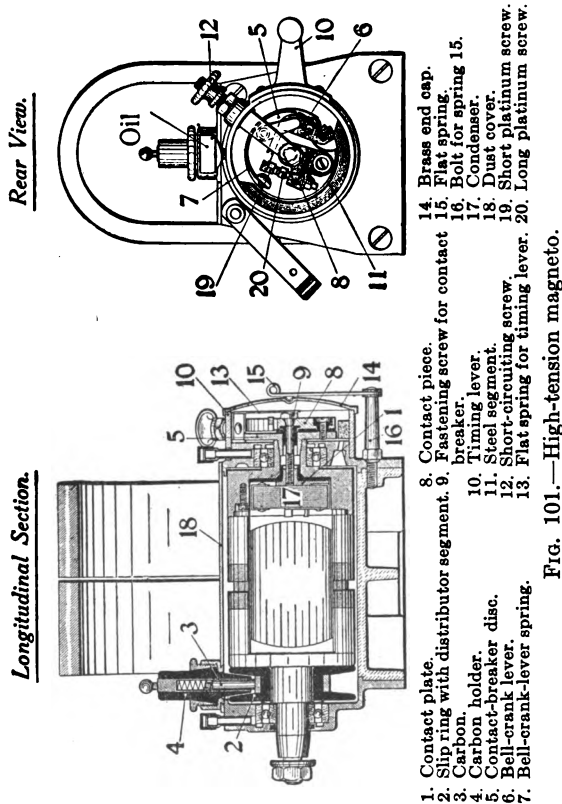

FIG. 101.—High-tension magneto.

duces a spark irrespective of the speed of the engine, which is an advantage in starting. This form of magneto is usually of the alternating-current low-frequency type and is best-adapted for slow-speed single-cylinder engines.

High-tension Magnetos.—A high-tension magneto is shown in Fig. 101. This type of magneto is used for the jump-spark

ignition systems and differs from the low-tension magnetos, in that the high-tension magneto can generate a high-voltage current without the aid of an induction coil. The armature of the high-tension magneto is provided with two windings, a primary and a secondary, carries a condenser and has a circuit-breaker at one end.

The high-tension magneto is provided with a distributor if it serves an engine with several cylinders. In traction engines and other large engines, the high-tension magneto is usually equipped with "impulse starters," which give intermittent

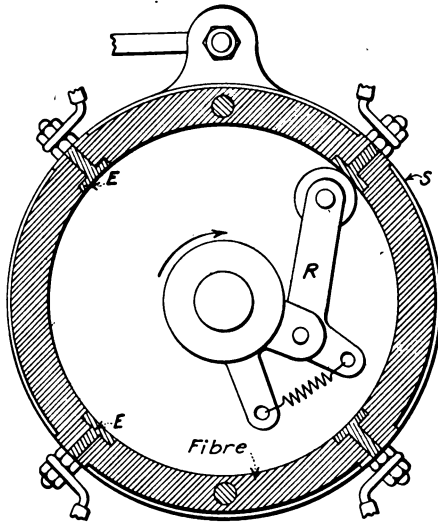

FIG. 102.—Timer.

rotation to the armature or to the rotating element of the magneto until the engine has attained a definite speed, after which time the magneto operates at constant speed.

Timers.—The function of a timer is to control the flow of the low-voltage current as it comes from the battery or magneto, by closing the primary circuit of the jump-spark system at the proper time. The timer consists of one stationary and of one rotating part. Both parts are insulated electrically from each other. One part is constructed of some insulating material, such as rubber or wood fiber, and has pieces of metal, called segments, set at defi-

nite distances apart, according to the number of cylinders and number of induction coils used. As the rotating part revolves, it comes into contact with these metal segments, completing the circuit. If a four-cylinder engine has induction coils for each one of the cylinders there is a metallic contact piece on the stationary part for each cylinder.

Two forms of timers are illustrated in Figs. 102 and 103. *S* is the stationary part of the timer, *R* is the revolving part, and *E* represents the segments which make contact as the timer revolves.

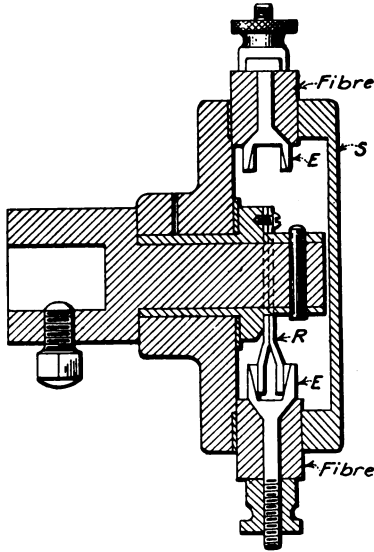

FIG. 103.—Timer.

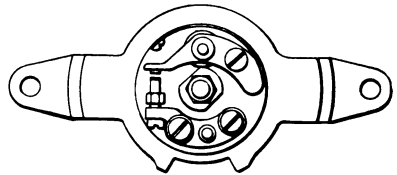

FIG. 104.—Circuit breaker.

In automobiles, the timer is connected to the spark lever on the steering wheel (Chapter V1).

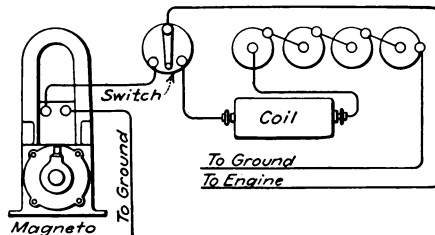

FIG. 105.—Wiring diagram, battery and magneto ignition.

Fig. 104 shows the construction of a circuit-breaker or interrupter. This form of timer is used in connection with high-tension magnetos or with a low-tension magneto and induction coil.

Fig. 105 shows a wiring diagram for a single-cylinder engine, with battery and magneto ignition.

Automatic Ignition for Oil Engines.—One type of oil engine, the Hornsby Akroyd, is illustrated in Fig. 106. The engine is provided with an unjacketed vaporizer *A*, which communicates with the cylinder by means of the small opening *B*. This vaporizer is raised to a red heat before starting, by means of a torch, and is kept hot by repeated explosions when the engine is running. This engine works on the regular four-stroke Otto gas-engine cycle. During the suction stroke of the piston only air is sucked

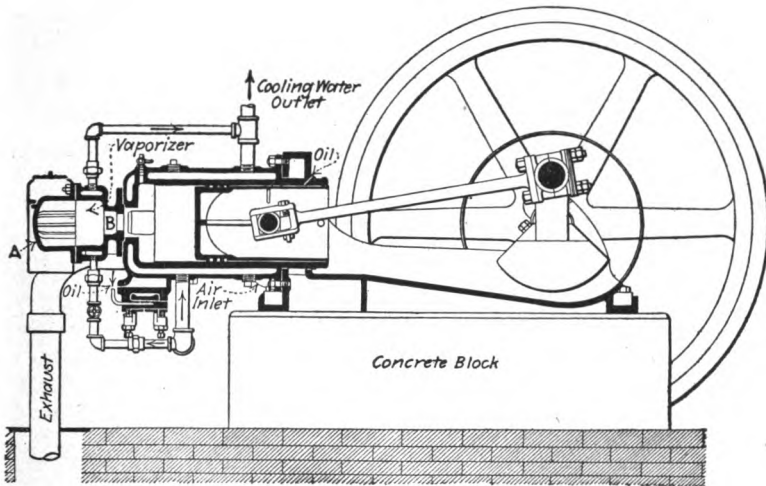

FIG. 106.—Hot-bulb oil engine.

into the cylinder and the charge of oil fuel is injected into the vaporizer by a pump. On the return stroke the air is compressed, forced in the vaporizer, mixed with the fuel and automatically ignited. This is followed by the expansion and exhaust strokes, as in other internal-combustion engines.

A modification of this type of engine is the so-called semi-Diesel type of oil engine, which is well-adapted for the burning of the lowest grades of petroleum fuels. In this case the air is compressed to about 250 lb. per square inch before the fuel is injected into the cylinder.

The Diesel engine was mentioned in the first part of this chap-

ter. It is very economical for the burning of low grades of fuel, but the high first cost of the engine limits its field of application in small sizes.

Lubrication of Gas and Oil Engines.—The selection of the proper lubricating oils and of the best oiling devices is of great importance, if reliability of operation and long life of an internal-combustion engine are desired.

The extremely high temperatures which are developed within the cylinder of a gas engine or of an oil engine and the absence of moisture make the selection of the proper oil a necessity. Oils employed for lubricating steam-engine cylinders are not suitable

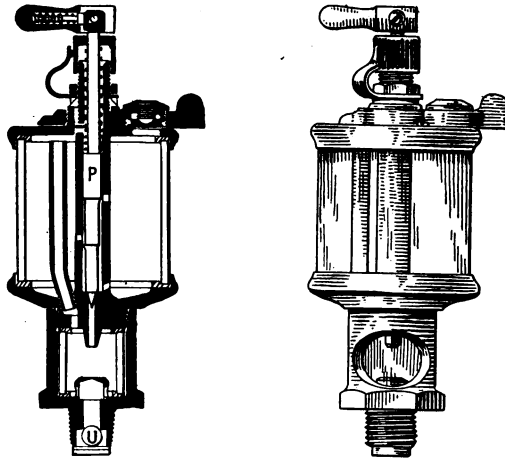

FIG. 107.—Sight-feed gas-engine oiler.

for internal-combustion engines. Such petroleum lubricating oils should be employed as are light, are fairly thin, will withstand high temperatures, are free from acid and from animal or vegetable matter and which will leave no carbon deposits. The lubricating oil should flow freely at all seasons of the year and should not easily vaporize at the high temperatures.

Oil which will gum or form carbon deposits will tend to make the piston rings stick or may produce preignition.

Graphite is satisfactory for lubricating certain parts of an internal-combustion engine outside the cylinder. In general, the gas-engine oil used for lubricating the engine cylinder will be

found satisfactory for bearings and other parts, but in large engines a saving can be produced by employing a cheaper oil for the bearings.

Single-cylinder gas and oil engines are usually lubricated by a sight-feed oiler (Fig. 107). This oiler differs from the ordinary sight-feed oiler in that a check ball (*U*) is used in order to guard the oiler during a portion of the cycle from the pressure within the cylinder.

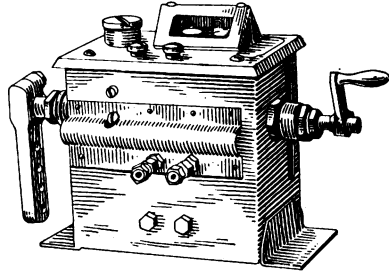

FIG. 108.—Mechanical oiler.

The mechanical oiler (Fig. 108) holds a large quantity of oil, is positive in action and requires little care. In high-speed motors, the forced-flooded system of lubrication is commonly employed (Fig. 109). In this

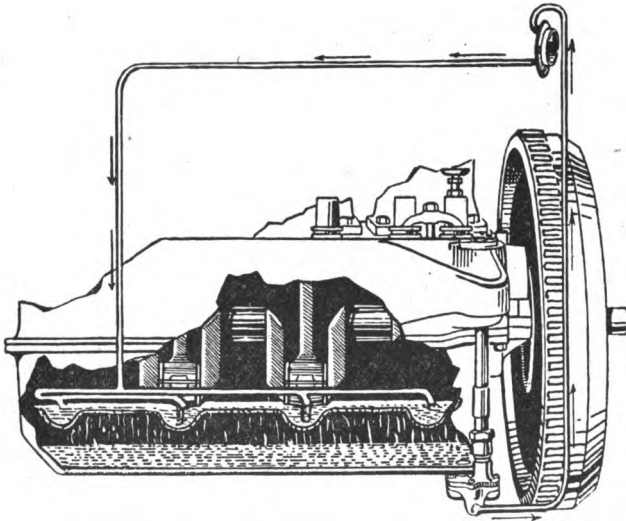

FIG. 109.—Forced-flooded lubrication system.

system a pump forces oil to the various bearings, keeping them flooded with oil at all times.

The splash system of oiling is usually more satisfactory with

gasoline engines than with kerosene engines, as the kerosene which gets by the piston is injurious to the lubricating properties of the oil in the crank case.

Governing of Gas Engines.—Every gas engine must be provided with some governing mechanism in order that its speed may be kept constant as the power developed by the engine varies. The governing mechanism is operated by the speed variations of the engine and the speed control is accomplished by the following methods.

1. Hit-or-miss Governing.—In this system the number of explosions is varied according to the load on the engine. This can be carried out in several ways, depending on the valve gear of the engine.

In the case of small engines, where the inlet valve is automatically operated by the vacuum created in the cylinder during the suction stroke, the governor operates on the exhaust valve by holding it open during the suction stroke. The free communication of the engine cylinder with the outside prevents the formation of sufficient vacuum in the cylinder to lift the inlet valve.

When the inlet valve is mechanically operated from the valve gear shaft, the governor acts on the inlet valve, keeping it closed part of the time at light loads. The governor used to accomplish this is usually some form of flyball governor. As the speed of the engine increases, the balls are thrown out by centrifugal force and shift the position of a cam on the valve gear shaft, preventing the opening of the inlet valve.

The hit-or-miss system of governing can also be carried out by having the governor open a switch, thus interrupting the flow of current to the igniter, as the load decreases. This method is very wasteful of fuel as the fuel drawn in at each suction stroke passes through the engine and is wasted. It should be used only in connection with one of the other methods of governing.

The hit-or-miss system of governing is very simple and gives good fuel economy at variable loads. As the explosions in the engine do not occur at regular intervals, this system of governing necessitates the use of very heavy flywheels in order to keep the speed fluctuations within practical limits. The hit-or-miss system is very well-adapted for small and also for medium-sized engines where very close speed regulation is not essential.

2. Varying Quantity of Mixture.—In this system the proportion of air to fuel is kept constant and the quantity of the mixture admitted into the cylinder is varied according to the load. This variation is accomplished either by throttling the charge or by changing the time during which the inlet valve is open to the cylinder. In fact, the two methods of varying the quantity of

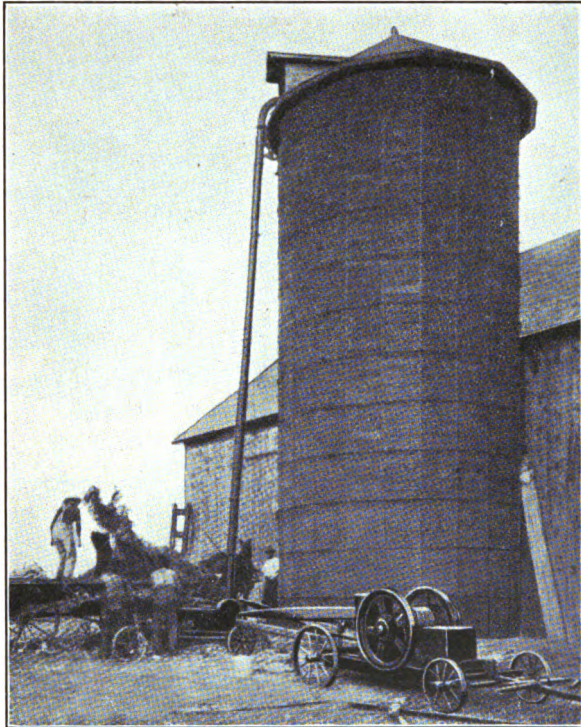

FIG. 110.—Silo filling.

the mixture are similar to those used in governing steam engines and as explained in Chapter IV.

3. Varying Quality of Mixture.—In this case the total quantity admitted into the cylinder is kept constant, but the amount of fuel mixed with the air is varied according to the load.

When gas engines are governed by varying the quantity or quality of the mixture, the speed is more uniform at variable loads. Also, since the explosions occur at definite periods, the

temperatures inside the cylinder are kept more constant. The throttling form of governor is used most commonly with traction engines.

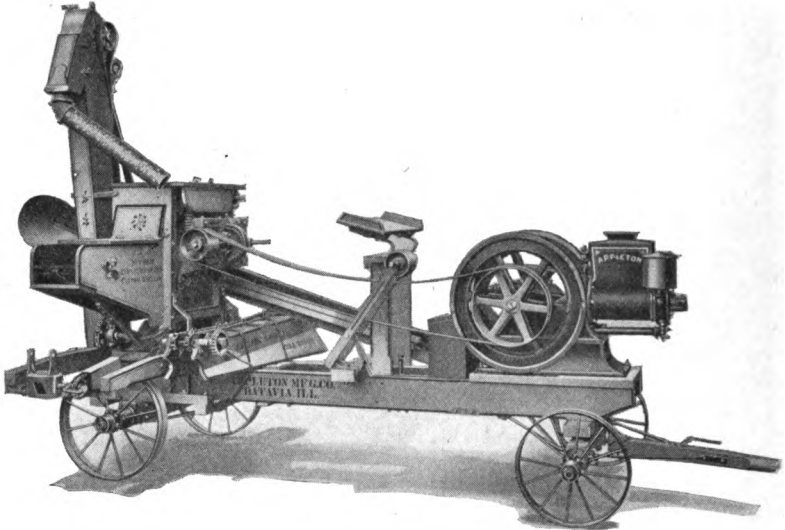

FIG. 111.—Gasoline engine and sheller mounting.

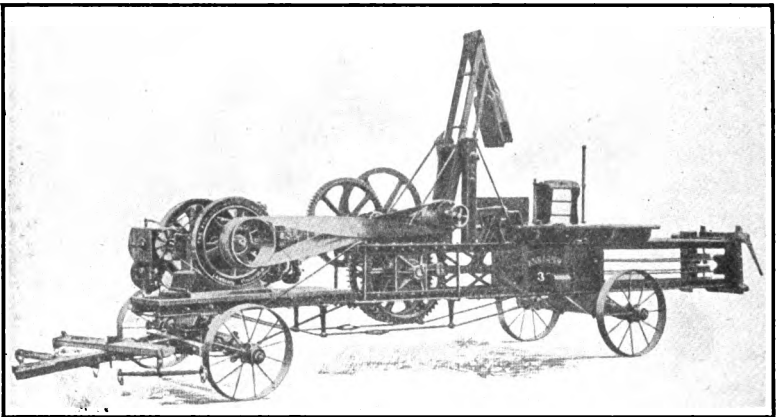

FIG. 112.—Engine driving a hay press.

The Gasoline Engine on the Farm.—Some of the uses to which a gasoline engine can be applied on the farm are illustrated in Figs. 110 to 117.

A 12-hp. gasoline engine is used for silo filling in Fig. 110.
Fig. 111 illustrates a gasoline engine applied to shelling corn.



FIG. 113.—Engine driving binder.

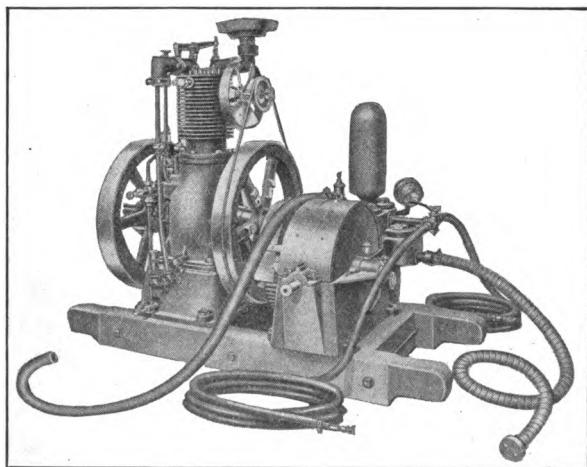

FIG. 114.—Spraying outfit.

A 7-hp. engine driving a hay press is illustrated in Fig. 112.
A binder driven by a 4-hp. engine is shown in Fig. 113.
An air-cooled gasoline engine of 2 hp., direct-connected to a



FIG. 115.—Pumping water.

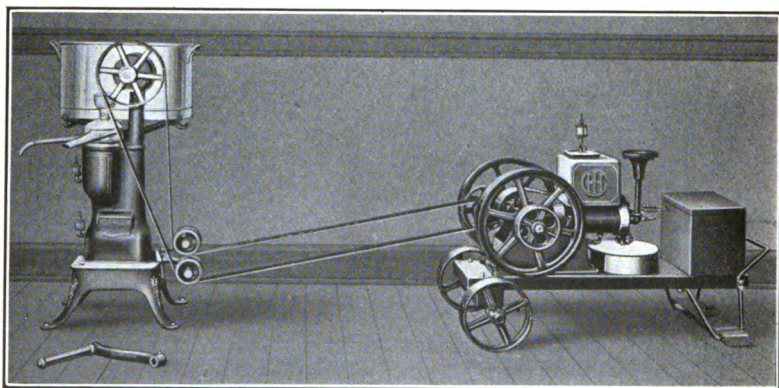

FIG. 116.—Driving cream separator.

spraying outfit (Fig. 114), is capable of producing a pressure of 100 lb. per square inch or more, as compared with about 50 lb. in the case of the hand sprayer.

The application of the gasoline engine to pumping water for farm use is illustrated in Fig. 115.

Fig. 116 shows the application of the small gasoline engine for the driving of cream separators.

A wood-sawing rig, Fig. 117, can be removed by loosening clamp bolts, and the engine used for grinding feed, pumping, shredding, or for any other farm work within its capacity.

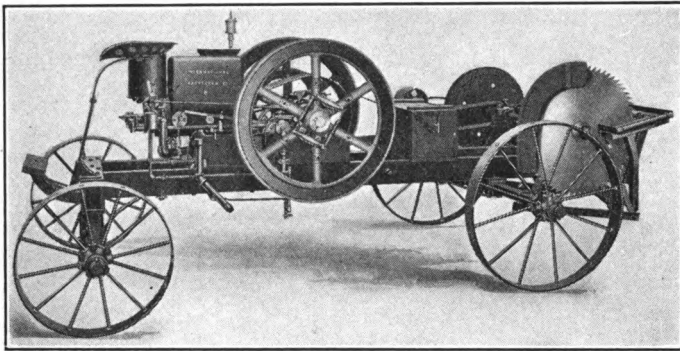

FIG. 117.—Wood-sawing rig.

Other uses to which the gasoline engine can be put include: the driving of cement mixers and rock crushers, the grinding of feed, the driving of grindstones and other tools in the farm shop, the driving of electric generators for farm lighting (see Chapter X), and for various other work about the house, barn and dairy which require power.

Gas tractors and their field of application will be taken up in Chapter VII.

SELECTION AND MANAGEMENT OF GAS AND OIL ENGINES

Selecting a Gas Engine.—A gas engine should be selected large enough to do the required work, as it will stand but little overload. This is due to the fact that the gas engine develops its maximum power when a full charge of the best mixture of

fuel and air, at the maximum density, has been admitted to the engine cylinder. On the other hand, an engine too large for the work it has to do will give poor fuel economy.

As the economy is very nearly independent of the size of the gas engine, it is better to buy two small engines than one large one. This applies especially to the farm, where the larger engine of 6 to 10 hp. can be used for the heavier work, such as feed grinding, threshing, wood sawing, etc., and a small engine of about 2 hp. for the many small tasks, about the house, dairy, and barn, which require but little power. An engine of 2 hp. is sufficient to drive a small dynamo, to light the house, barn, etc., and to charge a storage battery (see Chapter X). The same engine, if portable, can be used for driving a washing machine and wringer, a tree-sprayer outfit, a house pump, a cream separator, etc.

An engine governed by the hit-or-miss principle should carry such a load as will enable it to miss one explosion in every eight, as this will keep the cylinder free from inert burned gases and will improve the economy. If an engine is worked at its maximum power the largest part of the time, the wear on the parts will be too great.

An engine for farm use must be capable of being started easily and should be simple in construction. Every gas engine must have certain parts to carry out the cycle of operations, as explained in the earlier part of this chapter, but some engines are provided with many attachments, which have good points, but which complicate the engine so that the first cost is greater and the manipulation more difficult. An engine to be of value on the farm must be sufficiently simple in construction that ordinary adjustments and repairs can be made without the aid of experts.

In regard to the method of igniting the mixture, the electric system is best for gasoline engines. It is well to provide a gasoline engine with a magneto or ignition dynamo, as with batteries the cost of upkeep is considerable and the reliability of operation uncertain. Regarding drives for magnetos, friction and belt drives should not be selected, as they are not reliable. A magneto should always be positively driven from the engine by gears.

There is very little choice between the jump-spark and the make-and-break systems of ignition. For stationary engines the make-and-break is commonly used while the jump-spark is more common on automobiles and traction engines. No matter which system of electric ignition is selected, the various wires should be well-insulated, and inclosed in some moisture-proof conduit.

For irrigation work where the cost of fuel is an important item, an engine should be selected which will operate with the cheaper fuels. For engines under 100 hp., those which will burn kerosene or solar oil will usually be found satisfactory. Such engines employ electric ignition and the fuel is vaporized in a coil entirely outside the engine cylinder. For work requiring 100 hp. and more the various engines with automatic ignition, which use fuel oil, will be found more economical.

It is essential to select an engine from a reputable manufacturer. Every engine is subject to breakage of parts and it is important that duplicate parts may be easily secured. It is also well to investigate the work done by engines of various makes before making the final selection.

The rated horsepower of an engine does not often mean the same actual power for different makes of engines. An engine rated at 10 hp. by one manufacturer may be capable of developing 10 to 25 per cent. more power than an engine of the same rating by another manufacturer. The purchaser should insist on a definite statement as to the actual brake horsepower which the engine is capable of developing. The method of obtaining the brake horsepower of an engine was explained in Chapter II.

Installation of Gas Engines.—It is usually best to locate a gas engine in a separate room. The room should be well-lighted and ventilated, free from dirt and dust and large enough so that there is sufficient space for easy access to any part of the engine so as to facilitate starting, oiling and inspection of all parts.

In connection with gasoline and oil engines, the fuel tank should be located outside the building and preferably underground. In any case the tank must be lower than the pipe to which it is connected in the engine room.

As the mixture of fuel and air is ignited inside the engine

cylinder, the resulting explosion produces a shock of considerable magnitude on the mechanism, which in turn is transmitted to the foundation. The foundation should be as solid as possible. If the engine is to be set on a wood floor, it is usually well to lay long timbers on or under the floor and at right angles to the joists. If the foundation is to be built of brick or of concrete it should be sufficiently heavy and should be separated from the walls of the building, so that vibrations caused by the engine will not affect the building or surrounding buildings. If the engine has to be located over another room it is best to place the engine in a corner and near the wall.

The method of constructing foundations for steam engines was explained in detail in Chapter IV. The directions given there apply also to gas engines.

If the engine is to be connected to the machines to be driven by belt drive, the driver and the driven should be placed far enough apart, that the required power can be transmitted without running the belts too tight. A distance between pulleys equal to about eight times the size of the larger pulley will usually give good results. Open belts are preferable to crossed belts and should be used whenever possible.

The exhaust piping should be as straight and as short as possible. The exhaust gases should always be discharged out of doors, as the fumes are poisonous. Some engines are provided with exhaust mufflers (Fig. 71) which can be located near the engine. As a rule, it is better to locate the muffler outside the building. Engines should never exhaust into a flue or chimney.

The air supply can be taken from the room in which the engine is placed or from the outside. In all cases a screen should be placed over the air pipe.

Instructions for Operating Gas Engines.—Before an engine is started for the first time, all the working parts should be carefully examined and nuts and other fasteners properly tightened. The electrical connections should then be gone over and the spark plug or spark points removed from the cylinder and tried.

The operation and economy of a gas engine is greatly influenced by the proper timing of the valves and by the point of ignition.

The exhaust valve should open before the end of the power stroke. This is necessary to prevent loss of power when the

piston starts on the exhaust stroke. The exhaust valve should begin to open when the crank is at an angle of from 20° to 40° before the outer dead-center. The time of opening of the exhaust valve must be earlier for high-speed than for slow-speed engines.

The exhaust valve should remain open until the crank has turned 3° to 8° beyond the completion of the exhaust stroke.

The suction stroke follows the exhaust stroke, and, in order to prevent the mixing of the fresh charge with the burnt gases, the inlet valve should open about 3° (crank rotation) after the exhaust valve closes. The time of closing of the inlet valve should be after the crank has turned 10° to 25° beyond the completion of the suction stroke.

The setting of the gas-engine valves so that they will open and close at the proper time, can be accomplished by adjusting the length of the valve push rods or by changing the timing of the cam gears. The exact setting of the valves will depend upon the engine speed, and upon the fuel used.

Ignition should be timed to suit the fuel, the compression and the speed of the engine.

In order that the entire mixture may be ignited and burning at the beginning of the power stroke, it is necessary to have the spark advanced; that is, the point of ignition must occur earlier than the beginning of the power stroke.

Proper ignition can best be determined by an indicator (Fig. 1). The experienced operator can set the spark very nearly at the proper place by the sound of the engine. For the inexperienced operator the following approximate rules should prove of value:

For jump-spark system, turn crank and set spark mechanism so that ignition will occur, 5° ahead of dead-center, for every 100 r.p.m. of the engine speed rating.

For the make-and-break system, advance spark approximately 8° for every 100 revolutions of engine speed rating.

As an illustration of the application of the above rule, calculate the spark advance for a stationary engine operating at 350 r.p.m. If the engine has make-and-break ignition system, ignition should take place when the crank is at a position of 28° before dead-center. In case a jump-spark system is employed, the spark should occur when the crank is at a position of about $17\frac{1}{2}^{\circ}$ before dead-center.

The gas engine is not self-starting, as is the steam engine when steam is turned on. The reason for this is that the explosive mixture of fuel and air must be taken into the cylinder and compressed before it can give up its energy by explosion. It is, therefore, necessary to set the engine in motion by some external means not employed in regular operation, before it will pick up the normal working cycle. Engines under 20 hp. are usually started by hand. This is done by disconnecting the engine from its load and turning the flywheel by hand for a few revolutions. If everything is in good condition an engine should start with two or three turns of the flywheel and should continue to run after the first explosion. An easier method of starting gasoline engines is to set the engine at the end of the power stroke, inject some gasoline into the cylinder through a priming cock, turn the flywheel backward against compression as far as possible and then quickly trip the igniter.

As it is difficult to pull over an engine by hand against compression throughout the whole stroke, some engines are provided with a starting cam, which can be shifted so as to engage the exhaust valve lever. This relieves the compression while cranking, as the exhaust port is open during the first part of the compression stroke. After the engine speeds up the starting cam is disengaged.

Gas engines larger than 25 hp. are usually started with compressed air. If the engine consists of two or more cylinders, this can be accomplished by shutting off the gas supply to one of the cylinders and running this cylinder with compressed air from a tank, in the same manner as a steam engine is operated with steam from a boiler. As soon as the other cylinders pick up their cycle of operations the compressed air is shut off and fuel with air is admitted to the cylinder used in starting. With large gas engines of only one cylinder, the compressed air is admitted long enough to start the engine revolving, when the compressed air is shut off and the mixture is admitted. The air supply for starting is kept in tanks which are charged to a pressure of 50 to 150 lb. by a small compressor, driven either from the main engine shaft, or by means of an auxiliary small engine.

In starting a gas engine the following steps should be taken, preferably in the order given:

1. The fuel supply should be examined. Cases have been known in which an operator spent considerable time hunting for faults in the ignition system, valve setting, etc., when an examination of the gasoline tank would have revealed the fact that it was empty.

2. The ignition system should be tried by closing the switch disconnecting the end of one of the wires and brushing it against the binding post to which the other wire is attached. A good spark should have a blue-white color. If the spark produced is weak, the ignition system should be put in the proper condition.

3. The lubricators and grease cups should be filled and adjusted, so that the proper amount of oil is delivered to all bearings and moving parts.

4. The load should be disconnected from the engine by means of a friction clutch or similar device, the lubricators turned on, the spark retarded to the starting position, and the starting cam moved into place.

5. The engine is now ready for starting by either of the methods previously explained. In cranking, always pull up on the crank.

6. As soon as the engine picks up, disengage starting cam, turn on cooling water, advance spark to running position and throw on the load by means of the clutch.

7. Adjust fuel supply so that the engine carries its load with the cleanest possible exhaust.

To stop an engine, the fuel valve is closed, the ignition-system switch is opened, the lubricators and oil cups are closed and the jacket water is turned off. In cold weather the water should be drained from the engine jackets to prevent freezing. The practice of draining the jackets is also advisable in moderate weather, as this tends to clean the jacket from the deposit of sediment. Before leaving the engine it should be cleaned, all parts examined and put in order ready for starting up.

Causes of Gas Engines Failing to Start.—Failure to start may be due to one or more of the following causes:

1. *Ignition System Out of Order.*—This may be caused by the switch being left open, by a loose terminal, by a disconnected wire, by a broken wire the insulation being intact, by the ignition battery being weak if a battery is used, and by poor timing or wrong connections if a magneto is employed. Other causes of

faulty ignition are due to timer slipping on the shaft, to a short-circuit in the ignition system, to carbonized or broken spark points, to poor timing of the points of ignition. In the case of the jump-spark system, ignition will also be prevented if, the points on the spark plug are too far apart, the spark plug is dirty or broken, the insulation on secondary wires is poor, induction coil windings are broken or short circuited, vibrator of induction coil is not properly set.

2. An engine will not start if the mixture contains too much or too little fuel.

In very cold weather a gasoline engine may give trouble by the fuel not vaporizing. This can best be remedied by filling the jackets with hot water. Do not bring a flame near the carburetor or gas supply pipe. This is sometimes recommended for starting in cold weather, but the practice is a dangerous one.

Improper mixture may be caused by slow cranking, in which case the hand placed over the air inlet will often start the engine. Extra priming of the carburetor may also aid in starting, provided care is taken not to flood the engine with fuel.

3. Supply pipes clogged.
4. Dirt or water in the fuel.
5. Pump or carburetor out of order.
6. Water in carburetor.
7. Water in the cylinder due to leaky jacket.
8. Inlet valve poorly set or not operating due to broken valve stem, weak or broken spring, valve sticking or broken.
9. Poor compression due to leaky or broken piston rings, improper seating of valves, or to other leaks from the cylinder to the outside.
10. If the exhaust pipe or muffler is clogged, the engine will fail to start.

In any of the above cases the remedies are self-evident.

Causes of Motor Failing to Run.—A motor will sometimes start, but will soon afterward slow down and stop. This may be due to:

1. Fuel tank being empty or fuel pipe becoming clogged.
2. Poor or insufficient lubrication, which may cause the seizing of the piston or of the bearings.
3. Wire being jarred loose from its terminal, timer slipping on

shaft or to some other fault in the ignition system, such as weak cells, or vibrator or induction coil becoming stuck.

4. Engine carrying too great a load.

Care of a Gas Engine.—It is best to keep one man responsible for the care of an engine and in so far as possible confine the operation to one man. The engine should be kept clean and all the parts should be examined frequently to see that everything is in the best working order.

If an engine runs well at no-load but will not carry its rated load, this may be due to: poor compression, poor fuel, defective ignition, poor timing of ignition, incorrect valve setting, incorrect mixture, leaky inlet or exhaust valves, too much friction at bearings, or to engine being too small for the rated load.

The operator usually can tell whether the correct mixture is being admitted into the cylinder by watching the exhaust. Black smoke issuing from the exhaust pipe means that the mixture is too rich in fuel. This should be remedied by decreasing the amount of fuel supplied or by increasing the air supply. Insufficient fuel in the mixture, as explained in the section on "Carburetors," will cause the engine to miss explosions and may even cause back-firing.

Premature ignition, often called preignition, is due to the deposition of carbon and soot on the walls of the cylinder, the compression being too high for the fuel used; by overheating of the piston, exhaust valve, or of some poorly jacketed part.

Deposition of carbon on the cylinder walls is usually caused by the use of either an excessive amount or a poor quality of lubricating oil. This will not only cause preignition, but may also impair the action of the valves, igniter and piston rings. Carbon deposits will also be produced if the mixture is too rich.

Insufficient lubrication may result in abrading surfaces of piston and cylinder.

It is well not to economize when buying gas-engine cylinder oil. Due to the high temperatures developed inside the engine cylinder and to the absence of moisture, a cylinder oil should be selected which is light and thin, which will withstand high temperatures and will leave no carbon deposits. A cylinder-lubricating oil well-suited for steam-engine use will not do at all for gas-engine cylinder lubrication.

For the bearings and other wearing parts outside the cylinder, a good grade of machine oil will be found satisfactory.

A blue smoke at the exhaust indicates that too much cylinder oil is being used.

Pounding in gas and oil engines is either due to preignition, the causes of which were outlined above, to lost motion in some bearing of the engine, or to the engine being loose on its foundation.

In the case of oil engines using a water spray with the fuel, too little water will result in preignition and consequent pounding. This should be remedied by supplying more water with the fuel. Too much water will be indicated by white smoke issuing from the exhaust pipe.

In the case of a gasoline engine, white smoke at the end of the exhaust pipe usually indicates water in the gasoline, which may be due to a leaky jacket or to some other cause.

In regard to the temperatures of the jacket water, this depends on the compression carried and on the size of the engine. With small engines of the hopper-cooled type the jacket temperature is near the boiling-point of water. Ordinarily a temperature of about 150°F. will give good results. It is advisable to use cooling water over and over again, since after several circulations through the jackets, the impurities contained in the water will have been precipitated.

Problems: Chapter V

1. What is an internal-combustion engine and how does this form of motor differ from the steam engine?

2. Explain, using clear sketches, the Otto gas-engine cycle.

3. Show the difference in construction and in action between the four-stroke cycle and the two-stroke cycle gas engine. Use clear sketches to illustrate the important working parts.

4. What is gasoline and how does this fuel differ from kerosene?

5. What is denatured alcohol? How do the calorific values of alcohol and of gasoline compare?

6. Discuss the use of alcohol as a fuel for internal-combustion engines.

7. Give a clear sketch, showing the important parts of a gasoline engine. Name all parts.

8. Why is proper carburetion necessary for the economical and reliable operation of a gasoline engine?

9. Sketch and describe some form of mixer valve. When are mixer valves used?

10. Sketch and describe a concentric-type float-feed carburetor and explain in detail the function of the auxiliary air valve.
11. Describe in detail carburetors shown in Figs. 81 and 82.
12. Discuss carbureting kerosene and the heavier oils.
13. Sketch and explain some form of air-cooled engine. What limits the size of the air-cooled engine?
14. Give directions for preparing a non-freezing mixture to be used in a water-jacketed engine.
15. Explain with clear sketches the make-and-break system of ignition.
16. Explain, using sketches, the jump-spark system of ignition.
17. What is the difference between the coils used in the make-and-break and in the jump-spark systems of ignition?
18. Give wiring diagrams for a one-cylinder make-and-break ignition system, operated with dry cells to start and magneto to run on.
19. Give wiring diagram for a one-cylinder jump-spark ignition system operated with a dry battery to start and a magneto to run on.
20. Explain three methods for lubricating gas engines.
21. Describe two systems of governing gas engines.
22. Describe ten uses to which the stationary gasoline engine may be put by a farmer.
23. What should be considered when selecting a gas engine for farm use?
24. Give directions for installing a gasoline engine.
25. Prepare a diagram which should show the proper crank positions at which the valves should open and close.
26. What governs the point of ignition? Give approximate rule for setting an engine operated with the make-and-break ignition system so that the spark will occur at the proper time.
27. Give method for starting by hand, easily, a gasoline engine of 10 hp. capacity.
28. Explain causes for gas engine failing to start.
29. Explain the difference between preignition and back-firing.
30. Give directions for operating a stationary gas or oil engine.

CHAPTER VI

AUTOMOBILES

Types of Automobiles.—An automobile can be propelled by a steam engine, by an internal-combustion engine, or by an electric motor with current secured from storage batteries.

The majority of modern automobiles are propelled by internal-combustion engines using gasoline as fuel.

Steam and electric automobiles operate more quietly, are more flexible, and can be more easily controlled than gasoline automobiles. Then, the electric car has the additional advantage of cleanliness and ease of starting, while the steam automobile has a greater range of power and is best-adapted for climbing hills.

To offset the above advantages, electric cars are more expensive to operate, and can be run only for short distances without a fresh charge of electricity. They are, therefore, used mainly in cities and in other places where facilities are available for the charging of storage batteries.

The steam automobile requires considerable time to start after a long stop, as steam must be generated in the automobile boiler before the engine will start. The steam automobile must also have greater skill in operating, as constant attention must be given to the fuel and the water supply.

The gasoline automobiles possess the advantage that they are manufactured in many different types and designs, and can be secured at a great variety of prices from several hundred up to many thousand dollars per car. Repair parts can also be secured more easily for gasoline cars than for any other type of automobile. The gasoline automobile is more economical than the steam or the electric car and is usually provided with a fuel supply of sufficient quantity to propel the car several hundred miles.

The disadvantages of the gasoline automobile are that it is not self-starting, lacks overload capacity, must be provided with a clutch, as a gasoline motor will not start under load, and must

be built with a complicated system of gears for changing speed and for reversing.

This chapter will be devoted mainly to the consideration of the gasoline automobile, as steam and electric automobiles are seldom used in rural communities.

Essential Parts of a Gasoline Automobile.—The essential parts of an automobile are:

1. Power plant, which consists of an internal-combustion engine and its auxiliaries, such as the fuel system, carburetor, ignition system, cooling and lubricating systems, and starting systems.

2. Friction clutch, for disengaging the engine from the propelling gear.

3. Transmission mechanism, for speed-changing and for reversing.

4. Differential or compensating gear, the purpose of which is to allow one drive wheel to revolve independently of the other, this being necessary when turning corners.

5. Front and rear axles.

6. The frame which supports the power plant, transmission system, and body of the car. The frame is attached to springs which in turn are attached to the axles. The springs are built up from a number of broad and thin leaves.

7. Control system, which is made up of the steering mechanism as well as of the hand levers and foot pedals for controlling the spark position, carburetor throttle, clutch and transmission gearing.

8. Body, top, fenders, hood, dash, running board, front and rear wheels, tires, lighting system, tool chest, tools, wind shield, speedometer and odometer for showing speed per hour and total distances, alarm and similar equipment and accessories, which are found on the majority of automobiles.

Automobiles are required by law to carry two lights in front and one rear, or tail light. The tail light is for the purpose of preventing rear-end collisions.

The term chassis is applied to the car with the body and accessories removed (Figs. 118 and 119). The chassis shown in Fig. 118 is an automobile chassis and the power is transmitted from the motor to the rear axle by means of a shaft drive. In the

case of auto trucks the power from the motor to the axle is transmitted by worm or chain drive (Fig. 119).

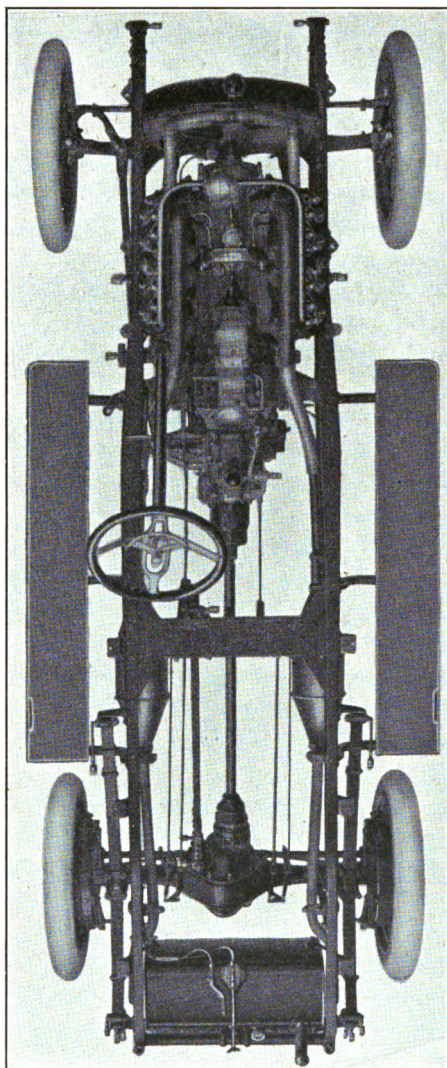

FIG. 118.—Automobile chassis.

Automobile Motors.—Automobile motors are usually of the multiple-cylinder vertical types of internal-combustion engines

which operate on the Otto four-stroke cycle. The motor is located in the front of the automobile frame, for accessibility and for the purpose of balancing the weight in the rear part of the car.

The earlier automobiles employed one-cylinder engines, but the modern automobile motor consists of four, six, eight, or

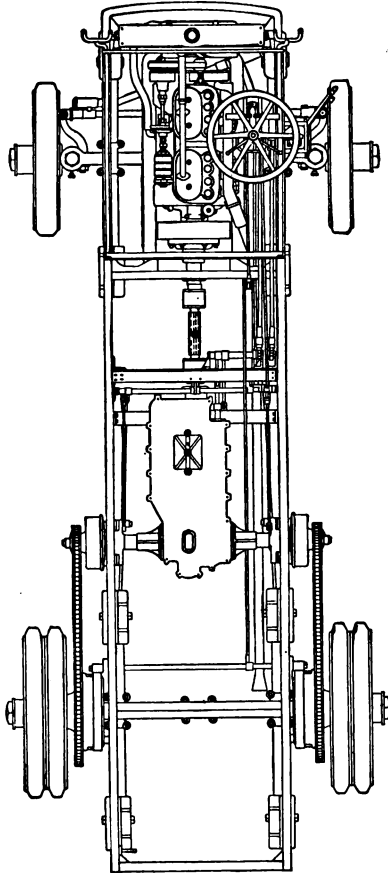

Fig. 119.—Auto-truck chassis.

twelve vertical cylinders, as multi-cylinder machines start easier, operate more smoothly, run with less vibration, and have a wider range of power and speed.

In the case of four- and six-cylinder motors, all the cylinders

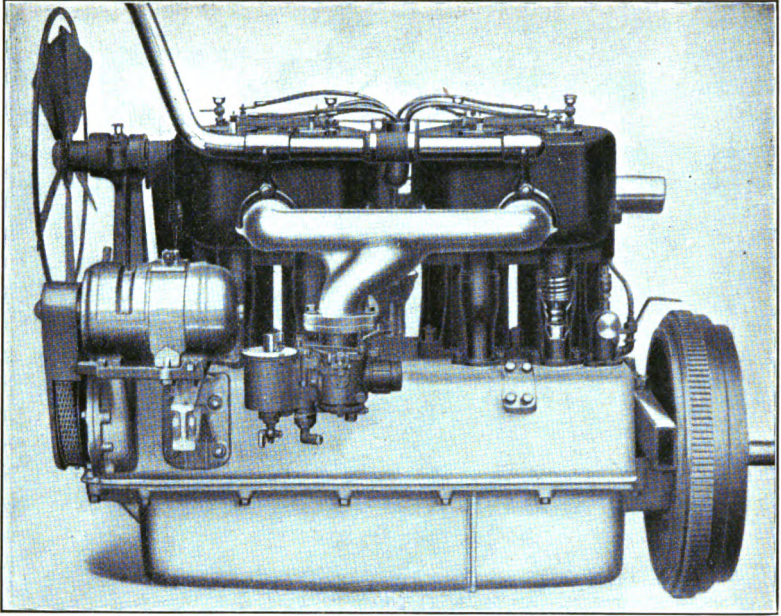

FIG. 120.—Four cylinder automobile motor.

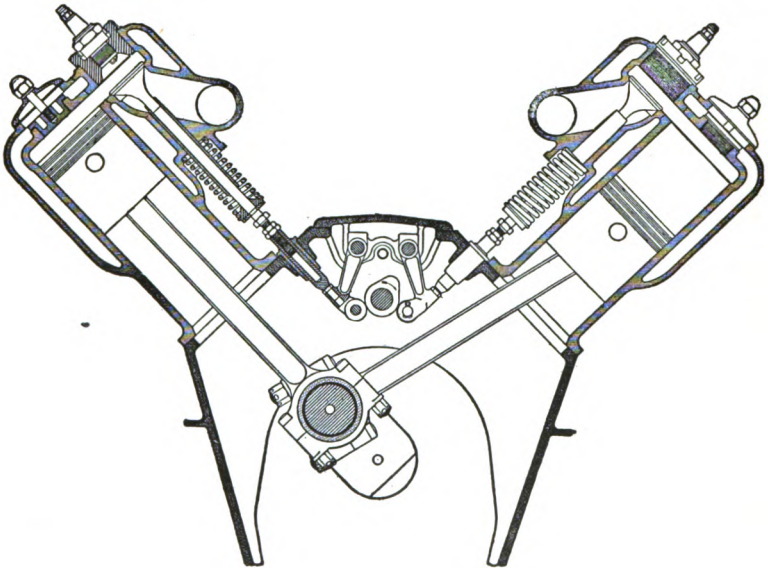

FIG. 121.—Cylinders at an angle of 90°.

are usually located on one side of the crankshaft (Fig. 120). Eight- and twelve-cylinder motors are arranged with the cylinders in two rows. Eight-cylinder machines are usually set as shown

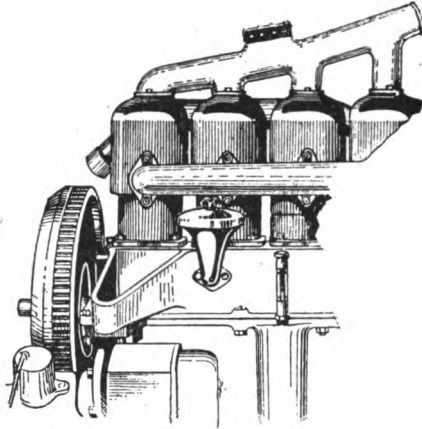

FIG. 122.—Automobile motor, cylinders cast singly.

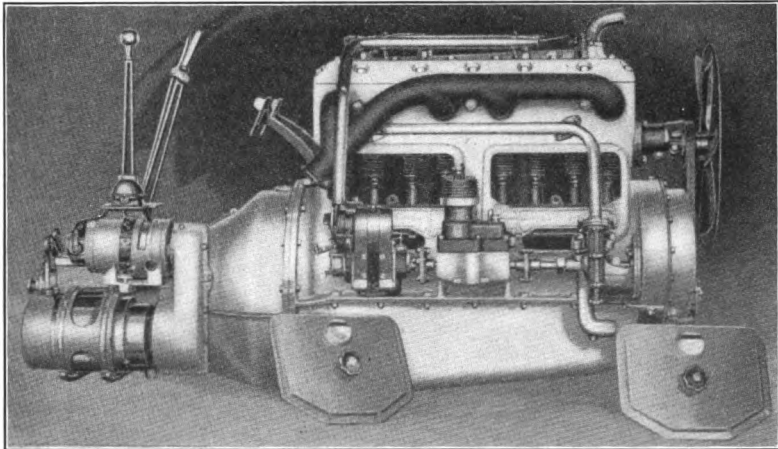

FIG. 123.—Motor with cylinder en-bloc.

in Fig. 121 with the cylinders at an angle of 90° . The twelve-cylinder motors are usually set with the cylinders at an angle of 60° .

Automobile motor cylinders are cast singly (Fig. 122), or en-bloc, which means that several cylinders are cast in one piece

(Fig. 123). The simple cylinder casting is light in weight, can be easily repaired, and is better adapted for the thermo-syphon system of cooling. The en-bloc motor is more rigid, occupies less space, and is more commonly used on modern automobiles.

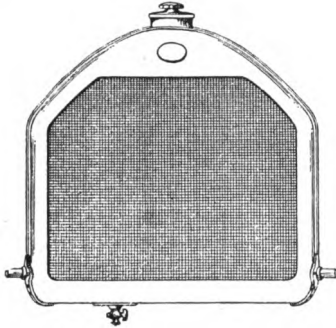

FIG. 124.—Automobile radiator.

Automobile motors are most commonly water-cooled and are provided with radiators (Fig. 124) for the purpose of cooling the water after it has absorbed heat from the cylinder walls. There are two systems of cooling automobile motors:

1. The thermo-syphon water-circulation system (Fig. 125) depends upon the fact that water rises when heated. The

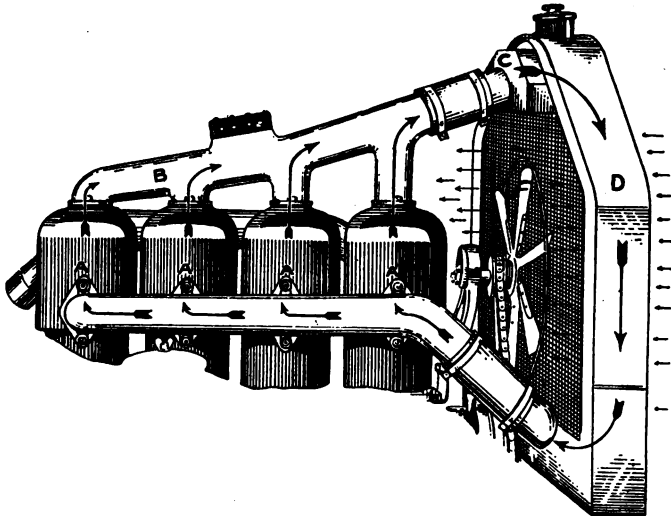

FIG. 125.—Thermo-syphon water-circulation system.

system does not require a force pump to circulate the water. The water enters the cylinder jackets at *A*. Upon becoming heated by the explosions going on within the cylinder of the engine, the water rises to the top, entering the pipe *B* and passing into the

radiator at *C*, where it is brought into contact with the larger cooling surface *D*. On being cooled, the water becomes heavier

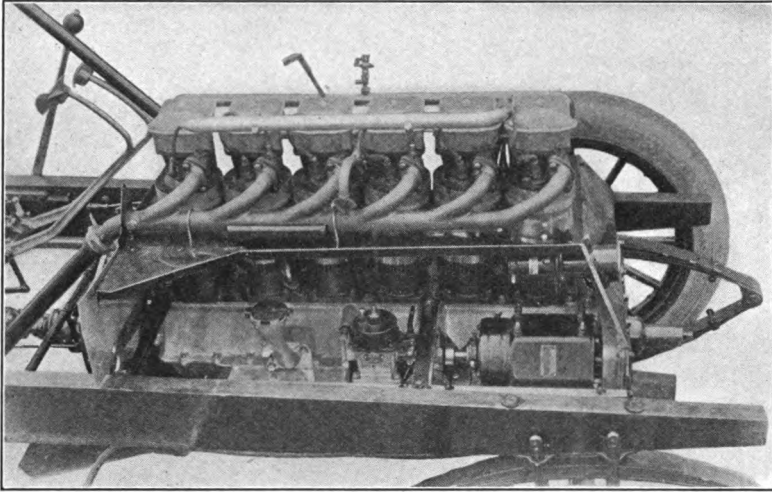

FIG. 126.—Air-cooled automobile motor.

and sinks to the bottom of the cooling system, to enter the cylinder once more and to repeat its circulation. The cooling action is further increased by a belt-driven fan (*F*) which draws air through the radiator spaces.

2. The forced circulation system depends upon a pump, driven by the engine, to keep the water in constant circulation through the engine jacket and radiator. This system is more positive in its action and is not influenced by obstructions as is the thermo-syphon system.

In one successful type of automobile, the cylinders are cast simply with ribs and are air-cooled. The circulation of the air is produced by means of a fan in the motor flywheel (Fig. 126).¹

Three types of valves are used on automobile motors. These are the poppet, the sleeve and the rotary.

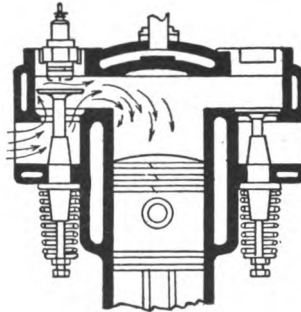
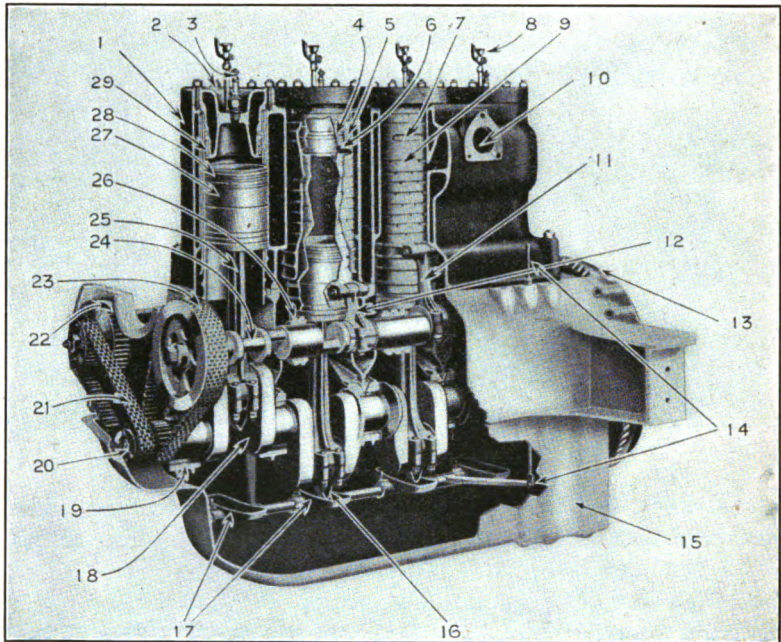

FIG. 127.—Motor with poppet valves.

The poppet valve (Fig. 127) is most commonly used and is similar to the valves used on stationary gasoline engines.

Fig. 128 illustrates the fundamental parts of the sleeve-valve type of motor. The sleeves slide up and down between the main



- | | | |
|--|---|--|
| 1. Cylinder. | 13. Fly wheel. | 22. Silent chain driving sprocket for electric generator (on 4-cylinder models). |
| 2. Water-jacketed cylinder head. | 14. Oil trough adjusting lever connected to throttle. | 23. Silent chain drive for eccentric shaft. |
| 3. Spark plug. | 15. Lower part of crank case, containing oil pump, strainer and piping. | 24. Eccentric shaft. |
| 4. Inner sleeve. | 16. Oil scoop. | 25. Connecting rod. |
| 5. Outer sleeve. | 17. Adjustable oil troughs. | 26. Bearing for eccentric shaft. |
| 6-7. Port openings in sleeves. | 18. Crank shaft. | 27. Piston. |
| 8. Priming cup. | 19. Crank-shaft bearing. | 28. Piston rings. |
| 9. Oiling grooves in sleeves. | 20. Starting clutch. | 29. Cylinder-head ring (junk ring). |
| 10. Port opening in cylinder. | 21. Silent chain drive for magneto shaft. | |
| 11. Connecting-rod operating outer sleeve. | | |
| 12. Connecting-rod operating inner sleeve. | | |

FIG. 128.—Sectional view of Stearns-Knight four-cylinder motor.

engine piston and the cylinder walls. The various parts are named in Fig. 128.

The rotary form of valve (Fig. 129) is little used. This type of valve consists of a slotted cylinder which, when rotating, opens a passage for the gases.

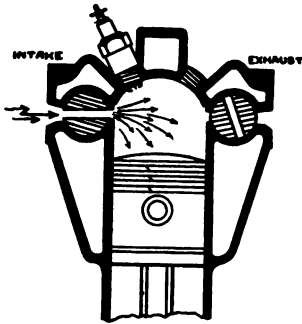

FIG. 129.—Motor with rotary valves.

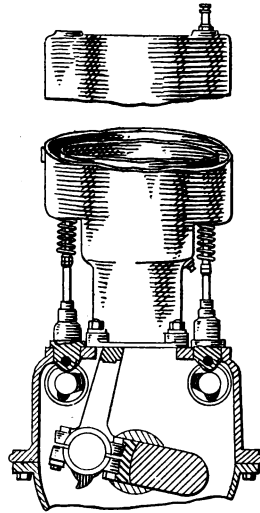

FIG. 130.—Tee-head cylinder.

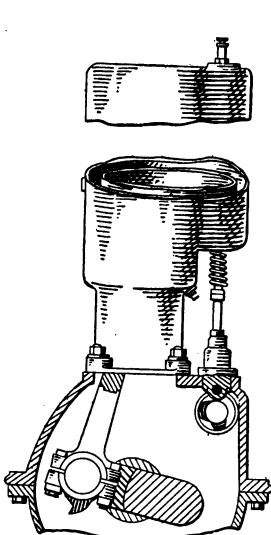

FIG. 131.—Ell-head cylinder.

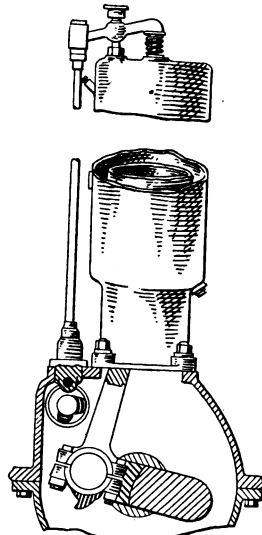

FIG. 132.—Valves-in-the-head cylinder.

Automobile motors with poppet valves are built in three forms:

1. The tee-head form (Fig. 130) with valves on opposite sides. This type of motor usually has two camshafts for operating the valves, but allows the use of larger valves. The compressing chamber is irregularly shaped in this type of motor.

2. The ell-head motor (Fig. 131). This form of motor has

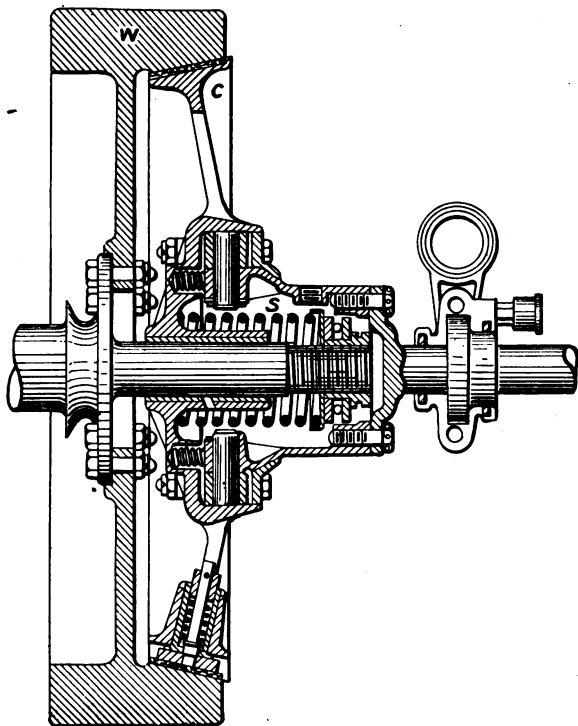

FIG. 133.—Cone clutch.

both valves on the same side of the cylinder and these valves are operated by a single camshaft.

3. The valve-in-the-head type of motor (Fig. 132). This type of motor has a very compact compression chamber, but is more noisy than the other types on account of the rocker arms and push rods.

Clutches.—The clutch is a device used for connecting the engine shaft to, and disconnecting it from, the propelling gear of

the car. Clutches depend upon the frictional adhesion between surfaces and are of the following types:

1. The cone clutch (Fig. 133) consists of a leather-faced cone *C* which is pressed by the spring *S* against the inside of a tapered rim of a flywheel (*W*).

2. The multiple-disk clutch (Fig. 134) depends on its action upon the friction between disks. Alternate disks are fastened to the driving and driven parts. The disks marked *A* are fastened

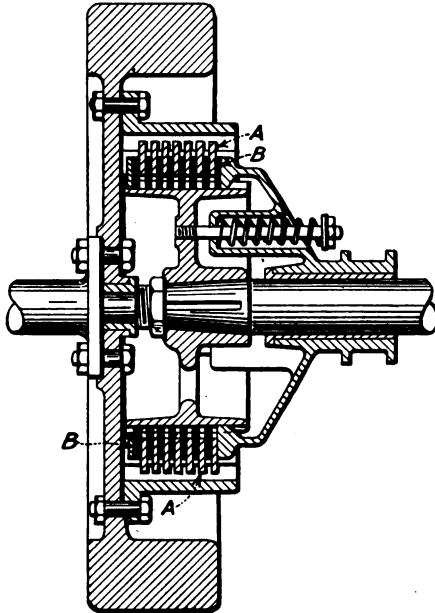

FIG. 134.—Multiple-disk clutch.

to the engine shaft and those marked *B* connect with the mechanism to be driven. If the clutch runs in a bath of oil, it is called a wet-disk clutch. A spring is employed to hold the disks in contact when the clutch is in action.

3. The expanding clutch has an annular ring which, by expanding, connects the driving and driven shafts. This type of clutch is seldom used.

Clutches are not necessary on automobiles which are propelled by steam engines or by electric motors, as the supply of steam or

of electricity is generated outside the motors proper and can be varied to suit the requirements of speed and load.

Transmission Gears.—The speed of an internal-combustion engine and its direction of rotation cannot be varied to meet the requirements of a self-propelled vehicle. This necessitates the introduction of a speed-changing and reversing-gear mechanism, so that different speed ratios can be secured between the engine and the drive axle.

From the definition of power (Chapter II), it is evident that a motor of a given power, in order to overcome increasing resistance, must propel the car at a less speed. This means that the speed of the car must be reduced, by shifting the speed-changing gears, when the automobile must climb hills or overcome other obstructions incidental to the road conditions over which the car

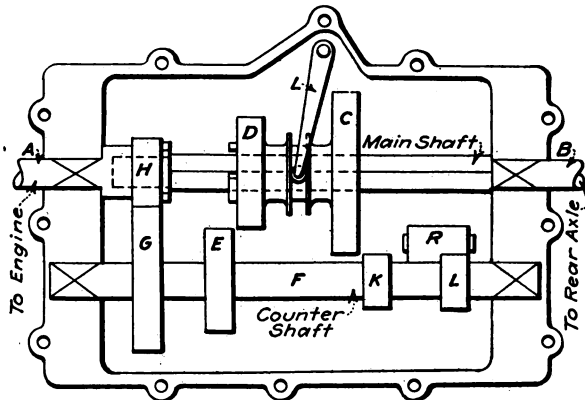

FIG. 135.—The progressive sliding-gear transmission system.

is operated. Before shifting the gears of the transmission system, the friction clutch should be thrown out.

Transmission gears are of four types: namely, the progressive sliding gear, the selective sliding gear, the planetary gear, and the friction drive.

The Progressive Sliding-gear Transmission System.—The change of gears is carried on in progressive steps. Fig. 135 illustrates a progressive transmission system. *A* is the driving shaft, which derives its power from the motor and through the friction clutch. *B* is the driver or propeller shaft which transmits the power to the rear axle. The gears *C* and *D* are fastened

together and can be slid by means of a lever *L* along the main shaft, which is square. If *D* on the main shaft is shifted so that it is in mesh with *E* on the countershaft and the shaft *A* is rotated, the shaft *B* will rotate in the same direction but more slowly. If the gears *C* and *D* are shifted so that *C* will engage *K*, the countershaft *F* will turn the shaft *B* at a slower speed than when *D* and *E* were in mesh. If the gears *C* and *D* are shifted so that *C* meshes with *R*, *A* and *B* will revolve in the opposite directions, thus propelling the car backward. If the gears *C* and *D* are moved to the left until the lugs on *D* and on *H* engage, shafts *A* and *B* will turn as one shaft and the car will be propelled at the high speed forward.

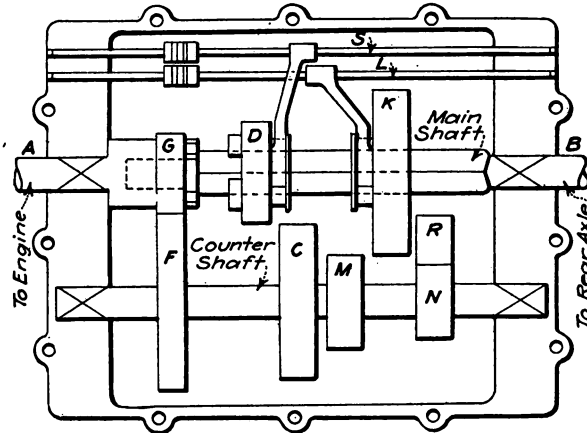

FIG. 136.—The selective sliding-gear transmission system.

The Selective Sliding-gear Transmission System.—The desired speed can be secured without shifting through other gear positions as in the progressive system. This system is used on the largest number of automobiles.

In Fig. 136, *A* is the driving shaft, *B* the driven shaft. *S* and *L* are slides carrying yokes that move the wheels *D* and *K*. All the wheels on the countershaft are fast to the shaft. A lever is arranged for shifting either *S* or *L* and for allowing the various gears on the shaft *B* to mesh with those on the countershaft. This system is commonly arranged for three speeds forward and one speed reverse, but can be modified to give any number of

speeds for forward and for reversing. Fig. 137 illustrates a selective transmission system and multiple-disk type clutch.

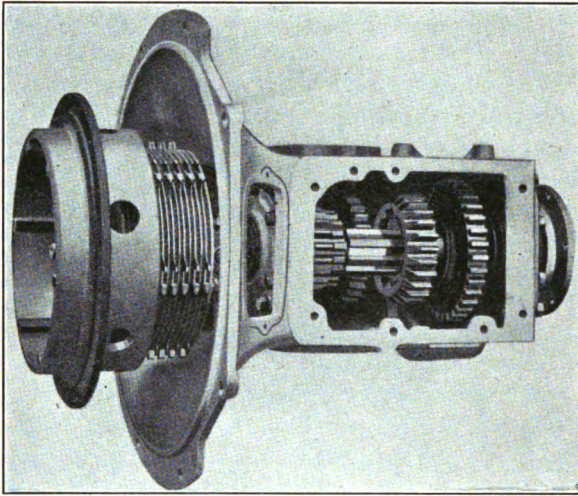

FIG. 137.—Transmission system and clutch.

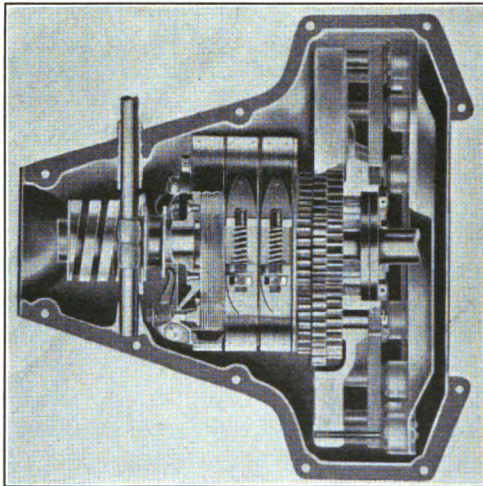

FIG. 138.—Planetary transmission system.

The Planetary Transmission System.—In the planetary system of transmission the speed changes do not depend upon the

shifting of gears, but clutches or brakes are employed for holding certain wheels in position. The drive is positive, and the gears are always in mesh.

The planetary system is particularly well-adapted for high speeds, as the entire system is clamped solidly and revolves with the motor crankshaft as a single mass, when the car is propelled at high gear; no gears are turning idly, and the transmission system, by its weight, serves to steady the rotation of the motor.

The objections to the planetary system are that it provides only two forward speeds and one reverse speed, and is not efficient on low and reverse speeds, on account of the power absorbed by the friction between the clutches and the gears. This system is used mainly on small automobiles.

A planetary transmission system, which is used in a Ford automobile, is illustrated in Fig. 138. Brakes applied by means of foot pedals are used for holding certain of the gears stationary for low speed and for reverse. For high speed forward, the friction clutch, which is of the multiple-disk type and is part of the planetary system, connects directly the driving and driven shaft.

The Friction Drive.—The friction-drive form of transmission is illustrated in Figs. 139 and 140 and depends upon the friction between rolling surfaces.

A flat-faced disk *A* is carried on an extension of the engine shaft. The other part of the transmission consists of a fiber-faced friction wheel *B* which can be slid along the shaft *S* and brought into frictional engagement with the disk *A*. The power is transmitted from the shaft *S* to the driving wheels by a chain (*C*) and sprocket wheel, or by bevel gears and a propeller shaft. As the wheel *B* is moved, by the aid of the lever *L*, nearer the center of the disk *A*, the shaft *S* rotates more slowly; shifting the wheel *B* nearer to the outer edge of the disk *A*, *S* is rotated faster. Sliding *B* to the right of the center of *A* reverses the direction of rotation of the shaft.

The chassis of an automobile with friction drive is illustrated in Fig. 140.

The friction drive is the simplest of all forms of transmission, is inexpensive, is more silent and permits the propulsion of the car, at an unlimited number of speeds in either direction. The

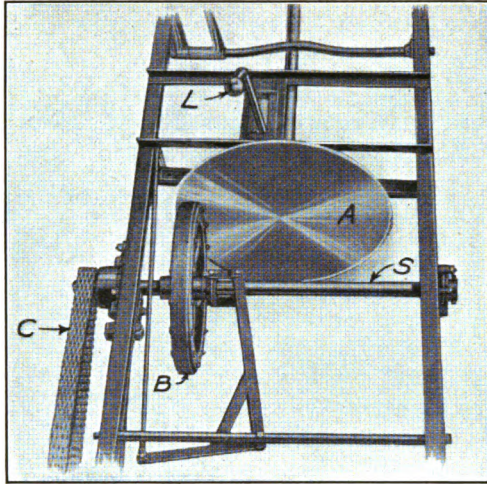

FIG. 139.—Friction drive.

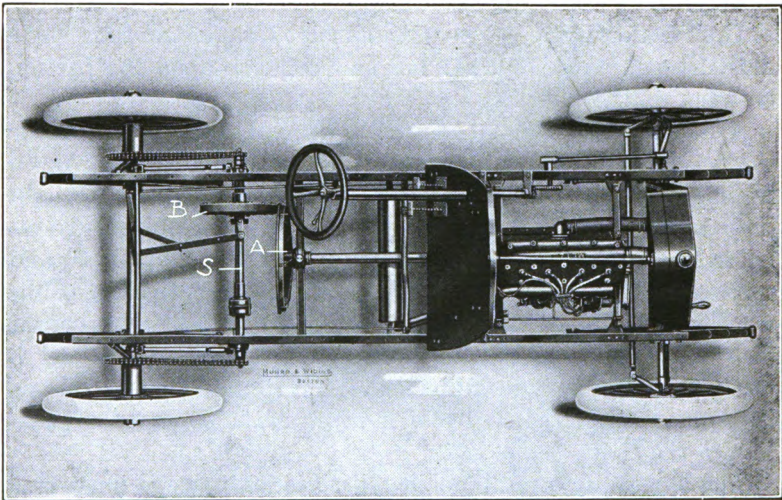

FIG. 140.—Chassis of automobile with friction drive.

disadvantages of this system are that the drive is not absolutely positive, that there is a loss of power due to slipping, that frictional surfaces wear rapidly, and that the system cannot be properly enclosed. The friction drive is used mainly on light cars.

Differentials for Automobiles.—When an automobile turns a

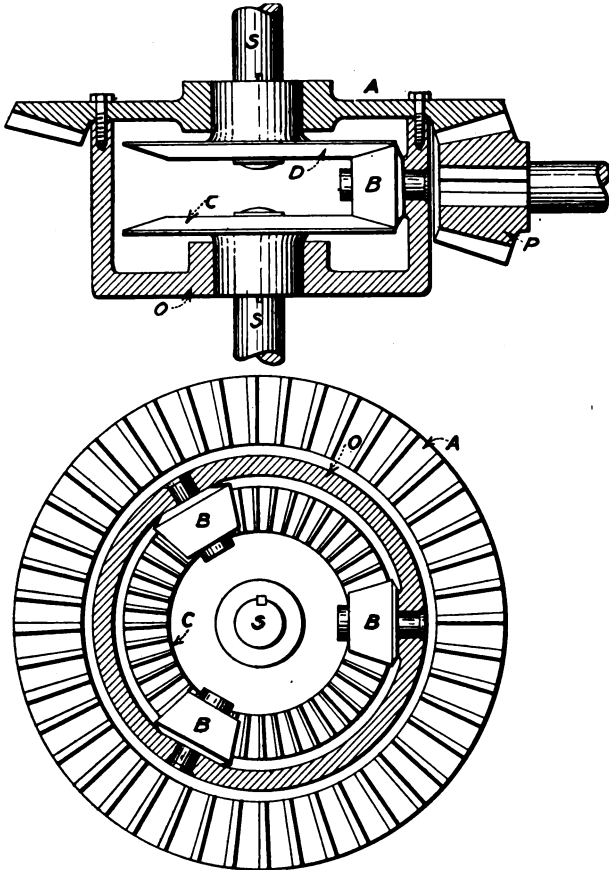

FIG. 141.—Bevel-gear differential.

corner, the drive wheel on the outside of the curve must turn faster than that on the inside. If the two drive wheels, which are the rear wheels, were rigidly connected, one would have to skid or slip when turning a corner or when going over an obstruction; this would throw a great strain on the front axles and wheels with

consequent wear on the tires. The differential, sometimes called a compensating or equalizing gear, allows one drive wheel to move ahead of the other when turning a corner or when overcoming resistances due to the unevenness of the road, while at the same time both wheels are driven from the engine.

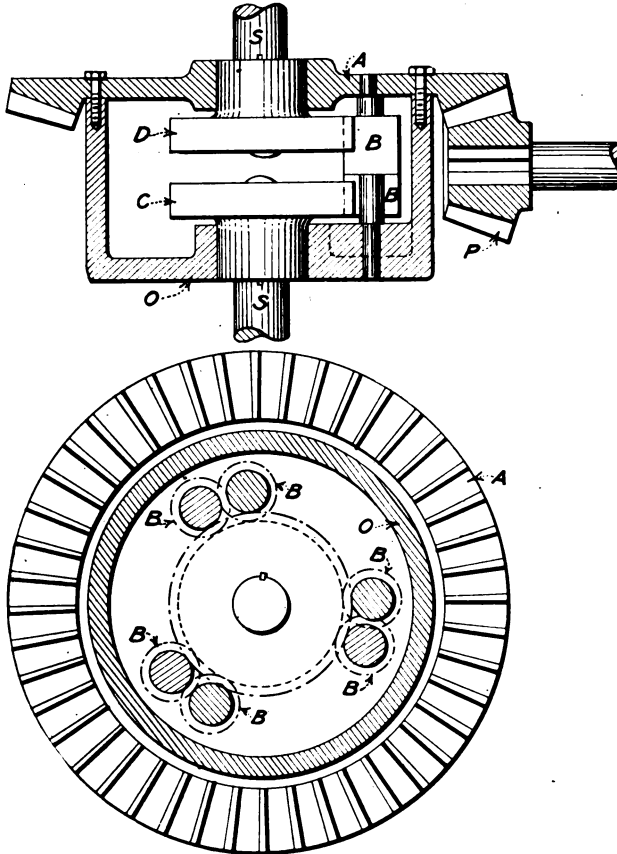

FIG. 142.—Spur-gear differential.

There are two types of automobile differentials, the bevel-gear type and the spur-gear type.

The bevel-gear type of differential (Fig. 141) is most commonly used. The rear axle *S* is divided into two halves. Each half of the rear axle carries a drive wheel at its outer end and a bevel

gear (*C* or *D*) at its inner end. The two bevel gears *C* and *D* are connected by three or four differential or compensating pinions (*B, B, B*) which are placed at equal distances apart around the circle. These bevel pinions (*B, B, B*) are capable of rotating loosely on radial studs which are fastened at their outer ends to the casing or housing *O*. Gear *A* is made to turn loosely upon the hubs of bevel gears *C* and *D* but is made fast to the casing or housing *O* by means of bolts. The power from the engine is transmitted to the housing *O* through the bevel gear *P* which meshes with gear *A*. The housing transmits this power through the small bevel pinions (*B, B, B*) to the bevel gears *C* and *D*, which are connected to the rear wheels or drive wheels.

On a level road with both drive wheels rotating at the same speed, the housing *O* with the gears and pinions will revolve as one mass and the small pinions, marked *B*, will remain stationary. In turning a corner, in meeting an obstruction, or in case one of the wheels slips, if the drive wheel attached to the bevel gear *C* must turn slower than that attached to gear *D*, the differential pinions (*B, B, B*) will revolve on their axes. The bevel pinions (*B, B, B*) act as balance levers, similar to the doubletrees or eveners on a team of horses, dividing the torque between the two bevel gears (*C, D*) and allowing the two drive wheels to run at different speeds.

The spur-gear type of differential, now seldom used, is shown in Fig. 142. The power from the engine is transmitted to the housing *O* through the bevel gear *P*, which meshes with the gear *A*. The housing transmits this power through the small spur pinions (*B, B, B*) to the spur gears *C* and *D*, which are connected with the drive wheels. The action of this differential is similar to the bevel-gear differential of Fig. 141.

The relative positions of the transmission, the differential, and the driving wheels are illustrated in Fig. 143.

Universal Joint.—Since the engine and the gearing are mounted on the frame of the automobile, while the driving wheels are connected to the frame by springs, automobiles with shaft drive must be provided with some flexible joint. The universal joint (Fig. 143), which consists of forked arms at the ends of shafts, and at right angles to each other, permits the lower end of the propeller shaft to move independently of the motion of the rear axle.

“Propeller shaft” (Fig. 143) is the term applied to the shaft which connects the transmission with the differential.

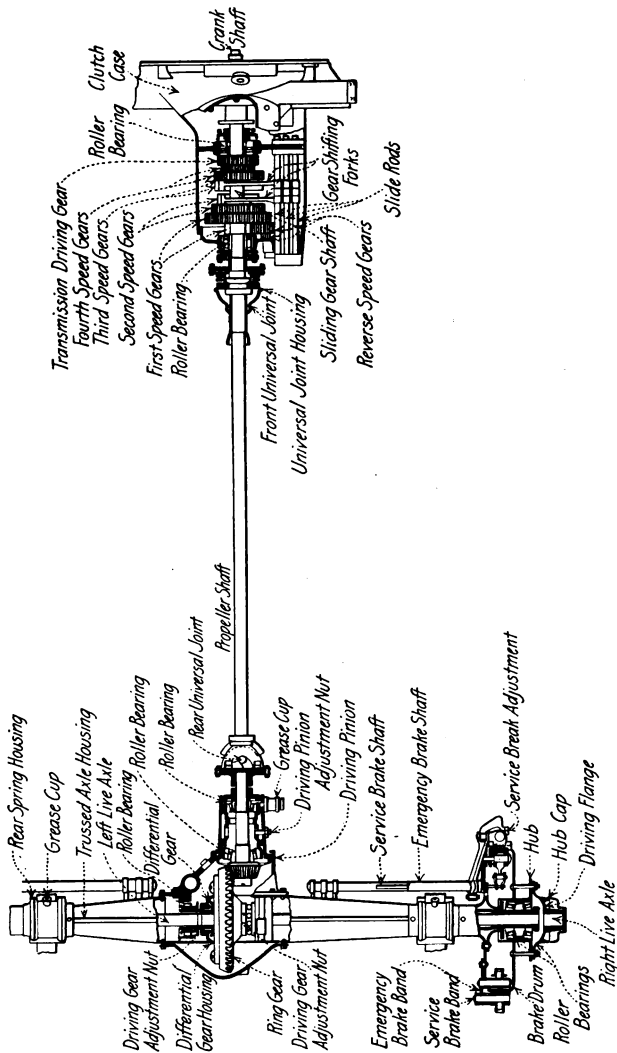

FIG. 143.—Transmission system of an automobile.

Front and Rear Axles.—The front axles are of a construction which permits the wheels to pivot near the hub. With this construction there is not the tendency for the wheel to swing

around when striking an obstruction in the road. The steering knuckles are a part of the front axle, on which the front wheels revolve. Steering arms are inserted in the knuckles and connect together with an adjustable tie-rod so that both knuckles turn simultaneously. A third arm attached to the left-hand knuckle connects the steering gear by means of the steering connecting rod. In Fig. 144 the various parts of the front axles are illustrated. Some front axles are constructed of heavy steel tubes, with dropped forged axle ends. The majority of automobiles are constructed with front axles which are dropped I-beam sections (Fig. 144).

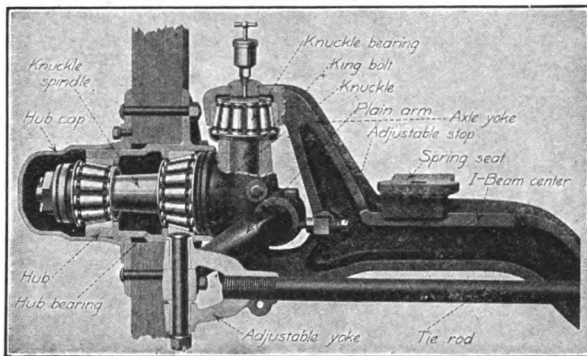

FIG. 144.—Details of front axle.

The rear axle of the automobile carries the differential and the two rear wheels. In one type of rear axle, called the semi-floating type, the axles carry the entire load. In the full-floating axle the weight of the car is carried by a housing through which the axle passes. In the full-floating axle the shaft may be removed without disturbing the wheel or the differential.

Steering and Control Systems.—Automobiles are steered by means of a hand wheel which is located on the top of the steering column. The steering gear operates on the front axle, through the steering connecting rod, and turns the knuckles and front wheels. The steering column (Fig. 145) usually contains several concentric tubes with connections to the alarm, the throttle control, the spark control, and the steering mechanism which reduces the motion of the steering wheel.

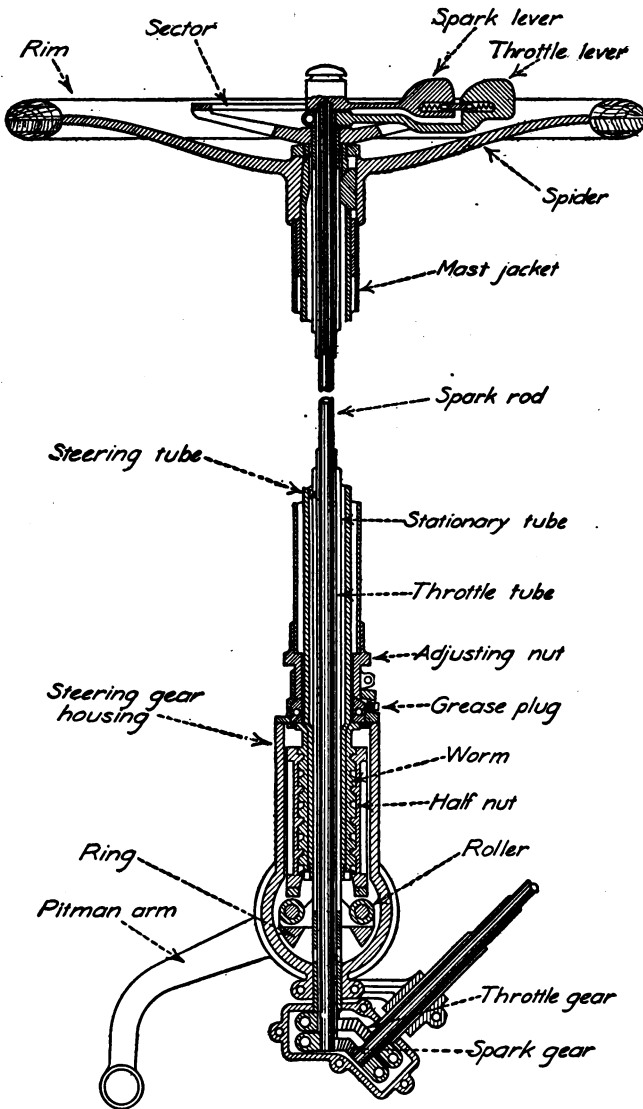

FIG. 145.—Steering gear.

The worm-and-nut form of steering gear (Fig. 145) consists of a double-threaded worm attached to the hand wheel and two half nuts, one of which has a right-handed thread and the other a left-handed thread. If the steering wheel is turned, one of the half nuts moves up and the other down, thus turning the steering yoke and moving the pitman arm back and forth. The motion of the pitman arm is transmitted to the steering knuckles and front wheels.

Another form of steering gear consists of a worm-and-worm gear (Fig. 146). The worm-gear shaft carries the pitman arm,

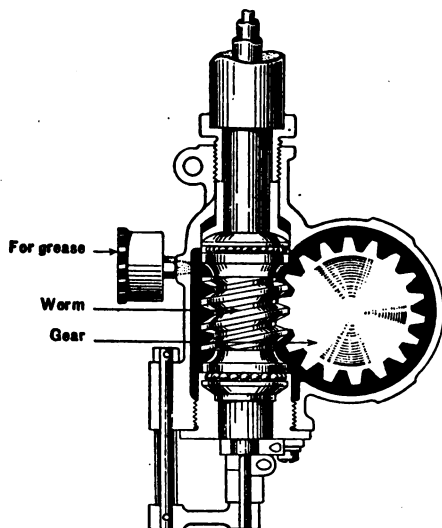

FIG. 146.—Worm-and-worm-gear steering mechanism.

which transmits the motion of the steering wheel to the steering knuckles and to the front wheels.

The spark and the carburetor throttle-control levers are usually located on top of the steering wheel (Fig. 145), but, in some few makes of cars, under the wheel on the steering post. The speed of the automobile motor is controlled by the throttle and spark levers.

The largest number of cars are provided with two methods of throttle control, the hand throttle-control lever on the steering wheel and a foot control of the throttle, commonly called the

accelerator. The foot throttle-control lever is usually employed when shifting the transmission gears, as one hand is required to operate the gear-shifting lever while the other is engaged in steering the car. The accelerator is also used when running an automobile through crowded streets. The hand throttle lever and the accelerator are interconnected, so that the accelerator will move up or down if the hand throttle lever is shifted.

The control system (Fig. 147) includes a pedal for operating

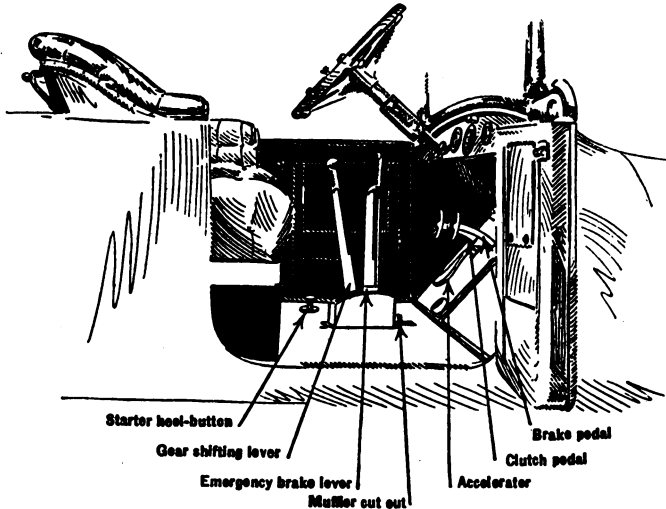

FIG. 147.—Automobile control system.

the friction clutch, one for operating the service brake, a lever for operating the emergency brake, and a lever for operating the speed-changing and reversing gears of the transmission.

The Ford automobile is controlled by three foot pedals and by one hand lever. The pedals operate the clutch, the reverse, and the service brake. The hand lever operates the clutch and the emergency brake.

Brakes.—Automobile tires being made of rubber, the brakes are not applied to the wheel tires but to metal drums which are usually fastened to the rear wheels. Two brakes are employed. One brake, called the service or running brake, is operated by means of a foot pedal. The other brake, called the emergency brake, is operated by a hand lever and is intended for use only in

case the service brake fails or in case a very strong braking action is required. Automobiles, with the planetary system of transmission (Fig. 138), have the service-brake drum near the transmission mechanism.

The braking effect can be produced by expanding the brake band or shoe within the brake drum or by contracting the brake shoe around the outside of the drum.

The brake bands are usually covered on the rubbing side with an asbestos preparation, which can be replaced when worn out.

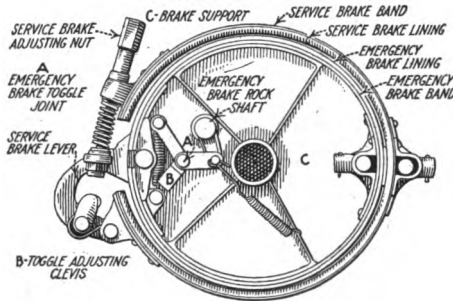

FIG. 148.—Section of brake.

The brakes in Fig. 148 consist of an external service brake and an internal emergency brake.

Wheels and Tires.—Automobile wheels are made of wood or of metal. The wooden wheels are considered more flexible, but the metal wheels are lighter.

Tires made of rubber are used to take up the road vibrations before they reach the car proper.

The double pneumatic rubber tire is used on gasoline automobiles, while the solid rubber tire is employed to a limited extent on trucks and on electric automobiles. The double automobile pneumatic tire consists of an inner rubber tube with a check valve to hold the air and an outer casing which protects the inner tube from wear. The outer casing is built up of strong canvas fabric covered with a tougher and denser rubber than the inner tube.

Single-tube pneumatic tires, similar to bicycle tires, have been used to some extent on automobiles. Double tires are preferable on account of the security of their attachment to the wheel rim.

In bicycles the single tire is practical as the danger of the tires rolling off the rim is averted by the inclination taken by the entire wheel when turning corners.

The tread of automobile wheels is usually 56 in., measured from wheel center to wheel center when the tires touch the ground.

Carburetors and Gasoline Feed Systems.—Automobile carburetors are of the float-feed type and are usually of the forms described in Chapter V and illustrated in Figs. 78 to 81. Multiple-nozzle carburetors are adapted for high-powered automobiles.

The carburetor throttle, as previously explained, can be controlled by the accelerator as well as by the hand throttle lever on the steering post. With the pressure removed from the accelerator, the carburetor throttle will close to the position set by a hand throttle lever.

To meet the requirements of the lower grades of gasoline, automobile carburetors are often jacketed and the air supply is preheated by the exhaust gases.

The concentric types of float-feed carburetor (Figs. 78, 80 and 81) are much used, as the fuel level in the float chamber is not affected by the inclination of the car. A carburetor should be of the proper size for the automobile motor. If the carburetor is too large, the fuel economy and the engine capacity will be reduced, as the air velocity through the mixing chamber would be too low to produce the proper mixture of air and fuel. A carburetor too small for the engine it is to serve will chill on account of insufficient heat supplied by the entering air and this will also result in poor fuel economy and loss of power.

The following systems are used for feeding fuel from the gasoline tank to the carburetor:

1. *The Gravity-feed System.*—The gasoline tank is placed above the level of the carburetor and the fuel flows by gravity. This system is simple, but when the fuel tank is placed under the seat, the pressure on the carburetor float valve is not constant, and, in ascending hills, the gasoline supply may become interrupted. Sometimes this difficulty is overcome by placing the fuel tank in the cowl, the space back of and above the engine.

2. *Pressure-feed System.*—The fuel tank is placed at the rear

of the car and the gasoline is forced to the carburetor by pressure. The initial pressure is secured by an air pump, and after the engine is in operation the exhaust gases create the necessary pressure. A safety valve keeps the pressure within the required intensity. This system is positive and the fuel is supplied to the carburetor regardless of the position of the car, but the pressure interferes with the proper operation of the float.

3. *Vacuum-feed System.*—The suction stroke of the engine is utilized to lift gasoline from the fuel tank to the auxiliary tank near the engine, from which the fuel flows to the carburetor by gravity. This system has all the advantages of the pressure-feed system and is more reliable. It is also superior to the gravity system in that the gasoline supply is independent of the position or location of the fuel tank.

Ignition.—The jump-spark electric system of ignition (Chapter V) is employed. In some makes of automobiles, batteries are used for furnishing current in starting and magnetos supply electricity for ignition, after the motor has attained normal speed. This is called the dual system.

The voltage of a magneto increases with its speed, and this makes it desirable to employ a battery for starting.

The advantages of magneto ignition are positive action, low upkeep, and simplicity. Magnetos can be constructed so as not to require hand advance of the spark. Various types of low-tension and high-tension magnetos (Chapter V) are used for igniting the mixture in an automobile engine.

In some makes of automobiles, two independent means of ignition are employed.

Other makes of automobiles employ the high-tension distributor system with batteries or a modification of this system, such as the Delco or the Atwater Kent system.

Fig. 149 illustrates an ignition system for a four-cylinder automobile engine which uses battery with master vibrator. The master vibrator, as previously explained, eliminates the necessity of adjusting the vibrators of four different coils, the master vibrator serving for all the cylinders.

The disadvantages of the master-vibrator system result from the fact that a faulty adjustment of this vibrator, which serves all the coils, will throw the entire system out of order. With

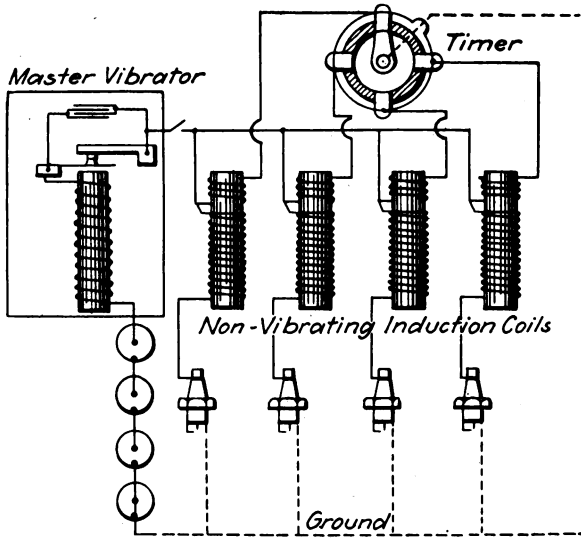

FIG. 149.—Ignition system with battery and master vibrator.

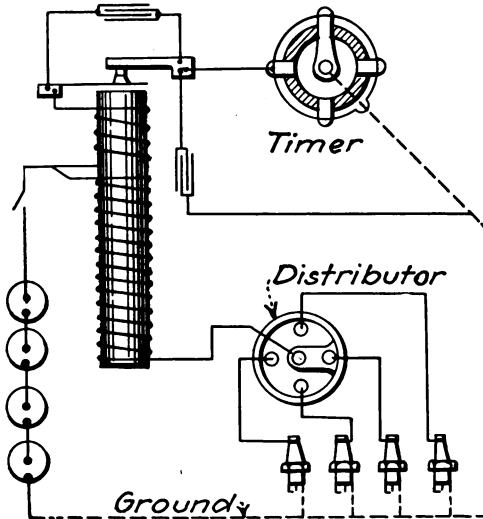

FIG. 150.—High-tension distributor system.

vibrators on each of the coils, an imperfect adjustment of one vibrator, while decreasing the power of the engine, will not disturb the entire system.

In some automobiles the high-tension distributor system, often called the synchronous ignition system, is used. This requires only one induction coil for all the cylinders. This system must be provided with an interrupter for the primary circuit and with a distributor to direct the discharge of the single coil to the spark plug of the several cylinders in rotation. The distributor and the interrupter are mounted together. The various parts of the high-tension distributor system are illustrated and named in Fig. 150.

The Atwater Kent system is of the high-tension distributor type and operates with a primary or storage battery (Chapter X). The essential parts of the Atwater Kent system (Figs. 151, 152, 153) are:

1. A non-vibrator type of induction coil with primary winding, secondary winding, and electric condenser. This type of induction coil produces only a single spark as the circuit is made and broken only once.

2. A timer or contact-maker in the primary circuit. The timer is constructed so that the length of contact is independent of the engine speed.

3. A high-tension distributor with as many contact points as there are cylinders.

4. A governor which advances the spark as the speed increases. This feature of the Atwater Kent system eliminates the necessity of the spark control lever on the steering wheel; and the driver has to control only the carburetor throttle. The automatic spark-advance mechanism, the circuit-breaker or contact-maker, and the distributor are all carried by one vertical shaft. The point of ignition can also be hand-controlled by turning a sleeve beneath the timer.

The Atwater Kent system works on the open-circuit principle, similar to that of door bells, and there is no danger of running down the batteries by leaving a switch closed.

The Delco system is illustrated in Fig. 154. This system includes starting, ignition, and lighting systems all combined in one. A motor-generator set performs the function of cranking

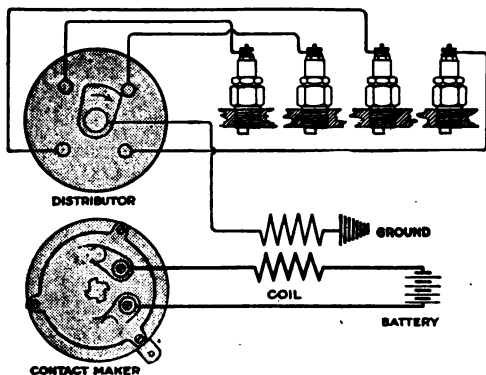

FIG. 151.—Wiring diagram of the Atwater Kent system.

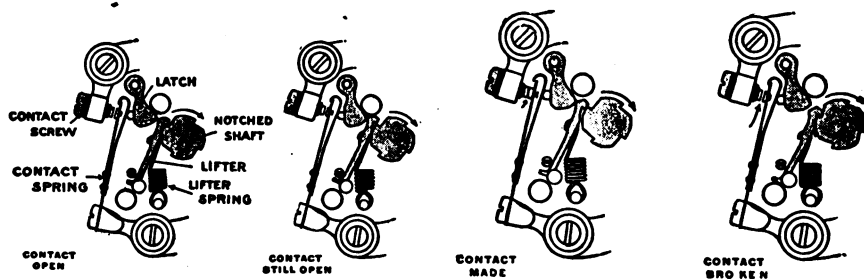

FIG. 152.—Contact maker of the Atwater Kent system.

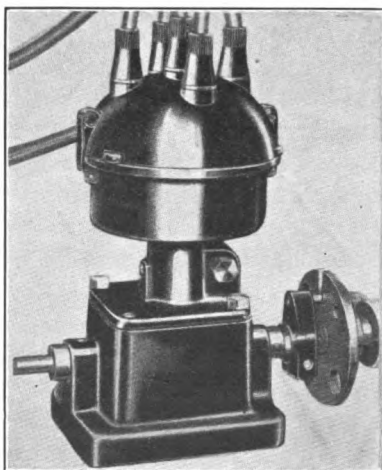

FIG. 153.—Atwater Kent unisparker.

the engine and of supplying electrical current for ignition, lighting, blowing the horn, and charging the storage battery. The motor-generator consists of a dynamo (Chapter X) with two field windings, and two windings on the armature with two commutators and corresponding sets of brushes. This construction is

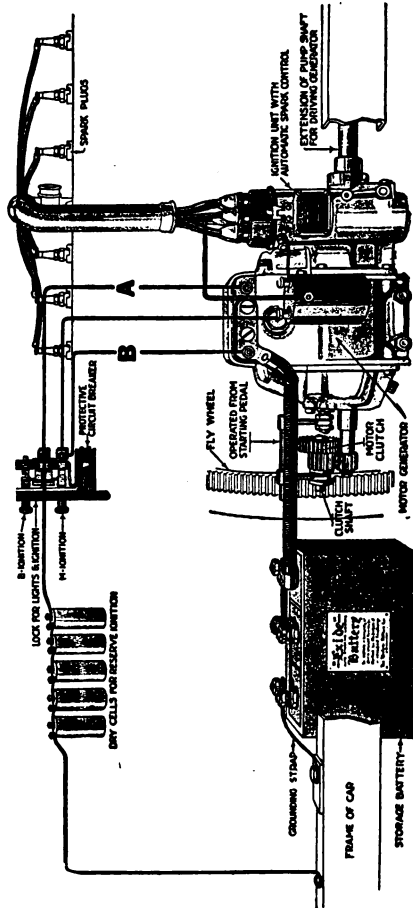

Fig. 154.—Delco ignition, starting and lighting system.

made in order that the machine may work both as a starting motor and as a generator. The ignition apparatus is incorporated in the forward end of the motor-generator. A combination switch is used for the purpose of controlling the lights, the ignition, and the circuit between the electrical generator and the storage battery.

For ignition the Delco system employs a non-vibrator type of induction coil with a timer in the primary circuit, and a distributor. A governor for automatic spark advance similar to that of the Atwater Kent, but of different design, is employed.

In Fig. 154, if button *B* is pulled out, the current for ignition will be supplied by the dry cells. By pulling button *M*, current will be supplied through wire *A*, if the generator is in operation, or by the storage battery through wire *B*.

Automobile Lubrication.—The parts requiring lubrication are the main shaft bearings, crankpin bearings, wristpin bearings, camshaft bearings, timing gears, cams, cam-lifter guides, cylinder walls and all other moving parts, such as the yokes and ends of rods, and steering mechanism.

Transmission gears, differential, and axle bearings are lubricated with heavy grease, as these parts and their casings are not oil-tight. In cold weather it may be necessary to thin down the lubricant of the transmission, the differential and the rear axle. Wheel bearings should be packed with thin cup grease.

Occasional oiling of the clutch will insure free shifting of the transmission gears. An engine oil mixed with graphite is often used for this purpose.

The lubrication of the steering mechanism should receive careful attention. The worm housing should always be packed full of grease.

Ball bearings and magnetos should be lubricated with vaseline.

In several of the light automobiles the splash system of lubrication is employed. The lubricating oil is supplied to the crank case of the motor. The connecting rods dip into and splash the oil to the various parts of the engine.

A combination of the splash constant-level system and force pump (Fig. 109, Chapter V) is used to a considerable extent. The circulating pump lifts the oil from a reservoir or pump below the main crank-case bottom. The oil passes through a sight feed or sight glass on the dash, so that the circulation can be observed by the driver, and to the various bearings. From the bearings the oil falls to the reservoir at the bottom of the crank case. The height of the oil in the crank case is such that the connecting rods give additional lubrication by splash.

The selection of a high-grade lubricating oil is of great impor-

tance, if good service and low cost of automobile maintenance are desired. The oil charts in the manufacturer's instruction book (Fig. 155) should be carefully followed and the parts should be lubricated at the intervals indicated. The oil best suited for the various parts usually has been determined by automobile manufacturers, and their recommendations should be followed for the various makes of cars.

If the lubricating oil is too light in body or if the piston rings are leaky, the oil will work into the combustion chamber, producing not only a loss of oil, but also carbon deposits on valves, cylinder walls, and spark plugs.

An oil which is too heavy will not spread freely, and poor lubrication will result.

Insufficient lubrication will be indicated by the overheating of the parts and by a metallic knock, and will result in cutting, scratching, twisting, or otherwise ruining the parts.

An excess of oil is usually more harmful to the motor cylinder than to the other parts, where the burnt oil will cause carbon deposits. Too much cylinder lubrication is indicated usually by a bluish, smoky exhaust, but a clear exhaust is not always an indication that the motor is properly lubricated.

Carbon deposits will result in preignition, sticky pistons, sticky valves, dirty spark plugs, and ultimate loss of efficiency. Too much lubrication of transmission, differential, or bearings will produce waste by the leaking of the lubricant at the joints.

Automobile Starting Systems.—Automobile motors are started by hand-cranking or by some automatic starting device. Before the motor is cranked, the carburetor throttle lever on the steering wheel should be moved up to open the throttle. The spark lever should be shifted to the retard position, as failure to do this may result in the engine kicking back on account of back-firing. The gears should be thrown into neutral position (Fig. 136).

In cranking by hand, the crank-handle latch should be thrown back in order to free the crank. The crank should now be pushed in as far as possible and turned in the clockwise direction until it catches. The motor should start if the crank is given a quarter or a half turn in the right-hand direction. In cranking an engine, always set the crank so as to pull up. One should not bear

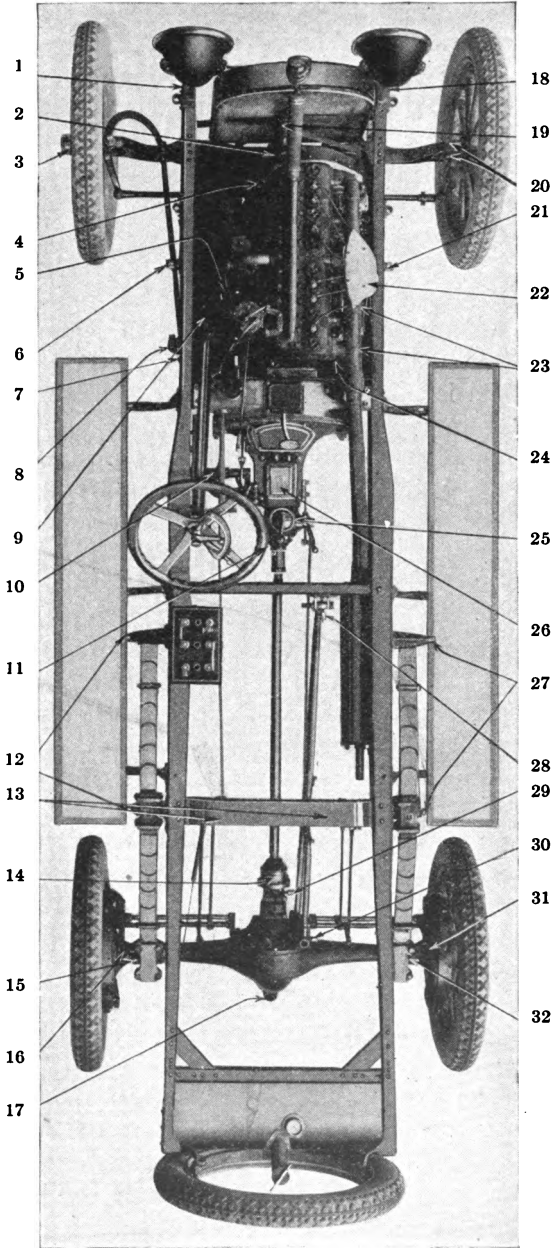

FIG. 155.—Lubrication chart.
(For description see page 157.)

DESCRIPTION OF FIG. 155.

1. Every 500 miles grease spring hanger, cup grease.
2. Every 500 miles grease motor trunion, cup grease.
3. Every 2000 miles remove front wheels and repack roller bearings with cup grease.
4. Always keep motor oil reservoir well supplied with motor oil.
5. Inspect the gauge.
6. Every 500 miles grease spring shackles, cup grease.
7. Every 500 miles grease drag link, both ends, cup grease.
8. Every 500 miles grease steering gear crank, cup grease.
9. Every 3000 miles remove plug in steering gear and fill with cup grease.
10. Every 300 miles oil brake and clutch shaft, motor oil.
11. Every 1000 miles fill universal joint, cup grease.
12. Every 500 miles grease spring shackle, cup grease.
13. Every 300 miles oil brake equalizer shaft, motor oil.
14. Every 1000 miles fill universal joint, cup grease.
15. Every 500 miles grease spring seat bearing, cup grease.
16. Every 500 miles grease rear axle outer bearing, cup grease.
17. Occasionally fill differential case, use transmission oil.
18. Every 500 miles grease spring hanger, cup grease.
19. Every 200 miles oil fan shaft, motor oil.
20. Every 300 miles grease king bolt, cup grease.
21. Every 500 miles grease spring shackles, cup grease.
22. Every 500 miles oil spark advance governor, above and below, motor oil.
23. Every 300 miles oil generator bearings, front and rear, five drops motor oil.
24. Every 300 miles grease starter gear bearing, cup grease.
25. Every 500 miles grease speedometer swivel joint, cup grease.
26. Every 500 miles inspect and fill to top of jack shaft, transmission oil.
27. Every 500 miles grease spring shackles, cup grease.
28. Every 500 miles grease torque hanger, cup grease.
29. Every 500 miles grease front bearing, cup grease.
30. Every 500 miles grease torque hinge, cup grease.
31. Every 500 miles grease rear axle outer bearing, cup grease.
32. Every 500 miles grease spring seat bearing, cup grease.

down on the crank. If the motor does not start after this is repeated three or four times, the cause of trouble should be determined before further cranking.

Electric automatic starting devices are usually employed in modern automobiles. An electric self-starter consists of an electric generator for furnishing electricity, a storage battery, and an electric motor to crank the automobile engine. The electric starting system is also supplied with switches for the purpose of controlling the supply of current; with protective devices such as fuses or circuit-breakers to prevent the discharging of the

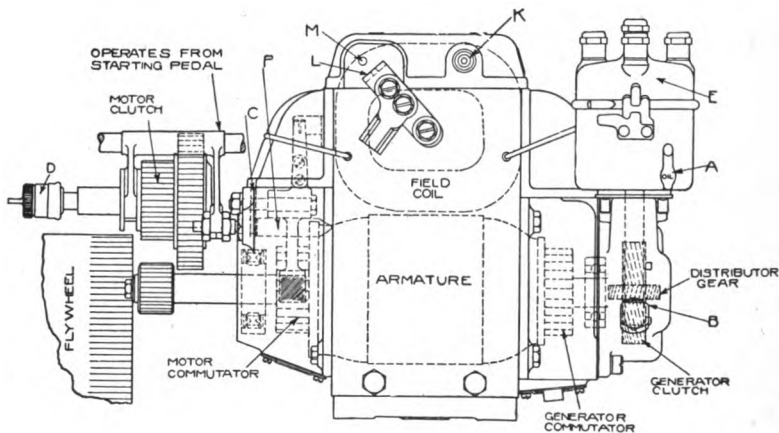

FIG. 156.—Delco starting system.

storage battery or damage to coils, motor, or lamps; with an electric regulator to maintain constant voltage for various speeds of engine, and with electric meters for the purpose of indicating the amount of current supplied by the generator to the storage battery, and for indicating how much current is being supplied by the battery for ignition, lighting, and starting.

Electric starters are built in connection with the single-unit, the two-unit, or the three-unit system. In the single-unit system electric generator and motor are in one unit and this motor-generator is used for cranking the engine, for charging the storage battery, and for furnishing current to be used for operating the engine ignition system and for the automobile lights. In the two-unit system a separate motor which receives its current supply from a storage battery is used for cranking the engine. The

electric generator supplies current for charging the storage battery and also for ignition and lighting. In the three-unit system a magneto furnishes current for the engine ignition system; a separate direct-current motor, supplied with current from a storage battery, is used for cranking; while the electrical generator is used only for charging the storage battery and for operating the lights.

There are a large number of electric self-starters on the market. Only two types will be described in this chapter in order to illustrate the fundamental details.

The Delco system (Figs. 154 and 156) combines in one unit the starting motor, the electrical generator, and the ignition

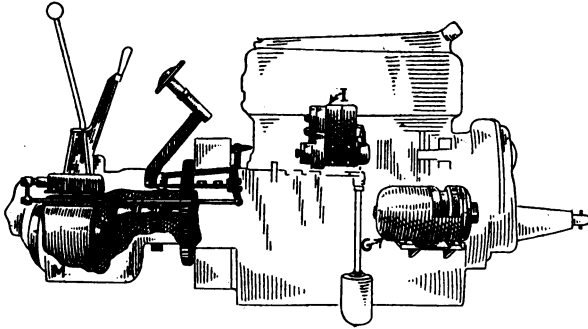

FIG. 157.—Three-unit starting system.

system. The motor-generator of this system has been described in connection with automobile ignition. This motor-generator has the ignition apparatus in the forward end and is located on the right side of the engine.

The arrangement of the various parts of a three-unit starting system is illustrated in Fig. 157. *G* is the electric generator, *M* is the starting motor, and *I* is the magneto for ignition. The starting, lighting and ignition features operate independently of each other.

Mechanical starters are also used to a limited extent on small cars, but have been largely superseded by electric starters. Some mechanical starters utilize springs, which when released revolve the engine crankshaft. Other mechanical starters depend for their action upon a clamp, and are mainly hand-cranking devices

with the driver remaining in his seat. In general, no mechanical starter will start an engine which cannot be started by hand.

Automobile Lighting and Accessories.—Automobiles are lighted by kerosene, acetylene, or electricity. Electricity is coming into general use. Kerosene, when used, is placed in a side light or a tail lamp.

Acetylene gas is generated by adding water to calcium carbide. The gas may be generated while the car is in operation, or may be bought in the compressed form in steel storage tanks under the name of prestolite. Prestolite gas is more commonly used. When the storage tank is exhausted, it is exchanged for a fully charged tank. Prestolite tanks are usually placed on the running board of the car. The acetylene gas may be lighted by a match or by an electric spark controlled from the seat of the operator.

Electric lights are most popular. Electricity for illumination is usually secured from a storage battery. In the cars with electric starters, the storage battery is recharged from the generator; in other cases the battery is recharged from an outside source. In some automobiles alternating-current magnetos furnish lighting current while the car is in motion.

A car lighted with a battery charged from an outside source is equipped with a storage battery of 80 to 100 amp.-hr. capacity (Chapter X) which supplies current for illumination and for blowing the horn. This lighting storage battery is usually not used for engine ignition, unless the car is equipped with a dynamo to recharge the battery. When the storage battery is used for lighting, ignition, and starting its capacity should be at least 90 amp.-hr.

The accessories of a modern automobile are: lamps, speedometer for measuring the speed of the car in miles per hour, horn, tool kit, jack, tire tools and tire repairs, gasoline gage on dash, and mirror.

Management of Automobiles.—Before an attempt is made to start an automobile, the operator should be certain that the fuel tank has sufficient gasoline, that the gasoline valve from the tank to the carburetor is open, that the lubricating system is in good working order, that the radiator is filled with clean water, and that the engine ignition system is working properly. In the case of a dual-ignition system the switch should be closed on the

battery side. The transmission gears should be thrown into neutral position (Figs. 135 and 136), and the emergency brake should be set. Before cranking the engine, the spark lever should be shifted to the retard position and the carburetor throttle lever should be advanced.

The rules given in the discussion of starting systems should be followed in starting an automobile engine by hand-cranking. With electric self-starters, the starting pedal is pushed forward and down as far as it will go and is held down until the engine starts. As soon as the engine starts, the foot should be removed from the starting pedal.

Easy starting may be obtained by throttling the air just as the engine stops, thus leaving a rich mixture in the motor.

In extremely cold weather, or after prolonged standing of the car, it may be necessary to prime the carburetor or even to inject gasoline into each of the priming cups.

When the engine starts, the spark lever should be advanced. To start the car, the emergency brake is released, the clutch is slowly disengaged while the transmission gears are thrown into slow gear forward, and the foot accelerator and spark lever are operated to take care of the increased load on the car.

To stop an automobile, the motor is slowed down by removing the foot from the accelerator, the clutch is disengaged, the service brake is operated so that the car comes to a gradual stop, and the transmission gears are shifted into the neutral position.

To stop quickly the operator presses on both foot pedals, releasing the clutch and applying the service brake, while applying also the hand emergency brake.

To reverse, the car is stopped by throwing the clutch out, thus disengaging the motor from the transmission; then the reverse gear is shifted and the clutch is thrown in slowly.

In changing from low speed to intermediate or to high speed, the foot accelerator is released, the clutch is thrown out, the gears are quickly shifted, the clutch is thrown in mesh, and the foot accelerator is adjusted for proper operation.

In going down a long, steep grade the foot and emergency brakes should be used alternately in order to equalize the wear on the brakes. The engine is also used sometimes as a brake when descending steep hills, with the throttle closed, the spark off, and

the clutch engaged. The car runs the engine against compression, and the engine acts as a brake. By using the engine in this manner, the wear on the brakes is lessened.

The low speeds are used in starting, in driving through bad or sandy roads and in climbing steep grades.

To increase engine speed the carburetor throttle should be opened by the throttle lever on the steering wheel or by the foot accelerator and the spark advanced.

In operating a car the clutch should always be thrown out before changing gears. No attempt should ever be made to engage the reverse gear until the car comes to a full stop. When the clutch is thrown in, the motor is connected to the propelling gear. The clutch should always be thrown in gradually in order that the motion of the motor shaft may be transmitted to the drive shaft without jarring. If the clutch is thrown in suddenly, the motor may stop or the mechanism of the car may be injured. The clutch should be thrown out when the automobile is to be slowed down, as this will reduce wear on the brake lining. The clutch should also be used for stopping the car, if a sudden stop is not desired.

Brakes should be used only when a rather quick stop is to be made. When using the brakes the operator should apply pressure gradually; otherwise the wheels will be stopped before the forward movement of the car and this will result in excessive wear on the tires.

When driving, the operator should keep his feet removed from the clutch and brake pedals, as otherwise undue wear will be thrown on the clutch and brake-operating mechanisms. Care must be taken also in automobiles equipped with self-starters not to push the starter pedal while the engine is running, as this would injure the starting gear.

In timing the valves of an automobile engine it is necessary to set the camshaft of only one cylinder, as all the cylinders are driving from the same camshaft. The exact timing of the valves depends on the engine. For automobile motors, the exhaust valve ordinarily should open about 40° before the end of the power stroke, should remain open during the entire exhaust stroke, and should close about 10° after the beginning of the suction stroke. The inlet valve should open about the time the exhaust valve closes,

should remain open during the remainder of the suction stroke and close 30° to 40° after the beginning of the compression stroke.

In cold weather all water from jackets and circulating system should be drained by opening all pet-cocks on cylinder jacket, pump, feed lines, and radiator. If it is not practical to drain the engine, some non-freezing jacket solution should be used. Glycerine, water and alcohol, or alcohol and water have been used successfully for non-freezing solutions.

The more common automobile troubles and their remedies are illustrated in Table 6.

An automobile engine will smoke if too much lubricating oil is used, if the lubricating oil is of poor quality, if the piston rings are worn or broken, or if the mixture of air and fuel is incorrect.

Engine hissing may be produced by loose or broken spark plugs, by leaving relief or priming cocks open, by having exhaust pipe loosely connected, or by leaky gaskets or intake manifolds.

Irregular action of the automobile engine may be due to incorrect fuel mixture, poor wiring such as defective insulation or defective connections, carbon deposits, poor fuel, or defects in carburetor, magnetos, spark plugs, or mechanism.

Misfiring is often due to carbon deposits on the spark plug.

Overheating of the engine may be due to incorrect valve or spark timing, defective water circulation, clogged radiator, or lack of proper lubrication.

Engine knocks are due to rich mixture, too much spark advance, carbon deposits in the cylinder, loose or worn bearings, loose flywheel, or lack of lubrication.

Gasoline Motor Cycles.—Motor cycles are propelled by air-cooled high-speed vertical gasoline engines. The motor-cycle engines operate usually on the four-stroke cycle and are built as single-cylinder, twin-cylinder, or four-cylinder types. The single- and twin-cylinder machines are most popular on account of the low first cost. The V twin cylinder is often used on account of its simplicity and lightness, there being only one crank and camshaft for both cylinders.

The splash system of lubrication is commonly employed. The lubricating oil must be carefully selected, as the average temperature of the cylinder walls of the motor-cycle engine is higher than that of the water-cooled automobile engine.

TABLE 6.—AUTOMOBILE TROUBLES AND THEIR REMEDIES.

Ignition out of time (rare—due to incorrect mounting). Inlet manifold broken or perforated. Exhaust valve remains seated (broken spring or stem). Links to throttle work poorly or not at all. Water in gas. Gasoline cock is closed or feed pipe clogged or broken. Gas tank empty.		Carburetor in working order.	
Carburetor flooded (needle valve needs grinding—float punctured or too heavy). Too little gas in float chamber (needle valve badly set—float too light when replaced—feed pipe obstructed or jet obstructed). Balance levers broken or worn.		Carburetor not in working order.	
Valve broken. Valve stem dirty or sticks in guide. Valve spring broken or has temper drawn. Cylinder or explosion chamber cracked.		Break or trouble outside of motor.	
Broken piston rings. Piston-ring slots in line or rings set wrong. Piston rings gummed to cylinder walls. Broken crankshaft, connecting rod, loose cam, etc. Water leaks into cylinder.		Break or trouble inside of motor.	
Stuck or wrongly set trembler. Trembler screws loose on coil. Leak between coil and spark plug. Broken secondary wire. Change or renew batteries.	Sufficient voltage or amperage. Insufficient voltage or amperage.	No spark at trembler.	
Run-down batteries. Leak in primary circuit. Dirty trembler, or platinum points too far apart. Timer misplaced.		No spark at outside end of spark plug.	
Broken spark plug. Dirty spark plug. Spark plug points too far apart. Voltage too low for passage of spark, with plug in cylinder.		Spark at outside end of plug.	
Magneto out of time. Wiring improperly connected up.		Spark at outside end of spark plug.	
No contact—broken wire. Timer badly set or damaged. Carbon brushes worn or gone. Distributor contacts fouled (worn down—not making contact). Wire attached to wrong terminal—particularly wire from coil. Poor insulation of wipers and spark plug.		No spark at outside end of spark plug.	
With storage or dry battery unscrew spark plug and place plug on metal.		Ignition not in working order.	
With mag-neto.			

Case 1
Motor
will not
run.

TABLE 6.—AUTOMOBILE TROUBLES AND THEIR REMEDIES.—Continued

CASE 2	{ Motor parts seized from lack of oil or water. Too much oil in crank case. Water has entered cylinders through cracks. Faults due to poor carburetor adjustment, float is stuck, clogged feed pipe, etc.	{ Motor starts and stops after a few revolutions or cannot be made to run for any length of time.	{ Sheared key on live axle. Differential spider broken. Broken drive shaft—key sheared on same. Broken bevel gear. Twisted or misaligned drive shaft. Broken universal joint.
CASE 3	{ Change speed lever indicates no trouble. Change speed lever shows an impediment. Teeth broken in corresponding pinions.	{ Clutch works normally. Clutch sticks at particular speed.	{ Shaft drive. Chain drive. Broken or mutilated gears. Broken ball bearings. Sticking or misalignment of gear shaft or of their operating mechanism. Deformed gear, loose operating mechanism, interior play and faults.
{ Motor runs normally but car does not.			
	{ Misalignment of transmission shafts. Seized bearings and cages. Foreign bodies between gear teeth. Dragging brake—improper adjustment.	{ Broken or weakened spring. Damaged leather. Shaft out of line or bent. Plates or discs buckled. Sheared keys. Seized shaft. Leather plates or discs "frozen" or gummed up.	

The jump-spark ignition system with magneto is employed. Float-feed carburetors of the automobile type are used.

The speed of the engine is regulated by the spark and throttle control. Gear transmissions are used to a very limited extent.

Belt, chain, and shaft drives are used. The coaster form of brake is used in some makes.

Motor cycles are started by the pedal, by a hand crank, or by a foot lever.

Some motor cycles are provided with a clutch to free the engine from the propelling mechanism and operate on two speeds.

Problems: Chapter VI

1. Compare the advantages and the disadvantages of the automobiles operated by gasoline engines, by electric motors, and by steam engines.
2. Name the essential parts of a gasoline automobile.
3. What are the advantages of a twelve-cylinder automobile engine as compared with a four-cylinder engine?
4. Why are the cylinders of the majority of automobiles cast enbloc?
5. Sketch and compare the tee-head, ell-head, and valve-in-the-head types of motors.
6. Describe, using a clear sketch, the thermo-syphon system for cooling automobile motors, and compare this with the forced-circulation system.
7. Explain the action of the sleeve-valve type of motor.
8. Which type of valve is most commonly used in automobile motors?
9. Sketch two types of clutches and explain how they work.
10. Sketch and explain the progressive sliding-gear transmission system.
11. Explain, with clear sketches, the selective sliding-gear transmission system.
12. Using Fig. 137 in the book and models, if available, make several views of the planetary system of transmission and explain how this system works.
13. Make a clear sketch and explain the friction drive.
14. Compare the four systems of transmission as to advantages and disadvantages.
15. Sketch and describe some form of differential for automobiles.
16. Show by means of sketches what is meant by a semi-floating and by a full-floating rear axle.
17. Explain by means of sketches the steering mechanism of an automobile.
18. What are the functions of the accelerator, the hand levers on the steering wheel, and the foot pedals of the automobile?
19. What are the functions of the service brake and of the emergency brake?

20. Explain three gasoline feed systems for automobiles.
21. What is the function of a master vibrator in an automobile ignition system?
22. Make a clear wiring diagram of the ignition systems for a four cylinder automobile engine, using batteries with a master vibrator and with four non-vibrating coils.
23. Explain with clear sketches and diagrams the Atwater Kent ignition system.
24. Give clear sketch showing the fundamental parts of the Delco ignition system.
25. Compare the various systems used for automobile ignition.
26. Which parts of an automobile require lubrication?
27. Why should the lubrication of the steering wheel receive more careful attention than that of any other part of an automobile?
28. What systems of lubrication are most commonly used for automobiles?
29. What are the objections to a lubricating oil which is too heavy? to an oil which is too light?
30. What are the results of using insufficient lubricating oil? Of using too much lubricating oil?
31. Give directions for starting an automobile motor by hand-cranking.
32. Explain, with clear sketches, the action of a two-unit electric starter.
33. Give directions for starting, for reversing, for stopping, and for operating an automobile.
34. Make a chart showing the most common automobile troubles and their remedies.

CHAPTER VII

TRACTION ENGINES

Fundamental Parts of a Traction Engine.—A steam or a gas engine, explained in the previous chapters, can be converted into a traction engine by mounting it on trucks and providing additional mechanisms, so that the engine not only will be capable of producing rotation at a shaft, but also will move itself over fields and highways, thus performing the work of many horses in a cheaper, quicker and better manner.

All traction engines must consist of the following fundamental parts:

1. *Power Plant.*—This, in the case of steam traction engines, consists of a steam engine and boiler. Gas traction engines employ an internal-combustion engine burning gasoline, kerosene, or some heavier oil.

Power-plant accessories include valves and piping from boiler to engine, fuel hopper, water tank, safety valve, water glass and try-cock, steam gage, blowoff, pump or injector or both, a stack and spark arrester. Some steam traction engines have also a feed-water heater which heats with exhaust steam the feed water before it enters the boiler. The accessories of the gas traction-engine power plant are fuel tanks, water tanks, batteries and battery boxes, magnetos, carburetors, cooling systems.

2. *Transmission Mechanism.*—The speed of the engine is too great for direct utilization, and a train of gears must be interposed between the engine and drive wheels.

3. *Reversing Mechanism.*—Reversing of a steam traction engine is accomplished either by a link similar to that used in locomotive practice, or by some form of single eccentric radial valve gear. It is more difficult to reverse a gas traction engine and a train of gears, similar to that of an automobile, must be employed.

4. *Steering Mechanism.*

5. *Differential or Compensating Gear*.—The purpose of this is to allow one drive wheel to revolve independently of the other, this being necessary when turning corners, as is the case with automobiles (Chapter VI).

6. *Friction clutch* for disengaging engine from propelling gear, so that the power of the engine can be utilized for the driving of separators or other machinery.

7. *Traction-engine frames* for supporting the power plant, transmission mechanism and other parts and for keeping all parts in proper alignment. Structural-steel I-beams, angles and channels are employed for frame construction. Cast iron is also used for certain parts.

8. *Traction or drive wheels* (Figs. 161 and 162), which must be provided with lugs to give them a firm footing on the ground, and with mud shoes.

9. *Front Wheels*.—These are made smaller and lighter than the traction wheels, and are provided with smooth tires. To prevent skidding the front wheels are built with a rim in the center (Fig. 170). The front wheels turn upon an axle which is attached to a ball and socket joint, or to some similar mechanism, so as to allow for uneven ground and also to facilitate steering.

STEAM TRACTION ENGINES

Boilers.—The boiler of the steam traction engine is internally fired. Some builders utilize the return-flue type (Fig. 158), others the direct-flue or the locomotive type (Fig. 159).

Coal, straw, wood and crude oil are used as fuels for traction engines. In some states lignite is used. Some builders supply traction engines with attachments for converting them from coal-burners into oil-burners.

When using straw for fuel, the furnace is modified as shown in Fig. 160. Slab grates are then substituted for the ordinary coal grates and the straw is fed through a chute *S*. A hinged trap *T* is provided to prevent the entrance of air when the straw is not being fed.

To maintain the proper draft, steam traction engines are provided with a blower through which live steam is passed into the

smoke stack when starting. When the engine is running it exhausts into the stack through an exhaust nozzle.

In some makes of traction engines, the boiler is mounted upon the truck and is used as the foundation for the engine (Fig. 161).

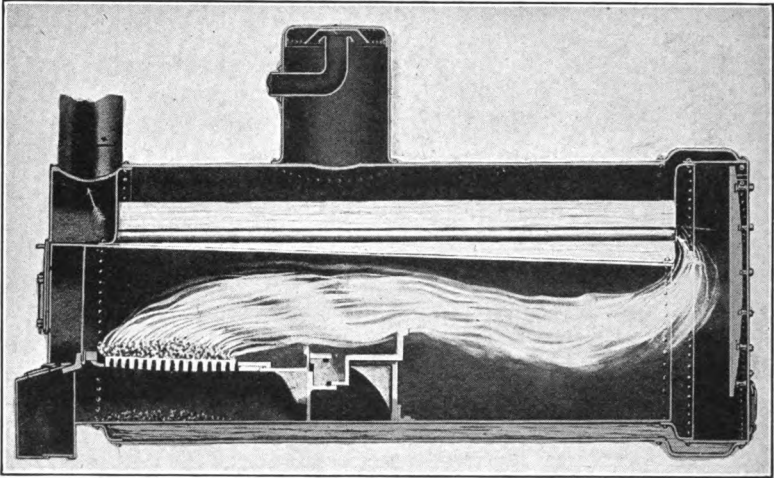

FIG. 158.—Flue-type boiler.

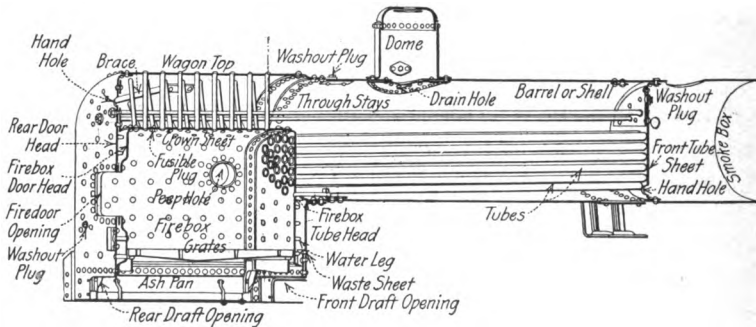

FIG. 159.—Locomotive-type boiler.

Other types (Fig. 162) have the engine mounted under the boiler, the frame supporting both engine and boiler.

Pumps.—Three types of feed pumps are used on steam traction engines: the independent pump which is similar to the types illustrated in Chapter III, the crosshead pump *P* (Fig. 163),

which is driven from the engine crosshead *C*, and the gear-driven pump (Fig. 164). As in the case of stationary engines, two independent methods should be provided for feeding water into a traction engine boiler, using either two pumps or an injector and a pump.

Feed-water Heaters.—Feed-water heaters are used on some traction engines. The type often employed is illustrated in Fig. 165. The feed water passes around the tubes and the exhaust steam passes through the tubes.

Engine Types.—The type of engine usually employed is some simple form of steam engine with a slide valve (Fig. 166). Some

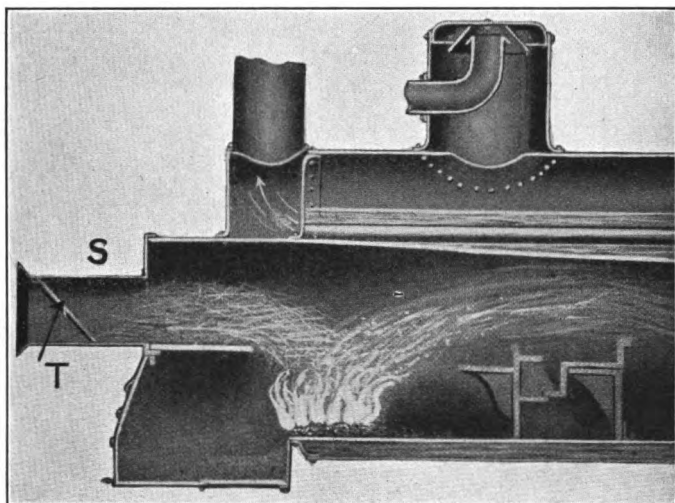

FIG. 160.—Furnace for straw fuel.

traction engines have double-cylinder engines. Compound engines (Fig. 167) are also used to some extent.

The details of the engines, governors and accessories do not differ from those described in Chapter IV.

Reversing Mechanisms for Steam Traction Engines.—A steam traction engine can be reversed either by a Stephenson link similar to that used on locomotives, or by some form of single-eccentric radial valve gear.

To reverse an engine by means of the Stephenson link, it must be provided with two eccentrics, each being connected by

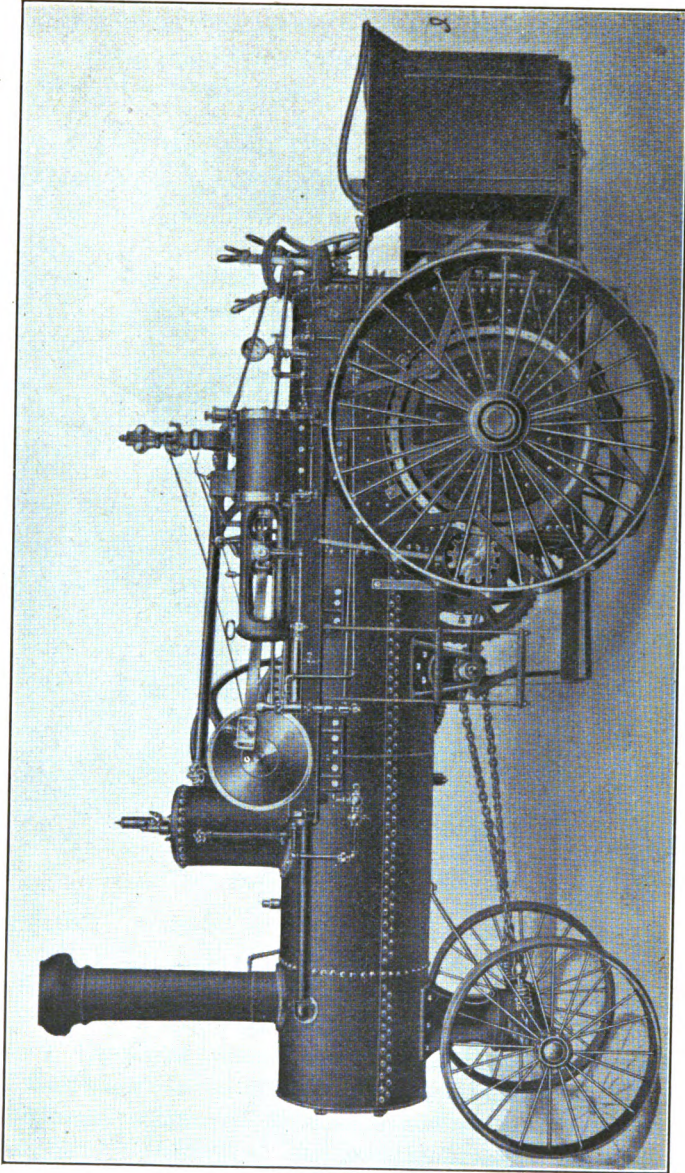

Fig. 161.—Over-mounted traction engine.

an eccentric rod to the end of a link. A block connected to the valve slides along a groove in the link.

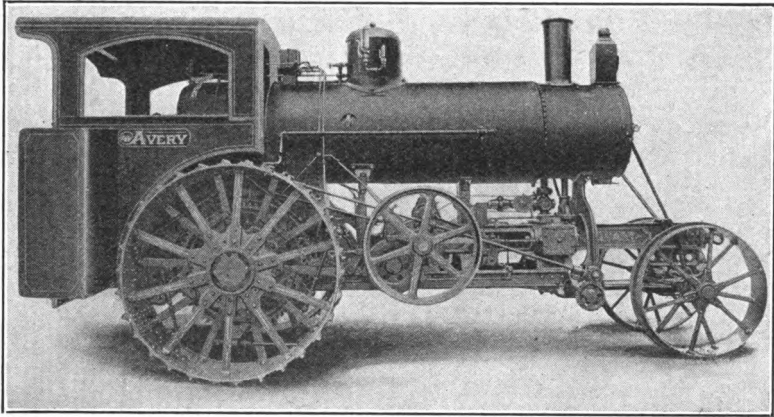

FIG. 162.—Undermounted traction engine.

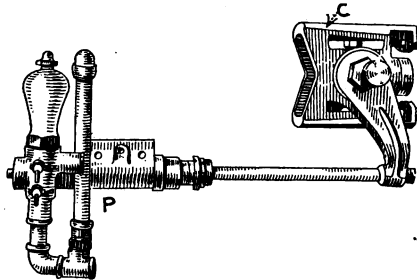

FIG. 163.—Cross-head pump.

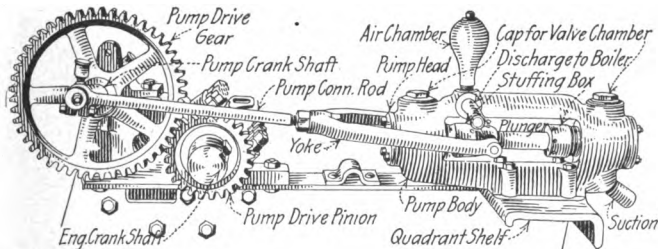

FIG. 164.—Gear-driven pump.

This type of reversing link as applied to a traction engine is illustrated in Fig. 168. The two eccentrics shown at *E* are

attached to the curved link *L* by means of the eccentric rods *A* and *B*. The position of the link is varied by the reverse lever through the reach rod. In one position of the link the motion to the valve is given by one eccentric, driving the shaft in one direction. This direction of rotation is reversed by raising the

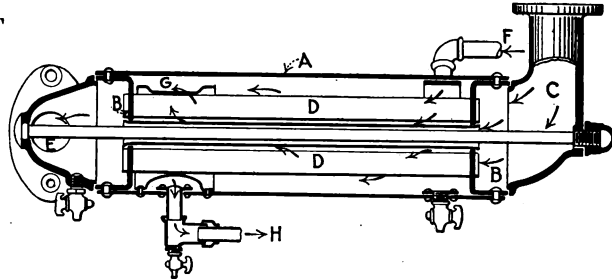

FIG. 165.—Feed-water heater.

link, so that the valve receives motion from the other eccentric. If the reverse lever is moved so that the block is in the middle of the link, the motion given by both eccentrics will be equal and opposite, and the valve will have no motion.

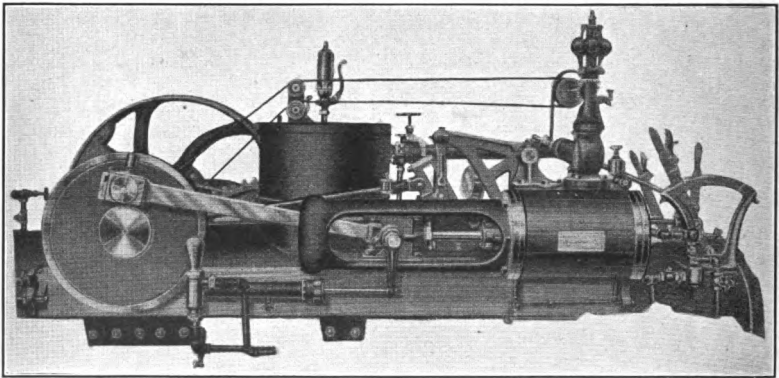

FIG. 166.—Engine for traction engines.

Most traction engines employ a single-eccentric radial valve gear (Fig. 169). This reversing gear consists of an eccentric fastened on the crankshaft with an eccentric strap which has an extended arm, pivoted in a sliding block. The block slides up and

down in a guide and gives motion to the eccentric rod, which is transmitted to the valve through the rocker arm and valve stem. The block guide is hung on a trunnion and it can be tilted in any direction by the reverse lever acting through the reach rod. The

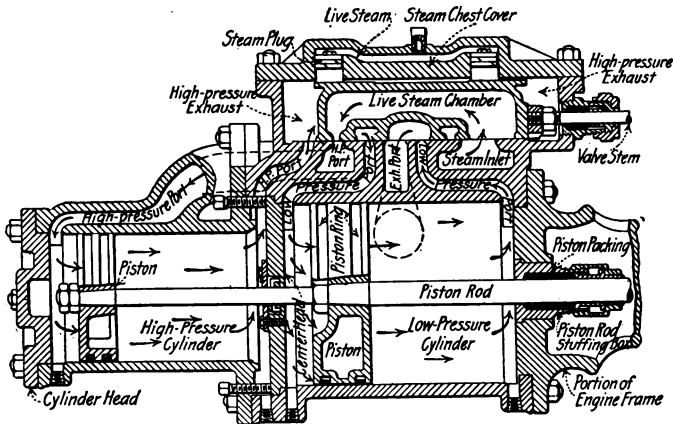

FIG. 167.—Compound engine for traction engines.

angle at which the guide is set determines the direction in which the engine is to run. The reverse quadrant is usually provided with three notches. When the reverse lever is in the central

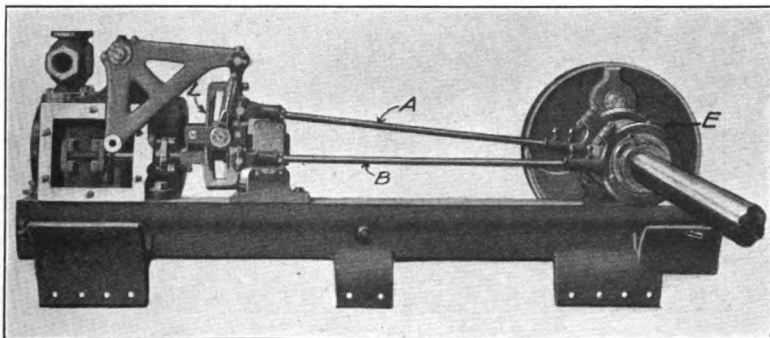

FIG. 168.—Stephenson reversing link.

notch, no motion is given by the sliding block to the valve stem. In the position shown, the block sliding up and down in the block guide moves the valve in one direction. Placing the reverse lever in the notch at the extreme right reverses the engine.

Steering.—Steering is accomplished by turning the front axle. This is done by chains *C* (Fig. 170) which wind upon a spool. The spool is operated by hand through a worm *W* and pinion *P* (Fig. 170). Another method is to operate a screw by the worm

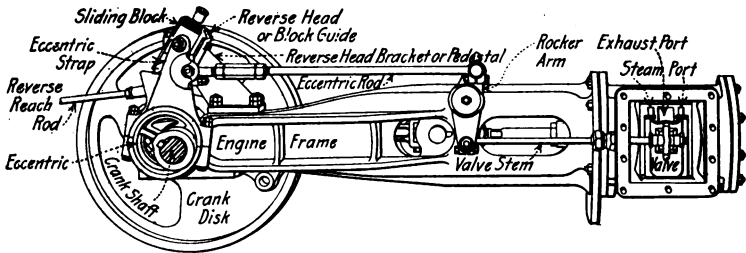

FIG. 169.—Radial valve gear.

and pinion, the screw moving a nut which is connected by a system of levers to the front axle. Some traction engines employ steering mechanisms similar to those of automobiles (Chap-

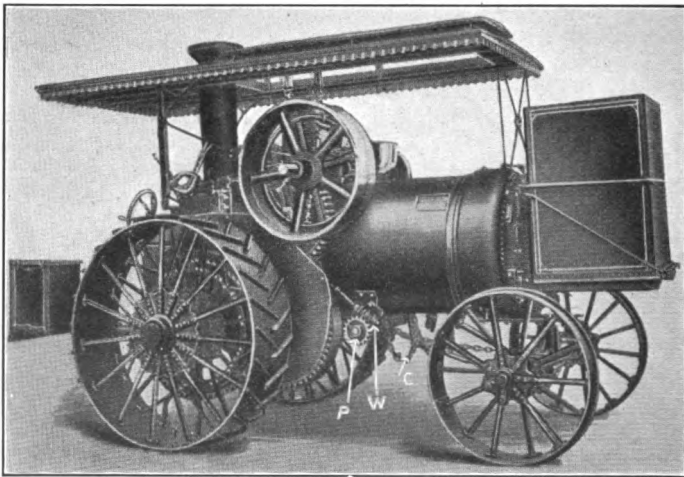

FIG. 170.—Traction engine illustrating steering mechanism.

ter VI). In large traction engines steering is accomplished by power furnished by the engine through a friction disc.

Transmission Systems and Differentials.—A friction clutch, the function of which is to disengage the engine from the pro-

pling gear, is illustrated in Fig. 171. The flywheel *W* is fixed to the engine shaft, and, when used as a belt wheel, it is not connected to the arm *C*, and thus does not transmit motion to the pinion *F* which is rigidly connected with the arms *C*. When the clutch is thrown in, pressure is applied at *E* which rests in a groove in the piece *D*. This results in *B* crowding the shoe *A* against the inner rim of the flywheel. The friction clutch has two shoes made of wood or of some other yielding material *AA*, which press against the inner rim of the flywheel when the clutch is thrown

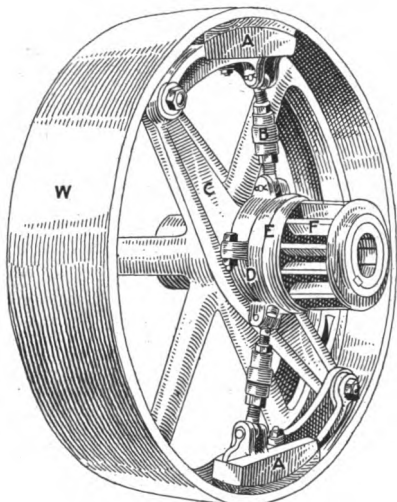

FIG. 171.—Clutch.

in, and this transmits the motion of the engine through the arms *C* and pinion *F* to the transmission. Means are provided for taking up the wear on the shoes so as to keep the clutch effective at all times.

The transmission mechanism delivers the power from the engine to the traction wheels which must revolve slower than the engine crankshaft. The transmission system of a steam traction engine is very simple and consists of a train of spur gears (Fig. 172). The gear *A* receives motion from the engine and delivers this through the train of gears to the gear *B*, which is connected to the traction wheel.

When a traction engine turns a corner, the drive wheel on the

outside of the curve must turn faster than that on the inside. If the two drive wheels were rigidly connected, one would have to

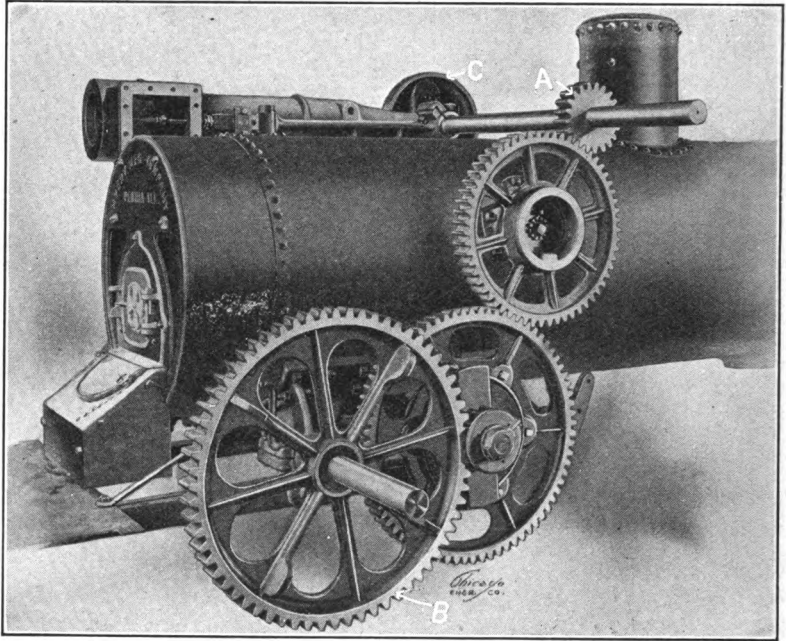

FIG. 172.—Traction-engine gearing.

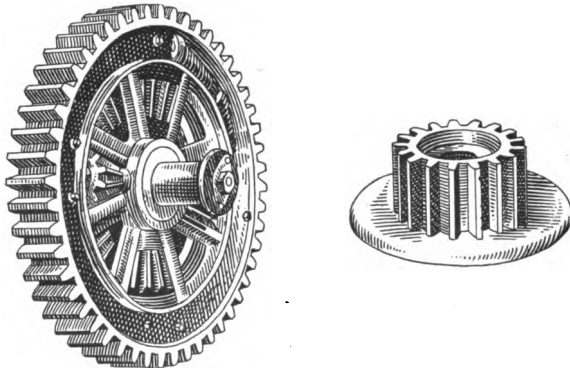

FIG. 173.—Differential.

skid or slip, when turning a corner, and this would throw a great strain on the front wheels and axles. The differential, sometimes

called a compensating gear, allows, if occasion demands, one drive wheel to move faster than the other.

In principle the traction-engine differential is similar to the automobile differentials (Figs. 141 and 142).

The differential can be placed between the two drive wheels on the rear axle. A more common method is to have the differential on a separate shaft, the traction wheels being driven from that shaft by means of pinions.

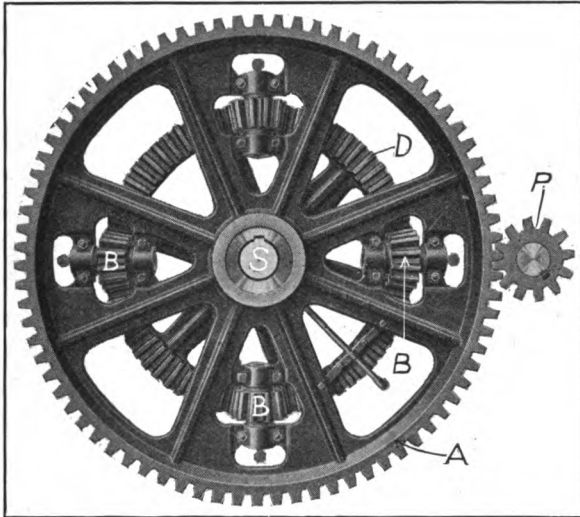

FIG. 174.—Differential.

The principle of differentials as applied to steam and gas traction engines is illustrated in Figs. 173 and 174. The differential shaft *S* consists of two parts, each being connected either directly or through gears to the drive wheels. Two bevel gears are keyed to these two differential shafts and engage several bevel pinions, marked *B*, which turn freely on their respective shafts. The power from the engine is transmitted through the pinion *P* to the large spur gear *A*. When the engine is going ahead on a level road and both drive wheels are rotating at the same speed, the two bevel gears will also revolve at the same speed and the small pinions marked *B* will remain stationary. In turning a corner or in meeting some obstruction, if the

drive wheel connected to one bevel gear moves slower than that connected to the other, *D*, the pinions *B* will revolve on the bevel gear *D*. In other words, the difference in motion between the two drive wheels is compensated for by the revolution of the pinions *B*.

Another traction-engine differential, as applied to gas traction engines, is shown in Fig. 175, the letters designating the same parts as in Figs. 173 and 174. The two pinions *E* and *F* connect the differential with the two drive wheels. *W* is a brake wheel.

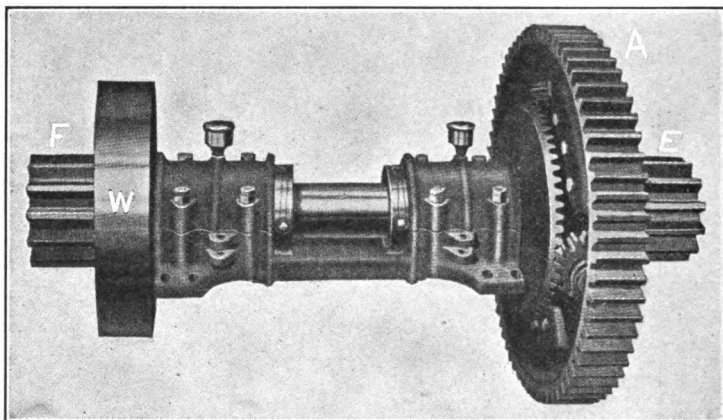

FIG. 175.—Gas traction-engine differential.

GAS TRACTION ENGINES

The term "gas traction engines" is applied to such as are propelled by internal-combustion engines. The fuels most commonly used are gasoline, kerosene and the heavier oils.

The use of gas traction engines has been increasing much more rapidly than that of steam traction engines. The reasons for this are as follows:

1. The gas traction engine is made in many special designs suitable for various uses.

2. The steam traction engine is practical only in large powers, while gas traction engines are built in sizes capable of pulling as few as two plows and as many as fourteen plows. This also means that gas traction engines sell at sufficiently low cost to

enable the fairly small farmer to use this form of mechanical power. The prices of gas traction engines vary from \$500 to \$4,500.

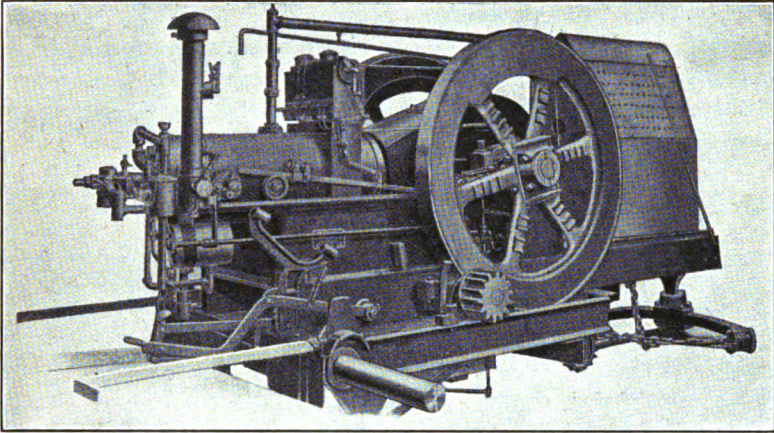

FIG. 176.—Single-cylinder motor.

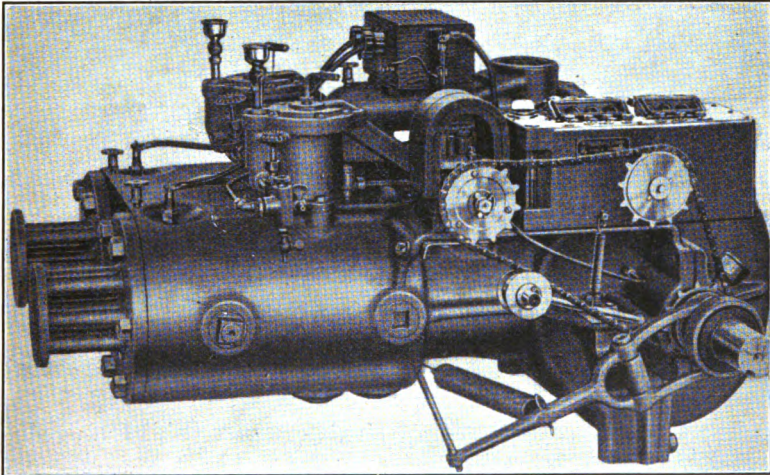

FIG. 177.—Twin-cylinder two-stroke cycle motor.

3. The operator of the steam traction engine must carry a tank wagon with water and a bulky fuel supply. This necessarily

limits the amount of plowing by this form of engine. With the gas traction engine the fuel and water supply occupy little space.

4. Considerable time must be consumed in getting up steam for operating a steam traction engine.

The Gas Traction-engine Motor.—The majority of gas traction engines employ internal-combustion motors which operate on the four-stroke Otto gas-engine cycle. The motors are either vertical or horizontal and of the long-stroke type and operate at moderate speeds as compared with automobiles.

The vertical motor resembles the automobile motor, but is usually heavier. The cylinders of the vertical motor are cast

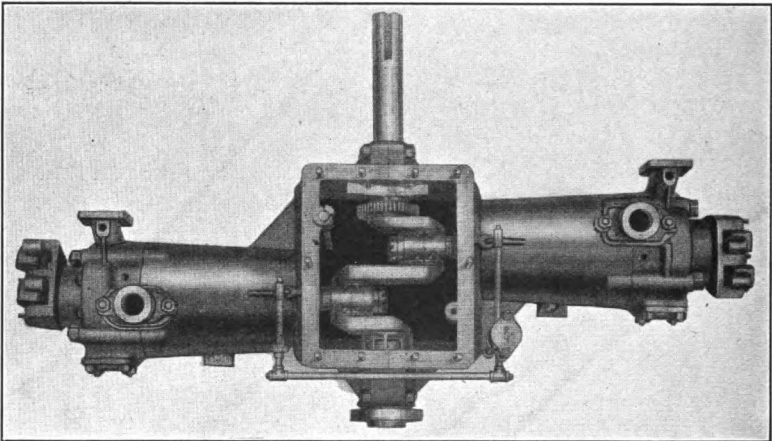

FIG. 178.—Two-cylinder opposed motor.

singly (Fig. 122); some makers cast cylinders in pairs. The four-cylinder en-bloc type, common in automobile practice, is used to a limited extent for traction engines.

The horizontal motor is more difficult to lubricate and is bound to wear more rapidly than the vertical types.

The types of motors used are single-cylinder (Fig. 176), twin-cylinder (Fig. 177), two-cylinder opposed (Fig. 178), and four-cylinder (Fig. 179).

The single-cylinder motor (Fig. 176) is usually of the long-stroke heavy-duty horizontal type and has a heavy flywheel.

The two-cylinder traction engine is built as a twin-cylinder

motor with cylinders mounted side by side, at one side of the crankshaft (Fig. 177), or as a two-cylinder opposed motor (Fig. 178) with two cylinders set horizontally on the opposite sides of the crankshaft. The two-cylinder opposed motor is better balanced and can be operated with lighter flywheels. The twin-cylinder type of motor (Fig. 177) occupies less space and has better carburetion.

Multiple-cylinder motors are more commonly used, as they are lighter than the single-cylinder motor for the same power

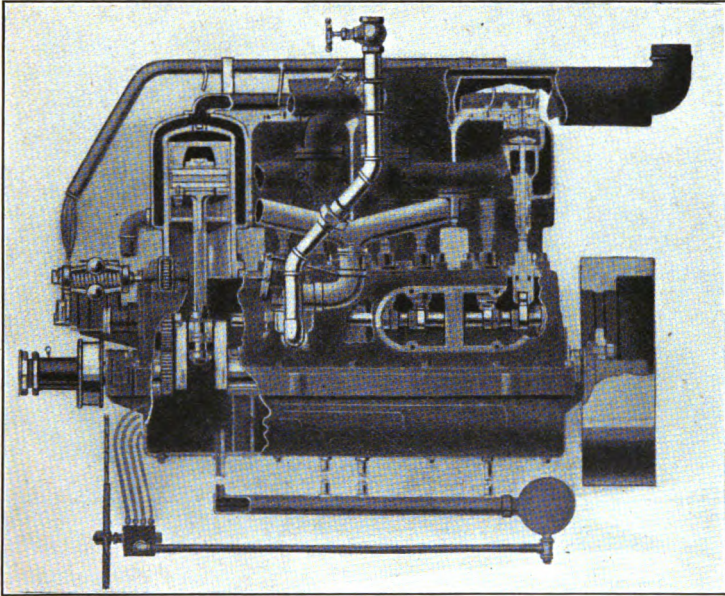

FIG. 179.—Four-cylinder traction-engine motor.

developed. Increasing the number of cylinders produces also a motor which has a more uniform turning effort at the crankshaft, the power impulses taking place more frequently.

The four-cylinder vertical motor (Fig. 179) is the most common type for large traction engines. The cylinders of the four-cylinder motor are usually placed so that the crankshaft is parallel to the tractor frame. In some designs the motor is set crosswise of the frame. In the crosswise arrangement the motor drive is direct, in the other method, the drive to the transmission is through

bevel gears. While the direct drive eliminates the use of a bevel gear, the other design can be built with longer bearings without widening the frame. The length of the bearing is an important consideration in large traction engines.

The motor crankshaft has two, three, or five main bearings and one camshaft usually operates all the valves. The valve camshaft is driven from the motor crankshaft by a two-to-one gear, as is the case in stationary and automobile engines.

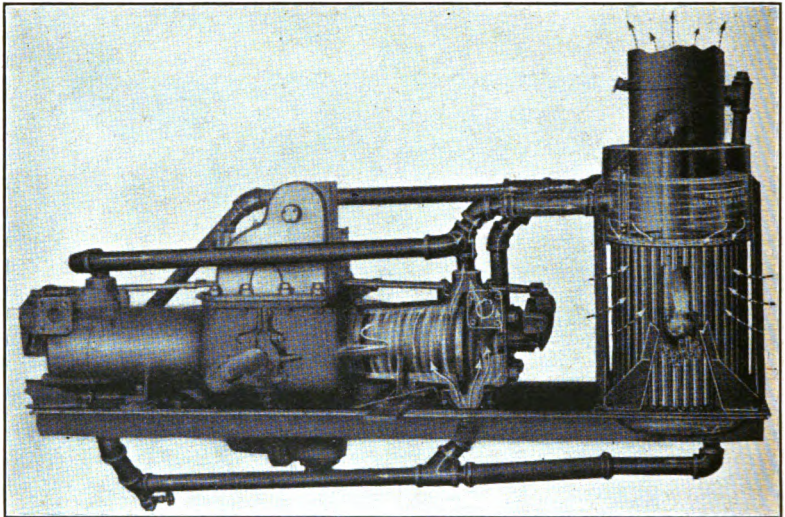

FIG. 180.—Traction-engine cooling system.

Traction-engine cylinders are made of cast iron and are provided with jackets for liquid-cooling. Air-cooled motors are not practical for traction engines.

Water is usually used as the cooling medium. Heavy oils and the various anti-freezing compounds, such as glycerine, alcohol and water, or alcohol and water, are also used to some extent.

A forced system of water circulation is usually employed with a rotary, a centrifugal, or a plunger pump. In the rotary pump the water is circulated by revolving gears and in the centrifugal pump by an impeller or paddle wheel. The rotary or centrifugal pumps are more generally used, as they are more simple. The

thermo-syphon system of water circulation (Fig. 125) is used in some makes of traction engines.

Some form of radiator (Figs. 180; 181) is employed which acts as a water tank and cooler. In most traction engines the radiators are similar to those of automobiles but heavier; a cooling fan is used to circulate the air through the radiator. The exhaust gases are also utilized in some designs to aid in the circulation of the air.

The poppet type of valve (Fig. 127) is always employed. Valves are constructed of a nickel-steel or cast-iron head, and a carbon-steel stem, stem and head being welded together.

The valves are arranged, as in automobiles (Figs. 130, 131, 132), in three distinct ways: namely, the tee-head, the ell-head and the valve-in-the-head construction. With the tee-head or

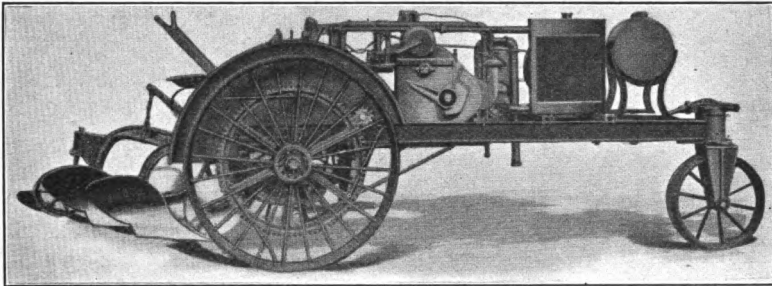

FIG. 181.—A small gas traction engine.

the ell-head construction the valve seats are in a pocket cast on the side of the cylinder proper, which forms a very inefficient combustion space. The valve-in-the-head motor has a very compact combustion chamber.

In the valve-in-the-head type of motor, the cylinder head carrying the valves is a separate casting (Fig. 182) or has the valves mounted in removable cages (Fig. 183).

Many makes of traction-engine cylinders are built with removable heads (Fig. 182). When the cylinder head is a separate casting, it can be removed easily for the purpose of cleaning, and the valves, with this form of construction, can be more thoroughly water-jacketed than when mounted in cages.

When the valves are placed in cages (Fig. 183), the cage contains a seat for the valve and a guide for the valve stem.

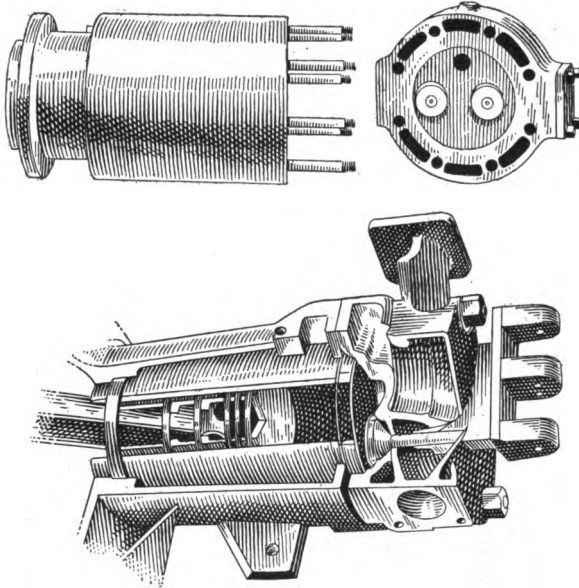

FIG. 182.—Traction-engine cylinders with removable heads.

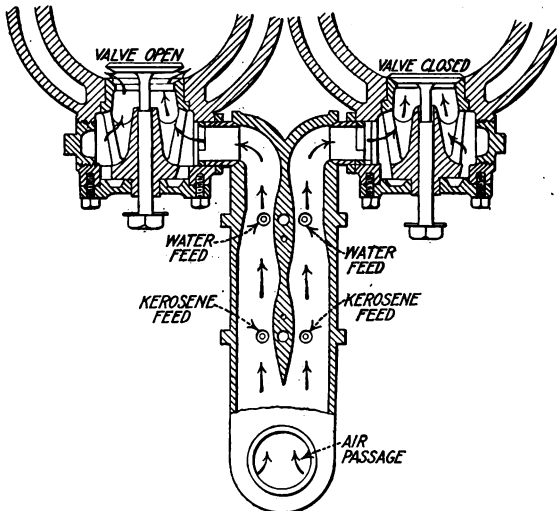

FIG. 183.—Valves in cages.

The exhaust valve seat is usually water-jacketed and in some designs the inlet valve seat is also water-jacketed in order to keep down the temperature of the incoming mixture.

Traction engines are generally constructed with mechanically operated inlet and exhaust valves.

Some gas traction engines are provided with an auxiliary exhaust port. With this construction the exhaust gases pass directly into the exhaust pipe, removing the hottest gases from the exhaust valve and decreasing the pressure at the time the

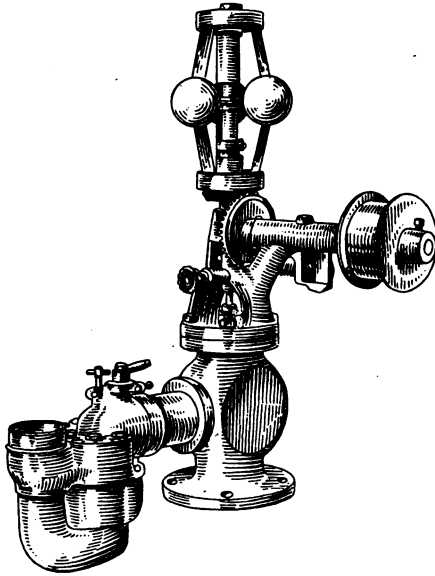

FIG. 184.—Throttling governor.

exhaust valve opens. This feature is particularly advantageous when the engine is operated continuously at heavy loads.

Traction engines are governed by the hit-and-miss or by the throttling type of governor. The hit-and-miss governor is not adapted for work where close regulation is essential. The majority of modern gas traction engines are equipped with throttling governors. The throttling governor is of the centrifugal type and controls the carburetor throttle (Fig. 184). In some cases the controlling mechanism is arranged so that the governor may

be cut out, and the carburetor throttle is controlled by a hand lever.

The speed of various makes of traction-engine motors varies from 365 to 1,500 r.p.m. The majority of motors operate at speeds of 500 to 750 r.p.m.

The belt horsepower of various makes of motors varies from 10 to 120 h.p.

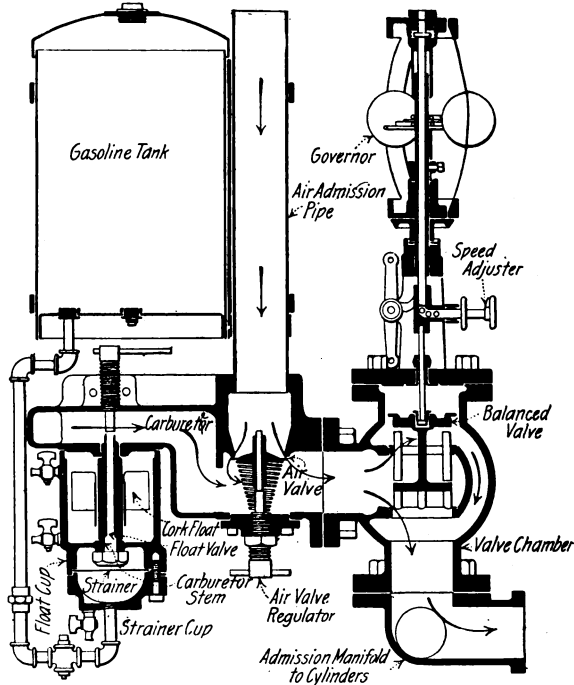

FIG. 185.—Traction-engine carburetor and governor.

Carburetors for Traction Engines.—Float-feed carburetors of the single-jet automobile type illustrated in Chapter V are used. The simpler designs, such as the Kingston (Fig. 78), are generally employed.

The arrangement of carburetor and throttling governor for one form of traction engine is illustrated in Fig. 185. The carburetor is of the concentric-float type. The gasoline passes through a strainer before entering the float chamber. The

fuel mixture on the way to the engine cylinder must pass through a balanced throttle valve which is under the control of the governor.

To burn kerosene, some makes employ the ordinary float-feed carburetor, which has a jacketed float chamber through which

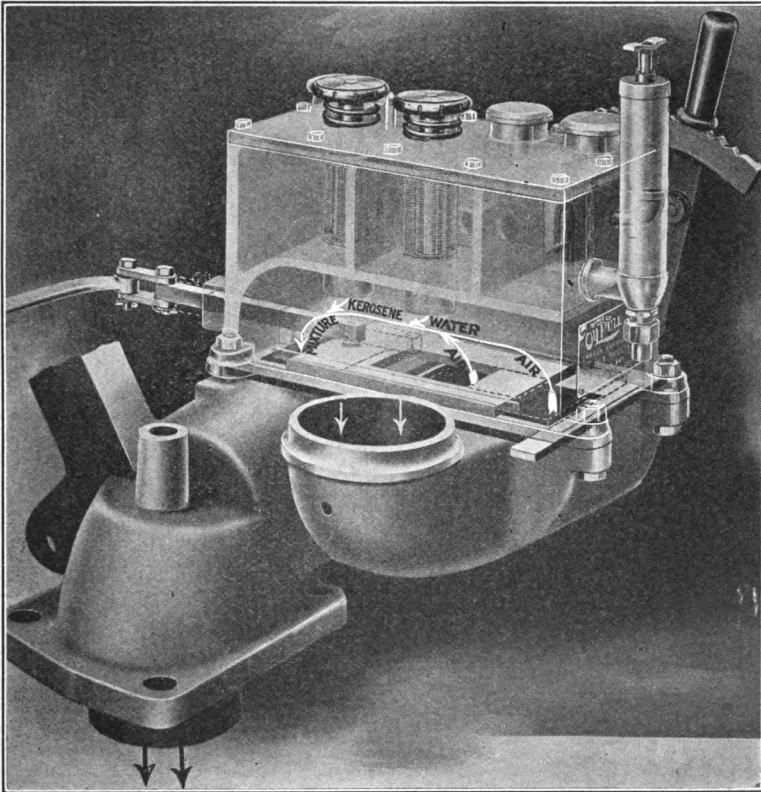

FIG. 186:—Kerosene carburetor.

hot water passes. The kerosene carburetor illustrated in Fig. 82 is used by some manufacturers.

Another form of kerosene carburetor, called the Secor-Higgins, is illustrated in Fig. 186. The three compartments from right to left are for gasoline, water and kerosene. The lower section is the mixing chamber. Gasoline is forced into the mixing

chamber by means of a hand pump. Plunger pumps force water and kerosene into the compartments. The air enters through air intake ports. The amount of air entering the mixing chamber is controlled by the governor. The throttle opening which admits the mixture to the cylinder is also under the control of the governor.

With kerosene fuel, water is generally mixed with the air and fuel to prevent preignition. Very little water should be used at light loads, and the quantity of water injected at higher loads

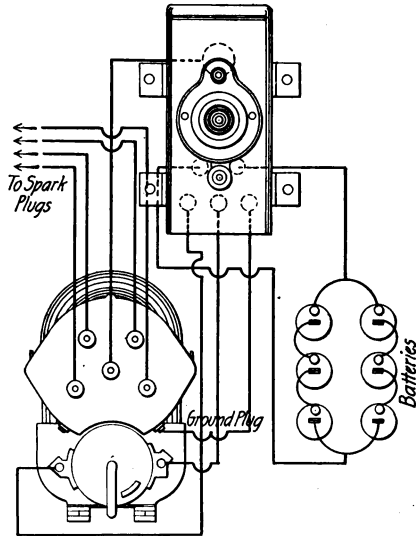

FIG. 187.—Wiring diagram for four-cylinder motor.

should be sufficient only to produce proper operating conditions. With heavier liquid fuels, the capacity of an engine of the same bore, stroke and speed is increased by water injection. Water injection also reduces the amount of carbon deposit, but produces a slower burning mixture with the consequent poorer fuel economy.

The majority of traction engines are equipped to burn kerosene as well as gasoline.

Ignition for Gas Traction Engines.—Nearly all traction engines operate with the jump-spark system of ignition (Chapters V and VI). The jump-spark system is more simple mechanically,

having fewer parts than the make-and-break system. The ignition system differs from that used in automobiles in that magnetos are commonly employed. In some cases the dual system is employed, in which the motors are started with current supplied from a dry or storage battery, but operate with magnetos. In other makes, the motor is started on the magneto. The present tendency seems to be to eliminate the battery and to use the magneto for starting.

A wiring diagram for a four-cylinder traction engine is illustrated in Fig. 187.

The make-and-break system of ignition is used to a limited extent for small traction engines in connection with a slow-speed

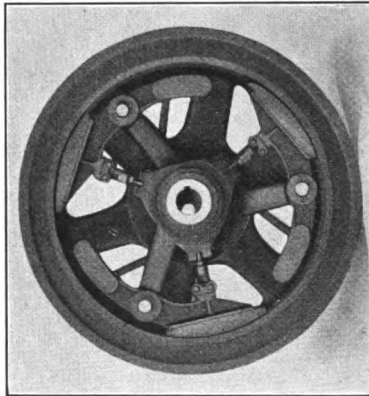

FIG. 188.—Clutch.

single-cylinder motor. With the make-and-break system an oscillating magneto (Fig. 100) is often employed.

Transmission Systems and Differentials.—The clutch of the gas traction engine has the same function as that of the automobile and connects or disconnects the motor from the propelling gear. The types of clutches used for gas traction engines are similar in principle to those illustrated in Figs. 133, 134 and 171. The expanding-cone, expanding-shoe, multiple-disc, floating-plate and clamp-plate types are employed. Usually one part of the clutch is part of the flywheel. A traction-engine clutch is illustrated in Fig. 188.

Some traction engines are constructed with a single reversing

mechanism and without speed-change gears, while other traction engines have the reversing mechanism incorporated with the speed-change gears; some manufacturers employ a reversing mechanism which is separate from the speed-changing mechanism. The highest speed in the case of traction engines is usually obtained through gearing instead of by the direct motor drive. The reason for this is that the traction engine is used most of the time for plowing or for other heavy work, which requires a slow speed; by operating the direct drive at the slower speeds the heavy work can be accomplished with few gears, thus increasing the efficiency of the drive.

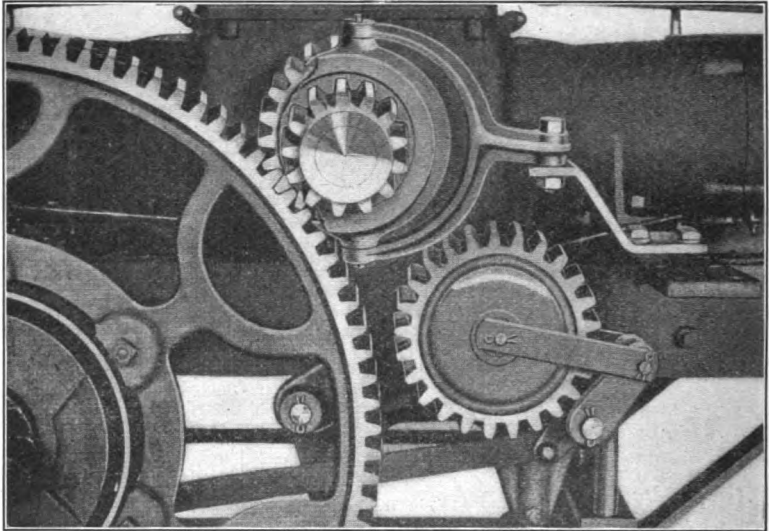

FIG. 189.—Traction-engine transmission system.

One simple form of gas traction-engine gearing is illustrated in Fig. 189. The differential gear used in connection with the engine of Fig. 189 is of the spur-gear type similar in principle to that illustrated in Fig. 142.

Another simple traction-engine transmission system is illustrated in Fig. 190.

A two-speed transmission system is shown in Fig. 191. The reversing mechanism consists of two bevel pinions (*A*, *B*) which are driven from the motor shaft. The bevel gears *A* and *B*

drive the differential driving gear *D* through the large bevel gear *M*. In the neutral position these bevel gears *A* and *B* revolve

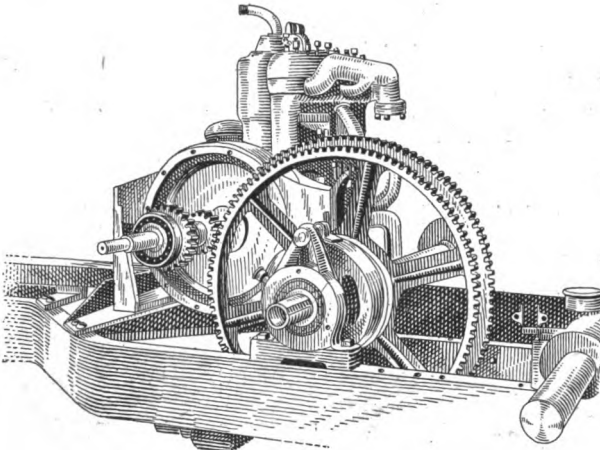

FIG. 190.—Traction-engine transmission.

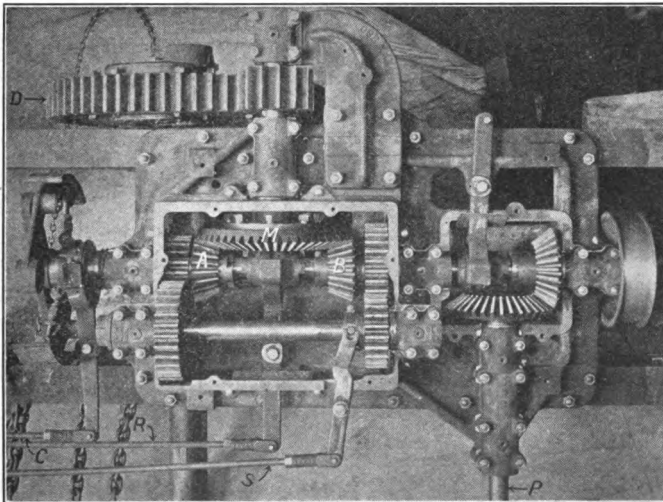

FIG. 191.—Two-speed transmission system.

freely. The lever *R* is used for connecting either bevel gear *A* or *B* with the driving shaft. The lever *S* controls the speed-

changing gears and the lever *C* is for the clutch. The shaft *P* is for the belt pulley.

In some traction engines the speed-changing mechanism is similar to that used in automobiles. The type generally used is the selective-transmission system (Fig. 192).

A friction drive (Fig. 193) is employed in some makes, this drive differing from the automobile friction drive in that the fibrous-covered friction wheel is mounted on the engine crank-shaft; in automobiles the disc is the driving member.

In some designs clutches are used for reversing. A single lever operates two clutches, one of which is used for reversing.

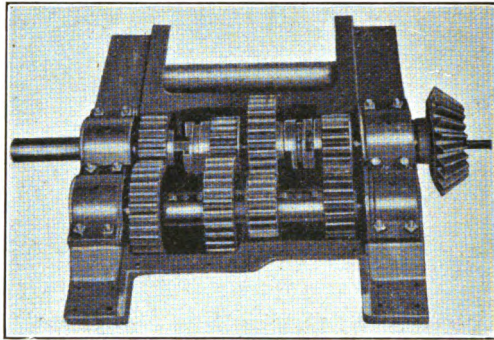

FIG. 192.—Selective transmission system.

Differentials for gas traction engines were illustrated and described in connection with Figs. 173, 174, and 175. Spur-gear differentials similar to that of 142 are also employed in some gas traction engines. Some of the light traction engines dispense entirely with the differential and use only one traction wheel.

Type of Traction.—The majority of traction engines use the two rear wheels as the traction wheels or drive wheels, while the two front wheels are for steering. Some makes use a traction drum, several are constructed so that the front wheels are the driving wheels, and in other makes, all four wheels drive. In the case of three-wheeled traction engines, one large drum, two front wheels, or two rear wheels are used for driving.

Traction engines are also built on the “creeping-grip” or “caterpillar” principle (Figs. 194, 195, 196), which employ a

crawler instead of a wheel or drum. The object of this construction is to have the traction wheels travel over a continuous, metallic track approximating as nearly as possible that over which

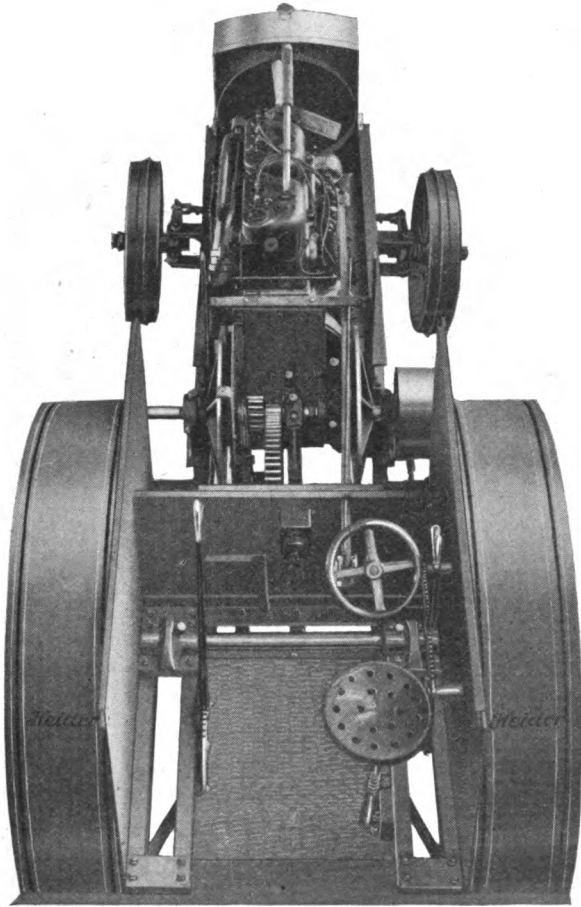

FIG. 193.—Traction engine with friction drive.

the locomotive travels. The creepers or tractor shoes run inside a continuous belt. Power from the motor is transmitted from a jackshaft to the creeper drive wheels by a chain and sprocket drive on either side. The advantages of this construc-

tion are greater gripping surface for the same weight and better distribution of weight.

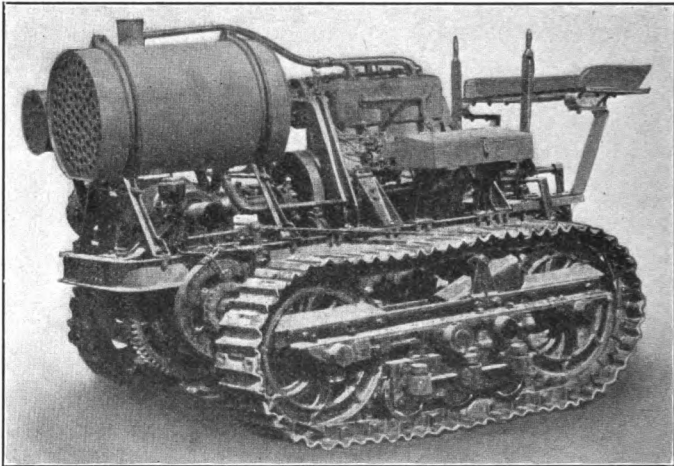

FIG. 194.—Creeping-grip tractor.

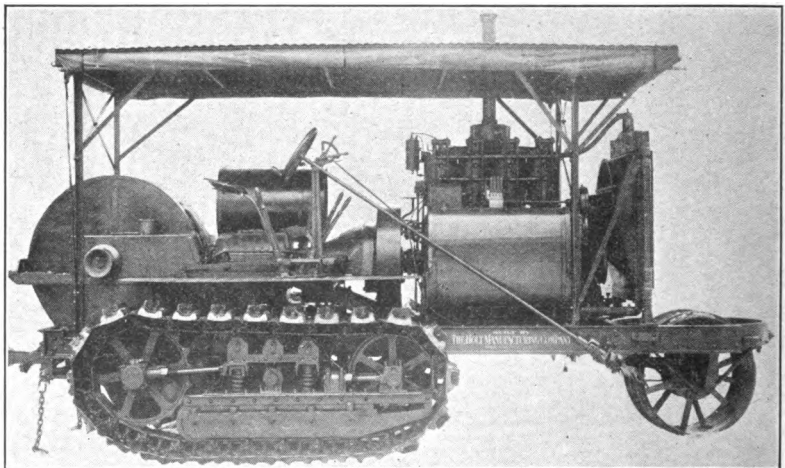

FIG. 195.—Caterpillar tractor.

Uses of Traction Engines.—Desire on the part of farmers to raise large crops and to put under cultivation great areas of land created a demand for mechanical power. With mechanical power

the number of horsepower under the control of one man becomes unlimited, if the man controlling the mechanical power is willing to learn the simple fundamental processes which govern

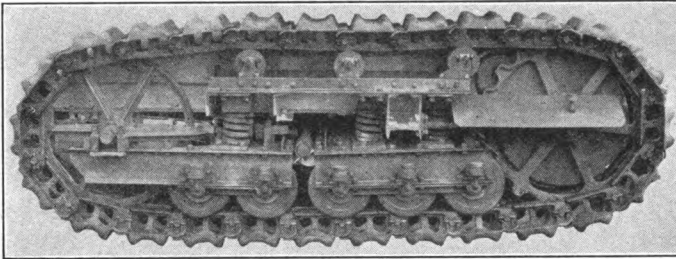

FIG. 196.—Track of crawler type tractor.

the conversion of fuel into mechanical energy as well as the simple laws of mechanics which enable one to keep machines and mechanisms in adjustment and in perfect working order.

A traction engine is capable of doing the following field work:

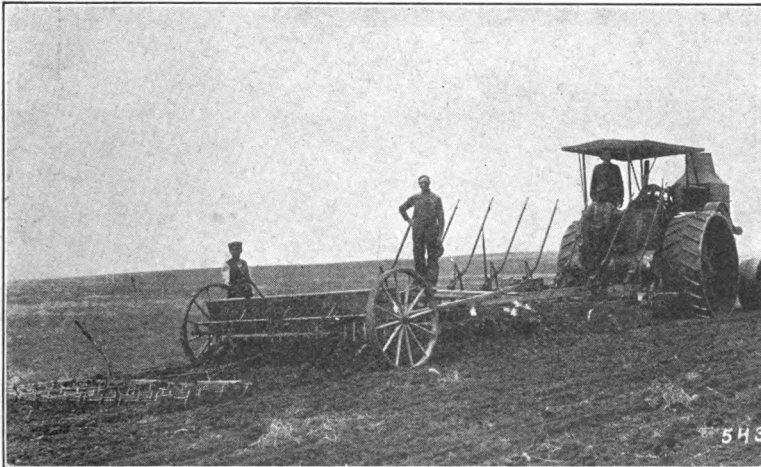

FIG. 197.—Plowing, seeding and harrowing.

Clearing the land: tearing out hedges, pulling up trees, stumps and stones.

Preparing the seed bed and seeding with the operation of plowing, listing, disking, harrowing, drilling, seeding.



FIG. 198.—Deep plowing.

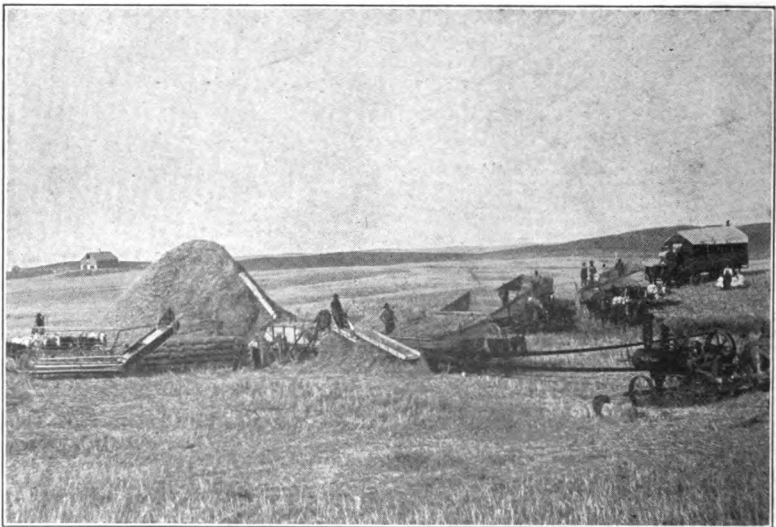

FIG. 199.—Harvesting with steam traction engine.

Harvesting operations such as mowing, hay loading, hay hoisting, and drawing binders and diggers.

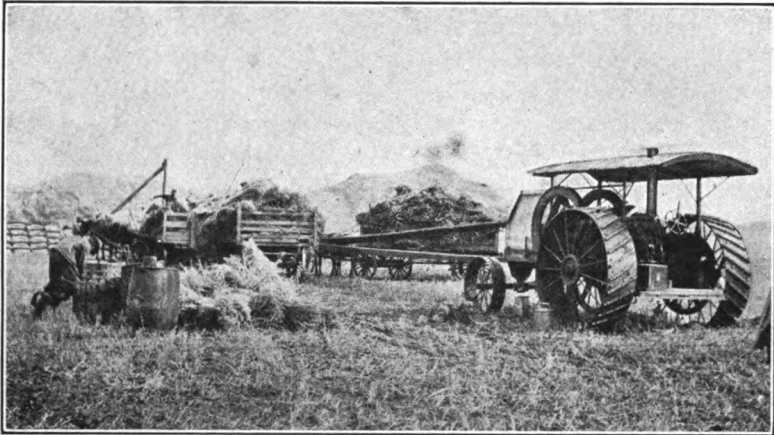

FIG. 200.—Harvesting with gas traction engine.

With a traction engine the processes of plowing, seeding, and harrowing can be carried on in one operation (Fig. 197). Deeper and more uniform plowing (Fig. 198) can be carried on. Harvest-

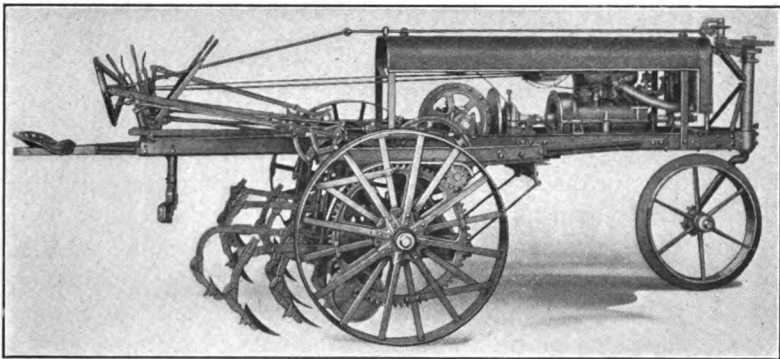

FIG. 201.—Tractor cultivator.

ing operations with steam and gas traction engines are illustrated in Figs. 199 and 200.

Some designs of traction engines are built low and are suitable for orchard cultivation.

Power cultivators are being placed on the market which are suitable for cultivating corn and other rowed crops. One form of tractor cultivator is illustrated in Fig. 201. The motor of this machine is placed on the frame near the front and is a four-cylinder vertical internal-combustion motor with the cylinders cast en bloc similar to automobiles. One of the special features of this traction engine is that the two drive wheels are operated separately by means of friction-drive transmission. The mechanism is so arranged that one wheel can be held stationary while the other travels forward or backward. To facilitate turning around at the end of a row of corn, in order to go up in the next row, the operator throws out the gear connection in the steering apparatus

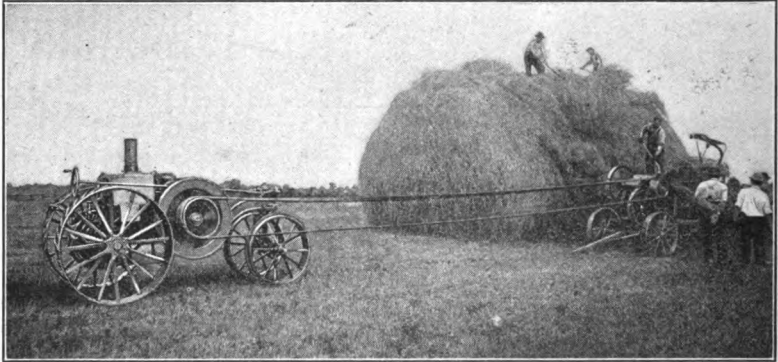

FIG. 202.—Hay-baling machine driven by traction engine.

and the front wheel acts as a caster. Then, by operating the rear wheels, the machine can be made to turn completely around. The cultivator gangs are operated by the driver's feet.

The traction engine is suitable for heavy-belt work, such as hay baling (Fig. 202), corn shelling, pumping water for irrigation and for other purposes, grinding feed, ensilage cutting, sawing wood, threshing, husking, hulling, shredding, filling silos, crushing rock, and elevating corn and grain.

Traction engines can be used for hauling grain and other farm products to the shipping point or to the market; for hauling fertilizer and other material to the farm; also for moving houses, barns and other structures.

In connection with road work, traction engines are used for

pulling graders (Fig. 203), scrapers, road plows, drags, and other road implements, as well as road materials.

Traction engines can be used for digging irrigation ditches and for filling drainage ditches.

Development of the Gas Traction Engine.—The development of the gas traction engine has been exactly the reverse of the automobile. The earlier automobiles were small and light in weight; the early gas traction engines were very heavy, developing 60 to 100 hp. on the belt. At the present time traction engines developing 5 to 15 hp. on the drawbar (10 to 30 b. hp.), and capable of pulling three or four 14-in. plows, are used in

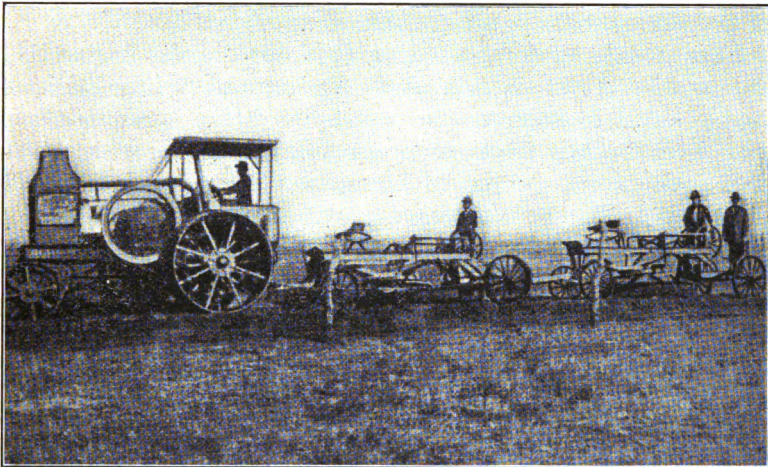

FIG. 203.—Tractor used for pulling graders.

great numbers in the corn belt. Large steam or gas traction engines developing 40 to 60 drawbar horsepower and capable of handling 10 to 14 plows, are used in the Northwest and in other parts where large areas must be cultivated and farm labor is scarce. The tendency seems to be for the large farmers to invest in several machines, each designed for a special purpose, than to buy one all-purpose machine capable of performing all the work of the farm.

Attachments are available for converting an automobile into a light traction engine, capable of pulling one or two plows. The rear wheels of the automobile are replaced with pinions which

mesh with gears on the traction wheels. The traction wheels revolve on a special axle at a speed which is one-eighth to one-tenth that of the automobile rear axle.

The traction engine probably will not replace the horse for all purposes very soon, but will replace many horses, on large farms, and especially in connection with the heavy farm work. The traction engine is a concentrated form of power plant which can work day and night, is not affected by heat, and can be used to advantage a large portion of the year.

Economy of Gas Traction Engines.—The cost of operating a gas tractor depends upon many varying factors, such as the kind of fuel used, the cost of fuel, the cost of attendance, the character of the soil, and the type of machine.

Experiments carried on during 1915–1916 in the engineering laboratories of the Kansas State Agricultural College indicate that the fuel consumption in pounds per brake horsepower per hour is very nearly the same for gasoline and for kerosene. The fuel consumption per brake horsepower per hour (average of tests on 12 different traction engines) was found as follows:

Traction-engine rating in brake horsepower	15 to 26	26 to 51	51 to 90
Gasoline consumption, pounds per horsepower			
Full load	0.855	0.720	0.73
Half load	1.147	0.893	0.93
Quarter load	1.853	1.416	1.47

With kerosene at 10 cts. per gallon and gasoline at 20 cts. per gallon, the cost of gasoline fuel will be about twice that of kerosene for the same power developed. The advantages of kerosene fuel, due to the lower cost, are offset to a greater or less degree, depending upon the operator, by the added trouble in handling the traction engine. The life of the motor probably will be less with kerosene fuel. To this should be added the lower reliability insurance with the heavier fuels. In some work done by traction engines reliability is the most important factor.

Rating of Traction Engines.—Two ratings are usually given to traction engines. One is in brake or belt horsepower. This means the actual power developed at the shaft of the engine,

which can be utilized for driving various machines by means of a belt drive.

The other rating is in tractive or drawbar horsepower. To obtain the tractive horsepower the amount of power lost in transmission to the drive wheels and that required to propel the traction engine must be subtracted from the brake horsepower developed at the shaft of the engine.

The tractive horsepower depends on the kind of transmission gearing and on the character of the roads over which the traction engine must be propelled. It is equal to from one-half to two-thirds of the brake horsepower. As an illustration, a traction engine equipped with a 40-hp. engine will be able to produce only 20 to 27 hp. at the drawbar under ordinary conditions.

The belt horsepower of various makes varies from 10 to 120 hp. and the drawbar horsepower from 5 to 60 hp.

The ratings are usually expressed as 8-16, 5-10, or 40-80. These ratings mean 8 drawbar horsepower and 16 belt horsepower, 5 drawbar horsepower and 10 belt horsepower, etc.

The relation between the rating and number of 14-in. plows a gas traction engine will pull is approximately as follows:

Rating	Number of plows
5-10	1 or 2
8-16	2 or 3
10-20	3
12-25	3 or 4
20-40	5 or 6
30-60	8 or 10

Gas traction engines range in road speed from $1\frac{1}{2}$ to 10 miles per hour. The average road speeds are 2 to 3 miles per hour. The furrow speeds in miles per hour vary from 1 to $3\frac{1}{2}$. The average furrow speed is not greater than 2 miles per hour.

The drawbar pull in pounds, of a traction engine, traveling at a rate of about 2 miles per hour, is approximately 180 times the drawbar horsepower.

Operation and Care of Traction Engines.—The general directions given regarding the care of stationary steam and oil engines apply also to the motors of steam and gas traction engines.

The wearing surfaces must be well-lubricated or they will wear out, and lost motion in bearings must be avoided to prevent

pounding and broken crankshafts. Many of the traction-engine troubles can be traced to inefficient lubrication or to the use of poor lubricating oil.

Bearings may be oiled by means of grease cups (Figs. 53, 54), or by sight-feed lubricators (Fig. 56). Gears are lubricated with grease or with some other heavy lubricant. Transmission grease is generally used for the transmission. In some cases heavy steam-cylinder oil is employed for the same purpose. Cylinders for steam traction engines are lubricated with heavy steam-cylinder oil by a mechanically driven oil pump or by an automatic sight-feed steam lubricator (Fig. 57). A medium gas-engine cylinder oil should be used for lubricating gas traction-engine

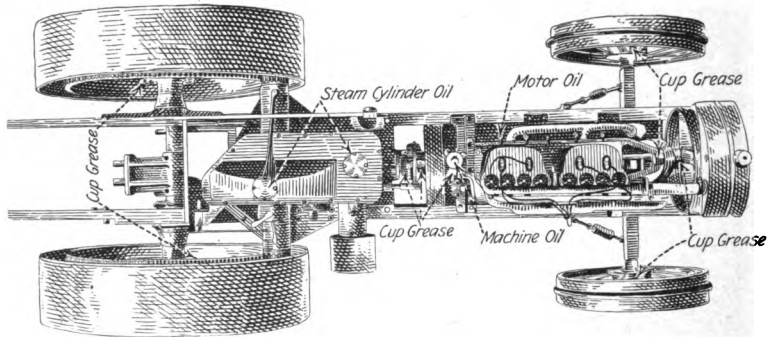

FIG. 204.—Traction-engine lubrication chart.

cylinders. A lighter gas-engine cylinder oil should be used in cold than in warm weather.

A combination of splash and forced-feed oiling system is often used for traction-engine lubrication.

The instructions furnished by the manufacturer regarding the kind of oil to be used and the lubrication of the various parts should be carefully followed. A lubrication chart for one make of traction engine is illustrated in Fig. 204. The bearings of magnetos require frequent attention. A high-grade sewing machine oil should be used for this purpose.

All reputable manufacturers test their traction engines before shipment from the factory. The purchaser, upon receiving a traction engine, should carefully examine all parts. The rail-

road company and the manufacturers should be notified at once if any parts are damaged or missing.

Before attempting to start the engine, it should be gone over carefully, all nuts tightened, bearings properly set, lubricators filled, and clutch adjusted so that all shoes come into contact with the inside of the wheel at the same time. The operator should make certain that the engine has a sufficient supply of fuel and water and that the lubrication system is in good working order. The fuel for a gas traction engine should be strained. A chamois skin strainer is best for gasoline while a funnel with a fine screen will be satisfactory for kerosene fuel. A strainer will prevent dirt from getting into the carburetor and the supply pipes from clogging.

In the case of steam traction engines the boiler is filled about two-thirds full of water and the fires are started as explained in Chapter III. Upon first using a boiler it is liable to foam, especially if the water is bad, but after washing the boiler, or changing the water several times, the oil and grease on the boiler plates are removed. Clear, soft water should be used. Care should be taken not to use water which contains lime. The water gage cocks should be tried often and the water level should not be allowed to be below the second gage. Before the feed-water pump is started the operator should make certain that the feed line to the boiler is not closed. It is desirable to use the pump and to keep the injector as a reserve for emergencies. In simple single-cylinder traction engines the safety valve is set at about 130 lb., in compound engines at 160 lb. The fire should be kept thin. The operator should fire frequently and lightly. In operating a steam traction engine on the road care must be taken not to allow the engine to remain with its rear end elevated for any great length of time, as this may result in the overheating of the crown sheet. The water glass must be blown out two or three times each day and the safety valve should be kept in good working order. The reverse lever should be kept as close to the center notch of the quadrant as possible in order that the engine may operate at its best economy. When running, the throttle should be wide open and the steam supply to the engine should be varied entirely by the reverse lever. The fire flues of the boiler

should be cleaned frequently, as the cleaner the flues the less fuel will be required to keep up steam.

In starting a gas traction engine, the operator should be certain that the change gears are in the neutral position and that the clutch is disengaged. In the case of a dual-ignition system the switch should be closed on the battery side. The spark lever is then retarded and the carburetor throttle is opened so as to admit a small supply of fuel. The shutoff valve at the gasoline tank is opened, the cylinders are primed through the priming cocks, and the motor is cranked. The quicker the crank is turned the easier the engine will start. After the motor starts, the spark lever is advanced. Some traction engines are started by means of small auxiliary gasoline engines.

To put the traction engine in motion the clutch is thrown in gradually after the lever controlling the change gears has been shifted to the position required. In stopping a traction engine, the carburetor throttle is closed, the switch is opened, the clutch is disengaged and the change-speed lever is placed in neutral. Failure to place the lever controlling the change gears in the neutral position will start the tractor if the clutch is disengaged. The operator never should try to reverse a traction engine without first bringing the machine to a stop. The operation of the traction engine is controlled by the carburetor throttle lever.

One accustomed to driving an automobile will find the traction-engine steering mechanism less sensitive. More turns of the steering wheel will be necessary on account of the slower speed of the traction-engine motor and the lower gear ratio of the steering gear.

In running a traction engine on the road, the operator should keep his eyes on the front wheels to prevent accidents. In case a traction engine is landed in a hole, it can be pulled out by placing chains, boards, or straw under the drive wheels. The same advice applies when the engine slips. Before crossing a bridge the operator should ascertain that it is safe. In case of doubt, planks should be placed to distribute the load.

A competent operator handles a traction engine slowly and deliberately, and never hesitates to stop, if something goes wrong with any part of the engine.

Overloading a traction engine is a serious mistake.

A traction engine should be kept at all times in adjustment and in perfect working condition. This cannot be accomplished unless the engine is housed properly. A traction engine represents a large investment, the depreciation of which can be greatly reduced if the housing question is carefully considered. A frame or a concrete structure should be provided which not only will house the traction engine but will leave sufficient space for a farm workshop where ordinary repairs can be made.

The tractor operator should do his repairing systematically. At the completion of a hard season's work the machine should be thoroughly overhauled. All old grease and oil should be removed from cylinders, bearings and transmission case. All parts should be cleaned with kerosene. Bearings should be examined, and adjusted by means of liners. In ordering repairs for engines, give description or sketch of the part as well as the number and letters found on the parts wanted. The number and size of the engine also should be stated.

The clutch should be examined frequently for worn parts.

It is well to have on hand an extra clutch lining, a set of piston rings, an extra connecting rod, several new spark plugs, cotter pins, belts, and nuts of various sizes and such other small repair parts as may be worn out or lost in the operation of the engine.

Valves for gas traction engines should seat properly and should be reground if indications show wear. To grind the valve into its seat the valve spring is removed and the valve is taken out. Flour emery dust and oil, or fine carborundum valve-grinding paste and oil is placed on the valve seat. By using a brace holding a screw-driver bit in the slot on the top of the valve, the valve may be revolved back and forth on the seat with very little effort. It is best to place a light spring on the valve stem so that the valve is held up and off from its seat.

The time of opening and of closing of the valves of gas traction engines depends upon the speed of the engine. The valves of a high-speed engine should open sooner and remain open longer than those of a slow-speed motor. Ordinarily, the exhaust valve should open 30° to 50° before the beginning of the exhaust stroke and should remain open 4° to 10° after the completion of that stroke. The inlet valve should open 5° to 12° after the

beginning of the suction stroke and should close 18° to 25° after the completion of the suction stroke.

The common sources of trouble with a traction engine are due to the incompetency of operators, who are responsible for poor or insufficient lubrication, dirty fuel, carbon deposits, poor fuel economy and high depreciation.

When it is desired to draw a number of machines at the same time by means of a traction engine, care must be taken that the machines are properly hitched to the engine. The hitch required for plowing is very simple. A hitch for three-disk harrows is illustrated in Fig. 205. This consists essentially of a supplementary drawbar *B* which is connected to the main drawbar by the chain *A*.

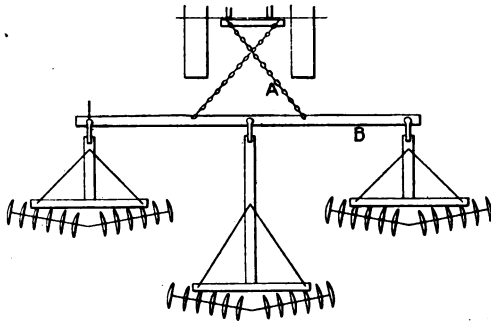

FIG. 205.—Hitch for three-disk harrows.

In laying by the engine for the winter, it should be placed under cover and be protected from rain and snow. It is well to remove pistons from the cylinders of gas traction engines, clean all deposits and then oil pistons, cylinders and valves with a heavy oil. Magnetos and batteries should always be removed to a dry place. All parts should be carefully drained. In fact, it is well to remove all drain cocks so as to prevent any water from remaining in cylinders and tanks.

The success of a traction engine depends not only on the operator but also on the business ability of the owner. The farmer should so plan his work that the traction engine is used not only for plowing, but for many other kinds of work. To secure the best results the traction engine should be kept busy most of the year.

Problems: Chapter VII

1. Name the fundamental parts of a traction engine.
2. What types of boilers are commonly used on steam traction engines. Sketch one type.
3. Describe, using clear sketches, two types of pumps used for feeding water to steam traction-engine boilers.
4. Sketch and explain in detail two types of reversing mechanisms for steam traction engines.
5. In which respect does the steering mechanism for a traction engine differ from that for an automobile?
6. Sketch and explain some form of differential for traction engines.
7. Why does the steam turned into the stack of a steam traction engine improve the draft? Explain in detail.
8. To which types of traction engines does the term "gas traction engine" refer? Give reasons for the great popularity of the gas traction engine.
9. Explain the distinctive features of gas traction-engine motors and compare the traction-engine motor with automobile motors.
10. Explain differences in construction between radiators employed for automobiles and for traction engines.
11. Show by means of clear sketch the action of a throttling governor.
12. Sketch and explain a jacketed float-feed carburetor, suitable for burning kerosene.
13. Explain with clear sketches, a kerosene carburetor suitable for traction engines.
14. Give a wiring diagram for a four-cylinder traction engine.
15. Explain, using clear sketches, two different types of transmission systems suitable for traction engines.
16. Investigate and report why some small traction engines are capable of working satisfactory without the use of a differential.
17. Explain the various types of traction.
18. What are the advantages of the gas traction engines which utilize a crawler instead of a wheel or drum?
19. What type of field work and of belt work is a traction engine capable of doing?
20. What are the fundamental parts of a power cultivator and in which respect does this differ from the ordinary traction engine?
21. How does the cost compare of operating a traction engine with gasoline and with kerosene fuel.
22. A farmer invests in a 10-20-hp. traction engine \$1,000. If he uses the traction engine only 60 days per year, calculate the approximate cost of this form of power per year, taking into consideration interest on investment at 6 per cent., depreciation 10 per cent., taxes, insurance, repairs. Compute this upon the basis of the market price for gasoline and for kerosene respectively.
23. What is the relation between the belt horsepower and the drawbar horsepower of a traction engine?

24. What is meant by the traction engine rating 5-10?
25. What determines the number of plows that can be pulled by a traction engine of a given rating?
26. What precautions must be taken in starting and in operating a gas traction engine?
27. Explain in detail how to grind a gas-engine valve.
28. Give directions for setting the valves of a gas traction engine.
29. Report on the possibility of utilizing the ordinary automobile as a traction engine. What special attachments would be needed?
30. What precautions must be observed in laying by a traction engine for the winter?

CHAPTER VIII

WATER MOTORS

A water motor converts the energy possessed by moving or falling water into useful work.

Determining the Power of Streams.—Before explaining the various commercial types of water motors, the method of determining the power available in any water stream will be given.

The power available in any stream depends on the head of water and on the quantity of water which can be utilized in a water motor.

The term head is applied to the fall of water available. The head can be determined most readily by running an engineer's level from a point at the upper line of water flow to a point at the lower line of flow. The vertical distance between the two points gives the head of the stream.

One method of determining the quantity of water available for utilization in a motor, is to find the cross-sectional area of the stream, and to multiply this by the velocity of the stream. The cross-sectional area of a stream can be obtained by multiplying the average depth of the stream by its width. To find the velocity, several floats are dropped into the water at a place where the depth and width is uniform for some distance, noting the number of seconds it takes for the floats to pass a certain distance. Since the velocity of a stream is greatest at the center and is least at the bottom and sides, the velocity as obtained by floats should be multiplied by 0.80 to obtain the average velocity.

As an illustration, the average width of a stream is 10 ft., its average depth is 4 ft., and the velocity of the water, as obtained by floats, is 30 ft. per minute. If the head of the water is 10 ft., calculate the power which could be obtained from a water motor, assuming the various losses in the motor as 30 per cent. and the average stream velocity 0.80 of the float velocity.

The area of the cross-section of the stream = $10 \times 4 = 40$ ft.
 The quantity of water available per second is equal to

$$40 \times \frac{1}{2} \times 0.80 = 16 \text{ cu. ft.}$$

As the weight of a cubic foot of water is 62.4 lb. at ordinary temperatures, the weight of water delivered to the motor per second is

$$62.4 \times 16 = 998.4 \text{ lb.}$$

The work done by the water is

$$998.4 \times 10 = 9,984 \text{ ft.-lb.}$$

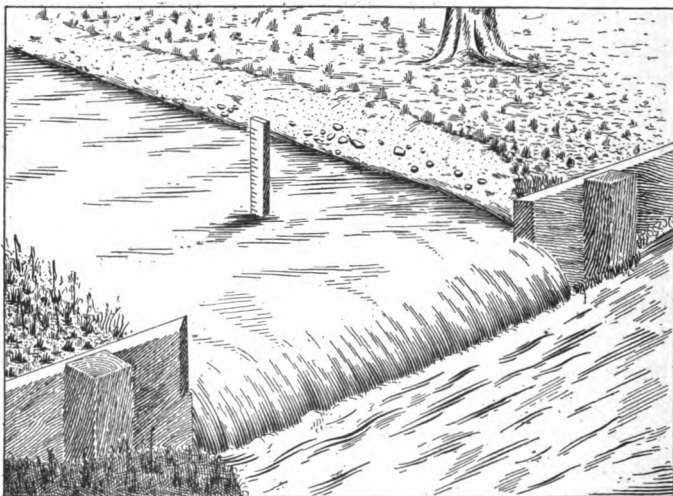

FIG. 206.—Water measurement by weir.

One horsepower is equal to 33,000 ft.-lb. per minute, or 550 ft.-lb. per second; allowing 30 per cent. for friction, the power available is

$$\frac{9,984(1 - 0.30)}{550} = 12.7 \text{ hp.}$$

Another method for finding the quantity of water available in a stream, called the weir-dam method, is illustrated in Fig. 206. A notch is cut in a thick board placed at some point in the stream.

The length of the notch should be less than two-thirds the

width of the board. The bottom of the notch is called the crest of the weir, and the depth of the water at that place should be more than three times the depth of the water flowing over the weir. The crest of the weir should be perfectly level and should be beveled on the downstream side. The edges of the notch should be beveled also on the same side. In the stream back of the weir, and at a distance somewhat greater than the length of the notch, a stake is driven level with the bottom of the notch or crest of the weir. When the water is flowing over the weir, measure the height of water above the top of the stake. If this height in feet is called H and the width of the notch in feet B , the quantity of water Q flowing through the stream, in cubic feet per second, can be determined by the formula:

$$Q = 3.33 BH\sqrt{H}$$

As an illustration, if the width of the notch is 4 ft. and the depth of water on the weir is 12 in. the quantity of water available per second is

$$Q = 3.33 \times 4 \times \frac{12}{12} \sqrt{\frac{12}{12}} = 13.32 \text{ cu. ft.}$$

Since 1 cu. ft. of water = 7.48 gal., the quantity of water delivered in gallons is

$$13.32 \times 7.48 = 99.6 \text{ gal.}$$

Types of Water Motors.—The water motors mostly used at the present time are waterwheels, which are made to revolve either by the weight of water falling from a higher to a lower level, or by the dynamic pressure which is produced by changes in the direction and velocity of flowing water.

Reciprocating water motors are used to a limited extent for special purposes. Any steam engine with slight modifications can be used as a reciprocating water motor, but would run at slow speed on account of the incompressibility of water.

Overshot, Undershot and Breast Wheels.—The earlier water motors derived their power from the weight of water acting on vanes placed around the rim of a wheel.

Of these the overshot wheel receives its power from the weight of water carried by buckets on the circumference of a wheel, the

water entering the buckets near the top of the wheel and being discharged near the bottom (Fig. 207). A wheel of this type can be constructed easily by inserting between two wooden discs a number of buckets, made like V-shaped troughs (Fig. 207), and putting a wooden or metal shaft at the center of the discs. Water is supplied from an open trough near the top of the wheel. Motors of this character can be built to operate on falls as low as 4 ft. and will supply from 3 to 50 hp., depending on the head of the fall and on the quantity of water available.

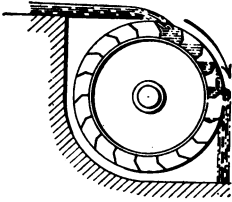

FIG. 207.—Overshot water wheel.

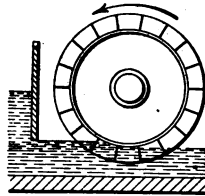

FIG. 208.—Undershot water wheel.

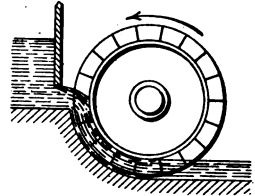

FIG. 209.—Breast water wheel.

The undershot wheel is propelled by water passing beneath it in a direction nearly horizontal, which impinges on vanes carried by the wheel. Such wheels have been used to some extent for irrigation work. Some of the undershot wheels have straight flat projections for vanes (Fig. 208), but the more efficient wheels are built with curved vanes. Such motors are suitable for very low falls, provided the velocity of the water is great.

The breast wheel (Fig. 209) receives water at or near the level of its axis, but is otherwise quite similar in its action to the overshot wheel. Breast wheels are provided with either radial vanes, or with vanes slightly curved backward near the circumference.

All these wheels are very bulky for the power developed, as compared with the more modern types of impulse water motors.

Impulse Water Motors.—Impulse water motors are provided with buckets or cups around the circumference of a wheel, which are acted upon by a jet of water issuing from a nozzle.

Among impulse water motors, the Pelton wheel illustrated in Fig. 210 is used to a considerable extent in the United States. It consists of a series of cups or buckets *B* placed at

equal intervals around the circumference of an iron wheel. The characteristic feature of the Pelton motor is the shape of the buckets. These are made in the form of two half cylinders with closed ends, joined together at the center by a straight

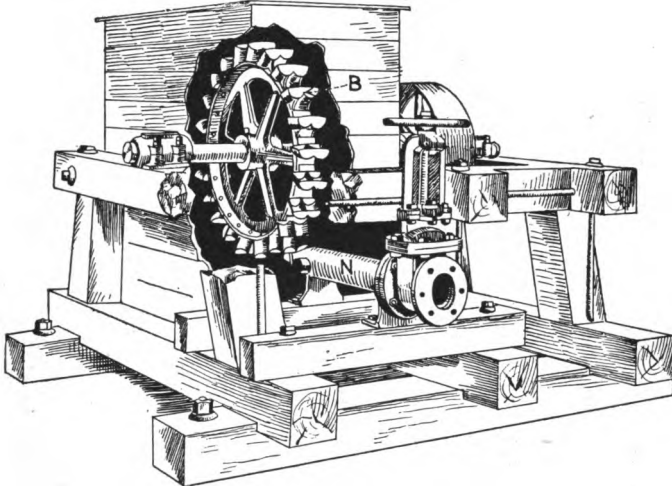

FIG. 210.—Pelton water wheel.

thin rib. The power is derived from the pressure of a head of water supplied by a pipe which discharges upon the buckets of the wheel. The water from the nozzle *N* striking the rib, divides

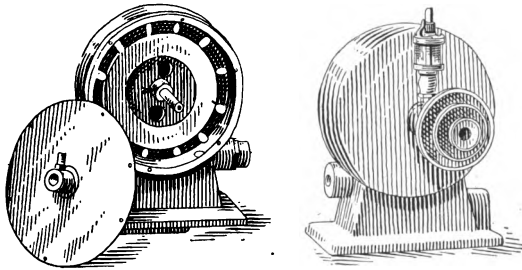

FIG. 211.—Water motor.

into two streams, one going into each half cylinder and exerting a pressure on the curved surfaces of the buckets. The Pelton water motor usually is furnished with two nozzle tips of different diameters. By changing the tip, the size of the stream on

the wheel is altered and a great variation in power may be obtained.

Pelton water motors can be secured in very small sizes under 1 hp. and up to several hundred horsepower. The efficiency of this type of motor is greatest at high heads, but in small sizes it will be found as efficient as most water motors, even for heads as low as 15 ft.

Another type of water motor illustrated in Fig. 211 is made in sizes less than $\frac{1}{2}$ hp. and can be used for running washing

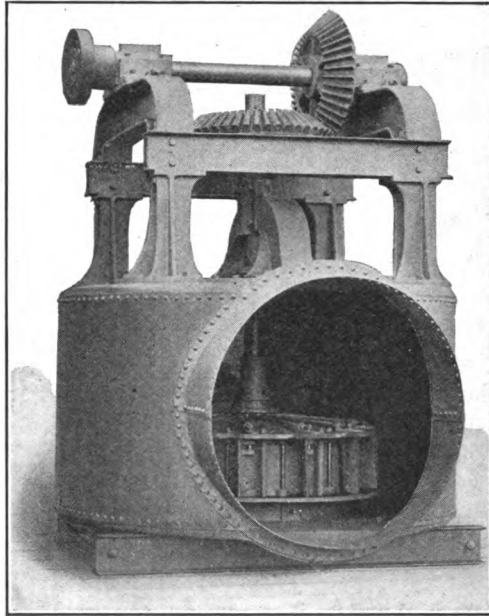

FIG. 212.—Water turbine.

machines, sewing machines, grindstones, fans, small feed grinders, and for other purposes requiring little power.

An impulse water motor can be operated from city water mains or from an independent stream.

Water Turbines.—A water turbine is a water motor which is made up of a number of stationary and movable curved pipes. It consists of the following parts:

1. A gate by means of which the supply of water to the turbine is regulated.

2. A guiding element consisting of stationary blades, the function of which is to deliver the water to the revolving element in the proper direction and with the proper velocity.

3. A revolving element or rotor, consisting of vanes or buckets

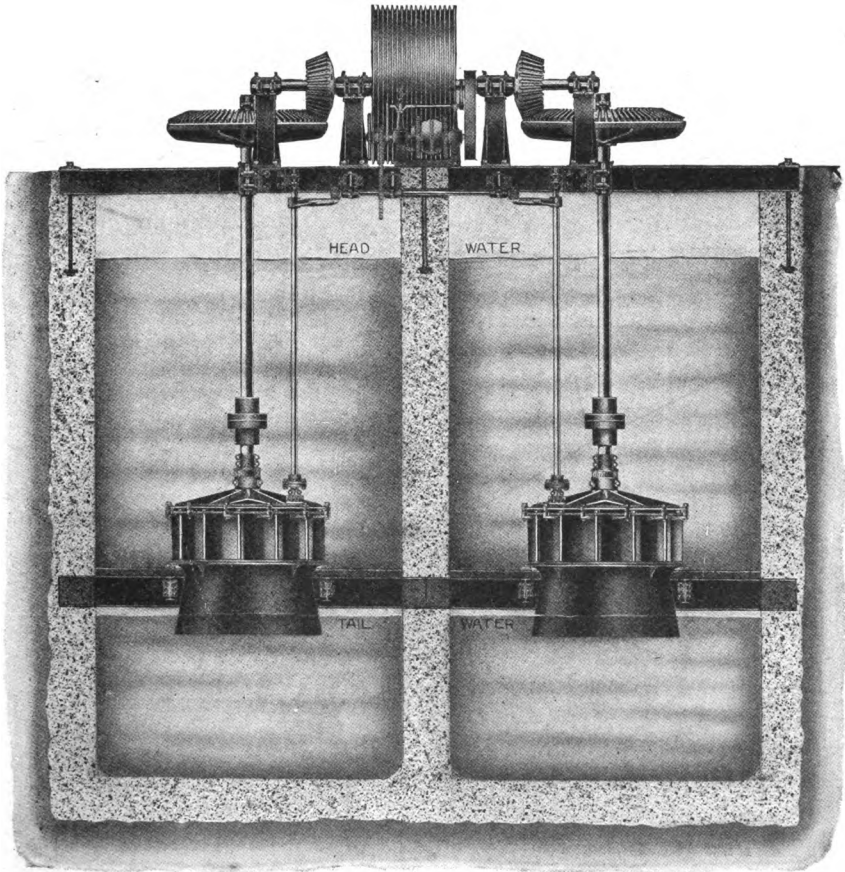

FIG. 213.—Water-power installation.

which are arranged in any one of several different ways around the axis of the motor.

Water turbines are divided into radial outward-flow, radial inward-flow and mixed-flow types.

In the radial outward-flow turbine the water is received at the

center and is delivered at the periphery of the revolving buckets. In the radial inward-flow types the stationary or guiding element is located on the outside of the revolving part, and the water flows from the rim toward the center.

The advantages of turbines over impulse wheels lie in the fact that a turbine can be utilized for very low falls. The turbines illustrated in Figs. 212 and 213 can be used on falls as low as 4 ft. and will develop about 3 hp. with a water supply of about 500 cu. ft. per minute.

The general appearance of a water-power installation with vertical turbines is shown in Fig. 213.

The Hydraulic Ram.—The hydraulic ram combines in one simple machine a motor and a pump. It is probably the simplest

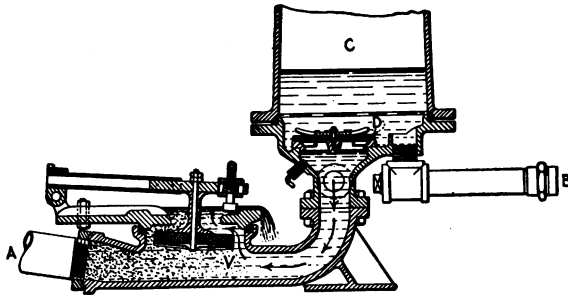

FIG. 214.—Hydraulic ram.

and most economical method for supplying water for the farm house, the feed yard, the barn and the dairy where conditions are favorable. It can also be used to advantage, under certain conditions, for irrigating small tracts of land.

Hydraulic rams are low in first cost and inexpensive to operate. They are not economical in water, as a large amount of water must be wasted in comparison with the work done.

The working of the hydraulic ram depends on the fact that the momentum of a large quantity of water falling through a small height is capable of lifting a small quantity of water to a considerable elevation.

A section of a hydraulic ram is shown in Fig. 214. It consists of a working valve *V*, a check valve *D*, an air chamber *C*, a drive pipe *A* which supplies water to the ram, and a delivery pipe *B* which carries the water to the place where it is utilized.

The ram is located at a place where a fall of 2 to 10 ft. can be obtained. The water from the source enters the drive pipe (*A* in Fig. 214) and flows through the working valve *V*. The velocity of water in this pipe increases and when a certain velocity is reached, the pressure of the water on the under side of valve *V* is sufficient to close it abruptly. The flow of the water through the working valve being interrupted, the pressure increases and causes the check valve *D* under the air chamber *C* to open, and a part of the water is forced into the air chamber compressing the air in that chamber. The velocity of the water in the drive pipe

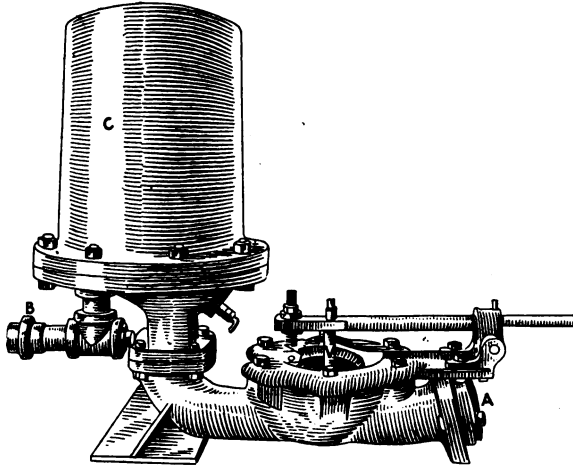

FIG. 215.—Hydraulic ram.

having been arrested, a recoil or ramming takes place, the pressure in the space below the air-chamber check valve *D* is reduced, thus closing the check valve *D* and allowing the working valve to open. The operations are then repeated. The delivery pipe to the storage tank at a higher elevation is attached to the air chamber below the water level. The air under compression in the air chamber forces the water in a steady stream through the delivery pipe *B* and to the storage tank. Hydraulic rams are also provided with a sniffing valve, not shown in the figure, the function of which is to replace any air in the air chamber, lost by being dissolved in the water.

A hydraulic ram is illustrated in Fig. 215. *A* is the drive pipe, *B* the discharge pipe, *C* the air chamber and *V* the working valve.

Problems: Chapter VIII

1. What determines the power available in a stream?
2. Calculate the horsepower available in a stream 24 ft. wide and 6 ft. deep, if the head of the water is 14 ft. and the velocity of the water is 20 ft. per minute. Assume the losses in the water motor equal to 25 per cent.
3. Give directions for constructing a standard weir suitable for measuring water.
4. Calculate the gallons of water flowing over a weir of the following dimensions: width of notch 3 ft., depth of water on the weir 15 in.
5. Explain, using clear sketches, the Pelton waterwheel.
6. What are the fundamental parts of a water turbine?
7. Explain, using clear sketches, the construction and action of the hydraulic ram.
8. Report on the future of water power for rural communities.

CHAPTER IX

WINDMILLS

Types of Windmills.—The windmill is a motor which converts the kinetic energy of the wind into useful work.

Some of the earlier windmills were constructed with sails which consisted of wooden frames, the broad sides of which were covered with cloth. These sails were turned by the wind in horizontal or vertical planes. One of these mills, the Dutch type, is illustrated in Fig. 216. As the direction of the wind changed, the entire wheel-house, including shafting and machinery, was rotated on a pivot so as to bring the wheel to face up to the wind. This limited the size of the mill. In the latter types of the Dutch mill, only the upper part of the wheel-house was rotated. These mills were governed by varying the extent of the sail surface exposed to the wind, while the wheel was at rest. The Dutch types of wooden mills are powerful, but bulky and expensive. They are but little used in this country at the present time.

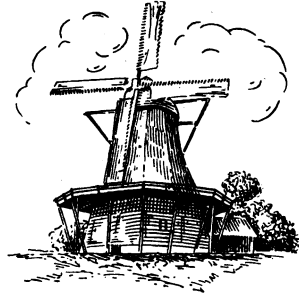

FIG. 216.—Dutch windmill.

The American mill is made up of a great number of narrow blades or fans. This means a mill of smaller weight and less bulk than the Dutch mill of the same power.

Windmills may be classified as pumping and power windmills. The pumping windmill gives a reciprocating motion to a vertical rod suitable for operating a pump, while the power windmill gives rotary motion to a shaft through a train of gears.

The wheel and rudder of American windmills are constructed either of wood or of steel. The best steel windmills are galvanized for protection from rust.

Windmills are designated by the diameter of the wind wheel. Thus the so-called 15-ft. mill has a wheel 15 ft. in diameter.

American windmills are built either as direct-stroke or as back-gearred. In the case of the direct-stroke windmill the main shaft carries a crank which is attached to the pump rod by a connecting rod, commonly called the pitman, there being no speed-reducing gears. In this type, the pump makes one complete stroke for each revolution of the wind wheel. Geared mills are back-gearred, so that the pump makes one stroke for every three or five revolutions of the wind wheel. The back-gearred mill will develop more power than the direct-connected mill for a wind wheel of the same diameter.

Principal Parts of a Windmill.—The principal parts of a windmill are:

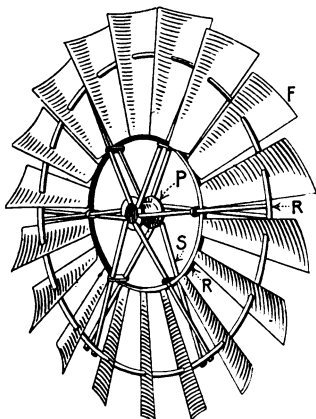

FIG. 217.—Wind wheel.

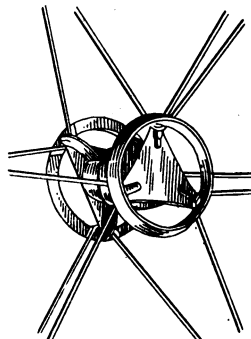

FIG. 218.—Hub of wind wheel.

1. A wind wheel which receives the kinetic energy of the wind. This wheel is carried upon the main shaft.
2. A rudder or vane which steers the wheel against the wind.
3. A governor, which regulates the speed of the wind wheel.
4. Gearing.
5. A brake which holds the wheel stationary when out of the wind.
6. Main casting which supports governor, gearing and brake. This with the parts which it supports is called the mill head.
7. A tower which is a support for the mill. The tower should be tall enough to raise the wheel sufficiently high above all obstructions, such as trees, houses, etc., that it will receive a steady breeze.

The Wind Wheel.—The wind wheel (Fig. 217) is that part of the mill which derives the energy from the wind.

The hub of the wheel either consists of two separate wheel spiders (Fig. 218) keyed to the main shaft, or it is constructed as a solid casting with the wheel spiders at either end.

The arms or spokes of the wheel (*S* in Fig. 217) are attached to the wheel spiders (*P*) and extend outward to the rim *R*. The spokes are usually of rectangular or circular cross-section, but some manufacturers use steel angles.

The rims are placed, one near the inner ends of the fans *F*, and the other either a little beyond the center or near the outer ends of the fans. The rims are made either of strap steel or of angle steel.

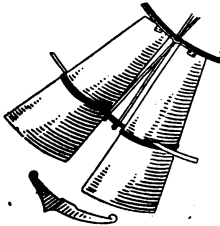

FIG. 219.—Fans of windmill.

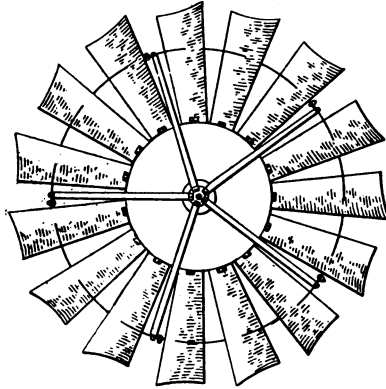

FIG. 220.—Samson wheel.

The fans (Figs. 217 and 219) are so curved that the wind on leaving one fan will not strike upon the back of the next. The spacing of the fans is such that the wind passes through freely and all parts of the wheel must be so designed as to offer the least resistance to the wind. The fans are fastened to the rims by brackets and the various sections of fans and rims are riveted together.

Fig. 220 shows a Samson wheel with strap steel spokes and hollow hub.

The general construction of a wooden wind wheel is similar to that of the steel wheel, except that the spokes, rims and fans are of wood. The rims are made either straight from spoke to

spoke or are bent in a manner similar to that of steel mills. A section of a wooden wind wheel is illustrated in Fig. 221. The wooden wind wheel is made up of six or more sections, each section consisting of 15 or more slats.

The Rudder or Vane.—Most windmills are provided with some form of rudder or vane for keeping the wheel in the direc-

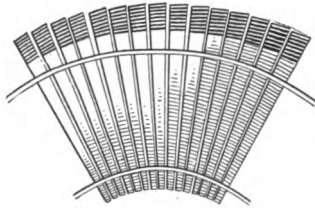

FIG. 221.—Section of wooden wind wheel.

tion of the wind. In some windmills no rudder is employed, and the pressure of the wind on the wind wheel is relied upon to bring the wheel in the right direction. Windmills without rudders are provided with folding wheel fans and have a weighted

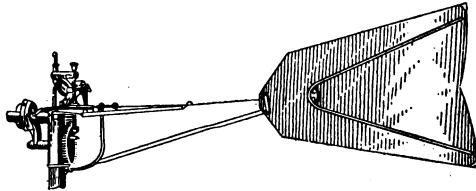

FIG. 222.—Steel rudder.

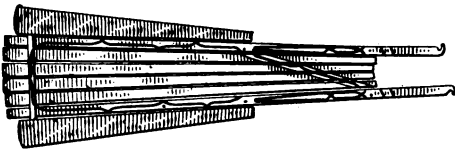

FIG. 223.—Wood rudder.

ball which performs the function of a rudder and opens the wheel when the wind is greater than the load. Then some of the larger windmills without rudders are provided with a small side wheel which is set perpendicular to the wind wheel, and turns the wind wheel into the proper direction by means of gearing.

The rudder is built either of steel (Fig. 222) or of wood (Fig. 223).

It is often desired to throw the wind wheel out of action. This in the case of the folding wheel is accomplished from the ground level by a wire or rod which extends up through the tower and connects with a system of levers which tip the sections of the wheel. The solid wheel is thrown out of action either by pulling it around parallel with the vane, so that its edge faces the wind, or by pulling the vanes parallel to the wind.

The Governor.—The function of a governor is to regulate the speed of the wind wheel.

In some windmills the governor consists of a coiled spring, one end of which engages with the rudder and the other with the mill head. When the wind pressure becomes too great, the wheel will swing so as to expose less surface to the wind.

To assist in governing, some mills are provided with a side vane.

In the case of folding-wheel mills the angle of the fans is changed, by a system of weights and levers, according to the intensity of the wind.

Most windmills are provided with a "pull-out reel," which consists of a ratchet and windlass for throwing the wind wheel out of action. When the ratchet is released the wind wheel is thrown into correct position by the rudder and governor. Some windmills use a lever instead of a ratchet and windlass for the same purpose.

Windmill Gearing.—The gearing of a direct-stroke windmill is illustrated in Fig. 224.

One simple form of a back-geared mill mechanism is given in Fig. 225. *E* represents the hub of the wind wheel. The pinion *P* is carried on the main shaft and meshes with a large gear *A* on a countershaft. The center of the gear *A* is placed to one side of the upper end of the connecting rod or pitman *B*, so that it requires more than half of a revolution to raise the pump rod and less than half of a revolution to lower it. Thus a quick return motion is obtained, the pump rod descending more rapidly than it rises. This is advantageous in that little power is required on the down-stroke, there being no water raised and the weight of the plunger, pump pole and pump rod being sufficient to produce that stroke. The slow motion on the up-stroke enables the mechanism to carry the load with the least strain. In this mechanism *D* is a hinge for attaching the rudder or vane.

The difference in construction between the gearing for pumping and power windmills is in the addition of a bevel gear *B* (Fig. 226) which meshes with another bevel gear on the power shaft.

All windmills should be provided with some form of buffer to protect the rudder and other parts from sudden shocks when the windmill is thrown out of gear. The buffer is usually constructed

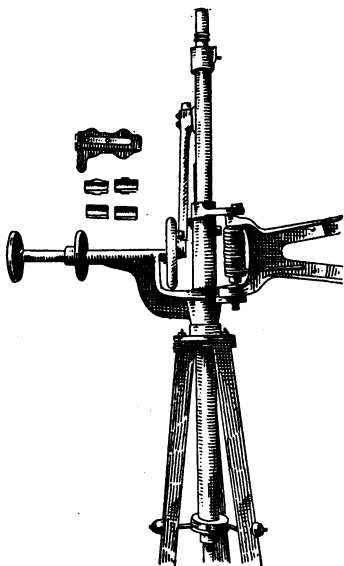

FIG. 224.—Direct-stroke windmill.

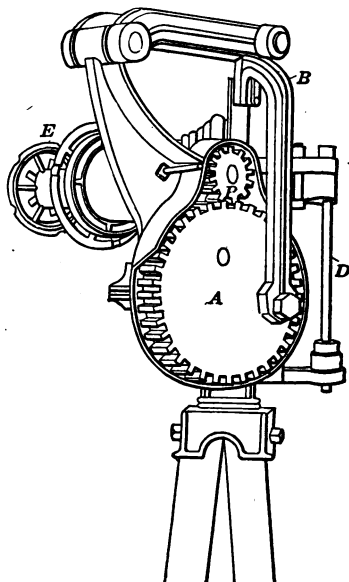

FIG. 225.—Back-geared windmill.

in the form of a helical steel spring placed upon the rudder rail near the hinge.

Windmill Brake.—Nearly all windmills are provided with an automatic brake, which holds the wheel stationary when out of the wind. The brake is a flexible steel band which encircles about three-fourths of the flange on the hub of the wind wheel and holds it stationary when out of gear. The brake is applied by a lever as soon as the windmill is turned out of gear.

Towers.—Windmill towers are constructed either of wood or of steel.

There are a great many different kinds of wooden towers, as

they are often "home-made." Four 4-in. by 4-in. or 6-in. by 6-in. timbers, depending on the size of the tower, are most commonly employed for the corner posts. They are spread about 8 or 10 ft. at the bottom and are brought together at the top and fastened to a cast-iron cap, usually provided by the manufacturer. A platform 2 or 3 ft. square should be provided directly below the wind wheel for the purpose of facilitating oiling, inspection and repairing. The tower ends of the corner

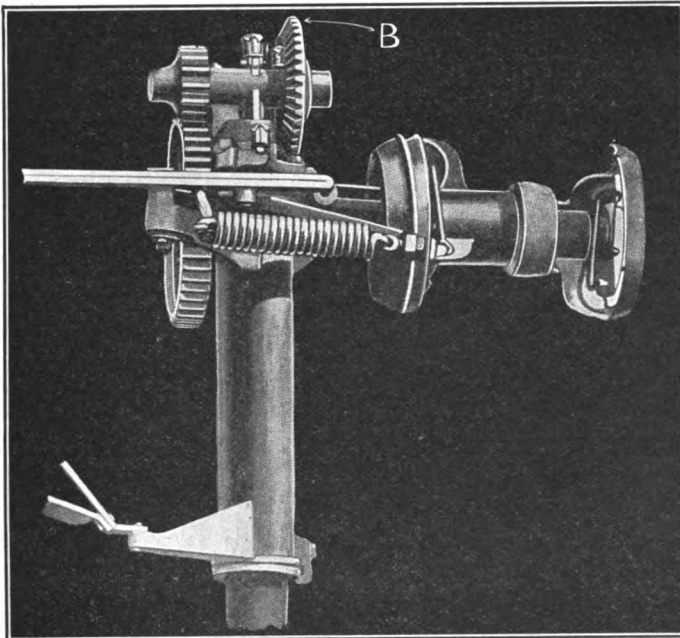

FIG. 226.—Power windmill.

posts are bolted to anchor posts which are set about 6 ft. in the ground with cross-pieces bolted to the lower end to form a better foundation.

Steel windmill towers are built with either three or four posts and should always be galvanized and not painted. A tower supported on four posts (Fig. 227) is protected from a wind in any direction. The three-post tower (Fig. 228) is somewhat cheaper than the four-post tower, and has the additional advan-

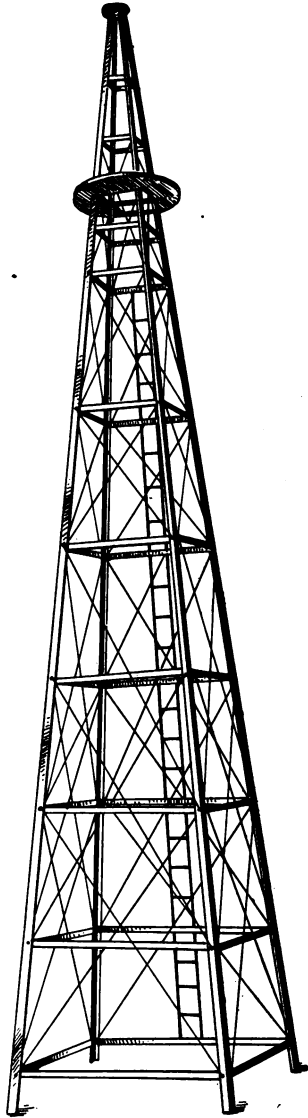

FIG. 227.—Four-post tower.

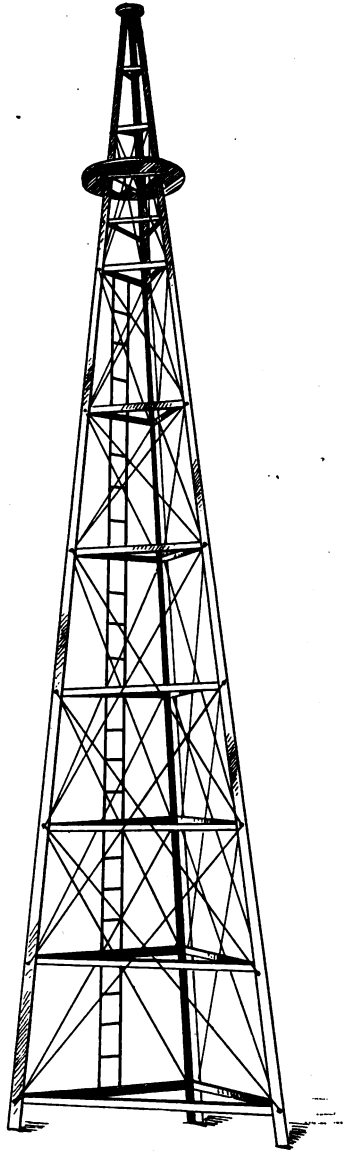

FIG. 228.—Three-post tower.

tages, in localities where the ground is soft, of always standing firm and rigid, and of being unaffected by unequal settling of anchor posts. A three-post tower when properly braced also is stiffer and stronger than a four-post tower.

The corner posts of a steel tower are usually of angle steel, but some are of gas pipe. The cross-girts are of angle steel and the braces may be of angle steel, rods, or wire cable. The anchor posts are about 6 ft. long and of the same material as the corner posts, with anchor plates attached at the lower end.

The method of fastening the corner posts of three- and four-post towers is shown in Fig. 229. The posts are beveled, notched and are held together by clamps and bolts.

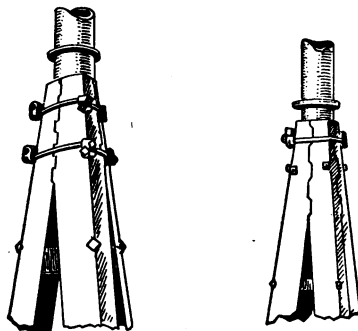

FIG. 229.—Method of fastening corner posts of three-post and four-post towers.

The tower in Fig. 230 has the lower braces of angle steel and the other braces of rods. Twisted-wire cable braces are shown in Fig. 231.

Method of Erecting Windmills.—A windmill is erected either by building it up in position piece by piece, or it is assembled on the ground and then raised into position. The method of raising a windmill from the ground is illustrated in Fig. 232.

After the holes for the anchor posts are dug, the anchor posts are placed loosely in them. In raising towers over 30 ft. in height, the lower portion should be reinforced by placing timbers in the tower (Fig. 232). A beam of wood is then placed across the lower ends of the legs, and stakes are driven at each end, in order to prevent the tower from sliding when it is being raised. A strong rope is attached to the tower near the platform and to

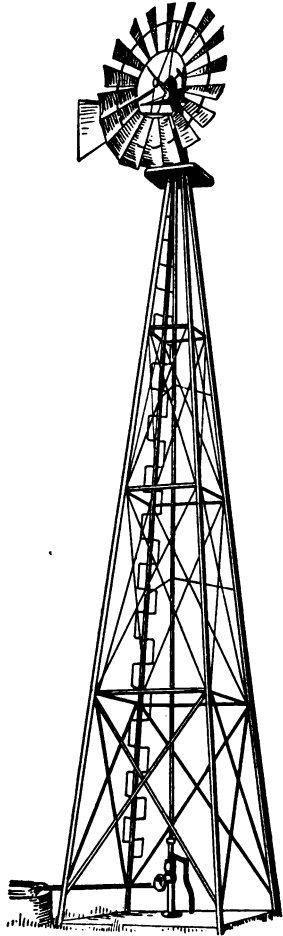

FIG. 230.—Tower of aeromotor windmill.

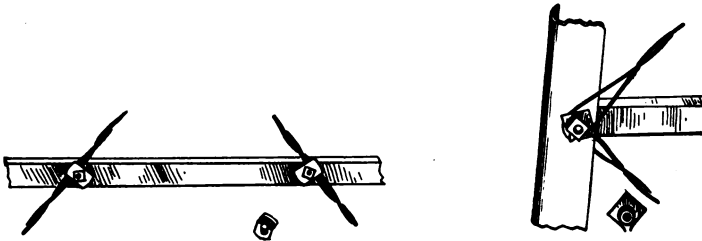

FIG. 231.—Twisted wire braces.

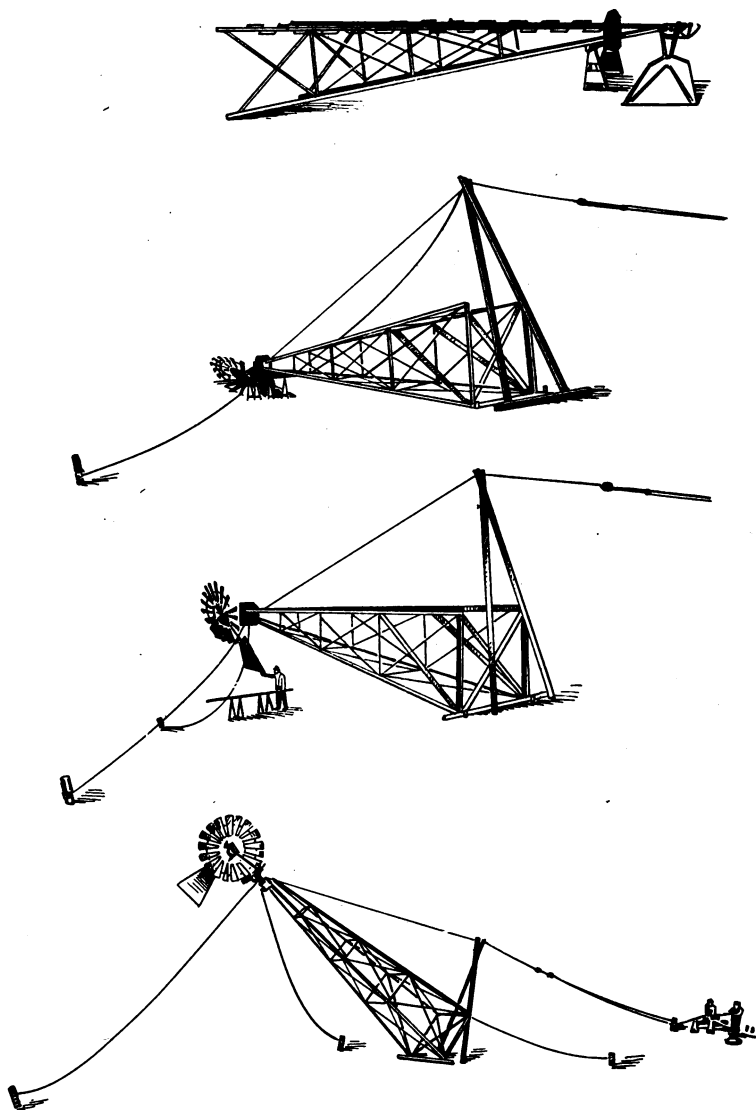

FIG. 232.—Method of raising windmill from the ground.

a block and tackle a little beyond the lower end of the tower. Another block is made fast to some stakes driven at a distance of one and one-half times the length of the tower from the lower end of the tower. Shear poles about one-half the length of the tower are then placed under the rope near the lower end of the tower. Stakes are driven at each side of the upper end of the tower, to which ropes are attached to retain the tower in position, and the tower is pulled into position by a traction engine, team, or windlass. Several men usually can raise a small tower by pulling directly on the tackle rope.

When the tower is nearly erect, the two front anchor posts should be bolted on and the rear guy line payed off until the two anchor posts come into place on the bottom of the holes. The tower is then tilted back and the other two anchors are attached in the same way.

After the tower is in position it should be leveled with a plumb bob, before the pump rod is put into place. All braces must be evenly tightened.

Loose stones are often placed below and above the anchor plate. For best results a concrete base should be used. When using loose stones, it is desirable that the anchor plates should rest on cap stones.

Care of Windmills.—A windmill requires some care if long and good service is expected.

When first erected it should be carefully examined every few days for loose bolts and bearings.

All bearings should be kept well-lubricated and brasses tight. If anchor posts work loose, they should be reset. It is always well to shut down a windmill during a heavy storm.

Windmills may be lubricated by means of oil cups, the oil being held in place by waste. With the ordinary oil cups a windmill would have to be lubricated every 2 or 3 days if it were running continuously. To reduce the necessity of frequent lubrication, some form of self-feed oil cup is used. This consists of a large oil cup with a tube extending nearly to the top of the oil cup. A twisted-wire wick passes from the bottom of the oil cup into the tube. The oil from the cup follows the wick into the tube and lubricates the bearing which is at the bottom of the tube.

Power of Windmills.—The power delivered by a windmill depends on the velocity of the wind, on the size and construction of the wheel, on the amount of power lost in friction and on the density of the air.

It has been found that an average wind velocity of 6 miles per hour is required to drive a windmill. The average velocity of the wind in the United States varies from 4.2 to 16 miles per hour. The best wind velocity is about 15 miles per hour. The velocity in most localities is great enough to operate a mill about 8 hr. per day.

The power developed by a windmill with winds of average intensity will vary from $\frac{1}{8}$ hp. for a 6-ft. wind wheel to about 1 hp. for a 16-ft. wind wheel. With strong winds and with large wheels, windmills will develop as much as 4 hp.

TABLE 7.—POWER OF WINDMILLS

Wind velocity, miles per hour	Indicated horsepower	
	12-ft. wheel	16-ft. wheel
8	0.10	0.18
10	0.20	0.36
12	0.34	0.60
15	0.67	1.21
20	1.60	2.90
25	3.12	5.50
30	5.40	8.50

The angle and spacing of the wind-wheel fans affect the power delivered by a windmill. Then the quality and condition of the gearing and bearings determine the actual power available for utilization either at the pump or power shaft.

The density of the air affects the pressure of the wind on the wind wheel. Thus the higher the altitude the lighter is the air and the less power is developed with a wind of a certain velocity.

The cost of windmill power is about 5 cents per horse power per hour, when considering cost of attendance, repairs, cost of lubrication and interest on investment.

Uses of Windmills.—The main use of windmills is for pumping water for domestic use and for stock. When used in pumping

water for irrigation, a storage tank of large capacity should be provided, sufficient for several days' use in case of calm weather.

For watering stock on small farms and for domestic use on the farm, the windmill is the cheapest and best form of motor. It requires but little attention. One-half hour per week devoted to oiling and inspection will keep the mill in good condition.

A windmill cannot be used for heavy work on the farm, but can drive small feed grinders, grindstones, corn shellers, feed cutters, wood saws, churns, or any other machine requiring little power.

In general the windmill is suitable for work requiring but little power, which will admit of suspension during calm weather.

Problems: Chapter IX

1. Explain the Dutch type of windmill. Why is this type of mill not used in the United States?
2. What are the principal parts of a windmill?
3. How are windmills rated?
4. Explain the construction of the wind wheel.
5. What is the function of the vane or rudder?
6. Explain construction and action of some type of windmill governor.
7. Explain in detail the action of the direct-stroke windmill illustrated in Fig. 224.
8. Show by means of sketches or illustrations the difference between the power windmill and the windmill which is designed for pumping only.
9. Give directions for building a modern windmill tower.
10. Compare the advantages and the disadvantages of the three-post and the four-post windmill tower.
11. Give directions for erecting a windmill.
12. Report on the uses of the windmill for irrigation and for the generation of electricity.

CHAPTER X

GENERATORS, ELECTRIC MOTORS AND BATTERIES

Before considering the various types of electric motors and their applications, the fundamentals of electricity and of dynamo electric machinery will be taken up.

Action of Electricity.—The action of electricity in an electric generator is analogous to that of water pumped from a lower to a higher level. The function of a pump in forcing water through pipes is well known. The pump exerts a pressure on the water. If the pressure exerted by the pump is doubled, the quantity of water handled by the pump will also be doubled, if the friction of the water through the pipe remains the same. It is also well known that the resistance offered to the flow of water through pipes increases with the length of the pipe. Also by increasing the size of the pipe the resistance is decreased.

The generator in the electric power plant performs a function similar to that of the pump. It generates electrical pressure in order to send electricity through the wires which correspond to pipes. The resistance offered by the wire to the flow of electricity is analogous to that offered by the water pipe to the flow of water. The quantity of electricity delivered to the circuit, which may consist of motors, lamps, or other appliances using electricity, corresponds to the amount of water delivered by the pump to an overhead tank or pipe from which water motors or other appliances requiring water under pressure can be operated.

Units of Electricity.—The pound is the unit of water pressure, while the unit of electricity is the volt. The amount of water flowing through a pipe is measured in gallons per minute, the quantity of electricity flowing through a wire in amperes. The resistance which a wire offers to the flow of electricity is measured in ohms.

The unit of electrical power is the watt, a watt being the product of a volt and ampere. The power available in a certain weight of water depends on the head, or on the distance the

water is allowed to fall. Similarly the power available at the terminals of a generator is the product of the quantity of electricity in amperes and the electrical pressure head in volts.

As an illustration, the power available at the terminals of a generator delivering 60 amp. at 110 volts is

$$\text{Power in watts} = 60 \times 110 = 6,600$$

Generators usually are rated in kilowatts (kw.), a kilowatt being 1,000 watts. Electric motors are rated in electrical horsepower, an electrical horsepower being equal to 746 watts. The relation between the kilowatt and the electrical horsepower is

$$\frac{1,000}{746} = 1\frac{1}{3}.$$

Thus an electric motor operating on a 220-volt circuit and requiring 30 amp. has delivered to it

$$\frac{220 \times 30}{746} = 8.85 \text{ electrical horsepower.}$$

If the efficiency of the motor is 80 per cent., the available power at the motor shaft is $8.85 \times 0.80 = 7.08$ b. hp.

Ohm's Law.—The law expressing the relation between the volt, the ampere and the ohm is of great value in electrical calculations. It is called Ohm's law and is expressed by the statement that

$$\text{The current in amperes} = \frac{\text{Pressure in volts}}{\text{Resistance in ohms.}}$$

Expressing the current by the symbol I , the voltage by E and the resistance by R

$$I = \frac{E}{R}$$

As an illustration, an ordinary 16-cp. carbon lamp operating on a 110-volt circuit offers a resistance of 220 ohms. How much current will be required to operate the lamp?

Applying Ohm's law—

$$I = \frac{E}{R} = \frac{110 \text{ volts}}{220 \text{ ohms}} = \frac{1}{2} \text{ amp.}$$

The power required to operate the lamp is

$$110 \times \frac{1}{2} = 55 \text{ watts.}$$

Considering no losses in the engine, generator and lines, the number of 16-cp. carbon lamps which can be operated by a generator driven from a 1-hp. engine is

$$\frac{746}{55} = 13.56 \text{ lamps.}$$

Due to line losses and to losses in the generator, it is customary to figure about ten 16-cp. carbon-filament lamps per engine horsepower.

Incandescent Lamps.—Table 8 shows the current consumed by carbon-filament and by tungsten-filament lamps of various candlepowers. From this table it is evident that the tungsten-filament lamp consumes about one-third the current required by carbon-filament lamps of the same candlepower. A tungsten-filament lamp will require about 1.25 watts per candlepower and will give a whiter light than the carbon-filament lamp.

TABLE 8.—CURRENT CONSUMED BY INCANDESCENT LAMPS AT 110 VOLTS

Candlepower	Amperes		Watts	
	Carbon	Tungsten	Carbon	Tungsten
8	0.25	28	
16	0.50	55	
20	0.228	...	25
32	1.00	0.364	110	40
48	0.545	...	60

Wires for Conductors of Electricity.—The resistance which a wire offers to the flow of electricity depends on its cross-section and on the material from which it is made. Silver when pure is considered to be the best conductor. Copper is very nearly as good a conductor as silver, and, being much cheaper, it is used in nearly all cases for the distribution of electricity.

Copper wire is sometimes used bare, but in most cases it is covered with a material called insulation, to prevent the transfer of electricity to surrounding substances. The insulation used on wire is either rubber or some weather-proof substance.

Copper wires are designated either by the Brown and Sharpe wire gage (B. & S. gage) or by their cross-section in circular mils. A circular mil is a circle $\frac{1}{1000}$ in. in diameter. The

designation of wire by the B. & S. gage is more common for small wires. This gage is constructed so that the numbers decrease as the size of the wire increases. Thus a No. 10 B. & S. wire is smaller than a No. 9 and larger than a No. 11.

The current-carrying capacities in amperes of various sizes of rubber-covered and weather-proof wire are given in Table 9.

TABLE 9.

Size of copper wire		Current-carrying capacity in amperes	
B. & S. gage	Circ. mils	Rubber-covered wire	Weather-proof wire
18	1,624	3	5
16	2,583	6	8
14	4,107	12	16
12	6,530	17	23
10	10,380	24	32
8	16,510	33	46
6	26,250	46	65
5	33,100	54	77
4	41,740	65	92
3	52,630	76	110
2	66,370	90	131
1	83,690	107	156
0	105,500	127	185
00	133,100	150	220
000	167,800	177	262
0000	211,600	210	312

The sizes of wire in the tables are given in terms of the B. & S. gage as well as in circular mils.

Electrical Batteries.—Batteries are used mainly in places where the current requirement is small, as in connection with the ignition systems of internal-combustion engines, also for operating telephones, telegraphs, electric bells, etc.

Batteries can be called chemical generators of electricity, and are of two types. One type, called the primary battery, generates electrical current by means of direct chemical action between certain substances. Another type, called a secondary battery or storage battery, requires charging with electricity from some outside electric source before it will generate electrical energy. The outside current acting on the substances within the battery

changes their chemical properties to such an extent that the battery is able to deliver current when connected to a circuit. After storage batteries furnish current to a circuit for a certain length of time, their active materials become nearly exhausted and they must be recharged with electricity before they can be used again. Here lies the difference between the storage battery and the ordinary primary battery. The active materials in the primary battery when once exhausted cannot be brought back to generate electricity, and must be renewed.

The term battery is applied to two or more cells, whether primary or storage types, which are connected together to increase the total amount of electrical energy delivered to a circuit.

Primary Batteries.—A primary cell consists essentially of a vessel containing some acid called the electrolyte in which are immersed two solid conductors of electricity, called electrodes, one of which is more easily attacked by the acid than the other. A simple cell consists of a weak solution of sulphuric acid, as an electrolyte, a plate of zinc, which is easily decomposed by the sulphuric acid, and a plate of some other solid like copper or carbon which resists the action of sulphuric acid. If the plates of zinc and copper are put side by side in a vessel containing sulphuric acid, and the circuit is completed by joining the two plates by a wire, chemical action will be set up within the vessel or cell. The zinc will dissolve in the acid, forming zinc sulphate, hydrogen will be given up by the sulphuric acid in streams of bubbles which will settle on the copper plate, and a current of electricity will be generated. The bubbles of hydrogen liberated from the electrolyte do not combine with the copper plate, but form a gaseous non-conducting film over the metallic surface which increases the resistance of the cell to the flow of electric current. The formation of the bubbles of hydrogen on the copper plate, called polarization, causes a rapid falling off in the power. It is possible to decrease or even eliminate polarization. One good method is to construct the cell with some strong oxidizing agent. The oxidizing agent gives up its oxygen, which combines with the particles of hydrogen, forming water and decreasing polarization. Cells using this method of decreasing polarization usually employ carbon plates, as most of the oxidizing materials

attack copper plates. The Leclanche cell shown in Fig. 233 is an example of this type of cell.

The dry cell, which is used extensively at the present time on

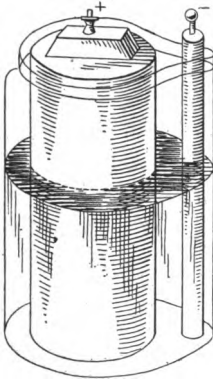

FIG. 233.—Leclanche cell.

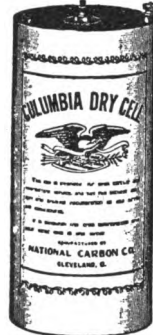

FIG. 234.—Dry cells.

account of its portability, is a modification of the Leclanche cell. It has zinc for the positive electrode, carbon for the negative electrode, sal ammoniac and zinc chloride as the electrolyte for decomposing the zinc, and some oxidizing agent like manganese dioxide to eliminate polarization. As usually constructed, the dry cell consists of a zinc cylinder which is the positive electrode and acts at the same time as a container for the other materials of the cell. The zinc cylinder is provided with a lining composed of plaster of paris, flour, blotting-paper, or some other absorbent material saturated with sal ammoniac and zinc chloride. At the center of the cell is a carbon rod, and this is surrounded by a paste consisting of manganese dioxide and chloride of zinc. The top of the cell is covered with a layer of hard pitch. A small hole through the pitch permits the escape of gases which may be formed within the cell. The outside of the cell usually is insulated with paper. Several forms of dry cells are illustrated in Fig. 234. The solution in the dry

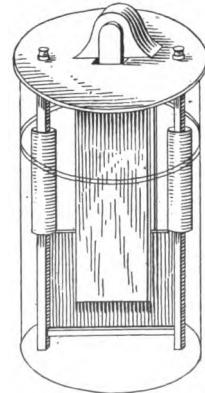

FIG. 235.—Edison Lalande cell.

cell evaporates slowly, so that a battery of dry cells will become worthless after a certain time even if it is not used. Generally a dry cell in good condition will have a current strength of 15 to 25 amp. and should show a pressure of $1\frac{1}{4}$ to $1\frac{1}{2}$ volts. A binding post is attached to the carbon and another one to the edge of the zinc cylinder.

The various Lalande wet cells are very good for gas-engine ignition. One form, the Edison Lalande, is illustrated in Fig. 235. One electrode in this cell is of zinc and the other of copper oxide. The electrolyte consists of caustic potash. The oxygen of the copper oxide prevents polarization. A film of heavy paraffin oil is put on top of the electrolyte, so as to prevent the absorption of carbon dioxide from the air by the caustic potash.

Storage Batteries.—A storage battery consists of two sets of plates or electrodes known respectively as positive and negative, submerged in a liquid called the electrolyte. The plates are encased in a jar or container. This type of battery must be charged frequently with electricity in order to give out current to the external circuit. The storage battery does not store electricity, but energy in the form of chemical work. The electric current produces chemical changes in the battery and these changes produce a current in the opposite direction when the circuit is closed.

Storage batteries are used for gas-engine ignition and are preferred for this purpose to primary dry or wet batteries on account of their greater capacity and more uniform voltage. Modern automobiles, as explained in Chapter VI, employ storage batteries for starting, lighting and ignition. Storage batteries are also used to a considerable extent for farm lighting in order to shorten the time required for operating the engine and electric generator.

The capacity of a storage battery is measured in ampere-hours determined by multiplying the current rate of discharge by the number of hours of discharge of which the battery is capable at that rate. As an illustration, a battery that will deliver 10 amp. for 8 hr. has a capacity of 80 amp.-hr. The ampere-hour capacity of a storage battery is dependent upon the rate of discharge. Most manufacturers specify the rate of discharge for their particular make of storage batteries. If the rate of discharge is greater than the specified amount, the capacity of the battery is

reduced. If a storage battery has a capacity of 80 amp.-hr. at the 10-amp. rate, it will have a greater ampere-hour capacity if discharged at a 5-amp. rate; that is, it will deliver a current of 5 amp. for more than 16 hr. The normal rate of discharge is the 8-hr. period.

A storage battery can be charged from any direct-current circuit, provided the voltage of the charging circuit is greater than that of the storage battery when fully charged. Before a storage battery is connected to the charging circuit its polarity should be carefully determined, and the positive and negative terminals of the battery connected to the positive and negative terminals of the source respectively. One good method of determining the polarity of the wires from the storage battery or source is to immerse them in a glass of salt water. Bubbles of gas will form more rapidly on the surface of the negative wire. Another test is that the negative wire will turn blue litmus paper red. Should the positive wire of the battery be connected to the negative wire of the source, the effect would be a discharge of the battery, and this being assisted by the incoming current, a reversal of action would take place, which is very injurious to the battery. It is not well to charge a battery at too rapid a rate, as this will raise its temperature and will cause buckling of the battery plates. It is well also to charge batteries at regular intervals.

Two types of storage batteries are used, the lead storage battery and the Edison. The Edison battery is also called the alkaline or the nickel-iron battery.

The Lead Storage Battery.—In the lead storage battery both the positive and the negative electrodes of a cell are of perforated lead plates. The perforations are filled with certain lead compounds (Pb_3O_4 and PbO) which react with the electrolyte of dilute sulphuric acid, forming lead peroxide on the positive plate and a spongy metallic lead on the negative plate. The lead peroxide and the spongy metallic lead are both converted into insoluble lead sulphate ($PbSO_4$) when this cell delivers current, and this lead sulphate is converted back into lead peroxide and spongy lead respectively when a reversed current is forced through the cell. The lead peroxide and spongy lead are called the active materials of the cell.

The voltage of the cell increases with the increased concentration of its electrolyte, which is sulphuric acid. When the cell is

completely charged, the electrolyte is more concentrated and the voltage is large. As the cell is discharged, the concentration of the sulphuric acid is decreased and the voltage drops.

A lead cell when fully charged will show 2.2 to 2.5 volts on open circuit and about 2.15 volts when the circuit is closed. A lead storage battery should not be allowed to discharge to a voltage lower than 1.8 volts while giving its full rated current.

The storage cell is composed of an odd number of positive plates and of an even number of negative plates, so that each side of a positive plate faces a negative plate. The plates are insulated from each other and from the bottom and are placed in a glass vessel, if the battery is to be used for stationary purposes, and in a vessel of hard rubber if the battery is for portable use. Various forms of lead storage batteries are illustrated in Fig. 236.

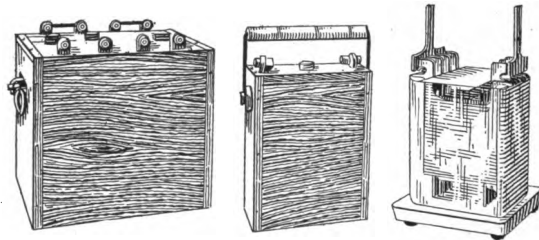

FIG. 236.—Lead storage batteries.

The positive and the negative plates of a storage battery can be distinguished by their color. The positive plates, when fully charged, should have a dark brown or chocolate color, and the negative plates more of a light gray or a metallic lead color.

Lead storage batteries deteriorate rapidly in service, if not properly cared for.

For successful operation and long life, storage batteries should be tested frequently with a pocket voltmeter for voltage and with a hydrometer for the specific gravity of the electrolyte. A battery hydrometer for measuring the specific gravity is illustrated in Fig. 237. The specific gravity of the electrolyte of a stationary battery should be 1.17 to 1.22 when the battery is fully charged. A portable battery should have a greater specific gravity, and, when fully charged, this will vary from 1.275 to

1.300. If too low, add stronger sulphuric acid until the correct specific gravity is obtained.

Water must be occasionally added to the electrolyte to make up for evaporation. When water is added, this should be poured to the bottom of the cell through a long rubber tube attached to a funnel. The electrolyte level should be about $\frac{1}{2}$ in. above the plates.

If a storage battery is to remain unused for any length of time, it should be discharged and immediately recharged about once per

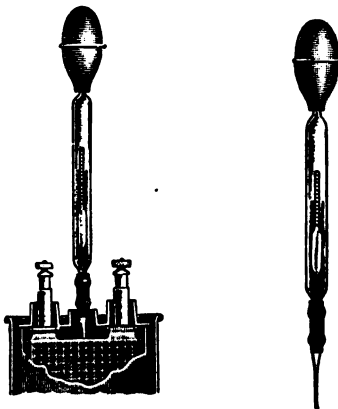

FIG. 237.—Battery hydrometer.

week. To allow a storage battery to remain discharged for any length of time is injurious to the plates.

The Edison or Nickel-iron Storage Battery.—The Edison storage battery consists of two sets of sheet-steel plates or grids, submerged in an electrolyte of caustic potash. The plates or grids support tubes and pockets containing the active materials (Fig. 238). These grids have holes at the top which fit snugly over connecting rods on which the poles are forced by pressure to a perfect fit. The plates are held apart by spacing washers on the connecting rod. The positive plates are assembled on one connecting rod with the positive pole and the negative plates on a similar rod with the negative pole.

The positive material of the positive plate is nickel hydrate. When the cell is charged, the nickel hydrate changes to a high oxide of nickel.

The active material on the negative plate is a specially prepared black oxide of iron.

The plates are held in a steel container which eliminates the danger of broken jars. Hard-rubber insulation at the bottom and sides prevents electrical contact between plates and container.

Edison batteries do not have as high capacity when new as

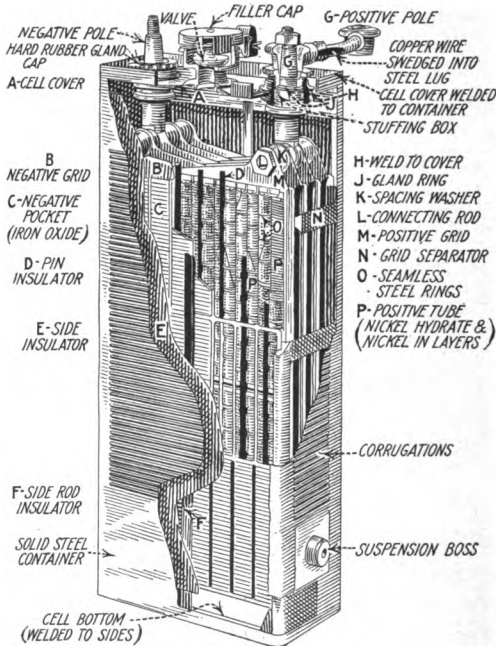

FIG. 238.—Edison storage battery.

after some weeks of use. This is due to the improvement of conditions in the nickel electrode, brought about by regular charging and recharging.

The voltage of an Edison cell when fully charged is less than 2 volts, while that of the lead cell is more than 2 volts. This means that more Edison cells will be required for a given voltage than lead cells.

The cost of Edison cells and of the best grades of lead cells is about the same. The cost of an Edison battery for higher volt-

ages is greater than that of lead batteries as the necessary number of cells for a given voltage is greater in an Edison battery.

The Edison cell has a tight cover, a valve being provided for the escape of gas. Very little water is lost by ordinary evaporation.

The normal strength of the electrolyte is 1.200, as measured by a hydrometer, but may at times be as high as 1.230.

Methods of Connecting Batteries.—The various methods of connecting batteries are illustrated in Figs. 239 to 241.

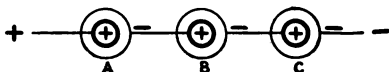

FIG. 239.—Batteries in series.

In the series battery connection (Fig. 239) the positive (+) of one cell is connected to the negative (−) of the other cell. The voltage of the battery is equal to the sum of the voltage of the

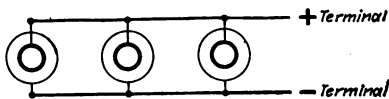

FIG. 240.—Batteries in multiple.

cells *A*, *B*, and *C*, while the current is equal to that of one cell only. If three storage cells, each having a pressure of 2.1 volts are connected in series, the pressure of the battery is 6.3 volts.

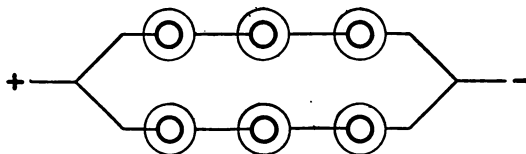

FIG. 241.—Batteries in multiple-series.

The multiple-battery connection method is illustrated in Fig. 240. In this case the positive terminals are connected, as are also all the negative terminals of the battery. If the external resistance is low, the current of the battery is proportional to the number of cells, while the pressure in volts is equal to that of one cell only.

Another method shown in Fig. 241 and called the multiple-

series method of connecting batteries consists of connecting the battery in two sets, the cells of each set being connected in series and the two sets are connected in multiple. The effect of this method of connecting cells is that the total pressure of the system is equal to that of three cells and the current is equal to that of two cells.

The Electric Generator.—The electric generator, popularly called a dynamo, consists essentially of an armature composed of coils of wire wound around an iron core, and one or more magnets. Either the armature or the magnets must be given motion by some form of motor with relation to the other before the generator can generate a current of electricity.

The magnet may be a permanent magnet or an electromagnet. The so-called "permanent magnet" is made of hard-tempered steel which, after having been brought under the influence of some magnetizing apparatus, will retain a certain amount of magnetism. Permanent magnets are expensive to make in large sizes and do not hold their magnetism for any length of time. They are employed only in the construction of small electric generators called magnetos, which are used mainly in connection with electric ignition systems for gas engines, and for signaling work.

Generators which generate electric current for commercial purposes employ electromagnets. An electromagnet consists of a piece of iron which has wound around it many turns of insulated copper wire. If a current of electricity is passed through the insulated copper wire, the iron becomes immediately magnetized, and remains magnetized as long as the current is passing through the wire. There is practically no limit to the strength of an electromagnet, as this depends only on the number of turns of copper wire and on the current passing through the wire, or on the ampere-turns.

Action of the Electric Generator.—The action of a generator depends on the fact that when a wire or other conductor of electricity is moved between the poles of a magnet, electrical pressure is induced in the conductor. In the simple electric generator, an armature consisting of only one coil of wire is rotated between the north and south poles of a magnet. The ends of the coil are connected to two insulated rings mounted on a shaft which gives rotary motion to the coil. If two brushes are allowed to bear on

the two rings and are connected to a measuring instrument, it will be noticed that the current will flow in one direction during half of a revolution and in the other direction during the next half of a revolution. If the readings of the instrument are recorded graphically, a curve like Fig. 242 will be obtained. In this curve the horizontal distances represent the angles turned, while in the vertical distances are recorded values of electrical pressure in volts which cause a corresponding flow of electric current at the various

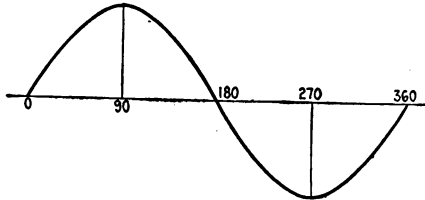

FIG. 242.—Alternating current.

angular positions. It will be noticed that the current starts at zero, and increases to a maximum during one-quarter turn. At the half turn it is zero again. After half of a revolution the direction of the current reverses, attains a negative maximum at three-quarters of a turn and then is again diminished to zero.

Direct and Alternating Currents.—The action of the simple generator, explained in the last section, produces an alternating current, which varies from a maximum to a minimum, first in one direction and then in the other. In the actual electric generator there are many conductors in the armature and several sets of poles, so that as the armature revolves, the current reverses its direction many times a second. For long-distance electric transmission this type of electric current usually is used, as alternating currents can be generated at very high voltage, and these voltages can be increased or decreased at pleasure by means of simple instruments called transformers. There are, however, certain uses to which the alternating form of electric current cannot be put. One case was mentioned in connection with the charging of storage batteries, where a direct current must be used, the chemical action necessary in a storage battery being an impossibility with an alternating current.

Direct current is generated in a generator by the addition of a

commutator shown in Fig. 243, which consists of a set of segments insulated from each other and from the armature shaft, and which rectify the current by shifting the position of the brushes with respect to the armature coils. The principle of the commutator can be seen from Fig. 244.

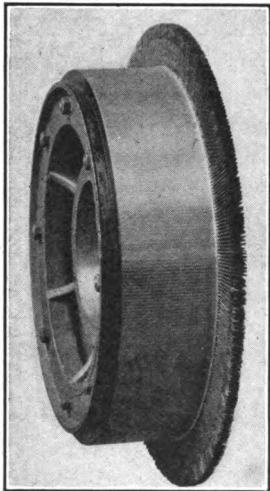

FIG. 243.—Commutator.

R is a split ring to the two segments of which are fastened the two ends of the coil, explained in connection with the working of the simple dynamo. The two brushes *BC* are connected to two wires carrying off the current to the external circuit. As the coil of the simple armature gets into the vertical position between the poles of the magnet each brush changes from the segment with which it was in contact to the other, so that the effect is just the same as if the brushes were interchanged, and the current generated during the second half of the revolution during the second half of the revolution flows in the same direction round the external circuit as the preceding current

did. The current, although generated in the reverse direction, enters the external circuit at the other end, and the result is a unidirectional current. This is changed into a direct current by the employment of an armature with a large number of coils and a commutator of many segments.

Principal Parts of Generators and Motors.

—The principal parts of all dynamo—electric machinery, whether they be generators of electricity or motors driven by electric current, are:

1. A magnetic field, commonly called a field, whose function it is to furnish magnetic lines. In the earlier machines this consisted of a two-pole magnet but the modern generators and motors are provided with four or more poles. The reason for this is that a more compact machine can be produced. A generator whose field consists of a two-pole magnet is called a bipolar generator, while one with a magnet consisting of four or more poles is called a multipolar generator.

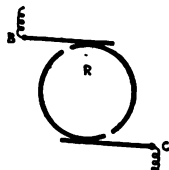

FIG. 244.—Principle of the commutator.

2. An armature which is made up of insulated windings of copper wire on an iron core. The function of the armature is to cut the magnetic lines of force furnished by the field. In all direct-current machines the field is the stationary part while the armature revolves. In alternating-current machines, the field is the revolving part in all but the very small machines.

3. A device which collects or delivers current to the armature, depending on whether the machine is a generator or a motor. In the case of alternating-current generators and motors this is accomplished by brushes pressing on collector rings, if the armature is the revolving element. In larger alternating-current

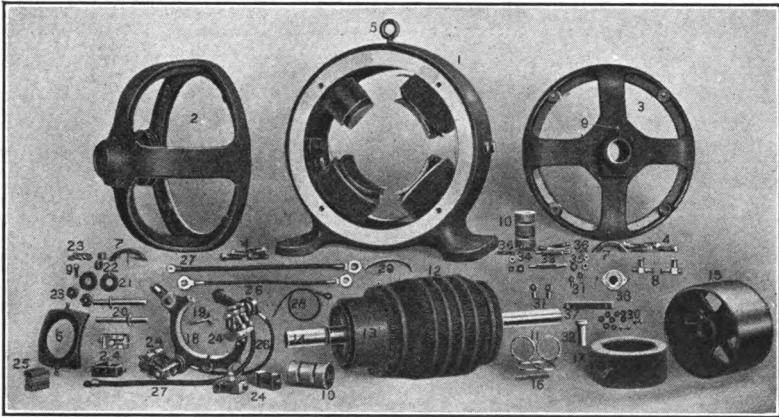

FIG. 245.—Parts of dynamo-electric machinery.

machines where the armature is the stationary part, the current is taken away from or delivered to the windings by leads entering the frame of the dynamo or motor. When dealing with direct-current machines, current is delivered to or taken away from the armature by brushes pressing on a commutator whose function, as explained in the earlier part of this chapter, is also to change the alternating current into direct current.

4. A shaft passing through the revolving part, which is connected to the engine furnishing power in the case of the generator and to the machine to be driven in the case of the electric motor.

5. A frame, usually made of cast iron, whose function it is to support the bearings in which the shaft of the generator or motor revolves.

The various parts of a direct-current generator or motor are illustrated in Fig. 245. The field and armature of an alternating-current generator are illustrated in Figs. 246 and 247 respectively.

Classification of Generators and Motors.—The first broad classification is into direct- and alternating-current generators and motors.

Direct-current generators and motors are divided into three classes depending on the type of field winding as series-wound, shunt-wound, and compound-wound. For simplicity these three types are represented as bipolar machines in Figs. 248, 249, and 250.

Series-wound Generators.—In the series-wound dynamo, illustrated by Fig. 248, one end of the field winding is connected to the positive brush and the other to the external circuit. The action of the series-wound machines depends on the fact that the soft iron poles retain sufficient magnetism to send out a current to the external circuit when the armature is rotated. The entire current passing through the field, the electromagnet of the field increases in strength as the current developed by the generator becomes greater. Series-wound generators are used mainly to supply electricity to direct-current arc lamps.

Series-wound Motors.—The series-wound motor has a winding similar to that of the series-wound generator. In fact, it is difficult to tell the difference between any direct-current motor and generator, the electrical features being the same. A series-wound generator when operated as a motor will run in reverse direction. The series-wound motor is used for work where hand control can be used as in the operation of hoists, cranes, and for the propulsion of electric cars. A series-wound motor can be started at full-load and should never be used where there is a possibility for the load to be removed suddenly. A series-wound motor will "run away"; that is, its speed will increase to such an extent that it may be destroyed by centrifugal force, if the load is removed. For this reason it is not safe to use belt drives with series-wound motors. A series motor is illustrated in Fig. 249.

Shunt-wound Generators.—The principle of a shunt-wound generator is illustrated in Fig. 249. The field winding consists of a great number of turns of very fine wire. Both ends of the field winding are connected to the brushes of the generator.

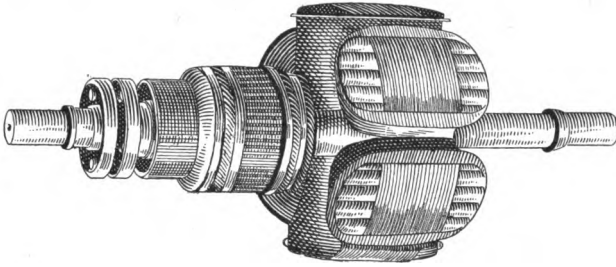

FIG. 246.—Field of alternating-current generator.

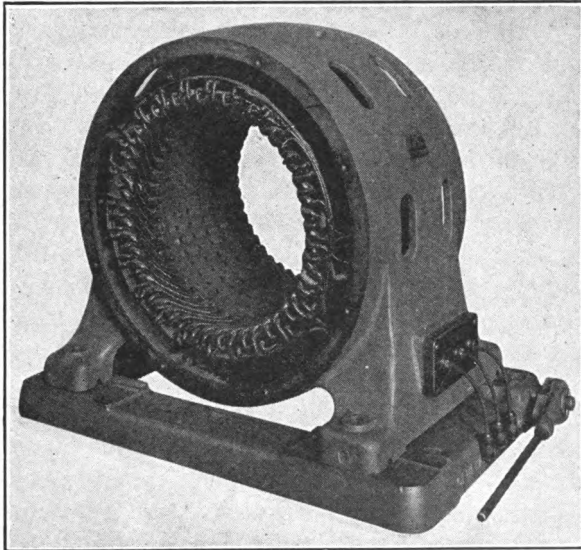

FIG. 247.—Armature of alternating-current generator.

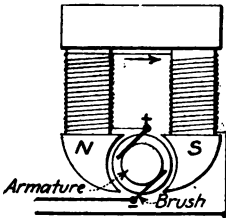

FIG. 248.—Series-wound dynamo.

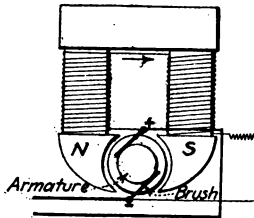

FIG. 249.—Shunt-wound dynamo.

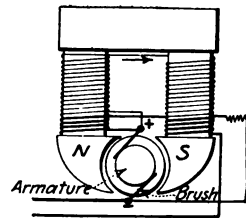

FIG. 250.—Compound-wound dynamo.

Since the field winding is very small in comparison with the line wire, only a small part of the current flows around the field coils. This type of generator is used for charging storage batteries. A shunt-wound generator will supply constant voltage provided the load does not vary much.

Shunt-wound Motors.—The shunt-wound motor has the same type of winding as the shunt-wound generator. Shunt-wound motors are used for all kinds of work where fairly constant speed is desired. A well-designed shunt-wound motor will not vary much in speed with a variable load. In starting a shunt-wound motor it is necessary to put considerable resistance in series with the field of the motor. This is due to the fact that the resistance of the armature of a shunt-wound motor is very low. If a voltage of from 110 to 220 volts is allowed to pass through an armature of low resistance, an enormous current would flow through the armature in starting, which would result in injury to the armature coils, and also to the commutator by excessive sparking. By putting a resistance in series with the armature the current which is allowed to pass through it is decreased. Then, as the motor begins to speed up, the armature turning between poles of a magnet, produces a generator action which sends an electrical pressure in opposition to that which is sent in from the mains. This tends to reduce the current passing through the armature to a safe limit. In connection with this, it must be remembered, that weakening the field of a shunt-wound motor, reduces the above-mentioned generator action, and speeds up the motor. A break in the field connection of a shunt-wound motor, while it is in operation, may result in considerable damage by overspeeding.

Compound-wound Generators.—The compound-wound generator is used extensively for the generation of current for all purposes, including that for light, power and street-car propulsion. The voltage of this type of machine is automatically regulated by a combination of a shunt and series winding. This type of winding is illustrated in Fig. 250. A large portion of the field is wound with many turns of fine insulated wire, which must produce a field of sufficient strength to generate the rated voltage of the generator when no load is placed on it. A series winding of several turns of heavy wire is wound over the shunt wind-

ing. This series winding adds sufficient strength to the field so as to develop the standard voltage at the maximum load of the generator. In some compound-wound generators, the series winding is arranged to increase the voltage slightly as the load increases, and to compensate for loss in voltage during transmission.

Compound-wound Motors.—The compound-wound motor has a series and shunt winding like the compound-wound generator. It is used mainly for the driving of machines where very close speed regulation is essential, such as printing presses, machine tools, and looms.

Various Types of Motors Compared.—For most purposes, the shunt-wound motor is very satisfactory, and, being much cheaper than the compound-wound motor, it is used for the driving of all kinds of machinery which can be started at no-load. If motors are to be used for pumping, the series-wound or compound-wound motor should be selected, unless a clutch can be inserted between the motor and the pump.

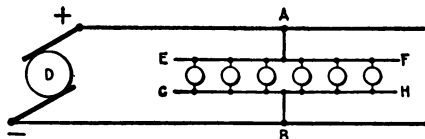

FIG. 251.—Parallel system of distribution.

Distribution of Electric Current.—Electricity may be distributed as direct or as alternating current. Direct current usually is used for short-distance distribution, the most common voltages being 110 and 220 volts. If the furthest point of the distributing system is a mile or further from the dynamo it is well to use alternating currents in order to reduce the cost of wire. Alternating currents are used in voltages of 1,100, 2,200, 4,400, 6,600, and higher.

When using direct currents the parallel system of distribution is most common. The principle of this system is illustrated in Fig. 251. The feeders *A* and *B* lead from the generator *D* to the switchboard. The mains *EF* and *GH* connect the feeders with the branches which supply current for lamps, motors, etc.

In another system of direct-current distribution, the series

shown in Fig. 252, the lamps are connected in series with the generator *D*. This system is very seldom used at the present time, and then only for supplying current to direct-current street arc lamps.

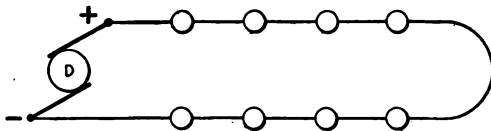

FIG. 252.—Series system of distribution.

Electric Meters.—The four most important quantities which must be known are: current, voltage or electrical pressure, resistance and power. Then most switchboards are also provided with ground detectors for the purpose of telling when the circuit is grounded.



FIG. 253.—Ammeter.



FIG. 254.—Voltmeter.

Electric current is measured by an instrument called an ammeter, and illustrated by Fig. 253. This instrument usually consists of a coil of wire between the poles of a permanent magnet. The current to be measured is sent through the coil, this producing a movement of the coil which is recorded by a needle on a graduated scale.

A voltmeter, illustrated in Fig. 254, is used for measuring electric pressure. This instrument differs from the ammeter in that a resistance is placed in series with the coil, otherwise the voltmeter and ammeter for the measurement of direct current are alike.

For the measurement of voltage and current of batteries a battery meter illustrated in Fig. 255 is used.

The method of connecting an ammeter M and a voltmeter V to a circuit is shown in Fig. 256. AB and CD are the two wires of the circuit.

Resistance can be measured by using a voltmeter and an ammeter together. The ammeter is connected in series with the resistance, while the voltmeter is connected to the terminals. The resistance can then be calculated by Ohm's law, explained

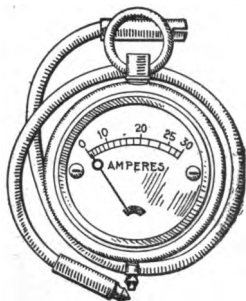

FIG. 255.—Battery meter.

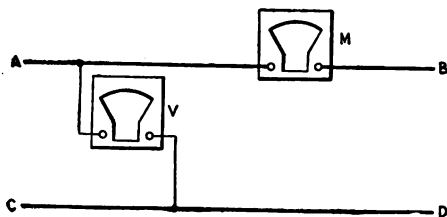

FIG. 256.—Method of connecting ammeter and voltmeter.

in the beginning of this chapter. If I is the ammeter reading and E is the voltmeter reading the resistance is

$$R = \frac{E}{I}$$

An instrument which measures the electrical power of a circuit is called a wattmeter. Since the power of a direct-current circuit is the product of the current flowing through the circuit by the voltage between the terminals, the power can be obtained by taking the product of the voltmeter and ammeter readings of any circuit. In alternating-current circuits this product of the voltmeter and ammeter readings does not give the true electric power of the circuit and a wattmeter must be used. Direct- and alternating-current wattmeters are illustrated in Figs. 257 and 258 respectively.

Fuses and Circuit-breakers.—The function of fuses and of circuit-breakers is to protect electric machines, appliances and

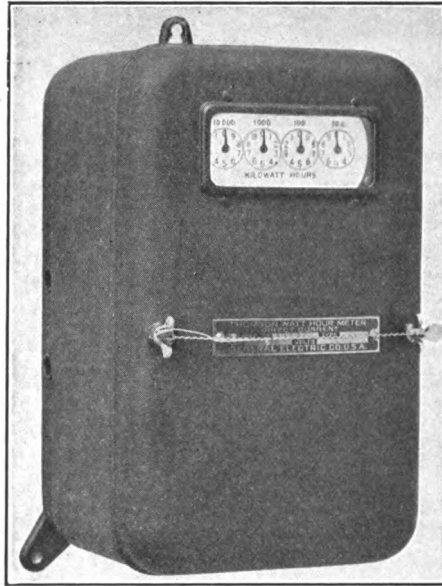

FIG. 257.—Direct-current wattmeter.

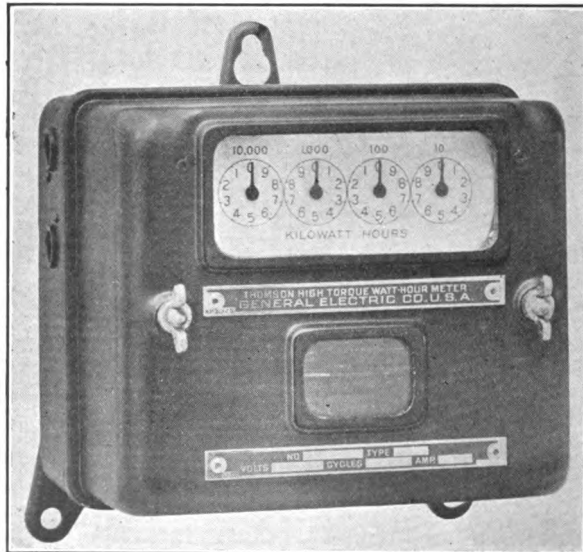

FIG. 258.—Alternating-current wattmeter.

wires from being traversed by currents above their safe carrying capacities.

Fuses are made of an alloy of lead and zinc. For temporary connections fuse wire is used. A better method is to solder the



FIG. 259.—Fuse.

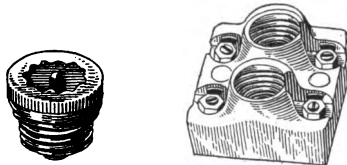

FIG. 260.—Edison plug cutout and fuse.

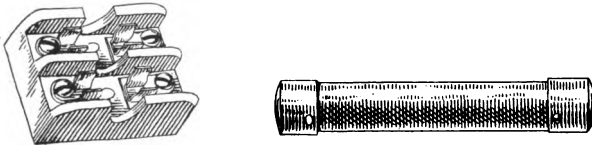

FIG. 261.—Enclosed-type fuse and fuse-block.

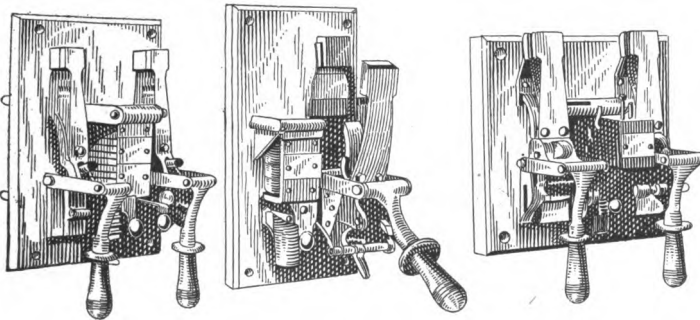

FIG. 262.—Circuit breakers.

wire to copper terminals as shown in Fig. 259. The Edison plug cutout and fuse, illustrated in Fig. 260, is very convenient. Another form, the inclosed type of fuse, is shown in Fig. 261.

Due to the uncertainty and unreliability of fuses, circuit-

breakers are employed for the protection of lines carrying heavy currents.

Several forms of circuit-breakers are illustrated in Fig. 262. A circuit-breaker is a switch which opens automatically where the current passing through it is greater than that for which it is set. Circuit-breakers are made to open either one or both sides of the circuit and are named accordingly single-pole and double-pole circuit-breakers respectively.

Switches and Rheostats.—The functions of a switch and rheostat in an electrical circuit are analogous to that of a valve in a

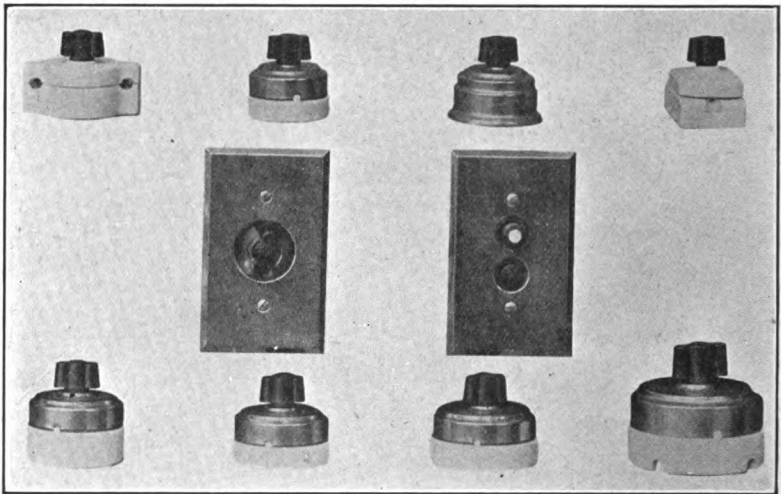

FIG. 263.—Switches.

steam or water line. The switch opens or closes the circuit while the rheostat regulates the strength of the current passing.

For controlling the flow of small currents in connection with the illumination of rooms, some form of snap switch or push-button switch is employed. These switches can be made to control the current from two, three, or four different places. A special form of push-button or snap switch, called the electrolier switch, can be used for turning on part or all of the lamps on an electric-light chandelier. Thus in the case of a four-light chandelier, this type of switch can be wired so that the burning of one, two, three, or all of the lamps can be controlled from the wall of the

room. Several forms of snap and push-button switches are illustrated in Fig. 263.

For currents above 25 amp. a knife switch should be employed. This type of switch has a contact-making piece of a shape somewhat like a knife. A single-pole knife switch opens

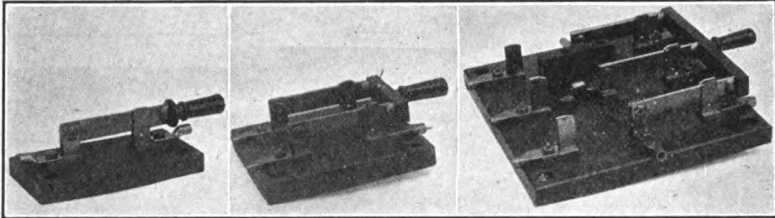

FIG. 264.—Knife switches.

only one side of a circuit, a double-pole two sides, etc. Double-throw switches are used when one of two circuits has to be controlled at a time. Several forms of knife switches are illustrated in Fig. 264.

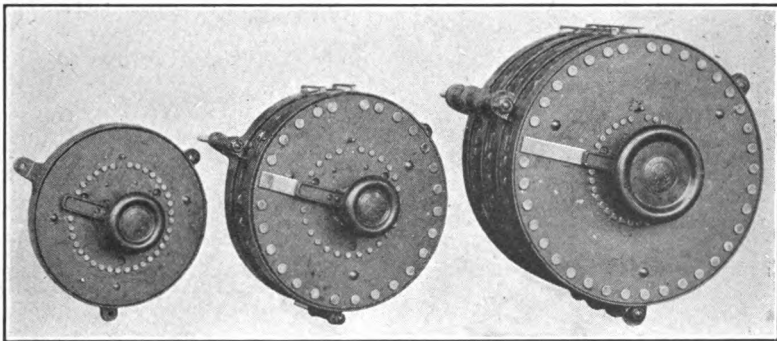

FIG. 265.—Rheostats.

A rheostat for controlling the strength of electric current is illustrated in Fig. 265. The fundamental parts of a rheostat are: coils of iron wire to absorb electric current, metallic points connecting the various coils to the outside, and an arm which is moved over the various points.

Method of Connecting Motors.—The method of connecting a shunt motor and its starting box to the circuit is illustrated in Fig. 266. *A* and *B* are the two leads which bring the current from the mains (connected to a generator) through the fuses *P*, *R* and to the switch *S*. One terminal of the switch *L* is connected to the field *F* and to the armature *G* of the motor. The other

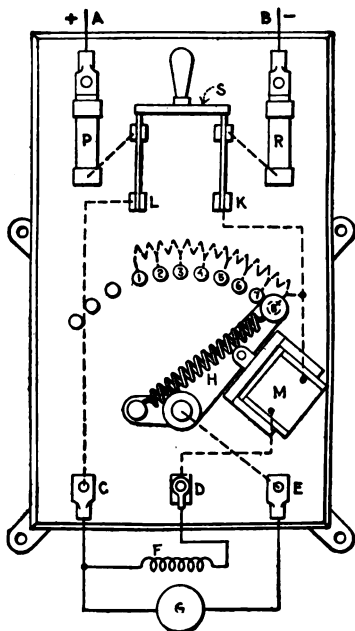

FIG. 266.—Method of connecting motors.

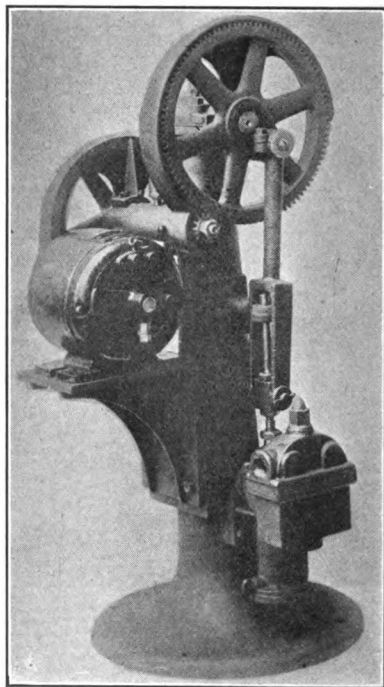

FIG. 267.—Motor-driven pump.

terminal *K* leads to the starting box. The handle *H* of the starting box is connected with the terminal *E*, which is attached to the armature of the motor. The other terminal *D* of the starting box is connected with the field of the motor *F*.

When the motor is to be started, the switch *S* is closed and the handle *H* is on the contact point 1. The handle *H* is then moved slowly to the right. When the handle *H* is on the last contact point, it is held in position by the magnet *M*. To stop

the motor, the switch *S* is opened. The magnet *M*, losing its magnetism, allows a spring to bring back the arm *H* to the starting point.

The Electric Motor on the Farm.—The electric motor is well-suited for most farm work which is accomplished by the small

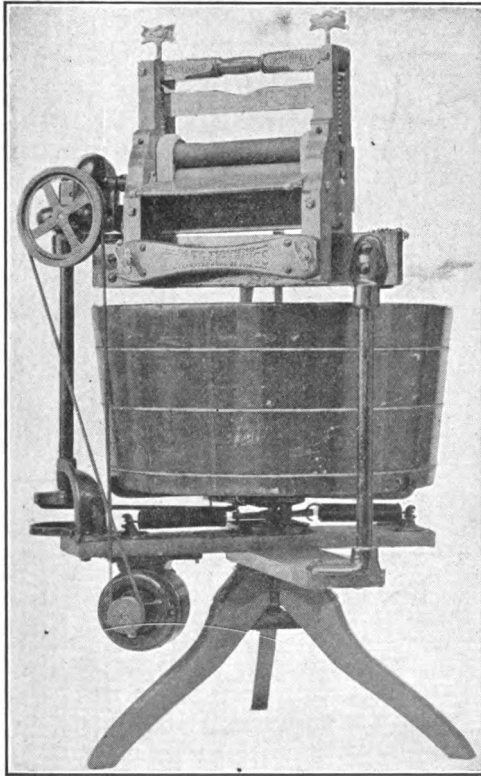

FIG. 268.—Motor-driven washing machine.

stationary gasoline engine. It is not as portable in any but the very small sizes, but possesses other advantages for certain uses. A small electric motor requires no special foundation and may be placed on the floor, on a truck, or may be fastened to the wall or ceiling, is easily started and requires less care than the gasoline engine. The cleanliness of the electric motor and

the absence of offensive fumes make it more desirable for use in the house, the dairy and the barn.

Some of the uses of the electric motor in the home are illustrated in Figs. 267 to 269. The house pump driven by a motor of $\frac{1}{6}$ hp. is shown in Fig. 267. Another electric motor of $\frac{1}{10}$ hp. drives a washing machine illustrated in Fig. 268. Still a smaller

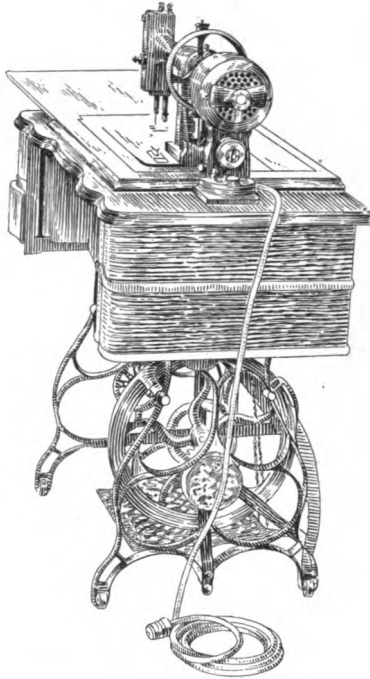

FIG. 269.—Motor-driven sewing machine.

motor is shown connected to a sewing machine in Fig. 269. Other uses to which the electric motor can be put in the farm household may be mentioned: the driving of fans during hot weather, of vacuum cleaners, of ice-cream freezers, of cream separators, of churns, of milking machines and of grindstones. An electric motor can also be used for the shelling and grinding of feed and for the many operations in the farm shop.

For outdoor use and for the heavier farming operations the electric motor is not as suitable as the gasoline engine.

The Farm Electric-light Plant.—For farms of the average size, which do not have the advantages of cheap power from a nearby transmission system, private electric-lighting plants driven by gasoline engines are becoming quite common.

When an electric-light plant is to supply current for lighting only, the complete installation, including the wiring of an average eight-room house and barn, will vary from \$350 to \$750. If the

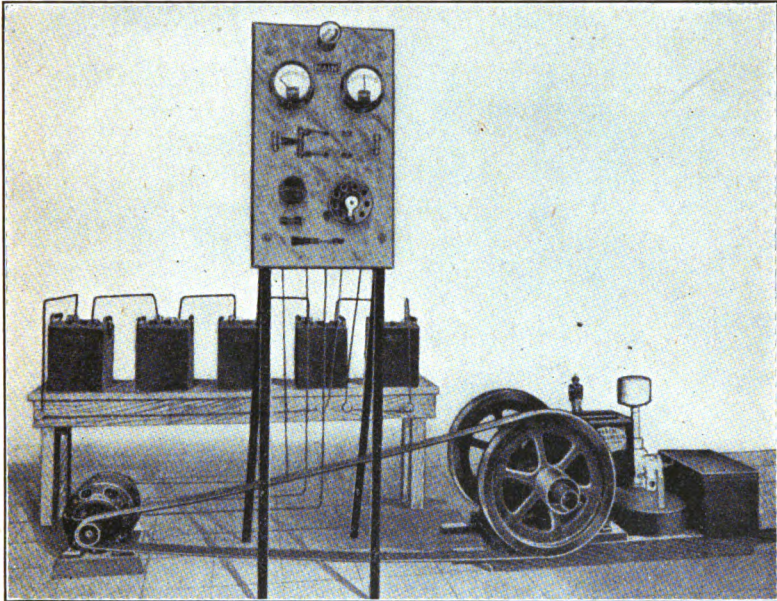

FIG. 270.—Farm electric-light plant.

plant is to supply current for motors as well as for lights the first cost will be from \$1,200 up, depending on the size of motors used. The cost of operating a plant for lighting only will usually be about \$15 a year. The cost of operating plants which supply electricity for power will depend on the size of motors and on the amount of work done.

The essential parts of a private electric-light plant are:

1. A gasoline engine and an electric generator.
2. A set of storage batteries for storing the electricity to be used when wanted and which supplies a steady light whether the engine is running or not.

3. A switchboard with an ammeter, a voltmeter, fuses and switches to control the operation of the dynamo and of the storage battery.

4. Wires from the switchboard to the house, barn and other places where electricity is to be used.

5. Wiring of the house, barn, etc.

In Fig. 270 is illustrated a farm electric-light plant.

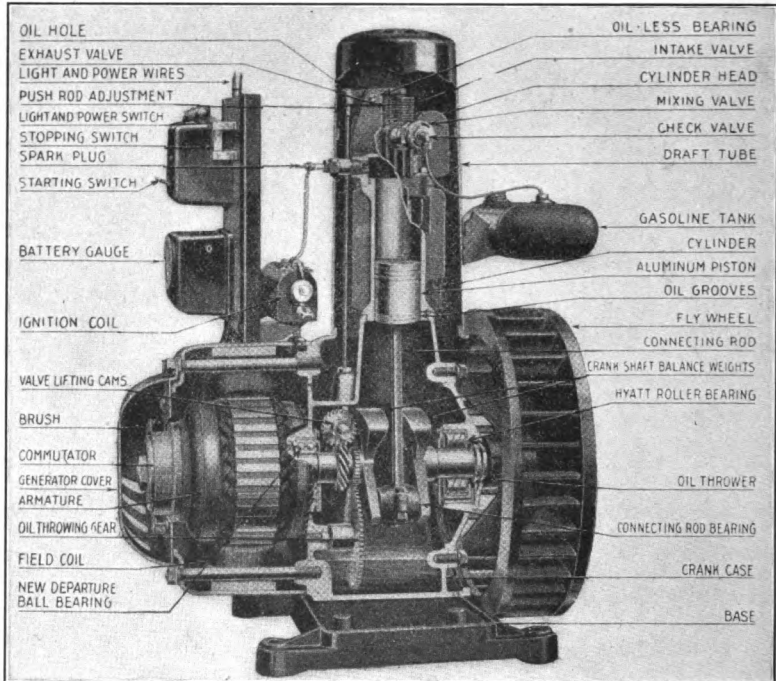

FIG. 271.—Engine and generator for farm electric-light plant.

The use of the private electric-light plant for farms of average size was out of the question until quite recently on account of the great cost of the storage battery. With the ordinary carbon lamps operating at 110 volts, about 60 storage cells were required to maintain the correct voltage when the engine was not running. The development of the tungsten lamp, which operates satisfactory at about 30 volts, necessitates the use of a battery of only 17 cells, and has the added advantage of greater safety from

short-circuits. Then the tungsten lamp consumes only about one-third of the electric energy required by the carbon lamp of the same candlepower.

Installation of Electric Motors and Generators.—A dry, cool and clean place, free from dust, should be chosen for the location of an electric machine. If the surrounding air is warm, the temperature of the various parts is likely to rise to a sufficient degree to endanger armature, or field, or both.

If a motor has to be located in a dusty place, or in connection

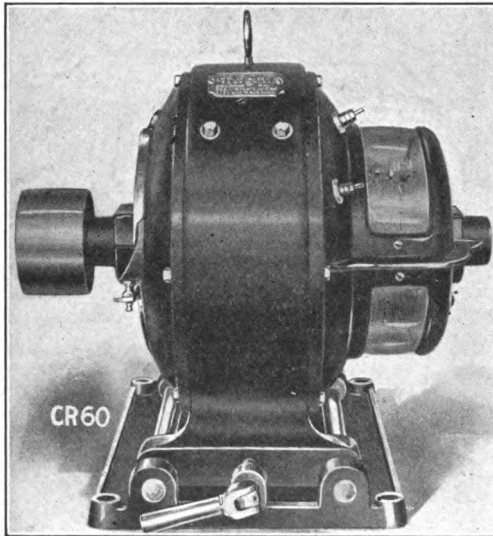

FIG. 272.—Enclosed-type motor.

with farming operations where particles of feed or trash may lodge on the motor, an inclosed type like the one shown in Fig. 272 should be selected.

In locating motors or generators care should be taken to provide easy access to all parts. Also sufficient distance must be allowed between the pulley centers of the driver and driven.

A substantial foundation of timber, brick, or concrete should be provided for all motors and dynamos above 25 hp. Small machines can be fastened to the floor and require no special foundation.

If an electric machine has been exposed to changes of climate,

it should be kept in a warm, dry place for several days, as the insulation always absorbs dampness which can be only slowly dried out.

Small machines usually are shipped complete and ready to run. Large motors and generators usually are shipped in boxes, "knocked down," as this reduces freight charges.

In assembling parts, all connections and parts should be wiped perfectly clean and free from grit. The bearing sleeves and oil rings should be placed in position on the shaft before the armature is lowered in place.

The bearings should be filled with a good grade of thin lubricating oil, care being taken not to fill the oil cellars so they will overflow.

In clamping the brushes in place, they should be adjusted so that the pressure on the commutator is about $1\frac{1}{2}$ lb.

The brushes are fitted to the commutator by passing beneath them No. 0 sandpaper, the rough side against the brush and the smooth side held down closely against the surface of the commutator. The sandpaper should be moved in the direction of rotation of the armature, and on drawing it back for the next cut, the brush should be raised so as to free it from the sandpaper. It is then lowered and repeated until a perfect fit is obtained between the brush and commutator.

Starting and Stopping Motors.—Before starting a machine for the first time, care must be taken that all set screws and nuts are tight and that the oiling system works properly. The armature is then turned by hand to see that it is free and does not rub or bind at any point. The wiring should be carefully gone over and all terminals screwed down tightly. When everything is in good condition, the switch is closed, but before doing this one must make certain that the starting-box handle is in the "off" position. After the switch is closed, the handle on the rheostat is moved, gradually cutting out the resistance as the motor speeds up.

It is well to run a new motor for a time before putting on the load.

In stopping a motor, pull the switch and the handle of the starting rheostat should fly back to the "off" position.

Starting and Stopping Generators.—The general rules in regard to starting an electric machine are alike for the generator and

motor. When the generator is ready to be started, place the driving belt on the pulley of the armature shaft and start the engine driving the generator, bringing the machine up to speed very slowly.

Generators usually are tested before they leave the factory. As a rule, generators will retain sufficient magnetism in their fields so they can be started. Sometimes a generator loses its field magnetism on the way from the factory to its destination. The fields can be magnetized by current from a battery or from another dynamo.

If a generator is supplying incandescent lamps, the main switch should not be closed until the machine is developing the correct voltage.

In stopping a generator, the load is first removed and the engine driving the generator is then stopped in the usual manner.

Care of Motors and Generators.—It is very important to keep electric machines clean and all insulation free from dust and gritty substances.

The commutator should be kept clean and allowed to assume a glaze while running. Oil should not be used on commutators, as it chars under the brushes, forming a film between commutator bars which may cause a short-circuit.

The commutator brushes should be kept in good shape. They should be removed frequently for inspection and cleaning, and if necessary should be filed. To remove grease or dirt the brushes should be soaked in gasoline.

If the brushes are not properly trimmed or are in poor condition the commutator will present a bright coppery appearance and will be found rough when felt by hand. If in very poor condition, the commutator may have to be turned down.

Sparking at commutators usually will occur if brushes are improperly set, commutator is rough, machine is overloaded, short-circuited or grounded.

Heating of armatures may be caused by the short-circuiting of some of the armature coils or by too great a load. A short-circuited armature coil usually can be detected by its high temperature. If a greater part of the coils are short-circuited the determination becomes more difficult and sensitive instruments have to be used.

A hot bearing also will cause the heating of the armature, and this usually can be detected and remedied.

Problems: Chapter X

1. What is meant by the following electrical terms: voltage, amperes, kilowatts, electrical horsepower, ohms?
2. Calculate the current consumed by a 25-watt tungsten-filament lamp, which is operated on a 110-volt circuit.
3. State and explain the application of Ohm's law.
4. How does the current consumed by the tungsten-filament lamp compare with that consumed by the carbon-filament lamp of the same candlepower?
5. Explain the Brown and Sharpe wire gage and calculate the size of rubber-covered wire required to carry a current of 10 amp. Neglect transmission losses.
6. Calculate the power of a gasoline engine required to drive an electrical generator of 3 kw. capacity.
7. Calculate the horsepower of a gasoline engine required to supply twelve 40-watt tungsten-filament lamps and four 16-cp. carbon-filament lamps. Allow 25 per cent. for losses.
8. If an arc lamp consumes 5 amp. at 110 volts, calculate its resistance.
9. What is a primary battery? a storage battery?
10. Explain the composition of the dry cell. In which respects does the construction of the dry battery differ from the ordinary wet battery?
11. What are the fundamental parts of a lead storage battery?
12. Give directions for testing a storage battery.
13. How distinguish the positive and negative plates of a lead storage battery?
14. How are storage batteries rated?
15. In which respects does the Edison battery differ from the lead storage battery?
16. What is the voltage of a storage battery of 32 Edison cells connected in series? How much greater would the voltage of this battery be if made up of lead cells?
17. How should a battery of six dry cells be connected to give the greatest voltage? Calculate the approximate voltage of the battery.
18. How should storage batteries be connected to give the greatest voltage and as much current as possible? Illustrate by sketch.
19. When should the multiple system of battery connection be used?
20. The reading of an ammeter connected in series with a coil is 18 amp. If the voltage between the terminals is 7 volts, calculate resistance of coil.
21. Calculate the current which will flow through a resistance of 440 ohms, the voltage between terminals being 110.
22. Can alternating current be measured by direct-current instruments? Give reasons for your answer.

23. Give clear abstract of *Bulletin* No. 1 of the Kansas State Agricultural College Engineering Experiment Station and of *Bulletin* No. 25 of the Iowa State College Engineering Experiment Station. These bulletins deal with illumination for farm homes.

24. Give directions for installing electric motors.

25. Give directions for starting a shunt-wound direct-current motor.

CHAPTER XI

ANIMAL MOTORS

Animals used in the United States as farm motors include mainly horses, mules, and oxen. Sheep, dogs, goats, camels, water-buffalos, elephants, reindeers, and caribous are used to a limited extent in other countries. The power developed by horses and mules on American farms exceeds that generated by all other forms of farm motors, animal as well as mechanical.

The Horse.—Of all animal motors the horse is the most important for farm use. The horse is intelligent, willing, a fast walker as compared with other draft animals, and self-reproducing. Large-sized hoofs make it possible for horses to be used on comparatively soft ground.

Selection of a Draft Horse.—Dr. H. J. Waters, in his book, "The Essentials of Agriculture,"¹ gives the following rules for judging draft horses:

"Size and weight are determining factors in the classification of draft horses. To belong to this class a horse should weigh 1,600 lb. or more and should be at least 15.2 hands high. Value increases with size, other things being equal.

"The draft horse should be deep, wide, and compact of body, and should carry his weight uniformly. The top line should be strong and short, while the under line should be long and straight. Quality is an essential of good service. It is indicated by fine hair; clean, strong joints clean, flat legs; and tough, firm feet. The head should be clearly defined and bony in appearance, with good width of forehead.

"The head should be proportionate to the body, neither too large nor too small, with clean muzzle, medium ear, bright eye, broad forehead, and a clean throatlatch. A thick throatlatch usually indicates 'poor wind.' The neck should be of medium length, with a slight crest, and should be well-muscled. The shoulders should be long and sloping, in order to give breaking surface for the collar and to lessen the concussion of hard streets. Good muscular development of arm and forearm is essential. The withers should be of medium height. A back with close coupling and with a long, heavy-muscled croup is a

¹ H. J. WATERS, "The Essentials of Agriculture," Ginn & Co., 1915.

conformation representing the greatest strength. Long, well-sprung ribs with a deep and well-filled rear flank make room for a well-developed digestive apparatus and strong vital organs. Muscular development of the hind quarters is essential. The draft horse should stand squarely on its legs. The legs should be clean, with bone of good size and with strong joints. The pasterns should be sloping, and the hocks should be large and of regular shape.

“Constitution is indicated by a deep, broad chest, together with a well-sprung rib, a deep body, bright eyes, and great energy.

“The action of draft horses is important. The stride at the walk and trot should be long, straight, and regular. Correct conformation gives elasticity to the walk and the trot in all horses. Reasonable grace and style of carriage are demanded.”

When pulling a heavy load there is a tendency for the horse to lift his front feet off the ground. This tendency decreases as the weight of the horse increases. The distribution of weight is also an important consideration.

The hock muscles should receive careful attention, as such muscles, when deficient in strength, limit the ability of a horse to pull a load. The wider the hock, the more leverage the muscle will have.

The other essentials for a draft horse are broad muscular breast, heavy muscles of arm and forearm, large well-supported knees, short cannons, strong fetlocks and pasterns, and large, sound feet.

Capacity and Power of Draft Animals.—The average draft horse can exert from day to day a pull from one-eighth to one-tenth of his weight for about 10 hr. a day, if walking at the normal rate of about $2\frac{1}{2}$ miles per hour. The skeleton and muscular development of the horse is such that he is adapted to pulling loads. A horse is capable of pulling a load several times his own weight, while his carrying capacity is only a fraction of the weight of his body.

A draft horse weighing 1,600 lb., when pulling a load one-tenth of his weight at the rate of 2 miles per hour, will develop:

$$\text{Horsepower} = \frac{\text{Draft} \times \text{distance traveled per minute}}{33,000}$$

In the case of the above problem, the draft of the horse is $\left(\frac{1,600}{10}\right) = 160$ lb., the distance traveled is 2 miles per hour or

$(2 \times 5,280) = 10,560$ ft. per hour, or $\left(\frac{10,560}{60}\right) = 176$ ft. per minute. The horsepower developed = $\frac{160 \text{ lb.} \times 176 \text{ ft. per minute}}{33,000} = 0.853$.

The weight of the ordinary draft horse usually is less than 1,600 lb. and the average power developed by a draft horse when worked at normal rate is about $\frac{3}{4}$ hp. Horses can develop power much in excess of the normal amount for short periods of time. Tests have demonstrated that for very short periods of time a good draft horse can develop as much as 4 or 5 hp. This ability of the horse to stand overloads may be advantageous in emergencies, but must not be taken advantage of too frequently.

Power being the rate of doing work, an increase in the speed of a horse should be accompanied by a reduction in the load to be carried by the animal. On the other hand, if the working day is reduced from 10 to 4 or 5 hr., the load may be increased. Thus the capacity for tractive effort decreases as the speed and the time increase.

The power developed by a horse when trotting or galloping is decreased by the fact that the heart action is greatly increased and heat is lost by the evaporation of water through the skin and lungs, thus leaving only a small portion of the energy in the fuel available for work; much energy is used up non-productively also in the horse's raising his own body in galloping.

It is not advisable to work horses of unequal size and weight together. Horses should be chosen similar in temperament, type, and weight.

It is not desirable to have horses work too close together or under conditions which may result in the draft animal fretting. Fretting uses up energy which should be made available for useful work.

Hip straps, if too short, will reduce the capacity of a horse for work, as the animal with short hip straps carries part of the load.

Other factors which influence the power developed by draft animals are the grip on the surface of the road and the angle of trace. The angle of trace is the angle between the tugs and the surface of the ground. This angle should be considered with reference to the comfort of the horse and the least draft.

Selection of Feed for the Horse.—The selection of proper feed is as important to the successful maintenance and use of a horse as is the securing of proper fuel and of good lubricating oil for operating a steam traction engine or an oil engine.

The feed supplied to the animal must contain sufficient nutritive material for building up the bodies of young animals, as in growth and for repairing the tissues of the bodies of animals of all ages which are constantly being worn out by work or other exercise. The feed must also, in addition to accomplishing these purposes, be capable of developing energy necessary for carrying on the complex processes within the animal body, as well as the energy for performing external work as a motor. The horse is fed properly, if constant body weight is maintained while doing normal work. Loss in weight means insufficient or improperly selected food or overwork, while a gain in weight indicates unnecessary expenditure of food, unless it be to overcome the effect of temporary overwork. In general, stationary body weight is a safe guide in the feeding of work horses, but in practice it frequently happens that horses are worked so hard for short periods, as during plowing and seeding season, or harvest season, that it is not possible to supply enough nutrients during such period to maintain a constant body weight, or to prevent the horse from losing weight. Such a period usually is followed by one of comparative idleness, as in the winter, when the horse is fed liberally enough to store fat on its body to be used as a source of energy during the rush season that is to follow.

Fat is the most concentrated form of animal food known and contains about $2\frac{1}{4}$ times as much energy per unit of weight as the starches and sugars.

When feed is abundantly nutritious, animals store up fat with which to protect themselves against the cold, or to supply the energy to enable them to travel to new sources of nourishment when the old supply fails, or to new sources of water.

The feed supplied for building up and for repairing the body and tissue must contain certain nutrients. These nutrients are protein, mineral matter, carbohydrates, and water.

Protein is the term supplied to a group of organic substances of which casein of milk, white of egg, and the gluten of wheat are

examples. The protein forms the basis of the living tissues, is a source of growth of animals, and is the material used principally in repairing the waste of the body. Protein may be also the source of energy, but there are many cheaper and more efficient sources of energy, and protein is too costly to be used principally for this purpose. There is, however, no substitute for protein as a source of growth, or as a means of repairing the worn body tissues.

Mineral matter, or ash, is the inorganic material present in different feeding stuffs. The mineral matter in the food supplies material principally for the formation of the skeleton, hoof, and horn, but is necessary also for the production of soft tissues. Most feeds contain plenty of mineral matter to satisfy all the requirements of work animals.

The carbohydrates are the principal source of energy and are chiefly used in building up the body and fat, which is simply stored energy. Familiar forms of carbohydrates are the sugars, starches, oils and fats, and woody fibers.

The animal body requires protein, mineral matter, and carbohydrates in definite proportions, depending upon the kind of animal, its age, and what the animal is doing. A young, active colt, for example, requires a more generous supply of all of these materials in proportion to its body weight than a mature horse. That is ideal, because the colt is growing rapidly and requires for the support of this process much protein and mineral matter. It is also active and requires considerable fuel, or carbohydrates, to supply the energy expended. A horse that is hard at work will require more food and a greater proportion of protein and mineral matter than will one that is idle, because there is greater expenditure of energy, and because activity causes a greater wear upon the body tissue.¹

The Mule.—The mule is tougher and hardier than the horse, is less subject to disease or inflammation from slight injuries, may be handled by less intelligent farm labor, and is better able to take care of itself than is the horse.

The mule is used very largely as a work animal in the Southern States.

The Ox.—The ox has much endurance and is not excitable,

¹ The composition of various feeds can be found in *Farmer's Bulletin* No. 170 of the United States Department of Agriculture.

but is slow and unintelligent, and has little spirit. Oxen are seldom used at the present time, but their use is increasing in some regions, because of the steadily increasing cost of horses.

Cost of Animal Power.—The cost of maintaining a horse, when there are taken into consideration feed, labor in caring, depreciation of horse, depreciation of harness, shoeing, shelter and interest on the investment, varies from \$100 to \$150 per year.

The cost of feed per horsepower per hour with animal motors has been estimated at about 6 cts. The total cost of power, with animal power, per horsepower per hour when considering the total cost of maintaining the animal has been estimated at about 12 cts.

Problems: Chapter XI

1. What animal motors are used in the United States?
2. How does the power developed by animal motors compare with that developed by all other forms of motors on American farms? (See *Transactions American Society of Agricultural Engineers*, vol. ix.)
3. Give directions for determining the suitability of a draft horse for work as a farm motor.
4. Make a study of the distribution in the weight of a draft horse and report how this will affect his ability to pull a load.
5. What is the normal capacity of a draft horse and what is his maximum pulling capacity?
6. A draft horse weighing 1,600 lb. will develop how much power when pulling 160 lb. and at the rate of $2\frac{1}{2}$ miles per hour?
7. A farm horse weighing 1,200 lb. pulls a load of 120 lb. at the rate of 2 miles per hour. How much power will this horse develop?
8. What is the relation between the capacity for tractive effort and the speed at which a horse is travelling?
9. Report in detail how the angle of trace affects the capacity of a draft animal.
10. What determines the proper feed for draft animals?
11. Give rations for a draft horse.
12. Compare the horse and the mule as draft animals.

CHAPTER XII

MECHANICAL TRANSMISSION OF POWER

While the transmission of power by electric means is advancing rapidly, it is probable that for some time to come power from one machine to another will be transmitted by mechanical means.

Mechanical transmission of power between different machines may be accomplished by means of:

1. Belts.
2. Chains.
3. Ropes and cables.
4. Friction gearing.
5. Toothed gearing.
6. Shafting.

To the above list should be added cams, eccentrics, connecting rods, cranks and levers as means for transmitting power to the various parts of the same machine.

Belts.—One of the most common methods of transmitting power is by means of leather, rubber, canvas, or composition belting. On account of slipping, the transmission of power with belts is not positive as is the case with gears.

The simplest arrangement is to have the belt connect two pulleys, one of which is the driver and the other is the driven. The belt may be open or crossed. In the first case the two pulleys turn in the same direction. Connecting two pulleys with a crossed belt reverses the direction of the driven.

The power transmitted by a belt depends upon the adhesion between the belt and the pulley. For indoor work and under reasonably dry conditions, leather has proved to be the most satisfactory and reliable material for belts. It is, however, the most expensive and its use cannot be recommended for outside work in inclement weather.

Leather Belts.—Leather belts are made up of short strips of oak-tanned leather, each strip varying from 44 to 60 in. in length. Before being tanned for belting purposes the head, neck, belly and tail portions of the hide are trimmed off. The remain-

der of the hide is divided into three portions from which the different grades of belting are secured. The best grade of belting comes from the center piece of the hide, after a strip is cut off crosswise from the shoulders. The second grade comes from the flanks, and the poorest grade from the shoulders.

Leather belting is made of single thickness, and is designated as single-ply, or single-belt. Double-ply belting is made by connecting the flesh sides of two thicknesses of leather.

The cost of double belting is just twice that of single belting, but it has been found that it will transmit twice as much power and will last more than twice as long as single belting. Owing to the greater stiffness of double belting it will not conform to the surface of the pulley as readily as a single belt, and its use is limited by the size of the pulley. Double belts generally are not used on pulleys less than 10 in.

Rubber Belts.—These consist of one or more layers of cotton duck alternating with layers of vulcanized rubber. The adhesion of rubber belts is somewhat better than that of leather belts. Rubber belts also will stand heat, cold and moisture better than leather belts. The life of a rubber belt is much shorter than that of a leather belt and the coating of rubber is easily ruined by the application of oil.

Canvas Belts.—Canvas belts are lighter than rubber belts. They are well-adapted for saw mills or for farm machinery where the belt is exposed to the weather. Canvas belts stretch and contract with temperature changes and are not durable. Painting improves canvas belts.

Care of Belts.—Leather belts must be kept clean and free from dust, dirt and oil. Dampness will loosen the cement which is used in building up the belt. Some manufacturers have now a process of waterproofing leather belts, but this has not been extensively tried out.

Most preparations called "belt dressing" contain rosin and are injurious to leather. If it is necessary to soften a leather belt, neat's-foot oil, tallow, or castor oil should be used.

The hair side of a leather belt should be run next to the pulley, as this is the weaker side, and being smoother than the flesh side will adhere much better to the pulley.

If possible, machinery should be so placed that the direction

of the belt motion is from the top of the driving to the top of the driven pulley, when the sag will increase the arc of contact.

Rubber belts should run with the seam side out, and not next to the pulley. All animal greases and oils should be kept away from rubber belts: Boiled linseed oil may be applied, but this should be done sparingly.

Belts will hold better when the pulleys are at long distances apart. Two pulleys connected by a belt should be spaced far enough apart so as to allow of a gentle sag to the slack side of the belt when in motion. This distance will be 10 to 15 ft. for narrow belts and small pulleys. In the case of wide belts working on large pulleys the distance between driver and driven

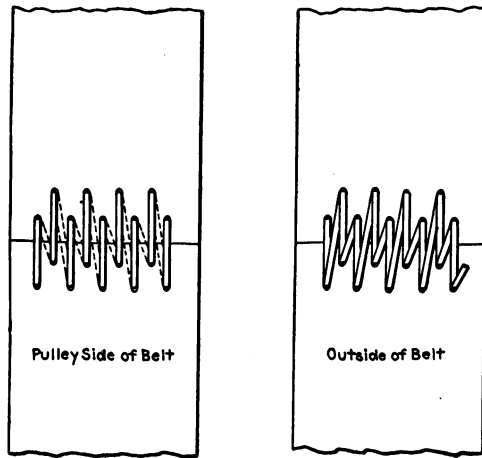

FIG. 273.—Belt lacing.

should be at least 20 ft. If too great a distance is used, the extra cost of the belt will be wasted and the extra weight of the belt will produce unsteady motion and great friction in the bearings.

Method of Lacing Belts.—The strength of the belt depends not only on the quality of the material from which it is made, but also on the method used in connecting the ends. The ideal joint is a cement joint. Such a joint should be made only after the ends of a belt have been stretched in position over pulleys.

Lacing made of rawhide is most commonly used. Metallic wire lacing also will give good results if the lace wire is hammered

below the surface of the leather so as to prevent excessive wear on the lace, and if care is taken not to have two wires cross each other on the pulley side of the belt. Wire lacing makes a less clumsy joint and does not decrease the strength of the belt on account of large holes as does rawhide lacing.

To cement a belt, a lap joint generally equal to the width of the belt is made by beveling the two ends, applying glue and then clamping the two ends together in the required position.

Before a belt is laced the two ends should be made absolutely square, otherwise the belt will tend to run off the pulleys. One method of lacing a belt is illustrated in Fig. 273.

Other methods of connecting the ends of a belt are by means of belt fasteners, rivets, staples and sewing. These methods are not recommended, as they will pull out in time and leave the belt ends ragged.

Pulleys.—Pulleys are made of iron, pressed steel, wood and paper. Pulleys are either solid (Fig. 274) or split (Fig. 275). Large pulleys are usually of the split type.

Pulleys designed to transmit power by belts usually are crowned; that is, the rim is rounded, so that the diameter is greater at the middle. When crowned pulleys are used, the belt will remain at the center of the pulley and will not run off. The width of the acting surface or face of a pulley always should be greater than that of the belt.

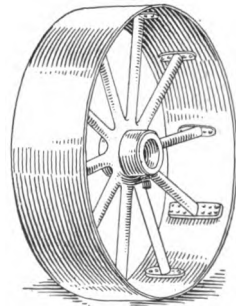

FIG. 274.—Solid pulley.

In order to be able to start and to stop the driven pulley without interfering with the driver, a combination of tight and loose pulleys is often used. In this case one pulley is fastened to the shaft and transmits motion, while the other is loose on the shaft. The driving shaft carries a pulley which has a width equal to that of the tight and the loose pulleys put together. The belt when in motion can be shifted so that it will run over the tight or over the loose pulley, thus throwing machinery into or out of gear. Where tight and loose pulleys are employed, or in any case where the belt may be shifted, the pulleys are straight; that is, are built without crowning, in order that the belt may be moved easily from one pulley to the other.

The average leather belt will not transmit its maximum force on account of slipping on the pulleys. The adhesion between the belt and the pulley can be increased by covering the pulley

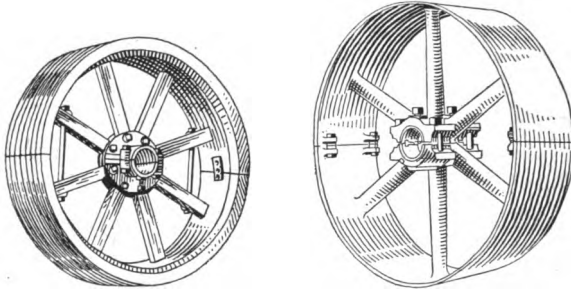

FIG. 275.—Split pulley.

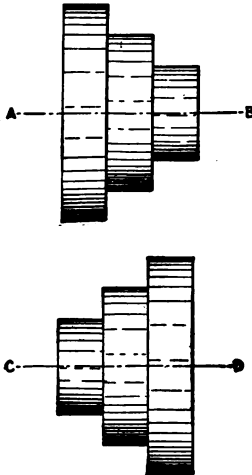

FIG. 276.—Stepped pulleys.

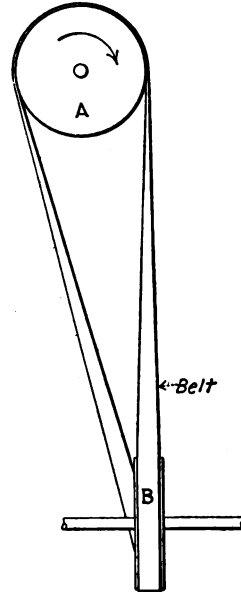

FIG. 277.—Quarter-turn belt.

with leather. This method of increasing the power transmitted should be used only in emergencies. A well-designed drive with the belts and the pulleys of proper size to transmit the desired power should not require pulley covering.

Small pulleys are secured to the shaft by means of setscrews. Large pulleys are fastened to the shaft by keys, or sometimes by both keys and set screws.

Stepped pulleys (Fig. 276) have several faces of different diameters on both the drivers *AB* and driven *CD*, for varying the speed of a shaft by means of a shifting belt.

Method of Calculating Sizes of Pulleys.—If there is no slip in the belt, the speeds of two pulleys connected by a belt will vary inversely as the diameters of the pulleys.

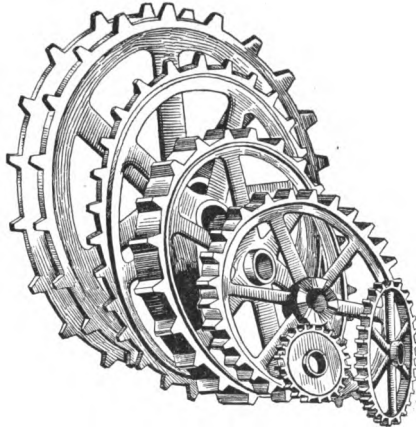

FIG. 278.—Sprocket wheels.

Calling *D* the diameter of the driver, *d* the diameter of the driven, *N* the revolutions of the driver, and *n* the revolutions of the driven, the following equation holds:

$$DN = dn$$

(The product of the diameter of the driver and its revolutions must be equal to the product of the diameter of the driven and its revolutions.)

As an illustration: A gasoline engine running at 300 r.p.m. has a belt pulley 20 in. in diameter. Calculate the size of the driven pulley if it is to run at 600 r.p.m.

From the above equation

$$d = \frac{20 \times 300}{600} = 10 \text{ in.}$$

The above rule applies equally well to gears, only the number of teeth in the gears is used instead of the diameters of the gears. For example, if the driving gear running at 100 r.p.m. has 80 teeth, the driven must have 40 teeth if it is to run at 200 r.p.m. and 160 teeth if it is to run half as fast as the driver.

Quarter-turn Belt.—Sometimes it becomes necessary to drive by means of a belt two pulleys which are at or nearly at right angles with each other. If this must be accomplished without the use of guide pulleys, as shown in Fig. 277, certain conditions are essential. If *A* is the driver, the follower *B* must be so placed, that the belt leaving the face of pulley *A* will lead to the center of the face of pulley *B* (Fig. 277). This means that the belt must be

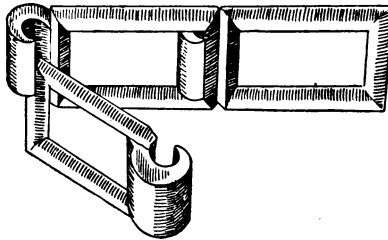

FIG. 279.—Links for chain drive.

delivered from each pulley in the plane of the pulley toward which it is running. If the direction of motion of the driver is reversed, the belt will be thrown from the pulleys.

Chain Drives.—Chains made of metal are used to some extent for transmitting power. The chains run on sprocket wheels, which are provided with suitable projections (Fig. 278).

Chain drives are more positive than belt drives and will operate in damp places. The disadvantages of chain drives are that they stretch, are noisy and are expensive to keep in repair. Fig. 279 illustrates links for a chain drive, used in connection with motors.

Chains for automobiles usually are supplied with rollers to reduce friction.

Rope Transmission.—Rope drives offer the following advantages for power transmission:

1. Power may be transmitted to much greater distances than is possible with belts.

2. Driver and driven can be very close together.
3. Power can be transmitted more readily to different floors of a building. This is advantageous in flour or cement mills.

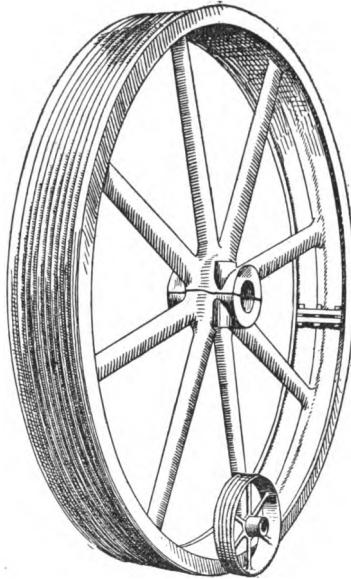

FIG. 280.—Pulley for rope drive.

4. Shafts of driver and driven can be at any angle with each other.
5. Drive is noiseless.

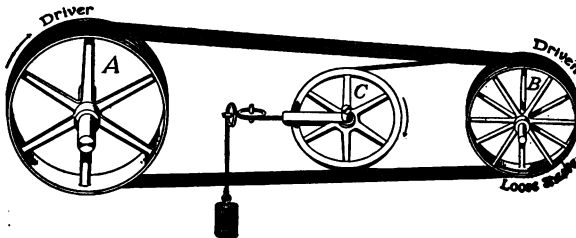

FIG. 281.—Rope drive.

6. Loss by slipping is very small.
- Hemp and cotton ropes are commonly used, these ropes running on cast-iron pulleys (Fig. 280) which are provided with grooves

upon their faces to keep the ropes in place. Wire ropes are used for the transmission of large power over great distances, and in connection with hoists, elevators, inclined railways and dredging machinery.

In the United States the continuous system (Fig. 281) is most commonly used. In this case ropes are wound over the driving pulley *A* and driven pulley *B* several times. The traveling tension carriage *C* keeps the ropes on the pulleys at the proper tension. This system is especially well-adapted for vertical and angle drives.

Another method is to run independent ropes side by side in grooves of pulleys (Fig. 282). This system is called the multi-

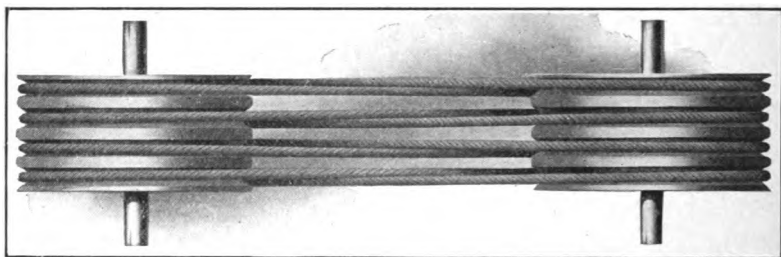

FIG. 282.—Rope drive.

ple system and is used to some extent for transmitting large powers, where the shafts are very nearly parallel. The continuous system (Fig. 281) has a much wider range of application than the multiple system.

Friction Gearing.—In the case of friction gearing the driver and driven are without teeth and pressed together, no belts or chains being used, and the power transmitted is due to the friction between the surfaces of the two wheels. In order to reduce the slipping to a minimum and to prevent the pressure between the two wheels from being too great, one or both of the gears are made of some slightly yielding material like wood, leather, or paper, as shown in Figs. 283 and 284. If only one of the gears is made of wood or paper and the other of iron, the gear with the softer material must be the driver.

Friction gears are made as spur gears (Fig. 283) if the axes

to be connected are parallel. Bevel friction gears (Fig. 284) are used for connecting axes at right angles to each other.

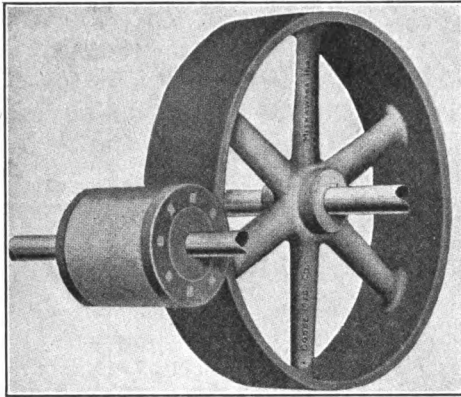

FIG. 283.—Friction gears.

Another form of friction gears consists of grooves cut in the circumference of two wheels, the projections of one gear being forced into the grooves of the other.

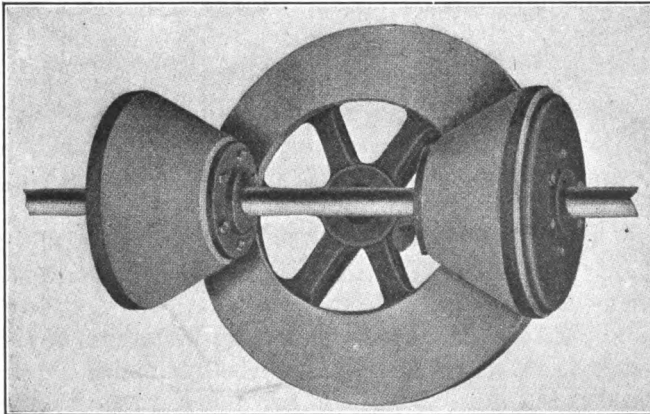

FIG. 284.—Friction gears.

The disc and roller constitute another form of friction gearing. If the disc revolves at a uniform speed, the speed of the roller can be increased by moving it away from the center and decreased

by moving the roller toward the center of the disc. If the roller is moved past the center, its motion is reversed.

The friction drive as applied to automobiles (Fig. 140) works on the principle of the disc and roller. A flat-faced disc *A* is attached to the crankshaft of the motor. The other part consists of a wheel *B* keyed to a shaft *S* parallel to the disc but free to move on the shaft. Speed changes and reversing can be accomplished by shifting the wheel on the face of the disc.

The objections to friction gears are:

1. The drive is not positive, as there always must be some slipping.
2. The transmission of power by friction gears produces excessive pressures on bearings.

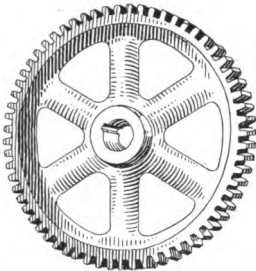

FIG. 285.—Spur gear.

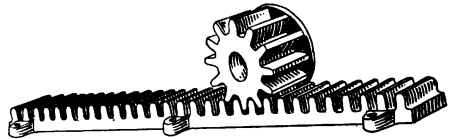

FIG. 286.—Rack and pinion.

Friction gears are used where the power to be transmitted is not very great and where changes of speed have to be made while the machinery is in motion, as is often the case with certain machine tools.

Toothed Gearing.—This form of power transmission is employed when a positive speed ratio is desired between the driver and the driven.

The projections of one gear which mesh with those of another are called teeth. The term “cogs” is sometimes applied to teeth inserted in the wheel of another material than that of the body of the gear.

Gears usually are made of cast iron. For rough work the gears are cast, while for accurate work cut gears, made in a special machine tool, are used. Noiseless gears are made of rawhide, compressed between brass or iron plates. Sometimes one of the

gears is provided with removable wooden teeth to decrease noise. Rawhide gears must not be used in places where they may get wet and must not be lubricated. For most farm machinery cast-iron gears are used.

Spur gears (Fig. 285) are used for transmitting power between parallel shafts. A combination of a gear meshing with teeth

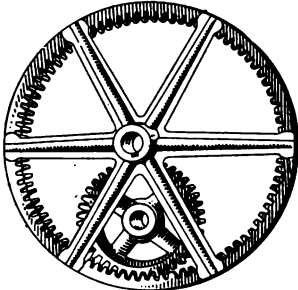

FIG. 287.—Annular gear.

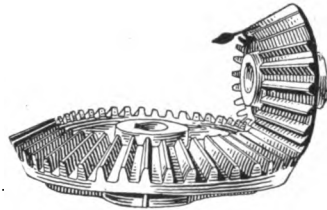

FIG. 288.—Bevel gears.

cut on a straight rectangular piece (Fig. 286) is called a rack and pinion. An annular gear (Fig. 287) is a wheel with teeth cut on the inside.

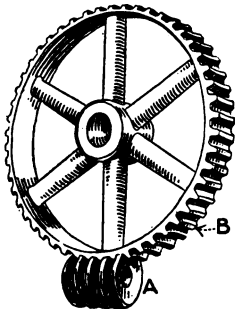

FIG. 289.—Worm and wheel.



FIG. 290.—Shaft collar.

Bevel gears (Fig. 288) are used for connecting two axes which intersect.

In the worm and wheel (Fig. 289) the screw-like action of the worm *A* revolves the wheel *B*. The worm and wheel is used for making fine adjustments on instruments. It is also employed in connection with hoisting machinery, as by the proper propor-

tioning of the screw great weights can be lifted on a drum connected on the same shaft with the wormwheel. The worm and wheel is also found on the steering mechanism of traction engines, as illustrated in Chapter VII.

Shafting.—Shafting is either employed directly for transmitting power or is used in connection with pulleys and gears.

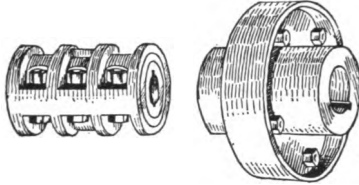

FIG. 291.—Shaft coupling.



FIG. 292.—Clutch coupling.

Shafting is made of wrought iron or of steel. The better the material in the shafting, the more power it will be able to transmit. Also, the greater the speed at which the shaft is run, the more power will it transmit. The torsional strength of a shaft,

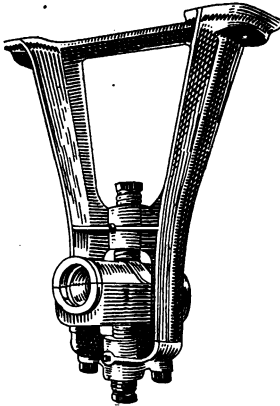

FIG. 293.—Shaft hanger.

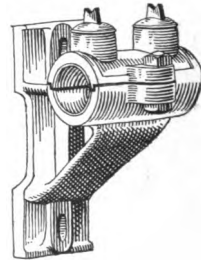

FIG. 294.—Bracket.

or the resistance which it offers to breaking by twisting, is proportional to the cube of its diameter.

To prevent a shaft from moving endwise, a collar (Fig. 290) is fastened to the shaft by means of setscrews.

To fasten two lengths of a shaft end to end, a coupling (Fig.

291) is used. To be able to fasten or separate two lengths of shafting while they are revolving, a clutch coupling (Fig. 292) or a friction clutch, illustrated in another part of the book, should be used.

The standard sizes of shafting are given in odd sixteenths of an inch, and advance by eighths. They can be obtained from $\frac{3}{16}$ in. up to $5\frac{1}{2}$ in. cold-rolled. Shafts above $5\frac{1}{2}$ in. usually are turned.

Shafting is suspended from hangers (Fig. 293) placed on beams, floors, or ceilings. A bracket (Fig. 294) is used for suspending shafting from walls. Hangers and brackets are provided with bearings in which the shafting revolves. The collar (Fig. 290) should be placed on the shaft against the bearing. A sufficient

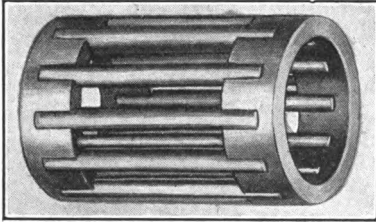

FIG. 295.—Roller bearing.

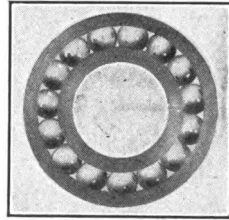

FIG. 296.—Ball bearing.

number of hangers or brackets should be used to prevent the shaft from bending.

The bearings used to carry shafting may be plain bearings, as illustrated in connection with the various types of motors. To reduce the frictional resistance of a plain bearing, a roller bearing or a ball bearing is used. In the roller bearing (Fig. 295) the shaft rolls on hardened steel rollers, while in the ball bearing (Fig. 296) the shaft revolves on balls placed in suitably designed grooves. Both roller and ball bearings are expensive and difficult to keep in good order.

In general, the work which can be accomplished by any motor depends not only on the quality of the motor, but also on the system used for transmitting the power of the motor to the machines where power is utilized.

Problems: Chapter XII

1. What are the different methods of transmitting power?
2. Discuss the advantages of leather, rubber and canvas belting.
3. What determines the spacing of pulleys which are connected by belts?
4. Explain the different methods used for lacing belts.
5. Why are pulleys crowned if they are to be used for transmitting power by belts?
6. An electric motor which runs at a speed of 1,200 revolutions per minute is to be used for driving a line shaft at 200 revolutions per minute. If the motor has a 7-in. pulley, calculate the size of the pulley on the line shaft.
7. A gasoline engine which operates at a speed of 350 revolutions per minute is to drive the following machines: a hay press, an ensilage cutter and a corn sheller. Find the best speeds at which these machines should operate and specify the sizes of pulleys on the line shaft and on the machines to be driven, if the gasoline engine has a 15-in. pulley.
8. Give clear sketch showing how the pulleys should be placed for a quarter-turn belt.
9. What are the advantages of rope drives, of chain drives?
10. Discuss the advantages and the disadvantages of friction gearing.
11. Explain the differences, using clear sketches, between an annular gear, a bevel gear, a spur-gear rack, a worm and wheel.
12. (a) Explain the functions of the following when used in connection with shafting: collar, coupling, hanger.
(b) Discuss the advantages and the disadvantages of roller and ball bearings.

INDEX

A

- Action of electricity, 236
- Air required for combustion, 20
- Alcohol denatured, 76.
 - fuel, 75-76
- Alternating current, 249-250
 - magneto, 98-100
- Altitude and barometric pressure, 7
- American windmill, 221-222.
- Ammeter, 256
- Ampere, 236
- Angle valve, 30
- Animal motors, 3, 4, 272
 - power, cost of, 277
- Anthracite coal, 19
- Armature, 251
- Atwater-Kent system, 151-152
- Automatic governors for steam engines, 52
- Automobile accessories, 160
 - axles, 142-143
 - carburetors, 148-149
 - chassis, 123-124
 - control system, 146
 - ignition, 149-154
 - lighting, 160
 - lubrication, 154-155
 - motors, 124-132
 - parts, 123
 - radiator, 128
 - starters, 155-160
 - steering systems, 143-146
 - tires, 147-148
 - transmission, 123, 134-139
- Automobiles, types compared, 122
 - wheels, 147
- Auxiliary carburetor air valve, 84
- Auxiliary exhaust port, 187

B

- Back-firing, 78
- Balanced valve, 48
- Ball bearing, 291
- Barometric pressure, 7
- Batteries, 239-248
- Baumé scale, 74-75
- Belt lacings, 280
- Belts, 278-281
- Bevel gear differential, 140-141
 - gears, 289
- Bituminous coal, 19
- Boiler, 22
 - classification of, 23
 - cleaning, 40
 - feed pump, 22
 - fire-tube, 23
 - management of, 39
 - operation, 40
 - rating, 39
 - setting, 22
 - traction engine types, 169-170

- Brake horse-power, 10
- Brakes, 146-147.
- Breeching, 21
- British thermal unit, 12
- Buckeymobile, 58-59

C

- Calculation of horse-power, 8
- Canvas belts, 279
- Capacity of storage battery, 242-243
- Carburetors, 78-87
 - automobile types, 148
 - auxiliary air valve, 83
 - concentric float-feed type, 82-83
 - function of, 78
 - jacketed types, 85

- Carburetors, kerosene, 86
 multiple jet, 85
 pump-feed type, 80-81
 traction engine types, 188-190
- Care of belts, 279
 electric generators, 269
 motors, 269
 gas engines, 119
 steam engines, 62-64
 traction engines, 203-208
 windmills, 233
- Caterpillar traction engine, 194-196
- Chain drives, 284
- Charging storage batteries, 243
- Chassis, 123-124
- Chimney draft, 37
- Chimneys, 21, 37-38
- Circuit breakers, 259-260
- Classification of gas engines, 66
 generators and motors, 252
- Clutches, 132-134, 176-177
- Coal, 19
- Coke, 20
- Combustion, 20
- Commercial value of fuels, 21
- Comparison of various motors, 3
- Compound steam engines, 50, 171
 wound generators, 254
 motors, 255
- Compression pressures for alcohol, 76
- Cone clutch, 133
- Connecting electric motors, method
 of, 262-263
- Cooling of automobile motors, 128-
 129
 gas engines, 87-91
 traction engines, 184-185
- Cost of animal power, 277
 farm electric light plants, 265
 power, 4
 traction engine power, 202
 engines, 181
 windmill power, 234
- Creeping-grip tractor, 194-196
- Crude petroleum distillates, 72-75
- Current required to operate lamps,
 238
- D
- Delco system, 151-154, 159
- Diesel cycle, 66
 engine, 103
- Differential, 123
- Differentials for automobiles, 139-
 141
 traction engines, 177-180
- Direct current magneto, 97
 currents, 249
- Dome for boiler, 23
- Distribution of electricity, 255
- Draft horse, 272-273
- Drawbar horse-power, 10
- Dry battery, 241-242
- Dual ignition system, 149
- Dutch windmill, 221
- E
- Eccentric, 43
- Economy of traction engines, 202
- Edison storage battery, 245-247
- Efficiency of engines, 66
- Eight-cylinder automobile motor,
 127
- Electric automobiles, 122
 condenser, 95
 conductors, 238
 distribution, 255
 generator, 248
 ignition system, 91-97
 light plants for farms, 265-267
 meters, 256
- Electricity, action of, 236
- Ell-head motor, 131-132
- En-bloc motor, 127-128
- Energy, 7
- Erecting windmills, 230-233.
- Expanding clutch, 133
- F
- Farm electric light plant, 265-267
- Feed for horses, 275-276
 pump, 32-34

Feed-water heaters, 36, 171, 174
 Firing methods, 38
 Flash point of gasoline, 73
 kerosene, 73
 Float-feed carburetor, 82-85
 Floats for carburetors, 85
 Force, 6
 Forced circulation cooling system,
 129
 Four-stroke cycle, 67
 Friction clutch, 123
 drive, 137-139
 gearing, 286-288
 Front automobile axles, 142
 Fuels, 19-21
 for gas engines, 71-76
 Furnace, 21
 Fuses, 257-259

G

Gage cocks, 31
 Gases, 6
 Gas engine, 65
 cooling system, 87-91
 cycle, 66
 fuels, 71-76
 horizontal and vertical, 78-
 79
 ignition system, 91-97
 indicator cards, 68
 lubrication, 104-106
 fuel mixture, 65, 78
 parts, 76-78
 selection, 111-113
 producers, 65, 72
 traction engine ignition, 190
 motor, 182-184
 engines, 180
 Gasoline, 72-74
 automobile, 122-165
 engine uses, 107-111
 feed systems, 148
 fires, 73
 storage, 73
 Gate valve, 29
 Globe valve, 29

Governing of gas engines, 106-108
 steam engines, 51-53
 windmills, 225
 Grades of coal, 19
 Grates for boiler furnaces, 26
 Gravity feed system, 148
 Grease cups, 55

H

Hammer-break igniter, 93
 Hangers, 291
 Heat, 11
 engines, 2
 of combustion of fuels, 21
 unit, 12
 Heavy oil engines, 103
 High-tension distributor, 150-151
 magneto, 100-101
 Hit-or-miss governor, 106
 Hitch for traction engines, 208
 Hopper-cooled engine, 79, 87
 Horizontal gas engine, 78
 Horse, 272
 Horse-power, 8
 Hot air engine, 2
 tube ignition, 91
 Hydraulic ram, 218-219
 Hydrometer, 73, 75, 244

I

Ignition, 149-154
 dynamos, 97
 systems, 91-97, 190-191
 timing, 115
 Illuminating gas, 72
 Impulse water motors, 214-216
 Incandescent lamps, 238
 Indicator for steam engines, 8-9
 Indicated horse-power, 8
 Inductance coil, 92, 95-96
 Induction coil, 95-96
 Injectors, 35
 Installation of electric machinery,
 267
 gas engines, 113

- Installation of steam engines, 60
 windmills, 230
 Internal combustion engine, 65
 efficiency, 66
 Interrupter, 102
- J
- Jacket water temperature, 88, 120
 Jump-spark ignition, 94-97
- K
- Kerosene, 73, 75
 carburetor, 86, 189
 engine, 75
 Kilowatt, 237
- L
- Lacing belts, 280-281
 Lead storage battery, 243-245
 Leather belts, 278
 Lever safety valve, 30
 Lignite fuel, 19
 Liquids, 6
 Locomobile, 58
 Losses in steam engines, 49
 Low-tension magneto, 97-100
 Lubrication for automobiles, 154-
 155
 gas engines, 104-106
 steam engines, 55
 traction engines, 203-204
- M
- Magneto alternating current, 98-100
 direct current, 97
 high tension, 100-101
 ignition, 149
 oscillating type, 99-100
 Magnetos, 97-101
 Make-and-break ignition system,
 92-94
 Management of automobiles, 160-
 165
- Management of boilers, 39-40
 electric motors, 268-269
 traction engines, 203-208
 Master-vibrator system, 149-151
 Matter, 6
 Mechanical automobile starters, 159
 equivalent of heat, 12
 Mixer valves, 80-82
 Motion, 6
 Motor cycles, 163, 166
 definition of, 1
 Motor-en-bloc, 127-128
 Motors for automobiles, 124-128
 gas traction engines, 182-188
 steam traction engines, 171-
 175
 Mule, 276
 Multiple disc clutch, 133
 Multiple-jet carburetors, 85
- N
- Natural gas, 20, 72
 Non-freezing mixtures, 91
- O
- Ohm's law, 237
 Oil cooling, 90
 cups, 55
 Oil engine efficiency, 66
 engines, 103-104
 Operating gas engines, 114-119
 traction engines, 203-208
 Oscillating magneto, 99-100
 Otto cycle, 66
 Ox, 276
- P
- Parts of gas engines, 76-78
 of gasoline automobile, 123
 generators and motors, 250-251
 traction engines, 168-169
 windmills, 222
 Peat, 20
 Pelton water wheel, 214-215

Petroleum fuels, 20
 Pipe fittings, 27
 grades, 27
 sizes, 27
 Piping for boilers, 26
 Piston valve, 47
 Plain slide valve, 44, 47
 Planetary transmission, 136-137
 Pop safety valve, 30
 Poppett valve, 129-130
 Power, 7
 cost, 4
 of horses, 273-274
 of streams, 211-213
 of traction engines, 188
 of windmills, 234
 on farms, 4
 transmission, 278
 Pressure, 6
 Pressure-feed system, 148
 Primary battery, 240-242
 Priming of carburetor, 85
 Producer gas, 72
 Prony brake, 10
 Progressive transmission, 134-135
 Propeller shaft, 142
 Properties of steam, 18
 Pulleys, 281
 Pump-feed carburetor, 80-82
 Pumps for traction engines, 170-173

Q

Quarter-turn belt, 284

R

Radiators, 128, 185
 Ram, hydraulic, 218-219
 Rating of boilers, 39
 of traction engines, 202-203
 Rear automobile axle, 143
 Repairing traction engines, 207
 Return tubular boiler, 23
 Reversing mechanisms, 171-175
 Rheostats, 260

Roller bearings, 291
 Rope transmission, 284
 Rotary valve motor, 130
 Rubber belts, 279

S

Safety valves, 30, 40
 Selecting a gas engine, 111-113
 a horse, 272
 Selective transmission, 135-136
 Series-wound generators, 252-253
 motors, 252-253
 Setting engine on dead centre, 48
 Shafting, 290
 Shunt-wound generators, 252-253
 motors, 252-253
 Sight-feed automatic lubricator, 56
 Size of pulleys, 283
 of steam engine, 44
 Sleeve-valve motor, 130
 Solids, 6
 Sources of energy, 1
 Spark plug, 96
 Specific gravity, 13-14
 of alcohol, 76
 of electrolyte, 244-245
 of gasoline, 73
 of kerosene, 75
 of petroleum fuels, 74
 heat, 12-14
 Speed of traction engine motors, 188
 engines, 203
 Spur gears, 289
 Spur-gear differential, 141
 Starting electric motors, 268
 gas engines, 116-117
 systems for automobiles, 155-159
 traction engines, 205-206
 States of matter, 6
 Steam automobiles, 122
 chest, 43
 engine, action of, 2, 42
 care of, 62-64
 description, 42

- Steam engine details, 53
 governors, 51-53
 indicator, 8
 cards, 49
 installation, 60-61
 losses, 49
 size of, 44
 gages, 31
 generation theory, 16
 power plant, 21-23
 properties, 18
 separators, 57
 superheated, 17
 traction engine motor, 171-175
 traps, 32
 turbines, 59-60
 Steering column, 143-145
 of traction engines, 176
 Stepped pulleys, 283
 Storage batteries, 242-247
 Straw fuel, 169-171
 Superheated steam, 17
 Switches, 260-261
- T
- Tee-head motor, 132
 Temperature, 11
 Theory of steam generation, 16
 Thermometric scales, 11-12
 Thermo-syphon cooling system, 128
 Throttling gas-engine governor, 107
 Throttle control of automobiles,
 145-146
 Timers, 101-102
 Tires, 147-148
 Toothed gearing, 288-289
 Traction engine boilers, 169-170
 carburetors, 188-190
 development, 201-202
 differential, 177-180
 governors, 187-188
 hitch, 208
 parts, 168-169
 power plant, 168
 rating, 202-203
 reversing gears, 171-175
- Traction engine speeds, 203
 transmission, 168, 176-179, 191-
 194
 valve setting, 207-208
 wheels, 169
 Tractor cultivator, 200
 Transmission gears, 134-139, 191-194
 of power, 278
 Two-stroke cycle gas engines, 66,
 69, 71
 Types of traction, 194-196
 of windmills, 221
- U
- Universal joint, 141-142
 Uses of electric motors, 263-264
 gas engines, 108-111
 storage batteries, 242
 Users of traction engines, 196-201
 windmills, 234-235
- V
- Vacuum-feed system, 149
 Valve-in-the-head motor, 131-132
 Valve gear types for steam engines, 47
 setting, 48
 Valves, 28-30
 for automobile motors, 129-132
 Various motors compared, 3
 Vertical boilers, 25
 gas engines, 78-79
 Vibrator, 95
 Volt, 236
 Voltmeter, 256
- W
- Water column, 31
 motor, 211-215
 tube boiler, 26
 turbines, 216-218
 Watt, 236
 Wattmeter, 257-258
 Wet cells, 242
 Windmill brake, 226

Windmill gearing, 225-226
 governor, 225
 parts, 222
 power cost, 234
 rudder, 224
 towers, 226-230
 uses, 234

Wind wheel, 223
Wipe spark igniter, 93-94
Wiring of batteries, 247-248
 of electric meters, 257
Wood as fuel, 19
Work, 7
Worm and wheel, 289

