

·WELDING AND CUTTING METALS

BY AID OF
GASES OR ELECTRICITY.

BY

guelm

DR. L. A. GROTH

CONSULTING ENGINEER

*Royal Commissioner at the International Patent Congresses of Vienna, 1873,
and Paris, 1878; Vice-President of the International Permanent
Commission for the Protection of Industrial Property, Paris;
Knight of the Royal Swedish Order, Gustavus Vasa; etc.*



NEW YORK
D. VAN NOSTRAND COMPANY
23 MURRAY AND 27 WARREN STREETS

1909

TS227
G8

GENERAL

PREFACE

AN examination of the various methods existing for the production and liquefaction of combustible gases, of their easy application and economical advantages, and of the phenomenal advance during the last three years in their adaptation to an immense variety of metallurgical and engineering operations, which have hitherto been carried out under less favourable conditions, proves that compressed gases have become an indispensable factor in almost every branch of industry.

The small space available for this important subject will be limited to a description of welding and cutting metals by means of combustible gases as well as the application of electric welding.

Recent investigation, personally made by the author in various countries, has proved that welding is being used to a far greater extent than is generally known.

Welding is, however, associated with and dependent upon many different factors, all of which must be simultaneously considered to enable even the most skilful workman to produce satisfactory results.

A general description, therefore, of the various and distinct methods, their suitability and selection for different operations,

together with a collection of results and tests obtained, in many cases intuitively illustrated, will, it is hoped, assist in the advance in technical knowledge and lead to gradual accumulation of practical experience so necessary in every new industry.

There are, however, many important points open for investigation, amongst which may especially be mentioned the effects of the different gases and their mixtures, as well as of the extreme temperatures, and their physical, chemical, and biological action upon the metals.

It would also be of great importance to find some means whereby an inferior weld, sheltered under a smooth and perfect surface, obtained by the use of gases of inferior purity or by unskilled labour, could be detected so as to render that safety which, in some branches of the industry, is of vital importance.

By the introduction of liquefied and compressed gases a new industry of great importance and almost unlimited possibilities has been created. That which has already been done, although of great extent, constitutes, however, merely an indication of what really can be accomplished in this vast industrial field opened up for investigation and development, resulting, as it may, in the entire revolution of present working methods in engineering and metallurgy.

In conclusion the author gladly expresses his indebtedness to the *Editors of the Technical Press* at home and abroad, amongst which may specially be mentioned the *Electrical Times*, *Marine Engineer and Naval Architect*, and many others, as the *Royal Society of Arts*; *Institute of Marine Engineers*; *A.G.f. Aluminium Schweissung*; *British Oxygen Co., Ltd.*;

PREFACE

v

Electric Welding Co., Ltd.; *Garuti & Pompilj*; *Hugo Helberger, G.m.b.H.*; and *Stewarts and Lloyds, Ltd.*, who have contributed information and kindly allowed the use of illustrations.

The author also desires to acknowledge the courteous manner in which he was received by the *owners* and *chief engineers* of many of the *leading engineering works* at home, as well as in *Belgium, France, Italy, Austria, and Germany*, and their readiness to show and explain everything that was desired.

L. A. GROTH.

LONDON, 10, Grattan Road, West Kensington, 1908.

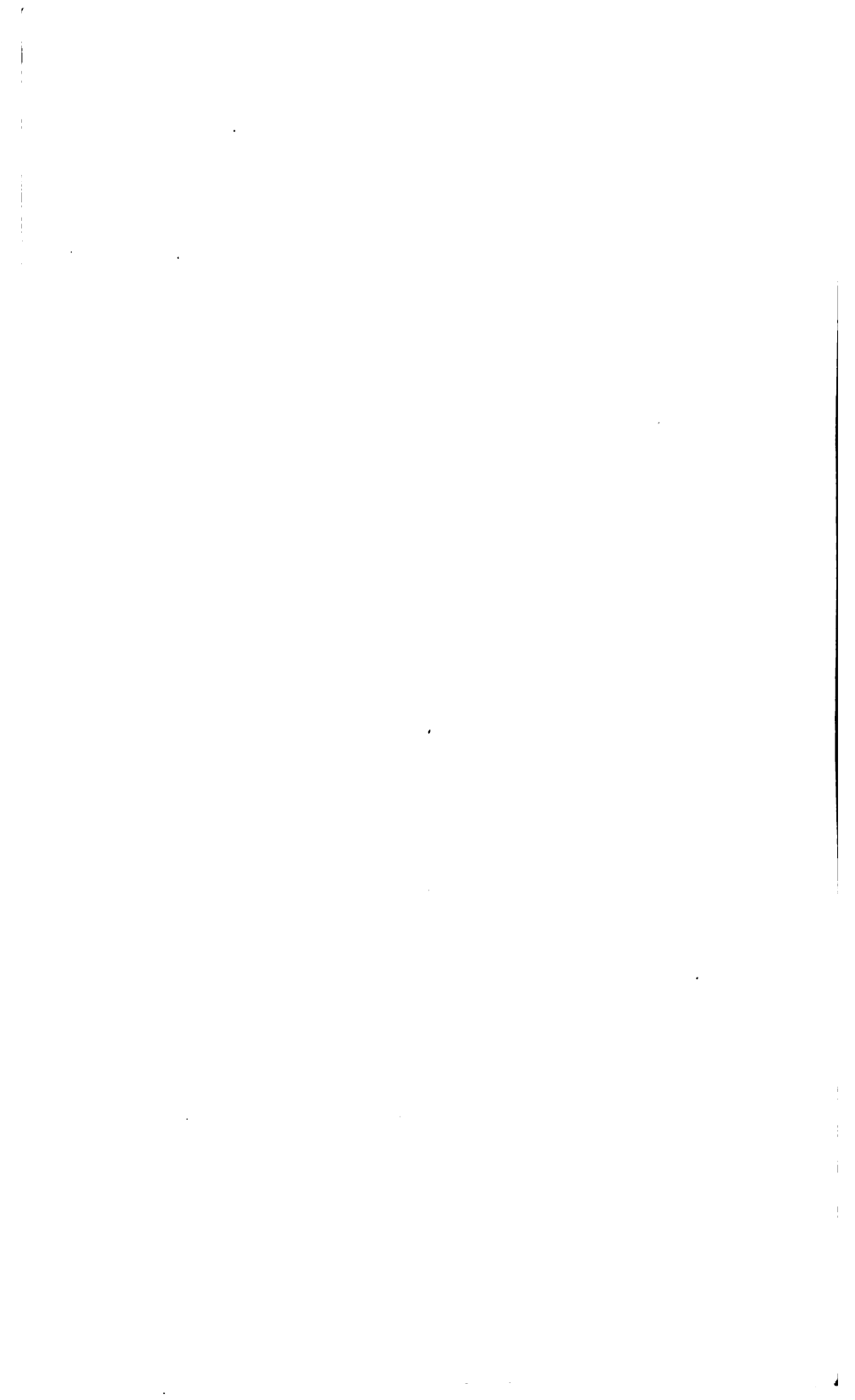

CONTENTS



PREFACE	PAGE iii
-------------------	-------------

CHAPTER I.

General Remarks	1
---------------------------	---

CHAPTER II.

GASES AND SOURCES FOR THEIR GENERATION.

Acetylene	9
Acetylene-Dissous	8
Aggregation	5
Atmospheric Air	6
Blau-gas	19
Brin's Process	25
Carbide of Calcium	7
Electrolysis of Water	25
Hydrogen	21
Liquefaction	5
Liquid Air	6
Oxygen	23
Water-gas	33

CHAPTER III.

WELDING.

Acetylene Welding	40
Aluminium Welding	61
Alumino-Thermic Process	67
Blau-gas Welding	82
Brazing	82
Chemical Welding	86
Coal-gas Welding	87

	PAGE
Description	35
Different Systems	39
Electric Welding	88
Forging	138
Hydrogen Welding	139
Insulators	57
Lead-burning	83
Soldering	82
Water-gas Welding	147

CHAPTER IV.

BLOWPIPES.

Acetylene Blowpipe	152
„ Illuminating Co., Ld.	153
Daniel's Burner	148
Draeger-Wiss Blowpipe	149
Fouché Blowpipe	156
General Remarks	148
High-pressure Blowpipe	153
Hydrogen Blowpipe	149
Jottrand and Lulli Blowpipe	149
Low-pressure Blowpipe	154
Oxy-Acetylene Blowpipe Plant	162
Oxy-Hydrogen Blowpipe Plant	149
Schuckert Blowpipe	149
Société L'Oxyhydrique Internationale	149

CHAPTER V.

WELDING OF SHEET IRON.

Articles of Complicated Form	174
Bending Tests	172
Durability of Welded Seams	168
Mains for Gas and Water	178
Methods Used	169
Patent Welded Tubes	168
Pioneer of Water-gas Welding	169
Relative Advantages of Cast-iron and Steel Pipes	182
„ Corrosion of Wrought Iron, Soft Steel, and Nickel Steel	188
„ Cost of Cast-iron, Steel, and Riveted Pipes	180
„ Strength of Cast-iron, Steel, and Riveted Pipes	171
„ „ Welded and Riveted Pipes	171

CONTENTS

ix

	PAGE
Schematic View of Welding by Coke Fire and Water-gas	170
Seamless Tubes	168
Steel Pipes	179
Stewarts and Lloyds, Limited	179
Testing Methods	172

CHAPTER VI.

WELDING APPLIED TO STEAM BOILERS.

Acetylene-Dissous Welding	197
Advantages of Welded Boiler Joints	193
Alumino-Thermic Process	80
Applications of Compressed Gases to Welding	221
Autogenous Welding	197
British Steam Users' Associations	221
Corrosion	198
Cost of Riveted Seams	225
Cracks	200
Defects of Welds	223
Difficulties of Riveted Joints	195
Disadvantages of Welded Boiler Joints	194
Electric Welding Process	212
General Remarks	192
German Steam Users' Associations	221
Hydrogen Welding	197
Institute of Marine Engineers: Paper read by Mr. Harry Ruck- Keene	201
Relative Cost of Riveting and Acetylene Welding	225
Repairs on Marine Boilers: Cracks, Internal Corrosion, Outside Corrosion	198
,, ,, Steam Boilers	195
Tests of Oxy-Acetylene Welding	211
Welding of Tanks	224
Welding <i>versus</i> Riveting	225

CHAPTER VII.

CUTTING METALS.

Armour Plates	232
Congress of Liège, 1901	229
Consumption of Gas and cost per metre of Cut Length	234
,, ,, Oxygen	233
General	229
Installation	229

	PAGE
Jottrand Blowpipe	229
Jottrand and Lulli Blowpipe	230
Metropolitan Railway, Paris	233
Oxy-Hydrogen Systems	232
Pressure of the Gases	231
Speed of Cutting	234

CHAPTER VIII.

REPORTS UPON ACETYLENE WELDING.

Bavarian Steam Users' Association	244
Belgian Steam Users' Association	248
British Institution of Marine Engineers	201
Chemical Fabrik Griesheim Elektron	243
Compagnie des Messageries Maritimes	247
French Steam Users' Association (Veritas)	247
German Steam Users' Association	245
Hartmann, C. L. J.	244
Hilpert, Dr.	236
Institute of Marine Engineers	201
International Association of Steam Users	248
Manchester Steam Users' Association	248
Michaelis, Dr. L.	240
Veritas	247

CHAPTER IX.

ACCIDENTS.

Acetylene Accidents in France	258
,, Explosive, Limit of	248
,, Generator, Explosion	255
,, Great Poison	258
,, Installations, Danger of	252
,, Regulation by the Prefect of Police, Paris	252
,, Rooms for Installations	257
Acetylene-Dissous, Explosion of Storage Vessel, Fatal Result	253
,, " " Fire at Works	253
Conseil d'Hygiène Publique: Regulations	252
Explosions of Acetylene Generator	255
,, " " Boiler Tubes, Fatal Result	254
,, " " Storage Vessel filled with Acetylene-Dissous, Fatal Result	253

CONTENTS

xi

	PAGE
Explosions of Acetylene-Dissous Works	253
Explosive Limit of Acetylene	252
,, ,, Coal-gas	252
,, ,, Hydrogen	252
,, ,, Water-gas	252
General	251
Prefect of Police, Paris, Regulations	252
Rooms for Acetylene Installations	257
Union des Propriétaires d'Appareils à Acétylène	258

CHAPTER X.

LEGISLATION RELATING TO CALCIUM CARBIDE AND ACETYLENE.

British Home Office Committee, 1901, dealing with Conditions for Acetylene Generators	260
English Acetylene Association Regulations	261
Exemption for certain Admixtures of Acetylene and Oil-gas	260
Order of Council, 1897, placing Acetylene-gas under the Explosives Acts	260
Order of Council, 1897, placing Carbide of Calcium under the Petroleum Acts	259

CHAPTER XI.

USEFUL ADDENDA.

Air, Weight and Volume of	266
British Thermal Unit	264
Centigrade, Conversion to Fahrenheit	266
Co-efficient of Heat	265
Combustible Gases, Consumption of	265
Combustion of Acetylene	262
,, ,, Carbon	262
,, ,, Coal-gas	262
,, ,, Hydrogen	262
Consumption of Combustible Gases	265
English and Metric Measures	266
Fahrenheit, Conversion to Centigrade	266
Metric and English Measures	266
Pressure	265
Temperature of Fusion	266
Weight and Volume of Air	266

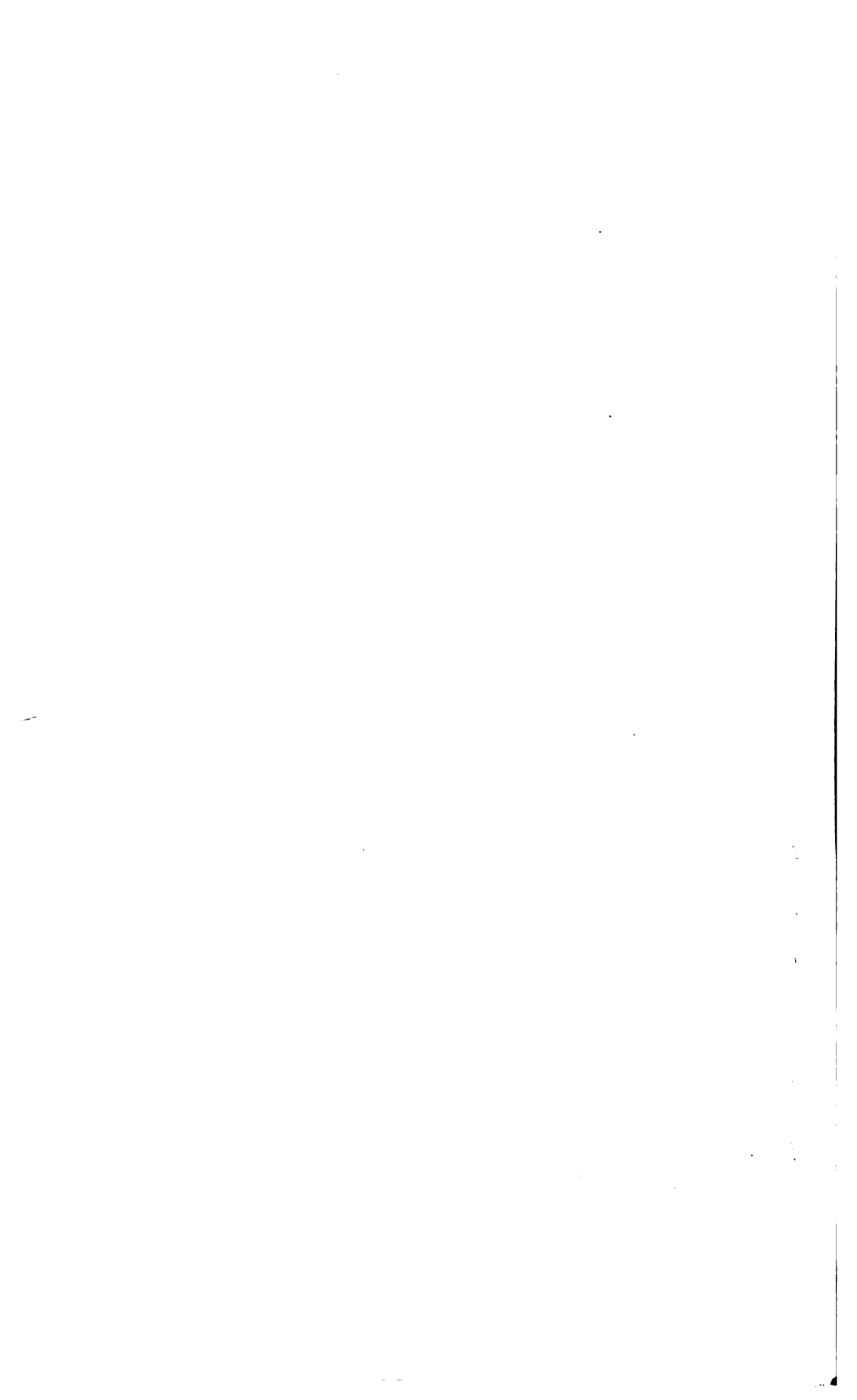

LIST OF ILLUSTRATIONS

FIG.	PAGE
1.	27
2.	27
3.	27
4.	29
5.	29
6. Schematic Illustration. Low Pressure Oxy-Acetylene Welding Plant	40
7. Draeger's Patent	42
8.	43
9.	43
10.	44
11.	44
12. Trolley Stand for Pair of Cylinders	45
13. Stretch Testing Apparatus for Cylinders	46
14. Connector between Regulator and two Cylinders	47
15. Draeger's High-Pressure Refill Pump	48
16.	62
17.	64
18.	64
19. Aluminium	65
20. Magnalium	66
21. Wolfram Aluminium	66
22. Complete Rail Welding Outfit	68
23. Mould, with Tools	69
24. Repair before Machining	79
25. Finished Repair	79
26. Cracks in Stern Frame opened up for Welding	80
27. Finished Weld	81
28.	83
29. Oxy-Coal Gas Blowpipe	85
30. Shoulder Taps	85
31. Endurance Regulator	86
32. Universal Machine for Welding or for Electrically Heating Pieces for Subsequent Working, with Swages, Hand- operated	94

FIG.		PAGE
33.	Universal Machine, Normal Pattern, without Swages	95
34.	Universal Machine, with Automatic Hammer and Adjustable Anvil for Hand and Mechanical Power	96
35.	Hand Chain Welding Machine, for Chains up to 6 mm. diameter	97
36.	Automatic Chain Welding Machine, for Small Chains	98
37.	Automatic Chain Welding Machine, for Large Chains	99
38.	Automatic Chain Welding Machine	100
39.	Ring and Buckle Welding Machine, for Ridgeless Welding in Swages, Machine-driven	101
40.	Buckle Welding Machine, with Transformer	102
41.	Special Machine for Welding Door-hinges, Hinge-hooks, Hinge-bands, etc., for Doors and Cupboards	104
42.	Machine for End to End Welding of Flat Hoops, Rings, and similar Articles	105
43.	Machine for Simultaneously Welding several Pins or Pieces of Metal to Discs or Rings of Metal (for use in Watch and Clock Making)	106
44.	Point Welding Machine	107
45.	Machine for Welding Pulley-spokes to Rim and Hub	108
46.	Hoop and Rim Welding Machine, specially suited for Welding Automobile and Cycle Rims	109
47.	115
48.	115
49.	116
50.	117
51.	117
52.	118
53.	120
54.	Pipe Coil for Refrigerating Machine, Electrically Welded by Thomson Process. Pipes Welded end to end by moving Welding Machine during Operation of Coiling	122
55.	Some Applications of Electric Welding (Thomson Process). Samples include Automobile Parts, Bicycle Parts, Steel Tubing welded Longitudinally, Stampings welded to Rods and Tubes, Channel Tyres, Baby Carriage Tyres, Cutlery, Cylinders, etc.	123
56.	Form of Special Facing for Electrically Welded Flanges: Plain Faced	125
57.	Single Spigot and Faucet	126
58.	Double Spigot and Faucet	126
59.	Facing Strips	126
60.	Branch and Boss on Centre Line of Pipe	129
61.	Branch on Centre Line of Pipe	129

LIST OF ILLUSTRATIONS

xv

FIG.		PAGE
62.	Branch off Centre Line of Pipe	129
63.	Drain Pocket	129
64.	Drain Pocket in Section	129
65.	Tee	130
66.	Bend	130
67.	Cross	130
68.	"Y" Piece	130
69.	Breeches Piece	130
70.	Elevation	132
71.	End View	132
72.	Double Bend	132
73.	Crank Bend	132
74.	"Horseshoe" Type	132
75.	Corner Expansion Bend	135
76.	"S" Expansion Bend	135
77 to 80.	Compound and Siding Expansive Joints, Electrically Welded	136
81.	Steam Dryer, Electrically Welded	137
82.	141
83.	149
84.	Acetylene Blowpipe, Draeger-Wiss, Model 1908	150
85.	Fouché Blowpipe	158
86.	Fouché Cyklop Blowpipe.	159
87.	Low-pressure Oxy-Acetylene Plant, without the Generator	162
88.	169
89.	169
90.	169
91.	170
92.	170
93.	Bending Tests of Welded Bootsdavits. The Imperial Arsenal, Dantzig	172
94.	Binding Tests of Welded Bootsdavits. The Imperial Arsenal, Dantzig	173
95.	174
96.	174
97.	175
98.	176
99.	Welded Water-mains in Hamburg. F. Fitzner, Laurahütte	177
100.	Galloway Boiler with Welded Longitudinal Seams, 96 q.m., 8 Atmospheres, 2,200 m.m. Diameter, 10,000 mm. long. F. Fitzner, Laurahütte	178
101.	Repairs by Oxy-Acetylene Process	202
102.	Repairs by Oxy-Acetylene Process	203
103.	Repairs by Oxy-Acetylene Process	204

FIG.		PAGE
104.	Repairs on Main Boilers by Electric Welding	205
105.	Repairs on Laminated Tube Plate by Electric Welding	206
106.	Repairs on Furnace and Combustion Chamber Plating by Electric Welding	207
107.	Repairs on Centre Furnace by Electric Welding	208
108.	Repairs of Cracks in Furnace by Electric Welding	208
109.	Repairs to a Furnace of a Boiler by Electric Welding	209
110.	Repairs to a Furnace and Way of an Adamson Ring by Electric Welding	210
111.	Repairs to Furnace and Combustion Chamber Plating by Electric Welding	211
112.	Repairs to Lower Front Plate by Electric Welding	213
113.	Repairs to the Bottom Shell Plate by Electric Welding	214
114.	Repairs to the Combustion Chamber Plating and Tube Plate of two Boilers by Electric Welding	216
115.	Repairs to Wasted Tube Plate of a Land Boiler by Electric Welding	217
116.	Repairs to the Wasted Seam of a Land Boiler by Electric Welding	218
117.	Repairs by Oxy-Acetylene Process	219
118.	Test Pieces from Oxy-Acetylene Welded Plates	220
119.	Repairs by Oxy-Acetylene Process	222
120.	Influence of different Thicknesses of Material upon the Strength and Ductility of Autogenous Acetylene Welds. Swedish Welding-rod was used and the Welds were hammered	237
121.	Influence of Mechanical Treatment of Autogenous Acetylene Welds on Plates of Various Thicknesses	238
122.	Influence of Welding-rods of Different Qualities upon the Strength and Ductility of Autogenous Acetylene Welds on Plates of Various Thicknesses	239
123.	256
124.	256



WELDING
AND
CUTTING METALS
BY AID OF
GASES OR ELECTRICITY

CHAPTER I

GENERAL REMARKS

THE art of welding iron is probably as old as the earliest production of that metal by man; in fact, the reduction of iron in the primitive forges demanded the union by welding of the reduced particles, for no true fusion could have resulted, the percentage of carbon present being too low.

Previous to the nineteenth century most iron work was forged by blacksmiths on anvils. It was the pride of the blacksmith to produce a fine weld, and the beautiful articles he made from iron, simply at his fire, even without a flux—sometimes, perhaps, he used some clay—are evidence enough of what perfection of skill he had reached.

Then came the period of cast iron, when everything that could be cast was made that way, because it was cheaper. During the last half of the century the use of forged iron and

steel increased enormously, owing to improved and cheapened methods of production.

Where forgings are so large that a smith cannot work them satisfactorily, because there is too much and too heavy hammering to be accomplished in the short time the metal retains its great heat, the machine hammer is resorted to.

The scope of his field of operation being more and more limited by the progress of time, which continually requires and produces new methods of manufacture, the blacksmith of old gradually disappeared in order to leave room for modern means of working.

Welding, especially, is now being carried out to great extent and advantage by means of fusion.

During the last few years a new method of joining metals by fusion by the aid of compressed combustible gases has been introduced, which has established itself with an amazing rapidity in almost every centre of industry.

The name of "autogenous welding," under which it has been introduced, is, however, unfortunate, indicating as it does, that results would be produced which could not be obtained by other means. Autogenous welding was therefore and still is being introduced with the specific notice that neither flux nor hammering or pressing is required in order to produce a perfect weld or union of the metals.

Such statements are not in accordance with true facts. The welding of cast iron, copper, zinc, and especially aluminium and their alloys, do require a flux. Forged iron and steel are also to a great extent influenced by the composition of the metal to be added in order to complete the weld; besides the form of the flame, its temperature and chemical composition will also play an important part in the production of a proper weld.

Autogenous welding, even of the thickness of 2.5 to 3 m.m.,

requires the plates to be operated upon to be previously prepared by cutting their ends so as to form a groove, into which is placed a piece of similar metal, in form of a bar or wire, which, when melted, will trickle down and fill the groove; care must be taken that the filling metal of the bar is being perfectly welded to the metals forming the groove.

The thicker the welding metal is, the larger must be the groove and the stronger becomes the weld, which will have the character of casting in contradiction to the superior quality of the welding plates.

Statements to the effect that plates of from 45 to 75 m.m. thickness may be welded by the autogenous system with absolute safety are simply promises of fraudulent nature. Such statements cannot but render great harm, particularly to a new industry, and may result in similar difficulties and even final disaster, which the industry of acetylene lighting had to encounter.

The limit of a qualitatively perfect autogenous weld is to be found where a mechanical finishing of the weld by ordinary means is possible, that is, probably, within a thickness up to 20 m.m.

As long as it aims only at joining two metals, without any special claim as to quality, a weld may be done at almost any thickness, as long as the temperature available is greater than that expended in the weld and the unavoidable loss from the surrounding atmosphere. Mass-distribution and large surface are the leading points in this case.

It is almost always forgotten, however, that the principal and incontestable condition for producing a perfect weld is an absolute purity of the combustible gases employed, and, furthermore, that the welding should be effected without any action upon the metal, chiefly that of carburization.

Amongst all combustibles the hydrogen alone fulfils these conditions, and it offers thereby great advantages over all other combustible gases, particularly over that of acetylene, because it does not leave any carbon; used even in excess, hydrogen still renders a reducing flame without harming the metal, while by acetylene and all other combustible gases the metal is irremediably carbonised.

Microscopical examination reveals that out of five samples welded by acetylene four were oxidised and one carbonised. This is easily explained from the fact that the flame of the oxy-acetylene blowpipe is composed of oxygen and acetylene. If there should be an excess of acetylene, a carburation takes place; if an excess of oxygen, an oxidation is produced. In order to realise a neutral flame inventors are still making proposals, but probably without much prospect of success.

CHAPTER II

GASES AND SOURCES FOR THEIR GENERATION

Aggregation—Liquefaction—Atmospheric Air—Liquid Air—Carbide of Calcium—Acetylene—Acetylene Dissous—Blau Gas—Hydrogen—Oxygen—Water Gas.

AGGREGATION.

It has been known for ages that matter is capable of existing in three different physical states: the solid state, the liquid state, and the gaseous state.

It has also been long known that most solids can be transformed into liquids by the application of heat, and that many liquids, water for example, can be transformed into vapour by a further addition of heat. Conversely, it is known that certain aeriform substances, such as steam, are converted into liquids by the mere abstraction of heat.

LIQUEFACTION OF GASES.

It was believed that an essential difference existed between gases and vapours, vapours being condensible to the fluid form, while gases were believed to be perfectly aeriform, and not condensible by any experimental means at our disposal.

In the early part of the nineteenth century the validity of this distinction came to be doubted, and *Faraday*, at the suggestion of *Davy*, undertook the systematic study of the question, with the result that he succeeded in reducing to liquid form quite a number of gases that had previously resisted liquefaction. Shortly afterwards *Thilorier*, *Cagniard*

de la Tour, *Régnauld*, *Natterer*, and many others improved the methods. Nevertheless oxygen, nitrogen, and hydrogen, or the "permanent gases," still resisted all attempts, until *Andrews* in 1868 made the important pronouncement that a certain temperature exists above which the gases cannot be liquefied by any pressure whatever, this temperature now being known as the "critical temperature,"¹ and similarly the "critical pressure," or the tension that exists in a liquefied gas at the critical temperature, and the "critical volume," or the volume occupied by a unit mass of gas at its critical point.

The problem of liquefying the permanent gases, and any other gas, was therefore resolved into the production of exceedingly low temperatures.

ATMOSPHERIC AIR.

This is a mixture of, approximately,

21 per cent. of oxygen,

78 per cent. of nitrogen by volume, and

1 per cent. of carbon dioxide and variable quantities of water vapour, ammonia, and other bodies, according to locality and conditions.

Owing to the complex composition of air, several different products are obtained by its liquefaction, notably liquid oxygen and nitrogen and solid carbon dioxide.

LIQUID AIR.

The principal method of effecting the liquefaction of atmospheric air on a commercial scale, after *Perkins*, in 1823, erroneously believed that he had liquefied air, and numerous unsatisfactory attempts by others, was proposed by the late

¹ For *Andrews'* conception "critical temperature" it would be better to substitute the conception "critical density," or the least density which the substance can have as a liquid.—*Wroblewski*.

Sir William Siemens in 1857, followed by the simultaneous but entirely independent labours of *Louis Cailletet* and *Râoul Pictet*, who succeeded in liquefying atmospheric air on a small laboratory scale, the former on the 30th December, 1877, and the latter on the 10th January, 1878, both having employed quite different means.

The impetus and foundation stone to the important industry to be created were, however, laid by *Sir James Dewar*, who in 1885 succeeded in producing liquid air from the atmosphere, an achievement which aroused great anticipations as giving the nucleus to the solution of problems of unforeseen importance to almost every branch of industry.

Amongst the numerous and different methods that were suggested from time to time, those of *Carl Linde* (1895) *Conrad Mix* and *Heylandt* (1896), *Hans Knudsen* (1899), and *Eugène Claude* (1900), with modifications of the methods for separation of gases by *René Lery* and *André Helbronner* (1902) and *Râoul Pictet* (1903), have brought the liquefaction of atmospheric air to an accomplished fact.

As to the commercial application of liquid air, it may be looked upon as an important, if not the principal, source of nitrogen and oxygen.

CARBIDE OF CALCIUM.

In its number for May, 1908, *Acetylene*, *The Lighting Journal*, states that *The Acetylene Illuminating Company, Limited*, were the founders of the acetylene industry in the United Kingdom, by introducing the manufacture of carbide of calcium in this country in 1895. For this purpose the Wilson patents were acquired by the company, and an experimental plant was started in Leeds. As the result of the successful experiments, a permanent plant was laid down at the Falls of Foyers, Scotland, which started turning out carbide on a commercial

scale in 1896. In 1902, however, it was found necessary to cease carbide manufacture, owing to the power being required for the manufacture of aluminium and the company's lease for power having terminated.

In 1901 the Acetylene Illuminating Company, Limited, acquired the patents for the manufacture of dissolved acetylene (acetylene-dissous) in Great Britain, the British Colonies and Dependencies.

Carbide of Calcium is a dark grey slag made by fusing together coke and lime in the intense heat of an electric furnace.

The following formula denotes the chemical reaction which produces acetylene :

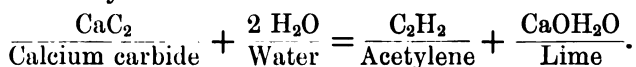

To put it simply :

Carbide of calcium consists of one atom of calcium combined with two atoms of carbon.

Water consists of two atoms of hydrogen combined with one atom of oxygen.

When brought into contact,

The carbon of the carbide of calcium combines with the hydrogen of the water to form acetylene.

The calcium of the carbide of calcium combines with the oxygen of the water to form lime.

After acetylene has been produced the residuum is a lime which may be used in the garden as a fertilizer.

The average quality of carbide of calcium will yield 4.7 cubic feet of gas per pound of carbide.

Carbide of calcium attracts moisture from the atmosphere so rapidly that it must always be stored in an air-tight and damp-proof receptacle to avoid generation of gas or crumbling of the carbide with consequent deterioration and waste.

Carbide of calcium in itself is not an explosive, and cannot be made to explode even if exposed to the highest degree of heat, but when water is added to it, or if it be kept exposed in a damp atmosphere, the carbide of calcium is attacked and acetylene gas evolved. But even with unpacked carbide of calcium, in a damp atmosphere the evolution is slow, as a hydrate of lime forms on the lumps and protects them, to a great extent, from atmospheric influence. If gas be evolved and allowed to accumulate, and a light be applied, it will of course fire and explode in the same way as coal gas. Its escape is easily detected owing to its pungent odour.

ACETYLENE.

Acetylene (C_2H_2) was first obtained by *Davy* in 1837 from the black mass which he obtained when making potassium. *Berthelot* in 1858-59 produced acetylene by passing hydrogen between the poles of an electric arc, and established the more important properties of the gas and its compounds. *Wöhler* in 1862 produced calcium carbide by raising a mixture of lime, zinc, and carbon to a white heat. He obtained acetylene by bringing the carbide into contact with water. Acetylene was first liquefied by *Cailletet* in 1877, and repeated by *Ansdell* in 1879, whose method was criticised by *Villard*, *Willson*, and *Suckert*. The method of using compressed acetylene was discovered by *Claude* and *Hess*.

Acetylene is a colourless gas of disagreeable odour, which is to a great extent due to impurities, and can be easily liquefied. It is an endothermic compound the formation of which is attended by the absorption or storing up of heat, in contradiction to those exothermic bodies which evolve heat in their formation.

Great care is evidently required in its use, as on account of

its endothermic property its decomposition is easily effected when under pressure and takes place with explosive violence.

As acetylene forms an explosive compound with copper, the use of this metal is to be avoided.

Another danger arises from the use of impure calcium carbide, in that phosphuretted hydrogen may be generated along with the acetylene.

Unfortunately, however, calcium carbide continues to evolve acetylene after the removal of the water on account of the presence of aqueous vapour, and the gas so generated, whilst the apparatus is not in use, accumulates until sufficient pressure is generated to force the water seal.

Dr. Frank Clowes has shown that the range of explosibility of acetylene mixed with air is greater than that of any other gas; escape of the gas must therefore be strictly avoided.

The Royal Society of Arts appointed a committee to report upon the exhibition of acetylene generators at the Imperial Institute in 1898, and the conditions laid down by the said committee form, so to say, the foundation stone upon which the construction of acetylene generators is based. It will therefore be of interest here to give the results obtained from the tests as kindly permitted by the said Society.

The committee have, for convenience in classification, divided the generators into three groups:—

1. Those in which water is by various devices allowed to drip or flow in a thin stream on to a mass of carbide, the evolution of the gas being regulated by the stopping of the water-feed.

2. Those in which water in volume is allowed to rise in contact with the carbide, the evolution of the gas being regulated by the water being driven back from the carbide by the increase of pressure in the generating chamber.

3. Those in which the carbide is dropped or plunged into an excess of water.

These are again subdivided into :

(a) *Automatic generators*, or those which have a storage capacity for gas less than the total volume which the charge of carbide is capable of generating, and which depend upon some special contrivance for stopping contact between the water and carbide.

(b) *Non-automatic generators*, or those in which a holder of sufficient capacity is provided to receive the whole of the gas made from the largest charge of carbide which the apparatus is capable of taking.

The following are the conditions, laid down by the committee, which the generators admitted to the exhibition at the Imperial Institute were required to fulfil :—

AUTOMATIC GENERATORS.

1. Under no condition, likely to occur in working, must it be possible for the pressure in any part of the apparatus to exceed that necessary to support a column of water 100 inches in height.

2. When the apparatus is first charged, in no case must the air in the generating chamber and receiver exceed one-fifth of the capacity of the apparatus.

3. On shutting off the outlet cock of the generator, the generation of the gas should be so speedily arrested that no large escape of gas may need to take place. But in any case there must be an arrangement by which any surplus gas can be delivered outside the building.

4. The apparatus should be so arranged that the decomposition of the carbide should not give rise to excessive heating.

NON-AUTOMATIC GENERATORS.

1. Under no condition, likely to occur in working, must it be possible for the pressure in any part of the apparatus to

exceed that necessary to support a column of water 100 inches in height.

2. The air space in the generating chamber should be as small as possible, and the apparatus should be so arranged that the decomposition of the carbide should not give rise to excessive heating.

3. There must be some arrangement by which, if the ordinary pipe from generator to holder becomes choked, the gas can escape by blowing a seal or by driving back feed-water and escaping through the tank.

The said committee also expressed the opinion :

That many types of acetylene gas apparatus can be so constructed as, with ordinary precaution, to be absolutely safe.

Although it does not follow that the generator which yields the largest amount of gas is necessarily the best, yet this factor is a most important one in the choice of any apparatus. The generators which combine the largest yield of gas with strength of material and simplicity in charging the carbide and in emptying the residue are those which will recommend themselves to the public.

Where the public is most likely to be misled is by the exaggerated claims made by makers as to the number of lights which a given machine will supply, and herein may possibly be an element of danger due to excessive heating caused by too rapid generation. Even if there be no danger, the overheating will considerably lessen the quantity and lower the quality of the acetylene gas evolved from the carbide, as well as tend to cause smoking of the burners.

The committee recommend—

That every apparatus sold should be accompanied by a written guarantee that it will light a specified number of burners consuming a given quantity of gas per hour over a consecutive number of hours without increasing the

temperature in any part of the carbide receptacle above 228° C., that is to say, the fusing point of tin.

That non-automatic generators with a holder capable of taking the gas generated from the largest charge of carbide the generator will hold are free from objections attending all automatic generators examined, and that every generator should be fitted with an arrangement by which all air can be rinsed out of the generating chamber by acetylene or some inert gas before action is allowed to commence between the water and carbide.

That every generator should be fitted with a purifying chamber or chambers in which the acetylene is purified from ammonia and sulphuretted and phosphuretted hydrogen, and from other impurities.

Another important point is the length of time over which generation of gas continues after the addition of water to the carbide has ceased.

The general idea which seems to exist among makers of automatic apparatus of this type is that all they have to do in order to stop the generation of acetylene is to stop the water supply; this, however, is an utter fallacy, as liberation of gas continues with ever-increasing slowness for sometimes an hour and three-quarters after the water supply has ceased, whilst the gas so evolved is very considerable in volume. The length of time over which the generation extends will of course depend to a certain extent upon the amount of water added, the percentage of carbide undecomposed, and the temperature at which the mass of carbide happens to be when the water supply ceases, whilst the generation will itself depend upon

The dehydration of the calcic hydrate first formed, and

The decomposition of water condensed from the gas present as the temperature of the generator falls.

TABULATING THE RESULTS.

These results are of very great interest, as they not only show clearly the facts already pointed out, but indicate that in any automatic apparatus on this principle the cut-off should be so arranged that at least one-fourth of the total holder capacity is still available to store the slowly generated gas.

Another very important deduction to be derived from the figures is the large excess of water over and above the theoretical quantity required to ensure complete decomposition of the carbide by this process, this being to a certain extent dependent upon the form of the generator.

According to theory, 64 parts by weight of carbide require only 36 parts by weight of water to completely decompose them and convert the lime into calcic hydrate. This would mean that each pound of calcic carbide needs a little under half a pint of water to complete the decomposition, whilst owing to evaporation due to the heat produced, half the added water is driven off as steam with the acetylene or left mechanically adhering to the lime, and the smallest quantity likely to complete the action would be a pint to a pound of carbide; in reality the only way is to add sufficient water to drown the residue.

If this is not done the lime forms so protective a coating to the carbide that small quantities often remain undecomposed, and if the residues are thrown into a drain or cesspool, the evolution of acetylene would give an explosive mixture, which, on account of its low point of ignition, would be a serious danger.

Points of considerable interest to the generator maker are the space occupied by a given weight of carbide, the volume of the lime formed from it on decomposition, and the volume of gas that can be evolved from a given space filled with carbide.

The density of calcic carbide is 2.2, and therefore a cubic foot of solid carbide would weigh 137 lbs. In practice, however, the weight of carbide which can be got into a cubic foot space depends upon the size commercially sent out. A fair average would be 80 lbs. per cubic foot of carbide space, and this weight of carbide at 5 cubic feet per lb. would yield 400 cubic feet of acetylene.

One pound of pure calcic carbide yields 1.15 lbs. of slaked lime (one kg. of carbide yields 1.156 gr. of slaked lime), and the volume this will occupy depends entirely upon the way in which the water is brought in contact with it.

In an automatic apparatus of the first class, where water drips slowly upon the carbide in sufficient quantity to decompose it but not to flood it, the lime swells up and occupies 2 to 2.5 times the bulk of the original carbide; when, however, the water flows in more rapidly, the impact of the water beats down the lime and the space occupied is not so large.

In generators of the second class, in which water rises from below, the weight of the undecomposed carbide above it presses down the lime below and keeps it in a compact mass occupying about half more space than the carbide from which it was formed.

With the third type of generator it really becomes a question of the rate at which the excess of undissolved calcic hydrate settles, and this will be discussed later on.

The large proportion of water vaporised during the evolution of acetylene at once draws attention to the necessity of arranging all the generator connections in such a way that condensation shall not lead to stoppage of the delivery pipes.

It must also be clearly borne in mind that the liquid products condensible from the gas are of the most corrosive character both to paint and metal.

The moment that acetylene is subjected to the action of

high temperatures, changes of great complexity at once commence, causing a great deal of impurities, and the tar is likely to cause considerable trouble, as it is of very viscous character, and, if it condenses in the delivery tubes, causes the lime-dust and carbon particles to collect and bring about stoppage.

A still more important evil, however, is to be found in the alteration which takes place in the composition of the gas, and which reduces the illuminating value of the gas to a serious extent.

A very considerable proportion of the generation takes place at a temperature above 600° C., about which point polymerisation commences. As benzene forms a large proportion of it, it is carried forward as vapours and remains suspended even in its passage through the gas-holder and ordinary pipes. Benzene requires three times the volume of air for combustion that acetylene does, and the result is that the most perfect acetylene burner shows a tendency to smoke directly any quantity of benzene is formed.

When acetylene has been made in a generator at an undue temperature, it carries with it benzene vapour, which as it commences to condense assumes a vesicular form, and on coming to the extremely minute holes which form the apertures of the burner the mechanical scrubbing which it encounters causes the breaking up of the vesicles and the deposition of the benzene and other hydrocarbons held in suspension by benzene, which soak into the steatite and carbonise. The pressure of finely-divided carbon has a great effect in determining the decomposition of acetylene itself, so that a rapid growth of carbon takes place at the burner, and no ordinary clearing of the deposited carbon from the exterior will ever make the nipple fit for constant use again.

It will be found with experience that the smoking of a

burner will be overcome quite as much by attention to the temperature in the generator as to the burner itself, and where a generator is in use which gives overheating, a well-arranged scrubbing apparatus that would get rid of the benzene from the gas would be found a distinct advantage in stopping burner troubles.

At first sight these results seem an absolute condemnation of the second type of generators, but the fact remains that they constitute a very large percentage of those on the market, and that the best of them show no signs of overheating.

The reason of this apparent anomaly is that under certain conditions, which can be clearly defined, excessive heating is avoided.

The raising bell which draws a mass of wet carbide above the surface of the water is bad from every point of view.

But generators in which water rises from below and so attacks the carbide can be made safe if the arrangements are such that the water is never driven back from the carbide and the bulk of carbide is sufficiently subdivided. Under these conditions the slowly rising water is always in excess at the point where it decomposes the carbide, so that the evaporation by rendering heat latent keeps down the temperature, and although the steam so formed partly decomposes the carbide in the upper portion of the charge, the action is never sufficiently rapid to give anything approaching a red heat. In order to fulfil these conditions it is necessary that there should be a holder of considerable capacity, and that the leading tube conducting the gas from the generator to the holder should be of sufficient diameter to freely conduct away the gas, the water at the same time being allowed to rise in the generator so slowly as to do away with any risk of over-generation.

In the best generators of this class these conditions are more
w. c



or less approached, and it is unusual to find that the melting point of tin, 228° C., has been reached in the charge of carbide during decomposition.

Where generators of this class are automatic and have no rising holder to take the gas, it is found that they work satisfactorily when supplying the number of lights for which they were designed, but if they are over-driven and the action becomes too violent, excessive heating takes place, whilst the turning off of the gas, and consequent driving back of the water from the carbide, also has a tendency to cause it. If however, the water has risen sufficiently slowly, the carbide below the surface has been practically all decomposed, so that the heating only takes place over a limited zone.

The makers of generators that are liable to give rise to excessive heating invariably deny the possibility of such an action taking place with their generator, and, if it is proved, fall back upon the defence that, even if the mass does become red hot, there is no particular danger.

In such generators the active danger of explosion only exists whilst any air is left mixed with the acetylene, and in those which have holders to take the gas as it is formed, the air remaining in the generator is swept rapidly over into the holder and out of the range of the source of heat; but with automatic generators this is not always the case, and the air space in the generators should always be made as small as possible, and some arrangement should be adopted, if possible, by which the air in the generator could be rinsed out by a little of the previously produced acetylene before decomposition of the carbide by water commences.

Under these circumstances danger from explosion during generation would disappear, but the drawbacks of smoky flames, reduced illuminating power, and choking tubes would still remain.

The generators of the third class are those in which carbide

is allowed to fall into an excess of water, and these have many advantages. In such generators, as long as there is water present, and lime sludge is not allowed to accumulate, it is impossible to get above a temperature of 100° C., whilst with a properly arranged tank the temperature never exceeds the air temperature by more than a few degrees. Under these conditions the absence of polymerisation and the washing of the nascent and finely-divided bubbles of gas by the lime water in the generator yields acetylene of a degree of purity unapproached by any other form of apparatus.

This form of generator, however, although exhibiting the great advantages mentioned above, has the drawback of being one of the least economical in the output of acetylene per pound of carbide used, as the gas having to bubble through the water is rapidly dissolved by it, whilst in an apparatus in which only the surface of the water touches the gas the amount dissolved is comparatively small. The result is that with generators of this class the generation rarely exceeds 4.2 cubic feet of acetylene per pound of carbide instead of 5 cubic feet per pound.

Probably, therefore, from a practical point of view, the generators which are the best for general working are those of the second class, which are used in connection with a holder of sufficient size to take the gas evolved from the full charge of carbide employed.

Approximately, after an hour's standing each kg. of calcic carbide will give ten litres of lime sludge, or 1 lb. of carbide will yield eight pints, which can be got rid of by a sludge cock at the bottom of the apparatus.

BLAU GAS.

This gas has been introduced under the name of the inventor, *Blau*.

It is liquefied illuminating gas produced by distillation of mineral oils in red-hot retorts. Chemically the gas consists of the same elements as ordinary coal gas, but in essentially different proportions. Blau gas is, however, free from carbon oxide, and has therefore the advantage over coal gas of not being poisonous.

The analyses give the following compositions of the Blau gas:—

One litre gas (1.246 gr.) contains, at 0° C. and 760 m.m. barometer pressure,

1.042 gr. carbon.

0.204 gr. hydrogen.

From the absolute weight (1.246 gr.) of one litre the specific weight of the gas is found to be 0.963.

The number of calories was found to be 12,318 per one kg., or 15,349 per one cubic metre.

By comparison of equal volumes of various gases in respect of heat and light the following results are obtained:—

Gas.	Calories per 1 cb. m.	Candle power. Hefner's candles.
Air gas . . .	2,900	500 incandescent
Coal gas . . .	5,000	700 incandescent
Acetylene . . .	13,000	1,666 Hale burner
Blau gas . . .	15,349	3,000 incandescent
Blau gas . . .	12,318 per 1 kg.	2,400 incandescent

The Blau gas can, like all active gases, be compressed and liquefied, and in this latter condition it occupies $\frac{1}{400}$ part of its gaseous volume. It is collected in the ordinary steel cylinders for transport, the smallest cylinder taking 0.49 litre or 0.25 kg., and the largest 49 litres or 25 kg. of liquid Blau gas under a pressure of 100 atmospheres.

The Blau gas, being very inert, is therefore difficult to bring

to explosion. Its extent of explosion embraces only 4 per cent. (from the mixing proportions of 4 per cent. of gas and 96 per cent. of air up to 8 per cent. of gas and 92 per cent. of air), while that of coal gas is 13 per cent. (from the proportions of $6\frac{1}{2}$ per cent. of gas and $93\frac{1}{2}$ per cent. of air up to $19\frac{1}{2}$ per cent. of gas and $80\frac{1}{2}$ per cent. of air), and that of acetylene 47 per cent. (from 2 per cent. of gas and 98 per cent. of air up to 49 per cent. of gas and 51 per cent. of air).

HYDROGEN.

This is an elementary gas and the lightest substance known. It is colourless, odourless, and non-poisonous, although, as ordinarily prepared, it frequently contains traces of disagreeably smelling or of poisonous impurities.

Hydrogen is obtained by the decomposition of water in various ways. It is usually prepared by the action of zinc or iron on a solution of hydrochloric or sulphuric acid. All metals which readily decompose water when heated readily furnish hydrogen on a similar treatment. Many other acids may be used, but none cut more readily. In all cases the action consists in the displacement of the hydrogen of the acid by the metal employed, and if the acid is not one which can enter into reaction with the displaced nitrogen, the latter is evolved as gas.

On the large scale mostly pure hydrogen may be prepared by passing steam over charcoal or coke heated to dull redness. If the temperature be kept sufficiently low, hydrogen and carbon dioxide are the products ($C + 2 H_2O = 2 H_2 + CO_2$), and the latter may be removed by causing the gas to traverse a vessel filled with slaked lime.

Hydrogen is also obtained pure by the electrolytic decomposition of water, as described under the heading "Oxygen" on page 27.

The liquefaction of gaseous hydrogen is an achievement the more remarkable as it was the result of the simultaneous but entirely independent labours of two distinguished physicists, *Cailletet* of Chatillon-sur-Seine and *Raoul Pictet* of Geneva—by the former on the 30th December, 1877, and by the latter on the 10th January, 1878.

When inhaled, hydrogen imparts a peculiar squeaking tone to the voice, due to the extreme tenuity of the gas; small animals, when put into it, die instantly. Hydrogen, however, is not directly poisonous, but may cause death by preventing access of oxygen to the lungs.

Hydrogen when mixed with air or oxygen is explosive; the loudest explosion is obtained by mixing together two volumes of hydrogen and one volume of oxygen.

Knowledge and Scientific News, in its October number, 1908, refers to a new method of preparing hydrogen as described by *Mauricheau-Baupré* in the current number of *Comptes Rendus*. A coarse powder is first prepared by the interaction of a small quantity of mercuric chloride and potassium cyanide with fine aluminium filings, and on adding water to the resulting compound in the proportion of one litre per kg., hydrogen is slowly evolved, the oxidation of one kg. being complete in about two hours. The hydrogen is very pure, and only the simplest apparatus is required for its production. Since the powder is quite stable if protected from moisture, it should form a useful source of gas; about 1,300 litres may be obtained from one kg. of the preparation.

Hydrogen is also obtained in large quantities as a by-product in some chemical processes; for instance, in Germany the *Badische Anilin und Soda Fabrik*, the *Chemische Fabrik Griesheim*, and the *Deutschen Solvay Werke* produce annually twenty to twenty-five million c.m. of chemically pure hydrogen, which, being of no use to them, is simply let out to escape in

the air. Ample opportunity is therefore given to find means to collect and utilise such an enormous quantity of a technically useful gas.

OXYGEN.

Oxygen was discovered almost simultaneously in the year 1774 by *Priestley* and by *Scheele*, the Swedish chemist having, however, nearly completed his discovery in 1772.

Priestley discovered that the red oxide of mercury evolved a gas when heated. This gas, oxygen, being superior even to the air as a supporter of combustion, was regarded by him as "dephlogisticated air." The incombustible part of the atmosphere he supposed to be saturated with phlogiston on the assumption that a gas was so much the better adapted for supporting combustion, as it contained within itself a smaller quantity of that body, common air, by drawing phlogiston from burning substances, because, as he thought, phlogisticated air on that account had no longer any attractions for phlogiston, or, in other words, any power of supporting combustion.

In 1789 *Lavoisier*, who by a series of carefully conducted and very ingenious experiments proved that the combustion of bodies in the air consisted essentially in their chemical combination with oxygen, and thus overthrew the "phlogiston" theory, gave it the name which it now retains (from *oxys* = acid and *gennao* = I produce), in consequence of his (erroneously) believing that it was a necessary constituent of every acid.

Oxygen was liquefied in 1877 by *Pictet* at a pressure of 320 atmospheres and a temperature of -140° . *Wroblewski* and *Olszewski* have shown that the critical temperature of oxygen (*i.e.*, the temperature above which no amount of pressure will liquefy it) is -113° , the pressure needed to liquefy it at that temperature being 50 atmospheres. Its boiling point is -181.4

at ordinary pressure. When the pressure is reduced or removed, evaporation takes place so rapidly that a part of the oxygen is often frozen to a white solid. Under 13·7 atmospheres solidification takes place at $-146\cdot8$. *Sir James Dewar* is endeavouring to obtain liquid oxygen at atmospheric pressure, and in 1892 he devised a vacuum vessel for containing liquid oxygen.

In 1808 *Gay-Lussac* made known to the world the laws of the combination of gases by volume, to which his attention had been directed by the discovery which he and *Alex. v. Humboldt* had made that a definite volume of oxygen combined with exactly twice its bulk of hydrogen. He pointed out that there is a simple relation between the volumes of two gases which unite together and also between their collective volume in the uncombined and in the combined condition.

According to the law of *Boyle* and *Mariotte* the volume of a given mass of any gas varies inversely as the pressure, provided that the temperature remains the same; for instance, the quantity of air which is contained in a vessel of the capacity of one pint under the pressure of one atmosphere, or 15 lbs. upon the square inch, may be contained in a vessel of half a pint capacity if the pressure be doubled.

According to the law of *Charles* and *Gay-Lussac*, on the other hand, all gases expand equally by heat, provided the pressure remains constant, the rate of expansion being $\frac{1}{273}$ of the volume at 0° C. for each rise of 1° C. in temperature; or, in other words, the volume of a gas varies directly as the absolute temperature. A gas which strictly conforms to these two laws is said to be a perfect gas, but none of the gases with which we are acquainted are perfect in this sense.

From the few accurate observations which have been made on this subject it appears that, in general, the departure from the laws of *Boyle* and *Charles* is greater the more the

temperature of the gas approaches to that at which it becomes liquid. The general resemblance in the behaviour of gases under the influence of pressure and heat is very great, however.

Numerous processes have been devised for the industrial production of oxygen, but most of them are so expensive, or require such complicated plants, that only two or three are in actual operation on a large scale.

Brin's process of producing oxygen by the alternate formation and decomposition of barium peroxide is an improvement upon the *Bausingault* process of 1851 and is being worked by *The British Oxygen Company, Limited*. The installation of the plant requires a considerable space, and special heating arrangements are required underground so as to produce a working temperature of some 800° Fahr. The process must be worked day and night, as, according to the nature of the process, the oxidation takes place every five minutes—that is to say, no oxygen is being produced; besides, the furnace cannot be left to cool during the night, as the success of the process depends upon certain fixed temperatures. The smallest change in temperature in the furnace, the smallest pollution of the air, when the purifier does not act properly, and the baryte itself being apt to change entirely in the furnace, may produce losses of considerable extent during a few days' time.

Brin's process has therefore many disadvantages, and its success depends upon so many contingencies that it cannot favourably compare with other processes which may be considered safe from a technical point of view.

The Production of Oxygen by Electrolysis of Water has of late found considerable extension, although it was considered that the inevitable loss attending the conversion of heat into power and power into electrical force, and the need of skilled labour, would make the process too expensive.

Amongst the various patents five different processes have found practical application, viz., those of *Garuti*, *Schuckert*, *Dr. Schmidt* (Zurich), *Hasard Flamand*, and *Renard*.

All these processes are based upon the decomposition of alkaline solutions by means of the electric current liberating two volumes of hydrogen and one volume of oxygen in accordance with the formula $H_2O = 2 HO$. They differ, however, in the type of electrodes employed. *Schmidt* and *Renard* work with porous diaphragms of non-conducting material, while in the processes of *Garuti* and *Schuckert* perforated partitions of a conducting material are used.

Professor Garuti's Process having many advantages is therefore described here:—

The principal points to consider are:

1. Reduction to a minimum of the electro-motive force required, and
2. Perfect separation of gases evolved.

In order to realise the first condition it is necessary to determine the most favourable composition of the electrolyte, that is, the liquid to be decomposed, and the proper separation of the electrodes. In Fig. 1 the electrodes are shown to be separated by the porous diaphragm D, but, as the circulation of the electrolyte is essential for the continuity of the process, it should be so constructed as to permit this; in order to assure the separation of the gases, they should not be permitted to pass through it, but to reduce the resistance the diaphragm should be a conductor.

The principal conditions required of a perfect diaphragm is that it should be permeable for water, impenetrable for gases, and a good conductor of electricity. It is evident that the construction of the diaphragm is the main difficulty. Various materials for the same have been employed, such as biscuit-baked porcelain, pipe clay, plates of carbon, amianthus,

but they have all offered disadvantages, particularly in respect of the electrical resistance and the inability of preventing the gases to pass through.

Garuti has suggested the application of metallic diaphragms, which also have been found to give satisfactory results. If a metal plate is placed between the two electrodes (Fig. 2) it is influenced by the current, the positive pole formed opposite the negative one in each compartment, whereby hydrogen and oxygen will be generated, *i.e.*, explosive gas. *Garuti* has discovered, however, that this will not take place if the electromotive force does not exceed three volts and the density of the current remains under two amperes per square decimetre of electrode; under such circumstances the diaphragm remains passive, and by reason of its low resistance it is possible to work with a potential under three volts.

It remains then to assure the circulation of the electrolyte.

On a first examination it is found that the better the circulation is assured the less is the resistance. It seemed sufficient to leave a space between the diaphragm and the bottom of the tank, and it has been found that the lower edge of the diaphragm should not reach below those of the electrodes (Fig. 3). A mixture of gas, however, takes place, forming

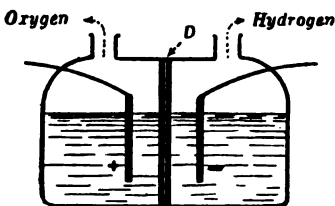

FIG. 1.

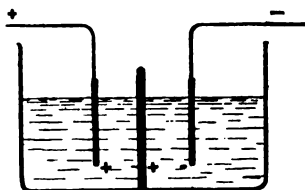

FIG. 2.

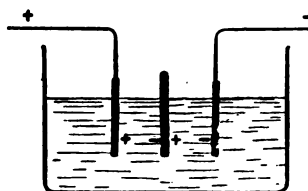

FIG. 3.

upon the electrodes a certain volume of bubbles, which, increasing and disengaging themselves, pass direct to the surface. Other bubbles, very small, almost microscopical, detach themselves, as soon as they are formed, from the electrodes and remain in suspension, probably by reason of their extreme tenuity, and darken or cloud the electrolyte, descend, and pass under the electrodes, turning into the neighbouring compartment, from whence the mixture of gas. In order to prevent this mixing it is found sufficient simply to lower the diaphragm until the proper resistance has been obtained.

In order to assure the circulation of the electrolyte the metallic diaphragm is perforated. Experience has proved that these perforations can have a diameter up to one m.m. each, and that they should be as numerous as possible and be united by means of a band some centimetres high, and placed in front of the electrode. Strangely enough, these perforations, being large enough to circulate the electrolyte, are almost impermeable for the gases, probably by some capillary reason. The metallic diaphragms, by being welded together, form cells (Fig. 4), each containing an electrode, and fulfil thereby every condition that is required.

By an ingenious arrangement the number of weldings is reduced to a minimum. The cells of the apparatus are placed side by side, with their lower ends open entirely, but their upper parts open about half their length. All the cells containing an anode are half open to the left side, and those containing a cathode are half open to the right. A bell or funnel enclosing the left ones collects oxygen, and a similar funnel containing the right cells collects hydrogen (Fig. 5). In apparatus of certain sizes the diaphragms as well as the electrodes are rigidly kept in their places by wooden combs placed at their lower ends.

In the construction of the apparatus lead is used, in some special cases, with an electrolyte composed of water and an acid, but in general iron or steel is used, and then with an

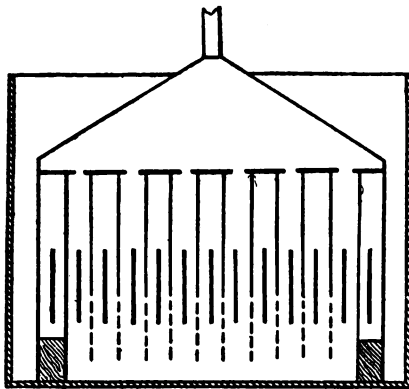

FIG. 4.

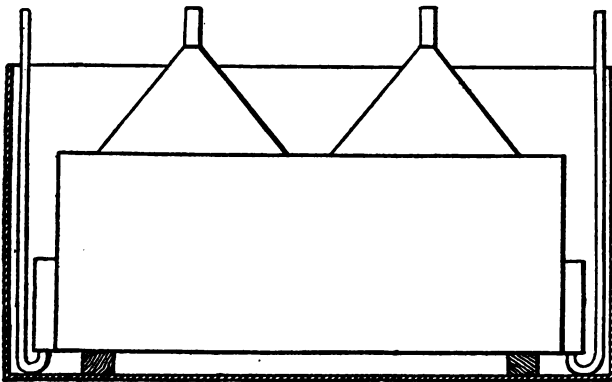

FIG. 5.

electrolyte composed of a solution of soda or caustic potash ; the latter presents a smaller resistance, but is more expensive. The solution has a minimum resistance of 15 per cent. for soda, but generally 25 per cent., and 29 per cent. for potash.

In order to facilitate the liberation of the gas bubbles and to avoid their passing through the perforated diaphragms the solution should be very concentrated.

The iron is not quite indifferent to the action of the alkali, and *Professor Eric Gerard* has found the wear and tear of the anodes in *Garuti's* apparatus to amount to 15 per cent. of the weight of the anode. In practice the anodes have a thickness of 0·7 millimetre at the beginning, and require to be exchanged after every three years' working; consequently a very small loss; otherwise the apparatus offers no alteration, the electrolyte does not change; should it, however, in length of time become highly carboniferous, it is easy to generate the solution by some lime. The anodes as well as the wooden combs require to be exchanged every three years; the costs of maintenance are therefore practically nil.

The generators work without intervention of manual labour, and they are arranged side by side in a room having a constant temperature; the gases produced are collected in iron piping and, after passing through a regulator, enter the gasometers. The attendance is limited to refilling each of the generators with three to four litres of water per day. In respect of safety it is advisable frequently to analyse the gases, easily done by *Hempel's* apparatus or by *Bassani's* electric density meter, or still better by an aerostatic scale, which has the advantage of giving continuous indications.

In reference to the commercial point it is well to remember that one coulomb liberates 0·0829 milligramme of oxygen and 0·703 milligramme of hydrogen, or 0·058 cubic centimetres of oxygen and 0·116 cubic centimetres of hydrogen at a temperature of 0° C. and at a pressure of 760 millimetres, *i.e.*, atmospheric pressure.

One ampere-hour liberates 208·8 cubic centimetres of oxygen and 417·6 cubic centimetres of hydrogen under the same

conditions in respect of temperature and pressure. As the operation generally takes place at a temperature of 15° to 20° C., it may be admitted, for practical purposes, and taking account of all the losses, that one ampere-hour will give 0.40 litres of hydrogen and 0.20 litres of oxygen.

As to the electro-motive force required,

One gramme of water releases, in its formation, about 3.8 calories, or $3.8 \times 425 = 1.615$ kilogramme metres.

One coulomb decomposes 0.0000933 gramme of water; in order to decompose one gramme of water an expenditure in work is therefore required represented by $\frac{1}{0.0000933} C \times X$

volts, or, expressed in kilogramme metres, $\frac{1 \times X}{0.0000933 \times 9.81}$

or, as abovestated, $\frac{X}{0.0000933 \times 9.81} = 1.615$, thus $X = 1.488$,

or in round figures 1.5 volts. *Gerard* has found, however, that the electro-motive force required by a *Garuti* apparatus made of steel, with an electrolyte of caustic potash as pure as possible, amounts to 1.988 volts. But for industrial purposes it is not possible to go as low as that; with an electrolyte composed of caustic soda an electro-motive force of 2.4 volts is required, while with potash it may be reduced to 2.2 volts.

Assume, however, a voltage of 2.4 at the most, and a production of 0.40 litre of hydrogen and 0.20 litre of oxygen per ampere-hour, the production per kilowatt-hour amounts to—

Hydrogen, 166.6 litres, equal to 37 gallons,

Oxygen, 83.3 „ „ 18.5 „

or 250 litres = 55.5 gallons of explosive gas.

The production of one cubic metre of explosive gas (666 litres hydrogen and 333 litres oxygen) requires thus 4 kilowatts.

One cubic metre of hydrogen alone requires 6 kilowatts.

One „ „ „ oxygen „ „ 12 „

Assuming a minimum voltage of 2·2, the production per kilowatt-hour would be—

Hydrogen	181·8 litres
Oxygen	90·9 „

The production of one cubic metre explosive gas requires 3·667 kilowatts, one cubic metre of hydrogen alone 5·50 kilowatts, and one cubic metre of oxygen alone 11·00 kilowatts. Finally, the gases produced are practically pure; the hydrogen contains an appreciable quantity of other gases, while the oxygen contains $\frac{1}{2}$ to 4 per cent. of hydrogen, which can easily be removed.

The Production of Oxygen from Liquid Air.—It has already been mentioned on page 7 that oxygen is produced through the liquefaction of atmospheric air, principally by *Linde*, *Knudsen*, and *Claude*.

Linde has, as the pioneer, by his strenuous efforts and scientific demonstrations created a new industry, which becomes more and more important by the extension of the practical applications of its products, oxygen and nitrogen. The patents for the United Kingdom have been acquired by *The British Oxygen Company, Limited*, which have works in London, Manchester and Birmingham producing oxygen of any required purity. The *Linde* system is simple and continuous; the plant may be erected almost anywhere without restrictions, requiring but a small space.

The *Knudsen* patents for the United Kingdom are owned by *The Liquid Air Power and Automobile Company of Great Britain, Limited*, having a 250 h.p. plant working at Battersea, London.

The *Claude* system is being worked principally in France, represented in the United Kingdom by *The British Liquid Air Company, Limited*.

As to the cost of production of oxygen by the various

systems, it is difficult to give exact figures, but the following statements have been obtained so far as the cost of the machines is concerned, in addition to which must be considered the spaces required, maintenance of plant, and other more or less important points bearing upon the question.

Assuming a production of 250 cubic metres of oxygen per twenty-four hours, the cost of the plants actually required for the production of the oxygen, but without cost of erection and of the compressors required for the compression of the gas, has been given as follows :—

<i>Brin's</i> process	£2,900
<i>Garuti's</i> electrolytic process	4,000
<i>Linde's</i> system	2,350

The cost per cubic metre is given by *Linde's* system at 12·7 pfg.; *Garuti's* system at 8 pfg.

When the annual consumption exceeds 5,000 cubic metres, or when the reduction in price would increase its application to welding and cutting, then it would be advisable to produce oxygen at the place of operation. Oxygen is a gas which can easily be produced at any place in similar manner as ordinary coal gas. By so doing its price would be materially reduced.

The oxygen used for welding must be free from chlorine, while its usual mixture with 5 per cent. of nitrogen and 2 to 3 per cent. of hydrogen is of no importance.

WATER GAS.

Lavoisier discovered in 1793 that when steam, unmixed with air, is passed through glowing coke, the coke is oxidised; carbonic oxide and hydrogen are produced theoretically pure, and in equal volumes; practically the product contains 3 to 8 per cent. of carbonic acid and 4 to 9 per cent. of nitrogen. The yield is, from coke (7,000,000 calories per ton), about 35,000 cubic feet, with a heating value of about 75,000 calories

per 1,000 cubic feet, or, on the whole, about 40 per cent of the heat value of the coke; from coal (7,800,000 calorics per ton), about 42,000 cubic feet at 95,000 calorics, or about 49 per cent.

When the by-product—"the producer gas"—which may be generated in large quantities by regulating the supply of air while the coke glow is being worked up, is used for boilers or gas engines, the net cost of making simple water gas is between 5*d.* and 6*d.* per 1,000 cubic feet, or about 8*d.* per 1,000 less than coal gas.

Water gas gives on combustion an extremely high temperature, which saves time in furnace work; gold, silver, and copper, and even an alloy of 70 per cent. of gold and 30 per cent. of platinum, are readily melted in quantity by it; hence for bringing objects such as Fahnehjelms combs (a series of rods of magnesia) into brilliant luminous incandescence, for welding or for metallurgical operations inducing high temperature, it is very suitable. Unfortunately, its high percentage of carbonic oxide, which is odourless, has caused a high death roll.

CHAPTER III

WELDING

Description—Different Systems—Acetylene Welding—Aluminium Welding—Aluminium Thermic Welding—Blau Gas Welding—Chemical Welding—Coal Gas Welding—Electric Welding—Forging—Hydrogen Welding—Water Gas Welding.

DESCRIPTION OF WELDING.

WELDING is the intimate union produced between the surfaces of two pieces of metal when heated to proper temperature and hammered together. The union is so close that when two bars of metal are properly welded the place of junction is as strong relatively to its thickness as any part of the bar. To weld bar iron to another piece of iron requires an intense heat. Wrought iron at the welding temperature possesses the property of expanding when cooled and contracting when heated, and the welding property is intimately connected with the critical condition in which this abnormal behaviour is exhibited.

The condition known as "the welding state" of iron or steel is one which exists only within a very limited range of temperature. If the smith takes his iron bars out of the fire at too low a temperature, welding cannot be effected. If, on the other hand, the iron is too hot, a failure is also certain.

The range of temperature, during which impact or pressure causes the union, known as welding, of two masses of iron or steel, is therefore comprised within narrow limits, and the familiar operation is really a critical one.

In welding by the forging process the parts to be united are

heated within the critical range of temperature, considerably less than that of fusion. The smith in striking with his hammer is assisted by the molecules which approach, though never arrive at, liquidity. This condition is favourable to the interpenetration of the molecules and consequent adhesion of the surfaces on hammering.

It has been shown by *Sir Thomas Wrightson* that the phenomenon of welding is akin to that of regelation, or the sticking together of ice under pressure. To prove this an experiment was made which showed a distinct decrease in temperature, amounting to 106° F., at 2,550° F. during welding, a similar result being known to take place during regelation. This abstraction of heat is caused by the melting of the iron or ice in either case, and the consequent need of latent heat for the liquefaction.

If the welding of two metals is caused by fusion by the aid of combustible gases in conjunction with oxygen, this latter acting as the gas of combustion, or by electricity, or even by the Alumino-Thermic process, the metals become subject to considerable alteration in their properties chemically as well as physically, offering thereby difficulties of great extent in the production of a perfect weld.

The welding by aid of combustible gases is very similar to casting; and if it may be termed a process of casting, then also must the conditions attributed to that process be applicable to welding more or less. The difference would then appear to be the composition of the moulds, those of sand being substituted by the metal to be welded, which, however, is of superior and more finished make as compared with the metal to be used for the completion of the weld. The molten or liquefied metal is poured at a considerable temperature into the grooved metal pieces to be welded, which have the temperature of the surrounding atmosphere only, and is then

subjected to a mechanical treatment, in order to increase the strength and ductility of the weld so that it may resemble that of wrought iron more or less.

Although the cast-iron expands at the moment of solidification and thus seemingly produces a weld, the subsequent cooling from a red heat to the ordinary temperature leads to a still greater contraction, and the net result is an imperfect weld. To overcome this difficulty, mechanical means must be employed to facilitate the union between the molten mass and the metals, converting the former, as far as possible, into a similar condition to that of the superior metal. The contraction that takes place during cooling after solidification is not uniform, but is interrupted by certain arrests or expansions which occur at particular temperatures. The shrinkage in welds is, however, by no means a constant quantity, but varies with the proportions of the weld and with the character of the metal used.

The strength and solidity of the weld are affected by the bulk of metal employed to complete the weld, and also by the form of the article to be welded. Thus, if a sample of cast-iron which would be suitable for a weld of small size be employed for making a very heavy weld, it will be found that, owing to the slower cooling in the latter case, the grain of the metal becomes much more open, and the strength is proportionately diminished. On the other hand, if the same metal were used for very small welds, the chilling in the seam or groove of the weld would tend to make the product close and hard, and in many cases this would be so marked as to make the weld quite brittle. The grade of the iron used must therefore depend upon the size of the weld to be made, and probably a closer grained iron must be used for large than for small welds. At the same time, it is generally found that the strength of a large weld per unit of area is somewhat less than that of a smaller

one, since the closeness of grain is usually though not always associated with increased tenacity.

It is also very important that in large welds, where strength is required, no sharp or re-entering angles should occur, as these in all cases lead to the formation of planes of weakness in the weld. When the metal cools in the weld a crystalline structure is developed, the crystals forming at right angles to the cooling surface. If this cooling surface be curved, the crystals interlace so as to yield a strong weld of uniform structure, while on the other hand, whenever a sharp change of curvature takes place a plane of weakness is the result.

It is much to be desired that some plan could be adopted by which a test piece weld would indicate exactly and directly the physical qualities of a weld of the same metal, but no method of doing this has been devised or seems likely to be.

Until it has been fully made clear what takes place during the operation of autogenous welding, the changes that take place in the chemical as well as the physical compositions not only of the metal parts to be welded together, but also of the liquefied metal which, from the welding bar is poured into the seam of the weld, and more so the intermediary and gradual interlacing action upon the two metals, it seems useless as well as fruitless to discuss what kind of repairs may or may not be made especially upon marine boilers, so as to satisfy not merely the insurance inspectors but to a greater extent to secure that safety in public conveyance which is of vital importance.

Discussion and professional examination in this direction would tend more quickly to solve the difficulties so vividly apparent in the great and important industry of autogenous welding.

DIFFERENT SYSTEMS OF WELDING.

Welding may be accomplished by various means, and the different systems employed may be divided into two main divisions :

The *Autogenous Welding*, by means of which the fusion or union of the metals is obtained direct, without the intermediary of any foreign material.

The *Heterogeneous Welding*, in which an additional foreign metal or alloy is introduced, the melting point of which is below that of the metals to be welded.

The autogenous welding is especially applicable to iron, steel and lead, while the heterogeneous welding is indispensable, or almost so, for zinc, brass, and, up to recently, also for aluminium, or, generally, for those metals which oxidise or volatilise at a temperature near that of the point of fusion.

In the autogenous welding of iron and steel two distinct processes may be distinguished :—

The *Forging Process*, which is based upon the property possessed by iron to become doughy or plastic at a temperature considerably below that of fusion.

The *Welding by Fusion*, which is carried out by means of compressed gases and blowpipes.

The other processes which have recourse to fusion of the metal, and are therefore also designated under the name of autogenous welding, are :—

The *Alumino-Thermic Process*.

The *Electric Welding*.

The *Aluminium Welding*.

The welding by means of compressed gases is generally effected by a mixture of various gases, amongst which oxygen plays the most important part, as being the gas of combustion.

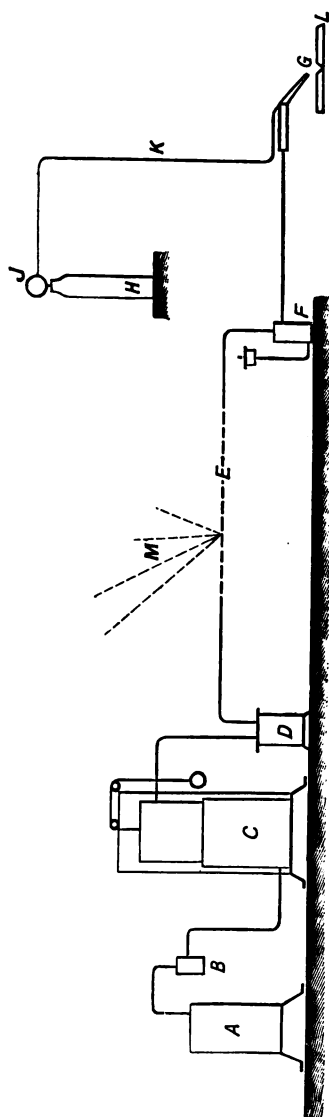

FIG. 6.—Schematic Illustration. Low Pressure Oxy-Acetylene Welding Plant.

The various welding systems are generally recognised under the name of the combustible gas employed, as follows :—

The Acetylene welding.

The Blau-gas welding.

The Coal-gas welding.

The Hydrogen welding.

The Water-gas welding.

Most of the combustible gases employed are generated by *automatic* or *non-automatic* plants, and the gases may be used under *low* or *high* pressure.

A description of each welding system will be given below.

ACETYLENE WELDING.

In the case of automatic or non-automatic welding plants the gas from the generator A passes into a condenser to cool it and to remove any tarry products ; it enters thereafter a washing apparatus B, filled with water, to extract water-soluble impurities ; from thence it travels to the gasometer C. In leaving the gasometer the acetylene passes

to the purifier D, and travels from there through ordinary mains E to a back-pressure hydraulic valve F. It is then ready to be drawn from these into the blowpipe G.

The oxygen, compressed into the cylinder H, passes into the pressure regulator J; a rubber tube K leads it from there into the blowpipe G, where it is mixed with the acetylene before the two gases leave the nozzle, in order to effect the welding of the plates L.

If the generator is of the carbide-to-water type, the condenser may be omitted, and the washer is required to retain any lime-froth.

Any number of blowpipes can be worked from these mains M, but at each point where gas will be used for a blowpipe a back-pressure hydraulic valve must be fixed.

REGULATORS.

Hydraulic Pressure-Regulating Valve.

The back-pressure hydraulic valve precludes the possibility of oxygen at any time flowing into the gasholder and also air from being drawn into the acetylene mains. Its action, illustrated by Fig. 7, is as follows:—

The acetylene pipe from the gas-holder is connected to the branch *f*, and the acetylene pipe leading to the blowpipe is connected to the branch *d*. Water is poured into the open chamber *b* until it reaches the closed vessel *a*.

The valve is then in working order. The filling pipe *c* is made long enough to hold a column of water equal to the pressure of the acetylene holder, which should be about 9 in. of water. The supply of acetylene to the blowpipe may be regulated by the tap on the branch *d* (where taps do not exist on the blowpipe itself), and the tap at *f* may be left permanently open.



Should the blowpipe nozzle at any time become choked whilst the oxygen supply remained unchecked this gas would be forced by its superior pressure along the acetylene pipe. The back pressure thus caused acting on the surface of the water in the chamber *a* would force this water up the pipe *e*,

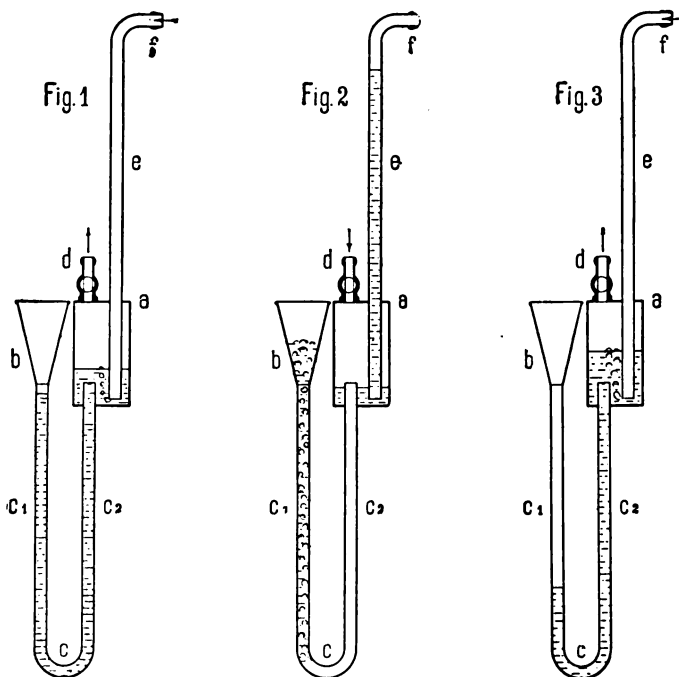

FIG. 7.—Draeger's Patent.

and prevent the oxygen from entering the acetylene supply pipe beyond the tap of the hydraulic valve.

High-Pressure Automatic Regulator (Fig. 8).—This is an automatic regulator which is made to deliver gas at any required pressure up to about 30 lbs. per square inch. The pressure can be adjusted by unscrewing the screw *R* for low pressure, or by screwing down *R* for high pressure. The indicator *M*

indicates the pressure of delivery as set by R. The maximum pressure at which the regulator will work is marked by a red line on the indicator M, and if this pressure is exceeded (by screwing R too far) a safety valve S will open and release the excess pressure. The tap H for controlling the supply is a convenience which the safety valve S renders possible. N is the delivery nozzle, and F is a gauge for registering pressure of gas in cylinder. This regulator is extensively used in blow-pipe work.

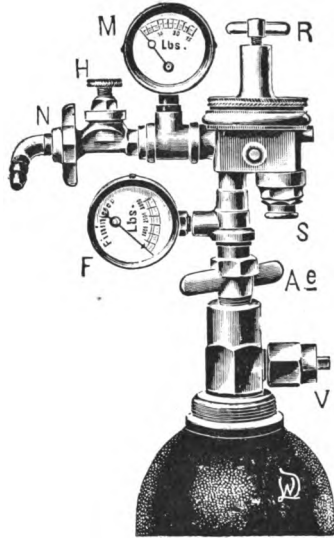

FIG. 8.

High-Pressure Automatic Regulator (Fig. 9) (*Patent*). — This regulator, fitted with or without high-pressure gauge, possesses

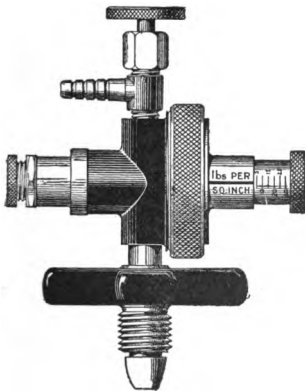

FIG. 9.

exactly the same features as the one in the preceding illustration. It is suitable for every class of work. It is of substantial construction, and has been specially designed for workshop use. It is specially recommended for all kinds of blow-pipe work. The adjustable screwed socket on the side of the regulator is graduated in pounds per square inch, and the regulator can be set by this means to any desired constant pressure, thus enabling

the usual low-pressure gauge to be dispensed with.

Gas Pressure Gauge (Fig. 10).—These pressure gauges are useful to frequent users of oxygen cylinders, and particularly to agents, as a means of ascertaining the quantity of gas in cylinders.

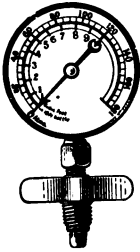

FIG. 10.

The gauges as illustrated are specially marked in atmospheres and feet, and the cubic contents of any cylinder may be readily calculated in the following manner:—

The figures on outer ring indicate pressure in atmospheres; 120 atmospheres being the pressure to which all cylinders are charged.

The figures on inner ring indicate the number of cubic feet of gas contained in a 10-foot cylinder. To calculate the quantity of gas contained in any cylinder, multiply the figure to which the needle points by the multiple of 10; thus, if the gauge is attached to a 40-foot cylinder, and the needle points to 6, then $6 \times 4 = 24$ feet = quantity of gas in cylinder.

Both types of pressure gauge are fitted with safety checks in the stem to prevent a sudden rush of gas into the gauge tube when the cylinder valve is opened.

Leak Tester (Fig. 11).—To use the tester. Press the conical rubber end into the outlet of the cylinder valve. If there is the slightest leakage of gas it will be at once indicated by bubbles passing through the water. If, on the other hand, there is no leakage, bubbles will not be perceptible.



FIG. 11.

The instrument is a handy substitute for the clumsy method of testing for leakage by pouring some water into the socket of the valve. It is only about 4 inches long, and can be carried in the waistcoat pocket. The water is found to evaporate very slowly, and will only require renewal at long intervals of time.

N.B.—Oil must not be used in the tester.

Steel Cylinders (Fig. 12).—All cylinders sold or employed by the British Oxygen Company are guaranteed to be made of steel complying with the British Government recommendations. They are made to the company's own specifications, and are regularly inspected during manufacture by one of the company's engineers. They are all re-annealed, valved, and tested hydraulically to a pressure of $1\frac{1}{2}$ tons per square inch, in the company's works, before being filled with gas. The company's methods of annealing, testing and filling cylinders are in accordance with the British Government recommendations.

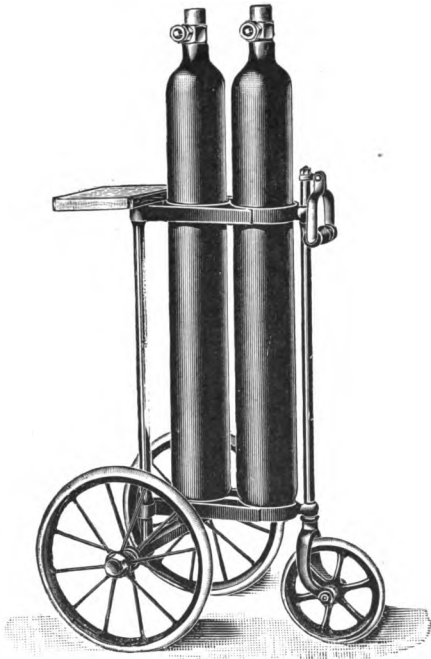

FIG. 12.—Trolley Stand for Pair of Cylinders.

*Cubic contents in feet fully charged.	Approximate external diameter in inches.	Approximate length over all in inches including valve.	Approximate weight in lbs. (empty).
10	4	19	13
20	4	35	23
40	$5\frac{1}{2}$	36	43
60	7	32	66
80	7	41	85
100	7	49	103

* All oxygen cylinders are filled to 120 atmospheres pressure.

Annealing.—In accordance with Government recommendations, all cylinders (before being subjected to the usual hydraulic test for the first time) must be annealed. All cylinders received at the company's works to be filled for the first time will, after annealing, be tested hydraulically to a pressure of $1\frac{1}{2}$ tons per square inch, and afterwards registered. The company re-test all cylinders annually, a periodical re-test

being necessary as much in the interest of the customer as of the company.

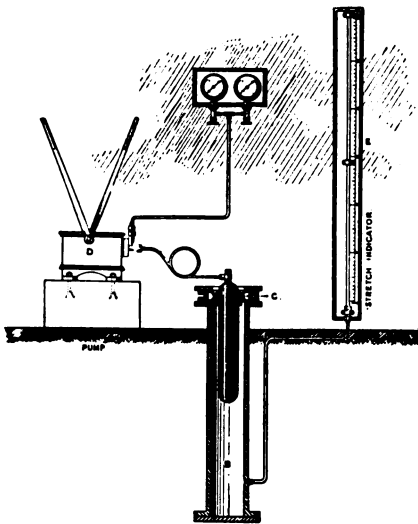

FIG. 13.—Stretch Testing Apparatus for Cylinders.

All hydraulic testing of cylinders is done by the company in their stretch testing apparatus (Fig. 13). This system was first introduced by the British Oxygen Company twenty years ago. It was officially approved by the British Government's Cylinder Committee of 1896, and has recently been added to

the official Cylinder Regulations of Germany and other countries. Being an apparatus of general interest it is now illustrated and described below :—

This apparatus consists of a cast-iron chamber B, in which the cylinder A to be tested is suspended. D, an hydraulic pump employed for testing the cylinder A. E, a gauge glass communicating with the bottom of chamber B; and C, an indiarubber joint ring, which is capable of closing and making

a perfect joint round the shoulder of the cylinder. The method of testing is as follows:—Both cylinder A and chamber B are filled with water to the exclusion of all air, and a perfect joint is made round the neck of the cylinder by inflating the indiarubber ring C, which can be instantaneously done by water pressure from the ordinary main supply. When the cylinder is gradually subjected to the test pressure by means of the pump D, its expansion is measured by the displacement of water from the chamber B, and this displacement is indicated by the rise of the water level in the gauge glass, which continues until the maximum test pressure is obtained. The pressure is then released, and if no permanent stretch has been given to the metal, the water will return to its original level in the indicator. If, however, any permanent stretch has been caused this will not be the case, and the cylinder would therefore be rejected as unfit for use.

The value of this apparatus is obvious. Its employment insures that a cylinder

is never strained beyond the "elastic limit" of its metal, and without this safeguard no hydraulic test is reliable.

In blowpipe work the only object of a combined regulator and high-pressure gauge is to guard against the oxygen supply running short in the middle of a job. Pressure gauges permanently attached to regulators are a fruitful source of trouble. They soon become inaccurate (particularly the small type so frequently employed) and being delicate in construction they are liable to injury in workshop handling. The connector (Fig. 14) is an excellent substitute for the pressure gauge

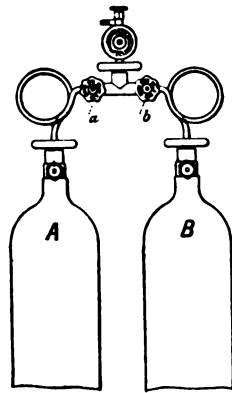

FIG. 14.—Connector between Regulator and two Cylinders.

permanently attached to a regulator. The regulator is in communication with two cylinders A and B, one of which can be shut off when the other is in use. Thus, if the valve of

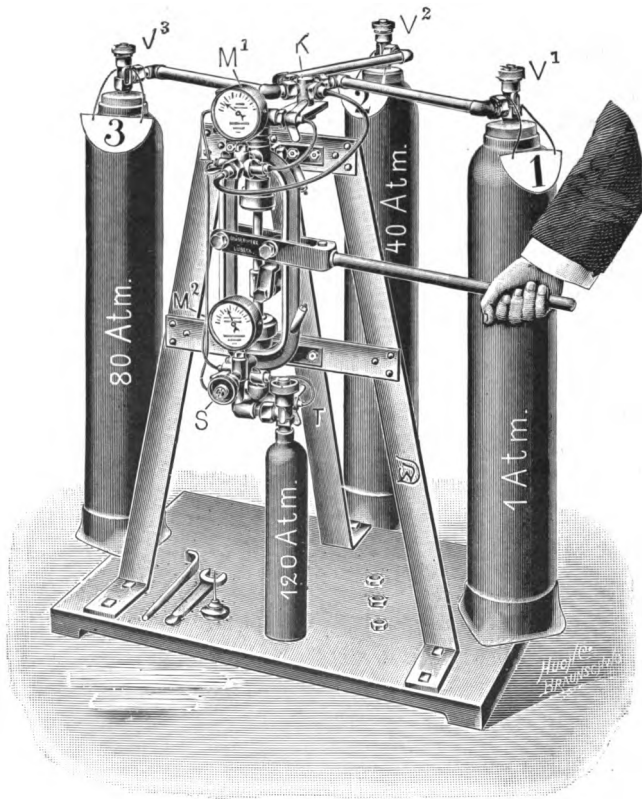

FIG. 15.—Draeger's High-Pressure Refill Pump.

cylinder A and the pipe valve *a* are open whilst the valve of cylinder B and the pipe valve *b* are closed, oxygen flows from cylinder A through the regulator until it begins to empty. The valves of cylinder A are then closed and those of cylinder B opened. Oxygen will then flow from cylinder B whilst the

empty A cylinder can be removed and replaced by a full one. Thus it will be readily seen that a continuous supply of oxygen can be maintained to the blowpipes by the employment of this connector, and for permanent work regulators with this connector will be found more convenient and reliable than those fitted with pressure gauges. A separate pressure gauge (Fig. 10, p. 44)—preferably of the larger diameter—should be in the possession of all constant users of cylinders to enable them to check the contents of cylinders when they arrive from the compressing factory.

Draeger's High-Pressure Refilling Pump, as illustrated in Fig. 15, enables trade cylinders to be filled, in various stages, from storage vessels containing the gas under different high pressures.

The three storage vessels, 1, 2, 3, containing the gas at pressures of, say, 1, 40, and 80 atmospheres, are connected by means of strong piping to the pump valves at K. The manometer M^1 shows the pressure in the respective storage vessels from which the gas is to be supplied, and the manometer M^2 the pressure obtained in the trade-cylinder. S represents the closing valve of the pump when the trade-cylinders are being exchanged, and T is the closing valve of the cylinders.

PURIFYING MATERIAL.

There are various purifying substances described by *Messrs. Leeds and Butterfield*, analytical chemists, as follows:—

There are three principal chemical reagents in regular use. These are chromic acid, cuprous chloride (sub- or proto-chloride of copper) and bleaching powder.

Chromic acid is employed in the form of a solution acidified with acetic or hydrochloric acid, which, in order to obtain the advantages attendant upon the use of a solid purifying material, is absorbed in the highly porous and inert silica or kieselguhr.

This substance was first recommended by *Ullmann*, and is termed commercially *Heratol*. As sold it contains about 136 grammes of chromic acid per kilogramme.

Cuprous chloride is used as a solution in strong hydrochloric acid, mixed with ferric chloride, and similarly absorbed in kieselguhr. From the name of its proposer this composition is called *Frankoline*.

As a special acetylene purifier bleaching powder exists in at least two chief modifications. In one, known as *Acogine*, it is mixed with 15 per cent. of lead chromate, and sometimes with about the same quantity of barium sulphate, the function of the latter being simply that of a diluent, while to the lead chromate is ascribed by its inventor, *Wolff*, the power of retaining any chlorine that may be set free from the bleaching powder by the reduction of the chromic acid.

Puratylene, as the second modification of bleaching powder, contains calcium chloride and quick or slaked lime.

It will be observed that both *Heratol* and *Frankoline* are powerfully acid, whence it follows they are capable of extracting any ammonia that may enter the purifier, but for the same reason they are liable to act corrosively upon any metallic vessel in which they are placed, and they therefore require to be kept in earthenware or enamelled receivers. But since they are not liquid the casing of the purifier is immaterial.

Puratylene also removes ammonia by virtue of the calcium chloride in it.

Acogine would probably pass the ammonia, but this is no objection, as the latter can be extracted by a preliminary washing in water.

Of all these materials *Heratol* is the most complete purifier of acetylene, removing phosphorus and sulphur most rapidly and thoroughly, and not appreciably diminishing in speed or efficiency until its chromic acid is practically quite used up.

On the other hand, Heratol does act upon pure acetylene to some extent, so that purifiers containing it should be small in size and frequently exchanged.

Frankoline is very efficacious as regards the phosphorus, but it does not wholly extract the sulphur. It does not attack acetylene itself.

Acogine and Puratylene, both being bleaching powders more or less, are alike in removing phosphorus to a satisfactory degree, but they leave some sulphur behind. Acogine evidently attacks acetylene to a slight extent.

Although some of these materials attack acetylene slightly and some leave sulphur in the purified gas, they may be all considered reasonably efficient from the practical point of view, for the loss of true acetylene is too small to be noticeable and the quantity of sulphur not extracted too trifling to be harmful or inconvenient.

For employment in acetylene installations a solid purifying material is generally preferable to a liquid one.

Acogine and Puratylene, although they may be excellent for lighting installations, are, however, unsuitable for a welding plant by reason of the severe suction of the acetylene by means of the oxygen, which may cause small particles of lime to be drawn into the burner.

For practical purposes about 1 kilogramme of purifying material is sufficient for 15 to 20 cubic metres of gas, *i.e.*, for about 50 kilogrammes of carbide.

ACETYLENE GENERATORS FOR WELDING.

A. Automatic Low-pressure Oxy-acetylene Welding Plant.

A low-pressure welding plant consists of an automatic or a non-automatic acetylene generator, oxygen cylinders with

regulators, one hydraulic back-pressure valve, rubber tubing for oxygen, rubber tubing for acetylene, spectacles, cylinder key, and one or more low-pressure blowpipes. The ordinary sizes of automatic acetylene plants have a container for 15, 30 and 60 lbs. of carbide, representing a supply of respectively 15, 30 and 60 cubic feet of gas.

B. Non-automatic Low-pressure Acetylene Plant.

This consists of one or more cast-iron generators, hydraulic main and washer, counter weighted gasholder of suitable size, and purifier.

The generation of acetylene by merely bringing calcium carbide and water into mutual contact within a suitable and closed vessel, and the great facilities offered to consumers to obtain the carbide in a condition ready for use and decomposition, is, at least from a theoretical point of view, characterised by extreme simplicity.

When, however, the question comes to select an apparatus for welding purposes great difficulties appear at once. The generator should be of the best make and principally of the right type, able to produce the gas in sufficient quantity and of the high degree of purity which is absolutely essential in producing a perfect weld. Moreover, it must not be forgotten that every maker does not possess that technical knowledge which is required to give proper advice, so often the case in a new industry, although it must freely be admitted that there are no generators made by responsible firms at the present time, which are not safe; from this, however, it must not be deduced that every type of generators is suitable for welding purposes.

The relative advantages of automatic and non-automatic apparatus, irrespective of type, from the consumer's point of view, may be stated to be as follows:—

The fundamental idea underlying the employment of a non-automatic generator is that the whole of the calcium carbide put into the apparatus shall be decomposed into acetylene as soon after the charge is inserted as is natural in the circumstances; so that after a very brief interval of time the generating chambers shall contain nothing but spent lime and water, and the gasometer be as full of gas as is ever desirable.

In an automatic apparatus the fundamental idea is that the generating chamber, or one at least of several generating chambers, shall always contain a considerable quantity of undecomposed carbide, and some receptacle always containing a store of water ready to attack that carbide, so that whenever a demand for gas shall arise everything may be ready to meet it.

Inasmuch as acetylene is an inflammable gas, it possesses all the properties characteristic of inflammable gases in general; one of which is that it is always liable to take fire in presence of a spark or naked light, and another of which is that it is always liable to become highly explosive in presence of a naked light or spark if, accidentally or otherwise, it becomes mixed with more than a certain proportion of air. On the contrary, in the complete absence of liquid or vaporised water, calcium carbide is almost as inert a body as it is possible to imagine, for it will not take fire, and cannot in any circumstances be made to explode. Hence it may be urged that a non-automatic generator, with its gasometer always containing a large volume of the actually inflammable and potentially explosive acetylene, must invariably be more dangerous than an automatic apparatus, which has less or practically no ready-made gas in it, and which simply contains water in one chamber and unaltered calcium carbide in another. But when the generating vessels and the gasometer of a non-automatic apparatus are properly designed, the gas in the

latter is acetylene practically free from air, and therefore, while being inflammable it is devoid of explosive properties, always assuming that the temperature of the gas is below 280°C . and that the pressure under which the gas is stored remains less than two atmospheres.

It may be well to remember that not only must calcium carbide and water be kept out of premature contact, but that moisture, or vapour of water, must not be allowed to reach the carbide; or alternatively, that, if water vapour reaches the carbide too soon, the undesired reaction shall not determine overheating, and the liberated gas be not wasted or permitted to become a source of danger.

The evolution of the gas must be slow and regulated so that an apparatus, for instance, with a storage of 17 kilogrammes of carbide, representing a capacity of $17 \times 300 = 5,100$ litres of gas, can be used during ten hours with a consumption of 500 litres of gas per hour; a similar apparatus with a storage of 50 kilogrammes of carbide with a consumption of 1,500 litres of gas per hour, and an apparatus with 100 kilogrammes storage of carbide with a consumption of 3,000 litres of gas per hour.

For a consumption larger than 3,000 litres of gas per hour, the non-automatic apparatus must be employed.

It is difficult, and it may not even be advisable, to give a direct answer to the question as to which is the best type of acetylene generators. Experience has, however, proved, so far as welding is concerned, that the apparatus in which granulated carbide is used, the generated gas is of too impure a quality to be used for welding, producing, as it will, a brittle weld.

The type in which the water is allowed to drip on to the carbide should on no conditions be used, as being the most unsuitable of all.

The carbide-to-water generator, by reason of its many advantages from a theoretical point of view, has, also for practical purposes, proved to be the best, producing, as it will, a perfect weld.

When deciding the size of the apparatus to be selected, it should be borne in mind that as little as, for instance, a dynamo can produce an unlimited quantity of energy without causing harm to the machine, as little can an acetylene apparatus generate an unlimited quantity of gas. The quicker the evolution, the more impure is the gas and the more unsatisfactory will the weld be.

A preliminary estimate should therefore be carefully made of the quantity of gas that would probably be required. Assuming, for instance, that 100 metres of plate, with a thickness of 8 m.m. shall be welded per day, four welders would be required, each with a blowpipe consuming 650 litres of gas per hour, making for the four blowpipes 2,700 litres of gas per hour. It would be necessary, therefore, to provide an apparatus capable of generating 3,000 litres of acetylene per hour. The weight of calcium carbide required to produce a certain quantity of gas may be estimated from the formula: Carbide in kilogrammes = $\frac{\text{consumption per hour in litres} \times 10}{\text{production of gas per kilogramme carbide}}$, or

$$\frac{3,000 \times 10}{300} = 100 \text{ kilogrammes of carbide would be required.}$$

As each kilogramme of carbide requires at least 7.5 litres of water, the gas generator should be provided with a space large enough to hold at least 750 litres of water.

It is indifferent, however, how the generated gas is consumed, if by ten welders, each with 150 litres, or by one welder with 1,200, and two welders with 150 litres each per hour, but the consumption per hour must be provided by acetylene generated in a normal manner.

The decomposition of the carbide in the water requires ample time. It may, however, be possible to provide additional quantities of carbide, but then the temperature would also increase accordingly, even up to 675° C. In addition to this the acetylene requires considerable time to cool, and only a certain quantity can pass through the chemical purifier to enable a normal and effective work to be done. The gas produced at too high a temperature would not only increase the danger of explosion but the products of condensation would tend to make the gas impure. The higher the temperature the greater is the quantity of sulphur and organic sulphur compounds. The more rapid the generation, the greater is the impurity of the gas, and the more unsatisfactory will the weld be.

Some automatic apparatus are being offered in the foreign market for a production of 4,000 and even 12,000 litres of acetylene per hour; they contain, however, only 8 and 25 kilogrammes of carbide, and should therefore be used for a consumption of 250 and 750 litres per hour respectively.

Another apparatus with an indicated generating power of 25,000 litres of gas per hour is likewise being offered. This apparatus should therefore have a storage capacity for 800 kilogrammes of carbide and 6,000 litres of water. In reality it contains 40 kilogrammes of carbide.

The effective size and not the indicated production should constitute the regulator of price of the apparatus.

It is easily understood the harm that may be done by offering acetylene generators of too small a size in order to facilitate a sale. The inevitable results will appear in increased danger of explosion and an imperfect weld, followed by suspicion and consequent delay in the development of this new, but so important, industry.

INSULATOR.

The insulation of buildings, more particularly those used for acetylene generators, is of vital importance from a point of safety. Perfect insulation is almost impossible, but a good insulation can be had.

Messrs. Lamb and Wilson, of Cambridge University, in a paper communicated to the Royal Society by *Prof. Ewing, F.R.S.*, in 1899, have published the results of tests made by them as follows :—

Insulator.	Average cubic cms. per day of water run off.	Weight of insulator. Lbs.	Comparative amount of heat lost per insulator (irrespective of weight).	Comparative weight.	Resultant theoretical number.
Silicate cotton ¹ . . .	789	75	0·860	1·000	·860
Cartvale flake charcoal	916	75	1·000	1·000	1·000
Felt ²	980	57	1·070	·76	·813
Fossil meal	1,044	100	1·138	1·33	1·513
Plain cork slabs	1,168	106	1·273	1·413	1·798
Tarred cork slabs	1,217	128	1·327	1·7	2·255
Lump charcoal ³	1,326	139	1·446	1·853	2·679
Ashes	1,943	273	2·110	3·64	7·716

The *Cartvale flake charcoal* is thus superior in its insulating value as compared with the other materials, while, owing to its lightness, much less weight of it is required to fill a given space, and yet give better insulation.

It may be remembered that the amount of heat to be overcome is not to be measured by the *cubical contents* of the insulating room, but by the *amount* of *square* or *wall* surface exposed to the heated exterior.

¹ *Silicate Cotton* has been found practically to be out of the question, as it breaks down easily, leaving open spaces, or falls down to powder.

² *Felt* absorbs damp very quickly, and, owing to its composition, draws up water by capillary attraction, thus spoiling it as a non-conductor and rotting it; in addition, it is apt to breed vermin.

³ The *lump charcoal* was first broken into pieces about half-inch cube.

C. High-pressure Oxy-acetylene Welding Plant.

In this type of welding plant the acetylene is used in a compressed state, similar to that of the oxygen.

Like all other gases, acetylene is capable of compression and liquefaction, and when used in this form is called "dissolved acetylene," and known abroad under the name of "acetylene-dissous." It is produced as follows:—

The acetylene, generated in the usual way, is thoroughly washed and subjected to no less than five different processes of purification, and dried. It is then compressed and passed into the ordinary steel cylinders for storage. The compression is carried out by a double-acting pump, which compresses it in two stages, as the process is accompanied by an evolution of much heat, which might cause the gas to explode during the operation; but since the pump is fitted with two cylinders, the acetylene can be cooled after the first compression.

The cylinders, of any size, are filled with a porous solid material in the form of a charcoal cement, and charged to about 43 per cent. of their capacity with acetone, thus leaving 37 per cent. of the space for expansion which takes place, making an explosion in the cylinder an impossibility. Acetone is a liquid, which has the peculiar property of absorbing twenty-five times its own volume of acetylene at atmospheric pressure and 15° C., and will continue doing this for every atmosphere of pressure that is applied to the gas. The quantity of acetone in the cylinders is so regulated that they contain ten times their own volume of acetylene for every atmosphere of pressure. The gas in the cylinders sent out by the company is compressed to ten atmospheres, so that they contain one hundred times their own volume of acetylene.

The safety of the system has been demonstrated in the fullest possible manner to the *Home Office*, in consequence of

which the *Secretary of State for the Home Department*, in April, 1901, issued an order recognising the safety of dissolved acetylene, and authorising its use according to the process adopted by the *Acetylene Illuminating Company* on condition that (1) the porous material used is to be exactly similar to the sample deposited with the Home Office, (2) all cylinders are to be tested according to certain rules laid down, (3) certain technical details in the manufacture of the gas and charging of the cylinders be carefully observed, (4) that every facility be given to the Government inspectors to inspect the company's plant and method of working, and (5) every cylinder or container to bear the name of the *Acetylene Illuminating Company, Limited*, and be marked "Acetylene compressed into porous substance exempted by order of Secretary of State, dated 10th April, 1901."

For autogenous welding in conjunction with oxygen dissolved acetylene offers many advantages, particularly in places inaccessible to other welding plants or systems, such, for instance, as the hold of a ship.

The gas being chemically pure is always cool and dry, and at a steady pressure most suitable to ensure maximum of efficiency. The consumption of the gas is shown by the gauge, so that the quantity remaining in the cylinder is known at a glance.

CYLINDERS FOR ACETYLENE-DISSOUS.

Cubic contents in feet.	External diameter in inches.	Length over all in inches.	Weight in lbs. approximately.
60	6·25	41·5	64
100	8·25	40·0	95
175	10·5	47·0	180
200	10·5	52·5	195
200	14·25	28·5	165

High-pressure oxy-acetylene welding plant consists of the acetylene cylinder; the oxygen cylinder; the regulator and safety device, fitted with two pressure gauges for the acetylene cylinder; and similar ones for the oxygen cylinder; one or more high-pressure blowpipes; two lengths of rubber tubing; spectacles; and cylinder key.

When working high-pressure plant, first examine cylinder valve to see if same is clean. The governor can then be screwed into the valve (this is a left-hand thread), making sure the joint is sound. The same thing must be done with the oxygen cylinder. In this case the thread of the governor is right hand.

The regulators for the acetylene cylinders are painted red and have left-hand connections to fit the valve in the acetylene cylinders; the regulators for the oxygen cylinders are painted black and have right-hand connections. This is done so as to make it impossible for the wrong regulators to be used with either gas, otherwise they are identical. The pressure can be adjusted by unscrewing the screw R (Fig. 8, p. 43) for low pressure, or by screwing down R for high pressure. The indicator M indicates the pressure of delivery as set by R. The maximum pressure at which the regulator will work is marked by a red line on the indicator M, and if this pressure is exceeded (by screwing R too heavily) a safety-valve S will open and relieve the excess pressure. The tap H for controlling the supply is a convenience which the safety-valve S renders possible. N is the delivery nozzle, and F is a gauge for registering pressure of gas in cylinder.

Then connect the outlet of the acetylene governor, by means of rubber tubing, to the nozzle on the blowpipe, stamped A, and the oxygen governor to the nozzle on blowpipe marked O. Care should be taken to bind the rubber at all joints with wire.

Then see that the milled head screw on outlet of each governor is open, and that tap R on top of each governor is free from the governor springs (this is so when tap R is nearly out of the socket). Then turn on the gas at both cylinder valves; no gas will pass to the burners if the tap R on the regulators is free. Screw down the tap R on top of the acetylene governor until pressure on outlet gauge shows 3 to $3\frac{1}{2}$ lbs.; light the burner, then screw down tap R on the oxygen governor until the necessary white tip on the burner is obtained, gradually increase the pressure on the acetylene until it reaches $5\frac{3}{4}$ lbs. Do not do this in one step, but work the two governors alternately.

WELDING OF ALUMINIUM.

The welding of aluminium has met with great difficulties by reason of the great ability of oxidation of the material. The moment it has been prepared and cleansed, the aluminium is at once covered with aluminium oxide, which prevents the pieces fusing together. By using a flux, however, the oxidation skin is dissolved, and a dross is simultaneously formed which enables the metal to flow and make a perfect weld. The weld remains indifferent in solutions of common salt and soda, and is in every respect comparable with rolled aluminium.

There are various systems for soldering aluminium, and for welding; for instance, those of *M. D. Schoop* and *W. C. Heraeus*. The former is described as follows:—

The numerous alloys of the aluminium-copper-tin or tin-bismuth-copper type, which have been used for soldering aluminium at moderately low temperature, are all open to the same objection, that the soldered joint slowly loses its cohesion, *i.e.*, mechanical strength. This is due to the fact



FIG. 16.

that aluminium, particularly in the presence of water, compares unfavourably with other metals on account of the "electrolytic local action," the aluminium becoming slowly decomposed.

Apart from the admixture of the deoxydising substance, which plays the same part as borax does in soldering, the welding of aluminium is similar to lead-burning. The welding requires no special preparations nor any plant beyond the equipment of tools necessary for the efficient handling of the aluminium.

The difficulty to be overcome was, therefore, to find means whereby welding of aluminium could be made without the addition of another metal, eliminating thereby electrolytic difficulties, and ensuring the same physical and chemical properties of the weld as those of the bar or plate to be welded.

The welding of aluminium has been successfully accomplished by the *Schoop's process*. The *Government Institution, Le Laboratoire du Conservatoire National des Arts et Métiers à Paris*, has made some microphotographic tests, reproductions of which are given in Fig. 17 of the autogenously welded aluminium, and Fig. 18 of the unwelded aluminium.

Again, it is well known that aluminium, like lead, is attacked by the atmosphere, and becomes coated with a layer of oxide, but whereas in the case of lead this oxidation-product can easily be removed, the coating on aluminium has hitherto resisted all practicable modes of removal. By means of a flux, however, the very tough layer of oxide is immediately removed under the blowpipe flame, and the surfaces thus cleaned and fused are readily united and produce a direct union of aluminium with aluminium without in any way impairing the original metal.

The principal point is that the blowpipe flame be of

sufficiently high temperature to fuse the surface of the aluminium. For aluminium sheeting 1 mm. thick coal-gas and

FIG. 17.

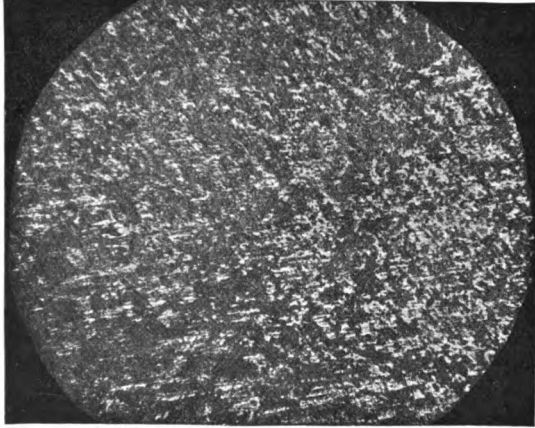
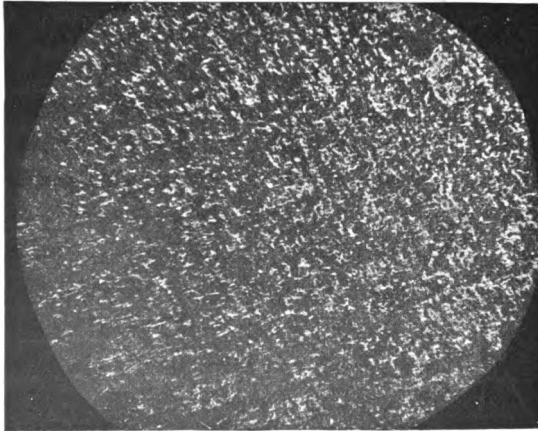

FIG. 18.



oxygen would suffice, whilst for stout aluminium sheeting acetylene and oxygen would be preferable.

Constants of Aluminium.

Atomic weight	27.0
Specific gravity (cast)	2.6 at 4 per cent.
" " (rolled or hammered)	2.67 " "
Melting point	650° C.
Tensile and compressive strength of cast aluminium .	10 at 12 kilos
	per sq. mm.
" " " rolled "	25 at 27 kilos
	per sq. mm.
Electric conductivity (copper = 100)	60

Tests of Tensile Strength.

By the *Swiss Federal Testing Institute, attached to the Polytechnicum in Zurich* :—

w = welded. u = unwelded. The spots where the pieces are welded are marked by a black line.

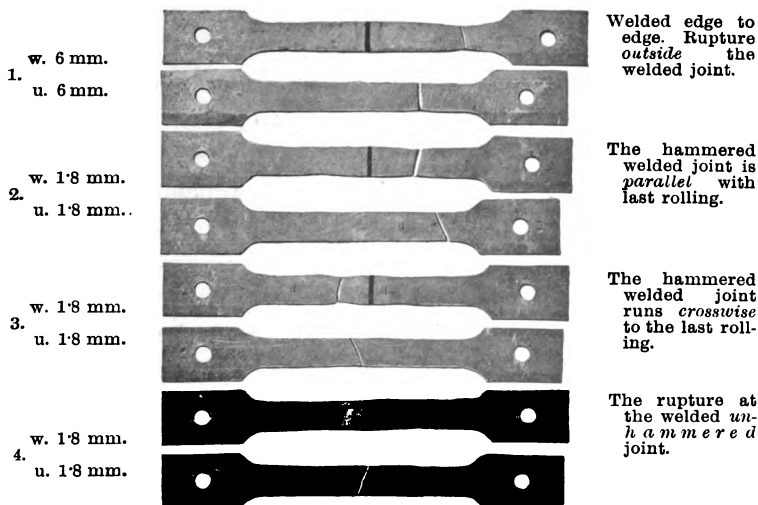

FIG. 19.—Aluminium.

W.

F



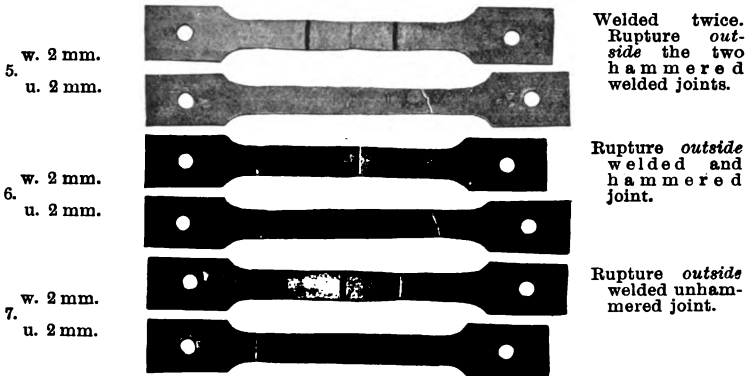

FIG. 20.—Magnalium.

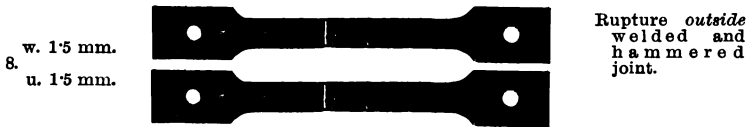

FIG. 21.—Wolfram Aluminium.

The results of the above tests show that the welding does not weaken the strength of the metal; on the contrary, the welded joints are showing even greater strength than the unwelded places, provided that they are hammered after welding. Local contraction and rupture always occurred outside the joint, with the exception of test 4, where the rupture occurred at an unhammered joint.

In test 4 the welded seam lies parallel with the direction of the last rolling. In test 5 it runs crosswise, for which reason the tensile strength is greater in 4, viz., 9.4 kg. per sq. mm., as against 9.1 kg.

Tests 5 to 7 refer to magnalium testing, the pieces being of the same thickness, showing increased breaking strain and resisting power; the former amounts to 147 per cent. of the

unwelded pieces and the latter to 104·6 per cent. On the other hand the percentage elongation (absolute value 20·3 per cent.) is reduced by two-thirds, viz., to 30·8 per cent. of the unwelded sheet.

In test 7 the unhammered piece parted outside the welded joint, contrary to the respective test for aluminium. This is only owing to the different mode of treatment of the aluminium and the magnalium. The former was suddenly cooled by being plunged into cold water whilst red hot, the latter being left to cool gradually.

The tests were concluded by two Wolfram aluminium samples 1·5 mm. thick. This alloy showed the greatest tensile strength, viz., 32·6 kg. per sq. mm., or nearly twice that of a 6 mm. aluminium sheet 16·7 kg.

The breaking strain is the same for welded and unwelded aluminium, the resistance somewhat lower, whilst the percentage elongation again is higher than the unalloyed aluminium.

THE ALUMINO-THERMIC PROCESS.

The two elements of most frequent occurrence are oxygen and aluminium. By exposing them in a suitable manner to a chemical combination, a temperature is created which is about equal to that of the electric arc. On this discovery is based the Alumino-thermic process.

The compound "Thermit" consists of a mixture of finely ground aluminium and an oxide of a metal; when this is ignited, the aluminium oxidises, that is, absorbs oxygen so rapidly that an intense heat is the result. In the process of oxidation, the aluminium takes the oxygen from the metallic oxide, leaving a pure metal and oxide of aluminium, both in superheated form.

The mixture or compound is placed in crucibles which are not in contact with any external source of heat, and the combustion, once started, embraces the whole mass in a very short time.

In the crucible after the reaction there are two layers. The bottom one is pure metal of equal weight to, but occupying

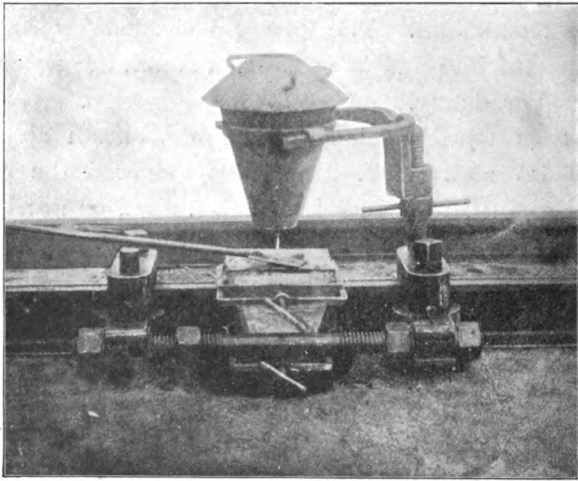

FIG. 22.—Complete Rail Welding Outfit.

only one-third of the space of the top layer, which is now oxide of aluminium, so-called corundum.

The crucibles consist of a sheet iron shell lined with a special mixture of magnesite and bituminous cement; they are of simple construction and will stand about twenty reactions; the wear and tear therefore amount to only a few pence per joint.

“Thermit” is not explosive. It can only be ignited at a temperature of about $2,000^{\circ}$ Fahr., which in practice is obtained by means of a special ignition powder placed in a little heap on the top of the compound and ignited by means

of a flaming vesta. The temperature generated is about 5,400° Fahr.

A simple application of the alumino-thermic process is that for welding of tramway rails, and the third or conductor rails of electric railways, obviating the use of bands and their

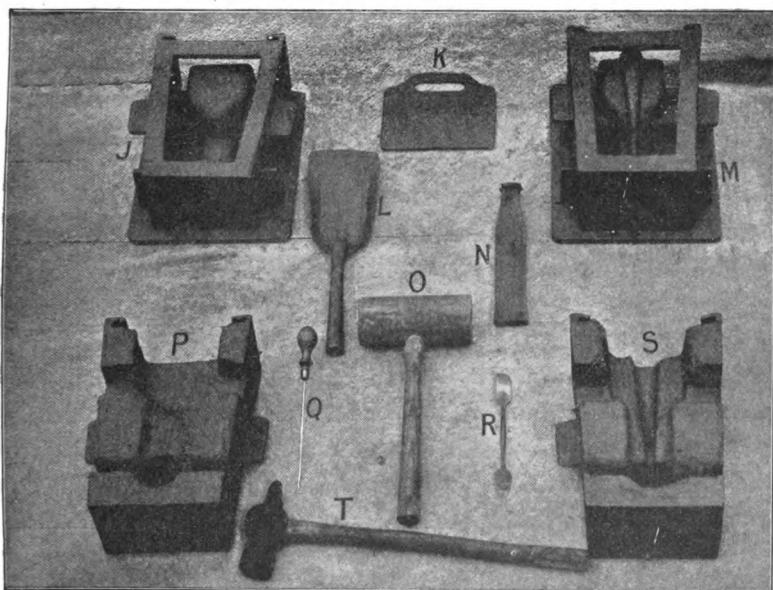

FIG. 23.—Mould, with Tools.

- | | |
|---|--|
| J. Outside Model of Rail and Mould Case. | O. Wooden Mallet. |
| K. Mould Case End. | P. Outside Mould filled ready for use. |
| L. Shovel. | Q. Pricker. |
| M. Inside or Check Side Model of Rail and Mould Case. | R. Moulders' Tool. |
| N. Mould Rambler. | S. Inside Mould filled ready for use. |
| | T. Hammer, $3\frac{1}{2}$ lb. |

consequent troubles. Underground systems can be welded throughout without fear of trouble from expansion or contraction, but on lines where the rails are entirely exposed occasional expansion joints should be allowed for.

A welding plant consists of a crucible, accessories, and

mould box, the whole of which can easily be carried on a hand truck (Fig. 22).

A mould is made according to a model designed specially for each separate operation; for instance, in the welding of rails, a mould in two parts, one on each side of the rail, firmly encloses and exactly fits the rail (Fig. 23). The steel running out of the crucible flows round the web and foot of the rail, and, melting them, forms one mass with them. The liquid slag which follows the metal is diverted to the top of the rail and brings the latter to welding heat. The whole section is thus heated equally and the rail ends will not buckle.

The welding is done automatically and does not require an expert welder, but may easily be carried out by the permanent staff of any company.

The *Paris Metropolitan Railway* made some experiments on a short track, with the result that after one year's trial 1,200 joints were welded in 1904; the rails are 104 lbs. per yard. In 1906 a further 1,800 joints were welded, part of which were on exposed track, in which case lengths of 250 yards were welded together, having an expansion joint between. The results obtained having proved satisfactory, the directors decided to weld the whole system, some 10,000 joints, in a similar manner.

On the suburban railway from *Berlin to Grosslichterfelde*, the *Allgem. Elektr. Ges.* of Berlin, have welded $13\frac{1}{2}$ miles of track. The rails on this track are exposed; three lengths of 45 ft. rails are welded together and connected to the next by an expansion joint.

The question of a continuous rail on exposed railways is not yet solved, for want of sufficient tests. That it is practicable within certain limits, and that it is desirable to have greater lengths of exposed track welded together, is admitted by permanent way engineers. In any case exposed rails can

undoubtedly be welded without any risk in tunnels and subways where differences of temperature are very slight, and contraction and expansion therefore only minimal.

The matter of securing a proper joint for fastening together the ends of rails so as to make a smooth riding track without appreciable jar or jolt when the wheels pass a joint deserves, therefore, great consideration, and many forms of such joints have been suggested. All of these welded joints fasten the ends of the rails together, so that the rail is practically continuous, just as if there were no joints, so far as the running surface of the rail is concerned.

It was thought at one time that a continuous rail would be an impossibility because of the contraction and expansion of the rail under heat and cold, which, it was thought, would tend to pull the rails apart in cold weather and to cause them to bend and buckle out of line in hot weather. Experience has conclusively shown, however, that contraction and expansion need not be taken into account when the track is paved, provided it is well constructed and long lengths of rail are not left exposed to the rays of a hot sun for a considerable period. The paving tends to hold the track in line, and to protect it from extremes of heat and cold. The reason that contraction and expansion do not work havoc on track with welded joints is probably that the rails have enough elasticity to provide for the contraction and expansion without breaking.

It is found that the best results are secured by welding rail joints during cool weather, so that the effect of contraction in the coldest weather will be minimum. In this case, of course, there might be considerable expansion of the track in the hottest weather, but this does not cause bending of the rails, whereas occasionally, if the track is welded in very hot weather, the contraction in winter will cause the rail to break.

The following tests, carried out by independent experts and

well-known engineers, show the relative strength of the "Thermit" rail joint compared with the rail itself, and proves that the running surface of the rail is not chemically altered during the process of welding, and that the electrical conductivity is higher than that of a joint with fish plates and bonds.

A. Tests made for Leeds Corporation Tramways.

Rails supported 5 ft. centre to centre, test made with 10 in. ram, 2 in. bearing on head of rail.

Up to 28 tons, no deflection, and then $\frac{1}{8}$ in.

„ 30 „ $\frac{1}{32}$ in.

„ 40 „ $\frac{1}{32}$ in.

„ 50 „ $\frac{3}{32}$ in.

„ 55 „ $\frac{3}{32}$ in.

„ 60 „ $\frac{1}{8}$ in.

Test was then stopped, and it was found that there was no permanent set whatever.

Pressure brought on again to 65 tons, still only $\frac{1}{8}$ in. deflection.

At 68 tons rail still sound.

„ 70 „ „ broke, not through the weld.

B. Second Test made for Leeds Corporation Tramways.

Hydraulic test; dead load; 5 ft. bearings, 10 in. ram, 2 in. bar on head of rail.

RAIL WITHOUT JOINT.

85 tons $\frac{3}{16}$ in. set.

90 „ $\frac{1}{4}$ „

95 „ $\frac{1}{2}$ „

and slight fracture.

RAIL WITH "THERMIT" WELDED JOINT.

Up to 60 tons no permanent deflection.

Safe dead load at 68 tons.

70 tons fractured at side of the weld, the welded portion remaining intact.

FISH AND SOLE PLATE JOINT.

Fish plates 62 lbs. per pair, 2 ft. long, six 1 in. bolts; sole plate 46 lbs., 2 ft. \times 8 in. \times $\frac{3}{4}$ in., twelve $\frac{7}{8}$ in. bolts.

Permanent set at 85 tons $\frac{3}{4}$ in.

„ „ 90 „ $\frac{7}{8}$ „

Fractured at 102 tons.

*Report of the Tensile Test carried out at Phoenix Works,
11th May, 1903, on "Thermit" welded Rail.*

Test pieces of equal size (diameter $\frac{3}{4}$ in., area 0.48 sq. in.) were taken from the head of the rail.

	Unwelded Rail.	Thermit Welded Rail.
Limit of elasticity	27,000 lbs. = 26.1 tons per sq. in.	26,400 lbs. = 24.5 tons per sq. in.
Maximum strain	49,720 lbs. = 46.09 „ „	43,560 lbs. = 40.4 „ „
Elongation	13 per cent.	4 per cent.
Dimension of fracture	$\frac{1}{4}$ in.	$\frac{3}{4}$ in.
Compression	16.5 per cent.	4 per cent.

Result shows that the welded part has 87.75 per cent. of the strength of the original material, which is very satisfactory indeed. The test was carried out in the presence of *Engineer Kurz*, of the above works.

(Signed) H. TIEMANN,
Engineer.

Essen Ruhr,
12th May, 1903.

P.S.—It should be noted that the above test refers to the rail

without the ring of "Thermit" iron, by which it would be materially strengthened.

Tests showing the Relative Resistance of "Thermit" Joints compared with Fish Plate Joints and Bonds.

(A.) Test made on a Leeds section of rail, 100 lbs. per yard. The readings below are the mean of several:

Resistance of 8 ft. of solid rail alone . . .				·00006772	ohms.
„ 8 „ with "Thermit" joint . . .				·0000712	„
„ 8 „ with "Thermit" joint and one bond . . .				·0000678	„
„ 8 „ with fish and sole plates only				·0001051	„
„ 8 „ with fish and sole plates and one bond . . .				·0000875	„
„ 8 „ with fish and sole plates and two bonds . . .				·0000776	„
The resistance per foot of solid rail . . .				·000008465	„
The bonds used were 4/0 B. & S. Chicago type.					

(B.) Test made by *Mr. J. Lord*, Borough Engineer, Halifax (1904):

Weight of rail, 96 lbs. per yard.

Resistance of 8 in. solid rail				·000067	ohms.
"Thermit" welded joint, same length of rail				·000072	„
„ „ „ with one bond				·000067	„
Fish plates, sole plate and two bonds, newly constructed				·000078	„
Ditto, after two years				·000095	„



ALUMINO-THERMIC WELDING

(C.) Test made by *Mr. I. E. Winslow*, Consulting Engineer to *Coventry Electric Tramways Co.* (1905).

Resistance of consecutive "Thermit" joints, 4 ft. rail 80 lbs. per yard, with joint, also 4 ft. of rail without joint.

Resistance of joint in ohms.		Resistance of rail in ohms.	
1.	·0000455		·0000420
2.	·0000446		·0000392
3.	·0000476		·0000415
4.	·0000468		·0000391
5.	·0000464		·0000375
6.	·0000405		·0000410
7.	·0000458		·0000365
<hr/>		<hr/>	
Average resistance	} ·0000453 ohms.	Average resistance	} ·0000395 ohms.
<hr/>		<hr/>	

Conductivity Test.

LEEDS CITY TRAMWAYS.

Conductivity test of "Thermit" welded rail joint on near rail, inward track, opposite St. Thomas Street, North Street, Leeds.

This track was put down in July, 1903, and has since been in continuous use.

Reading.	4 ft. rail.		4 ft. rail with joint and bond.		Equivalent length of rail with same resistance as joint and bond.	Per cent. greater conductivity than rail itself.
	A.	V. Drop.	A.	V. Drop.		
1	284	·0085	284	·008	3·76 ft.	5·9
2	252	·0075	252	·00725	3·86 ,,	3·5
3	252	·0075	252	·00725	3·86 ,,	3·5

Reading.	4 ft. rail.		4 ft. rail with joint, but without bond.		Equivalent length of rail with same resist- ance as joint and bond.	Per cent. less conductivity than rail itself.
	A.	V. Drop.	A.	V. Drop.		
4	224	·0065	224	·007	4·3 ft.	7·5
5	100	·0025	100	·00275	4·4 ,,	10·0

Conductivity of joint with bond is 4·3 per cent. better than the rail itself.

Conductivity of joint without bond is 8·75 per cent. lower than the rail itself.

NOTE.—The figures for current denote the amperes applied, but as the tests were made with rail in position and therefore not isolated, a proportion would pass round the tie-bars and cross-bonds.

J. BURBRIDGE,

Chief Electrical Engineer.

Leeds,

29th July, 1905.

Chemical Test.

Analysis of rails welded by alumino-thermic process at Leeds, made by *Messrs. Walter Scott, Limited*, Leeds Steel Works, 25th March, 1903.

Three separate drillings for analysis were taken from the Leeds rail which was tested under our machine.

No. 1. Sample was taken from the end of the rail away from the joint.

No. 2. Sample was taken from the end of the rail at the joint.

No. 3. Sample was taken from material composing the joint, which was slightly honeycombed in appearance.

	No. 1.	No. 2.	No. 3.
Carbon . . .	·52 per cent.	·50 per cent.	·18 per cent.
Phosphorus . .	·08 „	·08 „	·08 „
Manganese . .	·93 „	·94 „	·23 „
Sulphur . . .	·059 „	·058 „	·061 „
Silicon . . .	·019 „	·018 „	·170 „

I find that the welding has not made any difference in the hardness of the head of the rail. It is quite evident that the material forming the joint is much softer than the rail.

(Signed) ROBERT HAMILTON.

MANCHESTER CORPORATION TRAMWAYS.

TESTING OF TRAM RAILS.

Bending Tests.

Description.	Span.	Loads elastic limit.	Bending moment.
Solid rail	10 ft.	28,200	70,500
Fishplate jointed rail	10 „	10,000	25,000
“Thermit” jointed rail	10 „	25,000	62,500
Solid rail	5 „	74,000	92,500
“Thermit” jointed rail	6 „	42,000	63,000

Chemical Tests.

Ordinary steel rail.	“Thermit” weld.	Drillings from rail head near welded joint.	Drillings from rail head away from welded joint.
Iron . . . 98·520	Iron . . . 97·82	Iron . . . 98·3743	Iron . . . 98·331
Manganese 0·865	Manganese trace	Manganese 1·009	Manganese 1·038
Phosphorus 0·042	Phosphorus „	Phosphorus 0·067	Phosphorus 0·065
Sulphur . 0·054	Sulphur . 0·02	Sulphur . 0·059	Sulphur . 0·058
Silicon . 0·021	Silicon and	Silicon . 0·0027	Silicon . 0·018
Carbon . 0·498	Insoluble 0·51	Carbon . 0·488	Carbon . 0·490
Arsenic . trace	Carbon . 0·11		
	Aluminium 1·48		

These analyses indicate no alteration in the composition of the steel in the rail head.

Hardness Tests.

Load on die in tons.	Welded rail. Length of indentation produced.	
	Away from joint.	Close to joint.
0·25	0·26 in.	0·26 in.
0·50	0·32 „	0·32 „
0·75	0·37 „	0·36 „

Metal tested from head of rail.

The relative hardness was determined by measuring the lengths of indentations made by a hardened steel die with a curved edge struck to a radius of 1 in., and having a cutting edge whose angle was 50°.

From these results it would appear that there is no appreciable difference in the hardness of the surfaces.

J. M. McELROY,
General Manager.

29th November, 1906.

A few instances of general repairs actually carried out will give an idea of the applications of the "Thermit" process.

Figs. 24 and 25 show a repair to an axle gear of a 200 h.p. traction motor. This was a new gear which had never been in service, but after it had been cut, blowholes were found in the casting which practically severed the ends of three teeth from the rim. These were not apparent in the blank, hence all the workshop expenses had been incurred. The defective halves of the three teeth were chipped out, and a solid block of "Thermit" steel cast in, as shown in Fig. 24. The cutter was then run through, leaving a perfect gear, as seen in Fig. 25. This gear is now in constant use on one of the London electric railways.

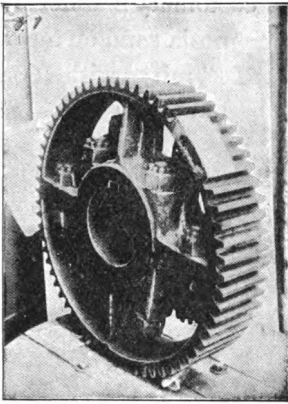

FIG. 24.—Repair before Machining.

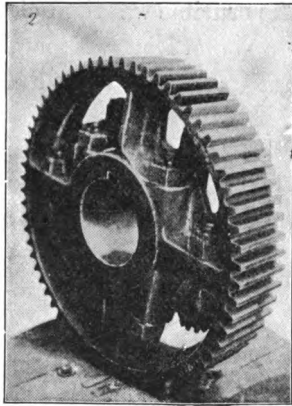

FIG. 25.—Finished Repair.

Figs. 26 and 27 show the application of the “Thermit” process to large marine repairs.

The s.s. *Rockton*, tonnage 1,971 tons, then owned by the *Australian Steam Navigation Company*, of Sydney, entered Mort’s Dock, Sydney, on Wednesday, 5th January, 1905. On examination it was found that the keel of the cast-steel stern frame had three distinct fractures, each about 6 ins. apart, the first fracture being about 12 ins. from the stern post. These fractures were opened 1 in. wide by drill and chisel until solid metal was met with for allowing the “Thermit” steel to flow into.

The mould box, consisting of three parts, was manufactured of $\frac{1}{8}$ in. plate, stiffened by angle irons, at Mort’s Dock during Thursday, and the mould formed therein with clay and sand during that night and placed in the drying chamber. After the fractured part of the stern post had been heated to a dull red, the mould was carefully placed in position on Friday, well packed with moist sand, and the crucible erected above the inlet of the mould.

The crucible was then closed in the customary manner by an asbestos and iron washer with $\frac{1}{2}$ in. magnesia sand on top of it, and charged with 1,200 lbs. of "Thermit" mixed with 120 lbs.

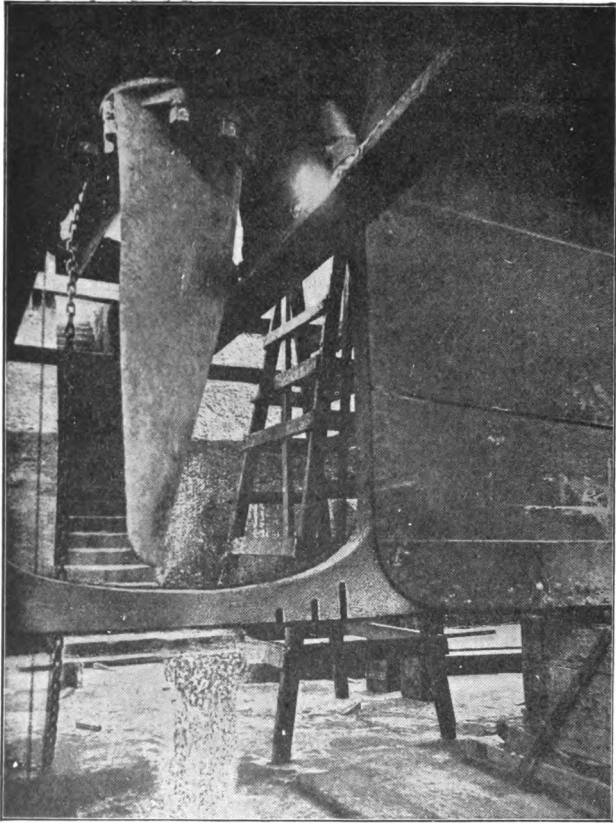

FIG. 26.—Cracks in Stern Frame opened up for Welding.

of steel punchings, on top of which $\frac{1}{2}$ oz. of ignition powder was placed. At 5.55 p.m. the match was put to the ignition powder. The reaction lasted for forty-five seconds, after which the crucible contained in the bottom part 720 lbs. liquid

“Thermit” steel of a temperature of $5,400^{\circ}$ Fahr. and about 600 lbs. of liquid slag flowing on top of the liquid steel. After waiting for a further thirty seconds the lever underneath the

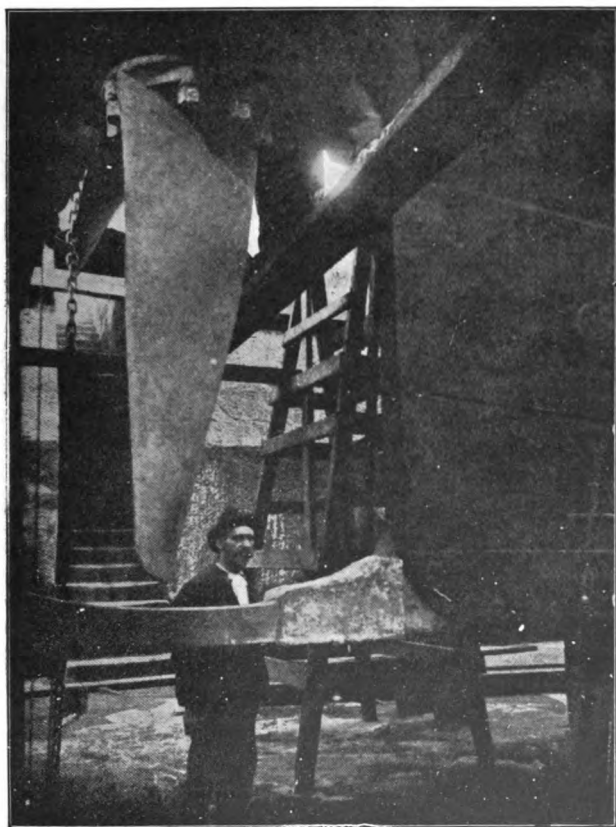

FIG. 27.—Finished Weld.

crucible was pressed and the liquid steel allowed to flow into the mould.

From the time of placing the match to the ignition powder until the last drop of molten steel had left the crucible and

flown into the mould $1\frac{1}{2}$ minutes had elapsed. The mould was opened five hours later, when it was found that the weld was a perfect one, the Thermit steel had entirely amalgamated with the metal of the stern-frame and formed one homogeneous mass therewith. The whole welding was then annealed for twelve hours, when the runner and two risers, which were formed by the shape given to the mould, were trimmed off. The toughness of the Thermit steel and the ideal amalgamation of the two metals, viz., the Thermit steel and the metal of the stern-frame, was much commented on by the leading marine engineers, marine surveyors, and managers of the various steamship companies, who witnessed the performance.

By this weld the opened up cracks were filled and welded with Thermit steel, and, at the same time, a steel collar 24 ins. long and $2\frac{1}{2}$ ins. thick at each side, 2 ins. thick at the top and $\frac{3}{4}$ in. at the bottom was cast round the entire fractured part of the stern-frame, and pronounced by the N.S.W. Government and Lloyd's surveyors as a perfect repair. Anyone knowing the nature and magnitude of such repairs as the one performed on the s.s. *Rockton*, must reflect on the speed with which this repair has satisfactorily been accomplished by Thermit, namely, within three days from the time the steamer floated into the dock until ready for leaving again.

BLAU GAS WELDING.

The application of Blau gas for welding purposes is being introduced, but there are yet no data as to results obtained.

BRAZING, LEAD BURNING, AND SOLDERING.

Brazing consists in uniting metal parts by flowering melted brass, technically called spelter, between them. It is practically

identical with soldering except that spelter is substituted for solder and that a much greater degree of heat is necessary.

In the greater heat required to melt spelter lies one of the advantages which brazed work possesses over that which is soldered, the finished work enduring more heat without breaking or weakening, but the chief advantage lies in the

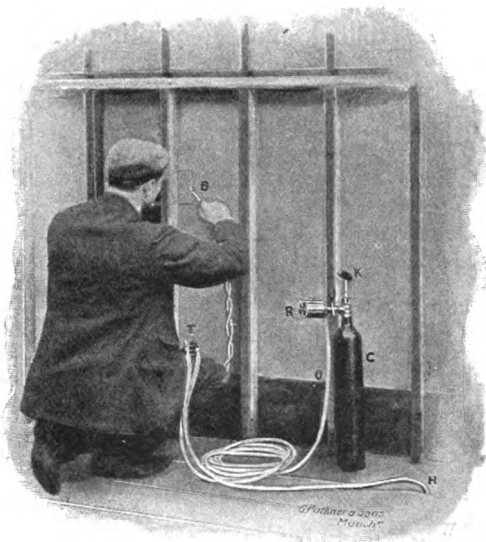

FIG. 28.

superior strength and its applicability to a large variety of uses.

Lead burning is often made by autogenous welding, using hydrogen or coal gas as the combustible gas in conjunction with oxygen. Hydrogen is largely used abroad for welding of lead accumulators; more convenient, however, is the use of coal gas, as generally more easily obtainable.

The oxy-coal gas blowpipe introduced by the *British Oxygen Company* is now extensively used by lead burners. It is constructed on the injector principle. By its use oxygen, delivered

under slight pressure from a trade cylinder, is caused to draw coal gas direct from the ordinary town supply, and then eject the mixed gases in the right proportion through the nozzle of the blowpipe. The use of pure oxygen instead of air for combustion with this blowpipe enables coal gas to be employed instead of hydrogen, as the combustible gas.

It is suitable for ordinary flat work, horizontal and upright joints, overhead patching, and the jointing of ordinary lead piping.

The illustration (Fig. 28) shows a man fully equipped with everything required by this system for a day's lead burning in any place where a supply of ordinary town's gas can be obtained.

Relative Advantages of the Systems.

(1) *Economy.*

To supply the requirements of one lead burner the comparative cost per week of the two systems is approximately as under:—

<i>Hydrogen-Air System</i>	£	s.	d.
Zinc and sulphuric acid	0	11	0
Boy's wages	0	10	0
Total	£1	1	0

<i>Oxy-Coal Gas System.</i>	£	s.	d.
Oxygen delivered in cylinder on the user's works	0	10	0
Coal gas from town supply	0	0	6
Total saving per week	£0	10	6

(2) The hydrogen generator is dispensed with.

(3) The air bellows is dispensed with, and consequently the services of a boy are not required.

(4) Instead of having to move a heavy hydrogen generator and air bellows from one job to another, it is generally only necessary to move a light cylinder containing the oxygen required.

(5) No apparatus to get out of order, involving expensive delays and repairs.

(6) As no zinc or sulphuric acid are used, there is no



FIG. 29.—Oxy-Coal Gas Blowpipe.

deleterious matter to be carried through the blowpipe to act injuriously on the lead seam.

(7) No pre-warmer or “fou-fou” required on heavy work. The blowpipe flame is so hot that even heavy lead in wet and cold positions can be burned *in situ* without pre-heating.

(8) No gas generated when the blowpipe is not in use, and consequently there is no waste of gas, and no charge to withdraw overnight.



FIG. 30.—Shoulder Taps.

(9) In places where a supply of town's gas is not available, coal gas or hydrogen can also be obtained from the British Oxygen Company in cylinders, or the oxygen may be used advantageously with a hydrogen generator.

In the oxy-coal gas system of lead burning compressed oxygen takes the place of air, and ordinary town's gas takes the place of the hydrogen used in the old system.

The blowpipe is an ordinary lead burner's blowpipe with two inlets, one for oxygen (O) and the other for coal gas (H).

The oxygen inlet is constructed in the form of an injector, by means of which the pressure of the oxygen (about 15 lbs. per square inch) coming from the cylinder through a regulator (Fig. 31) is made to suck the necessary supply of coal gas through the inlet H of the blowpipe, and deliver the gases well mixed and under sufficient pressure to the burner nozzle. The blowpipe (Fig. 29)

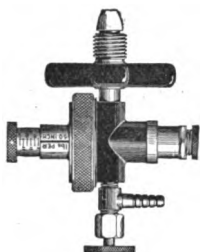

FIG. 31.—Endurance Regulator.

is constructed in two sizes, each being provided with two nozzles and a wind shield, the full equipment being capable of dealing with all weights of lead.

CHEMICAL WELDING OF IRON AND STEEL AT A LOW TEMPERATURE.

At the Franco-British Exhibition the *Société des Plaques et Poudres à Souder*, J. Laffitte exhibits some specimens of their welded articles of iron and steel.

The welding agent used consists of thin welding plates, principally of copper, chequered and sectioned so that they may easily be divided by hand according to requirement, or of a flux in form of a powder, different for welding, brazing, tempering, and which is sold in tins. The welding plate is placed between the two pieces to be welded together, put into the ordinary coal fire and heated, and then hammered together. The use of these welding plates, it is said, ensures in every case an absolutely homogeneous weld, equal to the original metal.

In exceptional cases, where the rigidity of the plate does not lend itself to the work to be done, such as cementing a flaw, welding in a hole, etc., the welding powder is successfully employed.

COAL GAS WELDING.

The ordinary coal or illuminating gas may be used for welding. The arrangement is extremely simple and inexpensive, as the heavy steel cylinder containing any of the combustible gases is substituted for a rubber tube, by means of which the gas is conveyed from the place of supply (from an ordinary gas-pipe tap) to the blowpipe as fully described under "Brazing," page 82.

The great advantage possessed by the coal gas over any other combustible gas is to be found simply in the cheapness of the installation, making it thus the cheapest welding system.

The application of coal gas is, however, limited to brazing, and welding of lead, bronze, brass, etc. How far it is suitable for welding of iron and steel is a question to be considered.

WELDING OF COPPER.

The welding of copper requires a larger sized blowpipe than that for iron of corresponding thickness, by reason of the greater conductivity of copper. A flux is always required, pulverised *acidum boricum* generally being used for such purpose. The weld should always be mechanically treated as soon as it has cooled.

The welding of copper is a substitute for brazing in copper work of various descriptions. By means of the coal-gas blowpipe, copper pipes and many kinds of sheet-copper structures can be fused together as one pipe, where brazing would otherwise be necessary.

A Parisian metallurgist claims to have perfected a process of welding copper to steel wire so as to make a non-corrosive coating. Many advantages, it is said, will result from the use of this new wire, such as high tensile strength and elasticity, combined with smaller surface exposed to wind and sleet than would be the case with iron wire at the same conductivity.

This wire, it is said, is especially useful over long spans, as pole intervals may be much greater where it is used. Compare with "Brazing," page 82.

ELECTRIC WELDING.

Electric welding is gaining rapid acknowledgment, the more as its great advantages combined with inexpensive machinery and easy manipulation are becoming known. It has, during the last few years, developed into many branches and industries which at the time of its inception were quite undreamt of.

The erroneous opinion that electric welding is expensive and difficult to manipulate, based, no doubt, upon results of antiquated systems, lack of technical knowledge, and general inexperience, is, however, easily overcome by simple investigation. It should not be forgotten that since the first introduction of electric welding some fifteen years since, great improvements have been made and that large works have been built with the sole object of building suitable machines for electric welding, with the result that the machines have reached almost perfect simplicity, being generally automatic in their working, reducing thereby manual labour to a minimum and limiting technical knowledge to that possessed by every mechanic.

There are several methods of electric welding, differing from each other both in principle and application—*Arc welding* being a *surface welding*, and *Resistance welding* being a *sectional welding* depending upon the internal resistance which a body presents to the passage of the electric current.

Arc welding appears to have been first employed by *De Meritens*, in 1881. In this instance leaden pieces designed to be united in the form of storage battery plates were arranged together as an extended positive electrode, and an arc was drawn between them and a negative carbon rod

manipulated by means of an operating handle. Part of the heat energy of the arc served to melt the lead and cause union of the adjacent pieces, but much the larger proportion of the energy escaped by radiation and convection. The electric arc was thus akin to a gas blowpipe as commonly used in lead burning in the construction of tanks for the chemical industries.

Following De Meritens, heating by electric arcs has been applied to the fusing and welding of metals, notably of iron and steel, by *Bernardos* and *Olszewski*, *Coffin*, and others.

When, as in the *Bernardos* and *Olszewski* method, the carbon electrode is made positive to the work, carbon is transported through the arc and is likely to enter the metal undergoing the process, which constitutes the negative pole. This addition of carbon may render iron and steel hard and unworkable and cause cracks to be formed during the cooling of the fused mass at the joint or filling.

By the employment instead of carbon of an electrode of the same metal as that of the work, *Slavianoff* overcame this difficulty. The gradual melting of the metal electrode furnishes metal for forming joints, or for repairing or supplementing castings which are defective, such as those which are incomplete or contain blowholes.

More recently the work is made the positive pole, and this results in a greater proportion of the energy than formerly being expended in heating the metal undergoing the operation.

Inasmuch as the conditions of energy supply for sustaining the arc are but little different from those often found in the commercial operation of arc lamps from constant potential mains, arc welding may often be practised by connections made to such mains. A steadying resistance is put in series with the fusing arc in a branch from direct current lines at a potential difference of 200 volts or thereabout.

With work such as that to which the Bernardos and Olszewski method has been found to be applicable, the current in the arc may vary from 150 amperes up to 500 or more. The potential across the arc itself will generally be from 100 to 150 volts.

With the metal electrode used by Slavianoff the current needed will be greater, and the arc potential less than the above amounts. It appears that in certain cases the current may even surpass 4,000 amperes.

Werdermann, in 1874, proposed to deflect an electric arc formed between the usual carbons by a jet of air, forming thereby an electric blowpipe.

More recently *Zerener* has in a similar way employed an arc deflected by a magnet as a sort of blowpipe for welding iron.

In addition, the curious electric heating action first published by *Hoho* and *Lagrange* has been proposed for welding metals.

If a negative electrode, of a direct current circuit having a potential of 100 to 150 volts, is of small surface relatively to that of the positive electrode and both are immersed in a liquid bath, such as a solution of potassium or sodium carbonate, the surface of such negative electrode glows with light, gas bubbles arise from it, and the electrode itself heats rapidly in spite of its immersion in cold liquid. A bar of iron used as the negative electrode may thus be brought to incandescence and removed for welding, or it may even be melted under the liquid of the bath. The loss of heat in such a liquid heating process is necessarily somewhat great.

While the moderate application of these arc processes for fusing and welding iron and steel has been made, the range of operations to which they are suitable is somewhat limited, and their success depends largely upon the skill of the workman. He must protect not only his eyesight but also the

surface of his body from the glare of the large arc, and also avoid the irritating vapours which arise from the flame. At the same time vigorous ventilation cannot be employed, for motions of the air tend to disturb the arc and render the work more difficult. A large proportion of the energy is radiated or carried off in the hot gases from the arc. To these energy losses must be added that due to the use of the steadying resistance for obtaining stability in the current of the arc.

On the other hand, the appliances needed for arc fusing or welding are simple, and the source of current energy often conveniently found in existing electric circuits.

The *Resistance system* of electric welding seems to have been first introduced by *Professor Elihu Thomson*, in 1877, whilst making some experiments in the laboratory of the Franklin Institute, Philadelphia, discharging a Leyden battery through the fine wire winding of an induction coil. The fine wire thus became a high potential primary, the ends of the coarse wire winding being brought into light contact and welded together, so that it took some little force to separate them. From this early experiment was developed the now familiar "Thomson process." No electric arc is employed, but the heat which effects the welding is solely due to the resistance of those parts of the metal pieces at the contact where they are to be welded together. This resistance is of course extremely low, and the delivery of sufficient energy for heating and welding is the result of the passage of relatively enormous currents. Their potential is only two or three volts, more or less.

The metal pieces to be welded together are held respectively in massive clamps or vices of highly conducting metal such as copper, with a slight portion only of each piece projecting to form the joint. These projections of the pieces are brought

together in firm contact, for which purpose at least one of the clamps is made movable toward and from the other, both of them being mounted on a firm support. The pieces having been adjusted to meet in correct relation for the subsequent formation of the weld uniting them, an electric current sufficient in amount to heat the meeting portions of the pieces to the temperature at which they soften and unite, is passed from clamp to clamp, thus traversing the joint and the short projecting portions of the pieces between the clamps. So heavy is the current at command that a solid bar without break spanning the space between the clamps could be heated and melted. The completion of the weld after heating is effected by pressure exerted to force one clamp towards the other, which results in a slight upsetting or extrusion of metal at the weld, called a burr.

For copper a pressure of about 600 lbs. per square inch of section is usual, while with iron it is 1,200, and with tool steel 1,800 lbs. or more.

The welding clamps are in practice carried directly upon the secondary terminals of a special welding transformer.

The various applications of the welding by resistance require different machines, according to the shape and size of the work. Mr. Hugo Helberger has kindly lent some of the following blocks.

The current may be supplied from an already existing generating plant, or a new plant (primary plant) may be erected. The most advantageous form of current is single-phase alternating current; in this case the machines may be connected to the electrical supply as easily as an ordinary incandescent lamp. In the case of two- or three-phase current the machine must be connected to one phase, care being taken that this phase is not overloaded in comparison to the other phases. If several welding machines are required these can

be distributed among the different phases, and the use of the multi-phase current presents no difficulties.

In cases where no alternating current is obtainable, only direct current being present, or where no electric current at all is obtainable, a single-phase generator must be installed, or *direct welders*, which are built as *current generating machines*, may be used, always assuming the presence of driving power. Direct welders are only built up to 10 h.p. ; above this, separate generators must be employed.

Motor-generators may be utilised where direct current is obtainable. The direct current is transformed into a suitable alternating current.

Each welding machine consists of two main parts, *i.e.*, the *welding apparatus* and the *transformer*. These two parts are rigidly secured to each other and built as one piece, whereby a higher efficiency is attainable than if each part were built separately.

The *welding apparatus* is essentially an arrangement of mechanical parts and consists of the contact device, the clamping arrangement and the means for exerting the necessary pressure. Rapid working being the chief advantage of electric welding machines, these devices are generally most carefully constructed, even in the smallest detail.

The construction of the welding apparatus with a view of reducing the time of manipulation to a minimum has caused the welding machines to be subdivided into *universal welding machines* and *special welding machines*.

Universal machines are built in such a manner that all kinds of objects can be welded therewith (Figs. 32, 33, 34). In order to increase its practical application the parts as well as the welding apparatus as a whole are made interchangeable.

These machines are chiefly used in constructive iron works, in workshops for architectural and artistic ironwork, and in

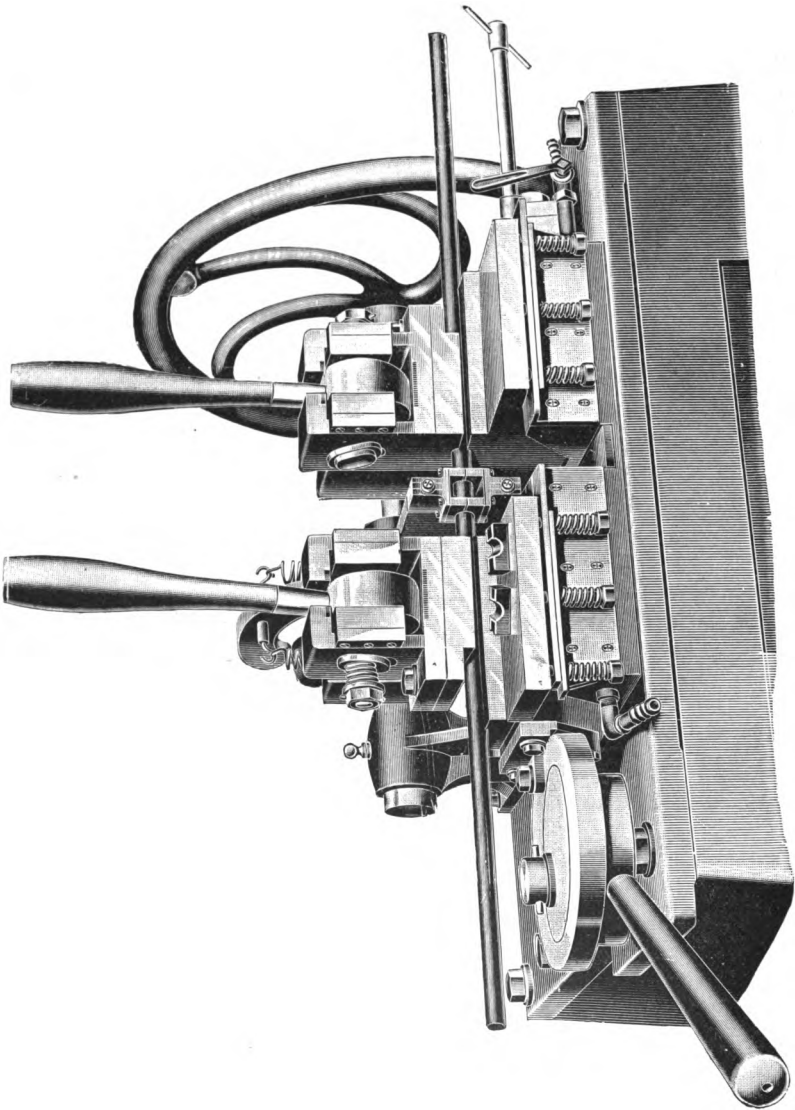

FIG. 32.—Universal Welding Machine for Welding or for Electrically Heating Pieces for Subsequent Working, with Swages, Hand-operated.

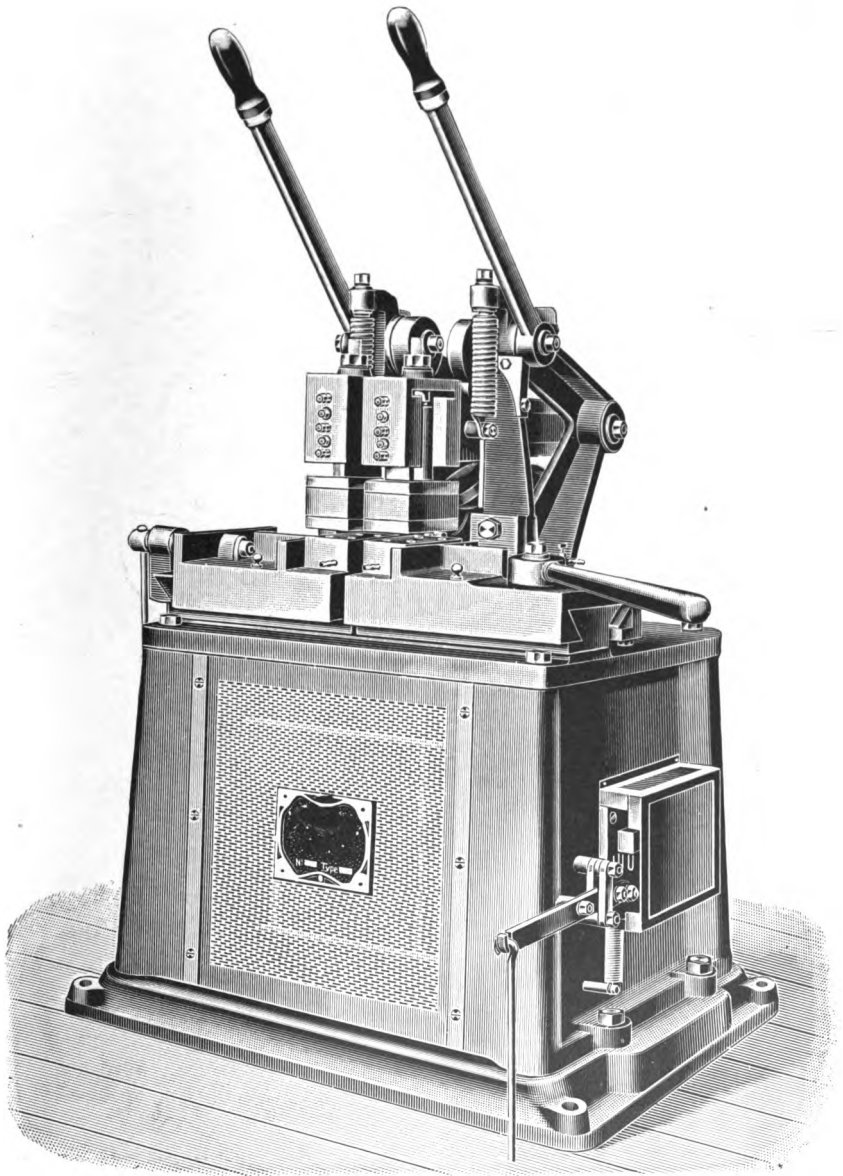

FIG. 33.—Universal Machine, Normal Pattern, without Swages.

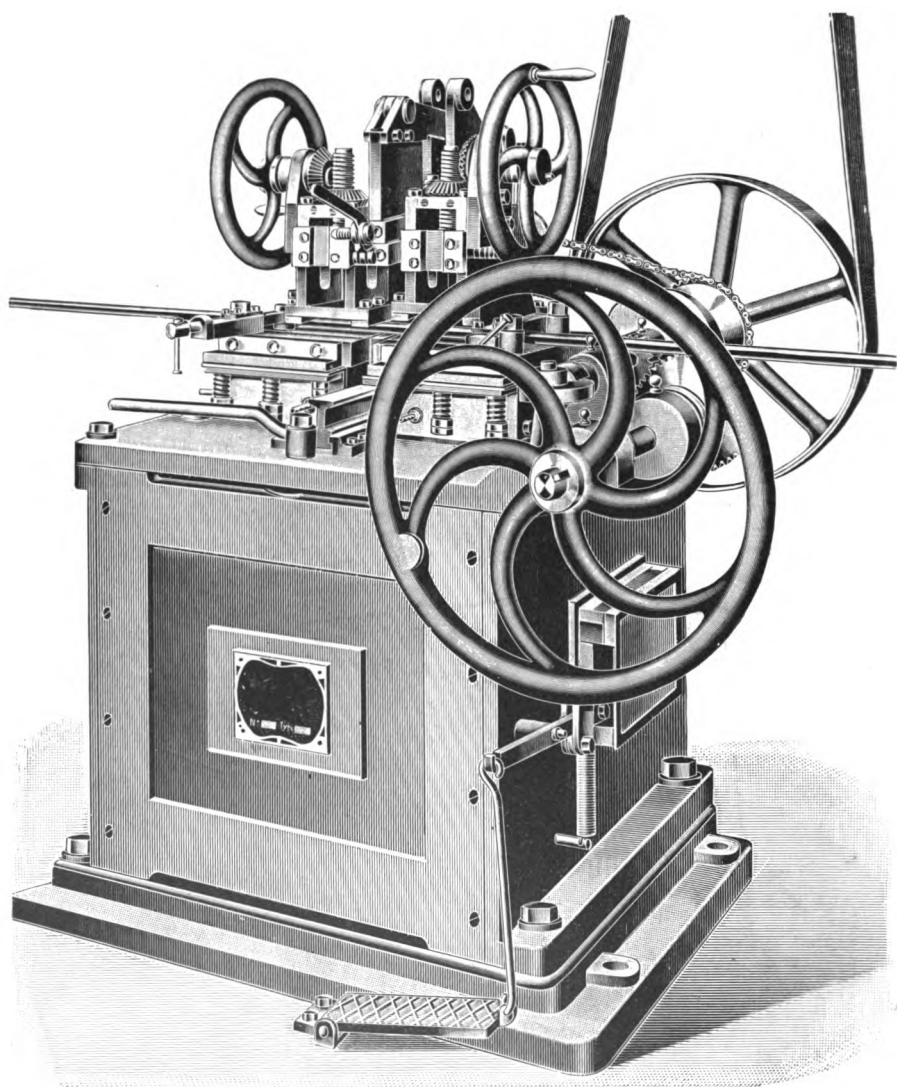

FIG. 34.—Universal Machine, with Automatic Hammer and Adjustable Anvil for Hand and Mechanical Power.

similar establishments for executing all those kinds of welding work which occur most frequently in such works; end to end welding; the welding of pieces at an angle to each other; the cross-welding of wire, rods, bands, square iron, L-iron and all other kinds of profiled iron and steel. By changing the

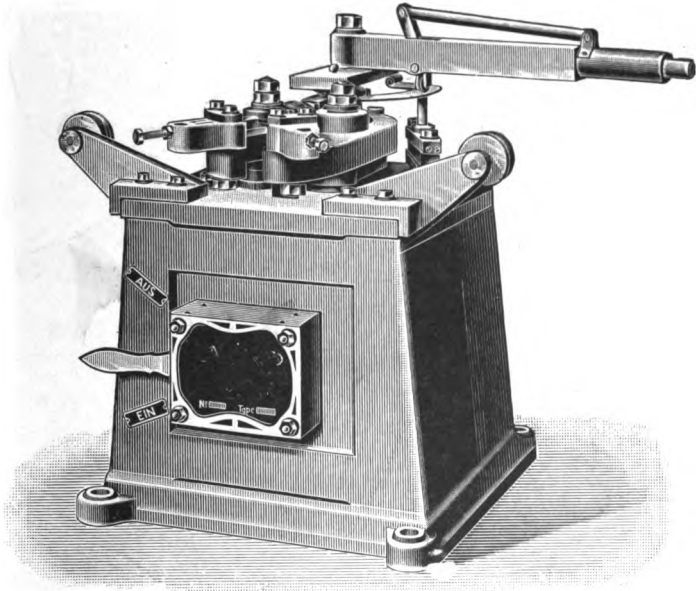

FIG. 35.—Hand Chain Welding Machine, for Chains up to 6 mm. diameter.

welding apparatus the machine can be employed for welding of tubes and hoops or rims.

Special welding machines are constructed for welding one particular kind of article, and should be selected in those cases where great numbers of the article are to be welded, for instance, chains (Figs. 35, 36, 37, 38), buckles (Figs. 39, 40), door-hinges, hinge-hooks, hinge-bands, etc., for doors and cupboards (Fig. 41); end-to-end welding of flat hoops, rings (Fig. 42); for simultaneously welding several pins or pieces

of metal to discs or rings of metal, for instance, as used in watch and clock-making (Fig. 43); for point welding in making iron furniture, grills, etc. (Fig. 44); for welding

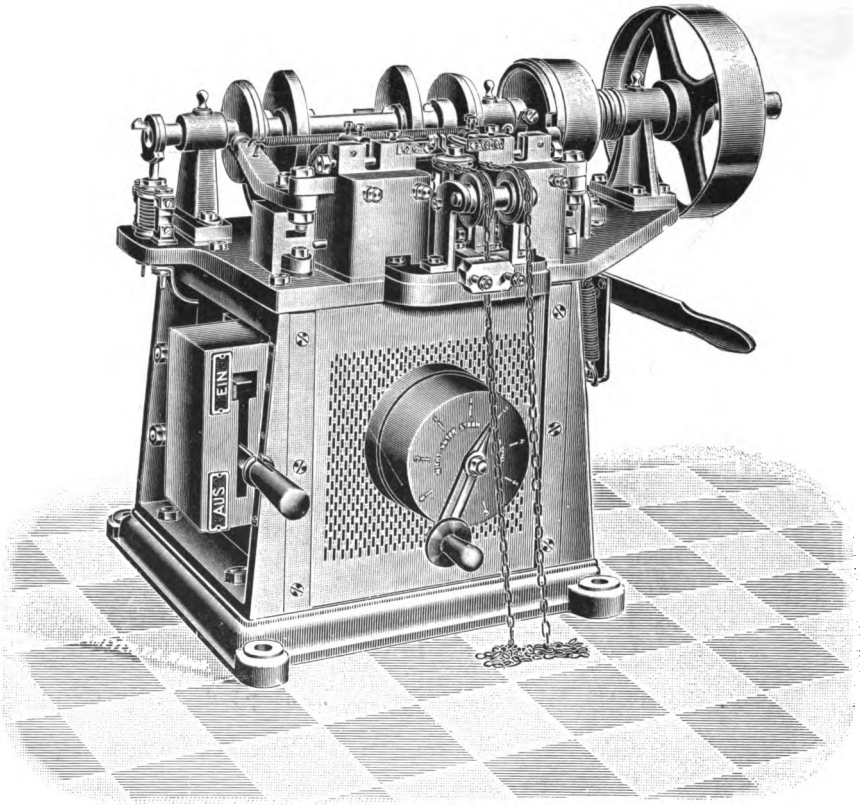

FIG. 36.—Automatic Chain Welding Machine, for Small Chains.

pulley-spokes to rim and hub (Fig. 45); for welding automobile and cycle rims (Fig. 46), and the like. Special machines are constructed for an infinite number of specialised purposes.

In many cases, especially for small articles, the special machines may be converted into automatic machines. The

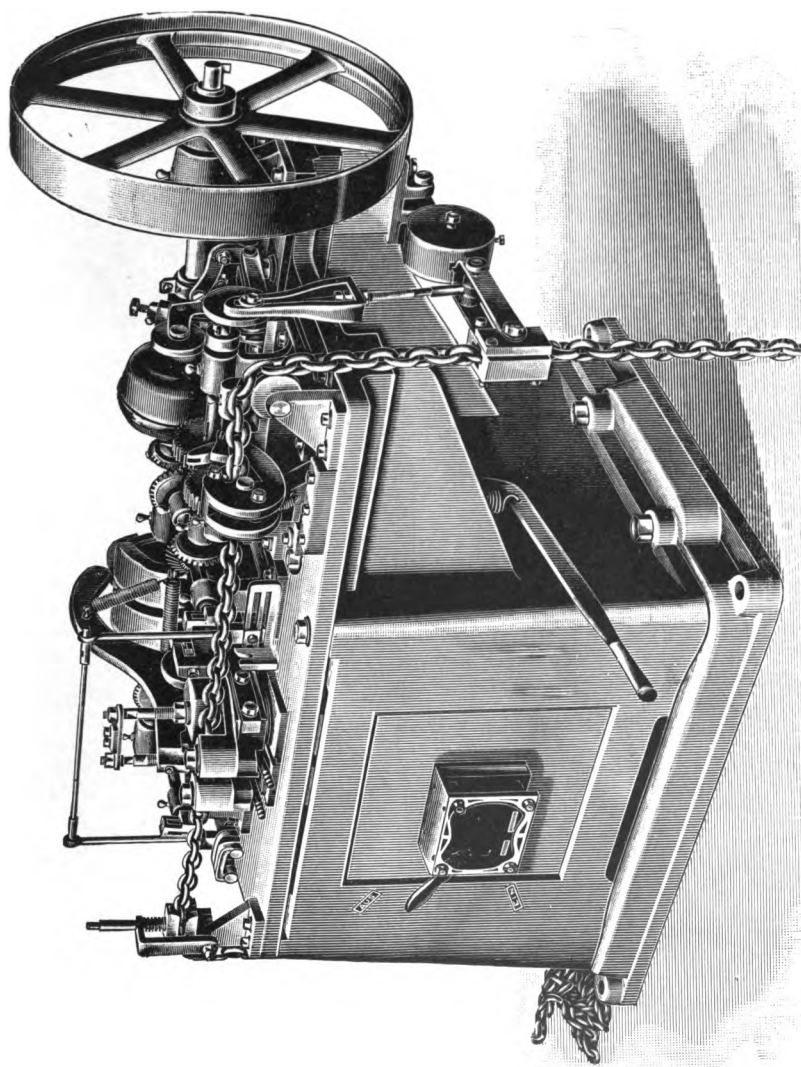

Fig. 37.—Automatic Chain Welding Machine, for Large Chains.

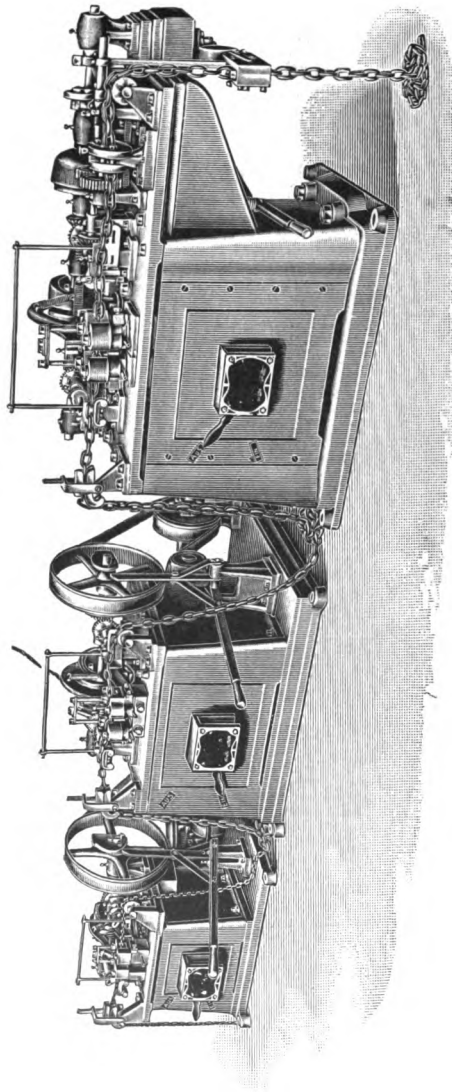

FIG. 38.—Automatic Chain Welding Machine.

removal and replacement of the articles is then performed by mechanical means, or in some cases by electro-magnets, and

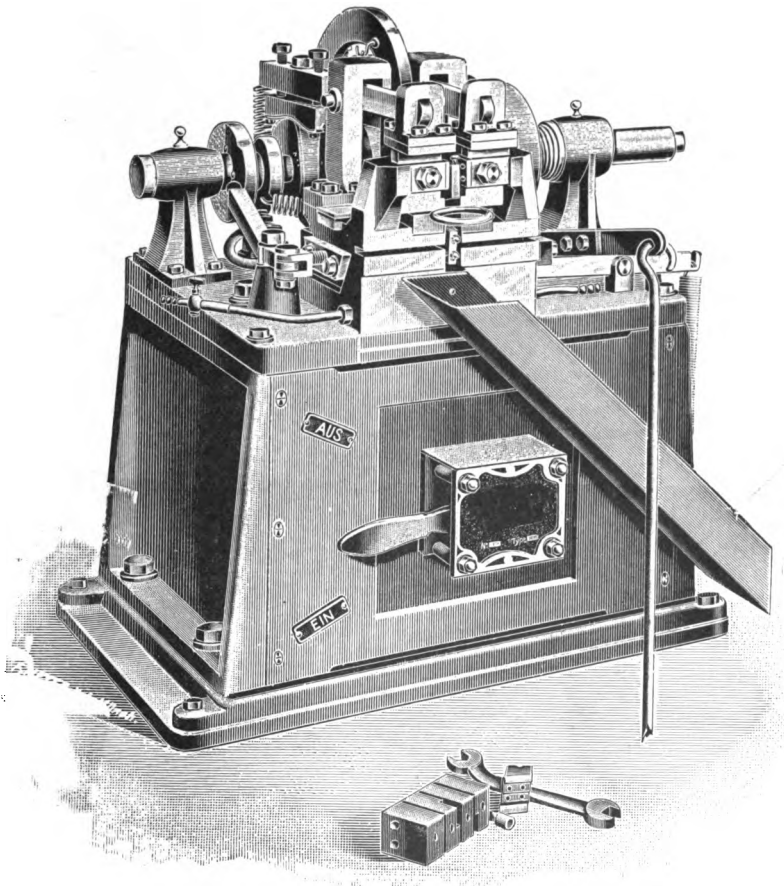

FIG. 39.—Ring and Buckle Welding Machine, for Ridgeless Welding in Swages, Machine-driven.

the functions of clamping and releasing, pressing together, opening and closing the circuit are under the influence of

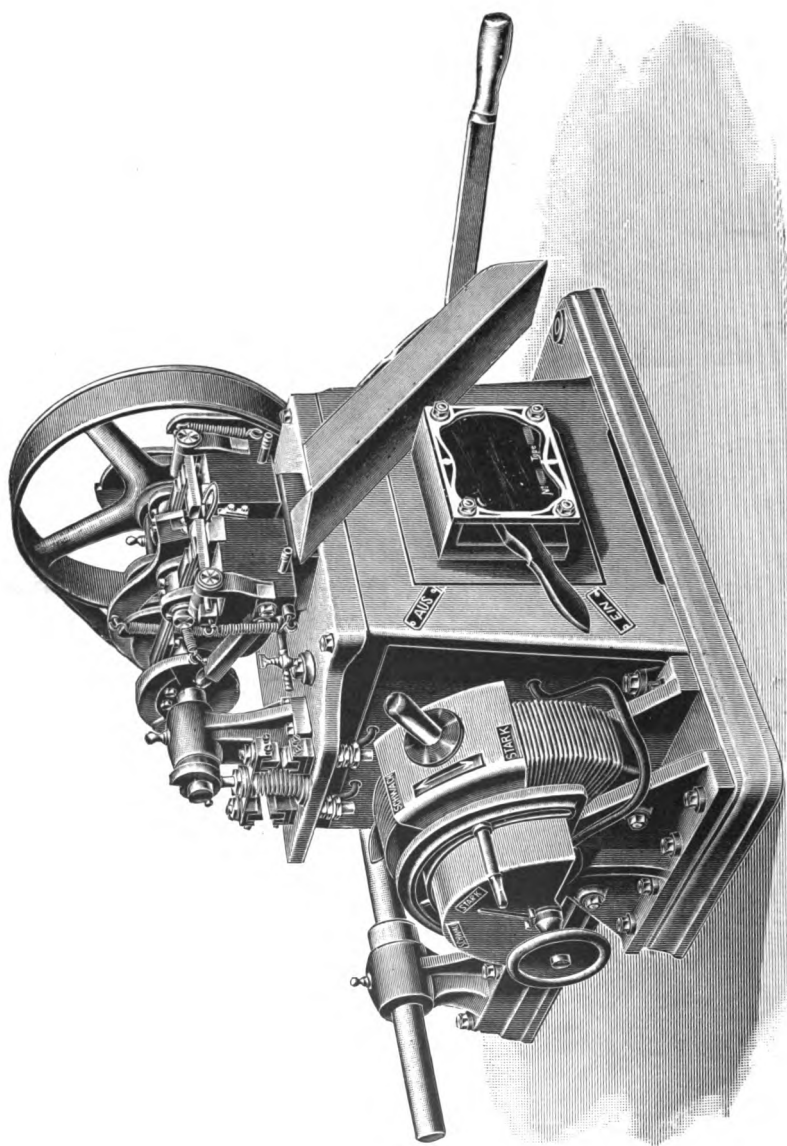

FIG. 40.—Buckle Welding Machine, with Transformer.

automatic relays connected with mechanical driving power, which is applied or shunted off at the right time by frictional devices.

These automatic machines do not require a special attendant, as one man can attend to several machines at the same time. The field of such machines is limited by the size and weight of the articles to be welded, and they are therefore more especially suited for welding small articles in very large quantities, where the occasional appearance of a defective piece is of no moment. For these machines it is important to have the articles previously prepared exactly alike, as even a small difference in the dimensions of the single article leads to unsatisfactory results.

The pressing together of the hot metal at the point of welding results, as already stated, in the formation of a burr, which must in most cases be afterwards removed.

The machines are sometimes provided with a device for surrounding the point of welding, as soon as the right temperature has been reached, with a swage (Fig. 39, page 101), whereby the welding is completed without a burr; such a joint is especially strong, as the hot, soft metal receives a lateral pressure from the swage, thereby greatly increasing the density of the metal at the weld.

In case of larger articles an automatic hammer with adjustable anvil can be substituted for the swage; this hammer is so arranged that the burr can be hammered down during the continuation of the heat.

The energy and time required for welding are approximately proportionate to the sectional area of the parts to be welded. It is possible to weld a given piece either by using greater power during a short time or by exerting a smaller power during a longer time; but, in order to ensure rational working, it is necessary for time and power to stand in certain

proportions to each other, which differ for different areas and different materials.

The permanent working of a machine increases the heating of those parts of the machine which are nearest to the weld. In order to keep the heating within admissible limits, water-cooling is provided. If there are no water mains two tanks

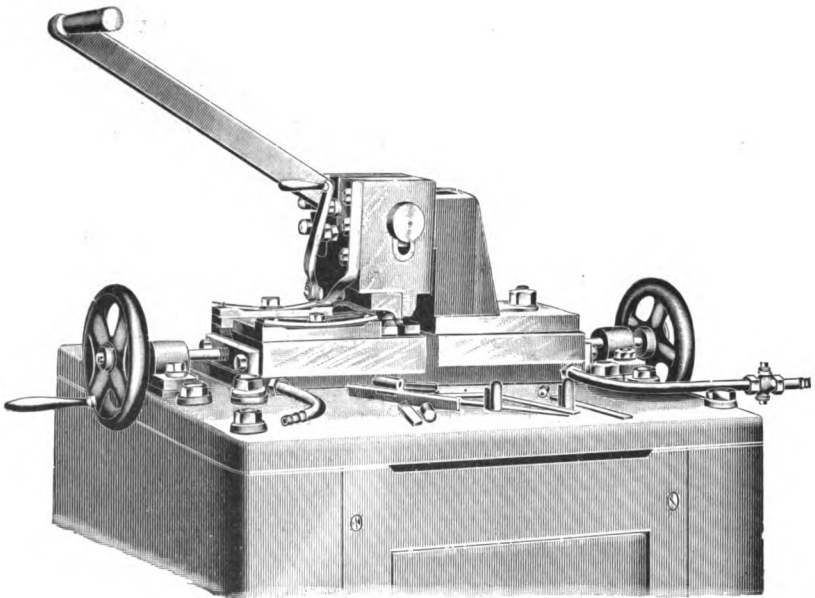

FIG. 41.—Special Machine for Welding Door-hinges, Hinge-hooks, Hinge-bands, etc., for Doors and Cupboards.

may be provided, one placed higher and the other lower than the machine, so that the water from the upper tank can flow through the machine into the lower tank. A moderate supply of water, from 20 to 100 litres per hour, is sufficient, according to the size of the machine.

Primary Plants.—Electric welding machines, as already stated, require alternating current for their operation. In the

case of *direct welders*, which can, however, only be considered for small types, the machine generates its own alternating current. Even if it is possible to use such direct welders for the small size, it will always be more desirable and of

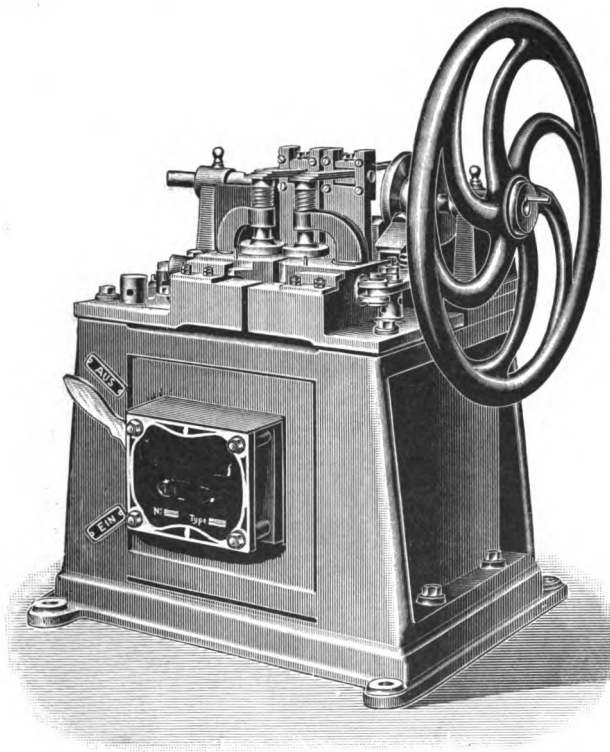

FIG. 42.—Machine for End to End Welding of Flat Hoops, Rings, and similar Articles.

greater advantage to provide separate welding machines, and to take the necessary alternating current from a generating plant.

The machines can be adapted to any existing plant for alternating current, whatever the voltage and periods.

Such a primary plant comprises—

(a) The generator for single-phase alternating current with

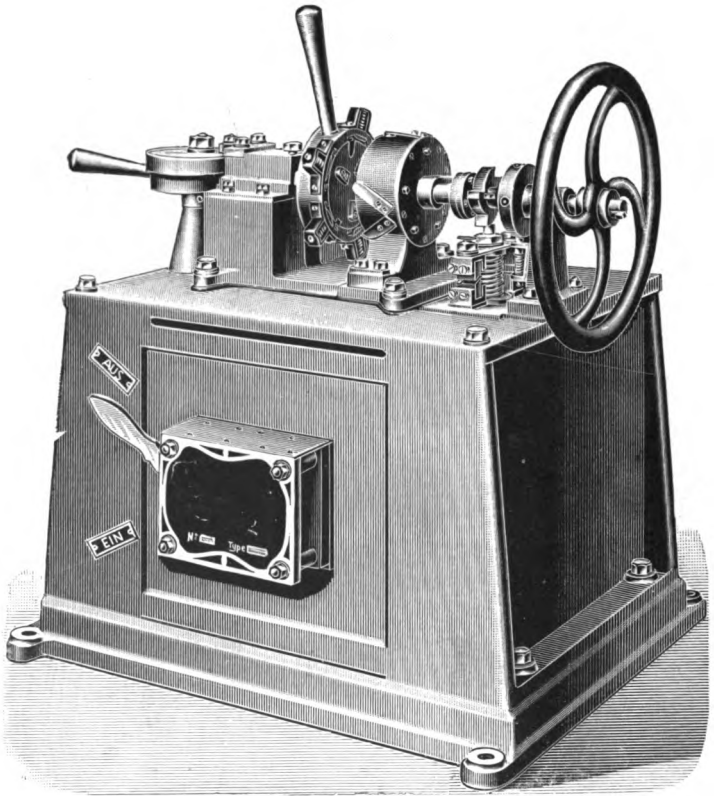

FIG. 43.—Machine for Simultaneously Welding several Pins or Pieces of Metal to Discs or Rings of Metal (for use in Watch and Clock Making).

exciting dynamo, or with separate excitement (by existing direct current);

(b) The switchboard, with all necessary switches, meters, cut-outs, and regulating apparatus;

(c) The connections between the generator, switchboard and welding machine.

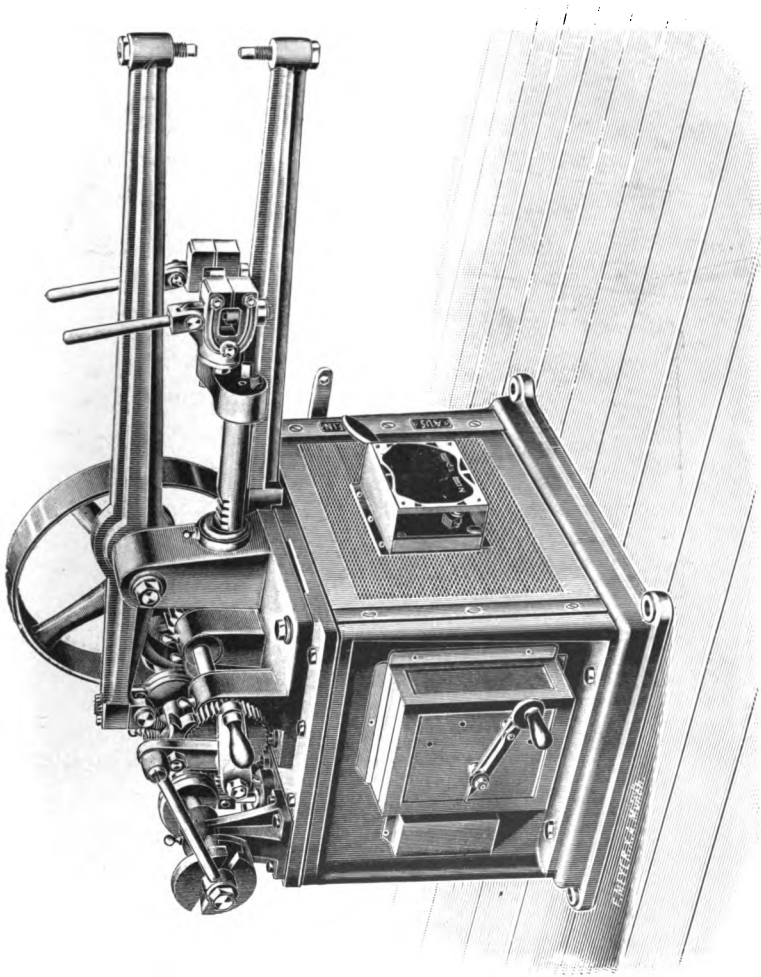

FIG. 44.—Point Welding Machine.

The generator with exciting dynamo must be used whenever no direct current for the excitement is obtainable. Existing direct current makes the exciting dynamo superfluous.

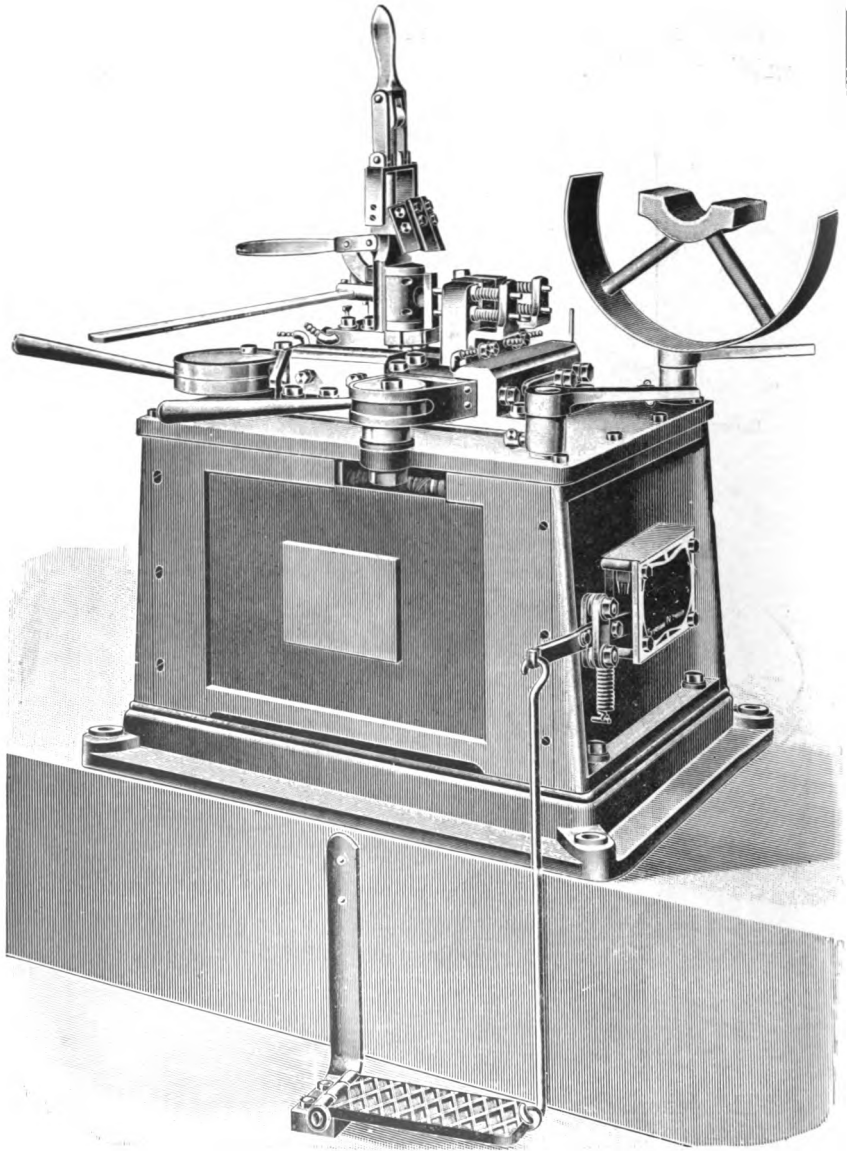

FIG. 45.—Machine for Welding Pulley-spokes to Rim and Hub.

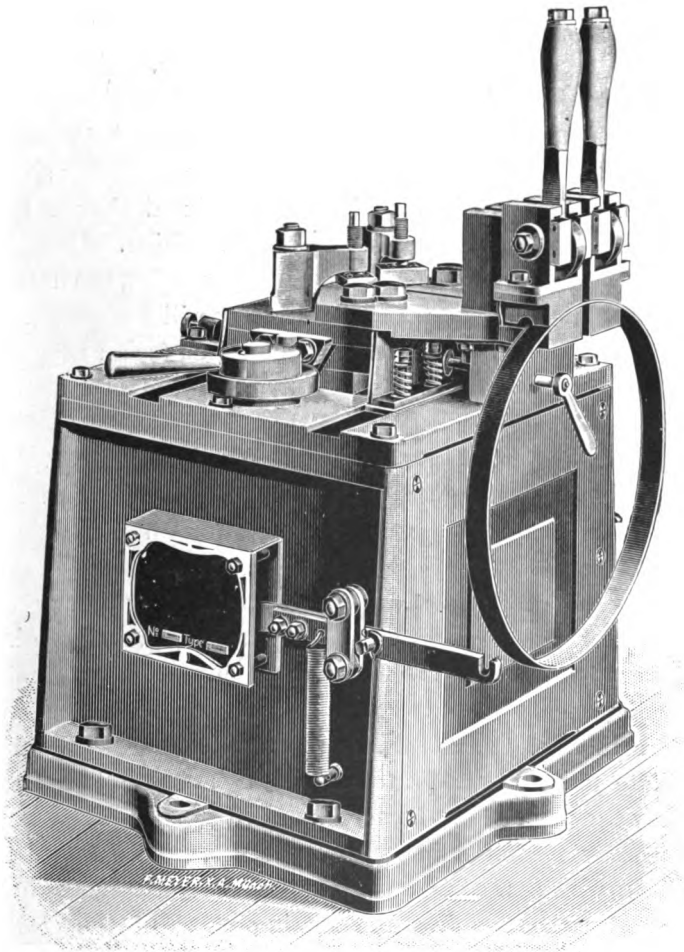

FIG. 46.—Hoop and Rim Welding Machine, specially suited for Welding Automobile and Cycle Rims.

The generators are specially constructed with stationary alternating current coils and rotating exciting coils, an arrangement which is best adapted to withstand the unavoidable current impulses accompanying the welding process. The voltage and number of periods is chosen with regard to the requirements of the welding machine it works, and vary between 100 and 500 watts at fifty periods a second. The generator should be chosen large enough, so that the continual change from full load to no load will not damage the machine. If several welding machines are worked from one generator, the total of the power required by each single machine will be sufficient for the generator, as the average power required for an aggregate of welding machines is essentially less than the total of each single power.

The welding machines are generally delivered mounted and ready for working, requiring only the electrical connections in as simple a manner as that for an incandescent lamp.

Nearly all of the metals, even those like antimony and bismuth, which are brittle and crystalline, may be joined together by electric welding, and many different metals and alloys joined one to another. In some cases, as with high carbon steels, a flux, such as borax, is employed to facilitate union at temperatures not high enough to burn or destroy the texture of the metal. Mild steel and iron welds are usually made, as in ordinary forges, at welding heat, or that which melts or fluxes the ordinary black oxide scale upon the metal. The heating effect of the electric current is so perfectly adjusted by regulating appliances that most of the metals formerly regarded as unweldable yield good results. Even leaden pieces, such, for example, as sections of lead pipe, may be joined together with great ease.

The Electric Welding Company, Limited, sole owners of the Thomson patents in the United Kingdom, have given the following information as to their standard types of welders:—

Type of Welder.	Kind of Work.	Watts approx.	Welding Capacity.		Approx. Dimensions.	Approx. Weight.
			Iron and Steel.	Copper.		
1-RW Hand . . .	Wires in rubber tyres	1,500	2 No. 8 S.W.G. . .	—	41½ × 10½ × 11½	Lbs. 392
1-AA Hand-Automatic	Copper wires . .	1,500	—	No. 24 to 17 S.W.G. .	16 × 11 × 13	92
2-A " "	Steel wires . . .	3,000	No. 17 to 10 S.W.G. .	—	15 × 12 × 15	150
2-AA " "	Copper wires . .	3,000	—	No. 17 to 8 S.W.G. .	13 × 14 × 15	140
EL-a " "	Copper wires . .	4,000	—	No. 22 to 16 S.W.G. .	21 × 13½ × 16½	114
E-1 " "	Steel and copper wires	4,000	No. 18 to 6 S.W.G. .	—	21 × 13½ × 16½	114
3-A Automatic . .	Steel hoops, etc.	4,500	No. 12 to 10 S.W.G. .	—	29 × 23 × 44	500
5-A Hand . . .	Steel rod, strip, etc.	7,500	No. 8 to ½ in. diam. .	—	27 × 15 × 18	525
5-AA Hand-Automatic	Copper wires . .	7,500	—	No. 8 to ½ in. diam. .	27 × 15 × 20	550
7-A Automatic . .	Steel hoops, frames, etc.	6,000	No. 10 to ⅝ in. diam. .	—	31 × 24 × 36	800
8-H Hand-Automatic	Steel chains . . .	6,000	¾ in. to ⅝ in. diam. .	—	34 × 22 × 45	1,100
E-2 " "	Steel and copper wires	10,000	No. 6 to ⅝ in. diam. .	—	36 × 21 × 24	626
10-A Hand . . .	Steel rod, strip, etc.	15,000	0.5 sq. in. (in rod form)	—	32 × 20 × 25	900
20-A " . . .	Steel rod and miscellaneous work	30,000	1 sq. ins. "	—	48 × 30 × 36	2,500
40-E Hand-Hydraulic.	Steel rods, bars, flat and channel tyres, tubes, bands, railway and coach iron-work and miscellaneous work	45,000	3 sq. ins. "	—	64 × 44 × 32	3,640
40-A " . . .		60,000	4 sq. ins. "	—	90 × 36 × 38	7,000
60-E " . . .		60,000	4 sq. ins. "	—	69 × 40 × 36	4,500

The above welders are in some cases fitted with detachable clamps, so that other kinds of work may be welded by using different clamps. Many other types of welders are also built for special purposes.

In the earlier electric welding systems the operations of clamping the pieces in place, applying and cutting off the electric current and exerting mechanical pressure, were usually manually controlled. Machines more or less automatic are now frequently employed.

In recent types adopted for rapid repetition of work upon identical pieces the action is entirely automatic; the machine runs continually and its sequence of actions is definitely determined by its construction. These machines are power-driven, movements being imparted for clamping the pieces as they are fed to the machine, for closing the current switch, for exerting pressure to complete the weld, for cutting off the current, and for releasing the pieces from the clamps after the operation. In wire fence and chain machines, for instance, the stock is itself fed automatically and the welding continued until the machine is stopped or the material exhausted.

The *Thomson* welding transformer is a construction like a lighting transformer, in which the usual secondary circuit of numerous turns is replaced by a very massive conductor constituting ordinarily only a single turn around the iron magnetic core. The primary or inducing circuit is similar to that of the ordinary transformer for alternating current, and it is supplied from alternating current dynamos on lines as usual in such work. The secondary conductor is unique in character, being often a bar or casting of many square inches of section of copper of short length. The circuit of this single turn secondary is completed only by the meeting ends of the work pieces in the clamps. It will thus be evident that the chief resistance or opposition to the flow

of the low-voltage current in the single secondary turn will be at the proposed joint or weld between the clamps. Here it is that the transformed energy is for the most part given out as heat, the section of metal which can be welded depending upon the scale of the apparatus used and the energy of the primary source which is available.

The welding transformer has found convenient application in the heating of metal pieces for forging, bending, shaping, brazing or the like. It has also in the *Lemp* process been divested of its welding clamps and applied to the local annealing of the hardened face of armour plates, so as to facilitate drilling and tapping, or cutting into desired shapes.

The welds made by the Thomson process are usually butt welds, though lap welds are also made with equal facility. In butt welding there is, of course, an upset, burr, or extrusion of metal at the joint. In many cases this is not removed, and it renders the joint stronger than other adjacent sections; oftentimes the joint is pressed or forged while still hot, so as to remove the burr at the joint. In other cases the joint is finished by filing or grinding.

The welding clamps are modified in form and disposition to suit the shape and size of the pieces to be held, and the pressure used to effect the weld is either manually applied by levers or is obtained from a strained spring, or again, in large works, by hydraulic means under control of suitable valves.

The energy required to effect electric welds naturally varies with the size of the pieces and with the material. It also depends upon the time consumed in the work, which time may be made shorter or longer even with exactly similar pieces.

The following table gives the results of some tests made upon different sections of iron, mild steel, brass and copper in the form of bars. The figures are stated to be only approximate. In general, working at a greater rapidity would lessen

the total power used, but require larger apparatus for the increased output required during the welding.

ENERGY USED IN ELECTRIC WELDING
BY THE THOMSON PROCESS.

Material.	Section. Square inch.	Kilowatts in primary of welder.	Time in seconds.	Total kilowatt- seconds.
Iron and Steel	0·5	8·5	33	280·5
	1·0	16·7	45	751·5
	1·5	23·5	55	1292·5
	2·0	29·0	65	1885·0
	2·5	34·0	70	2380·0
	3·0	39·0	78	3042·0
	3·5	44·0	85	3740·0
Brass	4·0	50·0	90	4500·0
	0·25	7·5	17	127·5
	0·50	13·5	22	297·0
	0·75	19·0	29	551·0
	1·00	25·0	33	825·0
	1·25	31·0	38	1178·0
	1·50	36·0	42	1512·0
Copper	1·75	40·0	45	1800·0
	2·00	44·0	48	2112·0
	0·125	6·0	8	48·0
	0·250	14·0	11	154·0
	0·375	19·0	13	247·0
	0·500	25·0	16	400·0
	0·625	31·0	18	558·0
0·750	36·5	21	766·5	
0·875	43·0	22	946·0	
1·000	49·0	23	1127·0	

The Electrical Times, in its number of 5th September, 1907, gives the following interesting particulars of applications of Thomson process :—

“ A new method of uniting the surfaces of metal plates has recently been patented, in which the Thomson process is

employed. The process consists in forming ridges or projections on the surfaces to be joined. These projections set up local heating, and when the projections are at the right temperature, they are welded together by pressure. Fig. 47 shows a number of different ways of forming such projections for this purpose.

One of the applications of this method lies in the manufacture of small pulleys for window sashes, etc. In these cases, the pulleys are each made of two cir-

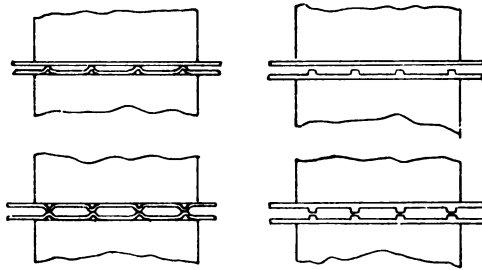

FIG. 47.

cular stampings, having a number of projections formed on the surfaces to be joined as shown in Fig. 48. These stampings are placed in the welding machine in the proper position and welded in the manner above described. The machine is entirely automatic, except that the stampings are fed into

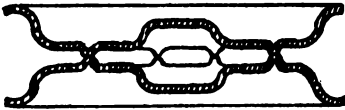

FIG. 48.

the machine by the operator. The work-holder consists of a link-belt working over two pulleys, and moved forward step by step by the main shaft of the machine. A centering

device ensures the welding points coming opposite to each other in the work-holder, and on reaching the welding position the electrodes advance automatically and weld the two stampings together, the complete pulley being delivered on the opposite side of the machine.

“Another patented method of forming joints in thin material is shown in Fig. 49. The strips are butted in the clamps of

the welder in such a way that when heated and pressed together the edges are turned up against each other as shown. An automatic hammer is then used to force the upturned edges down against the strip, and to press the heated metal

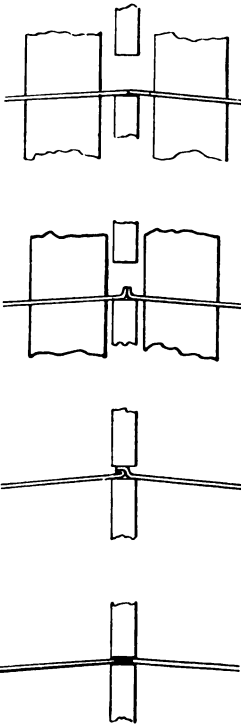

FIG. 49.

to about the same thickness as the original strip. An extremely strong and satisfactory joint is the result. A special machine is, of course, used for this work. In this case also the welder is driven by a pulley, and is automatic except that the work is placed in and taken out of the clamps by the operator. The strip or band being placed in the clamps, is immediately gripped automatically and heated to the welding temperature. The right hand plate is then moved towards the left by a cam, turning up the ends of the band against each other; the hammer die then falls, cutting off the current and finishing the joint. The clamps then open and the welded band is taken out; the cycle of operations is then repeated. From 350 to 600 welds are made per hour on this machine in steel strip varying from $\frac{3}{8}$ in. to $1\frac{1}{8}$ in. wide by No. 20 to No. 2 gauge.

“ Fig. 50 shows a Thomson electric welding machine specially adapted for the manufacture of hollow-handled table cutlery. The articles are made in three parts as indicated in Fig. 51. The hollow handle is pressed from a sheet or disc and is welded on to one side of a specially shaped bolster. The other side of the bolster has a projection so shaped as to

present, approximately, the same cross section as the blade. Two welds are required to complete the article. The machine illustrated is capable of making from 250 to 300 welds per hour, and requires only a boy to operate it. In the case of articles having German-silver handles, a steel ring is shrunk

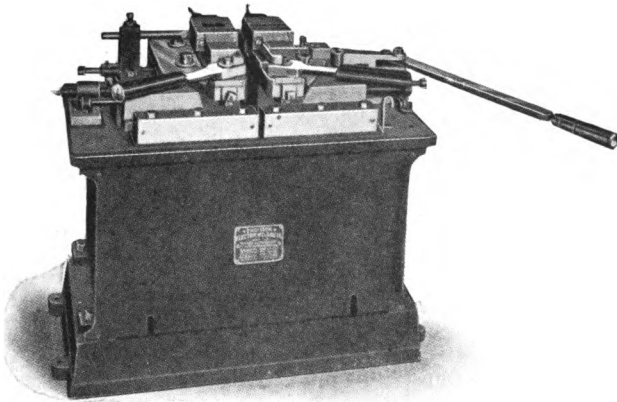

FIG. 50.

on to the end, and this is welded on to the bolster in the same way as the steel handle. One great advantage of this method of manufacture is that the welded joints prevent the



FIG. 51.

liquid used in plating from entering the hollow portion and corroding the metal.

“An interesting product of the Thomson process is electrically welded wire netting. The machine employed is entirely automatic and works continuously as long as the supply of wire holds out. The wires corresponding to the horizontal wires in the finished netting are fed into the machine from a

number of reels on the top, and another reel is placed at the side from which the lengths of wire forming the vertical wires in the finished netting are cut off automatically as the work proceeds. A series of small electric welders, corresponding in number to the horizontal wires in the netting, come into operation automatically and weld the joints together where the wires cross. The welded netting then moves forward a given distance and the work is repeated. A single machine turns out, in this way, complete rolls of wire fencing of any desired length. No twists or loops are made in the wire, and there is thus a saving in material; the joints are also much stronger than any form of twist.

“ Another mode of manufacture is employed in the case of

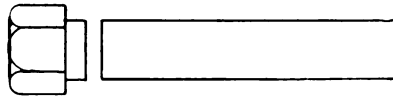

FIG. 52.

the crankshaft of an automobile engine which is built up by welding the several parts together. The two central portions are drop forgings, while the other two consist of drawn steel shaped to about the finished size. By means of a suitable welding machine, the parts are guided together and united with great accuracy.

“ It may be said that practically a new industry has arisen in the making of square and hexagon headed bolts by electric welding. For the heads, specially die-drawn stock of the required shape is used, the stock being drawn very accurately with a variation not exceeding 0.003 in. The heads are cut from the bar by automatic machines which turn a projection or shoulder to the diameter of the bolt to be welded as shown in Fig. 52. The bolt, drawn from high grade round stock of the finished diameter, is then electrically welded to the

projection on a specially designed welder fitted with hydraulic upsetting device. The burr is then milled off, and at the same time the top of the head is shaped, the under part of the head is formed, and the end pointed. In this way absolute uniformity in length of bolt, height of head, and alignment of head and body are obtained. It then only remains to cut the thread. The latter being cut on the surface of the die-drawn stock the tensile strength of the bolts is greater than that of milled or upset bolts. Special adaptations of the method include bolts of soft die-drawn stock with case-hardened heads, and steel bolts with brass heads, the latter being used largely by switchboard makers. A large factory has been established employing no less than 400 h.p. devoted exclusively to the manufacture of these electrically welded bolts.

“The Thomson patent chain welder is provided with an automatic hammer driven by a belt, which practically removes the burr caused by pressing the heated ends of the link together, leaving only a fin of metal which is easily shaken off by rumbling for a few minutes in the usual way. The link to be welded is held in a specially shaped die, and current is fed to this link by a pair of copper contacts mounted on slides which are made to engage the link by means of a foot lever. As soon as the welding temperature is reached, the hand lever on the right hand side of the machine is operated to upset the metal at the joint, and the automatic hammer is set in motion by a second hand lever on the left hand side of the welder. The current-carrying parts of the slides are water cooled. This machine is capable of welding about 300 links per hour made of $\frac{1}{4}$ in. diameter steel rod and is suitable for links up to $2\frac{1}{2}$ in. long by $1\frac{1}{4}$ in. wide. The welder may be used for either welding the links separately or in the form of a chain; in the latter case, every other link is

welded, and then the chain is passed through the machine a second time.

“Welders for harness rings and similar articles make as many as 800 welds per hour, the rings being previously formed to circular shape with their ends cut off square and butted together ready for welding. Such machines have two transformers and an automatic feeding device, the boy simply

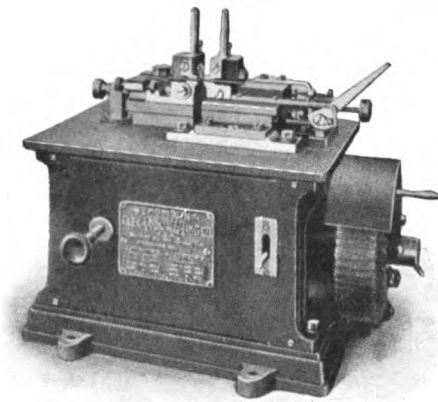

FIG. 53.

inserting the rings in the dies, from which they are removed automatically after being welded.

“Fig. 53 shows a new design of machine for welding the smallest sizes of iron, brass, German-silver, copper, and other wires in which it is essential that the action of the machine should be as nearly as possible automatic, and the mechanism so designed as to have the least amount of friction. One feature of this machine is a special arrangement to enable the welding operation to be safely and easily conducted by persons having little or no knowledge of the mechanical or electrical conditions necessary to produce good work. This consists in combining the automatic cut-off devices which,

when the weld is completed, automatically stop the flow of current through the work, with the starting switch. Thus the cut-off can only be re-set by restoring the starting switch to the 'off' position. This is accomplished by a push-rod which projects through the front of the case, and which closes the starting switch. A latch is fitted to the rod which engages with the cut-off device in such a manner that no current can flow through the primary of the transformer until the automatic cut-off has been re-set. Another feature of the welder is that the movable clamp which presses the ends of the wire together when the right temperature is attained, runs on roller bearings, and the connection between the clamp and the transformer secondary is made by a projection on the underside dipping into a mercury bath formed in the top of the secondary. A reactive coil for controlling the heat to suit any particular size or quality of wire is mounted on the frame of the welder, and is furnished with two windings. A two-way switch, operated by a sliding rod on the front of the case, connects these windings in series or parallel, thus giving a considerable range of control, and ensuring satisfactory welds in the smaller gauges of wire.

" Figs. 54, 55 illustrate some articles welded by the Thomson process.

" Central station engineers have hitherto been somewhat chary in connecting electric welders of large size to their mains on account of the fluctuating nature of the load, although there are numerous instances of small welders being so used. A very interesting installation has recently been completed in London by the Electric Welding Company, Limited, in which a welder of 90 kw. capacity is worked off a single-phase power supply at 400 volts. In order to prevent undue fluctuations of voltage on the mains, a special substitutional resistance is installed, built in three sections, each controlled by a switch, so

that one or more sections can be put in circuit according to the size of the work being welded. A large liquid resistance is also employed to prevent an undue rush of current when the primary circuit of the welding transformer is closed, the plates being raised and lowered by a small motor through suitable gearing. The controlling switch of the welder is so

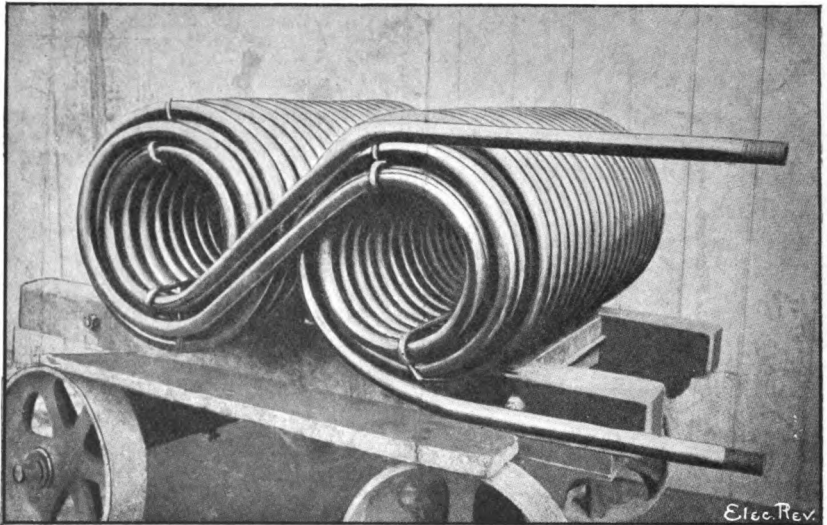

FIG. 54.—Pipe Coil for Refrigerating Machine, Electrically Welded by Thomson Process. Pipes Welded end to end by moving Welding Machine during Operation of Coiling.

arranged that when put in the 'on' position it starts the plate-lowering gear, thus gradually cutting out the starting resistance, and *vice versa*. This plant is in continuous operation, and no inconvenience to other power users in the neighbourhood has been reported. Another welder of smaller size has also been connected to this circuit. In this case a special economy coil is used as a regulating device.

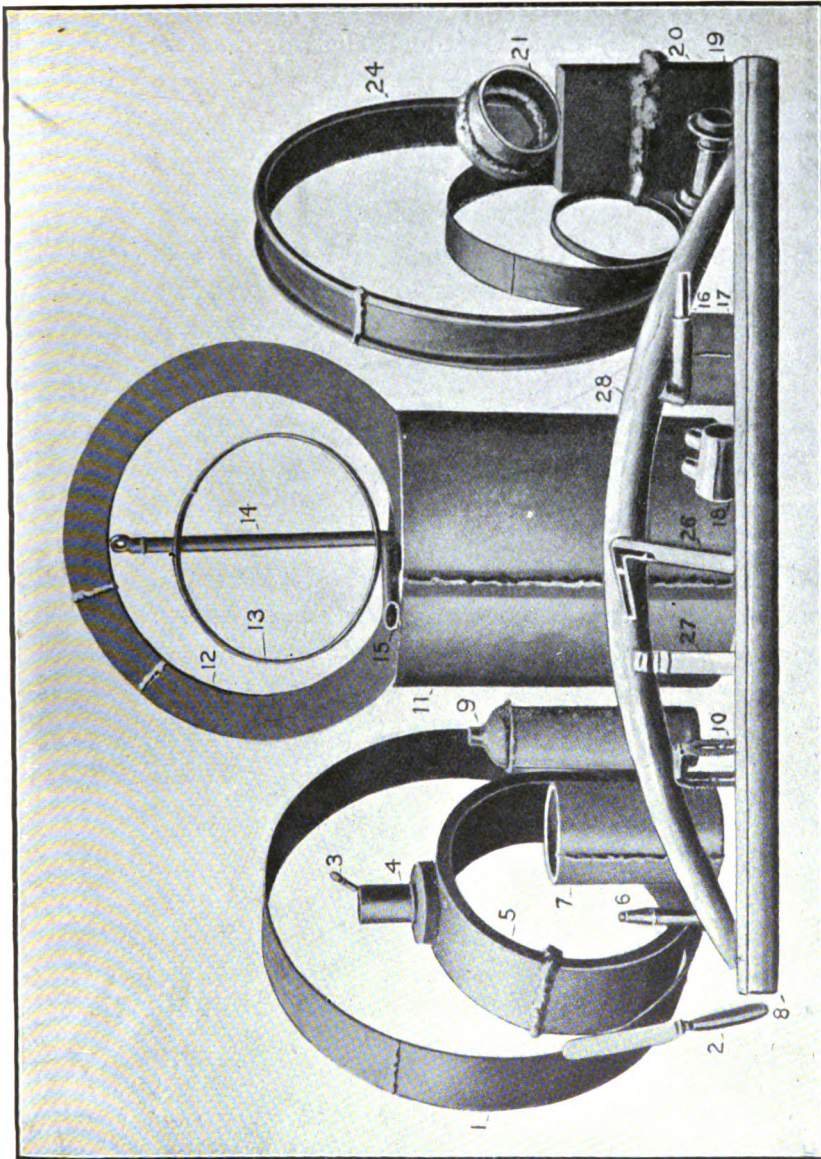

FIG. 55.—Some Applications of Electric Welding (Thomson Process). Samples include Automobile Parts, Bicycle Parts, Steel Tubing welded longitudinally, Stampings welded to Rods and Tubes, Channel Tyres, Baby Carriage Tyres, Cutlery, Cylinders, etc.

“ To facilitate the working of electric welding machines on polyphase circuits, Professor Elihu Thomson has recently patented a method of winding the transformers to prevent unbalancing the phases. This will doubtless lead to considerable developments in the near future, seeing that the power companies' supply mains are available in most manufacturing centres.”

Electric welding has been in constant operation, for many years, at the works of *Messrs. Stewarts and Lloyds, Limited*, and has chiefly been employed on large pipes and fittings for high-pressure steam.

The weld is absolutely solid, and exhaustive tests have proved it to be equally as strong as the tube itself.

When it was proposed a few years ago (owing to the increasing steam pressures and temperatures causing trouble with the copper and cast-iron pipes then in use) to adopt wrought-iron or steel piping for steam-pipe installations, great difficulty was experienced in obtaining a thoroughly satisfactory form of flange joint for the wrought piping; and it was not until the introduction by *Stewarts and Lloyds, Limited*, of their flanges welded solid to the pipe, that the use of wrought-iron and steel steam-pipes became general.

At first the flanges were welded on to the pipe plain; but subsequently the firm instituted an improvement by perfecting a machine which leaves a large fillet at the root of the flange. This fillet, which gradually reduces the thickness of the metal from flange to pipe, enables both to be brought to a welding heat and to be perfectly welded without overheating. This operation cannot be satisfactorily performed with plain flanges, nor with those formed with a large boss at back. The improved method ensures a sound weld over the whole area of contact, which, in consequence of the fillet,

is about twice as great as it was before the improvement was introduced.

This fillet also gives greater stiffness to the flange and makes the joint thoroughly reliable for the highest pressures. It also enables larger size pipes and higher pressures to be used for hydraulic purposes than formerly.

These welded-on flanges are now being specified by consulting engineers and steam users generally for all high-class

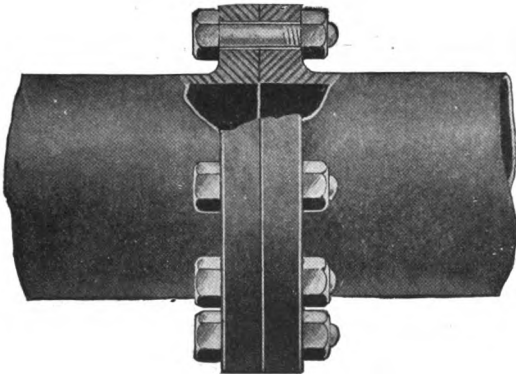

FIG. 56.—Form of Special Facing for Electrically Welded Flanges: Plain Faced.

work; and the prices, as a rule, compare favourably with those for inferior types of joints.

Pipes with these flanges have repeatedly been tested to destruction, and special tests have been made to satisfy the rigid requirements of the *Board of Trade*, and also of the *Engineering Standards Committee*.

As a result, it has been found that pipes of the thicknesses specified in the table given below for 200 lbs. steam working pressure (which carry a factor of safety of nine and over) invariably burst before the flanges show any signs of fatigue. Destruction tests have, in all cases, proved the flanges to

FIGS. 56 to 59.—Forms of Special Facing for Electrically Welded Flanges.

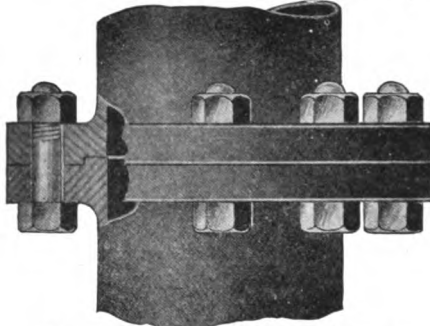

FIG. 57.—Single Spigot and Faucet.

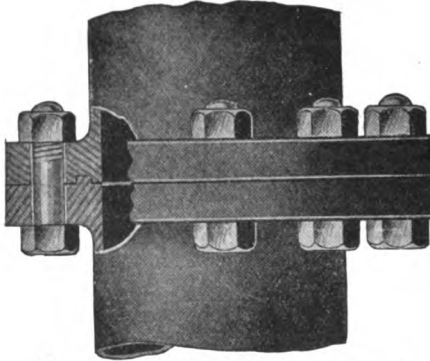

FIG. 58.—Double Spigot, and Faucet.

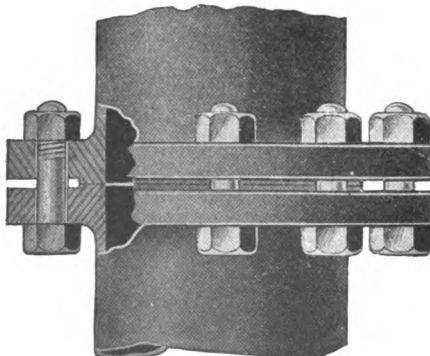

FIG. 59.—Facing Strips.

be thoroughly welded on to the pipe; and under mechanical tests, the flanges and pipes bent and finally broke, while the continuity of the weld remained undisturbed.

The tests under the Board of Trade requirements were made to the direction of their inspectors, who, after witnessing the various operations, and having satisfied themselves that the bursting tests of the pipe would not disclose any defect in the flange welds, proceeded to demolish a number of the flanged pipes under steam hammers.

The flanged pipes were divided longitudinally into four pieces, and bent cold to the various shapes, the object being to subject the metal in the neighbourhood of the welds to the greatest possible strain, and in no case was the weld in any way disturbed.

The result of these tests was the acceptance of pipes with welded-on flanges for any work under Board of Trade survey.

The flanges are generally made from wrought-iron, and all facing, edging and drilling is done on up-to-date machines, and the greatest care exercised to ensure a high standard of accuracy.

The joints are, as a rule, faced plain, as Fig. 56. If required, the flanges can be faced either with a single or double spigot and faucet, as Figs. 57 and 58, or with a double spigot as Fig. 59, all of which types of facing are frequently used in connection with high-pressure steam-pipes, and are eminently suitable for use with metal joint rings.

Wrought fittings of all kinds for steam and other pipe installations, such as bends, branch pipes, expansion bends, etc., can be fitted with electrically welded-on flanges, and a few specialities in this direction will be found illustrated below.

DIMENSIONS OF PIPES AND FLANGES.

For steam pressures up to 200 lbs. per square inch, as also the minimum thickness recommended for lap-welded steel pipes for that pressure :—

Bore of Pipe.	External Diam. of Pipe.	Thickness of Pipe.	Diam. of Flange.	Thick-ness of Flange.	Diam. of Bolt Circle.	Number of Bolts.	Size of Bolts.
Ins.	Ins.		Ins.	Ins.	Ins.		Ins.
1	$1\frac{5}{8}$	7 W.G.	$4\frac{1}{2}$	$\frac{1}{2}$	$3\frac{1}{4}$	4	$\frac{1}{2}$
$1\frac{1}{2}$	$1\frac{7}{8}$	6 "	$5\frac{1}{2}$	$\frac{9}{16}$	4	4	$\frac{1}{2}$
2	$2\frac{3}{8}$	5 "	6	$\frac{5}{8}$	$4\frac{5}{8}$	6	$\frac{1}{2}$
$2\frac{1}{2}$	3	5 "	7	$\frac{5}{8}$	$5\frac{1}{2}$	6	$\frac{3}{8}$
3	$3\frac{1}{2}$	$\frac{1}{4}$ in.	$7\frac{1}{2}$	$\frac{3}{4}$	6	6	$\frac{3}{8}$
$3\frac{1}{2}$	4	$\frac{1}{4}$ "	8	$\frac{3}{4}$	$6\frac{1}{2}$	6	$\frac{3}{8}$
4	$4\frac{1}{2}$	$\frac{1}{4}$ "	9	$\frac{3}{4}$	$7\frac{3}{8}$	6	$\frac{3}{8}$
5	$5\frac{1}{2}$	$\frac{1}{4}$ "	10	$\frac{7}{8}$	$8\frac{3}{8}$	6	$\frac{3}{8}$
6	$6\frac{1}{2}$	$\frac{1}{4}$ "	11	1	$9\frac{3}{8}$	8	$\frac{3}{8}$
7	$7\frac{1}{2}$	$\frac{1}{4}$ "	12	1	$10\frac{3}{8}$	8	$\frac{3}{8}$
8	$8\frac{1}{2}$	$\frac{1}{4}$ "	13	1	$11\frac{3}{8}$	8	$\frac{3}{8}$
9	$9\frac{5}{8}$	$\frac{5}{16}$ "	15	$1\frac{1}{8}$	13	8	$\frac{3}{8}$
10	$10\frac{3}{8}$	$\frac{5}{16}$ "	17	$1\frac{1}{8}$	$14\frac{3}{4}$	10	$\frac{7}{8}$
11	$11\frac{5}{8}$	$\frac{5}{16}$ "	18	$1\frac{1}{8}$	$15\frac{3}{4}$	10	$\frac{7}{8}$
12	$12\frac{5}{8}$	$\frac{5}{16}$ "	19	$1\frac{1}{8}$	$16\frac{5}{8}$	12	1
13	$13\frac{5}{8}$	$\frac{5}{16}$ "	20	$1\frac{1}{8}$	$17\frac{3}{4}$	12	1
14	$14\frac{5}{8}$	$\frac{5}{16}$ "	21	$1\frac{1}{4}$	$18\frac{1}{4}$	12	1
15	$15\frac{3}{4}$	$\frac{3}{8}$ "	22	$1\frac{1}{4}$	$19\frac{3}{4}$	16	1
16	$16\frac{3}{4}$	$\frac{3}{8}$ "	23	$1\frac{1}{4}$	$20\frac{3}{4}$	16	1
17	$17\frac{3}{4}$	$\frac{3}{8}$ "	24	$1\frac{1}{4}$	$21\frac{3}{4}$	16	1
18	$18\frac{3}{4}$	$\frac{3}{8}$ "	25	$1\frac{3}{8}$	$22\frac{3}{4}$	20	1
19	$19\frac{3}{4}$	$\frac{3}{8}$ "	$26\frac{1}{2}$	$1\frac{3}{8}$	24	20	1
20	$20\frac{3}{4}$	$\frac{3}{8}$ "	$27\frac{1}{2}$	$1\frac{3}{8}$	$25\frac{1}{8}$	20	$1\frac{1}{8}$
21	$21\frac{7}{8}$	$\frac{7}{16}$ "	29	$1\frac{3}{8}$	$26\frac{3}{8}$	20	$1\frac{1}{8}$
22	$22\frac{7}{8}$	$\frac{7}{16}$ "	$30\frac{1}{2}$	$1\frac{1}{2}$	$27\frac{5}{8}$	20	$1\frac{1}{4}$
23	$23\frac{7}{8}$	$\frac{7}{16}$ "	$31\frac{1}{2}$	$1\frac{1}{2}$	$28\frac{5}{8}$	20	$1\frac{1}{4}$
24	$24\frac{7}{8}$	$\frac{7}{16}$ "	$32\frac{1}{2}$	$1\frac{1}{2}$	$29\frac{5}{8}$	20	$1\frac{1}{4}$

Figs. 60 to 64 are some illustrations of the firm's electrically welded-on branches, drain pockets and bosses.

These are usually welded on to long lengths of pipe, and consequently the number of flange joints in a range of pipes, which would be necessary if short fittings were used, is materially reduced.

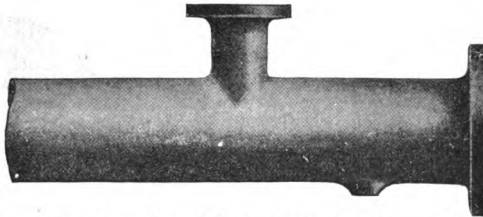

FIG. 60.—Branch and Boss on Centre Line of Pipe.



FIG. 61.—Branch on Centre Line of Pipe.

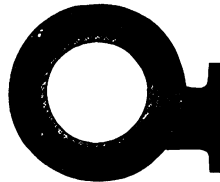

FIG. 62.—Branch off Centre Line of Pipe.

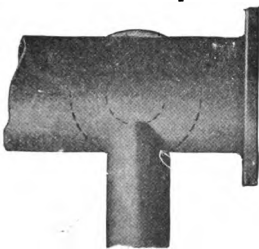

FIG. 63.—Drain Pocket.

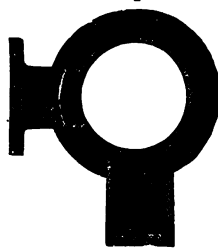

FIG. 64.—Drain Pocket in Section.

FIGS. 60 TO 64.—Various Forms of Electrically Welded Branch, etc.

The most general forms of branch are those on centre line of pipe (Fig. 61), and those off centre line of pipe (Fig. 62), but the firm make a speciality of curved branches, which are in favour with some engineers.

Several branches can be welded on to one length of pipe or bend.

Drain pockets (Figs. 63 and 64), with end welded in, and tapped to connect to drain piping, can be welded on to long

lengths of steam piping in any position, and are a valuable adjunct to a steam installation, as they dispense with super-

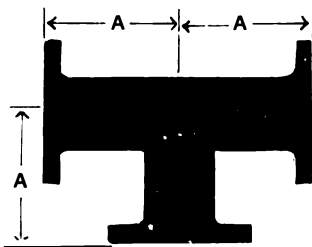

FIG. 65.—Tee.

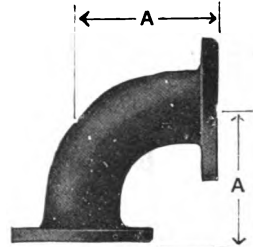

FIG. 66.—Bend.

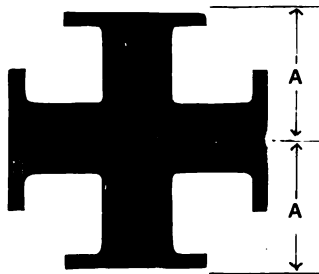

FIG. 67.—Cross.

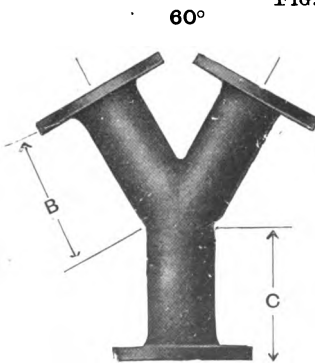

FIG. 68.—"Y" Piece.

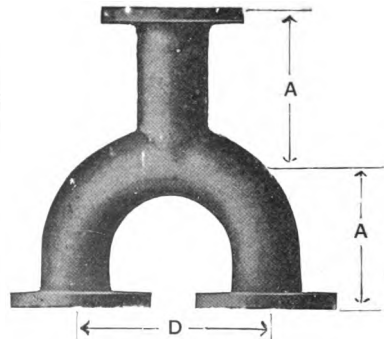

FIG. 69.—Breeches Piece.

Figs. 65 to 69.—Wrought Steel Fittings, Electrically Welded.

fluous flange joints, and are considerably stronger and cheaper than any other form of pocket. They are usually welded on to the main pipe directly under the branches to the engines.

Bosses for drain piping, steam gauges, thermometers, etc. are welded on pipes, faced, and tapped to requirements.

One distinct advantage peculiar to the electric welding process—as regards wrought fittings—is the ability to meet the long-desired want of the engineer who, having to contend with high pressures, is restricted by a very limited space at his disposal. With the assistance of the electric welding wrought-steel tees, crosses, “Y” pieces, bends, and breeches pieces—all fitted with welded flanges—can be supplied of shorter dimensions than can be made by any other process.

Figs. 65 to 69 and the following table, giving the minimum dimensions for each size up to 36 ins. diameter of the above fittings, will no doubt be of interest as indicating what may now be supplied for restricted positions.

MINIMUM DIMENSIONS.

Bore.	A	B	C	D	Bore.	A	B	C	D
Ins.	Ins.	Ins.	Ins.	Ins.	Ins.	Ins.	Ins.	Ins.	Ins.
1	$3\frac{1}{2}$	$3\frac{3}{4}$	$2\frac{3}{4}$	6	18	$15\frac{1}{2}$	25	7	29
2	$4\frac{1}{2}$	$5\frac{1}{4}$	$3\frac{1}{4}$	$7\frac{1}{2}$	19	$16\frac{1}{2}$	26	7	$30\frac{1}{2}$
$2\frac{1}{2}$	5	6	$3\frac{1}{2}$	$8\frac{1}{2}$	20	17	$27\frac{1}{2}$	$7\frac{1}{2}$	$31\frac{1}{2}$
3	$5\frac{1}{2}$	7	4	$9\frac{1}{2}$	21	18	$28\frac{3}{4}$	$7\frac{3}{4}$	33
$3\frac{1}{2}$	6	$7\frac{3}{4}$	$4\frac{1}{4}$	$10\frac{1}{4}$	22	19	30	8	35
4	$6\frac{1}{2}$	$8\frac{1}{2}$	$4\frac{1}{2}$	11	23	$19\frac{1}{2}$	31	8	36
5	7	$9\frac{3}{4}$	$4\frac{3}{4}$	12	24	20	32	8	37
6	8	11	5	13	25	21	$33\frac{1}{2}$	$8\frac{1}{2}$	39
7	$8\frac{1}{2}$	$12\frac{1}{2}$	$5\frac{1}{2}$	$14\frac{1}{2}$	26	22	$34\frac{1}{2}$	$8\frac{1}{2}$	40
8	9	$13\frac{1}{2}$	$5\frac{1}{2}$	16	27	23	36	9	41
9	10	$14\frac{3}{4}$	$5\frac{1}{2}$	18	28	24	37	9	42
10	11	16	6	20	29	25	38	9	43
11	$11\frac{1}{2}$	$17\frac{1}{4}$	$6\frac{1}{4}$	21	30	26	$39\frac{1}{2}$	$9\frac{1}{2}$	44
12	$12\frac{1}{2}$	$18\frac{1}{2}$	$6\frac{1}{2}$	22	31	27	$40\frac{1}{2}$	$9\frac{1}{2}$	46
13	13	$19\frac{1}{4}$	$6\frac{1}{4}$	23	32	28	42	10	47
14	$13\frac{1}{2}$	$20\frac{1}{2}$	$6\frac{1}{2}$	25	33	29	43	10	48
15	14	$21\frac{3}{4}$	$6\frac{3}{4}$	26	34	30	$44\frac{1}{2}$	$10\frac{1}{2}$	49
16	$14\frac{1}{2}$	$22\frac{3}{4}$	$6\frac{3}{4}$	27	35	31	$45\frac{1}{2}$	$10\frac{1}{2}$	50
17	15	$23\frac{3}{4}$	$6\frac{3}{4}$	28	36	32	47	11	51

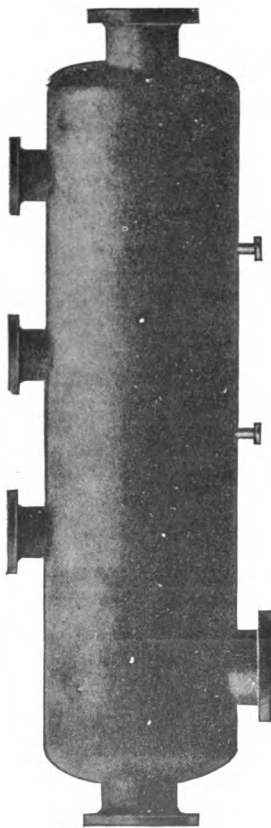

FIG. 70.—Elevation.

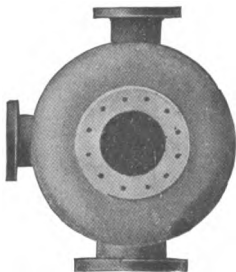

FIG. 71.—End View.

FIGS. 70 TO 71.—Wrought Steel Steam Receiver.

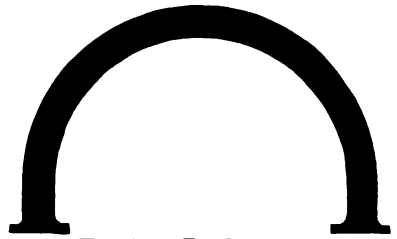

FIG. 72.—Double Bend.

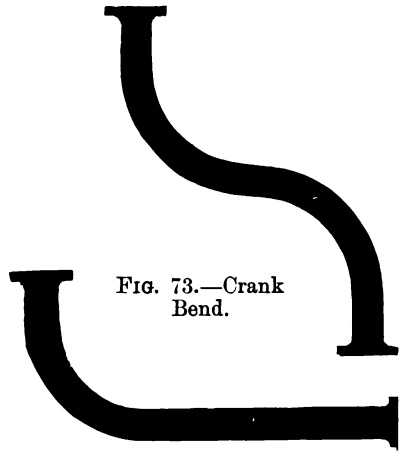

FIG. 73.—Crank Bend.

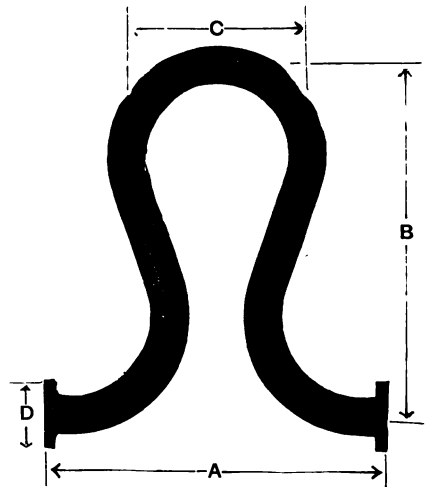

FIG. 74.—“Horseshoe” Type.

FIGS. 70 TO 74.—Receiver and Bends, Electrically Welded.

Four receivers (Figs. 70, 71) were made by Messrs. Stewarts and Lloyds, Limited, recently, for the Birmingham Summer Lane electric power station. They were 11 ft. long, and were manufactured from 30 ins. bore by $\frac{1}{2}$ in. thick wrought-steel lap-welded tube with ends swaged down and all branches and flanges electrically welded on.

The receivers were tested by hydraulic pressure to 500 lbs. per square inch.

DIMENSIONS OF STANDARD BENDS.

For full particulars of flanges, see page 124.

Bore.	Centre to Face. A		Radius. B		Straight at Ends. C		Diameter of Flange. D
	Ft.	Ins.	Ft.	Ins.	Ft.	Ins.	Ins.
1	0	6	0	3	0	3	4 $\frac{1}{2}$
1 $\frac{1}{2}$	0	7 $\frac{1}{2}$	0	4 $\frac{1}{2}$	0	3	5 $\frac{1}{2}$
2	0	9 $\frac{1}{2}$	0	6	0	3 $\frac{1}{2}$	6
2 $\frac{1}{2}$	0	11 $\frac{1}{2}$	0	7 $\frac{1}{2}$	0	4	7
3	1	1 $\frac{1}{2}$	0	9	0	4 $\frac{1}{2}$	7 $\frac{1}{2}$
3 $\frac{1}{2}$	1	3	0	10 $\frac{1}{2}$	0	4 $\frac{1}{2}$	8
4	1	5	1	0	0	5	9
5	1	9	1	3	0	6	10
6	2	1	1	6	0	7	11
7	2	4	1	9	0	7	12
8	2	11	2	3	0	8	13
9	3	2	2	6	0	8	15
10	3	9	3	0	0	9	17
11	4	3	3	6	0	9	18
12	4	10	4	0	0	10	19
13	5	5	4	6	0	11	20
14	6	3	5	3	1	0	21
15	6	10	5	9	1	1	22
16	7	8	6	6	1	2	23
17	8	3	7	0	1	3	24
18	8	9	7	6	1	3	25

Bends over 18 ins. are generally manufactured by the electrical process.

The above bends are manufactured from wrought steel lap-welded pipe and are fitted with welded flanges.

DIMENSIONS OF STANDARD "HORSESHOE" EXPANSION BENDS.

Bore.	Face to Face. A	Centre to Centre. B	Centre to Centre. C	Diameter of Flanges. D
Ins.	Ins.	Ins.	Ins.	Ins.
1	18	18	9	4½
1½	21	21	10½	5½
2	24	24	12	6
2½	27	28	14	7
3	30	30	15	7½
3½	35	34	17	8
4	40	39	18	9
5	50	48	24	10
6	58	60	30	11
7	64	72	36	12
8	72	84	42	13

Above bends are made from lap-welded steel pipe, and are fitted with welded-on flanges.

The illustrations (Figs. 77, 78, page 136) show a 24 in. "compound" expansion arrangement with 12 in. connecting bends.

"Compound" expansion arrangements, as shown above, are manufactured from wrought steel lap-welded pipe.

The branches on the headers are electrically welded into place, and all flanges are solidly welded on.

The standard types of sliding expansion joints are illustrated in Figs. 79 and 80, page 136.

These are solidly welded, of wrought steel throughout, and have the branches and internal baffle plate electrically welded into position.

Bosses for water gauge fittings are welded on when required.

The joints of rails have principally been welded by "Thermit" as mentioned on page 70, but it may also be done by electrical means. An electrically welded joint is made by welding steel blocks to the rail end. A steel block is placed on each side of the rail at the joint, and a heavy current is passed through from one block to the other. This current is so great that the electrical resistance between the rail and steel block causes that point to become molten. Current is then shut off, and the joint allowed to cool. There is in this case a true weld between the steel blocks and the rails.

An electric welding outfit being expensive to maintain and operate, this process is used only where a

large amount of welding can be done at once. Current is taken from the trolley wire, a rotary converter set takes 500 volt direct current from the trolley wire, and converts it into alternating current. This alternating current is taken to a static transformer, which reduces the voltage and gives a high current at low voltage, the latter current being passed through the

blocks and rails in the welding process. A massive pair of clamps is used to hold the blocks against the rails, and to conduct the current to and from the joint while it is being welded. These clamps are water cooled by having water circulated through them so that they will not become overheated at the point of contact with the steel blocks.

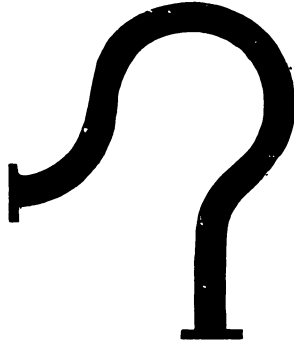

FIG. 75.—Corner Expansion Bend.

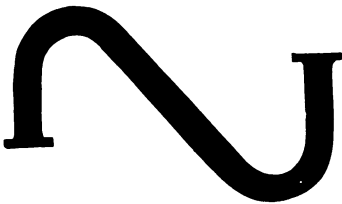

FIG. 76.—"S" Expansion Bend.

Cost of Electric Welding.—A few examples giving actual figures may be of interest.

(a) *Ordinary Articles.*—The cost of an universal machine for electric welding, size 3, for sections up to 3,000 mm.

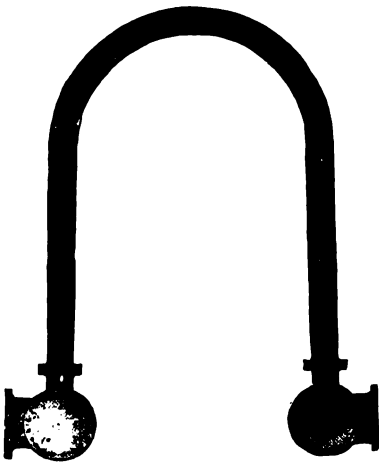

FIG. 77.

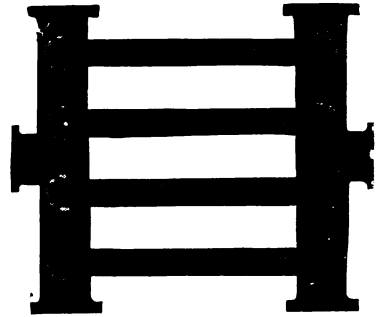

FIG. 78.

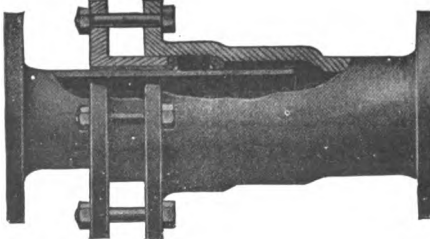

FIG. 79.

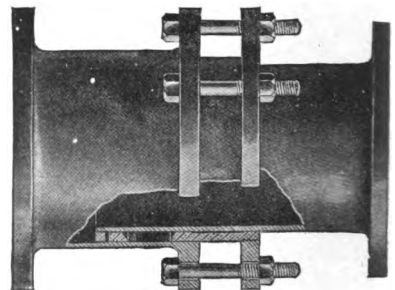

FIG. 80.

FIGS. 77 to 80.—Compound and Sliding Expansion Joints, Electrically Welded.

(about 45 square inches), is about £170; add to this 15 per cent. for interest and depreciation, equal to £25 10s., or an expense of 1s. 7d. per working day. With this machine three welds of maximum section can be made in two minutes

(fifty seconds of which being actually absorbed by the welding alone), making 900 welds every ten hours, requiring roughly 125 h.p. hours or 75 kilowatt-hours, or about 7s. 6d. for electric energy, and with a man at 4s. a day, a total cost for 900 welds would be 13s. 1d.

Assume that two men can make, in average, by fire, one weld in two minutes, or 300 welds per day, it would take them three days to make the 900 welds, earning thereby 24s.; add to this 1.5 cwt. of coal at 1s. 6d. per day = 6s. 9d., and 1s. for

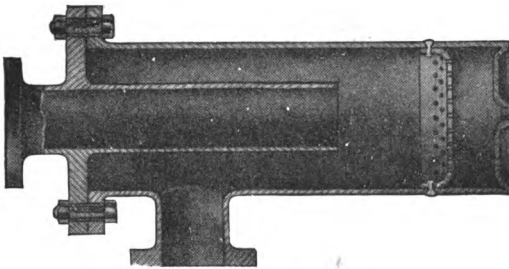

FIG. 81.—Steam Dryer, Electrically Welded.

tools, making a total cost of 31s. 9d., or a difference of 18s. 8d. in favour of electric welding.

The above figures refer to welding of ordinary articles, but the advantages of electric welding are still more prominent in complicated articles, the handling of which is difficult, if not impossible, for welding by fire.

(b) *Water-pipes*.—An able smith with two assistants can in the best case weld fifty ordinary water-pipes a day; the same man can easily with an electric welding machine make 300 such welds per day.

(c) *Chain Welding*.—A skilled chain-smith can weld two links per minute. At *Jserlohn* one man welds with an electric chain machine seventeen links per minute, or eight times as much as the chain-smith.

The great saving of cost in management, time and labour; the easy and often automatic manipulation of the machines, which do not require skilled labour; the cleanliness, there being no dust or smoke from fire; and the absolute freedom from danger, there being only secondary currents of low tension; and, in addition thereto, special machines for almost any conceivable article, offer to electric welding advantages of far greater extension and importance than those obtainable by any other welding system.

THE FORGING PROCESS.

By the forging process the parts to be united are heated to a temperature considerably less than that of fusion.

It is sufficient to put into contact the two metals brought to white heat and hammer them together. The hammering may be substituted for pressing or rolling, but these means are inferior, as it cannot produce a proper weld.

The weld by forging has some disadvantages. The temperature which is required easily causes the iron to oxidise; the presence of oxide of iron offers great resistance to the welding and renders difficulty for the metals to join with one another; during the operation of the welding, which ought to be done in the open air, the oxidation cannot be prevented. The welder, in order to minimise the oxidation, employs some sand or borax, but in both cases a silicate is formed, which is very fusible and must be removed by the hammering.

The inconvenience of the oxidation makes the forging unsuitable for articles of small and thin dimensions, such as tools, wires, etc., because the oxidation being too rapid, the metal burns but does not weld.

The necessity of hammering makes it also difficult to apply forging to various objects by reason of their form or the

difficulty of their removal; for instance, tubes, cisterns, or objects of a voluminous form.

It is in such cases, where the forge is insufficient, or the application difficult, that the welding by fusion is resorted to.

HYDROGEN WELDING.

The application of hydrogen to welding was introduced a few years since by *L'Oxydrique Internationale, Société Anonyme*, Brussels.

To effect a satisfactory hydrogen weld it is necessary to obtain not only a complete absorption of the oxygen by the hydrogen, but also an absolutely homogeneous flame.

At first it was suggested to obtain this by means of a blow-pipe. The fear of an explosion taking place prevented, however, for a long time, to carry this suggestion into effect. It was found advisable to mix the two gases before the inflammation, for which purpose they were separately conveyed in parallel or slightly converging tubes to the burner. It is easily understood what an unsatisfactory flame would thereby be obtained.

The proposal by *L'Oxydrique*, in 1901, to mix the two gases in the body of the blowpipe aroused considerable interest, as it really created the autogenous welding, soon followed by substituting the hydrogen with acetylene or other suitable combustible gases.

The gas of combustion is always oxygen, which may be obtained direct from the atmosphere, in which case it remains mixed with nitrogen, while the combustible gas is hydrogen, or acetylene, coal gas, and the like.

The molecules of the oxygen and the combustible hydrogen arrive at the flame entirely mixed in the proportions desired to produce a perfect combustion, for which purpose is

required one volume of oxygen to four or six volumes of hydrogen.

But a certain mixture of hydrogen and oxygen forms an explosive gas, which must as far as possible be prevented. This is easily done by giving the mixture of gas a velocity superior to the rapidity of the spreading of the flame. It is well known that the total mass of a mixture of explosive gas, contained in a tube, does not ignite instantaneously. If combustion is caused at one of the extremities of the tube, the burning of the mass spreads with a certain velocity, increasing as the square of the section of the tube. If, therefore, the gaseous mixture appears towards the point of ignition with a greater velocity than the propagation of the flame, then the fire does not reach the inner part of the tube. This may, no doubt, seem a simple discovery, nevertheless it is worth consideration.

It happens sometimes, however, that the velocity of the current decreases by reason of some momentary incident; for instance, if the welder brings the burner of the blowpipe too close to the weld, if it is brought into contact with the rubber tubes, or if the pressure regulator does not act. The result will be an interior combustion. It is an incident like those which always will happen, but of no importance or danger whatsoever, causing an interruption in the work for less than two seconds, as the flame reignites immediately by itself.

In order to avoid this small annoyance a special mixing apparatus, M (Fig. 82), is employed. It consists of a chamber filled with water to maintain a low temperature, or any other suitable material able rapidly to absorb the heat, and a finely-drawn metal spiral. The mixture of the gases takes place in the spiral in the same manner as in the blowpipe, becoming warmer and warmer. The surface as well as the diameter of the spiral must be calculated, so

that in the event of an explosion taking place in the interior the flame should instantly be extinguished by the exterior colder temperature. Furthermore, to increase the safety in the case of the flame not being put out, the volume of the spiral is such as to prevent the gases passing out from the mixing chamber completely burning, to reach either the blowpipe or the rubber tube connecting the mixer with the blowpipe. In the case of an explosion taking place, the combustion ceases immediately, the flame is extinguished,

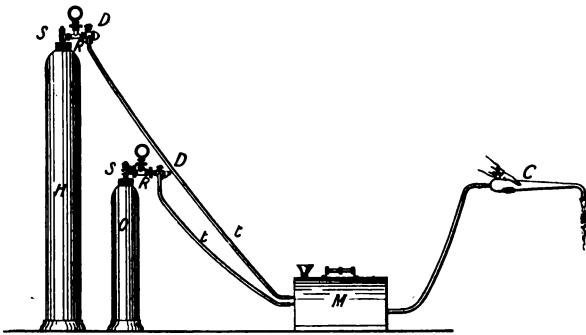

FIG. 82.

the gases produced escape, the combustible gases revive instantly, and the flame is ignited by itself. Fig. 82 illustrates a complete oxy-hydrogen welding plant.

The blowpipe introduced by *L'Oxydrique* under the name of *Pyrox*, and patented in almost every civilised country, has during its existence of five years proved to be entirely satisfactory in its action, no accident whatever having occurred during the operations with same, which speaks greatly in favour of its safety and ability of keeping a homogeneous composition of the flame; besides, it is light in weight and easy to handle.

The extent of the hydrogen welding may be judged from

the production of the gases required; for instance, the *L'Oxydrique Internationale*, at Brussels, produce per day at their works 200,000 litres of oxygen and 400,000 litres of hydrogen. The *L'Oxydrique Française*, Paris, at their works at Saint-André-lez-Lille (Nord); Beauval, by Trilport (Seine-et-Marne); Villeurbanne (Rhône); and Montbard (Côte-d'Or) produce per day more than 600,000 litres of oxygen and 1,200,000 litres of hydrogen. The gases are compressed at 125 atmospheres and delivered in ordinary steel cylinders, which latter are previously tested at 250 atmospheres' pressure.

The preference given to hydrogen welding, particularly on the continent of Europe, is attributed to the following facts, as summarised by *L'Oxydrique Française* :—

COMPARISON OF HYDROGEN AND ACETYLENE WELDING.

HYDROGEN WELDING.

ACETYLENE WELDING.

Installation.

The cost of the hydrogen plant is from £7 to £15.

The cost of the acetylene plant varies from £36 to £72, consequently four to five hydrogen plants could be obtained for the same expense; besides, the acetylene generating plant cannot last for more than five years, representing an amortisation of nearly 1s. per day.

By using acetylene-dissous, however, the generating plant may be sound.

Uncertainty.

There is no additional expense; the above price includes a complete hydrogen welding plant ready for immediate use.

To the above price must be added the cost of foundation and installation of the acetylene generator and washer, the laying of water-pipes for the maintenance of the generator, and a costly lead piping for the conveyance of the acetylene.

Facility of Installation.

The hydrogen welding plant does not require any installation; furthermore, it may be placed anywhere.

The installation requires official authorisation and approval by insurance companies. The generator must be surrounded by sufficient air and protected against freezing and deterioration.

Danger.

During a period of five years and with a registered number of more than 1,400 weldings, not one accident has been recorded.

Notwithstanding all precautions taken, more than ten fatal accidents have occurred during three years, besides those which have taken place in the use of acetylene for other purposes than welding.

It should not be forgotten that acetylene is the most explosive gas existing.

Application.

The hydrogen blowpipe is the most easy to handle.

The flame is not regulated according to its colour, to be judged by the welder, as is the case with the acetylene welding, but by a special indicator, which produces a saving of 15 to 20 per cent. as compared with previous arrangements.

The blowpipe is everlasting, that is to say, is replaced free of charge in case of being damaged.

A single blowpipe suffices for welding up to 20 mm.

The hydrogen blowpipe does not make any noise.

The acetylene blowpipe is difficult to regulate, and the welder never knows if the flame is of an oxidising or reducing nature, there being no indicator to guide him in this respect.

This explains why seventy reservoirs, delivered by an eminent French firm, were refused, sixty of them having split during the tests, although the welding appeared perfect on the surface.

It requires ten different blowpipes to weld the different thicknesses up to 20 mm., the total cost of the blowpipes alone amounting to about £50, besides the cost of their replacing when damaged.

The acetylene blowpipe makes a deafening noise.

Instruction.

Any mechanic can learn the handling of the hydrogen blowpipe in a few hours'

The mechanic *seems* to be sufficiently instructed as soon as he can make a weld, but

time, by reason of the flame being mechanically regulated. the weld is not perfect. It is only after a considerable time he can become a proper welder. *M. Le Chatelier*, in Marseilles, states that he never permits a welder to do the repair of a steam boiler unless he has had a previous practice in welding of at least eight months.

Poisoning.

The hydrogen blowpipe gives off vapours of water only.

The acetylene blowpipe, during the welding, emanates a formidable quantity of carbonic oxide besides carbonic acid.

This is even admitted by inventors of acetylene blowpipes, who affirm that the quantity of oxygen in the blowpipe does not permit a transformation of this carbon but in carbonic oxide.

Each litre of acetylene gives one litre of carbonic oxide.

This has been repudiated, basing it upon analyses made at the laboratories under totally different conditions than those which take place at the welding of steel. On

the other hand, it has been confirmed by the evidence of numerous welders, who complain, after one or two years' welding operations, of pains in stomach and great anguish in the chest, nausea, etc.

Economy.

The hydrogen blowpipe, "Pyrox, 1907," is very economical by reason of—

(1) Its low price.

(2) Not requiring any cleaning, consequently no delay.

(3) The hydrogen blowpipe, being very portable, minimum of time is lost in replacing the welding pieces.

The acetylene blowpipe is not the most economical by reason of—

(1) Every time the welding has been finished the generator still continues to generate gas, which escapes into the atmosphere.

(2) Every morning it takes at least one hour to clean the acetylene apparatus and to remove the nauseous residues.

By using acetylene-dissous the generator can be abandoned.

(3) The acetylene blowpipe, being less portable, causes troubles and expense in its displacement. The generator lasts for three to five years only.

Quality.

Hydrogen permits welding of iron, steel, brass, copper, bronze and aluminium, after a few hours' instruction.

Acetylene permits the welding of iron and steel only. The weld obtained is not malleable; it is hard to file and brittle, which explains why it should not be employed for pieces which have to resist a certain tension. Copper, brass, bronze, or aluminium cannot be welded by acetylene by reason of the great temperature it produces.

The weight of the hydrogen blowpipe is 250 grammes.

The weight of the acetylene blowpipe varies from 1 to 1.5 kilogrammes.

WATER-GAS WELDING.

To overcome the difficulties experienced by the forging process it has been suggested to employ the water-gas, which will enable the parts to be united to be heated locally even to the temperature of white heat. As soon as the temperature required has been reached the heating appliance is removed, and replaced by the hammer or press.

The application of water-gas is connected with complicated and expensive installations; besides, the high percentage of carbonic oxide which the water-gas contains, and which is odourless, has caused a high death roll.

The water-gas welding has found application principally in large works for making steam boilers and tubes, as fully described in Chapter V., page 168.

It is stated that it cannot weld plates with a thickness of less than one-fifth of an inch.

CHAPTER IV

BLOWPIPES

General Remarks—Daniel's Burner—Hydrogen Blowpipe—Schuckert—L'Oxyhydrique Internationale—Oxy-hydrogen Blowpipe Plant—Draeger-Wiss—Acetylene Blowpipe—High-pressure Type—Low-pressure Type—Acetylene Illuminating Company, Limited—Fouché Blowpipe—Oxy-acetylene Blowpipe Plant.

GENERAL REMARKS.

THE blowpipe is an instrument by means of which the operator approaches the metal upon which the work is intended to be done, while by the old system the metal had to be brought to the operator.

The blowpipe provides thus a method of dealing very simply with an immense number of metallurgical operations, which have until quite recently been carried out under less favourable conditions.

The various systems of welding seem, however, to require a special form of blowpipe ; at least, each system claims its own construction as a speciality. Blowpipes may therefore be classed according to the combustible gas which they employ, such as hydrogen, acetylene, ordinary coal gas, and naphtha ; but all of these utilise the same supporter of combustion gas, oxygen.

The facility by which oxygen and hydrogen can be obtained for commercial purposes drew attention to the possibilities of the oxy-hydrogen blowpipe as a welding agent. At first *Daniel's* burner was used, the gases being mixed at the mouth of the burner before combustion, but without satisfactory

results. Then it was remembered that if the mixing of the gases took place before the egression from the burner, their combustion would produce a higher temperature. This is the principle upon which all blowpipes are now being constructed.

So far as the oxy-hydrogen system is concerned, the mixing of the two gases may take place either outside or inside the blowpipe. *Schuckert*, for instance, mixes the gases before they enter the blowpipe, and employs for this purpose a special mixing chamber, placed about 1 metre from the blowpipe. The oxygen and hydrogen are passed in proper proportions through rubber tubes into the mixing chamber. The mixture

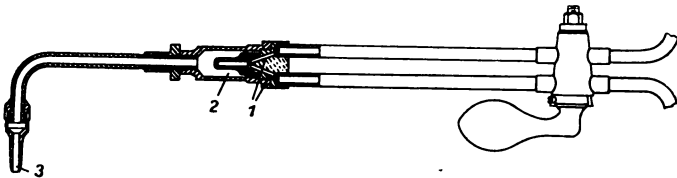

FIG. 83.

travels from there, by means of a rubber tube, into the blowpipe, ready for combustion.

In most cases, however, the gases are mixed in the blowpipes. This may be considered to be the safest way to obtain a proper mixture and the regulation of the gases. The *Soci t  Oxhydrique Internationale* mix the oxygen and hydrogen in a chamber formed in the mixing part of the tube, which also carries the burner. *Draeger-Wiss*, according to the journal *Vulcan*, modifies the construction by placing the channels 1 and 2 (Fig. 83) for the oxygen and hydrogen in an oblique position towards one another, and by producing a suction, prevents the gases to pass into the tubes of one another; the mixture of the two gases takes place in a larger chamber before it enters the nozzle 3 for combustion.

The Draeger-Wiss blowpipe is based upon the injector

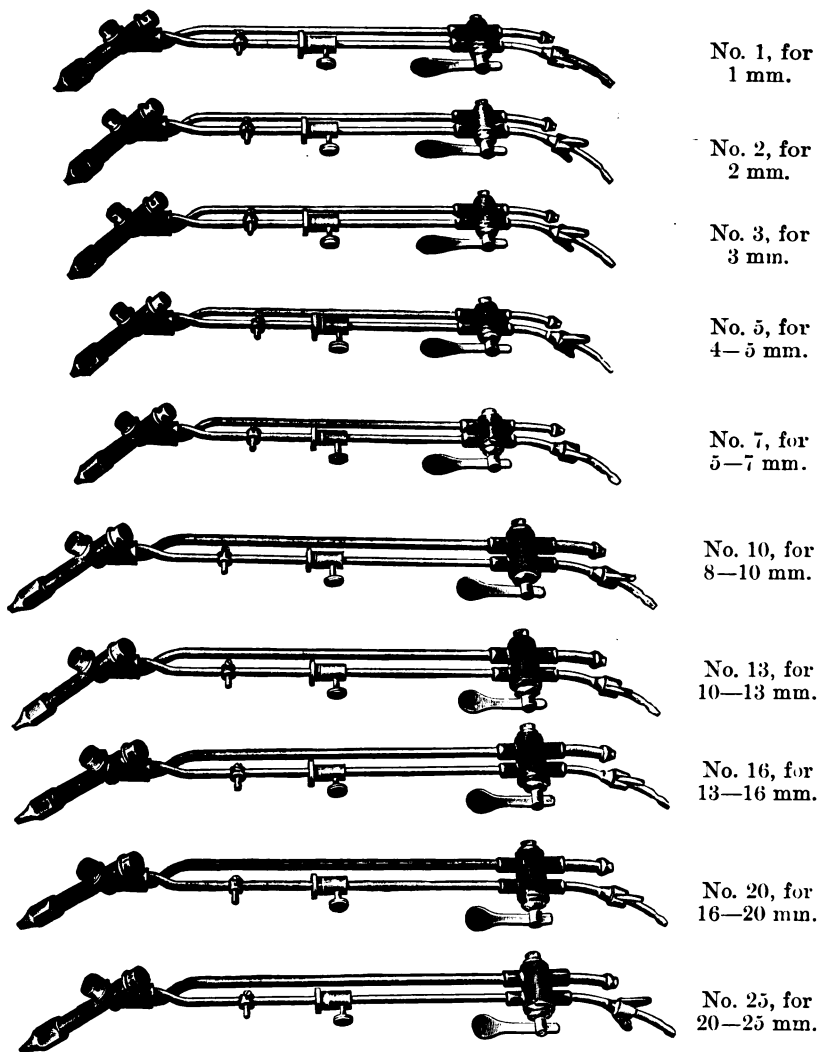

FIG. 84.—Acetylene Blowpipe, Draeger-Wiss, Model 1908.

principle, and although very simple in its construction it nevertheless embodies the qualities required of an effective blowpipe. Fig. 84 shows the various sizes of the model of 1908 applicable for different thicknesses of metal. The blowpipe is as suitable for hydrogen as for acetylene, and is very extensively used abroad.

In case the mixture is too poor in oxygen, the combustion becomes very slow. This can easily be verified by filling a glass tube with a gas mixture poor in oxygen. By lighting the mixture at one end of the tube the flame may be seen travelling towards the other end of the tube. The more oxygen added to the mixture, the faster and more complete will the combustion be; when it has reached its maximum, *i.e.*, hydrogen and oxygen in the proportion of 2 : 1, the activity amounts to about 2,800 metres per second, resulting in an explosion, but without dangerous effects. Oxy-hydrogen blowpipe plant is illustrated in Fig. 82 on page 141.

When the gases are burned in the proportion of two volumes of hydrogen to one volume of oxygen, the proportions required for complete combustion, the temperature of the flame produced is about 6,000° Fahr. In order, however, to ensure a non-oxidising flame which cannot injuriously affect the character of the metal operated upon, it is found that the gases must be burned in the proportion of about four volumes of hydrogen to one volume of oxygen, so that the temperature of the flame produced by this blowpipe in actual operation is probably about 4,000° Fahr.

The oxy-hydrogen blowpipe thus constructed supplied to a great extent what was wanted, but it has, like all other constructions of blowpipes, some drawbacks, which, to a small extent, will reduce its general use, the chief one being that of not producing, for certain purposes, a sufficiently high temperature; besides, an error in the mixture, however small,

will change the nature of the flame into an oxydising, or reducing one, consequent upon an excess or shortage of oxygen. Nevertheless, the oxy-hydrogen blowpipe renders quite as great service and offers similar advantages as those of other blowpipe systems, which is testified by the extreme extent to which it is being used on the Continent.

ACETYLENE BLOWPIPE.

The intense heat generated by the oxy-acetylene flame has resulted in various constructions of blowpipes for this welding system.

It is, however, not practicable to compress acetylene in cylinders, as may be done with hydrogen, because of its explosive qualities when compressed, *Claude* and *Hess* having devised the acetone solution method.

At first an ordinary form of blowpipe was used for burning acetylene with oxygen. The two gases were kept separate up to the nozzle of the blowpipe, that is to say, to the actual point of combustion.

With acetylene, however, a serious inconvenience appeared. A heavy deposit of carbon took place, the flame was suppressed, and, indeed, a kind of carbon mushroom resulted. It was therefore necessary to resort to some sort of blowpipe in which the mixture of gases might be made in the interior of the apparatus. But with acetylene a serious accident was to be feared, as the flame might flash back into the blowpipe and cause an explosion.

It is known that to prevent a back draught of the flame the issuing gas must ordinarily have a velocity higher than that of the explosion wave, which, for a mixture of oxygen and acetylene, is extremely high. Practical experience proves that it is not necessary to attain this point because of the very small section of the blowpipe nozzle. A velocity of flow

equal to about 150 metres a second is sufficient to prevent the flame from travelling back into the apparatus.

In further prevention of this return of the flame the interior was filled with a porous material, but this made it necessary to increase the pressure to the equivalent of 3 to 4 metres of water.

A problem still to be solved was that of utilising acetylene not under pressure, that is, generated immediately in the carbide apparatus. *Fouché* found a very interesting solution by introducing the oxygen into the apparatus through an injector, which draws a flow of acetylene with it. The acetylene enters through extremely small tubes, which do not permit the passage of the flame.

There are now in general use two types of oxy-acetylene blowpipes :

High-pressure type.

Low-pressure type.

The *High-pressure* blowpipe is one in which both the gases are used under pressure. The oxygen is supplied from an ordinary trade oxygen cylinder, and the acetylene from a cylinder in which it is dissolved in acetone absorbed by a porous material.

The *Acetylene Illuminating Company, Limited*, give the following information as to their high-pressure interchangeable blowpipes :—

INTERCHANGEABLE BLOWPIPES (HIGH-PRESSURE).

No.	Sizes.	Consumption of Acetylene per hour in litres.
A.D. 1	5	50, 75, 100, 150, or 225
A.D. 2	6	150, 225, 350, 500, 750, or 1,000
A.D. 3	6	500, 750, 1,000, 1,500, 2,000, or 2,500

No. 3 is fitted with water circulation round the tip.

The standard sizes of the patent high-pressure blowpipes are as follows:—

No.	Consumption of Acetylene per hour in litres.
H.P. 1	25
H.P. 2	35
H.P. 3	50
H.P. 4	75
H.P. 5	100
H.P. 6	150
H.P. 7	225
H.P. 8	350
H.P. 9	500
H.P. 10	750
H.P. 11	1,000

Note.—28 litres = 1 cubic foot approximately.

The *Low-pressure* blowpipe is one in which acetylene is used direct from a gas-holder, and the oxygen from a trade cylinder. This system is suitable for use in workshops situated in districts where dissolved acetylene cannot be obtained.

LOW-PRESSURE BLOWPIPES.

No.	Consumption of Acetylene per hour in litres.
L.P. 3	50
L.P. 4	75
L.P. 5	100
L.P. 6	150
L.P. 7	225
L.P. 8	350
L.P. 9	500
L.P. 10	750
L.P. 11	1,000
L.P. 12	1,500
L.P. 13	2,000

By the high-pressure type the adjustment of the flame is far easier with both gases under pressure; once the adjustment is made right it remains so; a more intimate mixing of the two gases is obtained than in the low-pressure type, and this secures higher efficiency. This is a point of great importance, as it is found that with the high-pressure blowpipe considerably less acetylene is required to do a fixed quantity of work than is necessary with a low-pressure blowpipe.

For some time experiments have been going on to perfect a blowpipe in which the consumption of gas could be regulated so as to do away with the necessity of having a large number of different sized blowpipes. Up to the present this has been found to be quite impossible in the low-pressure type of blowpipe, but blowpipes on the high-pressure system admit the gas consumption to be altered over a wide range by merely changing the nozzle. In this type of blowpipe both gases are used at the same pressure, which has the great advantage that if, while the work is going on, the orifice of the nozzle becomes partly choked by scale from the metal, the composition of the flame remains the same, but in the case of a low-pressure blowpipe, where the oxygen is introduced at a high pressure and in a constant quantity, and the acetylene at a low pressure, any choking of the orifice will result in an alteration of the composition of the flame and consequent oxidation of the metal.

The Acetylene Illuminating Company give (on pages 153 to 157) tables of practical instruction for using their blowpipes.

When a blowpipe is working properly the length of the small white cone of the flame for the different blowpipes should be as in the following table:—

Consumption of Acetylene per hour in litres.	Length of cone in mm.	Consumption of Acetylene per hour in litres.	Length of cone in mm.
50	6	500	10
75	6.5	750	11
100	7	1000	12
150	7.5	1500	13
225	8	2000	14
350	9	2500	15

The approximate internal diameter in inches of pipe required between the acetylene apparatus and the hydraulic back-pressure valve :

Quantity of Acetylene required per hour, in cubic feet.		10	25	50	75
Distance in feet between acetylene generator and hydraulic back-pressure valve.	50	$\frac{1}{2}$	$\frac{3}{4}$	1	$1\frac{1}{4}$
	100	$\frac{3}{4}$	1	$1\frac{1}{4}$	$1\frac{1}{2}$
	200	$\frac{3}{4}$	1	$1\frac{1}{4}$	$1\frac{1}{2}$
	500	$\frac{3}{4}$	1	$1\frac{1}{4}$	$1\frac{1}{2}$
	1000	1	$1\frac{1}{4}$	$1\frac{1}{2}$	$1\frac{1}{2}$
	2000	1	$1\frac{1}{4}$	$1\frac{1}{2}$	2
	3000	$1\frac{1}{4}$	$1\frac{1}{2}$	2	$2\frac{1}{2}$

Speed at which Work can be Welded and Proper Size of Blow-pipe to Use.—The table on p. 157 shows the approximate size of blowpipe to be used on different thicknesses of metal and the approximate rate at which work can be welded. Allowance must be made for the skill of the workman, the character of the job, and the type of blowpipe employed. The sizes of blowpipes given in the table are of the high-pressure type; it will be found that a larger blowpipe will be required when low-pressure plants are in use.

The *Fouché* blowpipe is a French invention based upon the injector principle. It was introduced a few years since, and has recently undergone some further improvements.

Experience has already confirmed, to a certain extent, what science has taught, that a proper weld is vitally dependent upon various matters, the foremost amongst which are the absolute purity of the gases employed, the composition and continuity of their mixture and its velocity at the nozzle of the blowpipe, the pressure and temperature of the flame and its application upon the metals to be welded. Furthermore, consideration must also be taken as to the thickness as well as the chemical and physical properties of the welding metal.

Thickness of Plate in m.m.	Size of Blowpipe to use.	Speed of work in foot run of weld per hour.
1	3	50
1·5	4	40
2	5	35
2·5	6	30
3	7	24
4	8	18
5·6	9	14
7·8	10	10
9·10	11	7
11·25	3 A.D.	

The orifice of the nozzle must be constructed accordingly, and the blowpipe must be light and easy to handle.

The velocity of the gas mixture when it leaves the nozzle must not be too great, as it would prevent the controlling of the welded metal with the flame, nor should it be too small, as it would then cause the flame to repel or to be driven back.

With a consumption of 3,000 litres of acetylene per hour, for instance, the working pressure should not exceed three atmospheres, and when the consumption is smaller it should be reduced accordingly, even to 0·5 atmosphere. The velocity of the gas would in such a case not exceed 250 metres per second.

A constant gas consumption, combined with a constant pressure and the largest orifice possible of the nozzle, constitutes the best burner.

It is evident, therefore, that the construction of a blowpipe must in the first instance be based upon theoretical principles, and the wide range of its application adds considerably to the difficulties of its construction.

The more exact and minutely correct in its construction the more will the blowpipe comply with the theoretical conditions, and the more perfect will be the weld.

Fouché has complied with these conditions by producing twelve different sizes of blowpipes of such a correctness that only a correctness that only can be produced with the most sensitive instruments. Other systems are generally satisfied with four or five different

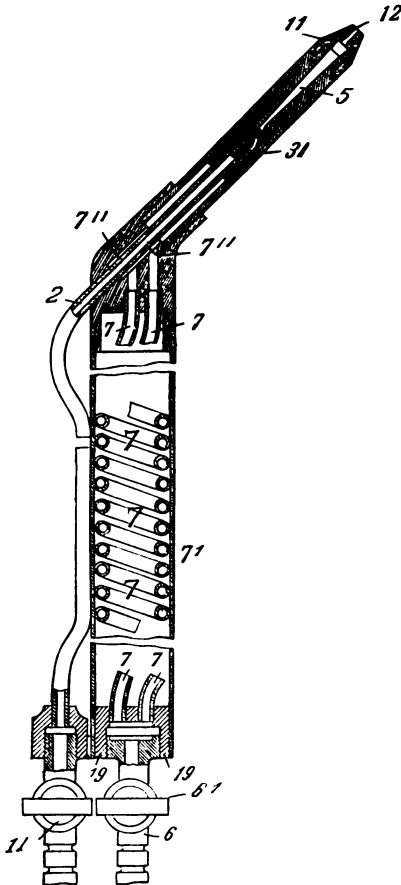

FIG. 85.—Fouché Blowpipe.

sizes of blowpipes for doing the same work, pointing out this as a great advantage by reason of saving expense to the welder. There is nothing to prevent a reduction in the number of sizes of the Fouché blowpipes, but this could only be done by

raising the working pressure in order to increase the working effect, which would result in an unsatisfactory weld.

A greater volume can certainly be obtained by working with a greater gas pressure, but the velocity of the gas mixture at the egress of the nozzle must remain unaltered. This is only possible when the oxygen injector and the mixing chamber as well as the orifice of the nozzle are all simultaneously altered. But the most important is that the mixture of the gases remains constant and does not decompose in any way.

The unavoidable heating of the blowpipe by radiation

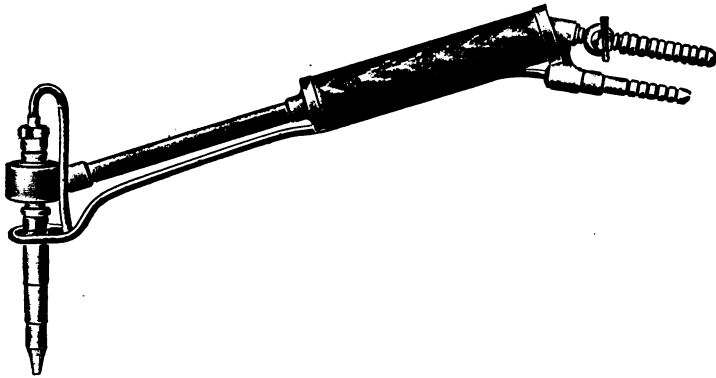

FIG. 86.—Fouché Cyklop Blowpipe.

of heat from the welding pieces will act differently upon the oxygen, which is introduced at a high pressure and in a constant quantity, and on the acetylene, at a low pressure, and will cause, after a few minutes' working, an alteration in the composition of the flame, which will become more and more rich in oxygen with corresponding oxidation of the welding metal. An attentive and skilful welder can notice these effects from the appearance of the flame, and will therefore stop the welding in order to cool the blowpipe or change the nozzle.

The Fouché blowpipe, 1908, avoids all these disadvantages

méchanically, and retains absolutely the reducing property of the gas mixture, while its weight is only one-third of that of the former construction (Fig. 85).

The following table shows the approximate consumption of acetylene by the various sizes of Fouché's low-pressure blow-pipes, 1908, for different thicknesses of plate :—

FOUCHÉ BLOWPIPE.

No. of Blowpipe.	Thickness of Plate in mm.	Consumption of Acetylene in litres per hour.
2	0·5	36
3	1·	75
4	2·	130
5	3·	210
6	3—5	300
7	5—7	450
8	7—10	650
10	10—13	1000
12	13—16	1500
15	16—25	2200

FOUCHÉ CYKLOP BLOWPIPE.—FIG. 86.

No. of Blowpipe.	Thickness of Plate in mm.	Consumption of Acetylene in litres per hour.
2	0·5	36
3	1·	75
4	2·	100
5	3·	150
6	3—5	225
7	5—7	350
8	7—10	500
10	10—13	750
12	13—16	1000
15	16—25	2000
16	25—30	2500

In workshops where various welders are engaged, it is advisable to have several blowpipes, but where repairing work is principally being done, or where one welder only is operating, a Fouché Gigant blowpipe would be the best to use.

In the Fouché Gigant, the oxygen injector, the suction, nozzle and the head of the blowpipe form all one solid piece which may be removed in one single operation; while in other similar burners the nozzle only and not the oxygen injector is generally exchangeable. The most favourable velocity of the gas mixture, and consequently also the rational working, is thereby secured; any confusion in employing a wrong nozzle is prevented and thus waste of gas avoided.

Fouché Gigant No. 1, with five exchangeable parts, represents the blowpipes Nos. 2, 3, 4, 5 and 6; Fouché Gigant No. 2, with six exchangeable parts, the blowpipes Nos. 4, 5, 6, 7, 8 and 10; Fouché Gigant No. 3, with three exchangeable parts, the blowpipes Nos. 12, 15 and 16. The Fouché blowpipes can be used either for low or high pressure.

Dr. Michaelis gives the sizes of the piping between the gasometer and the weld by Fouché's blowpipe as follows:—

Distance in Metres from Gasometer to weld.	Quantity of Acetylene required per hours in litres.							
	80	100	200	300	500	1000	2000	3000
	Internal diameter of pipe in m.m.							
10	10	10	10	13	20	20	26	32
20	10	10	13	13	20	26	32	32
30	10	10	13	20	20	26	32	40
40	10	10	13	20	20	26	32	40
50	10	10	20	20	20	26	40	50
75	10	13	20	20	26	32	40	50
100	13	13	20	20	26	32	40	50
200	13	13	20	20	26	40	50	60
500	20	20	26	26	32	40	60	80
1000	20	20	26	26	40	50	60	80

Fig. 87 is an illustration of a complete low pressure oxy-acetylene plant without the acetylene generator, which may be placed in any suitable position, preferably outside and at

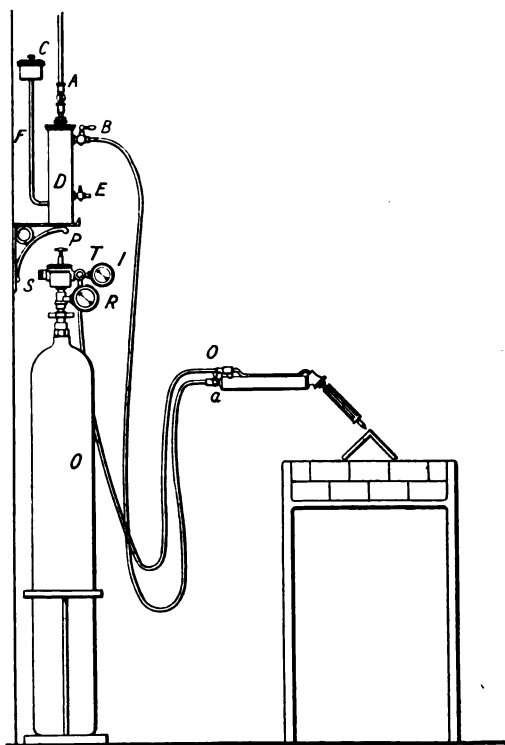

FIG. 87.—Low-pressure Oxy-acetylene Plant, without the Generator.

any distance from the blowpipe, and its connection with the blowpipe.

A is a tap connecting the inlet to the hydraulic safety valve with the acetylene supply pipe from the acetylene apparatus.

The blowpipe is connected at *a* by means of an ordinary stout rubber tube with the outlet tap B of the hydraulic safety valve. This forms the acetylene supply pipe to the blowpipe.

The blowpipe is connected at O by means of a special canvas-covered strong rubber pipe with the outlet tap T of the oxygen pressure regulator, which is fixed, as shown, on the oxygen cylinder.

This pipe conveys the oxygen supply to the blowpipe, and should be securely attached, as it is subject to pressures varying from 10 lbs. to 20 lbs. per square inch.

The hydraulic safety valve is supposed to have been previously charged with water, and the gas regulator securely attached to the oxygen cylinder.

The blowpipe apparatus is now ready for use, with the taps A, B, and T closed.

First open the cylinder valve by means of the key supplied for that purpose. Then by means of the thumb-screw, P, adjust the pressure of the low-pressure gauge, I, to the correct working pressure for the blowpipe used. Then open the taps A, B, and *a*, and when acetylene is unmistakably smelt at the nozzle of the blowpipe, ignite it by means of a gas jet, candle, or taper. Then open the tap T, which admits oxygen to the blowpipe, and correct the pressure on the gauge, I (which will be found to have dropped slightly through the tap being opened). Then by means of the tap *a* slowly throttle down the acetylene until the small white cone of flame at the nozzle of the blowpipe shows a clearly defined outline.

The tap A must never be used to regulate the supply of acetylene; in fact, after the hydraulic safety valve has been charged with water it is best to leave this tap always on.

The pressure of the acetylene supply due to the gas-holder should be not less than 5 ins. of water, and the supply pipe should be proportioned to the maximum quantity required per hour. It is a good plan to fix a water-pressure gauge near the inlet to the hydraulic safety valve in order to note the pressure supply during work.



On stopping work the acetylene taps *a* or B should be closed first and then the oxygen tap T. When work is completely stopped the oxygen cylinder should be shut off also, and the pressure released from the regulator.

When the apparatus is ready for operation, the welding should be done at the apex or outer extremity of the small bright green cone, which by the Fouché burner retains its radiating brightness and size, about 10 to 15 m.m.

The mixture of gas being ignited at the orifice of the burner, the acetylene will at the moment of combustion with oxygen decompose into its elements, carbon and hydrogen. The carbon takes part in the burning only, while the hydrogen, not being able to combine with the oxygen at the very high temperature in the neighbourhood of the flame, remains temporarily in its free state. The flame consists almost entirely of carbon monoxide, which is being converted at its extremity into carbon dioxide. The free hydrogen forms round the flame a relatively cool jacket, and protects the inner zone from loss of heat, and excludes almost any possibility of oxidation. The small white cone formed in the centre of the flame has at its apex a temperature of about 1,300° Fahr.

In order to obtain a perfect combustion two and a half volumes of oxygen to each volume of acetylene are theoretically required, but in practice it has been found that about equal volumes of the two gases will suffice, dependent, however, upon the purity of the gases and the regulating power of the blowpipe.

The blowpipe should never be kept in such a position as to enable the flame, thrown back from the weld, to strike the head of the burner.

If the flame is not properly regulated, it may fire back and go out. If so, the hydraulic safety valve should be closed at once, and a few seconds allowed to elapse before relighting.

The extinguishing of the flame may be attributed to some of the following reasons:—

(a) Deficiency in the oxygen pressure. See that the oxygen pressure regulator is properly arranged, and that the vessel is open.

(b) Heating of the nozzle of the burner, for instance, by working a deep weld or by placing the blowpipe in a very acute angle, enabling the flame to strike back around the head of the burner. In this case it is advisable to cool the burner in a bucket of water after first turning out the flame.

(c) Choking of the orifice in the nozzle of the burner through beads of iron being splashed into it, or from any other cause, in which case it should be cleaned with a wire brush. No other sharp instrument should be used in the holes.

The great advantage of blowpipe welding is that it is quite as applicable to mild steel as to iron, and that it permits the welding of thin plates, which were heretofore riveted or clinched together.

The blowpipe is further most valuable for use whenever it is necessary to work upon parts already in place, permitting the manufacture of forms of articles requiring numerous and complicated joints, impossible to manufacture by forging. It has the further advantage of being a light apparatus, easily manipulated and requiring no elaborate installation.

At first sight it might appear that the melted or cast metal produced would not have the qualities of strength, and particularly that of elasticity, shown by rolled or hammered material. Surprising results, however, are obtained unless care is taken during the process to avoid overheating or oxidation of the metal, or its alteration by the introduction of impurities such as sulphur or phosphorus. If, for example, thin sheets or tubes of a few millimetres thickness are subjected

to a light hammering or even a mild tempering, the metal will be found perfectly ductile, and the weld will exhibit a strength almost equal to the resistance of the original metal. Tubes thus welded may be crushed or twisted, and plates may be bent and refolded, following the weld, without showing any cracks.

When it comes to the welding of comparatively thick plates such as those of boilers, the problem is more complicated, because of the greater difficulty of producing uniform and thorough fusion to a thickness exceeding 6 or 8 m.m. Under such conditions use is often made of an artifice which should be condemned, and which has to some extent discredited autogenous welding of heavy plates.

This artifice consists in chamfering both edges which are to be joined, and filling the space thus left by melting an iron rod in the blowpipe flame. The procedure is not absolutely bad if it is very skilfully carried out and if the operator is careful to use a flame heating a large area and to let the drop of melted metal fall only on the part of the weld which has already been raised to the fusion temperature.

It is easily seen what extreme attention is necessary to succeed in manipulation of this kind. If it is badly done, a poor adhesion is obtained; if it is well done, the relatively large quantity of melted metal introduced between the two edges lowers the strength and destroys the ductility. Test pieces submitted to tension break without elongation.

The general procedure of welding plates from 6 to 25 m.m. thickness is as follows:—

The two pieces to be joined are brought edge to edge without superposition in perfect contact; if necessary to secure this, they are first subjected to a light cut on the planer; they are then heated by means of two blowpipes, one above and one below, exactly opposite to one another, and producing as large

a heated zone as possible. When fusion begins to appear on the surface it is probable that the interior of the plate is at white welding heat. The blowpipes are then withdrawn, and by a simple mechanical arrangement they are replaced by an anvil and a very light hammer, not exceeding one or two kilogrammes weight. The blow of this hammer is sufficient to cause a consolidation of the metal along the two butting edges.

Perfect welding is secured, and it is probable that the light hammering produces at the same time a certain orientation of the molecules favourable to the elastic properties of the metal. In fact, if test pieces of metal so welded are tested under tension to the breaking point, it is found that the grain of the fracture is not that characteristic of cast specimens, but is perfectly homogeneous and like that of the original plate. The strength is but a small percentage less than the original, and the elongation is satisfactory.

Metal of a tensile strength of 36 to 38 kilometres and elongation of 25 to 28 per cent. shows after welding a tensile strength of 36 kilometres and elongation of 13 per cent. These results are satisfactory for the majority of cases in which it is desirable to substitute for riveting the process of welding.

CHAPTER V

WELDING OF SHEET IRON

Patent Welded Tubes—Seamless Tubes—Pioneer of Water Gas Welding—Various Methods used—Schematic View of Welding by Coke Fire and Water Gas—Articles of Complicated Form—Relative Strength of Welded and Riveted Seams—Testing Methods—Durability of Welded Seams—Welded Tubes for Water Mains—Steel Pipes—Relative Advantages of Cast Iron and Steel Pipes—Relative Strength of Riveted and Welded Pipes—Relative Cost of Cast Iron Pipes, Steel Pipes, and Riveted Pipes—Relative Corrosion of Wrought Iron, Soft Steel, and Nickel Steel.

THE welding of sheet iron on a commercial scale is effected by means of water gas or electricity.

It was for a long time considered as a work of art, and was therefore left in the hands of a few, who preferred to keep the process as a secret.

This may be the reason why, even at the present time, so little is known about this industry, and why there is an entire absence of literature upon the subject.

By examination it will be found, however, that welding of plates of iron and mild steel is an important industry, extending its applications almost daily upon articles of the most complicated forms; but, unfortunately, the faults of the old workers are strictly adhered to by the present ones by keeping the various processes, and more particularly the mechanical appliances, as a secret.

It is not generally known that the manufacture of "patent welded" and "seamless" tubes ceases with a diameter of about 300 m.m., and that the present systems of welding sheet iron have taken their place by turning out pipes of any

diameter and length, limited only by regulations of transit, such pipes being preferable for high-pressure strain installations, water, gas, and air conduits of every description.

It is interesting to note that the pioneer of water gas welding was *F. Fütznér*, of Laurahütte, Ober Schlesien, Kommerzienrat, who some thirty years since conceived the idea of applying welding to the manufacture of pipes. He has gradually provided new and necessary mechanical appliances, ingeniously constructed, for the welding of articles of almost any shape and form. The process which is employed by

FIG. 88.



FIG. 89.

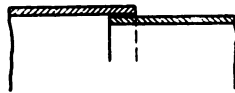

FIG. 90.

him is the water gas system, whereby any kind of iron and steel—*Siemens-Martin* or *Thomas*—may be welded. It is generally easier to weld mild metal than hard, and up to a strength of 45 kg/ 9 cm. Even hard steel plates may be welded, but the elasticity at the welding seam is reduced. The welding of steel plates has, therefore, a limited field.

The various methods used in welding of sheet iron are:—

End-to-end welding (Fig. 88) ;

Lap welding (Fig. 89) ;

Wedge welding (Fig. 90).

The end-to-end welding is limited to the welding of flanges.

The lap welding is mostly used for all plates up to a thickness of 20 m.m.

The wedge welding may be safely applied to thicknesses up to 50 m.m.; plates of greater thickness may also be welded; but in that case the ordinary mechanical means for pressing the welded joints together are insufficient, and must be substituted by hammers and the like worked by steam or hydraulic power.

The heat required to complete the weld is obtained either from coke fire, which may be stationary or portable, or from water gas. The water gas is mixed with atmospheric air and

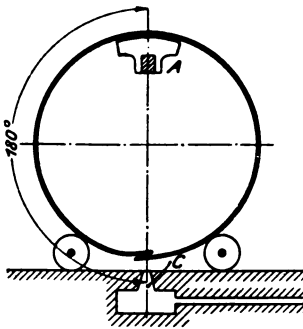

FIG. 91.

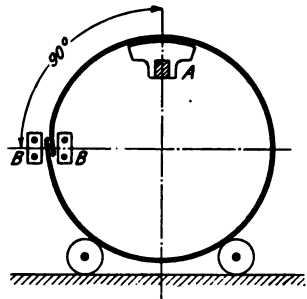

FIG. 92.

passed into special burners, which may be stationary or portable, and the flame is made to act upon the plates to be welded. The combustion is very satisfactory, and leaves a flame of great purity, the temperature of which is easily recognised and regulated during the time of operation.

A special advantage is obtained by the use of two burners, one on each side of the seam, producing thereby an almost homogeneous temperature, penetrating the whole thickness of the plates.

Figs. 91 and 92 give a schematic view of welding by coke fire and by water gas. A is the anvil on which the weld is being completed after it has been brought to the proper temperature;

BB are the two water gas burners, applied on each side of the seam; and C is the coke fire. It is evident that by the use of coke fire the weld must be turned 180° in order to reach the anvil, while by the water gas 90° only are required. Instead of such a circular turning, a longitudinal motion may be given to the welding plates.

But it is very seldom that the welding can be accomplished in such a simple manner. The more complicated the shape or form of the article to be produced, the more ingenious must the mechanical appliances be.

The usual method of welding gas-pipes and patent welded tubes consists in welding at once by means of one or several heatings along the whole length of the pipe. Welding by water gas, on the other hand, is effected by several heatings, one after the other, the length of which varies from 100 to 300 m.m., according to circumstances, no flux of any kind being used.

What security offers a welded tube as compared with a riveted one? The strength of a riveted seam amounts generally to 55 per cent. of that of the plate by single lap riveting, 70 per cent. by double-riveted and 75 per cent. by thrice-riveted lap when reference is made as to tightness and solidity of riveting. In respect of cost the single lap riveting can scarcely be compared with that of welding; therefore it remains to compare it with the riveted seam of 70 per cent. strength.

A welded seam gives almost the same strength as that of the plate it joins, the range of strength varying between 95 and 100; therefore a strength of 90 to 95 per cent. of a welded seam is always guaranteed, and experience has proved this to be within the range.

But it may be remarked that it is not always possible to obtain test pieces of the article in question without doing harm

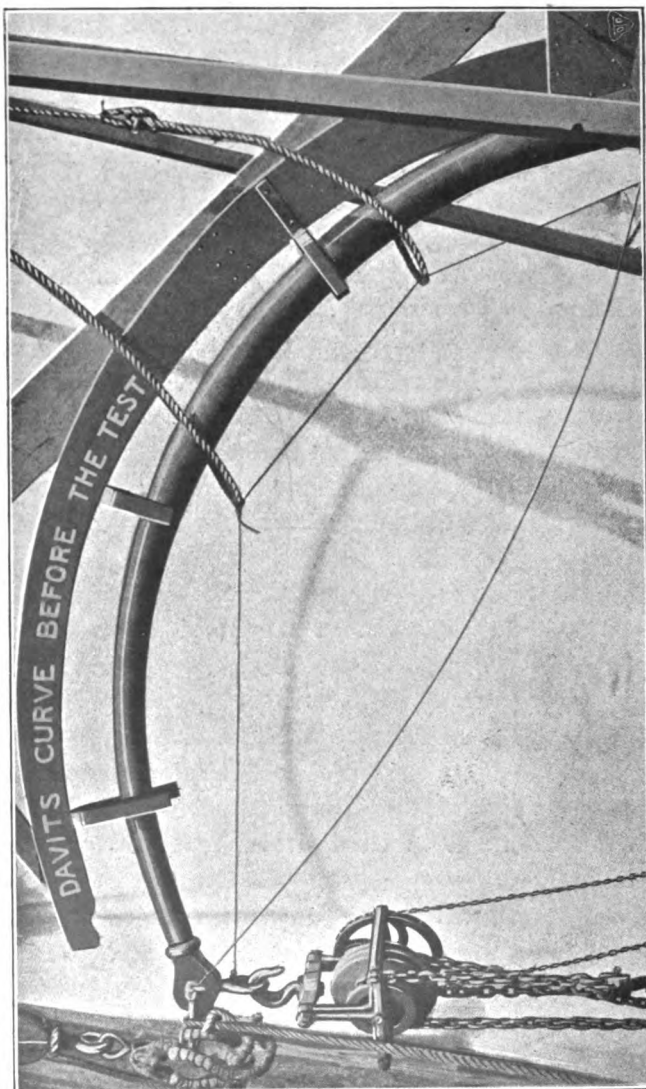

FIG. 93.—Bending Tests of Welded Bootsdavits. The Imperial Arsenal, Dantzig.

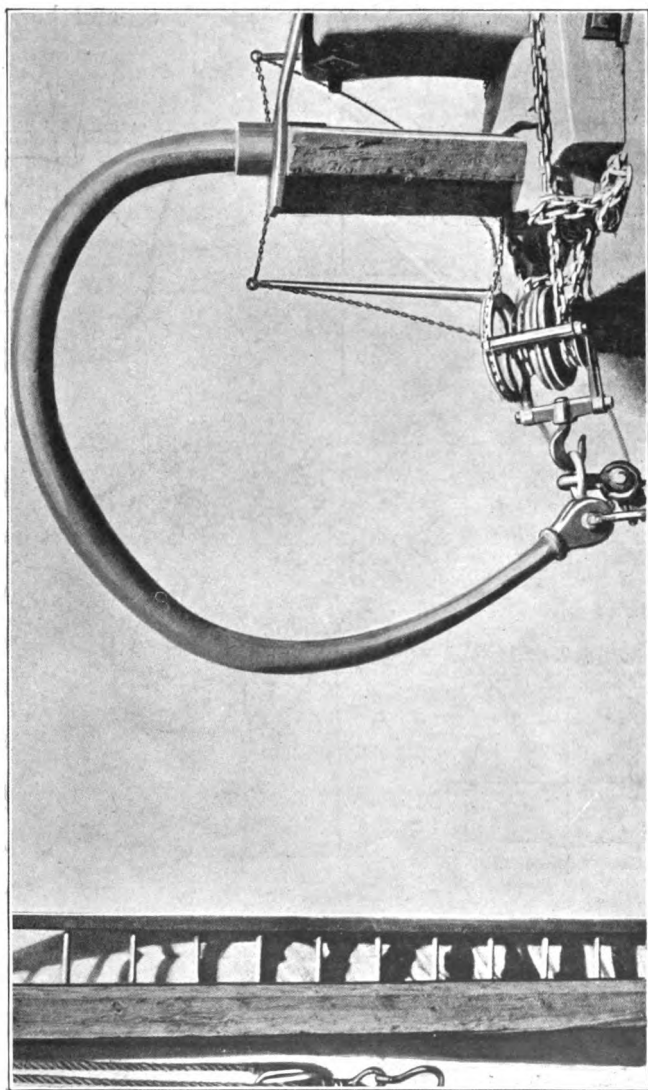

FIG. 94.—Binding Tests of Welded Bootdavits. The Imperial Arsenal, Dantzig.

to some, but in such cases other means of testing are at disposal, such as water pressure, loading, bending, falling, and the prac-

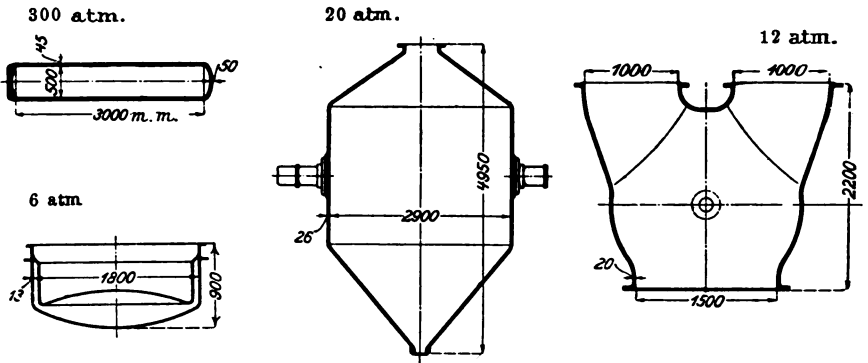

FIG. 95.

tical application of such tests is very extensive indeed. So, for instance, are the mains for water supply tested by water

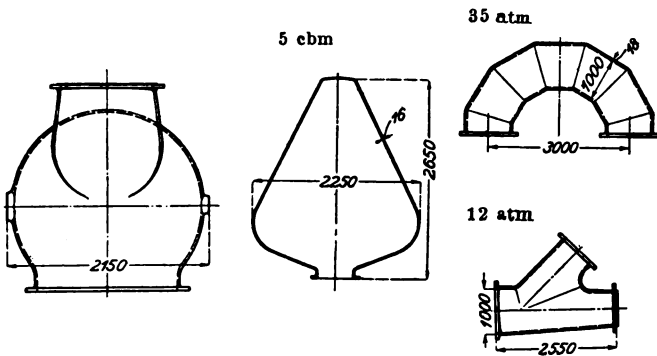

FIG. 96.

pressure, masts, yards, etc., by water pressure and weight, boatsdavits and pillars by weight, in order to ascertain the alteration or change in their form.

Figs. 93 and 94 show bending tests of boatsdavits as carried

out at the Imperial arsenal of Dantzig, with the excellent results obtained. It may be of interest to mention that *Lloyds* have approved the ship masts as delivered by *F. Fitzner*.

A special feature of the durability of welded seams is given by their application to the conduits of air for the ventilation of mines, one of the most severe tests to which a pipe may be exposed being used day and night in a very variable humidity, and consequently exposed to a particularly great strain.

As compared with riveting the advantage offered by welding is strikingly apparent where importance is attached to saving of material, where a smooth surface is desired or is a condition, and where permanent compactness, even against fire and the action of acids, is a desideratum.

The principal articles produced by welding of plates are tubes and pipes of every kind and size, with diameter ranging from 200 up to 1,500 m.m.

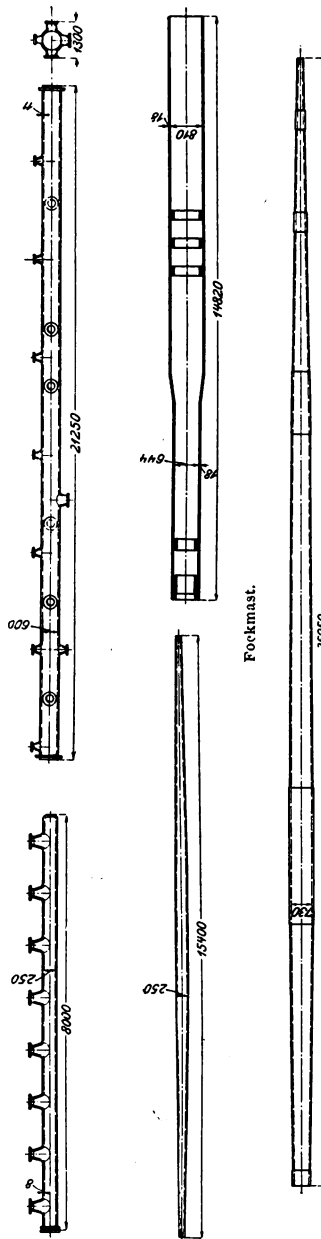

Fig. 97.

and of any desired length, limited only by the means of transit, which, for instance, by rail is about 42 m.

The manufacture of welded tubes for water mains has considerably increased, the municipalities having fear for the rust and therefore ordering welded pipes of mild steel. Besides,



FIG. 98.

the manufacture of welded tubes offers no difficulties, while other articles require almost every ingenuity in order to be carried out by welding. A few of those being frequently required are shown in Figs. 95, 96, 97. Amongst those offering peculiar difficulties in the manufacture is the vessel shown in Fig. 98, just immediately after completion of the weld, without any kind of improvement of the surface in order to

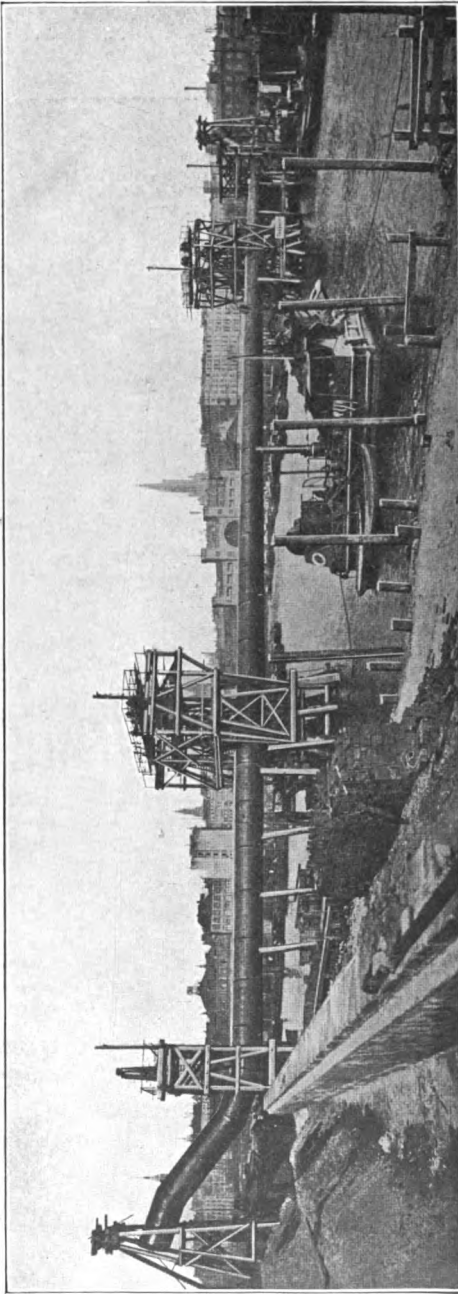

Fig. 99.—Welded Water-mains in Hamburg. F. Fitzner, Laurahütte.

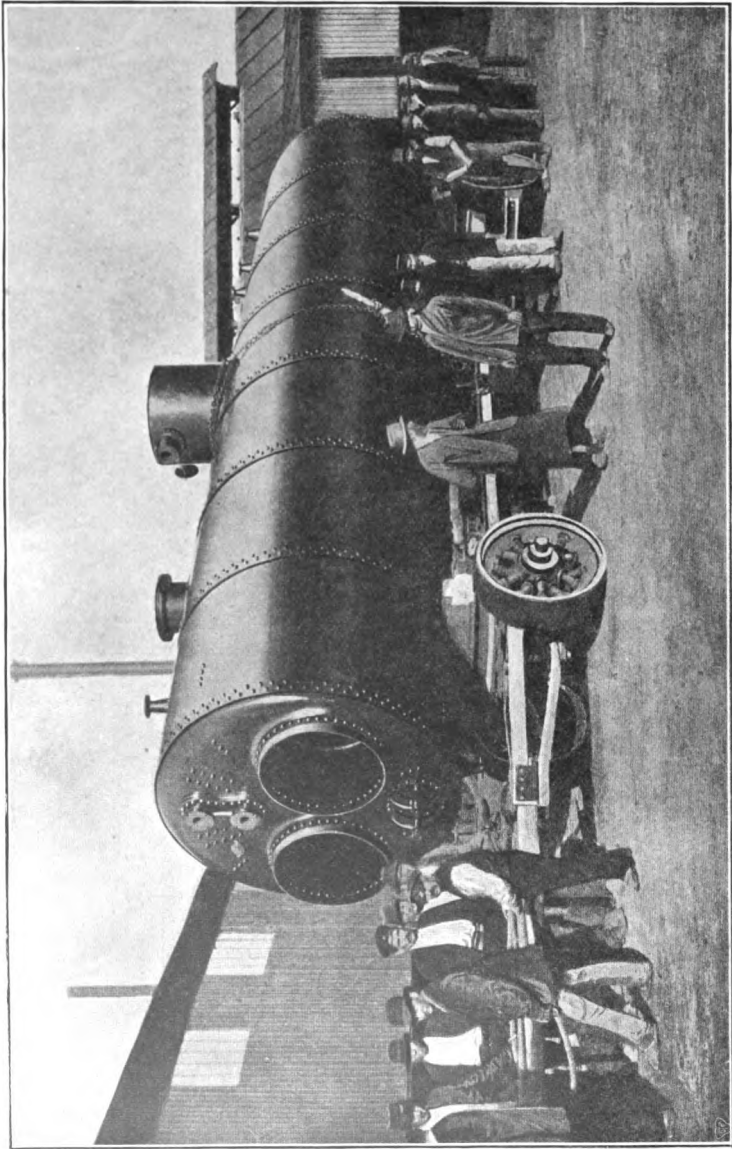

FIG. 100.—Galloway Boiler with Welded Longitudinal Seams, 96 q.m., 8 Atmospheres, 2,200 m.m. Diameter, 10,000 m.m. Long. F. Fitzer, Lauraütte.

give it a more attractive appearance. The manufacture of this vessel is carried out as follows :—

The flanges are lap-welded as seamless rolled rings. The previously bordered and welded branches, of 1,000 m.m. diameter, were welded to the upper half-bowl of the vessel, having a diameter of 2,000 m.m. To the lower part of the vessel, which was welded in form of a cone, were welded the flanges; thereafter the upper and lower parts of the vessel were welded together, and finally completed by the welding on of the side flanges (Figs. 95, 96, page 174).

STEEL PIPES.

Steel Pipes made at the works of *Messrs. Stewarts & Lloyds, Limited*, by the *Ferguson* patent process, although introduced only so recently as 1896, are already in use to a very great extent, and they are specially adapted for use as conduits for water, sewage, gas, or air, and for any working pressure up to 500 lbs. per square inch. They are usually made in 28-ft. lengths and of the following standard internal diameters :—18, 21, 24, 27, 30, 33, 36, 39, 42, 45, 48, 54, 60, 66, and 72 ins. They are made from acid or basic open hearth steel plates, having an average tensile strength of 27 tons per square inch of plate section.

Compared with cast-iron pipes of equal weight, Ferguson pipes have four and a half times the strength, or, for equal strength, are less than a third of the weight; this effects a considerable saving in first cost, freight, and handling. There is also a saving in cost of making and maintaining of joints, owing to the long lengths in which the pipes are supplied. Again, steel pipes are much more effectively coated than cast-iron pipes by dipping hot in solution, and are thus rendered much less subject to corrosion. Cast-iron pipes have been taken from the ground, after being in use a number of years,

through which daylight could not be seen owing to an accumulation of corrosion inside. Steel pipes, on the other hand, when properly coated, have been found as clean inside after twenty years as when first laid.

Cast-iron pipes cannot resist the effects of subsidence, distortion, and shocks to which they are frequently subjected, as pieces are apt to break out of the pipe, leaving it open full bore. This invariably results in heavy loss through waste of water, cost of repairs and relaying, cessation of water supply, and consequential damages. Ferguson pipes, on the other hand, may bend or flatten, but will not break. If by reason of excessive shock or pressure any failure should occur, it is only a crack of limited extent, usually causing little leakage or damage, which can be promptly repaired temporarily.

Compared with riveted pipes of equal strength, Ferguson pipes are little more than half of the weight of single-riveted, and less than two-thirds of the weight of best double-riveted pipes. They remain tight even after long transport by land or sea, whereas riveted pipes invariably leak badly before, and more so after, transport, necessitating constant caulking, with its attendant evils. Moreover, Ferguson pipes, as proved by exhaustive experiments, have 33 per cent. more carrying capacity than riveted pipes, and may consequently be at least $12\frac{1}{2}$ per cent. less in diameter for equal duty.

The examples given below show the differences in cost for a line of Ferguson pipes, cast-iron pipes, and riveted pipes to the following specification :—

The pipe line to be 1 mile long and 45 ins. clear internal diameter, to stand a working pressure of 250 lbs. per square inch, with a factor of safety of four on the average ultimate tensile strength of the pipe material.

First Example.—Cost of a line of Ferguson pipes 45 ins. bore by $\frac{3}{8}$ in. thick in 28-ft. lengths with collar joints for lead

and having an average ultimate tensile strength of 27 tons per square inch of plate section :—

	£	s.	d.
511 tons of pipes and collars @ £15 per ton	7,665	0	0
Carriage and cartage to site @ 11s. 8d. per ton	298	1	8
Cutting and filling trench, say	200	0	0
Handling at site @ 5s. per ton	127	15	0
Jointing 188 pipes @ 60s. each	564	0	0
	<hr/>		
	£8,854	16	8

Second Example.—Cost of a line of cast-iron pipes 45 ins. bore by 1½ in. thick in 12-ft. lengths with spigot and socket joint for lead and having an average ultimate tensile strength of 6 tons per square inch of pipe section :—

	£	s.	d.
1,822 tons of pipes @ £5 10s. per ton	10,021	0	0
Carriage and cartage to site @ 11s. 8d. per ton	1,062	16	8
Cutting and filling trench, say	200	0	0
Handling at site @ 4s. per ton	364	8	0
Jointing 440 pipes @ 30s. each	660	0	0
	<hr/>		
	£12,308	4	8

Third Example.—Cost of a line of double-riveted steel pipes 51 ins. bore by ¾ in. thick in 28-ft. lengths with Kimberley collar joints for lead and having an average ultimate tensile strength of 18 tons per square inch of plate section :—

	£	s.	d.
963 tons of pipes and collars @ £14 per ton	13,482	0	0
Carriage and cartage to site @ 11s. 8d. per ton	561	15	0
Cutting and filling trench, say	225	0	0
Handling at site @ 4s. 6d. per ton	216	13	6
Jointing 188 pipes @ 60s. each	564	0	0
	<hr/>		
	£15,049	8	6

NOTE.—The riveted pipes are taken as 51 ins. bore to give the same carrying capacity as Ferguson pipes or cast-iron pipes 45 ins. bore.

Copy of Letter received from the Minister for Works, Western Australia.

PUBLIC WORKS DEPARTMENT, PERTH,

22nd May, 1905.

GENTLEMEN,—In reply to your letter of the 26th ult., regarding the *Mephan Ferguson* Locking Bar Water Pipes, I have the honour to inform you that the locking bar main of a length of over 350 miles has now been carrying water for about three years without a single failure in any of the locking bar joints, although under a pressure as high as 500 ft. The lead joints joining the several lengths of locking bar pipe to each other occasionally leak and have to be caulked, but this has nothing to do with the class of pipe used, as the same trouble would be experienced with either a welded or riveted pipe. As regards the locking bar joints themselves, practically no trouble has been experienced with these, and, but for the necessity of attending to the lead joints, not more than about three men would be required to patrol the whole line.

I have the honour to be, Gentlemen,

Your obedient servant,

(Sgd.) W. D. JOHNSON,

Minister for Works.

Messrs. Stewarts & Lloyds, Limited,
Glasgow.

LIFE OF STEEL PIPE VERSUS CAST-IRON.

The question of the life of steel pipes *versus* cast-iron is one which has long been exercising the minds of engineers. As

it is not practicable to sit down and wait for the necessary time (which really means the passing of a generation) to elapse to prove beyond a doubt that the former is equal in life to the latter, the next best thing is to show, by what has been accomplished, what can reasonably be expected. There is no doubt that the life of a steel pipe mainly depends upon the coating, and, given a good covering, a steel pipe will, without doubt, equal in life that of cast iron. This coating is composed of a good mixture of Trinidad asphaltum and tar, and has proved to be most efficacious.

Since the Ferguson pipe was invented about eight years ago, the following, among other mains, have been manufactured.

In South Australia :—

8, 12, 31, and 8 miles respectively of pipes ranging from 15 ins. to 26 ins. in diameter, test pressure to 300 lbs.

West Australia :—

350 miles 30 ins. diameter for the Coolgardie water scheme, test pressure to 400 lbs.

New South Wales :—

13 miles 32 ins. diameter, test pressure to 300 lbs.

South Africa :—

12 miles of 21 ins. diameter pipes for the Premier Diamond Mines, tested to the following pressures : $\frac{1}{4}$ in. thick to 300, $\frac{5}{16}$ in. thick to 350, $\frac{3}{8}$ in. thick to 450, $\frac{7}{16}$ in. thick to 600 lbs. per square inch ;

2 miles 30 ins. diameter by $\frac{5}{16}$ in. for Durban Corporation ;

6 miles 30 ins. diameter by $\frac{5}{16}$ in. for Durban Corporation.

England and Wales :—

13 miles ranging from 21 ins. to 36 ins. diameter for the

South Staffordshire Mond Gas Company, test pressure to 800 lbs. ;

3½ miles of pipes ranging from 21 ins. to 48 ins. diameter for the Western Valleys Sewerage Board ;

1,500 ft. 86 ins. diameter by ¼ in. for Conway Hydro-Electric Power Main.

New Zealand :—

14 miles 24 ins. and 27 ins. diameter for Auckland.

India :—

4,350 ft. 24 ins. diameter by $\frac{3}{16}$ in. for Benares Municipality ;

3 miles 24 ins. diameter by $\frac{3}{16}$ in. for Jubbulpore Waterworks ;

1,680 ft. 18, 24, and 33 ins. diameter for Bombay Municipality.

The pipes supplied for the South Staffordshire Mond Gas Company are being laid in a part of the country which is the very worst for steel pipes. Besides containing sulphur and other chemical properties, which are most dangerous to the life of steel, the land is subject to subsidences. It was a matter of great concern to the engineer how best to protect the pipes against such enemies, and after much thought and experimenting he decided upon having the pipes coated once with asphaltum, then wrapped carefully round with Hessian or canvas, and afterwards a further coating of asphaltum applied on top of this. The result has been to produce a coating which is of great thickness, and adheres tenaciously to the pipes, and there is no question but it must go far to remove any trace of doubt as to the life of the pipes in this treacherous district.

The following correspondence confirms our contention that the life of wrought-iron pipes is equal to that of cast-iron, so far as this can at present be proved :—

DEPARTMENT OF PUBLIC WORKS, MELBOURNE,

25th February, 1902.

Mr. Mephan Ferguson.

SIR,—With reference to the life of wrought-iron or steel pipes, the fact is that anticipations have been so much exceeded, and dismal prognostications upset, that I am not yet able to fix a period as the limit of their durability.

It now seems almost that, given the conditions—(a) sound, well-selected plates, free from rust; (b) honest workmanship; (c) perfect coating with refined Trinidad asphaltum, or other equally efficacious envelope; (d) care in transit and laying so as to avoid abrasion of coating or the proper treatment of unavoidable abrasions—the life of wrought-iron pipes may equal that of cast-iron.

When I introduced wrought-iron pipes into Australia for water supply purposes, it was on the basis of Californian practice, and notably as carried out by *Mr. Schussler*, engineer of the Spring Vale (San Francisco) Waterworks, who at that date had nearly twenty years' experience of the system, with the result that whenever opened up the pipes were found to be in as good condition as when laid, and, with an added eighteen years, I am aware that the same condition prevails. Although at first I was rather sceptical as to a very extended life for them, I was able to demonstrate that, from a financial point of view, if wrought-iron pipes continued to be so effective in the Melbourne water supply system for fourteen years, and were then altogether abandoned, there would be an actual monetary gain at the then relative prices for cast iron and wrought iron, which made a difference of over 50 per cent. in favour of the latter.

But eighteen years have now elapsed, and it can be said of our original wrought-iron main, one of 7 miles long and

30 ins. diameter, that, as is also *Mr. Schussler's* experience in America, it is as sound in every particular as when laid down, and I see no reason why it should not be found as sound fifty years hence. I find that, before giving up the Melbourne water supply in 1890, I laid wrought-iron pipes as follows:—

DIAMETER.			LENGTH.			DIAMETER.			LENGTH.		
ins.			miles. chains.			ins.			miles. chains.		
58	3	76				30	14	68			
50	5	36				24	7	41			
32	20	40				18	5	70			

or say 58 miles. Excepting in the case of a few pipes laid through bad ground in South Melbourne, and in respect of which it was afterwards found that there had been carelessness in handling, there had been a complete absence of failure, and of the whole of them, as of our initial main, it may be said that they continue to be so sound, that no line is afforded from which to predict when they will be otherwise.

I continue to be, I assure you, quite satisfied with my action in successfully combating doubt and opposition to the adoption of wrought iron for large water mains.

Very truly yours,

(Sgd.) W. DAVIDSON,

Inspector-General of Public Works, Victoria.

DEPARTMENT OF PUBLIC WORKS, MELBOURNE,

18th May, 1902.

SIR,—In extension of my letter dated 25th February, on the subject of the life of wrought-iron pipes, I cannot now help apprising you of the great pleasure and satisfaction I have just received from the inspection of a length of the South Melbourne 24-in. wrought-iron main, the pipes for which, you will remember, you manufactured. The main crosses from Preston reservoir to Brunswick, and thence down the Sydney Road, and *viâ* Queen's Bridge into the city

of South Melbourne. It is, I think, about 10 miles long. The pipes are of the original pattern of $\frac{1}{4}$ -in. plate, with longitudinal double-riveted and transverse single-riveted seams in 28-ft. lengths, fitted with spigots and faucets. The M. and M. Board, within the past week or so, made some alterations in this main on the South Melbourne side of the bridge, which necessitated the cutting out of a length of 24-in. pipe, to which had been attached a cast-iron 12-in. branch, with sluice valve, etc. This is the pipe which I at once took an opportunity of inspecting.

It was laid early in 1887 in ground that is the most unfavourable of any in the Melbourne district to the preservation of ferruginous material. Inside, the pipe is now as if it had just come out of your works, so perfect and japan-like is the coating, and, making allowance for the adhering clay, the same may be said of the outside, excepting that in cutting out rivets (the pipe appears to have been taken out in sections), and in the handling and cartage, portions of the exterior coating have been knocked off. This, for the purpose of my examination, I found to be rather an advantage, as it afforded me a welcome opportunity for examining the plates in several places. These are in perfect order, and considering the absence of change in practically sixteen years of service, I see no reason why the same condition should not prevail for sixteen years longer, or, for the matter of that, for sixty years or longer—indefinitely. Where no change has taken place it is certainly warrantable to assume that, under a continuation of the like conditions, none will take place. Not the least source of my gratification, having first become satisfied as to the stability and certain longevity of this main, is in the splendid condition of the interior of the pipe. Its perimeter is perfect without signs of incrustation, obstruction, or deposit. This is the more remarkable from the fact that, in an equal period, a cast-iron pipe of 24 ins.

diameter would have lost at least 1 in., and more probably 2 ins. of section, from incrustation. The cast-iron branch, which had been connected to this wrought-iron pipe, with its valve, was heavily covered with material adhering to the inner surfaces in the form of nodules, and consisting of oxide of iron and earthy matter attracted to it. This deposit or incrustation is peculiar to all cast-iron pipes, large and small, in the Melbourne water supply system. Its rate of growth is equal to the complete filling up of a 4-in. pipe in from fifteen to eighteen years. The coating of the wrought-iron pipes, as used in the Yan Yean, is now demonstrated as being absolutely impervious to incrustation, the initial effort in which must be from the iron and establishes the impermeability of the Trinidad asphaltum process. Altogether the result is so pleasing to me, although I have now nothing to do with water supply affairs, that I cannot refrain from expressing it to you, who were so closely associated with my first efforts in introducing wrought-iron pipes, and indeed to ask you to share my feelings of satisfaction, and, in doing so, to authorise you to make any use of this note you see fit.

Very truly yours,
(Sgd.) WILLIAM DAVIDSON,
Inspector-General of Public Works, Victoria.

RELATIVE CORROSION OF WROUGHT IRON, SOFT STEEL, AND NICKEL STEEL.

(Paper read by *Professor Henry M. Howe* at the International Congress on Testing Materials of Construction (under the auspices of the Paris Exposition, 1900).

The facts presented were based on the determination of the loss of weight by oxidation of several plates of wrought iron, soft steel, 3 per cent. nickel steel, and 26 per cent. nickel steel,

after an exposure to sea water, river water, and also to the weather, for two periods of about one year each. Each of the plates was about 24 ins. long, 16 ins. wide, and $\frac{1}{8}$ in. thick, the total weight of all the plates was 2,597 lbs., and the total area exposed was 928 square feet. Professor Howe stated that the scale of these requirements was therefore not only much larger than that of any previous experiments of which he knew, but also larger than that of all previous experiments taken collectively. His paper includes tables and comparisons of all previous accessible reliable investigations on this subject.

Professor Howe sums up the results of his experiments in the following table:—

*Relative Corrosion of Soft Steel, Wrought Iron, and
Nickel Steel.*

(Wrought iron taken as a standard.)

	Sea Water.	Fresh Water.	Weather.	Average.
Wrought iron	100	100	100	100
Soft steel	114	94	103	103
3 per cent. nickel steel	83	80	67	77
26 per cent. nickel steel	32	32	30	31

He therefore found that soft steel corroded less than wrought iron in fresh water, but more than wrought iron in sea water; the difference, though always moderate, was in each case sufficiently constant to raise a considerable presumption that it was a real, and not merely an apparent, one. In *Krupp's* very important experiments the opposite results were obtained, for soft steel corroded much less than wrought iron in sea water; and here, too, the difference was so constant as to raise a considerable presumption that it was real, and not merely apparent.

Professor Howe draws two inferences :—

1. That the difference in the rate of corrosion between wrought iron and soft steel is rarely enough to be of great moment, except perhaps in marine boilers.

2. That the ratio of the corrosion of a given soft steel to that of a given wrought iron may vary greatly with the conditions of exposure.

He suggests two chief causes for the apparent discrepancies between the results not only of different observers, but even of the same observer :—

1. The quasi-accidental variations, individual peculiarities, etc.

2. That the susceptibility to corrosion of soft steel, taken as a whole, does differ somewhat from that of wrought iron taken as a whole ; but that this difference is of such a nature that wrought iron, as a class, corrodes, on an average, faster than soft steel under certain conditions, but slower than soft steel under others.

He referred to the strong and wide-spread belief, at least in the United States, that soft steel corrodes much more rapidly than wrought iron ; and stated that this belief has greatly retarded the introduction of soft steel for tubes and other purposes in which oxidation is a matter of vital importance ; and stated that, having before him the results of such extensive experiments indicating the reverse of this belief, he was led to study the cause of the discrepancy.

He looks upon the cinder of wrought iron, and the cementite of soft steel, as offering a protection to the pure iron or ferrite. The particles of ferrite on the surface are, of course, in each case, oxidised at once, but it may be possible that the mechanical protection of the flakes of cinder in the wrought iron increases with time, much more than the flakes of cementite of soft steel, so that it is quite possible that,

though wrought iron and soft steel corrode at the same rate initially, yet later the wrought iron should oxidise much less than soft steel. He stated that, fortunately, data for testing this hypothesis were at hand, for, in his own experiments and in another very extensive series, the oxidation of soft steel and of wrought iron, for each of two successive long periods, was given. Comparing these, he does not find that the oxidation of the soft steel accelerates relatively to that of wrought iron as the period of exposure continues. The hypothesis is therefore weakened, and he has hence concluded to continue his experiments by re-exposing all the plates, and he hopes to reweigh and report on them again after a further period of several years.

Referring finally to the nickel steels, he stated that the above table showed that, on a general average, the 3 per cent. nickel steel corroded 77 per cent. as fast as wrought iron, and the 26 per cent. nickel steel about one-third as fast. The superiority of the 3 per cent. nickel steel, though decided, is hardly enough to weigh heavily in determining its introduction. The 26 per cent. nickel steel, while having an enormous advantage over wrought iron and soft steel as regards corrosion, can still not be classed as a non-corroding metal under common conditions, but simply as a slowly corroding one.

CHAPTER VI

WELDING APPLIED TO STEAM BOILERS

General—Welding Instead of Riveting—Advantages and Disadvantages of Welded Boiler Joints—Difficulties of Riveted Joints—*Repairs on Steam Boilers*: Cracks—Locating the Cracks—Strength of Riveted Joints—Cost of Riveted Seams—Autogenous Welding—Electric Welding—Hydrogen Welding—Acetylene-Dissous Welding—*Repairs on Marine Boilers*: Outside Corrosion—Internal Corrosion—Cracks—Autogenous Welding—Electric Welding—German Steam Users Association—British Steam Users Association—Application of Compressed Gases to Welding—Defects of Welds—Welding of Tanks—Relative Cost of Riveting and Acetylene Welding—Keeping Down the Heap.

GENERAL.

IN 1863 an article appeared in the *Mechanics' Magazine* urging that boiler seams should be welded instead of riveted, and stating that almost the only difference between the seam then in vogue and that of a hundred years before was the use of a contrivance for finishing the rivet head.

The rings which form the cylindrical shell of the boiler are curved from flat plates, and must be joined at the edges and at their ends. The requisites of such joints are:—

1. Strength to resist the strain from internal pressure.
2. Tightness against leakage of water or steam, with a construction which shall not be too costly.
3. Ability to withstand heat.
4. Ability to undergo changes of shape from expansions and contractions without injury to the metal.

The two edges of the plate which are to be joined are

arranged so as to lap over each other to be secured together, and this attaching can be done by welding.

Bolting with a thread and nut will not meet the requirement of tightness against leakage unless the joint surfaces are planed and finished, and the boltholes seamed, and the bolts turned. This is prohibitory from its cost, and even if this were not a barrier, the friction of the nut so reduces the clamping power of the screw bolt that it would make a much weaker joint than is secured by the other plans.

Welding of boiler plate to make the joint with itself or other parts of the shell offers many advantages.

The welding property of wrought iron and ductile steel enables them to unite at clean surfaces when pressed together with sufficient force in a state of sufficient plasticity from heat. The presence of oxide of iron, or dirt, or cinder between the contact surfaces or inadequate pressure to unite the surfaces together will prevent a satisfactory weld. When satisfactory the weld may be expected to be as strong as the rest of the metal.

Welding of plate is done by lapping the two edges over for two or three inches, heating the lap to a welding heat on both sides by a flame or jet of gas free from sulphur or other oxidising tendencies, and then bringing the lapped surfaces together either by the force of percussive hammer or sledge blows or by steady pressure of cams or roller presses. Some fluxing material, like borax, which will make a fluid glass with oxide of iron, may be used as a protection for the contact surfaces, so as to prevent oxidation from exposure to air, with the expectation that it will be expelled from the joint by the welding pressure, and carry with it everything which would interfere with good welding.

Advantages of welded boiler joints:—

1. It makes the joint as strong as the rest of the plate, or nearly so.

2. The plate is no thicker at the joints than elsewhere. This avoidance of a lap keeps the tensile strain from internal pressure always in the axis of the plate and without a tendency to flux at the lap or joint.

3. Double or extra thickness is avoided at laps or joints. The plate gets unnecessarily hot at multiple thicknesses, and oxidation is more rapid there.

4. No rivets are required, which makes the boiler lighter and less liable to leak.

5. A good welded seam is watertight, and requires no caulking.

Disadvantages of welded seam in boilers :—

1. It cannot be inspected for its satisfactory quality, unless it is so bad as to allow water to leak through it under pressure. But it may be watertight and yet be far from having full strength. While a test by hammer taps to observe the resonance of the metal at the joint will reveal much to the practised ear, it lacks the convincing force of an inspection of each single rivet in a riveted seam.

2. Welded joints in large shells can only be obtained from a few firms with facilities and experience for such work. This has some effect upon the cost of such joints. But when a satisfactorily welded seam can be obtained it makes an ideal joint.

In cylinders with closed ends the last seam must be riveted even if the others are welded. The exception is where the head is flanged outward, or is convex inward so as to bring the closing joint outside the shell.

Riveted joints, with their consequent double thickness of metal, in parts exposed to the fire, give rise to serious difficulties. Being the weakest parts of the structure, they concentrate upon themselves all strains of unequal expansion, giving rise to frequent leaks, and not rarely to actual rupture.

The joints between tubes and tube sheets also give much trouble when exposed to the direct fire, as in locomotive and tubular boilers. This difficulty is partly overcome by welding.

REPAIRS ON STEAM BOILERS.

It is customary when a slight crack appears in a boiler plate to repair the leak by drilling small holes at the ends of the crack in order to prevent it from spreading any further, and then caulking the crack and covering it with a patch. This kind of repair can be easily done by any good boiler-maker, but there is one point which should not be overlooked: that it is absolutely necessary that the small holes which are drilled at the ends of the crack be located at the extreme ends of the crack, and not merely near the ends. It is often difficult to tell exactly how far the crack extends, and therefore these holes are sometimes located near the end instead of at the end. In this case, continued use of the boiler will develop the crack beyond the holes, and the trouble must be repaired again.

While ordinary careful investigation may fail to locate the ends of the crack, yet there is a simple way in which this may be safely done. First rub the plate in the vicinity of the crack with oil; wipe the oil off, and cover the plate with chalk. The oil which has penetrated the crack will then be exuded and show plainly the extent of the crack in the chalk, whereupon the holes may be located in their proper places, and either a hard or a soft patch may be applied, according to the position of the damaged plate.

Riveted joints have always been an expensive and troublesome part of a boiler to construct. An ideal boiler shell would be one in which there were no seams, so that the entire shell would be one homogeneous piece of metal, all parts of which were equally strong. A riveted joint must always be

weaker than the solid plate unless the plate at the joint is up-set so that its thickness is greater than the thickness of the rest of the shell, an operation which, for practical reasons, is impossible. The best-designed riveted joints rarely have more than 90 per cent. of the strength of the plate which they join, while the ordinary double-riveted lap and butt joints have a very much less efficiency, ranging from 65 to 85 per cent. Furthermore, it takes skilled labour and expensive machinery to lay out the seams, and punch or drill the rivet holes, and drive the rivets, and, even with the best work, there is apt to be trouble in making the joints steamtight, for the rivets must be thoroughly up-set in the holes and the edges of the seams carefully caulked.

The *Boiler-maker* estimates in the case of a 72-in. by 18-ft. horizontal tubular boiler, built to withstand a pressure of 125 lbs. per square inch, that the total cost of labour and material used in the boiler would be about \$561, of which 80 per cent. is the cost of material and 20 per cent. is the cost of labour. Of this amount the cost of labour on the riveted joints alone—that is, of laying out the rivet holes, punching, riveting, etc.—is 19 per cent. of the cost of labour and 3·7 per cent. of the total cost of the boiler. The additional material—that is, butt straps or laps and rivets—amounts to 5 per cent. of the cost of material and 3·8 per cent. of the total cost of the boiler. Therefore the cost of the riveted joints alone is about 8 per cent. of the total cost of the boiler. This is assuming that the longitudinal joint is a double-riveted butt joint, and that the holes are punched and all rivets driven on the machine. If a stronger joint were used, or if the holes were drilled or the rivets driven by hand, the cost of the riveted joints would be increased.

The only possible substitute for riveting seems to be some form of welding in which the metal itself is structurally

united in such a manner that the finished product forms one homogeneous piece of uniform quality and properties throughout. Furthermore, in order for such a system to be of any practical use, the tensile strength of the welded joint must be as great as or greater than that of a riveted joint, and the cost of doing the work, including the fixed charges on the apparatus, must not be greater than the cost of riveting; that is, it must be less than 8 or 10 per cent. of the total cost of the boiler.

The ordinary methods of welding by mechanical means, such as hammering, cannot be used in welding boiler shells, both for practical reasons and because the strength of a weld made in this manner is always uncertain.

By the autogenous welding the metal itself is raised to a temperature sufficiently high to cause it to be its own joining material; that is, the parts are joined together by the fusion of their own substance without mechanical aid. Such a process requires that only a small area of the metal in the vicinity of the joint be raised to a high temperature, and for this purpose electricity was first used. While the cost of electricity for this purpose is not excessive, yet it is rarely used, except on castings.

The hydrogen welding is successfully used on plates up to 30 m.m. thickness, and it is claimed that a joint of perhaps 95 per cent. of the strength of the metal can be made. The temperature (2,000° F.) obtainable with the hydrogen blow-pipe is, however, somewhat less than the melting point of mild steel (between 2,700 and 2,800° F.), so that for thick plates the heating must be continued for some time, and therefore the consumption of oxygen and hydrogen rapidly increases with the thickness of metal being welded, increasing the cost of welding.

A still more recent development is the use of acetylene-dissous, and this seems to have been fairly successful, since a

very high temperature (3,600° F.) can be obtained with it, so that plates up to 20 m.m. thickness can be welded more rapidly.

At present the use of autogenous welding will probably be confined to repair work, for which it seems particularly well adapted on account of its portability. It certainly will not, nor can it be recommended to, be used for welding seams of large boilers or pressure tanks until it is absolutely known that a reliable weld can be made which will be at least 85 per cent. as strong as the metal itself. The results obtained are, besides, largely dependent on the personal skill of the welder both in regard to the quality of the work turned out and the speed at which such welding can be done.

REPAIRS ON MARINE BOILERS.

Nearly all waters contain foreign substances in greater or less degree, and though there may be a small amount in each gallon, they become of importance where large quantities of water are evaporated. Naturally, when water is evaporated and turned into steam, salts held originally in solution must become deposited.

The accumulation of incrustation is of course objectionable in every form of boiler, for, irrespective of the greater wear and tear it entails, it is the cause of loss of efficiency.

Outside corrosion which is found upon the surface of the fire tube by contact of the water depends upon the boiler being fed with bad water. Generally this corrosion is not being properly considered, and it is found that salt deposits are formed upon the surface of the plate. The plate is thus in those places exposed to a higher temperature than in its other parts, and it is also being chemically acted upon by the salt.

These corrosions can appear upon the whole surface, but

generally they are limited to a width of 10 to 20 m.m., and run along the whole length of the tube above the grate bars. This is the place where the tube is exposed to the greatest heat, and where therefore the salt deposits are most easily formed. Such corrosion is often very deep, and the engineer who only can look over a comparatively small surface attaches little importance to them; besides, it is very difficult, if not altogether impossible, to make a correct examination by simply ocular inspection.

In cases where the corrosion has been freely exposed by scraping off the salt deposits, the true nature and extent of the dangerous state of the tubes will be apparent, the corrosion having reduced the thickness of the plates to that of a few millimetres. The corrosions which appear as a straight band along and on both sides of the tubes are very dangerous, being just on those places where an inspection or control is almost impossible, and produce thereby a considerable reduction in the safety of the boiler. For a long time no remedy could be found, and it was necessary to exchange the damaged tube for a new one.

Internal Corrosion.—Many and various have been the explanations offered for the phenomena of internal corrosion in marine boilers. *Professor Vivian B. Lewes*—a recognised authority on the subject of marine boiler deterioration—states that in the presence of moisture carbonic acid and oxygen simultaneously attack iron and steel, forming a thin layer of carbonate of iron. This is a very unstable salt, which almost immediately breaks down into iron oxide and ferric hydrate, liberating the carbonic acid, which, with a further supply of atmospheric oxygen, continues the process of corrosion or rusting. This process is further hastened by a certain degree of electrolytic activity between the iron and the electro-negative hydrated iron oxide. Inasmuch as the layer of oxide, or, as

it is commonly known, rust, is highly porous, the action progresses without interruption as long as the conditions are favourable. The above general conditions obtain when any iron or steel is exposed to the action of oxygen, carbonic acid, and moisture.

Cracks.—The question of the formation of cracks in iron and steel by heat stresses has been widely discussed, especially in the case of steam boiler construction. There is frequently doubt concerning the nature of the origin and the action of such stresses and concerning the true reason for the formation of the cracks. Lacking any other satisfactory explanation, one is easily inclined to ascribe the cause either to the material and its chemical composition or to the design of the boiler, or perhaps to its construction. Without doubt one or the other of these reasons enters into a great many cases in a greater or less degree, but it is also certain that cracks have been found where no known reason will suffice for an explanation, where material has failed which fulfils all specifications, where the design of the boiler is above criticism, and where its construction has been proved excellent.

The furnaces and combustion chambers of boilers suffer generally through overheating, caused principally through the presence of scale, the lavish use of oil, or shortness of water.

The special interest attached to the application of autogenous welding to repairs in marine boilers is based upon the following reasons:—

1. Repairs may be carried out at once, avoiding thereby extra delay in harbour.
2. Defects, caused, for instance, by corrosion, leakage, cracks, may be repaired which otherwise would necessitate the replacing of the damaged pieces by new ones.
3. Defects may be repaired almost as soon as they are

detected, and at any place. A boiler which could thus be repaired as and when required would naturally add to its durability. Sometimes it happens that a boiler has to be removed and replaced by a new one even after the first breakdown; it may now be possible to repair it, saving thereby considerable expense. For instance, where the tube plates are destroyed more or less by corrosion, it is impossible to take them out without first removing the boiler, and it is generally preferred, in such cases, to replace it by a new one. By means of the autogenous welding it may be possible to make a proper repair.

4. It happens often that the skin of the shell is unevenly affected, particularly on old vessels; it may be rectified, and thus extend the life of the vessel.

The following paper by *Mr. Harry Ruck-Keene*, read at the Engineering and Machinery Exhibition, Olympia, London, before the members of the *Institute of Marine Engineers*, on 28th September, 1907, is reprinted here, with kind permission of the said Institute and the editor of *The Marine Engineer and Naval Architect* :—

“The repairing of boilers is a subject which must always be of interest to marine engineers, and I propose in this paper to describe two processes of effecting repairs, by welding in place, which have so far given satisfactory results, and at the same time have effected repairs at probably less cost and in many cases in less time than by the ordinary methods of welding. These processes are the oxy-acetylene and electric systems of welding, whereby cracks in plates may be welded up in place patches may be fitted and welded in place without forming new seams, as would be necessary if they were riveted, and wasted plates and landing edges may be built up to their required thicknesses. Now the ordinary form of welding can certainly not be called a new process, for though I have been

unable to find who was the first discoverer of the art of welding, yet on referring to the fourth chapter of Genesis I find that Tubal Cain (who lived about 3,950 years B.C.), is there described as 'an instructor of every artificer in brass and iron,' and so we may fairly conclude that the ordinary form of welding was known in those days. And by the ordinary form of welding in wrought iron or steel I mean that which consists of the parts to be united being heated to a

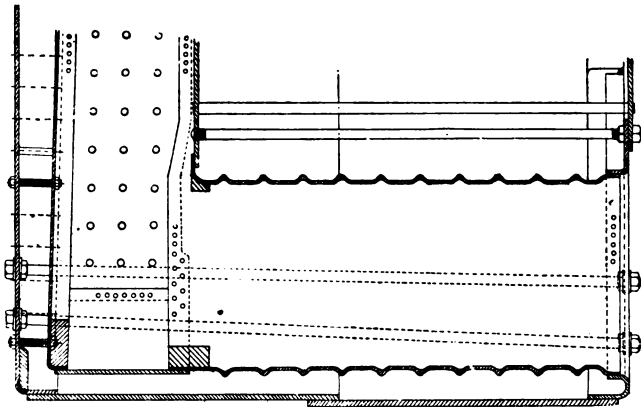

FIG. 101.—Repairs by Oxy-Acetylene Process.

suitable temperature at which they become plastic, but not actually fused, and are then united by hammering, squeezing or rolling. Although the metal itself does not become fused at this temperature, yet it becomes rapidly oxidised, but the oxide formed is liquid at this temperature, and in properly made welds it is entirely squeezed out from between the surfaces to be welded. To render the oxide still more liquid and, therefore, more easily expelled from the weld, a flux of white sand (silica) is sometimes used; this forms with the oxide a silicate of iron which has a lower melting point than oxide of iron, and although when a flux is used the iron or

steel is probably less adhesive than it is at the temperature at which the oxide melts, yet the importance of using every means of getting rid of the scale between the surfaces to be welded justifies the use of a flux in most cases. But to come down from the days of Tubal Cain to more modern times, it was the practice of several well-known firms when making

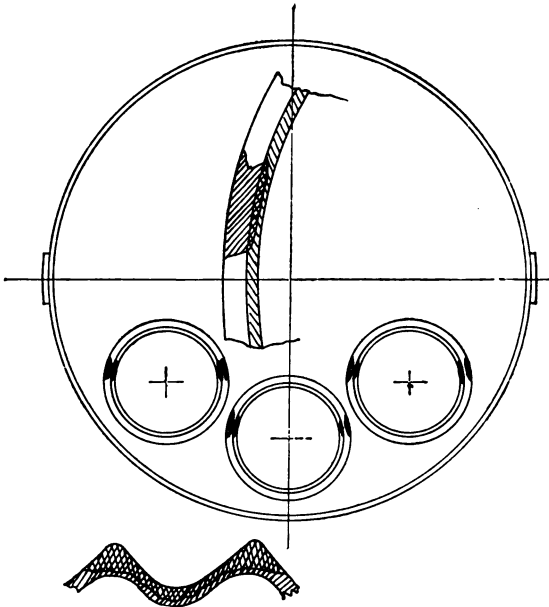

FIG. 102.—Repairs by Oxy-Acetylene Process.

iron boilers to weld the longitudinal seams of the shell plates of boilers instead of riveting them, and in 1874 some exhaustive tests then made proved the efficiency of these welded seams to be about 70 per cent. of the solid plate. And I have only heard of one case in which the weld gave way, and that was in 1889, when a boiler, eight years old, was subjected to hydraulic test, after undergoing repairs, and the longitudinal

seam cracked through the weld for a length of about 6 ins. When steel took the place of iron in the manufacture of boilers this practice of welding longitudinal seams was discontinued. But many firms still continue to weld the furnaces to the tube plates in steel boilers; and it is the universal practice nowadays to weld the longitudinal seams of furnaces, no matter whether they be of the plain, corrugated, or ribbed type. So that it will be seen that welding, though decried by many engineers, is still extensively used in the

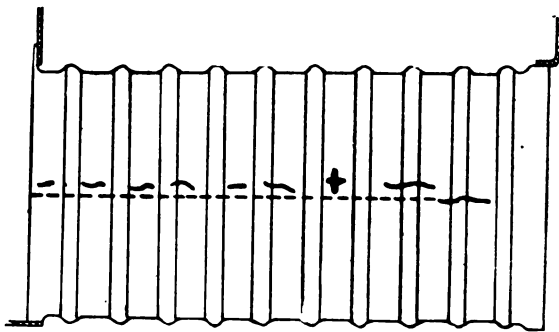

FIG. 103.—Repairs by Oxy-Acetylene Process.

manufacture of boilers. In the oxy-acetylene and electric processes of welding, though the surfaces of the metal to be welded are heated up to practically the same temperature as in the ordinary methods of welding, yet the subsequent hammering, squeezing, or rolling is dispensed with, except in that process of electric welding which I propose to describe where a certain amount of hammering is still used in making the weld. For the purpose of repairing boilers by the oxy-acetylene process the necessary apparatus practically consists of a steel cylinder containing oxygen gas and another containing dissolved acetylene, both under pressure, a special blow-pipe, flexible tubes for transmitting the gases from the

cylinders to the blowpipe, and small bars or rods of iron or mild steel about $\frac{3}{16}$ in. diameter, which are fused and attach themselves to the parts to be united. The oxygen and acetylene gases in these cylinders are led to the blowpipe by means of the before-mentioned pipes and there ignited at the nozzle, the resultant flame giving out an intense heat. Where plates are wasted away by corrosion or otherwise, the wasted parts are first thoroughly cleansed to remove any dirt or grease, and are then heated to a welding heat by means of

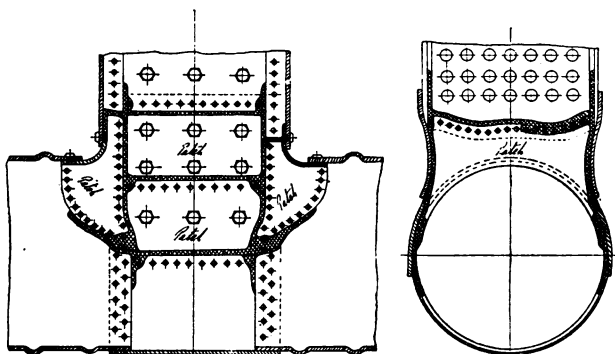

FIG. 104.—Repairs on Main Boilers by Electric Welding.

the flame from the blowpipe; the iron or steel bar is in the meantime held in this flame until a small portion at the end of the bar is melted off and attached to the part to be repaired, and this process is continued until by the addition of drop after drop sufficient metal has been added to bring the plate up to its required thickness. When a crack in a plate has to be welded up, the metal on either side of the crack is cut away to form a V-shaped groove, and thus enable the flame to penetrate to the bottom of the crack and heat the surrounding metal to the required temperature, metal being at the same time added from the small bar to fill up the groove, in the same way as the wasted plate was built up. In a similar

manner, by chamfering away the edges, two plates can be welded together. Naturally in all these cases great care must be taken to see that each and every piece of metal added becomes firmly attached before adding more metal to it. This process has been very satisfactorily employed in this country for many purposes, and more especially for welding flanges and branches on iron and steel pipes (which have to withstand

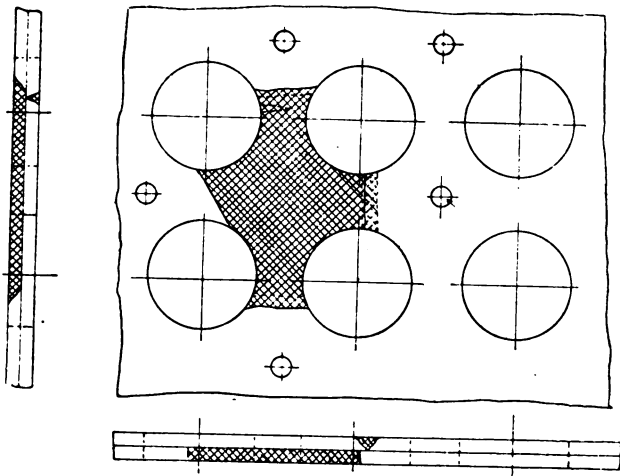

FIG. 105.—Repairs on Laminated Tube Plate by Electric Welding.

high pressure), but so far it has been little used for effecting boiler repairs. In Marseilles and Genoa quite a considerable number of boiler repairs have, however, been carried out in the last few years by this process with satisfactory results. Among other repairs I may mention those carried out to two marine boilers, where the bottom plating of the combustion chambers and the lower part of the combustion chamber back plating, and also parts of the furnaces ($\frac{1}{3}\frac{1}{2}$ in. thick), were considerably wasted by corrosion. The defective parts were cut out, patches made to suit, and instead of riveting them on,

they were welded in place by this process, thus avoiding the making of additional riveted seams in the furnaces and combustion chambers, which often give so much trouble in boilers.

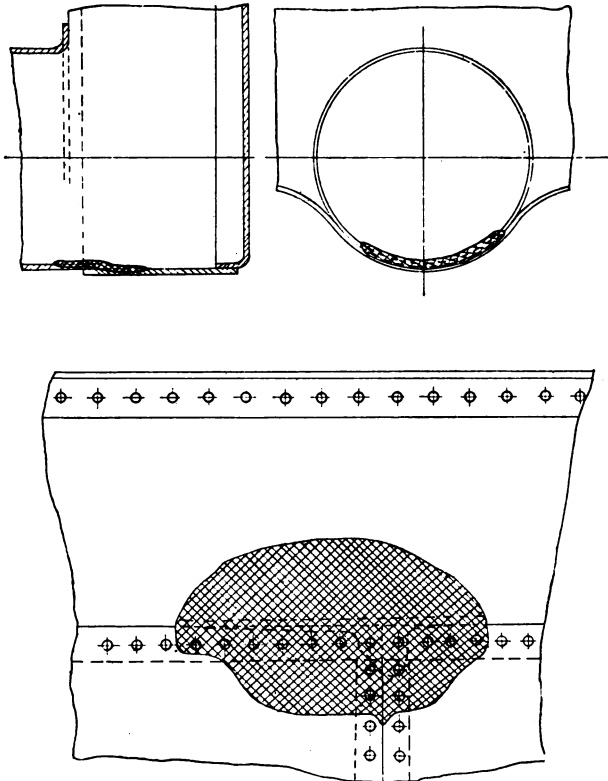

FIG. 106.—Repairs on Furnace and Combustion Chamber Plating by Electric Welding.

The landing edges of the lower part of the back end plates of these boilers were also considerably wasted, and these were made good and built up to their original thickness in the manner I have already described. These repairs were carried out under the supervision of my colleague (*Mr. Jones*) at

Marseilles, in June, 1906, and after twelve months' work they were again examined in July last and found to be quite satis-

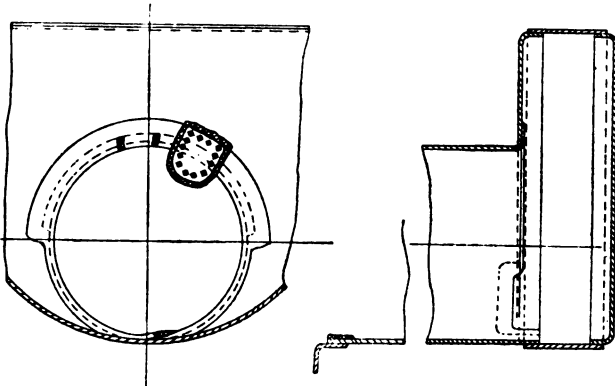

FIG. 107.—Repairs on Centre Furnace by Electric Welding.

factory and showing no signs of leakage. In another case eighteen furnaces of the main boilers of another vessel were

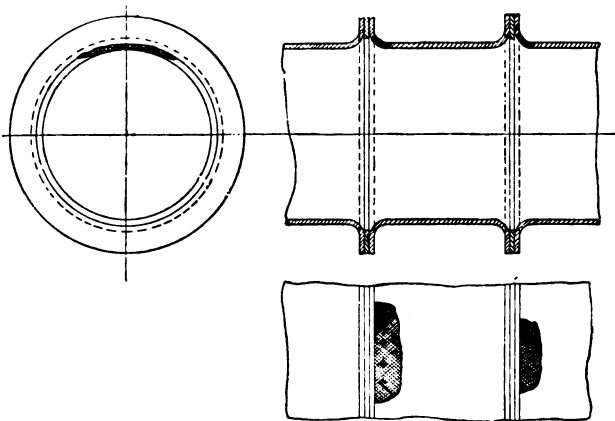

FIG. 108.—Repairs of Cracks in Furnace by Electric Welding.

so badly wasted by corrosion on the water side near the line of fire-bars, that in the ordinary way these furnaces would

have had to be renewed, but by this process the wasted parts of these furnaces were built up to their required thicknesses by welding on sufficient metal piece by piece, thus saving the time and expense of renewing the furnaces. In another case the furnaces of some other boilers were badly wasted and cracked, and these were satisfactorily welded up by the same process; there being in all about one hundred cracks in the two furnaces and the repairs taking about three weeks. Figs. 101 to 103, I think, explain these repairs better than I can describe them on paper. I could cite many more cases, but I think those I have mentioned will give some idea of what can and has been done in repairing boilers by this process. After the

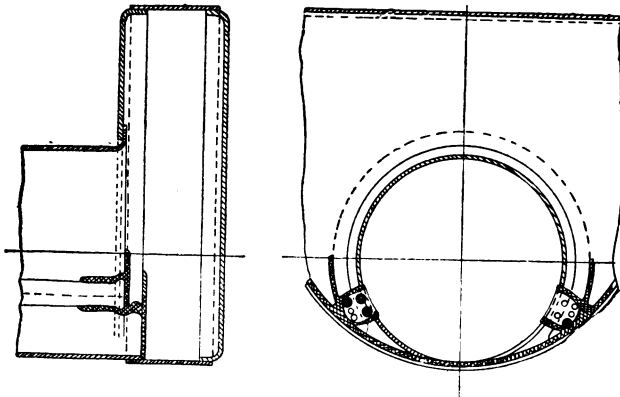

FIG. 109.—Repairs to a Furnace of a Boiler by Electric Welding.

welding operation it is usually considered better to heat the surrounding plate by means of the blowpipe flame to counteract, as far as possible, the strains that might be set up by the intense local heat. Naturally, if it were possible, it would be better to properly anneal the plate dealt with. This process has also been very usefully employed in the cutting out of defective and damaged plates, the flame from the blowpipe melting and thus cutting a groove about $\frac{3}{16}$ in. wide, in much

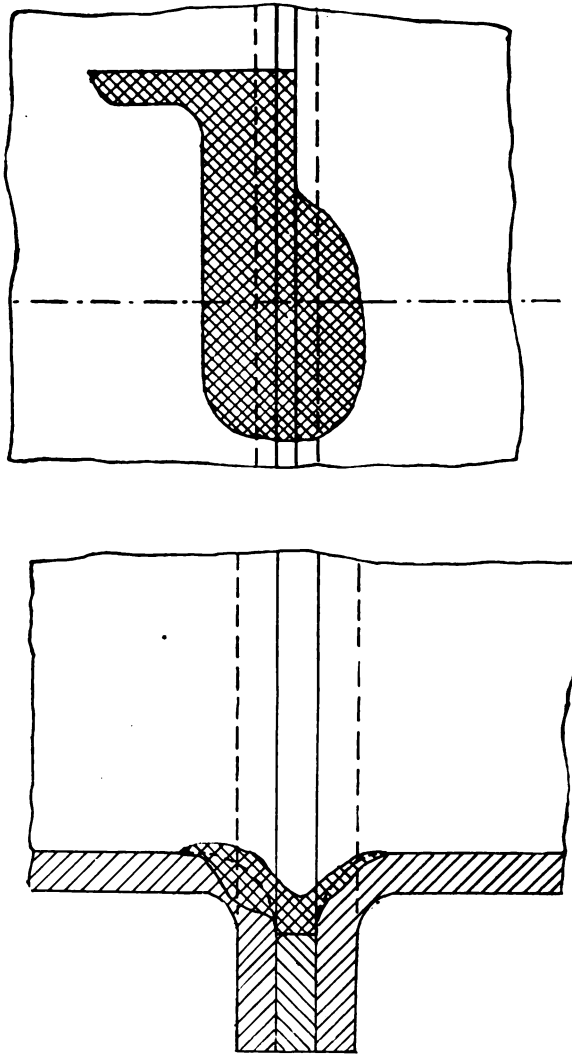

FIG. 110.—Repairs to a Furnace in way of an Adamson Ring by Electric Welding.

the same way as would be done by a band saw, the separation being quite as cleanly and accurately done and in much less time than by the ordinary methods of hand cutting. The following are results of tests, made in June last, from samples taken from a plate welded by the oxy-acetylene process, and

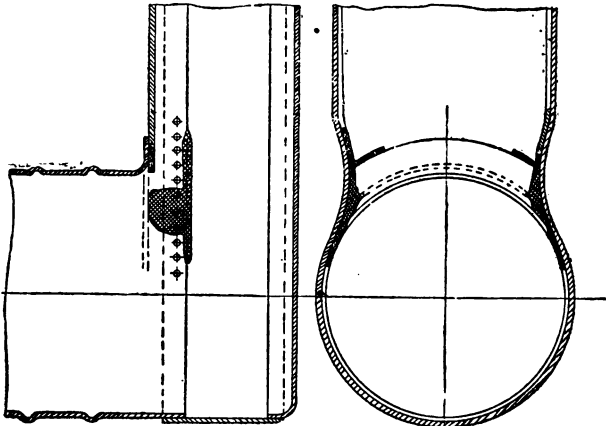

FIG. 111.—Repairs to Furnace and Combustion Chamber Plating by Electric Welding.

are the same as those I gave in a paper read at the Engineering Conference of the *Institution of Civil Engineers* :—

OXY-ACETYLENE WELDING.

	Breadth.	Thick-ness.	Area.	Tons, Total.	Tons per Sq. In.	Extension in 4 ins. per cent.
Not annealed	1·5	Ins. ·62	Ins. ·93	22·85	24·5	30 } Solid Plate.
Annealed .	1·5	·62	·93	22·35	24·0	
						Extension in 8 ins. per cent.
Not annealed	1·5	·62	·93	22·9	24·6	28 } Broke away from the weld.
Annealed .	1·5	·63	·945	22·1	23·3	

COLD BENDS.

Not annealed	180°
Annealed	180°

They show not only the efficiency of the weld, but also that the ductility of the surrounding metal in way of the weld has not been distressed by the intense local heat. It will be noticed that the tensile strength of the welded plate is the same as that of the solid plate, the elongation per cent. is also the same, and the bend tests are quite as good as those which might be expected from the solid plate.

There are several systems in use for welding by electricity which have been employed for a number of years, and are used, among other things, for welding tram-rails in place, in making good blow-holes, etc., in steel castings, and also in welding together pipes, more especially those for refrigerating plant which have to withstand high pressures. But as with the oxy-acetylene process, little use has so far been made of these processes in this country for repairing boilers. In the last few years, however, electric welding has been used abroad for this purpose, more especially at Gothenburg in Sweden, where quite a number of boiler repairs have been carried out by this process. The process there employed is somewhat similar to the oxy-acetylene process, but the heat is generated by the electric arc instead of by the flame from the blowpipe. The plant there used consists of a barge containing two dynamos of 45 kilowatt power driven by a steam engine, and a third dynamo of 3 kilowatt power for feeding the magnets. The voltage used is between 80 and 120. There are two sets of cables leading from the dynamos, so that work can be carried out at two different places at the same time. The cable from one pole of the dynamo is connected to some part of the boiler, and the cable from the other pole is connected to the welding bar (which consists of a bar of specially prepared steel about $\frac{3}{16}$ in. diameter). This welding bar is fixed in an insulated holder, and on being brought into contact with the article to be dealt with and then withdrawn a short distance,

an electric arc is formed, which rapidly heats the parts in close proximity to the arc, and at the same time the end of the bar is heated to almost a molten condition ; this is then

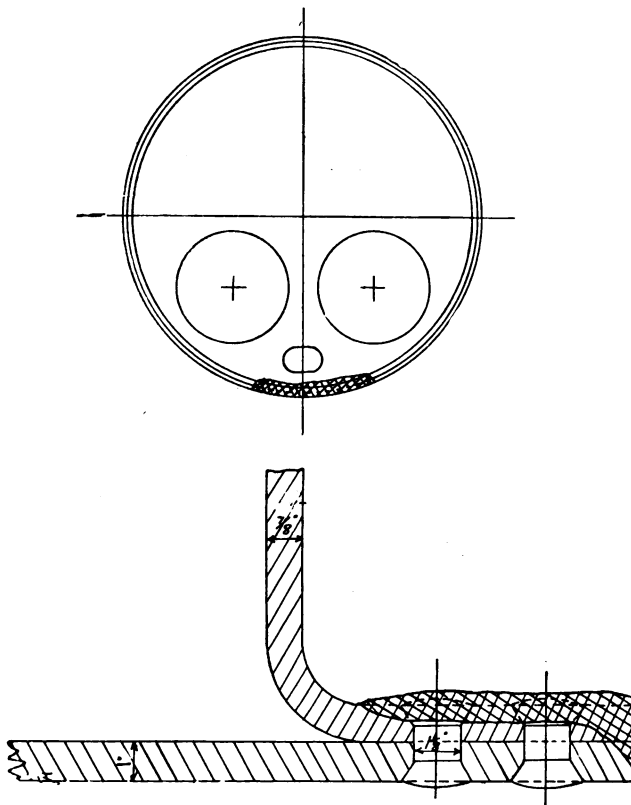

FIG. 112.—Repairs to Lower Front Plate by Electric Welding.

pressed against the parts to be welded, and they being now heated to a welding temperature, a small portion of the end of the bar attaches itself to them, in a similar manner as an almost melted piece of sealing wax is made to adhere to paper ; after this small portion of nearly melted metal is attached the

bar is withdrawn, thus breaking off the electric current. The added metal is then hammered to ensure its being thoroughly united with the parts to be welded. The welding bar is then again brought into contact with the parts being dealt with,

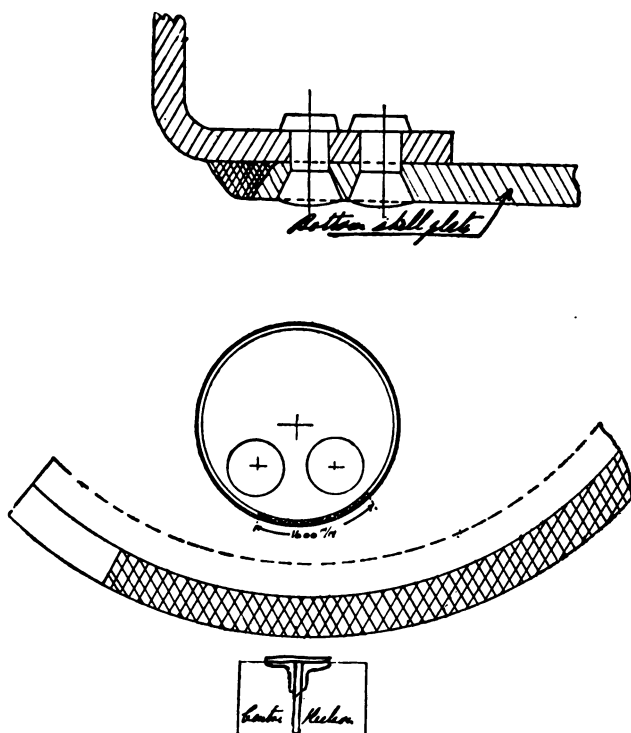

FIG. 113.—Repairs to the Bottom Shell Plate by Electric Welding.

and then withdrawn a short distance to again form an electric arc, and the surface of the metal and also the previously welded metal are again heated to a welding temperature and another small portion from the end of the bar is added and hammered as before, and so the cycle of operations continues until sufficient metal is added for the opening between the

two pieces of metal to be entirely filled up, in the case of welding two plates together, or the wasted portions of a plate have been brought up to the required thickness. The following are the results of tests made in June last from a plate welded by this process (and as in the case of the oxy-acetylene test samples, are the same as those given at the *Institution of Civil Engineers*):—

ELECTRIC WELDING.

	Breadth.	Thick- ness.	Area.	Tons Total.	Tons per Sq. In.	Extension in 4 ins. per cent.
Not annealed	Ins. 1·0	Ins. ·56	Ins. ·56	15·35	27·4	12 } Broke
Annealed	1·0	·55	·55	14·5	26·3	14 } through weld.

COLD BENDS.

Not annealed	.	58°	{ Showed signs of
Annealed	.	160°	{ fracture at weld.

“It will be seen that after annealing much better results were obtained than before annealing. But unfortunately one cannot anneal a boiler in place. Some cases of repairs carried out by this process can, I think, be better explained by showing sketches of them. Figs. 101, 102 and 103 are, as already stated, sketches of repairs carried out by the oxy-acetylene process, the remaining figures (104 to 116) showing repairs carried out by the electric welding process. Fig. 104 shows the repairs carried out to the two main boilers of a well-known Swedish vessel. It will be seen that these are double-ended boilers. Somewhat extensive repairs were carried out about three years ago (the boilers are fifteen years old) to the combustion chambers and furnace saddle plates, but they had given trouble by leakage, and at the beginning of this year the landing edges of all these patches and also several leaky rivets and local corrosions were welded up by

this process ; some joints were, as you see, welded up from the under side. I inspected these repairs after the vessel had been running about three months, and found there was not a sign of leakage anywhere. Fig. 105 shows a laminated tube plate repaired by this process ; the greater part of the lamina-

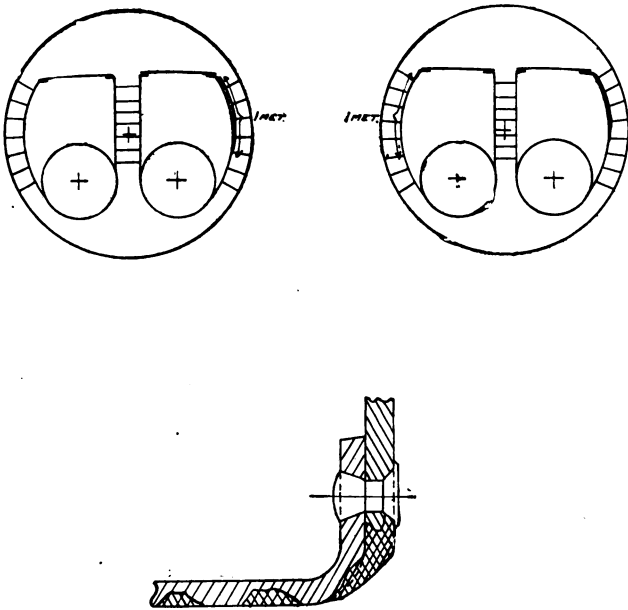

FIG. 114.—Repairs to the Combustion Chamber Plating and Tube Plate of Two Boilers by Electric Welding.

tion was cut away and the plate built up to its required thickness as shown ; the small screwed pins shown were put in as a safeguard to avoid any opening up of the lamination, in case it developed beyond what was thought to be its extent. Fig. 106. The landing edge of the lower part of the furnace and also the combustion chamber plating of this boiler in way of same were wasted away, together with the rivet heads, and these parts were built up to their original thicknesses, the

rivets themselves being so fused to the plates as to become integral parts of the same. Fig. 107. The landing edges of a leaky patch in the centre furnace of a small boiler were welded to the adjoining plating as shown, also two cracks in the furnace plating and a wasted portion of the bottom seam of the furnace was built up to its required thickness and welded to the adjoining plating. Fig. 108. The plating

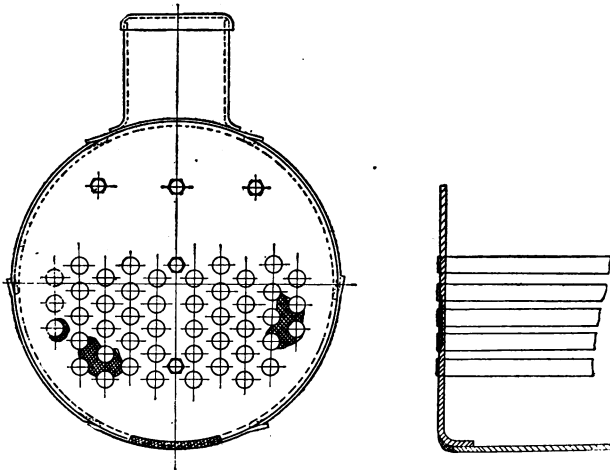

FIG. 115.—Repairs to Wasted Tube Plate of a Land Boiler by Electric Welding.

of this furnace was cracked through and wasted in way of the Adamson rings and repaired as shown. Fig. 109. This shows the furnace of a small boiler which was entirely wasted through in way of the buttstrap and landing edge of the furnace and combustion chamber plating, and was repaired as shown, the repairs taking three days. Fig. 110. Here, again, repairs have been carried out to a furnace in way of an Adamson ring. Fig. 111. This shows another repair where the landing edge of a furnace and combustion chamber plating and also a wasted portion of a tube plate were

repaired. The tube plate is not rightly shown, as it was on the water side of the furnace. Fig. 112. This plate shows the repairs carried out to the wasted portion of the lower front plate of a marine boiler; it will be seen that the rivets were here welded in to form integral parts of the plate. Fig. 113. This plate shows a repair carried out to the wasted

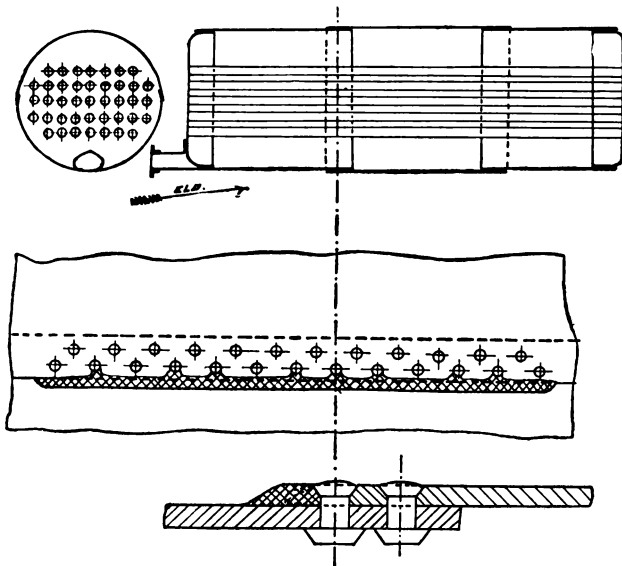

FIG. 116.—Repairs to the Wasted Seam of a Land Boiler by Electric Welding.

landing edge of the bottom shell plate of another main boiler, where a length of about 5 ft. was built up to its original thickness. Fig. 114. This shows repairs carried out to the combustion chamber plating and tube plate of two boilers which were, as will be seen, considerably wasted and pitted by corrosion, in each case the defective parts being about 3 ft. in length. Fig. 115. This shows repairs carried out to a wasted tube plate of a land boiler and also to the wasted

landing edge of the shell plating. Fig. 116. This shows repairs carried out to the wasted seam of a land boiler. In conclusion, I should like to express my thanks to my col-

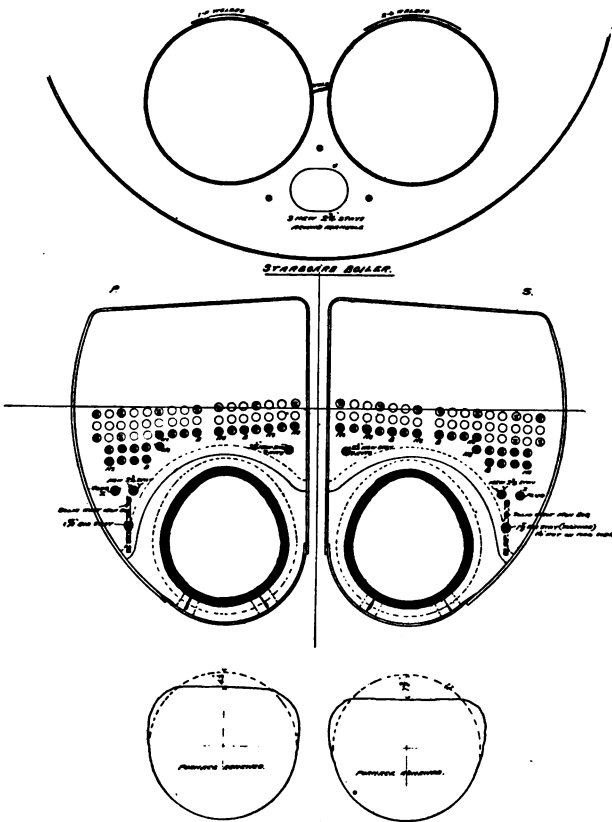

FIG. 117.—Repairs by Oxy-Acetylene Process.

leagues, *Mr. Bülow*, at Gothenburg, and *Mr. Jones*, at Marseilles, who have given me the greater part of the information on which this paper has been written."

In its October number, 1908, *The Marine Engineer and*

Naval Architect gives a description of some interesting repairs carried out on the boilers of the S.S. *Indraghiri*, in the Victoria Dock, London, during September. It had been found necessary to remove the furnaces from the boilers of the *Indraghiri* and fit a new set, on account of depressions and other defects. In ordinary circumstances the furnaces would have required to be cropped and ripped out by hand—a long and laborious process—in order to save disturbing the shell and tube plates. In a very short time the furnace tubes

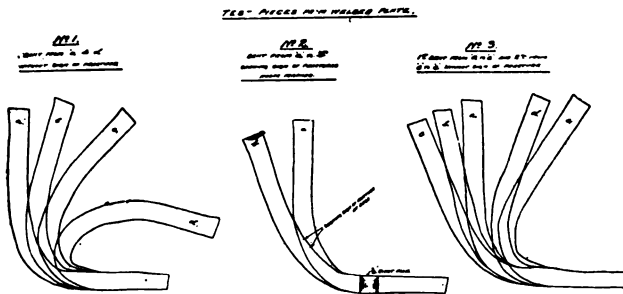

FIG. 118.—Test Pieces from Oxy-Acetylene Welded Plates.

were separated into pieces by the intense heat of the oxy-acetylene flame kept acting along the line it was desired to rip them, the rivets cut out and the divided furnace plates removed. In order to adapt the fronts and back-ends to receive the new furnaces—which were of the most modern style with the bottle-neck at the fire-box end—the front tube plate was pieced and built up to the necessary thickness where defective by grooving action at the top of the furnace mouth and flanged to suit the outside diameter. The lower part of the fire-box plating was altered and flanged to suit the flange of the furnace. The rest of the work was done in the usual way by the boiler makers employed by *Messrs. R. & H. Green*, Blackwall, to whom the repairs were entrusted. The

time taken to effect the repairs was less than would be required by the ordinary course, and less work was involved in cutting away.

After the repairs were carried out on the boilers, the usual hydraulic pressure test was applied, when the results were found satisfactory. The steam pressure on the boilers is 200 lbs.

The illustrations (Figs 117 to 119) show the depressions in the furnaces, also the work done by the oxy-acetylene process, and test pieces from welded plates.

The publication in various parts of *Dingler's Polytechnisches Journal*, 1908, by Dr. Hilpert, of repairs on marine boilers made by *L. Chatelier* in Marseilles, has aroused the *German Steam Boilers' Associations* to vigorous action, so far as Germany is concerned, in the direction of providing that kind of safety which the public has a right to demand.

In the United Kingdom, where autogenous welding is still in its infancy, scarcely known even in its most simple elements, much less in the serious and responsible application to repairs on steam boilers, and more particularly marine boilers, it is safe to assume that the *British Steam Users' Associations*, headed by *Lloyd's*, will take steps in a similar direction, so as to regulate that such repairs shall only be made under the most vigorous restrictions.

It must not be forgotten that the industry of compressed gases, more so their application to welding, is an entirely new industry, and that the present knowledge is not sufficient to advise, either as to the mixture of the gases employed, the best means of keeping a proper mixture, when ascertained, constant or without decomposition, more so as it always must differ according to the nature and thickness of the welding metal, or as to the right temperature of the flame.

Much less is there evidence, so far as marine boilers are

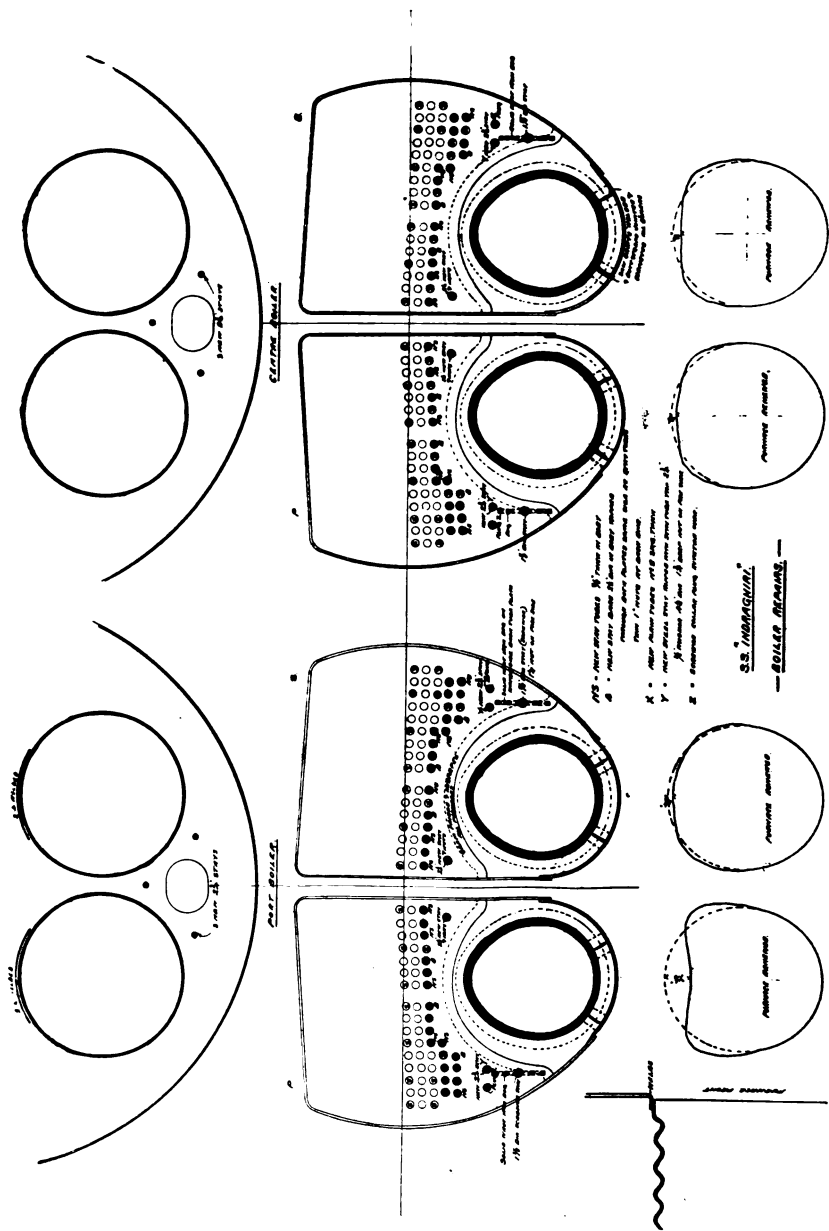

Fig. 119.—Repairs by Oxy-Acetylene Process.

concerned, to show the faults or defects of the welds executed. It may be easy to schedule the number of repairs and the names of the steamship companies ; but it is difficult, if not impossible, to say how many of the accidents which so repeatedly occur are, more often than not, caused by a bad weld, which *seemed* to have been properly executed.

The more the advantages of boiler repairs appear, the greater becomes the number of those who, in self-confidence, are willing to undertake such jobs, as they evidently are of a lucrative nature ; but it is apt to be forgotten that such repairs are often required on the most sensitive organs of the boiler, by which, therefore, certain conditions are required, and which have been duly defined ; the greater will also be the responsibilities of those undertaking to execute the job, and perhaps more so of those authorising the same to be done, knowing that there is no means of controlling the work, the only guarantee being left to ocular inspection and to the repute of the welder. Happily enough, the place of the weld will in many instances offer difficulties to the unskilled, securing thereby a certain safety.

Although welding with compressed gases has given satisfactory results, there are many instances to prove that the industry is still in its infancy, as even leading firms, which are entitled to inspire confidence, fail sometimes in producing a satisfactory weld.

Far from wishing to discourage the application of autogenous welding to repairs on steam boilers, a disclosure of its extreme difficulty, often combined with great peril, will assist in finding means for overcoming the obstacles and to gain knowledge ; but until that has been done such repairs should be entrusted, under most restricted conditions, to persons only who are intimately conversant with the construction and building of steam boilers.

WELDING OF TANKS.

In the majority of cases welding does away with a lot of preparatory work, caulking of edges, pulling apart of rivets and other fastenings, operations always expensive, and which are always to be avoided if possible.

Take, for instance, the case of a cylindrical tank with riveted bottom and head. If this tank is not of a sufficient diameter, and is not provided with a manhole, it will be necessary to make it with at least a convex bottom or head. Anyway its making requires a riveted cylindrical shell with two drawn heads at the ends to permit the riveting of bottom and head and caulked edges.

The same tank can be made by welding with solid welded heads.

It may be mentioned that welding has rendered possible the making, volume and resistance being equal, of tanks less cumbersome and lighter than those before its advent, in that it has made possible the building of tanks with two convex bottoms without regard to the diameter and absolutely free of the double thickness of plates necessitated by riveted coverings.

Nearly all the tanks built to contain gases under pressure or any liquids, such as petroleum, are now welded, because, apart from the advantages of weight, bulk, and price which they have over the riveted tanks, they do not leak, a quality which is difficult to obtain by riveting, and even with subsequent tin soldering, particularly when these tanks are supposed to travel and are, consequently, subject to continual rough handling.

Besides the saving which may be realised by welding over riveting by doing away, in a large measure, with preparatory forge work, the economy of the process in itself should be considered.

Take, for instance, the case of the ordinary riveting together of two plates of $\frac{1}{4}$ -in. thickness, as given by *The Boiler Maker*.

Riveting (one line of rivets), diameter of rivets $\frac{1}{2}$ in., number of rivets per foot, eight.

Price paid to the workman per foot of joint:—

	\$
Laying out the holes	0'006
Marking	0'006
Drilling	0'029
Chamfering	0'008
Riveting	0'019
Caulking plates	0'004
Caulking rivets	0'012
	<hr/>
Total	0'079
	<hr/> <hr/>

This cost does not include the general expenses arising from the necessary power, keeping, etc., of the machinery, and heating of the rivets.

	\$
Eight $\frac{1}{2}$ -in. rivets 1'23 \times 4 cents.	0'04
Workmanship, without general expenses	0'08
	<hr/>
Total cost of riveting, per foot	0'12
	<hr/> <hr/>

	\$
<i>Acetylene welding</i> (acetylene generator), chamfering of edges, per foot	0'0108
Welding { Acetylene 0'0186 { Oxygen 0'0312 { Workmanship 0'0162 }	0'066
	<hr/>
Total cost of welding, per foot	0'0768
	<hr/> <hr/>

This shows conclusively that acetylene welding is more economical than riveting.

To complete the comparison, consider the case of the building of a vertical tubular trailer by acetylene welding and by riveting. Those operations, which are similar in both processes of manufacture, are not considered: shearing and laying out of the plates, boring holes, assembling and expanding of tubes, etc.

ACETYLENE WELDING (GENERATOR).

		\$
Chamfering of edges	Shell, 8.5 ft. × 0.0054 .	.046
	Furnace, 2.925 ft. × .0072 .	.021
	Uptake, 5.85 ft. × .066 .	.038
Welding	Shell, 4.225 ft. × .066 .	.278
	Furnace, 1.462 ft. × .21 .	.307
	Uptake, 2.925 ft. × .12 .	.351
Rounding and planing after welding60
Forging of furnace (uptake and mouth)		2.40
Turning of circular plates40
Assembling of the boiler (mounter and help)80
Welding, 32.5 ft. @ \$0.27		8.78
Total cost of welding		<u>14.02</u>

RIVETING.—NECESSARY PLATE.

For shell	Lbs. 5.28
For furnace	4.62
For furnace flanges	9.90
For flanges of the outer circumferential plates	<u>51.48</u>
Total, 71.28 lbs. @ \$0.25	\$1.78
Forty-four $\frac{1}{2}$ -in. rivets, 5 lbs.; 275 $\frac{3}{4}$ -in. rivets, 112 lbs.; 117 lbs. @ .04	4.68
Brought forward	<u>\$6.46</u>

				\$
Carried forward	.	.	.	6.46
Marking rivet holes	.	.	.	1.40
Flanging the uptake with forge heat	.	.	.	1.00
Closing in on furnace boiler head flanges80
Forging the furnace (uptake and mouth)	.	.	.	4.00
Closing in the flanges	} 105 lbs. × 0.01	.	.	1.05
of the plate		} 132 lbs. × 0.009	.	1.19
Turning of circular plates	.		.	.
Assembling the boiler	.	.	.	1.60
Riveting	} 5.5 ft. × 0.08	.	.	.44
		} 35.75 ft. × 0.117	.	.
Chipping and caulking heads	.		.	.
				<hr/>
Total cost of riveting	.			\$24.32
				<hr/>

The above prices of riveting are taken on the supposition that the chamfering and caulking are executed by compressed air (except for the heads, which require some hand work). They do not include the general expenses (material, coal, and coke necessary for welding the charger, and for the various forge work).

These results show the considerable saving obtained by judiciously using acetylene welding in boiler-making.

The cost price may also be made lower by a preliminary heating of the parts to be welded, using a less expensive combustible than the acetylene or hydrogen mixture.

It is evident that in every instance where the method of manufacture, the shape of the pieces, the place where the work is to be done, will admit of such a previous heating, a great advantage will result by bringing the parts to be welded to the highest practicable degree of heat. The more expensive temperature from the blowpipe is thus used only for the actual welding, which the cheaper way of heating cannot effect.

Probably one of the widest fields for the adoption of the autogenous welding is in keeping down the *heap*. There are many instances, particularly in pressed steel work, where, owing to the development of a small split or the opening of a seam, a large and valuable piece of work has to be scrapped. A few minutes' application of the blowpipe will, at an almost insignificant cost, in most cases enable such a flaw to be repaired and the piece put into use.

CHAPTER VII

CUTTING METALS

General—Congress of Liège—M. Jottrand, La Société l'Oxydrique—
MM. Jottrand and Lulli Process—Installation for Cutting Metals—
Speed of Cutting—Metropolitan Railway, Paris—Hydrogen Process
for Breaking up Ships—Cutting of Ornamental Iron—Consumption
of Oxygen—Consumption of Gas and Cost per Metre of Cutting.

ONE of the most important applications of compressed gases, and more particularly that of oxygen, refers to cutting of metals.

The process is the reverse to that of welding: by welding a reducing gas mixture, by cutting an oxidising one by surplus of oxygen.

It is a well-known fact that there are many metals which when brought to a white heat burn in an atmosphere of pure oxygen. The experiment is familiar in every course in physics and chemistry. The same phenomenon occurs when a jet of oxygen is directed upon iron heated to a bright red; that is to say, the metal burns, and the heat evolved fuses the oxide. The process for cutting metals by oxygen is based on these phenomena. It can readily be seen that it is possible to divide a piece of metal by means of an oxygen jet, but it is not easy in practice to obtain a regular and clean cut.

At the congress of Liège, 1901, M. Jottrand, of *La Société l'Oxydrique*, exhibited for the first time a blowpipe for cutting iron and steel, which created a great deal of attention by reason of the important part its development probably would play in metallurgy.

The apparatus consisted of an oxyhydrogen blowpipe by means of which the part of the metal to be cut was brought to a bright red heat. Then the flow of hydrogen was cut off, and the pure oxygen was increased. A good combustion was produced, but it did not proceed very long. The resultant iron oxide, not being hot enough, lacked fluidity. It was with difficulty removed, became mixed with the partially melted iron, and thus obstructed the close contact of the metal with the oxygen. The combustion stopped, and it was necessary to bring the blowpipe into play again. The manipulation, even after long practice, could produce only an irregular cut, dirty and with edges incrustated with closely adhering oxide.

The process prepared in 1904 by *Jottrand* and *Lulli* is different, and remedies all the previously appearing difficulties. This process consists of two blowpipes in one piece, which travel along the section to be cut. The first is an ordinary oxyhydrogen blowpipe, which heats the metal to a bright red; the second one directs a fine jet of pure oxygen upon the heated spot under a pressure varying with the thickness of the metal.

The action of the two blowpipes is continuous. The first prepares the way for the second, furnishing a volume of heat sufficient to permit instantaneous combination of the oxygen with the metal in the heated zone. The metal is not melted, and the adjoining parts remain unaltered, as the action proceeds too rapidly for the heat to spread into the mass, and the oxidised portion is removed by the pressure of the oxygen; the section is cleaner than the raw cut, and its width never exceeds 4 m.m.

The speed of travel of the double blowpipe is about 20 c.m. a minute; in other words, the operation is quite rapid and comparable to hot sawing. The consumption of gas is

relatively small, depending upon the thickness of the metal to be cut; and as the work is rapidly done, the labour cost is not important.

The double blowpipe, which is easily handled, and furthermore may be guided by any sort of mechanical device, is available for cutting not only thick plates, but also, and with equal ease, tubes, beams, shafts, and all sorts of rolled sections.

The cutting may be made to follow any line, executing all sorts of curves and profiles, the smoothness of the surface depending a great deal upon the skilful handling of the blowpipe. The reaction takes place almost immediately; therefore even a shaking of the hand or raising or lowering of the blowpipe will cause an uneven surface. In all cases where a special appearance is desirable—for instance, the cutting of manholes, locomotive frames—it is advisable to use a mechanical appliance to guide the blowpipe.

An installation for cutting of metals is extremely simple, and consists of:—

1. The cutting blowpipe with various exchangeable burners to suit the different thicknesses of metal.
2. A high pressure regulator up to thirty atmospheres.
3. A high pressure rubber tube.

Besides the hydrogen-cutting blowpipe before mentioned, there are various other constructions, especially for the use of acetylene instead of hydrogen. One may be equally as good as the other known under various names, but this is of little importance, as the blowpipes are generally obtainable on trial, so as to enable the choice of the best construction for the special work in view.

As the pressure of the gases in the receptacles, the ordinary steel cylinders, is high, being about 150 atmospheres when filled, the gas passes through a pressure-reducing valve before

being used. The pressure of the oxygen, when used for cutting, varies from about one and a half to five atmospheres, for the hydrogen or any other combustible gas used a water pressure of 20 c.m. being sufficient.

The process of cutting metals is in no way limited by the mechanical properties of the material, whether it be hard or soft, tempered or annealed, chrome or nickel, the steel burning just as fast.

The problem of cutting armour plates is thus fully solved.

It might be assumed that the metal would be severely attacked on the surface by the influence of the oxygen, but this, however, is claimed not to be the case. With the exception of a layer of 0·01 in., at the most, next to the cutting edge, the metal keeps its original chemical composition, and the physical properties remain the same.

The essential qualities of the process may be thus summarised : extreme simplicity of the installation and appliances ; complete mobility ; independence of any need of motive power ; absence of any reaction upon the tool ; extraordinary speed of operation ; and, so to speak, unlimited adaptability.

In illustration of the rapidity which above all characterises the oxyhydrogen cutting, *J. B. van Brussel* gives some interesting examples in a paper recently read by him, abstracts of which appear in the *Engineering Magazine*, as follows :—

An armour plate 160 m.m. (6·3 ins.) thick was cut to a length of 1 metre in ten minutes. A cut of similar length in a plate 15 m.m. thick took less than five minutes, and the cost of application did not exceed 1·50 franc.

To cut a manhole 300 by 400 m.m. (12 by 16 ins.) in a plate 20 to 30 m.m. (0·8 to 1·2 in.) thick requires four to five minutes.

An opening 150 by 150 m.m. (6 by 6 ins.) in a tube 5 m.m.

thick required three to four minutes, while the cutting of the same opening with ordinary tools would need from three to forty minutes, the cost of this work being about fifteen centimes.

Another very striking example was furnished at the station of the *Metropolitan Railway at Place d'Italie, in Paris*. It was necessary to cut away an iron staircase, 6 metres high, the width of which impeded the traffic. It was cut down to a width of 1 metre in four hours' time.

At Bremen, Germany, the hydrogen-cutting process has been used for breaking up ships, and among other records the following time data are interesting:—

A plate 300 m.m. (12 ins.) thick was cut for a length of 1 metre to a depth of 426 c.m. in seven minutes. The same plate had been cut with a pneumatic chisel along the length of 1.15 metre and to a depth of 1.5 c.m., but this work had required one hour.

The hydrogen method was also used for rivet cutting; in less than twelve seconds the head of a 22-m.m. rivet could be burned without any injury to the plate; the rivet was then driven out with a punch.

The maximum thickness which has yet been cut is 210 m.m. (8.27 ins.) in armour plates, but 300 m.m. has been reached in round shafting.

As a matter of curiosity some work done by the aid of the hydrogen jet by the *Deutsche Oxyhydric Company* may be mentioned. A large bunch of grapes with leaves and branch of the vine was cut out from ordinary thin sheet iron. The imitation was good, and although the piece was of iron, it was very light. A branch of a pear tree with a large nice-looking pear and two leaves, and also a "lily of the valley" were made in the same way.

The following table gives the consumption of oxygen by

the *Fouché* blowpipe, and the time required for cutting up metals of various thicknesses :—

Thickness of Metal. Millimetres.	Consumption of Oxygen. Litres.	Time of Cutting.	
		Minutes.	Seconds.
5	110	2	50
10	140	4	—
15	230	4	30
20	270	5	45
30	370	6	—
40	420	6	—
50	550	6	30
75	900	7	—
100	1500	8	—
150	2200	10	—

The *Chemische Fabrik Griesheim-Elektron* gives consumption of gas and cost per metre of cut length as follows :—

Thickness of Metal. Millimetres.	Time of Cutting. Minutes.	Consumption of Gas in litres.		Cost of Gas in pfennige at hydrogen, 1 mark per c.b.m., oxygen, 1 mark per c.b.m.		
		Hydrogen.	Oxygen.	Hydrogen.	Oxygen.	Total.
Blowpipes for 2 to 50 m.m. thickness						
2	5—6	40	45	4·0	13·5	17·5
3	5—6	55	55	5·5	16·5	22·0
4	5—6	65	70	6·5	21·0	27·5
5	5—6	70	80	7·0	24·0	31·0
6	5—6	80	95	8·0	28·5	36·5
8	5—6	95	115	9·5	34·5	44·0
10	5—6	100	140	10·0	42·0	52·0
12	6—7	105	165	10·5	49·5	60·0
15	6—7	110	200	11·0	60·0	71·0
20	6—7	110	260	11·0	78·0	89·0
25	6—7	115	325	11·5	97·5	109·0
30	6—7	115	390	11·5	117·0	128·5
35	6—7	120	450	12·0	135·0	147·0
40	6—7	120	510	12·0	153·0	165·0
45	6—7	125	580	12·5	174·0	186·5
50	6—7	125	650	12·5	195·0	207·5

Thickness of Metal. Millimetres.	Time of Cutting. Minutes.	Consumption of Gas in litres.		Cost of Gas in pfennige at hydrogen, 1 mark per c. b. m., oxygen, 3 marks per c. b. m.		
		Hydrogen.	Oxygen.	Hydrogen.	Oxygen.	Total.
Blowpipes for 50 to 250 m. m. thickness.						
50	7—8	240	600	24	180	204
55	7—8	250	675	25	203	223
60	7—8	260	740	26	222	248
65	7—8	275	820	28	276	274
70	7—8	290	880	29	264	293
75	7—8	300	970	30	291	321
80	8—9	310	1050	31	315	376
90	8—9	320	1200	32	360	392
100	8—9	325	1400	33	420	453
125	8—9	350	1850	35	555	590
150	8—9	380	2350	38	705	743
175	10—12	400	2850	40	855	895
200	10—12	425	3350	43	1005	1078
225	10—12	460	3860	46	1158	1204
250	10—12	500	4500	50	1350	1700

CHAPTER VIII

REPORTS UPON ACETYLENE WELDING

Dr. Hilpert—Griesheim-Elektron—Dr. Michaelis—Belgian Steam Users' Association—French Steam Users' Association (Veritas)—German Steam Users' Association—Manchester Steam Users' Association—International Steam Users' Association.

Dr. A. Hilpert, Ingénieur, Professor at the High Technical College, Charlottenburg, Berlin, in part 24, 1908, of *Dingler's Polytechnisches Journal*, reports as follows:—

“In respect of the application of acetylene welding to repairs on steam boilers, and more particularly those of the marine type, my tests and examinations during a period of more than one and a-half years entitles me to the opinion that the present means offered by the autogenous welding in Germany are not sufficiently advanced for the application to repairs on steam boilers.

“My said experiments were not carried out with a view to test repairs made on steam boilers by the aid of acetylene welding—as at that time this system was almost unknown—but for purpose of ascertaining to what extent acetylene welding could be applicable to various materials of different thicknesses.

“For cast-iron, tempered iron or steel, and nickel-steel, I have obtained no satisfactory results; better results were obtained for cast-steel, mild ingot-steel, and particularly for pig-iron.

“In my opinion, the greatest field of operation will be found for acetylene in its application to welding of pig-iron.

“ The pig-iron material used for the experiments had a tensile strength of 37—39 kg. g.m.m. and an elongation of 28—31 per cent., on a length of 200 m.m. The experiments were carried out upon plates of 4—20 m.m. thickness

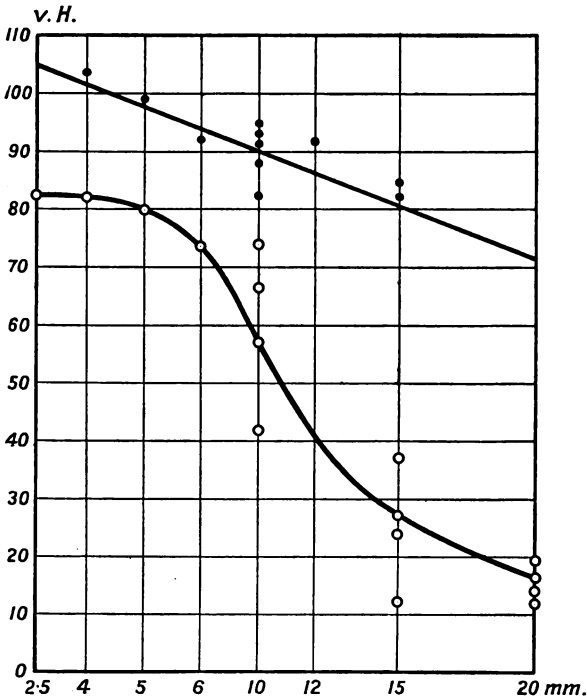

FIG. 120.—Influence of different Thicknesses of Material upon the Strength and Ductility of Autogenous Acetylene Welds. Swedish Welding-rod was used and the Welds were hammered.

by means of Fouché’s blowpipes and acetylene generated in an apparatus of the best construction and of a sufficient size for producing the quantity of gas required.

“ So far as strength is concerned, satisfactory results were obtained, but it was found that the strength decreases with increased thickness of the plate. The strength of plate-weld

on 20 m.m. thickness was found to be in average 70 per cent. of the strength of the material. More unfavourable were the results in regard to stretching, being satisfactory for thin plates, but sinking rapidly for plates of greater thick-

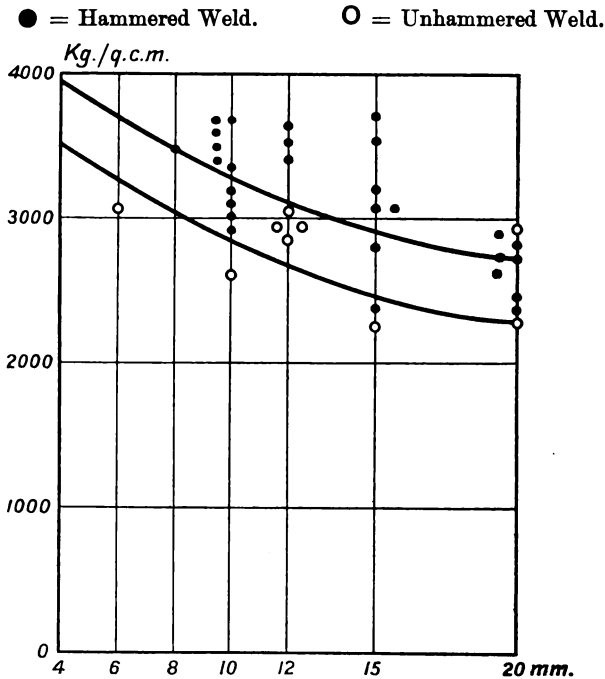

FIG. 121.—Influence of Mechanical Treatment of Autogenous Acetylene Welds on Plates of Various Thicknesses.

nesses. It was found in the latter case that the weld itself was less affected by the stretching. The bending tests over a roller of 80 m.m. diameter gave for small thicknesses satisfactory results, but those of 12 m.m. were uncertain.

“In all the tests, the best results were obtained in which the welding-rod was almost carbon free and in which the weld was completed by hammering and annealing.

“ Fig. 120 shows the influence of increased thickness of plates from 4 to 20 m.m. upon the strength and ductility of auto-genous welds, expressed in percentage of those of the unwelded

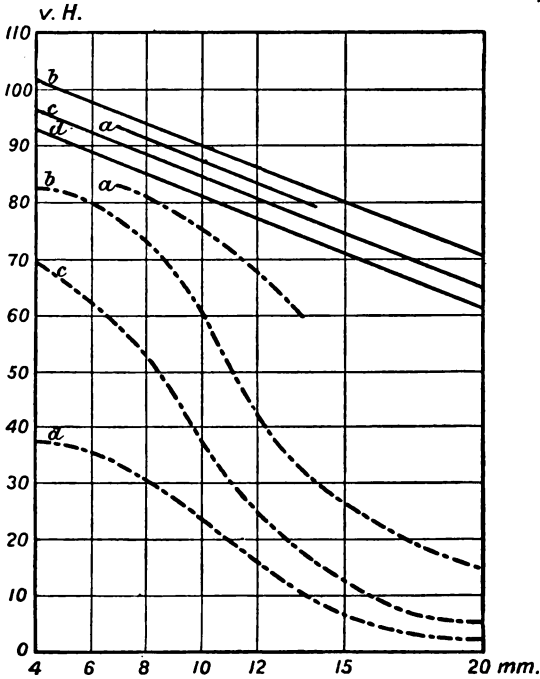

FIG. 122.—Influence of Welding-rods of Different Qualities upon the Strength and Ductility of Autogenous Acetylene Welds on Plates of Various Thicknesses.

- a = Welding-rod of Soft Iron, the Weld hammered.
- b = Welding-rod of Swedish Iron, the Weld hammered.
- c = Do., do., but the Weld unhammered.
- d = Welding-rod of Siemens-Marten Steel Weld hammered.
- = Strength.
- - - = Ductility.

material. Swedish welding-rod was used and the welds were hammered.

“Fig. 121 gives the tensile strength of the seam of auto-genous-welded soft-iron, and also the influence of mechanically finishing the weld.

“ Fig. 122 gives in similar way as Fig. 120, the difference, expressed in percentage, obtained by the use of three different welding-rods, that marked with the letter *b* (about $0\cdot05^{\circ}$ C.) giving the best result.

“ I may also state the reasons why I have not used my said results as a criticism upon the repairs carried out by the acetylene welding in Marseilles. Firstly, the circumstances differ in this respect, that the welding seam produced on the steam boilers working under heavy strain cannot be compared with a seam made on a test bar in a laboratory ; secondly, the acetylene used by me and generated in a separate generator cannot be compared with acetylene used in Marseilles, as being comparatively pure and delivered compressed in cylinders.

“ It is hoped that even in Germany during the next few years, particularly in the large sheet-iron works, where acetylene welding has been used, better results than mine may be produced, based upon practical knowledge and experience.

“ It remains a fact, however, that repairs of a most difficult nature have been made on steam boilers, without any objectionable remarks, and so far as I can judge, the excellent results obtained may be entirely attributed to the properly instructed and particularly skilful staff of workmen ; to the use of very pure acetylene and to the mechanical treatment of the weld.”

Dr. L. Michaelis (Autogen Werke, Berlin), in No. 8, 1908, of *Die Zeitschrift des Bayerischen Revisions Vereins*, gives his opinion as to the conditions required in order to produce a satisfactory acetylene weld as follows :—

“ 1. The use of chemically pure acetylene.

“ Such a gas has not been obtainable in Germany, there being no works for the production of acetylene-dissous. This gas is by a special method compressed in steel cylinders, in similar way as compressed hydrogen and oxygen. It possesses

all the virtues of hydrogen in respect of purity of gas and portability of the apparatus, combined with the economy and extension of acetylene welding. Acetylene could therefore, up to recently, be obtained in Germany from special generators only, which generally were too small or generated the gas too quickly, producing thereby a gas of unsatisfactory purity.

“The repairs on steam boilers must generally be done in a small space. The welder requires the welding apparatus as near as possible, and as the space available prevents the fixing of a cumbersome apparatus, it remains only to use one as small as possible, which will, however, by reason of the great strain it will be exposed to, deliver bad gas. The first condition for repairs on steam boilers is therefore to abandon the generators, as they cannot under the circumstances produce the quality of the gas as required. When, on the other hand, acetylene-dissous is obtainable, then a pure and cold gas can be used at any place.

“2. Another not less important point is the blowpipe. It can be proved in most instances that the blowpipes obtainable at the lowest price are those generally used. The conditions as to quality have not yet been extended to blowpipes.

“A satisfactory blowpipe should fulfil the following conditions:—

“(a) The gases must remain mixed in proper proportions.

“(b) The gases must leave the burner with a certain velocity, so as to keep the metal fluid, without chasing the metal.

“(c) The flame must, in certain welding operations, have a pressure sufficient to prevent the melted metal to drip from the weld. All burners working with oxygen under pressure and acetylene without pressure become after a short time of working useless. The radiating heat affects the oxygen, which is under pressure, with great velocity in a narrow space, in a different way than its action upon the acetylene contained in

a larger space and without pressure. The result is a decomposition of the flame and a burning of the metal. This can only be prevented by a skilful welder. It is therefore a difficult task to produce a burner in which the gases are kept under pressure in such a way so as to offer the same results in respect of expansion.

"3. If the technical conditions have been fulfilled and the acetylene-dissous is to be manufactured in Germany, the remaining condition of supplying a sufficiently trained staff offers very great difficulties. *Le Chatelier*, Marseilles, for instance, does not permit any of his mechanics to even attempt to make a weld unless he has had at least six months' training at the works.

"I wish to contradict the statement made that it would be impossible to make a perpendicular weld or one in a roof, as not only could such a defect be repaired by welding, but the mechanic could even remain resting on his back repairing any defects above him. The welding under such circumstances must of course be made by means of suitable burners, so as to prevent the melted metal from the welding rod to drip. It is often necessary to have the welder trained for weeks in the dark to enable him to judge the flame, and to prevent its decomposition, as repairs on steam boilers are generally made in the dark and not in a well-lighted workshop. The welder should also be prevented from long continuous working, as the faintest shake of the blowpipe may often result in an unsatisfactory weld; he must, of course, be paid accordingly. The firm undertaking repairs on steam boilers must be provided with a skilled staff of workmen, in interest of public safety.

"4. Another important point in the production of a satisfactory weld is the composition of the welding rod from the metal of which the crack or defect is to be filled. Based upon my

own experience and upon the results obtained, the size of the welding-rod plays also an important part.

“5. The last, but not the least, important part is the completion of the weld by mechanical means, such as hammering or otherwise. The technical and ingeniously arranged mechanical appliances in this respect, as used by *Le Chatelier* and others, and being the *sine qua non* of a satisfactory weld, are naturally withheld from inspection by competitors. It may, however, be stated that the said means consist of hammering and annealing, means which are also being used in welding by water-gas. So far as annealing is concerned, my own examinations tend to show that it has no influence upon the strength and elasticity, but produces a more homogeneous weld.

“How far these conditions may assist in the production of a satisfactory weld, experience and tests alone can show. There is reason to believe that such tests will be carried out in Germany within a reasonable time and on a large scale by proper authorities, not merely on test rods in the laboratory but upon actually welded articles. The importance of such tests cannot be over-estimated.”

The *Chemische Fabrik Griesheim-Elektron*, carrying on hydrogen welding on a large scale, in a recent letter addressed to the *Bayerischen Revisions Verein*, say:—

“Repairs on steam boilers by means of autogenous welding should be prohibited, because a perfect weld can only be produced on a horizontal and easily accessible surface. Corrosion on a perpendicular surface cannot, in general, be welded satisfactorily; besides, the plates are generally of a thickness of more than 10 m.m., and by such thickness an unsatisfactory weld only can be the result, even with the acetylene flame, which produces a flame of considerable heat. It is evident that by means of this kind of welding, a perpendicular or

overhanging weld cannot be done. Independent of the unsatisfactory repairs of steam boilers by means of welding, very few suitable opportunities would be offered."

C. L. J. Hartmann, an authority in Hamburg, in a letter dated 22nd April, 1908, says: "Electric welding has for years been used here for repairs on marine boilers with great advantage. It must, however, be stated that the respective firms using the system are fully conversant with boiler making. Experience has also here proved that attempted repairs of tension cracks have been unsatisfactory.

"I take as great an interest in autogenous welding as in any industrial development, and I truly hope that it will, besides the electric welding, bring advantages to the ship-building, but without injury to public safety. Precaution is, however, advisable, and it is necessary to be careful not to embark upon an insecure territory, otherwise the reaction will not fail, and the autogenous welding will disappear as quickly as it came."

The *Bayerischen Revisions Verein* (the Bavarian Steam Users' Association), in its technical reports for 1907, states:—

"Taken all in all, there are in Germany for the present a few firms only which offer guaranty enough for the safety of welding applied to repairs on steam boilers and steam vessels, and these firms seem especially to carry out repairs on marine boilers.

"Unfortunately, the number of persons, without necessary knowledge and experience, or suitable appliances, and more particularly without the properly trained staff of workmen, which offer to carry out the difficult repairs on steam boilers is very great indeed, and their great anxiety to obtain such jobs stands in reverse proportion to their ability.

"In our opinion, the autogenous welder must, in his profession as such, stand authoritatively independent and he must

also be a boiler maker, otherwise his care for our steam boilers would offer a danger which cannot be over-estimated. This is applicable to all times, even if the best results should be obtained by a skilful application of autogenous welding to steam boilers.

“ We must therefore advise our members, at least for the present, to refrain from the adoption of new methods, and rather retain the old and safe methods; and, besides, not to permit any welding to be done in cases where extension and bending are points of importance, or, at least, to entrust the welding to such firms only which possess not only great experience in such work but also are boiler makers.

“ But the advice to adopt the position of waiting until experience and tests have given satisfactory results must not be taken as a condemnation of autogenous welding. On the contrary, the indisputable great advantages offered by this system can only be in the interest of industry as soon as satisfactory tests will admit its adaptability, especially to repairs on steam boilers.”

The *Bayerischen Revisions-Verein* (the Bavarian Steam-Users' Association) has recently sent to the inspectors of their *Steam Boilers Control Associations* the following circular, which reads, in translation, as follows:—

“ 1. The owners of steam boilers are advised to discourage the application of welding on repairs of such surfaces which are exposed, during work, to stretching and bending; and also

“ 2. To refrain from engaging for welding repairs any firm which by their installations or knowledge does not give guaranty as to being able to carry out such tasks, which are often of a very difficult nature, and for such purpose to consider only such firms which are known to be professionally and thoroughly conversant with repairs in steam boilers.

“3. When the repair by welding is not limited to small spaces or grate-bars, a district water pressure test must always be made in accordance with the stipulations in reference to such pressure tests, and the weld should be hammered during such test being made.

“The same is applicable to approbation tests and wholly or partly new steam boilers or vessels which have been finished by welding. The weld must always be inspected before and after the pressure test, even on the water side.

“4. On this occasion it is also advisable to arrange so that the weld may be made accessible for inspection, even during the work.

“5. In the event of an inspection during the working being impossible, the boiler must then, within three months, or in the other case, within six months at the most from the date of repair, be subjected to an interior inspection, when the weld must be thoroughly inspected on the water as well as on the inner surface; the interior test must, if necessary, be done by water pressure.

“If the weld is thus found to be perfect, further interior inspection of Associations' boilers is postponed for one year (instead of two years).

“Applications for alterations of the time of inspection may be filed and addressed to the respective officers of the *Official Control of Boilers*, and reports of all such inspections and pressure tests must be filed with the Board.

“6. All the inspection members must make inquiries in every case as to which firms carry out welding repairs on steam boilers and steam vessels, where and on which boiler, etc., such repair has been done. Such boilers must as soon as possible be scheduled and inquiries made as to the reason of and in what way such repairs were made, and, if possible, an inspection of the weld should be made at the same time, eventually by the water-pressure test.”

Dr. Hilpert, in No. 10, dated 31st May, 1908, of the *Zeitschrift des Bayerischen Revisions Vereins*, page 107, publishes copies of the following three letters:—

1. *Compagnie des Messageries Maritimes*, No. 169.

“In reply to your letter of 31st October, N. 408, A. D. 14, I am glad to inform you that the numerous repairs on several of our boilers carried out by you by means of your welding system have given me full satisfaction.

“Welding has been done on cracks, and pieces have been welded to tube-walls in order to fill out flange joints which had been damaged by corrosion.

“None of these repairs has up to now given any reason of complaint.

“Yours,

“La Aotat,

“5 November, 1907.”

“*The Director of Works*,

(Signed) “RAYMOND.”

2. *General Direction*, “*Veritas*,” Paris.

“The undersigned, *Jacques Elie Boissevain*, inspector of ‘*Veritas*’ Bureau in Marseilles, certifies hereby, by order of the general direction of ‘*Veritas*,’ in accordance with letter of 7th August, 1907, that the numerous repairs on ships or ship boilers, which have been carried out by the *Société de l’Acetylene-Dissous de Sud-Est* in Marseilles, under the supervision of our engineers at our Marseilles Bureau ‘*Veritas*,’ have given us full satisfaction, and that, accordingly, the Board has authorised the said company to carry out such repairs on all ships controlled by ‘*Veritas*’ in any country.

“*The Inspector of the Veritas Bureau*

“Marseilles,

“9th August, 1907.”

in Marseilles,

(Signed) “BOISSEVAIN.”

3. *Belgian Steam Users' Association.*

"Hereby I inform you that my firm has been authorised to use the following words added to the heading of our notepaper :

" 'Travaux exécutés avec l'autorisation et sans la surveillance de l'association pour la surveillance des chaudières à vapeur.'

"Antwerp,

(Signed) "CHAMPY FRÈRES."

"28th April, 1908."

The Manchester Steam Users' Association, in a letter of 24th August, 1908, addressed to the Author, their Chief Engineer, *Mr. C. E. Stromeyer*, says :—

"I have absolutely no experience as regards modern welding practices in boilers. The old methods are barbarous, and are sanctioned only for plates which are in compression, and I should be delighted if welds could now be made reliable enough for parts subjected to tension or bending, but you must not forget that the personal element enters into the question, and that one will rather be satisfied with a 75 per cent. riveted joint, of which one can see the details, than with a weld which may be no weld."

International Association of Steam Users. The number of 3rd October, 1908, of the *Gewerbeblatt aus Württemberg* states :

At the annual *Congress at Dantzig, 1907*, of Delegates and Engineers of the *International Association of Steam Users*, embodying, amongst other countries, Austria, Belgium, France, Germany, Italy and Switzerland, it was resolved that a sum of 2,000 marks should be voted for testing repairs by autogenous welding upon steam boilers.

• The technical committee of the Association stipulated accordingly that samples of such parts, which had become defective in steam boilers, as well as of their repairs by autogenous welding, should be sent to the testing institution of

the *Royal High Technical College, Stuttgart*, which had been instructed to carry out said tests.

At the annual *Congress at Wiesbaden*, on the 8th and 9th September, 1908, of the International Association, the report of such tests was presented, and, after discussion, the following resolution was unanimously adopted :—

“ In reference to repairs on steam boilers and steam vessels by autogenous welding it is advisable that the greatest care should be exercised, and that such repairs should only be entrusted to reliable firms, and under supervision of the respective local inspectors of the Association. Special attention should be given to such parts which are subjected to tension and bending, and which are, by heating of the surrounding parts of the weld and the contraction of the filling welding material (without subsequent annealing), subjected to tensions which may cause accidents of more or less severe nature.

“ Seams which are exposed to the influence of changeable temperatures which may greatly affect tension and bending shall only be welded and permitted to be exposed to said influences when the seam, after having been welded, is subjected to annealing.

“ The above resolution is left to the earnest consideration of all members of the Association.”

CHAPTER IX

ACCIDENTS

General—Explosive Limits of a Gas—Explosive Limits of Acetylene—Danger of Acetylene Installations—Prefect of Police, Paris—Conseil d'Hygiène Publique et de Salubrité Regulations—Explosion of Storage Vessel filled with Acetylene Dissous: Fatal Result—Fire at Acetylene Dissous Works—Bursting of Boiler Tubes caused by Defective Welding: Fatal Result—Acetylene Generator Explosion—Acetylene a great Poison—Acetylene Accidents in France.

WHEN an accident has taken place it is generally too late to remember, at least so far as that special occurrence is concerned, that acetylene is the most explosive and, therefore, also the most dangerous gas yet known, when dissolved, more so than in its gaseous form.

The explosive limits of a gas and the range of explosibility are influenced by various circumstances, such as manner of ignition, pressure and other conditions. *Le Chatelier* and *Eitner* have obtained the following results:—

EXPLOSIVE LIMITS OF ACETYLENE MIXED WITH AIR (LE CHATELIER).

Diameter of Tube in Millimetres.	Explosive Limits.		Range of Explosibility.
	Lower.	Upper.	
	Per cent.	Per cent.	Per cent.
40	2·9	64	61·1
30	3·1	62	58·9
20	3·5	55	51·5
6	4·0	40	36·0
4	4·5	25	20·5
2	5·0	15	10·0
0·8	7·7	10	2·8
0·5	—	—	—

It appears, therefore, that no explosion of acetylene can proceed past an orifice of 0·5 m.m. in diameter.

PERCENTAGE BY VOLUME OF COMBUSTIBLE GAS IN A MIXTURE OF THAT GAS AND AIR CORRESPONDING WITH THE EXPLOSIVE LIMITS OF SUCH A MIXTURE (EITNER).

Description of Combustible Gas.	Explosive Limits.		Difference between Lower and Upper Limits, showing range covered by the Explosive Mixtures.
	Lower.	Upper.	
	Per cent.	Per cent.	
Hydrogen	9·45	66·70	57·95
Water-gas (uncarburetted)	12·70	66·75	54·35
Acetylene	3·35	52·30	48·95
Coal-gas	7·90	19·10	11·20

A mixture of acetylene and air becomes thus explosive (will explode if a light is applied to it) when only 3·35 per cent. of the mixture is acetylene, while a similar mixture of coal-gas and air is not explosive until the coal-gas reaches 7·9 per cent. of the mixture. And, again, air may be added to coal-gas, and it does not become explosive until the coal-gas is reduced to 19·1 per cent. of the mixture; while, on the contrary, if air is added to acetylene, the mixture becomes explosive as soon as the acetylene has fallen to 52·3 per cent. Hence the immense importance of taking precautions to avoid, on the one hand, the escape of acetylene into the air of a room, and, on the other hand, the admixture of air with the acetylene in any vessel containing it or any pipe through which it passes. These precautions are far more essential with acetylene than with coal-gas.

The danger is, however, materially increased, especially with acetylene installations for illuminating purposes, as they are generally delivered under the most impressive

assurances that there can be no danger whatever, and under that impression the apparatus is left, for daily manipulation, in the hands of persons who are entirely ignorant of the dangerous nature of the gas and the construction of the apparatus, and being more or less used to the easy handling of the ordinary gas, cannot or will not understand restrictions, but in case of the apparatus getting out of order, in their own self-confidence, and with the best intentions, take steps to put it in order, which may have serious results.

It is easy to forget that by placing the acetylene apparatus in the house a more or less dangerous result may always be expected, so also by careless and unskilled manipulation of the plant, or by natural wear and tear, or by corrosion or rust, which scarcely can be avoided, or by using inferior material in order to lower cost of production, all of which will sooner or later produce leakage, and cause an explosion as soon as the room, filled with the extremely small quantity of acetylene required, is entered with a light; or the gas may pass into another room, where a candle or an open fire is burning, causing the same result. Consequently, from a point of safety, an acetylene plant can only thus be considered free from danger when it is placed in a separate house, so constructed that the apparatus can be attended to from outside; but such a desire can scarcely be fulfilled.

The *Bulletin des Halles*, in its September part, 1908, states that the *Prefect of Police, Paris*, has, upon the suggestions of the *Conseil d'Hygiène publique et de Salubrité*, circulated additional regulations in reference to acetylene generators, amongst which may be mentioned, that the manipulation necessary for filling and emptying the generators must be done during daylight. The room in which the acetylene plant is installed must not be entered with light. In the vicinity of the door to

the plant-room must be affixed in a visible manner a board containing, in large letters, the following inscription: "After the daily attendance admittance prohibited."

Even with the utmost care accidents will happen, and they will more forcibly enforce a lesson than years of study. For this reason the following accidents are related:—

*Explosion of a Storage Vessel filled with Acetylene-Dissous—
Fatal Result.*

Dr. Paul Wolff, in the *Zeitschrift für Calcium Carbide-Fabrikation, Acetylene und Klein Beleuchtung*, No. 4, 1908, gives the description as follows:—

"Unloading cylinders containing acetylene-dissous one was suddenly dropped, falling with the closing valve upon the stone pavement, with the result that two explosions followed quickly, one after the other, causing great injury to four persons, one of which succumbed after a few days."

Fire at an Acetylene-Dissous Works.

In its May number, 1908, the *Zeitschrift für Comprimirte Gase* describes the fire at the Acetylene-Dissous Works at Döse, Cuxhaven, on the 28th May, 1908:—

"The *Cuxhavener Company* had recently acquired a system for welding by acetylene-dissous, probably from the *Compagnie Française de l'Acétylène-Dissous*. On the day of the accident an engineer of the said French company was filling one of the cylinders, under a pressure of fourteen atmospheres, and having finished, he screwed down the valve, when an explosion took place, setting fire to the works. He had, happily enough, already cut off the connection between the gas generator and the filling place, otherwise the entire works would have been blown to pieces."

Dr. H. Rasch, Geheimerat (Technical Councillor), Hamburg, finishes his long report as follows:—

“The accident, which did not cost any life, proves that the manufacture of the compressed acetylene-azetone mixture must be attended to with the greatest care. The pipings must in every part, especially in the joints, be made with special care, and seamless pipes of the very best material only be used, with a diameter not exceeding 9 m.m.

“The work should only be permitted to be carried out under the control and management of scientists and technically educated persons.

“The accident at Döse proves that explosions are constantly to be expected when the cylinders filled with the acetylene-azetone mixtures are exposed to fire.”

*Bursting of Boiler Tubes, caused by Defective Welding—
Fatal Result.*

In part 7, of 15th April, 1908, the *Z. f. Bayer-Revisions-Vereins* describes the fatal accident at Forcheim as follows:—
“The water-tube steam boiler, 300 q.m. and 12 atm., was built in 1900 by the firm *Petry Dereux*, in Düren, exhibited in Paris 1900, and in Düsseldorf 1902, and in 1903 installed in its present place. The boiler was alternately used with an active one to feed an engine of 800 h.p. At the inspection of 28th November, 1906, and 14th January, 1908, the boiler was found to be in perfect order. On Saturday, 15th February, 1908, one of the 193 tubes of 95 m.m. diameter burst open at a steam pressure of 11 to 12 atm.², emptying the boiler in eight minutes. The mixture of hot water and steam rushed out through the damaged tube, between the fire-tubes downwards over the grate, pushing open the fire-doors, and out into the fireplace, scalding the stoker and his assistant, who nevertheless were able to go to the porter's house at a

distance of almost 80 metres. Both succumbed during the night."

According to the report and the unusual situation of the crack (on one of the upper rear end tubes), the accident was deemed to have been caused by a defective welding of the seam of the tube. It is known that defective welds of tube seams frequently open even after years of use.

Acetylene Explosion.

The *Z. f. Bayer. Rev.-Ver.*, part 3, of 29th February, 1908, gives the report of the explosion of an acetylene generator. The installation, made in the autumn, 1906, was placed in a small room in the yard, and next to the general room of the hotel. The room was so small and without windows that the apparatus could only be attended to through the open door. The inspector ordered, however, amongst other alterations, that the room should be made larger and be provided with a window. A double window, 15 c.m. high and 20 c.m. wide, was made. The generator (Figs. 123 and 124) of the carbide-to-water type, with a capacity of 5 kilogrammes granulated carbide, dropping through the valve *V* into the generating chamber *E*. The valve rod *S* was provided with a packing *g* of indiarubber in the lid of the generator. Between the generator *E* and the gas-holder *B* is the water-safety regulator *W*, protected according to regulations against frost, and behind the gas-holder is the purifier *R*.

On the 5th January, 1908, at 7 p.m., the light was bad. The housemaid, who had to attend to the apparatus, went to the room, pulling the lever *h* in order to let in more carbide into the generator. The water was, however, frozen, so she tried to thaw it by means of some towels dipped in hot water. She fetched the house-butcher to help her, and probably

placed the lamp in the yard about 3 to 4 metres from the door of the installation room. The butcher commenced with the thawing, while the girl remained just behind him, when an explosion, although very small and soft, took place, followed by a second one, much stronger and more sudden, heaving up the generator. The girl, and especially the butcher, were considerably wounded, with their hair burnt off. A carbide

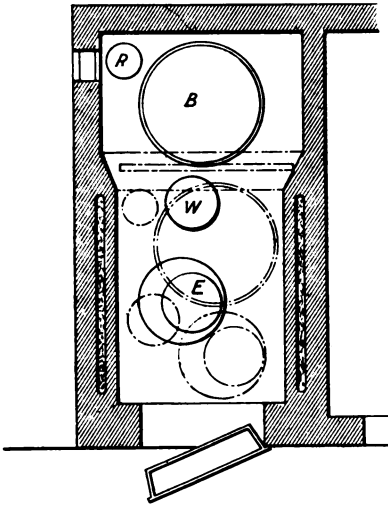

FIG. 123.

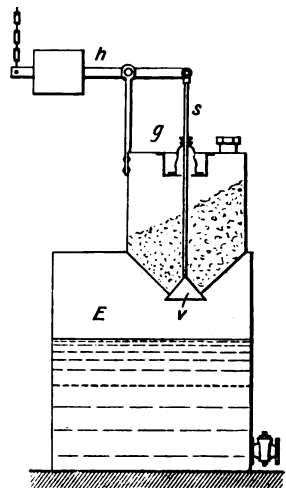

FIG. 124.

tin and the lid of the generator were fetched out by fire-hooks. Neither the gas-holder nor the purifier were destroyed, but the connection between the generator and the water regulator was blown off, and the rubber packing pushed out by the inner pressure. The small sheet soldered to the centre of the lid of the generator was melted by the heat and destroyed, and the carbide chamber was moved away and destroyed. The rear end of the house was damaged, and the roof was raised. On the lid of the generator was found some tallow, spilt from a

candle, which the landlord said was left there after the explosion. The procedure seems to have been as follows:—

The water was frozen; by letting more carbide drop into the generator and the impossibility for the gas thus generated to reach the gas-holder produced a greater pressure, pushing up the rubber packing and permitting thereby the gas to escape and mix itself with the atmosphere, igniting in the candle light. This caused the first explosion. The flame then reached, through the open valve, the interior of the generator, setting fire to the acetylene contained therein, causing the second explosion.

The lesson given is this:—

The room for the plant was exposed to a freezing temperature, the use of the rubber, a most unsatisfactory packing material, on the generator, and, in spite of all stipulations to the contrary, the use of a bare candle light in the room of the apparatus, although in this particular case the light was almost indispensable by want of illumination from outside.

The case is further instructive in this respect, that the illumination of the room of an acetylene plant should always be arranged from outside, especially in such cases where the apparatus must be attended to during evenings or nights. This refers especially to private houses, and more so where the gas-holder is not large enough to take the greatest quantity of gas required during the night; this is always the case with automatic apparatus, which generally have too small a gas-holder.

That too little attention is given to the construction of the room for acetylene installations is a well-known fact, particularly in such places where frost may be expected. The walls, as well as floors and roofs, should be provided with spaces for proper insulation by peat moss, coal-dust, or other similar insulating materials; the doors should be made from double

wood, and when possible be protected from the east and north winds. The installation of special heating apparatus can only be considered for central or large installations. A well-known and leading acetylene firm prefers even to build separate installation houses with insulating walls instead of using ordinary brick buildings with special heating apparatus. See "Insulators," p. 57.

Indiarubber, like glass, belongs to that kind of material which should never, or at least only with the greatest care, be used in acetylene installations, and never—as in the case just described—form part of the surface of an acetylene apparatus.

To the professional man the accident above mentioned is of particular interest, as it belongs to those very few instances of explosion taking place in the interior of the generator, such accidents occurring generally in the installation room, outside of the generator, without damaging the apparatus.

Acetylene a Great Poison.

According to *Z. f. Calcium-Carbid*, four persons inspected, from pure curiosity, the acetylene apparatus in Schnear, Bielefeld, and noticing some unpleasant smell, they soon left the room. Having taken ten to fifteen minutes' walk in the fresh air, they all four fell down unconscious; medical aid was soon available, and after their recovery the doctors explained the highly poisonous nature of the acetylene gas and its dangerous and speedy effect upon human life.

In its number of October 3rd, 1908, *Revue des Eclairages* states that ten to twelve acetylene accidents are generally reported every month, making about 130 a year. There are 13,000 acetylene installations in France inspected by the *Union des Propriétaires d'Appareils à Acétylène*.

CHAPTER X

LEGISLATION

Order of Council *re* Petroleum Acts—Order in Council *re* Explosives Acts—Home Office Conditions for Acetylene Generators—English Acetylene Associations' Regulations.

Legislation relating to Calcic Carbide and Acetylene.

EARLY in 1897 an *Order of Council* was issued placing carbide of calcium under the Petroleum Acts, not with any intention of hampering the industry, but with the object of bringing before the notice of the public that in the use of the new illuminant, acetylene, and in the employment of carbide of calcium, from which it is evolved, reasonable precautions would have to be taken. This action of the *Home Department* cannot be too strongly commended, and if it seems to some that it may have retarded the development of the industry, it must also be borne in mind that the injury of persons by avoidable accidents would have retarded it still more, and it is satisfactory to note that in this country we have not had to deplore such accidents as have occurred abroad. It is true that these accidents were chiefly due to the storage of liquefied acetylene in cylinders under very high pressures, the use of which is prohibited in this country, still, but for legislation, similar accidents would probably have occurred here.

The public, hearing of these accidents through the Press, could not of course be expected to distinguish between liquid acetylene, stored at a pressure of 700 lbs. to the square inch, and gaseous acetylene at low pressure, which with ordinary

care can be quite safely generated in properly constructed apparatus.

By an *Order in Council* of November, 1897, acetylene gas, when liquid or when highly compressed, was very properly brought under the *Explosives Acts*, but with the proviso that if it could be shown to the satisfaction of the Secretary of State that acetylene in any form or condition was not explosive, an exemption might be granted.

Exemption was subsequently granted for certain admixtures of acetylene and oil-gas on the initiative of the *Acetylene Illuminating Company*.

British Home Office Committee of 1901, dealing with the conditions which an Acetylene Generator should fulfil before it can be considered as being safe.

1. The temperature in any part of the generator, when run at the maximum rate for which it is designed, for a prolonged period, should not exceed 130° C. This may be ascertained by placing short lengths of wire, drawn from fusible metal, in those parts of the apparatus in which heat is liable to be generated.

2. The generator should have an efficiency of not less than 90 per cent. which, with carbide yielding 5 cubic feet per pound, would imply a yield of 4.5 cubic feet per each pound of carbide used.

3. The size of the pipes carrying the gas should be proportioned to the maximum rate of generation, so that undue back pressure from throttling may not occur.

4. The carbide should be completely decomposed in the apparatus so that lime sludge discharged from the generator shall not be capable of generating more gas.

5. The pressure in any part of the apparatus, on the generator side of the holder, should not exceed that of 20 ins. f

water, and on the service side of same, or where no gas-holder is provided, should not exceed that of 5 ins. of water.

6. The apparatus should give no tarry or other heavy condensation products from the decomposition of the carbide.

7. In the use of a generator regard should be had to the danger of stoppage of passage of the gas and resulting increase of pressure which may arise from the freezing of the water. Where freezing may be anticipated steps should be taken to prevent it.

8. The apparatus should be so constructed that no lime sludge can gain access to any pipes intended for the passage of gas or circulating of water.

9. The use of glass gauges should be avoided as far as possible, and, where absolutely necessary, they should be effectively protected against breakage.

10. The air space in a generator before charging should be as small as possible.

11. The use of copper should be avoided in such parts of the apparatus as are liable to come in contact with acetylene.*

The English Acetylene Association has drawn up the following list of *regulations*, which it suggests shall govern the construction of generators:—

1. The temperature of the gas immediately on having the charge shall not exceed 212° F. (100° C.).

2. Machines shall be so constructed that when used in accordance with printed instructions it shall not be possible for any undecomposed carbide to remain in the sludge removed from the generator.

3. The limit of pressure in any part of the generator shall not exceed that of 20 ins. of water, subject to the exception that if it be shown to the satisfaction of the Executive of the *Acetylene Association* that higher pressures, up to 50 ins.

* This refers evidently to *pure copper* and not to its alloys.—Author.

of water, are necessary in certain generators and without danger, the Executive may, with the approval of the Home Office, grant exemptions for such generators, with or without conditions.

4. The limit of pressure in service pipes within the house shall not exceed 5 ins. of water, subject to the exception that if it be shown to the satisfaction of the *Acetylene Association* that for certain purposes a higher pressure, up to 10 ins. of water, is necessary, the Executive may authorise such higher pressure to be used for such purposes.

5. The apparatus shall give no tarry or other heavy condensation products from the decomposition of the carbide.

6. In the use of a generator regard shall be had to the danger of stoppage of passage of the gas and resulting increase of pressure which may arise from the freezing of the water. Where freezing may be anticipated steps shall be taken to prevent it.

7. It shall not be possible under any conditions, even by wrong manipulation of cocks, to seal the generating chamber hermetically.

8. It shall not be possible for the lime sludge to choke any of the gas-pipes in the apparatus nor water-pipes, if such be alternately used as safety-valves.

9. The use of glass gauges shall be avoided as far as possible, and where absolutely necessary they shall be effectively protected against breakage.

10. The air space in the generator before charging shall be as small as possible, *i.e.*, the gas in the generating chamber shall not contain more than 8 per cent. of air half a minute after commencement of generation. A sample of the contents drawn from the holder, any time after generation has commenced, shall not contain an explosive mixture, *i.e.*, more than 18 per cent. of air. This shall not apply to the initial

charges of the gas-holder, when reasonable precautions are necessary.

11. Generators and apparatus shall be made of sufficiently strong material and of good workmanship, and shall not in any part be constructed of unalloyed copper.

12. Generators shall have sufficient storage capacity to make a serious blow-off impossible.

13. Wherever the generating plant is situated sufficient ventilation must always be provided.

A blow-off pipe shall, wherever desirable, be affixed leading from the gas-holder to the open air.

14. The Association strongly advise the use of an efficient purifier with generating plant for indoor lighting.

15. No generator shall be sold without a card of instructions suitable for hanging up in some convenient place. Such instructions shall be of the most detailed nature, and shall not presuppose any expert knowledge whatever on the part of the operator.

16. Every generator shall have marked clearly upon the outside a statement of the maximum number of half-cubic-foot burners and the charge of carbide for which it is designed.

CHAPTER XI

USEFUL ADDENDA

British Thermal Unit—Combustion of Carbon, Acetylene, Hydrogen, and Coal Gas—Coefficient of Heat—Consumption of Combustible Gases—Pressure, Weight, and Volume of Air—Temperature of Fusion, Metric and English Measures.

British Thermal Unit is the amount of heat required to raise the temperature of 1 lb. of water at 32° Fahr. 1° Fahr.

On the continent of Europe the caloric is used, and the standard is the heat required to raise the temperature of one kilogramme of water one degree Centigrade.

To convert British thermal units per pound of coal into calories per kilogramme of coal, multiply by 5 and divide by 9.

Combustion of 1 lb. of carbon requires 2.66 lb. oxygen, and as the atmospheric air contains only 23 per cent. of oxygen, it follows that 11.6 lbs. of air are necessary for the combustion of 1 lb. of carbon.

One volume of *acetylene* requires theoretically $2\frac{1}{2}$ volumes of oxygen for complete combustion, but with a satisfactory blowpipe the best welding results are obtained with 1.7 volumes of oxygen to one volume of acetylene.

Two volumes of *hydrogen* require one volume of oxygen for complete combustion, but in order to ensure a non-oxidising flame the gases must be burned in the proportion of about four volumes of hydrogen to one volume of oxygen.

One volume of *coal-gas* requires about 1.25 volume of oxygen for combustion, but for general purposes about 1.33 volume of oxygen is used.

COEFFICIENT OF HEAT.

Conductivity in Calories:—

Copper . . .	330·00	Water . . .	0·77
Iron . . .	40·00	Cement . . .	0·059
Masonry . . .	1·6	Air . . .	0·0175
Firebrick . . .	0·7		

COMBUSTIBLE GASES.

The consumption of liquefied and compressed gases during 1906 is given as follows:—

Belgium .	100,000 cubic metres =	3,500,000 cubic feet.
England .	150,000 " =	5,250,000 "
France .	300,000 " =	10,500,000 "
Germany	400,000 " =	14,000,000 "

It is interesting to note the steady and enormous increase in the consumption of liquefied and compressed gases in Germany, given as follows:—

1899 .	175,000 cubic feet.	1903 .	1,750,000 cubic feet.
1900 .	350,000 "	1904 .	3,150,000 "
1901 .	525,000 "	1905 .	4,200,000 "
1902 .	1,225,000 "	1906 .	14,000,000 "

Such an enormous annual increase in the production of liquefied and compressed gases, and their subsequent application for industrial purposes, as already indicated, is a proof so complete that the nature of enquiry cannot be touched by criticism; nevertheless, there is still room for improvement and for new fields to be found for their practical application.

Pressure.

One Atmosphere = 14·7 lbs. per square inch = 2116·35 lbs. per square foot; = 33·90 feet of water; = 1·033 kilogrammes per square centimetre = 760 m.m. of mercury.

Weight and Volume of Air.

A cubic foot of air at 60° and under average atmospheric pressure, at sea level, weighs 536 grains; and 13·06 cubic feet weigh 1 lb.

Air expands or contracts an equal amount with each degree of variation in temperature.

Temperature of Fusion.

Tin, 455°; bismuth, 518°; lead, 610°; aluminium, 850°; zinc, 700°; antimony, 810°; brass, 1,650°; silver, pure, 1,830°; gold coin, 2,156°; iron, cast, 2,010°; steel, 2,250°; and wrought iron, 2,910° Fahr.

Conversion.

$$\text{Fahrenheit} = \frac{9}{5} (\text{Centigrade} + 32).$$

$$\text{Centigrade} = \frac{5}{9} (\text{Fahrenheit} - 32).$$

METRIC AND ENGLISH MEASURES,
AS COMPILED AND PUBLISHED BY P. E. RADLEY.

Reciprocals for Rapid Approximate Calculations.

Centimetres to inches	÷ 2
Cubic centimetres to cubic inches	× 6 ÷ 100
" " to gallons	× '00022
" inches to cubic centimetres	÷ 16½
" metres to cubic feet	× 35½
" " inches	× 6102
" " yards	× 13 ÷ 10
Feet to metres	÷ 3
Gallons to cubic centimetres	× 4546·69
" to litres	× 4½
Grains to grammes	× '065
Grammes to grains	× 15·43
Inches to centimetres	× 2½

Inches	to metres	×	0254
„	to millimetres	×	25 $\frac{4}{5}$
„	Fractions $\frac{1}{32}$	to millimetres	×	8 ÷ 10
„	„	$\frac{1}{16}$	„	×	1 $\frac{1}{2}$
„	„	$\frac{1}{8}$	„	×	2
„	„	$\frac{1}{4}$	„	×	2 $\frac{1}{2}$
„	„	$\frac{1}{2}$	„	×	3
„	„	$\frac{3}{4}$	„	×	6 $\frac{2}{3}$
„	„	$\frac{5}{8}$	„	×	8 $\frac{1}{2}$
„	„	$\frac{7}{8}$	„	×	12 $\frac{3}{4}$
Kilogrammes	to hundredweights	×	0197
„	to pounds	×	22 ÷ 10
Litres	to gallons (Imperial)	×	22 ÷ 100
„	to pints	×	1 $\frac{3}{4}$
Metres	to feet	×	3 $\frac{1}{3}$
„	to inches	×	39 $\frac{3}{8}$
„	to yards	×	11 ÷ 10
Millimetres	to inches	×	4 ÷ 100
„	„	fractions $\frac{1}{32}$	×	1 $\frac{1}{4}$
„	„	„ $\frac{1}{16}$	×	6 ÷ 10
„	„	„ $\frac{1}{8}$	÷	2
„	„	„ $\frac{1}{4}$	×	4 ÷ 10
„	„	„ $\frac{3}{8}$	×	3 ÷ 10
„	„	„ $\frac{1}{2}$	×	16 ÷ 100
„	„	„ $\frac{5}{8}$	×	12 ÷ 100
„	„	„ $\frac{3}{4}$	×	8 ÷ 100
Pints	to cubic centimetres	×	568 $\frac{1}{3}$
„	to litres	÷	2
Pounds	to hectogrammes	×	4 $\frac{1}{2}$
„	to kilogrammes	×	4 $\frac{1}{2}$ ÷ 10
Square centimetres	to square inches	×	15 ÷ 100
„	feet to square metres	×	9 ÷ 100
„	inches to square centimetres	×	6 $\frac{1}{2}$
„	„ to „ metres	×	6 $\frac{1}{2}$ ÷ 10,000
„	metres „ feet	×	10 $\frac{3}{4}$
„	„ „ inches	×	1,550
„	„ „ yards	×	12 ÷ 10
„	yards to square metres	×	8 ÷ 10
Yards	to kilometres	×	9 ÷ 10,000
„	to metres	×	$\frac{9}{10}$



INDEX

A.

- ACCIDENTS, 248
Acetone, 58, 152
Acetylene, 9, 53
 blowpipes, 152
 burners, 16
 caloric value, 20
 combustion, 152, 264
 committee of Royal Society of Arts, 10
 compressed, 9, 58, 250
 corrosive nature, 15
 cylinders for, 45
 danger of, 10, 15, 143, 251
 decomposition of, 10, 16
 description, 9
 dissolved (dissous), 8, 58
 English Acetylene Association's regulations, 261
 explosions, 53, 251
 explosive nature with air, 10, 250
 copper, 10
 compressed, 250
 limit, 21, 250
 range, 10, 250
 flame, composition of, 164
 generators, 10, 16, 40, 51, 58
 explosion, 18, 255
 Home Office Regulations, 58, 260
 Illuminating Company, Ltd., 7, 59, 153
- Acetylene—*continued.*
 impurities, 16
 Journal ("The Lighting Journal"), 7
 leak tester, 44
 liquefaction, 9
 poisonous nature, 16, 258
 polymerisation, 16
 Royal Society of Arts, 10
 temperature, 164
 welding plant, low pressure, 40, 162
 high pressure, 40, 58
 report, 236
 versus hydrogen welding, 142
 riveting, 225
- Acogine, 50
Addenda, useful, 262
Aeriform, 5
Aggregation, 5
Air, atmospheric, 6
 diphlogisticated, 23
 liquefied, 6
Allgemeine Elektr. Gesellschaft, 70
Alloys, welding of, 2
Aluminium welding, 61
Alumino-thermic process, 67
Andrews, Thomas, F.R.S., 6
Annealing of cylinders, 46
 welds, 243
Ansdell, 9
Armour plates, cutting of, 113, 232
Arsenal, Imperial, Dantzig, 172
Articles of difficult form, 174

Atmospheric air, 6, 265
 liquefaction of, 6
 Australasian Steam Navigation
 Company, Sydney, 220
 Autogenous welding, 2, 39, 197
 Automatic low pressure welding
 plant, 51

B.

BADISCHE Anilin and Soda Fabrik,
 22
 Bar, welding, 3
 Bassanis density meter, 30
 Bausingault process, 25
 Bayerischer Revisions Verein, 244,
 254
 Belgium Steam Users' Association,
 248
 Benzene in acetylene, 16
 air required for combus-
 tion, 16
 Berlin Gross Lichterfelde, welding
 of rails, 70
 Bernados electr. process, 89
 Berthelot, 9
 Blacksmith and anvils, 1
 Blau gas, 19
 calorics, 20
 composition, 20
 explosive nature, range of, 21
 welding, 82
 Blowpipes, 148
 Acetylene Illuminating Co.,
 Ltd., 153
 brazing, 85, 113
 British Oxygen Co., Ltd., 85
 Brussel, van J. B., 232
 conditions of, 148, 241
 Draeger-Wiss, 149
 economy of, 146
 Fouché, 153, 158
 general, 148
 high pressure, 153

Blowpipes—*continued.*
 Jottrand-Lulli, 139, 149
 lead burning, 83
 low pressure, 154
 Board of Trade, 125, 260
 Boiler maker, 196, 225
 welded, advantages of, 193
 Boyle, Robert, F.R.S., 24
 Brazing, 82, 113
 Brin's oxygen process, 25, 33
 British Government Cylinder Com-
 mittee, 46
 British Institute of Marine Engi-
 neers, 201
 Liquid Air Company, Ltd.,
 32
 Oxygen Company, Ltd., 25,
 32, 45, 82
 Steam Users' Association,
 221
 Bulletin des Halles, 252
 Burners, acetylene apt to smoke, 16
 Butterfield and Leeds, 49
 Bülow, C. E., 219

C.

CAGNIARD de la Tour, 5
 Cailletet, Louis, 7, 9, 22
 Calorific value of acetylene, 20
 Blau gas, 20
 coal gas, 87
 hydrogen, 21
 water gas, 33
 Carbide of calcium, 7
 decomposition, 14
 density, 15
 description of, 7
 deterioration of, 8
 explosive nature, 9, 14
 legislation, 259
 moisture in, 8
 receptacle for, 8
 storage of, 8

- Carbide of calcium—*continued*.
 yield of gas, 8, 15, 54
 slaked lime, 15, 19
 space occupied by given weight,
 15
 volume of gas evolved, 14, 54
 lime formed by de-
 composition, 15
 weight of, 15, 55
 Zeitschrift, 253, 258
- Carbon,
 influence on welding, 4, 89
- Carburation, 3
- Cartvale flake charcoal, 57
- Cast iron pipes, 97, 110, 168, 171
- Casting, welding, 3
- Caution *re* use of copper, 10
 oil, 44
- Charcoal insulator, 57
- Chatelier, L., 221
- Chemical welding, 86
- Chemische Fabrik Griesheim Elek-
 tron, 22, 234, 243
- Claude, Eugene, 7, 32
- Claude and Hess, 9, 152
- Clowes, Dr. Frank, 10
- Coal gas, 87
 blowpipes, 85
 calorific value, 20
 combustion, 152, 264
 explosive nature, range of, 252
 welding, 87
- Coefficient of heat, 265
- Coffin electr. weld. process, 89
- Combustible gases, 3, 252, 265
- Combustion of acetylene, 21, 264
 benzene, 16
 Blau gas, 16
 coal gas, 21, 264
 hydrogen, 264
 water gas, 33
- Committee of Royal Society of
 Arts, 10
- Compagnie des Messageries Mari-
 times, 247
- Compagnie Française de l'Acéty-
 lène-Dissous, 253
- Comparative cost of acetylene and
 hydrogen
 welding, 142
 iron and steel
 pipes, 181
 welded and
 riveted
 tanks, 195,
 225
- Comparative corrosion of wrought
 iron, soft steel, and nickel steel,
 188
- Compressed gases, 24, 49, 232
- Comptes Rendus, 22
- Conditions for producing proper
 welds, 3
- Conductor rails, welding of, 69
- Congress of Dantzig, 248
 Liège, 229
 Wiesbaden, 249
- Conseil d'Hygiène publique et de
 Salubrité, 252
- Consumption of acetylene for weld-
 ing, 153
 coal gas, 152
 gases for cutting
 metals, 229
 hydrogen, 139
 oxygen, 139, 152
- Continuous rails, 70
- Copper,
 forming an explosive with
 acetylene, 10
 welding of, 87
- Corrosion, 192, 198
 acetylene, 15
 internal, 199
 marine boilers, 198
 nickel steel, 188
 outside, 198
 soft steel, 188
 steam boilers, 192, 195
 wrought iron, 188

- Cost of cast-iron and riveted pipes, 180
 labour and material for tubular boilers, 196
 riveting *v.* welding, 225
- Coventry Electric Tramways Co. tests, 75
- Critical density, 6
 point, 6
 pressure, 6
 temperature, 6
 volume, 6
- Cutting metals, 229
- Cuxhavener Company, 253
- Cylinders, 45
 annealing of, 46
 Committee of British Government, 46
 compressed gases for, 45
 proving of, 45
 size of, 45
 stands for, 45
 stretch testing apparatus for, 46
 tests of, 45
 valves for, 41
- D.
- DANTZIG, Congress of, 248
 Imperial Arsenal, 172
- Davy, Sir Humphry, F.R.S., 5
- De Meritens, 88
- Decomposition of acetylene, explosive violence, 10, 16
- Density, critical, 6
 of carbide of calcium, 15
 meter (Bassani's elec.), 30
- Department of Public Works, Victoria, 185, 186
- Dephlogisticated air, 23
- Dereux, Petry, Düren, 254
- Deterioration of calcium carbide, 8
- Deutsche Oxhydric Company, 233
- Deutsche Solway Werke, 22
- Dewar, Sir James, 7, 24
- Diaphragms of conducting material, for electrolysis of water, 26
 metallic, 27
 non-conducting, 26
 perforated, 28
 porous, 26
 size of, 28
- Dingler's Polytechnisches Journal, 221, 236
- Disadvantages of welding on steam-boilers, 194
- Dissolved acetylene, 8, 58
- Draeger-Wiss blowpipes, 149
 pump for compressed gases, 49
- E.
- ELASTIC limit, 47
- Electric arc, 88
 current in, 90
 electrodes, 89
 energy for welding copper, 92
 iron, 89
 steel, 89
- poles of, 89
 potential, 89, 90
 resistance, 88
 temperature, 90
- Electric density meter, 30
 energy for welding, 89, 103, 113
 brass, 114
 copper, 111, 114
 iron, 111, 114
 steel, 111, 114
 pressure to complete weld, 92
 resistance, 91
 transformers, 93, 112
 weld, finishing of, 92

- Electric Welding Company, Ltd.,
111
- Electric welding, 88
cost of, 88
generators, 91
welding machines, 91
direct welder, 93
special, 93, 97
standard types of, 111
transformers, 93, 112
types of, 111
universal, 93
for automobiles, 98, 109,
118, 123
baby carriages, 123
bends, 97, 111, 127,
132
bicycles, 98, 109, 123
bolts, square and
hexagon, 118
bosses for drain pipes,
129
buckles, 97, 102
chains, all sizes, 97,
111, 119, 137
clock making, 98, 106
coils for refrigerating,
122
cost of, 136
crank shafts, 118
cutlery, hollow-
handled, 116, 123
cycles, 98, 109, 123
cylinders, 123
door hinges, 97, 104
drain pockets, 129
fittings, 130
flanges, 124
forming joints in thin
material, 115
frames, 111
harness rings, 120
hinge bands, 97, 104
hooks, 97, 104
hoops, 97, 105, 109, 111
- Electric welding—*continued.*
welding machines—*continued.*
for iron furniture, 98
lead, 110
mains, electric, gas
and water, 97, 110,
122, 124, 129
pipes and tubes, 97,
110, 122, 124, 129
plant of, 212
point-welding, 98, 107
pulley and spokes to
rim, 98, 108,
115
window sashes,
115
rails, 69, 135
receivers, 132
rings, 97, 105, 120
simultaneous welding
of pins and pieces to
discs, 97
spiral of iron tubing,
122
steam dryers, 137
gauges and
thermometers,
welded to pipes,
131
switchboard, 119
tubes, 97
tyres, 123
water mains, 137
wires and wire net-
tings, 97, 111, 117, 120
- Electric welding processes, 88
arc processes, 88
Bernados, 89
Coffin, 89
De Meriten, 88
Haho and Legrange, 90
Olszewski, 89
Slavianoff, 89
Werderman, 90
Zerener, 90

- Electric welding processes—*continued*.
 resistance processes :
 Elihu Thomson, 91
 Helberger, 92
 Lemp, 113
- Electrical Times, 114
- Electrolysis of water, 25
 diaphragms, 27
 electrodes, 27, 30
 electrolyte, 27, 29
 electromotive force, 27
 gases evolved, 27, 30
 separation of, 26
 processes by :
 Garuti, 26
 Hasard Flamand, 26
 Renard, 26
 Schmidt, 26
 Schuckert, 26
- End-to-end welding, 97, 105
- Endothermic compounds, 9
- English Acetylene Association's
 regulations for generators, 260
- Engineering Magazine, 232
- Engineering Standard Committee,
 125
- Evaporation of oxygen, 24
- Ewing, Professor, F.R.S., 57
- Examination, microphotographic,
 63
 microscopical, of
 welded metals, 4
- Exothermic compounds, 9
- Expansion of gases, 24
- Explosion, range of for acetylene,
 10, 21, 251
 Blau gas,
 21
 coal-gas,
 21, 252
 hydrogen,
 22, 252
 water-gas,
 252
- Explosive gas, 22, 31
 acetylene generator, 18, 255
 dissous, storage vessel, 253
 works, 253
 Acts applied to acetylene gas,
 260
 calcium carbide,
 259
 boiler tubes, 254
 defective weld, 254
 mixture of acetylene, 10, 251
 violence of acetylene, 18, 251
- F.
- FAHNEHJELMS combs, 34
- Falls of Foyers, 7
- Faraday, Michael, F.R.S., 5
- Ferguson, Mephan, 179
 pipes in various countries, 183
- Fertiliser obtained from acetylene,
 8
- Fitzner, W., 169
- Flame, 2
 carbonising, 4
 decomposition, 242
 form, 164
 neutral, 4
 oxidising, 4, 144
 poisoning, 145
 reducing, 4, 144
 temperature, 151, 164
- Flux for welding, 87
- Forging of iron and steel, 39, 113,
 138
- Fouché blowpipes, 153, 158, 234
- Foyers, Falls of, 7
- Frankoline, 50
- French Steam Users' Association
 ("Veritas"), 247
- Fusion of metals, 39, 266
- G
- GARUTI, P., Professor, 26
- Gas, combustible, 36, 251, 265

- Gas combustion, 36
 compressed, 24, 192, 231, 252
 expansion, 24
 liquefaction of, 5
 permanent, 6
 Gaseous state, 5
 Gases and sources for their generation, 5
 Gay-Lussac, 24
 General remarks, 1
 Generators for acetylene, 10, 51
 Blau gas, 19
 electric welding, 88
 hydrogen, 25
 oxygen, 25, 33
 water-gas, 33, 168
 Gérard, Eric, Professor, 30
 German Steam Boilers Association, 221
 Gewerbeblatt aus Württemberg, 248
 Green, R. & H., 220
 Griesheim Elektron, Chem. Fabrik, 22, 234, 243
- H.
- HABO and Legrange, 90
 Halifax Borough, tests, 74
 Hartmann, C. L. J., report, 244
 Hasard Flamand, 26
 Heap, removing of, by the blow-pipe, 192
 Helberger, Hugo, 92
 Helbronner, André, 7
 Hempel's gas analysing apparatus, 30
 Heraeus, W. C., 61
 Heratol, 50
 Hess and Claude, compressed acetylene, 9, 52
 Heterogeneous welding, 39
 Heylandt, 7
 High pressure automatic regulator, 43
 blowpipe, 148
 oxy-acetylene welding plant, 58
- Hilpert, Dr., 221, 236, 247
 Home Office,
 conditions for acetylene generators, 58, 260
 Explosives Acts, 260
 Petroleum Acts, 259
 Howe, Professor, 188
 Humboldt, Alexander von, 24
 Hydraulic pressure regulator, 41
 testing of cylinders, 46
 Hydrogen, 21
 blowpipes, 178, 229
 caloric value, 21
 consumption, 230, 252, 264
 cutting metals, 229
 description, 21
 explosion, range of, 22, 252
 generators, 25
 inhalation, 22
 liquefaction, 22
 pressure for cutting metals, 232
 relative advantage *versus* acetylene welding, 142
 welding, 139, 197
- I.
- IGNITION of undecomposed carbide, 14
 Imperial Arsenal of Dantzig, tests, 172
 Institute, exhibition of acetylene generators, 10
 India, 184
 Inhalation of hydrogen, 22
 Inspector-General of Public Works, Victoria, 182
 Inspectors, Steam Users' Associations, 221
 Insulators, 57
 International Association of Steam Users, 221
 Congress of 1900, testing materials, 249

- Institute of Civil Engineers, 211
 Marine Engineers, 201
- Iron, forging of, 39, 113, 138
 welding of, 1, 32, 192
- J.
- JOINING metals,
 by forging, 39, 113, 138
 by fusion (welding), 1, 32, 192
- Jottrand and Lulli, 229
- K.
- KNOWLEDGE and Scientific
 News, 22
- Knudsen, Hans, 7
- Krupp, 189
- L.
- LABORATOIRE du Conservatoire
 National des Arts et Métiers à
 Paris, 63
- Lamb and Wilson, Cambridge
 University, 57
- Lap-welding, 113, 169
- Lavoisier, 23, 33
- Lead burning, 82
- Leak tester, 44
- Leeds and Butterfield, 49
- Leeds Corporation Tramways, tests,
 72
 Steel Works, tests, 76
- Legislation, 259
- Levy, René, 7
- Lewes, Vivian B., Professor, 199
- Liège, Congress of, 229
- Life of steel pipes and cast-iron
 pipes, 182, 184
- Lime, 14
 sludge in acetylene generators,
 quantity produced, 14
 volume of, formed by decom-
 position, 14
 weight of, from carbide, 14
- Linde, Carl, Professor, 7, 32
- Liquefaction, 5
 of acetylene, 9
 atmospheric air, 6
 Blau gas, 19
 hydrogen, 22
 nitrogen, 7, 23, 32
 oxygen, 7, 23, 32
- Liquid air, source of oxygen, 7
- Liquid Air Power and Automobile
 Company of Great Britain,
 Limited, 32
- Liquid state, 5
- Lloyd's, 82, 175, 221
- Low pressure
 automatic acetylene welding
 plant, 51
 blowpipes, 148
 non-automatic acetylene weld-
 ing plant, 52
- L'Oxydrique Française, 142
 Internationale, 139,
 229
- Lulli and Jottrand blowpipe, 229
- M.
- MAGNOLIUM, 66
- Manchester Corporation Tram-
 ways, 77
 Steam Users' Asso-
 ciation, 248
- Marine boiler, 192, 198
 autogenous welding, 200, 220
 electric welding, 205, 212
 general repairs, 198
- Marine Engineer and Naval
 Architect, 201
- Mariotte's law, 24
- Mauricheau-Baupré, 22
- Mechanics' Magazine, 191
- Melbourne, water mains, 182
- Metals, cutting of, 229
- Metric and English measures, 266
- Metropolitan Railway, Paris, 233
- Michaelis, L., Dr., 240

- Microphotographic tests, 63
 Microscopical examination of
 welded metals, 4
 Minister for Works, Western
 Australia, 182
 Mix, Conrad, 7
 Moisture in carbide of calcium, 8
 Mond gas, 184
- N.
- NATTERER, 6
 Neutral flame, 4
 New South Wales, 183
 Zealand, 184
 Nitrogen, 6
 Non-automatic acetylene gene-
 rators, 52
- O.
- OLSZEWSKI, elec. welding, 89
 Oxhydrique Française, 142
 Internationale, 139,
 229
 Oxidising flame, 4
 Oxy-acetylene blowpipe, 153
 plant for cutting
 metals, 229
 plant for welding,
 51, 58
 Oxy-coal-gas blowpipe, 85
 plant for cutting
 metals, 85
 plant for welding, 84
 Oxy-hydrogen blowpipe, 148, 229
 plant for cutting
 metals, 229, 232
 plant for welding,
 141
- Oxygen, 23
 Bausingault's process, 25
 boiling point, 23
 Brin's process, 25
 British Oxygen Company,
 Limited, 25, 32
- Oxygen—*continued.*
 cost of plant, 33
 production, 32
 critical temperature, 23
 electrolysis of water, 25, 30
 evaporation, 24
 liquid, 23
 liquid air process, 7, 32
 pressure for liquefaction, 23
 cutting metals,
 232
 solidification of, 24
 vacuum vessels for, 24
- P.
- PARIS Metropolitan Railway, 70,
 233
 Perkins, Jacob, 6
 Permanent gases, 6
 Perth, Public Works Department,
 182
 Petroleum Acts applied to calcium
 carbide, 259
 Phlogiston, 23
 Phoenix Works, tests, 73
 Physical states, 5
 Pictet, Raoul, 7, 22, 23
 Pipes, 97, 110, 168, 171, 179
 cast-iron, welding of, 97, 110,
 124, 168
 corrosion of wrought-iron, soft
 steel and nickel steel, 188
 life of cast-iron pipes, 184
 riveted pipes, 180
 steel pipes *v.* cast-iron,
 182
 wrought-iron, 178
 reports, 182
 steel, welding of, 124, 179
 strength of cast-iron, steel and
 riveted pipes,
 171, 179
 riveted *v.* welded
 pipes, 171, 175,
 195

- Poles, electric, welding of, 175
 Polymerisation of acetylene, 16
 Polytechnicum Zürich, 65
 Prefect of Police, Paris, 252
 Pressure,
 critical, 6
 gauges, 41
 liquefaction of gases, 5
 Priestley, Joseph, F.R.S., 23
 Proving cylinders, 45
 Public Works Department,
 Perth, 182
 Sydney, 183
 Victoria, 185
 Western Australia, 182
 Puratylene, 50
 Purifying materials, 49
- R.
- RADLEY, P. E., 266
 Rails, cutting of, 233
 welding of, 69
 Range of explosion,
 acetylene, 10, 21
 Blau gas, 21
 coal-gas, 21
 hydrogen, 22
 water-gas, 22
 Rasch, Dr. H., Hamburg, 254
 Receptacle for carbide of calcium, 8
 compressed gases, 45
 liquefied air, 45
 Reducing flame, 4
 Regnault, Henri Victor, F.R.S., 6
 Regulators, 41
 Relative advantage of acetylene and
 hydrogen welding,
 142
 of acetylene welding
 and riveting, 225
 of hydrogen *v.* coal
 gas, 84
 corrosion of wrought-iron,
 soft steel and nickel steel,
 188
- Relative strength of cast-iron, steel
 and riveted pipes, 171,
 175
 strength of riveted and
 welded seams, 171, 175,
 195
 Relegation, 36
 Renard, electrolysis of water, 26
 Repairs on marine boilers, 82, 192,
 198, 243
 steam boilers, 192, 195,
 243
 Reports upon acetylene welding, 14,
 225, 243
 aluminium, 63
 Alumino-Thermit, 72
 electric, 201
 hydrogen, 233
 iron and steel pipes,
 180
 mains for water, 180
 Revue des Eclairages, 258
 Riveted mains, 192, 195
 pipes, 171
 seams, 192
 tanks, 224
 tubes, 171
 Riveting *v.* welding, 171, 175, 192,
 196, 225
 Royal Society of Arts Committee,
 10
 Ruck-Keene, Henry, 201
- S
- SCHEELE, Carl Wilhelm, 23
 Schmidt, Dr., 26
 Schoop, Dr. M. D., 61
 Schuckert, 26, 149
 Scott, Walter, Ltd., Leeds, 76
 Seams, welded, 192, 195
 Siemens, Sir William, 7
 Slavianoff, electr. weld., 89
 Sludge-line, 14

- Société L'Oxydrique Française, 142
Internationale, 139, 149
de l'Acétylène-Dissous de Sud-Est, 247
- Society of Arts, Royal, Committee, 10
- Soldering, 82
- Solid state, 5
- Solidification of oxygen, 24
- South Australia, 183
- Space occupied by carbide of calcium, 15
- Speed of cutting metals, 234
welding metals, 157
- Steam boilers, 192
repairs, 195
welding, 192
- Steam Users' Associations, 192, 221
Bavarian, 244
Belgium, 248
British, 221
French, 247
German, 221
International, 248
Lloyds, 221
Manchester, 248
Veritas, 247
- Stands for cylinders, 45
- Steel pipes, 124, 179
corrosion of wrought-iron, soft steel and nickel steel, 188
reports, 182
strength of cast-iron, steel and riveted pipes, 180, 184
riveted *v.* welded pipes, 171, 175, 195
welding, 179
- Stewarts and Lloyds, Ltd., 124, 129
- Strength of welded mains, 180, 184
- Strength of welded pipes, 180, 184
seams, 180, 184
tubes, 180, 184
welding *v.* riveting, 171, 175, 195
- Stretch testing apparatus, 46
- Stromeyer, C. E., Manchester Steam Users' Association, 248
- Suckert, 9
- Swiss Federal Testing Institute, 65
- T.
- TANKS, 192, 224
relative cost of welding and riveting, 195, 225
riveting, 224
welding, 224
- Temperature,
of acetylene flame, 151, 164
generation, 12, 16
coal-gas flame, 20
critical, 6
electric arc, 90
fusion of metals, 39, 266
hydrogen flame, 151
liquefaction of gases, 5
liquid acetylene, 9
air, 6
hydrogen, 22
nitrogen, 7, 23, 32
- Tension of liquefied gas, 5
- Testing Materials Congress, 248
- Tests of welds :
acetylene, 142
aluminium, 63
Alumino-Thermit, 72
electric, 215
hydrogen, 142
main pipes, 179
microphotographic, 63
microscopical, 4
water-gas, 172
- Testing of cylinders, 45
- Thermal unit, 264
- Thilorier, 5

Thomson, Elihu, 91
 Tramway rails, welding of, 69
 Tubes, 97, 110, 168, 179
 cast-iron, 168, 179
 life of steel pipes *v.* cast-iron,
 182
 patent welded, 168
 relative corrosion of wrought-
 iron, soft steel, and
 nickel steel, 188
 strength of cast-iron,
 steel, and riveted,
 180, 184
 strength of cast-iron *v.*
 Ferguson pipes, 179
 strength of riveted
 tubes *v.* Ferguson
 pipes, 180
 strength of welding *v.*
 riveting, 171, 175,
 195
 strength of wrought-
 iron *v.* cast-iron
 tubes, 184
 riveted, 171, 175, 180
 seamless, 168
 steel, 179
 welded, 148, 171

U.

ULLMANN, 50
 Union des Propriétaires d'Appareil
 à Acétylène, 258

V.

VACUUM vessel for liquid air, 24
 Vapour, 5
 Veritas, 247
 Villard, 9
 Volume,
 critical, 6
 of gas evolved from carbide of
 calcium, 14, 54

Volume—*continued.*

lime formed by decomposi-
 tion of acetylene, 15, 19

W.

WATER, electrolysis of, 25
 Water-gas, 33, 147, 168, 252
 general, 33, 147
 welding, 147, 168
 Water mains, 168, 171, 179
 cast-iron, 92, 110, 124, 168
 corrosion, 192, 198
 steel, 124, 179
 strength, 171, 175
 tests, 171, 179
 Wedge-welding, 169
 Weld, 3
 limit of, 3
 perfect, conditions of, 3, 242
 Welding, 1
 acetylene process, 40
 alloys, 110
 aluminium process, 61
 Alumino-Thermic process, 69
 autogenous, 3
 axle gear, 78
 bar, 3
 bends, 97, 111
 Blau gas process, 82
 bolts, square and hexagon, 118
 bootsdavits, 172
 bosses for drain pipes, 131
 brass, 82
 buckles, 97, 102
 cast iron, 97, 110, 124, 168
 chains, 97, 111
 chemical process, 86
 clock-making, 98, 106
 coal-gas process, 87
 coke fire, 170
 compressed gases, 39
 copper, 87
 crank shafts, 118

Welding—*continued.*

cutlery, hollow-handled table,
116, 123
cycles, 98, 109
defective, fatal results, 254
description, 35
different systems, 39
door hinges, 97, 104
drain pockets, 129
electric process, 88
end-to-end, 97, 169
flanges, 124
forging, 39
forming joints in thin material,
115
frames, 111
fusion, 39
harness rings, 105
heterogeneous, 39
hinge bands, 97, 104
hooks, 97, 104
hoops, 97, 105, 109, 111
hydrogen process, 21, 139, 197
iron, cast, 97, 110, 122, 124,
129
forged, 39, 113, 138
furniture, 98
sheet, 97, 168
lamp posts, 175
lap, 113, 169
lead process, 82
mains, electric, gas, water, 178
masts, 175
methods, 39
pipes and tubes, 97, 110, 179
point, 98, 107
pulley and spokes to rim, 98,
108
window sashes, 115
rails, 69
receivers, 132
rims, 97
rings, 97, 105

Welding—*continued.*

ship masts, 175
simultaneous, of pins and
pieces to discs, 97
spiral of iron tubing, 122
steam boilers, 177, 192
gauges to pipes, 131
systems, 39
tanks, 192, 224
thermometers to pipes, 131
tubes, 97, 110, 124, 168, 179
water-gas, 147, 168
wedge, 169
Werdermann, elec. welding, 90
wire and wire nettings, 97, 111,
117, 120
zinc, 82
Western Australia, Minister for
Works, 182
Willson, 9
Wilson, 7
Wiss-Draeger, 149
Wöhler, 9
Wolff, Paul, Dr., 253
Wolfram aluminium, 66
Wrightson, Sir Thomas, 36
Wroblewski, 6, 23

Z.

ZEITSCHRIFT für,
Bayerischen Revisions-Verein,
240, 254
Calcium Carbide-Fabrikation
und Klein Beleuchtung, 253,
258
Comprimierte Gase, 253
Dingler's Polytechnisches
Journal, 221, 236
Gewerbeblatt aus Würtem-
berg, 248
Vulcan, 149
Zerener, Dr., 90



