

OXY-ACETYLENE WELDING
PRACTICE

KEHL

OXY-ACETYLENE WELDING PRACTICE

A PRACTICAL PRESENTATION OF THE MODERN PROCESSES OF
WELDING, CUTTING, AND LEAD BURNING, WITH SPECIAL
ATTENTION TO WELDING TECHNIQUE FOR STEEL,
CAST IRON, ALUMINUM, COPPER, AND BRASS

BY

ROBERT J. KEHL, M. E.

CONSULTING MECHANICAL ENGINEER, CHICAGO
AMERICAN SOCIETY OF MECHANICAL ENGINEERS
ASSOCIATE, AMERICAN INSTITUTE OF ELECTRICAL ENGINEERS

ILLUSTRATED

AMERICAN TECHNICAL SOCIETY
CHICAGO

1920

**COPYRIGHT, 1917, 1920, BY
AMERICAN TECHNICAL SOCIETY**

**COPYRIGHTED IN GREAT BRITAIN
ALL RIGHTS RESERVED**

238519

OCT 29 1920

TDH

K26

6933136

INTRODUCTION

HIGH-TEMPERATURE flames, such as the oxy-hydrogen flame, were known for many years, but the oxy-acetylene flame was first used experimentally in 1901 by Fouché and Picard. The same experimenters also developed the first welding blowpipes, used industrially in 1903, and started the developments in oxy-acetylene welding which were destined to become so important in the modern manufacturing and repair fields. Cutting by means of oxygen was first made commercially possible in 1905 by Jottrand, who took out his basic patent in that year.

¶ Many difficulties were encountered in the early development, owing to imperfect knowledge of the character of the flame and of the technique of the method of application, but notwithstanding these difficulties, the oxy-acetylene welding and cutting processes have developed wonderfully, especially during the last ten years, during which time they have replaced old methods and have made possible operations which hitherto could not be accomplished. The discovery of liquid air greatly decreased the cost of oxygen, and the increase in the number of oxygen supply points throughout the country has removed the last obstacle to the rapid advance of the art. Everywhere manufacturers are very willing to supplant their old methods by the oxy-acetylene process.

¶ Their rapid increase in the number of plants using the process has produced an active demand for skilled operators, a demand which unfortunately has been always much greater than the supply. However, now that the apparatus on the market has become standardized and our knowledge of good oxy-acetylene practice has reached a point where methods can be carefully outlined, the publishers of this little volume feel that an authoritative article on this subject will be appreciated by the many persons interested in the welding field. The material has been written for the welding operator as well as for the superintendent and manager. The examples have been taken from the automobile industry because in that field almost every phase or class of welding is covered, and while the instructions and data deal with automobile welding in particular, the repairman and manufacturer will find no difficulty in applying this information to their own particular needs. The publishers will be very glad to give special information to any reader, either through their own experts or through the help of the author himself.

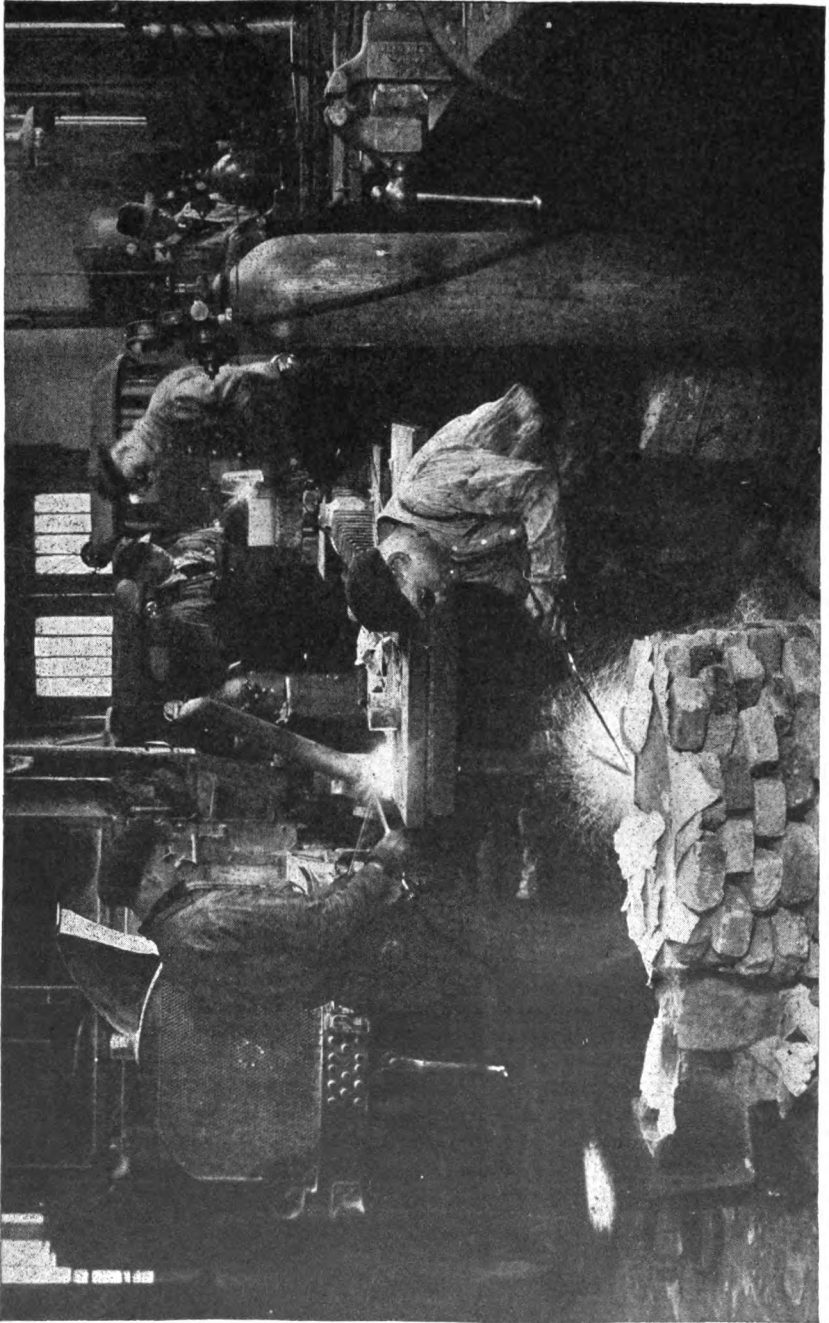

OXY-ACETYLENE WELDING IN AN AUTOMOBILE REPAIR SHOP

CONTENTS

WELDING PROCESSES

	PAGE
Oxy-acetylene process	3
Advantages.....	3
Gases.....	3
Generators.....	5
Welding blowpipes.....	7
Oxy-acetylene flame.....	8
Expansion and contraction.....	8
Preparation of work.....	8
Welding rod.....	8
Flux.....	9
Strength of weld.....	9
Oxy-acetylene cutting.....	10
Electric processes	11
Methods.....	11
Spot-welder.....	11
Arc welder.....	12

TECHNIQUE OF OXY-ACETYLENE WELDING

Simple welding job	14
Apparatus required.....	14
Preparing the metal.....	14
Connecting the apparatus.....	14
Welding.....	15
Operation and care of welding apparatus	16
Necessity for care.....	16
Necessary welding apparatus.....	16
Welding blowpipe.....	16
Regulators.....	19
Hose.....	21
Instructions for connecting apparatus.....	22
How to light blowpipe.....	23
How to shut off blowpipe.....	23
Back-firing.....	24
Character of flame.....	24
Position of blowpipe.....	27
Position of welding rod.....	29
Haste fatal to good welding.....	31
How to weld up a hole.....	31
Overhead and vertical welding.....	31
Beginning a long weld.....	31
Defects in welds.....	32

CONTENTS

	PAGE
Welding different metals	34
Properties of metals.....	34
Expansion and contraction.....	36
Handling simple case of expansion and contraction.....	37
Handling complex case of expansion and contraction.....	39
Pre-heating.....	40
Steel welding.....	43
Cast-iron welding.....	59
Malleable-iron welding.....	67
Aluminum welding.....	68
Copper welding.....	72
Brass and bronze welding.....	74

MISCELLANEOUS OXY-ACETYLENE PROCESSES

Cutting	76
Principle of cutting with oxygen.....	77
Cutting blowpipe.....	78
Regulators.....	79
Care of apparatus.....	79
Instructions for connecting apparatus.....	79
How to light blowpipe.....	79
To shut off blowpipe.....	80
Back-firing.....	80
Notes on cutting.....	81
Lead burning	81
Different methods.....	81
Lead-burning apparatus.....	83
Operation of lead-burning apparatus.....	83
Lead-burning process.....	84
Carbon removing by use of oxygen	85
Old process of removing carbon.....	85
Carbon-removing apparatus.....	86
Burning out carbon.....	86

EXAMPLES OF AUTOMOBILE REPAIR

Pressed-steel parts.....	87
Frames.....	87
Bodies and fenders.....	89
Springs.....	92
Shafts and axles.....	93
Axle housings.....	94
Manifolds.....	94
Engine cylinders.....	95
Crankcases and transmission cases.....	97

COSTS

Measuring oxygen consumption.....	99
Measuring acetylene consumption.....	102



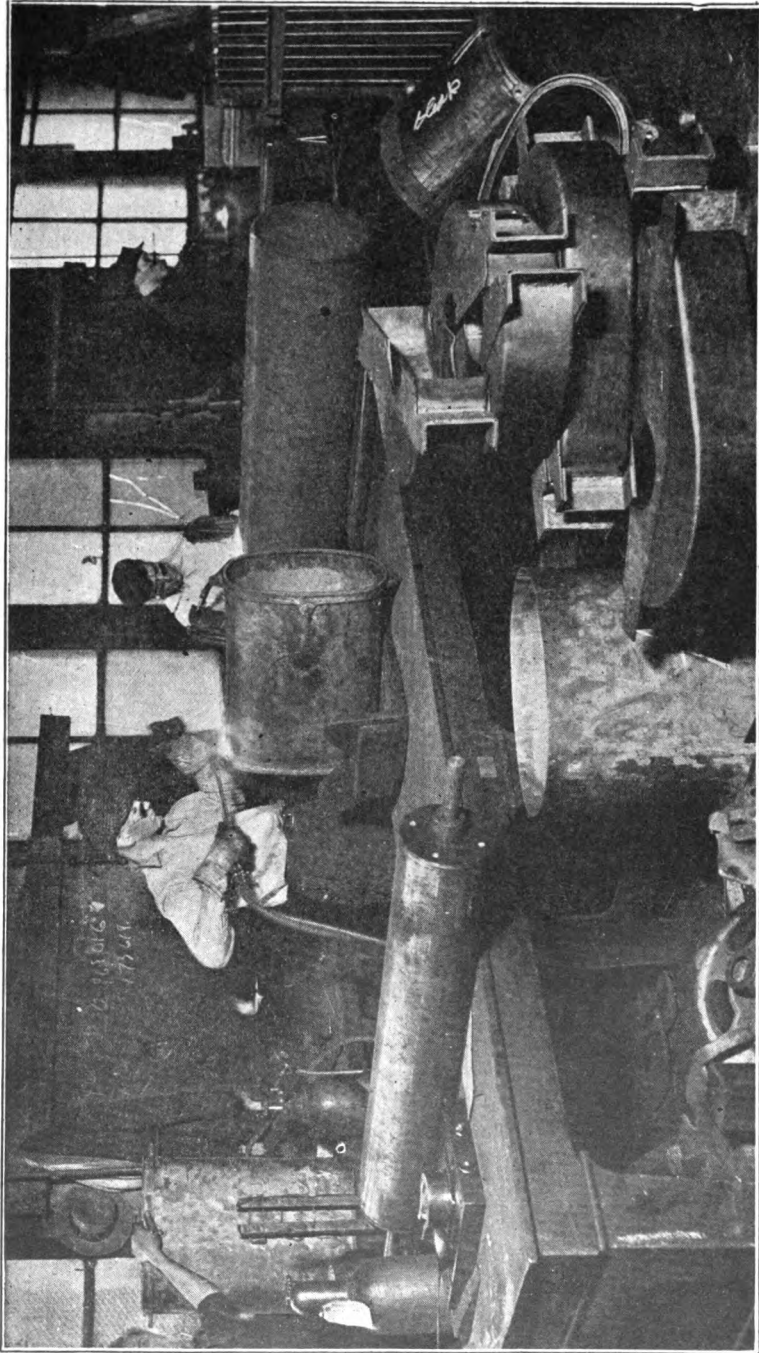

WELDING LIGHT SHEET-METAL TANKS AND CONTAINERS BY THE OXWELD PROCESS

This view is taken in the plant of one of the largest makers of such articles in the United States. The gas-welding process has been found to produce better results in quicker time and with more economy than any other method.

Courtesy of Oxweld Acetylene Company

OXY-ACETYLENE WELDING PRACTICE

INTRODUCTION

Welding Field. The welding process is undoubtedly one of the greatest contributors to the efficient and economical manufacture of the modern automobile. It has made possible higher standards of body design and may be given almost exclusive credit for the light weight and great strength of the present-day motor car, producing stronger and better working parts through the use of pressed steel instead of the heavy castings or riveted parts, such as axle housings, Fig. 1, and manifolds, tanks, bodies, etc., Fig. 2.

In the field of automobile repair it is rapidly assuming an equally important place, affording a quick and inexpensive means of permanent repair to parts no longer obtainable from the supply house or manufacturer and permitting the building up of weak parts or the altering of the chassis, as may be required. This great adaptability of the welding unit has made it an essential part of the equipment of every efficiently managed repair shop.

WELDING PROCESSES

Old and New Methods. The old systems—blacksmith, or forge, welding, and brazing—are now seldom used in automobile work. In fact, most blacksmiths have equipped themselves to do welding in the modern way, using it almost exclusively for their repair work because it is cheaper, simpler, more efficient, and can be used on materials which could not be welded by means of the old-style methods. The modern systems of welding include the flame and electric processes. Because it is almost universally used in repair shops, the flame process and the apparatus required in its use will be discussed first. Several flame-welding processes have, from time to time, been introduced, all utilizing oxygen in combination with some fuel gas, such as acetylene, hydrogen, city gas, natural gas, liquid gas, Blau gas, carbo-hydrogen, thermaline, etc. Many enthu-

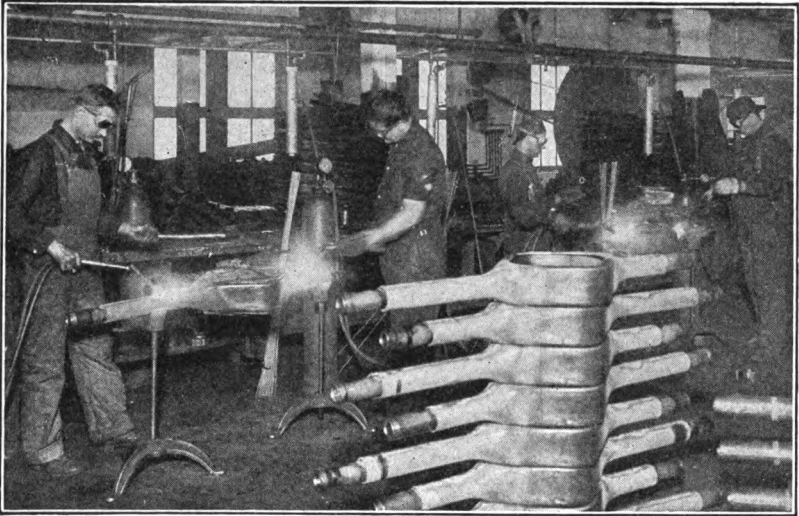

Fig. 1. Oxy-Acetylene Welding in Manufacture of Rear Axle Housings

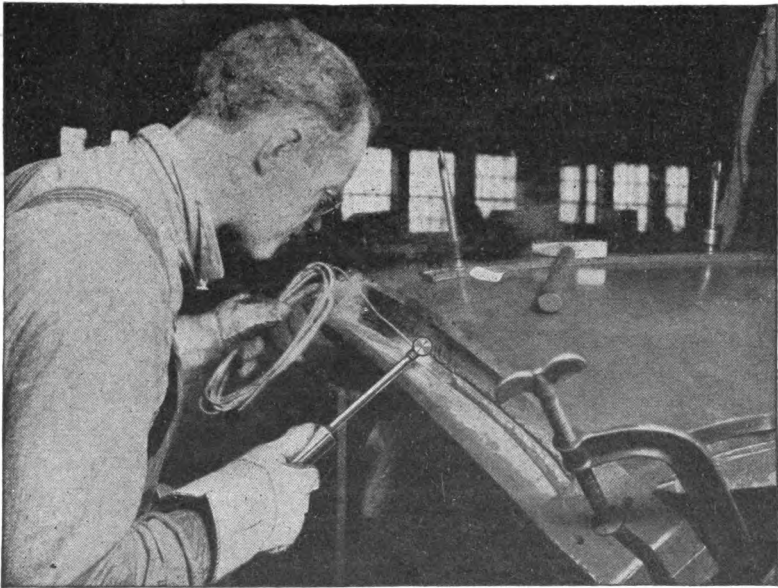

Fig. 2. Oxy-Acetylene Welding in Manufacture of Automobile Bodies

siastic claims of superiority have been made for each of these combinations by their advocates.

OXY-ACETYLENE PROCESS

Advantages. The easy control and intensity of the heat developed by the oxy-acetylene flame (approximately 6300° F.) and the adequate supplies of carbide and dissolved acetylene which are maintained in every industrial center in the United States have proved the greater desirability, economy, and efficiency of the oxy-acetylene process.

Another factor which has contributed largely to the popularity of the oxy-acetylene process is the comparatively inexpensive apparatus required and the low cost of its operation. Its speed, portability, and the ease with which its method of operation may be learned by any intelligent workman make it especially well fitted to the need of the automobile repair shop. Very seldom is any extensive dismantling of parts necessary in making an oxy-acetylene repair and, for this reason, it simplifies greatly the work of the repair man.

Gases. As is generally known, two gases are used in the oxy-acetylene process—oxygen and acetylene.

Oxygen. Oxygen is manufactured from air by liquefaction or from water by electrolysis. The former method is by far the greatest source of supply, furnishing practically all the oxygen used in this country and abroad. Oxygen made by the liquid-air process can contain only an impurity such as nitrogen, which cannot possibly do any harm. On the other hand, oxygen made by the electrolytic method contains some hydrogen, which will render it dangerous to handle if more than two per cent is present.

Because of the very high cost of an oxygen plant and the ease with which an adequate supply of compressed gas may be obtained from manufacturers' supply stations, it has been found impractical for even the largest consumers to attempt the manufacture of their own oxygen.

Almost everybody is familiar with the appearance of the oxygen cylinder, shown at the right in Fig. 3, which plays so important a part in present-day manufacturing. These steel cylinders contain 100 or 200 cubic feet of gas compressed to a pressure of 1800 pounds per square inch. They are furnished to the consumer without charge,

the customer paying only for the oxygen and returning the cylinder to the manufacturer when the gas has been exhausted.

Acetylene. The acetylene may be obtained in cylinders, shown at the left in Fig. 3, containing 100 or 300 cubic feet, or, where large

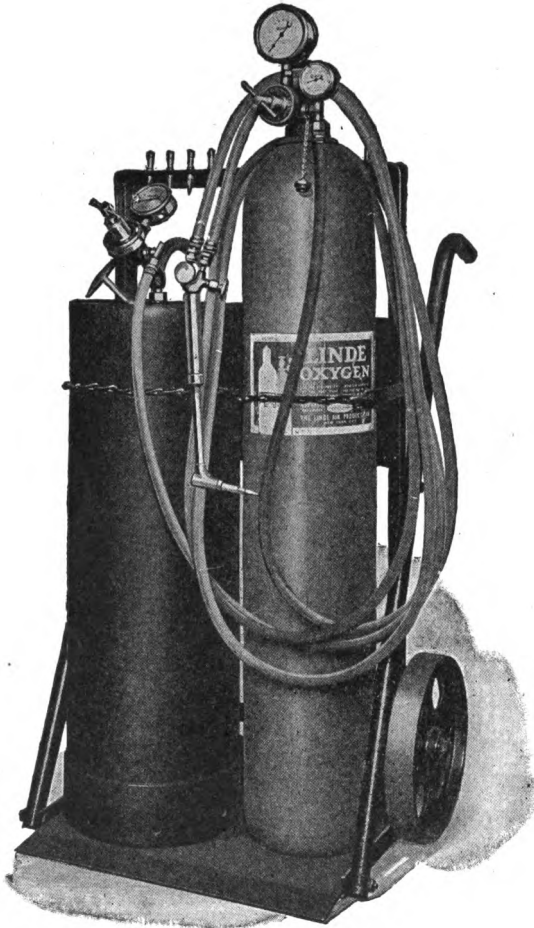

Fig. 3. Welding Unit for Use with Acetylene in Cylinders,
Mounted on Emergency Truck
Courtesy of Ozweld Acetylene Company, Chicago, Illinois

quantities are required, it is generated on the premises. Though frequently referred to as compressed, the acetylene in cylinders is really not compressed, but is dissolved in a solvent which has the property of absorbing many times its own volume of acetylene as pressure is applied. This liquid in which the gas is dissolved in no way affects the flow of gas except when the acetylene is drawn off from the cylinder at too rapid a rate. Experience has proved that when the gas is used at a rate greater than one-seventh the capacity of the cylinder per hour, the solvent is very likely to travel with the acetylene, lowering the

temperature of the flame and thus hindering the work. To overcome this difficulty, where it is necessary to supply gas at a greater rate, several cylinders may be coupled to a manifold, or header, so that the total capacity is at least seven times their hourly discharge.

Generators. By means of the acetylene generator it is possible to produce pure acetylene at less than half the cost of dissolved acetylene, so that if any considerable work is to be done a generator will pay for itself within a few months or a year. In these generators small quantities of calcium carbide are automatically fed into a large

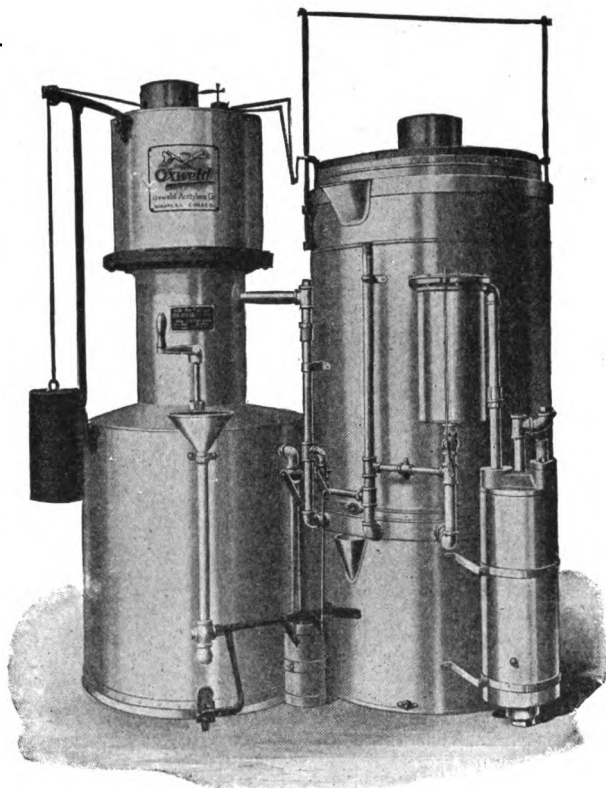

Fig. 4. Low-Pressure Acetylene Generator
Courtesy of Ozweld Acetylene Company, Chicago, Illinois

quantity of water, producing the gas at just the rate required by the work in hand.

There are two recognized systems of generating acetylene—the low-pressure system and the pressure system.

Low-Pressure Generator. This type of generator, Fig. 4, delivers acetylene to the blowpipe under a pressure of less than one pound. This system has the advantage of maintaining at all times an abso-

lutely constant pressure, which is an essential requirement. The carbide feed is controlled by the rise and fall of the gas bell, in which the pressure is always the same, without the use of any pressure-regulating device.

Pressure Generator. The pressure generator, Fig. 5, delivers acetylene at a pressure of more than one pound. The carbide feed is controlled by the pressure in the generator. As the acetylene is drawn off and the pressure decreases, carbide is fed into the water;

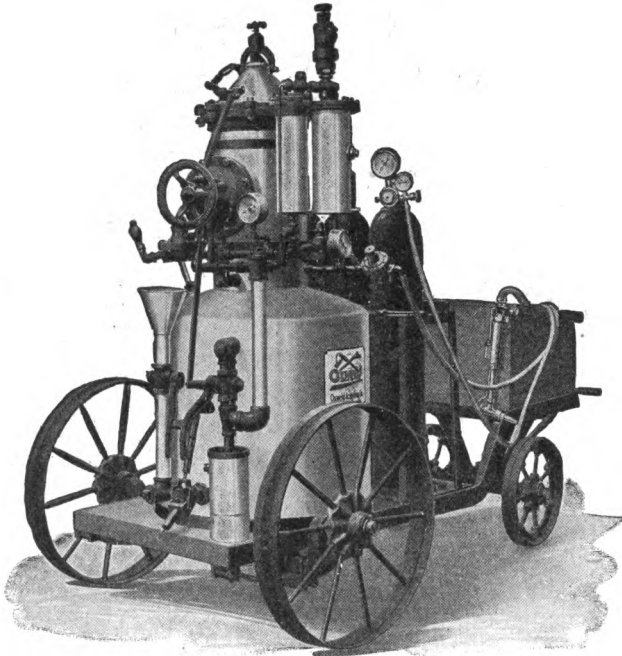

Fig. 5. Portable Pressure Acetylene Generator
Courtesy of Oxweld Acetylene Company, Chicago, Illinois

the generation of gas increases the pressure and the feeding stops. In order to compensate for this pressure variation, a pressure-diaphragm regulator, or reducer, is necessary so that the acetylene may be supplied to the blowpipe at a constant pressure.

The low-pressure generator furnishes the most satisfactory service under average conditions, though where portability is essential, pressure generators of compact construction may be obtained to meet this need.

Welding Blowpipes. There are two types of oxy-acetylene welding blowpipes, namely, the low-pressure, or injector type and the equal-pressure type.

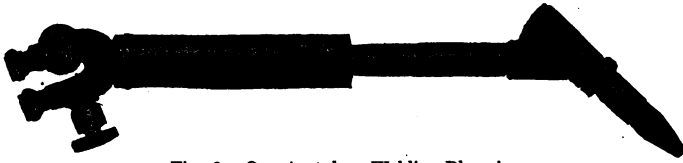

Fig. 6. Oxy-Acetylene Welding Blowpipe
Courtesy of Ozweld Acetylene Company, Chicago, Illinois

Injector Blowpipe. In the injector type, Fig. 6, the acetylene is delivered to the blowpipe at a pressure of only a few ounces. The oxygen at a higher pressure passes through the injector, Fig. 7, and expands rapidly into the mixing chamber. This rapid expansion and high velocity of the oxygen form a suction and draw in the acetylene at a constant ratio. A slight variation in pressure of either

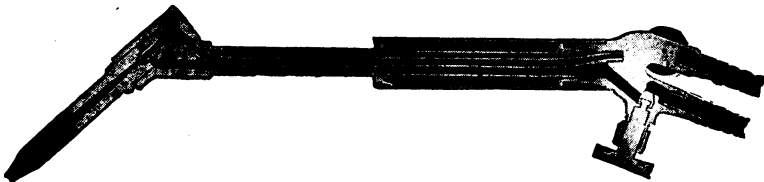

Fig. 7. Section of Injector-Type Blowpipe

the oxygen or acetylene is automatically taken care of by the injector, so that a neutral flame is maintained at all times.

Pressure Blowpipe. In this blowpipe the acetylene is used at almost the same pressure as the oxygen. The oxygen enters the mixing chamber at the rear and the acetylene through a couple of holes at the side.

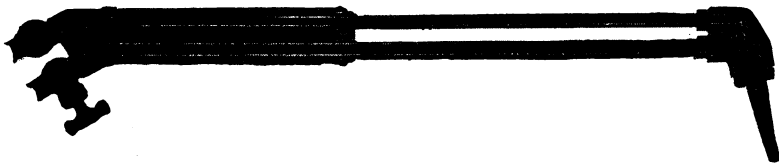

Fig. 8. Section of Pressure-Type Blowpipe

In the injector blowpipe the rapid expansion into the tapered mixing chamber sets up a whirling action and produces an intimate mixture of the oxygen and acetylene so that a ratio of 1.05 parts oxygen to 1.00 part acetylene is obtained, which is almost the theo-

retical or perfect ratio of 1.00 to 1.00. In the pressure blowpipe there is no means of obtaining such an intimate mixture of the gases in the mixing chamber, Fig. 8, which in most cases is not tapered and consequently about the best ratio obtainable is 1.14 to 1.00. A larger amount of oxygen is, of course, wasted and, besides, tends to produce an oxidized weld. It is the surface oxidation, or burning, of the molten metal that leads some operators to believe that they are welding fast, while in reality they are only burning the surface and are not fusing the metal underneath.

Oxy-Acetylene Flame. The oxy-acetylene flame is the hottest flame obtainable. Its temperature of 6300° F. is 2000 degrees above that of any of the other flames. This high temperature allows the work to be done quickly and with only a very slight loss of heat due to conduction and radiation.

There are three phases of the oxy-acetylene flame, Fig. 18, namely, the neutral, or welding, flame; the carbonizing, or reducing, flame; and the oxidizing flame. Each of these has its characteristic appearance and it takes only a little practice to instantly recognize them. The appearance of these will be taken up later under "Flame Regulation", page 25.

Expansion and Contraction. These natural changes of the work, due to the heat of the welding, are taken care of in the case of rolled or forged materials by proper spacing of the edges or by holding the work in suitable jigs and, in the case of castings, by proper pre-heating and cooling. The most satisfactory methods of handling this feature will be taken up under the instructions for welding various materials.

Preparation of the Work. This is a very important feature and should receive the operator's best thought and effort. A fair amount of reasoning and planning on the part of the operator before he attempts a job will save considerable time and keep the cost of the welding low. The operator should figure out several ways and means of handling the particular task at hand, and should then select the best. This applies especially to castings, such as crankcases and cylinders, which may be welded perfectly if the operator uses good judgment but which will be ruined if he does not.

Welding Rod. Thin plates may be welded by bringing the edges into contact and fusing them together. For heavier work, the edges are beveled to form a groove, and a filling material, or "welding-

rod", is fused into the groove. In most cases a material similar to the work being welded is used. The operator may build up the weld by means of the welding rod so that the section at the weld is greater than the section before welding, thus insuring a strength even greater than the rest of the piece.

Flux. A suitable flux is used in cast iron, aluminum, brass, copper, etc., welding to dissolve any impurities and to give a film, or protecting coating, to the fused material to prevent oxidation.

Both the welding rod and the flux used are extremely important factors in the welding and should be obtained from a reliable manufacturer who supplies only materials that are tested and analyzed to determine their purity and suitability for the work.

Strength of Weld. With proper equipment and suitable rods and fluxes, the strength of the weld will depend mainly upon the skill

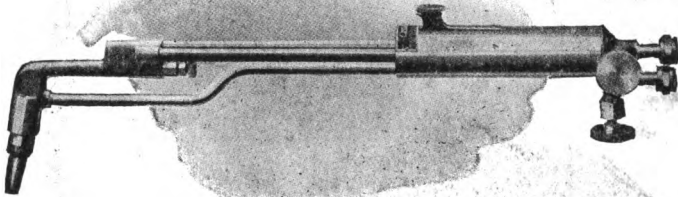

Fig. 9. Oxy-Acetylene Cutting Blowpipe
Courtesy of Oxweld Acetylene Company, Chicago, Illinois

and care of the operator. An operator who has had considerable experience and who is careful with his work should be able to obtain as high as 95 per cent the strength of the original material, although 85 per cent may be taken as a safe lower limit for the average good welder.

Working and Hammering. If the weld is hammered when at the proper temperature, its strength will be increased, in the case of welds in steel, by making the grain of the material finer.

Experience of Operator. Poor work due to carelessness or inexperience of the operator, poorly designed and cheaply constructed apparatus that is not capable of handling the work, may be held responsible for such failures as may occur in the oxy-acetylene process.

The handling of the process is not difficult and, therefore, some operators undertake difficult jobs before they are sufficiently capable or experienced. When such a job fails, it is but natural that both the

customer and the operator should blame the process rather than the way in which the work was handled. Time may be very profitably spent in practice on scrap material before undertaking work on materials with which the operator is unfamiliar. By thus laying the foundation for a satisfactory result, the operator may quickly develop

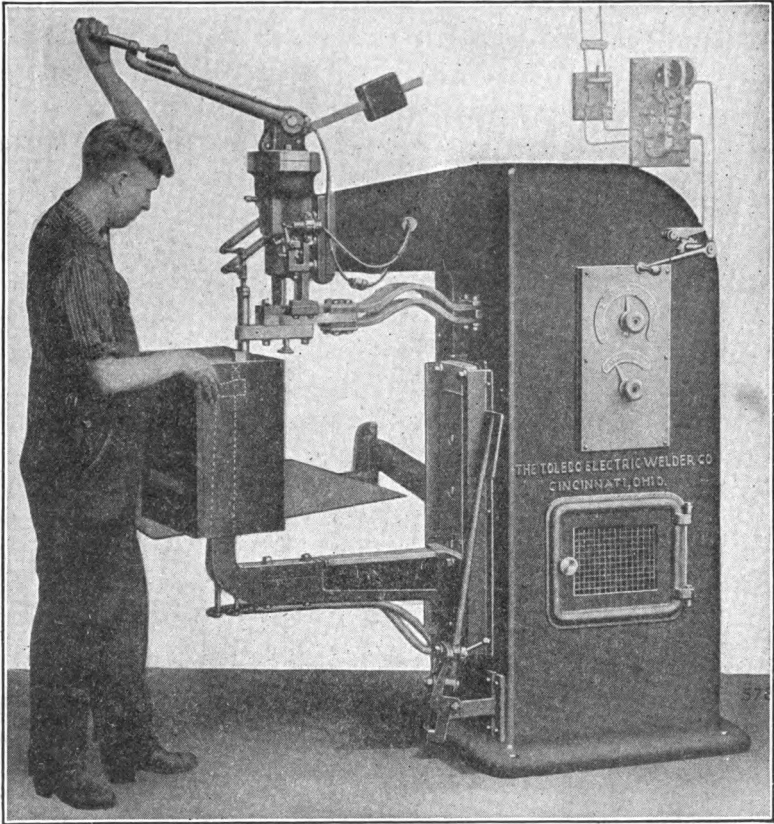

Fig. 10. Electric Spot-Welding Machine
Courtesy of Thomson Spot Welder Company, Cincinnati, Ohio

his skill to the point which will bring him the confidence and patronage of a constantly increasing number of customers.

Oxy-Acetylene Cutting. Cutting by the oxy-acetylene process is done by means of a separate blowpipe, Fig. 9, quite different in construction from that used for welding. A more detailed description of the cutting process is given on page 77.

ELECTRIC PROCESSES

Methods. For a number of years electric welding was used as a laboratory experiment, but recently the process has been more fully developed. Two distinct methods are utilized: one, the electric-resistance welder, or spot-welder, Fig. 10; and the other, the electric-arc welding machine, Fig. 11.

Spot-Welder. The electric-resistance welding process provides for the passage of a heavy current through the joint between the pieces to be welded, allowing the resistance of the bad contact to heat them locally until they are soft enough to stick together; squeezing

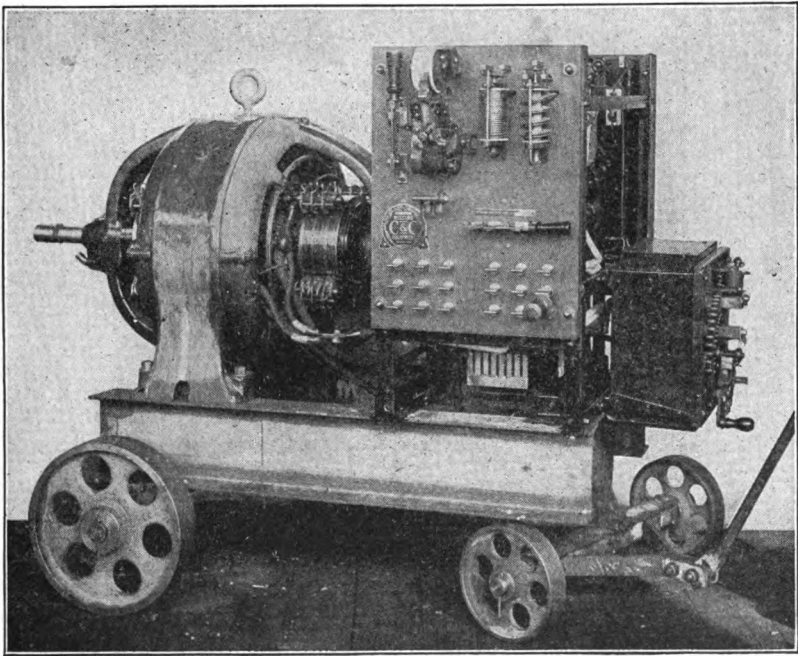

Fig. 11. Portable Arc-Welding Outfit

Courtesy of C & C Electric and Manufacturing Company, Garwood, New Jersey

the pieces while soft will then cause them to adhere. This process is used mostly in making light automobile parts, such as mud guards, bonnets, etc., rather than for repair. It is also used to some extent instead of small rivets in light sheet-metal work and for spotting, or tacking, small parts together preparatory to welding them with the oxy-acetylene flame.

Arc Welder. In order to do welding with the electric arc, after suitable equipment has been provided, it is necessary to first connect the work to the positive side of the power-supply circuit and the welding electrode to the negative side of the circuit by means of wires or cables, with the regulating devices in circuit to control the amount of current flowing. The negative electrode is then placed lightly in contact with the work and quickly withdrawn to make the circuit



Fig. 12. Operator Using Metallic Electrode
Courtesy of C & C Electric and Manufacturing Company, Garwood, New Jersey

and draw the arc, thus providing the high temperature required for welding.

Electric-arc welding usually consists in using the heat of the arc to fuse, or melt, the filling material into the place to be filled, although the article worked upon may be melted down sufficiently to fill the space if it is large enough at the point to be welded.

Two methods, or processes, using the arc for welding, are in commercial use, these being the metallic and the graphite, or carbon, processes.

Metallic Electrode. The metallic welding process consists in using a piece of wire of the proper kind as the negative electrode of the arc and fusing it into place, drop by drop, Fig. 12.

Graphite Electrode. The graphite process consists in using a piece of graphite, or carbon, as the negative electrode and fusing a piece of metal into place by the heat of the arc.

Apparatus. It is possible, though not practical, to do electric-arc welding, having nothing but a source of primary current, and some

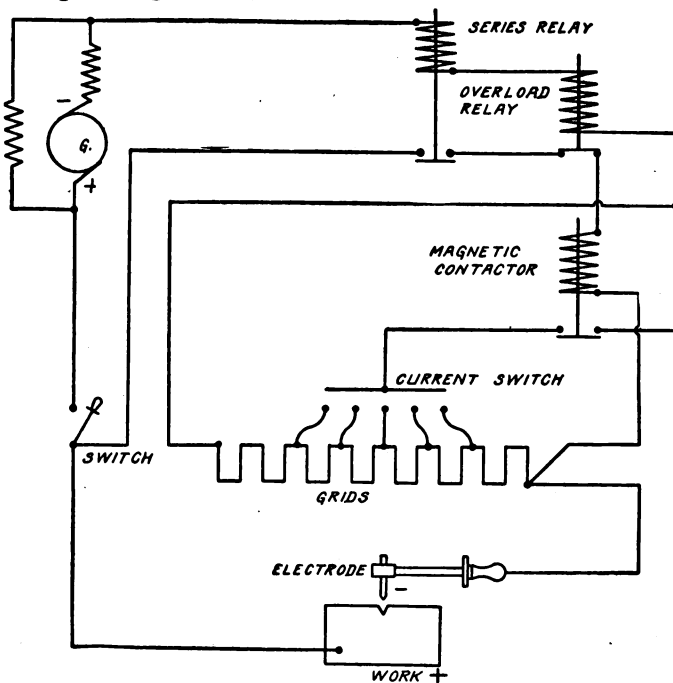

Fig. 13. Wiring Diagram for C & C Welding System

means for regulating the amount of current flowing, but the use of resistance only as a means of regulating the amount of current flow is so wasteful that other apparatus must be used for the sake of economy. It is well known among electrical men that a motor-generator set gives the best regulation of voltage, therefore, the leading arc-welding outfits in use today consist of a motor-generator set with suitable rheostats, resistances, circuit-breakers, fuses, indicating instruments, and switches for controlling the motor-generator and welding circuits, Fig. 13.

From the foregoing description, it will be surmised that an electric-arc welding equipment will be too expensive in initial cost for the average auto repair shop. However, it finds a useful field in the welding of very heavy work where there is sufficient volume of it to justify the investment.

TECHNIQUE OF OXY-ACETYLENE WELDING

SIMPLE WELDING JOB

Apparatus Required. The material in the following paragraphs must not be considered as instructions for welding but merely as a brief discussion of the various steps in making a simple weld. Complete instructions for connecting and operating the equipment are given in detail later. In general, the following equipment is needed for every welding job, no matter how small:

- (a) A welding blowpipe
- (b) A supply of oxygen
- (c) An oxygen regulator
- (d) A supply of acetylene
- (e) An acetylene regulator
- (f) Hose to connect blowpipe to oxygen and acetylene supplies

Preparing the Metal. First, the edges of the two pieces of metal to be welded are chamfered or beveled, so that when they are placed together the two beveled edges form a V, the width of the V being about equal to the thickness of the metal.

Next, the two pieces are placed together on a flat surface of fire brick, or other nonconductor of heat, so that the edges just touch at the bottom of the groove. This gives the line of the weld. The two pieces are then ready to be welded as soon as the apparatus is connected.

Connecting the Apparatus. To connect the apparatus, the following steps should be taken:

- (1) The oxygen regulator is connected to the oxygen cylinder.
- (2) The acetylene regulator is connected to the acetylene cylinder.
- (3) The one hose is connected to the oxygen regulator and to the blowpipe.
- (4) The other hose is connected to the acetylene regulator and to the blowpipe.

- (5) A welding head is selected and attached to the blowpipe.
- (6) The oxygen and acetylene are turned on and the blowpipe is lighted.

Welding. The operator is now ready to weld. He takes the lighted blowpipe in his right hand, Fig. 14, and plays the flame upon the beveled edges of the two pieces of metal to be welded. The intense heat of the flame melts the edges and they flow together. As



Fig. 14. Simple Job of Welding

the edges flow together, the operator melts in new metal from a rod which he holds in his left hand, so that the entire groove is filled up, producing a perfect union or weld.

When the entire groove has been filled in this manner, the operator turns out the blowpipe, and allows the metal to cool.

The foregoing is a brief outline of the steps taken by an operator in performing a simple operation of welding two small pieces of steel.

We will now take up these different steps and will give more specific and detailed descriptions of the welding apparatus and complete instructions in its operation and use.

OPERATION AND CARE OF WELDING APPARATUS

Necessity for Care. It is proper that in the operation of the welding apparatus we should lay stress upon the importance of careful and orderly methods in the handling of such apparatus. It should be borne in mind that the regulators and gages are sensitive measuring devices, that in the blowpipe the orifices are carefully designed and accurately machined to permit the passage of a definite quantity of gas and, therefore, that rough usage and abuse will certainly decrease their efficiency. It is not necessary in this place to give detailed instructions for the operation and care of the various makes of apparatus, because these are invariably furnished by the manufacturers with their equipment.

Because of the fact that dissolved acetylene is most generally used in garages and small job shops, we will confine our explanations to the use of apparatus with cylinder equipment. Owing to the greater simplicity of handling, however, the operator will have no difficulty in making use of generated acetylene when the opportunity arises.

Necessary Welding Apparatus. A complete welding station, Fig. 15, for use with acetylene dissolved in cylinders, consists of the following apparatus:

Welding blowpipe *G* with set of welding heads

Oxygen welding regulator *C* with two gages

Acetylene regulator *D* with one or two gages

Adapter *L* for acetylene cylinder

Two lengths high-pressure hose *E* and *F*

Darkened spectacles, wrenches, hose clamps, etc.

Welding Blowpipe. The two types of welding blowpipes were described on pages 7 and 8, and need no further explanation as to the principles of operation. They are furnished by the manufacturers in various lengths to take care of various classes of work, from short light-weight blowpipes less than a foot long for light sheet-metal work up to blowpipes several feet long, which allow the operator to stay away from the intense heat as far as possible when working on heavy jobs.

Welding Heads and Tips. About ten sizes of welding heads, or tips, are supplied for use on different thicknesses of metal and various classes of work, each giving its own special size flame. The

oxygen consumption of the various size heads ranges from about 4 to 70 cubic feet per hour. In some makes the heads are made of one

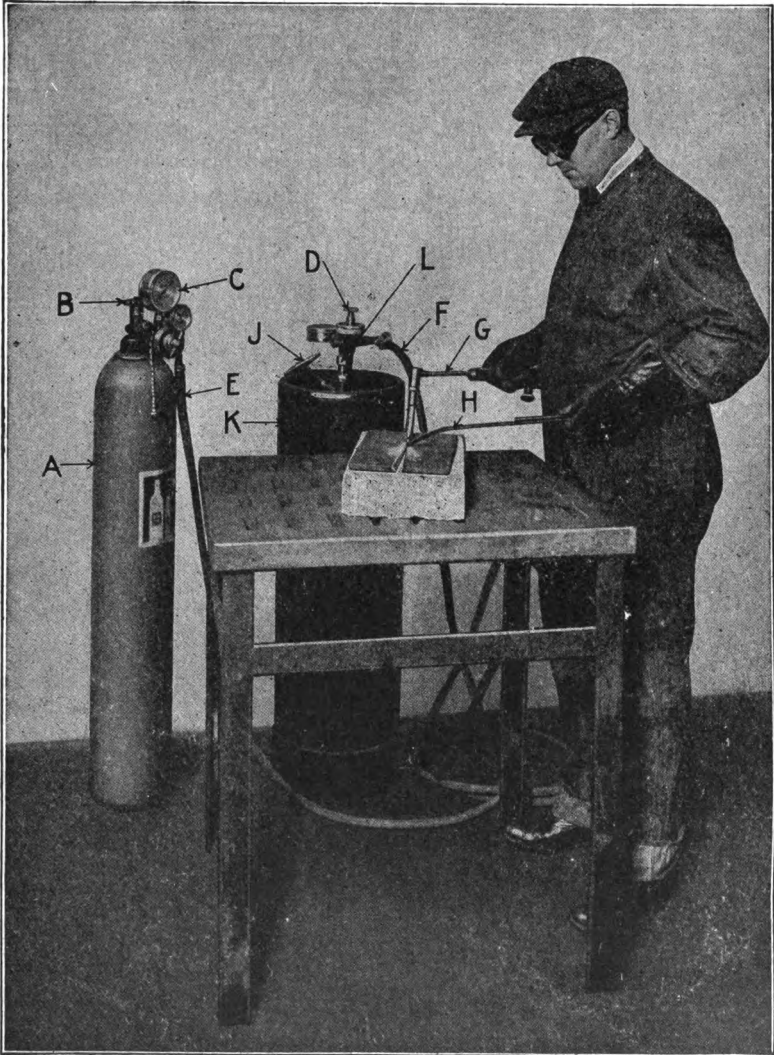

Fig. 15. Complete Welding Station

piece, while in others they consist of a brass or bronze body and a copper tip, which can be easily and cheaply replaced when necessary.

Working Pressures. The necessary pressures of the gas that are required by the different size welding heads are given by the manufac-

turers, and it is very important that the operator use only the pressures recommended if he wishes to get the best economy and the strongest weld possible. Some operators believe that by increasing the pressure above that specified by the maker of the apparatus that they are able to do the work more quickly and easily. This idea is wrong, because when the pressure is increased, the larger volumes of oxygen and acetylene cannot mix as well, so that oxide forms in the weld and has to be removed. This takes more time and is very likely to leave a slightly oxidized and weak weld.

If the welding head being used is not large enough, use a larger size; never try to increase the ability of the smaller head by increasing the pressure.



Fig. 16. Cleaning Blowpipe by Means of Oxygen under Pressure

It is equally bad to use a pressure that is too low. If this is done, continual back-firing will result.

Care of Blowpipe. If the blowpipe is handled properly there will be very little deterioration. It should only be necessary to clean the replaceable and working parts and occasionally ream out the tips.

The tips should never be reamed out with any instrument other than a copper or brass wire having a long taper. Care should

be taken that the orifices of the tips are not enlarged by reaming. If they become enlarged, they may be closed slightly by placing a conical swag over the end and tapping lightly with a hammer. The end of the tip should then be dressed off square by means of an extra fine file, and the orifice trued round by reaming with a twist drill of the proper size.

The blowpipe may be cleaned by removing both the acetylene and the oxygen hose and connecting the tip to the oxygen hose. Fig. 16, and turning on the oxygen to a pressure of about 20 pounds per square inch, having the *acetylene* needle valve *open* and the *oxygen* needle valve closed, so as to drive any obstructions through the larger acetylene passages of the blowpipe. Then close the acetylene valve and open the oxygen valve to clean out the oxygen passages.

Regulators. There are various types of regulators on the market today, but the most successful ones are very similar in design and construction. The principal parts of a constant-pressure regulator, Fig. 17, consist of the body proper, regulator valve, diaphragm, pressure-adjusting spring, safety-relief valve, and gages.

The diaphragm may be either special reinforced rubber sheeting or phosphor bronze. The former is preferred, because it is less likely to crack, or split, is more readily replaced, and gives more sensitive regulation because of its finer elastic properties.

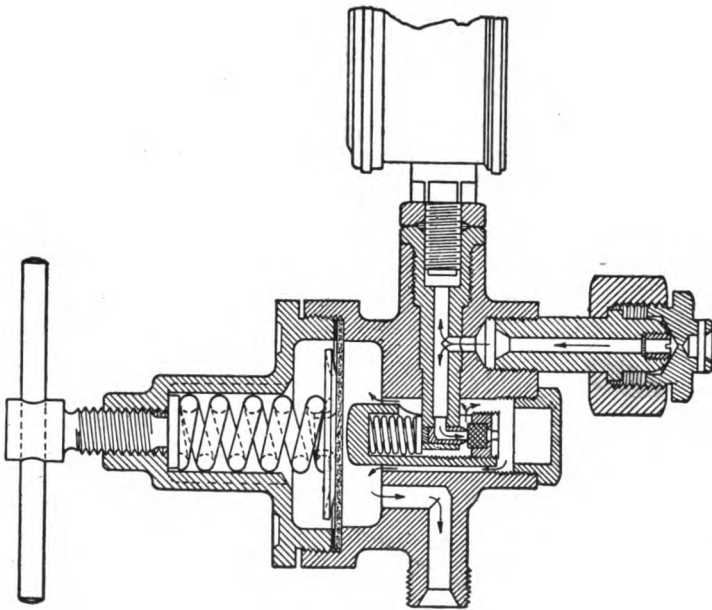

Fig. 17. Section of Pressure Regulator
Courtesy of Oxweld Acetylene Company, Chicago, Illinois

Operation of the Regulator. Gas passes from the cylinder valve through the passageway to the regulator valve. The pressure overcomes the tension of the inner spring and moves the sleeve-piece toward the back of the regulator, opening the valve. This allows gas to pass into the diaphragm chamber and out of the regulator by way of the hose connection. As the pressure in the diaphragm chamber increases, the tension of the pressure-adjusting spring is overcome, the diaphragm deflects, the sleeve-piece moves forward, and the valve

closes partly or all the way. Then, as gas passes out of the regulator and the pressure in the diaphragm chamber decreases, the tension of the pressure-adjusting spring and the pressure of the gas entering the regulator move the sleeve-piece backward, admitting more oxygen to the regulator. The pressure in the diaphragm chamber builds up as before, the diaphragm deflects, the sleeve-piece moves outward, and the valve closes.

Oxygen Welding Regulator. This is an automatic regulator which is especially designed for welding operations. It is connected to the oxygen cylinder and is designed to deliver oxygen to the blowpipe at any uniform pressure at which the regulator is set. To do successful welding, the oxygen regulator must be as nearly perfect as it is possible to construct it. This device is required to reduce a pressure which may be as high as 1800 pounds per square inch in the cylinder and which is constantly varying, down to a pressure from 10 to 30 pounds per square inch; at the same time the regulator must keep the lower pressure constant.

Oxygen regulators are usually equipped with two gages. The high-pressure gage shows the pressure of the gas in the cylinder and may be used to determine the amount of oxygen in the cylinder (see under Measuring Oxygen, page 99). The low-pressure gage shows the operating pressure at which the oxygen is being supplied to the blowpipe.

Acetylene Regulator. The acetylene regulator is used with acetylene supplied in cylinders. It is connected to the acetylene cylinder adapter, and this to the acetylene cylinder. The acetylene regulator is designed to deliver acetylene at a uniform pressure, as needed by the blowpipe.

Acetylene regulators are usually equipped with a large gage that shows the pressure in the cylinder, but which cannot be used to accurately determine the contents of the cylinder (see Measuring Acetylene, page 102). A small gage is not necessary with the low-pressure, or injector, blowpipe, because the acetylene pressure required by this type of blowpipe is very low—only a few ounces. With the pressure blowpipe, however, a small gage is necessary, because it is important to know that the acetylene pressure, which ranges from 2 to 13 pounds per square inch, is supplied to the blowpipe at the required pressure for the tip used.

Care of Regulators. Never drop or jar a regulator. Do not use oil, grease, or any organic material for lubrication in connection with regulator. If it becomes necessary to lubricate the pressure-adjusting screw, or to repack a needle valve, make use of a little glycerine—nothing else.

Do not allow dust to enter the regulator. Always insert the dust plug when the regulator is not in use. These are supplied with most regulators and are intended to keep dust out of the regulator when it is not in use and to protect the union nipple at the back.

Do not change the regulator from one cylinder to another without releasing the pressure-adjusting screw. The diaphragm is liable to be ruptured if there is tension on it when the sudden rush of gas takes place as the cylinder valve is opened.

Do not attempt to repair, adjust, or change the internal mechanism of the regulator, other than replacing the diaphragm and resurfacing or replacing the valve seat. Send it to the manufacturer for repairs.

Do not replace diaphragms or valve seats with any material other than that supplied by the manufacturer for this purpose.

Hose. The best hose that it is possible to obtain should be used, because it is really the most economical in the end, although it might cost more at the beginning. A good grade of two-ply hose will be found to be flexible, light weight, easy to handle, and, at the same time, will not kink easily nor be permanently flattened if heavy objects happen to accidentally fall on it. In selecting a hose, the welder should see that he gets a hose that has a finished inside surface, so that small particles of rubber and dust will not flake off and be blown into and clog the blowpipe or welding head.

It is best to use different colored hose for the oxygen than for the acetylene to prevent errors in connecting and to avoid any possible danger from interchanging.

Care of Hose. Both the acetylene and the oxygen hose should be blown out occasionally so that dirt and dust will not be carried into the blowpipe. This can be done by removing the hose from the blowpipe, connecting each in turn to the oxygen regulator, and allowing oxygen of about 20 pounds per square inch to blow through it. Examine the hose, from time to time, for leaks by immersing in water when under pressure.

INSTRUCTIONS FOR CONNECTING APPARATUS

Preliminary Operations. The following directions are given as a starting point for beginners in the operation of welding equipment. The letters given refer to the labeled parts in Fig. 15, page 17.

1. First open the oxygen cylinder valve *B* for a moment to blow out any dirt or dust which may have collected in the valve, so that it cannot enter the oxygen regulator when it is attached to the cylinder.

2. Remove the regulator dust plug and attach the oxygen regulator *C* to the oxygen cylinder *A*.

3. Connect the oxygen hose *E* to the oxygen regulator and to the oxygen hose connection on the blowpipe *G*. The hose connections are usually readily distinguished by markings on the needle valves.

4. Release the pressure-adjusting screw on the oxygen regulator by turning to the *left* until it is perfectly free.

Do not open the valve on the oxygen cylinder until positive that the adjusting screw on the regulator is fully released. The diaphragm may be ruptured and the regulator put out of commission.

5. Slowly open the oxygen cylinder valve *B* as far as it will go. *Not part way.*

Do not leave the valve on the oxygen cylinder only part way open. This valve seats when fully opened or closed, but is likely to leak when open only part way.

Do not handle the regulator with greasy hands nor allow any oil, soap, or organic matter to come in contact with any part of the regulator or cylinder valve. Oxygen under high pressure coming in contact with these substances is dangerous.

6. Wipe out the acetylene cylinder valve to remove any dirt or dust which may have collected in the valve, so that it cannot enter the acetylene regulator when it is attached to the cylinder.

7. Attach the adapter *L* to the acetylene cylinder *K*.

8. Remove the regulator dust plug and attach the acetylene regulator *D* to the adapter.

9. Connect the acetylene hose *F* to the acetylene regulator and to the acetylene hose connection on the blowpipe *G*.

10. Release the pressure-adjusting screw on the acetylene regulator by turning to the left until it is perfectly free.

11. Open the acetylene cylinder valve about three full turns by means of the wrench *J*.

12. Select the welding head of the size suitable for the work in hand. Screw the welding head down firmly, but not too tightly, into the head of the blowpipe with the wrench provided for that purpose.

Starting the Work

How to Light the Blowpipe. 1. Take the blowpipe in hand and open the oxygen needle valve fully.

2. Turn the oxygen pressure-adjusting screw to the right until the required pressure for the welding head being used shows on the low-pressure gage. See the maker's chart for the correct pressure.

3. Close the oxygen needle valve.

4. Open the acetylene needle valve fully.

5. Turn the acetylene pressure-adjusting screw to the right until a good jet of acetylene issues from the welding-head orifice. In the case of pressure blowpipes, turn the screw until the required pressure for the welding head being used shows on the low-pressure gage. (See the maker's chart for the correct pressures).

6. Open the oxygen needle valve slightly and light the blowpipe by means of the pyro-lighter that is usually furnished.

7. Open the oxygen needle valve fully.

NOTE: A back-fire might occur when turning on the oxygen if there is not enough acetylene being supplied. If this occurs, increase the acetylene supply by turning the acetylene pressure-adjusting screw farther to the right.

8. Adjust the acetylene pressure-adjusting screw to give a slight excess of acetylene to the flame.

9. Adjust the acetylene needle valve to give a neutral flame (see under Flame Regulation, page 25).

How to Shut Off the Blowpipe. In the case of the *injector type blowpipe*, first close the *acetylene* needle valve, and then the oxygen needle valve.

In the case of pressure blowpipes, first close the oxygen needle valve, and then the acetylene needle valve.

When laying aside the blowpipe for a short time, the pressure-adjusting screws on both regulators should be released by turning to the left until free.

When work is suspended for any considerable time, the valves on both cylinders should be closed.

Never light the blowpipe unless some oxygen is passing through it. If the blowpipe is lighted, or burned, with only acetylene passing through it, there will be a deposit of carbon made in the tip, which will in time clog the orifice and interfere with the perfect operation of the blowpipe.

Back-Firing. If the flame is not properly adjusted, or the tip becomes clogged, the blowpipe may back-fire. When this occurs, first close the acetylene needle valve quickly, then open it again fully and relight the blowpipe. If the back-fire continues, close both the acetylene and oxygen needle valves. Then relight the blowpipe and proceed in the usual manner.

If the blowpipe becomes overheated, it may back-fire. When this occurs, it may be cooled by plunging it into a bucket of water. Be sure that the acetylene has been shut off and a small quantity of oxygen is flowing through the blowpipe to prevent water backing into the tip and causing further back-firing when the blowpipe is relighted.

Oxy-Acetylene Blowpipe Flame

Character of Flame. The oxy-acetylene flame consists of two parts—an inner cone, which is incandescent; and an outer envelope, or nonluminous flame, which is sometimes called the secondary flame.

The temperature of the oxy-acetylene flame, taken at the extremity of the inner cone, is very much higher than that of all other flames. It is calculated to be approximately 6300° F. One of the main reasons for the superiority of the oxy-acetylene flame over all other welding lies in the fact that this high temperature is concentrated at the point of inner cone.

The character of the oxy-acetylene flame depends upon the proportion of oxygen and acetylene contained in the mixture and the thoroughness of the mixture as it issues from the tip of the blowpipe. Varying proportions of the gases produce three characteristic types of flame, Fig. 18, called, respectively, reducing, or carbonizing, flame; neutral, or welding, flame; and oxidizing flame. Each type has its characteristic appearance, and it takes only a little practice to instantly recognize each. The welder should at all times observe carefully the type of flame produced and promptly correct any divergence.

Neutral, or Welding, Flame. A neutral flame is produced when acetylene and oxygen burn in the proper proportion, theoretically 1.00 volume of oxygen to 1.00 volume of acetylene. The appearance of this flame is characteristic, Fig. 18 b. It is made up of a distinct and clearly defined incandescent cone, or jet, of bluish hue, surrounded by a faint secondary flame, or envelope, purplish yellow in color and of a bushy appearance.

The incandescent cone may be from $\frac{1}{16}$ to $\frac{3}{4}$ inch in length and is usually rounded or tapered at the end. The maximum temperature of the oxy-acetylene flame is $\frac{1}{16}$ to $\frac{3}{16}$ inch beyond the extremity of this cone.

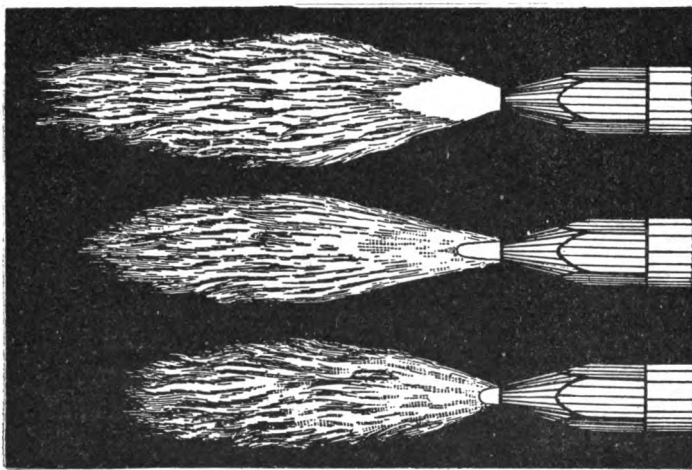

Fig. 18. Oxy-Acetylene Flame. Top, Reducing Flame; Middle, Neutral Flame; Bottom, Oxidizing Flame

The middle illustration in Fig. 18 shows roughly the characteristic appearance and formation of the neutral, or welding, flame. This flame is the one most extensively used, and no welder is proficient until he is thoroughly familiar with its appearance and distinguishing characteristics and is able to maintain this flame under working conditions.

Flame Regulation. The neutral flame is obtained by starting with a flame having a slight excess of acetylene and gradually cutting down the acetylene supply by means of the blowpipe needle valve. As this is done, the streaky appearance of the inner cone will

gradually diminish. The flame is neutral when the streakiness just disappears.

Carbonizing, or Reducing, Flame. The reducing, or carbonizing, flame is produced when there is an excess of acetylene in the flame. This flame is of an abnormal volume, dirty yellow in color, of uniform consistency, and has a streaky appearance. By gradually decreasing the acetylene supply at the needle valve, the size of the flame is decreased, and gradually a white cone of great luminosity appears at the blowpipe tip. The extent of the reducing, or carbonizing, action of the flame is judged practically by the size and definition of the luminous cone. When this cone becomes more clearly defined and takes the form and color of a bluish white incandescent cone, or pencil, the streakiness is further diminished, and the flame approaches the neutral stage. The upper illustration in Fig. 18 shows a reducing, or carbonizing, flame that has a fair but not large excess of acetylene. The temperature of the reducing flame is considerably lower than that of the neutral flame.

Use of Reducing Flame. A slight excess of acetylene is used in the welding of brasses, bronzes, aluminum, and certain alloy steels to guard against the burning out of easily oxidized elements. It has also been used in the case of certain mild steels to increase the carbon content to secure greater hardness. In this connection it must be remembered that increase in hardness is usually accompanied by decrease in strength, so that in general welding an excess of acetylene should not be used.

Oxidizing Flame. An oxidizing flame is produced when there is an excess of oxygen in the flame. The effect of too much oxygen is to diminish the size of the flame, blunt or blurr the inner cone, and produce a weak, streaky, or scattering flame. In some blowpipes, the inner cone is not only diminished in size but is slightly bulged at its extremity as compared with the neutral flame, which is shown in the middle of Fig. 18. The lower illustration in Fig. 18 shows the oxidizing flame.

Caution Against Oxidizing Flame. An oxidizing flame should be carefully guarded against or it will become a source of trouble. An excess of oxygen will burn the metal, causing weak welds, and in the case of cast iron it will produce a hard weld that will be difficult to machine.

Manipulation of Blowpipe and Welding Rod

Position of Hose. Occasionally the hose is thrown over the operator's shoulder. In this case the weight of the blowpipe is suspended and held by the hose so that it is only necessary to impart the peculiar welding motion to the blowpipe, which can usually be done by the fingers. However, this method is not generally recommended, as it seriously hinders the free movement of the welding flame. It should be used only as a relief when the work is of long duration and the operator's wrist and forearm become tired.

Position of Blowpipe. The operator, having lighted the blowpipe and properly adjusted the flame, is now ready to begin welding. Grasp the blowpipe firmly in the hand, as shown in Fig. 19. The blowpipe is so designed that it balances properly when grasped at this point. It is not good practice to hold the blowpipe in the fingers, because it is not possible to

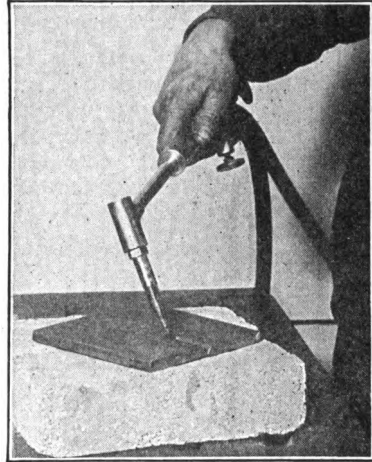

Fig. 19. Correct Method of Holding Welding Blowpipe



Fig. 20. Blowpipe Should Not Be Inclined Too Much

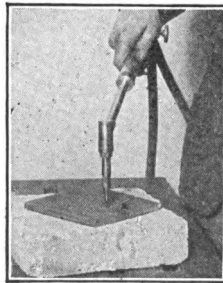

Fig. 21. Blowpipe Should Not Be Held Too Vertical



Fig. 22. Blowpipe Should Not Travel Backwards

manipulate the flame with as great regularity and control, nor will it be possible to do as heavy work without tiring.

Inclination of Blowpipe. The head of the blowpipe should be inclined at an angle of about 60 degrees to the plane of the weld.

The inclination of the head should not be too great, Fig. 20, because the molten metal will be blown ahead of the welding zone and will adhere to the comparatively cold sides of the weld. On the other hand, the welding head should not be inclined too near the vertical, Fig. 21, or the secondary flame will not be utilized to its full value for pre-heating the metal ahead of the actual welding.

In ordinary welding practice it is best that the top of the blowpipe be so inclined and so directed that the maximum amount of pre-heating is obtained without blowing the molten metal ahead.

Travel of Blowpipe. The travel of the blowpipe should be away from the welder and not toward him, Fig. 22, as the work can be observed more closely and done more easily and quickly.

Movement of Blowpipe. In making a weld a simultaneous fusion of the edges of the parts to be joined and the welding rod is necessary. If this does not occur, a true weld is not produced.

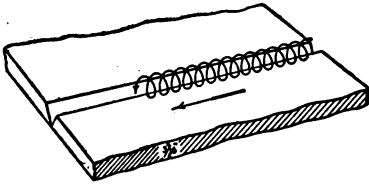

Fig. 23. Circular Motion of Blowpipe for Welding Light Sections

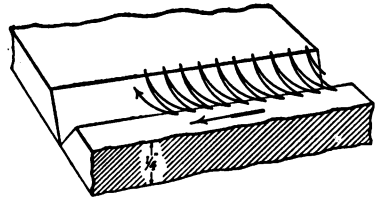

Fig. 24. Oscillating Motion of Blowpipe for Welding Heavy Sections

In the case of parts which have been chamfered out and which require the use of filling material, a peculiar motion must be imparted to the blowpipe, which will take in both edges of the weld and the welding rod at practically the same time.

In comparatively light work a motion is imparted to the blowpipe which will cause the incandescent cone to describe a series of overlapping circles, as shown in Fig. 23. This overlapping extends in the direction of the welding. This motion must be constant and regular in its advance so that the finished weld will have a good appearance. The speed of progress should be such that complete fusion of the three members referred to is secured. The width of this motion is dependent upon the size of the material being welded and varies accordingly with the nature of the work. It does not take much experience to establish the proper size motion and the proper rate of advance for the various sizes and kinds of metals.

In very heavy work, if the above system were used, a great deal of the motion would be superfluous. Consequently, a movement in which the cone of the flame will describe semi-circles should be used, as shown in Fig. 24. This confines the welding zone and concentrates the heat. While the progress is not so fast, it is more thorough than the other system for this class of work.

Importance of Movement. To the average beginner the regular control from these motions is difficult. It requires considerable practice and experience to become skilled in this, but it is the regularity of these motions that produces the characteristic rippled surface of good welding. The progress of a welder and the quality of his work can be determined to some extent by the skill with which he produces this effect.

Position of Welding Rod.

After the beginner has mastered the peculiar motions of the blowpipe, his next step will be to properly introduce the welding rod into the weld in such a manner that the regular advance of the blowpipe will not be hindered or retarded.

The welding rod, or wire, should be held and inclined, as shown in Fig. 25. In this position a sufficient quantity of material may be added at the right time. If the welding rod were held in a vertical or horizontal position, the welder would be liable to add an excess of metal, part of which would not be properly fused.

When to Add Welding Rod. Great care must be taken in adding this metal that the edges of the weld are in their proper state of fusion to receive it. If the metal is not hot enough, the added material will simply adhere to the sides, resulting in adhesion only, not a true weld. It is, therefore, necessary to produce equal fusion at the edges of the weld with that of the welding rod by the correct motion of the blowpipe.

How to Add Welding Rod. When the proper time arrives to add the filling material, the welding rod is lowered into the weld until it is in contact with the molten metal of the edges. When in this position the flame of the blowpipe is directed upon it, and thus fusion is produced.



Fig. 25. Correct Method of Holding Welding Rod

In welds of unusual depth the end of the rod is immersed in the molten metal and the blowpipe flame is played around it. The material is thus protected from the air and the gases of the blowpipe. The heat of fusion in this case is supplied mostly from the molten metal which surrounds the rod.

Faults to Be Avoided. The usual faults of the average beginner are: first, failure to introduce the welding rod into the welding zone at the proper time; second, to hold the rod at the wrong angle; and third, to fuse either too little or too much of the rod. The filling material when melted should never be allowed to fall into the weld in drops, or globules, Fig. 26.

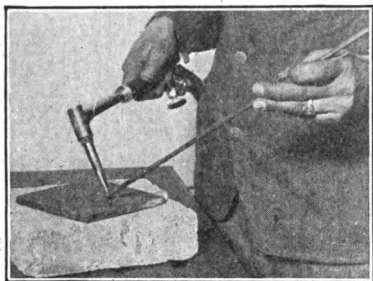

Fig. 26. Welding Rod Should Not Be Allowed to Fall into the Weld in Drops

Building Up the Weld. In welding it is customary to build up the welded portion in excess of the thickness of the original section.

There are several reasons for doing this. First, the weld is reinforced and the strength is accordingly increased. Second, in case it is desired to finish the surface there is sufficient stock to allow machining. Third, in some cases small pinholes or blowholes may be found just under the surface of a weld, which do not extend to any depth in the weld and may be removed by filing or machining.

GENERAL NOTES ON WELDING

The above are basic principles involved in producing all good oxy-acetylene welds. There are many detailed operations which must be learned by practice for the successful handling of the different metals, but by keeping in mind these basic principles and by applying them properly, the more difficult operations can be readily mastered.

Haste Fatal to Good Welding. It is a fundamental rule for successful welding that the operator must give his undivided attention to the work in hand. *Do not try to hurry over or slight any step of the work.* You cannot weld faster than the metal will melt and fuse together.

Burning a Hole in the Metal. Occasionally an operator becomes so interested in some minor detail of his work that he allows the flame to burn through the metal and form a hole.

How to Weld Up a Hole. It is a difficult operation for a beginner to fill these holes. His first attempts usually result in enlarging the holes instead of closing them. The proper way to take care of this is to incline the blowpipe so that the flame is almost parallel to the surface of the work, Fig. 27.

With the blowpipe in this position, play the flame upon the upper edge of the hole until the sides become plastic, taking care that the edges do not become entirely fused. When the edge is in the proper condition, the welding rod is interposed and a small amount of metal is added to the top edge of the hole. This operation is repeated until the hole is filled in. As the work progresses, the blowpipe is gradually raised until it resumes its normal position.

Overhead and Vertical Welding. In welding overhead, Fig. 28, or vertically, Fig. 29, the same procedure is followed as in filling a hole. The metal should not be allowed to reach the state of fusion that is secured in ordinary welding. It should be hot enough to assimilate the welding rod, but not so fluid that it will flow out of the weld. In overhead welding care should be taken that oxidation does not occur, because the molten oxide will flow from the weld and seriously inconvenience the operator.

Beginning a Long Weld. In beginning a long weld pains should be taken to see that it is started properly, and at this point of the

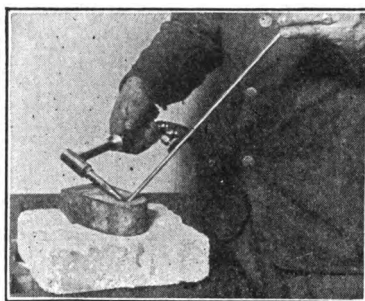

Fig. 27. Method of Filling in a Deep Hole—Start at the Upper Edge

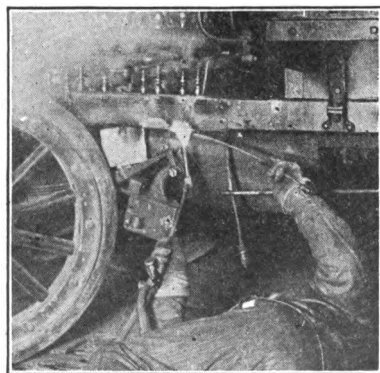

Fig. 28. Overhead Welding

work time should not be spared. When the weld is properly started the speed may be increased. As the weld advances the speed becomes

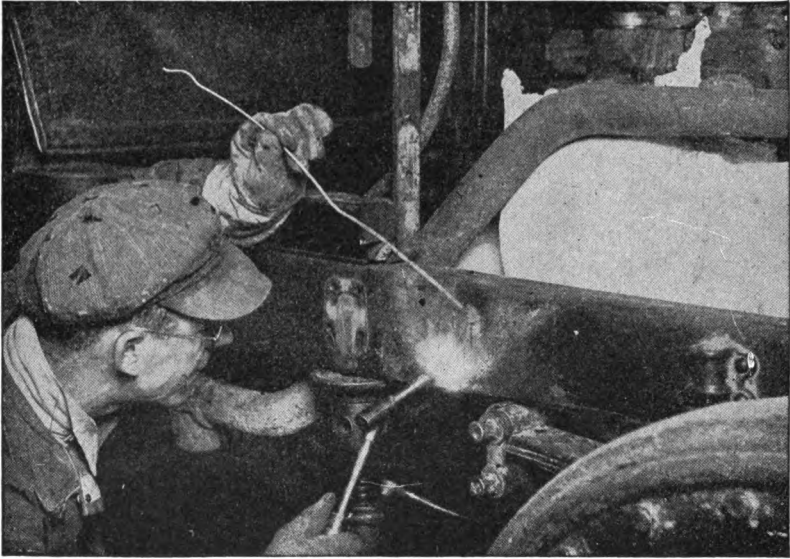

Fig. 29. Vertical Welding

greater, because the material becomes heated up and the blowpipe action is faster.

Defects in Welds. There are a number of sources of defects in welds, and the average beginner usually encounters all of them before he becomes a skilled welder.

Improper Flame Adjustment. If the flame is not properly adjusted the weld will be inferior. The commonest fault is the presence of too much oxygen in the welding flame. Unless the operator takes a great deal of care in removing the oxidized particles, they will be incorporated in the weld, Fig. 30. The oxide, of course,



Fig. 30. Oxidized Weld

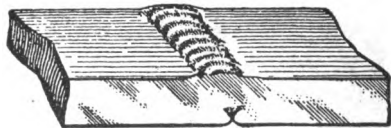

Fig. 31. Failure to Completely Penetrate to the Bottom of the Weld

greatly decreases the strength and greatly affects the other mechanical properties of the weld.

Failure to Penetrate. A fault, not only of the beginner but also of the skilled operator, is failure to penetrate to the bottom of the weld, Fig. 31, and is the cause of a great many defective welds. In his desire to complete a weld as soon as possible, the operator very often hastens over the most important part of the work, which is to secure the absolute fusion of the edges at the bottom of the weld. Failure to do this not only reduces the section of the metal at the weld, but also gives a line of weakness in case the welded pieces are submitted to bending or transverse strains.

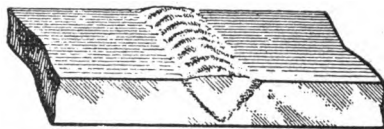

Fig. 32. Adhesion of Added Metal to Edges of the Weld

Adhesion of Added Metal. When molten metal from the welding rod is added to the edges of the weld which are not in fusion, a weld is not secured. The added metal merely adheres to the cooler metal, Fig. 32, and perfect fusion is not secured. Adhesion may be caused by improperly chamfering the pieces to be welded, by improper inclination of the blowpipe, by improper use of the welding rod, or by faulty regulation and manipulation of the welding flame.

The tendency of beginners is to not prepare the pieces properly for welding. Usually the chamfering, or grooving, is either not deep enough, that is, does not extend entirely through the section to be welded, or it is not wide enough. In welding pieces improperly prepared the tendency of adhesion is great.

The most common fault is the addition of the welding rod to the edges of the weld before they are in fusion. The adhesion in this case is applied to both edges. Sometimes one edge of the weld is in fusion, but the other is not. In this case adhesion is applied to only one side,

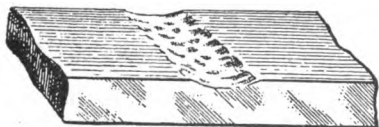

Fig. 33. Weld Not Properly Reinforced

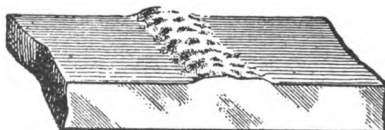

Fig. 34. Weld Properly Reinforced

but with the effect that the strength of the weld is lessened the same as when adhesion occurs on both sides.

In some cases the edges of the metal are brought to a state of fusion too soon, so that oxide has an opportunity to form on the edges

of the weld. Then, when the welding rod is added, adhesion occurs with a film of oxide separating the edges and the added material.

Often an operator will concentrate the flame upon the welding rod and the edges of the weld. Then, as the blowpipe is played around the welding rod, some of the molten metal is forced ahead. The metal ahead is not in the proper state of fusion and consequently adhesion results.

Insufficient Reinforcing. It is not uncommon to see welds produced that do not contain enough metal, Fig. 33. All welds should be reinforced with additional metal as in Fig. 34. In case a smooth finish is desired this excess metal can be removed by grinding or machining. Too great an excess of metal must not be added because this takes extra time and the gases are wasted.

WELDING FOR DIFFERENT METALS

PROPERTIES OF METALS

Before the beginner takes up the actual welding of metals, it is necessary that he study their properties, peculiarities, and behavior under the action of the welding flame. Some of the physical properties of the more common metals are given in Table I.

• **Melting Point.** The first property that the welder should consider is the melting point or temperature at which the metal will fuse or become fluid. The average welder is usually fairly familiar with the difference in melting points of lead or zinc, and iron or steel; but he is usually not familiar with the difference between the melting points of brass, bronze, copper, white cast iron, gray cast iron, etc. This knowledge is especially important if it becomes necessary to weld members of dissimilar materials.

Thermal Conductivity. The conductivity of a metal is its ability to transmit heat throughout its mass. This property, which is not the same for all metals and varies within wide limits, is of great importance to the welder. It can be seen that if one metal conducts or transmits the heat from the welding blowpipe more rapidly throughout its mass than another, it is necessary that allowance be made both as to the pre-heating equipment and the size of the blowpipe used.

In welding metals of high thermal conductivity, it is necessary to use oversize blowpipes—as in the case of copper. Although the

TABLE I
Properties of Metals

METAL	Weight Lb. per Cu. In.	Tensile Strength Lb. per Sq. In.	Melting Point Deg. F.	Relative Thermal Conductivity Copper = 1.00	Specific Heat	Coefficient of Linear Expansion	Approximate Expansion from 60° to Melting Point In. per Ft.
ALUMINUM	0.093	15,000	1210	0.524	0.22	0.0000123	1/4 1/4
	0.098	24,000 to 40,000				0.0000136	
BRASS	0.3103	20,000	1740	0.251	0.09	0.00000957	1/4 1/4
	0.2959	18,000 40,000 to 78,000		0.208		0.00001052	
BRONZE	0.32	75,000 to 90,000	1692	0.735		0.00000986	1/4
		50,000 60,000 to 100,000					
COPPER	0.3195	22,000	1980	1.00	0.095	0.00000094	1/4
		31,000					
IRON	0.2604	20,000	2190	0.124	0.11	0.000000556	1/4
		18,000	2000			0.00000648	
		55,000	2730				
LEAD	0.411	1,780	620	0.091	0.03	0.0000155	1/4
		76,000	2650	0.155	0.11	0.0000007	1/4
NICKEL	0.312	50,000 to 75,000 65,000 to 80,000	2690 2570	0.118	0.117 0.1175	0.0000063	1/4
STEEL	0.283	5,500	785	0.29	0.09	0.0000144	1/4
ZINC	0.2526						1/4

melting point of copper is low, yet the conductivity is high, and, consequently, a blowpipe of the same size as would be used on a similar section of steel must be used.

The conductivity of a metal will have a great bearing on the consideration of expansion and contraction. If one metal absorbs or leads the heat away from the welding blowpipe more rapidly than another, the heated area will become very much larger, and, consequently, the expansion and contraction more severe.

Specific Heat. The specific heat of a metal is the amount of heat that is absorbed when it is raised through a certain range of temperature. A metal having a low melting point but relatively high specific heat may require as much heat to bring it to its point of fusion as a metal of high melting point and low specific heat— as in the case of aluminum compared to steel.

Coefficient of Expansion. The linear increase per unit length when the temperature of a body is raised through one degree is its coefficient of expansion.

The coefficient of expansion varies materially with the different metals. Of the metals most commonly welded, as seen from Table I, aluminum has the greatest expansion, bronze and brass next, then copper, steel, and iron. Aluminum expands almost twice as much as iron or steel, consequently, in dealing with aluminum work it is necessary that this feature be considered very seriously.

Expansion and Contraction. When a body of any material is subjected to an increase in temperature, it expands and its volume and linear dimensions are increased. When the temperature is lowered a reverse action takes place, the body contracts, and its volume and linear dimensions decrease. Metals or metallic bodies are very susceptible to this change in volume due to variations in temperature.

The effect of this expansion and contraction is of great importance to the welder. It is impossible for the welder to produce satisfactory work until he has a knowledge of the nature and the amount of expansion usually encountered and of how to compensate for it.

The expansion and contraction of the welded piece cannot be controlled or arrested mechanically, because the force of expansion is irresistible. In malleable, or ductile, metals the expansion is liable to produce warping or deformation of the piece, while in materials

that are not of this nature—brittle materials—such as cast-iron, the result of the expansion and contraction, unless properly taken care of, is fracture.

If the expansion can take place in all directions, it will give the welder no trouble, as the piece will expand equally all over, and upon cooling will contract to its original volume. If, however, the welding takes place at a point that is confined by various parts or by the particular construction of the piece, it is then necessary to give it due consideration.

The resultant effect of contraction, produced by the cooling of the welded object, must be considered equally with that of expansion. Contraction produces as much cracking, or checking, and warping as does expansion. Therefore, it is essential that the welder study not only the effect of expansion, but also the subsequent result produced by contraction.

Methods of Handling Expansion and Contraction. There are many ways of taking care of expansion and contraction, such as heating the entire piece to a dull red heat, simultaneously heating opposing similar parts, and breaking the piece at certain

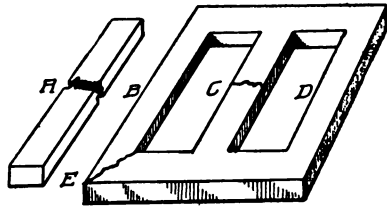

Fig. 35. Simple Case of Expansion and Contraction

points to allow free expansion and then re-welding at the break. If the material is ductile or malleable, it may be warped or bent out of shape to such an extent that the spring will take up completely the opposing force of expansion and contraction. This, however, entails an accurate calculation and should not be used except where no other means are feasible.

Handling Simple Case of Expansion and Contraction. We will first consider the simplest condition of welding. Assume that a long bar which is free at each end has broken at point A, Fig. 35. In this case the welding may be carried out without any fear of encountering difficulties due to expansion and contraction. The bar is free to expand and contract at each end. While there might be some warping or deformation due to the heat of welding if the blowpipe is not handled properly, yet, there is very little danger of weakening the weld because of internal strains.

Now let us assume that this bar is part of a casting, as shown at *C*, which is surrounded and joined to a rigid frame *B* and *D*. In this case the expansion and contraction due to welding must be taken care of. It is readily seen that the expansion is not the force that will cause trouble, because when the two pieces expand during welding, the metal, which is in a fused condition, is so soft that the expansion can take place in the weld and the edges will approach each other. This will not affect the confined frame. However, consider the action on the metal when it starts to cool. Contraction sets in and, as it is irresistible, there must be some compensation for the shortening of the bar *C*. If the material is ductile and one that will stand bending, deformation or warping will occur. But, if it is of low ductility, such as cast iron, a break will occur either at the weld or at a line of less resistance.

Methods of Handling. In welding an article of the general nature, shown in Fig. 35, when the break is in an internal member, such as at *C*, there are several ways of handling it.

Heating Entire Casting. The entire piece can be raised to a high temperature as referred to above and in this way produce an expansion in the entire mass, and, consequently, equal contraction. However, this is not necessary, and in some cases is not possible; the operation also takes more time and costs more. It is only necessary at the time of welding to heat simultaneously similar parts to a good red heat, in order that the stiffness of the frame may be lessened, and thus take care of the contraction.

Heating Confining Members. In the example referred to, the application of a pre-heating burner at the points *B* and *D* will cause the frame to expand in the linear direction of the expansion and contraction produced by the weld. Therefore, when the weld is finished and the frame starts to cool and contract, the parts *B* and *C*, in as much as they were raised to practically the same temperature as the metal surrounding the weld, will contract equally and, therefore, a successful weld will be produced.

Use of Wedges. If it is impossible to apply pre-heating at the points referred to, another method may be used. By the use of jacks, wedges, or similar devices, a casting such as shown in Fig. 35 may be sprung or bent out of shape, and the edges of the part to be welded may be separated. After the weld is executed and con-

traction sets in, the jacks, wedges, etc., may be withdrawn. The return of the sprung parts to their original positions will compensate the contracting strains.

Breaking Another Member. Another method of taking care of expansion and contraction is that of breaking the piece at some extraneous point, such as at *E*. In this case the expansion and contraction will be free to act at the point *C* without any fear of serious after-effect, as the casting is free to spring in any direction, because of the loose joint at *E*. As the point *E* is not confined, it is an easy matter

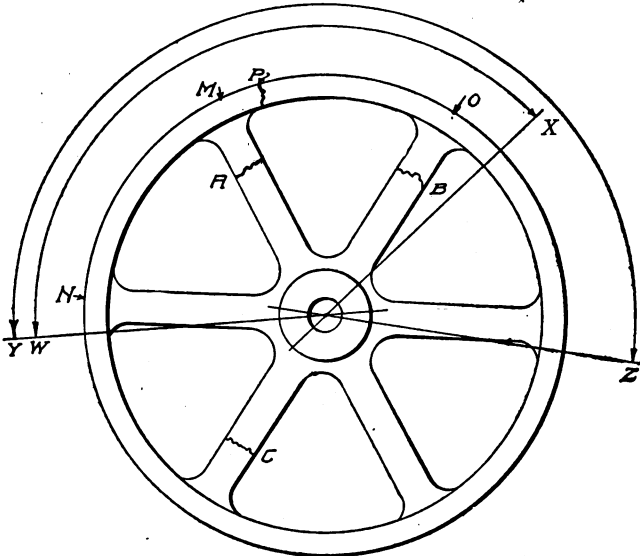

Fig. 36. Complex Case of Expansion and Contraction

to reweld this break without fear of any bad results. This method, however, is dependent upon the thickness of the metal and is one that should not be attempted unless no other means are feasible.

While this diagram is extremely simple, nevertheless the principles to be considered and the methods of handling them are identical with those experienced in all practical work. A clear conception of the forces acting, the nature of their action, and how to counteract them, is essential in work with the oxy-acetylene blowpipe.

Handling Complex Case of Expansion and Contraction. A good example of a complex case of expansion and contraction is the fly-wheel or pulley with broken spokes, as shown in Fig. 36.

Assume that the spoke is broken at *A*. If this were welded without considering and allowing for expansion and contraction, the shrinkage strain would be so great that failure would occur.

Pre-heating the rim from *W* to *X* to a dull red heat will cause the rim to expand outwardly, separating the edges of the broken spoke. While in this state the weld should be made rapidly and then the entire wheel allowed to cool slowly. Thus a good weld without the presence of internal strains will be produced. The expansion of the rim, due to the pre-heating, will offset the contraction of the weld in the spoke.

If the crack in the spoke is near the rim, it is only necessary to apply a gas or oil burner to the rim at *M* until it is at a red heat. This will expand the spoke and rim, and separate the edges of the break sufficiently to offset the contraction of the weld.

The spoke may be welded at *A* without pre-heating if the confining member—in this case the rim—is broken to lessen the rigidity. In order to do this the rim must be broken at a point *P*, always close to the spoke. First one side of the spoke is strongly tacked at the weld. Then the other side is welded two-thirds the way through. The tack is then melted out and the weld completed. The rim is then welded at point *P*. If the edges do not meet accurately, they may be brought to do so by heating either at *M* or *O*, according to which edge is low.

If two spokes are broken as at *A* and *B*, the same general procedure as given above may be followed. In case it is necessary to pre-heat a large portion of the casting it is important that the pre-heated area always extend beyond the spokes adjacent to those fractured, from *Y* to *Z*.

If two diametrically opposite spokes are broken such as *B* and *C*, each may be treated as independent of the other and welded by any of the methods given above.

PRE-HEATING

Reasons for Pre-Heating. Pre-heating is employed for three fundamental reasons:

To Compensate for Expansion and Contraction. When pre-heating is used to counteract the effects of expansion and contraction, it is necessary that the casting be heated either in certain confined

localities or entirely to a dull red, or in some cases to a bright red heat. With this treatment the internal strains existing in all welds are reduced to a minimum.

To Decrease Cost of Welding. When a weld is being executed on a large casting, it is too expensive to supply the total amount of heat required from the blowpipe alone. To offset this, pre-heating by some cheaper method is used, and the result is usually a saving of from 25 to 60 per cent of the cost of welding by means of the blowpipe alone. Then, too, it is possible to accomplish the welding with greater speed, due to the casting being at a higher temperature.

To Make Metal More Receptive to Action of Welding Flame. When the temperature of a metallic body is raised, the state of the metal



Fig. 37. Pre-Heating with Welding Blowpipe



Fig. 38. Gas Burner for Pre-Heating

surrounding the weld is more nearly that of the molten metal in the weld, and the result is a more homogeneous and smoother-grained union, dependent upon the temperature reached in pre-heating.

Methods of Pre-Heating. There are various means of carrying out this preliminary heating. The method used should be governed by the particular work in hand.

Pre-Heating with Welding Blowpipe. The simplest method and the one most used on light objects is that of utilizing the flame of the welding blowpipe, Fig. 37. In welding thin castings, it is only necessary that the flame of the blowpipe be played upon the parts at the line of the weld for a few moments, in order that the pieces may obtain a red heat. This is, however, expensive, and should only be employed on small objects.

Gas and Oil Burners. If the article to be welded is of fairly large size, the use of gas, Fig. 38, or oil burners, Fig. 39, is economical.

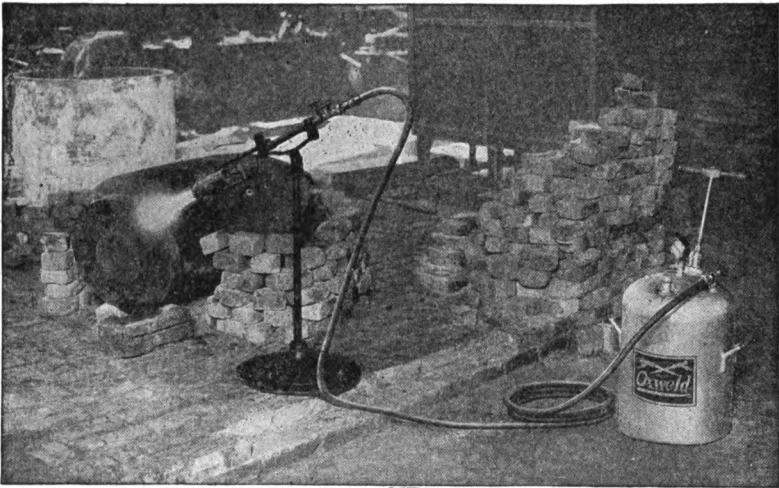

Fig. 39. Oil Burner for Pre-Heating
Courtesy of Oswald Acetylene Company, Chicago, Illinois

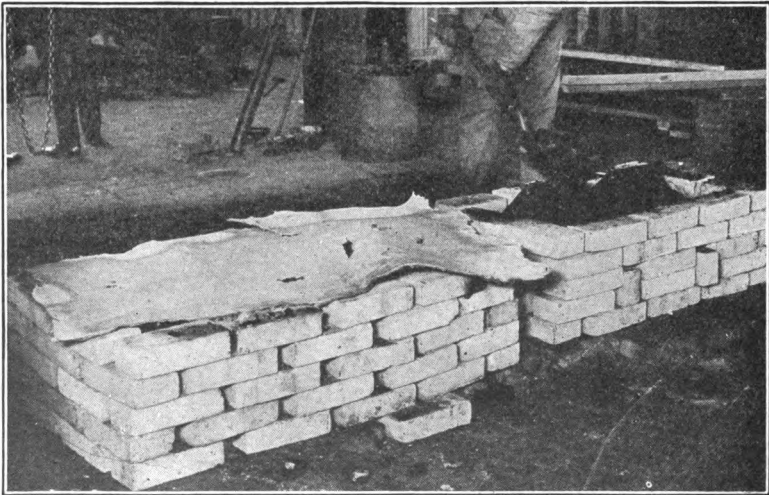

Fig. 40. Charcoal Fire for Pre-Heating Castings

These pre-heating torches, however, limit the area of the surface covered, so consequently are used more successfully on that work

which requires localized pre-heating. The flames produced are of sufficient temperature, but not the necessary volume to evenly heat the entire casting.

Charcoal Fire. The most satisfactory method of pre-heating is by means of a charcoal fire built around the article to be welded. The usual procedure is to build a small temporary fire-brick furnace around the piece and fill in with charcoal, Fig. 40. This is ignited by means of kerosene. As the progress of the ignition of the charcoal is rather slow, the pre-heating is carried out gradually. The nature of this pre-heating flame is of such evenness and volume that the temperature imparted to the casting is the same throughout its mass.

In welding large castings of a complicated nature, such as engine cylinders, it is necessary that they be pre-heated evenly throughout and that the welding be carried on while the casting is at a dull red heat. Therefore, the most satisfactory means of accomplishing this is by embedding the casting in charcoal and carrying on the work while it is embedded in the hot coals.

STEEL WELDING

General Considerations. The welding of steel is apparently simple, but in reality it is a fairly difficult material to weld and should receive the welder's best thought and care. It is simple to produce a nice looking weld that has a smooth even surface, but it is not easy to produce a weld that is strong and will stand up under service. Welds of high strength are absolutely necessary in cases like automobile frame and crankshaft repairs, because a poor weak weld might prove fatal.

Oxidation. It is practically impossible to prevent a certain amount of oxidation; but it is very important that it be kept to a minimum. The oxide that forms on the top of the weld may be removed quite easily, because it melts at a lower temperature than the metal. It may be floated off the weld while hot, or removed as a thin skin after the weld becomes cold. Care must be taken, when adding the welding rod, Fig. 30, page 32, that this film of oxide is penetrated, because if this is not done the oxide will be incorporated in the weld, which will therefore be very weak.

Expansion and Contraction. The effect of expansion and contraction is not as severe in steel welding as in cast iron or aluminum;

but, nevertheless, it must receive due consideration. In steel castings it is taken care of in a manner similar to that used for cast iron, that is, by pre-heating. In sheet-steel work the creeping, or drawing, of the edges is taken care of by arranging the edges of the sheets at an angle, or by tacking, or by the use of jigs to hold the work.

Welding Rod. Each welding head is designed for use with a certain thickness of metal. As the volume of the flame varies with the size of the welding head, care must be used to select a welding rod of the correct size in making welds in sheets of various thickness. There is great danger of burning a welding rod that is too small, or, if the rod is too large, it may not melt through and will enter into the weld in a semifused condition and not be thoroughly incorporated in the weld. The following table shows the proper size of welding rod to be used for the different thicknesses of sheets:

THICKNESS OF SHEET	SIZE OF WELDING ROD
Up to $\frac{1}{8}$ inch	$\frac{1}{16}$ inch
$\frac{1}{8}$ to $\frac{3}{16}$ inch	$\frac{1}{8}$ inch
$\frac{1}{4}$ to $\frac{3}{8}$ inch	$\frac{3}{16}$ inch
$\frac{1}{2}$ inch and over	$\frac{1}{4}$ inch

Never use twisted wire made up of two or more strands, because this offers a very large surface for oxidation, which is a condition operators must try to avoid.

Neutral Flame. The importance of maintaining a neutral flame at all times cannot be emphasized too strongly. An excess of acetylene in the flame tends to carbonize the work, resulting in a hard brittle weld; while an excess of oxygen will oxidize or burn the metal. It is seldom necessary to adjust the flow of gases through the blowpipe after correct adjustment has once been made, except in the case of very heavy welding where the intense heat of the molten metal tends to expand the orifice in the tip of the welding head. This has some effect on the size and shape of the flame and necessitates more or less frequent adjustment to keep the gases in correct proportion to maintain the neutral flame.

Movement of Blowpipe and Addition of Welding Rod. In welding sheet steel, it is necessary that the oscillating movement previously referred to be imparted to the blowpipe and used continuously—both because of its high-melting point and the behavior of the molten metal under the action of the blowpipe flame. Steel cannot be pud-

dled and it is therefore necessary to add the filling material in thin overlapping layers. The importance of securing a perfect bond between every two layers can be readily seen. To make a true weld, a simultaneous fusion of the edges of the sheets and the welding rod must be produced.

To do this with light- and medium-weight sheets, a motion is imparted to the blowpipe which will cause the flame to describe a series of overlapping circles as previously described, page 28. This overlapping extends in the direction of the welding and, in order to make a weld of good appearance, must be constant and regular in its advance.

In heavier plates, while the same rule governing simultaneous fusing of the edges of the sheets and welding rod apply, the filling of the groove is accomplished in a slightly different manner. On account of the depth of the weld the flame is not large enough to fuse a body of metal of so great an area, and it is impossible to fill the groove entirely from bottom to top with one layer of metal. The bottom edges of the groove must first be thoroughly fused for an inch or two before adding metal. When this is done, bring the flame back to the starting point and when the metal is in the proper molten condition add the filling material, oscillating the blowpipe in a series of semicircles, as previously recommended for welding heavy sections, page 29. Follow this method of filling the groove in sectional layers until the proper height is reached, making sure that thorough fusion is accomplished between the layers themselves and the edges of the sheet and the layers of filling material.

After-Treatment. Correct after-treatment is as essential for successful welding of steel as the actual welding operation. Proper after-treatment will improve the grain of the metal and will materially increase the strength and toughness of the weld. There are three principal treatments that will benefit the material and are easily employed in the repair shop. These are called annealing, hammering, and quenching.

Annealing. Annealing consists of reheating the work to the proper temperature and then allowing it to cool slowly. The work should be heated to a bright cherry red by means of a blowpipe or suitable burner, or in a furnace that can be carefully regulated. Care must be taken that the work reaches the bright cherry red, because

heating to a lower temperature will be detrimental and may leave the weld weaker than if not annealed at all. After the work has been heated, it should be allowed to cool very slowly and evenly. It should be covered over with asbestos or dry sand, packed in lime, or left to cool in the furnace. Care must be taken that cold air currents do not strike the work before it has become cold.

Hammering. Hammering consists of reheating the weld to the proper temperature and then hammering while at this temperature with a hand hammer. The weld should be heated to a bright yellow heat and then hammered with quick light blows. Heavy hammers or heavy blows should never be used. The hammering should cease as soon as the weld falls to a dull red, for otherwise the fine grain of the metal will be spoiled and the weld will be weak.

Quenching. Quenching consists of reheating the work to the proper temperature and then plunging it into water, brine, or oil. This method is used mainly for small articles. It is used quite often for hardening and tempering. Quenching should be employed only in special cases, because, although it will make the work strong, it will also make it hard and brittle.

Light Sheet-Steel Welding

Preparation. In welding two short pieces of flat steel, up to $\frac{3}{8}$ inch in thickness, no special preparation of the plates is necessary, except to have them flat as possible and to be sure that the edges are reasonably true. The two pieces of metal should be placed on a level surface, preferably fire brick or some other nonconductor of heat.

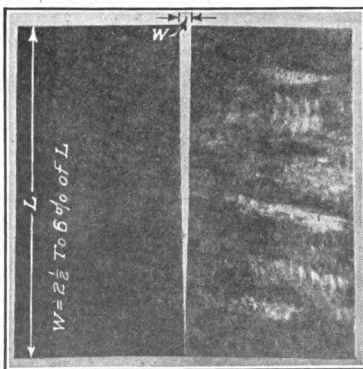

Fig. 41. Light Sheets in Position for Welding

Expansion and Contraction. With light sheet, expansion and contraction are cared for by tacking the seam at certain intervals or by arranging the sheets so that the edges to be welded are set at a slight angle rather than parallel,

Fig. 41. The correct amount of divergence is determined by the thickness of the metal and should be from $2\frac{1}{2}$ to 6 per cent of the

length of the weld. The amount of divergence between these limits varies also with the speed of welding, fast welding requiring less spread. After the plates are in this position, place two pieces of flat bar steel on each side, about $\frac{1}{2}$ inch from, and parallel to, the line of the weld. Clamp or weight these pieces down so that they cannot be readily moved. The work is now in position for welding.

Jigs. In making this type of weld in flat sheet steel in longer lengths, up to several feet and up to $\frac{3}{8}$ inch in thickness, a welding jig made up with two slotted jaws hinged at one end and provided with hold-down clamps at the other end will be found more convenient than the individual hold-down bars.

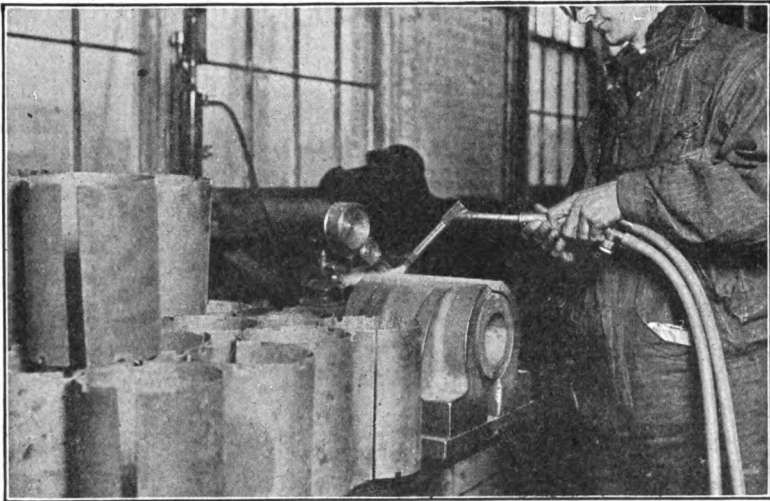

Fig. 42. Jig for Holding Light Sheet Cylinders for Welding

For welding short cylinders, a jig made similar to that shown in Fig. 42 will be found satisfactory.

Tacking. Tacks, or short welds, at intervals of from 2 to 6 inches, according to the thickness of the sheet, can be made the entire length of the seam to hold the edges in position for welding if jigs are not available.

One of the above methods must be used to take care of the creeping action due to expansion when the flame of the blowpipe is applied to the metal. If this action is not provided against and the two sheets are placed with parallel edges, they will first diverge

when the welding is started, as in *a*, Fig. 43, and then gradually come together. When about half of the weld has been made, they will again become parallel as in *b*. From this point on as the welding continues the sheets will draw together until they overlap, as shown in *c*.

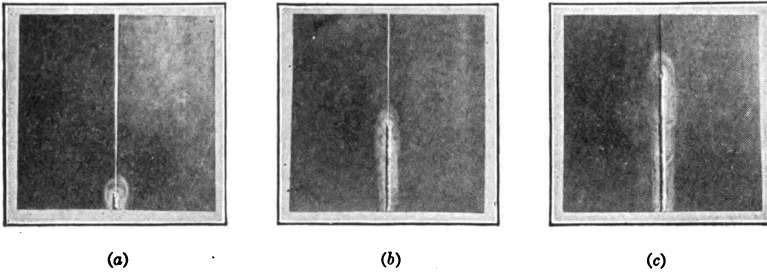

Fig. 43. Result of Not Providing for Expansion

Welding Light Sheet. Select the welding head and a piece of iron welding rod of the size suitable for the thickness of the sheet and place the work in position for welding.

As steel is very sensitive to the action of the carbonizing flame and particularly to that of the oxidizing flame, a constant, nonvarying, neutral flame should be maintained. The incandescent jet should be of maximum size and clear outline at all times.

With the correct neutral flame, start welding at the point where the two sheets meet. Impart the circular motion to the blowpipe, described under Movement of Blowpipe, page 28, to produce the correct rippled surface on the finished weld. When the

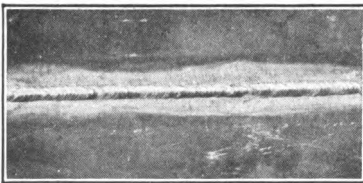

Fig. 44. Appearance of Good Weld in Light Sheet Steel



Fig. 45. Appearance of Poor Weld in Light Sheet Steel

weld is finished, turn out the blowpipe and allow the work to cool until the metal is black.

Then remove the hold-down bars and examine the weld. If you have followed instructions, your weld will have the appearance shown in Fig. 44 and will not be like that shown in Fig. 45. On

closer examination you will find that all the particles of dirt and impurities you noticed floating on the top of the molten metal when you were welding are now lying with the oxide on top and alongside of the weld where they can be readily brushed or scraped off. Now take your job to the shears and cut off one or two pieces. Upon examination, the cross-section should present the same uniform texture and color in both the weld and the sheet.

Fig. 46. Lap Welds Should Never Be Used

Types of Welds in Light Sheet. *Lap Weld.* Lap joints, either single or double, Fig. 46, *should never be used* in welding sheets of any thickness because the weld will be subjected to a shearing strain.

Fig. 47. Butt Weld in Light Sheet

Welds should be under tension or compression strains, never under shearing or bending strains.

Butt Weld. The most common and the simplest weld to prepare in light sheet is the butt joint, shown in Fig. 47.

Flange Weld. Another type of weld in light sheet, but one that entails some preparation, is made by flanging up the welding edges about $\frac{1}{32}$ to $\frac{1}{16}$ inch, Fig. 48, laying the two pieces flat and parallel on the welding table and executing a flange, or edge, weld. It is not necessary to use welding wire with this type of weld, because the metal in the flanges when they are fused together acts as a filling agent. By careful manipulation the edges can be fused down to a small bead, practically flush with the surface of the sheet.

Fig. 48. Flange Weld in Light Sheet

Cylinders. In welding light sheets that have been rolled in cylindrical form, the separation of the edges can be accomplished by placing a wedge about two-thirds of the way down the length of the seam after the welding is started, Fig. 49. As the welding progresses the wedge should be moved further along the seam and withdrawn entirely as the work nears completion.

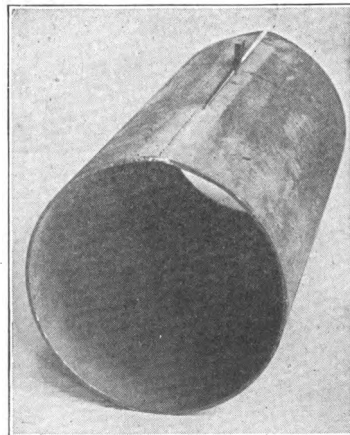

Fig. 49. Method of Welding Light Sheet Cylinders—Using Wedge to Space the Edges

As the welding progresses the wedge should be moved further along the seam and withdrawn entirely as the work nears completion.

Tacking can also be resorted to in welding cylindrical forms, although this results in the deformation of the cylinder, as shown in Fig. 50, and makes it necessary to hammer or re-roll the cylinder into shape.

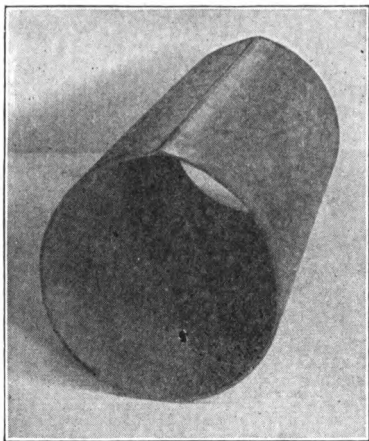

Fig. 50. Result of Tacking a Light Sheet Cylinder—The Weld Draws up Pointed

The edges of very light sheet cylinders can be flanged and an edge, or flange weld, executed; but this method cannot be recommended with sheets heavier than $\frac{1}{8}$ inch.

Corner Welds. In making a corner weld in the lighter gage sheets up to $\frac{1}{8}$ inch, the edges of the sheet should be flanged, as shown in Fig. 51. In sheets from $\frac{1}{16}$ to $\frac{3}{16}$ inches in thickness, it is only necessary that the edges of

the sheets run as true as possible in position, as shown in Fig. 52. Tacking is necessary in this case, as the sheets, due to expansion,

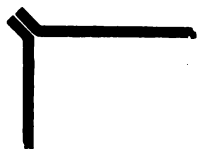

Fig. 51. Corner Weld for Very Light Sheets, up to $\frac{1}{8}$ Inch Thick

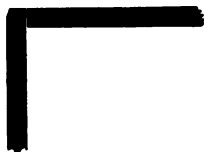

Fig. 52. Corner Weld for Light Sheets, $\frac{1}{16}$ to $\frac{3}{16}$ Inch Thick

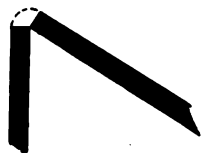

Fig. 53. Sharp Corner Weld for Light Sheets

readily move out of position when welding is commenced. On welds of this latter type it is necessary to use welding wire.



Fig. 54. Broad Corner Weld for Light Sheets

Two other forms of corner welds are illustrated in Figs. 53 and 54. These sheets should be tacked and, if $\frac{1}{8}$ inch or thicker, welding wire should be used.

Tank Heads. In making tanks when either a bottom or heads in both ends are required, the method of putting in the heads is governed by the design and purpose for which the tank is intended.

Storage Tanks. If the tank is to be used as a storage receptacle, such as gasoline tanks, the heads can be cut to the outside diameter of the shell, laid flat on the end of the shell and tacked at intervals all the way around, Fig. 55. Then the shell, with the heads securely tacked in place, is laid on its side and the welding is started at any point, the tank being turned, from time to time, as the welding progresses. Or, the heads can be flanged to any depth desired, and backed into the shell until the edge of the flange and the edge of the shell are even, Fig. 56, making sure that the head fits the shell snugly. They are then tacked and welded in an upright position. This latter method is the better of the two from the welding standpoint.

Pressure Tanks. When a tank is built to stand a considerable pressure, such as air-compressor tanks, the heads should always be dished and flanged, the boiler-maker's standard specifications govern

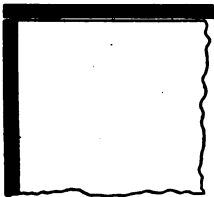

Fig. 55. Head Weld for Storage Tanks

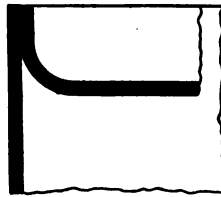

Fig. 56. Head Weld for Storage and Medium-Pressure Tanks

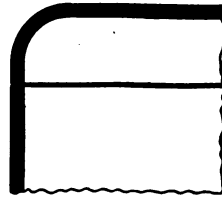

Fig. 57. Head Weld for Pressure Tanks

this. The heads can be either backed in and an edge weld made, Fig. 56, or set up so that the edges of the flange exactly meet the edges of the shell, Fig. 57. In either case the parts should be tacked together before welding. In the second case, care should be used in flanging to have the outside diameter of the flange exactly the same as the outside diameter of the shell. This method is the best because the weld is under direct tension or straight pull.

Tubes. Light-weight tubing should be squared off and fitted nicely before welding is attempted. It should be tacked in several places and then welded.

Heavy Sheet-Steel Welding

Preparation. In welding heavy sheet metal above $\frac{1}{8}$ inch in thickness, a certain amount of preparation is necessary. The success of the weld depends in a great measure upon the proper

preparation of the work to be welded. While the preparation is governed largely by the particular location of the weld and form of the sheets to be welded, there are certain general rules that must always be observed.

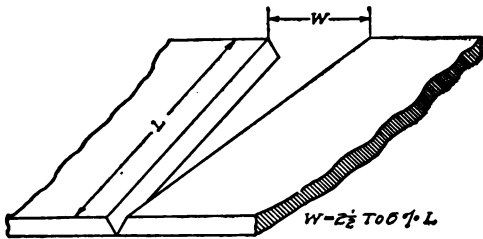

Fig. 58. Heavy Sheets in Position for Welding

In making a perfect weld it is necessary that the metal at the weld be completely fused throughout its entire thickness. In light sheets the projection of the flame is great enough to produce this result, but heavy sheets would require a flame of such magnitude that it could not be readily handled. Therefore, in order to facilitate complete fusion, the edges of the sheets to be welded are

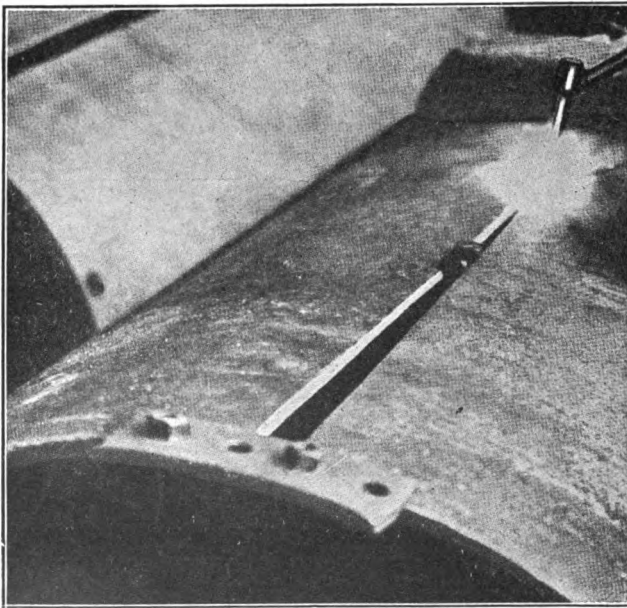

Fig. 59. Welding Heavy Plate Steel Cylinder
Note grooving of edges, spacing clamps and wedge about half way along the seam

chamfered or beveled to form a V-groove, the width of this V being equivalent, or nearly so, to the thickness of the metal.

Expansion and Contraction. With heavy sheet, expansion and contraction are cared for by observing the same rules of spacing, Fig. 58, and clamping, Fig. 59, or, in some cases, tacking, in order to hold the work in position for welding, as described for light sheets on page 47.

Welding Heavy Sheet. Select a welding head and a piece of iron welding rod of the proper size to accomplish the work in hand.

Because steel is sensitive to the carbonizing and oxidizing flames, it is necessary to maintain the correct oxygen pressure and a neutral flame at all times. In ordinary heavy sheet welding there are two general methods of procedure, either of which will produce a good weld when properly executed. These methods may be called welding by sections, and continuous welding.

Welding by Sections. Welding is started by first playing the flame of the blowpipe along the edges of the pieces to be welded. This is done merely as a preliminary heat treatment. The flame is then played on the bottom of the groove at the beginning of the weld until the edges are in a molten condition, at which time the blowpipe is momentarily withdrawn and the molten metal allowed to flow together. This is done without the aid of any filling material. Care must be exercised at this point, because successful welding depends upon complete penetration and perfect union of the bottom edges. When a perfect union of the two members is secured for about one or two inches, the welding rod is brought into use. By playing the flame around the welding rod in contact with the edges of the weld instead of directly on the welding rod, it is possible to bring them both to the point of fusion simultaneously. The rod is then gradually added to the weld, layer by layer, until this particular section of the weld is built up to the required height. The flame is then played on the face of the metal just added and on the bottom of the groove until fusion of these parts is secured. The welder then repeats the operation described above until the next small section of the groove is filled up to the proper level. The welding progresses by means of these small sections, each being built up completely before another is started.

While the metal is in a fused condition, the velocity of the flame will cause the molten metal to become slightly indented. The flame should be withdrawn momentarily, from time to time, thus

allowing the fluid metal to flow back to its normal level, in which position it will solidify. Skill in steel welding depends greatly on this manipulation, as the flowing together of the different molten centers produces the weld.

Continuous Welding. In this method the weld advances continuously with each addition of metal. By this method the metal is added in short layers, sloping rather than horizontal. The weld is started by fusing together the bottom edges of the groove as previously described. The filling material is then added so that it will be from $\frac{1}{8}$ to $\frac{1}{4}$ inch high at the starting point and slope to nothing in a length of 1 or $1\frac{1}{2}$ inches along the bottom of the groove. This will give an inclined surface to which the filling material is added in parallel layers. The added metal being on a sloping plane, the fusion of the bottom edges is always carried ahead with the welding, as each layer includes a small section of the bottom of the groove.

Types of Welds in Heavy Sheet. *Lap Weld.* As explained on page 49, the lap weld *should never be used.*

Butt Weld. The beveled or grooved butt joint is the only welded joint that should be employed on heavy sheets; Fig. 60.



Fig. 60. Butt Weld in Heavy Sheets

The most satisfactory method of handling the work is to space the edges, because tacking is very likely to not hold on heavy sheets.

Never weld sheets from both sides, because unequal strains are likely to be introduced by localized heating when working on the second side.

Cylinders. Heavy cylinders should also be prepared for the grooved butt weld, for the same reasons as for heavy sheets.



Fig. 61. Corner Welds for Heavy Sheets

Corner Welds. The two most satisfactory corner welds for heavy sheet are shown in Fig. 61. Although the second is a little

more costly to prepare, it is more satisfactory than the first because it insures better penetration.

Tank Heads. In welding bottoms or heads in tanks of heavy sheet, the purpose for which the tank is to be used governs the method of constructing the heads as it does in welding tanks of lighter gage. The same general rules apply in both cases, the main difference being

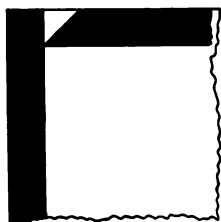

Fig. 62. Head Weld for Storage Tanks

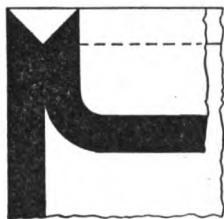

Fig. 63. Head Weld for Medium-Pressure Tanks

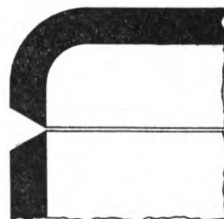

Fig. 64. Head Weld for High-Pressure Tanks

that the edges of the heavy shells and heads are chamfered, dependent on the design of the tank. All require tacking to hold the members in position for welding.

Storage Tanks. In the case of putting on a flat head, the edge of the head only is chamfered, Fig. 62, while in putting in a flanged head where an edge weld is to be executed, as in Fig. 63, both shell and head are chamfered to make the V-groove.

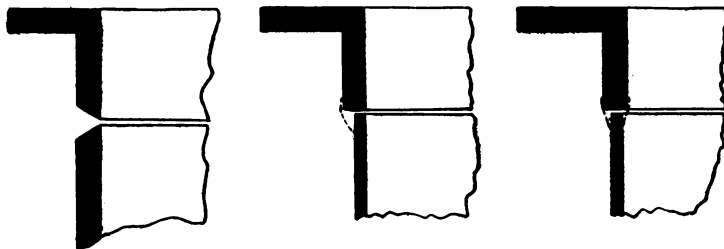

Fig. 65. Welds for Tank Reinforcing Rings

High-Pressure Tanks. When a head is put in, as shown in Fig. 64, both the edge of the flange and the edge of the shell are chamfered. This type of head is the best for high-pressure tanks because the weld is in tension.

This method also applies to the welding of two cylindrical shells end to end in making tanks of such dimensions that one single sheet of steel is not large enough to make a complete shell.

Tank Rings. In welding angle-iron rings to tanks of the same thickness, it is necessary that the edges of both ring and shell be

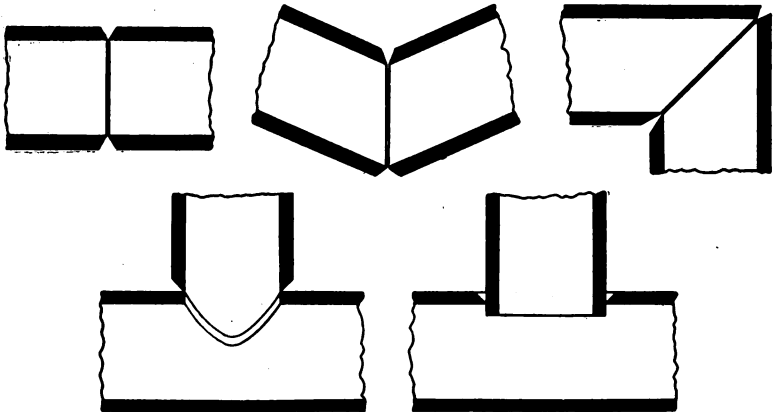

Fig. 66. Various Pipe Joint Welds

beveled as at the left, Fig. 65. Two methods of welding heavy rings to lighter shells are shown at the middle and right. The inside weld at the right should be only enough to smooth off the joint.



Fig. 67. Welds for Pipe Heads

If too much heat is applied from the inside there is likely to be trouble from warping or buckling. Rings should always be tacked to prevent bowing, twisting of the rings, and buckling of the shell.

Tubes and Pipes. Various tube and pipe welds are given in Fig. 66.

The methods for closing the end of a pipe with a head are shown in Fig. 67. The first is the easier and stronger of the two.

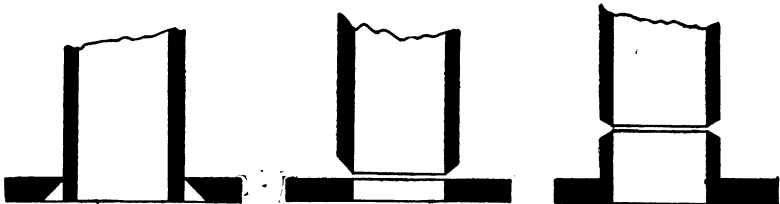

Fig. 68. Welds for Pipe Flanges

Three methods of welding flanges to pipe are shown in Fig. 68. The first method is easier to weld than the second; but the latter

is the stronger. The third method is the best method of welding flanges to pipe, but is, of course, a special type of flange.

Welding Heavy Steel Forgings and Steel Castings

Preparation. In welding heavy steel sections, such as crankshafts, axles, and the like, the weld is prepared by grooving or beveling from both sides. This is done because it is easier for the operator to do the work and for the sake of economy, because by beveling from both sides less filling material is necessary and, consequently, less time and gas are needed.

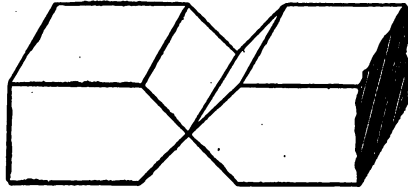

Fig. 69. Preparation of Heavy Forgings for Welding

Square Sections. Square or rectangular sections of forgings are best prepared by beveling half way through from each side, Fig. 69. After the welding has been carried on from one side, the piece turned over and the welding completed from the second side, there will probably be a slight bow, or curve. In the case of forgings, this is not objectionable, because the work can be, and, in fact, should be, reheated and straightened.

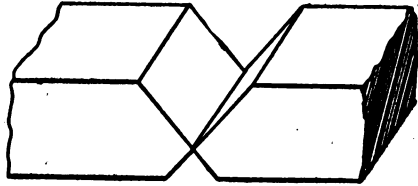

Fig. 70. Preparation of Heavy Castings for Welding

The reheating in the case of forgings is beneficial to the grain of the material and the strength of the weld. With castings, however, this bending is not possible. Therefore, to keep the work in alignment, it is best to prepare the work as shown in Fig. 70. The welding is carried on two-thirds of the way through from the first side, and then finished by turning over and working from the second side.

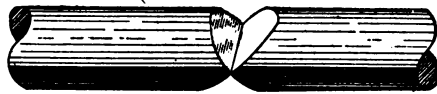

Fig. 71. Preparation of Round Sections for Welding

Round Sections. Round or elliptical sections should be prepared by beveling the ends to a wedge as indicated in Fig. 71. They should never be turned down to a point. By preparing the pieces as shown

in the illustration, the welder will have a flat surface to build his weld upon. If the work were prepared to a point, the filling material when added would have no surface to lie upon and would run down in drops, necessitating burning or melting away when the work is turned over, and probably resulting in a weak weld with considerable oxide.

Expansion and Contraction. Expansion and contraction will probably cause very little trouble to the operator in the case of shafts and other heavy pieces that are not connected. The only difficulty the operator will encounter in these cases will be the possible bending, which was noted above, when welding from two sides. However, if the broken part is confined by rigid members, the work should be handled either by pre-heating, or one of the other methods

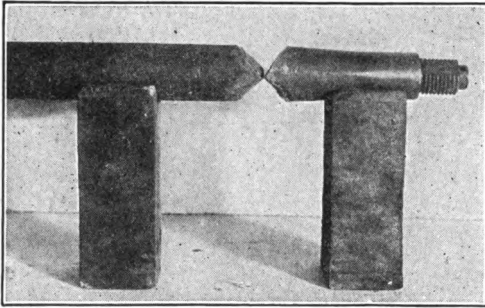

Fig. 72. "V" Blocks for Welding Shafts

recommended and explained under Expansion and Contraction, pages 36 to 40.

V-Blocks. When welding shafts, it is advisable to line them up in position on V-blocks, so that they may be turned over and still kept in alignment, Fig. 72.

Welding Heavy Section. In the case of a heavy section select the proper size welding head and a piece of welding rod of the correct analysis for the particular work at hand, and place the work in alignment.

If the section is over or about one inch, it should be pre-heated by means of a gas or oil burner until it is at a red heat. This will save oxygen and acetylene, and will bring the material to a temperature at which it will be more receptive to the action of the welding flame and thereby insure a more homogeneous weld. If not objectionable to the operator, it is advisable to let the pre-heating burner play on the work while the welding operation is going on, taking care, of course, that the materials of combustion of the pre-heating burner do not strike the molten metal and have a detrimental effect on the weld.

The welding flame is first played on the edges at the bottom of the groove until they are in a molten condition. The flame is then momentarily withdrawn to allow them to flow together and "set", and form the bottom of the weld. When a perfect union of the bottom is secured all the way across, the welding rod is brought into use. By playing the flame around the welding rod and the edges of the weld instead of directly on the welding rod, it is possible to bring them to a fusing temperature at the same time. The rod is then gradually added to the weld, layer by layer, until the entire groove has been filled up. The welding rod is kept plunged into the molten metal all the time to prevent oxidation. Any oxide that forms during the welding is floated to the top and removed by scraping with the welding rod, or by blowing away with the force of the welding flame. The welder must be careful that he does not allow the molten metal to run over the sides of the weld. Each layer is added in such a way that it extends slightly beyond the end of the groove. Then, from time to time, as the groove is filled up, the operator smooths down the two ends.

Hammering. As each section, about $\frac{1}{4}$ inch thick, is added to the groove, the operator stops the welding operation, heats the work to a bright yellow, and hammers the weld lightly but rapidly to give it as fine a grain as possible. After the weld has been completed, it is either hammered or annealed, as directed on page 45.

CAST-IRON WELDING

General Considerations. Many defects are experienced by the beginner in welding cast iron because of its peculiar properties. The two principal faults noticed are the production of hard, glassy, and brittle metal in the weld, and subsequent cracks, breaks, and checks either in the weld or in the adjacent metal, owing to excessive internal strains set up by unequal contraction. Both are serious defects, and the liability of their occurrence is so great that proper preventive methods should be continually borne in mind and applied while welding this material.

Oxidation. Cast iron melts at about 2000° to 2190° F., and iron oxide melts at about 2450° F. The oxide is formed, however, at low temperatures, a bright red heat being sufficient to cause the combination of oxygen from the air with the iron of the casting.

It is not possible to melt this oxide and flow it from the weld, so it remains in the casting in the form of thin flakes or crust. This not only prevents the alloying of the molten metal, but also combines with the free carbon and is, consequently, conducive to the formation of white iron. Therefore, this oxide must be removed or destroyed.

Expansion and Contraction. Cast iron is absolutely lacking in elasticity, and its tensile strength is very low. In preparing work for welding, it is always necessary to take fullest precautions against the bad effects of expansion and contraction. Expansion and contraction should be treated with more importance in the welding of cast iron than in any other metal.

When the internal strain produced by contraction is greater than the tensile strength of the section to which it is confined, failure will occur. When the strain is not great, but still exists, the resistance of the section to external stresses is reduced in proportion. Thus a casting may appear to be normal after welding but the excessive internal strains caused by the welding may make it fail at the slightest shock.

One of the three general methods of coping with the forces of expansion and contraction, which are given on pages 36 to 40, must be used when welding cast iron. The proper method to pursue is determined by the size and shape of the casting and the nature and location of the break. A very large percentage of the failures due to shrinkage cracks may be prevented by an intelligent anticipation of the forces of expansion and contraction and the proper handling of the work to overcome these.

Pre-Heating. Pre-heating should be used to some extent in all cast-iron welding. If the piece is small and the break is so located that it is not necessary to consider expansion and contraction, the blowpipe should be played upon it until the chill is removed from the casting. If the casting is large, an oil or gas burner, or charcoal fire can be used. In a large casting this preliminary heat treatment not only favors the execution of a good weld but also requires less oxygen and acetylene because of this large volume of heat from a cheap source, thereby reducing the cost of welding.

Welding Rods. The success of cast-iron welding depends greatly upon the selection of a suitable welding rod. It has been proved time and again that hard, brittle, and weak welds have been

produced for no other reason than because inferior filling material was used.

The presence of silicon in proper proportion tends to produce a soft gray-iron weld. It increases the fluidity of the metal, retards oxidation, and prevents decarbonization and blowholes. The success of the filling rod is dependent upon the amount of this element it contains. From 3 to 4 per cent is the average silicon content of good welding rods. The welding rod must be of high-grade cast iron, soundly cast and absolutely homogeneous. It must be free from all sand, grit, and rust. For convenience in handling, it is usually cast in 24-inch lengths of three diameters, $\frac{1}{4}$, $\frac{3}{8}$, and $\frac{1}{2}$ inch. In case either a longer or heavier rod is desired, two or more are welded together.

Flux. The principal problem that confronts the welder is to prevent the formation of oxide, and in case it is formed, to reduce it and remove it from the weld. If this is not done, the molten metal will be enclosed in a thin film of nonmetallic material, and any additional metal that may be fused or added will adhere to this film rather than break through it and fuse homogeneously with the other metal. It is not possible to satisfactorily break up this film mechanically, therefore it must be reduced to a molten, or slag, condition. To accomplish this a suitable flux is used that will dissolve the oxide.

A flux is not used solely to dissolve the oxide, but also to float off other impurities, such as sand, scale, and dirt. It forms a protecting glaze on the weld and surrounding surfaces and increases the fluidity of the molten metal.

Borax and salt (sodium chloride) are two compounds often used by welders, but they really contain little merit as a flux. Their low fusibility seems to be the only point in favor of their use. Occasionally, they may be employed to advantage in welding heavy sections or burned iron, such as are found in firebox and grate castings, but their function is only that of a cleanser. Both tend to produce hard iron. There are certain flux powders put on the market that contain large proportions of manganese. These powders cannot help but have a hardening effect on the iron. Others contain potassium perchlorate, a violent oxidizing agent. Still others contain material that chlorinize the weld. Needless to say, powders of this

kind must not be used. It is best to guard against the purchase of such defective mixtures by obtaining flux powders from reliable sources.

It is necessary that the welder learn to apply flux properly. An excess will cause as much trouble as an insufficient quantity. Blowholes may be increased in size and number by using too much flux. Also the molten iron will incorporate certain constituents of the flux if it is applied in excess. The amount to be applied depends upon the flux used. A welder must learn to know his flux as well as his blowpipe.

The powder should be applied regularly by dipping the hot welding rod into it. The quantity adhering is sufficient. Do not throw large quantities into the weld as plenty will be added by the welding rod.

Preparation of Welds. All cast iron over $\frac{1}{8}$ inch in thickness should be beveled or chamfered before welding. If this is not done, it is necessary that the metal be burned out by the blowpipe in order that complete penetration be assured. This is bad practice as it is almost impossible to do it without either changing the state of the metal in the groove due to the forced flame, or causing partial adhesion. The chamfering should be a little wider than on other metals for the reason that it is good practice to introduce as much special metal from the welding rod as possible.

The chamfering can be done by various means. If the casting is light and broken in two pieces, it may be taken to an emery wheel and the edges ground off. If the casting is too heavy to move, a portable grinder or cold chisel and air or hand hammer can be used. If the casting is only cracked, the cold chisel and air or hand hammer are the most satisfactory tools to use.

After the weld has been beveled satisfactorily, the adjacent metals should be cleaned about $\frac{1}{4}$ to $\frac{1}{2}$ inch from the edge. This is important, because all dust, sand, scale, etc., should be removed from the welding zone.

To Prevent Crack from Extending. If the defect in a casting is a crack that shows a tendency to extend upon heating, a hole should be drilled in the casting a short distance from the end and in the direction the crack would follow. The crack will not extend beyond this hole, and the hole can be very easily filled in.

Welding Process. Although the melting point of cast iron is not high, the total heat required to bring it to fusion is great, therefore a blowpipe of large size is used. The speed of welding is increased considerably, and the selection of the proper size blowpipe is influenced by the extent of the pre-heating.

Cast iron melts very rapidly after the fusing point is once reached, and when molten is extremely fluid. Because of this property, the welding should be carried on horizontally, otherwise the metal will flow toward the lowest point. This is not desired, because it will tend to produce adhesion. In case it is not possible to arrange the casting so that the weld will be horizontal, the welding must be started at the lower end, and skill must be used to prevent the too rapid advance of the molten metal. It is very difficult to produce vertical and overhead welds because of the fluidity. In welding thin sections of cast iron, the rapidity with which it melts and its fluidity often cause the metal to sink, bulge downward, or drop in. Consequently, it is necessary that close observation and careful manipulation be used on this kind of work.

Flame. The incandescent jet of the oxy-acetylene flame should never impinge on the molten metal. The tip of this jet should be held at a distance of $\frac{1}{8}$ to $\frac{1}{2}$ inch from the metal according to the thickness. The molten iron is seriously influenced by the high temperature of this jet and may become oxidized and decarbonized. This must be rigidly observed except when it is necessary to use the jet to burn out sand holes, blowholes, etc.

Manipulation of Blowpipes and Welding Rods. Because cast iron fuses rapidly when once the melting point is approached and the molten iron is extremely fluid, the circular or oscillating motion imparted to the blowpipe need not be so pronounced. The welding of cast iron is nothing but a succession of overlapping miniature pools, or puddles, of molten metal.

The weld is started by playing the blowpipe on the two lower edges of the weld. The flame should strike the weld almost perpendicularly, because if the blowpipe is inclined, the flame will blow the molten metal ahead of the weld, and adhesion will result. When at the proper temperature, these edges are fused together without any filling material by the aid of a little flux. It is important that this first operation be carefully carried out, as the strength of

the weld is dependent upon a good bottom and top. When this first fusion has been successfully obtained, the welding rod is brought into play and the high silicon metal is added. With each addition,

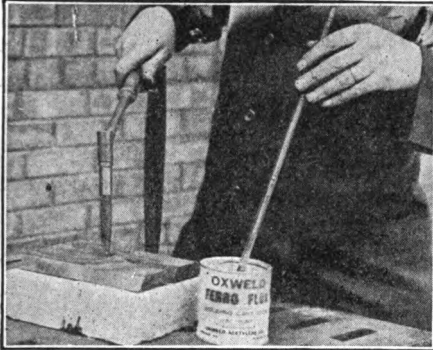

Fig. 73. Warm Welding Rod Is Dipped into the Flux before Each Addition to the Weld

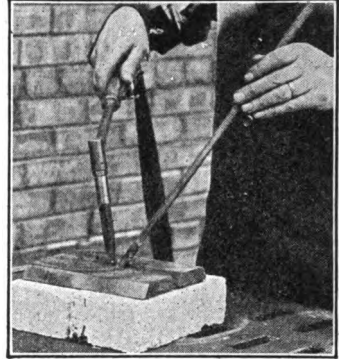

Fig. 74. For Cast-Iron Welding, Blow-pipe and Welding Rod Are Held Almost Vertical

the welding rod is previously dipped into the flux can, and the adhering flux introduced in the weld, Fig. 73. As the welding of cast iron is a comparatively rapid procedure, the welding rod can



Fig. 75. Dirt May Be Scraped off by Means of the Welding Rod



Fig. 76. Welding Rod Should Not Be Held Too Far from Welding Zone.

be held more vertically and added faster, Fig. 74. In welding "dirty" iron it is sometimes convenient to hold the rod in a horizontal position and scrape out sand, carbon, or any other dirt by means of the rod

as soon as it appears, Fig. 75. In this connection, it may be added that the welding rod should be used constantly to work out impurities and blowholes. The welding rod should be melted as much as possible in the molten metal of the weld. It should be plunged into this liquid, and the fusion carried out by playing the flame around it. The welding rod should not be held too far from the welding zone, Fig. 76, nor should it be added to the weld drop by drop as shown in Fig. 77.

As a section of the weld is finished, it should be scraped or rubbed with a file while red hot, Fig. 78, to remove the film of flux, scale, sand, and dust that is present. This film if allowed to cool becomes very hard and is quite resistant to machine tools. Regardless of the

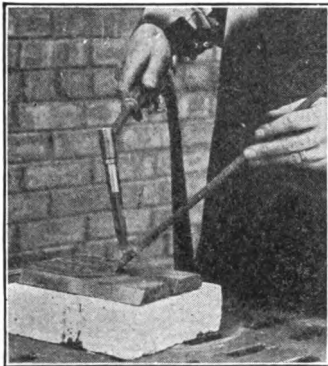

Fig. 77. Welding-Rod Should Not Be Added Drop by Drop

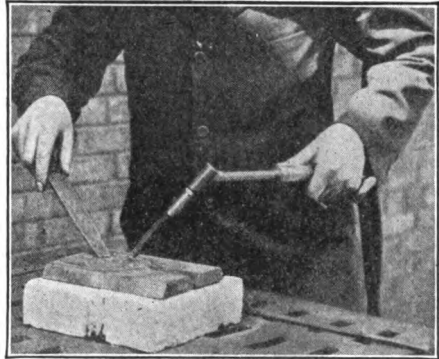

Fig. 78. Scraping Finished Weld with File to Remove Scale

quality of metal beneath it, many welds have been rejected because of the hardness of this superficial surface.

If the weld is carefully executed and the surface is cleaned, it will look like the left of Fig. 79, while if poorly executed and not cleaned, it will look like the right of Fig. 79.

Never go over a weld the second time if it can be avoided. In case it is absolutely necessary, always add fresh metal from the welding rod, as a failure to do this will cause a loss of silicon in the weld and destroy its value to the metal.

Always perform the welding as fast as possible, because extended heating will tend to lower the silicon content of the weld, with the resultant formation of hard iron.

Blowholes. Blowholes occur frequently in the weld and are particularly troublesome if in the bottom of the weld. Their presence can be caused by mechanically enclosed gases or by improper blow-pipe handling. When blowholes appear in the weld, they should be instantly worked out. This may be done by forcing with the welding rod and applying flux. In beginning a weld, it is necessary that the presence of blowholes be guarded against, as it is difficult to work out a blowhole at the bottom of the weld after it is finished. Occasionally, in going over a weld, a blowhole is discovered; this must first be

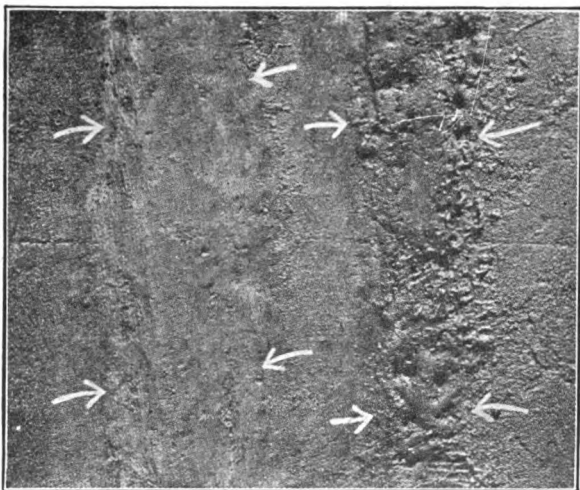

Fig. 79. Appearance of Cast-Iron Welds That Have Been Properly (left) and Poorly (right) Executed

burned out by the white jet of the flame and then worked over with the welding rod.

After-Treatment. The rate of cooling materially influences the structure of the metal in the weld. If rapid cooling is allowed, hard brittle iron is produced. If slow cooling is employed, soft gray iron is formed. Internal strains and stresses may be distributed and adjusted or, in some cases, eliminated by proper cooling and annealing.

Castings which are not large or which it has not been necessary to pre-heat extensively may be satisfactorily annealed by playing the blowpipe on the weld and surrounding metal until it is at a bright red heat. The heated portion is then covered with asbestos

paper, cinders, or other nonconducting material that will retain the heat and protect the castings from air currents. For small castings, a barrel or bin of hydrated lime and fiber asbestos is recommended. This makes a convenient arrangement and is very satisfactory as an annealing agent.

Where it is necessary to heat the entire casting in a charcoal or coke fire, the same temporary furnace used for pre-heating may be used in annealing. After the welding has been completed, the casting should be covered over with hot coals and ashes, and the furnace should be bricked up, i. e., all large air ports closed, the top covered with asbestos paper, and the casting allowed to cool with the fire.

The castings should never be removed from the annealing fire until they are entirely cold. This is imperative, as cold air currents on the warm castings may cause checks or cracks. In some cases, 12 to 24 hours are required for satisfactory cooling.

Use of Carbon Blocks. In case it is not possible to line up the weld horizontally, or it is necessary to fill in a wide hole, carbon blocks or steel plates are sometimes used to dam or retard the flow of the metal.

MALLEABLE-IRON WELDING

Malleable Iron. Malleable cast iron, or malleable iron, as it is commonly called, is used extensively in castings where toughness, malleability, and resistance to sudden shock are required. The characteristic that gives malleable iron its greatest value as compared to gray iron is its ability to resist shocks. Malleability in a light casting, $\frac{1}{4}$ inch thick and less, means a soft pliable condition and the ability to withstand considerable distortion without fracture, while in the heavy section, $\frac{1}{2}$ inch and over, it means the ability to resist shock without bending or breaking.

In the manufacture of malleable-iron parts, white iron castings are packed in annealing pots with suitable material, such as mill-scale, borings, etc., and subjected to a cherry red heat for from 48 to 96 hours, after which they are allowed to cool slowly. During this annealing process, the material in which the castings are packed absorbs the carbon from the surface of the casting. In this way the surface becomes really a steel, while the inside, or core, becomes gray cast iron.

Fusion Weld Not Possible. When malleable iron is heated to a fusing heat the malleable properties are destroyed and cannot be regained.

Brazing Malleable Iron. The most successful method of joining malleable iron with the oxy-acetylene blowpipe is by brazing with Tobin bronze. While this gives a joint of different color, yet the strength, malleability, and machining qualities are satisfactory.

The two pieces to be joined are beveled as for cast-iron welding. The edges are brought to a point just below fusion, great care being taken that they *do not* become fused. When the edges are at the right temperature, a rod of Tobin bronze is fused into the groove with the aid of a good brass flux. The work should be carried out by using a flame having a slight excess of acetylene and should be done as rapidly as possible to prevent oxidation of the bronze.

ALUMINUM WELDING

General Considerations. When aluminum approaches its melting point, it does not change color in ordinary light, but retains its silvery appearance even when in the molten condition. When molten, it is very fluid and is, therefore, rather difficult to control under the welding flame.

Oxidation. Aluminum oxidizes very easily when in a molten condition, forming an oxide that melts at about 5400° F. The oxide, therefore, cannot be penetrated by means of the flame, but must be removed either chemically by means of a flux or mechanically by means of a paddle.

Expansion and Contraction. Because of the high heat conductivity of aluminum, expansion and contraction do not give great difficulty owing to localized heating. However, because aluminum expands greatly and is very weak when at high temperatures, contraction strains are very likely to produce cracks or checks unless the work is allowed to cool evenly and slowly. It is advisable to pre-heat aluminum castings to between 300° and 400° F. to aid the distribution of the heat and prevent warping.

Welding Rod. In welding sheet aluminum, such as automobile bodies, the welding rod should be clean material of the same alloy as the sheets that are being welded. If wire cannot be obtained of the same composition as the sheets, narrow strips should be

sheared from the sheets themselves and used for a filling material. The strips should be sheared about as wide as the sheets are thick.

For aluminum castings, such as crank cases, a good grade of aluminum wire about $\frac{1}{4}$ inch in diameter should be obtained. Welders should not use the cheap solders or very low fusing cast rods that are sometimes sold, and for which great claims are made. The operator will readily appreciate that when these materials are added to the weld they will merely adhere to the sides, because, while the filling material will be quite fluid, the edges of the weld will not be at a fusing temperature.

Flux. It is impossible to weld sheet aluminum without the use of a good flux to dissolve the oxide and float it to the top as a slag. In cast-aluminum work a paddle may be used to accomplish this result, but such a device is not practical for sheet work. The flux may be applied either by dipping the warm welding rod into the flux powder or by mixing the flux with water to form a paste and applying this to the joints by means of a brush. Care must be taken that too much flux is not used, because an excess will produce a porous weld and one with a poor surface. After the work has been completed the flux should all be washed off with warm water.

Flame. In order to be sure that an oxidizing flame is not being used, it is permissible and advisable to use a flame showing a slight excess of acetylene. This flame will also have the advantages of being slightly larger in volume than the neutral flame and of lower temperature, this last feature being helpful, especially to the new operator.

Sheet-Aluminum Welding

Sheet-aluminum work may be handled very similarly to sheet steel as regards preparation and allowance for expansion and contraction.

Types of Joints. For light sheets under $\frac{1}{16}$ inch the flange weld should be used. The butt joint may be successfully made on light sheets by an experienced operator, but there is a great deal of danger of burning through and having to fill up holes, which will leave a poorly finished weld.

For sheets above $\frac{1}{16}$ inch the butt weld is found to be the best, and for sheets above $\frac{1}{8}$ inch the edges should be beveled the same as for steel plates.

Welding Process. Select the proper size blowpipe and welding rod, a good flux, and arrange the work for welding. Start the welding by playing the secondary flame of the blowpipe over the parts surrounding the weld, to warm them up slightly. If the flux is to be applied with a brush, it should be done at this time, because the heat will evaporate the water and leave the solid flux evenly distributed over the weld. Welding should then be started from $\frac{1}{2}$ to 1 inch from the end—not at the end. The blow pipe should be handled about the same as for steel welding, care being taken that the inner cone of the flame does not come in contact with the metal. For very thin sheet welding it is not necessary to give the circular or oscillating motion to the blowpipe; it is merely necessary to move it forward in a straight line.

On the heavier work, however, the same motions should be used by the welding operator as are used for steel. The welding wire is best held directly in line with the weld and always in contact with the metal just ahead of the blowpipe. If the wire is not in contact with the edges when they become molten, they will be likely to curl up or draw away instead of flowing together. After the main weld has been completed, the operator should go back and weld the short section that was left unwelded at the very beginning. After the work has cooled the flux should be removed by washing off with warm water.

Re-Welding. The operator should be careful that the weld is completed as he goes along, so that he will not have to go back to make repairs or to do re-welding. If it is necessary to go back over a weld, cracks or checks are very likely to result because of the weak condition of the metal when it is at a fusing temperature. If it is necessary to re-weld a certain portion of the joint, the surface should be chipped off so as to present a clean surface for the new filling material to fuse to. Following the suggestions already made, the seam and the surrounding surfaces should be thoroughly pre-heated before the welding is started to prevent cracking as much as possible.

After-Treatment. If possible, welds in aluminum sheet should be reheated evenly to equalize any internal strains. Then, after the weld has become *cold*, it should be hammered to improve the grain of the metal.

Cast Aluminum Welding

Aluminum Castings. Most aluminum castings are alloys of aluminum, zinc, and copper; the alloy being added to the aluminum to give it a higher tensile strength and increase its resistance to shock. The welding of cast aluminum is different from that of sheet aluminum and resembles in a general way the welding of cast iron. Oxidation is taken care of by using flux or by scraping the oxide out by means of a paddle. The second method is faster and is the one preferred by most operators.

Paddle. The paddle is made by flattening down the end of a $\frac{1}{4}$ -inch steel rod to a smooth short flat blade about $\frac{3}{8}$ inch wide. The handle may be left straight or bent to suit the operator. The paddle should be used only when just below a red heat. If it is cold, the molten metal will stick to it, and if it is too hot it will burn and the metal will stick to the roughened surfaces.

Preparation. Sections if over $\frac{1}{4}$ inch in thickness should be chamfered before the welding is started. Sections thinner than this may be worked without beveling. The old metal may be scraped out by means of the paddle in order to give a clean bright surface for the new material to be added to.

Pre-Heating. Because aluminum alloy castings are not very ductile and are weak when at a high temperature, expansion and contraction must be taken care of. This is handled in the same general way as in the case of cast-iron work. The casting should be pre-heated either partially or wholly by some *slow* heating agent, such as a gas burner or mild charcoal fire. The pre-heating should never be carried to too high a temperature, because of the danger of the metal sinking, or caving in. The casting will be sufficiently warm for welding when a file or chisel will mark it easily, or when a piece of dry pine stick is charred upon being drawn across the heated section.

Welding Process. When a flux is used in welding cast aluminum, the work is carried on in the same general manner as in welding cast iron, and the same general precautions regarding the peculiarities of the metal are to be observed as in welding sheet aluminum.

If a paddle is used to break the film of oxide and scrape it out of the weld, the edges are brought to a state of fusion for a length of about 1 or $1\frac{1}{2}$ inches. The paddle is then used to scrape out the weld

to make a slight bevel and present clean surfaces for the filling material to be added to. The welding rod is then introduced into this groove. The paddle is used continually to work in the filling material, scrape off any oxide that forms, and then to smooth off the surface of the weld. After a small section of the joint has been completed, the casting is turned over, and the weld for this length is smoothed off on the underside by means of the blowpipe and paddle. The welding is carried on in this manner, section by section, until the entire joint is completed. If the weld were completed on the first side and then turned over and smoothed its entire length on the underside, cracks would develop, and the casting would warp out of shape.

After-Treatment. When the welding has been completed, the casting should be reheated slightly to remove any local strains and should then be covered over with asbestos paper to protect it from drafts and to allow it to cool very slowly. If the cooling is carried on rapidly, or if air currents are allowed to strike the casting, it will very likely crack either in the weld or some weak section.

COPPER WELDING

General Considerations. Because of the high thermal conductivity of copper, the heat from the blowpipe is conducted back into the work rapidly and is lost to the weld. This necessitates the use of a large size welding head or the use of an auxiliary source of heat to assist the welding flame in the case of heavy work. When at high temperatures, copper is weak in tensile strength the same as aluminum. Because of these two factors the effects of expansion and contraction must be carefully considered, so that the work will not cool too rapidly after the welding has been completed, and will not crack at high temperatures.

Oxidation. Copper oxidizes quite readily, forming an oxide which dissolves in the molten metal and changes the structure of the weld. The amount of oxide that can be absorbed is very high, consequently great care must be exercised to keep the absorption at a minimum. Welding rods containing a small percentage of phosphorus and suitable fluxes are used to counteract the oxide and reduce it as much as possible.

Welding Rod. For successful copper welding, it is necessary to use electrolytic copper containing about one per cent phosphorus,

supplied in coils and drawn rods. The cast copper alloy rods that are on the market are not satisfactory, because the structure and composition will vary even in a single rod to such an extent that a homogeneous weld cannot be made.

Flux. In welding copper the flux is used not only to cleanse the weld, but also to protect the metal adjacent to the welding zone from the gases of the flame. When welding sheet copper it is advisable to make a paste of the flux by adding water and to coat the metal about one inch adjacent to the edge of the weld. When this flux is melted, it will form a glassy film that will protect the metal from the gases of the flame and the air surrounding the work. Additional flux is added to the weld as the work progresses, by dipping the warm rod into the dry flux, as in welding other materials.

Flame. It is very important that the neutral flame be maintained at all times, and the operator should use great care in adjusting his gases, so the flame will not have an excess of acetylene nor be oxidizing. Because of the peculiar properties of the metal, the gases of the reducing flame are very likely to be absorbed, and because of the ease with which the metal oxidizes, oxidation is liable to occur if the flame contains an excess of oxygen.

Preparation. Sheets that are less than $\frac{1}{8}$ inch in thickness may be butted together without beveling. Sheets heavier than this should always be beveled, and no attempt should be made to depend upon the flame to penetrate the heavier thicknesses. In all cases of copper welding, the edges to be joined and the material adjacent to the edges should be scraped or filed to present a clean surface for the filling material to be added to.

Welding. The edges of the metal surrounding the weld should be raised to a fairly high temperature before the actual welding is started. On small pieces and light-weight work, this may be done by means of the welding blowpipe, but for heavy work and long welds, it is best to do this by means of a gas or oil pre-heating burner. After the work has been brought to a high temperature, the welding should be started at one end and should be performed as rapidly as possible. The welding rod and edges of the weld should reach the state of fusion at the same time, so as to prevent adhesion and to insure a good weld. This feature is harder to accomplish in welding copper than in other metal, because the heat is conducted back into

the rod or into the work very rapidly, necessitating very careful and skillful manipulation of the blowpipe and rod. The blowpipe should be held almost vertical, about the same as in the case of cast-iron welding. If held at too great an angle, the molten metal will be blown ahead and will adhere to the cold edges of the weld in advance of the blowpipe. The inner cone of the flame should never come in contact with the metal, but should be held about $\frac{1}{8}$ or $\frac{1}{4}$ inch above the surface of the weld to prevent burning the metal. The oscillating motion should be carried on about the same as in steel welding but a little more rapidly, and should consist of smaller circles. The welding rod should be plunged into the molten metal all the time and should be continuously moved around or stirred, so that it will be thoroughly incorporated and will bring the oxide and slag to the surface. The weld should be built up above the surface of the sheets, so there will be enough material to allow for hammering after the welding has been completed.

Re-Welding. In case it is necessary to re-weld a portion of the joint, it is necessary that the old material be chipped out and new material added.

After-Treatment. After the welding operation has been completed, the work should be heated very carefully and evenly until it is almost at a bright red heat. The weld should then be hammered while hot, so that the strength of the joint will be increased as much as possible. After the hammering has been finished, the work should be again reheated to a red heat and cooled quickly by means of an air blast or chilled by plunging in water. Care must be exercised in this operation if the work be a casting having confined, or rigid members, so that cracking, or checking, does not occur.

BRASS AND BRONZE WELDING

General Considerations. Brass and bronze are both alloys of copper, brass consisting mainly of copper and zinc, and bronze of copper and tin. Both brass and bronze are welded in about the same general manner as copper, but because of the peculiar properties of the alloying metals, zinc and tin, it is necessary that they receive certain variations in welding.

Oxidation. In both brass and bronze, the alloying metal is greatly affected by the high temperature of the flame, and the material

will be subject to a loss of zinc or tin, unless proper precautions are taken. These metals will combine with the oxygen and pass off as white vapor, and leave a weld of different composition and color.

Absorption of Gases. The molten metal in both brass and bronze absorbs certain gases very readily, and unless this absorption is counteracted, the weld will be spongy and weak. This may be taken care of by using a suitable welding rod and flux.

Welding Rod. Because of the varying composition of brass and bronze, and because of the loss of the alloying elements when welding, it is practically impossible to produce welds of the same color as the original material. When welding brass, a good grade of drawn brass will be found most satisfactory, and in the case of bronze, a good drawn bronze, such as manganese or Tobin bronze. The cast rods that are on the market are not satisfactory, because it is quite impossible to cast a rod having the same composition throughout.

Flux. The flux used for brass and bronze is practically the same as that used for copper. It should be applied by dipping the warm welding rod into the powder and adding it to the weld in this manner. It is not necessary to use as much flux as in welding pure copper, and care must be taken that an excess is not used, because the weld may become porous.

Flame. A neutral flame must be maintained at all times for the same reasons as explained under copper welding. The blowpipe should be held between $\frac{1}{8}$ to $\frac{1}{4}$ inch from the metal. If the flame is held too close in the case of bronzes, the concentrated heat will cause a segregation or separation of the tin from the copper, and it will be practically impossible to again unite these elements.

Preparation. The edges of the metal for a thickness of less than $\frac{1}{8}$ inch may be merely butted together and welded, while for metals above this thickness the edges should be beveled or chamfered, so as to allow penetration of the flame and insure a good weld.

Welding. Because of the high conductivity of these materials, it is best that they be pre-heated to bring them to a suitable condition for rapid welding. Care must be taken when pre-heating bronze that it does not get too hot, because it is weak at high temperatures and is liable to break or crack under its own weight. The welding is carried on in about the same manner as for copper, and the blowpipe is handled in practically the same way. The welding

rod should be in contact with the edges of the metal at all times, and the blowpipe should be played constantly on both the rod and the edges of the metal to keep them at the same temperature in order that adhesion may be prevented.

Re-Welding. Re-welding should be avoided, but if it is absolutely necessary to re-weld the work, the section should be chipped out, and new material added, as in the case of copper.

After-Treatment. Both brass and bronze should be annealed after welding by reheating evenly, and then allowed to cool slowly. Brass may be improved by hammering before the final annealing. Brass of low zinc content, i.e., red brass, should be hammered while hot, while brass of high zinc content, i.e., yellow brass, should be hammered cold.

MISCELLANEOUS PROCESSES

CUTTING

Cutting In Automobile Repairs. The oxy-acetylene cutting blowpipe finds considerable application in the automobile repair shop for beveling the ends of shafts and other pieces of work preparatory



Fig. 80. Beveling Round Shaft for Welding.
The other piece is on the table



Fig. 81. Beveling End of Heavy
Square Shaft for Welding

to welding, Figs. 80 and 81, cutting reinforcing plates out of large sheets for frame repairs, altering chassis, etc., Fig. 82. The cutting

blowpipe is capable of doing this work cheaply and quickly, two necessary factors for the successful first-class repair shop.

Principle of Cutting with Oxygen. At ordinary temperatures, steel oxidizes in the air, forming what is commonly called "rust". At a white heat it will oxidize more rapidly, as is seen in the blacksmith shop when pieces are brought to a very high temperature. When steel is heated to a red heat, and a stream of pure oxygen is directed on it, the oxidation takes place more rapidly and more violently and is restricted to the locality upon which the stream of oxygen is played. This localized oxidation is the basis upon which the oxy-acetylene cutting blowpipe operates.

Metals That Can Be Cut. Steel and wrought iron are the only metals that can be cut successfully by means of the oxygen jet. Although cast iron, copper, brass, bronze, aluminum, etc., oxidize easily, nevertheless they cannot be cut.

When the oxygen combines with the iron, heat is generated. This heat of formation, with the aid of the heat supplied by the pre-heating flames of the blowpipe, brings the oxide to a molten condition. The molten oxide either flows or is blown out of the cut and leaves a fresh thoroughly heated line through the metal for the further action of the cutting oxygen. In the case of steel and wrought iron, the oxide melts at a much lower temperature than the material being cut and therefore blows out without melting the surface of the material. In the cases of cast iron and certain alloy steels, the melting temperature of the oxide is as high and in some cases higher than that of the metal, and therefore melts the edges or freezes in the kurf and so hinders the cutting. Also, in the case of some of these materials, the heat of formation produced by the combination of the oxygen with the metal is not sufficient to carry the cut through the thickness of the work.

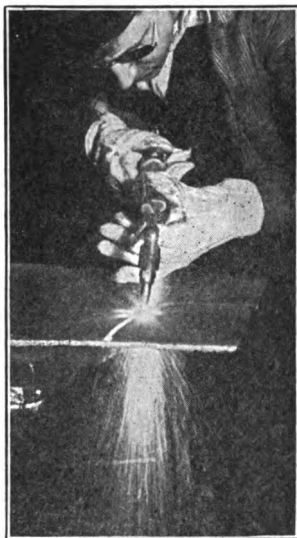

Fig. 82. Cutting Reinforcing Plate
Out of Large Sheet Steel for
Frame Repair

Necessary Cutting Apparatus. A complete cutting station, Fig. 83, consists of the following apparatus:

- Cutting blowpipe with set of cutting nozzles
- Oxygen cutting regulator with two gages
- Acetylene regulator with one or two gages
- Adapter for acetylene cylinder
- One length high-pressure rubber hose for acetylene
- One length copper armoured hose for oxygen
- Darkened spectacles, wrenches, hose clamps, etc.

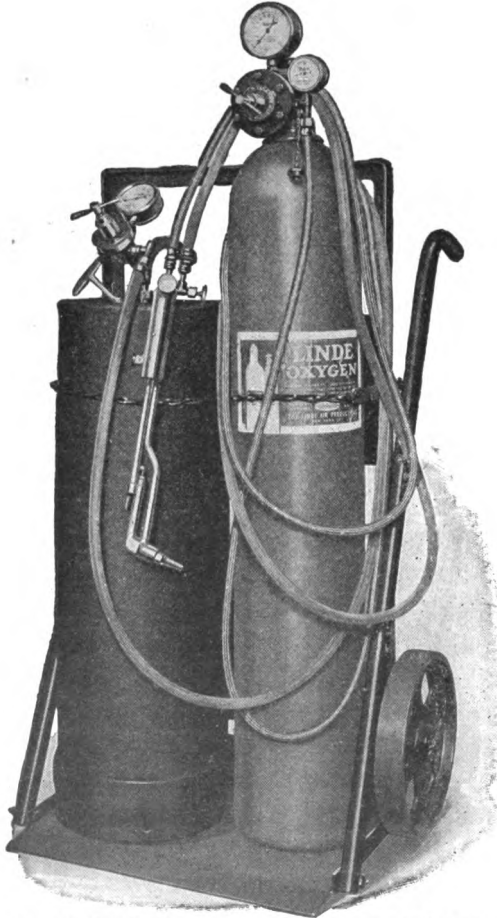

Fig. 83. Cutting Unit for Use with Acetylene in Cylinders,
Mounted on Emergency Truck

Courtesy of Oxweld-Acetylene Company, Chicago

Cutting Blowpipe.

In the cutting blowpipe, Fig. 9, page 9, there are usually six small oxy-acetylene flames surrounding a center orifice through which pure oxygen is directed. The six heating jets are used only for the purpose of bringing the edge of the material to a temperature at which the jet of pure oxygen will unite rapidly with the steel, as explained above.

Cutting Nozzle.

There are usually four sizes of cutting nozzles furnished for handling work of various thicknesses, from very thin plate up to material 14 and 16 inches thick. Besides these, some manufacturers also furnish what is known as a "rivet cutting nozzle".

This is a thin flat nozzle that can be laid against the sheet, allowing the rivet head to be cut off close to the sheet.

Working Pressure. The necessary pressures of the gas that are required by the different sizes of cutting nozzles and for the different thicknesses of material are given by the manufacturers. It is very important that the operator use these pressures instead of higher pressures because of the increased amount of oxygen used and the consequent high cost of operation, also because the cut will not be smooth if too much oxygen is used.

Care of Blowpipe. If the blowpipe is handled properly there will be very little deterioration. It should only be necessary to clean the replaceable and working parts, repack the valves, and occasionally ream out and true up the nozzles. Care should be taken that the orifices of the nozzles do not become enlarged by reaming, because the heating jets will be made thicker and shorter and the cutting jet will spread rather than leave the blowpipe as a long thin stream.

The blowpipe may be cleaned the same as the welding blowpipe by removing both the acetylene and oxygen hose and connecting the nozzle to the oxygen hose, Fig. 16, page 18, and turning on the oxygen to a pressure of about 20 pounds per square inch, having first the cutting oxygen valve open, then the acetylene needle valve, and lastly the oxygen needle valve. This will allow the large particles to be blown out of the larger passages before they have a chance to clog up the smaller passages.

Regulators. The cutting regulator, in principle, is the same as that described on page 20, but in size it is much larger than the welding regulator and is capable of both a higher delivery pressure and a greater volume.

The acetylene regulator is the same as is used in the welding equipment, and described on page 20.

Care of Apparatus. The blowpipe, regulators, and hose should receive the same care and attention as is explained for the welding apparatus on pages 18 to 21.

Instructions for Connecting Apparatus. The regulators and the blowpipe are connected up in the same manner as the welding apparatus, and therefore the operator is referred to pages 22 to 23 for instructions.

How To Light the Blowpipe. (1) Take the blowpipe in hand and open the oxygen cutting valve fully.

(2) Turn the oxygen pressure-adjusting screw to the right until the required pressure for the work to be done shows on the low-pressure gage. (See the maker's chart for the correct pressure.)

(3) Close the oxygen cutting valve.

(4) Open the acetylene needle valve fully.

(5) Turn the acetylene pressure-adjusting screw to the right until a good jet of acetylene issues from the heating orifices. In the case of pressure blowpipes, until the required pressure for the thickness to be cut shows on the low-pressure gage. (See the maker's chart for the correct pressure.)

6. Open the oxygen needle valve one-quarter turn and light the blowpipe by means of the pyro-lighter that is usually furnished.

NOTE—A back-fire might occur if there is not enough acetylene being supplied. If this occurs increase the acetylene supply by turning the acetylene pressure-adjusting screw farther to the right.

7. Adjust the acetylene pressure-adjusting screw to give a slight excess of acetylene to the flame.

8. Adjust the acetylene needle valve to give a neutral flame (see under Flame Regulation, page 25) when the cutting oxygen valve is open.

To Shut off the Blowpipe. In the case of the injector type of blowpipe, first close the acetylene needle valve and then the oxygen needle valve.

In the case of pressure blowpipes, first close the oxygen needle valve and then the acetylene needle valve.

To Cut. With the cutting valve closed apply the heating flames to the edge of the metal, keeping the nozzle at such a distance that the small flames barely touch the metal. As soon as the metal becomes heated to a cherry red, open the cutting valve, raise the blowpipe slightly to increase the distance between the nozzle and metal, and then move it along the surface as fast as a distinct and clear kurf can be secured. The blowpipe should be held at a constant distance from the work. It should travel away from the operator in order that he may watch the cut advance.

Back-Firing. Occasionally, particles of molten metal will impinge on the nozzle of the blowpipe, or the operator will allow the nozzle to touch the surface of the metal, and the blowpipe will back-fire. When this occurs, first close the acetylene needle valve

and allow oxygen to clear the passage, then open the acetylene needle valve fully and relight. If the back-firing continues, close both the acetylene and oxygen needle valves, cool the blowpipe by plunging in water and relight. Other causes of back-firing are loose internal and external nozzles or dirt on the nozzle seat. These can be eliminated by tightening the nozzles and cleaning the seat. These back-fires are usually only a series of pops or sharp reports, and, as a rule, will not extinguish the flame.

Notes on Cutting. *Heating Flames.* The heating flames should be small to produce smooth cutting. If the flames are too small, the blowpipe is liable to back-fire. If they are large, the top edges of the cut will melt and produce a rough cut.

Speed of Cutting. The speed of the blowpipe travel should be slow enough to allow the oxygen jet to penetrate yet not so slow that the oxygen will be wasted.

Restarting Cut. If the blowpipe travels too fast, and the cut is "lost", it is necessary to shut off the cutting oxygen and apply the heating flames to the point of stopping until the metal is hot enough to start the cut again.

To Cut Round Shafts, Etc. The cutting of round pieces will be made easier if the surface of the work is first chipped with a chisel. This will present a good edge for the cutting blowpipe to bite on.

To Pierce Holes. When piercing holes, a high oxygen pressure is necessary, and the metal must be brought to fusion before the cutting oxygen is employed. The blowpipe is held at a slight angle so the sparks will be blown out of the hole and away from the blowpipe.

Cutting Dirty and Poor Material. If there is considerable rust, scale, paint, etc., on the surface, the cutting will be interfered with by small particles flying against the end of the nozzle and perhaps causing back-firing. To overcome this, the heating flames may be made longer, allowing the blowpipe to be held farther away from the surface, or the scale or paint may be removed by first passing the flame over the line of cutting before the cutting is started.

LEAD BURNING

Different Methods. Formerly, lead burning, or lead welding, was confined to garages and service stations that catered to the electric automobile only, but since the introduction of electric lighting and

starting batteries for gasoline automobiles, lead burning has become one of the works of the repair man in all garages. It is therefore important that the repair man have a sufficient knowledge of this class of work to enable him to handle any work of this nature that may happen to come into his shop.

Up to the time of the recent development of a very small oxy-acetylene blowpipe for lead-burning work, the hydrogen air burner was used by most lead burners. The oxy-acetylene blowpipe, how-

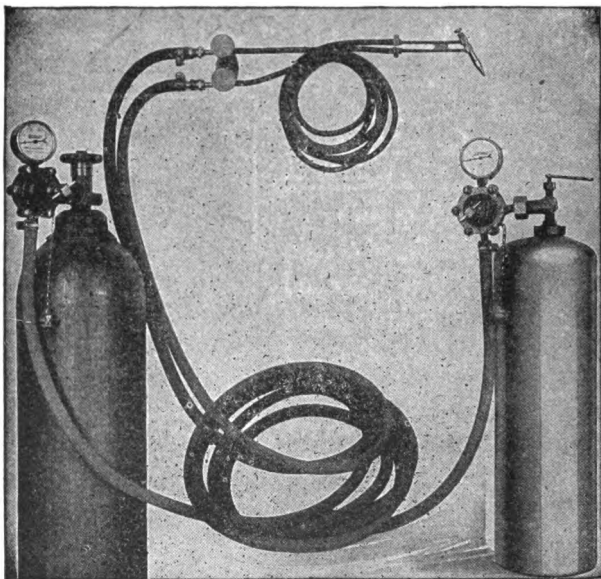

Fig. 84. Oxy-Acetylene Lead Burning Apparatus
Courtesy of Oxweld Acetylene Company, Chicago

ever, is rapidly supplanting the old method and, as a matter of fact, within two years it has become universally accepted as being far superior to the old method in handiness of operation, speed, and consequent economy, and has been adopted by the large battery makers in both their factories and service stations.

When an operator accustomed to the old flame tries the oxy-acetylene blowpipe, he is very likely to discredit it at first and claim that it is not satisfactory. However, every operator who gives the oxy-acetylene lead-burning blowpipe a fair trial and uses it in accordance with the methods recommended by the manufacturers

of the apparatus must acknowledge it as being superior to any method he has ever used. Its advantages are emphasized even more emphatically if he returns to the old, slower, and more costly methods.

Lead-Burning Apparatus. A complete lead-burning station for use with oxygen and acetylene, Fig. 84, consists of the following apparatus:

- Lead-burning blowpipe with set of tips
- Oxygen regulator with low-pressure gage
- Acetylene regulator with low-pressure gage
- Adapter for acetylene cylinder
- Valve-block
- Two lengths of high-pressure hose to connect regulators to valve block
- Two lengths of small hose to connect blowpipe to valve block

Lead-Burning Blowpipe. To make the blowpipe as light in weight and as handy as possible there are no large valves. Instead, a valve block is furnished for regulating the gases, which may be attached to a bench or a wall. In order to make minor or finer adjustments of the flame, and to allow various size tips to be used on the blowpipe and still maintain a perfect flame, an adjustable injector is provided at the top of the blowpipe within reach of the operator's fingers.

Tips. There are about five sizes of tips supplied for use on different thicknesses and various classes of work, each giving its own special size flame. The oxygen consumption of the various size tips ranges from $\frac{1}{2}$ to 6 cubic feet per hour. For storage-battery work the average consumption is about 2 cubic feet per hour.

Regulators. The regulators supplied with lead-burning apparatus operate on the same principle as the regulator described on page 19, the only difference being that they are of smaller size and especially adapted to small flames.

Operation of Lead-Burning Apparatus. The apparatus is connected in the same general manner as the welding apparatus for which instructions are given on pages 22 to 26. The needle valves on the valve block are used to obtain approximate adjustment of the flame, and then the small thumb-nut on the blowpipe is used to make the finer adjustment. The pressure-adjusting screws should be set to give pressures of about 10 pounds per square inch for the oxygen, and 2 pounds per square inch for the acetylene.

The blowpipe, regulators, hose, etc., should receive the same care and attention as the welding apparatus and for which suggestions are given on pages 18 to 21.

Lead-Burning Process. The oxy-acetylene blowpipe should be handled in such a manner that the flame strikes the work perpendicularly. If the blowpipe is used on a slant, the inner cone will not bring the work to the fusing temperature as rapidly as if held vertically, and the secondary flame, or outer envelope, will be very likely to heat the surrounding metal to such a temperature that it will give way and break under its own weight. When working with

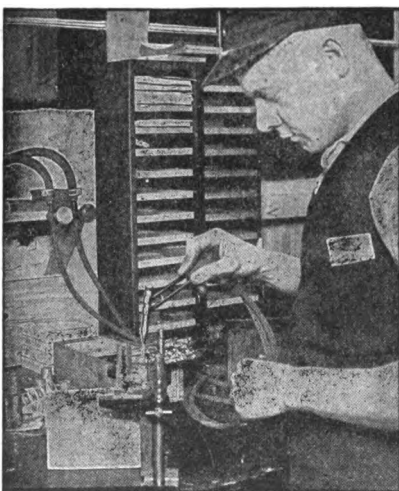

Fig. 85. Assembling Terminal Groups

the oxy-acetylene flame on storage batteries and the like, the operator should do the burning quickly. He should bring the flame down to the work, fuse the metal, add the necessary burning bar, or filling wire, smooth off the work, and remove the flame, all as rapidly as possible.

Burning Terminal Groups.

When burning plates to terminal bars, a small flame should be used, and the work should be held in a fixture, as shown in Fig. 85. The small ends on the plates should extend up into the terminal bar slots about two-

thirds of the way. The burning should be carried on by first fusing the ends of the plates to the bottom of the slots, then filling up the rest of the slot by adding lead from a coil of wire or a burning bar. After the several plates have been burned on in this way, the flame should be moved perpendicularly over the surface to smooth it off and leave a nice finish. The flame should *not be held flat* against the work. It will take longer to smooth off the work, and it will not have nearly as neat an appearance if the flame is used flat.

Burning-On Connecting Links. The terminal poles should extend up into the links about one-third of the way. The flame should be brought down into the hole until the inner cone almost

touches the top of the pole, and the pole fused and united with the bottom of the link as quickly as possible. After a good union has been secured in this manner, the burning bar should be introduced and the rest of the cavity filled up, Fig. 86. When working on links and poles it is advisable to do only part of one pole, move to another for a few minutes, and then come back to the first for a few minutes. This will allow the work to cool off slightly and will prevent breaking down or melting away. When burning this class of work, especially if the lead is old and pitted with dirt and cut by acid, it is advisable to increase the supply of oxygen and use an oxidizing flame when working down in the pocket. This will burn out any dirt and will prevent the blow-pipe from puffing out when it is burning in the rare atmosphere that exists in the pocket.

Forms or Molds. Small steel frames, or molds, are found very convenient, especially when working on terminal links. These molds are shaped to conform to the work and are placed around it while burning. They are a great help in preventing the corners of the work from break-

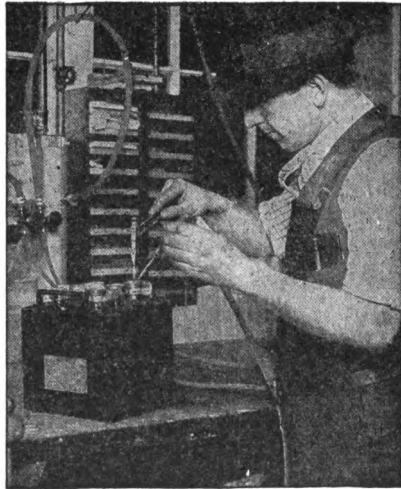

Fig. 86. Burning-On Connecting Links

ing down and melting away and, in this manner, relieve some of the tediousness of the work and allow the operator to work under less strain, and permit the work to be done by men who are not skilled lead burners, but who have occasional work of this sort to do.

CARBON REMOVING BY USE OF OXYGEN

Methods. Old Process. Up to within the last few years the methods used for removing the carbon from gas-engine cylinders were very impractical and unsatisfactory. To do this work meant the dismantling of the motor, the removal of all the parts, and the scraping of the cylinder walls by hand. Because this

operation necessitated a great deal of work it was not done, in most cases, until the carbon deposit became very heavy.

Oxygen Process. The introduction of the inexpensive process of removing the carbon by burning it out by means of pure oxygen has replaced the old methods and they are no longer used. This new process is so simple, necessitates so little work, can be done so quickly and cheaply, that it can be employed every few months and, in that way, keep the cylinders free from carbon.

Carbon-Removing Apparatus. Complete apparatus for removing carbon by means of oxygen, Fig. 87, consists of the following:

- Carbon-removing handle with flexible tube
- Oxygen regulator with low-pressure gage
- One length of high-pressure rubber hose

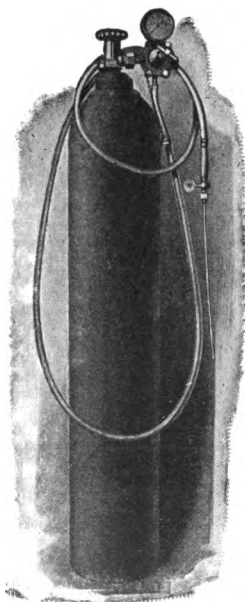

Fig. 87. Carbon-Removing Apparatus

It will be seen from this list that all that is necessary for a garage to have in addition to its welding equipment is the carbon-removing handle with a flexible tube.

Burning Out Carbon. Shut off the gasoline at the tank or just in front of the carburetor and allow the engine to run until it has sucked the gasoline out of the lines. Remove the valve caps and spark plugs from all the cylinders.

Turn the engine over by hand until the first piston is at the *upper end of its stroke* and both its *valves are closed*. Introduce a small quantity of kerosene into the cylinder head by means of an oil can or a piece of saturated waste. Light the kerosene in the cylinder, introduce the end of the flexible tube into the cylinder and allow the oxygen to play on the carbon at a pressure of about 5 pounds per square inch. The carbon deposit will catch fire and will continue to burn as long as there is carbon present. Of course, if the carbon is deposited in patches it will be necessary, after one patch has been removed, to start another by means of kerosene.

After the first cylinder has been thoroughly cleaned, turn the engine over by hand until the piston of the second cylinder is at

its upper stroke with its valves closed, and then proceed to remove the carbon from this cylinder in the same manner.

After all the cylinders have been thoroughly cleaned, clean the valve caps and spark plugs by scraping or by burning off the carbon and then replace them in the engine.

Notes on Carbon Burning. Before burning out the carbon be sure that there is no chance of gasoline being present which might cause back-firing into the intake manifold.

The oxygen pressure should not be too high. Only enough oxygen should be supplied to keep the carbon kindled. Too much pressure will waste oxygen and increase the cost of burning out the carbon.

Too much kerosene must not be used, because there is a chance of the operator burning his hands with the sudden burst of flame that might result.

EXAMPLES OF AUTOMOBILE REPAIR

Pressed-Steel Parts. All pressed-steel parts of automobiles, such as frames, bodies, fenders, axle housings, tubing, etc., should be welded, using a pure iron welding wire for a filling material.

Frames. Almost all frame repairs necessitate a certain amount of dismantling of other parts. The extent of the dismantling depends upon the location of the proposed weld. If the work is to be done under the body, it is best to remove the car body. This is not absolutely necessary, however, because the work can be done by merely jacking up the body several inches to give enough room to do the work, and protect the body from the heat of the welding flame. If the weld is to be done close to the radiator, this should be removed so that the solder will not be melted out, Fig. 88. If the weld is about 12 inches from the radiator, the solder can be protected by placing sheet asbestos over the radiator. In this connection it is well to remind the operator that it is always advisable to cover the parts of the car near the welding with sheet asbestos to protect them from any possibility of the flame or heat getting too close.

Jacks should be placed under the frame and the frame brought into alignment before the welding is started; the jacks should not be removed until the weld has been completed and has become thoroughly cooled.

It is always advisable to bevel the work by chipping. In the case of frames of light-weight pleasure cars this may be dispensed with if the operator is careful to penetrate through the thickness of the material. All paint, dirt, and grease must be scraped off next to the weld from both the inside and outside of the frame before the welding is commenced, to prevent dirt from being incorporated in the weld.

A reinforcing plate should be prepared about the same thickness as the frame, as wide as the frame is high, and about three times

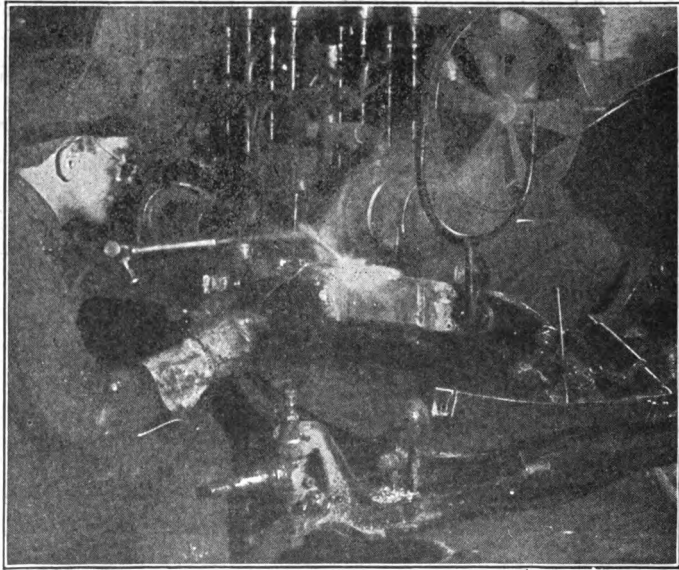

Fig. 88. Radiator Is Removed if Welding Flame Is Near It

as long as it is wide. This may be cut out of sheet steel by means of the cutting blowpipe, Fig. 82, page 77, or by means of a hack saw. The blowpipe is the quickest and easiest method, especially for cutting plates for curved frames such as are used on pleasure cars. The weld will look better if the reinforcing plate is welded on the inside of the frame, but in some cases that is impossible without a great deal of extra dismantling. It is then allowable to weld it on the outside.

The welding should start at the lower end of the frame and move upward as explained under Vertical Welding, page 31. The

two flanges of the channel should then be welded, starting at the corner and moving toward the edge. When welding the lower

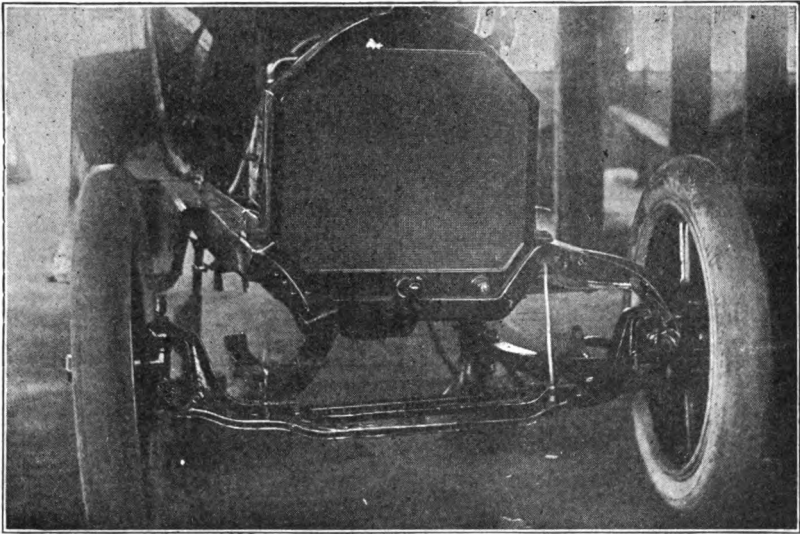

Fig. 89. Badly Bent Frame

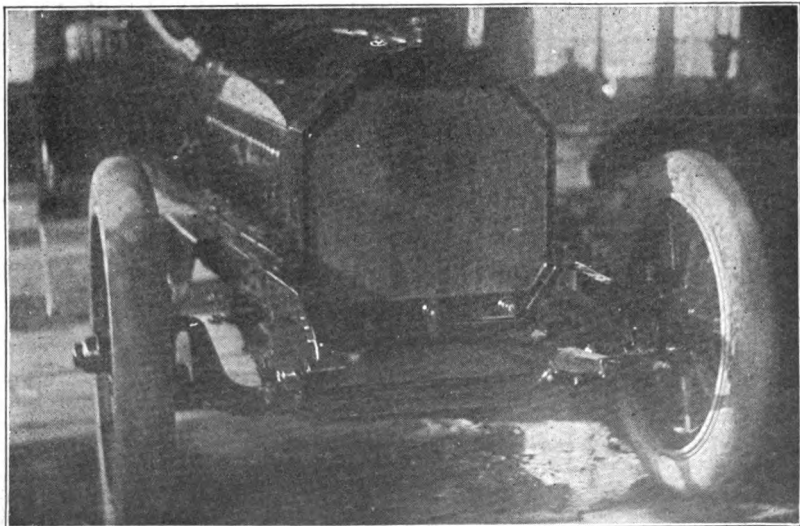

Fig. 90. Frame after Heating with Welding Flame and Straightening

flange, the work should be carried on as explained under Overhead Welding, page 31. After the frame has been welded, the reinforcing plate should be welded on by welding the horizontal edges first and the ends last.

The weld will be materially strengthened if it is hammered during the process of welding, as explained under Hammering, page 46.

The oxy-acetylene blowpipe is also very valuable in straightening

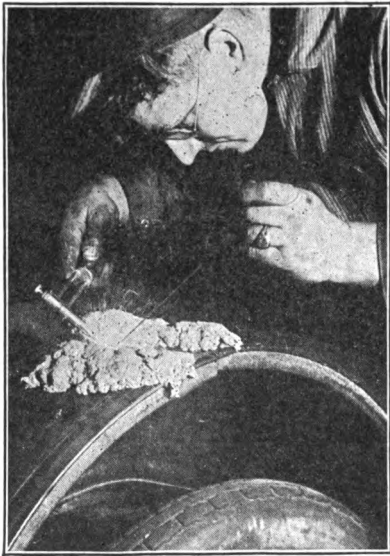

Fig. 91. Welding Torn Fender. Wet Asbestos along Weld Will Prevent Buckling of Light Sheets

frames that have become bent in accidents. A frame of this sort is shown before and after straightening in Figs. 89 and 90.

Bodies and Fenders. Bodies and fenders that have been torn can be successfully welded if the operator uses his best efforts and is careful.

Fenders, as a rule, do not present very much difficulty because the break usually extends to the edge. It is advisable to pack wet asbestos along both sides of the weld to prevent buckling as much as possible, Fig. 91. The wet asbestos will absorb the heat and will not allow it to be conducted back into the sheet.

Bodies should be welded in a similar manner when they are torn. If possible, it is advisable to bend the edges outward slightly before welding. Then, as the weld is cooling, hammer it flat to compensate for the contraction that takes place.

If a patch must be welded in, it should be prepared either round or oval, or should have rounded corners of large radii. The patch should be dished to compensate for the contraction that will take place when the work cools. The hole in the body and the patch should be trimmed so as to fit well. When the patch is ready, it should be tacked in place. The welding should be carried on as quickly as possible. After the weld has

been completed, the flame should be played on it to heat it evenly. As the weld starts to cool, the center of the patch should be heated

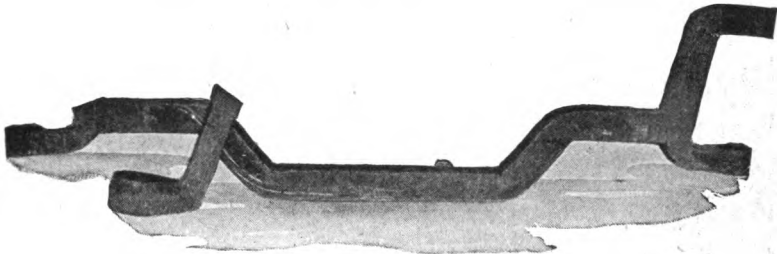

Fig. 92. Broken Front Axle

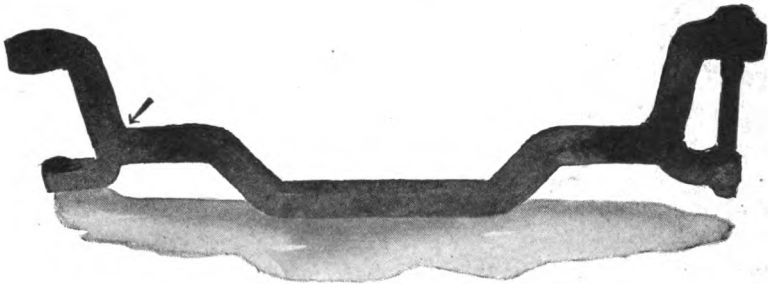

Fig. 93. Welded Front Axle

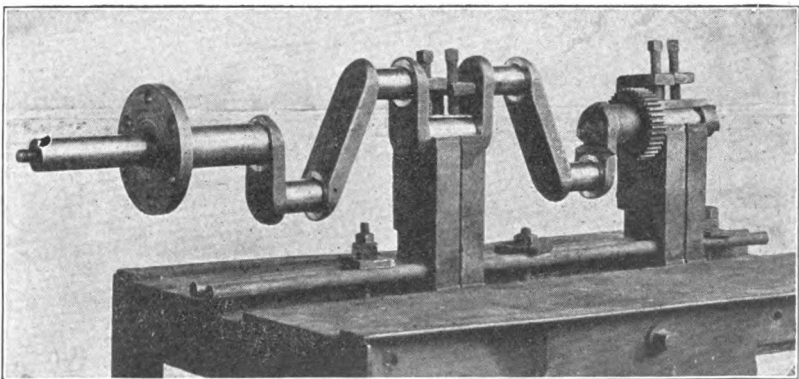

Fig. 94. Crankshaft in Crankshaft Jig Table for Welding

slightly so that it will stretch easily and compensate for the contraction taking place in the weld.

Springs. The welding of springs should not be attempted except for emergency repairs to allow the car to be used until a new spring can be obtained. A steel welding rod of low-carbon content

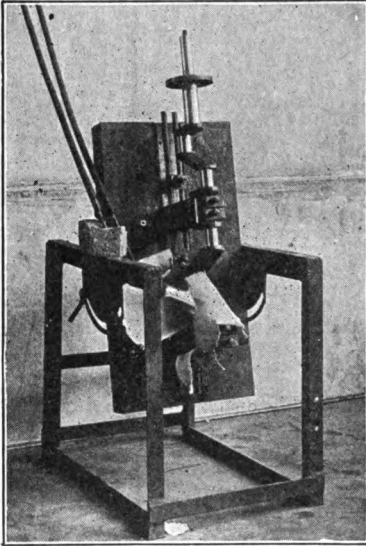

Fig. 95. Pre-Heating Crankshaft with Gas Burner

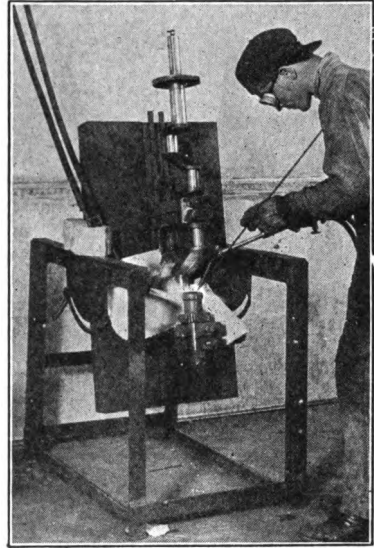

Fig. 96. Welding Crankshaft. Note that the Pre-Heating Burner Is Used to Assist the Welding Flame

should be used for filling material. No attempt should be made to re-temper the spring, because the average garage is not equipped to handle work of that nature and, consequently, the spring is very

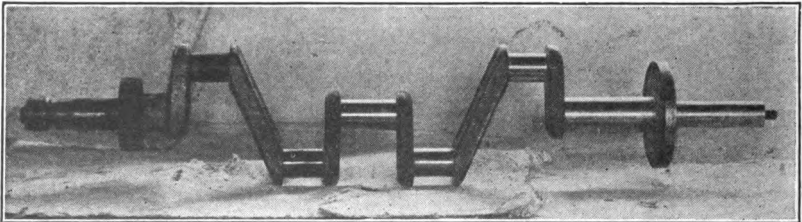

Fig. 97. Welded Crankshaft

likely to be worse if a poor job of tempering is done than if tempering is not attempted. It is well to pack wet asbestos around the spring next to the weld to prevent the heat being conducted back into the rest of the spring.

Shafts and Axles. Shafts and axles are alloys of nickel, nickel and chromium, or chromium and vanadium. It is desirable to have the filling material of the same composition as the shaft or axle, but this is practically impossible. The most suitable welding rod

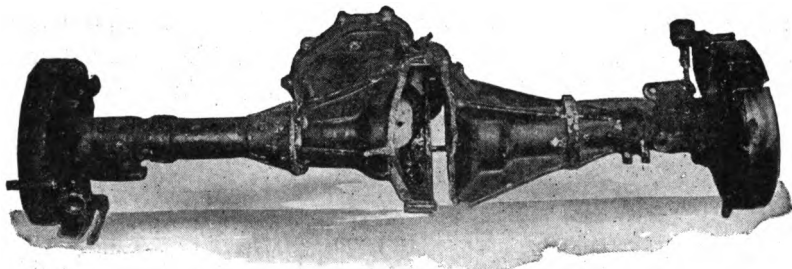

Fig. 98. Broken Malleable-Iron Rear-Axle Housing

that can be obtained for this work is one containing about 3.50 per cent nickel, or one containing about 0.20 per cent vanadium and 0.12 per cent chromium. This latter steel is more difficult to handle under the welding flame, so that most welders prefer the 3.50 per cent nickel rod.

Square shafts, Figs. 92 and 93, and round shafts, Fig. 80, page 76, should both be beveled by means of the cutting blowpipe or by grinding, and should then be placed in alignment or in suitable jigs, Fig. 94. A gas or oil pre-heating burner should then be directed

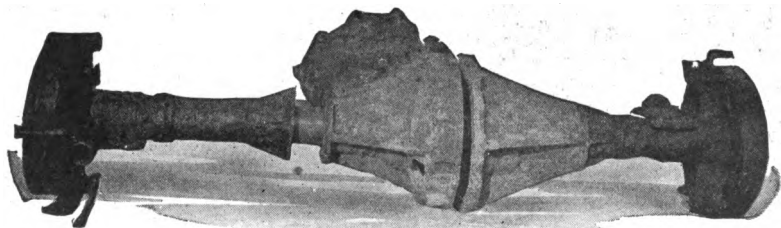

Fig. 99. Repaired Malleable-Iron Rear-Axle Housing

on the point of welding, Fig. 95, and the work heated to a red heat before welding is started. The welding should then be carried on, Fig. 96, according to the instructions given under Welding Heavy Sections, page 58. After the welding has been completed the work should be reheated and any straightening done that is necessary.

The weld should then be heated up evenly, covered over with sheet asbestos, and allowed to cool slowly. The finished weld is shown in Fig. 97.

Axle Housings. If the housing is of pressed steel, it will not present any particular difficulty to the welder, except that he will have to take care that it does not get out of alignment. A pure iron welding wire should be used, and the work should be prepared and carried on as explained under Light Sheet-Steel Welding, pages 46 to 50

If the housing is of malleable iron, Figs. 98 and 99, it should be beveled, placed in alignment, and then *brazed*, using Tobin bronze



Fig. 100. Welding Broken Flange on Manifold

for a filling material as explained under Malleable-Iron Welding, page 67. The work may be pre-heated slightly to relieve the effect of expansion and contraction, but *must not be heated above a dark red*. The operator must be very careful to not bring the malleable iron at the weld to too high a heat or its malleable properties will be destroyed and the housing will be weak.

Manifolds. Pressed-steel manifolds should be welded according to the

directions given under Light Sheet-Steel Welding, pages 46 to 50.

Cast-iron manifolds, as a rule, have only simple breaks to be repaired, such as broken flanges, Fig. 100. These should be beveled, and the parts clamped to a flat surface to keep them straight. They should then be pre-heated in the vicinity of the weld by means of the welding blowpipe before the welding is started. After the weld is completed they should be reheated evenly and then covered over and allowed to cool slowly.

Engine Cylinders. If the water jacket is cracked, the crack should be chipped out and the surface of the casting next to the groove should be cleaned by scraping. If the cylinder is cracked in

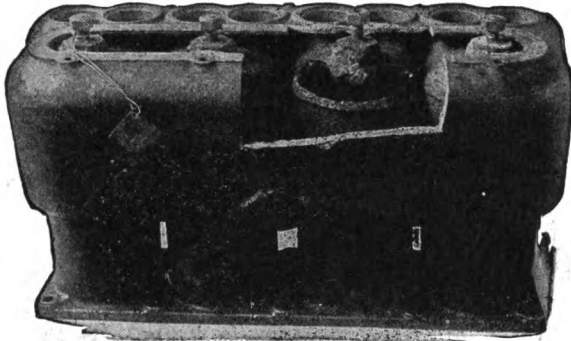

Fig. 101. Water Jacket Cut Away to Allow for Welding Cylinder Wall

the head end, it will be necessary to cut away a section of the water jacket by drilling or sawing, Fig. 101. After the cylinder head has been welded, the water-jacket section can be welded back into place, Fig. 102. Sometimes it is quite difficult to detect how far the crack really extends, therefore, care must be taken to be sure that it is chipped out its entire length.

All of the plugs and other fittings must be removed from the cylinders before pre-heating. The cylinders should be placed in

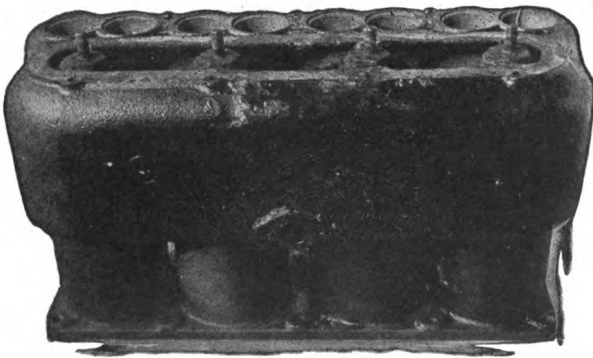

Fig. 102. Cylinder Wall Welded and Section of Water-Jacket Replaced

the pre-heating fire with the open end of the cylinder upward, Fig. 103. They may be placed on a slant if the crack is on the side of the water jacket; but they must be in such a position so there

will be no chance for dead air to remain in them. If this precaution is not taken, the cylinder walls are very likely to crack.

The welding should be carried on according to the directions given under Cast-Iron Welding, pages 59 to 67. The cylinders must be left in the charcoal fire all during the welding. It is even advisable to keep the top of the fire covered over and to weld through a hole in the asbestos paper, Fig. 103, to prevent air currents from striking the cylinder while it is hot. After the welding has been

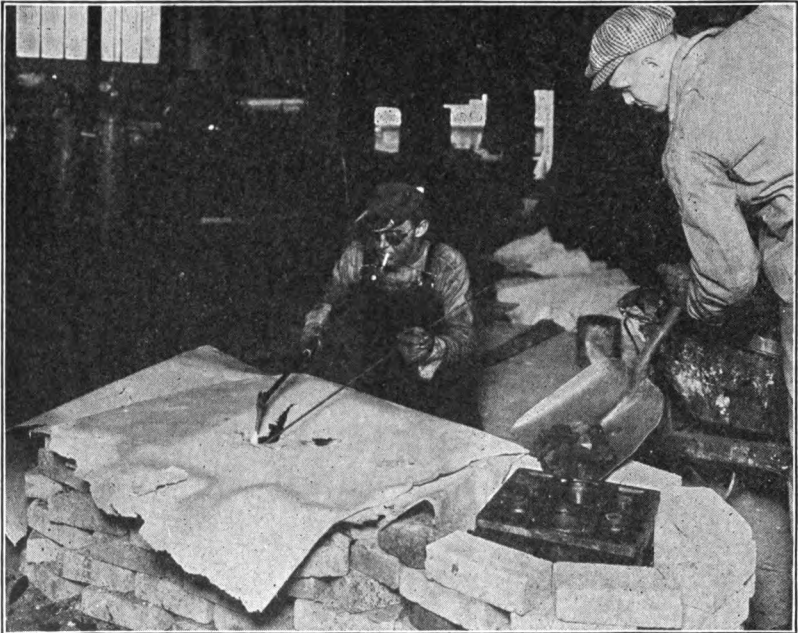

Fig. 103. Welding Cylinders and Preparing Pre-Heating Fire for Cylinders

completed, the fire should be started up enough to heat the entire casting evenly, and should then be covered over and allowed to die out. The cylinder must not be removed until it has become cold enough to be handled with bare hands.

Protection for Machined Surfaces. The finish in the bore of the cylinder will be affected by the heating if some means is not used to protect it. The best protection that can be used is to coat it and other machined surfaces with flaked graphite and oil. This can be made into a paste and painted on, or the surfaces can be oiled

and the graphite dusted on. The latter method is really the best if carefully applied. The graphite must be coarse; the fine flake will not do.

Testing Welded Cylinders. There are several ways of testing welded cylinders. The two most generally used are by water pressure and by gasoline. In the first method, the water jacket is tightly plugged, filled with water, and then subjected to pressure by means of a hand pump. The method of using gasoline is simpler and quicker. The water jacket is plugged and filled with gasoline, Fig. 104. If there are any cracks or leaks the gasoline will work its way through and will spread out over the surface surrounding the crack or leak.

Crankcases and Transmission Cases. It is usually necessary to remove the case from the car. But, if the arm is broken some distance from the main case, it may be welded while in position, as shown in Fig. 105. When welding in this manner, it is necessary to cover the parts near the welding with asbestos sheets to protect them from the flame of the blowpipe. The arm should be

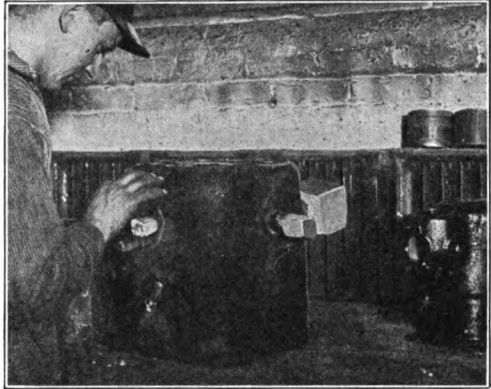

Fig. 104. Water Jacket Plugged and Welds Being Tested with Gasoline

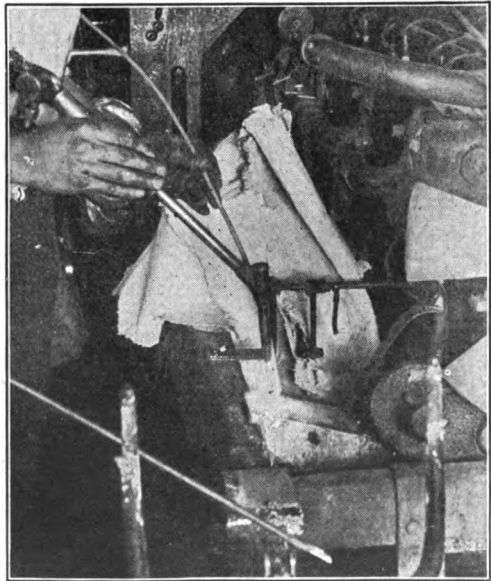

Fig. 105. Welding Arm of Crankcase without Dismantling

pre-heated slightly by means of the welding blowpipe before the actual welding is started, and, after the welding has been completed, it should be reheated to relieve any internal strains, and must then be covered over to allow it to cool slowly.

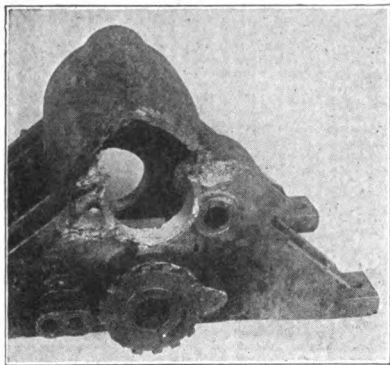

Fig. 106. Badly Broken Transmission Case—
Must Be Pre-Heated All Over

Some operators spend a great deal of time trying to keep the bearing of the case in line, and while doing this they allow the rest of the case to twist, so that it is necessary to take a machine cut off the edges in order that they may fit the other half of the case. It is much better to keep the edges true and dress up the bearings, because it is quite likely that the bearings will have to be trued up anyway. The case should be clamped flat against two straightedges, but not too tight, or the case might crack from the strains produced when heat is applied.

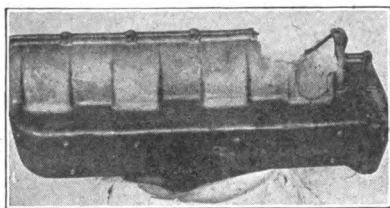

Fig. 107. Lower Half of Crankcase with Piece
Broken Out—Must Be Entirely Pre-Heated

The case should be placed on the welding table in such a position that the welder can work on the outside and smooth off the inside without having to disturb its position.

The most satisfactory method of pre-heating is to place

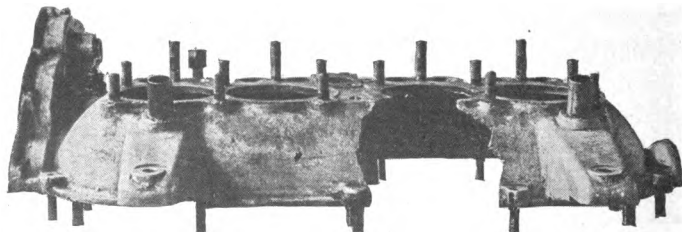

Fig. 108. Upper Half of Crankcase with Piece Broken Out and Missing

a gas burner under the case and let it burn *without an air blast*. If an air blast is turned on, the case is liable to become overheated and

cave in. In fact, unless there are holes to allow some of the heat to escape, the case is liable to become overheated with only the soft gas flame. If the case is broken at one end, as shown in Fig. 108, it is only necessary to heat the one end; but it is very necessary to heat both sides of that end to prevent warping. If like the case shown in Figs. 106 or 107, it is best to heat the entire case. This can best be done by using two gas burners so that the heat will surely spread.

If the case is cracked or a piece is broken off, the welding should start at the inner end of the crack and move toward the edge or corner. The welding should be carried on as directed under Cast Aluminum Welding, page 71.

If a piece has been broken out and lost necessitating building

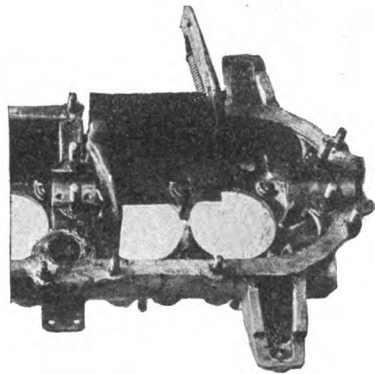
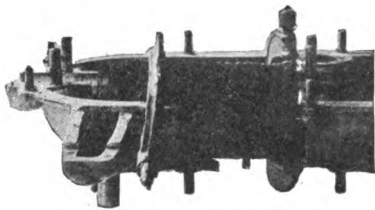

Fig. 109. Sheet-Iron Form to Back Up Section to Be Welded-In

up a section of the casting, Fig. 108, it is necessary to back-up the work by means of a piece of sheet iron bent to the required shape, Fig. 109. The welding should be started at one edge and should move across the space in a line parallel to the edge. When the added material gets almost to the opposite edge, the welding should stop, the edge of the case and the edge of the new added section should be cleaned, and then the weld completed in the same manner as for welding up a crack, Fig. 110, as outlined above.

COSTS

The cost of welding varies within wide limits for the different metals and the different classes of work. It is, therefore, not possible to give cost tables that will apply to all work. The costs given in Tables II and III are for steel work under fair conditions.

Measuring Oxygen Consumption. Oxygen is supplied compressed to 1800 pounds per square inch, in cylinders containing

TABLE II
Welding Cost Table

Thickness of Metal (in.)	Speed (ft. per hr.)	Oxygen per Linear Foot (cu. ft.)	Acetylene per Linear Foot (cu. ft.)	Cost per Linear Foot Labor 45c Oxygen 2c Acetylene . . 2½c
$\frac{1}{8}$	26	0.15	0.14	\$.024
$\frac{1}{4}$	22	0.22	0.21	.030
$\frac{3}{8}$	17	0.43	0.41	.045
$\frac{1}{2}$	14	0.68	0.65	.063
$\frac{5}{8}$	11½	1.03	0.98	.083
$\frac{3}{4}$	9	1.84	1.74	.13
$\frac{7}{8}$	7	3.01	2.88	.20
1	4½	6.74	6.44	.40
1½	3	13.2	12.5	.73
2	1½	38.7	37.0	2.00
3	1	76.7	72.9	3.81

TABLE III
Cutting Cost Table

Thickness of Metal (in.)	Speed (ft. per hr.)	Oxygen per Linear Foot (cu. ft.)	Acetylene per Linear Foot (cu. ft.)	Cost per Linear Foot Labor 45c Oxygen 2c Acetylene . . 2½c
$\frac{1}{8}$	90	0.34	0.10	\$.014
$\frac{1}{4}$	74	0.55	0.17	.021
$\frac{3}{8}$	55	1.16	0.33	.040
$\frac{1}{2}$	46	1.91	0.47	.060
1	40	2.75	0.61	.082
1½	33	4.70	0.85	.13
2	29	6.97	1.06	.18
3	24	12.3	1.46	.30
4	20	19.4	1.96	.46
6	15	38.3	3.04	.87
8	11	69.7	4.60	1.55

TABLE IV
Factors for Correcting Oxygen Volumes

Deg. F.	Factor	Deg. F.	Factor	Deg. F.	Factor
100	0.929	75	0.972	50	1.020
95	0.937	70	0.981	45	1.030
90	0.946	65	0.990	40	1.040
85	0.954	60	1.000	35	1.051
80	0.963	55	1.010	30	1.061

100 and 200 cubic feet. The amount of oxygen in a cylinder can be measured quite accurately by means of the high-pressure gage on the regulator. Most of these gages are supplied with two rows

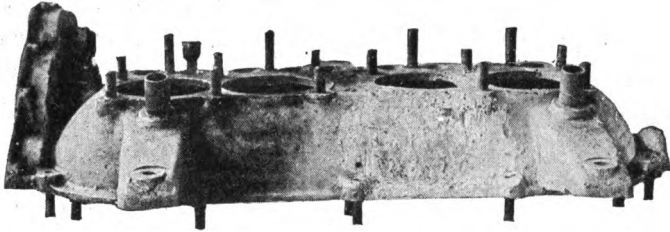

Fig. 110. Upper Half of Crankcase with Section Built-In

of figures on the dial, Fig. 111. The outer circle gives the pressure in the cylinder in pounds per square inch, and the other circle gives the per cent of oxygen remaining in the cylinder. The latter set of numbers makes the calculation very easy: e.g., if a 100-cubic foot cylinder is being used and the gage hand indicates 73, there is 73

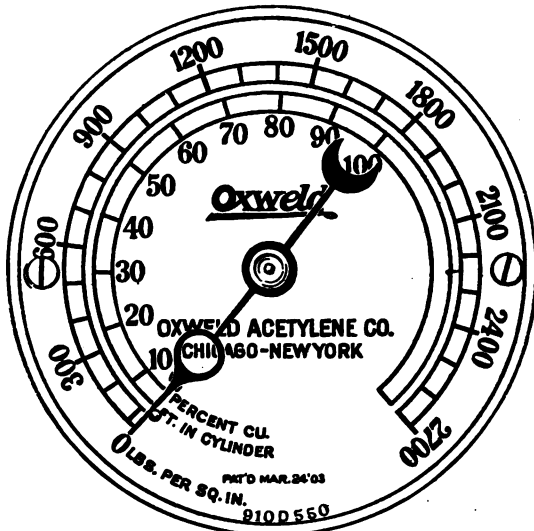

Fig. 111. Dial of High-Pressure Gage of Oxygen Regulator

cubic feet of oxygen in the cylinder. If a 200-cubic foot cylinder is being used, there is $200 \times 0.73 = 146$ cubic feet in the cylinder. The amount of oxygen indicated by the gage reading is more or less approximate and depends upon the temperature of the oxygen in the

cylinder. The correction factors given in Table IV should be used to determine the volume of the oxygen at "standard temperature", 60° F., if an accurate measurement is required, e.g., if in the case given above the temperature is 50° F., then the real volume at standard temperature would be $146 \times 1.020 = 148.9$ cubic feet.

Measuring Acetylene Consumption. The amount of acetylene in a cylinder cannot be determined by means of the high-pressure gage. All the high-pressure gage can be used for, in the case of acetylene, is to indicate very roughly the amount of acetylene in the cylinder. There is only one method that can be used to determine the amount of acetylene used, and that is to weigh the cylinder. Each pound by weight of acetylene is equal to 14.5 cubic feet. Therefore, to determine the amount of acetylene used on a certain job, it is necessary to weigh the cylinder before and after welding and calculate the volume of acetylene used from the difference in weight, e.g., if the cylinder weighs 217 pounds before welding and $207\frac{1}{2}$ pounds after welding, then $(217 - 207\frac{1}{2}) \times 14.5 = 9\frac{1}{2} \times 14.5 = 137.7$ cubic feet.

INDEX

INDEX

A

	PAGE
Acetylene.....	4
consumption.....	102
cylinders.....	4
generators.....	5
Adhesion.....	33
After-treatment.....	45, 66, 70, 72, 74, 76
Aluminum welding.....	68
cast.....	71
sheet.....	69
Annealing.....	45
Automobile repair, examples.....	87
axle housings.....	94
bodies and fenders.....	89
crankcases and transmission cases.....	97
engine cylinders.....	95
frames.....	87
manifolds.....	94
pressed-steel parts.....	87
shafts and axles.....	93
springs.....	92

B

Back-firing.....	24
Blowholes.....	66
Blowpipe.....	7, 16
how to light.....	23
how to shut off.....	23
inclination.....	27
injector.....	7
manipulation.....	28, 44, 63
position.....	27
pressure.....	7
Brass welding.....	74
Bronze welding.....	74
Butt weld.....	49, 54

C

Carbon removing by use of oxygen.....	85
Carbon blocks.....	67
Cast-iron welding.....	59
Charcoal fire.....	43
Connecting apparatus, instructions for.....	22

INDEX

	PAGE
Copper welding	72
Corner welds	50, 54
Costs	99
Cutting	10, 76
apparatus	78
principle	77
Cylinder welding	49, 54

D

Defects in welds	32
------------------------	----

E

Electric welding	11
apparatus	13
arc welder	12
spot-welder	11
Expansion and contraction	8, 36, 43, 46, 53, 58, 60, 68
complex case	39
methods of handling	37
simple case	37

F

Flange weld	49
Flux	9, 61, 69, 73, 75

G

Generators	5
low-pressure	5
pressure	6
Graphite electrode	13

H

Hammering	9, 46, 59
Holes, welding up	31
Hose	21

J

Jigs	47
------------	----

L

Lead burning	81
apparatus	83

M

Malleable-iron welding	67
Metallic electrode	13
Metals, properties of	34

INDEX

	O	PAGE
Overhead welding.....		31
Oxidation.....	32, 43, 59, 68, 72, 74	74
Oxy-acetylene flame.....	8, 24, 44, 69, 73, 75	75
Oxy-acetylene process.....		3
advantages.....		3
Oxygen.....		3
consumption.....		99

P

Penetration.....		33
Pipe welding.....		56
Pre-heating.....	40, 60, 71	71
methods.....		41
reasons.....		40
Preparation of work for welding.....	8, 14, 46, 51, 57, 62, 71, 73, 75	75

R

Regulators.....		19
acetylene.....		20
care.....		21
cutting.....		79
operation.....		19
oxygen welding.....		20
Reinforcing welds.....		34
Re-welding.....	70, 74, 76	76
Rods.....	8, 29, 44, 60, 68, 72, 75	75

S

Spot-welder.....		11
Steel welding.....		43
castings.....		57
forgings.....		57
heavy sheet.....		51
light sheet.....		46
Strength of welds.....		9

T

Tables.....		
cutting cost table.....		100
factors for correcting oxygen volumes.....		100
properties of metals.....		35
welding cost table.....		100
Tacking.....		47
Tank welding.....	51, 55, 56	56
Tube welding.....		51, 56

V

Vertical welding.....		31
-----------------------	--	----

INDEX

	W	PAGE
Welding		15
brass		75
bronze		75
cast aluminum		71
cast-iron		63
copper		73
heavy sheet-steel		53
light sheet-steel		48
malleable-iron		68
sheet-aluminum		70
steel castings		58
steel forgings		58
Welding processes		1, 63
electric		11
old and new methods		1
oxy-acetylene		3

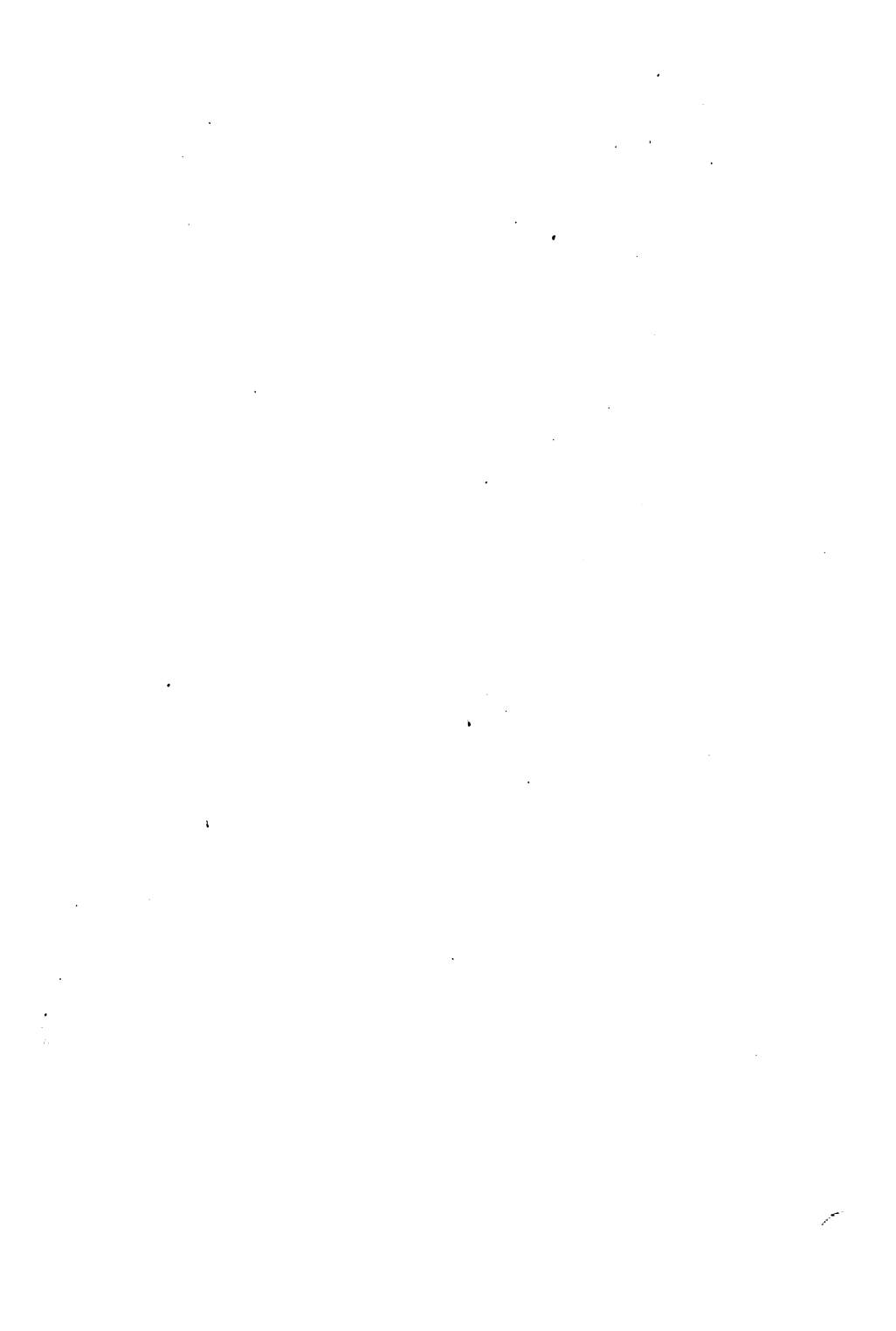

89089663702

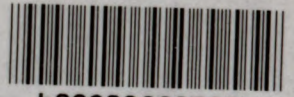

b89089663702a