

ELECTRIC WELDING AND
WELDING APPLIANCES

CARPMAEL

D. VAN NOSTRAND COMPANY
PUBLISHERS NEW YORK

THE ENGINEER SERIES

**ELECTRIC WELDING AND
WELDING APPLIANCES**

"THE ENGINEER" SERIES

What Industry Owes to Chemical Science. By RICHARD B. PILCHER and FRANK BUTLER-JONES, B.A. With an Introduction by SIR GEORGE BEILBY, LL.D., F.R.S. Crown 8vo.

The Production and Treatment of Vegetable Oils. By T. W. CHALMERS, B.Sc., A.M.I.MECH.E. Imperial 8vo. 9 Folding Plates, 95 Illustrations.

Paper Making and its Machinery. By T. W. CHALMERS. Imperial 8vo. Illustrated.

Electric Welding and Welding Appliances. By H. CARPMAEL. Imperial 8vo. Illustrated.

THE ENGINEER SERIES

ELECTRIC WELDING AND WELDING APPLIANCES

BY

HERBERT CARPMAEL, A.M.INST.C.E., A.M.I.E.E.

(ON THE EDITORIAL STAFF OF "THE ENGINEER")

WITH 84 DRAWINGS AND
OTHER ILLUSTRATIONS

NEW YORK
D. VAN NOSTRAND COMPANY

1920

Printed in Great Britain.

232588
OCT -5 1920

TDH
C22

6931396

PREFACE

THE chapters which go to make up this book are reprints,—almost *verbatim*, the editorial “ we ” even having been retained,—of articles which appeared in *The Engineer* during the present year. The first was published on February 14th and the last on August 29th.

To the average individual, perhaps, electric welding appears to be an outcome of the War ; an expedient rendered necessary by the insistent demand for the speeding up of production by all available means. As a matter of fact various processes of welding by the aid of the electric current, notably carbon arc welding, have been in commercial operation for a quarter of a century or more, this country having been among the first to adopt and develop some of them. Some of them, too, had, long before the War, been much in vogue both on the Continent and in the United States of America. In the case of the latter country electric welding had, for years before the outbreak of hostilities, been most successfully resorted to for many purposes to a considerable extent, especially for repair work on railway rolling stock. Sweden, among countries on this side of the Atlantic, may be cited as being in the forefront in the employment of electric welding for ship repairing.

Nevertheless it is quite true that the War gave such an impetus to the use of the newer method of welding as many years of endeavour during times of peace would have failed to impart to it. Moreover, the War greatly enlarged the sphere of its application, and was instrumental in bringing home to our manufacturers what a powerful agent was the electric current for the carrying out of certain types of work. As a consequence it has, nowadays, become the rule, rather than the exception, to find electric welding plants in our factories, and there appears to be every probability of such plants being even more extensively employed than they are at present. Furthermore, the War has undoubtedly had the effect of developing and improving the machines and appliances which both arc and resistance welding call for.

The central idea around which the articles were written for *The Engineer* was to impart to the readers of that Journal a good general knowledge of the different systems of electric welding which have been evolved and of the various machines and pieces of apparatus which are required or are desirable for their efficient operation. No attempt was made to go, in detail, into the history of the subject, though certain historical matters are referred to. Nor was it sought to provide a handbook to the subject by giving minute instructions as to the correct manner in which to work the various systems. To have done either, or both, would have entailed the introduction of a vast amount of matter which would have resulted in the enlargement of the volume to unwieldy dimensions, as well as in the production of a sense of weariness in the mind of the reader, who, if he intends to adopt electric welding, in one or other of its various forms, will naturally seek for practical instruction in the manner of working it, which it is, of course, impossible adequately to convey in a book. Again, it was considered undesirable to endeavour to enumerate, at length, the possible

applications of electric welding. Such an effort would have proved to be a futile task since the number of such applications multiplies from day to day. Yet it will be found that mention has been made of such a varied selection of applications as will enable the reader to form a very fairly accurate conception of the wide area which has already been covered.

It should be borne in mind that, though discovered in the middle eighties, and though usefully employed ever since that time, electric welding, as a science, has really, as yet, scarcely passed its infancy. It is very certain that the future—possibly the very near future—will witness great developments in connection with it. Nevertheless, it does not appear to be likely that there will be any great fundamental departure from the general principles, either of arc or resistance welding, which it has been the endeavour of the author to deal with in this volume.

H. C.

LONDON, *November*, 1919.

CONTENTS

	PAGE
CHAPTER I	
INTRODUCTION	1
CHAPTER II	
THE BENARDOS CARBON ARC PROCESS	8
CHAPTER III	
RESISTANCE WELDING	14
CHAPTER IV	
ARC WELDING AT A STEEL BARREL WORKS	19
CHAPTER V	
THE PONTELEC METHODS AND MACHINES	25
CHAPTER VI	
THE QUASI-ARC PROCESS	33
CHAPTER VII	
RESISTANCE WELDERS OF THE BRITISH INSULATED AND HELSBY CABLES, LTD.	39
CHAPTER VIII	
MACHINES AND APPARATUS FOR ARC WELDING	49
CHAPTER IX	
MACHINES AND APPARATUS FOR ARC WELDING (<i>continued</i>)	58
CHAPTER X	
MACHINES AND APPARATUS FOR ARC WELDING (<i>continued</i>)	65
CHAPTER XI	
(1) RESISTANCE WELDERS OF THE ELECTRIC WELDING CO., LTD.	75
(2) SOME LARGE AMERICAN "SPOT" WELDERS	78
CHAPTER XII	
OIL-DRUM-MAKING BY RESISTANCE WELDING	84
CHAPTER XIII	
RESISTANCE WELDERS OF THE A I MANUFACTURING CO., LTD.	89

CONTENTS

	PAGE
CHAPTER XIV	
THE STRENGTH OF ELECTRIC WELDS	97
CHAPTER XV	
A LARGE BRITISH "SPOT"-WELDING MACHINE	103
CHAPTER XVI	
THE "PLASTIC-ARC" WELDING SYSTEM	108
CHAPTER XVII	
THE "A.C." SYSTEM OF ARC WELDING	117
INDEX	123

LIST OF ILLUSTRATIONS

FIG.	PAGE
1. HELMET FOR ARC WELDING	5
2. EXAMPLES OF WELDING (BENARDOS)	9
3. THE BENARDOS ELECTRODE HOLDER	9
4. DEVICE FOR "POINT" WELDING (BENARDOS)	10
5. THE "ELECTRIC FORGE" (BENARDOS)	10
6. DEVICE FOR CONTINUOUS OR FOR "POINT" WELDING (BENARDOS)	11
7. SUGGESTED FORMATION OF ARMOUR PLATE (BENARDOS)	12
8. DIAGRAM OF THOMSON WELDING SYSTEM	16
9. DIAGRAM SHOWING PRINCIPLE OF "SPOT" WELDING	16
10. DIAGRAM SHOWING PRINCIPLE OF "SEAM" WELDING	17
11. DIAGRAM SHOWING "BUTT" WELDING OF TYRES	17
12. JOINT WELDED BY ACETYLENE	19
13. CARBON ELECTRODE HOLDER (T. T. HEATON)	20
14. WELDING-IN THE END OF A BARREL	23
15. PUTTING ON STIFFENING RING TO A BARREL	24
16. "PONTELEC" RESISTANCE WELDER	26
17. MACHINE FOR BRAZING COLLARS ON TUBES ("PONTELEC")	28
18. SPECTACLE-FRAME SOLDERING MACHINE ("PONTELEC")	29
19. TYPICAL "PONTELEC" "SPOT" WELDER	30
20. "SPOT" WELDER FOR BENCH WORK ("PONTELEC")	30
21. "PONTELEC" "BUTT" WELDER	31
22. TYPICAL "PONTELEC" "SEAM" WELDER	32
23. DIAGRAM ILLUSTRATING "QUASI-ARC" WELDING	34
24. WELDED RIVETED JOINT	35
25. B.I.W. "BUTT" WELDER, NO. 57	40
26. B.I.W. CHAIN-LINK-FORMING MACHINE	41
27. B.I.W. "BUTT" WELDER	43
28. B.I.W. CHAIN WELDER	43
29.)	
30.) EXAMPLES OF B.I.W. "SEAM" WELDERS	45
31.)	
32. GROUP OF B.I.W. NO. 13 "SPOT" WELDERS	47
33. WESTINGHOUSE ARC WELDING EQUIPMENT ON A MOTOR LORRY	50
34. DIAGRAM OF CONNECTIONS OF WESTINGHOUSE GENERATOR FOR ARC WELDING	51
35. ARRANGEMENT OF PREMIER ELECTRIC WELDING CO.'S PORTABLE WELDING SET	53
36. PREMIER WELDING SET IN CABIN	54
37. PORTABLE PLANT OF THE PREMIER ELECTRIC WELDING COMPANY	55
38. LANCASHIRE DYNAMO AND MOTOR CO.'S ARC WELDING SET	56
39. CONNECTIONS OF LANCASHIRE DYNAMO AND MOTOR CO.'S ARC WELDING SET	57
40. THE DAVIES-SOAMES (DAYSOHMS) ELECTRO-MAGNETIC DIFFERENTIAL CLUTCH	59
41. THE DAVIES-SOAMES CLUTCH CONNECTING A MOTOR TO A GENERATOR	60

FIG.		PAGE
42.	DAVIES-SOAMES CLUTCH ARRANGED FOR ARC WELDING	61
43.	DIAGRAM OF CONNECTIONS OF DAVIES-SOAMES CLUTCH	62
44.	ELECTRIC CONNECTIONS OF "CONSTANT-ENERGY" BALANCER SET	63
45.	HOLMES PORTABLE GENERATING SET FOR ARC WELDING	66
46.	HOLMES RESISTANCE FRAME FOR ARC WELDING	67
47.	TILLING-STEVENS LORRY EQUIPPED FOR ARC WELDING	68
48.	TILLING-STEVENS ARC WELDING LORRY—INTERIOR	69
49.	TILLING-STEVENS ARC WELDING LORRY—DRIVER'S SEAT	70
50.	TILLING-STEVENS ARC WELDING LORRY	71
51.	CROMPTON SELF-CONTAINED ARC WELDING SET	72
52.	CROMPTON MOTOR GENERATOR SET FOR ARC WELDING	73
53.	EQUIPMENT AND ENGINEERING CO.'S ELECTRODE HOLDERS	73
54.	ELECTRIC WELDING CO.—"BUTT" WELDER FOR TUBES, RODS, ETC.	76
55.	ELECTRIC WELDING CO.—"BUTT" WELDER WITH RADIAL WELDING BLOCKS	76
56.	ELECTRIC WELDING CO.—"BUTT" WELDER FOR MISCELLANEOUS REPAIR WORK	77
57.	ELECTRIC WELDING CO.—"BUTT" WELDER FOR STRIPS, ETC.	79
58.	ELECTRIC WELDING CO.—"BUTT" WELDER FOR HOOPS, RINGS, ETC.	79
59.	AMERICAN "SPOT" WELDER FOR SHIP WORK	80
60.	LARGE AMERICAN DUPLEX "SPOT" WELDER	81
61.	ELECTRICAL ARRANGEMENTS OF DUPLEX WELDER	82
62.	"A 1" "SPOT" WELDER	90
63.	"A 1" AUTOMATIC SWITCH	91
64.	"A 1" "BUTT" WELDER	93
65.	"A 1" "BUTT" WELDING ATTACHMENT	94
66.	"A 1" "SEAM" WELDING ATTACHMENT	95
67.	WELDED AND RIVETED JOINTS	101
68.	LARGE "PONTELEC" "SPOT" WELDER, WITH STAKES ARRANGED HORIZONTALLY	103
69.	LARGE "PONTELEC" "SPOT" WELDER, WITH STAKES ARRANGED VERTICALLY	104
70.	LARGE "PONTELEC" "SPOT" WELDER—UPPER AND LOWER STAKES OR ARMS	105
71.	LARGE "PONTELEC" "SPOT" WELDER—ARRANGEMENT OF ELECTRODE SLIDE	106
72.	LARGE "PONTELEC" "SPOT" WELDER—ARRANGEMENT OF TRANSFORMER	106
73.	S.S. <i>George Washington</i> —FRACTURED CIRCULATING-PUMP CASING	109
74.	S.S. <i>Prinz Joachim</i> —BROKEN CYLINDER-HEAD AND BROKEN LOW-PRESSURE CYLINDER	109
75.	S.S. <i>Kaiser Wilhelm II</i> —FRACTURED LOW-PRESSURE CYLINDER LINER	110
76.	S.S. <i>Friedrich der Grosse</i> —BROKEN STEAM INTAKE, SECOND INTERMEDIATE CYLINDER	110
77.	"PLASTIC-ARC" WELDING AND CUTTING PANEL	113
78.	"PLASTIC-ARC" WELDING AND CUTTING PANEL, ELECTRICAL CONNECTIONS	113
79.	CRACKED LOCOMOTIVE FRAME—EARLY STAGE OF REPAIR BY ARC WELDING	116
80.	CRACKED LOCOMOTIVE FRAME—FINAL APPEARANCE OF REPAIR BY ARC WELDING	116
81.	THE "A.C." ELECTRIC WELDING AND CUTTING MACHINE	117
82.	METHODS OF CONNECTING UP THE "A.C." MACHINES WITH DIFFERENT TYPES OF CIRCUITS	118
83.	THE "A.C." ELECTRODE HOLDER	120
84.	THE "A.C." ELECTRODE HOLDER GRIPPED TO RELEASE ELECTRODE	120

CHAPTER I

INTRODUCTION

ELECTRIC welding, which is far from being a novelty, has recently come prominently into public notice. It has not only been employed by the Admiralty for the construction of vessels, but Lloyd's Register has issued regulations under which it is prepared to sanction its use in shipbuilding operations generally. Moreover, the astonishing rapidity with which the damaged interned German liners were repaired by this process, thus enabling many thousands of American soldiers to be brought to Europe long before such transportation was deemed to be possible, is still fresh in the public memory. We feel sure, therefore, that a discussion of the subject will be of interest to our readers, and we propose in the present and succeeding chapters to deal with the question at some length. No attempt will be made to go in detail into the evolution of the various processes involved, our purpose being, rather, to show what has been and is being done, than to relate exactly who was the inventor of this and who was the discoverer of that. It will suffice to say that, quite early in the use of electric energy, experiments with a view to using the current for welding purposes were instituted, and that thirty years and more ago electric welding was practised notably by that prolific inventor and distinguished investigator, Elihu Thomson, and by the Russian Benardos. Of the work of these two men we shall have much to say, but we shall not attempt to deal with it exhaustively, so that what follows in no way claims to be a complete history of their discoveries, nor, indeed, of electric welding as a whole. It is noteworthy that though introduced at no widely differing periods of time the methods of Thomson and Benardos were entirely dissimilar, the one employing what is termed the resistance process and the other the arc process. All the electric welding systems in use at the present day may be classed under one or other of these two heads, though there are numerous variations in the application of the two principles.

Resistance welding resembles much more closely the original welding of the blacksmith than does arc welding; indeed, saving that the manner of arriving at welding heat is different in the two cases, the welding of the smithy is identical with the welding by the resistance method. In both the portions of the parts to be joined together are raised to a proper heat in the immediate neighbourhood of the proposed weld, and then welding is effected either by means of pressure or by percussion. The same precautions regarding the cleanness of the surfaces to be joined together have to be exercised in each case. Arc welding is essentially different in that the metal is in the majority of cases actually melted at the weld, and that neither pressure nor hammering is absolutely necessary, though in some cases, they may be beneficially applied. As we shall show, however, there are cases in which the arc is used simply to obtain welding heat. In such instances, of course, percussion or pressure is required to consolidate the welds. Both arc and resistance welding are being more and more extensively employed and, from present indications, it would appear highly probable that both will continue in vogue, since each has its own sphere of usefulness, in which it performs with better effect than does the other. Nor does it seem likely that either

will oust the acetylene method, which likewise is pre-eminent in certain directions ; so that the engineer of the present day is fortunate in having three more methods by which welding can be effected than had his predecessor of the last generation. It may be even said that he has more than that if the oxy-hydrogen or oxy-coal gas methods be taken into account.

In both resistance and arc welding a certain amount of special machinery or apparatus is required, though with the latter it is generally less elaborate than with the former. For resistance welding alternating current is almost universally employed in practice, though there is no reason why direct current should not be used, saving the difficulty of dealing with the heavy currents. In arc welding, on the other hand, either direct or alternating current can, under certain circumstances, be employed, though direct current is most generally used. Resistance welding may be effected by three methods :—(a) Butt welding ; (b) spot welding ; and (c) line or seam welding, together with several modifications. Arc welding may be performed either with bare metal electrodes, with flux-covered metal electrodes, or with carbon electrodes.

The quality of the current—if such an expression be permitted—employed in the two processes differs very widely. In resistance welding there must always be a very heavy current—in some cases it amounts to thousands of ampères—and a very low pressure, say, from $\frac{1}{2}$ to 6 volts. Some large machines have recently been built in America in which voltages considerably in excess of the higher of these figures have been employed. We shall refer to them later. In arc welding, on the other hand, the voltage must always be high enough to maintain an arc—say, from 20 to 55 volts—and the current is relatively small. As a matter of fact, it is found in practice that the electromotive force available should, at any rate with metal electrodes, be at least from 60 to 75 volts, while some processes require an available pressure of from 100 to 110 volts.* With carbon electrodes a pressure of 90 volts is commonly employed. The current in arc welding is adapted to the nature of the work being carried out. It may be quite small, say, from 15 to 20 ampères, and it is very rarely, we believe, that it exceeds 800 ampères with carbon electrodes, and less than half that with metal electrodes, the average in actual practice being considerably less than the smaller figure. In the arc process, as originally introduced by Benardos, the work which was to be welded was connected to the negative terminal of a source of electrical energy—in the first instance storage batteries were employed—while the positive terminal was connected to the carbon electrode. An arc was formed by touching the work with the electrode and quickly withdrawing the latter, the result being that the metal immediately adjacent to the point of impingement of the arc was quickly raised to a very high temperature, and a stick of similar metal could also be melted just over the spot much in the same manner as solder is melted with a soldering iron. Later, this arrangement was found to possess the disadvantage that, as the direction of the current was from the electrode to the work, there was a tendency for the carbon, either in the form of vapour or in minute highly heated particles, to be carried over to the latter, so that it entered into combination with the molten metal, and sometimes, undesirably altered its composition. Hence the polarity of the work and electrode were interchanged, the former becoming the positive and the latter the negative. A further reason is put forward by the advocates of the carbon arc process as to why the work, and not the metal electrode, should be made the positive terminal, and that is that the positive terminal of an electric arc is hotter than the negative terminal. We believe we are right in stating that carbon arc welding was first employed commer-

* It will be found in a subsequent chapter that this statement is modified. The tendency would appear to be to reduce the voltage.

cially in this country by the firm of Lloyd and Lloyd, of Birmingham, which is now merged in the firm of Stewarts and Lloyd. It has also been used with success, for twenty years or more, by the Steel Barrel Co., Limited, of Uxbridge.

Some ten years after the introduction of the Benardos process the idea occurred to another Russian—Slavianoff—to employ a metal electrode instead of a stick of carbon, his idea being to fill up blowholes in defective castings. Previously Benardos had suggested the employment of a cored carbon, the core consisting of metal. Whether such composite electrodes had any great vogue we are unable to say, but having regard to latter-day developments in coated electrodes the suggestion coming, as it did, as far back as the year 1885, is distinctly interesting. Covered metal rods are, as we shall show later, in very extensive use at the present day, but the covering is not carbon; indeed it is, for the most part, a non-conductor. It is interesting to note that in 1893—some two years before Slavianoff introduced the use of metallic electrodes—Mr. T. T. Heaton, of the Steel Barrel Company, Limited, had suggested a mild steel electrode to the late Mr. Dickinson, of the Bowling Iron Company, and that it was tried, though without success, the experiment not being persevered with. The Slavianoff method has, of recent years, been very considerably developed, and though it would be erroneous to imagine that the metal electrode has entirely displaced the carbon electrode, for it has done nothing of the kind, yet it is safe, we believe, to say that in the large majority of welding installations in which the arc process is employed, metal electrodes of one kind or another are used.

A development of the carbon arc process is that in which the arc is struck between two carbon rods arranged at an angle to one another, the angle pointing downwards. By means of an electro-magnet arranged between the carbons, the arc is projected downwards on to the work. The device is cumbersome and not particularly easy to apply, so that it is hardly surprising that it has not come largely into use, though there would appear to be no reason why it should not do its work perfectly well. In the only example we have seen, the arrangement was such as we have described above, and the whole apparatus was suspended from a hook. It was not, therefore, possible to use it for vertical or overhead work. Its invention is attributed to Zerener, of Leipzig, and, to the best of our knowledge, the system is only in operation in Germany, and only there to a quite limited extent.

For arc welding the special appliances actually necessary are but few. In addition to the source of electric current and the electrode with its holder, all that is essential is a steadying resistance, connected in series with the arc, and possibly an ammeter as well. As will be seen later, however, special machines have been introduced with the purpose of preventing rushes of current. It will be readily understood that, unless means for controlling the current are employed, a resistance, or some such device, in series with the arc is an absolute necessity, for without it when the electrode touches the work there is a complete short circuit until the arc is struck. Although, however, but few special appliances are required, it is generally found that the supply of current available is not suitable for welding. For instance, it is very rare nowadays to find a public supply with as low a voltage as even 110. Hence it is necessary, if the current be not specially generated, to reduce the pressure so that there may not be an excessive waste of energy in the resistance. If the current be alternating the reduction in pressure is readily effected by means of a static transformer, which may have different tappings in the primary, so that different voltages and currents to suit different kinds of work may be obtained. This arrangement, of course, applies only if alternating current is to be employed in the arc. As a matter of fact, direct current is, as we have said, almost universally used, at any rate in this country, and to pro-

duce the low voltage direct current a motor generator may be employed. The direct current half of motor generators designed for arc welding are ordinarily compound wound, and are preferably provided with commutating poles, so that sparking may be minimised. The size of machine required depends, naturally, upon the nature and amount of the work being carried out. The variation in the current when using metallic electrodes may be between, say, 15 and 250. These may be regarded as extremes, only met with in special cases, the more usual range experienced in actual practice being between, say, 20 and 200 ampères. With carbon electrodes, on the other hand, much heavier currents are experienced. We understand that satisfactory results cannot be looked for with currents under 300 ampères, and that not infrequently 500 and in special cases as many as 800 ampères may be required. With these figures an estimate may be arrived at regarding the capacity of the machine necessary for any given number of welders.

At this point, perhaps, a few words may be said with regard to the arc itself and its effects on the human frame. In the first place, the arc with a carbon electrode is long and the temperature in the positive crater is very high. In a paper which he read before the Institution of Engineers and Shipbuilders, in Scotland, on June the 22nd, 1918, Captain James Caldwell, R.E., Deputy Assistant Director of Materials and Priority, stated that it was estimated to be 7500 deg. Fah. It is not, as Captain Caldwell explains, necessary to reach such a temperature as this in welding, and the carbon rod is therefore moved along at a rate which will ensure good fusion to the necessary depth. With metal electrodes, partly because of the shorter arc and partly because of the pressure of the vapour of the metal, it is lower but still high. In both cases, and particularly in the former, ultra-violet rays are freely emitted. The effect of exposing the eyes, face, and hands to direct rays from the arc is very similar to severe sunburn, such as is familiar to climbers in high altitudes on freshly fallen snow. The results of being burnt in this manner by careless exposure are exceedingly painful, and whereas there are those who say that no permanent injury is caused to the eyes of operatives constantly engaged in electric welding, there are also those who aver that cataract may result in cases of careless exposure. However, with reasonable care and with proper precautions, there need not, apparently, be any ill-effects whatever. It is necessary, however, adequately to shield not only the eyes but the face and neck as well, and, of course, the hands. In some cases screens sufficiently large to protect both the head and neck are employed, the screens being furnished with glasses of colours of such a character that while the harmful rays are cut off the operator can readily see what he is doing, at any rate when the welding is actually in progress. Then, too, aluminium helmets, or cylinders, put on over the head and resting on the shoulders, are used. An example of a helmet which is being employed in some shipyards is shown in Fig. 1. It will be observed that the protective glasses can be raised when required so as to give the operator unobscured vision. It is customary also for heavy leather gauntlets to be worn so that both hands and wrists may be protected, and, though ordinarily the clothing is sufficiently thick to give protection to the body, it is the wisest course to wear a leather apron, reaching down to the boots, for splashes of metal, and, when coated electrodes are used, of molten slag, may be projected from the arc. Coat-sleeves must, in no case, be rolled up so as to expose the forearms. These precautions may sound formidable, but in reality they are not so, and in order to ensure immunity from injury, which may be exceedingly painful if it be nothing worse, it is imperative to take them. Further than this, it is most desirable that any workshop or compartment in which arc welding is in progress should be adequately ventilated.

The fumes sometimes given off are offensive, and if not carried away as formed may injure the health of the operatives.

It is important, too, that the colours of the glass screens should be such that they entirely absorb all the ultra-violet rays. Certain combinations of blue and deep red glass will effect this absorption. So will glass having a greenish amber tint, and this colour is, we gather, largely used in the United States. There are other glasses, too, for which it is claimed that they are impervious to ultra-violet rays. We shall have more to say regarding this matter in a later chapter.

There is a great deal of difference of opinion as to whether or not in arc welding a flux is necessary. There are those who allege that, whereas it is not required with metal electrodes, it is most desirable when carbon electrodes are used, since it enters into combination with any carbon which may be projected in the direction of the

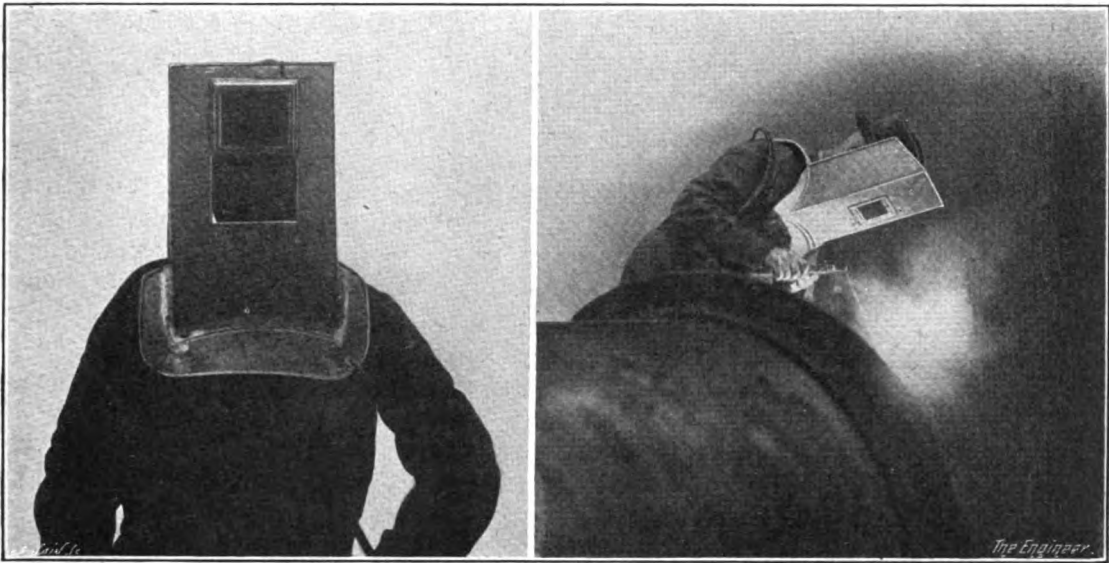

FIG. 1.—Helmet for Arc Welding.

weld and prevents it combining with the metal. Then, again, there are those who maintain that a flux is necessary to increase the fluidity of the metal. It is urged, too, that welding by means of the carbon arc without a flux results in the formation of a crater of boiling metal, which greedily absorbs oxygen from the atmosphere, and that a weld which has absorbed oxygen will always be weak, because the oxygen will react and combine with the carbon in the metal, and with the metal itself, and the metal becomes porous. The same allegations are made regarding the use of metal electrodes without flux. Into this controversy we do not, at the moment, propose to enter; nor do we propose to discuss the relative merits of bare and coated electrodes. Each has its own advocates. In the United States bare electrodes were, as we have said, almost exclusively employed up to within quite a short time ago; whereas, in this country covered metal electrodes have been most extensively used. In both countries a large amount of excellent work has been carried out, and we are not prepared, with our present knowledge, to adjudicate between the two methods. It is significant, however, that in the case of the electrically welded barge, to which we made reference in our issue of August 9th 1918, and work on which was carried out under the super-

intendence of the Admiralty authorities, and under the eyes of experts from Lloyd's, metal electrodes, provided with a special slag-forming coating, were exclusively used. It is noteworthy, too, that coated electrodes are much more frequently used in the United States nowadays than they used to be. It is also an undoubted fact that excellent work can be and is constantly being done with the carbon arc on mild steel without the use of any flux whatever. The question is rendered all the more difficult in that there is no sort of agreement as to the composition of the flux or the flux-forming coating which it is best to employ, and because an excessive current in the arc may bring about a condition in the weld which is very similar to, if not actually identical with, that stated to be caused by the use of, say, a carbon electrode without a flux. The only point on which there seems to be no divided opinion is that if a flux is to be used, the most convenient method of applying it is to coat the electrode evenly with it. One authority on the subject states, with regard to this point: "When applied in this way the coating may be made to serve two useful purposes, providing it contains sufficient refractory material: (1) It permits the electro-magnetic effect of the welding current to act upon the molten metals; and (2) it applies flux to the weld at the rate that adjusts itself perfectly to that of the melting of the welding pencil."

It should be mentioned, however, that all the coatings applied to metal electrodes are not flux forming, or, we should more correctly say, liquid flux forming. In what is known as the "gaseous flux process," which was introduced and patented by Kjellberg, the metal electrode is—again to quote Captain Caldwell—"covered with a fireproof sleeve of non-conducting material, so that as the metal is removed by the arc the sleeve projects beyond the end of the rod and forms a guide for the molten welding metal, the sleeve itself falling away automatically. The sleeve protects the metal from oxidation and reduces heat losses." "The process," continues Captain Caldwell, "is an improvement on the bare metal electrode, and a great deal of satisfactory work has been done with it, mainly in repairing marine boilers, stern frames, and other ship parts. It is also successfully used to build up worn parts, such as propeller shafts, worn crank shafts and axles, which are afterwards machined to size. The patent specification claims the use of no particular material for the fireproof sleeve, and no other purposes than those mentioned, but the company exploiting the process states that the sleeve can be made the vehicle for constituents which will give desired characteristics to the added metal." The arc actually dissipates the flux, so that no slag is formed.

It is not to be supposed that electric welding will always produce work which is free from defects, for that is not the case, and unfortunately, it is by no means always that a defect, should it exist, can be detected, even by careful observation from the outside. In resistance welding some foreign matter may have got between the surfaces being operated upon and have reduced the area properly welded. In metal arc welding, if the operator has used too small a current, or held the electrode too far away from the work, the melting of the edges of the work may not have been properly effected, so that there is not adequate adhesion between them and the added metal. The joint, to outside appearance, may look all right, but there may be cracks between the work and the added metal which will, in time, certainly lead to trouble. An excess of current, on the other hand, will have the effect of what is known as "bad metal" being deposited. Then, again, bubbles of gas may form in the weld, and hence reduce its strength. It is quite possible, too, when using a carbon arc incorrectly, to burn the metal by using too heavy a current or by keeping the arc playing on one particular spot for too long a time. However, it is by no means always that a perfect weld is

obtained, either by the blacksmith or by the use of the acetylene torch, and it is probably accurate to say that, with arc welding at any rate, the proportion of imperfect welds on any given piece of work made by even a comparatively unskilled worker, is as small as, if it be not smaller, than is the case with any other welding process. Moreover, there is no reason to suppose that when reasonable care has been taken resistance welding produces—in general practice—welds which are inferior to those obtained by the smith, and it certainly can do work which he cannot carry out.

We shall have more to say regarding the strength of electric welds in a later Chapter.*

* See Chapter XIV.

CHAPTER II

THE BENARDOS CARBON ARC PROCESS

As we said in our first chapter, this series is by no means intended to constitute a history of electric welding. To have attempted to make it do so would have introduced an immensity of weary details, and made the whole thing unwieldy. Hence, we shall not discuss the claim made for Benardos that he invented arc welding, further than to say that there are those who allege that de Meritens, whose pupil Benardos was, was the actual discoverer of the arc welding process. On this point we shall not make any definite assertion; nor is it necessary for our present purpose to do so. It can be truthfully said, however, that the Russian was largely instrumental in bringing the subject to public notice, and that in 1885 he, in conjunction with a fellow countryman of his, one Stanilaus Olszewski, an engineer of St. Petersburg, obtained a British patent—No. 12,984 of that year—in which the first claim read as follows: “The method substantially as herein described of uniting and soldering metals together, either at separate points or in a continuous joint by heating them by means of an electric current,” and that the methods described embodied the employment of the carbon arc. It would be interesting to inquire into the question of how much of the invention was due to the one inventor and how much to the other. Nicholas de Benardos is described in the patent specification as “Gentleman,” his partner, as we have said, as an engineer. What part did he, whose name has alone survived as being coupled with the invention, actually play in the discovery? This, again, is a point which we shall leave to others to discuss, and shall confine ourselves to giving certain extracts from the specification, which is certainly a most comprehensive document.

The invention is described at the outset as relating to “an improved method of and apparatus for the direct application of electric currents for the following purposes :

1. The union of metals.
2. Their disunion or separation.
3. The formation of apertures in metals.
4. The union of metals in layers.

The process, which we term *electrohephaest*, consists of the formation of voltaic arcs when necessary.” It is explained that the voltaic arc is formed by the approach of carbon—or *any other body serving the purpose*, the italics are ours—to the part of the metal to be operated upon, the carbon forming one pole of the circuit and the metal the other pole.

It is curious what wide area of ground is covered and how many are the uses to which the inventors claim that their invention can be put. It is pointed out in the first place that the union of parts of one or more kinds of metal may be effected in two ways, namely, “either in points or continuously : 1. In points by agitating the voltaic arc at one point for a certain time, after which it ceases ; 2, continuously, in which case the voltaic arc advances uninterruptedly in a defined line. In both

cases, the union or cohesion of the parts is simultaneous, and they become one homogeneous whole." One is at once struck with the similarity between the processes described and present-day spot and seam welding, though nowadays spot welding, at any rate, is almost invariably, if not universally effected by the resistance process, and many kinds of seam welding are only practicable by the latter method. "Point union," the inventors declare to be "in every way superior to riveting," while "Continuous union" is also described as superseding riveting, "particularly in the case of boiler joints, etc., and is generally applicable in all cases of joining or uniting metals."

A variety of different methods of making joints is illustrated. Among them is a joint formed between two plates by welding the slightly projecting ends of headless rivets, and another in which only one of the plates has holes drilled in it, and the joint is effected by filling up the holes with melted metal which itself becomes welded to the metal of the imperforated sheet. Sketches roughly illustrating these two methods of jointing are shown in Fig. 2. Presumably, hammering was resorted to in order to consolidate the weld, as is indicated in the right-hand joint in each case, but hammering is not actually mentioned in connection with joints of this type, though the utility of hammering or pressing was fully understood by the inventors, as we shall show later.

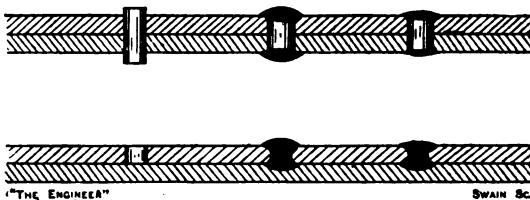

FIG. 2.—Examples of Welding.

The inventors were not backward in praising their process, as is amply evident from the following extract, which is taken from that part of the specification which immediately follows the reference to jointing: "As compared with existing processes, the advantages claimed for the present invention are its rapid action, cheapness, the reduction in weight owing to the absence of joints, cover joints and heads of rivets. By this process the strength of the joints becomes equal to that of other parts of the object, which is most important in boiler and armour plate, iron and steel vessels, hydraulic apparatus, etc., and had hitherto been attained with great difficulty. Besides the advantages above enumerated, the great feature of our invention consists in the

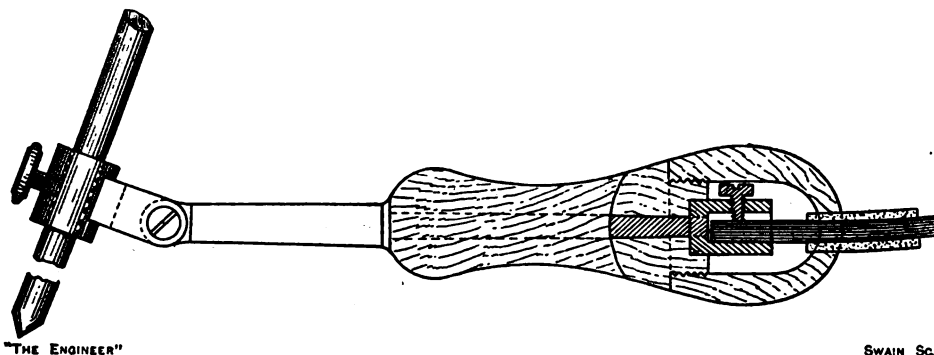

FIG. 3.—The Benardos Electrode Holder.

facility with which it can be applied on the spot in cases of emergency or accident without taking the object to pieces: as, for instance, in the case of the bursting of boiler plates, the cracking of armour plates, etc."

The carbon electrodes which might be used are referred to as being of various forms,

the most practical for operations on a small scale being "either a solid or hollow pencil or rod. The hollow carbon is filled with various metals or their alloys, which play the part of solder." To this we shall refer again later. Of holders, various forms are illustrated. The simplest is very similar to that in use at the present time. It is shown in Fig. 3. The hollow at the end of the wooden handle contains a contact screw which

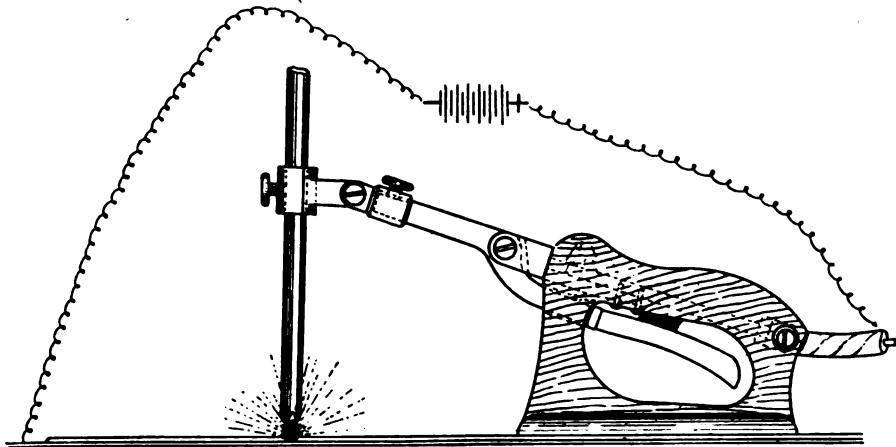

FIG. 4.—Device for "Point" Welding.

serves to fix the wire of the conductor, while the electrode consists of a carbon pencil held in a tube by means of a screw. This carbon-containing tube works on a hinge, and may at the will of the operator assume various inclinations with regard to the lever which connects the conductor with the carbon. A more complicated arrangement,

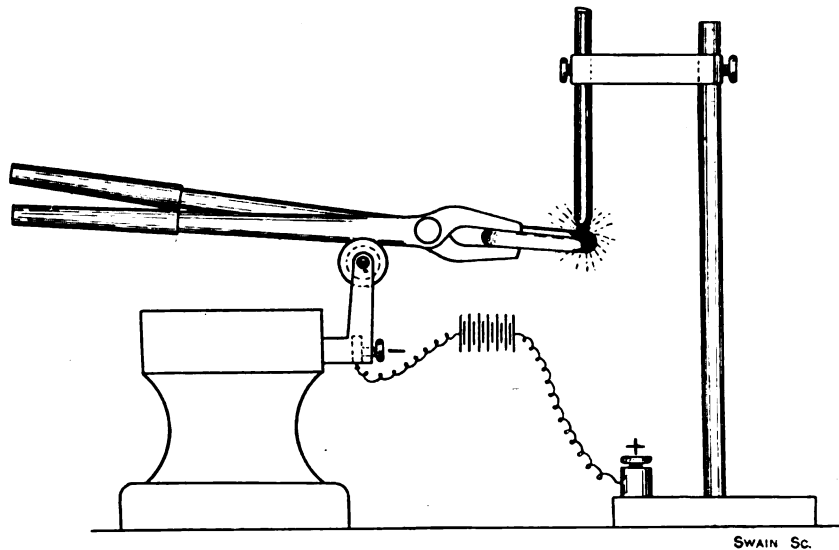

FIG. 5.—The "Electric Forge."

which is specially intended for use in "point" welding, is shown in Fig. 4, which gives a side view of the apparatus. It is, as will be observed, furnished with a lever or trigger for pressing the carbon down to the point where the arc is to be formed, this motion being accomplished by simply pressing the lever. The breaking of the arc is

effected when the pressure on the trigger is removed by the action of a spring pressing against the trigger, tending to force it downwards. The conductor is fixed to a contact post contained in the handle of the lever. A still more complicated device is shown in Fig. 6. It is intended for use either in "point" or continuous welding, and is furnished with a protecting screen and also a stop watch, which was started by the same mechanism which struck the arc, so that the observer might see how long the current had been at work. When it was to be used for continuous welding, the rails, on which the apparatus ran on wheels, were to be of the ordinary plain topped type, but when employed for "point" welding one of the rails was to be corrugated, the distance between the corrugations determining the distance apart of the welds.

Reference may also be made to Fig. 5, which shows what the patentees called an "Electric forge." It consists of an anvil carrying a bracket, furnished with a pulley,

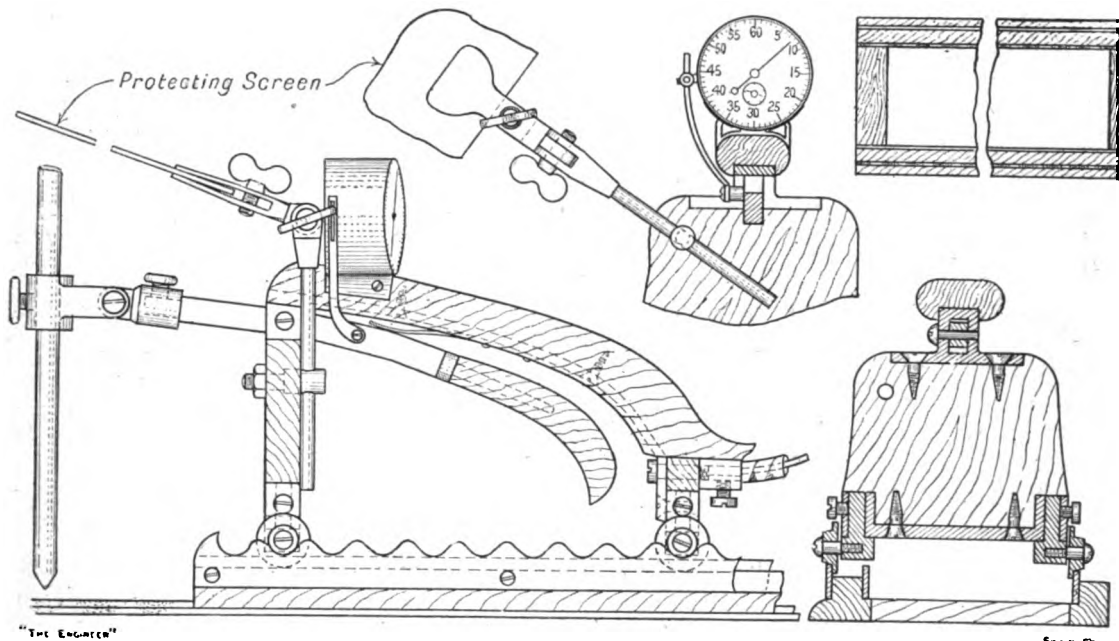

FIG. 6.—Device for Continuous or for "Point" Welding.

to which is attached a pair of tongs for holding the object to be operated upon. The carbon is arranged on a stand to which is fastened one conductor leading to the source of current. The other conductor, which is attached to the anvil, is in electrical contact with the object to be heated. When the latter is touched on the carbon electrode and withdrawn, an arc is formed, the object is heated and is then transferred to the anvil for forging.

By their process the inventors claimed that fusion of layers of metal one on top of the other might be brought about by introducing into the arc a "carbon pencil prepared with the metal with which the fusion is to be effected, which falls drop by drop in a continuous jet. The pencil is insulated. . . . This process can be employed in a number of cases for soldering, for filling up flaws, cracks, hollows, etc., moreover it can be applied for steelifying objects for making stays, supports, etc." By steelifying the inventors intended to convey, we take it, hardening or tempering. The use of the arc for making holes is claimed and so is "the separation and disunion of metal," or as we call it nowadays, simply "cutting." "Parts of metal of considerable dimensions

may," says the specification, "be detached by this process with facility on the spot. The tension and quantity of the electric current must be increased in proportion to the size of the metal operated upon. Numerous cases occur where the separation or detachment of metallic parts cannot be effected by existing means, and which could be easily accomplished by our process."

One of the most curious claims made for the process was, however, its use for the formation of armour plates. The resulting product is shown in Fig. 7. The steel plates were to be joined together both by point and continuous union. They were to be laid one on the top of the other, with intermediate layers of some elastic substance such, for instance, as caoutchouc, felt, cardboard, wood, etc. The elastic substance is shown in the drawing by shading. The inventors point out that these armour plates might serve for protecting vessels and for numerous other purposes; that they are exceedingly light, offer great resistance, are not liable to crack and split, and that they may, with great facility, be made on the spot where they are to be used, either whole or attached layer by layer when they are being mounted.

The inventors evidently realised that in some of the processes carried out in

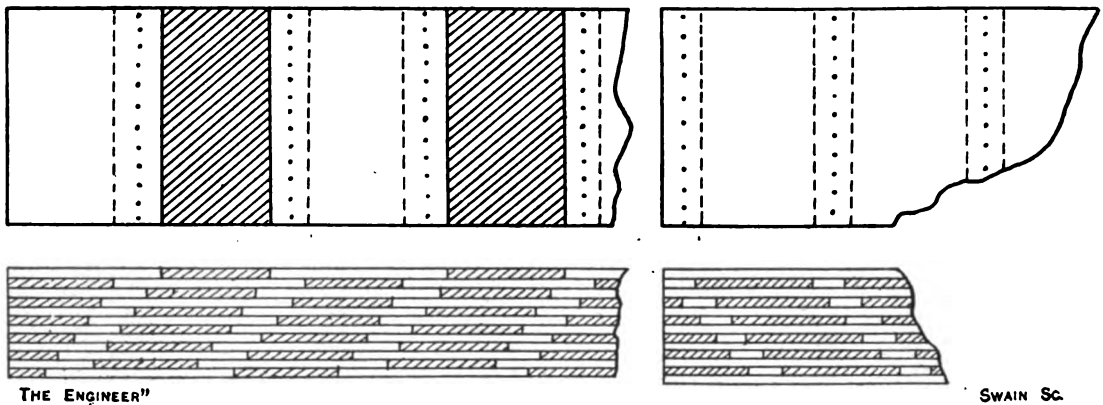

FIG. 7.—Suggested formation of Armour Plate.

accordance with their invention, consolidation of the welds would be necessary, for they state that the apparatus described "can also be directly connected with other instruments, as, for instance, with the rolls, stamping press and automatic hammer to which the metal is automatically conducted on the cessation of the arc, for the purpose of further cohesion and final planning." They were also aware of the necessity for protecting the eyes of the user, for they explain that the various pieces of apparatus described are fitted with "Coloured glass screens or some similar substance, so as to allow of the operation being watched without injury to the eyesight of the operator.

We give one further extract from this interesting document: "This process of working metals may be combined with a gas apparatus, whereby gas or a mixture of gases could be introduced by pipes into the voltaic arc, and increase its tension. Into these gases may be introduced pulverised carbon, which is a good conductor of electricity, and also increases the action of the voltaic arc. If it be necessary to fuse any heterogeneous substance with the metal operated upon, the carbon may be replaced by any other substance in powder."

It must be admitted that this specification, the date of which, it should be remembered, is 1885, very nearly covers the whole sphere of electric welding as it is now practised. Butt welding, spot welding, seam welding, and the building-up process

are all of them either mentioned by name or shown in the illustrations. It is true that the specification had to be amended in 1891, but none of the points which were excised in the emendation, have been referred to in the foregoing. It is quite clear that it was foreseen that electric welding was bound to assume a very important position in engineering construction, and it is a matter for wonder that, though in several outstanding examples the process has been successfully employed commercially for getting on for a quarter of a century, it is only comparatively recently that it has in any sense been widely used. It is not so very long ago that the Admiralty refused to permit the use of electrically welded tanks, though it has now definitely relinquished that position. Moreover, as showing the trend of feeling in other directions, we may say that we have before us a copy of the railway companies' specification for iron or steel drums, suitable for the conveyance of acetone, acetone oils, ketone oils, coal tar, naphtha, benzole, toluol, turpentine substitutes, xytol, mineral naphtha, petroleum, benzine, benzoline, carburine, motor spirit and petrol, in which it is set out that not only must all the joints be electrically welded, but that each drum must also be provided with a well-fitting screw bung, the boss of which must be electrically welded to the head of the drum.

CHAPTER III

RESISTANCE WELDING

RESISTANCE welding, like many other valuable inventions, was discovered by accident. As it happened, too, the discovery of the process came at a most opportune time, for early makers of dynamos were seriously handicapped by the fact that the wire manufacturers could not or would not supply the insulated wire in sufficient lengths. It was impossible to wind even a comparatively small coil without having to make one or more joints in it. These joints had to be brazed or silver soldered by means of a blow-pipe and then insulated by taping-up, with the result that the wire was considerably thicker at the joints than elsewhere. The extra thickness made the winding of a really neat coil a matter of great difficulty, and the wire makers were urged again and again to make the joints in the first place before applying the insulation. Among those who endeavoured unsuccessfully to get them to do so was Professor Elihu Thomson, who was then (about the year 1885) connected with the Thomson-Houston Electric Company, of Lynn. The reply he got was that what he suggested was impossible by any method known at the time. However, he himself was destined to discover a means by which the joints could be easily and efficiently made, and the story of how he came to do so was told in the following words by Mr. J. B. Clapper, plant engineer of the Rim and Tube Division of the Standard Parts Company, Cleveland, Ohio, in a paper which he read before the Cleveland Engineering Society, on March 26th, 1918.

“While giving a lecture on electricity in general at the Franklin Institute of Philadelphia, one evening, among other apparatus for demonstration purposes, Prof. Thomson had with him a large high-tension jump spark coil and also some Leyden jars. After showing how a long spark could be produced from the secondary terminals of this coil by applying an interrupted direct current at the primary terminals, he then thought of trying an experiment with this coil the other way around. Accordingly, he arranged for one of his assistants to discharge several of the Leyden jars in series—thereby effecting a very high potential—through the secondary winding of the spark coil, while he held two wires together, end to end, which were connected across the primary terminals of the coil. After discharging the jars in this manner, the Professor found that he could not pull the wires apart that he held—they had become joined at the ends through the heating effect of the current passed through them—in short, the first electric weld had been made quite unintentionally. However, since the wires that the Professor held in his hands were copper, it immediately dawned on him—here was his solution to joining two lengths of copper wire together—electric welding.”

The Professor, being a business man as well as a distinguished scientist, at once decided to put his invention on a commercial footing. He patented the invention, and the first practical machine which he designed was known as the “Jews’ Harp Welder.” It was the parent of the very many different machines which are now employed for applying resistance welding for a large number of different purposes. In it, according to Mr. Clapper, the secondary winding was solid and of U form, the metal being thinned in cross section at the bottom of the U so that the ends on which

the clamps for holding the ends of the wire to be welded were mounted could be moved together or apart enough to permit pushing up the stock in welding. The primary winding was a circular coil of many turns, laid within the secondary, which is said to have exactly resembled a Jews' harp in shape. The core consisted of many turns of iron wire wound "around and through the primary coil, embracing the secondary for its portion immediately adjacent to the primary winding." The pressure on the work was effected by a spring, tending to draw the outer ends of the secondary together, the tension being varied by a hand-operated screw passing through the spring. In 1888 the Thomson Electric Welding Company was formed commercially to develop, manufacture and put on the market apparatus for adapting the Thomson process of welding to all lines of business coming within its scope.

The original application of resistance welding was thus to the joining together of lengths of copper wire. It very soon, however, came to be used not only for iron and steel, but also for brass, aluminium and the finer metals, and how wide is the range of its applications nowadays may be gauged by the fact that the machines employed to carry it out vary in weight from considerably under half a hundredweight to many tons.

As has been already mentioned, resistance welding resembles in several respects the welding of the ordinary smith. But, though like it in some ways, it is very different from it in others, and perhaps, before all, in that the heating and welding operations are performed practically at the same time and almost instantaneously. As soon as welding heat is reached, the welding is immediately effected, and in the lighter kinds of work the rapidity with which the welding heat is attained is quite remarkable. Although the process is not applicable to every sort and kind of welding, yet the sphere of its utility is very wide, and the quality of the work effected by it unquestionably good. It is necessary for its effective operation to have at command heavy flows of current, but, on the other hand, the voltage necessary is very low. In some cases as low an electromotive force as half a volt is all that is required. In actual practice, from four to six volts is about the highest pressure worked with, though in some special machines recently built in America higher voltages than those named are employed. The temperature of the metal to be welded is raised simply by allowing a very heavy current to flow through a restricted area, and to those who are unacquainted with the process, the rapidity with which welding heat is arrived at when using properly designed and proportioned machines will appear extraordinary.

As can be well imagined, the difficulties attending the use of direct current for this system of welding are practically insuperable, except for the welding of exceedingly small articles. It is, however, only the difficulty of using it which precludes its commercial use in this direction. It is not because resistance welds cannot be made with direct current. For the purpose, direct current would be just as effective as alternating, but there is no comparison between the relative ease with which the two kinds of current may be applied. With the former, the heavy current has to traverse the whole of the machinery involved, whereas in an alternating system the heavy welding current only flows in part of the apparatus where it can be accommodated without any trouble. The supply voltage may be anything within reason. All that is necessary is so to proportion the primary and secondary winding of the welding machine that the desired secondary voltage is obtained. In the large majority of cases the secondary winding only consists, as in the original Thomson machine, of one turn, the two terminals of which are short-circuited by the object or objects which it is desired to weld. In such a case, supposing a secondary pressure of one volt to be required with a primary voltage of, say, 500, then the primary winding would be

composed of 500 turns, and the conductor of the secondary would need to have a carrying capacity of 500 times that of the primary. As for some purposes many thousands of ampères are required, it can readily be seen that the cross-sectional area of the secondary conductor must, in some cases, be very large. Generally speaking, the one turn of the secondary is built up of a large number of thin sheets or ribbons of hard copper joined in parallel, the reason for this subdivision being that flexibility is desired.

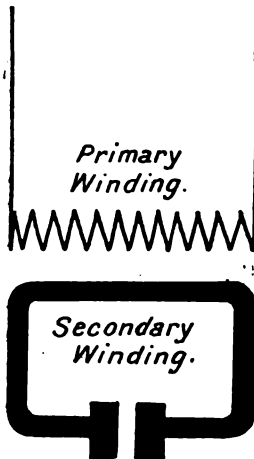

FIG. 8.—Diagram of Thomson Welding System.

The two sets of ends of these sheets of copper are attached respectively to two heavy copper jaws or terminal pieces, which have to be capable of motion towards and away from one another, so that the object or objects to be welded may be pressed together. The junction between the many sheets of the secondary winding and these terminal pieces or jaws is effected as carefully as possible, so that there may be perfect electrical connection, and that each strand of the coil may carry its proportion of current. The jaws or terminal pieces are made of many forms to suit different kinds of work, and since they are liable to become very hot during continuous welding operations, they are, as a rule, made very massive, and are almost universally cooled by water circulated through cavities formed in their interiors. The simplest form of resistance welding machine is shown in Fig. 8, which represents diagrammatically the Thomson principle. It will be realised that, if the articles or parts to be welded are introduced between the two terminals of the secondary winding, the circuit of the latter will be closed and current will flow if the primary winding be energised. Stated briefly, the machine is completed (a) by means for bringing the two terminals nearer to one another, so as first of all to close the electric circuit and afterwards, when welding heat is attained, to apply pressure to the heated parts, so as to form the weld, and (b) by means for energising and de-energising the primary winding. In many cases these two motions are interlocked so that they may work in unison and

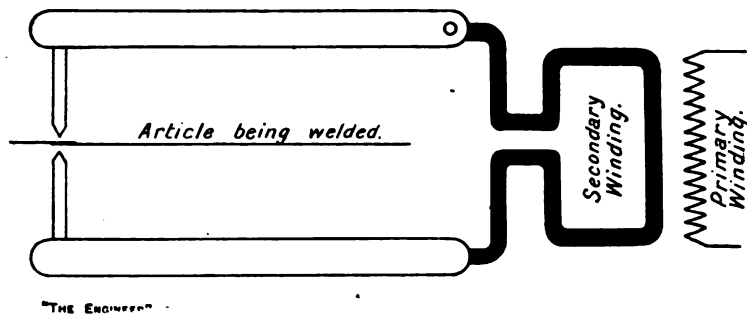

FIG. 9.—Diagram showing Principle of Spot Welding.

so that the current may be cut off when welding heat is reached, and just before the final pressure comes on. The mechanism used for advancing and withdrawing the jaws and terminal pieces or electrodes is of a varying character, depending on the nature of the work to be dealt with, and on the taste and fancy of the designer. There are machines which are operated by a hand lever; others in which the lever is worked by foot, while in some cases the motion is provided by a hand wheel and quick pitched screw, and in others by a hydraulic cylinder. There are machines which are power

driven, so that the top electrode is continuously being moved up and down, a weld being made at each stroke, if there be material to be welded between the jaws or electrodes. Such machines may be automatic, in that the current is turned on and off and the pressure applied and relieved without requiring to be touched by the attendant, who has only to concentrate his attention on the articles to be welded.

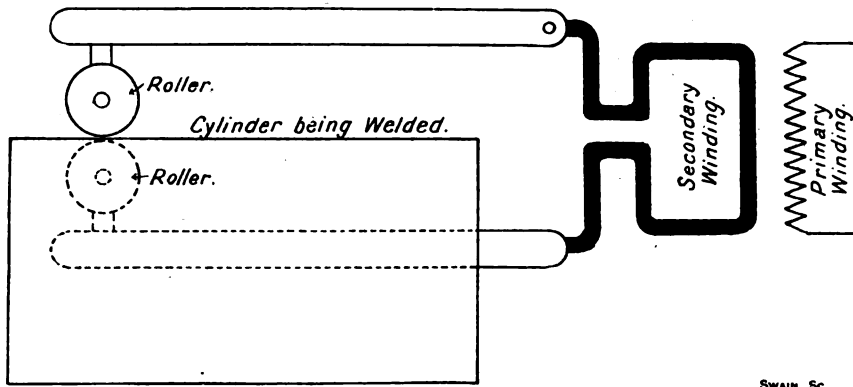

FIG. 10.—Diagram showing Principle of Seam Welding.

Some machines may be made available for a large number of different welding operations, but it is frequently necessary to have specially designed machines for special classes of welds. In fact, for each of the three resistance welding methods to which we have already made reference, i.e. (1) Butt welding, (2) spot welding,

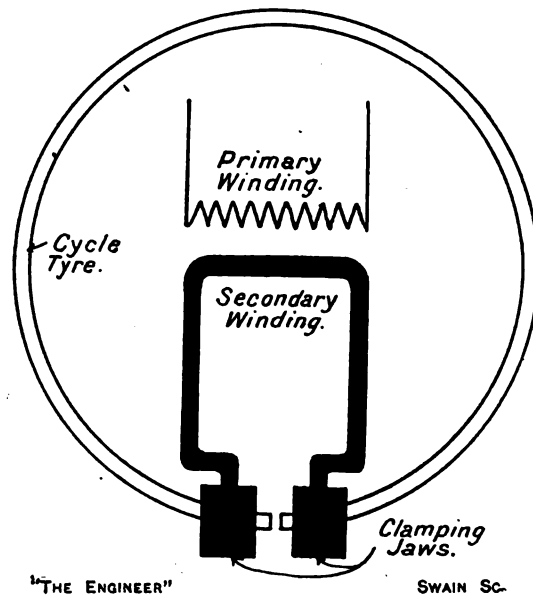

FIG. 11.—Diagram showing Butt Welding of Tyres.

(3) seam welding, many different types of machine have been evolved. To some of them we shall refer in later chapters. In all of them, however, the electric principle is the same. Comparatively high voltage alternating current of small volume is transformed in a static transformer, which actually forms an integral part of the welding

machine, to large volume with very low voltage. The differences between the various machines consist, among other things, in (a) size, (b) the means of applying the pressure and cutting the current on and off, and (c) in the forms of the terminal pieces, jaws or electrodes of the secondary windings, and of the arms carrying them. Just as in a hydraulic riveting machine it is necessary to have a considerable depth of gap, so it is with certain types of electric welders. The arms holding the electrodes are, in such cases, long. A diagrammatic example of such a case is shown in Fig. 9. On the other hand, there are many things which can be welded while held in the hand simply by being placed between two advancing jaws. In other cases, such as in that of such things as the rims of bicycles, the two ends to be welded have to be held tightly in clamps, which, when moved towards one another, cause the edges to be welded to press against each other. A diagrammatic sketch of such an arrangement is shown in Fig. 11. Then again, for seam welding the electrodes may consist of wheels or rollers as shown diagrammatically in Fig. 10. Machines of this type are employed for the seam welding of cylindrical articles.

CHAPTER IV

ARC WELDING AT A STEEL BARREL WORKS

THE work carried out by the Steel Barrel Company, of Uxbridge, affords an excellent example of the employment of different welding processes for varying kinds of work, and would appear to confirm the assumption that, as far as can be seen at present, both arc and resistance welding, as well as the acetylene method, have come to stop. For upwards of twenty years now the company has been using electric arc welding, and it has more recently adopted resistance welding and the oxy-acetylene flame for operations for which arc welding is less suitable. An account of what is being done at its establishment at Phoenix Wharf, Uxbridge, should, therefore, prove of interest.

At the outset it may be explained that the output of the works consists not only of the steel barrels which the name of the firm would lead one to expect, but cylindrical steel vessels of all descriptions from small drums to large tanks capable of holding 3000 gallons or so, and of withstanding heavy internal or external pressures. The products include such things as buoys, cylindrical casks and vessels of all sorts and sizes, and even, we understand, small steam boilers at times. The material employed is steel sheet or plate of varying thickness, and we believe we are right in saying that every joint is welded, not a single rivet being used in anything which is made.

As acetylene welding does not come within the scope of this Work we may dismiss its employment at Uxbridge with a few words, though in so doing we must not be understood to infer that the process is regarded by the firm as being of small value, for that is far from being the case. Indeed, Mr. T. T. Heaton, the company's managing director, who has certainly had as much experience as, and probably more than anyone else in the country in methods of welding other than those practised by the smith, regards it as a most useful adjunct to his electric equipment, and as being exceedingly well adapted for certain classes of work—in fact, in its sphere, better than any of the electric arc processes. In some cases the particular utility of the acetylene flame is due to the fact that its temperature is considerably lower than that of the electric arc. Hence it can be employed with thinner material than is practicable, without burning the metal, by any but a most experienced operator with the carbon arc.

As far, however, as our own personal observation went, on the occasions which were courteously afforded us recently of

visiting the works, the special use to which the acetylene blowpipe is put is in building up work over comparatively wide areas, such as in the joints connecting outwardly dished ends to cylinders of large diameter, and made with comparatively thick plates. In work such as this it is the firm's custom to build up a layer of material round the external joint in such a way that the step that is shown in the left-hand view of Fig. 12 is entirely obliterated, the joint being made to have the

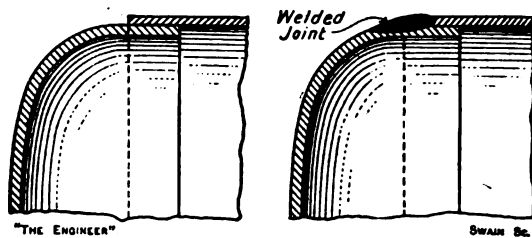

FIG. 12.

appearance shown in the right-hand view. The width of the welded portion was, in the cases which we have in mind, 2 in., or something over. For such operations as this, Mr. Heaton has found the acetylene flame to produce better results than the electric arc.

Passing on to steel barrel manufacture, it may be first explained that only the carbon arc system is employed, and that it is carried on in exactly the same manner as it was when revised by its inventors, Benardos and Olszewski, the "work" forming the positive pole, and the carbon the negative pole of a direct current arc. The requisite accessories are of the simplest description. There is, first of all, a source of electrical energy with a voltage of 90; then there are: (a) a resistance of coiled wire carried in a wooden frame attached to the wall; (b) a flexible cable connecting the resistance with (c), an electric holder of a very simple type, and (d) a carbon electrode. In pre-war times graphite electrodes were employed, but owing to the difficulty in

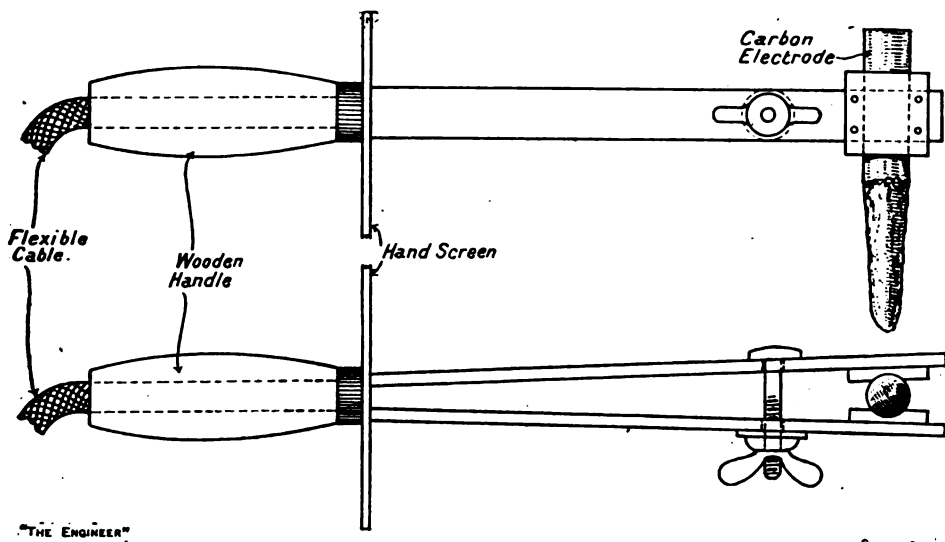

FIG. 13.—Carbon Electrode Holder.

obtaining them during the war period ordinary carbons are now used, and they answer perfectly, though the resistance of the carbon is somewhat higher than that of the graphite. The holder consists of a wooden handle with a hole through it from end to end for the passage of the flexible conducting cable, and furnished with a heavy brass cap or ferrule to which are attached, in addition to the cable, two strips or arms of steel, 15 in. long or so. Riveted to the outer end of each of these arms is a stout steel plate, an inch or so square and a quarter of an inch thick. Each plate has a groove cut in it, so that the two plates when pressed together may so clasp the electrode that it is held firmly. Pressure is applied by means of a screwed bolt and butterfly nut, the former passing through holes in the two clip arms. The apparatus, the appearance of which is roughly shown in the accompanying sketch, Fig. 13, is completed by a large circular screen some 9 in. in diameter, and made of tinned sheet steel, which is attached to the wooden handle, and is, of course, for protecting the hand and arm of the operator from the effects of the rays emanating from the arc. The only other accessory is a hand screen, some 18 in. square, furnished with a handle, and having a rectangular opening in its centre measuring about 6 in. by 3 in., which is covered by three glasses. That which is held facing the arc is ordinary blue

glass, and its purpose is only to protect the glasses behind it from splashes of metal. Of the other two glasses, one is deep ruby and the other deep blue. We gathered that no particular precautions are taken to examine these glasses spectroscopically. They are simply bought, of the darkest shades possible, in the open market. The handle is further protected by an auxiliary screen which envelops and protects the left hand of the operator. Each welding space is partitioned off from those on either side of it, and from the rest of the shop by screens of sacking.

We may here say that no ill-effects have been experienced with the eyes, face, hands, or arms of any of the operators, when the appliances provided have been properly used and reasonable precautions taken. It will be realised, however, that there is some small disadvantage in the use of combined deep ruby and deep blue glasses, in that it is quite impossible to see anything through them unless the arc has been actually struck. For some little time now the company has been studying the question with a view to obtaining glass which, while preventing the passage of harmful rays, would allow the operator a better view of his work. So far, however, it has, we gather, been unable to obtain glass—such, for example, as Crookes' glass—in pieces large enough to suit the particular requirements. The ruby and blue glasses have done very well for over twenty years, and from our own experience we can say that, as soon as the arc is struck it is perfectly easy to watch the welding operations minutely, even when standing at some little distance away.

To the unexperienced onlooker the welding operation might seem to be quite simple, but, as a matter of fact, it requires no inconsiderable amount of skill. Mr. Heaton is of opinion that, taking the sum total of the factors going to make up a successful carbon arc weld as one hundred, operating skill would be represented at sixty. Yet it is skill which is not, by any means, insurmountably difficult to acquire. Some of the operators who have been trained into highly successful workmen had had no previous mechanical or scientific experience. We observed two men who were doing excellent work whose original occupations had been, we were informed, that of milkmen. A man of average intelligence can, we gather, be trained to carry out the simpler operations within a period of some three months.

A description of the making of an ordinary steel barrel will give a good idea of the general run of this department of the firm's activities. A sheet of steel of the required size and gauge is first of all passed several times through a pair of rolls, so shaped as to give the metal the required curvature and form. The edges which are to be welded are then accurately marked off and sheared in a machine which was specially designed for this purpose. A hole, which is eventually to receive the bung-ring, is then punched. The bent sheet is then clipped on to a substantial anvil arm which has the same curvature as a completed barrel and hence, also, as the rolled sheet. A space of about one-eighth of an inch is left between the two sheared edges, which are arranged to come immediately over the centre of the anvil arm, which is connected to the positive pole of the electric supply.

The welding of the seam is done in lengths of about 6 in. The procedure is as follows: A shearing of steel sheet of the same composition as the sheet being welded, about $\frac{1}{2}$ in. wide, $\frac{1}{8}$ in. thick, and some 6 in. long, is laid flat immediately over the length of seam which it has been decided to weld first. Usually it is at one end of the seam, though the exact position does not appear to matter. The operator then, with the screen in his left hand and the electrode holder in his right, brings the point of the carbon electrode into contact with the work, and immediately withdraws it. The result is, of course, the formation of an arc, which, in the operations that we watched, was varied during the process from about $1\frac{1}{2}$ in. to 2 in. in length. This arc is made to

play on the piece of sheared metal just mentioned, being moved from end to end of it, until, in a remarkably short space of time, the whole is a white-hot mass. The operator then causes the arc to play on the metal sheet on either side and at the ends of this white-hot mass, taking it round and round the latter until the correct welding heat is reached, which is judged by the appearance of the metal. The arc is then smartly broken by withdrawing the electrode quickly, and the weld is consolidated by a few blows of a wide-faced flat hammer. This cycle of operations is repeated until the whole length of the seam has been welded. The seam of a barrel to hold 100 gallons is welded in from nine to ten minutes.

It might be asked why the weld does not extend to the anvil so that the partly formed barrel would adhere to it. That it does not do so is due, of course, to the fact that, having large mass, the metal of the anvil is not raised to anything near welding heat. Moreover, the arc is never allowed to play actually on the anvil itself; there is always some metal in between.

The art in the welding process is in keeping the temperature just right, neither too high nor too low. If too high the metal is burnt, if too low a bad weld will result. The temperature is regulated by the current flowing in the arc and by the length of time the latter is allowed to play on any particular spot. The current is controlled to some extent by the resistance in the external circuit, but not entirely. The operator can, however, increase or decrease it at will, over a fairly wide range, by decreasing or increasing respectively the length of the arc. He judges by the appearance of the heated metal whether the temperature is correct or not, and he acts accordingly.

It is noteworthy that no flux whatever is used. The company never has used any. It maintains that, provided the operation is skilfully performed, there is, for mild steel, no necessity to use a flux either to assist in the flow of the metal or to prevent oxidation. It will be remembered that it is only the strap—if such a description may be applied to the added piece of metal—which is actually melted, and, as we saw it, it was only just melted and not raised nearly to the burning point. The metal on either side of it was not brought to nearly such a high temperature, as was quite evident from the colour. The result, however, is that a perfect joint is produced, which is only very slightly thicker than the sheet, the edges of which it unites and which is quite smooth.

The next process is the welding-in of the bung receiver, which is a ring of mild steel, with its hole screwed to receive the bung and with a fairly wide shoulder which, when the part with the smaller diameter is inserted in the punched hole, prevents the ring from falling through. This shoulder also serves another purpose. There is no added metal as in the longitudinal seam of the barrel, but a large proportion of the shoulder itself is melted by the arc being made to play on the periphery of the ring. At the same time the temperature of the metal sheet of the barrel is raised to such a point that fusion takes place between it and the metal of the ring. Hammering is not resorted to, and it can well be imagined that considerable skill is required correctly to regulate the heat. In some cases the bung ring is only welded on the outside in the manner just described, but in others it is welded inside as well. We observed no tendency to distortion either in the welding-in of the bung rings or in the formation of the longitudinal seams. Moreover, we were informed that no injury was done to the screw of the bung ring, though it may be necessary to run a sizing tap through the hole if the bung will not screw in with sufficient ease.

The filling in of the ends of the barrel is performed in the following manner: The two end pieces are dished so as to form circular trays with rims about 1 in. deep. They are of just the correct diameter to be driven into the open ends of the barrels, which are left parallel to the axis for a sufficient length for that purpose. The appear-

ance is then as shown diagrammatically in view "a" in Fig. 14, the thickness of the metal being, of course, greatly exaggerated. Two steel rings R^i and R^o are then placed inside the dished end and outside the end of the barrel respectively. These rings are made to fit fairly tightly, but no great care appears to be taken to make them fit accurately all the way round. The appearance is then as shown in view "b" in Fig. 14. The body of the barrel, which is stood on end, is then made the positive pole of an electric circuit, and the operator then proceeds to strike an arc, with a carbon electrode forming the negative pole of the circuit, on the upper surface X formed by the rings R^i and R^o , the rim of the end piece, and the end of the barrel proper. In this manner, by taking the arc gradually right round the circle, all the four rings are welded together as shown in view "c" in Fig. 14, and a stout projecting rim is formed which, from the look of it, will stand a good lot of knocking about. Again no flux is used nor is hammering required. The time taken to weld round the end of a barrel is about $1\frac{1}{2}$ minutes per foot.

Finally, the ends are examined and any rough places removed by filing. As a matter of fact, the work is left wonderfully flat and smooth, and only where the metal has run over the edges of the inner or outer rings is any attention necessary as a rule.

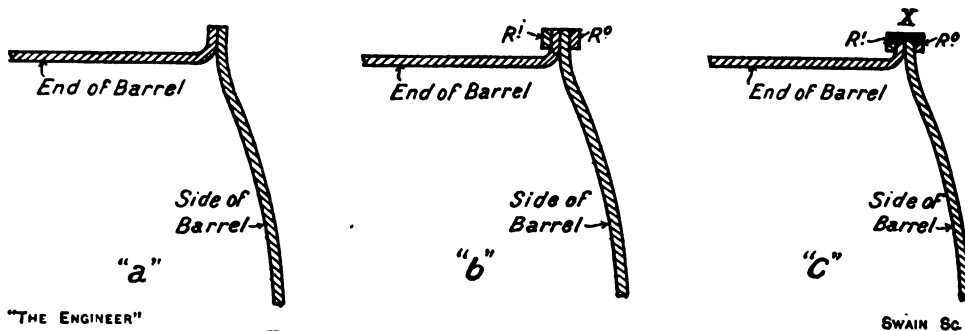

FIG. 14.—Welding-in the End of a Barrel.

All that now remains to be done is to test the completed barrel for tightness—which is effected by immersing it in water and applying air pressure internally—fitting the bung and painting. The average time taken to produce a complete barrel, including rolling, welding the seam, fitting the bung ring, welding-in the ends, testing, painting, etc., is about an hour.

The procedure with cylindrical vessels with parallel sides is substantially the same, but, of course, the plates are only rolled so as to form a cylinder, and are not bulged. If stiffening rings are required they are threaded on and welded in place before the ends are welded in. In some cases, too, when barrels are required to be specially strong, thick stiffening plates, bent into the form of rings and welded, are put over them where their diameter is largest. The rings are bedded to the body of the barrel, and the edges finally welded to the latter. The procedure is as follows: A welded ring of sheet steel with an internal diameter exactly the same as the largest external diameter of the barrel, or cask, which it is desired to strengthen, is slipped over the barrel, as shown diagrammatically in view "a" in Fig. 15. The ring is then connected to the positive terminal of a direct current circuit and an arc is struck on one side, say, at "x," by means of a carbon electrode which forms the other pole of the circuit. A comparatively low current is employed, and the arc is not allowed to remain in one place, but is quickly moved about over a considerable area until the metal in that area has become red hot. The heated portion is then quickly hammered down with a large

flat hammer until it comes into close contact with the outside surface of the barrel, a suitably shaped anvil arm being, of course, arranged inside the latter. Things are then as shown diagrammatically in view "b" in Fig. 15. This process is then repeated on the other side, "y," of the ring, so that that side, too, is brought into contact with the barrel. These processes are repeated all round the periphery of the barrel, so that the bent ring is brought to the same shape as the barrel, as shown in the view "c" in Fig. 15. Finally, the edges of the ring are welded all round to the body of the barrel, so that the ring adheres tightly to the latter and provides a most effective stiffening.

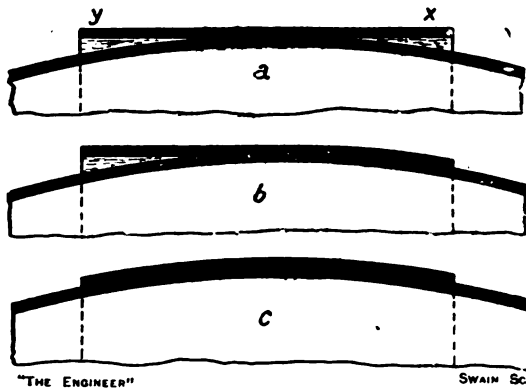

FIG. 15.—Putting on Stiffening Ring.

It may also be mentioned here that when necessary the company cuts metal by means of the electric arc.

The electric energy used in the foregoing processes is generated on the site. There are two vertical high-speed steam engines, one by Belliss and Morcom and the other by Brown-Lindley. They obtain their steam from two hand-fired Lancashire boilers, and each drives a 200-kilowatt direct current generator. The voltage is 90, and the available current is, therefore, about 4500 ampères. When in full work twenty welders are employed, and each dynamo supplies current to ten welders.

The voltage across the welding arc varies, of course, with the resistance in circuit and the length of the arc itself, and the variation is usually within the limits of 50 to 55 volts. There are no instruments by which the operator can tell what the voltage is, or what current is passing. His experience tells him if the conditions are as he wants them. If they are not, he can make the necessary correction by altering the length of his arc. There are, however, instruments on the switchboard in the engine-room by which the operations of each of the workmen can be checked. We gather that for ordinary welding work the current employed is somewhere in the neighbourhood of 300 ampères. For such a current carbons 15 mm. in diameter and 12 in. long are employed, and they last for some few hours.

As to the quality of the work done there can be no two opinions; it is excellent, and it has stood the test of many years' service. It is quite evident, therefore, that for the particular articles dealt with at Uxbridge the carbon arc process is, in skilful hands, and without the use of flux of any kind, perfectly successful and satisfactory.

We defer a description of the resistance welding system employed in these works to a subsequent chapter.

CHAPTER V

THE PONTELEC METHODS AND MACHINES

THE business of Pontelec Welding Patents, Limited, dates from early times as electrical matters go. Mr. A. Jevons, who succeeded Woodhouse and Rawson United (Midland Branch), Limited, and who was one of the pioneer contractors in electric light and power, established himself in the Minories, Birmingham, in 1888. On the introduction of electric welding he was appointed representative for the original "Thomson" patents, and he himself subsequently obtained patents for welding the seams of tubes, chain welding plant, and automatic switches for welding machines. His office was at Constitution Hill, Birmingham, and the present company, which was formed to take over the rights of the Universal Electric Welding Company of New York, fitted up a demonstration shop in the immediate neighbourhood. Eventually, owing to the keenness of continental competition, as well as to Mr. Jevons' failing health, the company arranged to take over the latter's business, and removed its plant to 46 Constitution Hill, at which place, for some years past, demonstrations of its various special processes have been given, and also the manufacture of some twenty-two different types of machines carried on.

We have recently had an opportunity of visiting the works and of observing a number of machines in operation. Seeing that all the latter embody the Thomson method of welding, single-phase alternating current is, of course, alone employed. As the public supply available in the neighbourhood of the works is direct current it was necessary to employ a means of converting it to alternating current. All electrical engineers will realise the difficulty of dealing with a highly inductive load used intermittently and often only at 0.6 power factor, thrown on and off, it may be, several times per minute. However, the machine which is employed has, according to the testimony of the company, which has during the past few years purchased several of them for use in various places, answered its purpose admirably. It was made by the Phoenix Dynamo Manufacturing Company, Limited, of Bradford, which took up this particular branch of the subject a number of years ago now, and, as a result, developed a special design of inverted rotary converter.

The actual machine used at the Pontelec Works is of 50 kilovolt-ampère capacity. It had, so we gathered, been running for over 8 years, and had been in almost constant use during that period, frequently being called upon to work up to as much as 70 kilovolt-ampères, and was still in good working order. The company, in fact, was quite enthusiastic concerning its behaviour, and we certainly saw it undergo some fairly severe treatment.

It would be impossible for us to refer separately to all the many types and designs of machines which this firm manufactures, and we therefore propose to deal with only a selection. The machine illustrated in Fig. 16 is typical of the firm's standard type, a series of which is built in sizes varying from 5 to 100 kilowatts in capacity. In the particular instance shown the working is effected, both as regards the electric and mechanical arrangements involved, by means of the hand. In other forms, however, the current can be switched on and off by means of a treadle. The whole apparatus

is wonderfully simple. The electric portion, which, with the exception of the switch A and ammeter B at the top, is not visible in the engraving because it is hidden by parts in front of it, consists of a static transformer, the primary winding of which comprises a number of turns, while the secondary winding is of one turn only. The

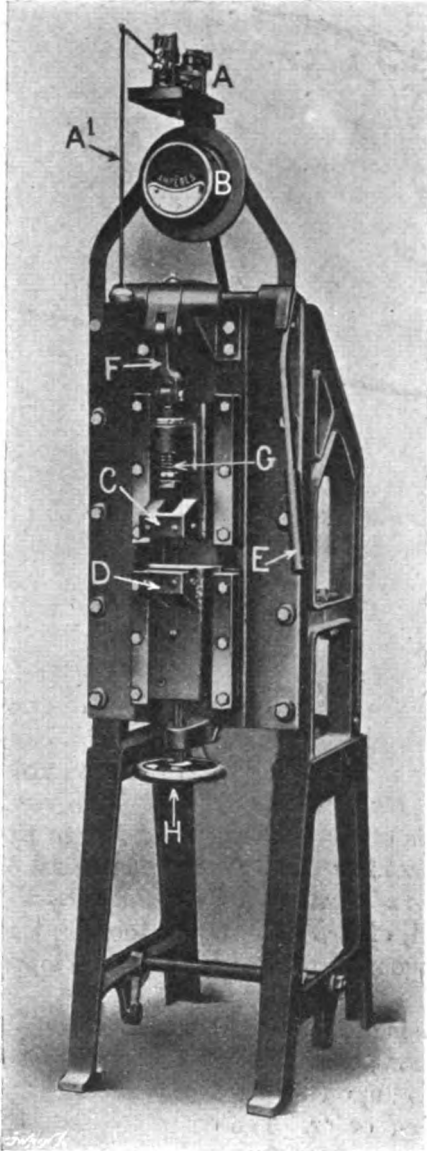

FIG. 16.—Pontelec Resistance Welder.

latter is made up of numerous strands of thin sheet copper, which are not only quite flexible, but have a negligible ohmic resistance. The two terminals of this winding are respectively connected to the two jaw carriers C and D, which are mounted in slides formed on the front of the machine. These jaw carriers, which are, of course, electrically insulated from one another, are capable of vertical motion upwards and downwards in their slides. The upper jaw carrier C is moved up and down by the manipulation of the hand lever E, which operates through the toggle F. The range of movement is, therefore, always the same. In order that articles of varying thickness may be received within the jaws the lower jaw carrier D may be moved vertically up and down by means of the hand wheel H. The jaw carriers are formed of heavy masses of copper, and they are cored out so as to permit of water circulation. Jaws of V, or any other desired shape, can be fitted to their faces.

In operation the article to be welded is inserted between the jaws, the height of the lower jaw being adjusted so that a very small movement of the hand lever will cause the work to be gripped. The circuit of the primary coil is then completed by pulling the switch handle rod A¹, and current immediately begins to flow in the secondary winding, since its circuit is completed by the article between its terminals. The flow of current is heavy, being only limited by the resistance offered by the surfaces in contact, and by the article being welded. The result is that the latter is very quickly raised to welding heat, while the jaws, because of their mass, and of the fact that they have water circulating inside their carriers, remain comparatively cool, even when large numbers of articles are welded consecutively.

As soon as welding heat is reached—and the time it takes to do so varies, of course, with the nature of the article being dealt with, though it is never very long and is frequently only a few seconds—the current is cut off by opening the switch, and at the same time additional pressure is put on the work by the hand lever and toggle, and the weld is consolidated. We may say that it is impossible to put excessive pressure on the work with the toggle mechanism, since the pressure which can be

exerted is controlled by the spring G. We have watched the machines of this type doing a large variety of work, and dealing with articles ranging from thin sheets and fairly fine wire up to plates each three-eighths of an inch or so in thickness. In some cases the pieces of material to be joined were simply laid one on the other without any preparation. No special care, for instance, was taken to remove rust.

The company has developed and patented several processes for use in connection with machines of this type. One of them, which is known as bridge welding—hence the name of the firm “Pont-Elec” (trac)—consists of laying small pieces of metal either over the joint of a tube or between two separate parts of an article, and placing the whole between a pair of electrodes. When the current is allowed to flow and welding temperature reached, pressure is applied, the metal is forced together, and providing the superimposed pieces are close enough together a continuous joint results. In a second process, which is termed multiple point welding, a number of dents, or projections, is formed on either one, or both, parts to be united. In this case contact only takes place at those points, so that when the current passes heating is only set up in their neighbourhood, and when pressure is applied and intimate contact effected the metal in those parts alone is welded. In some cases as many as 20, or more, of these small welds can be made in an article at one operation, and the tenacity with which the two portions of the welded article adhere to one another can be imagined. For certain purposes machines working on this system can be made automatic. The process is, of course, particularly suitable for thin metal work, and the electrodes, or jaws, may have large flat surfaces. The company draws attention to the fact that in this case it is the work or material being dealt with that has the points on it, and not the electrodes, so that not only are more uniform results obtained than with ordinary spot welding, but the electrodes, being removed from the point of maximum temperature, are little affected, whereas with single-pointed electrodes the copper points which, by reason of the high temperatures and the hammer action to which they are subjected during the welding operation, are apt to become flattened, which necessitates their being frequently attended to and reshaped.

A third process is particularly intended for use in connection with heavier work such as the welding together of plates of half an inch or more in thickness. In such operations it is an exceedingly difficult matter to maintain the points of the electrodes in good condition, even though the electrodes themselves are as efficiently water-cooled as it is possible to make them. There is, moreover, another trouble in that, owing to the plastic character of the metal being welded when heated, indentations on both faces of the plate may be caused by the heavy pressures which are necessary to ensure good welds with thick plates. Disc welding, as it is termed, has been devised to overcome these troubles. It consists in placing small discs of the same metal as that which is being operated on, on one or both sides of, and in some cases between, the parts being welded, the first two discs being arranged at the points of contact between the electrodes and the work. On the passage of the current, the parts heated are in this way restricted to the area of the discs or something a little greater. Welding heat is by this means obtained very quickly, and when pressure is applied the discs are forced into the work. By suitably arranging the diameter and thickness of the discs a flush surface results. If desired, too, bosses may be put on, and such bosses may be shaped like rivet heads so as to give the finished article the appearance of having been riveted. The company is careful to explain, however, that the strength would be greater than that possessed by riveted work since the area of the weld is always somewhat greater than that of the superimposed disc. A particular advantage claimed for this method is that greatly varying thicknesses of metal can be welded together

without any chance of burning the thinner sheet. Thus by it, it is perfectly feasible to weld a thin sheet of, say, 26 or 30 gauge on to a plate 1 in. or $1\frac{1}{2}$ in. in thickness.

Still another process which can be practised with this machine is that known as ridge welding. In it ridges are formed during rolling on the surfaces of the metal, so that when the two articles to be welded are brought together the area in contact is much reduced as compared with what it would be were the surfaces plain, and welding only takes place along the ridges. This process, it is pointed out, is especially useful in constructional work, but has not received in this country the attention which has been accorded to it both on the Continent and in America.

We understand that a licence is required to use the special processes of this com-

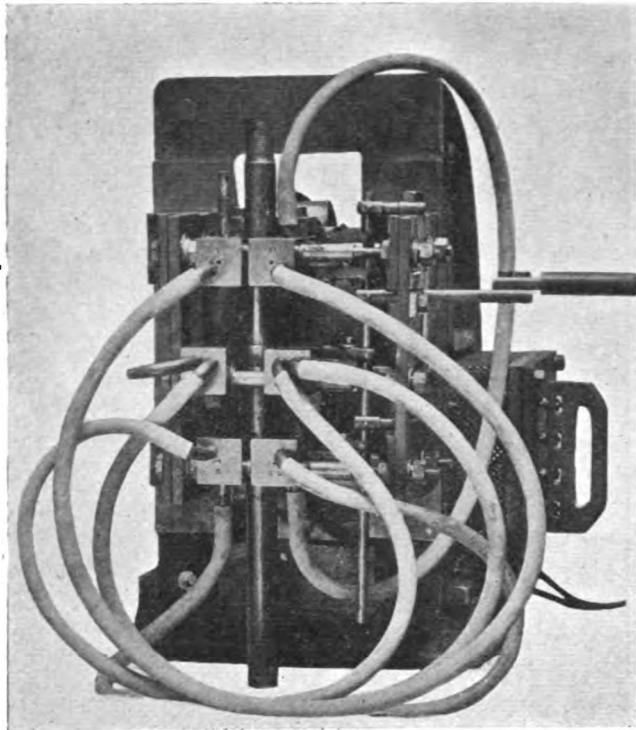

FIG. 17.—Machine for Brazing Collars on Tubes.

pany, even though they are carried out on machines of another make, since the processes themselves are subjects of patents.

Passing on now to some of the other machines made by this firm, attention may be directed to Fig. 17, which shows a machine recently designed for brazing steel collars on to tubes. In this case the electrodes have horizontal instead of vertical motions, the pipe being dealt with being held vertically. The pipes seen in the engraving are for the water circulation, and give the machine the appearance of being rather complicated, which, as a fact, it is not.

It will be observed the welding circuit is divided and forms three pairs of jaws, or tools as the makers call them, the upper and lower pairs fitting the tube, whilst the middle pair makes contact on opposite sides of the collar to be brazed on. In operation, the handle on the right-hand side is pressed back and all three tools on that side are carried to the right; the left-hand tools being fixed. The collar is first placed in the

middle tool, resting upon supports provided on the inside of the tools. A ring of brazing wire is then placed on the collar and the tube passed through both from the top, an adjustable support at the bottom—not seen in the engraving—taking the weight of the tube and at the same time fixing the position of the collar in relation to the ends of tube. The handle being then pulled forward, all three pairs of tools are brought into contact with their respective parts, the secondary circuits being so arranged that one is completed through the tube, which becomes heated midway between the upper and lower contacts, whilst the other circuit is completed through the collar, which becomes heated at the same time, there being only one primary circuit controlled by a foot-switch so that the operator has both hands at liberty. A little borax is applied and the current kept on until the brass wire flows into the joint between the tube and the collar. Owing to the heat being internally generated, the outside of the collar remains clean and nothing is needed, so we understand, but a rub over with a wire brush, the whole operation only occupying about one minute. The tubes are about one and five-sixteenths inches external diameter and one-quarter of an inch thick, the collars being about one and one-quarter inches long, and three-eighths of an inch

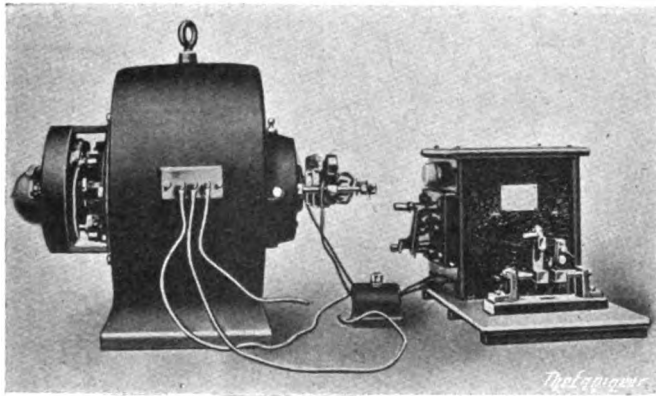

FIG. 18.—Spectacle-frame Soldering Machine.

thick. The regulator provides six variations of power, with a maximum of 10 kilovolt ampères.

Fig. 18 is interesting as showing what is thought to be the smallest resistance heating plant ever made commercially. It is not, strictly speaking, perhaps, a welding machine any more than is the machine just described, but they both approach, we think, sufficiently nearly thereto to warrant mention of them being made in this Work. The whole apparatus is contained in an oak case which measures 10 in. each way, and it weighs only about 28 lb. It was designed and built for the Army Spectacle Department, and is used, so we are informed, for the hard soldering of spectacle frames.

The machine on the left is a 4 horse-power motor rewind, and slip rings added. The transformer is enclosed in an oak case, which has a regulator attached to its side. The small switch shown in between the two is intended to be foot-operated, and is placed on the floor, the converter being arranged in any convenient position. The small machine shown in front of the oak case consists of two end frames supporting a pair of parallel bars carrying a pair of copper blocks, both insulated and connected respectively to the two ends of the secondary winding, but capable of being moved on the bars and fixed in position by a small thumbscrew. Each copper block carries

a tool formed to hold the different parts, which are pressed together by a light spring. On the foot-switch being closed the points of contact become heated, and hard solder, in the form of a fine wire, is touched upon the heated parts, with the result that it is melted and, flowing in, forms a clean and neat joint. Several hundreds of spectacle frames are, we are informed, completed by one operator per hour, whilst the heating is so local that adjoining parts are not softened, and the articles are easily handled. This machine has a maximum capacity of about 2 kilovolt-ampères. It is used on both steel and gold-filled fittings of spectacle frames.

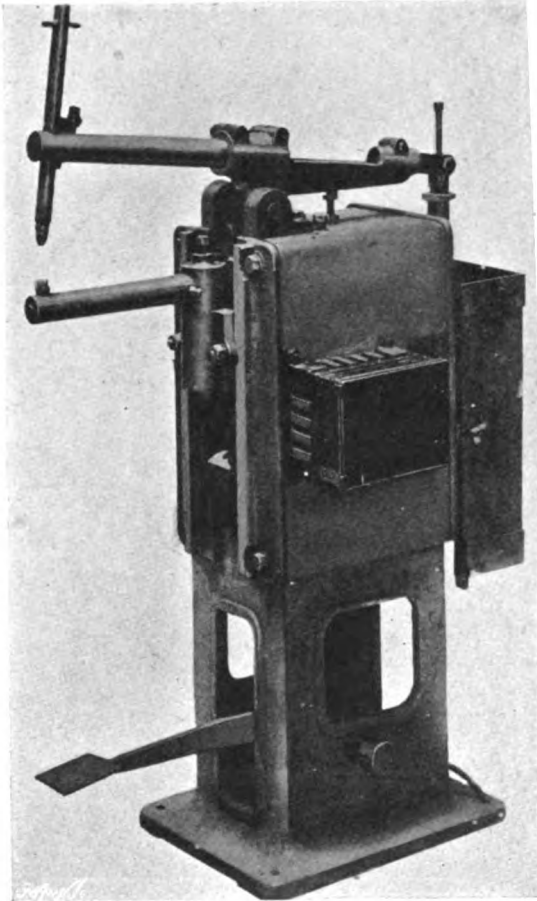

FIG. 19.—Typical Pontelec Spot Welder.

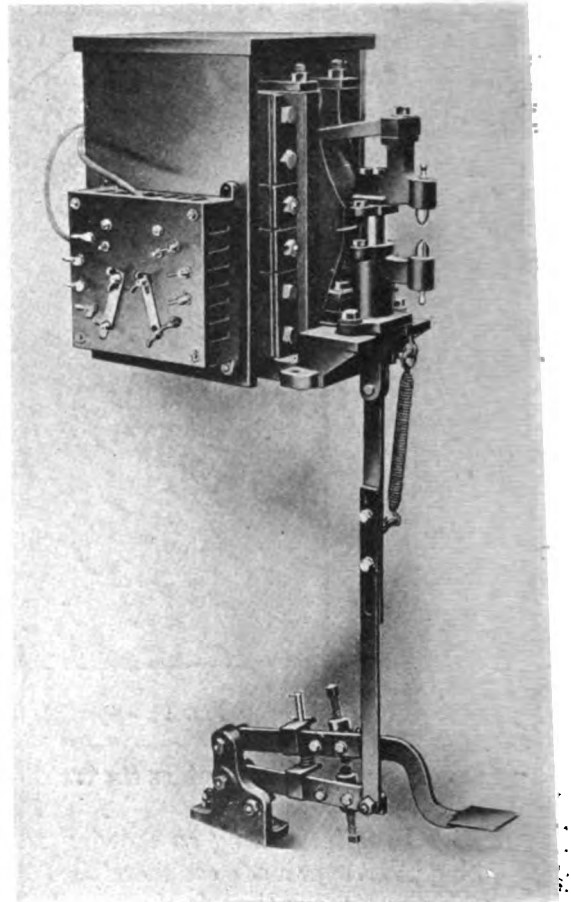

FIG. 20.—Spot Welder for Bench Work.

Spot welding machines of various types are made by the company. A typical example of one of them is shown in Fig. 19. It is of a light type, and is operated by pedal. It is intended specially for welding hollow-ware previous to enamelling, and is made in sizes ranging from 5 to 20 kilowatts in capacity. As will be observed, the lower electrode or anvil is capable of adjustment vertically by moving it in its slide, where it can be clamped in any desired position by the nuts and bolts which may be seen in the engraving. The upper electrode can also be adjusted by the movement of a nut up and down the vertical screwed spindle seen at the rear of the pivoted arm. The distance apart of the two electrode points, and hence the amount of pressure applied during welding, can in this manner be arranged.

A much lighter type of spot welding machine for bench use is shown in Fig. 20. It also is pedal worked, and it will be observed that the lower portion of the link connecting the pedal with the upper electrode is slotted, so that the latter can be raised to admit larger or smaller work. Then, too, the amount of travel of the pedal, and hence of the electrodes, can be regulated to suit the altered circumstances by means of the two sets of screws seen at the bottom of the engraving. The spring connecting the frame with the pedal operating link raises the latter, and hence the upper electrode when pressure is taken off the pedal. It will be observed that there are two series of terminals on the box at the side of the frame. They are for employing different tappings on the primary of the transformer inside the machine, so as to obtain different voltages in the secondary to suit differing classes of work. This, we may mention, is an attribute possessed by the other machines made by the company.

While on the subject of spot welding machines, we may say that on the occasion of our visit to the Pontelec Company's works we were shown the drawings of a very large machine of that type—probably, it was thought, the largest which had been undertaken in this country—which was then under construction for an enterprising British firm. It was to have copper arms 7 in. in diameter, projecting 5 ft. clear from the body of the machine, and its weight, when completed, was to be something over 5 tons. An interesting insight into the range of machines built by the firm may be obtained when comparison is made between that weight and that of the spectacle-frame machine weighing 28 lb.

Fig. 21 shows one of a series of butt welding machines, which are made in sizes varying from 5 to 60 kilowatts capacity. The actual machine illustrated had been specially designed for welding motor-cycle rims, which it does, we gather, at the rate of 150 per hour, with a consumption of 12 kilovolt-ampères of energy. In operation the two ends of the rim which are to be welded are gripped between two specially formed jaws, which can be moved backwards and forwards horizontally, so that pressure can be applied to the weld by means of a hand lever and toggle mechanism, observable on the right of the picture. The electrodes have, of course, water circulation. We have seen this machine in operation doing excellent work. It is fitted with an oil break automatic cut-off switch.

A machine of quite a different type, which nevertheless shares many features in common with those already referred to, is shown in Fig. 22. It is a machine for welding the seams of cylinders, and its operation will be readily understood. The cylinder is fixed in a frame which can be traversed backwards and forwards by means of the

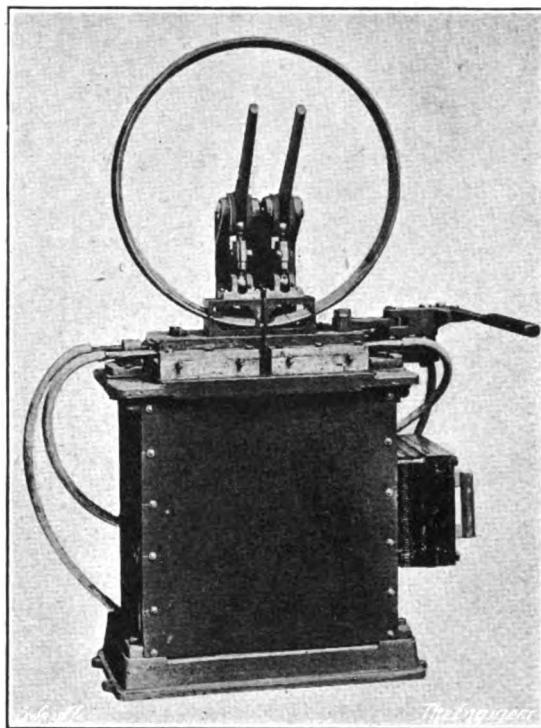

FIG. 21.—Pontelec Butt Welder.

hand lever. The seam rests on a horizontal anvil which forms one of the electrodes, and has its ends carried by uprights which form part of the cylinder-holding frame. The upper electrode is formed by a copper roller which is revolved by power by means of a chain which is sufficiently slack to permit of the small amount of movement necessary to bring the wheel into contact with the work. Both

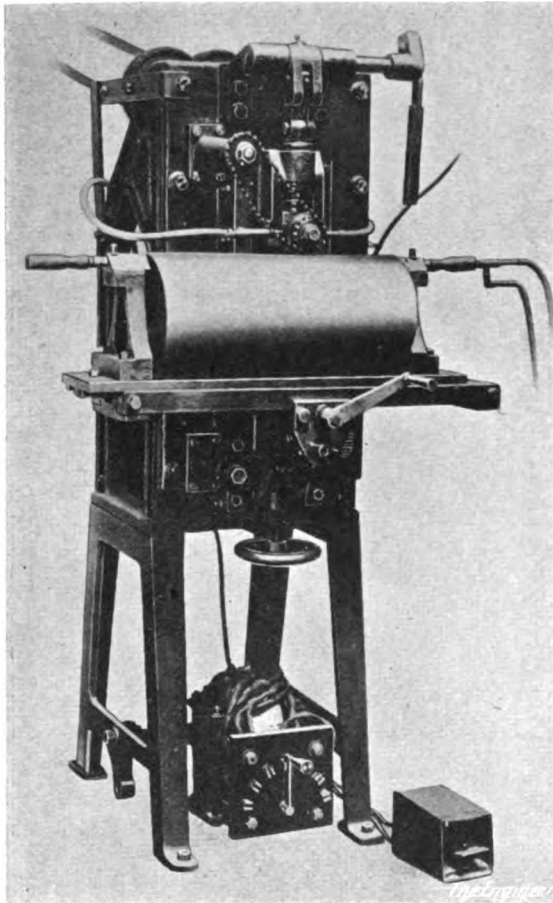

FIG. 22.—Typical Pontevec Seam Welder.

anvil and wheel are water cooled. When the cylinder is in position, the bed and frame carrying it are moved by the hand lever, so that one end of the seam may come directly under the roller. The latter is then depressed until it just touches the work. The pedal switch is then operated so that current flows, while simultaneously the pressure between the roller and cylinder is increased, with the result that the latter is gripped between the anvil and the roller, and, by reason of the rotation of the latter, is caused with its bed and frame to move horizontally. The result is that the wheel follows along and welds the seam as the cylinder is gradually traversed from one side to the other of the machine. As in the machine shown in Fig. 16, there is a spring which prevents excessive pressure being put on the work. In giving the foregoing descriptions of selections of the machines made by this firm, it is not pretended that all the different types of machine which it makes have been mentioned; but a fairly representative reference has been made. The company, it may be mentioned, does not issue any catalogue. It has found such a course

impossible because there is such a great variation in the voltages, periodicities and systems of distribution, that hardly any two cases are alike in every respect. In some instances, for example, only polyphase current may be available, and it is not by any means always permissible to put a welding load on one phase only. Then, again, continuous current only may be available. It prefers, therefore, to treat each separate case on its own merits, and is prepared, when supplied with full information, to give its considered view of the matter; and it lays stress on the fact that it makes a point of never booking an order unless it is sure that a commercially satisfactory result can be obtained.

CHAPTER VI

THE QUASI-ARC PROCESS

As an example of coated metal electrode processes we have chosen that which is known as the Quasi-arc process, and we discuss it in the following chapter :—

The Quasi-arc—or the “Quazarc,” to use the trade mark name that has been adopted—process of electric welding is the invention of Mr. Arthur Percy Strohmenger, of the Quasi-Arc Company, Limited, of 3 Laurence Pountney Hill, E.C. 4, who holds several patents in connection with it. It is a fusion process, and the electrodes used are coated in a special manner, both they and the method of their application having been patented. The electrodes can only be obtained direct from the company, and with each parcel is granted to the purchaser a direct licence for the use of the process in conjunction with the electrodes supplied in that parcel, and for such use no royalty is charged. The firm has extensive works in the East of London, and at them we have had an opportunity of observing, not only the manufacture of the electrodes on a large scale, but the actual process of welding in operation. Mr. Strohmenger, who, we believe, was born in South Africa, has had, at any rate, a wide experience with the asbestos deposits of that country. Our readers will remember much of the asbestos found there is of a blue colour, and is largely composed of a ferrous silicate. Its chemical composition is such that Mr. Strohmenger was led to the belief that it would answer perfectly as a flux in electric welding. His first idea was to coat a metal rod with the asbestos and to lay it along the joint or seam which it was intended to weld. An arc was then struck by means of a carbon or other electrode, and both the coating and metal rod were gradually melted, together with the edges to be welded, so that a welded joint protected by a covering of flux or slag was obtained. We believe that the character of the weld was all that could be desired, but the method was clumsy and did not, moreover, permit of overhead working. So Mr. Strohmenger decided to use the coated rod itself as the electrode, and he has since made certain improvements in the manufacture of the electrodes themselves. Perhaps the most important of these improvements is the introduction between the coating and the rod of a fine aluminium wire which represents in bulk about two per cent. of that of the electrode metal itself. It is claimed that the effect of adding the aluminium is that a strong reducing action is brought about, the metal having a strong affinity for oxygen at welding temperature. The asbestos itself acts as a reducing agent and forms a slag which covers the weld and prevents oxidation. The alumina passes away with the slag and the coating formed on the weld is easily chipped off by hammering, and removed with a stiff brush when the metal has cooled. The temperature at which the coating melts can be controlled to a certain extent by the addition of such compounds as aluminium silicate or sodium silicate. We may say here that the coating is applied in the form of yarn, and is so regularly put on that the surface of the rods is quite smooth to the touch.

Under the Quasi-arc system either single phase alternating or direct current can be employed. When we saw it in operation direct current was used. The supply voltage was 110, and beyond the special holder for the electrode the only other accessories were a resistance and an ammeter, and, of course, the protecting screen. The

negative pole of the current supply is connected to the work or to the metal plate or bench on which the work to be welded rests, though in the latter case it is, of course, necessary to make certain that there is good electrical connection between the work and the plate. The positive terminal of the electric supply is connected to one terminal of the resistance, the other terminal being connected by means of a flexible cable with the electrode holder. One end of the electrode is left bare of coating and it is, of course, that end which is inserted in the holder. In working, the electrode is first of all held in a nearly vertical position—supposing the work to be horizontal—and when the tip of the electrode is brought into contact with the work an arc is formed. The electrode, still kept in contact with the work, is then dropped to an angle, and the arc is destroyed owing to the covering passing into an igneous state, and, as a secondary conductor, maintaining electrical connection between the work and the metallic core of the electrode. The action once started, the electrode melts at an uniform rate, so long as it remains in contact with the work, and leaves a seam of metal, which, if the operation has been properly performed, is perfectly fused into

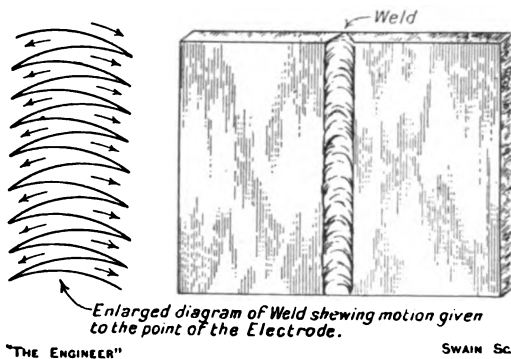

FIG. 23.

the work. The covering material of the electrode acts as a slag and spreads over the surface of the weld as it is formed, and it is claimed that the fused metal is thereby protected from all risk of oxidation. It is recommended that the operator should commence at the furthest point of the joint away from himself, and bring the electrode towards himself with a slightly to-and-fro movement so as to spread the heat and the deposited metal equally to both sides of the joint. This zigzag movement, and the appearance of the weld formed by means of it, are

shown in the accompanying engraving, Fig. 23. The length of the arc varies, we gather, between $\frac{1}{8}$ in. and $\frac{1}{4}$ in., depending on the size of the electrode used.

It is necessary, of course, that care should be taken to feed down the electrode to the work at the same rate as the former melts away, and the operator is warned not to draw the electrode away from the work so as to form a continuous arc, as by doing so the quality of the metal laid on will be impaired, and the work, if thin, may be burnt. The aim, it is explained, should be to keep the electrode just in the molten slag, and this may be done by the "feel" of the covering just rubbing on the work. Care must also be taken to see that the "work" is fused or melted where metal is being deposited. It is quite possible, as we ourselves observed, to distinguish between molten slag and molten metal when using the special screens employed by the company, the metal being dull red in colour, and the slag very bright red.

In discussing the sphere of its applications the company states that the Quasi-arc process can be used for a variety of purposes, such as constructional steel work, including shipbuilding, in the manufacture of pressure tanks, air receivers in boiler work, including the reinforcing of worn plates and general repairs, and in the making up of crank-shaft journals, worn key beds, repairs to hydraulic rams. It claims, too, that the ease with which seams of any length and thickness can be welded renders it most useful in industries in which hitherto riveting and caulking has been solely employed—see Fig. 24—and that on plate work it shows a high percentage of saving in cost as compared with oxy-acetylene welding, being more than twice as rapid,

and the resulting joint much stronger, while there are no difficulties owing to distortion of the work. On this point, which is due to the heat being highly localised, great stress is laid. With regard to the foregoing it may be said that practically identical claims are made by other arc welding specialists, who would hence dispute that they are peculiar to the Quasi-arc process. They may therefore be taken as being indicative of what can be done with metallic arc welding in general.

The Quasi-arc electrodes as supplied are in lengths of 18 in., and they are of various diameters, according to the size and nature of the work for which they are required. For the general welding of mild steel or iron, constructional work, tanks, wheel tyres, filling steel castings, etc., mild steel electrodes are supplied and in the following sizes: S.W.G. Nos. 14, 12, 10, 8, 6, and 4. For reinforcing worn parts of machinery, building up the teeth of gear wheels, reinforcing tramway rail treads, etc., there are carbon steel electrodes. As being suitable for reinforcing or building up manganese steel crusher jaws, dredger bucket lips, tramway points and crossings, manganese steel electrodes are recommended. They are made $\frac{3}{16}$ in. in diameter. Finally there are special electrodes for boiler plate reinforcement and any overhead or vertical work.

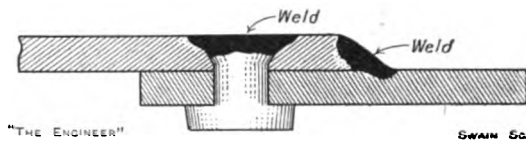

FIG. 24.—Welded Riveted Joint.

With regard to the sizes of electrode required for different sizes of work in sheet and plate welding the company publishes a table which we reproduce on page 37.

It will be noticed that in thick work no attempt is made to do the whole depth of the weld at one operation. The process is, in fact, essentially a building-up process. Two, three, four or even more "runs" may be required, a proportion of the depth being filled in at each "run." For the bottom portion a comparatively small electrode is used, so that its point may be taken down to near the bottom of the seam. It need hardly be said that the slag from a preceding "run" must be chipped or brushed away before a further "run" is commenced, and that care must be taken to fuse the surface of the preceding layer of metal as well as the sides of the joint whilst depositing new metal.

As regards special precautions to be taken whilst welding by this process, the company recommends that the electrode holder should be gripped firmly, but the arm left free; a light touch and a lateral movement from the wrist give the best results. Sufficient current should be used to admit of the metal, which is being deposited, running freely, with no tendency to pile up. If too much current be used the metal will run fiercely and be uncontrollable. The point of the electrode should be kept well down to the work, just in contact, in fact, with the molten slag, and at such an angle as will keep the molten metal and the slag flowing in front of the electrode, that is to say, away from the operator, who, it will be remembered, gradually draws the electrode towards himself. Care should be taken not to allow the slag to get behind the electrode, that is between it and the operator. We have already explained that slag can readily be distinguished from metal by reason of the difference in colours.

The following table gives the limits of current admissible with various sizes of Quasi-arc electrodes:—

Size of electrode.	Current limits. (ampères).
No. 14 S.W.G.	15 to 40
„ 12 „	35 „ 90
„ 10 „	75 „ 110
„ 8 „	90 „ 140
„ 6 „	110 „ 175
„ 4 „	140 „ 200
$\frac{1}{4}$ in.	150 „ 220
$\frac{3}{8}$ in.	250 „ 300

The following remarks which the company makes regarding special applications of the process are of interest : For reinforcing worn or weak work and for the repair of faulty castings, the size of the electrode will depend upon the amount of work to be deposited, but, in the case of work liable to distortion, overheating by the use of unduly large electrodes must be avoided. In other words, it is a mistake to attempt to lay on too much metal at one operation. For reinforcing work, such as the repair of a worn crank shaft, the new metal should be deposited in strips parallel to the shaft, and each strip should be cleaned of slag, etc., before the next is deposited at the side of it. Then again, before commencing to fill up blow-holes the work should be prepared by opening it out sufficiently with a chisel, or by fusing away the overhanging portions with an electrode—using a higher current than for welding—so as to enable the bottom of the hole to be reached by the electrode when welding.

Overhead welding, for which, as mentioned above, special electrodes are provided, takes longer than a seam of similar length on the flat. Good, sound homogeneous metal can, it is said, be fused into the joints by holding the electrodes nearly vertical and moving slightly from side to side, keeping the point of the electrode close to the work. The weld should then be chipped over until an even surface is left, and then other “runs” put on until the required thickness is obtained. For vertical welding, the ordinary mild steel electrode may be used up to No. 8 size, the best angle to hold the electrode being just below the horizontal. Most operators, the firm states, obtain the best results by commencing at the bottom of the joint and working upwards, although the process should be reversed when welding in an angle fillet. When sufficient metal has been put on, if the electrode is worked downwards from the top with a slightly higher current, it will have a smoothing effect on the metal previously deposited. We may say that, as far as we are aware, hammering is very rarely, if ever, used with this process. The seams which we saw, whether they were horizontal, vertical, or overhead, had a rippled surface—caused, doubtless, by the zigzag movement given to the electrode—which stood up slightly above the surface of the work. When the slag was chipped off after welding, the deposited metal was perfectly bright and not in the least discoloured.

For welding cast iron it is best, the company states, to use a small diameter electrode and a low current, so as to retain as large a percentage of the silicon as possible in the neighbourhood of the weld and thus keep the metal soft. Good grey iron, high in silicon and low in phosphorus, welds the best. In welding heavy cast iron—say, above $\frac{3}{8}$ in. thickness—it is best to vee out the crack, weld in at the bottom with a small electrode, and then build up with successive layers of metal. In welding light castings of box section, it is advisable to heat the casting to a black heat, to relieve local strains, and then to weld over the crack without vee-ing. This operation will result in the welding going quite half-way through. If the underside of the crack is accessible it is advisable to repeat the operation from that side.

Though not strictly coming within the scope of this Work we may briefly

refer, here, to cutting metals by means of the Quasi-arc process. For this purpose the company recommends the use of a mild steel electrode of No. 8 gauge. Just before commencing operations the electrode is dipped in water, then, the resistance having been set to give a current of about 200 ampères, the point of the electrode is applied to the plate to be cut. The molten metal is allowed to drop away, and the cut formed is followed up by feeding in the electrode and moving the point of the latter quickly

SIZES OF QUASI-ARC ELECTRODES AND CURRENT REQUIRED FOR SHEET AND PLATE WELDING

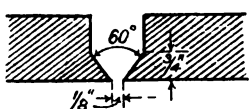
Thickness of work.	Preparation of joint.	Size of electrode.	Current in amp.
16 s.w.g.	Close joint	No. 14	20 to 25
14 "	"	" 12	30 " 35
12 "	"	" 12	40 " 45
10 "	"	" 10	50 " 65
$\frac{3}{8}$ in. plate	$\frac{1}{8}$ in. open	" 10	75 " 95
$\frac{1}{4}$ in. plate	Veed half-way through and $\frac{1}{32}$ in. open ..	" 8	93 " 110
$\frac{1}{8}$ in. and $\frac{3}{8}$ in.	Veed right through to 70 deg. and $\frac{1}{8}$ in. open Two runs are necessary— First run Second	— " 10 " 8	— 75 " 85 95 " 110
$\frac{1}{2}$ in. plate	Veed right through to 60 deg. and $\frac{1}{8}$ in. open .. Two runs are necessary— First run Second run	— " 10 " 6	— 75 " 85 100 " 120
$\frac{5}{8}$ and $\frac{3}{4}$ in.	Veed right through to 60 deg. and $\frac{1}{8}$ in. open .. Three runs are necessary— First run Second run Third run	— " 10 " 8 " 6	— 75 " 85 95 " 110 100 " 120
Over $\frac{3}{4}$ in.	Prepare thus :— 	.. 4	150 " 175
	Up to $\frac{3}{4}$ in. carry the 60 deg. angle, then parallel upwards through the thickness of the plate. After welding as for $\frac{3}{4}$ in. fill up with .. For heavy plates, say, $1\frac{1}{2}$ in. thick, it may be sometimes advisable to veed half-way through from both sides		

up and down through the thickness of the plate. During the process the electrode is again dipped once or twice in water. The point of the electrode should always be kept as close as possible to the metal to be cut, but not so close as to get a dead short circuit. If that occurs the electrode will stick and get red hot.

As regards the ease with which the operator can learn to employ this process we are enabled to give the following testimony of an independent witness who is entirely unconnected with the company. He says : " Electric welding by this method is not difficult to learn, and with good instruction, skill in it can be acquired, and fairly good welds produced, after one or two weeks of practice, according to the ability of the

learner. The work is suitable for female and other unskilled labour. The welder may either stand or sit to the work. If the weld is of long duration it is advisable to provide seats, particularly for female operators, so as to make them as comfortable as possible. Neither the quality of the welds nor the speed at which they are effected suffers from this attention." Here again, we would say, that advocates of other covered electrodes make practically identical claims for their products.

CHAPTER VII .

RESISTANCE WELDERS OF THE BRITISH INSULATED AND HELSEY COMPANY

To say that the British Insulated and Helsby Cables, Limited, of Prescot, Lancs., makes an infinity of machines for electric welding on the resistance system would, of course, be an exaggeration, yet one is almost tempted to make such an assertion when contemplating the multiplicity of designs which it has evolved for effecting numerous operations.

We shall not attempt, therefore, even to give a full list of, much less to describe all the machines which it is prepared to supply, though such a description would be full of interest, but shall content ourselves with referring to what may be termed a fairly representative selection. We may premise what we have to say by explaining that the electric arrangements involved in all the machines are fundamentally the same as those employed in all systems of resistance welding. That is to say, each machine embodies a transformer wound so as to perform the particular work desired under the conditions of voltage and periodicity of the supply current available. The secondary coil of the transformer consists of a single convolution, having a large cross section of copper, which terminates externally in two electrodes, which are of various forms. The pieces to be welded are brought between these electrodes, thus completing the electric circuit of the secondary coil, so that when the primary circuit is closed a heavy current flows in the former. As the resistance to the flow of that current is practically all centred in the surfaces in contact—since the ohmic resistance of the secondary winding is comparatively negligible—great heat is developed between the electrodes, and the material between them is quickly brought up to welding temperature. There is in each machine provision for regulating the pressure at the points of contact, and also for cutting off the current at the right moment. The latter operation is, in some cases, performed automatically, though in others it is effected by a separate motion. Generally speaking, too, there are means of altering the current in the secondary by means of tappings on the primary winding. Such in brief outline are the general principles underlying the working of the machines, which we can now proceed to refer to in greater detail.

In the first instance attention may be drawn to butt welding machines, of which the company makes various types to suit different purposes, the principal being : (1) Welders for wire with automatic upsetting gear for uniform section iron, steel or non-ferrous metals ; (2) welders for manufacturing purposes with hand or automatic upsetting gear for irregular section, iron, steel, or non-ferrous metals ; and (3) chain welders.

“ Wire welders ” is the term which the firm itself applies to the machines in category No. 1, and some of the machines made are capable of dealing with wire with as small a diameter as 0.024 in. Other and larger machines of the same type are, however, able to weld material up to 1 square inch in cross section. Such machines are all fitted with automatic upsetting and current control gear. With them the parts to be welded are clamped between the jaws of the welder and the ends held together under

spring pressure. When the current is switched on heating occurs at the junction to the two pieces, and when the heat is high enough to permit of it, the ends are forced together into still more intimate contact by the action of the spring and the current is automatically switched off. Wires joined in this manner are subsequently redrawn so as to do away with the thickened portion where the upsetting has taken place.

The machines in the second category are used for such manufacturing purposes, amongst a host of others, as welding pipes, refrigerator coils, milk-can rings, perambulator rims, printers' chases, fittings to casement frames, carriage and coach work parts, trellis work, coupling links, brake rigging, travelling-bag frames, low grade steel shanks on to high grade steel tools, drills, taps, etc., lubricators, valves, tyres, etc.,

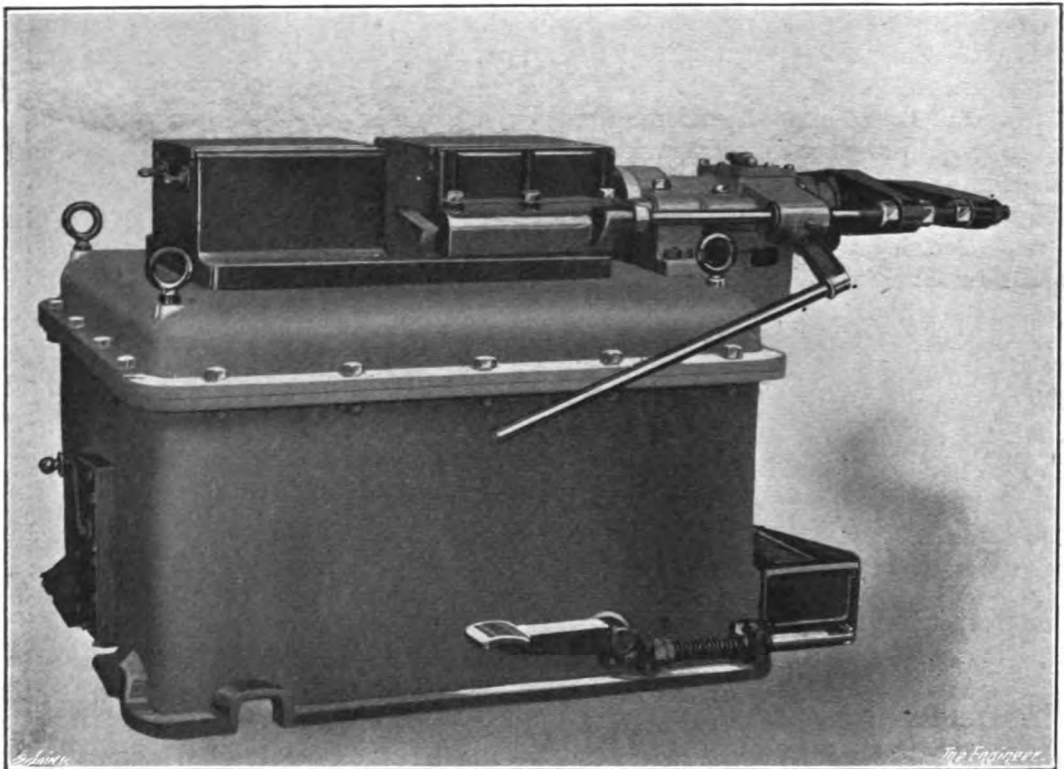

FIG. 25.—B.I.W. Butt Welder, No. 57.

and for the building up of drop-forged parts into complete forgings. They work very much as do the so-called wire welders, saving that in the majority of cases the switch and upsetting gear are hand controlled instead of being automatic.

The chain welders really form a class by themselves, though the general principles involved are very much the same as those of the other machines, as we shall show when we come to describe them.

Two examples of the firm's butt welding machines are shown in Figs. 25 and 27. The first-named is what is known as welder No. 57, and it has been designed to deal with welds up to 5 square inches in cross section, and to be suitable for welding bars, tyres, etc. It will be observed that the jaws open and shut horizontally, and that the pressure is applied hydraulically, the electric current being turned on and off by means of the foot pedal. There is, of course, a water circulation for cooling. The transformer

is contained in the cast iron base, and different tappings on the primary can be employed by means of the switch, shown at the left-hand side, for work of different characters. Eye-bolts are provided at the top of the casing, so that the whole plant can be slung and carried to the point where it is desired to use it.

The machine shown in Fig. 27 differs from the foregoing in several respects. It is smaller, for one thing, being only intended to deal with welds up to 2 square inches in area, and the pressure is applied by the spoked hand wheels acting on a screw and a series of levers. The current is turned on and off by means of the hand switch on the left-hand side. The articles to be welded are gripped in the jaws by the two hand wheels, and the jaw carriers, which are of stout proportions, are all of them provided with water circulation. The machine is particularly intended for welding drills.

The manufacture of chains from coils of wire is carried out by two machines, the first of which bends the links and threads them into a chain, while the second forms

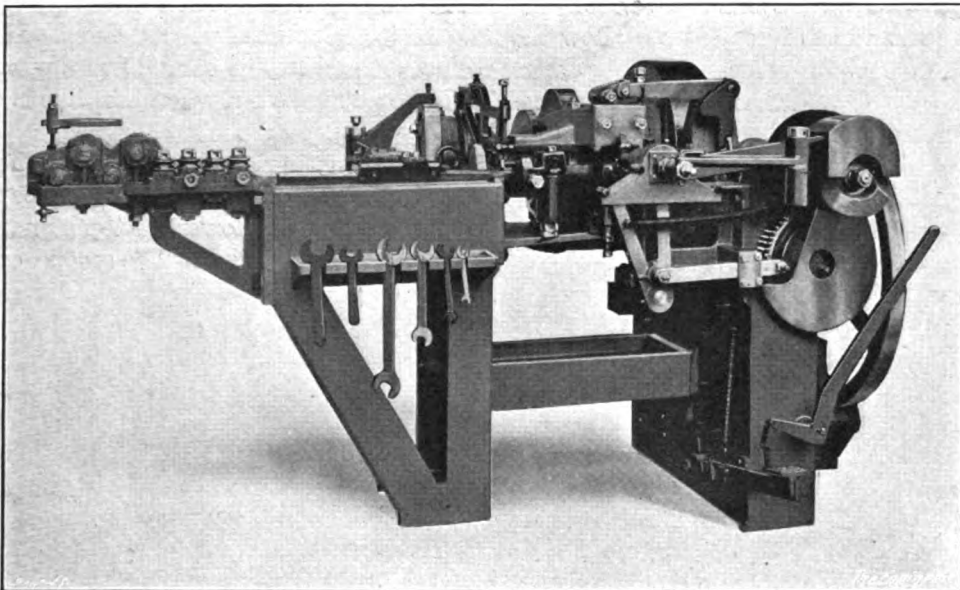

FIG. 26.—B.I.W. Chain-Link-Forming Machine.

the welds. Although the first machine does not correctly come within the scope of this Work it is necessary to describe it, since the complete process cannot properly be understood without it. Three sizes of machine are made. They deal respectively with wires having diameters of from $3\frac{3}{2}$ in. to $1\frac{3}{4}$ in., $1\frac{3}{8}$ in. to $1\frac{5}{8}$ in., and $1\frac{5}{8}$ in. to $1\frac{7}{8}$ in. The smallest machine turns out from fifty to sixty links per minute, and takes from 1 to $2\frac{1}{2}$ horse-power to drive it; the middle size machine can make from forty to fifty links per minute, and requires from 2 to 4 horse-power; while the output of the largest machine is from twenty to thirty links per minute, and a horse-power of from 3 to 7 is needed to drive it. One of the machines is shown in Fig. 26. The minimum proportions of the links made on these machines are—length 5 diameters of wire, and width $3\frac{1}{2}$ diameters of wire. The machines are belt-driven and provided with fast and loose pulleys. The control is by the hand lever seen at the right-hand or driving end. There is also a foot-operated lever which is attached by chain to the hand lever, and which, when depressed, throws the belt on to the loose pulley and brings into operation a brake which acts on the fly-wheel, thus enabling the machine to be stopped

almost instantly in case of emergency. Power is transmitted to a back shaft through a pair of double helical wheels. Mounted on the back shaft are three cams, the first of which is a triple-path cam, which operates all the tools forming the links. The centre path pushes forward the main slide, which carries a parting-off tool and two bending tools, which form the link into a U shape from the back of the mandril. The two side paths operate levers carrying the tucking tools, which close the link at the front of the mandril. The second cam on the back shaft operates a gripping lever, which holds the wire while it is being parted off. The length of the path of this cam can be varied. The adjustment for gripping different diameters of wire is made by a screw at the gripping end of the lever. The third cam operates the feed. It is made adjustable, so that any length of feed can be obtained to suit any link within the range of the machine. From it the feed slide is operated through a bell crank lever, the feeding end of which is fitted with a device which grips the wire on the feed stroke of the slide and automatically releases it when the end of the stroke is reached. This gripping device is fitted with a small cam which enables it to be thrown out of action at any time, but the main use of which is to allow the machine to be started up and the motions put into operation before actually starting to make chains. The cam is fitted with a lever for finger and thumb operation, and should be put in action when the slide is on the back stroke.

Running from the front to the back of the machine on the right-hand side is a shaft driven from the back shaft through a pair of bevel gears. Mounted on it are two cams and a spur pinion. The first cam operates levers which raise and lower the top mandril, an operation which allows the formed link to be taken out by fingers. The second cam is responsible for the in-and-out motion of the lacing spindle. The pinion drives a spur wheel, in the face of which is sunk a cam path. From this path motion is given to a quadrant which drives the lacing spindle in a semi-rotary manner. The semi-rotary movement is done in two stages, each of 90 deg. The stroke of the lacing spindle is adjustable.

The mandril is in two parts, upper and lower. The latter is stationary, and only acts as a stop and stiffening block for the upper mandril, round the bottom end of which the link is bent. A groove is formed down the front of the lever for convenience in lacing. An adjustable cutting die is fitted so that the wire may be parted off clean. On the extreme left of the machine is a straightening device.

In operation the first 2 ft. or 3 ft. of the coil of wire are straightened by hand, and the end is threaded through the straightening rollers—which are slacked off for the purpose—through the gripping device on the feed slide, and through the cutting die until it—the end—projects through about $\frac{1}{2}$ in. on the mandril side. The straightening device is then adjusted, after which the fly-wheel is turned round until the shearing tool cuts off the projecting $\frac{1}{2}$ in. of wire. After adjusting the feed grip, main grip, length of feed and stroke of lacing spindle to suit the wire and link, the machine is ready for work. The belt is first thrown on to the fast pulley. Then, when the feed slide is on the back stroke, the small cam is slipped over and the feed grip thus put into action. The machine then works automatically.

The cycle of operations is as follows: On the forward stroke of the feed slide the wire is pulled through the straightening rollers and the end is fed behind the mandril. As the slide reaches the end of the feed stroke, the main grip comes down and holds the wire on the anvil. Meanwhile the back slide is moving forward, and as soon as the wire is gripped the shearing tool cuts off the length of wire necessary to form the link. This piece of wire is caught by the back-bending tools and bent into a U shape round the mandril. Next, the tucking tools come into operation and bend the ends of the U

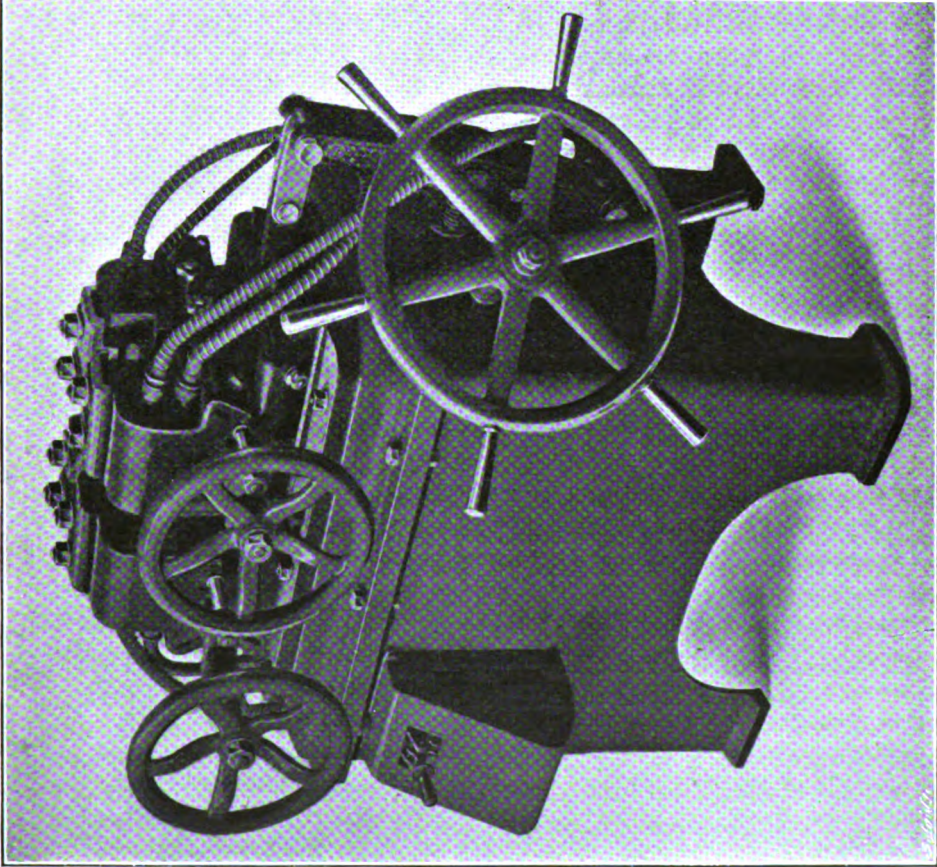

FIG. 27.—B.I.W. Butt Welder.

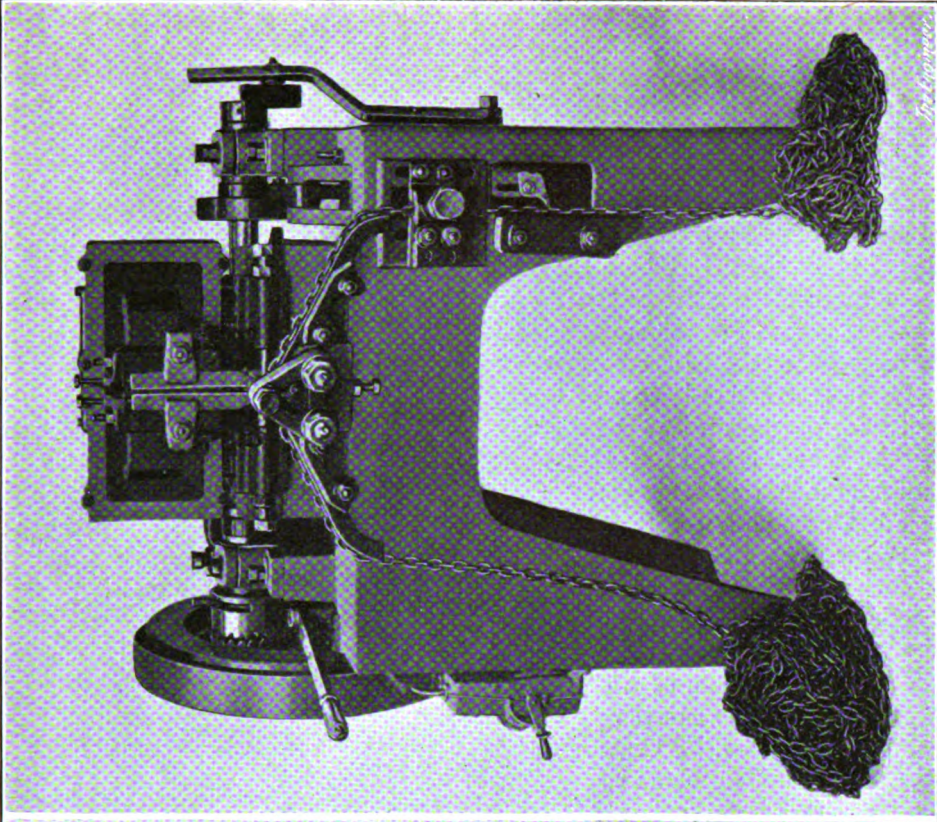

FIG. 28.—B.I.W. Chain Welder.

towards each other, thus completing the link. The lacing spindle then moves forward, and the fingers close on the completed link. As soon as this happens the top mandril rises to allow the link to be withdrawn. When it is clear the mandril drops down and the wire is fed behind for the next link. Simultaneously, the lacing spindle makes a quarter of a turn, thus changing the position of the first link from the horizontal to the vertical plane, and then moves forward again to enable the fingers to place the link in the groove in the mandril. When the second link is formed it is threaded into the first link. The fingers then retire and are again turned through an angle of 90 deg. to the horizontal plane ready to take out the second link. The motions of the lacing spindle are so arranged that the joint on every second link is on the same side, so that the chain when being welded has only to pass through the welder twice.

We can now pass on to the welding machines, one of which is shown in the engraving Fig. 28. Three sizes of machine corresponding with the three sizes of bending machines are made, and there is a modified form of each of the two larger machines, but the modifications are only in detail. The three machines require from one-half to 1 horse-power ; from 1 to 2 horse-power ; and from 2 to 3½ horse-power respectively. The first can turn out from 15 to 20 links per minute, the medium-sized machine—and our illustration shows one of them—from 10 to 18 links per minute, and the largest machine from 5 to 8 links per minute.

Each machine consists of a cast iron stand on which is mounted a single-phase transformer, and all the necessary working parts. Power is supplied by a belt drive on to a fly-wheel pulley. Spur teeth, cut on the inner side of the fly-wheel rim, drive a pinion and half clutch which runs loose on the end of a cam shaft. The other half of the coupling slides along the cam shaft and is thrown into mesh by a hand operated lever on the left-hand side of the machine. All the cams are mounted on the one shaft.

The welding electrodes are clamped in position on the front of the secondary casting. The transformer is pivoted, and can be tilted forward by a cam to bring the electrodes into contact with the link. A spring pulls it back after the welding of the link has taken place. Each of the upsetting tools is operated by a separate two-step cam. The first step closes the ends of the link to make contact and the second upsets the weld. When welding is complete the tools are opened again by springs. There are swaging tools which are closed by cams and opened by a spring. Both sets of tools may be adjusted. There is also a trimming tool for cutting off the fins which are left on the links after swaging. It is operated through a bell crank lever actuated by a cam.

At the extreme right of the machine is the feed cam, which acts upon a lever. At the feeding end of this lever is a pawl which engages the links of the chain on the feed stroke, and slides over them on the return stroke. The length of the feed is adjusted in the cam. When being welded the chain rests upon an adjustable saddle guide.

At the back of the machine is fitted a cam-operated automatic switch. A main switch and a fuse box are fitted on the left-hand side of the machine. For regulating the speed of heating at the weld, there is a 5-speed plug box at the back of the transformer. The front part of the secondary is fitted with four nipples to provide for the cooling water circulation.

A full cycle of operations is as follows : (1) The automatic switch opens ; (2) the weld is upset ; (3) the transformer tilts back ; (4) the weld is swaged, and the upsetting tools release the link ; (5) the feed draws the next link into position ; (6) the fins are trimmed off the link which enters the trimming-box ; (7) the upsetting tools close the joint in the new link ; (8) the transformer tilts forward and causes the electrodes to make contact at each side of the joint ; (9) the automatic switch closes and heating commences ; and (10) the clutch is automatically thrown out.

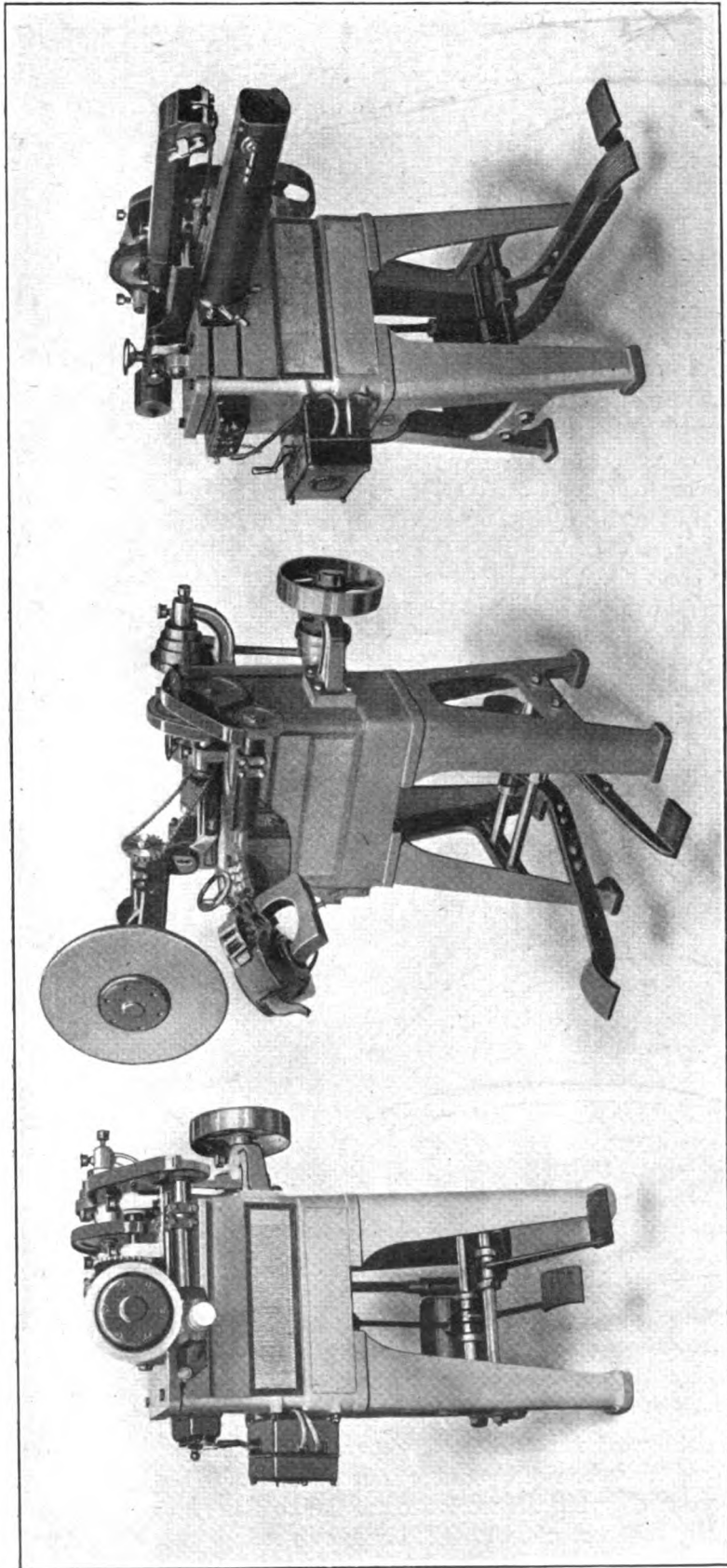

FIGS. 29, 30, 31.—Examples of B.I.W. Seam Welders.

The company affirms that seam welding, the progress of which has been considerably delayed owing to the war, but which is now being quickly developed, is undoubtedly the cheapest and best method of jointing thin material up to, say, No. 18 S.W.G. in thickness. With it welds can be made at the rate of 5 ft. per minute on thin material—say, No. 33 S.W.G.—and at the rate of $1\frac{1}{2}$ ft. per minute with No. 18 S.W.G., with a current consumption of one and seven units per 100 ft. respectively. A limitation of seam welding, however, is that, though there are cases in which a machine may be used for welding different kinds of work, generally speaking, each particular kind of work requires its own machine. Hence there are many different types which, though they work on the same general principle, and have many parts and motions in common, yet have their own distinctive features. It should be said, though, that in many cases the variation is only in the form of the electrodes and of the arms carrying them, the bodies of the machines remaining the same. A feature, however, which we believe is common to all the seam welders made by the company, is that the operator can sit down while working, it being recommended that the stool should be about 22 in. high, and placed in such a position that each of two pedals may be easily reached. The left pedal operates the top electrode arm, and it applies pressure for consolidating the weld. It also automatically switches on the current when the pressure applied reaches the required amount. The right-hand pedal, on the other hand, controls the driving clutch and thus causes the electrodes to revolve. There are other points which all the machines have in common. For instance, the electrodes may be run at different speeds by means of cone pulleys, and it is also possible to obtain four different heating speeds by means of a plug box. We illustrate three examples of these machines in Figs. 29, 30, and 31.

Figs. 29 and 31 show two views of what is known as Welder No. 60, one of them—that given in Fig. 29—provided with a circular seaming attachment, and the other with 20 in. longitudinal stakes. The body of the machine shown in the two views is the same. It is only the electrodes that are altered. Machines of this type are intended for a large number of purposes, including the production of paint drums, canisters, kettles, oil-cans, milk-cans, etc. In each case the electrodes consist of copper rollers which are driven at definite speeds by means of chain gearing, provision being made to vary the speeds to suit the material being welded. Special bearings are provided so that the passage of the current through them does not interfere with their mechanical function, and they are kept cool by a water circulation system. The pressure applied to the rollers is adjusted by means of a compression spring at the back end of the upper electrode. The machines are power driven and require about a half horse-power. The primary winding has four tappings so that four welding currents are obtainable.

Fig. 30 shows Welder No. 61, a machine which is very similar to the foregoing, and which is especially designed for welding the spouts on to kettles. Its general design and method of working are so evident from the illustration that no description appears to be necessary. It is intended to weld iron or mild steel sheet up to $\frac{3}{8}$ in. added thickness.

In all cases the article to be welded is placed on the bottom electrode in such a position that when the top electrode is brought down, by depressing the left pedal, it makes contact exactly where it is desired to make the weld. In some cases the article is clamped when in its correct position. As soon as contact between the upper electrode and the work is made, further pressure is exerted to switch on the current, and at the same time the right pedal is depressed so as to set the electrodes revolving for the purpose of carrying the work around the bottom electrode. In some cases the work is actually taken round with the lower electrode.

The company makes spot welders in five sizes, according to the thickness to be welded. Standard machines are made for welding the following added thicknesses : 0.16 in., $\frac{1}{4}$ in., $\frac{1}{2}$ in., $\frac{3}{8}$ in., and $\frac{3}{4}$ in., the maximum current required varying from 6 to 30 kilowatts. For different classes of work a large number of different designs is made. For instance, the arms, or stakes, as the company calls them, are made in lengths varying from 9 in. to 36 in. Fig. 32 shows a group of what are known as No. 13 spot welders fitted with different length stakes. These particular machines are intended for the welding of iron, or mild steel sheets up to $\frac{1}{4}$ in. aggregate thick-

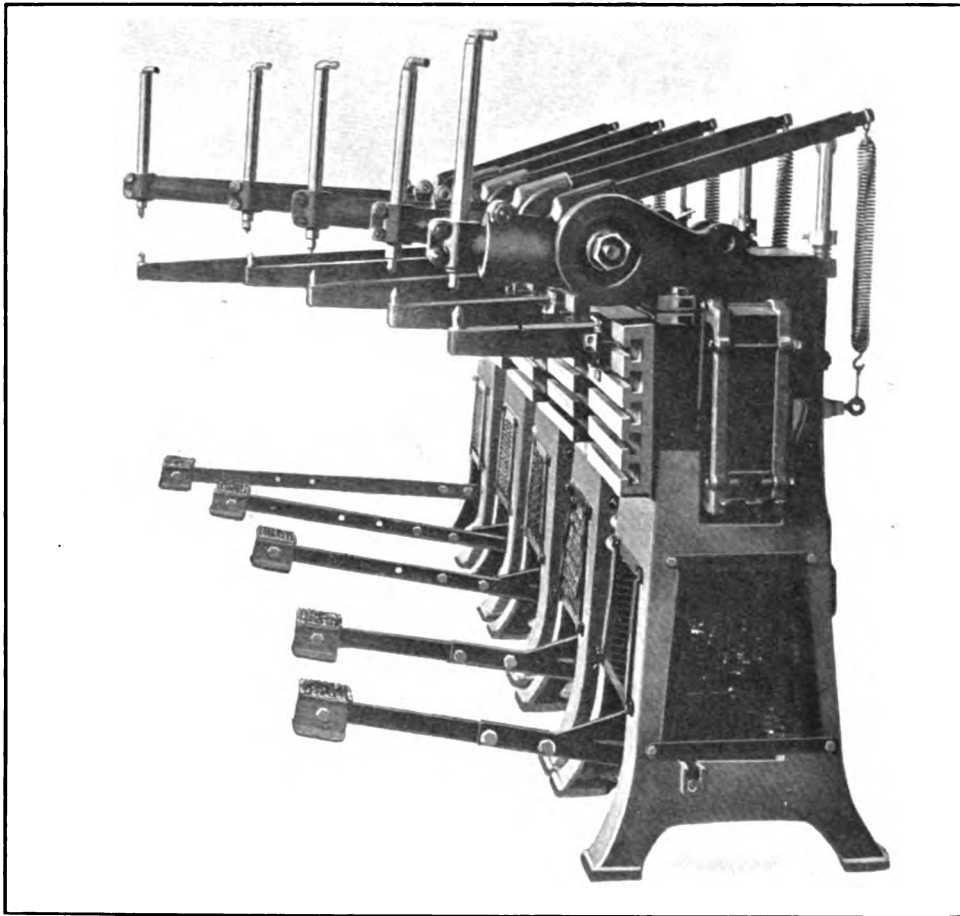

FIG. 32.—Group of B.I.W. No. 13 Spot Welders.

ness—though they may, we gather, be used intermittently for sheets up to $\frac{3}{8}$ in. aggregate thickness. The top stake is fitted with a swivel joint, and the bottom stake can be fixed in any desired position on the face plate. The welder is foot operated. Depressing the pedal brings down the top electrode into contact and switches on the current. Directly welding temperature is reached, additional pressure on the pedal cuts off the current while still maintaining pressure on the weld and consolidating it. The electrode tips are water-cooled and are renewable. By means of four tapping plugs, four heating speeds for varying thickness of work are obtainable.

Some of the spot welders which the firm makes are operated by hand-lever, and

some—the larger sizes—by means of a spoked wheel. In such machines two operators are required. In some machines, too, the current is cut on and off by hand, the switch not being interlocked with the pressure-applying system.

In all types and sizes the method of working is practically identical, and as we have already described it, with, of course, slight variations necessitated by the differences in arrangement to which we have already alluded. The actual time occupied in welding may vary from a fraction of a second in the case of the thinnest material up to, say, 40 seconds with the thickest metal. The current consumption may similarly vary from, say, one-quarter of a unit for 1000 welds with thin sheets up to 330 units per 1000 for the heaviest material. The speed of working varies, of course, with the type of machine, the thickness of material, and the personal equation of the operator. In one case, we understand, an operator using a small machine has made as many as 12,000 welds during a 7½-hour day. On larger machines the output is, of course, less.

As giving some idea of the different kinds of articles which are being successfully welded by means of this company's spot welders we append the following list: Fittings to enamelled hollow-ware; tanks; pulleys; straight sheet iron tubes, and elbows; spades, shovels and trowels; automobile and bicycle parts, mud-guards, bonnets, fittings to chassis, etc.; machinery guards; sheets and expanded metal to flat and profile iron for shelves, lockers, etc.; agricultural machine parts; fuse parts; fan propellers; tin ware; lattice for reinforced concrete, etc.

CHAPTER VIII

MACHINES AND APPARATUS FOR ARC WELDING

IN an earlier chapter we explained that, for arc welding, the only absolutely essential accessory, in addition to the electrode and holder, was a resistance to go in series with the arc. The only other thing necessary is a supply of current at a suitable voltage. Some consider it desirable to have an ammeter in the circuit, but in many cases instruments of all kinds are dispensed with for the actual welding circuits. Now, although the absolute essentials are only as set out above, yet it is highly probable that in practically every case some additional arrangements beyond those actually existing in any given works will have to be made in order to obtain current of the desired character and pressure. In the large majority of cases in this country, at any rate, direct current is used for arc welding. If the available electric supply be alternating, there will have to be a motor generator to convert the energy into direct current. If, again, the available supply be direct current, but of a voltage in excess of that required for the welding circuit, it will also be necessary to have a motor generator or a rotary motor converter to reduce the pressure. Many firms make motor generators which are suitable for arc welding circuits, and among them we may mention the following: The British Electric Plant Co., Limited, 78 St. Vincent Street, Glasgow; The British Westinghouse Electric and Manufacturing Co., Limited, Trafford Park, Manchester; Crompton and Co., Limited, Chelmsford; The Electric Welding Co., Limited, 28 Basinghall Street, London, E.C. 2; J. H. Holmes and Co., Newcastle-on-Tyne; The Lancashire Dynamo and Motor Co., Limited, Trafford Park, Manchester; Mather and Platt, Limited, Manchester; Mavor and Coulson, Limited, of Glasgow; Bruce Peebles and Co., Limited, East Pilton, Edinburgh; The Phoenix Dynamo Manufacturing Co., Limited, Bradford; The Premier Electric Welding Co., Royal Liver Building, Liverpool; The Rees Roturbo Manufacturing Co., Limited, Wolverhampton. Some of these firms make motor generators for converting alternating into direct current; some machines for reducing direct current voltage, while some of them make both types of machines. All the machines can be used in arc welding, though in some cases they are simply combinations of standard motors and dynamos made by the various firms. In other cases, however, they embrace machines specially designed to produce certain specific effects, and to some of the latter we shall refer in what follows. Some of the firms, too, are prepared to supply portable self-contained arc welding generating sets which can be readily moved about from place to place as may be required, and are able to start producing current at a moment's notice. We shall have occasion to refer to machines of that type also.

First of all we may deal with some of the apparatus supplied by the British Westinghouse Company. A business-like self-contained arc welding equipment, embodying some of this firm's machines, is shown in Fig. 33. The plant, which, as will be observed, is mounted on the platform of a motor lorry, and which is ordinarily protected by a covering which can be lifted off when desired, as shown in the engraving, was built to the order of The British Arc Welding Company (Bristol Channel), Limited, of Cardiff, a firm which concerns itself largely with shipbuilding

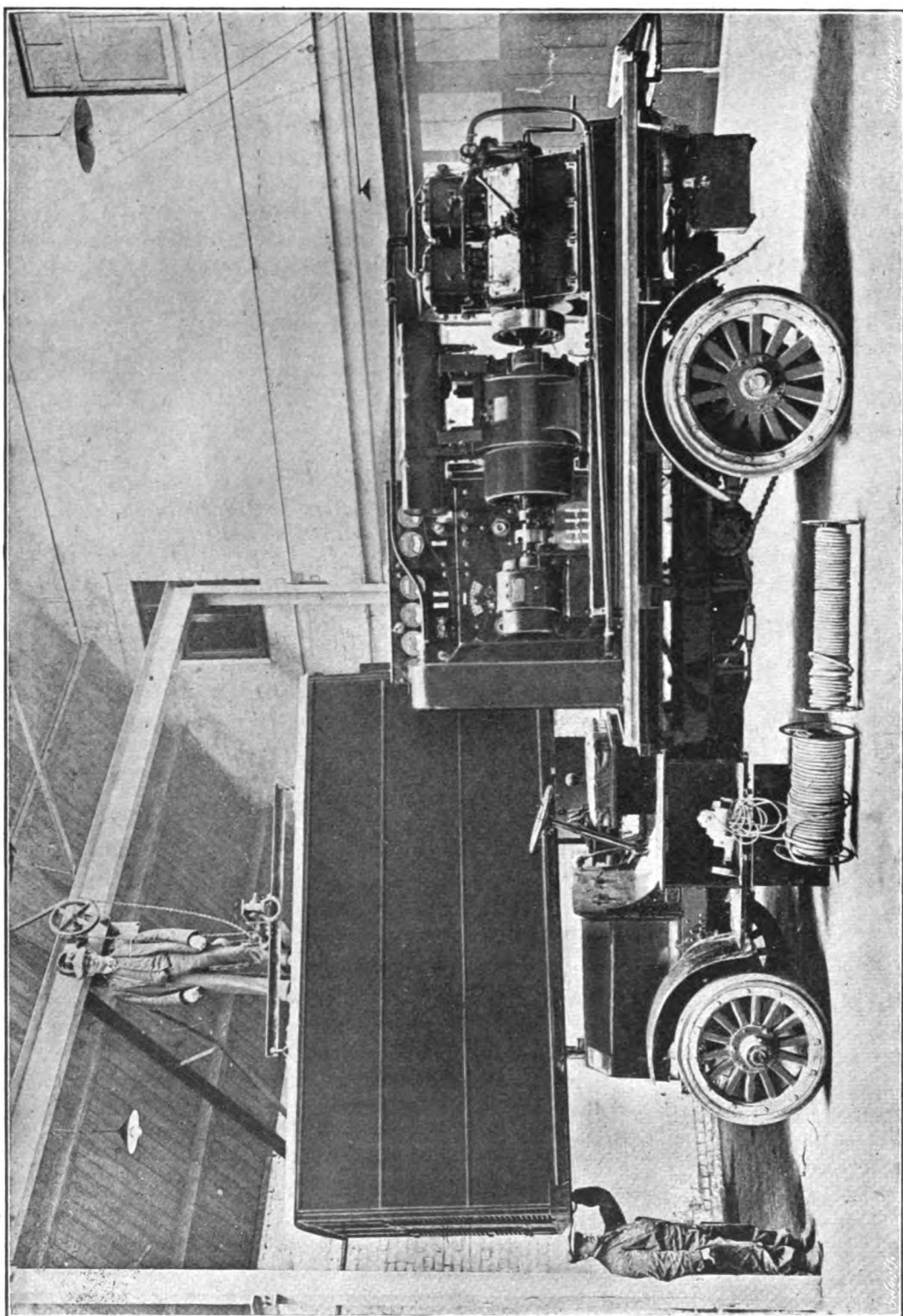

FIG. 33.—Westinghouse Arc Welding Equipment on a Motor Lorry.

and other repair work. The generator, which is of 26 kilowatts normal output, and which is designed to permit of working multiple arcs in parallel and intermittently when using either carbon or metallic electrodes, is driven by a petrol engine designed to develop some 55 horse-power when running at a speed of 1150 revolutions per minute. The generator is intended to permit of satisfactory operation over a considerable regulation curve, thus allowing a variety of work to be carried out economically. The direct coupled exciter also provides current for lighting, and for driving portable grinding or drilling machines.

This firm builds machines with a special winding which has for its object the doing away with the necessity for using a resistance in the welding circuit or, in other words, so controlling the working of the machine that injurious rushes of current are impossible. The winding which, we understand, was designed by the company in cooperation with Mr. H. S. Marquand, is shown diagrammatically in Fig. 34. There

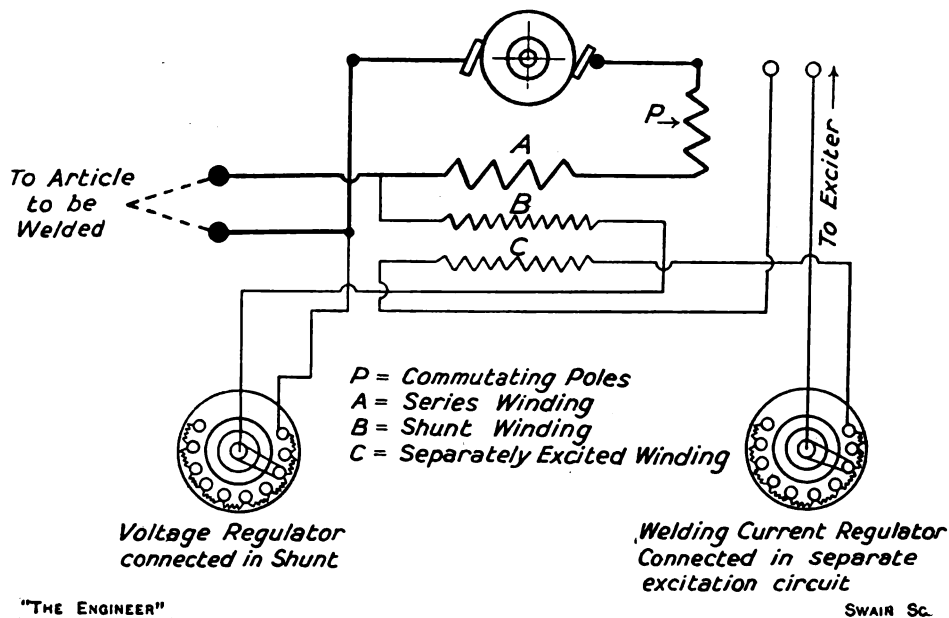

FIG. 34.—Diagram of Connections of Westinghouse Generator for Arc Welding.

are three separate windings, or four, if that of the commutating poles be taken into account. The series and commutating pole windings—A and P respectively—are in series with one another, and, of course, with the armature. The shunt winding B is connected not across the armature alone, but across the terminals of the machine, and hence outside the series and commutating pole windings. It has an adjustable resistance in series with it. There is a further winding C which is separately excited from a constant voltage exciter, and which also has an adjustable resistance in series with it. The windings B and C assist one another while winding A opposes both of them. When considering the effect of these three windings the demagnetising effect of armature current must not be lost sight of. Let us suppose that the machine is running at full speed, but with open circuit. Then the series winding is practically inoperative, since it is only carrying the comparatively negligible current required to energise the shunt winding B. On the other hand, the latter winding is fully effective, and the winding C is energised to give in conjunction with winding B the desired initial voltage on the armature. If now the electrode, that is to say, one terminal of the generator, be

brought into contact with the "work," which is connected to the other terminal, the tendency is, naturally, for a heavy current to flow through the armature and the series winding A. As soon as current begins to flow, however, the demagnetising effects of the series winding and of the armature reaction tend to reduce the armature voltage, the amount of reduction depending, of course, on the relative strength of the series field and the combined shunt and separately excited windings. But this is not all that happens, for, since the generator terminals are short circuited, the shunt winding B is also short circuited, and becomes non-effective. Hence, the separately excited winding C is then opposed by the series winding A and the armature reaction, and matters can be so arranged that the short circuit current will be actually less than the normal full load current of the machine. In practice, of course, the actual time during which the machine is short circuited is only under ordinary working conditions for a fraction of a second, but even if by accident the short circuit period is prolonged, no harm can happen to the machine, and in working no steady resistance is required in series with the arc. As the makers point out, this means a considerable reduction in the power consumed, since all the C^2R losses in the resistance are avoided. It is of interest to see to what these losses amount.

Let us suppose, say, that a welder is taking current from a 100-volt generator. If he be using a metal electrode, the current may be between 50 and 200 ampères. Take it that the average is 125 ampères. The voltage across the arc may be, say, from 25 to 40. Let us take the best case as far as losses are concerned, and imagine it to be 40. That means that the resistance is absorbing 60 volts. The energy being consumed in the resistance is, therefore, 125 by 60, or 7500 watts, while the energy in the arc which is doing the welding is only 125 by 40, or 5000 watts. More than half of the total energy in the circuit is therefore absorbed in the resistance. Of course, this does not quite tell the whole tale, for the energy consumed in the exciter of the protected machine has to be taken into account, but the loss in that machine is small compared with the loss in the resistance. Moreover, the loss is, of course, greater if a higher voltage than 100 be used. With a carbon arc, if we take the figures of the Steel Barrel Company, Limited, of Uxbridge, to which reference has been made in an earlier chapter, the initial voltage is 90, and the voltage across the arc from 50 to 55. Taking the higher figure, as was done in the case of the metal arc, the voltage absorbed is 35, so that whereas the arc, with a current of 300 ampères, absorbs 300 by 55, or 16,500 watts, the resistance loss is only represented by 35 by 300, or 10,500 watts.

Thus in the two cases we have taken, whereas with metal electrodes the ratio of energy wasted to energy usefully employed in the arc may be as 7.5 to 5, with a carbon arc the ratio is as 10.5 to 16.5. In both instances the losses are heavy, but proportionately the carbon arc system appears to be the less wasteful.

Let us attempt to get some idea of what this waste means in pounds, shillings and pence. Suppose for the sake of argument that a carbon arc welder works eight hours a day, and that he is actually using his arc for only half that time, say, four hours for five days a week and two hours on Saturdays, a total of twenty-two hours per week. During that time the energy wasted in the resistance will be $10,500 \times 22 = 231,000$ watt-hours, or 231 Board of Trade units. Taking the cost of the energy at 1d. per unit, there is, hence, a loss of nearly £1 per week, or, say, £50 per year for each welder. These figures become worse the greater proportion of his working time the operator is using his arc, and if he were actually welding during the whole of his time the annual loss per man would, on the basis of calculation we have taken, be over £100.

By means of the two adjustable resistances in the Westinghouse-Marquand arrangements, the current flowing in the arc can be varied within certain limits, so

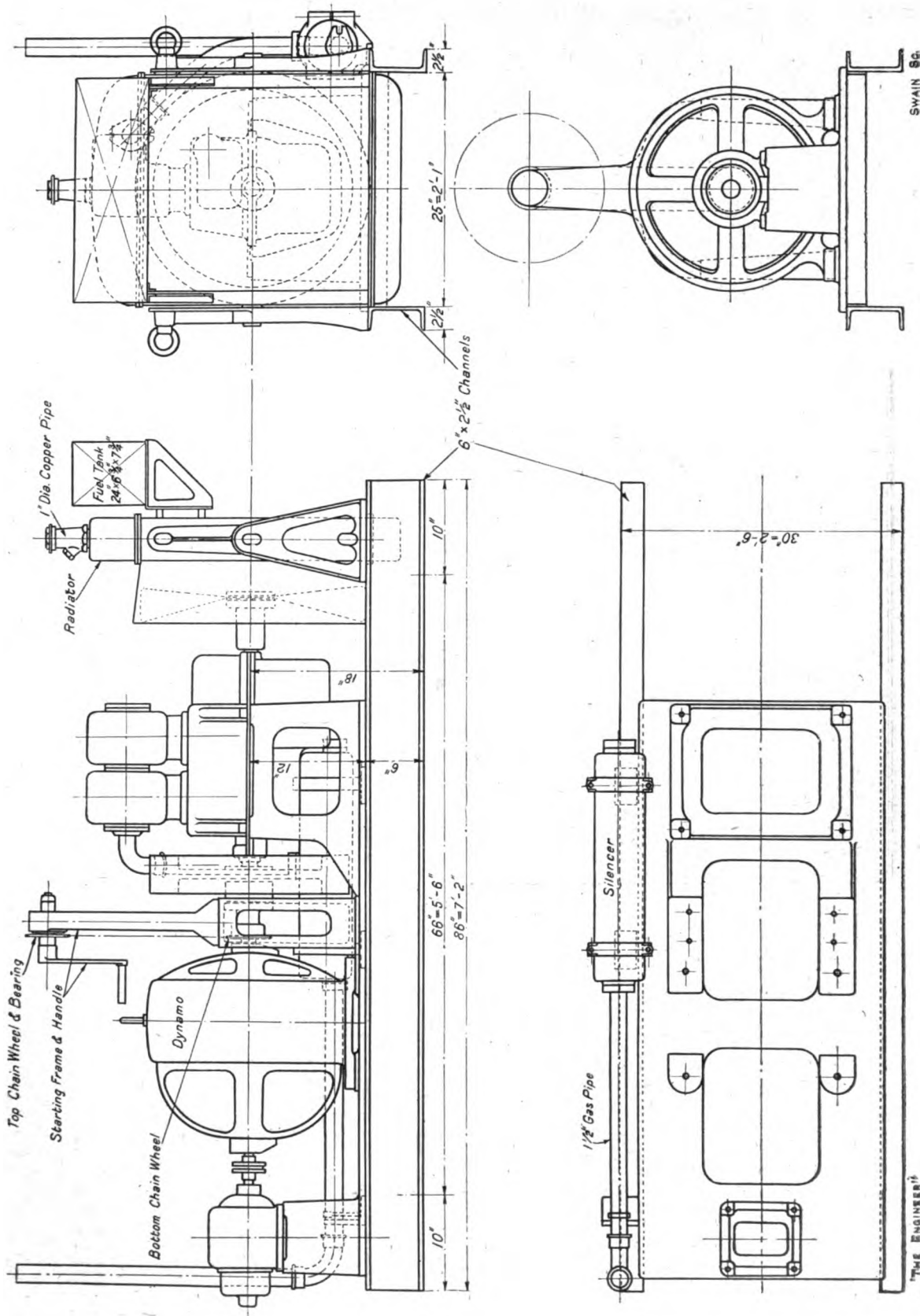

Fig. 35.—Arrangement of Premier Electric Welding Company's Portable Welding Set.

that the same machine can be used for different kinds of welding work calling for currents of different strengths. In addition to this means of control, we understand that alteration of the brush positions affords a further means of regulation. The commutation is said to be sparkless under practically any brush position. Sets of this type have been successfully arranged on boats, so that work can be carried on from the water, an arrangement which in ship repairing is sometimes most convenient. The generators are rainproof, since they may frequently be called upon to run continuously for long periods under conditions of weather and position which may be anything but good.

Going back to the plant illustrated in Fig. 33, it may be mentioned that each lorry is provided with 550 yards of cable, so that current can be conveyed for that distance away from the point at which the vehicle is stationed. The cable has cab-tyre sheathing and is carried on rollers in damp-proof boxes mounted on the chassis. The lorry can carry some 150 gallons of petrol in its tanks. The tank, which is seen mounted above the generator, is kept full by pumping up from a larger tank arranged beneath the chassis.

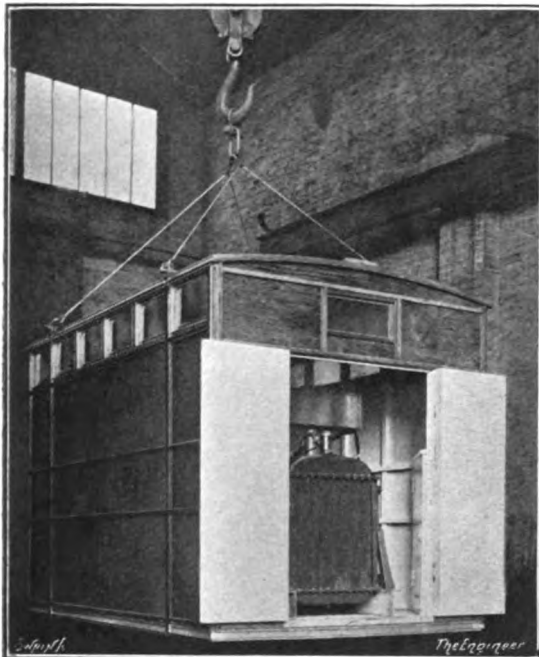

FIG. 36.—Premier Welding Set in Cabin.

Another self-contained welding set of a similar character is supplied by the Premier Electric Welding Company, of Royal Liver Building, Liverpool. It is shown in Figs. 35, 36 and 37. It also can be mounted on a lorry or in a special hut of its own, which can be slung on shipboard and lowered on to the deck or into a hold (see Fig. 36). The set was specially designed for use with the metal arc process. It consists of a 10-brake-horse-power petrol engine, direct coupled to a 4.3-kilowatt generator with a separate exciting dynamo connected to the same shaft and mounted on a common

bed-plate. The main generator has three windings—a series winding, a shunt winding connected across the armature, and a separately excited winding. The two latter assist one another, while the series winding opposes both of them. The combined effect of the shunt and separately excited winding produce a field strength which determines the voltage of the generator before the welding arc is established. When the arc is struck, however, current flows through the armature and the series winding, with the result that the strength of the field is reduced and the voltage in consequence lowered. When the combined effect of the series winding and the armature reaction is sufficient to balance the counter-effect of the separately excited winding, the resistance drop of the external winding of the generator will then determine the voltage of the generator terminals. The makers point out that with a separate exciter maintaining a constant current, the armature current of the main generator must necessarily remain constant in order to keep the armature reactance and the differential series field constant. This gives a machine with an

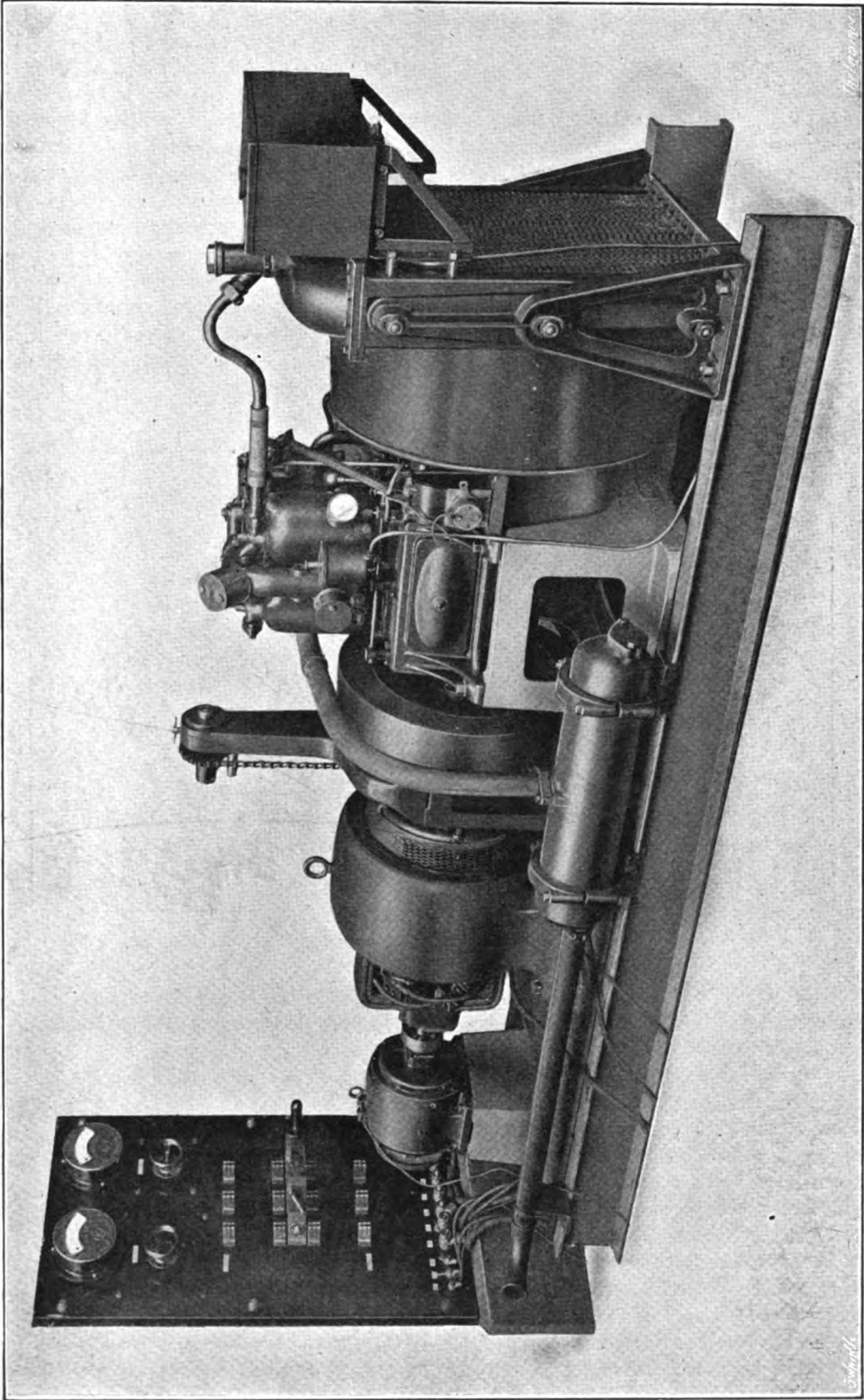

FIG. 37.—Portable Plant of the Premier Electric Welding Company.

external current characteristic which is nearly constant within the limitation of the welding voltage.

In operation a reactance is used in series with the arc on the negative leg of the generator. This reactance has four terminals, which are so connected to the two terminals of the welding circuit and to the terminals of a three-pole double-throw switch that in one position of the latter the two coils of the reactance are connected in parallel, whilst in the other position they are in series with the generator and the welding arc. It is claimed that a reactance and switch so arranged in connection with a generator wound in the manner above described enable an operator, without having to change the generator speed or any of the connections, to arrange simply by throwing the switch over in one direction or the other to provide either a small current for welding small articles and building up thin and worn plates, or a larger current for use in connection with heavier work.

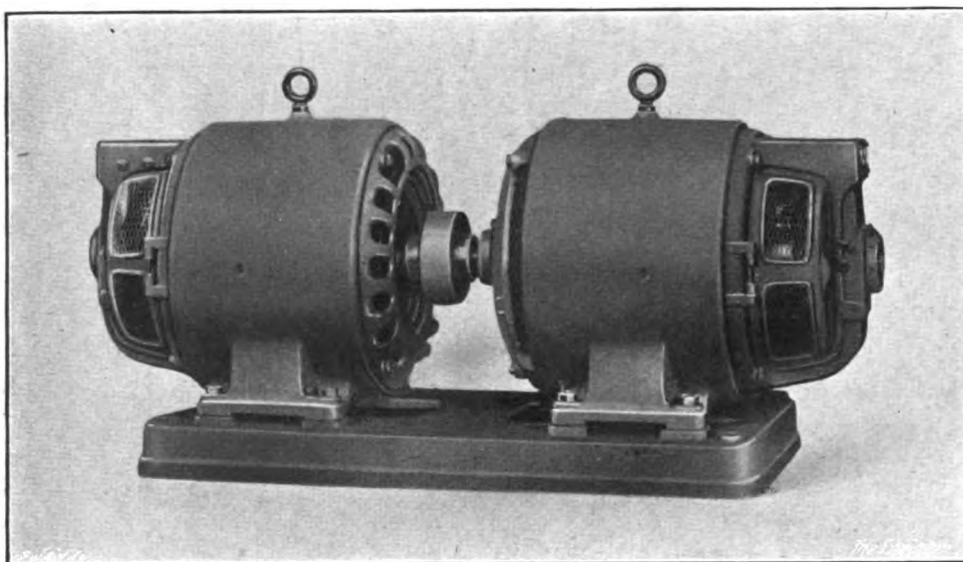

FIG. 38.—Lancashire Dynamo and Motor Company's Arc Welding Set.

Another differentially wound generator, specially intended for electric arc welding work, is made by the Lancashire Dynamo and Motor Company, Limited, of Trafford Park, Manchester. It is shown coupled direct on the same bed-plate to its motor in Fig. 38, while a diagram of the windings of the two machines is given in Fig. 39. As will be observed, the arrangement of the winding is different in several particulars from the windings of the machines which have been described above. There is a shunt winding A which is connected across the armature of the generator, and has a regulator in circuit with it, and a series winding which is in the arc welding circuit, and there is a third separately excited winding B which, however, is arranged in series with the field winding of the motor across the supply mains.

In describing the arrangement the makers write as follows: "The arc may be struck across the armature of the generator without any resistance in circuit, and the plant is capable of running for short periods with the armature of the generator short circuited." The windings A and B tend to assist one another, while the winding C opposes both, and hence tends to lower the generator voltage. No series resistance

is used in the welding circuit. At the moment of touching the work with the electrode there is a tendency for an excessive current to flow in the generator circuit. This current, of course, flows through the series winding, and is limited to the value which will demagnetise the generator field by an amount sufficient to prevent any larger current from flowing. Similarly, when an arc is struck, the resistance of the circuit is increased, and the current tends to fall. This tendency is compensated for by a diminished demagnetising effect of the C winding, whereupon the generator voltage is increased to an amount which will permit of the flow of the desired current."

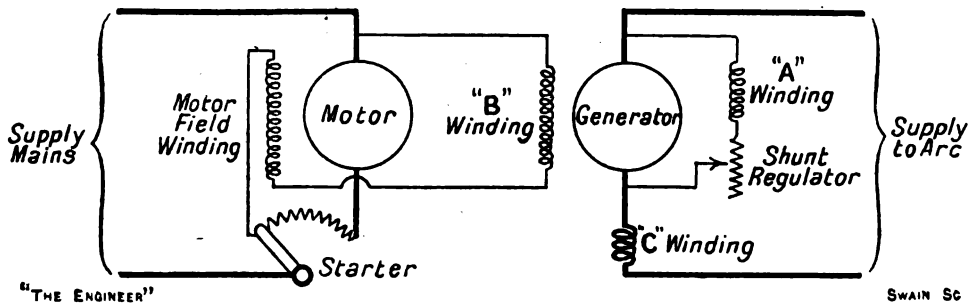

FIG. 39.—Connections of Lancashire Dynamo and Motor Company's Arc Welding Set.

CHAPTER IX

MACHINES AND APPARATUS FOR ARC WELDING (*continued*)

As an example of apparatus particularly suitable for arc welding we may at this point refer once more to the differential electro-magnetic clutch devised and patented by Messrs. Walter L. Davies and Alfred Soames, both of Faraday House, 66 Southampton Row, Holborn, London, which was described at some length in the issue of *The Engineer* of January 25th, 1918. The advantages claimed for this device, for which the Equipment and Engineering Company, has acquired the exclusive licence in the United Kingdom, are, as far as electric arc welding is concerned, as follows :—

(1) Any dynamo giving sufficient power and driven from any suitable source of power may be used, its characteristics being so altered as to make it suitable for the work.

(2) The maximum current to be taken can be set at any value within the limits of the dynamo.

(3) When the apparatus has been set for any desired current the latter will remain practically constant from short circuit to the maximum length of arc that the volts will maintain. There is no necessity to “snatch at” the arc when striking it. The electrode can be rubbed on the work, and the arc drawn out as desired. A short arc does not produce a rise of current and consequent burning. The operator is thus enabled to give his full attention to the work, since the arc cannot “run away from him.” There are no jumps or breaks in the current.

(4) No resistance is required in the welding circuit, and consequently the whole of the watts generated are used upon the work.

The clutch is shown in Fig. 40. It may be placed either between a motor and a generator, as shown in Fig. 41, or between a steam engine or other prime mover and a generator. A is the driving shaft and B the driven shaft, which is coupled direct to a separately excited dynamo. Keyed to the shaft B is a coupler D, which is furnished with driving-pins H. Housed in the coupler is a Skefko bearing C, which receives the end of the shaft A. Near the end of the shaft A is another Skefko bearing E, which is housed in a disc G, to the periphery of which is bolted a cast-iron ring F, the disc G and the ring F forming the transmission member of the clutch. In the disc G, arranged at similar intervals to the pins H on the coupler D, are holes in which are inserted leather rings J, the latter also being pierced with central holes to accommodate the pins H. The disc G and the ring F are free to float and move to the extent permitted by the Skefko bearing. The body of the clutch is indicated by the letter K, and the magnetic circuit is completed by the ring L.

There are three windings, A, B and C. Fig. 42 is a diagram showing the basic principle of the application of the clutch to a motor generator when the apparatus is used for electric arc welding, and Fig. 43 shows the electrical connections. In both these cases the clutch is, of course, only shown diagrammatically. Coils A and C are made up of many turns of fine wire, while coil B consists of comparatively few turns

of thick wire. No part of the clutch moves longitudinally, so that its reluctance remains constant and the variation of the magnetism produced by the coils varies the pressure of the clutch members against one another only.

The action of the clutch is as follows: The coil A is energised either from the mains which supply current to the motor, or, if an alternating current motor be used, from a small exciter on the driving shaft. The coil is so proportioned as to produce an initial pressure of the clutch members, which is more than sufficient to transmit the load. Coil B is connected in series with the armature of the dynamo on the driven shaft, and its polarity is such as to counteract the effect produced by the coil A. That is to say, as the current in the coil B increases, as it does when the load on the driven machine increases, the pressure of the clutch members against one another decreases, until a point is reached when the pressure is only just sufficient to transmit

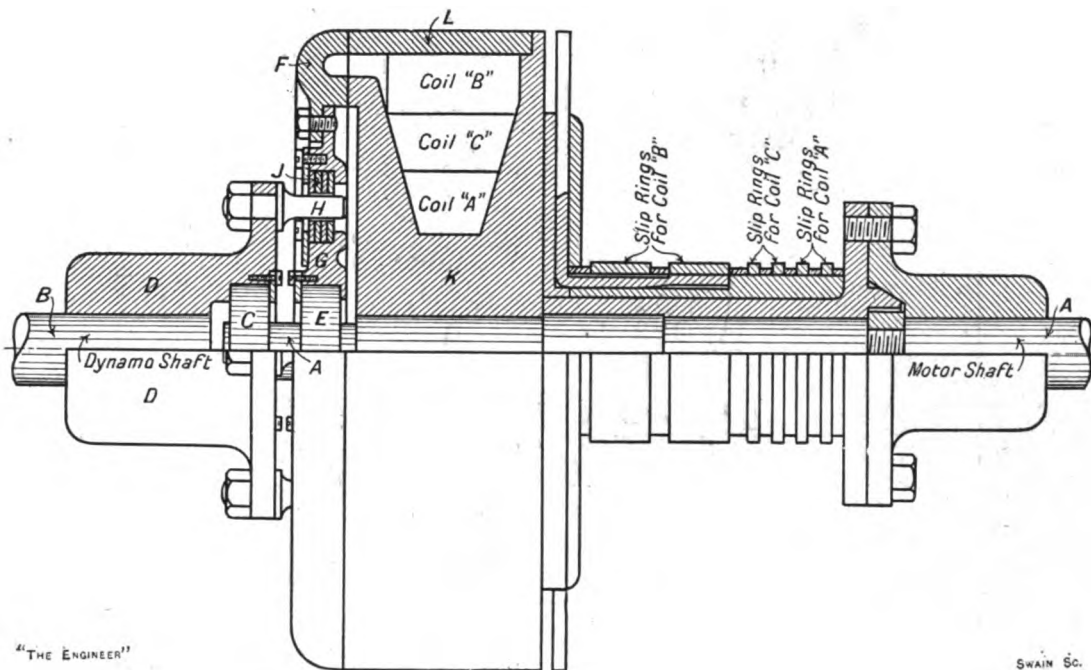

FIG. 40.—The Davies-Soames—Daysohms—Electro-Magnetic Differential Clutch.

the load without slipping. If that point be passed the clutch slips. It is apparent, therefore, that the current taken from the dynamo cannot pass a given maximum even if the machine be short circuited. The particular maximum to be reached can be arranged by adjusting the excitation of the coil A with a rheostat.

The coil C, which, like coil B, opposes and tends to weaken the effect produced by the coil A, is connected across the brushes of the driven dynamo. In a separately excited dynamo the torque required to drive it at any speed is proportional to the current taken from the dynamo, irrespective of the speed and volts. If a constant current be taken, it requires a constant torque to drive it at any speed in a fixed field. It is to counteract the variation in the coefficient of friction that the coil C was added to the apparatus. On open circuit the coil A gives an initial pressure or attraction between the members of the clutch. The coil C, which, as explained above, is arranged across the brushes of the dynamo, reduces the pressure produced by A. If current be now taken from the dynamo the coil B still further reduces the pressure

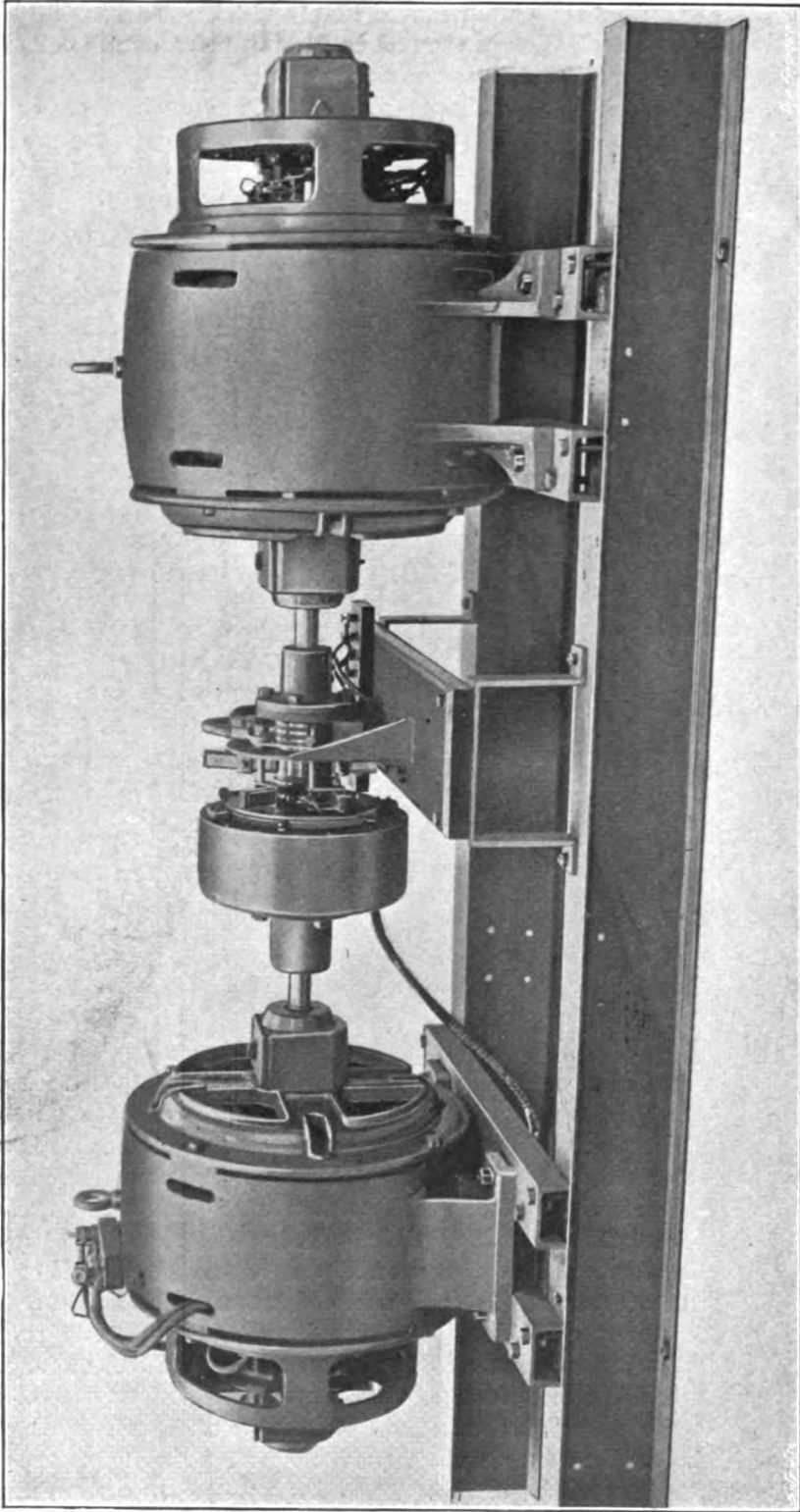

FIG. 41.—The Davies-Soames Clutch connecting a Motor to a Generator.

or attraction between the clutch members until a point is reached when the clutch slips. When slip occurs, however, the volts of the driven dynamo decrease, and, consequently, the effect of the coil C is weakened, which is equivalent to increasing the effect of A. By this means the slip is prevented from increasing unduly. Should the current taken from the dynamo tend to increase, the action of the series coil B would decrease the pressure attraction between the two clutch members. As a net result, therefore, the coils B and C adjust the pressure, so that no matter what is done with the arc, the current remains practically constant. By suitably proportioning the ampère turns in coils A and C, which may be done by means of rheostats in series with them, any desired characteristics, within reasonable limits, may be obtained.

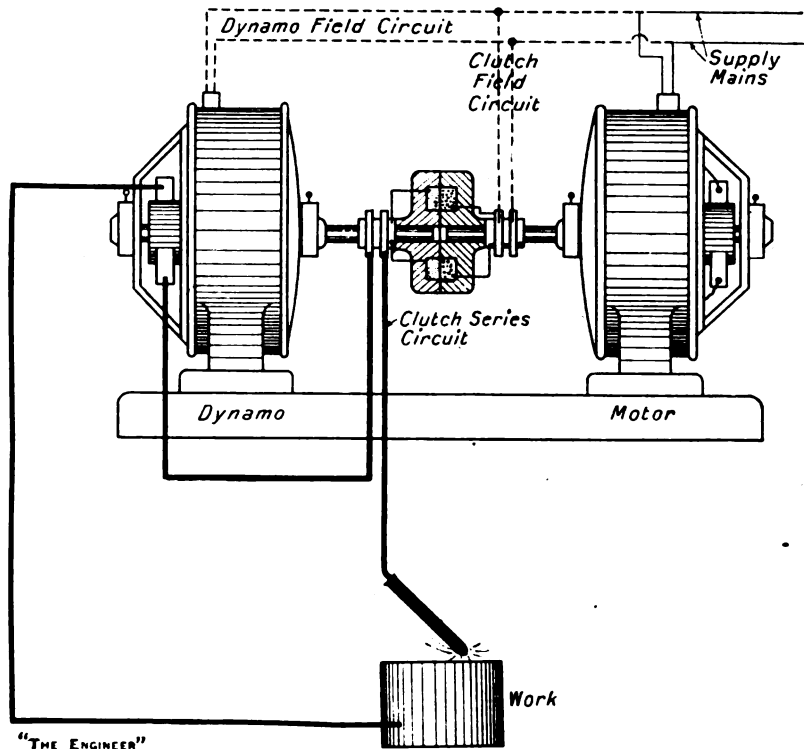

FIG. 42.—Davies-Soames Clutch arranged for Arc Welding.

The clutch, therefore, can be used for driving a dynamo the current from which is being used for light or heavy work.

We may add that since our description, of which the foregoing is an abbreviation, was published, and, indeed, since the earlier chapters of this book were penned, Messrs. Davies and Soames have made sundry modifications of their device, which, they claim, have increased its efficiency. For example, they have altered the shape of the magnetic circuit of the clutch, with the result that there is less leakage of lines of force and a higher efficiency is arrived at. Moreover, they have succeeded in reducing the electro-motive force of the welding circuit to as low a figure as 33 volts. We have watched the apparatus in operation with that voltage, and observed that, as might be expected with such a low pressure, it was quite impossible to have a long arc, with its accompanying disadvantages. At the least attempt to draw out the arc beyond a certain point the circuit was interrupted. On the other hand, a skilled operator appeared to have no difficulty whatever in maintaining an arc and in doing excellent

welding with a current that only varied within small limits, the work produced being of an even character. A coated metallic electrode was, of course, being used. It should be mentioned, in conclusion, that Messrs. Davies and Soames now use a reactance in the welding circuit.

While on the subject of special windings, attention may be drawn to an article which appeared in the December, 1918, issue of the *American General Electric Review*, and was entitled "The Constant-Energy Arc-Welding Set." The article was written by Mr. P. O. Noble, of the Direct Current Engineering Department of the General Electric Company of Schenectady. The author takes for his text that "all will agree

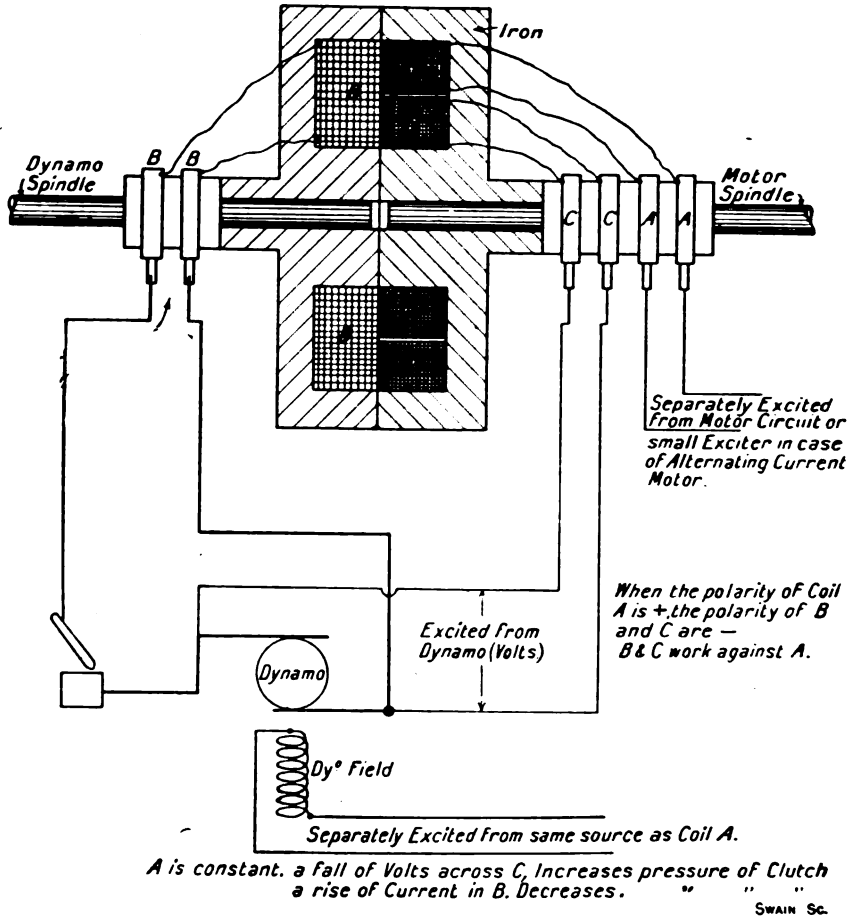
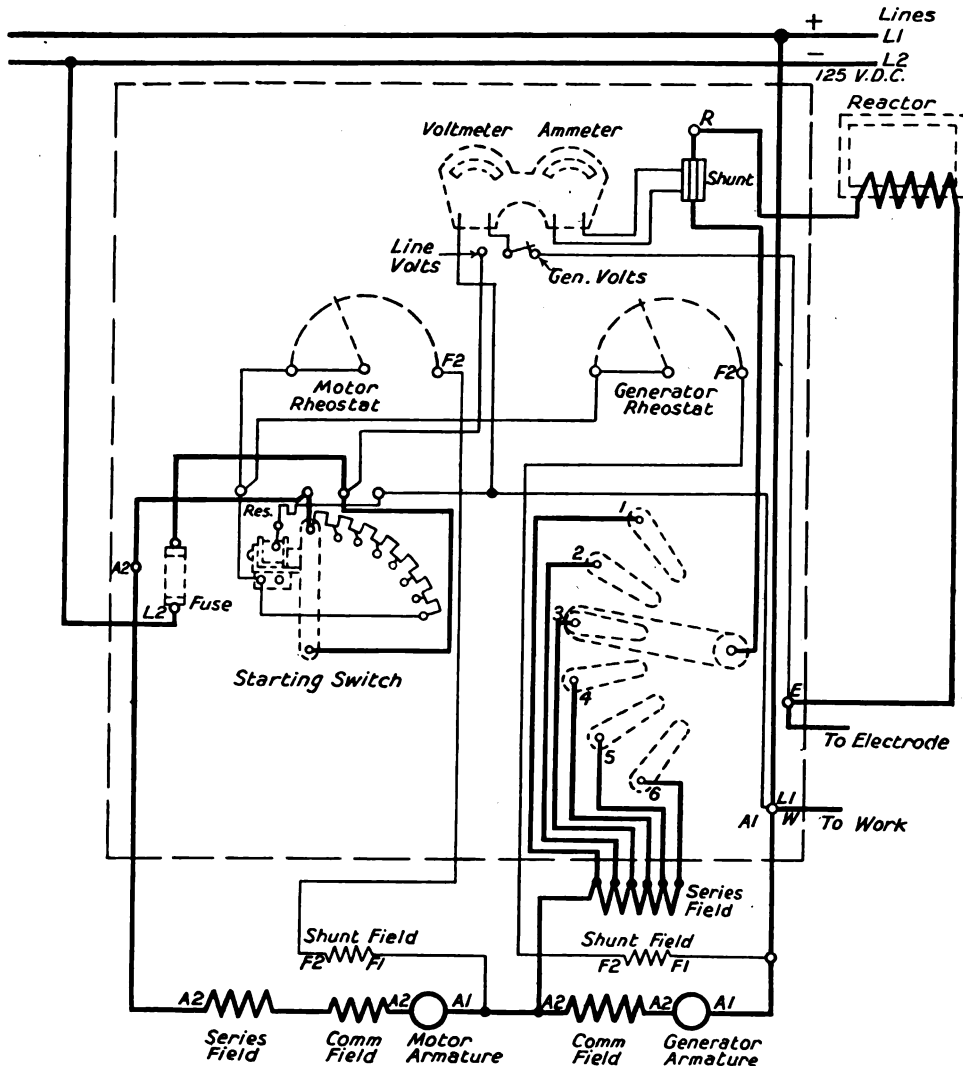

FIG. 43.—Diagram of Connections of Davies-Soames Clutch.

that the ideal condition for a homogeneous weld on a given piece of work is obtained when the voltage and the current at the arc are constant," a condition which is, he maintains, impossible with the manually controlled arc. Hence the *raison d'être* of the machine which he describes, the principal advantage claimed for which is that it facilitates the maintenance of a short arc and makes it difficult to obtain a long one. Mr. Noble explains that the rate of consumption of electrode material is proportional to the current in the arc and is independent of the voltage across the arc. "In the constant-energy system," he continues, "when the operator shortens the arc, the current increases and the rate of wire consumption increases, thereby tending to bring the arc length back to normal. If he lengthens the arc, the current decreases and the

rate of wire consumption decreases. This automatic action tends to maintain the arc at the proper length. If the arc is unduly lengthened, the current will decrease until the electrode does not fuse properly and the arc will go out. In the constant-current system, the rate of wire consumption is constant, and there is no such corrective effect as that just described. This system also makes possible the maintenance of a long arc with the consequent deposition of a large amount of highly oxidised and porous metal.



"THE ENGINEER"

SWAIN & Co.

FIG. 44.—Electric Connections of Constant-Energy Balancer Set.

The oxidisation is evidenced by the fact that with a long arc there is present, in addition to the black oxide of iron— Fe_3O_4 —which is present on all bare wire welds, an abundance of red oxide of iron— Fe_2O_3 —showing that the metal is more highly oxidised in passing through the arc."

The constant-energy balancer set consists of a direct-current motor mechanically connected to a direct-current generator. The electrical connections of the two machines are shown in Fig. 44. It will be observed that, in addition to being mechanically con-

nected, the motor and generator are also electrically connected in series across a supply circuit of constant potential. One terminal of the welding circuit is taken from the connection between the two armatures, and the other terminal from the positive line. The polarities of the motor and generator are so arranged that the armature currents of the two machines add together in the welding circuit, which, Mr. Noble remarks, makes possible an approximate 50 per cent. reduction in the size of the units involved. No series resistance is used in the motor, generator, or welding circuits, the difference between the supply voltage and the arc voltage being absorbed by the motor. This, adds Mr. Noble, "results in saving the power which is usually wasted in rheostats. The ratio of the energy at the arc to the input to the set is 56 per cent. With the ordinary set of corresponding capacity using series regulating resistance, this ratio is approximately 22 per cent."

The initial voltage for striking the arc, and the average current for the particular work in hand, may be regulated at will by means of the motor and generator field rheostats, and by means of the switch which changes the number of effective turns in the differential series field winding of the generator. Changes of current may be obtained, it is stated, from 40 to 150 ampères by very small increments. After the arc is established, the variations in current and voltage at the arc with changes in the relative positions of electrode and work, follow, approximately, a constant energy law. The regulation is entirely inherent in the set itself, and is accomplished without the use of energy-consuming resistances or vibrating regulators.

Mention may also be made of a rotary motor converter or self-contained rotary transformer, which is made by the Equipment and Engineering Company, of 2 and 3 Norfolk Street, Strand, London, W.C. 2. The machine has a single field and a single armature, the latter being furnished with a double commutator. The motor side is arranged to absorb current at 500 volts, and the generator side to deliver current at from 80 to 100 volts. The current available for the welding arc is 250 ampères for steady working, but it can be raised by 50 per cent. or to 375 ampères for short periods. The machine is of the semi-enclosed type, and is fitted with carbon brushes. It is especially intended for use in traction work in which the working voltage is in the neighbourhood of 500.

CHAPTER X

MACHINES AND APPARATUS FOR ARC WELDING (*continued*)

LARGE numbers of portable generating sets designed for arc welding in works and shipyards have been supplied by J. H. Holmes and Co., of Newcastle-upon-Tyne. The particular arrangement adopted by this firm is shown in Fig. 45.* The generating plant consists of a four-cylinder petrol engine of 28 brake-horse-power running at 850 revolutions per minute, coupled to a direct current compound wound dynamo having an output of 250 ampères at 65 volts. This voltage, it will be noticed, is considerably lower than that employed in some cases of arc welding. The plant is mounted on a combined bed-plate, and has a special framework which enables the equipment to be easily lifted and moved from place to place. On the framework is also fixed a radiator for cooling the circulating water, the air being drawn through it by means of a fan driven from the dynamo shaft. There is also mounted on the framework a small switchboard carrying a single pole switch, double pole fuses, shunt regulator, volt meter and ammeter. The special resistance used in conjunction with this plant is shown in Fig. 46. It has four switches mounted on a slate base in front of the resistance. The four switches have capacities of 100, 75, 50 and 25 ampères respectively. The resistances are so connected up that it is possible by different combinations of the switches to obtain currents of from 25 up to 250 ampères in ten steps of 25 ampères each. The resistance is built up of cast iron grids, having the firm's patented stiffening arrangement, which strengthens the grid and, it is claimed, makes it absolutely rigid, thus preventing breakages due to movement or vibration.

Numerous self-propelling arc welding equipments have been supplied to ship-building and arc welding companies in London, Belfast, Cardiff, Glasgow, Liverpool, South Shields, etc., by Tilling-Stevens, Limited, of Victoria Works, Maidstone. This company has developed three types of equipment, in each of which the vehicle is self-propelling, and is driven by the well-known petrol-electric combination which is associated with the name of the firm. In the first case the vehicle has an ordinary lorry type body on which, at the back of the driver's cab, is a compartment for containing the control gear and equipment, thus leaving a large proportion of the platform free for ordinary carrying purposes. In another form, which we gather is the more popular of the two, the vehicle is provided with a box-type body, which serves as a workshop and a mess-room for the operators, as well as for containing the welding gear and accessories. This type of vehicle is frequently fitted with a petrol-driven air compressor for driving pneumatic tools. Both of these equipments are intended for supplying the current for one arc only. In the third equipment arrangements are made for supplying two arcs, one of which derives its current, as in the case of the first two, from the main dynamo, which also serves to propel the vehicle through

* In a letter to the Editor of *The Engineer* dated April 23rd, 1919, and published in the issue of that Journal of May 2nd, Mr. J. E. Weyman of Newcastle-upon-Tyne pointed out that the illustration shown in Fig. 45 appeared to represent a set which he designed and supplied to the British Arc Welding Co., Ltd., and of which, with some modification, he had since supplied some eight further examples, for all of which Messrs. J. H. Holmes and Co. supplied him with the electrical outfit.

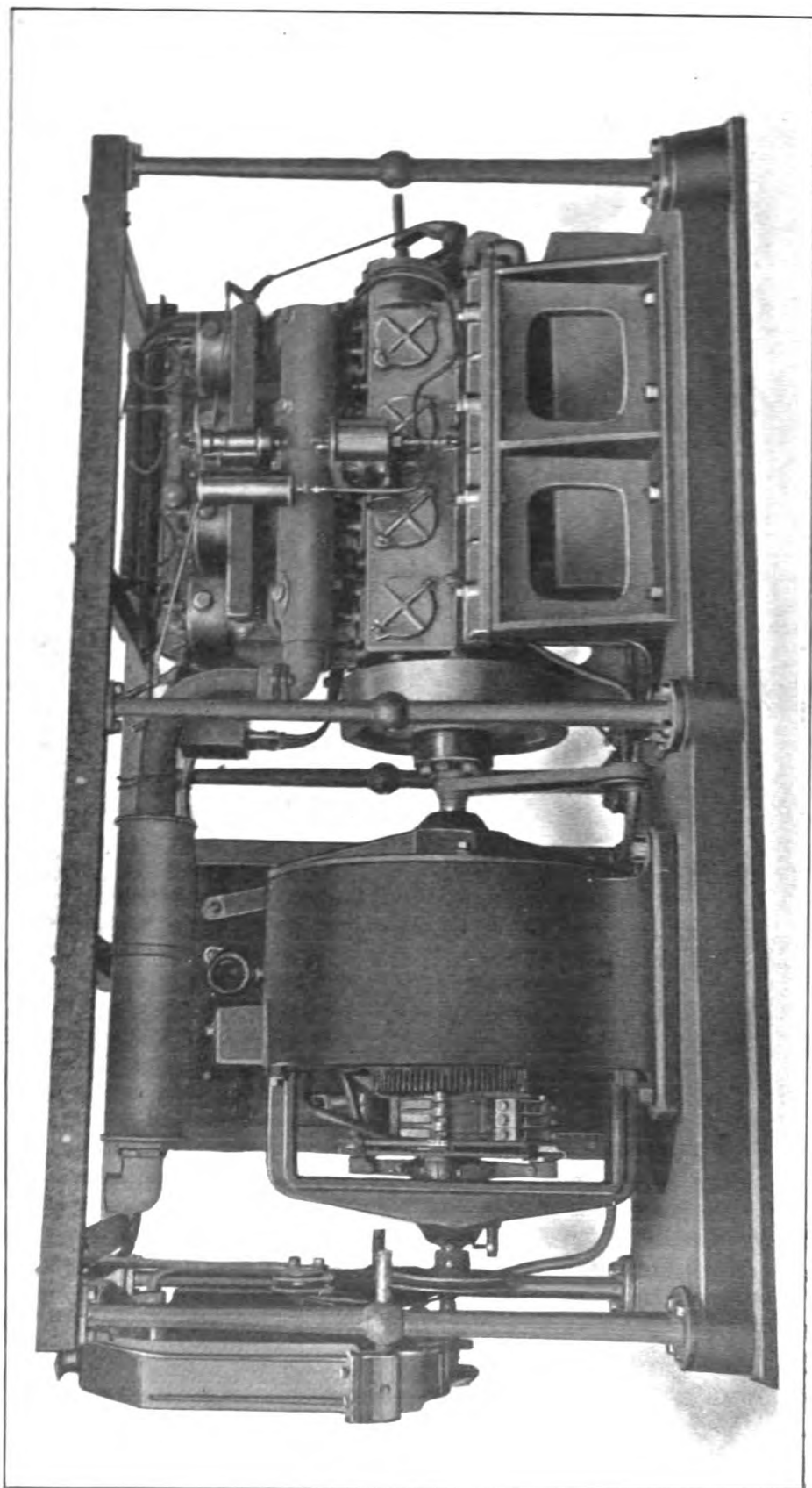

FIG. 45. --Holmes Portable Generating Set for Arc Welding.

the intermediary of a motor, while the other derives its current from a small separate direct-coupled petrol-electric generating set. Exterior and interior views of one of the second type of equipments are given in Figs. 47, 48 and 49, while an exterior view of another design is given in Fig. 50. The chassis in all three cases is the same as that of the firm's 40 horse-power standard vehicles. The prime mover is a 40 horse-power petrol engine, which is direct coupled to an electric generator, designed to give 80 to 100 volts, and compound wound to give a level or slightly falling voltage curve. For propelling the vehicle this machine, of course, supplies current to the motor, which in turn drives the back axle through a cardan shaft and worm gearing. The control of the

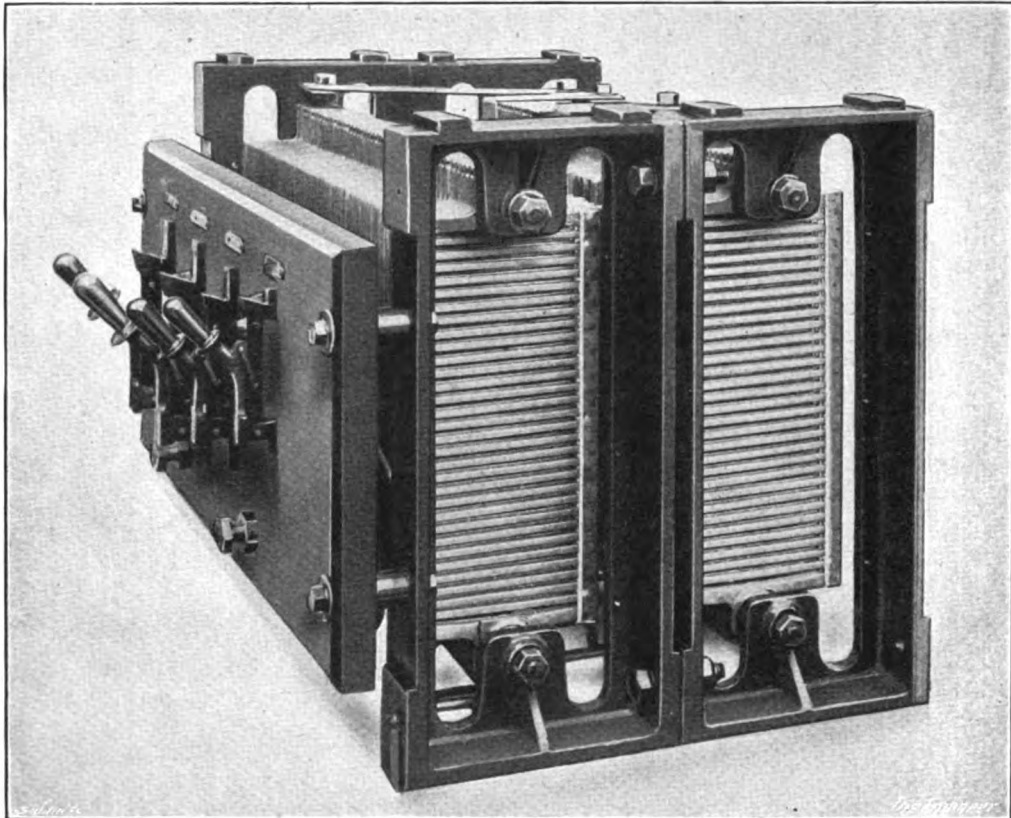

FIG. 46.—Holmes Resistance Frame for Arc Welding.

vehicle when travelling on the road is effected by means of the engine throttle and a resistance, which varies the strength of the generator and motor fields, the entire range of speed being controlled by the throttle pedal and resistance lever. The body is of the box type, and is provided on the near side with hinged doors for lighting and ventilation, and on the off side with one window and louvres. The driver's cab is boarded up on the off side, and there is a hinged door on the near side. A sheet-steel weather screen is also provided. At the back of the cab folding doors give the driver access to the welding control gear, so that he can manipulate it from his seat. In the interior of the body, on the near side, there is a locker seat extending for about half the length, and a bench fitted with a vice, and provision underneath to contain cable for conveying current to the welder—and pneumatic hose if a compressor is fitted—occupies the remaining space on that side of the body.

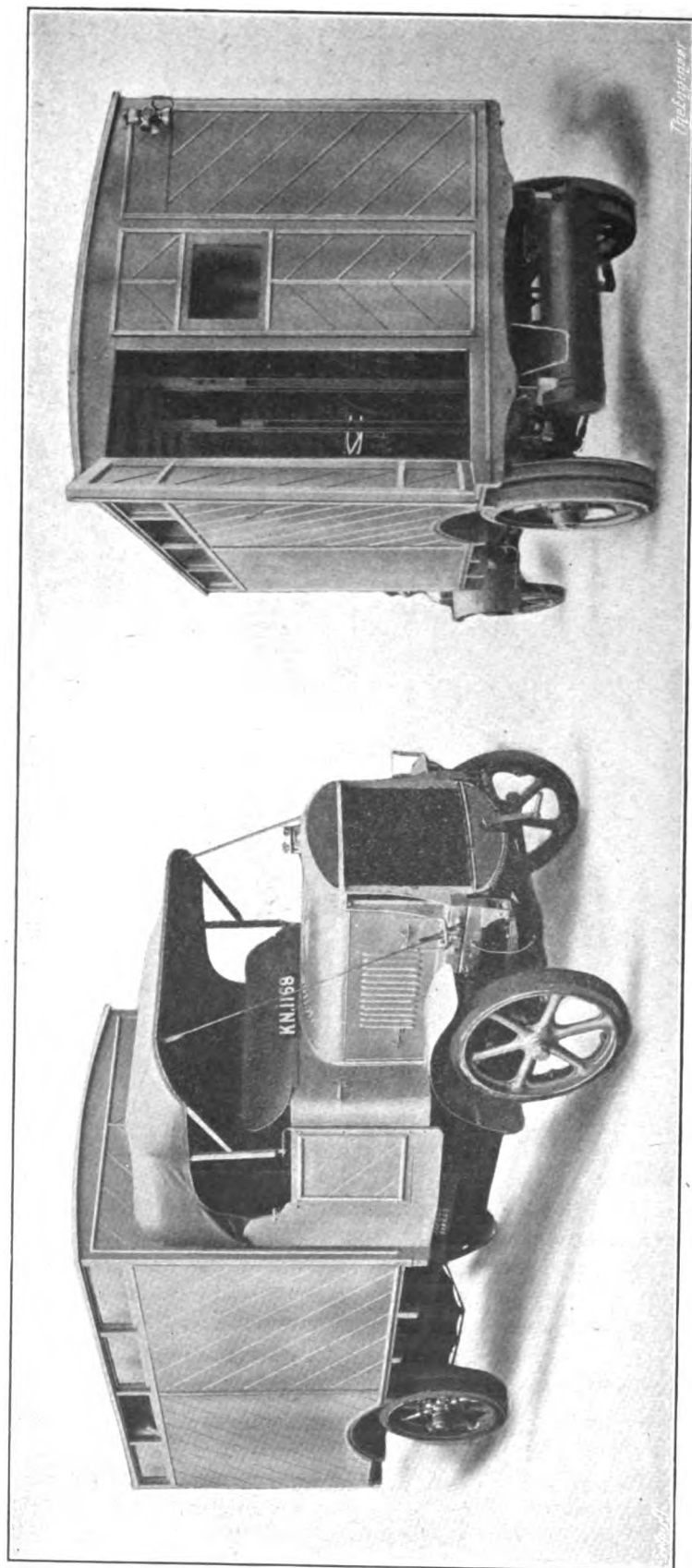

FIG. 47.—Tilling-Stevens Lorry Equipped for Arc Welding.

The switchgear and resistances for the welding circuit are fitted in the front portion of the body on the off side. The cables from this gear run down through the floor to terminals on either side of the body. From these terminals the cables can be taken to where the arc is required. The welding leads are supplied in convenient lengths, which can be thimble together as required, and junction boxes are provided for the insulation and protection of temporary connections.

The plant is designed to weld mild steel plates from $\frac{1}{8}$ in. to 2 in. thick and upwards, and for all descriptions of steel and iron forgings and castings. The output of the dynamo is from 18 to 20 kilowatts. When the car has been taken to the place where the repairs are to be carried out, the controller-lever on the steering column is put into the neutral position, and the main switch on the welding switchboard is closed. The

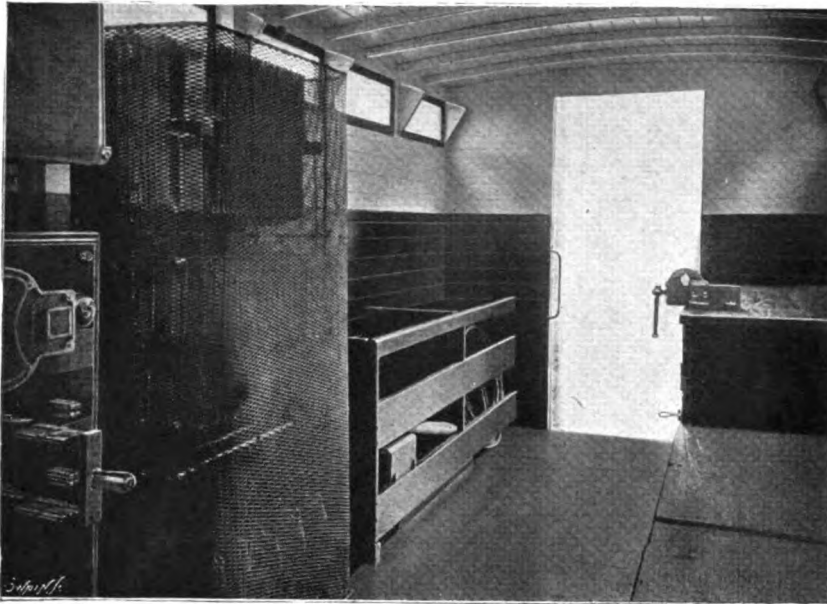

FIG. 48.—Tilling-Stevens Arc Welding Lorry—Interior.

motor is then entirely out of the circuit, and the engine and dynamo are set ready for generating current for welding.

Another firm which has specialised in the manufacture of machines for supplying current for arc welding is that of Crompton and Co., Limited, of Chelmsford, and it has turned out some large machines for this particular class of work. It makes machines of various types, from those designed to keep one single arc going to those intended to supply current to several separate welders working in parallel, each with his own steadying resistance. Such generators as the latter are simply compound wound, so as to give a level characteristic and to ensure stability. They do not differ essentially from ordinary compound-wound dynamos, and do not therefore call for special comment or for more detailed reference. Single welder machines, however, may sometimes be compound wound so as to give a falling characteristic, that is to say, be over compounded so that increase in current tends to reduce the voltage, or they may have three windings, one of them energised from a separate exciter. Then, again, the machines may be motor-driven, the motor being either for alternating or direct current. All the Crompton machines intended for arc welding purposes are, so

we understand, designed to withstand overloads of 25 per cent. for two hours, 50 per cent. for short periods and 100 per cent. momentarily. To make a provision of this kind is distinctly wise, because the duty of a welding generator is without doubt extremely arduous, since the load is a very varying quantity. In the case of a small generator, supplying only one welder, the variation may well amount, momentarily, to overloads of twice the normal, the load rising instantaneously from zero value.

Two machines have been chosen to illustrate the special products of the Crompton firm. They are shown in Figs. 51 and 52. The former shows a petrol-driven self-contained welding set, the engine, petrol tank, oil tank, radiator, generator and switch-board being mounted on one bed-plate, so as to be readily portable. The generator is compound wound to give any desired voltage characteristic, and is of 5 kilowatts capacity at 110 volts when running at 1500 revolutions per minute. The machine



FIG. 49.—Tilling-Stevens Arc Welding Lorry—Driver's Seat.

shown in Fig. 52 is a motor generator of 12 kilowatts capacity at 60 volts. The motor is of the three-phase type, and the direct-current generator has three windings and a separate exciter, so that effects which have been discussed in an earlier chapter in connection with other machines are obtainable.

As examples of some of the electrode holders for metal or carbon electrodes now being used, we may draw attention to Fig. 53, which shows two types of holder. That on the left is intended specially for use with metal electrodes up to No. 6 gauge, and in it the electrode is gripped by spring action, and there are no binding screws to manipulate. The heat guard is of vulcanised fibre. The holder on the right is of a heavier pattern, and is intended for carbon or graphite electrodes, from $\frac{3}{8}$ in. up to $\frac{1}{2}$ in., and for currents up to 250 ampères. The heat guard is of metal. Both these holders are made by the Equipment and Engineering Company, which also supplies a still heavier holder, designed to take electrodes up to 1 in. in diameter, and to be suitable for currents of 400 ampères.

According to Mr. A. M. Candy, as set out in a paper which he read in November,

1918, before the Pittsburg Section of the American Institute of Electrical Engineers, the carbon holder, as used in the United States, comprises an aluminium rod, one end of which is fitted with a connection for attaching the feeder cable, while to the other end is welded a tube which contains two jaws or clamps for holding the electrode. The portions of the clamps which are in the tube are tapered, so that when forced into the tube they grip the electrode firmly. The cable end of the holder is furnished with an insulating, heat-resisting handle, and a disc shield to protect the operator, not only from electric shocks but from the heat and light rays emanating from the arc. The electrode is of solid graphite, usually one inch in diameter and from six to eight inches long. The holder, which is intended for currents up to 500 ampères, is, Mr. Candy explains, sufficiently light to be handled easily and is strong mechanically. For heavier currents a larger holder is necessary. The metal electrode holder as used in

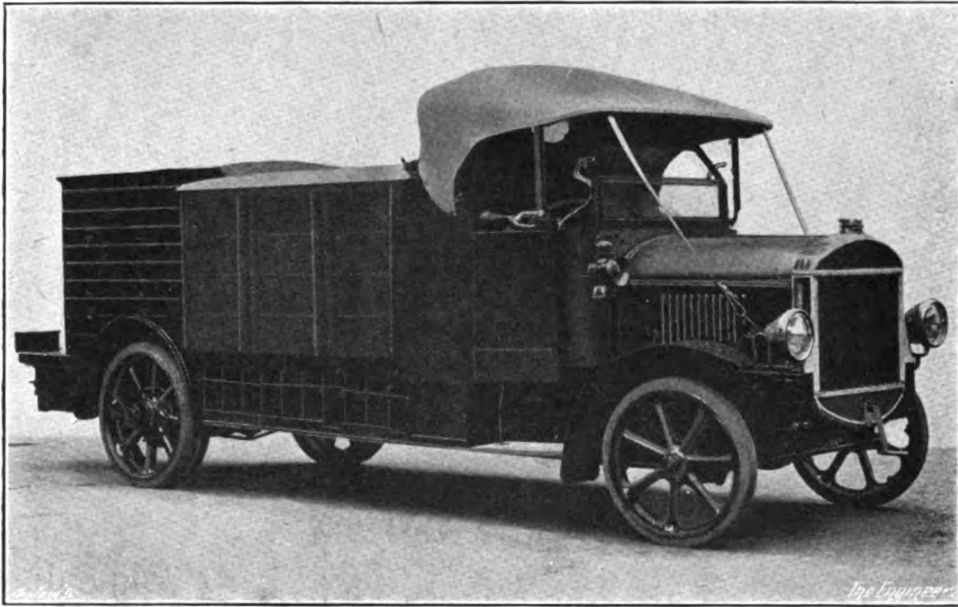

FIG. 50.—Tilling-Stevens Arc Welding Lorry.

the United States—and we repeat here that in that country bare metal electrodes were much more extensively used, at all events until comparatively recently, than were covered electrodes, whereas the reverse is the case on this side of the Atlantic—is considerably lighter than the carbon holder, and the disc shield is generally omitted because the heat at the arc is much less intense. The electrode is clamped in the holder by a cam device, which is so designed as to be capable of accommodating electrodes of various diameters.

The forms of screens employed for the protection of the eyes and faces of operators when engaged in arc welding are numerous and varied. We illustrated one of them in an earlier chapter, and we might deal with many more if it were not that no really useful purpose would be served by doing so. The fact of the matter is that it does not matter what shape or form they take as long as they afford efficient protection. For some classes of arc welding the necessity for protection is considerably less urgent than in others. The long carbon arc, for instance, has a much more potent effect on the surfaces of the human body than have the considerably shorter arcs with which some

types of coated metal electrodes operate. Even so, we have seen cases in which only a screen held in the hand was employed for carbon arc welding, while much more elaborate precautions are sometimes taken by coated electrode welders. It is quite clear, therefore, that there is no reason why the screens or shields should be of any particular shape, though it would be as well for factory owners to satisfy themselves that what is employed will, if properly used, afford the necessary protection.

In this connection there arises the question of the best type of glass to use. It must be admitted that hitherto this aspect of the matter has been treated by many—

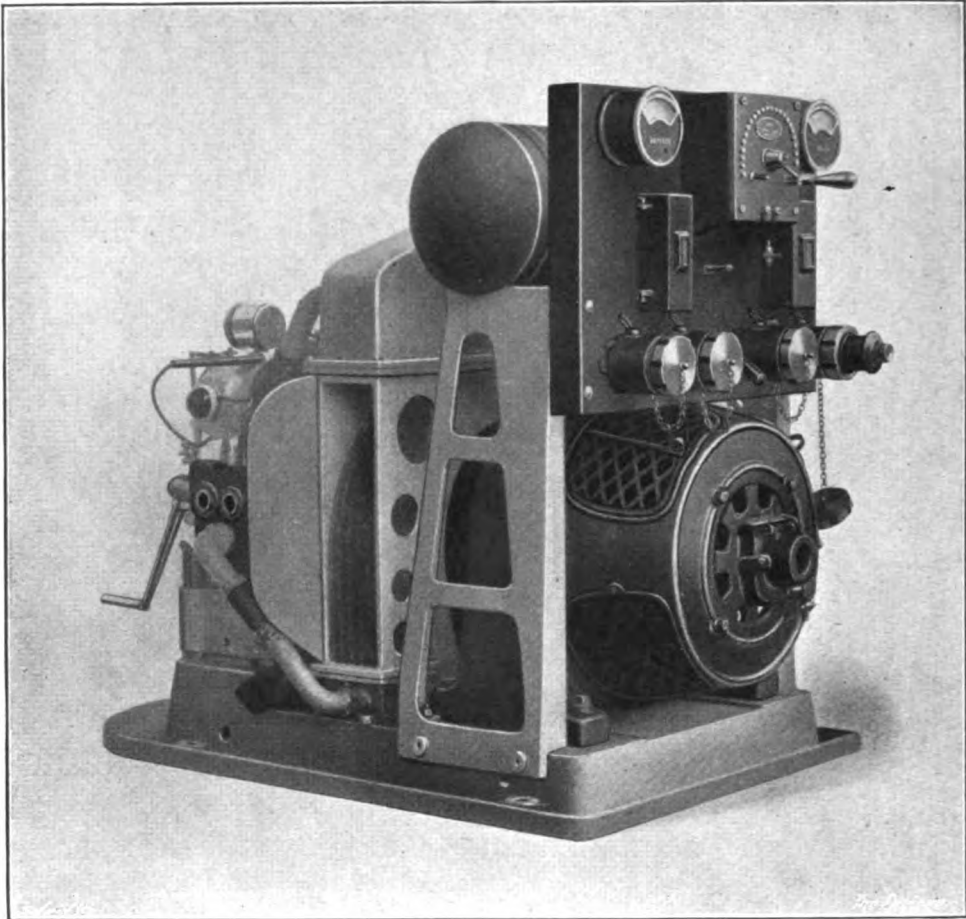

FIG. 51.—Crompton Self-contained Arc Welding Set.

though not by all—in a far too haphazard manner. Notable examples to the contrary were the labours of such investigators as the late Sir William Crookes, who devoted much careful study to the production of glass which, while affording a good view of the work, would protect the eyes of workers. The problem, however, has not, we think, yet reached a definite solution, though several different kinds of “safety” glasses have been evolved, and many combinations of coloured glasses are in use.

It is comparatively easy to select a combination of colours which will cut off a very large percentage of the harmful rays, whether of light or heat, and which will at the same time enable the worker to see what he is doing perfectly well when once

the arc has been struck. With many such combinations, however, it may be quite impossible, with ordinary illumination, to see anything at all of the work. Such a disability cannot be helpful, though we must admit that, when observing the opera-

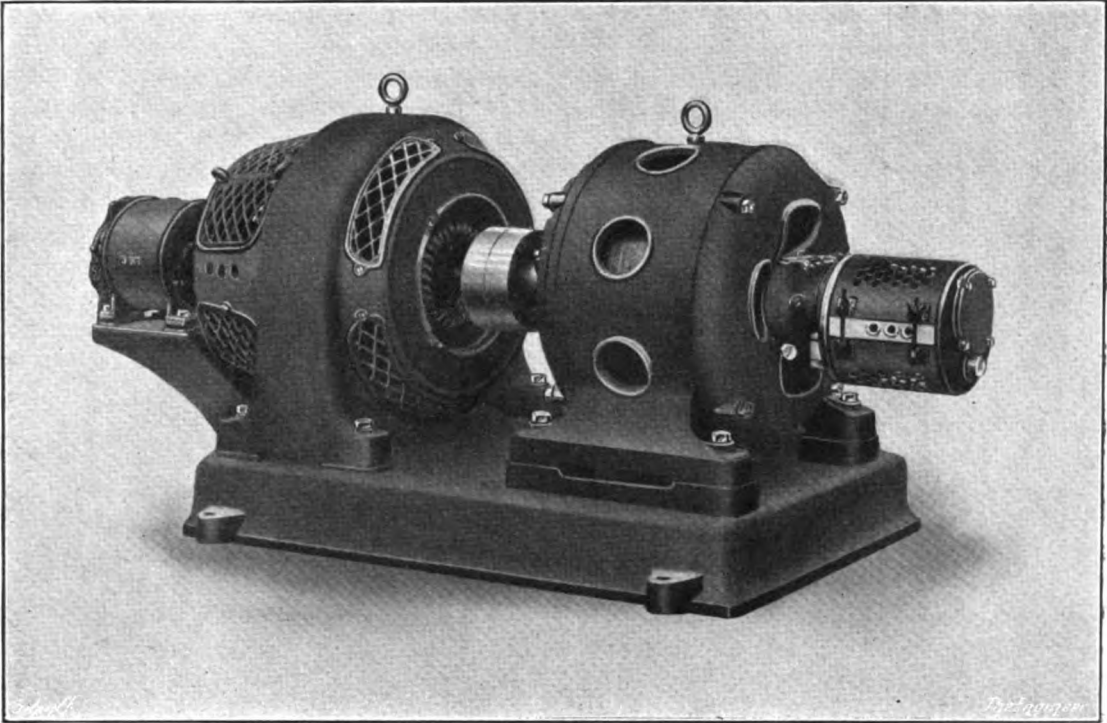

FIG. 52.—Crompton Motor Generator Set for Arc Welding.

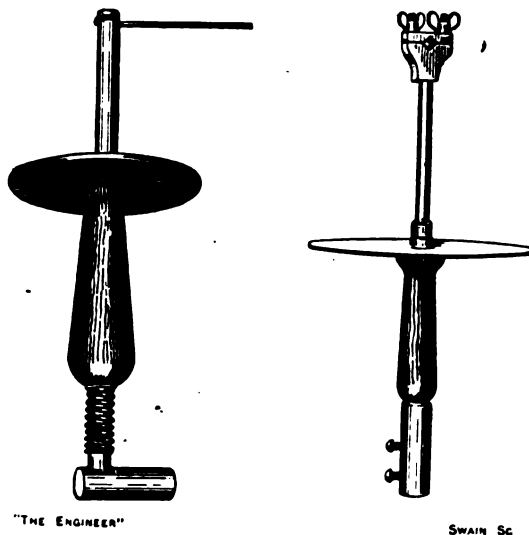

FIG. 53.—E. and E. Company Electrode Holders.

tions of workers using combinations of coloured glasses through which ordinary daylight could only be faintly seen, we have been struck by the small amount of hindrance it has been.

It has to be remembered that it is not only the visible light rays which have to be guarded against; there are also those in the infra-red and ultra-violet ends of the spectrum. Glass which may cut off those at one end may allow the free passage of those at the other. It has, however, not been beyond the powers of science to provide a solution to the problem. Certain glasses having greenish tints have been found to give excellent results, and it is rather curious that they have not been more extensively used in this country than has, so far as we are aware, been the case. Glass having tints of this character and capable of passing a large proportion of the visible rays, has considerable vogue amongst welders in the United States, especially that made by the Corning Glass Company, of Corning, New York. Gold-plated glass has also a remarkable capacity for stopping heat rays, but it is inferior in transparency to other glasses.

The following summary of the effective means for eye protection against the various harmful radiations that are particularly associated with welding operation, forms the conclusion of an article recently written on the subject by Mr. W. S. Andrews, of the Consulting Engineering Department of the General Electric Company of America, and will doubtless be read with interest. It appeared in the December, 1918, number of that company's *Review*, from which we have already quoted in preceding chapters:—

(1) "The intense glare and flickering of the visible rays should be softened and toned down by suitably coloured glasses, selected by an expert and having a depth of colouration which shows *the clearest definition combined with sufficient obscuration of glare*, which last feature can be best determined by the individual operator.

(2) "When infra-red rays are present to a dangerous degree, a tested heat-absorbing or heat-reflecting glass should be employed, either in combination with a suitable dark-coloured glass, when glaring visible light is present, or by itself in cases where the visible rays are not injuriously intense.

(3) "In guarding the eye from the dangerous ultra-violet rays, it must be carefully noted that 'pebble' lenses are made from clear quartz or natural rock crystal, and this material being transparent to these rays offers *no protection* against their harmful features. On the other hand, ordinary clear glass is a protection against these rays when they are not very intense, but dark amber or dark amber-green glasses are absolutely protective. Glasses showing blue or violet tints should be avoided, excepting in certain combinations wherein they may be used to obscure other colours."

CHAPTER XI

RESISTANCE WELDERS OF THE ELECTRIC WELDING COMPANY, LIMITED

AMONG the pioneers in the use of the Thomson system of electric resistance welding in this country was the Electric Welding Company, Limited, of 28 Basinghall Street, London, E.C. It has consequently had a considerable amount of experience in the design and construction of machines working on this principle, and the result of that experience has been that it has arrived at the conclusion that it is wise to make electric welding machines amply strong, since the users of such machines are very apt to demand from them very considerably more than their rated capacity. Hence one of the distinguishing features of the machines which the company builds is robust construction, and since the machines are also characterised by good mechanical and electrical design a short reference to some typical examples will doubtless be of interest. It so happens that just recently the company has introduced several new types of electric butt welders, and to them we propose to refer in what follows. It must not, however, be thought that it only constructs machines of that type, for it also makes spot welders, seam welders, wire welders, chain welders, and machines for many other purposes, all of which it would be manifestly impossible to discuss.

The machine illustrated in Fig. 54 is intended for butt-welding heavy steel tubes up to $3\frac{1}{2}$ in. in diameter. It will be observed that the electrode clamps for gripping the pipes are of the horizontal type with top opening so that the pipes to be welded may be dropped in from above. This construction is advantageous when the work is of a heavy character, or when the tube being dealt with is in the form of a close spiral as, for example, in the case of the coils for a refrigerating machine. The adjustment between the clamps to suit various diameters of pipes is obtained by means of the two hand wheels at the back of the machine which adjust the position of the rear clamps. Each of the forward or working clamps is furnished with a hand-operated cam lever by which the work is firmly gripped by one movement. The clamping blocks and the platens on which they move are cooled by water circulation.

Heavy work such as the welding of pipes as large as $3\frac{1}{2}$ in. in diameter requires a considerable pressure properly to consolidate the weld, and in the machine under consideration it is applied by means of a 12-ton hydraulic jack which is operated by a lever.

The machine, working as it does on the Thomson principle, embodies a static transformer, and the primary winding is provided with five tappings controlled by a selector switch for adjusting the voltage, and hence also the current in the secondary winding, to suit the various sizes of tube, etc., dealt with, the smallest tube which the machine is designed to weld being $1\frac{1}{2}$ in. in diameter. The main control switch, which is oil immersed and enclosed in a galvanised steel tank, is operated by the foot lever and wire rope, which may be seen at the front of the machine at the left-hand side. Machines of this type, some of which are, we understand, being used by some of the largest tube makers in this country, are also suited for the welding of straight rods and

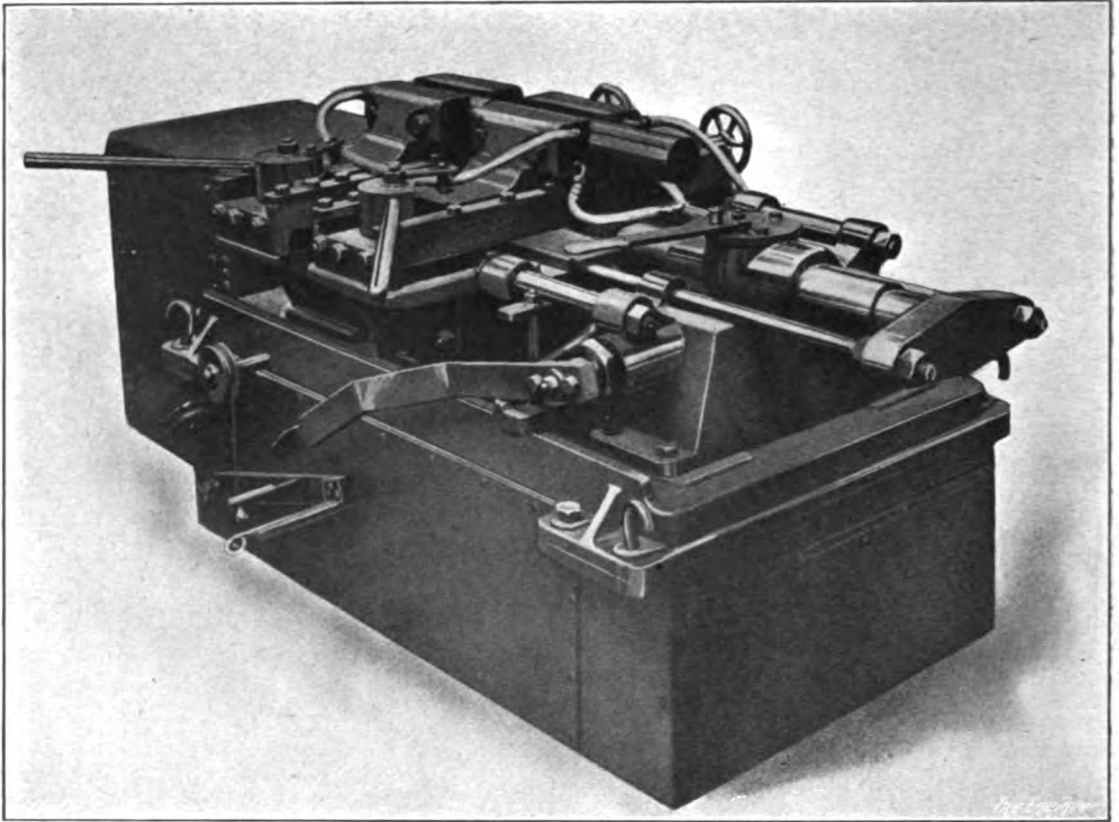

FIG. 54.—Electric Welding Co.—Butt Welder for Tubes, Rods, etc.

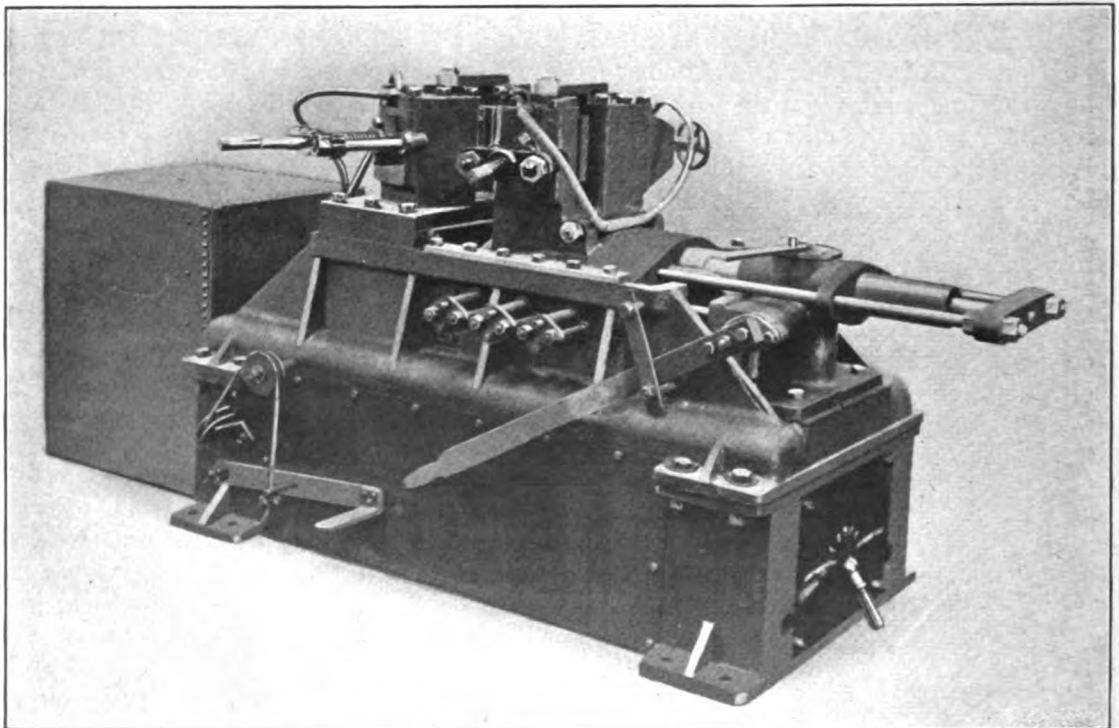

FIG. 55.—Electric Welding Co.—Butt Welder with Radial Welding Blocks.

bars, angles, corner welds in rectangular frames, and other forms of work in effecting which it is convenient to insert the parts to be welded from the top.

A machine similar to the foregoing in size, but differing from it in the fact that the clamps are of the horizontal-oblique type, is shown in Fig. 55. In it the welding blocks are arranged in radial fashion, and are operated by screws and hand wheels. This form of clamp is especially suitable for the welding of rings, tyres and other endless shapes of work, and the particular machine illustrated is designed to deal with cross-sectional areas up to six square inches. Adjustable springs are provided so that the applied pressure may not exceed a predetermined amount.

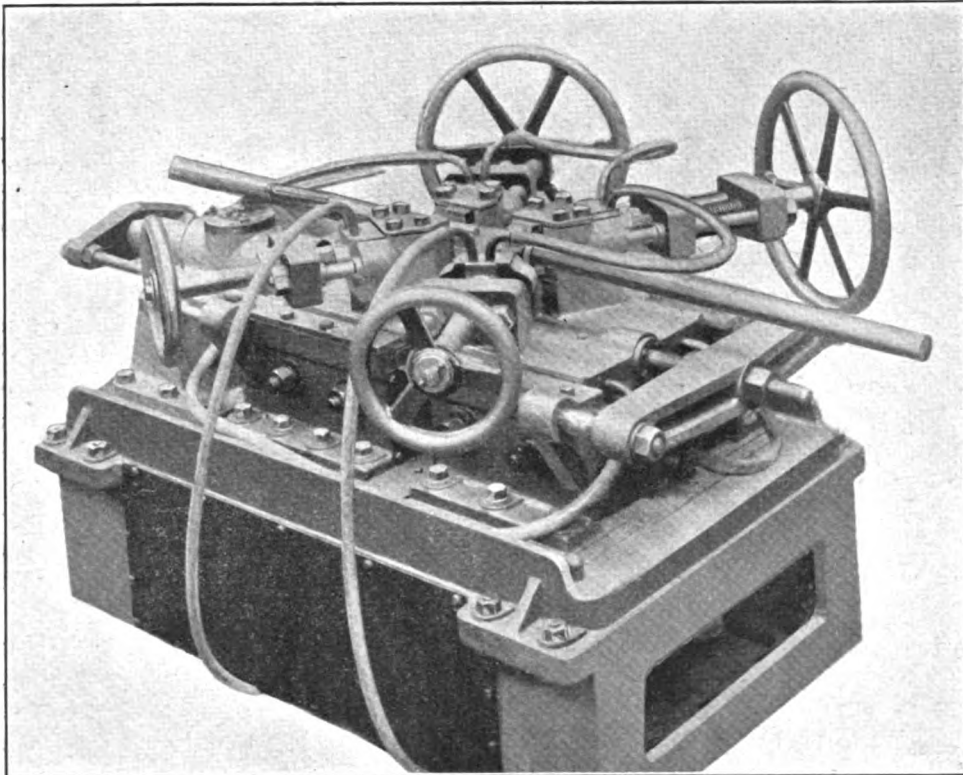

FIG. 56.—Electric Welding Co.—Butt Welder for Miscellaneous Repair Work.

A welder specially designed for miscellaneous repair work, which has been adopted by several British railway companies for renewing the iron work of rolling stock, is shown in Fig. 56. The four clamps, or jaws, are set at an angle and are adjustable by hand wheels. Each has its own water circulation system. The pressure is applied, as in the case of the first two machines, by means of a hydraulic cylinder. This type of machine has proved very serviceable in many kinds of railway material repair work. For example, the truss rods, brake rods, draw-bar rods, and similar parts of the underframing of coaches, are frequently found to be corroded and worn, while the forgings at their ends may still be in good condition. By cutting away the worn rods and welding on new ones the cost of new forgings is saved, and the resulting economy is found to be quite considerable.

A machine of considerably different type is shown in Fig. 57. It is a hand-operated welder specially designed for light work on steel strips, small rings, perambulator tyres,

cycle parts and such-like small articles. In the illustration the casing of the lower part has been removed in order to show the construction of the transformer. The secondary winding consists of laminated copper strip, which encloses the primary coil and embraces one limb of a rectangular iron core. The ends of the secondary winding are bolted to fixed platens which carry the clamps and pressure device. The clamps, which are of the vertical type, are operated by cam levers, and are so arranged as to enable the work to be inserted from the front, and to be gripped by a single movement of the cam lever. The pressure device consists of a toggle and lever, and there is an automatic switch, which, however, is not shown in the engraving, by means of which the primary current can be cut off as soon as the sliding clamp reaches an adjustable stop. This machine is, we are informed, capable of welding steel strip as thin as No. 22 S.W.G., two inches wide, with uniform and reliable results when operated by a lad.

An entirely automatic welder is shown in Fig. 58. It is intended for welding hoops, rectangular frames, buckles and rings at a speed which may amount to as many as 600 welds per hour. The transformer and the electric parts of the machine are of standard type, but the clamps are mechanically operated by a system of cams from a main shaft which is driven by a clutch pulley controlled by a treadle attached by chain to the rod suspended from the pulley at the right-hand side of the machine. The machine is belt-driven, and as soon as it is started up the right-hand platen moves away from the left, with the result that the space between the arms of the clamping device is increased and the clamping jaws raised. As soon as this occurs the operator puts the pieces to be welded on the electrodes, so that they abut against each other evenly with the joint in the centre. The clamping jaws then descend and securely hold the pieces in place. The primary switch then closes and the current flows. As the metal softens the pressure of a spring causes the right-hand platen to move towards the left, with the result that the metal is upset at the points, and the weld made. The steel clamping jaws are then raised, the right-hand clamp then again moves away from its fellow, the operator removes the welded piece, and the cycle of operations is again repeated.

This machine is of 6 kilowatts capacity, and is intended for welding stock up to $\frac{1}{4}$ square inch cross section, at the rate, as already said, of 600 welds per hour, the actual time required for heating each weld being, we gather, about three seconds. In both this machine and in that shown in Fig. 57 there is a circulating water-cooling system.

SOME LARGE AMERICAN SPOT WELDERS

Some exceptionally large resistance welding machines, which give some idea of the far-reaching possibilities of this method of welding, have recently been constructed by the General Electric Company of America. First of all a fixed experimental machine was built which had a welding current capacity of no less than 100,000 ampères, and a pressure capacity of 75,000 lb. As a matter of fact the maximum current and pressure at which the machine had been used up to the time at which the memorandum from which we are obtaining our information, and which appeared in the issue for December, 1918, of the *General Electric Review*, was written, were 72,000 ampères and 30,000 lb. respectively. With them three thicknesses of 1 in. plate had been spot welded. Working on the data obtained with that machine the company set about the designing of special portable appliances for use in the fabrication of structural parts, particularly intended for ship work. An investigation of the subject showed that four-fifths of the work of this character could be carried out by a machine

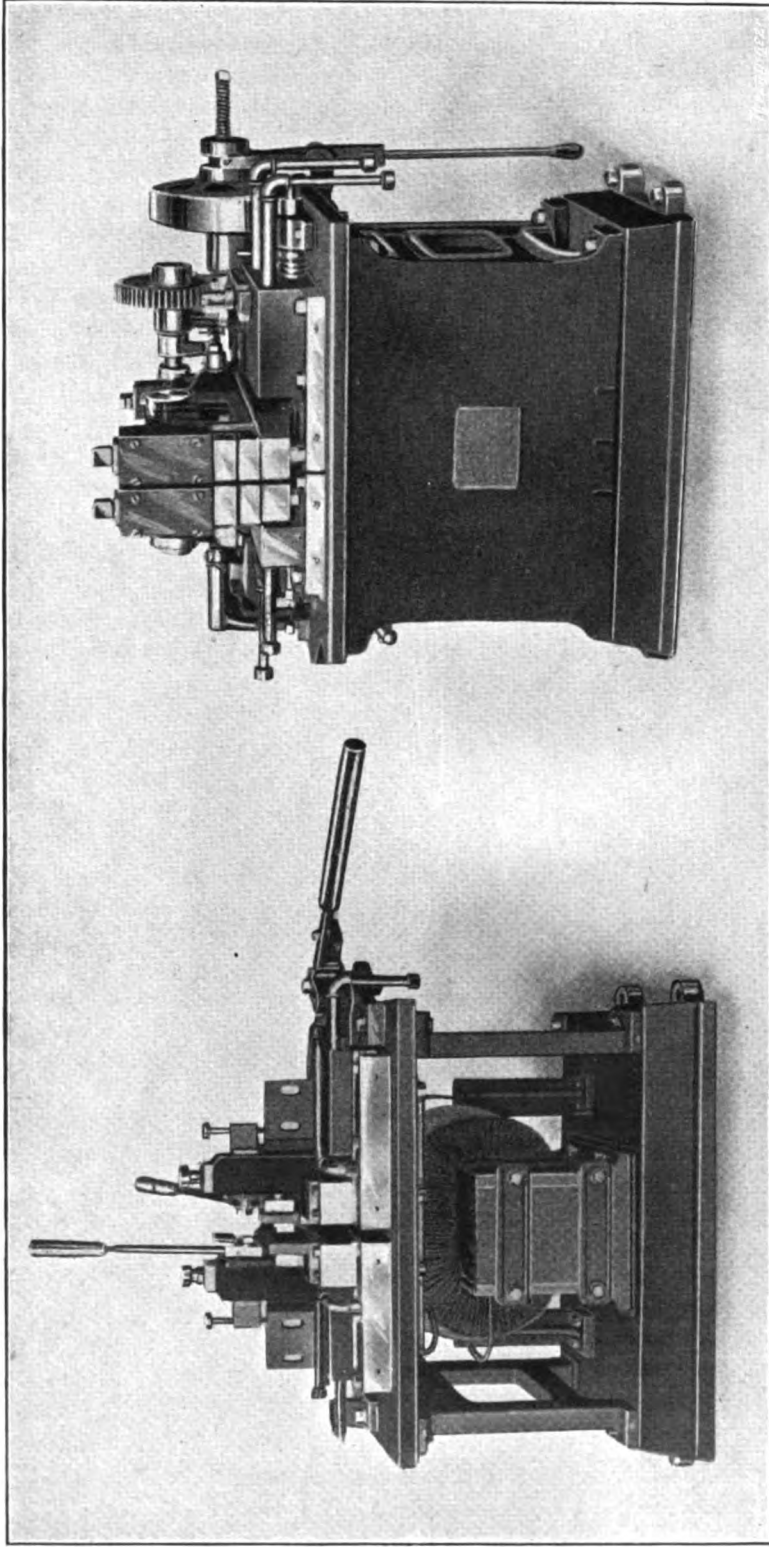
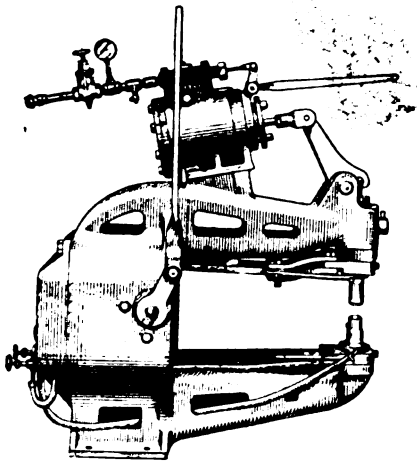

FIG. 57.—Electric Welding Co.—Butt Welder for Strips, etc.

FIG. 58.—Electric Welding Co.—Butt Welder for Hoops, Rings, etc.

having a reach of 12 in., and that a machine with a reach of 27 in. would include the other fifth. Since it was calculated that both the weight of the machine and the kilovolt-ampères required for its operation would be about 33 per cent. greater for the 27 in. reach machine than for that having the 12 in. reach, it was decided to build two machines rather than only that with the longer reach. The standard pneumatic riveter was taken as a model, so far as the general construction of the machines was concerned, the mechanical pressure being applied by means of an air cylinder and a lever system. Bales were also provided so that the machines could be picked up by a crane and held suspended where required. An engraving showing the larger of the two machines is given in Fig. 59, which is reproduced from the *Review* mentioned above.

The maximum welding current available in these machines, with a steel plate enclosed to the full depth of the gap, is about 37,500 ampères. The current applied to the primary winding had a periodicity of 60 and a voltage of 534. Reduced voltages



"THE ENGINEER"

SWAIN & Co.

FIG. 59.

American Spot Welder for Ship Work.

to give smaller currents in six progressive steps—the lowest being 267 volts—were furnished by means of separate regulating transformers. This arrangement was provided to meet the possible requirements for a considerable range of thickness of work, as well as for experimental purposes. As a matter of fact, however, it was subsequently ascertained that the machines would operate satisfactorily, on work of thicknesses extending over the range on which they are likely to be used, when connected directly to a 440-volt, 60-cycle current with no regulating transformers. Two plates are with these machines welded together in spots from 1 in. to $1\frac{1}{4}$ in. in diameter in from twelve to fifteen seconds. Thicker plates, of course, require more time, and thinner plates less time.

The welding current under these conditions is about 31,000 ampères, the corresponding primary current for the 12 in. machine being about 600 ampères, and for the 27 in. machine about 800 ampères, the voltage in each case being 440. The expenditure of energy was therefore 264 and 352 kilovolt-ampères in the two machines respectively. The secondary voltages with these figures work out at about $8\frac{1}{2}$ for the smaller machine and $11\frac{1}{2}$ for the larger.

The maximum mechanical pressure for which these machines were designed is 25,000 lb. It is obtained by means of an 8 in. cylinder working with air at 100 lb. per square inch pressure, and a lever arm with a ratio of 5 to 1. Alteration in the pressure applied is obtained by varying the air pressure, a reducing valve being provided for the purpose. A gauge pressure of 70 lb., giving a pressure on the work of 17,500 lb., has been found to give good results with $\frac{1}{2}$ in. plates.

The conductor for the primary windings of these transformers is $\frac{3}{8}$ in. by $\frac{1}{2}$ in. annealed copper tubing, insulated with asbestos tape, wound directly on an insulated core, alternate layers of sheet asbestos and mica pads being used between layers of the primary winding, between primary and secondary, and between primary and the core. There are four layers of thirteen turns each in the 12 in. machine, and three layers of thirteen turns each in the 27 in. machine. The U-shaped single-turn secondaries, which were slipped over the outside of the primary windings, were constructed of two copper plates, each $\frac{3}{8}$ in. thick and $6\frac{3}{8}$ in. wide, assembled one inside the other, $\frac{1}{4}$ in.

apart. Narrow strips of copper were inserted between the plates along the edges, and were brazed in position so as to make a water-tight passage for the circulation of the cooling water. At 31,000 ampères the current densities in the secondaries is about 6200 ampères per square inch, the corresponding densities in the primary windings being about 7000 ampères per square inch in the 12 in. machine and 9000 in the 27 in. machine.

Spacing blocks of a compound of asbestos and Portland cement were used at the ends of the core and at the ends of the winding layers, and the complete transformer, after assembly, was impregnated with "bakelite." The result, we gather, was a solid mechanical unit which is not injured by heat as long as 150 deg. Cent. is not exceeded. Several welds can, we are informed, be made without turning on the cooling water before that temperature is reached. The cooling water was given two paths, one being through the primary winding, and the other through the secondaries and the electrodes in series.

When it was found that these machines worked satisfactorily it was decided to go

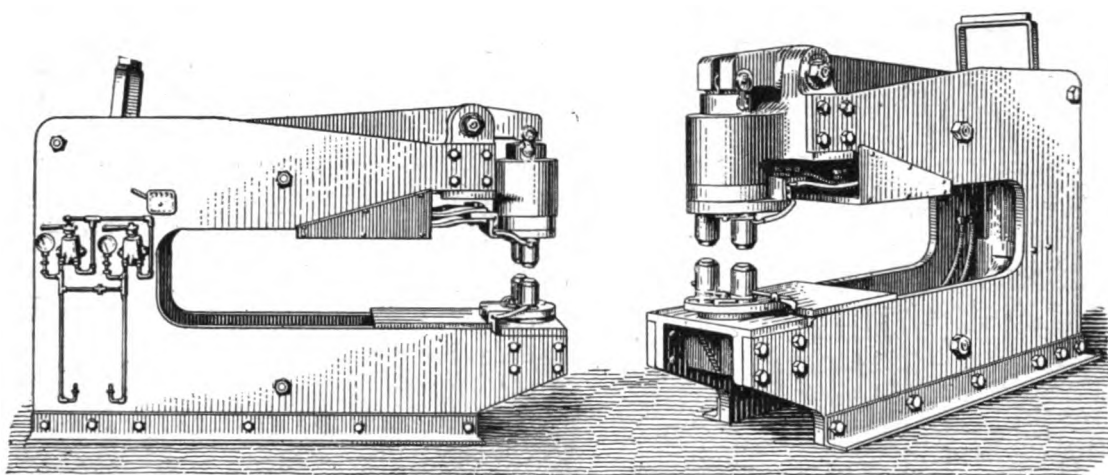

Fig. 60.—Large American Duplex Spot Welder.

a step further, and to build a larger machine, intended specially for the application of electric welding as a substitute for riveting on parts of ships hulls composed of large-sized plates, which may be "fabricated" before they are assembled in the ship. It was decided to give the machine a 6 ft. gap, and to make it capable of welding together two plates $\frac{3}{4}$ in. thick in two spots at the same time. It was realised that it would be useless to attempt to make the machine even semi-portable and the form it was given is shown in Fig. 60. With the welding circuit enclosing a 6 ft. gap, and carrying the very heavy current necessary to weld $\frac{3}{4}$ in. plates, the kilovolt-ampèrage would have been very high. It was proposed, therefore, as a means of greatly reducing the energy consumption, and at the same time of doubling the amount of work turned out, to use two transformers with two sets of electrodes, and to arrange them as shown diagrammatically in Fig. 61. By this arrangement it was made possible to weld two spots at the same time. The transformers are mounted in the frame of the machine as near to the welding electrodes as possible, so as to obtain the minimum reactance in the welding circuit. The polarity of the electrodes on one side of the work was made the reverse of that on the opposed electrodes, thus giving a series arrangement of the transformer secondaries, the pathway of the current being indicated by the dotted

lines. It will be gathered that the current from each transformer flows through both of the spots being welded. The bottom electrodes are stationary, while the top electrodes are capable of independent vertical motion, so as to engage the work. Previous tests with the original experimental machine had shown that successfully to weld two spots at the same time with such an arrangement as we have described, it was necessary that the pressure should be independently applied. Otherwise, because of inequalities in the thickness of the work, or because of wear and tear of the electrodes, the pressure might be much greater on one of the spots than on the other, which would naturally result in unequal heating, since the resistance to the flow of the electric current and the consequent heating effect are less on the spot with the greater pressure. The two top electrodes were therefore mounted on separate plungers operated by separate pistons through independent levers.

The pressures obtained in this duplex machine with an air pressure of 100 lb. per square inch are 30,000 lb. on each spot, or a total pressure of 60,000 lb. on the work. The two air cylinders are mounted on a cast iron bed-plate in the back part of the machine. The levers connecting the pistons to the electrode plungers, which are 7 ft. in length, were made of cast steel in order to obtain the necessary strength.

The maximum welding current for which this enormous machine was designed is 50,000 ampères, this secondary current being obtained with 60-cycle current at a voltage of 500 applied to the primary winding. With this current in the secondaries the current in the primaries of the two transformers was 1800. The primaries of the two transformers are arranged in series and the kilovolt-ampère in each transformer is 450, or a total of 900 kilovolt-ampères. The current densities in the primaries and the secondaries of these transformers was no less than 9000 and 7000 ampères

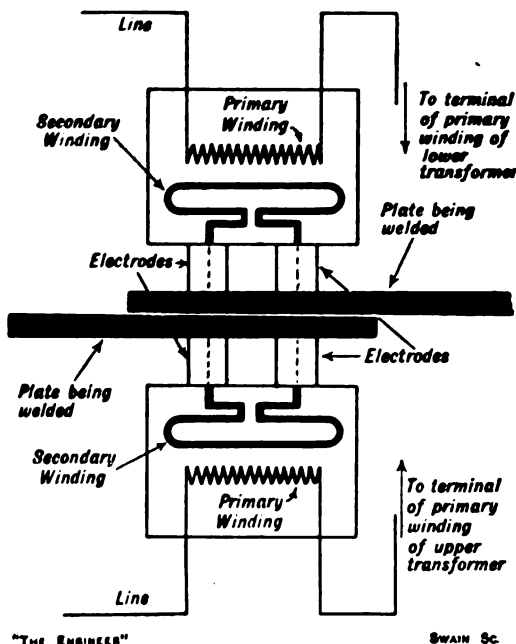

"THE ENGINEER"

SWAIN SC.

FIG. 61.

Electrical Arrangements of Duplex Welder.

per square inch respectively. The winding consisted of two layers of fourteen turns each for each of the primaries, and a single turn for each of the secondaries, one layer for the primary being arranged inside and the other outside the single turn secondary winding. These transformers, which, exclusive of terminals, only measure 11 in. by 16 in. by 18 in. over all, are thought to be the smallest ever built for so large a rating.

It can be well understood that when dealing with such heavy currents the question of the electrodes becomes of great importance. In the portable machines described above the current density in them is given as being about 60,000 ampères per square inch. It has to be remembered, too, that when heated by the passage of this current the tips of the electrodes are subjected to a pressure which may amount to as much as from 15,000 lb. to 20,000 lb. per square inch, and that copper—the best available material for the purpose—softens at a temperature considerably below the welding

temperature of steel. The electrodes, which have tips in the form of very flat truncated cones, are given such shape as is calculated to afford as free conduction as possible of the current to, and of the heat away from, their tips. Moreover, they are adjacent to large masses of metal of high electrical and heat conductivity, and their bodies are internally water-cooled by a stream of water flowing continually through. Still, in spite of every precaution, which included the clearing away by means of a sand blast of rust and scale from the surfaces of the plates at the points of impingement of the electrodes, deformation of the tips of the electrode occurred, thus increasing the area of contact with the work and reducing both the current and the pressure densities below the values needed for welding. To overcome this difficulty thin copper caps— $\frac{1}{16}$ in. thick—fitting over the tips of the electrodes have been tried, and as many as 160 welds have been made with a single cap before it required to be renewed. Another method tried was to have renewable tips to the electrodes, and it has been proposed to employ electrodes which combine the features of the removable tip and the cap, but the last-named had not been tried at the date of the *Review* to which we are referring.

As far as we are aware, the machines described in the foregoing are the largest and most powerful which have, up to now, been constructed.

CHAPTER XII

OIL-DRUM-MAKING BY RESISTANCE WELDING

IN an earlier chapter we mentioned that the Steel Barrel Company, Limited, of Uxbridge, in addition to its extensive use of the carbon arc, also employed the resistance welding process. It does so for the production of sheet-steel drums such as are used for containing petrol, petroleum and other such oils and liquids, and it finds it most satisfactory for the purpose. We ourselves have seen a five-gallon drum made by this method at Uxbridge which, when filled with petrol, and weighing in all about 49 lb., had undergone the drastic test of being dropped no less than seven times from different heights—nearly 20 ft. was, we believe, the highest—and it did not show the least sign of leakage, though it was severely battered about and distorted. We have on several occasions watched the various processes of the manufacture of these drums and we shall now proceed to describe them.

It may be explained at the commencement that some years before the outbreak of hostilities, Mr. T. T. Heaton, the general manager of the company, when on a visit to Germany saw in operation a series of machines which he thought could be adapted to perform the kind of work which he had in view. A set of machines was, therefore, ordered and eventually delivered. As originally built, however, they failed to do what was required of them, and had to be considerably modified, with the result that in their present forms they certainly operate extremely well, and with great speed. The size of drum which we have seen made was that intended to hold five gallons, but the same machines are equally well fitted for making larger or smaller vessels, the largest or smallest for which they are suited being, we understand, 2 and 15 gallons respectively. For making the drums four distinct types of machines are employed, and one type is represented by two slightly different machines, so that it may be said for the welding alone five different machines are required. We shall refer to them in the order in which they are used.

The drums are made of mild sheet steel of Nos. 24 to 18 B.G. thickness. The sheets are first of all cut to correct size, and accurately squared. They are then curved into cylinders, by passing them through rolls in the usual manner, the pressure being so adjusted that only one passage through the rolls is necessary in order to obtain the desired curvature. To obtain really satisfactory welds by the processes employed it is necessary that the sheets should not only be free from scale and rust, but that all oil, grease and dirt should be removed from their surfaces. To effect this the cylinders, when rolled, are immersed for a short time in a bath containing a mixture of acids diluted with water. When they have remained for a sufficient time in the bath they are taken out, washed in several changes of water and dried. In this connection we may mention that, as the washing water has, after use, to be discharged into a canal which passes by the works, its acid contents have to be neutralised. To do this it is passed through a channel which is charged from time to time with the spent material—calcium hydrate—taken from the acetylene generators. We understand that this employment of an otherwise useless waste product has given quite satisfactory results.

The cleaned and dried cylinders are then ready for the welding processes, the first of which is to give the necessary overlap to the edges of the longitudinal seam, and to secure these edges in the correct position for the welding of the seam. The machine employed for the purpose is a pedal-worked spot welder, the lower electrode of which is fixed, while the upper is reciprocated vertically by the pedal. The machine is manipulated by two boys, one of whom only assists in holding the cylinder in the required position. The correct overlap is obtained by causing the longitudinal edges of the rolled cylinder to enter two slots arranged one on one side, and the other on the other of a horizontal bar, the two slots being at slightly different levels, and being given such depths that when the edges of the curved cylinder plates are pressed as far as they can go into them by the two boys, one pressing on one side and one on the other, the exactly correct overlap for the joint is obtained. The machine operator then, after making certain that the ends of the two edges, which, we may explain, are allowed to project some little way from the end of the slotted rod so that they can be readily pressed together, coincide, or, in other words, that the circumferential edge lies in one plane, adjusts the extreme end of the seam immediately beneath the vertical electrode of the machine and presses the pedal. The result is the formation of a minute spot weld, which effectually holds the two edges together with the correct overlap. The amount of overlap being given when we saw the machines at work was about three-eighths of an inch, and the diameter of the spot weld about one-eighth of an inch. Still keeping the edges of the cylinder in the slots in the bar, the cylinder is moved horizontally for a short distance, and another spot weld made. This process is repeated several times, until only the length of seam at the end remote from the first spot weld remains. The cylinder is then removed from the machine, the unsecured end of the seam is adjusted in position on the lower electrode, and the upper electrode brought down by the pedal so as to make the final spot weld. The whole process, which may from the description appear to take a long time, is actually carried out in a few seconds, and results in the formation of an accurate cylinder, the edges of the longitudinal seam of which are held securely in place for the next operation, which is that of welding the seam.

For the welding of the seam the cylinder is placed in the horizontally reciprocating frame of a machine, which is furnished with revolving wheel electrodes arranged, vertically, one above the other. When in position in the frame with the seam of the cylinder coming immediately between the two wheels, the movement of a horizontal lever causes the top wheel to be moved downwards, so that the seam is pressed between the two wheels, while simultaneously the horizontal frame, and with it the cylinder, is made to move slowly in such a way that the wheels, or rollers, as they revolve with the seam between them follow the latter accurately and weld the two edges securely together. As in the case of the first machine the whole length of seam is not welded from one end. The welding of the seam is begun three or four inches from one end, and the weld taken from that point to the further end of the seam. The cylinder is then taken out of the frame, reversed, and put into the frame again. The remainder of the seam is then welded in the same manner. The whole process, including the reversing of the cylinder, takes only about ten seconds. By reason of the fact that the cylinder is held in and moves with the frame, the weld is in an exactly straight line and looks extremely neat and businesslike.

The next process is the fitting and welding in of the top end of the drum, that is to say, that end which carries the bung-hole. The ends, whether that at the top or that at the bottom, are formed of circular steel plates of Nos. 24 to 18 B.G. thickness, dished so as to have a rim standing up at right angles to a depth of about 1 in. The

ends when dished are of such a size that they are an easy driving fit into the end of the cylinder. The hole to take the bung ring is, of course, punched before the end is fitted into the cylinder. After the end has been placed in position, an operation which is effected simply by pushing, or, if necessary, light tapping, the operator satisfies himself that it is neither too far in or too far out, and then places the cylinder horizontally on a frame in a welding machine, the arrangement being such that the cylinder can revolve on its axis. The welding machine is of the wheel type, the two wheels being placed vertically one above the other. The top wheel is revolved by power, while the lower wheel is free to revolve on its spindle. All being in readiness the machine attendant depresses a lever which raises the bottom wheel so that the rim of the cylinder end is gripped between the two wheels, and welding commences. As the upper wheel is revolved mechanically the drum cylinder is revolved with it, and gradually the whole seam is welded right round its periphery. All that the attendant has to do is to see that the rim is kept continually between the two wheels, this being done by guidance with the hand, which ensures that the end of the cylinder revolves in one plane. This operation, like those which have gone before it, is also effected in but a few seconds of time.

The next operation is the welding on of the bung socket, or boss, which may be of two types, i.e. that for use with a cork bung, and that for a screw plug. In both cases the welding process is the same. The cylinder is threaded over an upright, the top of which is provided with a spindle which fits into the hole punched in the end piece, and is provided with a shoulder on which the metal of the end piece can rest, and which forms the lower electrode and the anvil for the welding operation. With this arrangement, as will be understood, the cylinder can be revolved vertically round the bung hole as a centre. When the cylinder is in position the bung socket is threaded over the projecting top of the spindle above mentioned, and the machine put in motion. The effect is to cause an upper electrode to be mechanically reciprocated vertically up and down, and at the lowest point of each stroke to press the metal of the cylinder top and the flange of the bung socket together, and form a spot weld. Between each stroke of the machine the cylinder is revolved through a small angle, the effect being that a series of spot welds, which just overlap one another, is formed all round the periphery of the flange of the bung ring, and when the cylinder has been revolved through a full circle the welding is completed. The result is neat and satisfactory in every way, and the whole operation is very quickly effected.

Next comes the welding on of the handle, which is simply a strip of sheet steel bent through four right angles in the following manner . The machine used for the welding is of a similar type to that used for welding in the bung socket, but of a slightly different construction. There is, however, a vertical lower electrode which also acts as an anvil, and a power-worked vertically reciprocating upper electrode. The handle is placed in position and some five spot welds quickly made on each of its ends where they come in contact with the metal of the drum top. These welds, though they look quite small, are sufficient to weld on the handle so securely that a very considerable pull would be required to tear the handle from the drum top.

Finally, as far as the welding processes are concerned, the bottom piece, which exactly resembles the top piece, saving that it has no bung hole, is fitted in and welded in place, the machine employed being identical with that used for welding in the tops.

The finished drum is then taken to a grindstone, by means of which the rough edges of the ends are smoothed, and it is then ready for testing and painting. Testing is effected by inserting a closely fitting nozzle into the bung hole, applying internal

air pressure, and plunging the drum in water. Out of a large number which we saw tested we saw no sign of air leakage. Drums of this type are turned out in large numbers and with wonderful rapidity. There is not, we should say, a single one of the welding operations which takes a quarter of a minute, the shipping and unshipping of the cylinder in the machine being included in that period.

Having described the welding processes, we can say a few words regarding the machines. They all, of course, work with alternating current. The company does not generate alternating current nor does it convert its own direct current into alternating. It so happens that a supply from a local company is available. The voltage at which it is received on the works is 2800, and the periodicity is 50. Near the point at which the current enters the works the pressure is transformed down to 220 volts, at which pressure it is distributed to the resistance welding machines. The secondary voltage of the latter, that is to say the difference of potential between the electrodes applied to the work, is very low. In no case is it, we understand, more than 1 volt, and in one machine, at any rate, it is as low as half a volt. In this connection it has to be remembered, of course, that the material being dealt with is very light, only Nos. 24 to 18 B.G.

Of the machine used for spot welding the longitudinal seams there is not much to say beyond that which has already been said. The motion involved is simply the reciprocation of the upper electrode, which is effected by pedal against a spring. Just after the final pressure is put on, the current in the primary circuit is automatically cut off. Both upper and lower electrodes are cooled by water circulation.

The longitudinal seam welding machine, on the contrary, has many points of interest. Its two electrode wheels, the spindles of which are carried in bearings, are mounted at the ends of two long arms which form the two terminals of the secondary of the transformer. They are both of them free to revolve and are cooled by a large portion of their surfaces being in rubbing contact with cheeks which are provided with a water circulation system. Rubbing contact is depended upon for the conduction of electric current. The mechanical arrangements are worthy of special mention. It will be remembered that the movement of a horizontal lever both brings the electrode wheels nearer together so that they press on both sides of the work, and also puts the cylinder-carrying frame in motion. The action is, briefly, as follows: The upper arm, which carries the upper electrode wheel, is hinged near its rear end, that is the end away from the wheel, and the rear end itself is pin-connected to a system of levers which are actuated by the horizontal lever. The motion of the latter imparts just sufficient motion to the arm carrying the wheel to enable the latter to bear with the desired pressure on the work. Connected to the horizontal lever is also the actuating member of a clutch which can put a train of revolving gearing into and out of mesh with a toothed wheel on a shaft carrying a pinion which is in mesh with a toothed rack attached to the horizontally reciprocating frame which carries the cylinder. There is an arrangement by which the frame when it has completed its forward movement is quickly returned to its starting-point. The power to work this machine, and the others that require it, is obtained by belting from a countershaft. It will be understood that in this case the current is kept on during the whole of the welding operation, and that as the cylinder is forced between them the electrode wheels revolve so that no one point in their peripheries is kept long in contact with the heated metal which is being welded. The weld is continuously being consolidated by the pressure between the electrode wheels.

The top and end welding machine is, like that which has just been described, exceedingly ingenious. The upper wheel, as we have said, is kept continually revolving,

the lower wheel being free on its shaft. The latter, of course, revolves when work is being done. The lower carriage wheel is capable of vertical motion by means of a system of levers which produce a certain pressure on the work when it is gripped between the wheels. In order, however, to allow for irregularities in the thickness of the material passed between the wheels, as, for example, the overlap of the longitudinal joint, the carriage of the lower wheel is furnished with a strong coiled spring which allows of just sufficient "give" to prevent injury to the machine or undue pressure on the work. In this machine also the current is kept on during the whole period of welding. Cooling of the electrode wheels is effected in a manner very similar to that employed for the longitudinal seam machine. The electrode wheels in both machines are of pure copper. It has been found impracticable to employ an alloyed material, since the alloy is eventually volatilised leaving the copper in a spongy state. During use the contact surfaces of the wheels become coated with a more or less non-conducting surface, formed, possibly, by oxide from the steel plates. This is removed at intervals by light scraping. After continuous work for perhaps a fortnight, the wheels may get slightly out of shape. If this be the case they are removed from the machine and a very light cut taken from the peripheries in a lathe.

The reciprocating spot welding machines employed for affixing the bung socket and handle do not call for any extensive description. The reciprocating motion is mechanically operated, the upper electrode in the case of the former machine making strokes at the rate of about one per second, or even less, which appears to give ample time for the operator to revolve the drum through the requisite angle between each stroke. Each and all the machines work smoothly and well, and produce excellent results. Taken altogether the whole system turns out drums of first-rate quality in a wonderfully expeditious manner.

CHAPTER XIII

RESISTANCE WELDERS OF THE A 1 MANUFACTURING COMPANY

A FIRM which, though it has not been in existence for many years, has nevertheless developed some excellent welding machines of various types is the A 1 Manufacturing Company, of Industry Works, Sunbridge Road, Bradford. It confines its activities entirely to resistance welding and to the production of machines and accessories for welding on that principle. It contends, and with some show of right, that resistance welding and its possibilities have been to a large extent outshone and overlooked by reason of the extensive publicity which has recently been given to arc and acetylene welding. It points out that neither of the two latter processes lends itself to anything like the same extent to repetition work as does resistance welding, and further, that whereas both of them require a no inconsiderable degree of skill for the production of good sound welds, there are many directions in which quite unskilled labour can achieve excellent results with resistance welders without the necessity for any special training. The comment we would make concerning these contentions is that it was largely with the idea of correcting wrong impressions regarding electric welding as a whole that the publication of this series of articles was undertaken. Electric welding in various branches has been practised for a number of years now, but it must be admitted that the multifarious nature of its applications has not, until comparatively recently, been recognised by the large majority of our manufacturers. There is little doubt, however, that the future will see its adoption far more extended than it is even now, and it will be found that there will be ample scope for both the resistance and arc systems; for each will be discovered spheres in which it operates with best effect. This by the way.

Let us now turn to the firm's machines. We have before us a list which shows that it has evolved as standard patterns eight spot welders numbered 0 to 7, three seam welders, Nos. S3, S4 and S5; and eight butt welders, numbered B00 to B8. The rated continuous working capacities of the spot welders vary from $\frac{1}{16}$ in. added thickness in the smallest machine to $\frac{3}{4}$ in. added thickness in the largest machine, the material dealt with being mild steel and iron. For intermittent working the thicknesses may be increased to $\frac{3}{2}$ in. and $\frac{7}{8}$ in. respectively. "Added thickness," it need hardly be explained, is the total thickness of the pieces of metal that are to be welded together. The six smaller machines are also stated to be capable of welding brass and aluminium, the thicknesses dealt with varying from $\frac{1}{32}$ in. with machine No. 0 to $\frac{3}{16}$ in. with machine No. 5. The smallest seam welder is designed to take $\frac{3}{2}$ in. added thickness, and the largest $\frac{3}{16}$ in. with mild steel or iron, the thicknesses with brass being just half those figures. The diameter of material which the smallest butt welder—No. B00—is intended to take is $\frac{1}{16}$ in., while the largest machine—B8—is designed to operate with material up to $2\frac{1}{2}$ in. in diameter, or, say, 5 square inches in cross section—the figures given relating to ferrous metals. Copper and brass can be welded in the five smaller machines, the diameters varying from .02 to .0625 in the smallest machine to $\frac{3}{8}$ in. for copper and $\frac{1}{2}$ in. for brass in machine No. B5. In addition to the foregoing, there are four sizes of seam welding attachments and three butt welding

attachments which can be applied to different sizes of the firm's spot welders, so that the latter can be temporarily converted for the purposes named. The four seam welding attachments can deal with added thicknesses of $\frac{1}{16}$ in., $\frac{3}{32}$ in., $\frac{1}{8}$ in. and $\frac{3}{16}$ in. respectively, while the three butt welding attachments can take diameters of from $\frac{1}{8}$ in. up to $\frac{1}{2}$ in., $\frac{5}{8}$ in. and $\frac{3}{4}$ in. respectively, the sizes given referring to mild steel or iron in each case.

The foregoing are standard machines and appliances, but they do not by any means constitute the whole of the firm's output, for a not inconsiderable proportion of its business consists in the design and manufacture of machines specially worked out and constructed to meet the peculiar requirements of clients.

In principle, of course, the "A1" machines are identical with other resistance welders. They all work with alternating current, and each contains a static transformer, the primary winding of which has many turns, while the secondary, in general, consists of one or two turns only. It is in their details that these machines are differentiated from the products of other makers.

As typical of the company's spot welders, we give in Fig. 62 a view of what is known as the No. 2 spot welder. It is a machine which is specially intended for the production of hollow-ware and general light work with iron or mild steel up to $\frac{1}{8}$ in. added thickness for continuous working, and up to $\frac{3}{16}$ in. added thickness occasionally. As a maximum it requires 6 kilowatts of energy to operate it. The standard clearance of the stakes or arms—that is to say, the distance clear from the electrodes to the back of the arms, is 9 in., and the top arm is so designed that it can be extended to 16 in. in length as required. With arms of standard length the net weight of the

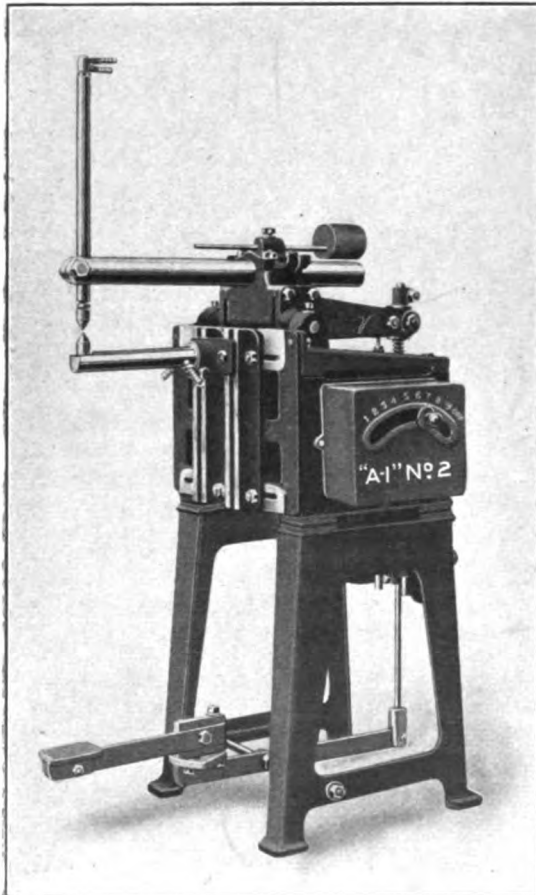

FIG. 62.—"A1" Spot Welder.

machine is 462 lb. Stakes of greater length, so as to give clearances of 18 in., 24 in., or 36 in., can, however, be fitted if required, and the weight with the longest stakes becomes 501 lb. The top arm or stake is hinged at the same level as the top of the lower electrode, with the object of ensuring a straight pressure on the weld and none of the current passes through the hinge, so that the latter does not become heated. The top and the bottom arms are both fitted into round sockets, so as to allow them to be twisted to the right or to the left, so that awkward positions of the weld may be reached, while the lower electrode can also be moved up and down in the slots formed in its carrier and the latter can, itself, be moved from side to side. In the standard machine the top arm is solid, and the electrode it carries is water-cooled, as is also the lower

electrode. The upper electrode, as will be observed in the engraving, is of considerable length, so as to allow of a long range of adjustment of the lower electrode arm. The upper electrode is pierced at its lower end with a hole drilled to a Morse taper so as to take the shank of a tip piece, which can hence be replaced when it is worn or deformed. The lower electrode tips are also renewable, but the tips are screwed in and not tapered. The renewable tips are conical in shape, and are made flat at the extreme tip. It will be noticed that the hinged upper electrode arm is fitted with an adjustable balance weight, so that different lengths of overhang of the arm can be allowed for. By it the force necessary to operate the machine may be reduced to a minimum.

It is said that on small articles of, say, 30 B.W.G. mild steel, that can be quickly handled, from 40 to 50 welds per minute can easily be made with this machine. The standard winding is for 50-period single-phase alternating current at 200 volts, but, of course, other windings can be supplied if required, though for them we understand that an additional charge is made. The slotted box seen at the side of the machine is a change-over switch by which nine separate tapings on the primary winding, which will give nine strengths of current, may be obtained in the secondary winding. The speed of working can therefore be varied over a wide range. No. 1 is the fastest and No. 9 the slowest, and there is an "off" position by means of which the winding is cut right out of circuit. In some of the firm's machines this switch is replaced by a series of plugs, there being a fast (F) plug and a slow (S) plug and four further plugs available for use with either the S or the F plugs, the combination giving eight working speeds. A thimble is provided on the pedestal into which can be sweated an earthing wire, so as to remove the possibility of the operator receiving a shock should the frame of the machine accidentally be made "live."

The machine is worked by pedal, which can be swivelled so as to be arranged in the position most comfortable for the operator, and this pedal actuates a vertical rod fitted at the rear of the machine. The top of the rod passes through a hole in the end of the upper electrode rocking arm.

The upper part of the rod is threaded through a spring, which, when the pedal is operated, is compressed and causes the upper electrode to be pressed down on to the work and eventually to consolidate the weld. The initial compression of the spring can

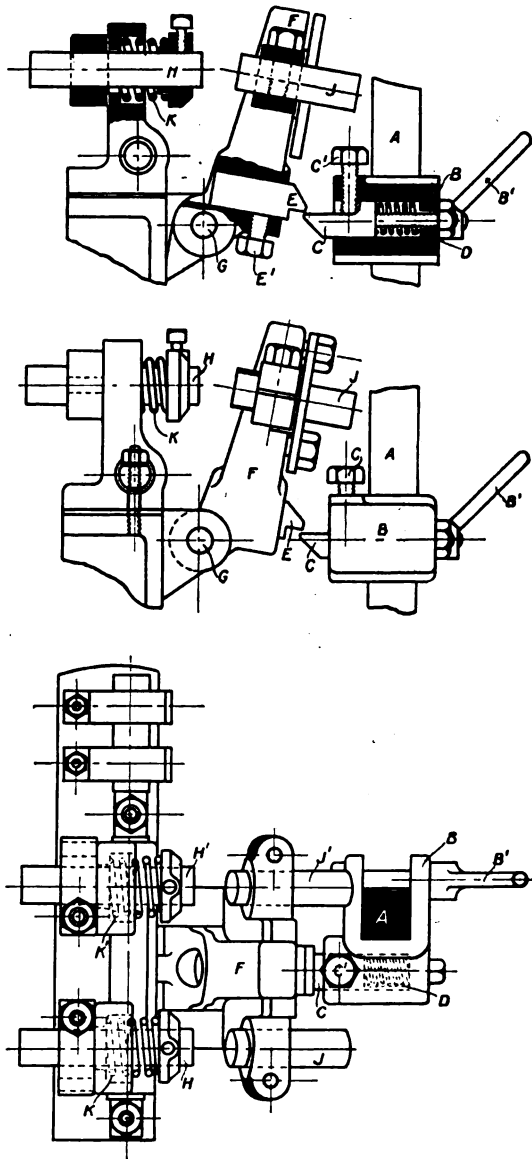

FIG. 63.—"A 1" Automatic Switch.

be regulated by means of a nut, so as to allow for the different pressures required when welding different thicknesses of metal. There is a further spring which acts as a buffer and takes up the shock when the pressure on the pedal is suddenly relieved.

To complete the equipment of the machine there is an automatic switch which is operated by the pedal-worked vertical rod, and which permits current to enter the primary winding when the work is lightly gripped between the electrodes and cuts it off as soon as welding heat is reached. In operation the work is lightly gripped between the electrodes by the depression of the pedal causing the actuating spring to be compressed. A further depression of the pedal—with a resulting additional compression of the spring—causes the switch closing the primary circuit to be operated, while a still further depression of the pedal trips and opens the switch and still further compresses the spring, with the result that the weld is firmly consolidated.

The makers claim for their spot welders, of which the foregoing may be considered a typical example, that they are practically fool-proof, and that they can be operated by a boy, girl or other un-killed labourer, and that about an hour's practice is all that is required to enable a person of average ability to make thoroughly satisfactory welds continuously on a large variety of repetition work.

The arrangement of the automatic trip switch is shown in Fig. 63. The vertical actuating bar is shown at A. Mounted to slide up and down on it is a tripper carrier B, which can be clamped in any desired position, so as to allow for different thicknesses of metal being welded and different travels of the electrodes by means of the small hand lever B¹. The trip plunger C slides in a hole on the carrier B, and is continually being pressed forward by the action of the spring D, but is prevented from being pushed out of the hole by reason of the set screw C¹. When the actuating bar A is pressed upwards by the depression of the pedal by the operator, it takes the carrier along with it and the trip plunger C engages with the catch piece E, which is clamped in a hole formed in the lower portion of the hinged switch arm F, which is pivoted at G. The catch piece E can be given any desired amount of projection, and is firmly clamped in position by means of the bolt E¹. The effect of continued depression of the pedal is that the switch arm, which is normally held in the open position by the action of gravity, is revolved about its pivot and the contact pieces J J¹ are brought into contact with the contact pieces H H¹ respectively, and the primary circuit of the transformer in the machine is closed. Current then, of course, flows through the secondary winding and through the metal being welded, since arrangements are made so that the switch is not closed until the work is firmly gripped between the electrodes. Still further depression of the pedal will cause the springs K and K¹, which encircle the contact rods H and H¹, to be compressed to such an extent that the trip plunger C becomes disengaged from and can slide past the catch piece E, with the result that the switch flies open and the circuit is broken. The period of time during which current is permitted to flow may be regulated by the various adjustments provided. The material of which the contact rods of the switch are made is a yellow metal termed by the makers "non-arcing metal." Its composition was not disclosed to us, but we understand that it has been found to be quite successful, no trouble of any kind having been experienced with it.

The other spot welders made vary in certain details from the machine described in the foregoing, but they all operate on the same fundamental principle.

A typical example of the firm's smaller sized butt welders—which represents the machine known as welder B3—is shown in the drawing Fig. 64. In it the two pieces of material to be welded are clamped in the gripping jaws A and B by means of the cam handles A¹ and B¹ respectively. The jaw B can be reciprocated horizontally by means of the hand return lever D, which is pivoted to a sliding carriage C. The initial position

of the lever D can be varied to permit of different distances apart of the jaws by changing the length of the link D¹, in which several holes are formed for the purpose. The pressure for upsetting the weld is provided by a spring, which is contained in the sliding carriage C. The initial compression of the spring can be adjusted by means of the small star wheel E, and the screw of the spring spindle can be locked by the star wheel F. It will be understood that the first motion to the left of the hand return lever D brings the two pieces of work into contact. Further motion of the lever puts more compression on the spring, and hence increases the pressure between the pieces being welded.

The electrical arrangements are somewhat different from those of the spot welding machine. There is, in the first place, provision for only five working speeds. Then there are two switches—a push switch and an automatic switch or circuit breaker. The normal position of the latter is with the circuit closed so that if the push switch is in, current begins to flow as soon as the two pieces being welded come into contact. The movement of the hand lever and of the sliding carriage C has the effect of bringing the tripping piece G into contact with the switch trip tool, and when a predetermined point has been reached the piece G forces open the switch and breaks the circuit, the arrangements being such that the switch is thereafter kept open while the lever is held to the left, since the tripping piece impinges on the flat under surface of the switch trip tool. When the upsetting of the weld is completed the spring push switch is released by removing the hand from it. The welded work can then be taken from the jaws, and the lever D moved to its starting position.

In ordinary working the amount of travel of the sliding carriage C is controlled by the adjustable slide stop E, which ensures that when there is no work in the machine the jaws themselves can never be brought into contact with one another. For use when it is considered necessary to anneal the welds—as, for

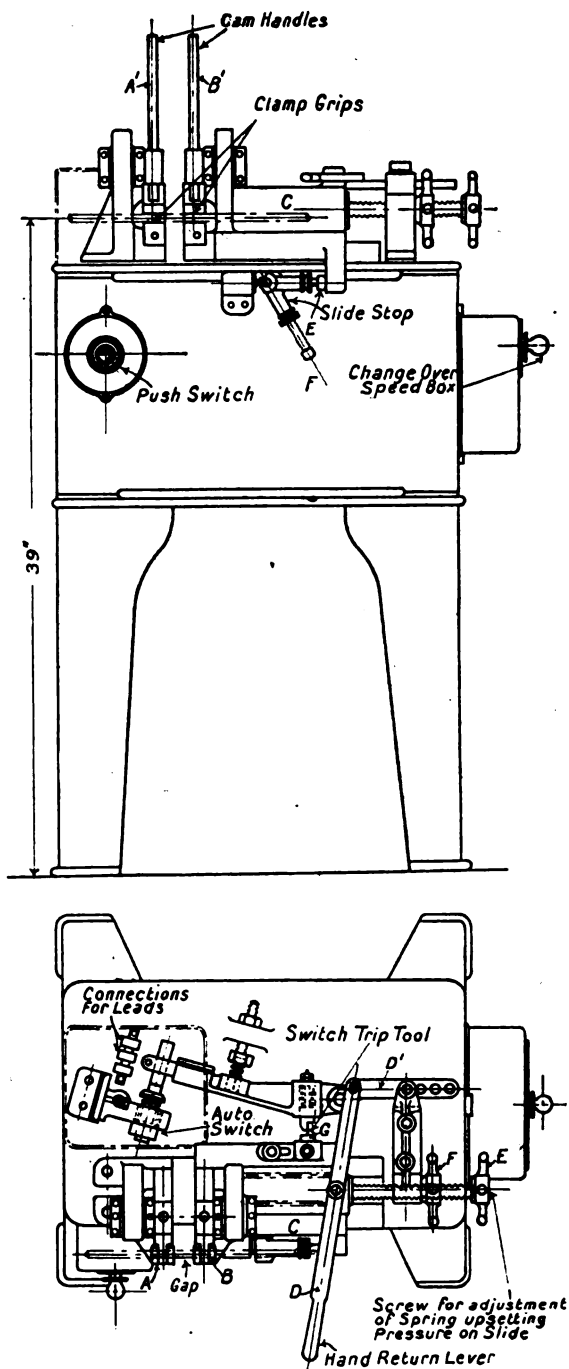

FIG. 64.—"A1" Butt Welder.

instance, when dealing with high-carbon steel—another adjustable slide stop F, which is embodied in the same casting as the slide stop E, is swung into the position occupied by the latter stop and held there by a catch. The stop F permits of there being a greater length between the jaws than is possible with the stop E, so that when the current is turned on a greater length of material is heated. When the

desired temperature is reached the work is removed from the jaws and allowed to cool slowly. We may say, with regard to the distance between the jaws when welding, that the company enunciates as a rough-and-ready guide that generally it may be taken that with round steel a projection from the jaws equal to double the diameter of the material will be found to be most satisfactory.

The butt and seam welding attachments, of which mention has been made above, are exceedingly ingenious. As far as we are aware, the A I Company is alone in the manufacture of these special attachments for application to its standard spot welding machines. It is, not unnaturally, rather proud of them, and it draws attention to their utility in cases in which there is not more work of all kinds than can be effected with one machine.

The butt welding attachment does not call for detailed description. For it, the ordinary stakes or arms of the machine are used. The attachment, as will be seen from Fig. 65, which shows it applied to a No. 4 spot welder, consists of two gripping jaws, one of which fits on and can be clamped to the top stake, the other being fitted on the lower stake. When in position the clamping jaws come vertically one above the other and the pieces to be welded are held in a vertical position. The machine is operated exactly as for spot welding.

The jaw pieces, which are of massive construction, are not themselves water-cooled, as it is found that the water-circulating system of the stakes is sufficient to keep the jaws sufficiently cool for intermittent working. The bulk of the metal in the two portions of the attachment is brass, but the actual jaws in which the work is gripped are made of a readily renewable piece of copper on that side through which the current flows and of steel on the side on which the clamping pressure is applied. The initial distance apart of the jaws can be varied from $\frac{1}{2}$ in. to 2 in. by means of the milled nut on the vertical spindle seen at the right-hand side of the top jaw.

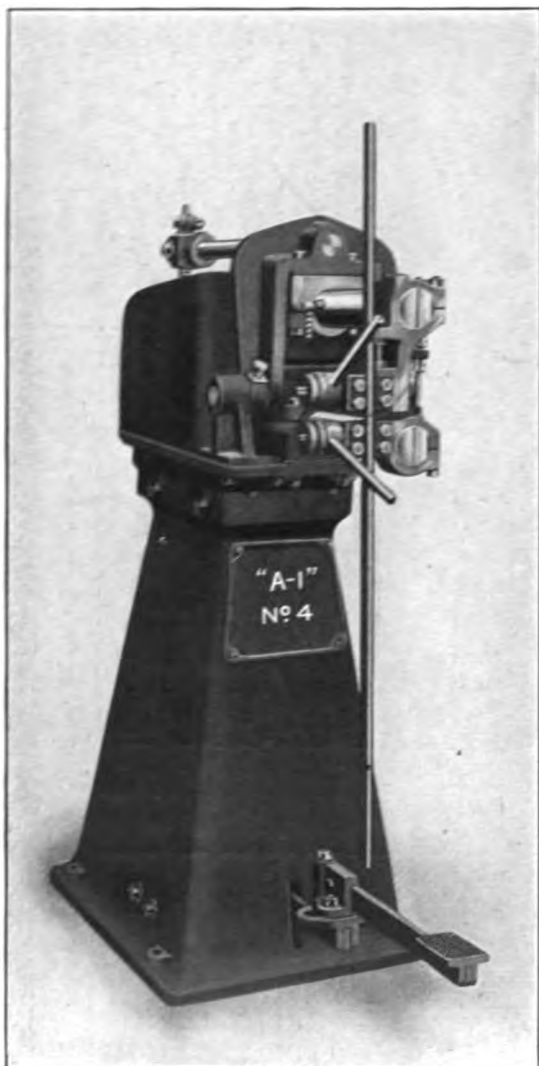

FIG. 65.—“A1” Butt Welding Attachment.

The seam welding attachment must be described at greater length. First of all, it may be said that it is made in various forms. There is, for instance, one in which the welding operation is performed longitudinally straight in towards the body of the machine, and in it the top roller only is revolved. We show an example of it in Fig. 66. In another form, which is for circular welding, the rollers are mounted at right angles to their carrying arms. In still another the lower arm is made right-angular for such work as the circular welding of the ends of tins. Finally, there is a form in which both

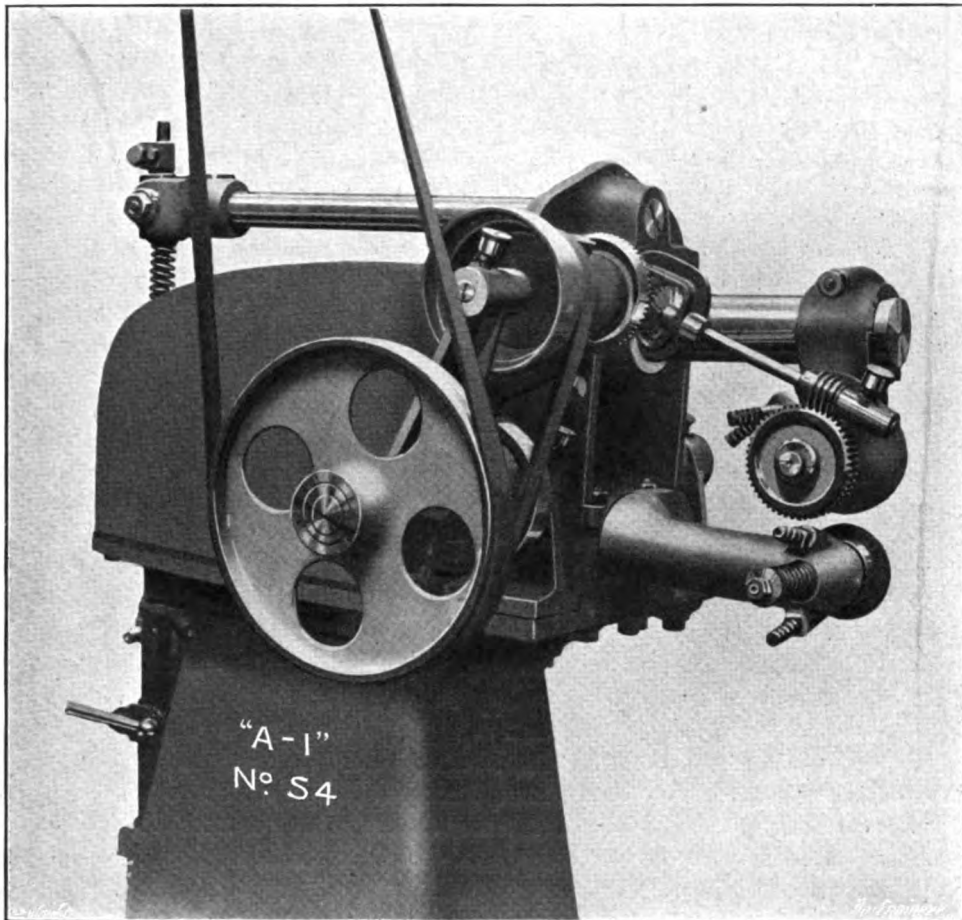

FIG. 66.—“A1” Seam Welding Attachment.

the bottom and top rollers are power driven. For thin work, such as $\frac{1}{16}$ in. added thickness, it is not necessary for the lower wheel to be power driven, but with heavier work power driving is advisable in order to prevent “plucking” of the metal while it is at welding heat.

We cannot spare the space to describe each particular form in detail, and we propose, therefore, to confine our remarks to the form illustrated in Fig. 66, which illustrates the seam welder attachment known as No. S 4A as applied to a No. 4 spot welder. The latter machine is slightly different in construction from the spot welder described above, which is that known as No. 2.

The general arrangement and working of the appliance may be readily understood

from the illustration. The bottom stake of the spot welder is removed and its place taken by an arm which carries the lower roller. The portion carrying the upper roller is slipped on to the upper stake, from which, of course, the electrode has been removed. When in the correct position the appliance is securely clamped on the stake by means of the nut seen at the top. Power is applied through a belt drive on to a shaft from which a short countershaft is also driven by belt. The countershaft, which has three speed cones, carries at its end a toothed bevel wheel, which meshes with a bevel wheel carried on a spindle at the other end of which is a worm meshing with a worm wheel on the short spindle, which, in its turn, meshes with a worm wheel on the short spindle carrying the upper wheel.

The upper roller is attached to a large block of copper, and is water cooled, there being a thin sheet of copper between the revolving roller and the water reservoir. The lower roller is also water cooled. In the illustration given the water nozzles are shown clearly. In another form of the attachment the nozzles are at the rear of the lower roller carrier arm, and the water is sprayed through a small jet into a small tank or trough in which the lower half of the roller dips.

In the form of attachment in which the lower roller is power driven the drive is obtained by means of a chain from the upper shaft to a point at the root of the lower arm, the chain then being taken along the inside of the lower arm to the roller.

It will not be necessary to illustrate or describe at any great length the firm's seam welding machines proper. They are, in principle, substantially similar to the seam welding attachments, and they are operated in very much the same manner as are the spot welders, saving that pressure is kept on the pedal during the welding of the whole length of seam, the current of course being allowed to flow during that period also, and not being cut off as in spot welding. In the smaller machines only the top roller is revolved by power, but in the larger sizes both rollers are power driven. There is also a pedal-worked clutch, by means of which the rollers may be started or stopped. With the rollers not revolving a quick depression and release of the arm-operating pedal will cause the formation of a "tack" weld, this being intended to do away with the necessity for a separate spot welder for "tacking." The welders are furnished with plug boxes having fast and slow plugs, as well as four additional plug holes, so that eight heating speeds are available. The top arm carrying the roller is, as in the spot welders, hinged at the welding level of the bottom roller, so that a straight pressure may be obtained on the weld, and no current flows through the hinge. The standard top arm is not water cooled, but the revolving roller is cooled as in the seam welding attachment. The standard bottom arm is cooled as in the alternative method referred to in connection with the seam welding attachment, the roller actually revolving in a small water trough. The standard machine has 9 in. arms, but arms up to a maximum of 36 in. can be fitted. The maximum capacity for which the machines are built is 10 kilowatts. The pressure applied to the work can be adjusted in the same manner as in the firm's spot welders.

In addition to making welding machines, the firm supplies various accessories, including rotary converters, generators, switchboards, switches, etc. In particular, it makes a rotary converter for transforming direct current at 460 volts to alternating current at 230 volts. This machine, which is of 16 kilovolt-ampère capacity and runs at 1500 revolutions per minute, is designed to operate three of the firm's No. 3 welders.

CHAPTER XIV

THE STRENGTH OF ELECTRIC WELDS

THE question of the strength of electric welds is, naturally, of first-class importance, and it has in consequence received a considerable amount of study. The matter is of great complexity by reason of the varying conditions under which the process is carried out, as well as of the different systems of welding which are available. We shall not attempt, therefore, to discuss it in all its bearings; indeed, there are not sufficient data in existence to enable such a course to be taken. Nevertheless, very valuable investigations have been carried out, both in this country and abroad, and we propose briefly to review some of them. We would preface our remarks, however, by repeating that, in our opinion, finality has by no means been reached, and that it would not surprise us if the figures, which will be found in what follows, were to be considerably modified when the whole subject has received the more extended research which it undoubtedly deserves.

As might have been anticipated by all who have had any experience of the methods of Lloyd's Register, which is always willing to give trial to novel methods, that institution, as soon as the application of welding to ship construction was mooted, decided to carry out an exhaustive series of tests with a view to ascertaining whether a set of rules, under which electric welding might be employed in shipbuilding, could be formulated. The original tests occupied a period of some six months, and they resulted in the issuing in August, 1918, of "Tentative Regulations for the Application of Electric Arc Welding to Ship Construction." The actual regulations do not concern us at the moment, but the general nature of the experiments performed and the conclusions which they led to may be profitably given. This we are enabled to do by the courtesy of the Secretary of the Society, who communicated to us the decision of the General Committee as soon as it was arrived at. We may say here that those who desire to follow the matter more closely than we are, by reason of space, enabled to do in the present instance, may do so by perusing a paper entitled "Experiments on the Application of Electric Welding to Large Structures," which was read before the Institution of Civil Engineers on March 11th last, by Mr. Westcott Stile Abell.

It appears that the general scope of the experiments included: (a) Determination of modulus of elasticity and approximate elastic limit; (b) determination of ultimate strength and ultimate elongation; (c) application of alternating stresses with (1) rotating specimens, (2) stationary test pieces; (d) minor tests, such as (1) cold bending of welds, (2) impact tests of welded specimens; (e) chemical and microscopic analysis.

The tests were carried out on specimens which were as large as possible, particularly in connection with the static determinations of elasticity, ultimate strength and elongation, some of the test specimens being designed for a total load of just under 300 tons. The advantage of these large specimens was that the effect of workmanship was better averaged and the results were more comparable with the actual work likely to be met with in ship construction. For alternating stresses the specimens were relatively of small size. For the rotating test pieces, circular rods, mainly

machined from a welded plate, were used, the diameters selected being 1 in. and $\frac{3}{4}$ in. These bars, about 3 ft. in length, were attached to a lathe headstock, and a pure bending movement in one plane was applied by means of two ball races to which known weights were attached. The material of the bar was thus exposed alternately to maximum tension and to equal maximum compression once in each revolution. The machine was run at about 1060 revolutions per minute. Bars of identical material were tried in pairs, one specimen welded and the other unwelded, and the number of revolutions before the specimens parted was observed for various ranges of stresses varying from ± 15 tons to ± 6 tons.

In the second series of alternating stress experiments flat plates of three thicknesses, viz. $\frac{1}{4}$ in., $\frac{3}{8}$ in. and $\frac{1}{2}$ in., were used. These specimens were tried in groups of four, each group consisting of one plain, one butt welded, one lap welded and one lap riveted plate. The specimens, which were about 14 in. long by 5 in. broad, were clamped along the short edges, so that the distance between the fixed lines was 12 in. Each plate was also clamped, near the middle, to the end of a pillar, which by means of a crank arm was caused to oscillate and to bend the specimen equally up and down by adjustable amounts, the maximum total movement in any of the experiments tried being $\frac{5}{16}$ in. The machine was run at various revolutions—not exceeding 90 per minute—and the number of repetitions at which the specimen parted was observed.

Minor tests of various kinds were undertaken, of which the principal had reference to the suitability of the welded material to withstand such bending and shock stresses as might occur in the shipbuilding yards. The experiments on bending consisted of doubling the welded plate over a circular block of diameter equal to three times the plate thickness, and comparing the results with those of the plate of the same material but unwelded.

In the impact tests heavy weights were dropped from various heights on to the welded portion of a plate 5 ft. in length and 2 ft. 6 in. in breadth, the weld being across the plate parallel to the shorter edge. The deflections were noted and the condition of the weld was examined after each blow. The chemical and micrographical examination followed the ordinary practice.

The results arrived at are summarised in the following :—

(1) *Modulus of Elasticity and Approximate Elastic Limit.*—(a) In a welded plate the extensions in the region of the weld are sensibly the same as for more distant portions of the unwelded plate. (b) With small welded specimens containing an appreciable proportion of welded material in the cross-sectional area, the relation between extension and stress is practically the same, up to the elastic limit, as for similar unwelded material. (c) The elastic limit, or the limiting stress beyond which extension is not approximately directly proportional to stress, appears to be slightly higher in welded than in unwelded material. (d) The modulus of elasticity of a small test piece, entirely composed of material of the weld, was about 11,700 tons per square inch, as compared with about 13,500 tons for mild steel and about 12,500 tons for wrought iron.

(2) *Ultimate Strength and Ultimate Elongation.*—(a) The ultimate strength of welded material with small specimens was over 100 per cent. of the strength of the unwelded steel plate for thicknesses of $\frac{1}{2}$ in., and averaged 90 per cent. for plates of $\frac{3}{4}$ in. and 1 in. in thickness. (b) Up to the point of fracture the extensions of the welded specimens are not sensibly different from those of similar unwelded material. (c) At stresses greater than the elastic limit, the welded material is less ductile than mild steel, and the ultimate elongation of a welded specimen when measured on a length of

8 in. only averages about 10 per cent., as compared with 25 to 30 per cent. for mild steel.

(3) *Alternating Stresses.*—(a) Rotating specimens (round bar): (1) Unwelded turned bars will withstand a very large number of repetitions of stress, exceeding, say, 5 millions, when the range of stress is not greater than from $10\frac{1}{2}$ tons per square inch tension to $10\frac{1}{2}$ tons per square inch compression; (2) welded bars similarly tested will fail at about the same number of reversals when the range of stress exceeds $\pm 6\frac{1}{2}$ tons per square inch. (b) Stationary test pieces (flat plate): (1) Butt welded specimens will withstand about 70 per cent. of the number of repetitions which can be borne by an unwelded plate; (2) lap-welded plates can endure over 60 per cent. of the number of alternations necessary to fracture a lap-riveted specimen.

(4) *Minor Tests.*—(a) Welded specimens are not capable of being bent, without fracture, over the prescribed radius to more than about 80 deg. with $\frac{1}{4}$ in. plate, reducing to some 20 deg. where the thickness is 1 in. Unwelded material under the same conditions can be bent through 180 deg. (b) Welded plates can withstand impact with a considerable degree of success; a $\frac{1}{2}$ in. plate, 5 ft. in length by 2 ft. 6 in. in width, sustained two successive blows of 4 cwt. dropped through 12 ft., giving a deflection of 12 in. on a length of about 4 ft. 6 in. without any signs of fracture in the weld.

(5) *Chemical and Microscopic Analysis.*—(a) Chemical analysis: (1) The electrode was practically identical with mild steel, but there was a greater percentage of silicon; (2) the material of the weld after deposition was ascertained to be practically pure iron, the various other contents being carbon .03, silicon .02, phosphorus .02 and manganese .04 per cent. respectively. (b) Microscopic examination: (1) The material of the weld is practically pure iron; (2) the local effect of heat does not appear largely to affect the surrounding material, the structure not being much disturbed at about $\frac{1}{16}$ in. from the edge of the weld (the amount of disturbance is still less in thin plates); (3) the weld bears little evidence, if any, of the occurrence of oxidation; (4) with welds made as for these experiments, i.e. with flat horizontal welding, a sound junction is obtained between the plate and the welding material.

(6) *Strength of Welds (Large Specimens).*—(a) Butt welds have a tensile strength varying from 90 to 95 per cent. of the tensile strength of the unwelded plate. (b) Lap welds: (1) With full fillets on both edges the ultimate strength in tension varies from 70 to 80 per cent. of that of the unwelded material; (2) with a full fillet on one edge and a single run of weld on the other edge the results are very little inferior to those where a full fillet is provided for both edges. (c) Riveted lap joints: For plates of about $\frac{1}{2}$ in. in thickness, the specimens averaged about 65 to 70 per cent. of the strength of the unperforated plate.

There are two points in connection with the foregoing which call for mention. The first is that the experiments only referred to work effected by arc welding, and the second that only one particular form of coated electrode was employed. In this connection it may be mentioned that the "Tentative Regulations" provide that (a) the process of manufacture of the electrodes must be such as to ensure reliability and uniformity of the finished article; (b) specimens of the finished electrodes, with specifications of their nature, must be supplied to the Committee; (c) that the Committee's officers shall have access to the works where the electrodes are made, so as to ensure that the electrodes produced are identical with approved specimens; and (d) that no alteration in the method of manufacture may be adopted without the consent of the Committee. It is quite obvious, therefore, that the Committee attaches great importance to the question of electrodes.

Early in last year Captain (now Major) James Caldwell, R.E., Deputy Assistant

Director of Materials and Priority at the British Admiralty, was, at the request of the United States Shipping Board, lent to the Emergency Fleet Corporation. At the conclusion of three months' service Captain Caldwell issued a voluminous report on "Electric Welding and its Applications in United States of America to Ship Construction." Included in the report is a lengthy table setting out the results of an extensive series of tests carried out under the direction of Mr. W. T. Bonner, of the Chester Shipbuilding Company. In order to be fully appreciated, the whole of the information given in the table should be taken into consideration, but, as space will not permit of us to reproduce the table *in extenso*—it would take a page and a half of the *Engineer*, and even then be reproduced to a small scale—we must content ourselves by giving the following summary. The starting-point is an ordinary single-riveted lap joint effected in accordance with Lloyd's regulations, one seam being caulked. The thickness of the plates employed varied from .234 to .30 square inch, the width from 9 in. to $9\frac{1}{6}$ in., and the area involved from 2.106 square inches to 2.719 square inches. The mean of a series of tests made on joints of this type and size showed that the riveted plate had a tensile strength of about $52\frac{1}{2}$ per cent. of the strength of an unperforated plate of like size and form. For simplicity's sake we will call this joint A. A double-riveted joint, singly caulked, of approximately the same dimensions was found to give a mean of $76\frac{3}{10}$ per cent. of the strength of an unperforated plate. A joint similar to A, but with one seam welded instead of caulked, gave as a mean a strength of $71\frac{3}{10}$ per cent of the unperforated plate. With a similar joint, but with a full fillet weld, the percentage rose to $75\frac{6}{10}$. A lap joint of very similar dimensions to A, but with a fillet weld at both plate edges and no rivets, gave as a mean of several tests a strength of 94 per cent. of unperforated plate of equal dimensions. A butt-welded joint furnished with a strap fillet-welded at both edges, but no rivets and having dimensions comparable with those of joint A, gave as the result of several tests a mean strength of $95\frac{4}{10}$ per cent. of that of unperforated plate. The foregoing tests were apparently made with the joints just as they were left by the welder, for later in the table are given side by side examples of butt joints before and after being machined. The joint before machining gave in the two cases recorded a strength equal to 100 per cent. of that of unperforated plate, while the two cases of machined joints showed strengths of $70\frac{4}{10}$ and $77\frac{4}{10}$ per cent. respectively.

In the case of all the foregoing arc welding was employed, but there is no indication as to what type of electrode was used. There is only one set of tests in which the specimens were spot welded. The joint was of the lap type, had a length of 10 in. and an area of 3.08 in., the thickness of the plate being 0.308 in. The strength of the joint was found to be only 5 per cent. or under of the unperforated plate, and the remark is made the efficiency was "too low for serious consideration." This is interesting in the light of the results which we shall now refer to.

In the April, 1919, number of the *Proceedings* of the American Institute of Electrical Engineers there is printed a paper on "Welding Mild Steel," which was read by Mr. H. M. Hobart at a joint session of the Institute with the American Institute of Mining Engineers held at New York on February 20th, 1919. The paper deals principally with the investigations undertaken by the Welding Research Sub-committee of the Welding Committee of the Emergency Fleet Corporation, and it forms a valuable contribution to the literature on the subject. With the bulk of it we are not at the moment concerned, but there is one portion of it which deals with the strengths of various types of joints that bears directly on the matter which we have under consideration. Mr. Hobart points out that a great deal of progress is being made in America in the use of spot welding as a means of joining thick plates. It is believed,

he remarks, that spot welding has a great future as applied to shipbuilding, and several large welders have been built for shipyards.* "In some of its applications," he continues, "spot welding affords a method of preliminarily jointing the hull plates, after which the additional strength is provided by arc welding. The Welding Research Sub-committee has already made some progress in comparing combined spot and arc welds and combined rivet and arc welds with riveted, spot-welded, and arc-welded joints. It is not a question, in such an investigation, of spot *versus* arc welding, but of spot *and* arc welding."

In the tests alluded to the specimens were made up of the following combination :—

(1) Spot and welded fillet, as in A in the accompanying diagram, Fig. 67.

(2) Fillet welded, made by welding fillets about 2 in. in length at the ends of the plates, as in B.

(3) Riveted and fillet welded, as in C.

(4) Spot welded, made by welding two spots approximately 1 in. in diameter on the plates, as in D.

(5) Riveted joint made by riveting a ½ in. by 4 in. by 12 in. plate with two plates ½ in. by 4 in. by 16 in., using two ¾ in. rivets and a 4 in. lap.

The ultimate loads borne by these joints were as follows :—

- (1) Spot and fillet welded, 50,350 lb.
- (2) Fillet welded, 37,000 lb.
- (3) Riveted and fillet welded, 35,000 lb.
- (4) Spot welded, 28,000 lb.
- (5) Riveted joint, 13,000 lb.

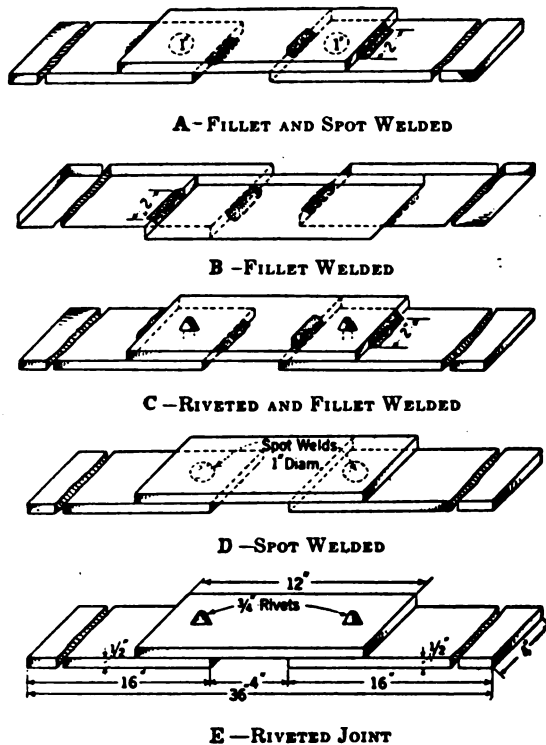

FIG. 67.—Welded and Riveted Joints.

It is not quite clear why No. 3 should be less than No. 2, but possibly were a larger number of test pieces to be made than was actually the case the figures might show some modification. A noticeable feature is the strength of the spot-welded as compared with the riveted joint. It would seem likely that in the tests made under the supervision of Mr. Bonner, and quoted above, the strength of the spot welding machine used was not great enough to deal adequately with plates of the thickness which he was employing.

The foregoing embodies some of the latest published data regarding the strength of various types of electric welds. In it, however, it has been possible to do no more than touch upon the fringe of what is really a very wide subject. It has to be realised that in electric welding, and especially in arc welding, the personal element counts for a great deal. It is, unfortunately, by no means easy to ascertain by inspection after it has been made whether a weld is good or not. An efficient and experienced

* There is little doubt that Mr. Hobart was referring to the machines described in Chapter XI.

arc welder will be able to tell as he is making the joint whether the joint is good or bad. The inexperienced welder may not be able to do so, and he may yet produce work which to outward seeming is good. As we pointed out in an earlier chapter, however, there is no guarantee that a welded joint made by a smith in the ordinary way is sound throughout. A good smith will make it so, while an inefficient smith may leave impurities between the surfaces he is trying to weld. In fact, it may be said that after taking everything into consideration the evidence available seems to indicate that in the various forms of electric welding the present-day engineer has at his command methods of joining metals together which, if properly applied, are in most cases at least as efficient as, and in some instances more efficient, than any which have gone before. In saying this we do not wish to be taken as minimising the value of acetylene welding. On the contrary, we are satisfied that, in some directions, the acetylene torch is the most efficient tool which can be employed. We are convinced, however, that a good deal of weeding out is required and that a not inconsiderable amount of improvement of existing methods will have to be effected before the full benefits derivable from electric welding can be experienced. Such weeding out is bound to be done, however, and such improvements are certain to be brought about, so that the engineer of the future will most certainly possess more perfect methods than those which exist at the present day, excellent as, in most ways, they are.

CHAPTER XV

A LARGE BRITISH SPOT-WELDING MACHINE

IN that chapter of the series on "Electric Welding and Welding Appliances" in which we dealt with the machines and processes of Pontelec Welding Patents, Limited,* we made mention of having seen the drawings of a large spot-welding machine which was, at the time the chapter was written, under construction. The machine has now been completed, and it is believed by its makers to be the largest spot welder of its type which has up to now been constructed for commercial purposes in this country.

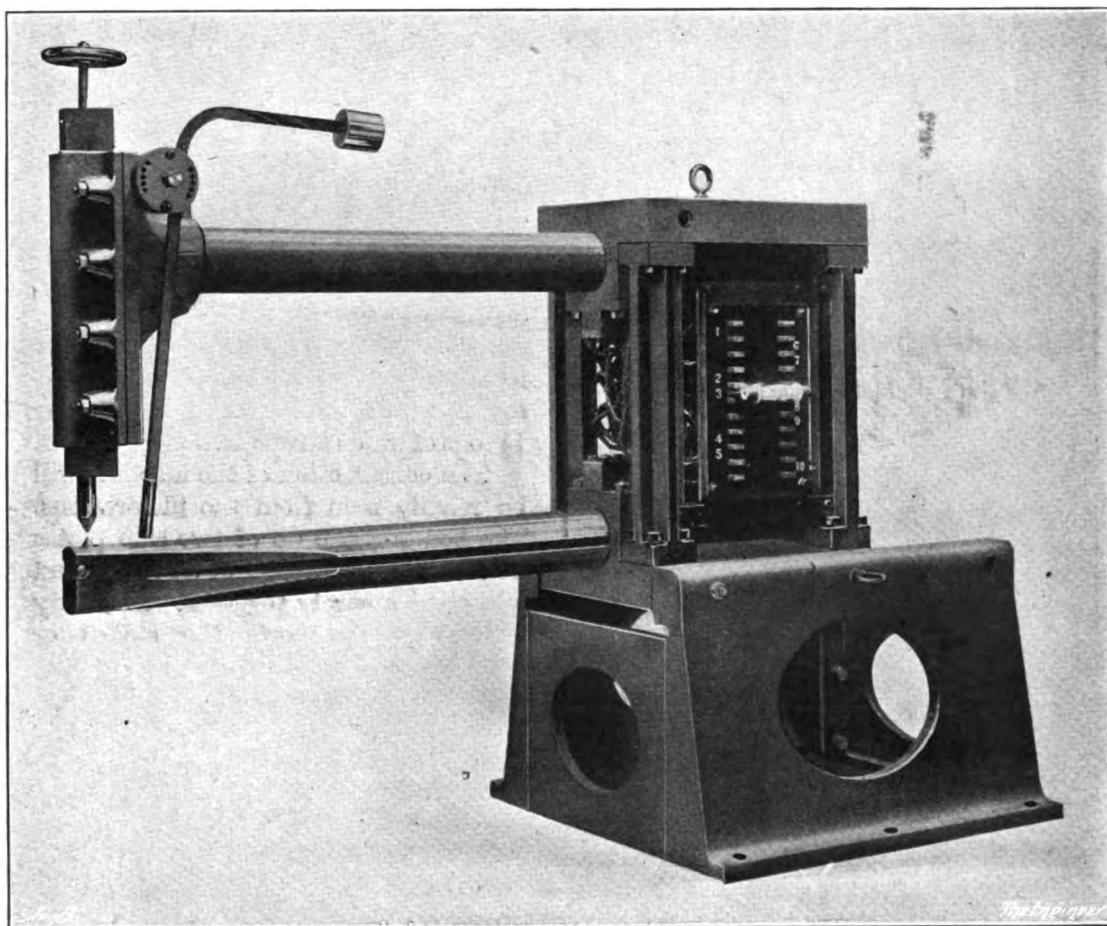

FIG. 68.—Pontelec Spot Welder, with Stakes arranged horizontally.

The particular work which it was designed to perform is the spot welding of tubes in 5 ft. lengths made of $\frac{1}{4}$ in. steel plates, and having an internal diameter as small as 8 in. Naturally, however, larger diameters can be dealt with. In the two views of the machine which are given in Figs. 68 and 69 it will be observed that the design is such that the

* See Chapter V.

stakes or arms can either be used in a vertical or a horizontal position. The body of the machine is hinged to the bed by bolts, one of which, with its nut, can be seen at the left top corner of the side frame in both illustrations. When the stakes are horizontal the body is held in position by means of two eye-holed pins, which pass through holes in the side frames and enter similar holes formed, one on one side and the other on the other of the framework of the body of the machine. When it is desired to have the arms vertical, the weight of the body of the machine is taken by means of a crane, the hook of which is passed through the eye-bolt seen at the top. The supporting pins can then be withdrawn, and the body of the machine is allowed to hinge down so that it enters the

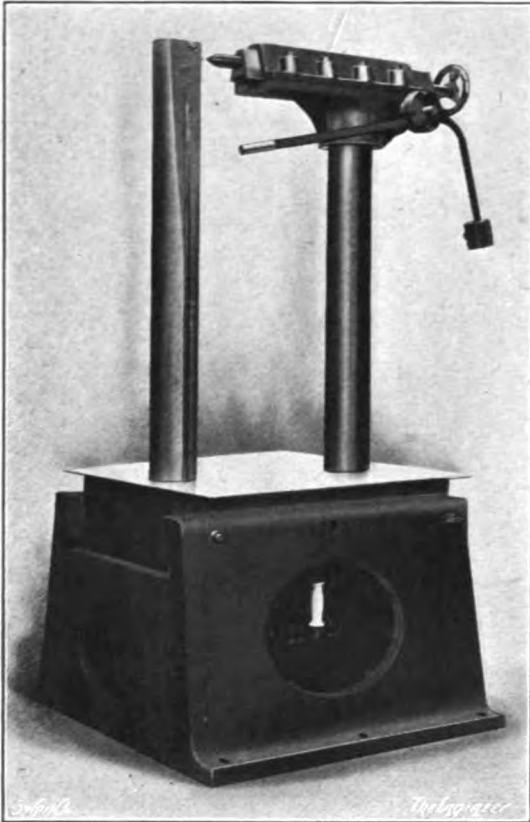

FIG. 69.

The Welder, with Stakes arranged vertically.

space between the side frames of the base. When the stakes are vertical, holes in the body of the machine—one of which is seen at the top, just to the left of and below the eye-bolt in Fig. 68—register with holes in the side frames—one of which is seen at the right top corner of the side frame in Fig. 68—and the pins, which were removed just before lowering commenced, can be inserted. When in either the horizontal or vertical positions the weight of the body is taken on four pins, one at each corner. The pins are 2 in. in diameter, and hence of ample strength to support the heavy weight of the body. The total weight of the machine is, we may say here, in excess of $4\frac{1}{2}$ tons, some $1\frac{1}{2}$ tons of which is represented by copper.

The construction of the machine will be readily seen from the illustrations. The bed is made up of two side plates and two end plates, all of cast iron, and all bolted securely together. The body part, which supports the stakes or electrode arms and contains the transformer, is composed of cast iron end pieces separated by and bolted to cast iron pillars, which are star-shaped in cross section. The transformer core is

built between and is supported by these pillars. The end pieces have each cast in the centres of their ends semicircular channels, which are more or less in the form of plummer blocks, and which are machined to a radius of $3\frac{3}{8}$ in. so as to receive the stakes. The latter, which are $6\frac{3}{8}$ in. in diameter, are secured in position by means of caps bolted on in the same manner as are the caps of bearings. The caps at the front side of the machine—that is, the side from which the stakes project—are of copper, and to them are connected the terminals of the secondary winding of the transformer. The caps at the back side are of cast iron, since they are not required to carry any current. The primary of the transformer is furnished with ten tappings, so that a wide range of welding speeds is obtainable.

As it was necessary for the machine to have such a wide reach as 5 ft., special

consideration had to be given to the construction of the stakes. It was realised from the outset that pure copper alone would not give the requisite stiffness, but would have excessive "spring." On consideration, it was decided to use cores of manganese steel with electrolytic copper, containing a small amount of silicon, cast on them. For the cores Hadfield's Hecla manganese steel bull-headed railway rails, weighing 95 lb. per yard and rolled in accordance with the British Standard Specification, were employed. As showing the degree of stiffening imparted to the arms by the rail reinforcement we may say that we understand that with a load of from 10 cwt. to 15 cwt. at 5 ft. extension the "spring" does not exceed $\frac{1}{4}$ in. The arrangement of both top and bottom arms is shown in Fig. 70. Both arms are of the same diameter, and both are machined so that they can be slid backwards and forwards in their bearings when the caps of the latter are slacked off. The top arm has an extreme length of 7 ft. 3 in., and is parallel from end to end. The rail reinforcement is taken to within 3 in. of the extreme forward end, and it projects 1 in. at the rear end. The lower arm has an overall length of 7 ft. 9 $\frac{1}{2}$ in. Its sides are parallel for a length 5 ft. 1 in. from the rear end, and in the remaining 2 ft. 8 $\frac{1}{2}$ in. the sides of forward portion are machined off taperwise until, as

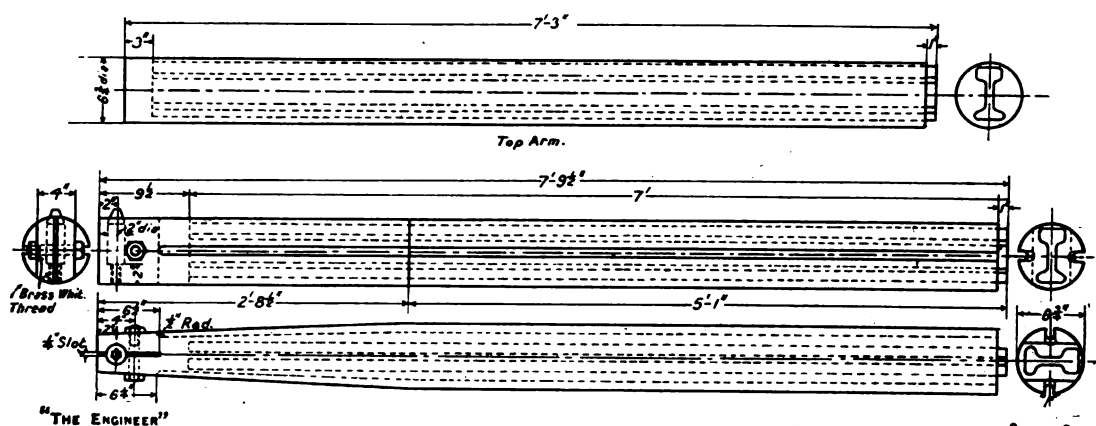
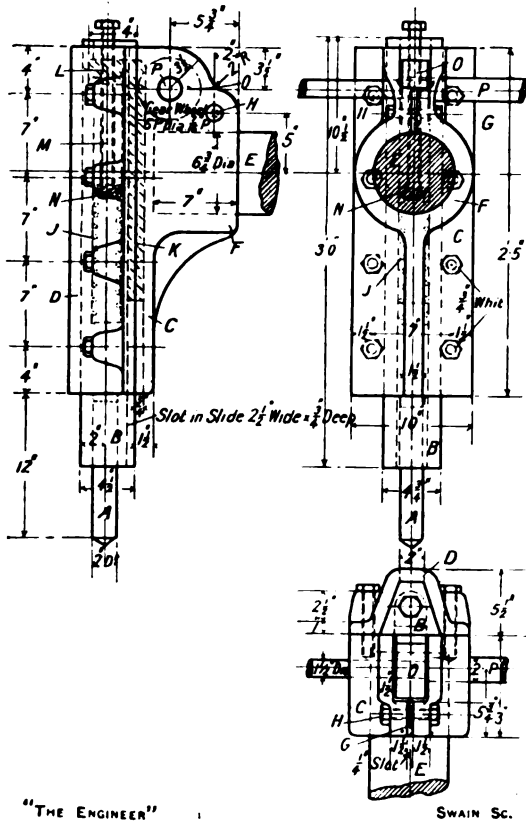

FIG. 70.—Upper and Lower Stakes or Arms.

may be seen in the drawing, the distance between them is only 4 in. Two inches from the extreme front end a vertical hole 2 in. in diameter is drilled for a depth of 4 $\frac{1}{2}$ in. for the reception of renewable electrodes, the projection of which above the top of the arm can be adjusted by means of a set screw 1 in. in diameter, for which a tapped hole is formed concentrically with and at the bottom of the hole containing the electrode. A $\frac{1}{2}$ in. slot is cut vertically in the end of the arm for a depth of 6 $\frac{1}{2}$ in., and a horizontal hole is drilled in the arm at a distance of 4 in. from its end, so that by means of a bolt and nut the electrode may be firmly gripped. The rail reinforcement is only taken to a point 9 $\frac{1}{2}$ in. of the front end, the remainder of the arm being copper. There is a projection of 1 in. of the rail at the rear end, as in the upper arm. The lower arm has two grooves 1 in. wide and 1 in. deep, with their bottoms curved to $\frac{1}{2}$ in. radius, formed one on each side of the horizontal diameter. These grooves are intended for the accommodation of pipes for carrying water for cooling purposes should they be found necessary. We gather, however, that, so far, artificial cooling has not had to be resorted to, the large mass of copper in the arms having proved ample for the conduction away of the heat during working. It should be mentioned, though, that up to the present the machine has not been worked to its full capacity. The maximum energy at the disposal of the Pontelec Company for testing purposes is only 50 kilovolt-amperes. With

that amount of energy we understand that the machine has satisfactorily welded $\frac{1}{4}$ in. plates—or an added thickness of $\frac{1}{2}$ in.—with the arms fully extended. It is thought probable, however, that when sufficient power is available the machine will readily weld two $\frac{1}{2}$ in. plates—or an added thickness of 1 in. The current regulation is such that, at the other end of the scale, sheets as thin as No. 22 gauge can be dealt with.

The makers point out that it is not, of course, necessary that the electrode-carrying arms should be circular in section. In the present case the form was practically settled by the fact that the tubes, which the machine was specially designed to weld, were only 8 in. in diameter, and because it was desired to have the gap adjustable in height.



"THE ENGINEER"

SWAIN SC.

FIG. 71.—Arrangement of Electrode Slide.

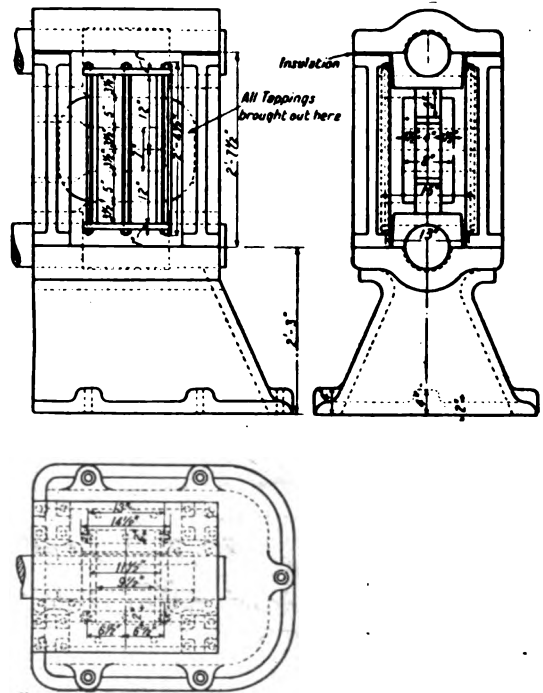

"THE ENGINEER"

SWAIN SC.

FIG. 72.—Arrangement of Transformer.

It will be understood, of course, that by slacking away the caps holding the arms in position the length of projection of the latter can be altered at will. We gather that the minimum projection gives a free-reach of only about 9 in.

The upper electrode arm remains, as may be gathered from the illustrations, rigid, and is not moved up and down, as in some forms of spot welders. It is the electrode which is reciprocated, and the means by which the reciprocation is effected is clearly shown in Fig. 71. It will be observed that the electrode A, which is 2 in. in diameter, is inserted in a hole drilled in the extremity of a solid copper sliding piece B. The latter, which has, in cross section, the form of a truncated cone, fits into and can be moved up and down or backwards and forwards, as the case may be, in a slide of exactly similar shape as itself, which is formed by a body C and a cap D, the latter being securely attached to the former by means of screwed bolts. The sliding piece,

body, and cap are of copper, the studs of brass, and the nuts only of iron. The extremity of the upper electrode arm E fits into a boss F formed on the body C, and, since there is a slot G cut in the periphery of the latter, the electrode arm can be gripped tightly by means of the bolt and nut H.

Housed in a channel formed in the sliding piece C is a spring J, and arranged in a channel $2\frac{1}{2}$ in. wide and $\frac{3}{4}$ in. deep cut in the sliding piece is a toothed rack K, which is furnished at its upper end with a right-angled extension L. The latter is bored and tapped to receive the screw M, at the end of which is an enlarged portion N, which impinges on the top of the spring J. By means of this arrangement any desired initial compression may be put upon the spring. Meshing with the toothed rack is a toothed pinion O, which is keyed to the shaft P. The shaft can be rotated by means of the lever seen in Figs. 68 and 69, the balanced weight on which is so arranged that the tendency is always to draw the upper electrode away from the lower. It will be understood that the effect of moving the lever is to push the electrode down on to the work, further depression giving greater compression to the spring, and hence greater pressure on the work. The makers point out that, of course, any other mechanical means of exerting the pressure necessary for welding, as well as compressed air or hydraulic pressure, can be applied to take the place of the mechanism illustrated.

The winding of the transformer is for 50-period alternating current at 160 volts, though, naturally, any other winding to suit different conditions can be applied. The primary circuit is closed and opened by means of a foot-operated switch. In Fig. 72 we show the outline of the arrangement of the transformer for a machine of similar size to that described in the foregoing, but with a permanent base for horizontal work only. The electrical connections are, however, identical in both cases.

CHAPTER XVI

THE PLASTIC-ARC WELDING SYSTEM

THE Plastic-arc welding system is the name given to the process of electric arc welding which is controlled by the Wilson Welder and Metals Company, of 2 Rector Street, New York City. It was by means of it that the German steamships which were interned in harbours in America, and which had been wilfully and seriously damaged by their crews, were repaired. Before describing the system itself, it will perhaps be of interest to our readers if we briefly refer to the manner in which the vessels were damaged and to the steps taken to repair the breakages.

On the declaration of war the United States authorities took over all the enemy ships which had been interned in various ports in the country. There were 103 vessels in all. In the port of New York alone there were interned 31 steamships, of which 27 were German and 4 were Austrian. Of the 27 German vessels 2 were sailing ships and 4 were small steamers. The latter had evidently been considered by the Germans to be of comparatively small importance, for the destruction wrought in them was but slight; but the remaining 21 vessels, which ranged in size from the 56,000 tons or so of the *Vaterland* to the 3900 tons of the *Nassovia*, had been so seriously damaged that, when taken over by America, they were entirely valueless for transport purposes. The Germans, with the thoroughness which characterises them even when engaged in work of destruction, had so mishandled the machinery that in no case was there an engine which could turn round. A survey showed that of the 20 vessels in New York Harbour which were fitted with reciprocating engines—the *Vaterland* is turbine-driven—there were 118 fractures of an important character, which would, had ordinary repair procedure been followed, have necessitated the replacement of seventy steam cylinders. As a matter of fact, it was at first proposed to proceed with such replacement, but when the question had been further investigated it was realised that the length of time required to carry out the repairs in that manner would be prohibitive if the ships were to be used for the transport of troops across the Atlantic so as to be of any real service in the war. The principal damage done, according to a report made by the Secretary of the Navy, was the breaking of cast iron parts of the main engines—chiefly the cylinders—though in one case piston-rods, connecting-rods, and boiler stays were sawn half-way through, and in others the boilers were ruined by dry firing. There was, in addition, much vandalism of a minor character, but the task of remedying it was insignificant in comparison with the gigantic business of repairing the cylinders, some of which were more than 9 ft. in diameter. The methods of destruction adopted were various. Apparently some sort of a battering-ram had been extensively employed, and if that apparatus were not by itself capable of doing what was required of it numerous holes were drilled, in some cases a complete line of holes being made round the part at which the battering-ram was being applied. The different kinds of damage were, however, too numerous to be described in detail in the present instance. We can only refer to the engravings Figs. 73 to 76 inclusive, which are reproductions of certain photographs of different pieces of machinery in various vessels taken before the work of repair was commenced.

MACHINERY IN GERMAN LINERS, SHOWING DAMAGE
DONE BY CREWS

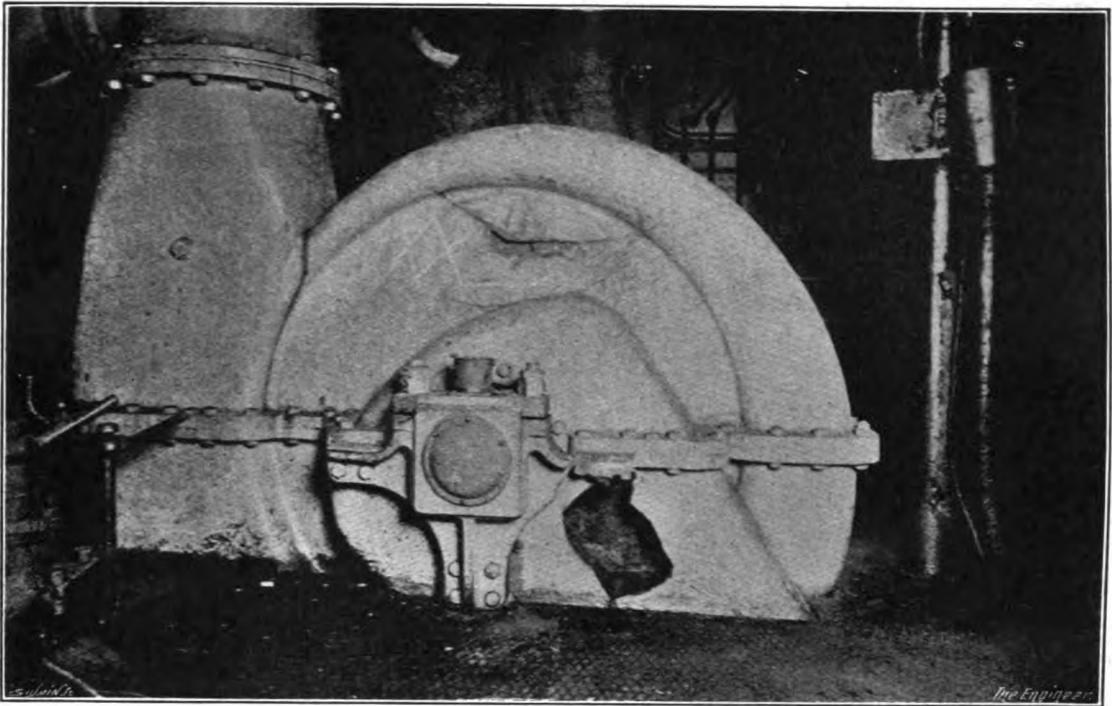

FIG. 73.—S.S. *George Washington*—Fractured Circulating-Pump Casing.

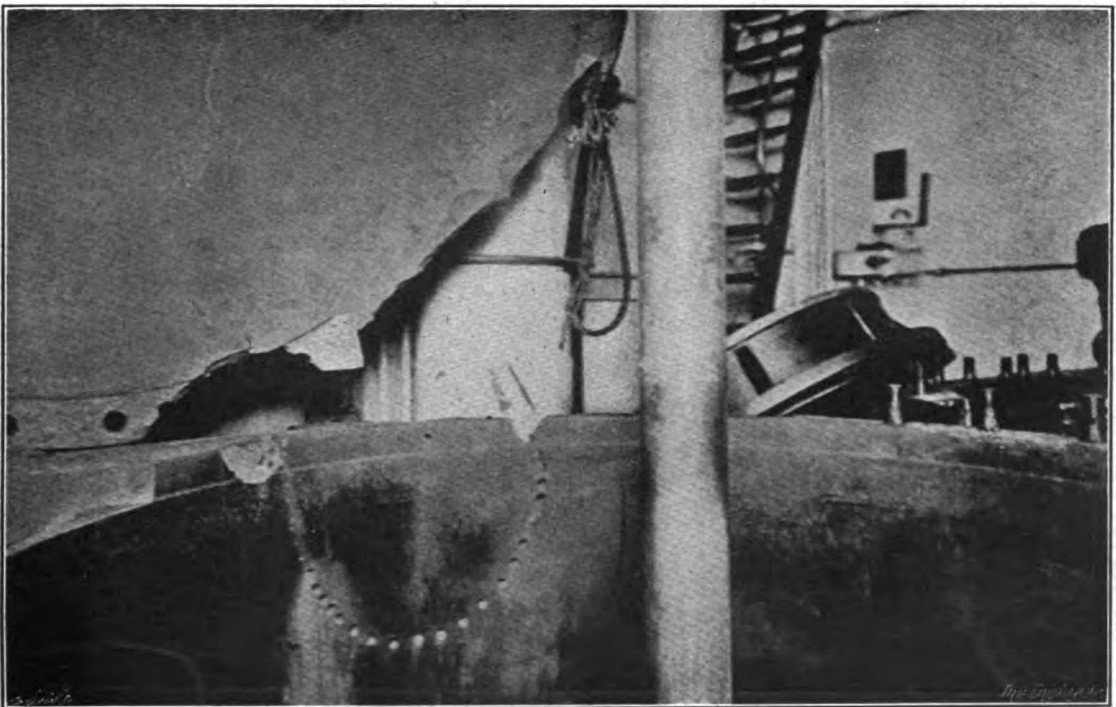

FIG. 74.—S.S. *Prinz Joachim*—Broken Cylinder-Head and broken Low-Pressure Cylinder.

MACHINERY IN GERMAN LINERS—*continued.*

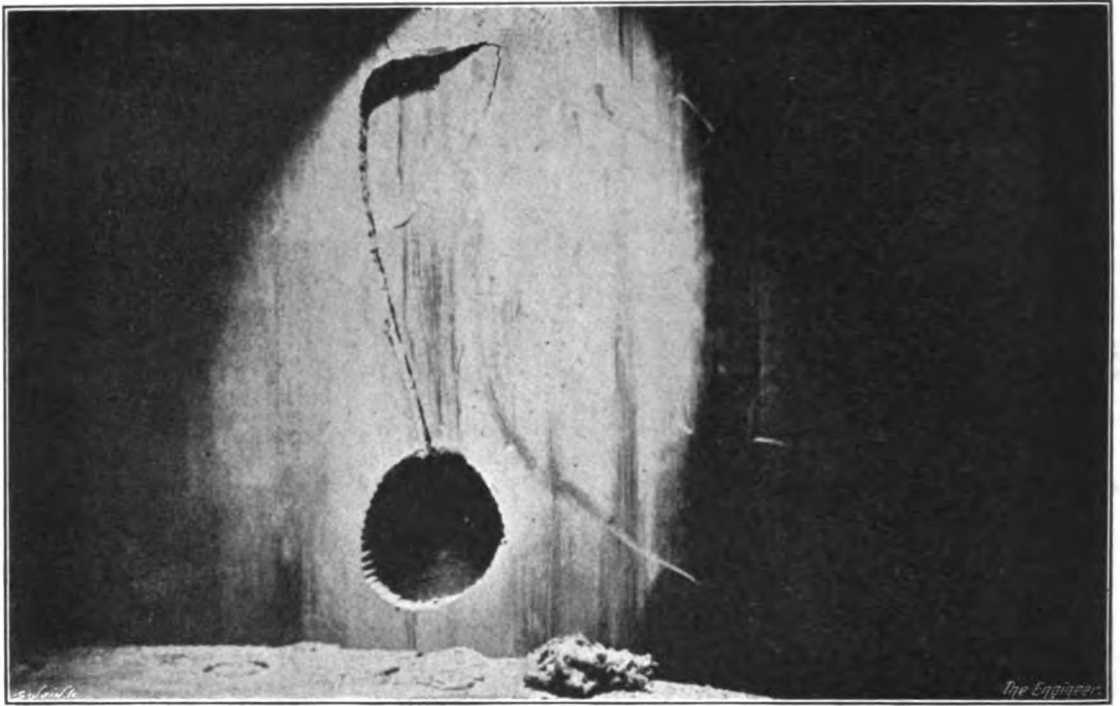

FIG. 75.—S.S. *Kaiser Wilhelm II.*—Fractured Low-Pressure Cylinder Liner.

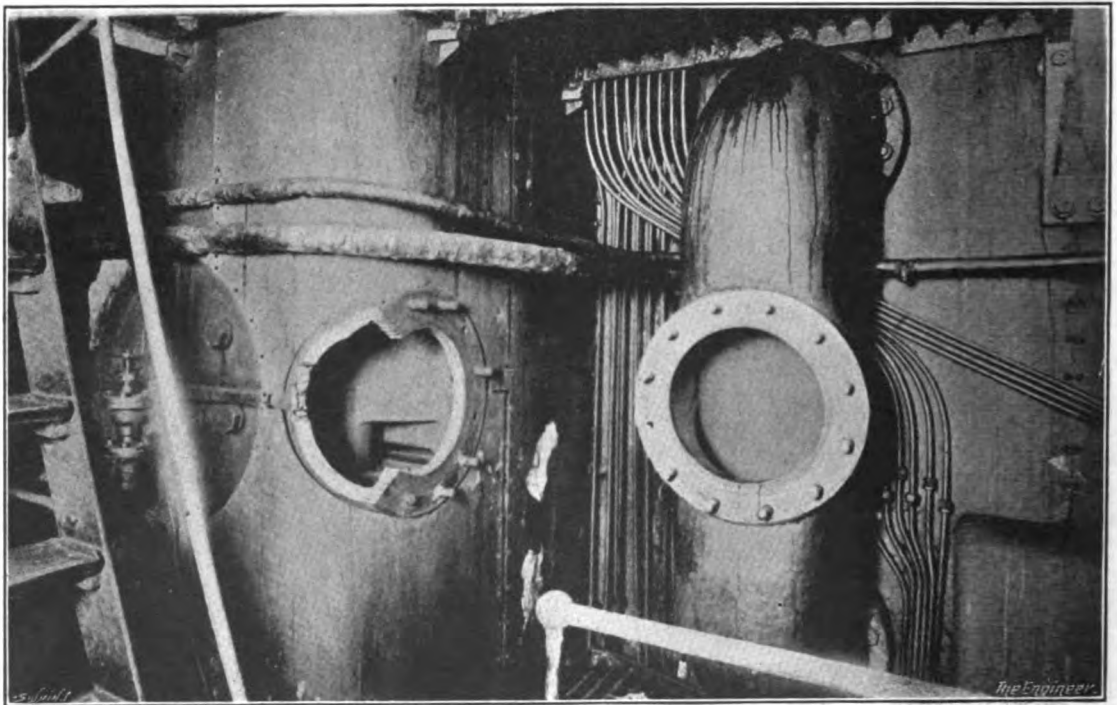

FIG. 76.—S.S. *Friedrich der Grosse*—Broken Steam Intake Second Intermediate Cylinder.

The credit of having suggested that the repairs might be effected by means of arc welding is attributed to Capt. E. P. Jessop, of the United States Navy, the Engineer Officer of the New York Navy Yard, to which place a few of the vessels were transferred for repair in the first instance. His recommendation was readily endorsed by Rear-Admiral Burd, the industrial manager of the yard. The matter was referred to the Bureau of Steam Engineering, and Capt. O. W. Koester, assistant to the Bureau, was directed to make a thorough examination of all the conditions on the ex-German ships. As a result of his investigation, orders were issued to make all the necessary repairs, where possible, by electric welding, and to resort to mechanical patching only where welding was impracticable.

It is explained by the Secretary of the Navy, in his report for the year ending December 1st, 1918, that the "decision, so far-reaching in its application and so fraught with danger to the professional reputation of the officers concerned," was come to in the face of opposition from engine builders and marine insurance companies, but that it was made "with such confidence in the ultimate result as left no room for doubt of its success." Yet, though, of course, electric welding had been in successful operation for some considerable time in connection with ship repairs, it had never before been employed on such an extensive scale as was then proposed. It was realised, however, that if it could be successfully applied, it would not be necessary to remove the cylinders from the vessels, and it was calculated that the ships would be ready for service months earlier than would be the case if the cylinders were taken out and replaced, and, further, that there would be a great saving in money.

The decision was fully justified by the results attained. "So well and so successfully were the repairs accomplished that," states the Secretary of the Navy, "there was not a single instance of a defective weld, nor has one developed during the months of arduous service on which these ships have been engaged." And he continues, "as a sidelight on this work it has been made the subject of careful estimate and determination that the repair of these ships resulted in the saving of twelve months in time, enabled us to transport at least 500,000 troops to France, and effected an economy which is conservatively estimated at upwards of 20,000,000 dols."

We understand that the cylinders of fifteen of the vessels were repaired by electric welding, while those of six were repaired by fitting mechanical patches. In other words, eighty-two of the major injuries were repaired by welding and thirty-six by mechanical methods. We are informed that the whole of the welding work in connection with the vessels shown in the accompanying table (see page 112) was effected on the Wilson system, which we shall now proceed to describe.

The first sixteen vessels in the above table, representing over 288,000 gross tonnage, were made available for the transport of American troops and supplies overseas within the space of five and a half months. The first two ships to be tackled—the *Friedrich der Grosse*, now the *Huron*, and the *Prinzess Irene*, now the *Pocahontas*—were ready for sea within two months from the time that the repairs were undertaken, in spite of the fact that their engines were among the worst damaged of all—so badly, indeed, that with ordinary methods nine cylinders would have had to be replaced.

The sole agents in this country for Plastic-arc welding plant and apparatus are G. D. Peters and Co., Limited, of 15 Dean's Yard, S.W. 1, and of Windsor Works, Slough. At the latter we recently had an opportunity of witnessing the system in operation within a day or two of its having been got to work. The current was supplied by an ordinary motor generator set, the generator being compound wound with interpoles and designed to generate direct current at 37 volts. There is nothing special in either the motor or the generator, nor are they electrically connected. The gist of the system

lies in the control panel, which is illustrated in Fig. 77, and the connections of which are shown in Fig. 78. The panel is equipped for both welding and cutting, but it is in the connections for welding that its chief interest lies, since, when used for cutting, only the reactance coil, the resistance grid shown at the left-hand bottom corner of the illustration, and the ammeter are in circuit. When, however, the connections are set for welding—that is, when the double-pole knife edge switch is, as shown in the left top corner of the engraving, Fig. 77, thrown over to the right-hand contacts—other pieces of apparatus, which differ from those of any other system with which we are acquainted, are brought into play. On tracing the connections shown in Fig. 78, it will be observed that the positive terminal of the generator is connected directly—and without passing through any apparatus saving the knife switch and plug switch E—to the work. The negative pole, on the other hand, runs from the knife switch

VESSELS REPAIRED BY THE WILSON SYSTEM.

German name.	U.S. name.	I.H.P.	Gross Tonnage.
Grosser Kurfurst	Aeolus	8,400 ..	13,102*
Kaiser Wilhelm II	Agamemnon	45,000 ..	19,361*
Amerika	America	15,800 ..	22,621*
Neckar	Antigne	5,500 ..	9,835*
Cincinnati	Covington	10,900 ..	16,339*
George Washington	George Washington ..	21,000 ..	25,570*
Friedrich der Grosse	Huron	6,800 ..	10,771*
Vaterland	Leviathan	90,000 ..	54,282*
Koenig Wilhelm II	Madawaska	7,400 ..	9,410*
Martha Washington	Martha Washington ..	6,940 ..	8,312*
Barbarossa	Mercury	7,200 ..	10,984*
Kronprinzessin Cecelie	Mt. Vernon	45,000 ..	19,503*
Prinzess Irene	Pocahontas	9,000 ..	10,983*
Hamburg	Powhatan	9,000 ..	10,893*
President Grant	President Grant ..	8,500 ..	18,072*
President Lincoln	President Lincoln ..	8,500 ..	18,168*
Saxonia	Savannah	2,500 ..	4,424†
Rhein	Susquehanna	9,520 ..	10,058*
Bulgaria	Philippines	4,200 ..	10,924‡

* Transport.

† Repair ship.

‡ Shipping Bd.

first of all to the solenoid A, Fig. 77, which may be termed the brains of the apparatus. The plunger of the solenoid is furnished at its upper extremity with a graphite piston which works in a dashpot B, and so controls the motions of the plunger that hunting is prevented. From the solenoid connection is made to the right-hand side of a resistance C and from the left-hand side of the latter through the ammeter D to the opposite terminal of the plug switch E to that occupied by the positive lead. The resistance C consists of a series of carbon plates which are plain on one side and provided with numerous regularly placed projections, carefully ground to the same height, on the other. The amount of resistance offered to the passage of current through this pack of carbon plates can be varied by the amount of pressure put upon them by means of the lever F¹, which is pivoted at F and is rocked up and down on that point by the movements of the plunger in the solenoid. If the current in the welding circuit tend to increase beyond a predetermined value, then the plunger, and with it the lever F¹, are raised, with the result that the pressure on the carbon plates is relieved,

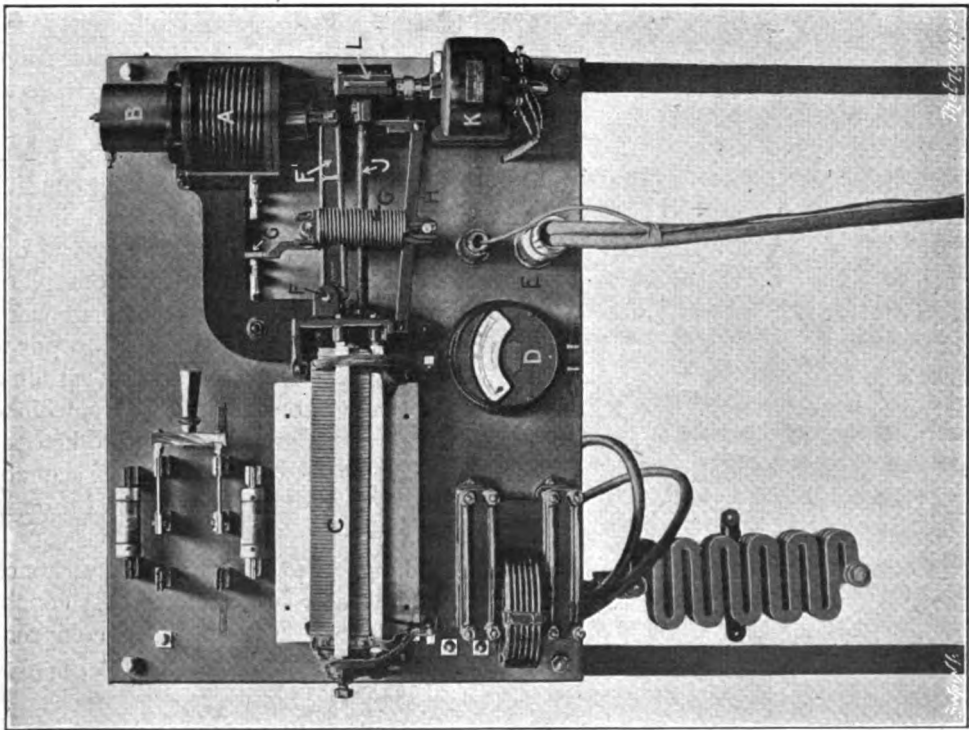

E. W.

I

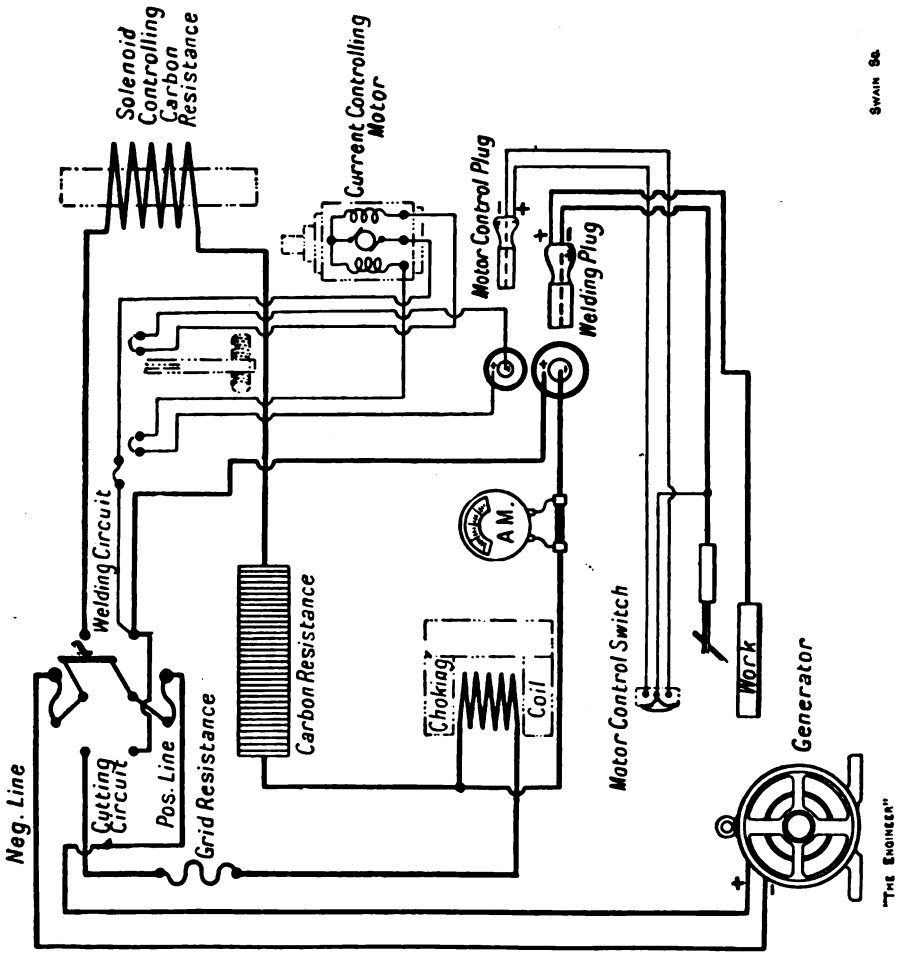

SWAIN 86

Figs. 77, 78.—Plastic-Arc Welding and Cutting Panel and Electrical Connections.

and in that way additional resistance inserted into the circuit. Then, if the other conditions remain the same, the current flowing in the circuit will fall, since the supply voltage is constant. Conversely, if the current tends to fall below the required value, the plunger and with it the lever F^1 will also tend to fall, with the result that the resistance of C is reduced by the compression of the carbon plates, and the current flowing in the circuit will rise.

The quantity of current to be allowed to flow can be varied at will by what is equivalent to running a weight backwards and forwards along the lever F, so that the effort to raise it required of the solenoid is decreased or increased. As a matter of fact, instead of a weight, the required effects are actually produced by decreasing or increasing the tension on two coiled phosphor-bronze springs, the front of which, G, is clearly shown in the engraving, that at the rear being hidden by its companion in front. These two springs are connected to two small roller trolleys, one of which can travel on the top of the lever F^1 , while the other impinges on the lower edge of the fixed inclined guide H. It will be readily understood that since the guide H is inclined downwards from the resistance C, the further the springs G are away from C the greater will be the effort required of the solenoid to lift the lever F^1 and hence to reduce the pressure on the carbon plates. It follows, therefore, that the greater the distance of the springs G from C, the larger the current will be before the solenoid will begin to take control. Conversely, the nearer the springs G are to C, the less the effort required of the solenoid and the smaller the current flowing in the circuit before the solenoid begins to act. Hence, by varying the position of the springs G, the exact working current can be arranged for before operations commence. For the initial adjustment of the carbon plates there is a screwed bolt at the left-hand side. This bolt, however, will only require to be used for initial adjustment, and not in ordinary working.

In some forms of the Wilson equipment this adjustment of the desired working pressure on the carbon plates is effected by a hand wheel and screw, but in the equipment which we saw, and which is shown in Fig. 77, the screw J, which passes through a threaded member forming an integral part of the spring-carrying trolley that travels on the top of the lever F^1 , can be revolved in one direction or the other by the revolution, in one direction or the other, of the small vertical spindle motor K. The advantage of the latter arrangement is that if the operator finds on commencing to work that the current flowing in his arc is either in excess of or smaller than the quantity required to do the work to the best advantage—and he becomes aware of the ruling conditions by the aspect of the work in progress—he can either decrease or increase it at will by moving the motor control switch—see Fig. 78—either to one side or the other. The switch may be arranged so as to be portable and to be carried from one place to another, so that the required alteration in the working conditions can be made without the operator having to make a special journey to the control board for the purpose. It may be added that there is a post G^1 rising vertically from the trolley running on the lever F, which can engage with and can open two carbon block switches, which are normally kept closed by spring action. One of these switches is arranged to be opened at one end of the travel of the trolley, and the other at the other, so that if the trolley should tend to overrun its travel in one direction or the other the circuit of the motor K is opened.

In actual operation the movements of the plunger in the solenoid, and hence of the lever F^1 , are not large, and the pointer of the ammeter keeps remarkably constant. Still, there is a continuous and quite clearly visible compression and decompression of the carbon blocks with the variation of the arc at the weld. All that happens if

the electrode is kept on the work is that the resistance C gets hot, and would undoubtedly burn if the short circuit were continued long enough ; but we understand that no damage would be done to the generator, since the resistance offered by the carbon plates would be enough to preclude the passage of a current sufficiently heavy to injure the machine.

We mentioned earlier in this chapter that the initial voltage was 37. In some equipments at work in the United States the initial voltage is some two volts lower than that. In the equipment that we inspected the voltage drop across the resistance when welding was being performed was about 20. Hence for maintaining the arc and for overcoming the resistance in the leads and solenoid there was only available 17 volts, and that is all that is required. The electrode being employed when we saw the plant in operation was plain iron wire about $\frac{5}{32}$ in. in diameter. It was not coated, nor was flux of any kind employed. The work being done was, to all appearances, excellent, and from tests, the data of which were shown to us, there is no doubt that the system is capable of doing work of the very highest quality, the consequence, it is explained, of having the current "just right" for each particular operation, and of the ability to adjust it to the desired quantity without difficulty. The critical heat at which the particular metal being welded should be fused is thus kept constant at the arc, and there are neither voids nor burning. With an electrode of the size mentioned— $\frac{5}{32}$ in.—we are informed that the amount of metal deposited by one operator per hour with a heat value of from 90 to 140 ampères at from 35 to 40 volts ranges from $\frac{3}{4}$ lb. to as much as 2½ lb. to 3 lb., the average being about 1½ lb. per hour, the actual quantity depending on the character of the work being carried out. Furthermore, we gather that the number of lineal feet that may be welded by one welder ranges from 1½ ft. on $\frac{3}{4}$ in. plate, with a liberal overlap of metal, to as much as 10 ft. per hour on $\frac{1}{4}$ in. stock, with no extra metal applied, a safe average being probably about 4 ft. per hour. The results of tests which have been shown to us demonstrate that the average tensile strength per square inch at the weld arrived at with eleven specimens having an area of 0.628 square inch, the weld being planed flush with the plate, was 54,700 lb., the elongation in 2 in. averaging 7.67 per cent. Nine specimens having an area of 0.572 square inch gave 56,700 lb. as tensile strength and 10.0 per cent. elongation in 2 in., while eleven further specimens having an area of 0.595 square inch gave 58,900 lb. and 7.53 per cent. respectively, the figures being average in all cases. These results were obtained by taking a rectangular boiler plate 18 in. by 20 in. of known tensile strength, cutting through the centre the long way and welding with a quality of wire suitable for the purpose. The plates were then cut into test pieces 1½ in. wide and tested in the regular way after the welds had been planed flush on both sides. It is claimed that welds made by the Plastic-arc system will stand much more in the way of twisting and bending than will welds made by any other system.

The Wilson system was in the first instance, and long before it was employed for ship repairs, developed for railway work. A very large volume of railway repair work has been done by arc welding in the United States for a good many years past, and has been found to be convenient, effective and cheap. As an example of the class of job which is frequently met with, we may mention cracked locomotive frames. Wrought steel is largely used for locomotive frames in the United States, and it has been found that when cracks develop in them the damage can readily be repaired by electric welding. The engraving, Fig. 79, shows a broken frame of engine No. 1653 of the Grand Trunk Railway in process of being repaired by the Plastic-arc system at Stratford, Ontario. The method employed is to cut away the metal, as shown, on each side of the frame in the neighbourhood of the crack by means of pneumatic hammers.

The space left by the material cut away is then filled by a piece B of metal identical with the metal of the frame and square in cross section, and with two opposite corners matching with the V-shaped ends of the frame formed as a result of the metal being cut away. Welding is then commenced at the bottoms of the V-shaped cavities formed on each side of the frame, as shown in Fig. 79, and the process is continued until the cavities are filled up and their surfaces brought flush with or perhaps a little proud of the original surface of the frame, as shown in Fig. 80. Repairs such as that just described are frequently carried out, and are found to be quite effective.

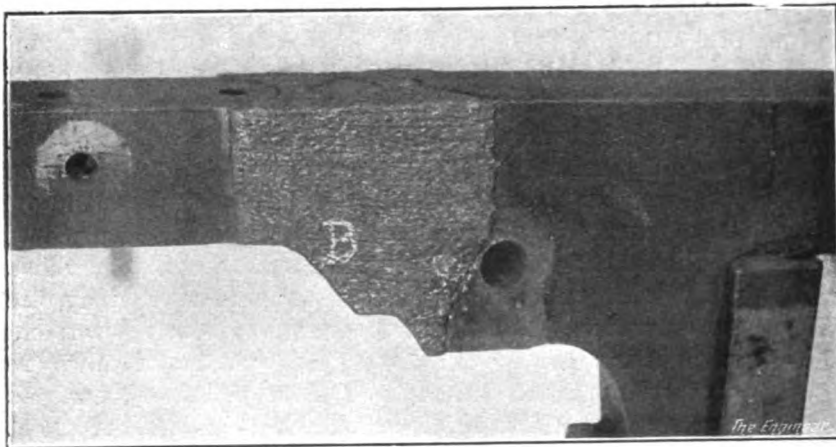
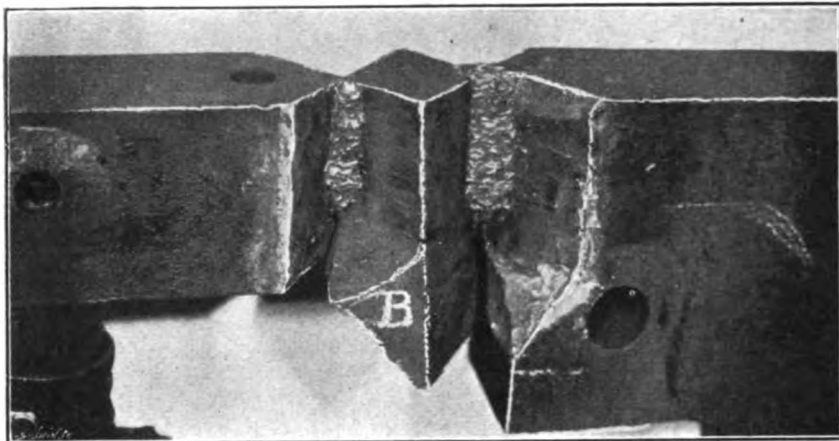

FIGS. 79, 80.

Cracked Locomotive Frame—Early Stage and Final Appearance of Repair by Arc Welding

CHAPTER XVII

THE A.C. SYSTEM OF ARC WELDING

As has been pointed out in an earlier chapter, direct current is almost exclusively used for arc welding in this country. In the United States, however, alternating current has been employed somewhat extensively, with, so we are given to understand, considerable success. A company known as The A.C. Cutting and Welding Company, Limited, the offices of which are at 25-27 Theobalds Road, Holborn, London, W.C. 1, has recently been formed to introduce into this country the machine and methods of an American firm. The machine, as the name of the company suggests, works with alternating current, and for alternating current, at any rate if used with its machine, the company claims numerous advantages. We may perhaps enumerate these claims

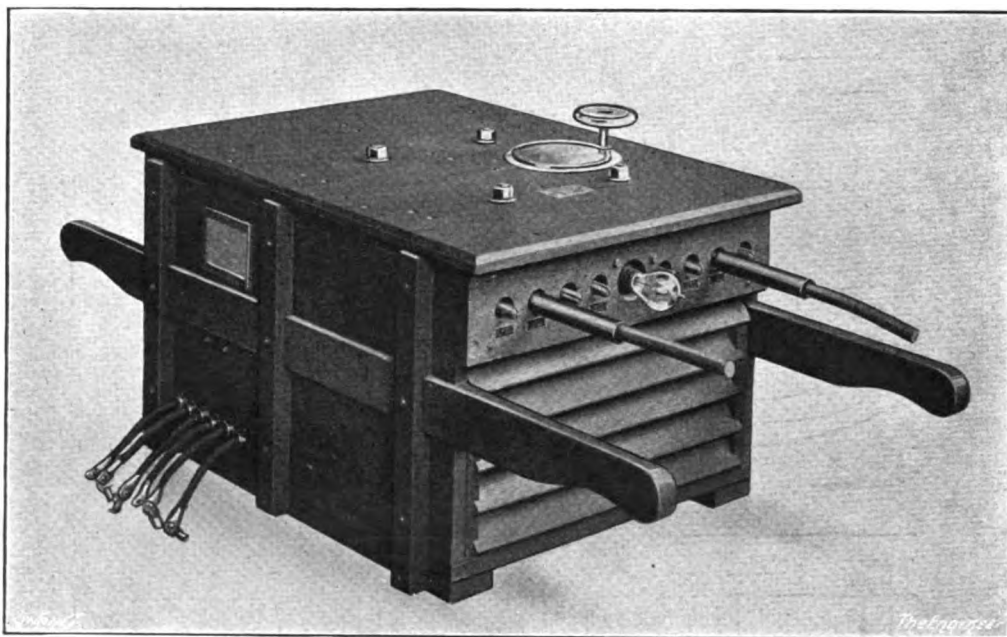
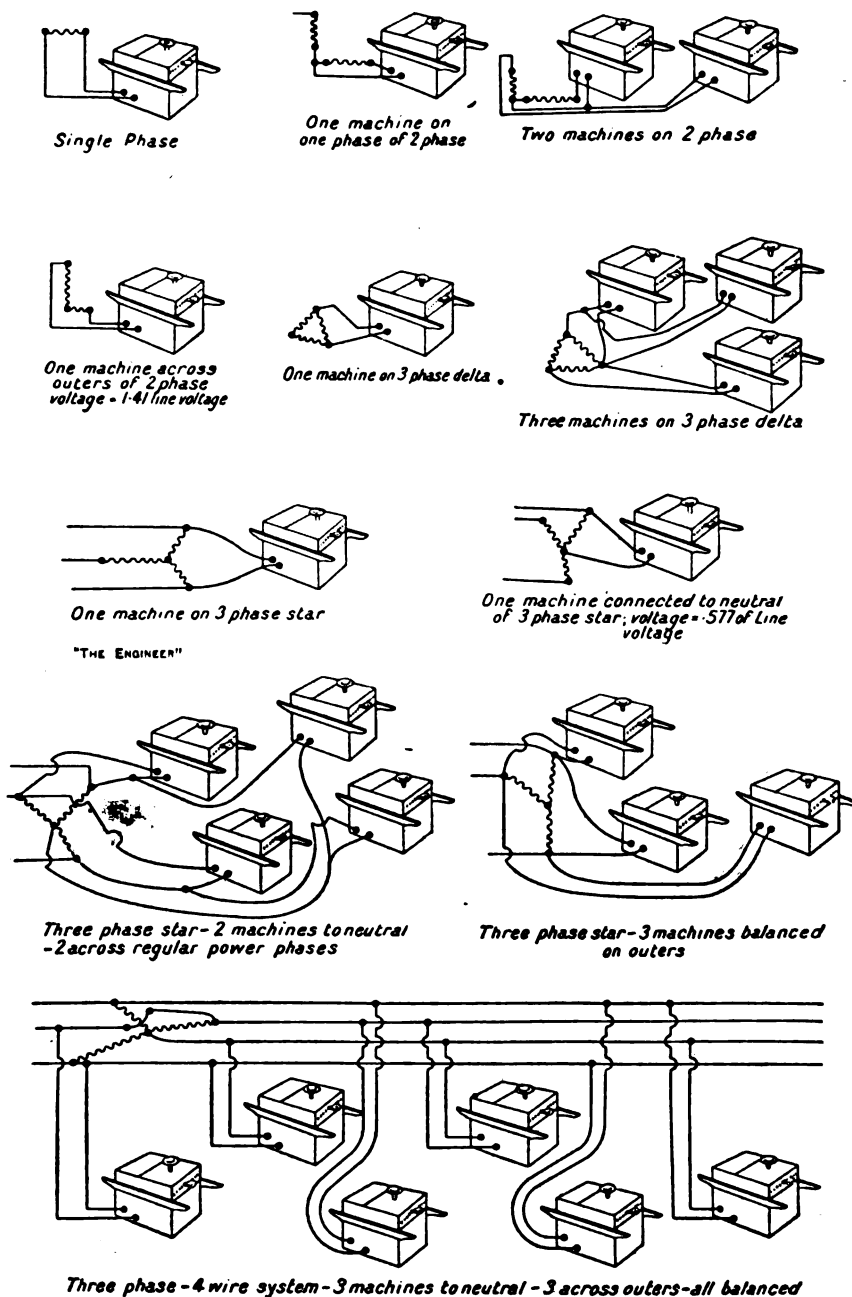

FIG. 81.—The A.C. Electric Welding and Cutting Machine.

before going on to describe the machine itself. First, there are low cost of operation and no maintenance charges. In this connection it is pointed out that the A.C. apparatus has no constantly moving parts, and that there is nothing, except accidental mechanical injury or abuse, to prevent its lasting indefinitely. The apparatus, it is stated, consumes approximately 0.15 kilowatt at a power factor of 65 per cent. when not in actual operation, and when working will deposit a pound of metal for from 1 to 2 kilowatt-hours of energy. Then there is low cost of machine and wiring. On the first portion of this claim we make no comment, but as concerns the second portion it may be said that the distribution wiring is on the high-voltage side and that only small-sized wires are required as compared, say, with a direct-current system using a motor

generator in which the distribution cables to the arc welders are necessarily of large cross section. The A.C. machine can be taken right up to the work, so that only quite short welding-circuit cables are required.



SWAIN Sc

FIG. 82.—Methods of Connecting up the A.C. Machines with Different Types of Circuits.

A third claim made for the A.C. machine is that with it there is greater speed of deposition of the electrode metal than with other systems, and that no chipping or brushing of the work is necessary. The company maintains that alternating current

provides a faster speed of welding than direct current when the electrode in the latter case is negative, because with the electrode negative approximately 60 per cent. of the heat is in the work, whereas with alternating current the heat is naturally divided equally between the work and the electrode. It is admitted that direct current with the electrode positive will provide a faster speed of welding, but it is urged that generally it is "too fast to be of any use . . . unless the arc is closed in by very heavy coating, so that the metal is enclosed in a viscous sleeve, or where the work is very rough, such as filling in with a large electrode on a casting where strength is not required." The following figures have been supplied to us of a test recently made with direct-current and alternating-current machines. In each case in which conditions of currents and voltage were strictly comparable it was found that alternating current was from 20 to 30 per cent. faster than direct current. Thus at 150 ampères and 25 volts 4 lb. per hour of metal were deposited with alternating, as against 3 lb. per hour with direct current. At 175 ampères and 25 volts 5 lb. per hour were deposited with alternating current and 4 lb. per hour with direct current. As regards the contention that no chipping or brushing is necessary, it is certainly true that with the A.C. machine an arc can be struck from a rusty surface; but we may say that the same thing can be done with direct current.

A fourth claim for the A.C. system embodies "penetration, smoothness and absence of electrolytic corrosion." It is asserted that an alternating-current arc has a penetrating power superior to that possessed by a direct-current arc, and that on that account there is set up a molecular diffusion extending from $\frac{1}{4}$ in. to $\frac{3}{8}$ in. below the surface of the work, so that its use is specially applicable to cast-iron welding. Again, the surface of the metal deposited by the A.C. arc is said to be smoother than that of metal deposited by direct-current arcs. Then with regard to electrolytic corrosion, it is pointed out that whereas with direct-current welding there is the choice of making the electrode either positive or negative, so that in either case there is a liability of the formation of a voltage couple with consequent electrolytic corrosion, especially in damp places, with alternating-current welding that liability is eliminated, as is also the chance of the deposition of dross in the weld, as may happen when the electrode is negative.

Finally, the claim is made that the A.C. machine is more portable than any other and that the system is very flexible. It is pointed out that (a) the apparatus can be taken by two men exactly where it is required; (b) the system is not tied down to a certain number of machines or certain positions; (c) the system operates as efficiently with one machine running as with a few or a great many; and (d) the machine, having no continually moving parts, will work in any position.

Having set out the claims made for the system and apparatus, let us now consider the apparatus itself. Its outward appearance is shown in the engraving, Fig. 81. It consists of an oak box with louvred ends for ventilation, and with four arms like those of old-fashioned Sedan chairs for carrying purposes. As to the internal arrangements of the box, beyond the statement that they consist principally of a specially wound transformer the company prefers at the moment to give no definite particulars. All that we know for certain, therefore, is that the transformer has certain tappings, which will be again referred to later; that there is a flux diverter, by means of which fine adjustments in the welding circuit are obtained; and that the box also contains an electrically driven blower, the purpose of which is, by circulating a current of air through them, to keep the windings cool, and which absorbs some 60 watts. The complete apparatus is said to be weather-proof, so that it can be used out of doors as well as under cover, and skids are provided to facilitate movement of the box. The louvred openings are provided with fine-mesh screens.

The primary leads are led out from the side of the box through insulated bushes. There are in all eight secondary plugs. They are arranged at one end of the box, and are mounted on a slate bed protected by an oak fronting. The plugs are split so as to make firm contact with the sockets at the ends of the welding leads. The eight welding tap plugs provide adjustment for various types of welding or for different sizes of electrode, any required adjustment within the limits of the machine being made by taking a socket off one plug and putting it on another, no other means of switching being necessary. The plugs may, in fact, be considered as being the means of bringing about what may be called the coarse adjustment of the welding circuit. The flux diverter, which is manipulated by the small hand wheel seen at the top of the box, and the movement of which can be observed through a circular glass window, is for fine adjustment after correct conditions have been roughly obtained by means of the plugs. It is explained, too, that the flux diverter also determines the depth of the penetrative effect of the arc—that is to say, whether the metal will be sunk in as in sealing or added on as in padding. The flux diverter handle is provided with an indicator dial to facilitate resetting when repetition work is being carried out.

It will be observed that there are six primary leads. Only two are actually employed when the machines are at work, the others being carefully insulated, but the

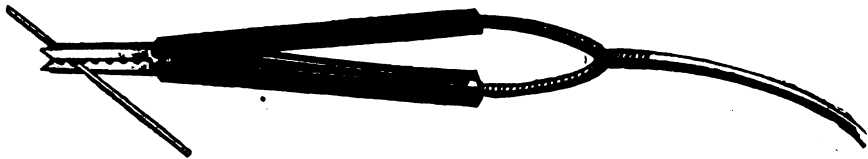

FIG. 83.—The A.C. Electrode Holder.

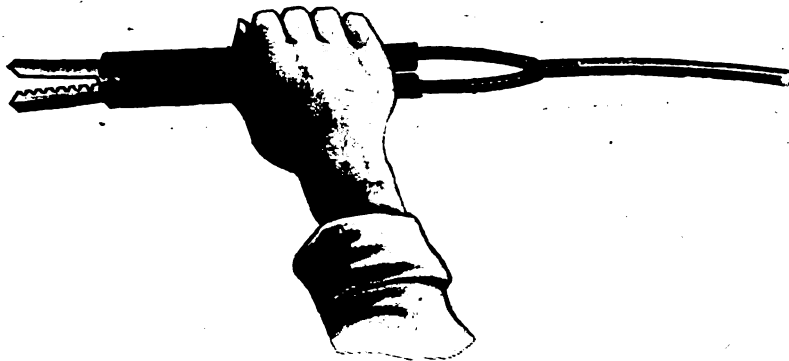

FIG. 84.—The Holder Gripped to Release Electrode.

three sets are provided so as to enable the apparatus to be used on circuits the voltage of which is below the standard voltage for which the machine is intended. Moreover, should the supply voltage be higher than the voltage for the highest set of tappings on the primary, proper regulation can still be obtained by variation of the secondary plugs. The range of primary voltage with which any one apparatus can be successfully operated is therefore fairly wide. We return to this question later. Shifting the secondary leads on to plugs from left to right on either side of the lamp in the centre gives more heat in the weld. The function of the lamp, it may be explained, is to take up the "kick" of the arc when the circuit is opened, and any 110-volt lamp is suitable

for the purpose. The lamp also gives indication when the machine is ready for work. The A.C. machines are made in five sizes as follows :—

Type.	Range in welding. Ampères.	Weight. Lb.	Efficiency. Per cent.
L.W.	40 to 110	250-300	80
W.	75 to 175	300-350	80
C.W.	100 to 350	350-400	80
H.C.G.	300 to 650	400-500	85
E.C.G.	500 to 1200	600-800	90

The weights vary according to the periodicities for which the transformers are wound. The machine can be wound for any voltage, but it is not considered good practice to have a primary voltage in excess of 650. The machines are made as ordinarily wound for single phase for any voltage or frequency, but if occasion requires it they can be made for two or three-phase current, the power being taken from a two or three-phase circuit balanced on each phase, the welding circuit, of course, consisting of only two wires. The company informs us, however, that experience has taught it not to recommend these polyphase machines, as they cost much more and weigh much more, so that portability is lost with no attendant advantage of any kind. The diagram, Fig. 82, is interesting, as showing the methods of connecting the machine to various types of circuit.

The standard machines are wound for one voltage only, such as 110, 220, 440, etc. ; but by reason of the means for connecting up the primary which are provided, and to which we have already referred, the 110-volt primary circuit can be 100, 105, or 110 ; the 220-volt primary circuit can be 200, 210, or 220 ; and the 440-volt primary circuit can be 400, 420, or 440. These figures correspond to 5 and 10 per cent. low to the nominated voltage. The secondary plugs provide a further range of 5 and 10 per cent. high.

The power factor of the machine in welding is given as varying from 45 to 65 per cent., a fair average being 55 per cent., which means that the kilovolt-ampère required is approximately twice the kilowatts paid for. It is claimed that the load factor with the machine may be as high as 75 per cent. on the average, since there is no necessity to chip slag. Taking a power factor of 50 per cent, and a load factor of 75 per cent., the cost of one machine per hour with energy at 1½d. per kilowatt-hour is said to work out at less than 4d. In cutting, the power factor is so much higher and the load factor so much lower that the average demand in a given time is the same as when welding. The demand of the machine for the heaviest type of welding is said to be 5 kilowatts, and for cutting 10 kilowatts.

In discussing the machine with the company's representatives emphasis was laid on the following points : " A fundamental feature in all arc welding machines should be that a constant rate of heat should be automatically given out at the terminals. Constant rate of heat means constant energy, or, in other words, constant watts. This condition is brought about in our special transformer by a careful balance of the secondary and primary windings, so that as the voltage tends to increase, owing, say, to the arc lengthening or because of oil slag being in the path of the arc, the current tends to diminish and *vice versa*, so that energy is delivered at an approximately constant rate.

" A fundamental essential for good welding is that a short arc be held. This condition is obtained in our machine by the swinging in and out of the voltage phase relations of three voltages in series in the secondary winding of the transformer. Such adjustment can be made that any short length arc can be held, and, when once set, the adjustment can be locked so that it is impossible for a longer arc to be drawn than

the fixed maximum. This company considers it as beyond argument that a short arc is desirable in every case, for there is then less oxidation and nitrogenisation in the crater and less radiation than with a long arc, while there is more certainty of the electrode metal being deposited into the crater.

“ We are able to hold an A.C. arc with 31 volts open circuit, although in practice, because of line drop, poor contact, and various other reasons, we actually give more than that, taps on the machine providing different voltages, both essential—for keeping the arc going—and ‘ kick ’ voltages for different types of electrode and arc.

“ In addition to the transformer supplying all these requirements automatically without continually moving parts, it further renders itself harm-proof when the secondary terminals are short-circuited, in that the voltage drops to zero with a current which can be adjusted to be less or greater than normal full-load current. As a matter of fact, we adjust it for slightly in excess of that current so that slightly greater heat is allowed for getting started.

“ The one characteristic of our machine which is not shared by self-regulating direct-current sets, which embody much the same characteristics of constant rate of energy in the welding circuit, is that each voltage can be changed—both ‘ essential ’ and ‘ kick ’—without changing the current, whereas with direct-current sets change in the voltage causes a corresponding change in the current.”

We have not, ourselves, seen any tests carried out on welds made by this apparatus, but we are informed that it will weld pieces which will bend flat on themselves—the bend being in the weld—and which in a twisting test may be twisted through two complete revolutions before tearing.

The A.C. machine can be used with any type of electrode—bare wire, flux-coated, gaseous flux-coated, carbon, or graphite. The particular form of electrode holder or welding handle, as the company prefers to call it, recommended is illustrated in Figs. 83 and 84. It consists of a spring grip insulated holder, the metal portion of which is composed of a metal which is not affected by the heat of the arc. It enables all types of electrodes to be gripped at any desired angle without the necessity of keeping pressure on either handle. On a slight squeeze being given to the holder, as seen in Fig. 84, the stub end of a used electrode may be got rid of and a fresh electrode inserted. The current is led to the electrode through both halves of the handle equally. The flexible leads are brazed into the handle so that they become part and parcel of it.

INDEX

A

ABELL, Mr. Westcott Stile, 97
 A.C. Cutting and Welding Co., Ltd., The, 117
 Electrode Holder, The, 120, 122
 Machines, Methods of Connecting up with
 different Types of Circuits, 118, 121
 Acetylene Welding, 2, 19
 "Added Thickness," 89
 Admiralty Authorities, The, 6, 13
 Aluminium, 15, 33
 for Flux for Electric Welding, 33
 American Bureau of Steam Engineering, The,
 111
 American Duplex "Spot" Welder, Large, 81
 Electrical Engineers, Institute of, 71
 "Spot" Welders for Ship Work, 80
 Andrews, Mr. W. S. (American General Electric
 Co.), 74
 A 1 Automatic Switch, 91
 "Butt" Welder, 93
 Manufacturing Co., Ltd., 89 *et seq.*
 "Spot" Welders, 90
 Apparatus for Arc Welding, Machines and,
 49 *et seq.*
 Arc between Two Electrodes, Welding by means
 of, 3
 Arc, Crater of. Absorption of Oxygen by, 5
 Effect of, on Human Frame, 4
 Introduction of Gas into (Benardos), 12
 Positive Crater of, Temperature of, 4
 Process, The Benardos Carbon-, 8, 20
 Projected by Electro-magnet, 3
 The Plastic-, Welding System, 108 *et seq.*
 Use of for Making Holes (Benardos), 11
 Arc Welding, 1 *et seq.*, 8 *et seq.*, 33, 49, 65, 108, 117
 At a Steel Barrel Works, 19 *et seq.*
 Company, Ltd., The British, 49
 Arc Welding Equipment, Self-contained (The
 British Westinghouse), 49 *et seq.*
 Arc Welding Equipment on Motor Lorry
 (British Westinghouse), 50
 Arc Welding Equipments, 50, 54, 65
 Arc Welding, Flux for, 5
 Arc Welding, Generator for (British Westing-
 house), 51
 Arc Welding, Glass Screens for Protection while,
 5, 20, 72
 Arc Welding, Helmet for, 4, 5
 Arc Welding, Loss in Steadying Resistance
 during, 52
 Arc Welding, Machines and Apparatus for, 49
et seq.

Arc Welding, Motor Generator for (Crompton),
 70, 73
 Arc Welding, Polarity of Electrodes for, 2
 Precautions to be taken when, 4
 Screens for Use when, 5, 20, 71
 Arc Welding, Self-regulating Generators for,
 51, 53 *et seq.*, 62, 63, 64
 Arc Welding Set (Lancashire Dynamo and
 Motor Co., Ltd.), 56
 Arc Welding Set, Portable (J. H. Holmes), 65, 66
 Arc Welding Set, Self-contained (Crompton), 72
 Arc Welding, Special Appliances Necessary
 for, 3
 Armour Plate, Formation of, by Electric
 Welding (Benardos), 12
 Asbestos, Blue, as Flux-forming coating for
 Electrodes, 33
 Attachments, "Butt" Welding (A 1 Manu-
 facturing Co.), 89, 94
 Attachments, "Seam" Welding (A 1 Manu-
 facturing Co.), 89, 95

B

"BAD Metal," 6
 Bakelite, 81
 Balancer Set, "Constant-energy," Electrical
 Connections of, 63
 Bare Metal Electrodes, 3, 5, 71
 Barge, Electrically-welded, 5
 Barrel Co., Ltd., The Steel (Uxbridge), 19 *et seq.*,
 84 *et seq.*
 Barrel, Steel, Description of Making, 21
 Works, Arc Welding at a Steel, 19
 Benardos, Nicholas de, 1 *et seq.*, 8, 9, 20
 and Olszewski Patent, 8 *et seq.*
 Carbon Arc Process, 8 *et seq.*
 Electrode Holders, 8 *et seq.*
 Machines for Arc Welding, 10 *et seq.*
 Bench Work, "Spot" Welder for ("Pontelec"),
 30
 Blocks, Radial Electrode-, "Butt" Welder
 with, 76, 77
 Blow-holes, The Filling up of, 36
 Blue Asbestos, as Flux-forming coating for
 Electrodes, 33
 Bonner, Mr. W. T. (Chester Shipbuilding Co.,
 U.S.A.), 100
 Borax used as a Flux in Brazing, 29
 Bowling Iron Co., The, 3
 Brass, Welding, 15
 Brazing Collars on Tubes, Machine for, 28

- Bridge Welding (Pontelec), 27
 British Electric Plant Co., Ltd., 49
 British Insulated & Helsby Cables Ltd. (B.I.W.),
 39 *et seq.*
 B.I.W. Resistance Welders, 39 *et seq.*
 "Seam" Welders, 45, 46
 "Spot" Welders, 47, 48
 Wire Welders, 39
 British Westinghouse Electric & Manufacturing
 Co., Ltd., 49
 Bruce Peebles & Co., Ltd., 49
 Bubbles, Gas, in Electric Welds, 6
 Burd, Rear Admiral, U.S.N., 111
 Bureau of Steam Engineering, The American,
 111
 "Butt" Welder (Electric Welding Co., Ltd.), 79
 "Butt" Welder for Miscellaneous Repair Work
 (Electric Welding Co., Ltd.), 77
 "Butt" Welder for Hoops, Rings, etc. (Electric
 Welding Co., Ltd.), 79
 "Butt" Welder for Hoops, Rods, etc. (Electric
 Welding Co., Ltd.), 75, 76
 "Butt" Welder for Tyres (Pontelec), 31,
 "Butt" Welders (A1 Manufacturing Co., Ltd.),
 89 *et seq.*
 "Butt" Welders (B.I.W.), 39 *et seq.*
 "Butt" Welders (Electric Welding Co., Ltd.),
 75 *et seq.*
 "Butt" Welding, 2, 17, 31, 39 *et seq.*
 "Butt" Welding Attachments (A1 Manu-
 facturing Co., Ltd.), 89, 94
 "Butt" Welding of Tyres, Diagram Showing
 Principle of, 17
- C
- CALDWELL, Capt. (afterwards Major) James,
 4, 6, 99 *et seq.*
 Caps for Electrodes of Large Welders, 83
 Candy, Mr. A. M., 70, 71
 Carbon, Alteration of Composition of Welded
 Metal by, 2
 Carbon Arc Process, The Benardos, 8
 Welding, 6, 20
 Carbon Arc Welding, First Employed Com-
 mercially, 2, 3
 Carbon Electrode Holder, 20
 Electrodes, 2, 3
 Carbon Electrodes Cored, 3
 Cast Iron, Welding, 36
 Chain-link-forming Machine, B.I.W., 41
 Chain-link Welder, B.I.W., 43, 44
 Chains, Machines for Making, B.I.W., 41 *et seq.*
 Clapper, Mr. J. B. (Standard Parts Co., Cleve-
 land, Ohio), 14
 Chester Shipbuilding Co., U.S.A., 100
 Clutch, The Davies & Soames (Daysohms)
 Electro-magnetic, 58 *et seq.*
 Coated Electrodes, 5 *et seq.*, 33 *et seq.*
 Coating, Slag-forming, for Electrodes, 6
 Coatings for Electrodes, all not Slag-forming, 6
 Collars, Machine for Brazing on Tubes, 28
 Connections, Electric, for A.C. Welding
 Machines with different Types of Circuits, 118
 Connections, Electric, of British Westinghouse
 Generator for Arc Welding, 51
 Connections, Electric, of "Constant-energy"
 Balancer Set, 63
 Connections, Electric, of Davies & Soames
 (Daysohms) Differential Electro-magnetic
 Clutch, 61, 62
 Connections, Electric, of Lancashire Dynamo &
 Motor Co.'s Arc-welding Set, 57
 Connections, Electric, of Large American
 Duplex "Spot" Welder, 82
 "Constant-energy" Arc-welding Set, The, 62,
 63
 Continuous or "Point" Welding Machine
 (Benardos), 11
 "Continuous-union" Welding (Benardos), 9
 Converter, Rotary, 96
 Converter, Rotary Motor, 64
 Cored Carbon Electrodes, 3
 Corning Glass Co. of New York, 74
 Crater of Positive Arc, Temperature of, 4
 Crompton & Co., Ltd., 69 *et seq.*
 Crompton Self-contained Arc Welding Set, 72
 Crookes', The late Sir William, Glass, 21, 72
 Current Limits admissible with different sizes
 of Quasi-arc Electrodes, 36
 Current Variation in Arc Welding, 4, 22
 Currents, Primary and Secondary, in Large
 American Welders, 80
 Cutting & Welding, The A.C. Co., 117
 Cutting & Welding, The A.C. Co. Machine, 117
 Cutting of Metals, The, 11, 37, 112
- D
- DAMAGE to German Steamships, 108
 Davies & Soames (Daysohms) Electro-magnetic
 Differential Clutch, 58 *et seq.*
 Davies, Mr. Walter L., 58
 Defects in Electric Welds, 6
 de Meritens, 8
 Device for Continuous or "Point" Welding
 (Benardos), 11
 Device for "Point" Welding (Benardos), 10
 Dickinson, Mr. (The Bowling Iron Co.), 3
 Differential Clutch, The Davies & Soames
 (Daysohms) Electro-magnetic, 58 *et seq.*
 Disc Welding ("Pontelec"), 27
 Disunion of Metals (Benardos), 11
 Drills, Machine for Welding (B.I.W.), 41
 Drums, Oil-, Manufacture of, by Electric
 Welding, 84
 Duplex "Spot" Welder, Large American, 81
 Duplex "Spot" Welder, Large American,
 Electrical Arrangements of, 82
 Dynamo & Motor Co., Ltd., The Lancashire,
 49, 56 *et seq.*
- E
- EARTHING Wire for Welding Machine, 91
 Effect of the Arc on the Human Frame, 4
 Elastic-limit of Electric Welds, 98
 Electric Arc Welding, Benardos', Machines for,
 10, 11
 Electric Forge, Benardos', 10
 Plant Co., Ltd., The British, 49
 Welding Co., Ltd., The, 49, 75 *et seq.*
 Welding Co., Ltd., The Premier, 49
 et seq.

- Electric Welds, Defects in, 6
 Examples of (Benardos), 9
 Electrical Arrangements of Large American Duplex "Spot" Welder, 82
 Electrical Engineers, American Institute of, 71
 Electrically-welded Barge, 5
 Electro-magnetic Clutch, Davies & Soames (Daysohms), 58 *et seq.*
 Electrode Holder, The A.C. Cutting & Welding Co., Ltd., 120
 Electrode Holder, The Benardos, 9
 Electrode Holder, The Equipment & Engineering Co., 70, 73
 Electrode Holder, The T. T. Heaton, 20
 Holders, American, 70, 71
 Electrodes, Bare Metal, 3, 5, 71
 Benardos, 2, 3
 Carbon, 2
 Coatings for, not all Slag-forming, 6
 Cored Carbon (Benardos), 3
 Flux Coated, 5, 33
 Graphite, 20, 71
 Heat of Positive and Negative, 2
 Kjellberg, 6
 Electrodes, Mild Steel, suggested by Mr. T. T. Heaton, 3
 Electrodes, Polarity of in Arc Welding, 2
 Quasi-arc, 35
 Electrodes, Quasi-arc, Sizes for Sheet and Plate Welding, 37
 Electrodes, Slag-forming Coatings for, 6, 33
 Slavianoff, 3
 Emergency Fleet Corporation, The, U.S.A., 100
 "Energy, Constant-", Arc Welding Set, 62, 63
 Equipment and Engineering Co., The, 58, 64, 70
 Eye Protection during Arc Welding, 71 *et seq.*
- F
- FILLING up Blow-holes, 36
 Fleet Corporation, The Emergency, U.S.A., 100
 Flux for Arc Welding, 5, 6, 22, 29
 "Flux, Gaseous," Process, 6
 Forge, Electric, Benardos', 10
 Formation of Armour Plate, Benardos' Suggestion for, 12
 Frame, Human, Effect of Arc on, 4
 Spectacle-, Soldering Machine, 29
 Franklin Institute of Philadelphia, 14
Friedrich der Grosse, Damage to German Liner, 110, 111
- G
- Gas Bubbles in Electric Welds, 6
 Gas, Introduction into the Arc, proposed by Benardos, 12
 General Electric Co. of America, 74
 Generating Set for Arc Welding, Portable, J. H. Holmes, 65, 66
 Generators for Arc Welding. Self-regulating, 51, 53 *et seq.*, 62, 70
 German Steamships in America, Damage to by Crews, 108
 Glass, Coloured, for Protecting the Eyes, 12, 20, 72
 Glass, Crookes', 21, 72
 Glass, Gold-plated, for Eye-protection during Arc Welding, 74
 Glass, "Safety," for Arc Welding, 72, 73, 74
 Screens for Protecting the Eyes, 11, 20, 72, 73
 Grand Trunk Railway, Repairs on, 115
 Graphite Electrodes, 20, 71
- H
- HAND-OPERATED Welder (Electric Welding Co.), 77, 79
 Heaton, Mr. T. T., 19, 20, 21, 84
 Helmet for Arc Welding, 4, 5
 Holder, Electrode, American, 70, 71
 The A.C., 120
 The Benardos, 9
 Holder, Electrode, The Equipment and Engineering Co., 73
 Holder, Electrode, The T. T. Heaton, 20
 Holmes, J. H., & Co., 49, 65 *et seq.*
 Hoops, Rings, etc., "Butt" Welder for (Electric Welding Co.), 78, 79
 Human Frame, Effect of Arc on, 4
Huron, S.S. (ex-German *Friedrich der Grosse*), Damage to, 111
 Hydraulic Pressure for Consolidating Welds, 75
- I
- IRON, Welding Cast, 36
- J
- JESSOP, Capt. E. P. (U.S.N.), 111
 Jevons, Mr. A., 25
 Jews' Harp Welder (Elihu Thomson), 14
 Joint, Welded-riveted, 35
 Joints, Welded and Riveted, Comparative Strength of, 101
- K
- Kaiser Wilhelm II*, German Liner, Damage to, 110
 Kjellberg, Coated Electrode, 6
 "Gaseous-flux" Process, 6
 Koester, Capt. O. W. (American Bureau of Steam Engineering), 111
- L
- LANCASHIRE Dynamo and Motor Co., Ltd., 49, 56, 57
 Large "Spot" Welders (American General Electric Co.), 78, 80 *et seq.*
 Large "Spot" Welding Machine, A (Pontelec), 103
 Line Welding, 2
 Link Welder, Chain (B.I.W.), 43, 44
 Lloyd & Lloyd, Ltd., 3
 Lloyd's Register, 1, 97
 Lloyd's Register, Tentative Regulations for Electric Welding, 97
 Locomotive Frame, Cracked, Repair of, 116

- Lorry, Motor, Arc Welding Equipments (Tilling-Stevens), 65 *et seq.*
 Lorry, Motor, British Westinghouse Arc Welding Equipment on, 49, 50
 Loss in Steadying Resistances During Arc Welding, 52
- M**
- MACHINE**, A Large British "Spot" Welding, 103
 Machine, Arc Welding (Benardos), 3, 4
 Machine, Chain-link-forming (B.I.W.), 41
 Machine for Brazing Collars on Tubes (Pontelec), 28
 Machine for Soldering Spectacle-frames (Pontelec), 29
 Machine for Welding Drills (B.I.W.), 41
 Manufacture of Chains, Machines for (B.I.W.), 41 *et seq.*
 Marquand, Mr. H. S., 51
 Mather & Platt, Ltd., 49
 Mavor & Coulson, Ltd., 49
 Metal, "Non-arcing," 92
 Metals, Cutting, by the Quasi-arc Process, 37
 Metals, Separation or Disunion of, Benardos, 11
 Mild Steel Electrodes suggested by Mr. T. T. Heaton, 3
 Miscellaneous Repair Work, "Butt" Welder for (Electric Welding Co.), 77
 Modulus of Elasticity of Electric Welds, 98
 Motor Lorry, Arc Welding Equipments (Tilling-Stevens), 65 *et seq.*
 Motor Lorry, British Westinghouse Arc Welding Equipment on, 49, 50
 Motor Generators for Arc Welding, 4, 49 *et seq.*, 70, 73
- N**
- Nassovia*, German Liner, 108
 Navy, U.S., Secretary of, 108, 111
 Noble, Mr. P. O. (American General Electric Co.), 62
- O**
- OIL Drums, Manufacture of, by Resistance Welding, 84
 Oil Drums, Resistance Welders for the Manufacture of, 87
 Olszewski, Benardos and, Patent of, 8, 20
 Stanilaus, 8
 Operators, Training of, Time taken in, 21, 89
 Overhead Welding, 36
- P**
- PATENT**, Benardos and Olszewski, 8
 Peebles, Bruce & Co., Ltd., 49
 Peters, G. D. & Co., Ltd., 111
 Phoenix Dynamo Manufacturing Co., Ltd., 25, 49
 Plastic-arc Welding and Cutting Panel, 113
 System, The, 108 *et seq.*
 Plate and Sheet Welding, Sizes of Quasi-arc Electrodes required for, 37
 Plate Armour, Suggested Formation of, Benardos, 12
- Pocahontas*, Repaired and Re-named German Liner, 111
 "Point-union," 9
 Point, Multiple, Welding, 27
 Polarity of Electrodes in Arc Welding, 2
 Pontevec Machine for Brazing Collars on Tubes, 28
 Pontevec Methods and Machines, 25
 Resistance Welder, 26
 "Spot" Welder, Large, 103
 Typical, "Seam" Welder, 31, 32
 Welding Patents, Ltd., 25 *et seq.*, 103, 105
 Pontevec Welding Processes, 27 *et seq.*
 Portable Welding Set (Crompton), 72
 (J. H. Holmes), 65, 66
 Portable Welding Set (Premier Electric Welding Co.), 53 *et seq.*
 Precautions to be taken when Arc Welding, 4
 Premier Electric Welding Co., 49, 53 *et seq.*
 Premier Welding Set in Cabin, 54
 Pressure, Hydraulic, for Consolidating Welds, 75
 Prinz Joachim, German Steamship, Damage to, 109
 Prinzess Irene, German Steamship, Damage to, 109
 Process, The Benardos Carbon Arc, 8
 The Quasi-arc, 33 *et seq.*
 Processes, Pontevec Welding, 27
- Q**
- QUASI-ARC Co., Ltd.**, 31 *et seq.*
 Electrodes, 35
 Quasi-arc Electrodes, Current Limits Admissible with Different Sizes of, 36
 Quasi-arc Electrodes, Sizes Required for Sheet and Plate Welding, 37
 Quasi-arc Process, The, 33 *et seq.*
 Cutting Metals by, 37
- R**
- RADIAL** Blocks, "Butt" Welder with, 76, 77
 Railway, Grand Trunk, Repairs on, 115
 Rawson, Woodhouse &, 25
 Reactance in Arc Welding Circuit, 62
 Rees-Roturbo Manufacturing Co., Ltd., The, 49
 Regulating, Self-, Generators for Arc Welding, 51; 53 *et seq.*, 62, 70
 Reinforcing Worn or Weak Work, 36
 Repair Work, Miscellaneous, "Butt" Welder for (Electric Welding Co.), 77
 Repair Work, Railway, 115
 Resistance Frame for Arc Welding (J. H. Holmes), 65, 67
 Resistance, Steadying, for Arc Welding, 3, 33, 34, 52, 65, 67
 Resistance, Steadying, Loss in, 52
 Resistance Welder, Caps for Electrodes of Large, 83
 Resistance Welders (A1), 89 *et seq.*
 (B.I.W.), 39 *et seq.*
 Resistance Welders, Electric Welding Co., Ltd., 75 *et seq.*
 Resistance Welders for Oil-drum-making, 87

- Resistance Welders, Large American "Spot," 78, 80 *et seq.*
 Resistance Welders (Ponlelec), 25 *et seq.*, 103
 Resistance Welding, 1, 14, 15, 25, 38, 39, 75, 89
 Resistance Welding, Discovery of, by Elihu Thomson, 14
 Resistance Welding, Manufacture of Oil-drums by, 84
 Resistance Welding, Voltage for, 15
 Ridge Welding (Ponlelec), 28
 Riveted and Welded Joints, Comparative Strength of, 101
 Rotary Converter (A I Manufacturing Co.), 96
 Rotary Transformer (Equipment and Engineering Co.), 64
 Roturbo Manufacturing Co., Ltd., The Rees, 49
- S
- SCREENS for Arc Welding, 5, 20, 71
 "Seam" Welder, Longitudinal (A I), 89
 "Seam" Welder, Typical Ponlelec, 31, 32
 Seam Welding, 3, 9, 17, 31, 45 *et seq.*
 Welding Attachments (A I), 89, 95
 "Seam" Welding, Diagram Showing Principle of, 17
 "Seam" Welders, Examples of B.I.W., 45, 46
 Self-contained Arc-welding Set (Crompton), 73
 Self-regulating Generators for Arc Welding, 51, 53 *et seq.*, 62, 70
 Separation or Disunion of Metals (Benardos), 11
 Sheet and Plate Welding, Sizes of Quasi-arc Electrodes required for, 37
 Ship Work, American "Spot" Welders for, 80
 Skill, Operator's, Percentage Factor in Successful Welding, 21
 Slag-forming Coating for Electrodes, 6, 33
 Slavianoff, 3
 Soames, Mr. Alfred, 58
 Spectacle-frames, Machine for Soldering (Ponlelec), 29
 "Spot" Welder (A I Manufacturing Co.), 90
 for bench Work (Ponlelec), 30
 "Spot" Welder, Large American, for Ship Work, 80
 "Spot" Welder, Large American Duplex, 81
 Typical Ponlelec, 30
 Welders (B.I.W.), 47, 48
 Welding, 2, 9, 16, 26, 27, 30, 31, 47, *et seq.*, 78, 80 *et seq.*, 90 *et seq.*, 103 *et seq.*
 "Spot" Welding, Diagram Showing Principle of, 16
 "Spot" Welding Machine, A Large British (Ponlelec), 103 *et seq.*
 Standard Parts Co., Cleveland, Ohio, 14
 Steadying Resistance for Arc Welding, 3, 33, 34, 52, 65, 67
 Steel Barrel Co., Ltd., Uxbridge, 3, 19, 84
 Works, Arc Welding at, 19
 Steel Barrels, Description of making of by Carbon Arc Welding, 21
 Stewarts & Lloyd, Ltd., 3
 Strength of Electric Welds, 97
 Strips, "Butt" Welder for (Electric Welding Co.), 79
 Strohmenger, Mr. Arthur Percy (Quasi-arc), 33
 Switch, Automatic ("A I"), 91
 System, The Benardos Arc Welding, 8 *et seq.*
 The Plastic-arc Welding, 108
 of Arc Welding, The A.C., 117
 of Arc Welding, The Benardos, 8 *et seq.*
 Thomson Welding, Diagram of, 16
- T
- TEMPERATURE of Arc, 4
 "Thickness, Added," 89
 Thomson Electric Welding Co., The, 15
 Elihu, 1, 14
 -Houston Electric Co., 14
 Welding System, Diagram of, 16
 Tilling-Stevens, Ltd., 65 *et seq.*
 Traction Work, Rotary Transformer for Welding Work in, 64
 Training of Welding Operators, Time taken in, 21, 89
 Transformer, Arrangement of, for Large American "Spot" Welder, 81, 82
 Transformer, Arrangement of, for Large Ponlelec "Spot" Welder, 106, 107
 Transformer, Rotary, for Traction Arc Welding Work, 64
 Transformer, Static (Electric Welding Co.), 75
 Transformers, Regulating, 80
 Transformers, Static, 3, 14 *et seq.*, 16, 75, 80, 81, 82, 106
 Tubes, "Butt" Welder for (Electric Welding Co.), 75, 76
 Tubes, Machine for Brazing Collars on (Ponlelec), 28
 Typical Ponlelec "Seam" Welder, 31, 32
 "Spot" Welder, 30
 Tyres, "Butt" Welding of, Diagram showing principle of, 17
- U
- ULTIMATE Strength and Elongation of Welded Material, 98
 "Union, Continuous-" Welding (Benardos), 9
 "Union, Point-" Welding (Benardos), 9
 United States Shipping Board, 100
 Uxbridge, Steel Barrel Co.'s Works at, 19, 84
- V
- VARIATION of Current in Arc Welding, 4
 Vaterland, German Liner, Damage to, 108
 Voltage for Arc Welding, 2, 24, 33, 61, 111, 115, 119
 Voltage for Plastic-arc Welding, 111, 115
 of A.C. Co.'s Machines, 121
- W
- Washington, George, German Liner, Damage to, 109
 Weld, Absorption of Oxygen by, 5
 Welded Barge, Electrically, 5
 and Riveted Joints, Comparison of, 101
 Welded Material, Ultimate Strength and Elongation of, 98

- Welder, "Butt" (B.I.W.), 40, 43
 Welder, "Butt," for Tubes (Electric Welding Co.), 75, 76
 Welder, "Butt," with Radial Welding Blocks (Electric Welding Co.), 76, 77
 Welder, Chain Link (B.I.W.), 43, 44
 Hand-operated (Electric Welding Co.), 77, 79
 Welder, Jews' Harp (Elihu Thomson), 14
 Large American Duplex "Spot," 81
 Resistance, Typical Pontelec, 26
 Welder, "Spot" for Bench Work (Pontelec), 30
 Welders, "Butt" (A 1 Manufacturing Co., Ltd.), 89
 Welders for Longitudinal Seams, 31, 32, 87
 Welders, "Spot," for Ship Work, American, 80
 for Steel barrel Manufacture, 87
 Resistance (Electric Welding Co.), 75 *et seq.*
 Welders, "Seam" (B.I.W.), Examples of, 45, 46
 "Spot" (A 1), 89, 90
 (B.I.W.), 47, 48
 Wire (B.I.W.), 39
 Welding, Acetylene, 2, 19
 Welding, Arc, 1 *et seq.*, 14 *et seq.*, 19 *et seq.*, 33, 49, 65, 108 *et seq.*, 117
 Welding, Arc, at a Steel Barrel Works, 19
 Welding, Arc, Electrode Holders for, 9, 20, 70, 71, 73, 120
 Welding, Arc, Helmet for, 4, 5
 Welding, Arc, Machines and Apparatus for, 49 *et seq.*
 Welding, Arc, Precautions to be taken when, 4
 Welding, Arc, Set, The "Constant-Energy," 62, 63
 Welding, Arc, Set, Petrol-driven, Self-contained (Crompton), 70
 Welding, Arc, Set, Petrol-driven, Self-contained (J. H. Holmes), 65, 66
 Welding, Arc, Set (Lancashire Dynamo and Motor Co.), 56, 57
 Welding, Arc, Steadying Resistance for, 3, 33, 34, 52, 65, 67
 Welding, Bridge, 27
 Welding by Arc Struck between Two Electrodes, 3
 Welding, "Butt," 2, 17, 31, 39 *et seq.*, 76 *et seq.*, 89 *et seq.*
 Welding, "Butt," of Tyres, 17, 31
 Cast Iron, 36
 Welding, "Continuous," or "Point," Machine for (Benardos), 11
 Welding, "Continuous-union" (Benardos), 9
 Disc (Pontelec), 27
 Drills, Machine for (B.I.W.), 41
 Welding Hoops, Machine for (Electric Welding Co.), 78, 79
 Welding, Line, 2
 Machine, a Large British "Spot," 103
 Machines, Examples of Benardos, 10, 11
 Multiple-point (Pontelec), 27
 Overhead, 36
 Polarity of Electrodes in Arc, 2
 "Point" Machine for (Benardos), 10
 "Point-union" (Benardos), 9
 Portable Arc Plant (Premier), 54, 55
 Processes of (Pontelec), 27
 Premier Electric Co., The, 49
 Welding, Resistance, 1, 14 *et seq.*, 25, 39, 75 *et seq.*, 84 *et seq.*, 89 *et seq.*
 Welding, Resistance, Discovery of, by Elihu Thomson, 14
 Welding, "Ridge" (Pontelec), 28
 "Seam," 2, 9, 17, 32, 44 *et seq.*
 Welding, "Seam," Diagram showing Principle of, 16
 Welding, Sheet and Plate, Sizes of Quasi-arc Electrodes required for, 27
 Welding, "Spot," 2, 9, 16, 26, 27, 30, 31, 47 *et seq.*, 78 *et seq.*, 84 *et seq.*, 89 *et seq.*, 103
 Welding, "Spot," Diagram showing principle of, 16
 Welding System, The Thomson, Diagram of, 16
 The Electric Co., Ltd., 49
 Thomson, System of, 14, 25
 Welds, Electric, Defects in, 6
 The Strength of, 97 *et seq.*, 115
 Gas Bubbles in, 6
 Westinghouse Co., The British, Arc Welding Equipment for Motor Lorry, 49, 50
 Weyman, Mr. J. E., 65
 Wilson System of Welding, List of Vessels Repaired by, 112
 Wilson System of Welding (Plastic-arc), 111
 Wilson Welder and Metals Co., 108
 Wire, Earthing, 91
 Welders (B.I.W.), 39
 Woodhouse & Rawson, 25

Z

 ZERENER of Leipzig, 3

89089662217



b89089662217a