

TS 227
.L5
1921
Copy 1

ELECTRIC ARC WELDING

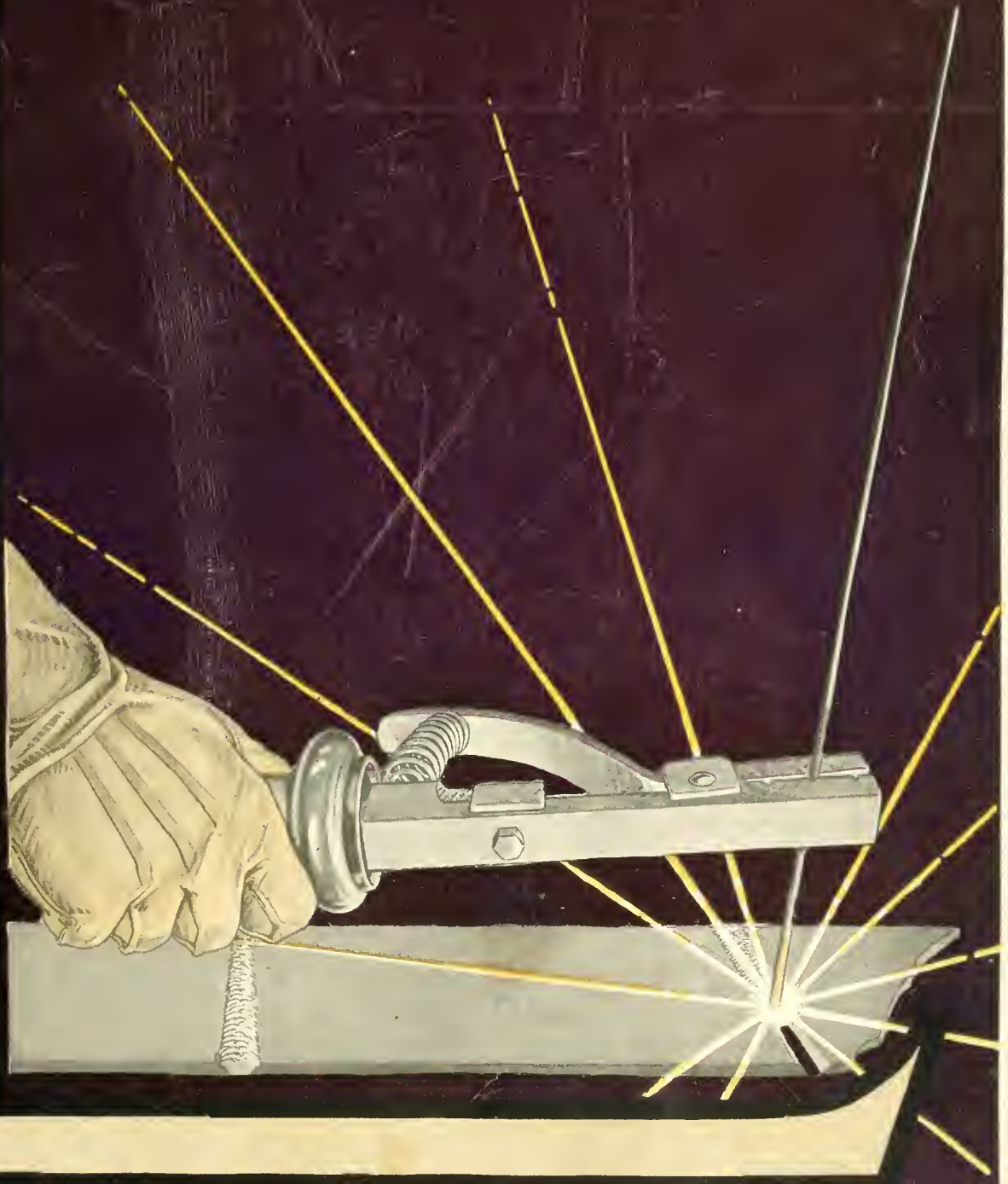

AUG 26 1921

Electric Arc Welding

*SIXTH
EDITION*

PUBLISHED BY

The Lincoln Electric Co.

GENERAL OFFICES AND PLANT

CLEVELAND, OHIO

Standard Lincoln Motor
Operating Under Water

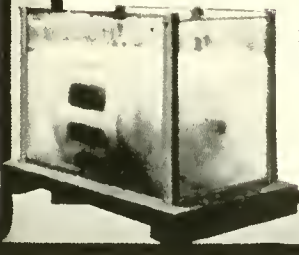

Branch Offices at

New York City	Philadelphia	Hartford, Conn.
Buffalo	Detroit	Chicago
Syracuse	Columbus	Charlotte, N. C.
Boston	Pittsburgh	Toronto
Cincinnati	Minneapolis	Montreal

Agencies in other principal cities



7-21-11

© 1A623399

21 /

ELECTRIC ARC WELDING

WELDING in the modern sense of the word, covers a number of distinct operations. In order to thoroughly understand the subject it is necessary to divide welding into two classes of work. 1st, forge or pressure welding, 2nd, autogenous welding.

Forge or Pressure Welding

This term, for want of a better one, is applied to welding processes where two pieces of metal are heated to the plastic state, then forced together by pressure or hammering to thoroughly unite them, and complete the weld. The familiar example of this is the weld which the blacksmith makes by heating two pieces of steel or iron in the forge fire, then hammering the ends together on his anvil.

A weld similar to this has been made for some time by the use of electricity, where two pieces of metal are heated by an electric current, then forced together to complete the weld. This process is known as butt or spot welding and is *not* the process under discussion in this book.

Autogenous Welding

This term is applied to welds which are made by heating metals to such temperature that they will fuse together on contact, without any pressure being applied. The difference between autogenous welds and those formerly described is mainly the difference in temperature of the metal. In the autogenous weld, the metal is heated to a state of fluidity and the two pieces flow together.

The use of the autogenous process, however, is not confined to the uniting of two pieces of metal. It is used to even a greater extent for adding molten metal to other metal pieces or parts, thus building them up or filling defects.

Electric Arc Welding

Electric Arc Welding is an autogenous process. It is used both for joining metal parts and also for adding or building metal on such parts. In fact, when two pieces are welded together by this process, it is done by filling in molten metal, between the two pieces, rather than by melting the two so that they will join.

The Electric Arc

The Electric Arc is formed when electric current is made to jump or arc from one electric conductor to another, through the air or some other substance, which is not a good conductor of electricity.

A familiar example of this is the sparking which occurs when you touch together two wires connected with an ordinary electric door bell battery. Another familiar example is the spark which passes between two wire terminals on the spark plug in the automobile engine and serves to ignite the gas.

The arc or spark is produced because the electric current is forced through a medium which offers great resistance to its passage and hence produces heat.

The object, or the conductor, *from* which the current comes is called the positive electrode, the object *to* which it passes is called the negative electrode.

In arc welding, one wire of an electric circuit is attached to or laid upon the steel which is to be welded, the other wire is attached to a piece of carbon or metal which the welder holds and which is called the negative electrode. The current passes or arcs from the piece which is to be welded to the electrode which the operator holds. In doing so it creates such great heat on the

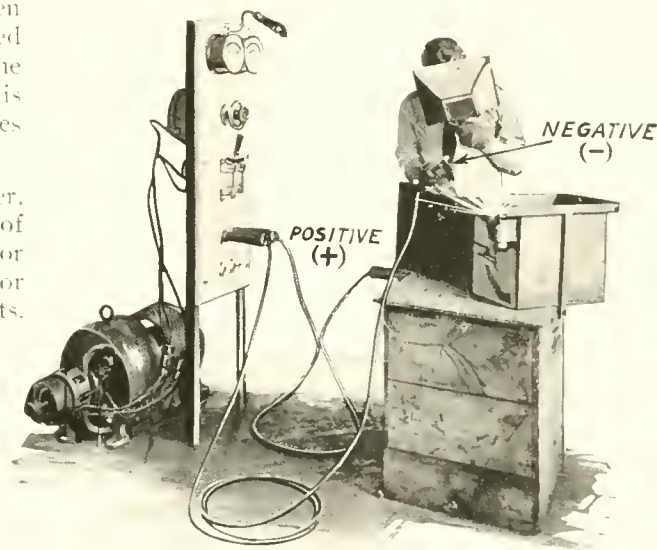

Fig. 1. In arc welding, one wire (the positive) from the welding apparatus is attached or laid upon the steel which is to be welded; the other wire (the negative) is attached to the electrode of carbon or metal which the operator holds.

ELECTRIC ARC WELDING

piece, that the portion of the piece around the arc actually melts and turns into vapor and the arc is continuously passing through this vapor.

The only purpose of the electric arc in welding is to produce the heat for melting the metal.

Advantages of the Arc

The electric arc has no mysterious qualities which makes it especially adapted for welding purposes. It is simply the most efficient means known for producing welding heat.

Heat for welding purposes may be supplied by the blacksmith's forge fire, by chemical combination of materials such as thermit or by the burning of a gas such as acetylene in the presence of oxygen. The heat produced by any of these agencies is the same in every particular as that produced by the electric arc; the only advantages of the arc are:

- 1st—Production of a Higher Temperature.
- 2nd—Convenience in Application.
- 3rd—Low Cost.

Arc Produces Great Heat

It is a well known fact that the highest obtainable temperature can be produced in the electric arc. In fact, a temperature can be reached which is so high that it cannot be measured with any instruments developed up to the present time. The reason an electric arc produces such a high temperature is that a large amount of heat is produced in a very small area. This in itself suggests why the arc is the most efficient means of heating metals for welding.

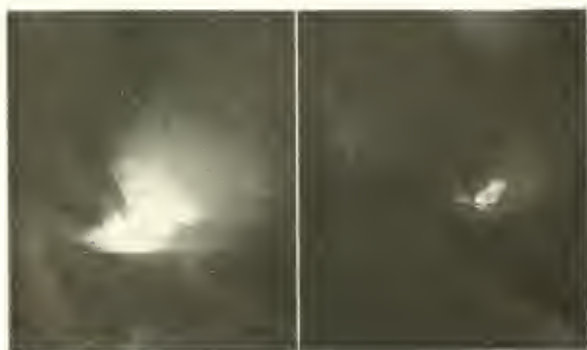

Fig. 2. Photograph of Electric Arc in operation. A large amount of heat is produced in a very small area, which makes the arc a most efficient means of heating metals. (Courtesy THE WELDING ENGINEER.)

Adaptability of Different Processes

As stated above, any of the other methods of producing heat will serve for welding work, but the difficulty comes in applying them in just the way desired.

The forge fire, for instance, serves very well where two pieces of metal can be placed in it, heated and then put together as they are on the anvil. This application is, of course, very limited. In fact, most welding is now done by the addition of new metal between the welded pieces.

Thermit Welding

It was the necessity of adding new metal in certain welds which led to the development of the Thermit process of welding. This process depends upon the chemical combination of certain substances which produce a great heat and release molten iron from the combination. This process has been wonderfully successful. Its advantages can be readily seen in case of two pieces such as a broken locomotive frame, which could not be conveniently welded by the forge process. By building up a mold around the two ends and by pouring in the molten steel generated by the Thermit process, new metal could be added between the ends and they could be thoroughly united.

Thermit welding is in fact a casting process and always requires the mold built up around the parts to be joined and usually requires pre-heating of those parts in a charcoal fire or by gas torches. While applicable to quite a range of repair work, it is not usable in the great field of welding, recently developed.

Oxy Acetylene Welding

Oxy-Acetylene Welding has the advantage over both forge welding and thermit welding in that this process can be applied to any surface. The heat is produced by burning acetylene gas in oxygen gas.

Oxy-acetylene has gradually widened the use of welding and has made it a common manufacturing process. Even the small garage, the blacksmith, and the jeweler can now use oxy-acetylene welding and make great savings over former methods.

COMPARED WITH OTHER PROCESSES

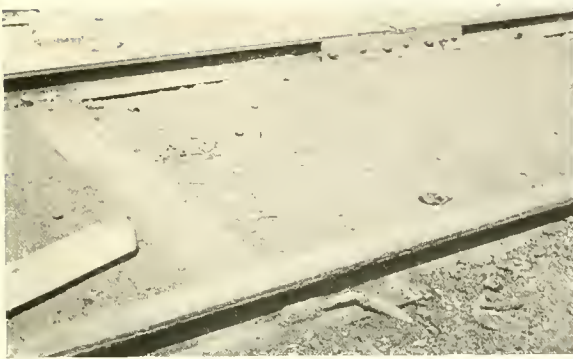

Fig. 3. A rail which has been welded together by the electric arc process and is as solid as a new rail.

The cutting of metals by oxy-acetylene is another field which has been very widely developed. It is used for cutting up scrap, for wrecking steel structures, bridges, vessels, etc., and is without any rival as far as speed is concerned in this field of work.

There are many places, however, where even acetylene welding cannot be conveniently or successfully applied. In the first place, the heat of the acetylene torch is spread over a relatively wide area. The greatest heat in the acetylene torch is produced at a point in the inside of the flame proper, and in order to get this point down to the metal, it is necessary to hold the flame very close so that it spreads out over the surface of the metal to a considerable degree.

In welding steel sheets or plates, for instance this causes a great deal of difficulty, owing to the buckling and bulging of the sheets, produced by the wide heating.

At a recent convention of the Railway Master Blacksmiths' Association, Joseph Grine, of the New York Central Railroad, in discussing this point says, "In welding boiler sheets the electric process is superior to oxy-acetylene because the latter generates too much heat and causes the sheets to buckle."

In another discussion of this same subject at a General Foreman's Convention, J. M. Kerwin of the Chicago, Rock Island Railroad, says, "We use the electric and oxy-acetylene processes, and have found that the electric is the best for welding patches and cracks, and oxy-acetylene is best for cutting."



Fig. 4. A rail which has been welded together by the oxy-acetylene process but owing to the severe contraction of the metal on cooling the rail has broken.

Still another expression of opinion is given by the Committee On Design, of The American Railway Master Mechanics' Association, who state, in their report, "From the reports received from different roads, they indicate that considerable difficulty is experienced from welding flues with oxy-acetylene process, while roads using the electric process report very satisfactory results."

These opinions from railway men, are given at length, because of their very wide experience with welding processes.

Safety

Another factor which enters into consideration of the acetylene process is the matter of safety. It is not to be denied that there is a great element of danger in the oxy-acetylene welding process, particularly where a generating plant is used.

At the meeting of the West Coast Safety Engineers' Association, in San Francisco, January, 1917, R. L. Hemingway, of the Industrial Accident Commission of California, called particular attention to the possible small amounts of hydrogen existing in the oxygen gas and this commission has issued a warning to the public not to use oxygen gas, for acetylene welding, unless absolutely assured that it does not contain more than 2% of hydrogen gas.

These matters are not brought up in any effort to discredit acetylene welding, but because they are necessary to any intelligent practical consideration of the subject.

ELECTRIC ARC WELDING

Arc Welding is Convenient and Safe

Now let us compare arc welding with the other processes, as to convenience and safety.

Arc welding can be applied anywhere that electric current is available or can be generated, and where an electric cable can be carried. It



Fig. 5. Arc Welding can be applied anywhere that electric current is available and a cable can be carried. This is the most convenient method of welding.

can be used inside boilers and fire boxes, in ship holds, perhaps the most inaccessible location that can be imagined. Owing to the action of the arc seams, etc., can be welded over the head of the operator with no great difficulty.

Electric arc welding can be used for joining parts, for building in molten metal or for building up.

With apparatus of the proper design, arc welding is the simplest welding process in existence. It requires a minimum of preparation. Preheating of the parts to be welded is necessary only in the case of high carbon steel or cast iron. The heat is applied on a very small area, so that there is no buckling or undue expansion of sheets or plates.

The steel for filling in or building on is produced by the melting of the electrode which the operator holds in his right hand, thus the left hand is always free for placing of parts and adjustments, making the process practically continuous.

There is absolutely no danger in the operation of properly constructed electric arc welding apparatus.

The voltage employed is very low, in fact lower than that of a residence lighting system, and cannot by any possibility injure the operator.

Comparative Cost of Arc Welding and Acetylene Welding

It is not necessary to discuss the forge welding process or thermit welding, as to cost. In each of these processes the cost of preparing the parts for welding is very high and neither of the processes are usable except in certain limited applications.

The question of cost resolves itself into a comparison of electric arc welding with oxy-acetylene. The simple fact that the electric arc produces a higher temperature than the acetylene gives the arc a decided advantage.

Perhaps the best comparison can be obtained by giving actual figures on such operations. One large manufacturer of tanks and similar products, employs both oxy-acetylene and arc processes and has made careful comparisons of cost. The report from one particular test made on identically the same work is summarized below and shows conclusively that the arc will weld this tank at less than one-half the cost of the acetylene process.

Objects Welded: Six 215 gallon tanks, $\frac{3}{16}$ " shell, $\frac{1}{4}$ " heads with one 3" and 2" and 1 $\frac{1}{4}$ " standard couplings.

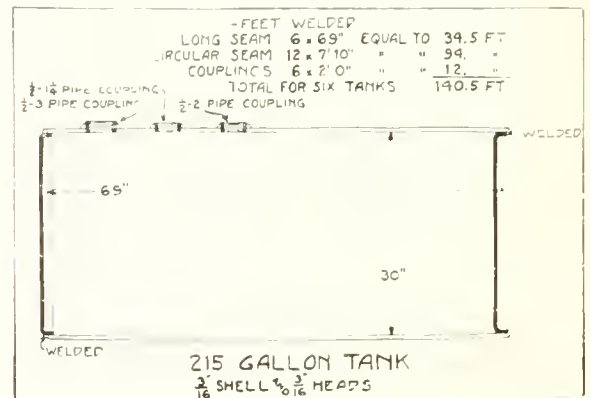

Fig. 6. 215 Gallon Tank on which comparative cost test was made.

COMPARATIVE COSTS

Acetylene Welding

Welding Outfit:—Stationary Generator, No. 2,
Welding torch number 7 and 8 tip.

Time of welding, 18¼ hrs. @ 30c per hr. \$ 5.78
Oxygen consumed, 371 cu. ft. at .0135c..... 5.0085
Acetylene consumed 325 cu. ft. at .008c cu. ft. ... 2.60
Filling material, 15¾ lbs. at 12c per lb. 1.89

Total cost for 6 tanks.....\$15.2785
Cost of welding 1 tank..... 2.51

Arc Welding

Welding Outfit—Transportable type for one operator,
manufactured by The Lincoln Electric Co., Cleveland,
Ohio.

Time of welding, 14 hrs. @ 30c per hr.....\$4.20
Kilowatts consumed, 60 kilowatts @ 2c per..... 1.20
Filling rod used, 27 lbs. @ 7.3-10c..... 1.97

Total cost of 6 tanks.....\$7.37
Cost of welding 1 tank..... 1.23

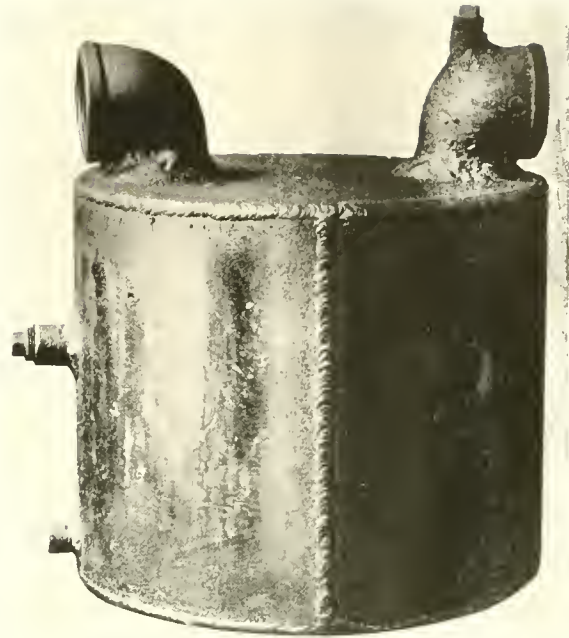

Fig. 7. Gas tank made by the Boom Boiler & Welder Co., Cleveland. This tank has been made both by arc welding and by acetylene welding. The arc welding costs 1 to 1½ as much as gas welding. The tank is tested at 150 lbs. water pressure.

The Railway Electrical Engineers' Association have made a very careful investigation of this subject, since the railroads use welding to an enormous extent. Their committee on this subject reporting at their 1916 Convention, states, "Three kilowatt hours of electric energy (cost 6 cents) will produce the same amount of heat as may be produced by approximately 6-6/10 cubic feet of acetylene (cost 11½ cents) and 7-5/10 cubic feet of oxygen (cost 15 cents)."

The parentheses in the above quotation are our own and they indicate the 1916 prices of electric current, acetylene and oxygen. The same ratio would still obtain. It will be seen that 6 cents expended in electric energy will do the same amount of welding work as 26½ cents spent for oxy-acetylene gas, on the assumption that the two processes make equally effective use of the heat produced.

This assumption, however, is not in accordance with the facts, since it can be shown that on any welding operation, the heat produced by the electric arc will be at least three times as effective; that is, three times as much welding can be accomplished with it as can be done by the same amount of heat produced by the oxy-acetylene torch.



Fig. 8. A radiator welded by the Standard Oil Co., of Indiana. Comparative costs by Acetylene and Arc Welding were as follows:

Cost of Acetylene Welding Radiators		
40 cu. ft. acetylene at	\$.01	\$.40
48 cu. ft. oxygen at	.16	7.68
2 hrs. time at	.45	.90

		\$2.08

Cost of same with Electric Weld		
16.6 K. W. H. at	\$.006 per K. W. H.	\$.10
2 hrs. time at	.45 per hr.	.90

		\$1.00

ELECTRIC ARC WELDING

The same committee submitted to the Convention, a chart which is reproduced on page 7, showing the cost comparison between gas and electric welding, based on the amount of heat produced.

The table on page 6 shows a complete comparison of costs compiled by an engineer, who has made a special subject of welding, in a number of different fields.

Gordon Fox, writing in the *Railway Mechanical Engineer*, November, 1916, sums the whole matter up as follows:

"For work on brass, bronze or aluminum the oxy-acetylene flame has no competition. The main point of superiority of the arc method is its economy, as the electric arc produces the necessary heat at a much lower cost than does the oxy-acetylene flame. In its field, the arc also produces results as good, if not better, than can be obtained with gas, i. e., flue-welding, etc. To avoid excessive cost, pre-heating is almost always necessary in gas welding, but may often be dispensed with in arc welding. The cost of electric power for a welding job will only be from 15 to 25 per cent of the cost of oxygen and acetylene for the same job."

It will be seen from a careful study of the above authorities that arc welding is beyond question far more economical than acetylene welding, where a large amount of work is to be done.

In a small shop, such as a garage or blacksmith, or in any place where welding is only done at long intervals, such as repair work in machine shops, the acetylene process has the advantage because of the low first cost of equipment.

Wherever there is work enough in a commercial welding shop to keep two or three operators continually busy, arc welding will show a saving great enough to pay for the additional cost of equipment in a very short time.

In a manufacturing plant where the work can be done with the arc, it will sometimes pay to install an arc welder when there is only enough work to keep an operator busy with the gas torch five hours per day.

While some saving may be made in acetylene welding, by generating the acetylene at the plant, a good generator for this purpose will cost quite as much as arc welding apparatus, and acetylene welding will still cost twice as much as the arc process.

TABLE OF COMPARATIVE WELDING COSTS—METAL SHEETS AND PLATES
BASED ON FIGURES IN YEAR 1919

Thickness of Metal	<i>Acetylene Welding</i>				<i>Arc Welding</i>						
	Cost Acetylene	Cost Oxygen	Time per hr.	Cost Gas	Cost per foot welded	Amperes per in. Arc	K. W. Input M. G. Set	Cost of Power	Feet welded per hr.	Total Cost per hr.	Cost per ft. welded
1/8	3.21	3.65	30	.14	.74	50	3.00	.06	25	.66	.026
1/4	4.84	5.50	25	.21	.81	60	3.08	.06	20	.66	.033
3/8	8.14	9.28	20	.35	.95	80	3.20	.06	15	.66	.044
1/2	12.50	14.27	15	.53	1.13	90	3.52	.07	10	.67	.067
5/8	17.81	21.32	9	.77	1.37	110	4.15	.08	8	.68	.085
3/4	24.97	28.46	6	1.06	1.66	120	4.30	.09	8	.69	.086
7/8	33.24	37.90	5	1.41	2.01	140	4.75	.10	5	.70	.140
1	41.99	47.87	4	1.78	2.38	150	5.75	.12	3	.72	.240
1 1/8	57.85	65.95	3	2.45	3.05	160	5.85	.12	3	.72	.240

Above data based on following costs: Acetylene 21¢ per cu. ft. Oxygen 13¢ per cu. ft.
Power 2¢ per K. W. Hr. Labor 60¢ per Hr.
Calorific value of acetylene is 1555 B. T. U. per cu. ft. One K. W. Hr. is equivalent to 3413 B. T. U.

CARBON AND METAL ELECTRODES

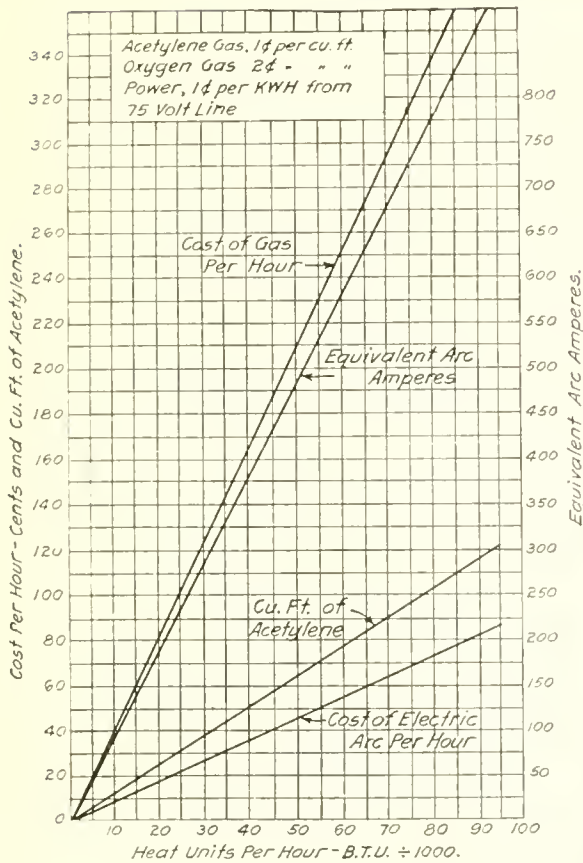

Fig. 9. Curves showing the comparison between cost of gas and electric welding based on the number of heat units per hour. Taken from Association of Railway Electrical Engineers Report.

Carbon and Metal Electrode

In electric arc welding there are two distinct processes. In one, the electrode manipulated by the operator is a carbon pencil, from $\frac{1}{4}$ inch to $1\frac{1}{2}$ inch in diameter, and 6 to 12 inches in length, pointed to bring the arc into as small a space as possible. The carbon arc is simply used to supply the heat and the operator feeds in the filling metal from a melt bar held in his left hand.

In the other process, known as the metal electrode process, the electrode is a metal wire of comparatively small diameter and this wire gradually melts itself away, furnishing the metal for filling.

The carbon electrode process is only used where it is desired to do fast melting and to

heat over a large area. Such work would be found in the filling in of large holes in castings. The carbon arc demands from 300 to 600 amperes of current and the heat produced is so intense and the glare so blinding that the operator must wear gauntlet gloves and a shield completely covering the head and shoulders.

The metal electrode process is used for 90 per cent of all welding work. The heat is only spread over a very small area, enabling the operator to deposit the metal very accurately on edges of sheets, plates, etc. This process requires 50 to 250 amperes current and since the heat is not so intense the head and shoulder

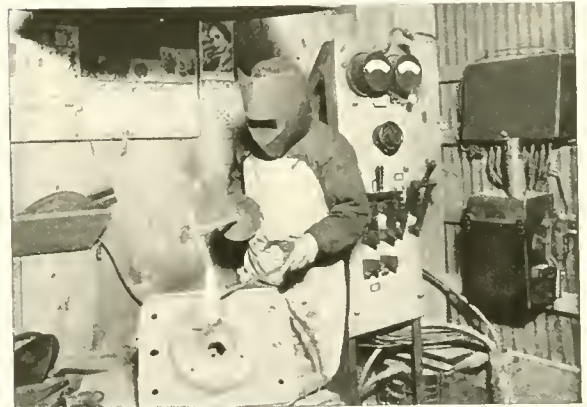

Fig. 10. Carbon Electrode Welding. The operator holds the carbon electrode with the right hand and feeds the filling metal into the weld from a roll held in his left hand.



Fig. 11. Metal Electrode Welding. The electrode in this case is a metal wire of small diameter and this wire gradually melts itself away, furnishing metal for the weld.

ELECTRIC ARC WELDING

shield is not necessary but a face shield with colored glasses can be worn instead.

The question of which process to use is determined entirely by the work to be done and a good idea can be obtained by studying the various applications of welding presented later in this book.

Operation of Electric Arc

Generally speaking, no greater skill is required in the operation of the electric arc than would be necessary in any other modern manufacturing process. An intelligent man can learn to do simple welding work in from two days to a week's time, depending on the nature of the work. Great skill is of course acquired by practice. Electrical knowledge is not necessary. The

apparatus now available for this use practically never needs attention and can be operated with less care than almost any machine tool used in the modern shop.

Characteristics of the Weld

It should never be overlooked in considering welding that the new metal in a weld is simply metal which has been melted and cooled again, and it partakes of the properties of a cast metal rather than of rolled or wrought metal.

For instance, in welding two pieces of boiler plate the weld will have just as great tensile strength as the original plate, but being cast steel it cannot have the ductility which rolled steel stock possesses. The cast steel in the weld may have the properties of ingot steel so far as ductility is concerned.

It used to be common opinion that a weld could not be made which could be readily machined, but this mistaken impression has long since been corrected. The weld, when properly made, can be machined as readily as any steel casting or flange steel.

Welding has been used to such an extent for repairing breakage and defects that unless thoroughly posted, the average man is apt to look upon it as a "patching" or "doctoring" process, whereas it is accepted in the most advanced engineering practice and is used to a wonderful extent in automobile, locomotive and other construction of the highest character.

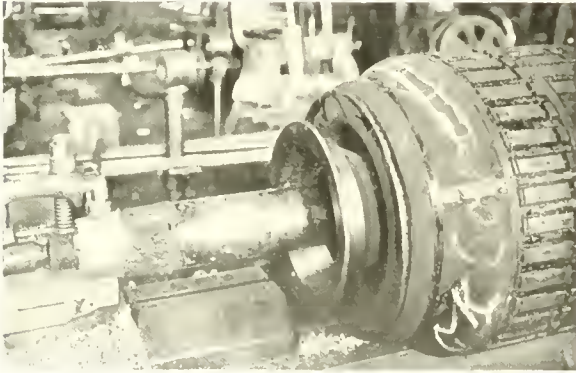

Fig. 12. An Arc Welded cast iron flange cut to the size of a machine shaft which has been worked to the full size by welding. The new metal has the same strength as the original.

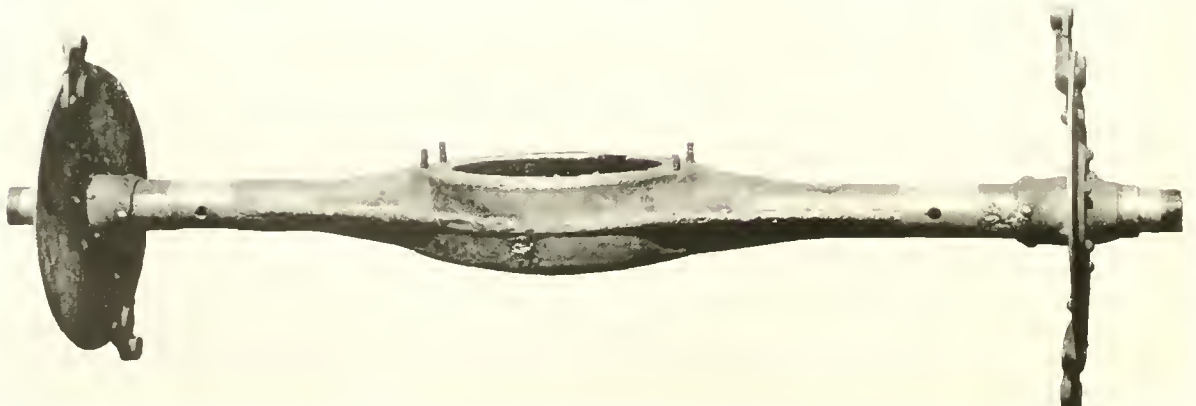

Fig. 13. Electric Arc Welded Automobile Rear Axle Housing

Applications of Arc Welding

It is beyond the power of any one man and certainly beyond the limits of this book to give an adequate idea of the applications of electric arc welding.

Within the last few years the apparatus for this purpose has been highly perfected. Such enormous strides have been made in its application and use, that it is difficult to see any limits to its adaptability.

The following pages are intended as an outline of work which has actually been done. To any one interested in applying the process to his product, the best advice is to consult an expert in this line of work as to the feasibility of the particular job he has in mind.

What Metals Can be Welded

Electric arc welding is most successful on steel, iron and the various alloys of these metals. It has been applied with great success to the welding of cast iron in various forms but cannot always, because of the great heat produced, be used on cast iron where the sections are thinner than $\frac{1}{4}$ inch.

The arc is not practicable for welding aluminum. Acetylene is the best process thus far discovered for this work.

General Rule

Wherever steel or iron parts are to be joined or breakage and wear of such parts repaired, there should at least be a careful investigation of the possibilities of arc welding. It can be stated with certainty that any job of this char-

acter which can be done with acetylene can be done at lower cost and at greater speed with the electric arc.

While the following pages do not represent one per cent of the total possible applications of this process, they will serve as suggestions to manufacturers and others interested in the high development of iron and steel fabrication.

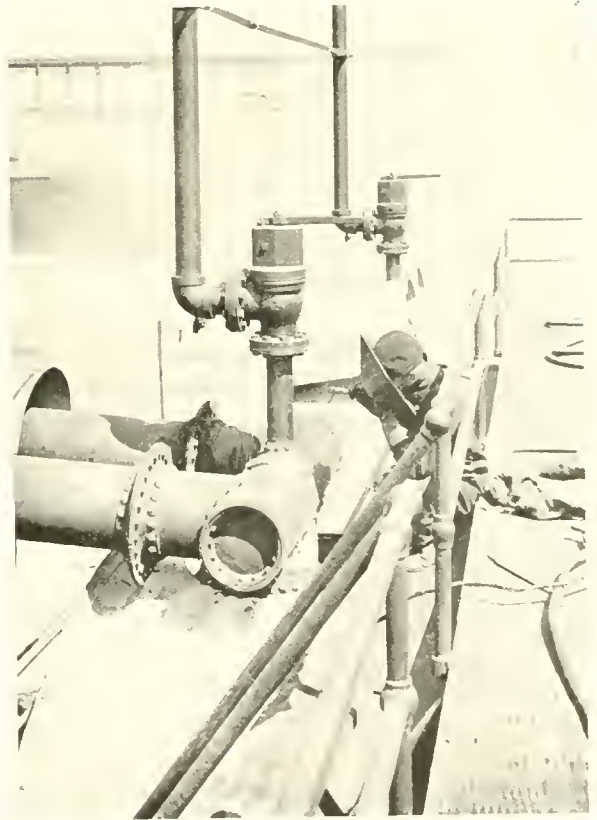

Fig. 14. Electric Arc Welder used by the Standard Oil Co. to caulk leaks in vapor lines and oil stills. The vapors are very inflammable and every joint must be absolutely tight, hence welding is used in addition to riveting. (See Fig. 73)

ELECTRIC ARC WELDING

Steel Foundries



Fig. 16. Filling blow hole in a cast steel motor truck wheel. These castings, though subject to severe strain, were approved for use in military motor trucks when defects were repaired with the electric arc.

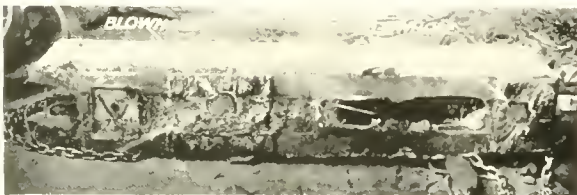

Fig. 15. Blow holes in steel casting which can be repaired in a few minutes by electric arc welding.

The first large commercial use of arc welding was in the repairing of defects in steel castings. The manufacture of these castings is a most difficult process owing to the high melting point and the difficulties of pouring molten steel.

Even in pouring the straight steel ingot, it is difficult enough to secure a sound ingot, owing to the gases which are given off, causing blow holes in the castings. In the more complicated shapes in which steel castings are made, it is almost impossible to produce a large run of castings without sand spots, caused by the washing away of parts of the mold, or blow holes caused by the formation of gases. Even where the casting is otherwise sound, the excessive shrinkage of the steel frequently causes shrinkage cracks to appear or causes undue strains to be set up in the inside of the casting itself. A few years ago, automobile construction and refinement in agricultural implements and other lines greatly

increased the demand for steel castings. Large numbers of these castings had small defects which did not seriously affect their strength, but did impair their appearance. The high cost of the steel castings and the percentage of waste



Fig. 17. Steel truck wheel casting (disk type). The defects in this wheel were found after machining had been done, and were perfectly welded and repaired with the Lincoln Arc Welder.

STEEL FOUNDRIES

led some one to hit upon the electric arc as a method of repairing these minor defects. They reproduced on a small scale the conditions of the electric furnace. It was a perfectly logical conclusion that if steel was melted and poured into these defects, the defect would be filled with cast steel which would be in every way as good as the rest of the casting.

It was not long before the steel foundryman and all users of steel castings became convinced of the merits of this process and castings with defects repaired in this manner were accepted and used without question, as being in every way equal to castings which came perfect from the mold.

Better Deliveries

This use of the electric arc has not only saved great sums of money for the steel foundryman, but it has greatly improved deliveries of castings. Formerly, the foundryman could not absolutely assure his customer that all of any given day's production could be counted upon, but with the introduction of the electric arc, defects are quickly repaired and delivery schedules can thus be accurately maintained.

Manufacturers who use steel castings frequently find it advisable to install their own welding outfits, thus saving the return of the castings to the foundry when small defects are discovered in machining or in testing.

In face of the traffic conditions recently existing one firm found it very profitable to install the arc welder rather than to ship the castings back to the foundry thirty miles away.

The use of the arc welder saved both money and time.

Less Skilled Labor

Electric arc welding has also relieved the labor situation in the foundry. It has become harder and harder to secure skilled labor, especially molders, for this work. The supply of such men does not keep pace with the increase in demand.

Under former conditions it was useless to put an apprentice on such work, as the material he would spoil and the floor space he would occupy would lose for the foundryman far more than it would gain for him.

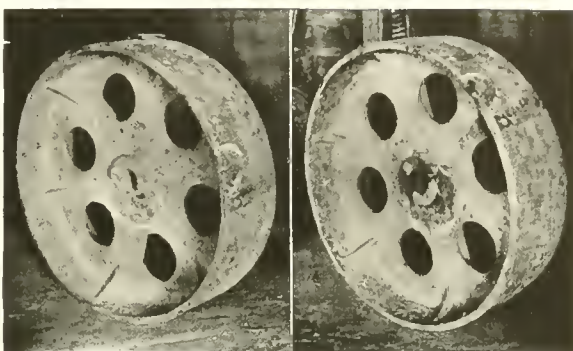

Fig. 18. Steel Pulley Casting on which a defective boss has been repaired by building up with the arc welder. A shrinkage crack in the rim had also been repaired by arc welding.

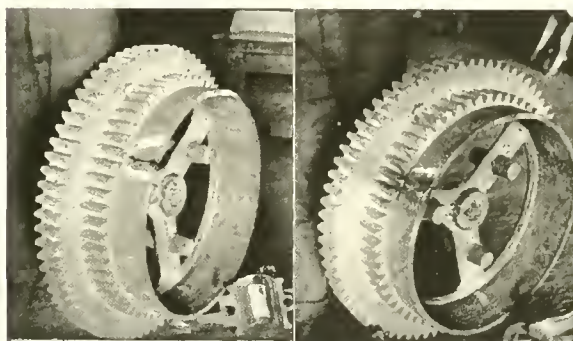

Fig. 19. Large Steel Gear showing shrinkage crack which would have made it necessary to scrap the casting had it not been for arc welding.



Fig. 20. Motor Bracket Steel Casting from which a riser has been cut with the arc welder. This cut was through about 3 inches of steel and took approximately six minutes.

ELECTRIC ARC WELDING

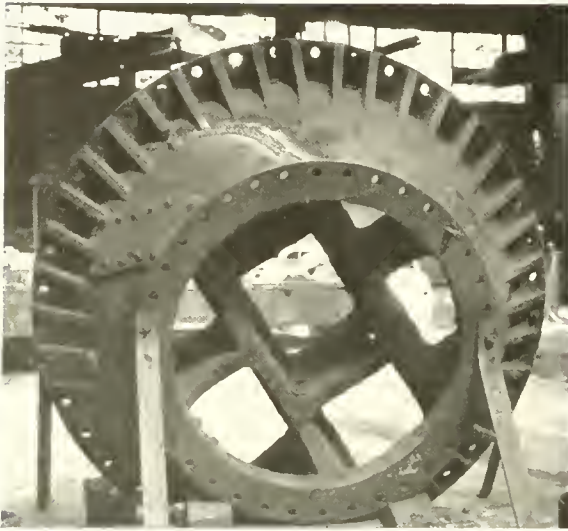

Fig. 22. Large steel casting repaired by arc welding after it had been in service. This casting was also been repaired once by riveting. Note how much cleaner the welded job is.



Fig. 23. Repairing defect in large casting with Lincoln Arc Welder.

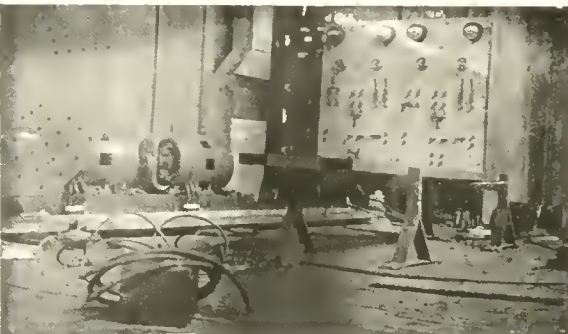

Fig. 23. Lincoln Arc Welders at the plant of William Wharton Co., Easton, Pa.

With the electric arc, however, the mistakes which the beginners make can in nine cases out of ten be remedied and one or two welders can take care of the work for a fairly large foundry, even where the proportion of cheap help is quite high.

As has been stated, arc welding is not in any sense a "patching" or "doctoring" process. The defective parts of the casting are melted and cast again in solid steel. These welded parts are just as strong as any other portion of the casting and when the work is carefully done they machine and finish perfectly. Many steel foundries where welders are in use arrange to take back castings which have shown defects in the machine shop and after welding them return them to the customer.

Operation of Arc

It is easy to prevent the usual trouble due to the so-called "chilled" or hard weld, by applying the arc for some minutes to the part to be welded, thus thoroughly pre-heating the surrounding metal. When the weld is made the whole mass then cools off slowly and the sudden chilling of the new metal is avoided.

The arc can be used for pre-heating the castings in exactly the same manner as the oxy-acetylene flame is used.

Sometimes a slag covering is provided to exclude the air from the molten metal and thus prevent the presence of oxide in the finished weld. This is only necessary in special cases.

With these simple precautions any steel foundry can use the arc welder successfully and save many castings that would otherwise be a dead loss.

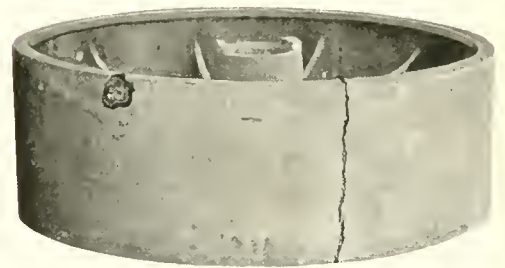

Fig. 24. Defective pulley casting. Repairing this with a Lincoln Arc Welder saved \$10.20 in 10 minutes.

STEEL FOUNDRIES

Welds Easily Machined

The weld in the casting is as soft and is as readily machined as any other portion of the work. The blow holes or shrinkage cracks, sand holes, etc., are first pre-heated by playing the arc over the surface, holding the casting in such a position that sand and foreign matter will be flushed out. This work is done with the carbon electrode. The filling material can be obtained from steel wire, especially made for the purpose or even from steel scraps or bars of suitable analysis. Burning out sand spots with the oxy-acetylene flame is impractical, because the reflected heat burns off the end of the tip. Where the oxy-acetylene flame is used, it is necessary to chip out sand spots with a pneumatic tool, which makes the cost of the operation very high.

Electric Steel Foundry

The electric steel foundry can use electric arc welding to particular advantage. In these castings, the metal electrode process will ordinarily be best suited. The defects can be chipped out with a pneumatic hammer and since they are not large, can be readily repaired with the metal electrode.

Sizes of Welders

The size of welder adapted for certain work is a matter which should be passed on by the manufacturer of the apparatus. However, certain general sizes can be suggested.

For steel foundries using the metal electrode or very light carbon electrodes on small work, a welder supplying 200 amperes will usually be sufficient. This is an ideal size for the electric steel foundries.

For the foundry making castings up to 1000 pounds, a welder should be used which has a 300 ampere capacity. For the very large foundry, where large work is produced a 400 ampere welder is the ideal size, and is arranged so that two or more machines can be connected together in parallel, thus giving the current for heavy carbon electrode cutting.

Equipment

See page 46 for illustration of apparatus suitable for steel foundries.

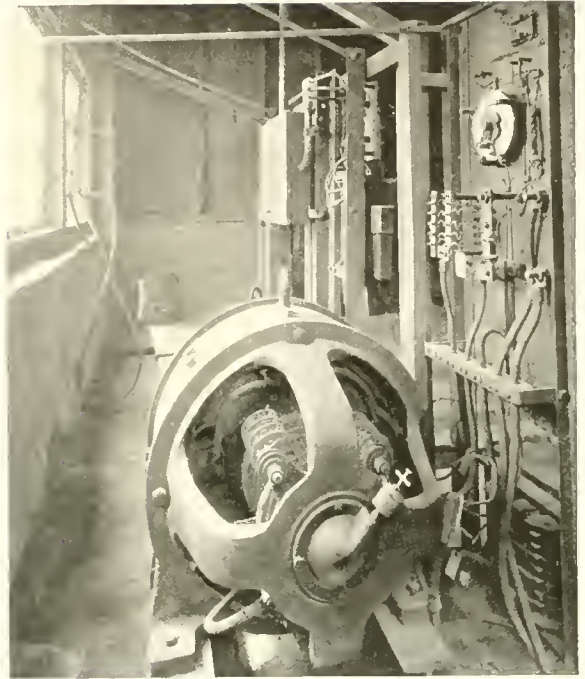

Fig. 24. Lincoln Arc Welder 400 ampere capacity installed in the plant of The Standard Steel Castings Co., Cleveland, O. In the background is space provided for the installation of another welder.



Fig. 25. Filling in a blow hole in a steel casting by the Carbon Electrode process

Grey Iron and Malleable Foundries

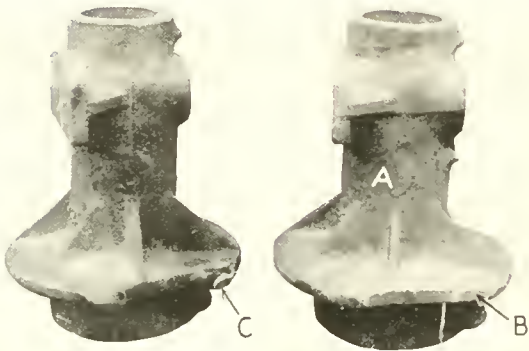

Fig. 26. Malleable Iron Brake Spider in which part of the flange at "C" was missing. This was readily filled out by welding, where mechanical repair would not have been practical.

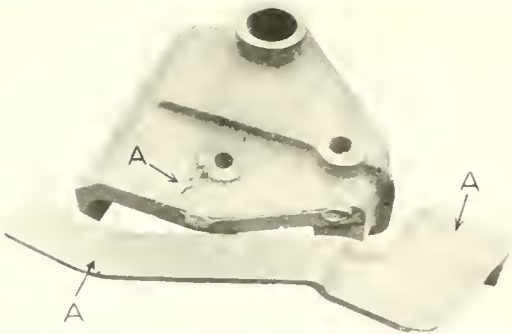

Fig. 27. Automobile parts showing slight defects which can be remedied by Arc Welding.

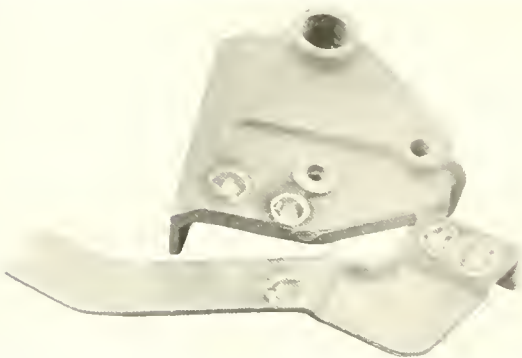

Fig. 28. Same parts as shown in Fig. 27, after welding. The faces are ground off clean and no difficulty was experienced in machining.

Illustrations Courtesy AMERICAN MACHINIST

The use of electric arc welding has been extended to grey iron and malleable castings to a very large extent. There are many minor defects in both grey iron and malleable castings, which mar the appearance of the casting but do not seriously affect its strength. These can be repaired and filled to good advantage with the arc welder, unless the castings are very thin.

The *American Machinist* says: "The arc electric welder is used on malleable iron castings for two purposes: First, for adding material that has been either swept away in the mold or is lacking because of a mistake in the design, and second, to save castings that have blow holes or sand holes. If metal could not be added to make a sound repair, castings would often have to be scrapped; a poorly patched casting would be condemned for appearance sake, and one with unsound joints would be weak and tend to fracture."

The difficulty encountered in welding cast iron arises from the expansion and contraction of the local area heated by the arc and the tendency of the weld to become hard when the casting has cooled. With the proper equipment for pre-heating furnaces and with skilled operators it is probable that 80% of all grey iron castings can be welded using the carbon electrode process. The metal electrode process is very difficult to use on cast iron because of the extremely small area heated by the arc. This, of course, would be an advantage in welding any other material than cast iron.

The Welding Engineer says in a recent article: "Welding cast iron with the electric arc process will become a very common practice within a few years."

The grey iron or malleable foundry contemplating the use of arc welding should call a welding engineer and consult with him as to the possibilities of the process on the particular class of work which they desire to do.



Fig. 29. Malleable Iron Switch Stand showing a defect which was sufficient to reject it for appearance sake, but which was readily remedied by Arc Welding.

Railroad Shops

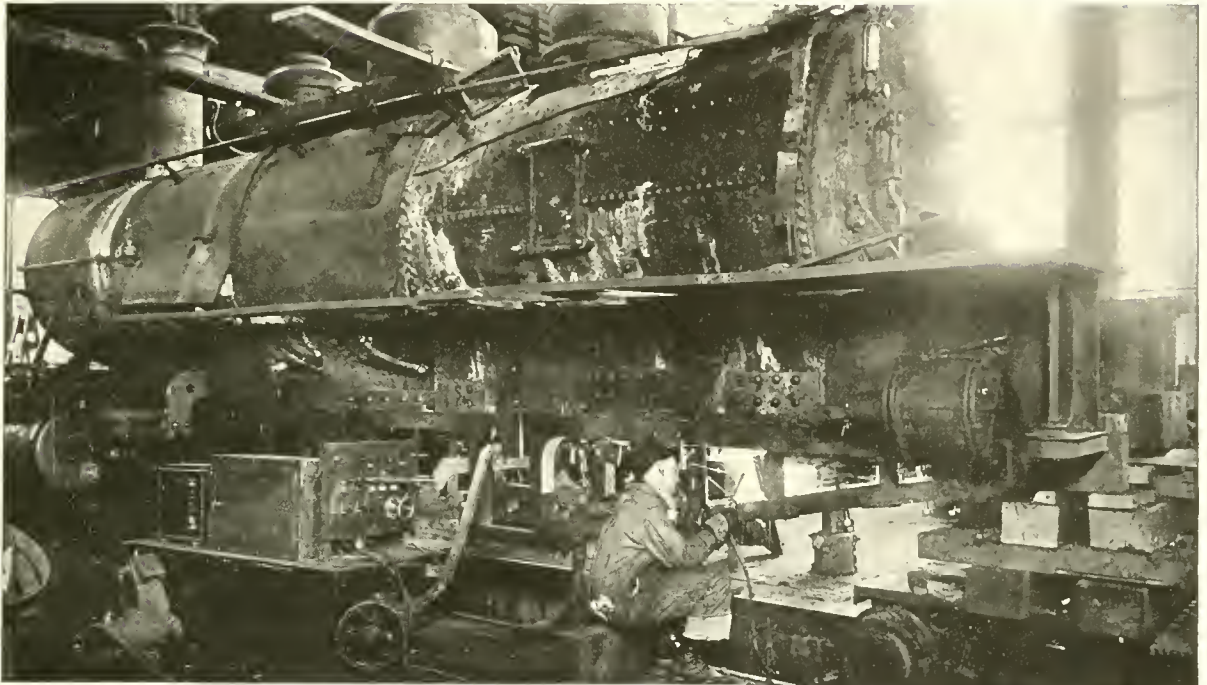

Fig. 10. Welding a locomotive frame using a portable Lincoln Arc Welder. The same week that this photo was taken \$6 000 was saved through arc welding done on this welder.

Next to the steel foundry, the railroad has probably made the widest use of electric arc welding.

Mr. E. Wanamaker, Electric Engineer of the Rock Island R. R., recently in a very interesting article in the *Railway Electrical Engineer*, among other things, says: "Our figures show that the saving effected by the electric arc welding system is being made at the rate of approximately \$200,000 a year with our present equipment. This figure includes a direct saving as compared with other methods of about \$136,000. There is also a saving arising from the fact that we keep engines in service a greater portion of the time, which makes up the balance of the \$200,000. Our figures show that we are saving about 1400 engine days per year. We have obtained, in other words, service of four additional engines without any expenditure beyond that required to install the welding system.

"The net returns secured on the electric welding investment amounts to approximately 500% per year. These figures show that the installation of the electric welding system on the Rock Island Lines has been a very profitable investment.

"There is still a totally unexplored field in the maintenance of freight and passenger cars, which promises to eclipse in importance maintenance of motive power. The present indications are very strong that when we go fully into the electric welding process in the fire box, boiler, locomotive, machinery, steel tanks, car work, track work, etc., we can well use 150 units and effect a net saving of approximately one million dollars a year.

"We could with this equipment in operation show a saving of around 7000 engine days a year which means that we would be able to secure from our present engines a mileage that will

ELECTRIC ARC WELDING



Fig. 31. Engine sub-roads repaired by electric arc welding. The ends of these rods were badly worn and new metal was built in by the use of the arc. One of these has been machined, the other shows only the rough weld, but so neatly was the work done that it is difficult to tell which is which.

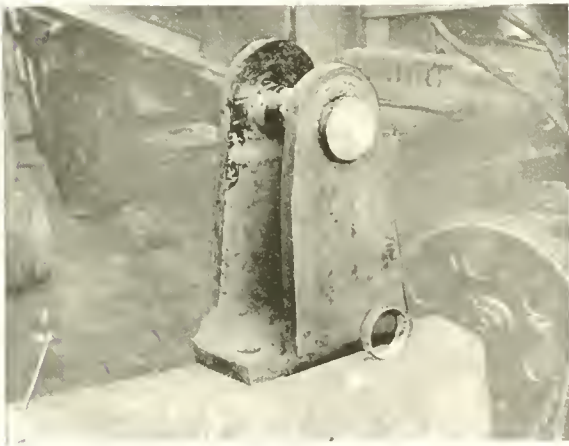

Fig. 32. Brake fulcrum repaired by Electric Arc Welding. The hole in this fulcrum was badly worn. By placing a copper band or ferrule of the right size in the hole and building up around it the hole could be knocked out after the welding was completed, leaving a perfectly smooth, round hole, which needed no machining.

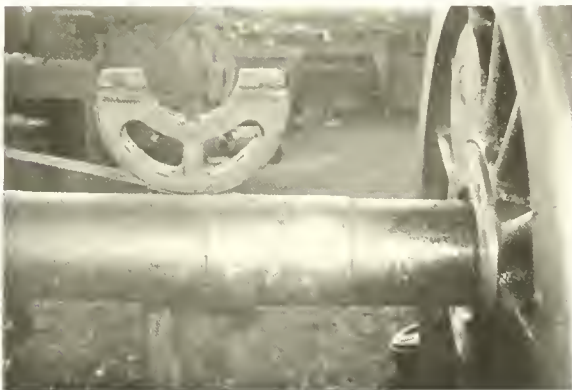

Fig. 33. An eccentric shay repaired by electric welding showing how it is possible to weld both malleable and grey iron. The key way in the driving wheel shaft has also been built up and milled out, saving the scrapping of the entire shaft.

equal that which could otherwise only be secured by the purchase of 23 additional engines."

The figures on the work done on the Rock Island R. R. are reproduced on page 25 and are worthy of very careful study.

Every day that the locomotive is laid up in the repair shop means a loss of a large sum of money for the road. The use of the electric arc has made it possible to repair a great number of cases of breakage and wear without dismantling the locomotive, thus putting it back into service within a day or two, instead of keeping it in the shop a week or ten days.

The importance of reclaiming broken and worn parts of rolling stock has become a subject of vital importance with the railroads in the past few years. Greater attention than ever before has been given to these smaller economies with a view to building up the earning capacity of the road. In fact, the motive power department has assumed a very large part in putting the roads on a dividend paying basis.

The chief uses of the electric arc in the railroad shop are:

1. Welding flues in back flue-sheet.
2. Building up worn surfaces on the steel castings of the locomotive.
3. Repairing broken frames and other steel castings.
4. Fire box welding.
5. Repairing of shop tools.
6. Welding in side sheets, tube sheets and door sheets.

Metal Electrode Used

In practically all railroad work, the metal electrode is used. The Railway Mechanical Engineer in the issue of November, 1916, says:

"The metal process usually gives a more reliable weld, gives finer texture to the metal, leaves it less porous, can be more neatly executed and finished, requires less power and may be easier controlled. The carbon process is well suited for filling holes in large castings and similar work, but the metal process is best for building up metal on surfaces since the addition of metal is largely automatic and the confinement

RAILROAD SHOP REPAIRS

of the heat avoids flowing and run-off tendencies; in other words the added metal stays where it is put. With suitable control provisions it is possible to combine methods, heating the working zone by the use of the carbon arc, and building up the new metal with the metal electrode, the procedure depending upon the character of the work and the ability to reach the molten condition simultaneously upon object and electrode."

The carbon process can only be used effectively where the work can be placed upright on a table and where the casting can be subsequently annealed, which practically eliminates its use from the Railroad Shops.

Repairing Breakage

In repairing broken and worn parts, the preparation consists mainly in cleaning the piece of all traces of oil, rust, etc., before welding is begun. Where two pieces are to be joined, the edges of the sections are chipped out with a chipping hammer to provide a "V" shaped groove at their junction, thereby insuring that the joint is completely filled with metal. Where thick sections are to be joined, it is often advisable to provide a groove in each side, in any event the groove should extend entirely through the junction of the two pieces.

In beginning, the arc must reach the bottom of the groove. Liquefy the metal at that point first. For this reason, the groove between the pieces must have an angle sufficiently large to allow the operator to get to the bottom. On

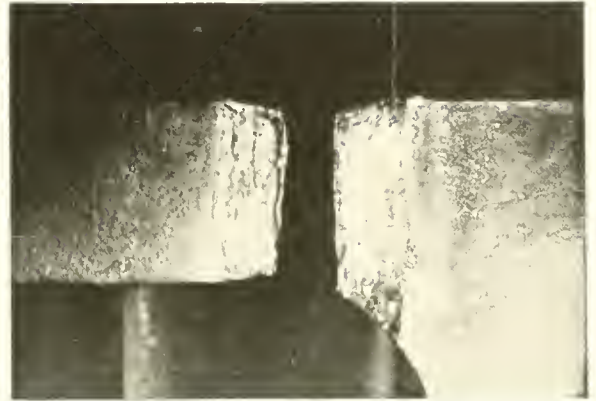

Fig. 35. BEFORE. Broken Engine Frame with break cut out, prepared for welding.

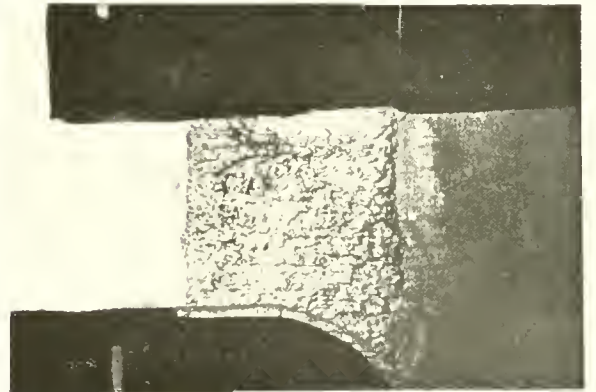

Fig. 35. AFTER. The Completed Weld. A piece of boiler plate is placed around the bottom of the gap as shown in the illustration, in order to hold the new metal in place during welding.

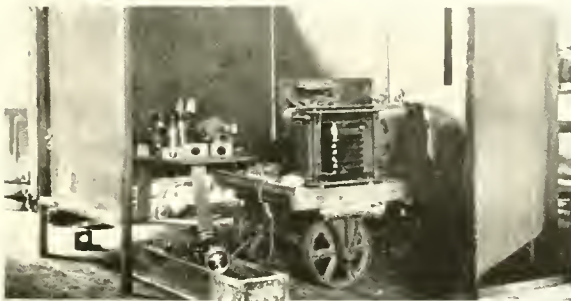

Fig. 34. Lincoln Arc Welder in Rock Island R. R. shops, Selvis, Ill., showing the black canvas screen with which the Welder is surrounded, thus protecting the eyes of other workmen from glare.

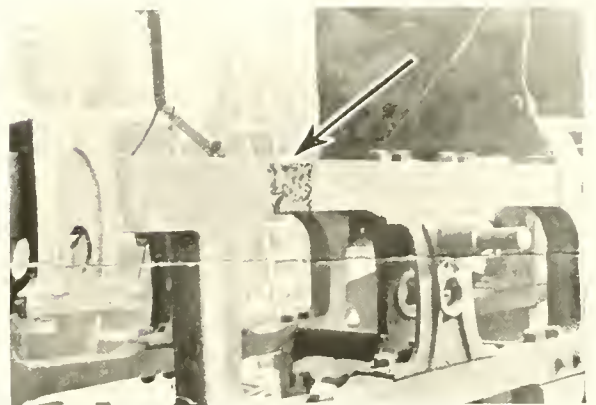

Fig. 36. Engine Frame repaired by the Lincoln Arc Welder at the Rock Island Shops.

ELECTRIC ARC WELDING

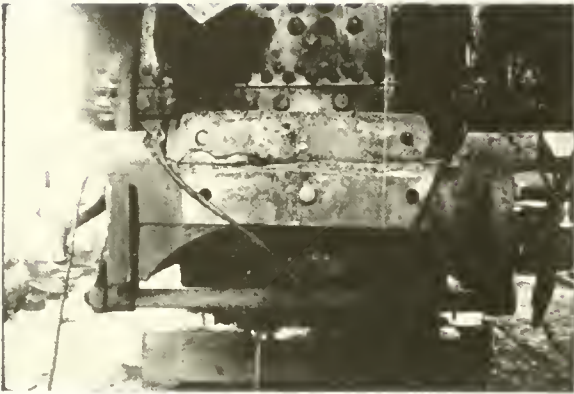

Fig. 37. BEFORE. The edges of the sections are clipped off with the hammer, making a "V" shaped groove.

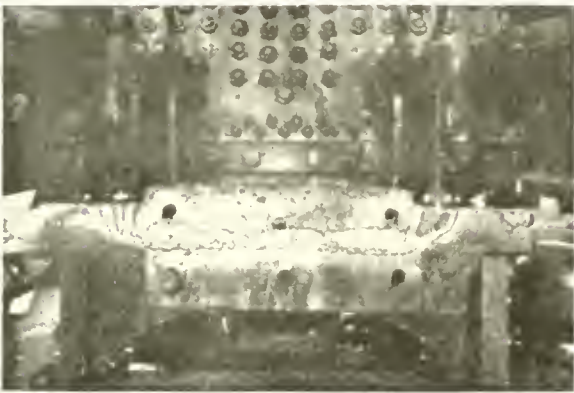

Fig. 37. AFTER. The new metal has been filled in to make the complete weld.

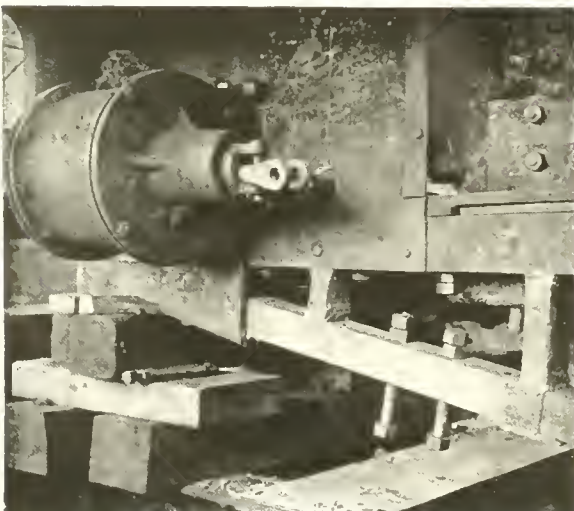

Fig. 38. A Locomotive Side Frame with five separate welds in it. A patch on the mud ring can also be seen.

boiler plates, the angle is usually 90 degrees, while on large steel castings the angle may be from 45 to 60 degrees.

On most work, it is necessary that the two pieces first be aligned, and clamped together or clamped to a third piece. If a one-sided heat occurs, some allowance must be made for unequal contraction. This part of the work calls for experienced men. If it is desired to build up metal of any height with the carbon arc process a mold of asbestos, fire clay or carbon must be made to retain the molten material. The work of welding should if possible be done in one continuous heat. One good example is given by The Railway Mechanical Engineer, drawings for the job being reproduced on page 18 (Fig. 39).

They say regarding this job, "The frame at crack is first v'd out on both sides with the oxy-acetylene cutting flame, and chipped out with an air hammer and chisel to get a clean surface as shown at A in Fig. 39. A 5/8-inch plate, about 1 inch wider than the frame, is then fastened to the bottom. From this as a basis the electric welder builds up the full width of the frame first on one side and then on the other as shown at B. After the v is filled on both sides, 5/8-inch round bars about 2 inches longer than the full width of the v are welded on the outside as reinforcement, starting at the bottom and building up (see C, Fig. 39). The very fact that these bars are round enables the operator to easily and successfully weld them in by being able to get

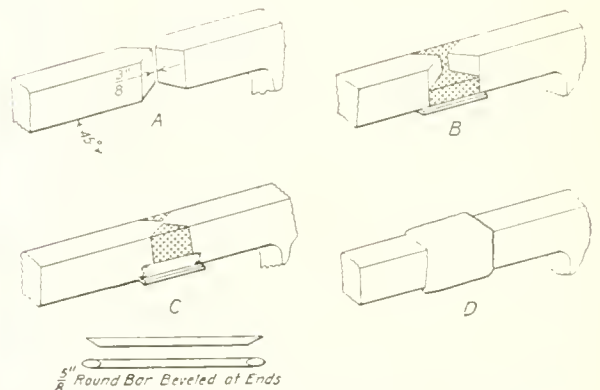

Fig. 39. Drawing showing method of repairing engine frame. (Courtesy RAILWAY MECHANICAL ENGINEEFF)

WELDING CRACKS AND PATCHES

in around them. The completed weld is shown at D."

The cost table on page 24 compiled in one of the largest locomotive shops in the country, shows the variety of work and the saving over a period of seven months. The cost of electric current is figured at 2 cents per kilowatt hour.

Flue Welding

Welding the flues and back flue-sheet, if properly done, will enable a set of flues to go the three-year limit without attention in a "good water" district. The old practice of rolling a few leaky flues after the engine comes in from a run, is entirely eliminated by welding. Welding flues, however, will not entirely cure the flue trouble, which arises from bad water.

The Welding Committee of the Railway Electrical Engineers' Association makes the following recommendations for flue welding with the elec-

tric arc: "The ideal preparation of a set of flues for welding is as follows:

1. Put flues in exactly as if they were not to be welded.

2. Fire the boiler, or, better still, send the engine out for a run. The object is to burn the oil out from under the beads of the flues and allow the flues to take a permanent set.

3. The flue sheet should then be brushed off with a stiff wire brush or sand blasted. The object is to eliminate, so far as possible, the scale of oxide on the flue sheet and flues. Iron oxide is not a good conductor of electricity and causes difficulties with the arc which in turn may produce a poor weld.

The welding of 2-inch flues is done best with $\frac{1}{8}$ -inch electrode. On sand blasted flue sheets 90 to 100 amperes is enough current. Flue sheets that have a thick coat of oxide require from 120 to 130 amperes on this size wire. Five-

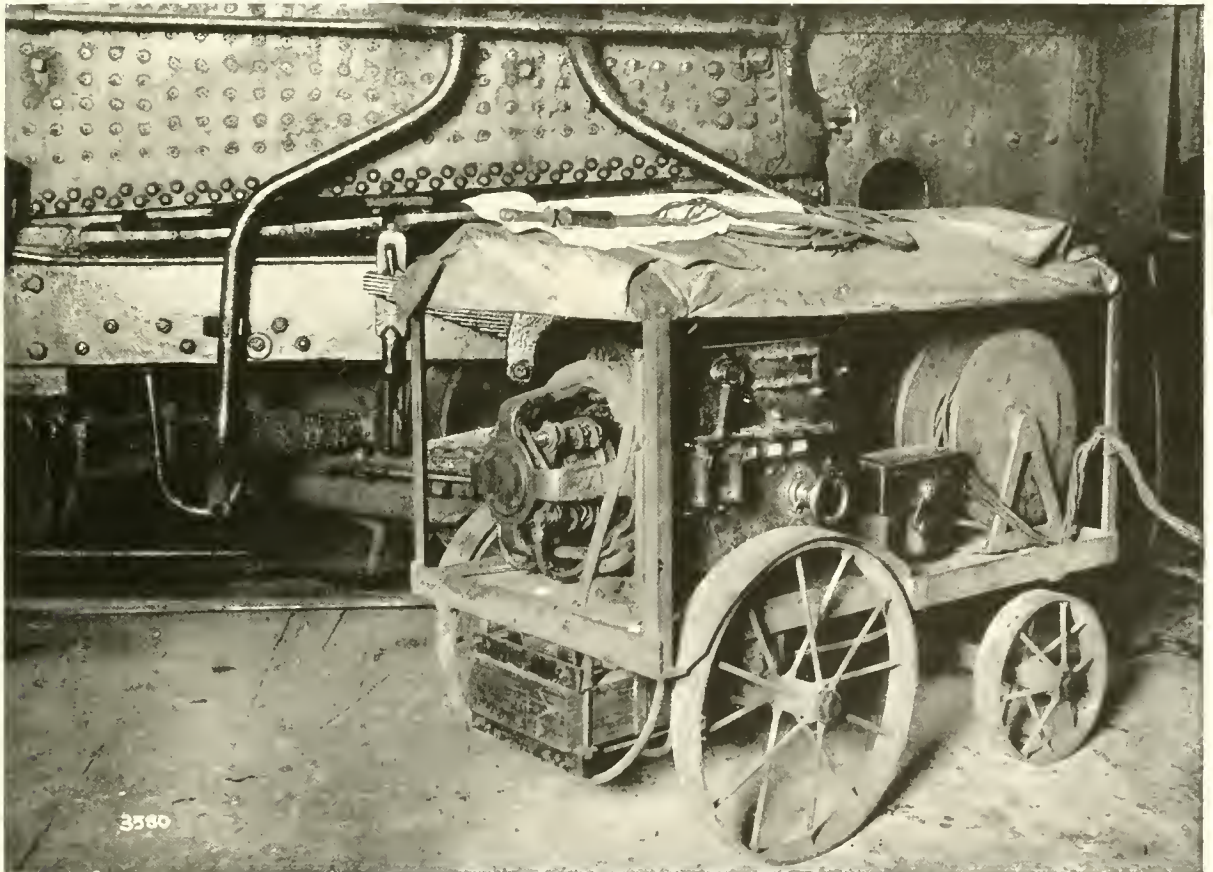

Fig. 40. 200 Ampere Lincoln Arc Welder on welded truck for engine house service.

ELECTRIC ARC WELDING

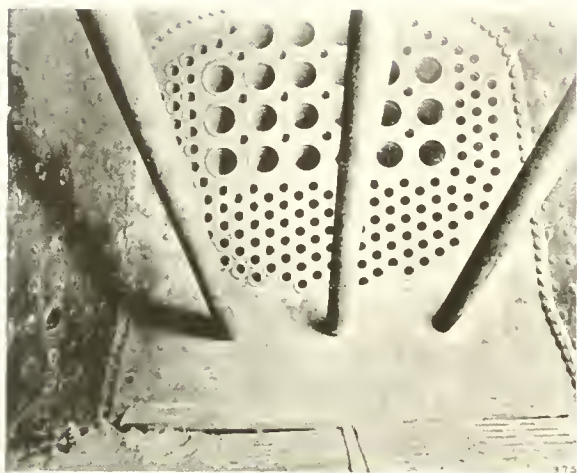

Fig. 41. Tubes welded into the tube sheet of the locomotive boiler. This is an exceptionally good example of this kind of work.

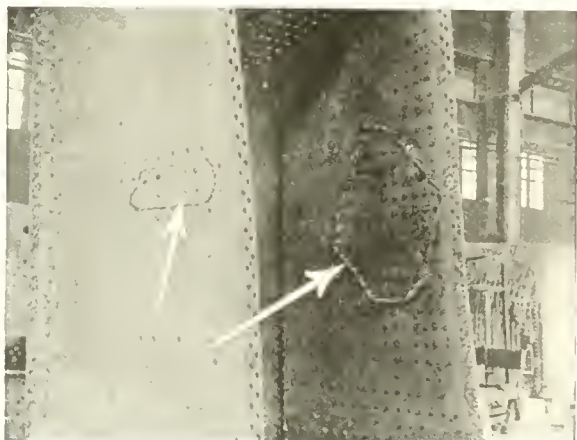

Fig. 42. Welded Side Sheets in locomotive fire box showing two patches made with the arc welder. Ordinarily this weld would have been made without disassembling, but the fire box was taken out for other repairs.

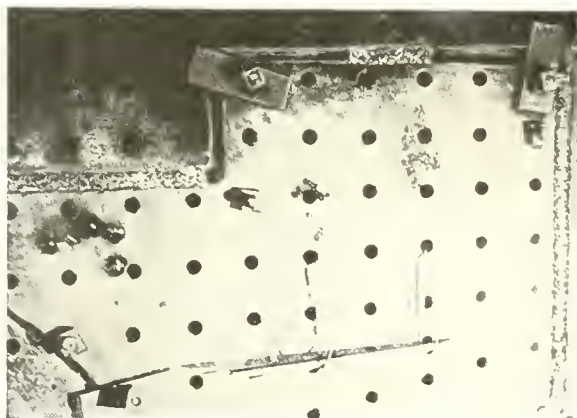

Fig. 43. Providing for expansion in side sheets by making the weld in the alternate sections.

inch flues should be welded with $\frac{5}{16}$ -inch electrode with 120 to 140 amperes depending upon the condition of the flue sheet."

The American Railway Master Mechanics' Association is very favorably disposed toward the use of electric welding and as long ago as 1912, had recommended its use. Even at that time, one road had 200 engines running with flues welded in and it was found unnecessary to remove flues when engines came in for repairs. It was found that maintenance cost was almost entirely eliminated, engine failures were avoided and engines could be kept in service a greater length of time.

See "Suggestive Applications," Page 45.

Welding Cracks and Patches

The welding of cracks and patching of seams offer the most difficult problems to the welding operator. The Association of Railway Electrical Engineers offers the following directions for this class of work: "A crack should be located and at least two inches beyond each end a $\frac{1}{2}$ -inch hole drilled. The edges of the crack should then be beveled so that the operator can get at them to make the weld. On horizontal cracks, the lower edge does not need to be beveled but should be clipped to give a square edge. The upper edge should be beveled at least 45 degrees. Vertical cracks should be beveled from 30 degrees to 45 degrees on each side. The less material removed from the crack the better. All welds should be made with the least possible amount of metal between the edges of the original material.

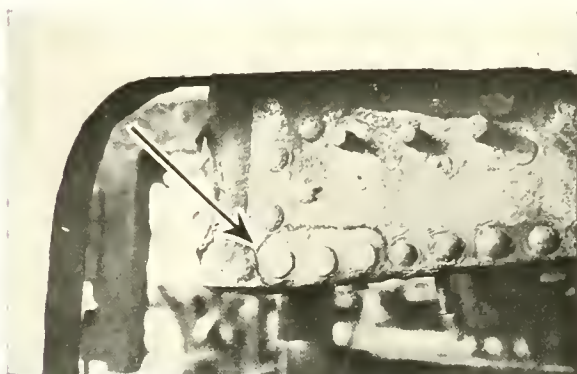

Fig. 44. Leaky Rivets in mud ring repaired by building up metal around the head of the rivets as shown.

STANDARD RAILROAD PRACTICE

"If the crack or seam is a long one, the metal should be put in alternate sections 4 inches to 6 inches long. The operator should put one layer of metal in each of these alternate sections starting near the center of the seam or crack. The open sections can then be filled, starting at the coolest point. Successive layers of metal can then be applied until the seam is completed. Wherever possible, at least 30 per cent of reinforcing should be applied so that the cross-section through the weld is 30 per cent greater than the section of the original plate. After each layer of metal is welded into the seam, it should be thoroughly brushed with a stiff wire brush to remove as much of the oxide as possible. Where the sand blast is available and can be used on the job the results will justify the expenditure of time necessary to clean the metal between layers. The same general care should be taken in the welding of locomotive frames as in the case of the boiler plate of the fire box.

"Aside from the use of judgment in the application of the electric arc welding process, there are three rules which the operator must observe to get the best results in welding: 1. Hold a short arc. 2. Use a low current. 3. Always work on clean metal."

Provision for Expansion

"Where long seams are to be welded, as for example, in welding in a half side sheet, practice again differs as to the best method of taking care of expansion. Some operators prefer



Fig. 45. A patch built up around a locomotive mud ring. This patch is nearly 8 feet long and made a saving in cost of over \$2,000, besides the saving of a month's delay in making the repair.



Fig. 46. Worn Engine Cross head repaired by welding on piece of boiler plate at the top and welding crack as shown.

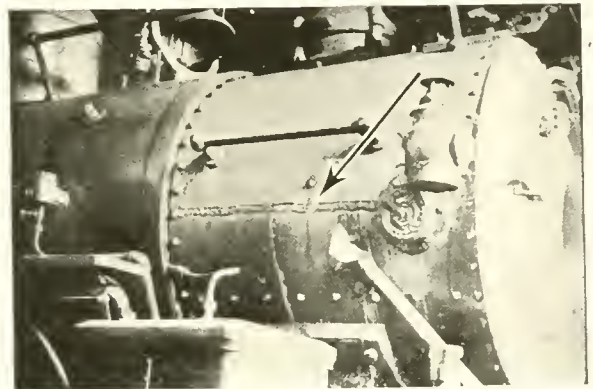

Fig. 47. Arc Welding as used in making smoke box for locomotive boiler.

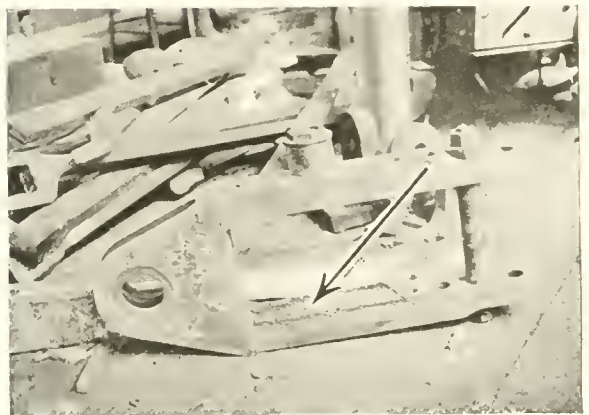

Fig. 48. Worn Steel Casing—Locomotive Part—repaired by building up worn surface by arc welding.

ELECTRIC ARC WELDING

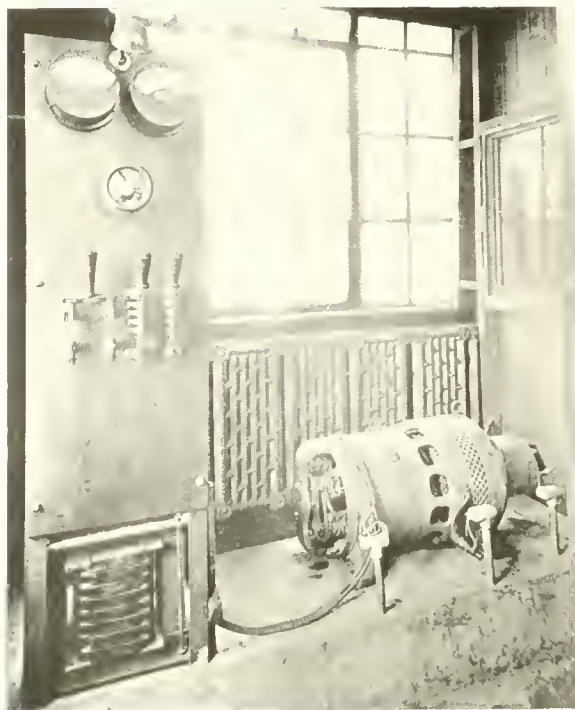

FIG. 49. Lincoln Arc Welder in the shop of the Big Lake R. R. at Minneapolis, D.

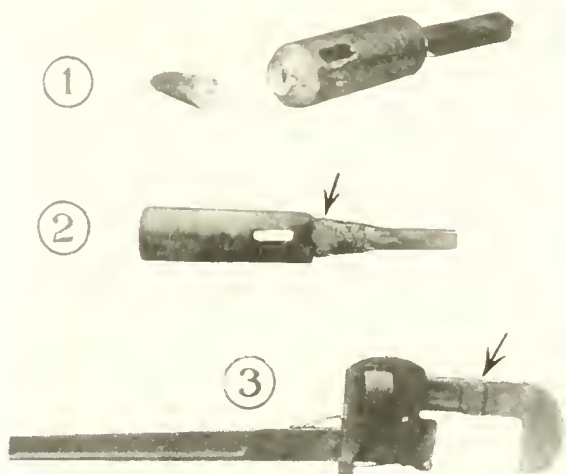

FIG. 50. The prompt repair of broken shop tools is often of great importance in the railroad repair shop. (1) A broken air drill socket for 1" diameter drill. A new socket would have cost \$1.80, besides delaying an important repair job. (2) The same drill socket repaired by the Lincoln Arc Welder. Cost of repair, including preparation of weld, was 12 cents. (3) Broken pipe wrench for 3" pipe, repaired by the Lincoln Arc Welder. A new wrench would have cost about \$6.00. The repair cost 20 cents, including preparation, welding and grinding off superfluous metal at weld.

to allow for expansion by widening the gap between the sheet, this being done by setting the new sheet away at a slight angle; the allowance usually made by these operators is about $\frac{1}{8}$ -inch to $\frac{1}{4}$ -inch per foot of length. Then when the weld is begun at one end and the work is carried on, the two edges will gradually draw together, due to the contraction in the weld at cooling. Other operators prefer to place the two edges in final relation to each other, holding them at the proper distance apart by means of 'tacks' at intervals of 12 inches to 18 inches. The weld is then begun at either end and as it approaches a 'tack' the tack itself is cut out by use of a chisel and solid metal welded in, the tack simply serving the purpose of holding the sheets in proper relation until the weld is made. When tacking is used, it has often been found advisable to weld a short space, say six or eight inches from one end to the seam, then go to the other end of the seam and weld a like distance, thus keeping heating and expansion at a minimum."

Standard Welding Practice

The Association of Railway Electrical Engineers has recommended the following with reference to standardization and shop organization based upon the experience of their various members on different roads.

"The importance of the welding operations in a locomotive shop or engine house is so great that it is necessary for the work to be done under the direction of a competent and responsible member of the railroad organization. A very successful solution to this problem has been made on several systems by the appointment of a Supervisor of Electric Welding who is responsible directly to the general superintendent of motive power. The Supervisor of Electric Welding makes the practice of the several shops uniform so that the failure of one shop to get results from a process can be traced to its origin. The Supervisor of Electric Welding must find a successful way of doing each job and require every shop to perform the operation according to his instructions.

"Operators are obtained in most cases from a shop organization. On roads where an apprenticeship training is provided most of the opera-

STANDARD RAILROAD PRACTICE

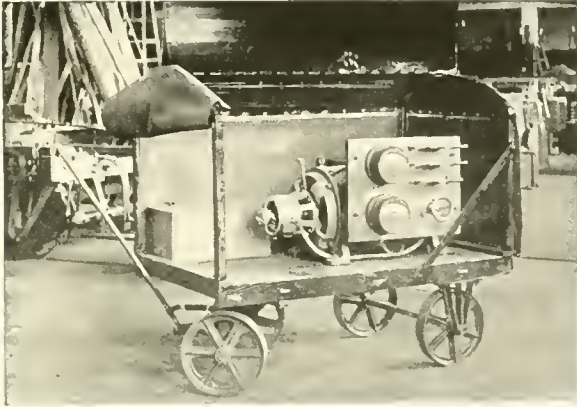

Fig. 51. Lincoln Arc Welder (Portable Type) with canvas housing as used in engine house on Eastern Railroad. The canvas burns out the dust and dirt prevalent around the engine house.



Fig. 52. Lincoln Arc Welder (Stationary Type) installed in engine house on large railroad.

ters are men who have just completed the apprentice work. It is desirable to have operators who have had general experience in a railroad shop. In shops which have a local electrician the care of the electric arc welding equipment is handled by the chief electrician. In engine houses the operator of the equipment is usually trained to give the equipment whatever care is necessary."

Standardization of Operations

The tendency at the present time is to standardize the welding operations in the same manner that the machine shop and other operations have been standardized. Where welding operations are thoroughly standardized the work can be paid for on a piece work basis. The standardization of welding operations is comparatively simple on systems which employ a Supervisor of Electric Welding. On other roads it is more difficult to standardize the operations, but the necessity for having them standardized is greater. Ninety-five per cent of the electric arc welding done in railroad shops is on operations which can be standardized. The following factors should be determined for each job of this nature: 1—Size of electrode, 2—Kind of electrode, 3—Current in the arc, and 4—Time required for the operation.

Equipment

A thorough discussion of the equipment available for electric welding in railroad shops will be found on pages 46 to 56.



Fig. 53. Engine frame prepared for welding.

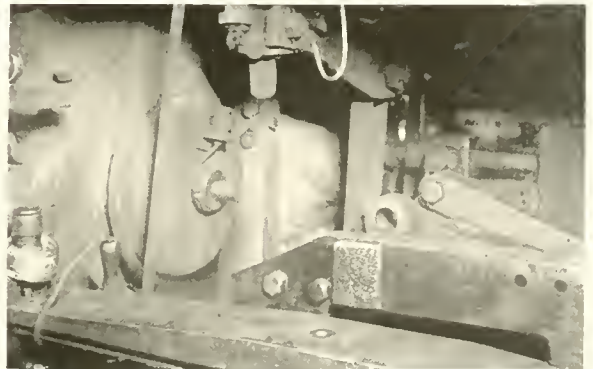

Fig. 54. Engine frame after welding.

ELECTRIC ARC WELDING

MISCELLANEOUS ELECTRIC WELDING—LOCOMOTIVE SHOP—NAME WITHHELD—ONE MONTH

	No. of Operations	Labor	Material	Current	Total cost	Other Method	Saving
Bumper Beam	1	\$ 1.41	\$ 0.33	\$ 1.35	\$ 3.09	\$ 5.00	\$ 1.91
Brake Shoe Heads	102	11.79	2.48	9.55	23.82	80.58	56.76
Brake Hanger Bracket	1	.33	.02	.08	.43	1.25	.82
Crossheads—Piston	17	12.06	3.29	10.53	26.78	133.06	106.28
Crossheads—Valve	22	2.39	.55	1.95	4.89	13.93	9.09
Crosshead Pins	3	.83	.18	.53	1.54	4.47	2.93
Deck Castings	7	30.23	6.90	20.70	57.83	484.32	426.49
Driving Boxes	4	2.10	4.20	1.80	8.10	105.48	97.38
Driving Box Lugs	10	1.08	.33	.88	2.29	6.90	4.61
Frames	2	5.11	1.25	4.20	10.56	57.84	47.28
Frame Cross Braces	1	2.59	.60	1.80	4.99	21.75	16.76
Eccentric Blades	5	.96	.21	.86	2.03	5.44	3.41
Eccentric Crank	1	.19	.05	.15	.39	12.74	12.35
Guide Bars	69	99.52	28.91	86.33	214.76	423.03	208.27
Guide Yoke	1	.66	.10	.30	1.06	9.74	8.68
Levers—Combination	17	2.66	.60	1.73	4.99	32.37	27.38
Links	33	3.44	.89	2.35	6.68	36.41	29.73
Link Hangers	12	1.36	.30	.90	2.56	3.24	.68
Link Saddles	2	.59	.10	.45	1.14	8.32	7.18
Miscellaneous	6	1.48	.19	.50	2.17	4.86	2.69
Quadrants—Teeth	3	.28	.05	.23	.56	2.43	1.87
Rods—Main	9	2.48	.75	2.18	5.41	9.99	4.58
Rods—Side—Grease Plug Holes	106	20.61	2.70	10.03	33.34	89.04	55.70
Rods—Side—Spade Pin Holes	1	.65	.23	.68	1.56	12.29	10.73
Rod Straps	7	4.16	1.10	3.30	8.56	53.78	45.22
Reverse Lever Heels	3	.57	.15	.45	1.17	7.80	6.63
Reverse Lever Latches	6	.66	.13	.53	1.32	11.55	10.23
Spring Saddles	8	2.19	.60	1.80	4.59	22.99	18.40
Spokes—Driving Wheel	9	6.91	1.50	4.20	11.71	42.50	30.79
Shop Tools and Machinery	2	.72	.13	.50	1.35	6.00	4.65
Tail Sheet	1	.33	.05	.15	.53	1.50	.97
Tumbling Shaft	2	3.13	.85	1.00	4.98	49.21	44.23
Tender Truck Equalizers	8	4.18	.80	3.15	8.13	78.30	70.17
Transmission Hangers	6	.57	.10	.38	1.05	1.38	.33
Total	487	\$228.22	\$60.62	\$175.52	\$464.36	\$1,839.54	\$1,375.18
Net saving for month							\$1,375.18

MISCELLANEOUS JOBS

1916	No. of operations	Labor	Material	Current	Total cost	Other method	Saving	Saving per operation
January	461	\$183.07	\$47.88	\$155.70	\$386.65	\$1,176.58	\$ 789.93	\$1.71
February	433	218.08	59.89	187.70	465.67	1,558.56	1,092.89	2.52
March	584	253.37	64.57	199.13	517.07	1,871.44	1,354.37	2.32
April	325	172.92	42.62	134.20	349.74	1,232.65	882.91	2.72
May	487	228.22	60.62	175.52	464.36	1,839.54	1,375.18	2.82
June	579	210.09	54.94	175.52	440.55	1,726.10	1,285.55	2.22
July	523	165.97	41.12	135.62	342.71	1,501.33	1,158.62	2.22
TOTALS	3,392	\$1,431.72	\$371.64	\$1,163.39	\$2,966.75	\$10,906.20	\$7,939.45	\$2.34

TABLE I—STATEMENT OF WORK PERFORMED WITH ELECTRIC WELDER AT LOCOMOTIVE SHOPS.

1916	No. of engines	No. of flues welded	Actual time welding hr. and min.	Labor	Material	Current	Total cost, actual welding	Time preparing for welding hr. and min.	Cost preparing for welding	Total cost to engines	Average cost per engine
Total for 2-in. flues	247	42,640	2,811' 15"	\$990.77	\$181.09	\$843.72	\$2,015.58	222' 45"	\$80.39	\$2,093.97	\$8.48
Total for 5-in. flues	196	5,034	1,473' 45"	520.61	85.47	442.16	1,047.64	24' 00"	10.08	1,056.12	5.39
Total for smoke consumer tubes	244	1,946	122' 00"	42.85	9.76	36.60	89.21			89.21	.37

Ship Building and Repairing



Electric arc welding outfit mounted on motor truck. This outfit is the property of The Boom Boiler & Welding Co., Canton, Ohio, and is here seen doing repair work on the "Screambug," the largest passenger steamer on the Great Lakes. The equipment consists of a 3 H. P. Newo Engine belt connected to a 150 ampere Lincoln Arc Welder. The engine also operates an air compressor for operating a pneumatic hammer. The cable which carries the welding current can be seen entering the ship through the opening in the side.

Closely allied to its use in railroad shops is the use of arc welding in shipbuilding and repairs.

Here again tremendous developments have taken place in the year since the United States entered the war. Very wide use is now being made of electric welding in the actual construction of ships, where it not only costs less than riveting, but makes a very vital saving in time. Unfortunately censorship rules did not permit the photographing of this work or the giving of detailed information concerning it. Ship builders who are interested, however, can obtain all the data, and the wonderful possibilities of this process in ship building will be substantiated by any one who takes the pains to thoroughly investigate it.

At the present time the insurance rules do not permit the welding of any strength members on the vessel, that is, the welding of plates or ribs, or the welding of the plates to the ribs.

Regarding this use of electric welding, James G. Dudley, Research Engineer, has the following to say, in a recent issue of *International Marine Engineering*: "For more than five years past, railways of the United States have been employing metallic electrode welding in largely increasing amounts and with astonishing technical and economic gains in securing practically leakless conditions of tubes and furnace sheets of the locomotive boilers.

"The technical literature of railways and welding demonstrates beyond successful controversy that jointures of more than 100 per cent efficiency can be readily and commercially secured by electric welding means. Even the truly remarkable results secured under the punishing conditions of steam locomotive service have not as yet overcome the friction and inertia of 'standard practice' in so far as the design and fabrication of a complete locomotive is concerned, but eventually the insurance and inspection interests must voluntarily 'approve' or be compelled by the march of events to 'permit' the fullest possible use of electric welding in this field of transportation.

SHIP BUILDING AND REPAIRING

"Passing to marine practice, it is more or less common knowledge in marine circles that electric welding has been successfully and economically employed for many years past in many ports of many countries in repairing of parts of ships, which otherwise must have been tied up for costly periods."

At present the rules permit the welding of the following parts, and these after all are of very great importance because they are the parts on which riveting takes the most time and on which the greatest saving can be made:

The classification societies have so far considered and approved the application of electric welding to the following parts of vessels:

- Deck Rail Stanchions to plating.
- Clips for Detachable Rail Stanchions.
- Continuous Railing Rods (Joints).
- Attaching Deck Collars (L. Rings) around ventilators.
- Attaching Deck Collars (L. Rings) smoke stack.
- Attaching Cape Rings, Smoke Stack Pipes, etc.
- Attaching Galley Fixtures to Plating.
- Attaching Bath and other Fixtures in officers' quarters.
- Attaching Cowl Supporting Rings to Ventilators.
- Bulwark Top Splicing and End Fitting.
- Skylights over Galley.
- (a) Engine Room Stairs and Gratings.
- (b) Boiler Room Stairs and Gratings.
- Attaching (A) and (B) to Plating Grab Rods on Casing.
- All Stairs and Ladders including Rail Attachments.
- Door Frames to Casing, Hinges, Catches Hold Coach-books, etc.
- Clips for attaching Interior Wood Finish to Casing.
- Entire Screen Bhd.
- Coal Chutes.
- Butts of W. T. and O. T. Boundary Bars on Bhds. or floors in double bottom.
- Ventilator Cowls.
- Stacks and Uptakes.
- Bulkheads (that are not structural parts of the ship), partition bulkheads in accommodations.
- Framing and Supports for Engine and Boiler Room Flooring or Gratings.
- Cargo Batten Cleats.
- Tanks (that are not structural parts).
- Shaft Alley Escapes.
- Steel Skylights over accommodation spaces.
- Engine Room Skylights.
- Grab Rods on exterior and interior of Deck Houses.
- Deck Houses not covering unprotected openings through weather decks.
- Reinforcing and protecting angles round manholes.
- Joints of W. T. Angle Collars at frames in way of W. T. Flats.
- Other parts of a vessel in which electric welding is proposed must be submitted for consideration.

March 25, 1918, *Lloyd's Register of Shipping*,
17 Battery Place, N. Y. C.

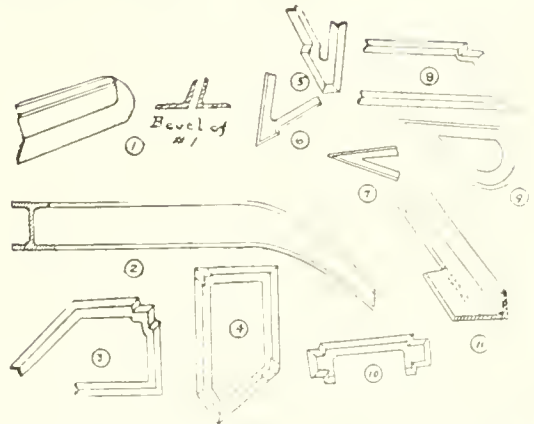

Fig. 56. The sketches show pieces which can be made with the electric arc in ship yards. No. 1 is a very difficult and expensive job for the angle smith, but can be made for a few cents with the electric arc welder. No. 2 is a boat davit made from an 8 inch I beam split and rewelded. The cost of this from the angle smith would be \$6.00 or \$7.00, whereas it can be electric welded for \$1.00.



Fig. 57. Welding a Hatch Cover on a steel case.

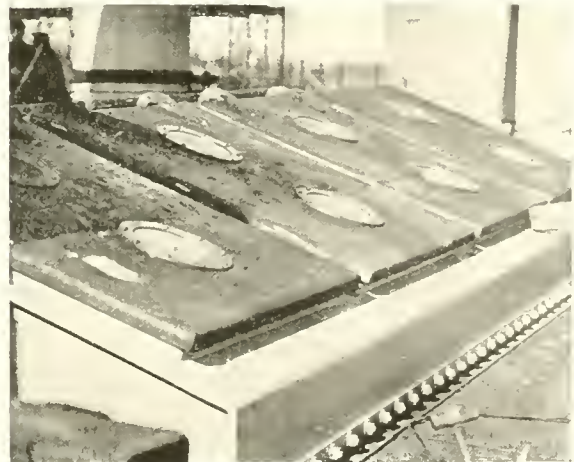

Fig. 58. Hatch cover completely welded.

ELECTRIC ARC WELDING



Fig. 2. Model of Electric Welded Keel for steel ship. Figures 1 and 2 are reproduced from *International Electrician*.



Fig. 3A. Fresh water tanks for welded ship. Lincoln Arc Welder. Speed of welding on these tanks is about 20 feet per hour.



Fig. 3B. Lincoln Arc Welder installed at Hog Island shipyard used for overhead and vertical welding.

It is the opinion of experts on the "Electric Welding Committee of the Emergency Fleet Corporation," that four welded ships can be built for the cost of three riveted ships and the welded ship will require about half the time for complete fabrication.

The British Admiralty launched a channel barge of some 200 tons deadweight built completely by the electric welding process.

Plans have been made for a 7500 tons electrically welded merchant ship of standard construction which would make use of the steels already on order and would be built in a yard designed especially for the construction of electrically welded ships.

It is estimated that on continuous welding—side and down welding, an average speed of 4 feet per hour could be maintained and that on overhead or intermittent welding a speed of 2 feet per hour could be averaged.

To give an idea of the work involved, a ship of this character would require the equivalent of about 186,000 lineal feet of welding in half inch plate, and the number of rivets to be driven in the yards and on the ways would be reduced to about 17,000. This is an extremely important development in view of the difficulty of obtaining riveters and the unusually high wages paid for this class of work. Due to the saving in steel weight resulting from a re-distribution of material and a substitution of welding for riveting joints, it is estimated that a welded vessel would have 500 tons more cargo capacity than a riveted ship of the same dimensions.

According to the best available information the cost of welding on such a ship would be about \$41.00 per ton of steel. Figuring the highest possible prices for labor, material, etc., and that this figure might fairly be expected to be reduced to \$29.50 per ton, added to this would be the cost of shop preparation for welding, erecting and fitting the plates in place, which would give a total cost of \$87.00 per ton (not including steel), at a maximum, with a fair chance of an average cost as low as \$75.50 per ton.

Inasmuch as there are only 2300 tons of steel in the welded ship as compared with 2800 tons for the riveted ship, the total cost of all work

SHIP BUILDING AND REPAIRING

should be considered in making comparisons and not the cost per ton.

A recent issue of the *Welding Engineer* contains some valuable suggestions for arc welding on ship building work. Especial mention is made of the fact that steel foundries are now working at full capacity and that the time consumed in sending back defective castings to them is wasted. Electric welding equipment for immediate repair of these castings should be installed in the ship yards and the transportation conserved.

A number of pieces which can be welded to good advantage are shown in the sketch herewith, reproduced by the courtesy of the *Welding Engineer*. All of these pieces can be welded and are being welded in some yards. Such welds are perfectly reliable, providing the operator is careful and good material is used, precautions which must be observed on any kind of mechanical work. The metal electrode is the only suitable method for welds of this character. Two hundred amperes per operator should be installed.

Repairs

The most important work done by the arc welding process on board ships is in the repair of the ship's boiler. Owing to the strain which is brought to bear upon the shell and fire box of the boiler, due to the heaving, rolling and pitching of the ship, there is a greater tendency for the riveted joints and stay bolts to leak than in the case of a stationary boiler. Also, as a general proposition marine boilers work harder for their nominal rating than stationary boilers. This means greater corrosion and more rapid deterioration.

In general, the two classes of defects which occur are cracks in the furnace and leaks in the riveted seams and stay bolts. The United States government has very strict rules regarding the application of the process to the welding of marine boilers, but the defects just named can be repaired by the arc welding process. In the case of a riveted seam which leaks due to the fact that the caulked edge has worked away from the plate a reinforcing strip is usually put on the seam, extending from the extreme edge of the caulked edge to a point beyond the heads of the rivets. This will effectively stop all leaks



Fig. 60. Repair Tug, *Carrie A. Ryerson*, property of A. J. Mitchell & Son, Chicago. This tug carries a 200 ampere Lincoln Arc Welding outfit in the small house on the deck. This Welder is driven by a Novo Gasoline Engine and by actual test it performed the same amount of work on 6 gallons of gasoline as a constant voltage type of welder owned by the same company, driven by a steam turbine and consuming 7 tons of coal. (See page 48 for description of Constant and Variable Voltage Welders.)

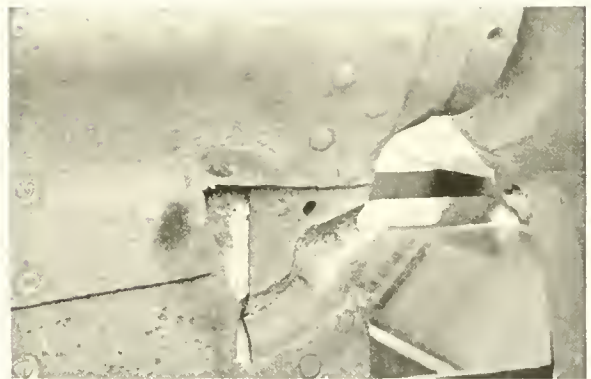

Fig. 61. Broken stern post on *S. S. Cygnus* before welding. Note that the break has been chipped out to a "V" shape for welding.



Fig. 62. Stern post on *S. S. Cygnus* (See Fig. 61). The weld was made with a Lincoln Arc Welder and was practically completed when this photograph was taken.

ELECTRIC ARC WELDING

either around the rivets or at the caulking edge. Where the edge beyond the line of rivets has been eaten away by the corroding action of leaking steam a whole new edge is built up, all work being done by the metal electrode process.

Leaky stay bolts are repaired by reinforcing and welding clear over the top of the stay bolts. Cracks in the fire box are first located and holes drilled in the shell at each end of the crack to be sure that the end of the crack has been reached. Then the intermediate space is chipped out giving two beveled edges.

The electric arc process is used almost exclusively for this work, for the reason that it is almost impossible to do the work with the oxy-acetylene, and a good many United States Government steamboat inspectors refuse to pass the work of the oxy-acetylene operator for this purpose. The trouble arises from the wide distribution of the heat of the oxy-acetylene flame which causes contraction difficulties in the plate of the boiler. Another serious defect of the oxy-acetylene process is that it is almost impossible to weld overhead with the use of the gas flame. About one operator out of fifty can do successful work in the overhead position. Since a large part of the boiler work encountered in marine practice is overhead, this practically eliminates the oxy-acetylene process. The fire rules prohibit its use in most instances.

A great deal of welding is done on the decks and deck houses of boats. Most of this work at the present time is in the nature of repair work rather than new construction. On board the ships of the Great Lakes a great deal of welding is done about the hatches which become damaged from loading and unloading. Miscellaneous small jobs are done about a boat when it is laid up for repairs, which mean a great saving of time and money. While at the present time there is very little welding done on the outer shell of the hull there is considerable work being done about the engine room, and on the arches and tank tops. One of the latter applications is in burning off rivets where certain plates are to be taken off and new plates put on. Where a rivet is to be driven it is necessary to get one head of the rivet off before it can be taken out. Burning off the head of the rivet and then driving it through is the quickest way devised up to the present time for doing this job. Another application of arc welding when the boat is in drydock is the repairing of what is known as the rudder shoe. This is the heavy steel casting

which extends from the stern end of the keel of the ship to support the rudder post. It is a rather frequent occurrence for this shoe to become broken and it is necessary to drydock the ship in order to repair it. This job was formerly done with the thermit process, but has been done successfully a number of times with the carbon arc process. The rudder frame is usually a steel casting with boiler plate riveted on it. In collisions and wrecks the rudder frequently suffers and repairs are made using the arc welding process.

While a great many applications of the arc welding process have been made up to the present time in shipbuilding and repair practice, there is no doubt but that only a few of the possible applications have been made.

Equipment

Up to the present time the equipment used for arc welding purposes in marine practice has been of three types. The engine driven unit, direct connected to a reciprocating engine; the belt driven engine type unit, and the turbine driven engine type unit. The equipment is usually mounted on a boat which is self-propelled by its own steam engine. The boat must carry a licensed engineer in addition to one or more boiler makers and one or more operators for the arc welding plant. The charge for the services of the repair boat varies somewhat in different localities. On the Great Lakes a great deal of contract work is done, that is, a price is given on each proposed job, and there really is no standard price.

The arc process is used rather than the oxy-acetylene process for marine work because the most important part of the work—boiler repairs—can be done only by the arc process. The cost of producing the heat for welding is certainly as high with most electric outfits now in operation as it would be if the gas could be used. This high cost of producing the electric power is due to the high investment in the repair boat, the emergency character of the service rendered, which means that the boat lies idle a good percentage of the time, and the practice of using steam driven equipment on a self-propelling boat. But owing to the fact that boiler repairs cannot be successfully done by the gas process and the enormous saving resulting from the application of welding in repair work, the electric welding outfit has become a recognized and indispensable

SHIP BUILDING AND REPAIRING

part of the ship repair company's equipment. The actual cost per hour per operator on a steam driven outfit which includes air tool equipment varies of course with the continuity of the work. On the Great Lakes the actual cost per operator per hour, considering investment and the variation in the amount of work done is probably not less than \$2.50 per operator (1916). The cost of operating the air compressor is an addition to this figure. The cost of operation in harbors on the sea coast probably does not exceed one-half the above figure on the average, due to the greater amount of work. Gasoline or oil driven equipment can be operated at a figure in the neighborhood of \$2.00 per operator per hour, owing to the fact that a licensed engineer is not required. This type of equipment is to be recommended for small welding repair companies in all cases. The steam equipment is economical, however, for large ship repair companies on the sea coast.

Regarding what to specify for marine repair work, it is recommended that in all cases individual units be used; that is, an individual unit for each operator. Unless the individual units are used, a machine of considerably greater capacity must be installed in order that there will be no interference of one operator with another. The 150 ampere gasoline engine equipment is recommended for this work.

Equipment

A description of the various types of arc welder adapted to ship building and repair will be found on pages 46 to 56.

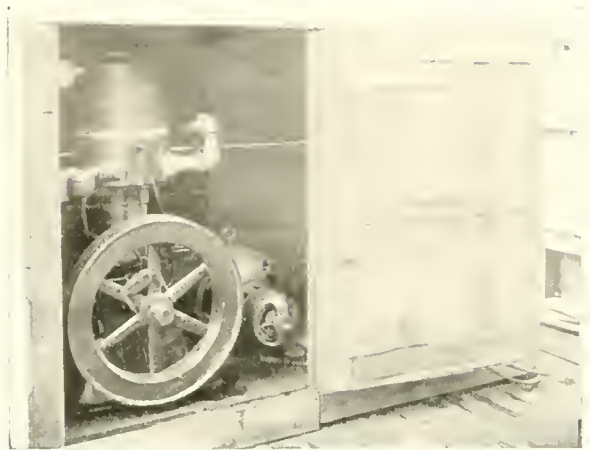

Fig. 63A. Lincoln Arc Welder direct geared to a 10 H. P. Novo Gasoline Engine, making an ideal outfit for ship building and repair work, where a portable outfit is required.



Fig. 64. Weld in intermediate cylinder of marine engine. (Courtesy BOOM BOILER & WELDING CO.)



Fig. 63. Welding a coal shovel in the Great Lakes district. Arc Welding can be done at any point where an electric cable can be carried.

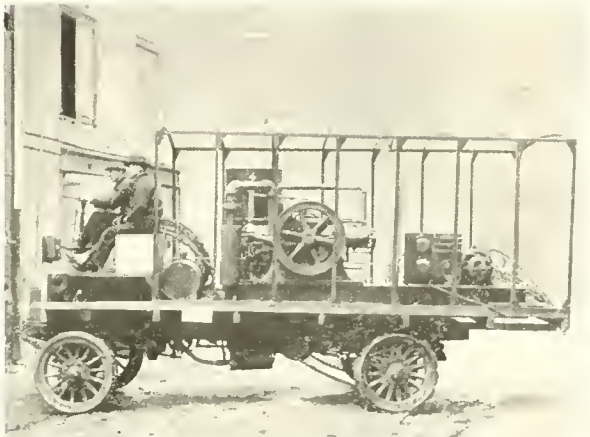

Fig. 65. Gasoline driven unit on motor truck.

ELECTRIC ARC WELDING

Boiler Plate Work



Fig. 66. Welder repairs to bottom blow-off valve of vertical boiler. The corroded plate was made good, the leaky rivet heads were welded over with new metal, and a new blow-off valve socket welded in. This repair saved replacing 50 sq. ft. of boiler plate, or scrapping the entire boiler.

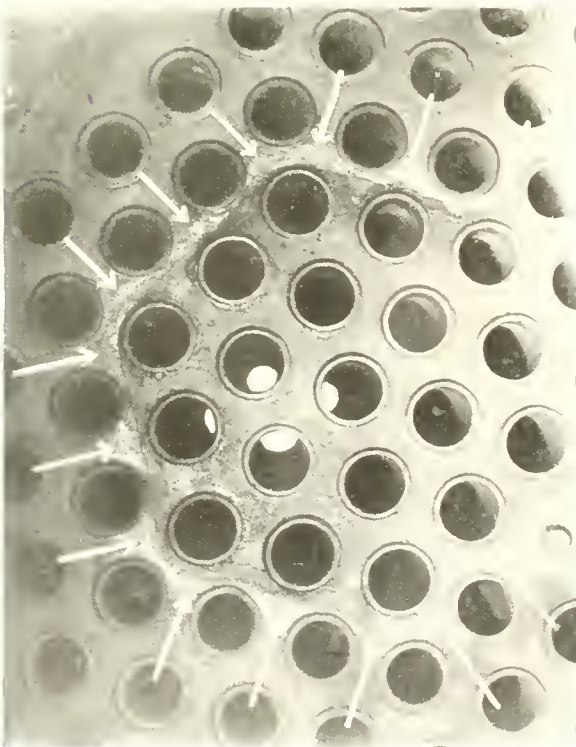

Fig. 67. Finished arc welded "diamond patch" on bottom flue sheet of vertical boiler. Notice the neatness of the finished job.

In locomotive shops of the large railway systems of the country, the arc welding process has been used for a period of from six to eight years and in many shops the process is used not only in the repairing of old boilers, but in the manufacturing of new ones. The work in repairing old boilers may be grouped under the head of welding in flues, welding in tube sheet and welding cracks in the fire box.

See "Suggestive Applications," Page 45.

It has also been widely used for general tank work. The American Machinist, in a recent issue, presents quite a discussion on this use of arc welding, stating: "Nowhere is the saving of arc welding exemplified to a greater extent than in the manufacture of steel tanks. Not only have the actual manufacturing operations been simplified and cheapened by the elimination of riveting and caulking, but the resistance of the finished weld to leakage or rupture is much greater than that of the riveted joint."

At a recent meeting of the Boiler Code Committee of The American Society of Mechanical Engineers, the following facts were presented by speakers before that committee bearing particularly on the use of welding for boiler and similar high pressure vessels.

"The recent improvements in the art of welding in the apparatus and in methods of testing the product, notably in the electric arc process, have made it possible to make welded joints which are stronger and more reliable than riveted joints and that the formerly accepted idea that

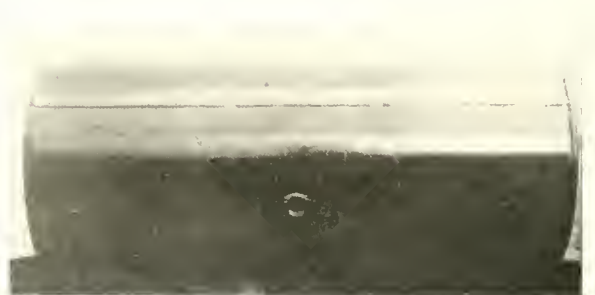

Fig. 68. Pressure Vessel made by Arc Welding, at the plant of the Leader Iron Works, Decatur, Ill.

BOILER PLATE WELDING

the welded joint is an 'unknown quantity' has been disproved by present day practice. (In this connection, photo-micrographs show that the thermal disturbance in the metal adjacent to the weld is negligible in the arc process and that the crystalline structure of the metal in the weld is that of normal cast steel.)

"The autogenous welding processes are being used extensively in all kinds of high pressure vessels.

"A manufacturer of such vessels has more than 2,500,000 in service to show that the percentage of failures on welded vessels is actually lower than on riveted vessels. The period covered by this manufacturer's experience is fifteen years and both electric arc and oxy-acetylene processes were used.

"The demand for large high pressure drums has reached the point where the thickness of the metal required to withstand the pressure is too great to be riveted owing to the excessive thickness of the metal obtained in the joint and the consequent difficulties encountered in exposing such a joint to the fire. The obsolete forge welding process does not offer a solution to this problem because of the unreliability of welds and the impracticability of welding vessels of such size in this manner. The autogenous welding processes offer a reliable and entirely practicable means of welding such vessels regardless of the thickness of the plate or size of drum."

The boiler shop does not, of course, confine itself to making of boilers and pressure vessels. In a great deal of the other work the boiler shop does, the electric arc is especially adapted. This includes the manufacture of the following class of articles:

Tumbling barrels	Cotton mill equipment
Revolving driers	Special bodies for automobiles
Vats for breweries	Concrete mixers
Tanks, vats and flues	Tank cars
Industrial cars	Steel gondolas
Dump cars	Steel box cars
Clamshell buckets	Gasoline tanks
Converter shells	Feed water heaters
Spelter tanks	Wagon tanks
Annealing pots	Fan and blower cases
Transformer housings	Hydraulic accumulators
Oil refinery equipment	
Sugar refinery equipment	



Fig. 69. Rotary Cement Kiln made of 1½ inch plate welded with the Lincoln Arc Welder. The weld is only partially completed and the "V" shaped joint before welding can be seen at the right.



Fig. 70. Welding end on cylindrical tank.



Fig. 71. Top of oil still showing welding, which makes these stills vapor tight. The Standard Oil Co. use the Lincoln Arc Welder on all their stills.

ELECTRIC ARC WELDING

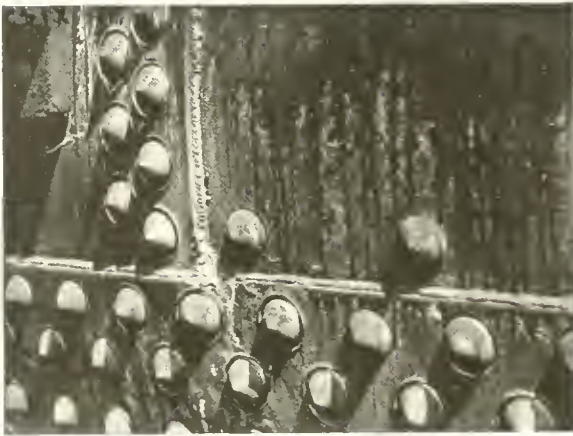

Fig. 72. Welding in place of caulking on ends of shells made by The Standard Oil Co., where Lincoln Arc Welders are extensively used for boiler plate construction. Such construction has stood years of service.

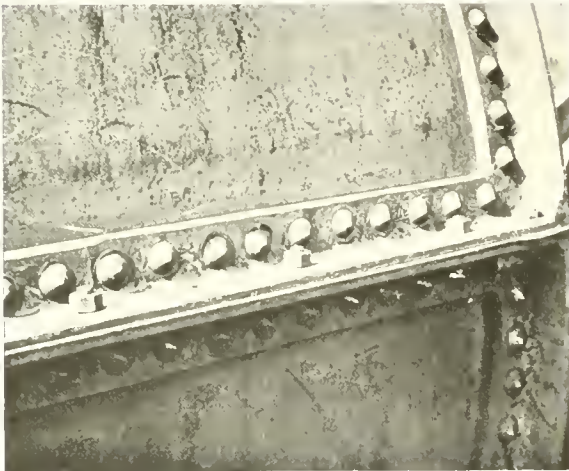

Fig. 73. How the Lincoln Arc Welder simplifies forward corner riveting. The edges of the angle irons were formerly machined at their meeting edges and riveted to corresponding strips on the inside of the sheet. They are now simply welded to the sheet and to each other at the corner.



Fig. 74. Long Vertical Seam in Boiler Plate Construction made by Arc Welding.

In this work, electric arc welding comes into direct competition with riveting and for that reason a comparative cost of the two processes is of interest.

Cost of Welding and Riveting

In order to compare the cost of riveting with the cost of welding we may take the amount of work accomplished under given conditions by the riveting gang, analyze the cost of the work and compare it with the cost of doing the same work with the arc welding process. Taking the thickness of the plate as $\frac{3}{16}$ -inch, spacing the rivets at $1\frac{1}{2}$ -inch, the size of the rivets at $\frac{1}{2}$ -inch in diameter, we can safely estimate that the riveting gang will put in 60 of these rivets in one hour, under ordinary shop conditions. The analysis of the cost is as follows:

Figures based on conditions in 1919.

RIVETING

Boilermaker's time, one hour.....	\$.75
Rivet bucket's time, one hour.....	.45
Rivet heater's time, one hour.....	.40
One caulker's time, $\frac{1}{2}$ hour.....	.37
One layout man's time, $\frac{1}{2}$ hour.....	.37
Two punchmen's time, $\frac{1}{4}$ hour.....	.30
Two erector's time, $\frac{1}{3}$ hour.....	.40
Two roll men's time, $\frac{1}{3}$ hour.....	.40

Total Labor \$3.11

Length of riveted seam, 7 ft. 6 in.

Pounds of rivets required, 3.6.

Cost of rivets, 10.8c.

Power required to drive pneumatic hammer and caulking tool, approximately 10 K. W. hours.

Investment per riveting gang, in air compressors, with motor drive, storage tanks, distributing piping system, air hammers, and other machines \$870.00

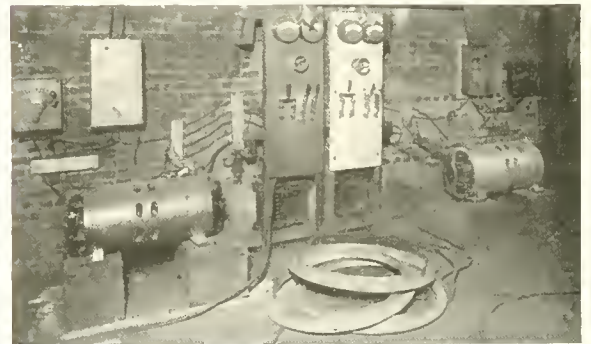

Fig. 75. Lincoln Arc Welders at the shop of The Ohio Boiler and Machine Co., Cleveland. In the foreground are stiffening rings for boiler work made with the Lincoln Arc Welders, which are used in this shop for a wide variety of work.

COMPARED WITH RIVETING

In order to get a comparative cost of the arc welding process, we will analyze the cost of doing the same work, namely making a seam 7 feet 6 inches long, which is a lap joint, welded inside and out. The following is an analysis of the cost, also on 1919 conditions:

ARC WELDING

One operator at 75c per hour for 1 1/4 hours.....	\$.94
No bucker required.	
No heater required.	
One man with a chipping hammer, 1/2 hour.....	.37
One layout man, 1/4 hour.....	.20
Two punchers, 1/8 hour.....	.15
Two erectors, 1-0 hour.....	.20
Two roll men, 1/3 hour.....	.40

Total Labor \$2.29

Pounds of electrode required, 25.
 Cost of electrode, 21c.
 Kilowatt hours required to run the welder, approximately 5.
 Investment in welding machine for one man, \$1,025.00

Labor has changed considerably since this time but riveting gangs' wages have changed with welders' wages so that the comparison is very fair.

It is to be noted from the above analysis that the labor cost item in the manufacture of boiler plate construction by riveting is approximately 50% greater than in the case of the welded construction.

The amount of power required for riveting is double the amount required for welding. The investment required by the arc welding appara-

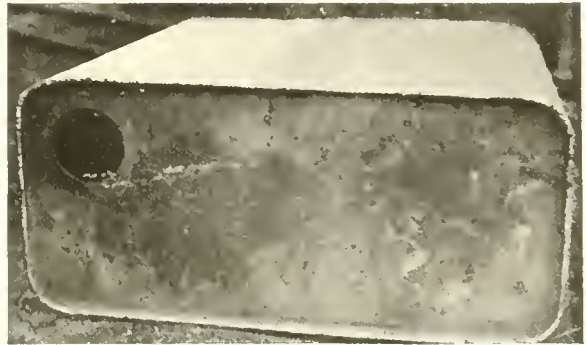

Fig. 77. Storage tank made complete by electric arc welding. The flanged end is welded into the sides by melting its edges together with the edges of the side sheets.

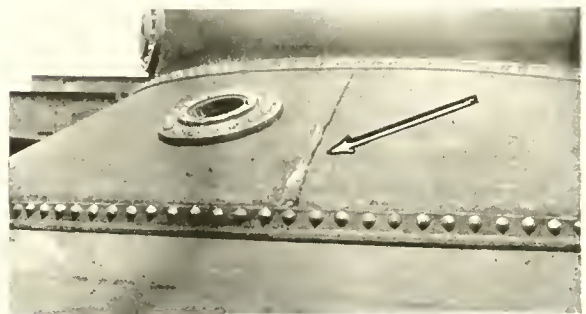

Fig. 78. This conical sheet was welded at the point shown, in order to avoid a double lap at the edge of the work which would have been difficult to rivet.



Fig. 76. Annealing Pot made with the Electric Arc Welder.

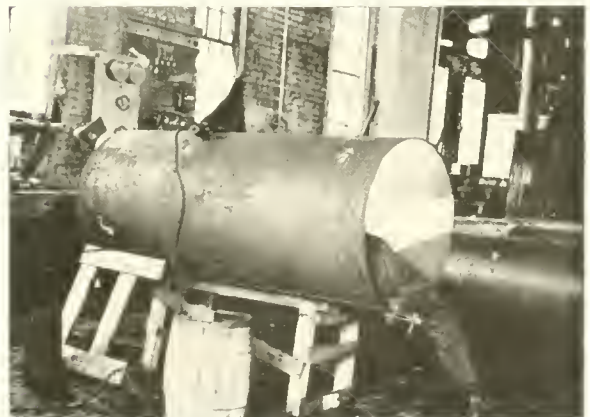

Fig. 79. Cylindrical Tank in process of welding. This shows an ingenious method of mounting the tank on a "horse" and clamping the edges of the sheets by means of two plates secured together by bolts.

ELECTRIC ARC WELDING

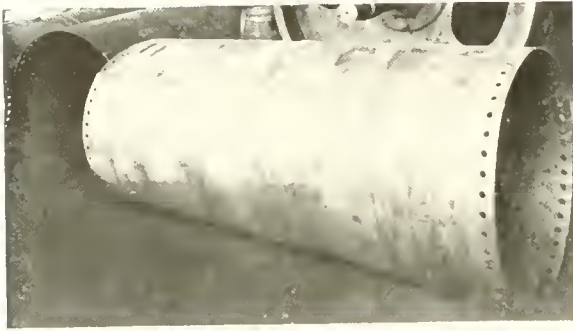

Fig. 80. Owing to lack of material plates of sufficient size could not be secured for this job. Four smaller plates were therefore welded together with the electric arc, saving long delay.

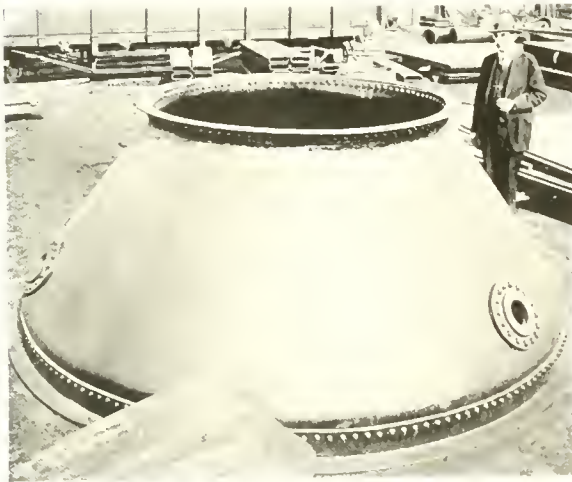

Fig. 81. Vacuum Pan for Sugar Boiler, made of boiler plate in three pieces. The vertical electric welded seams in these pieces save a difficult and expensive flanging operation.



Fig. 82. Diffusion cell for Sugar Boiler apparatus. This is welded all around circular seams and furnishes a good example of the use of welding in combination with riveting. Welding on this job saves awkward and expensive flanging work.

tus is somewhat higher than in case of the riveting machinery, but this of course is off-set by the lower operating cost.

Strength of Weld

The above analysis has been made with reference to jobs which can be either riveted or welded and it shows rather conclusively that it is considerably more expensive to rivet a joint than it is to weld it.

The strength and durability of the welded joint is greater than the same properties of the riveted joint in the case analyzed above. The welded joint may be 100% efficient or as strong as the original plate which is a strength impossible in a riveted joint.

In addition to the actual work outlined above reinforcing of boiler plate with steel angles offers a further opportunity for the arc.

Frequently a vessel must be manufactured in which one of the plates is larger than any of the standard sizes of plate. Two plates can then be butt welded together for this purpose; this has been done with perfect satisfaction in a number of cases in strainers, driers, water heaters, etc.

In the substitution of the welded joint for the riveted joint, it is recommended that in plate of $\frac{3}{16}$ -inch in thickness and over, wherever possible a joint be made as a lap joint rather than a butt joint. The amount of lapping should be at least four times the thickness of the plate. The work can be held together preparatory to welding by the use of bolts and after the job is welded the bolt holes can be filled up and chipped off. The use of a hammer for the purpose of hammering the metal welded on after the weld is completed



Fig. 83. Section of smoke-stack made by the New York Edison Company by electric arc welding.

BOILER PLATE WELDING

in order to "pack the metal in" should be discouraged. This is of no benefit and a positive harm may come to the metal from this practice. The chipping tool can be used, however, to dress the welded joint up to make it neat in appearance. In case the welded joint is to be subjected to a pressure test and it is found that there are small pin hole leaks, these leaks can be satisfactorily repaired either by chipping out a small amount of metal at that joint and filling in new metal or by a small amount of peening with a center punch at the point at which the leak occurs.

Where heavy plate is being welded and more than one layer of metal is put into the joint the operator should always be required to brush the thick layer of oxide from the metal with a stiff brush commonly known as a casting brush or a painter's wire brush. This is done so that the metal throughout the whole weld will be as free from slag and oxide as possible. Neglect of this important practice may mean a leaking or spongy weld. On pressure tank work where a homogeneous weld free from blow holes is an absolute necessity, the operator should hold as close an arc as possible and the speed of the work should be sacrificed in order to use a comparatively low current and consequently get the metal into the weld in the best possible condition.

Most of the welding in boiler shops should be done with the metal electrode, although on very heavy plate above $\frac{3}{4}$ -inch the carbon arc may be used to speed up the operation.

With the metal electrode 150 amperes current for each operator represents the capacity required in the welding machine. In the general practice of the boiler shop, the majority of the work would be done with $\frac{3}{16}$ -inch metal electrode and 150 to 175 amperes current.

Equipment

A discussion of the various types of equipment available for boiler shop work will be found on pages 46 to 56.

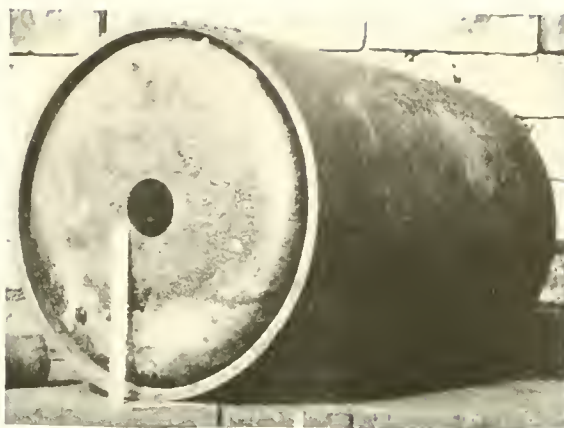

See illustration of finished work below



Fig. 84 Part of "header" made by electric arc welding a dish-shaped steel head into a cylindrical shell and welding in piece of pipe. Heads are made of $\frac{1}{2}$ inch plate, and the cylinder is $\frac{1}{4}$ inch material. The cost of this operation was 50c per head by arc welding, against \$1.50 per head by the acetylene process. Pressure test of 1800 pounds per square inch did not show the slightest sign of leakage or failure.



Fig. 85 Lincoln Arc Welder in the plant of The Standard Oil Co., Cleveland, Ohio.

Drop Forge Shops



Fig. 86. Repairing drop forgings by the metal electrode process (shown a Lincoln Arc Welder).

The arc welding process is being used successfully at the present time in the repair of defects in drop forgings before the forging leaves the shop. The work is done to improve the appearance of the forging rather than to improve its strength, although the correction of certain defects does increase the strength of the piece. The most important class of forgings which require the correction of small defects is automobile forgings. The defects corrected are low spots, parts not properly filled out, and certain kinds of cold shuts.

The defect is simply filled in by the metal electrode process and the excess metal ground off with an emery wheel. It is not often necessary to re-anneal the forging after the welding process owing to the very great localization of the heat, although if the piece is annealed after welding, the point at which the correction was made cannot be located. The work can be done very rapidly owing to the fact that the instant the operator strikes the arc, he can start filling in the metal. No preheating is necessary. The lowest priced man in the shop can do the welding.

The designation of the forgings to be corrected by welding should be done by a competent foreman or the superintendent of the shop. Knowing that the metal to be added will have a certain tensile strength and ability to resist shearing stress and that it will have a very small degree of elasticity due to the fact that it is cast steel,

there is little room for difference of opinion as to where to apply the welding process. The place on the forging at which the defect occurs has an important bearing on the question of whether or not it can be corrected. The service expected of a forging also affects the application of the welding process. It is evident that a defect of certain dimensions can be corrected if it occurs on an automobile lamp bracket which could not be safely corrected if it occurred on a six cylinder crank shaft. The foreman of the shop, or the superintendent knows what to weld, it should not be left to the welding operator.

Since there are only two welding processes applicable to the correction of flaws in drop forgings, electric arc and oxy-acetylene, a comparison may be interesting. The cost of producing a unit of heat by the gas process is approximately six times the cost of producing a unit of heat by the arc process. Owing to the great localization of the heat in the arc process, approximately three times the welding can be done with a given amount of heat as can be done with the same amount of heat produced by the gas process. By actual test, the cost of gas for general work on automobile front axles runs from twenty to twenty-five times the cost of electric power to do the same work. One operator with the electric arc can do at least twice as much work in a day as an oxy-acetylene operator.

The advantage has been claimed for the oxy-acetylene process that it enables the operator to burn down to the bottom of a cold shut and thus fill in the whole defect. This practice is also possible using the carbon arc process, but the practice is dangerous. A forging which shows evidence of having a deep cold shut in a part subjected to heavy stress should not be welded. A forging which has a cold shut which will not materially affect the usefulness of the forging will actually be in poorer condition after the defect has been burned out and filled in than if the defect were not corrected at all. The application of the gas flame in such a case will overheat a large amount of metal around the defect while the burning out is being done. After the area is sufficiently burned out, a comparatively large amount of cast metal will be filled in which is known to be inferior to the metal of the original forging. There is no heat treatment which will bring the forging back to a condition equal

DROP FORGE SHOPS

to its condition before the welding was done. It is much better to simply fill the defect to a depth of approximately a sixteenth of an inch with the metal electrode process which will not materially affect the metal surrounding the defect.

Overheating the metal in a drop forging is always undesirable, particularly in the case of the alloy steels used for certain automobile drop forgings. The high temperature reached in the gas flame and the electric arc affect the structure of the steel to such an extent that it can never be made identical to the structure which has not been affected by the welding process. It is evident, therefore, that the heat used for welding should be localized as much as possible. The oxy-acetylene flame will heat from three to five times the volume of metal in performing a given welding operation that will be heated when the arc process is used. The arc produces heat in the metal at exactly the point where it is needed, while the gas flame produces the heat external to the metal and blows it over a large area.

The welding of defects on drop forgings is a delicate matter among some manufacturers at the present time. This condition of affairs appears to be due to the fact that the process is new

rather than that it is immoral. When the steel foundries first started to correcting defects in important locomotive castings there was the same feeling prevalent. In fact most of the welding was done in the dead of night and behind carefully guarded doors. This was only five or six years ago. Now practically every steel foundry has one or more arc welders, and every kind of a steel casting is welded in the presence of the inspectors. Defects in gun carriages for the Navy Department are corrected in and out of the Navy Yards.

The responsibility for a drop forging rests with the manufacturer. If he can make forgings at a price at which they can be sold at a profit and the forgings stand the service he can stay in business. If the manufacturer sends out bad forgings, he loses his business. As long as a manufacturer must scrap forgings with insignificant defects on them which his competitor can save, his price on the product will be high or his profit low. The present tendency of prices of automobiles does not permit the quotation of fancy prices on drop forgings. The welding of small defects on drop forgings therefore is a matter of business economics, and will undoubtedly be solved in exactly the same manner as it has been solved in the case of the steel foundries.

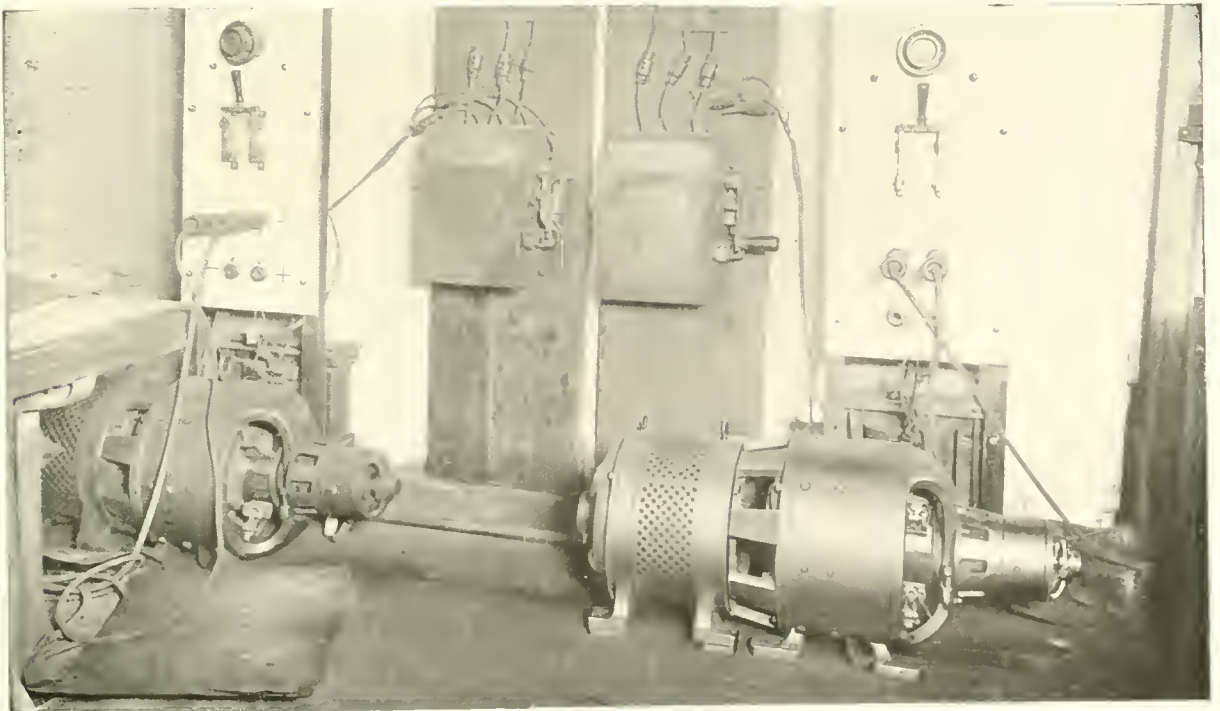

Fig. 87. Lincoln Arc Welders in use in large Drop Forging plant

ELECTRIC ARC WELDING

Commercial or Job Welding



Fig. 88. Welding airplane cylinder socket with electric arc process.

Every city of any size has a number of small shops where welding of all sorts is done.

For a long time acetylene welding was the chief process in use in these shops. They were started, mostly, by men who had done acetylene welding in various manufacturing plants until they had become very expert in its application to all sorts of work.

On starting business for themselves, they naturally adopted the process with which they were familiar. They were prompted not only by this, but by the fact that it required only a very small capital to buy the necessary equipment for acetylene welding.

These early shops have grown in number and have increased in size remarkably in the past ten years. The larger ones have now come to the point where there is a continuous stream of work passing through their plants and they have been obliged to look very carefully into methods of reducing production cost. Competition has grown keen in proportion to the success which the early shops made of their business.

Owing to this condition, many of the shops have carefully investigated and have been putting in arc welding apparatus to take care of a great deal of their work. An investigation has shown that from 30 to 60 per cent of the work which is welded by oxy-acetylene can be done equally well with the arc process, and what is more important, it can be done usually for less than half the cost of acetylene work.

There are undoubtedly cases in which oxy-acetylene must be used in preference to the arc, such as the case of welding automobile cylinders, but this class of jobs forms only a small percentage of the work done by a large commercial plant. Many such plants employ ten to fifteen operators and in a plant of this size, there is always work enough to keep two or three arc welding operators busy using the arc.

Comparative Costs

The tables given on page 6 are authentic, and will give the commercial welder a basis on which he can compare his present costs with those of arc welding.

The importance of doing this work at the lowest possible cost need not be emphasized for every welder knows that every cent he saves on any given welding job goes into his pocket as that much extra profit or in other cases it enables him to bid lower on desirable work and secure it at a good profit against competition from smaller shops who are figuring work for acetylene welding.

The best possible basis for comparison is the actual installation of an arc welding outfit in the commercial shop and a thorough trial covering a period of two or three months' time. This sort of a trial can be arranged at a slight expense and has proven a means of cost cutting to commercial welding shops in Detroit, Pittsburgh, Providence, R. I., Cleveland, and other places where it has been tried.

Portable Outfits

One source of profit to the commercial shop is that class of work which cannot be brought to the welder, but which operators must go out to do. For this purpose the Portable Arc Welding Outfits are made which can be operated conveniently and at very low cost.

Equipment

The commercial welding shop needs a welder of at least 200 amperes capacity. This will be suitable for any metal electrode work or light carbon electrode welding.

Two or more 150 ampere welders are of course to be preferred to one of 200 ampere output, as this will allow a larger number of operators to work at the same time.

Illustration and complete description of welding equipment suited for commercial work will be found on pages 46 to 56.

General Manufacturing

The use of welding in repair work has perhaps been over emphasized by all manufacturers of welding apparatus. Opportunities for this work are most easily found and it is very easy to demonstrate the saving made.

The field for this class of work does not compare, however, with the field for general manufacturing work, where welding can be used to take the place of riveting and other methods of joining metal parts.

There are hundreds of such applications of welding now being made. In these cases the work has either been accidentally discovered by the manufacturer himself, or some welding engineer has carefully sought out this application and demonstrated it to the manufacturer.

It is exceedingly difficult to obtain data or photographs on this class of work. The manufacturer who has successfully applied it, is naturally averse to giving out the fact, since he is usually making savings which are important to him in meeting competition. Strictest secrecy is often maintained regarding this work.

Each manufacturer is therefore obliged to find his own application for arc welding to a great extent.

We have endeavored to present on page 45 certain typical illustrations which show not any particular manufacturing process, but the general



Fig. 89. Welding steel sheets together to form gear cases. The flanges on the inside of the case are also welded on. Jobs similar to this can be found in hundreds of manufacturing plants.

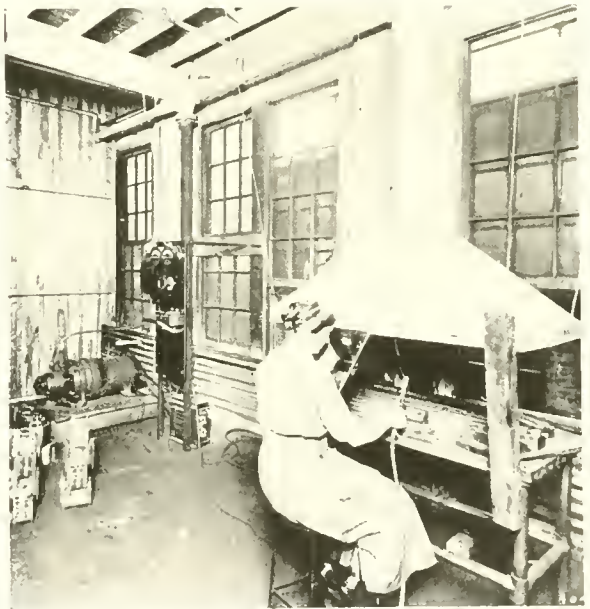

Fig. 90. Factory production of auto starter frames using Lincoln Arc Welder.

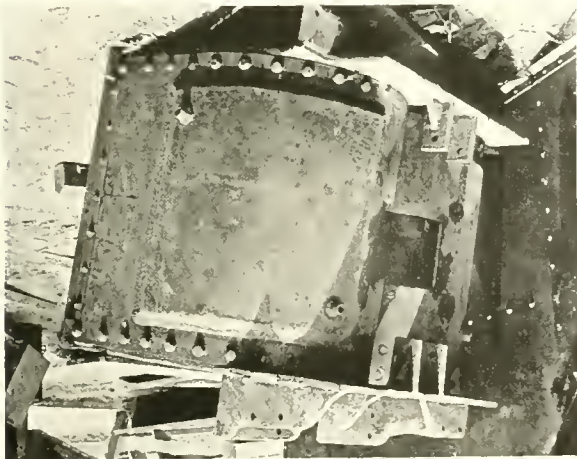

Fig. 88A. Asphalt Mixer with arc welded Heating Jacket. Welding saved 70% over riveting and increased jacket capacity by avoiding flanges and rivets on the inside.

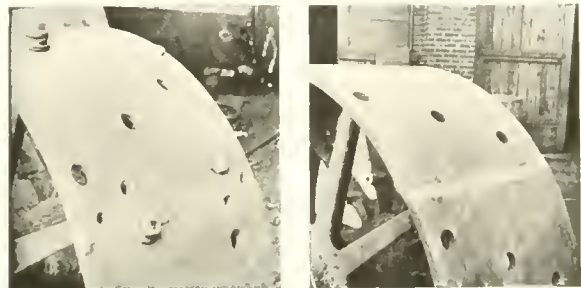

Fig. 91. BEFORE GRINDING. Steel Wheel made by welding a steel plate rim and bolting it to steel spokes. AFTER GRINDING. Steel Wheel after the weld in the rim has been ground down to give smooth surface.

ELECTRIC ARC WELDING

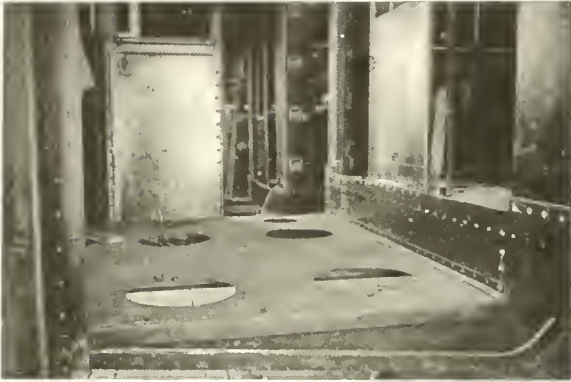

Fig. 90 Street car entrance showing use of electric welding in car manufacture.

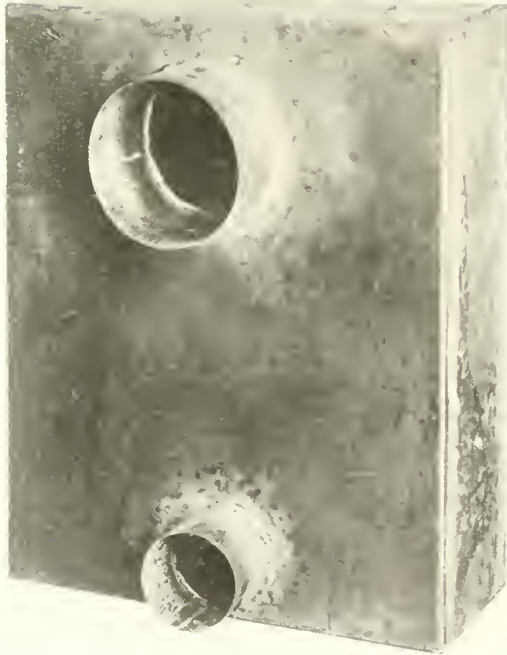

Fig. 91 Grange heater electrically welded. This is a good example of welding in light sheet steel.

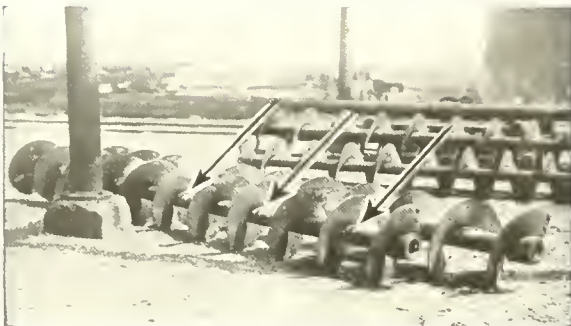

Fig. 92 Screw conveyors made by arc welding the spiral steel vanes to a central shaft.

application of welding so that each manufacturer can apply the principles shown in these samples to his own particular problem.

Sheet and Plate Welding

The application of welding to this class of material has been covered in boiler plate work. The range of work is so wide here that there is no possibility of giving definite rules covering the subject. The best that can be done is define the limits within which welding can be successfully performed on sheets and plates.

Generally speaking, arc welding cannot be successfully applied to steel sheets of less than 20 gauge. In certain instances where sheets are welded to reinforced angles or are backed up by some heavier material, it is possible to weld thinner material successfully.

Reinforcing of sheets or plates by angles, rims, etc., presents another possibility for arc welding. It has been successfully applied for welding angle iron supports on tank wagons, reinforcing rims in large storage tanks and other work of this general nature.

Pipe Welding

The advantages of welding for pipe construction have been a subject of careful investigation by The National Tube Co., and others interested in this subject.

It has been found that welding gives a more permanent joint in pipe than the couplings ordinarily used, that it gives a strength equal to that of the solid pipe and reduces the tendency to leakage at joints by eliminating couplings, the



Fig. 95 Welding door hangers for fireproof steel doors. The square tubes on the horse are also arc welded on the seams.

GENERAL MANUFACTURING

whole being practically one unbroken length of pipe.

These advantages are of special importance in the construction of superheaters and similar material made from pipe products.

A development of this process is the welding of flues in locomotive boilers which has been very widely practiced in railroad shops and locomotive manufacturing plants.

It is the present theory that welded pipe lines reduce electrolytic action and corrosion. The welded pipe presents a continuous conductor in which the resistance is lower than in coupling pipe, thus reducing the tendency of the current to jump joints and set up electrolytic action.

This use of welding is applicable not only in shop manufacturing work, but in laying of pipe lines and can be taken care of to good advantage by a portable arc welding set, which either takes current from the trolley or electric supply line. A portable welding set, driven by a gasoline engine or mounted on a truck and driven by a truck engine will accomplish the same result.

Repairs

The repair of defects in manufactured pieces has already been discussed under the subject of steel castings and forgings, where arc welding has thus far had its greatest application.

There is undoubtedly another wide field in building up of pressed metal parts which come imperfect from the dies and which have cracks, "short sides" or similar minor defects, which could be readily repaired by adding new metal.

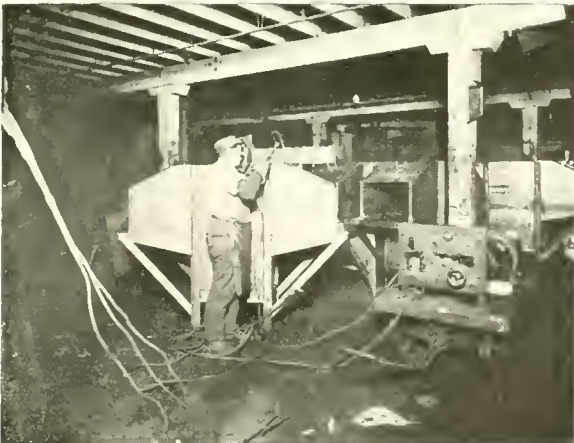

Fig. 96. Tanks for dish-washing machines welded with a portable Lincoln Arc Welder, shown in illustration.



Cracked engine bed repaired by Lincoln Arc Welder. Completed weld was soft enough to be easily machined.

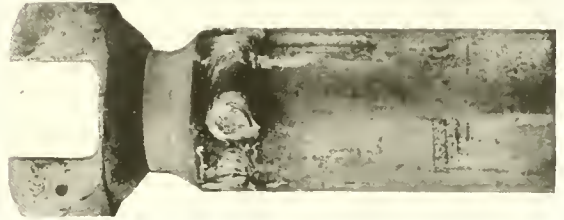

Fig. 97. Flexible shaft for automobile, arc welded.

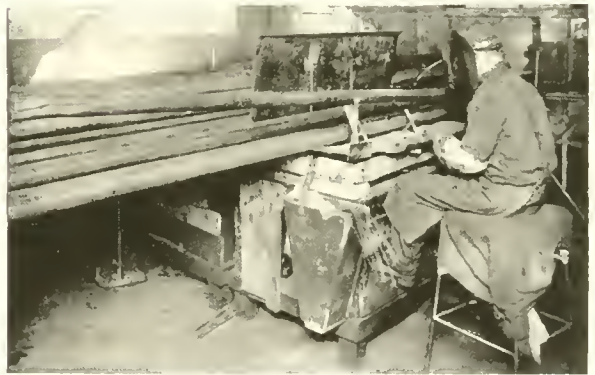

Fig. 98. Welding defects in steel tubes with an electric arc welder.



Fig. 99. Steel Machinery Bed-plates manufactured by use of Lincoln Arc Welder. Better and cheaper than a cast iron bed plate.

ELECTRIC ARC WELDING



Fig. 100. Welded patch on steel kettle. The patch is clearly shown and also several portions around the patch which were built up by arc welding.



Fig. 101. Hoisting Engine Boiler, in which a large part of the flange had been badly corroded by use of poor water. This damage was completely repaired by a Lincoln Arc Welder, saving the boiler which would otherwise have been scrapped.



Fig. 102. Steel parts incorrectly machined built up by the arc welder and afterwards re-machined to proper size.

The repair of broken machinery or parts can be made quickly and at low cost by the arc welding process. Unless the plant is a large one and would have a considerable amount of this work, acetylene would be cheaper than arc welding, but where there is enough such work to keep an operator busy a great portion of the time, the arc welding would be found most economical.

The general nature of such repair work, follows under several headings. Bolt holes often become worn and necessitate replacing the worn piece with a new casting. This can be avoided by filling the worn hole with new metal then redrilling it. Bearing surfaces on slides, cams, etc., are repaired by somewhat similar processes. Patches are applied on ladles, tanks, and vessels used in different manufacturing processes.

Steel mills have found it economical to install arc welders for the purpose of repairing wobblers in the rolling mill. The ends of these wobblers are built up with new steel to original shape, saving the cost of a new roll casting, which is much more expensive than the ordinary casting steel. Work is also being done successfully on the working surface of the roll.

Steel shafts are built up in somewhat the same manner, new material being welded on to the worn end, and the shaft then being put into the lathe and turned down.

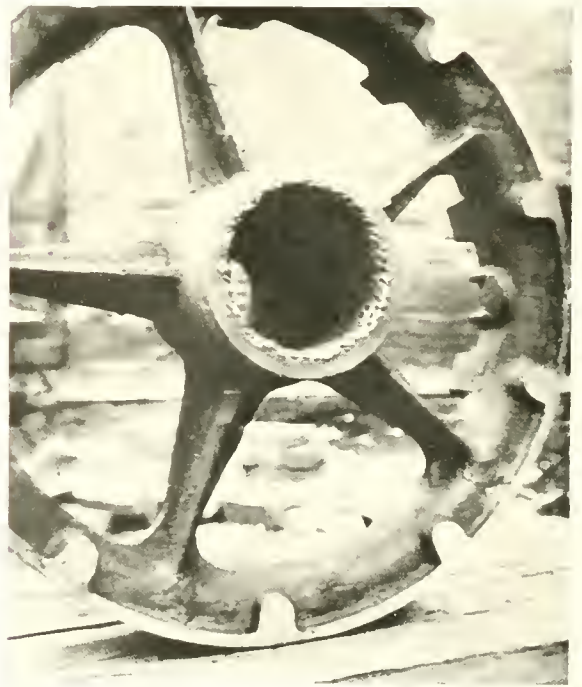

Fig. 103. This steel casting was wrongly machined. The hole in the center being machined out too large. This shows how it was built up with a Lincoln Arc Welder and afterwards machined to the proper size, saving the casting from the scrap heap.

ELECTRIC ARC WELDING

Suggestive Applications

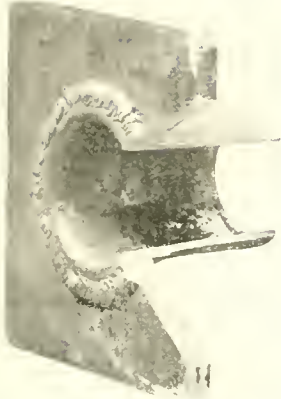

Fig. 104A. FLUE WELDING. 2" Flue—Locomotive Back Flue Sheet. Actual Time 2 minutes 2" Flue; 7 minutes 5" Flue—Electrode 2" Flue—90-100 Amp—5" Flue—5/32"—120-130 Amp. The total time to weld a complete set of flues and flue sheet. A fair average may be calculated from the above figures by adding 50% to the total time for rest periods.

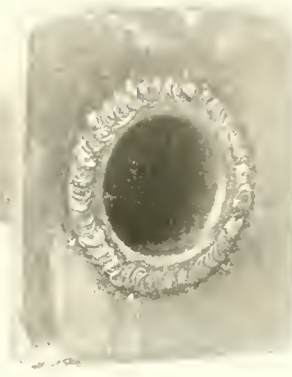

Fig. 104B. FLUE WELDING. 1. Put the flue in if it were not to be welded. 2. Send the engine out for a few trips to let the tubes take their set. 3. Sand blast the flue sheet. 4. Weld flues. A heavy bead of welded metal around the flue is not desirable. Put on the smallest bead that can be thoroughly welded to both flue and sheet.

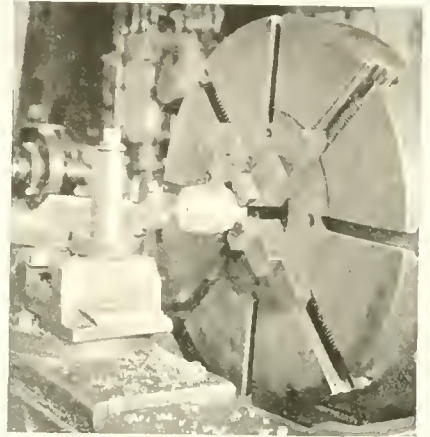

Fig. 105. BUILDING UP OPERATIONS. (Note that the weld is easily machined.) 5/32" Electrode 130 Amp., 20 Volts will deposit one pound of metal in approximately 30 minutes. 3/16" Electrode, 175 Amp., 22 Volts, will deposit one pound of metal in approximately 20 minutes. Using 5/32" Electrode, one cubic inch of steel may be deposited in about 7 1/2 minutes. The metal when deposited on mild steel by the metal electrode process will always be soft and easily machined. The carbon electrode process should be used for building up operations only when the built up piece can be later annealed to take out contraction strain.



Fig. 104C. FLANGED HEAD BAKED INTO SHELL.



Fig. 104G. Typical welding job on 3/8 inch plate, and rings made of 5/8 inch stock. Using 200 ampere welder, 1/4-inch electrode welding 14 feet of seam per hour.



Fig. 104H. BOILER PLATE WELDING.

Size	Ft per Hr	Electrode	Current
1/4"	8	5/32	110 Amps.
3/8"	7	5/32	120 Amps.
1/2"	6	5/8-3/16	150 Amps.

Above figures include straight welding time only. Loss of time in handling the job must be taken into account on each job. Vertical or overhead welding speeds are at least 50% below speeds given above. 1/4" wire is used to fill in bottom of seam.



Fig. 104D. FLANGED HEADS—BOILER PLATE.

5/32" Plate—Speed—7 ft. per hour. 5/32" Electrode 130 Amperes. For High Pressure, joints should be welded inside and out.



Fig. 104F. WELDING IN PLACE OF CALKING. Speed of work depends on amount of metal added. Strength of joint may be raised 25% doing the work at three times the welding speed given in table, page 6, for any thickness plate above 1/4". This makes a single riveted joint equivalent to a double riveted joint and makes a double riveted joint as strong as the original plate. Joints welded in this manner stand much abuse without leaking.

How to Buy Equipment for Electric Arc Welding

Electric Arc Welding has had a marvelous development during the past three or four years.

The absolute necessity for tremendous production in war times gave to electric arc welding the impetus that was necessary to its recognition.

Unfortunately, this rapid development of arc welding has been taken advantage of and the process has been recommended for work which it cannot satisfactorily do. Electric arc welding apparatus has been devised over night by those with no practical experience in its manufacture, who are endeavoring to make the most of the unusual demand for this equipment.

Unless this unfortunate situation is immediately corrected, electric arc welding is going to fall into discredit among firms who are using it for impractical purposes or under wrong conditions. For instance, the statement is being widely made that any metals whatever can be welded in the electric arc without pre-heating. Such overstatements of the adaptability of the process cannot but do harm not only to those who would use it, but to those reputable manufacturers who are endeavoring to build up the welding industry on a substantial basis.

The Lincoln Electric Co. feel that they owe it to the electric welding industry and to those who may be prospective users of this process, to make a frank and complete statement on the present situation in the industry. This Company is in position to make this statement by reason of the fact that they are the pioneers in the successful commercial application of electric arc welding in this country.

Their first accomplishment was the use of the electric arc to melt new steel into defects in steel castings, thereby saving the casting from the scrap heap. The Lincoln Electric Co. devised the apparatus for this purpose and has sold it to practically every leading steel foundry in the United States.

In this work, they have endeavored always to be conservative in their statements as to what the arc will do and confidence in their judgment is shown by the fact that steel army truck wheels and other parts for ordnance use were fully ap-

proved after having been welded with the electric arc.

The following information is issued by The Lincoln Electric Co. to intending purchasers of equipment for arc welding. In submitting this information, every effort has been made to confine the discussion to absolute proven facts and to give only such information as would be of constructive value to the prospective purchaser and to the electric arc welding industry.

What Metals Can be Welded

Generally speaking, iron, steel and the various alloys of these metals can be welded successfully with the electric arc. As for the other metals, aluminum, brass, bronze, copper, etc., there is a certain amount of welding that can be done on these metals in a commercial way. However, any statement that all of these metals can be welded without any trouble and without pre-heating is a distortion of the facts. Any firm which claims that *any* metal whatever can be commercially welded condemns itself by its own statement and the intending purchaser would do well to avoid any organization which makes such claims for the electric arc welding process.

Commercially Practicable Welding

Right here it is pertinent to say that there is a vast difference between what can be welded as a matter of show or display and what can be welded commercially.

A highly skilled operator with years of experience and apparatus which he thoroughly understands can perform work on display which can never be duplicated in a factory with the sort of help available for such operations.

In advising on electric welding, The Lincoln Electric Co. never advocates welding for any work where it cannot be done by a reasonably skilled operator under normal shop conditions.

We would advise any intending purchaser of welding equipment to insist upon a test in his own shop with his own workmen under actual shop conditions before purchasing equipment.

LINCOLN ARC WELDER

The Lincoln Arc Welder Will Do More Work Per Day

Arc welding apparatus is purchased for the purpose of doing certain work. The best arc welder to buy is the one that will do the most of that work in a day and do it at the lowest cost.

Every prospective purchaser of welding equipment should keep that simple thought first and foremost in his mind and not lose sight of it in considering the mass of technical specifications which are necessarily submitted with every bid for electrical apparatus.

The work turned out by the equipment is something which any buyer can judge without any technical knowledge whatever and it is one thing which determines the value of the equipment to the purchaser.

The Lincoln Arc Welder will do 20 per cent more welding work per day under actual commercial welding conditions than any other electric welding equipment made.

This is a well-considered statement based on the results of many competitive tests and it is a

claim which The Lincoln Electric Co. are prepared to prove at any time or place where welding is being done continuously by commercial operators.

The following are the facts on a few tests recently conducted by prospective purchasers to determine the relative value of the Lincoln Welder and three other competing machines.

In each of these tests the articles welded were standard products being produced in large quantities and in each test the operator of the machine was an employee of the company that proposed buying the equipment and the same operator worked on all of the different types of welders. Names of these firms are not published here because they do not wish to have the particulars of their shop practise known, but further facts can be furnished to any one on request, or better still, a similar test can be arranged in his own shop for any intending purchaser of welding equipment.

TEST No. 1

Make of Welder.	Average Time Welding One Piece.	Relative Speed Percentages.
Make "B"	24 min. 20 sec.	Lincoln welds 60% more
Make "C"	29 min. 50 sec.	Lincoln welds 100% more
Make "A"	17 min. 33 sec.	Lincoln welds 18% more
Lincoln	15 min. 3 sec.	

Note: The manufacturer's engineer reporting on these tests commented as follows: "Lincoln weld good clean fracture, good penetration." On each of the other three machines tested he reports either poor penetration, porous weld or both poor penetration and porous weld.

Fig. 200. This is the type of Lincoln Arc Welder supplied for heavy steel foundry work where current up to or exceeding 400 amperes is required.

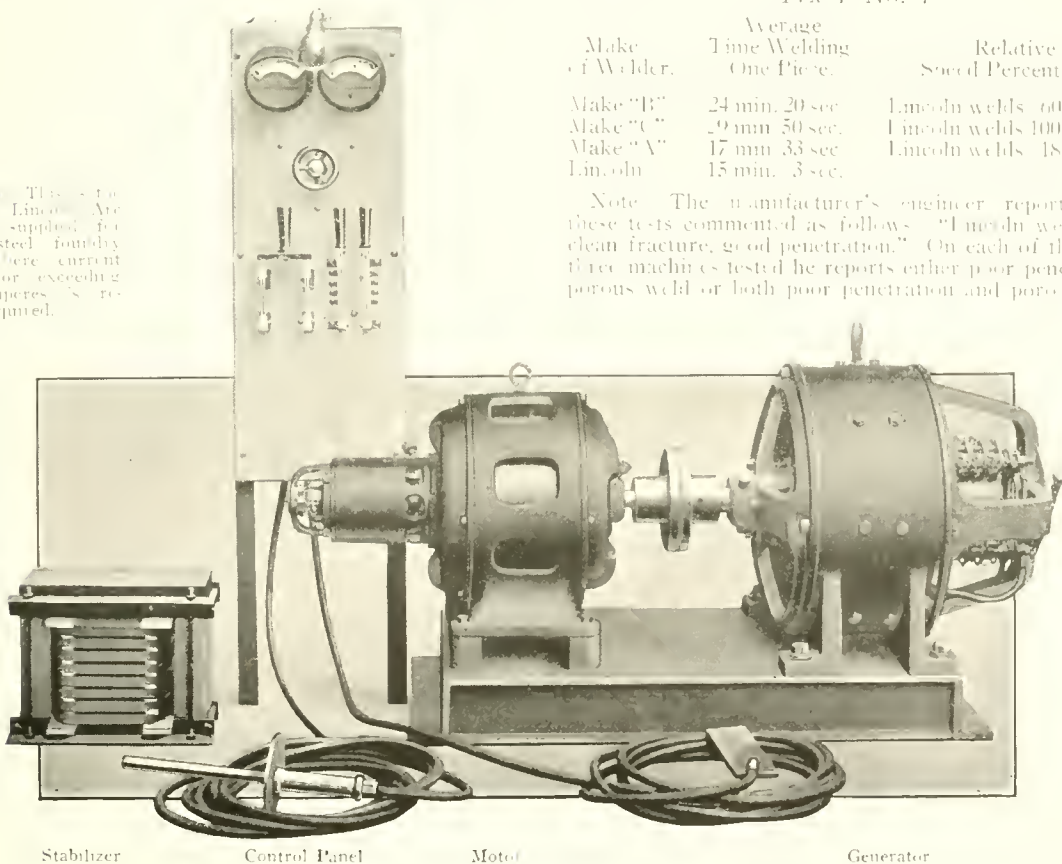

Stabilizer

Control Panel

Motor

Generator

LINCOLN ARC WELDER

TEST No. 2

Make of Welder	No. of Finished Pieces per Day	Relative Speed Percentages
Make "A" Lincoln	11 14	Lincoln welds 27% more

TEST No. 3

Make of Welder	No. of Finished Pieces Per Day	Relative Speed Percentages	Tensile Strength of Weld
Make "B"	14	Lincoln welds 43% more	39,700 lbs.
Make "C"	16½	Lincoln welds 21% more	46,614 lbs.
Lincoln	20		46,843 lbs.

The last item of tensile strength was added in this test to determine which welder produced the best weld regardless of speed. In this also, the Lincoln Welder won by a safe margin.

The importance of such tests as these cannot be over emphasized for it represents the only method by which the relative merits of different machines can be fairly decided.

The "Rating" of Electric Welders

Because the welder is a piece of electrical apparatus, it is ordinarily rated according to the number of amperes current it will deliver. This rating is supposed to be a measure of the welding work which the machine will do. This is not actually the case, however, unless full particulars are given as to the conditions under which this current is delivered.

For instance, two welders, each rated to deliver 200 amperes are not necessarily capable of doing the same amount of work. As a matter of conforming to general custom on electrical apparatus The Lincoln Electric Co. rate their welders on amperes current delivered. The Lincoln rating, however, gives the number amperes current which the welder will deliver at the voltage necessary for actual welding. Some other manufacturers give, as a rating, the maximum current which the welder will deliver for a short period. By far the most satisfactory method and the one which The Lincoln Electric Co. recommends is to buy welding equipment which is guaranteed to do certain welding work regardless of any arbitrary rating. This The Lincoln Electric Co. is prepared to do on any kind of welding work.

Why The Lincoln Works Faster

The Lincoln Arc Welder will do more work per day because it is an easier machine to operate.

The heat for arc welding is generated by electric current jumping or arcing from the welded piece to the electrode which the operator holds.

The voltage of current necessary to make it jump across this gap depends upon many things. Among them is the distance of the electrode from the welded piece.

The slightest movement of the operator's hand will increase that distance and increase the volt-

age. These conditions change so rapidly in actual welding that at one instant there will be almost no voltage required—the next instant a considerable voltage may be necessary.

The Lincoln Arc Welder takes care of these variations better than any other type of equipment. The arc does not "go out" so easily—the operator is not fatigued by an effort to hold his hand perfectly steady nor does he have to work slowly to keep the arc in operation.

Laminated Steel Frame

The fact that the Lincoln Arc is easy to operate is due to the construction of the magnetic field or frame of the welder which is built up of steel laminations or sheets. The electrician will readily understand that this type of construction permits a very rapid change in the amount of "magnetism" or "flux density" and this in turn makes it possible for the electric current to adjust itself almost instantly to any demand. The complete magnetic circuit of the Lincoln Welder is laminated instead of the pole pieces alone.

The Lincoln Stabilizer

In addition to the laminated steel frame the Lincoln Arc Welder is provided with a Stabilizer which acts upon the electric current much like a fly wheel does on any other piece of machinery. It stores up energy which permits the machine to take care of an extraordinary demand without any trouble.

Operators Like The Lincoln

Under present labor conditions this fact is of the utmost importance. Anything which tends to produce a muscular or nervous strain upon the workmen will lead to their doing indifferent work or cause them to leave the job altogether.

Most welding work depends for its success upon careful, painstaking attention and this cannot be had unless the equipment is easy to operate. On piece work this ease of operation is especially essential and piece work operators invariably favor Lincoln equipment where they have had the opportunity to observe it along with other types.

The Steady Arc Means Good Welds

Because of the laminated frame construction and stabilizer the Lincoln Welder produces an arc which is steady and easy to maintain. The fact that the arc is easy to maintain with a Lincoln Welder tends to produce better welding work. Continuous breaking of the arc and the necessity of frequent starting produces a brittle, porous condition in the weld. The best welds are made where the arc is kept steadily in operation and the metal thus deposited is homogeneous and strong.

LINCOLN ARC WELDER

Fig. 107. Lincoln Arc Welder for use where the shop supply is direct current. Any electrician can understand this equipment. It is all standard.

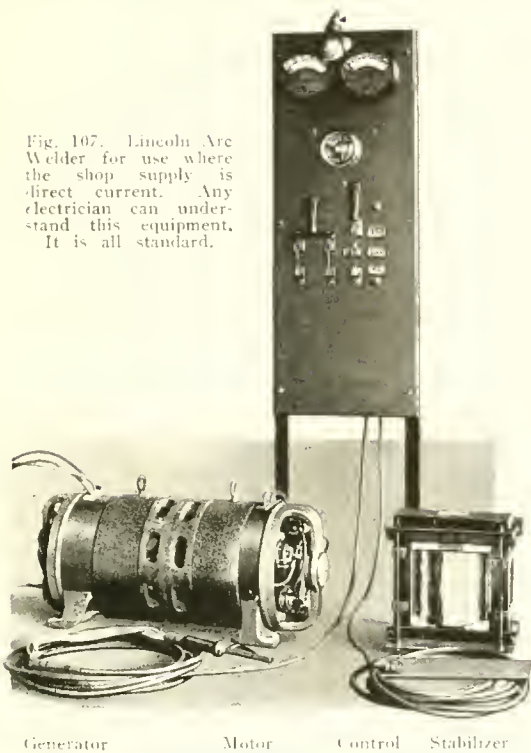

Generator Motor Control Stabilizer

Fig. 108. Lincoln Arc Welder for use where the shop supply is alternating current. Note the simplicity of this equipment and freedom from any complicated switches or electrical

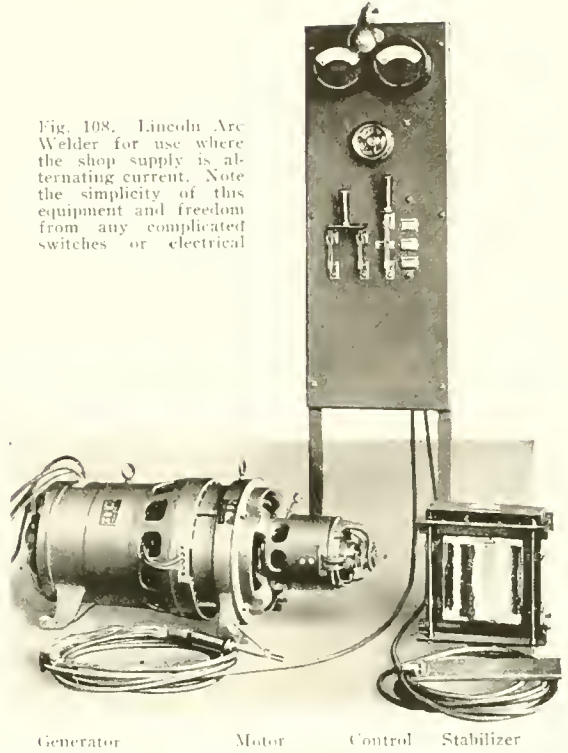

Generator Motor Control Stabilizer

Lincoln Arc Welder Is Standard Equipment

The illustrations presented in this book show the standard Lincoln Arc Welder. We urge the intending purchaser to take these illustrations, with the simple explanations under each one, and compare them with the illustrations of any other arc welding equipment he may be considering.

The entire absence of any solenoids, clapper switches or any other complicated devices will be noticed. The Lincoln Arc Welder consists simply of:

1. A Standard Motor driven by the shop current, whatever it may be, alternating current or direct. (This furnishes power to drive the generator. Where electric power is not available: belt driven or gasoline engine driven welders are supplied.)
2. A Standard Generator, delivering current at the proper voltage for welding.
3. A Stabilizer to give permanence and stability to the arc.
4. An electric control panel with simple knife switches and meters for adjusting the amount of welding heat.

The simplicity of the Lincoln Arc Welder can be understood by any person at a glance and we would further advise, if possible the examination by a competent electrician of the competing types of apparatus to determine which would be the simplest and cheapest to maintain.

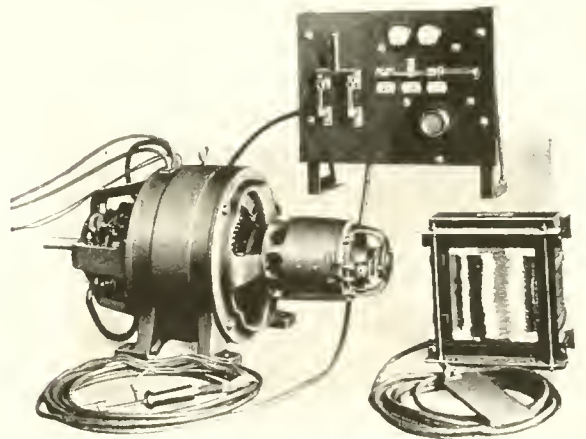

Fig. 109. Lincoln Arc Welder belt driven. This type of welder is used where a plant is not supplied with electric power.

FOR RAILROAD SHOPS

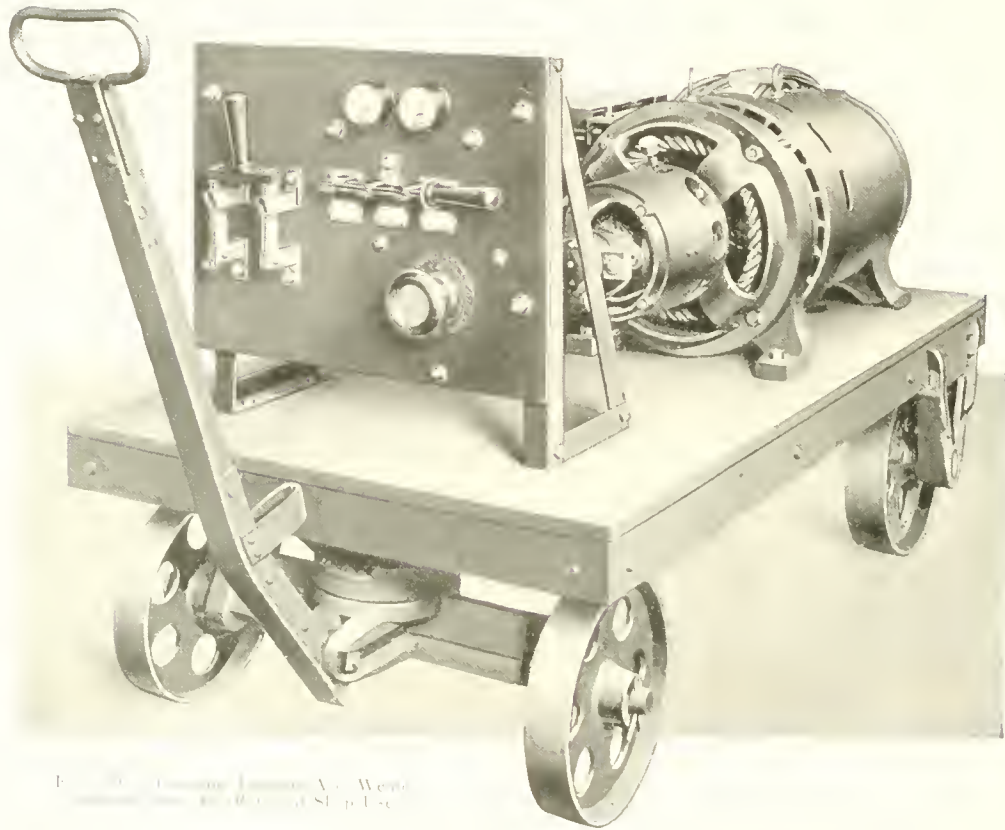

Fig. 20. Lincoln Arc Welder for Railroad Shop Use.

Lincoln Arc Welder for Railroad Shops

This equipment is the same in all respects as the standard welding outfits. For convenience in railroad shop operation, however, it is mounted on a specially designed truck which permits it to be moved readily about the shop.

Special Advantages of Lincoln Welders

This outfit is intended to take care of one operator and can be placed at any point in the shop where an electric motor is installed. In other words, there need be no special provision for the welding outfit and no special wiring and re-arrangement of the shop.

Other types of welder are designed to take care of several operators from one machine. The disadvantage of this system is that it requires a low tension distributing system carried from the welding machine to any station where welding is to be done. Such a system requires large copper wire and is a very expensive installation

to make, and it does not offer any advantage whatever.

The Lincoln Arc Welder can always be taken to the place where the locomotive is standing and welding work can go on at the same time with other repairs. With other systems, the locomotives all have to be brought to special stations for welding work or a low tension wiring system has to be carried over the entire shop.

Instead of moving the heavy locomotive about, the Lincoln Arc Welder, on its light truck, can be taken anywhere even for a few minutes work. This is an important advantage of the Lincoln type of equipment.

With the Lincoln Arc Welder any number of operators desired can work on the same engine without interference, something which should not be overlooked.

Should occasion arise to use carbon arc welding, needing a welder of greater capacity, this can be provided by connecting two or three individual units. Occasion for this will practically never arise in the railroad shop.

LINCOLN ARC WELDER

Economical With Power

The Lincoln Arc Welder uses no resistances of any sort in the line to cut the voltage of the machine down to that required for welding. The equipment generates at all times the correct amount of voltage required at the arc. This, together with the fact that the equipment is very simple and efficient in operation, makes the Lincoln Welder the most economical from the point of view of power consumed. This is an important point as the cost of current for a welding machine will amount to many times the cost of the machine itself during the life of the machine.

The Lincoln Electric Co. Were Pioneers in the Welding Field

This statement is not an idle boast, but a fact worthy of consideration by every purchaser of welding equipment. This company has in operation today more arc welding outfits than all of the other manufacturers of such apparatus combined.

The Lincoln Electric Co. originated the so-called "variable voltage" welder which delivers

at the arc the exact amount of current needed and makes unnecessary the use of resistances. This principle was widely criticized by competitive manufacturers but today practically every successful maker of welding equipment produces the variable voltage type of machine in some form or other.

Those who followed in the field have necessarily been obliged to use a plan for obtaining variable voltage which had already been tried out and rejected by The Lincoln Electric Co. The design at present employed by The Lincoln Electric Co. is thoroughly protected by patents.

"Alternating" Current Welding

During the war a great amount of interest was excited by claims that alternating current could be successfully used for arc welding. Practically every attempt to use alternating current for this purpose, however, has proved a failure, due to the fact that the apparatus is very difficult to operate and the welds produced are brittle, porous and unsatisfactory.

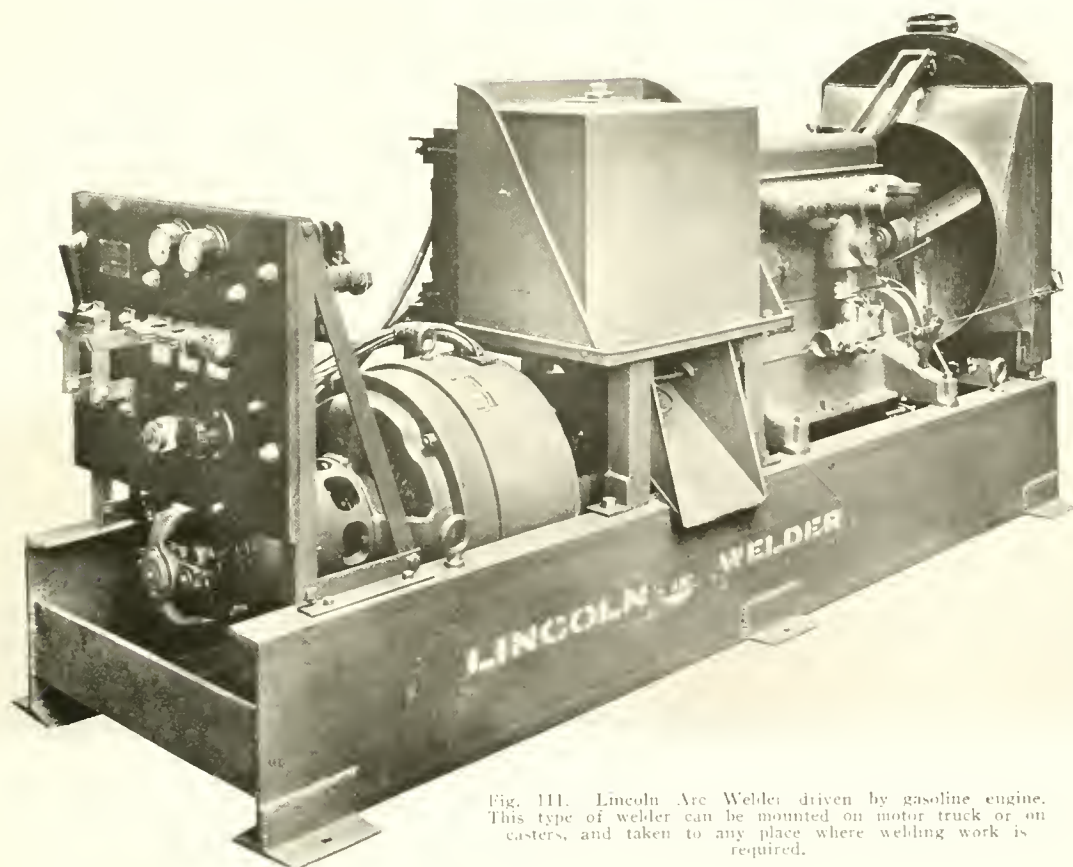

Fig. 111. Lincoln Arc Welder driven by gasoline engine. This type of welder can be mounted on motor truck or on casters, and taken to any place where welding work is required.

LINCOLN ARC WELDER

Multiple Operator Welding Outfits

Welding outfits have been designed from which a large number of operators could work at one time. This outfit makes necessary a resistance in series with each welding arc, resulting in tremendous loss of powder which quickly outweighs any saving which may be made in the first cost, by buying an outfit which will serve a number of operators instead of an individual outfit for each operator. Another difficulty with this apparatus is the interference when all operators happen to work at the same time. The current varies greatly and the result is uneven work.

Such an outfit can be used only when there are an average of over ten operators and even then there is a decided disadvantage.

The individual unit is to be preferred at all times because in case of breakdown or trouble only one welding operator is affected.

The Lincoln Arc Welder Is Backed by a Complete Service Organization

Electric Welding is and has been one of the only two sources from which The Lincoln Electric Co. derives its income. It has therefore been advisable for them to develop a high class organization.

In fourteen principal cities of the United States there are now Lincoln welding engineers, men who have served their apprenticeship in the different applications of welding and who are prepared to advise with the manufacturer upon any welding problem which may arise.

These men are in constant touch with every user of welding equipment and are under the direct supervision of the men who have practically created electric arc welding and brought the process to its present stage in this country.



Above shows part of the equipment at the Lincoln Electric Welding Department, where operators are trained in the fundamentals of welding practice. This department was established at the request of the United States Government during the war, and trained many operators for war work before it was turned into commercial uses.

Automatic Welding

The Lincoln Electric Co. have been working for some years to develop a thoroughly practical device for automatic welding.

This takes the form of a carriage which feeds the pieces to be welded under the electric arc and at the same time feeds down the electrode so that welding is continuous and is practically a mechanical process.

This process is only suitable where there is production work, that is, a number of pieces of the same kind to be manufactured.

Full particulars regarding this automatic welding process can be had upon application and demonstration can be arranged for which will enable the prospective purchaser to judge whether or not it will fulfill the requirements for his work.

How to Use the Arc Welder

The following sections on Design of Welded Joints and "Ten Lessons in Electric Welding" are offered as an aid in acquiring the knowledge and skill necessary to make successful applications of the electric arc welding process. It would be impossible to write any text book on this subject which would include all of the things which it is necessary for an operator or engineer to know in order to always make a successful application of the process. The application of the process is a new science that has been explored in only a few of the directions in which it will eventually prove successful. The art of welding with an electric arc is like any other mechanical art which may profitably be studied, but which only experience can perfect.

The manual training idea has been followed out in the lessons on welding to a certain extent so that the operator may learn to weld by welding according to definite instructions. The operator should follow the instructions to the best of his ability. It has been found by actual experience that if the operator merely "plays" with the apparatus and follows no definite plan during his training period, little is accomplished so far as the learning of the fundamental principles involved is concerned. The operator must try to make the samples required in the lessons

as good as possible. By so doing, he will acquire a knowledge of the fundamental principles involved in any welding application. It is important that the operator cut the welds as required in the lessons and criticise his own workmanship and allow other competent workmen to criticise it for him, so that in the end he will know beyond question whether or not he is making a weld while he is operating the arc.

It will be found much cheaper in the long run to have the operator spend enough time to become thoroughly familiar with the fundamental principles of welding during his training period than to put him on commercial work and allow him to get his experience there. It should be thoroughly understood that the operator will not be an expert by any means when he has completed the samples required in these lessons. It requires a large amount of experience to become an expert operator and owing to the rapidity with which the process and apparatus are being developed, it is impossible for one man to know all there is to be known about electric arc welding. The operator should continually study ways of improving his practice and if possible study the practice which has been developed by other experienced operators.

Design of Welded Joints

From an engineering point of view, every metallic joint whether it be riveted, bolted or welded, is designed to withstand a perfectly definite kind and amount of stress. An example of this is the longitudinal seam in the shell of a horizontal fire tube riveted boiler. This joint is designed for tension and steam tightness only and will not stand even a small amount of transverse bending stress without failure by leaking. If a joint performs the function for which it

was designed and no more, its designer has fulfilled his responsibilities and it is a good joint economically. Regardless of how the joint is made the design of joint which costs the least to make and which at the same time performs the function required of it, with a reasonable factor of safety, is the perfect joint.

The limitations of the several kinds of mechanical and welded joints should be thoroughly understood.

STRENGTH OF WELDED JOINTS

A bolted joint is expensive, is difficult to make steam or water pressure tight, but has the distinguishing advantage that it can be disassembled without destruction. Bolted joints which are as strong as the pieces bolted together are usually impracticable, owing to their bulk.

Riveted joints are less expensive to make than bolted joints but cannot be disassembled without destruction to the rivets. A riveted joint, subject to bending stress sufficient to produce appreciable deformation, will not remain steam or water pressure tight. Riveted joints can never be made as strong as the original sections because of the metal punched out to form the rivet holes.

There is no elasticity in either riveted, bolted or autogenously welded joints which must remain steam or water pressure tight. Excess material is required in the jointed sections of bolted or riveted joints owing to the weakness of the joints.

Autogenously welded joints have as a limit of tensile strength the tensile strength of cast metal of a composition identical to that of the joined pieces. The limit of the allowable bending stress is also set by the properties of cast metal of the same composition as that of the joined pieces. The reason for this limitation is that on the margin of an autogenous weld adjacent to the pieces joined, the metal of the pieces was heated and cooled without change of composition. Whatever properties the original metal had, due to heat or mechanical treatment, are removed by this action, which invariably occurs in an autogenous welding process. Regardless of what physical properties of the metal used to form the joint may be, the strength or ability to resist bending of the joint, as a whole, cannot exceed the corresponding properties of this metal in the margin of the weld. Thus assuming that an autogenous weld be made in boiler plate, having a tensile strength of 62,000 lbs. Assume that nickel steel, having a tensile strength of 85,000 lbs. be used to build up the joint. No advantage was gained by the excess 23,000 lbs. tensile strength of the nickel steel of the joint since the joint will fail at a point close to 62,000 lbs. If appreciable bending stress be applied to the joint it will fail in the margin referred to above.

The elastic limit of the built-in metal is the same as its ultimate strength for all practical purposes but the ultimate strength is above the elastic limit of the joined sections in commercial structures.

In spite of the limitations of the autogenously welded joint referred to above it is possible and practicable to build up a joint in commercial steel which will successfully resist any stress which will be encountered in commercial work. The advantage lies in the built up structure and the inherent steam and water pressure tightness of a welded joint.

The fundamental factor in the strength of a welded joint is the strength of the material added by the welding process. This factor depends upon the nature of the stress applied. The metal added by the welding process, when subject to tension, can be relied on in commercial practice to give a tensile strength of 45,000 lbs. per square inch. This is an average condition; assuming that the metal added was mild steel and that the operation was properly done, the metal will have approximately the same strength in compression as in tension. When a torsional stress is applied to a welded joint the resultant stress is produced by a combination of bending tension and compression, as well as shear. The resistance of the metal to shear may be figured at 8/10 its resistance to tensile stress. The metal added by the welding process, with the present development in the art of welding, will stand very little bending stress. An autogenously welded joint made by the electric arc process must be made stiffer than the adjacent sections in order that the bending shall not come in the joint. An electric weld, when properly made, will be steam and water pressure tight so long as bending of members of the structure does not produce failure of the welded joint.

Little is known at the present time in regard to the resistance of an electrically welded joint to dynamic stress, but there is reason to believe that the resistance to this kind of stress is low. However, owing to the fact that in most structures there is an opportunity for the members of the structure to flex and reduce the strain upon the weld, this inherent weakness of the welded joint does not interfere seriously with its usefulness.

A few tests have been made of high frequency alternating stresses and it has been found that using the ordinary wire electrode the welded joints fails at a comparatively small number of alterations. This is of little importance in most structures since high frequency alternating stress is not often encountered.

ELECTRIC ARC WELDING

Stresses in Joints

The drawings reproduced on pages 55, 56, 57, show several typical metallic joints and the stresses which are brought to bear on them. The method of welding is indicated.

In Fig. 112 it will be noted that a re-enforcing plate is welded to the joint to make the joint sufficiently stiff to throw the bending outside the weld.

Figure 113 shows a joint in straight tension. Since no transverse stress occurs the heavy re-enforcing of Figure 112 is not required. Just enough re-enforcing is given the joint to make up for the deficiency in tensile strength, of the metal of the weld.

Figure 114 shows another method of building up a joint that is in straight tension. It should be noted that in both Figure 113 and Figure 114 as much re-enforcing is placed on one side of a center line thru the plates as is placed on the other.

Figure 115 shows the original form of lap joint such as is used in riveting. The method shown for welding this joint is the only method which can be used. It cannot be recommended because such a joint, when in straight tension, tends to bring the center line of the plate into coincidence with the center line of the stress. In so doing an excessive stress is placed on the welded material.

Figure 116 shows the construction used in certain tanks where a flanged head is backed into a cylindrical shell. The principal stress to be resisted by the welded joint is that tending to push the head out of the shell. The welding process indicated in the figure will successfully do this. Owing to the friction between the weld and the shell, the outer weld would be sufficient to hold the weld in place for ordinary pressure. For higher pressures the inside weld should be made in addition.

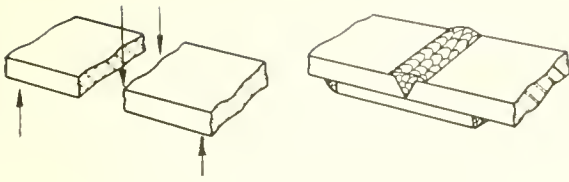

Fig. 112

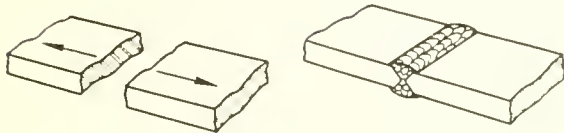

Fig. 113

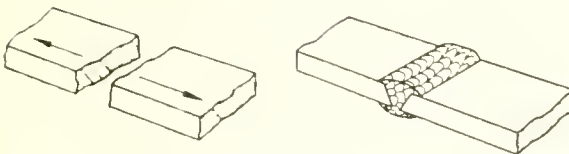

Fig. 114

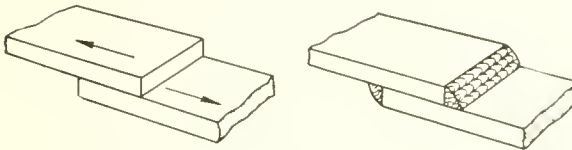

Fig. 115

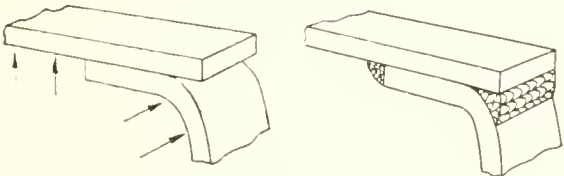

Fig. 116

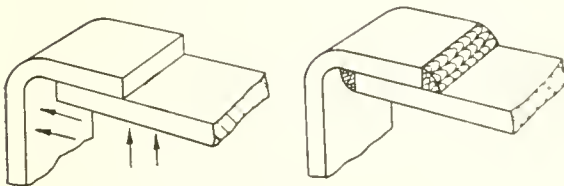

Fig. 117

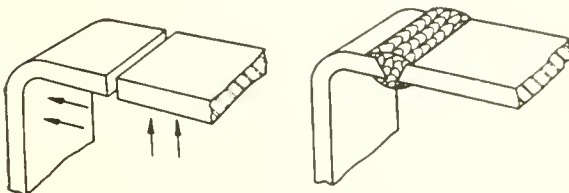

Fig. 118

DESIGN OF WELDED JOINTS

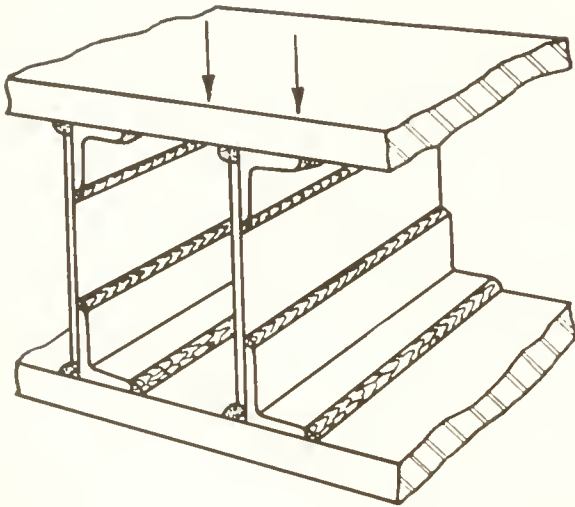

Fig. 117

Figures 117 and 118 show another method of welding a flanged head to the cylindrical shell. These methods are preferable to the method indicated in Figure 116. Figure 118 represents the recommended practice.

Figure 119 shows a plate and angle structure which might be used in ship construction. The particular feature to notice in the welding practice indicated, is that the vertical plates do not reach the entire distance between the horizontal plates. This is merely a method of eliminating difficulties in welding the plates to the angle.

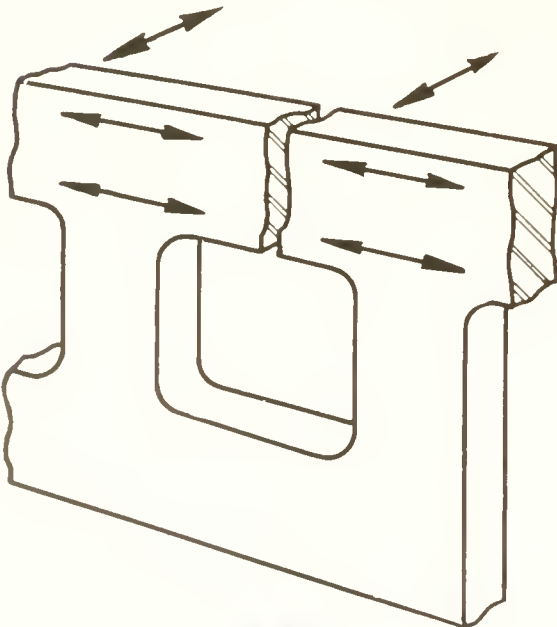

Fig. 119

Figures 120A, 120B, 120D and 120C show a method of welding a crack in a locomotive frame. The object in this practice is to reduce the amount of metal deposited by the electric welding process. The metal of the plate laminated structure is of better quality than the welding process will deposit. And also a large amount of time is saved by this practice. The plates should be $\frac{3}{8}$ or $\frac{1}{2}$ inch in thickness. *In making any weld, the smallest amount of metal should be added by the welding process which is possible to add with perfect fusion.*

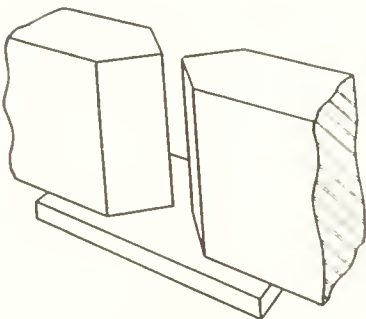

Fig. 120B

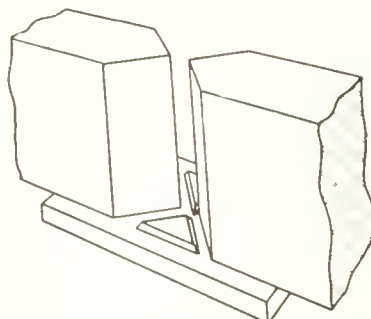

Fig. 120C

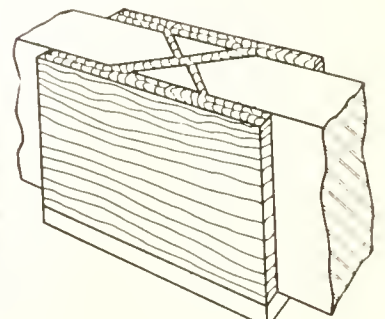

Fig. 120D

ELECTRIC ARC WELDING

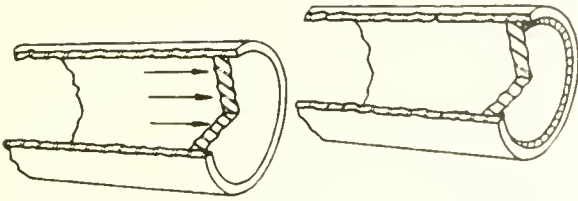

Fig. 121

Figure 121 shows a method of welding a head into a cylindrical pipe. The thickness of the head should be approximately twice the thickness of the wall of the pipe. The extra thickness plate is to gain sufficient stiffness in the head to make the stress on the welded material purely shear. The pressure from the inside tends to make the head assume a hemispherical shape. This would place a bending stress on the welded material if the head were thin enough to give at the proper pressure.

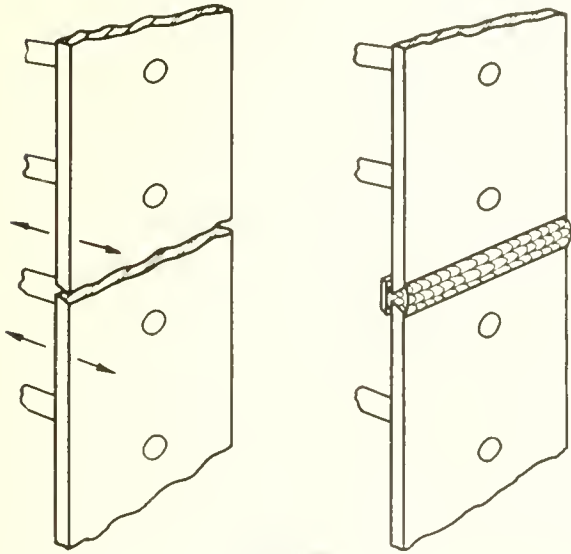

Fig. 122

Figure 122 shows a method of welding a crack in a fire box sheet. The thin plate backing introduced at the weld makes the operation very much easier for the operator and produces the re-enforcing of the water side of the fire box sheet which is most desirable.

Data for Calculations

1 cu. inch of steel weighs .28 pounds.

3.57 cu. inch of steel weighs 1 pound.

One pound of $5/32$ inch electrode may be deposited in 27 minutes with 130 amp., 18 volts.

25 to 30% of all electrode is wasted in "ends."

15 ft. of $5/32$ inch electrode weigh one pound.

One K. W. H. of electric power will produce 3413 B. T. U. of heat.

On straight-away welding the ordinary operator with helper will actually weld 75% of the time.

WELDER PARTS

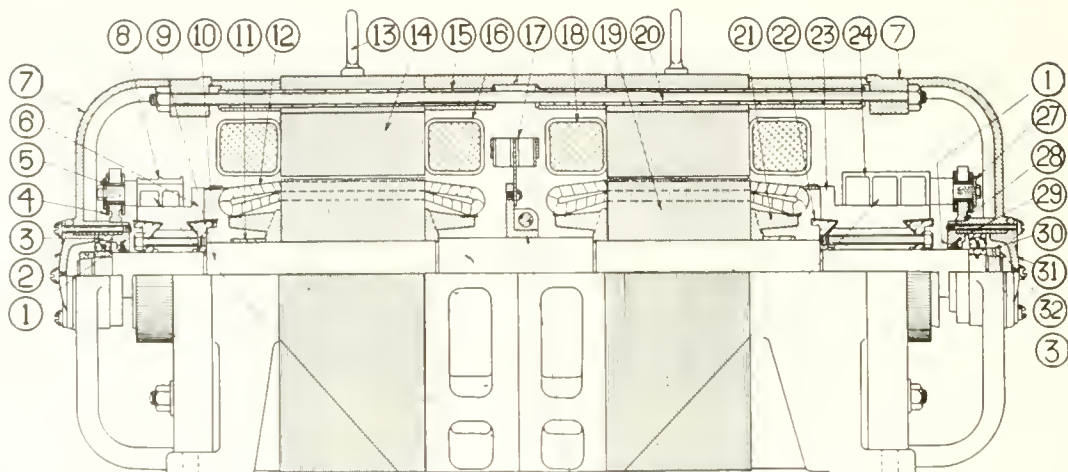

- No. 1 Dust Cap, Inner
- 2 Dust Cap, Outer, Motor End
- 3 S.K.F. Bearing
- 4 Insulating Washer
- 5 Tube, Brush Holder
- 6 Commutator Bar, Motor End
- 7 Bracket
- 8 Brush Holder, Motor End
- 9 Nut
- 10 Commutator Cap
- 11 Shrink Collar
- 12 Armature Coils
- 13 Eye Bolt
- 14 Stator Lamination

- No. 15 Frame Rivet Tubes
- 16 Pole Coils, Motor End
- 17 Blower
- 18 Field Coils, Generator End

- No. 19 Armature Lamination
- 20 Frame Bolt
- 21 End Plate
- 22 Mica Ring

- No. 23 Commutator Bar, Welder End
- 24 Brush Holder, Welder End
- 27 Clamping Washer
- 28 Rocker
- 29 Felt
- 30 Lock Nut Spring
- 31 Dust Cap, Generator End
- 32 Lock Nut
- 33 Spring, Brush Holder
- 34 Finger Stud
- 35 Finger
- 36 Brush
- 37 Blower Support

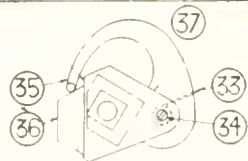
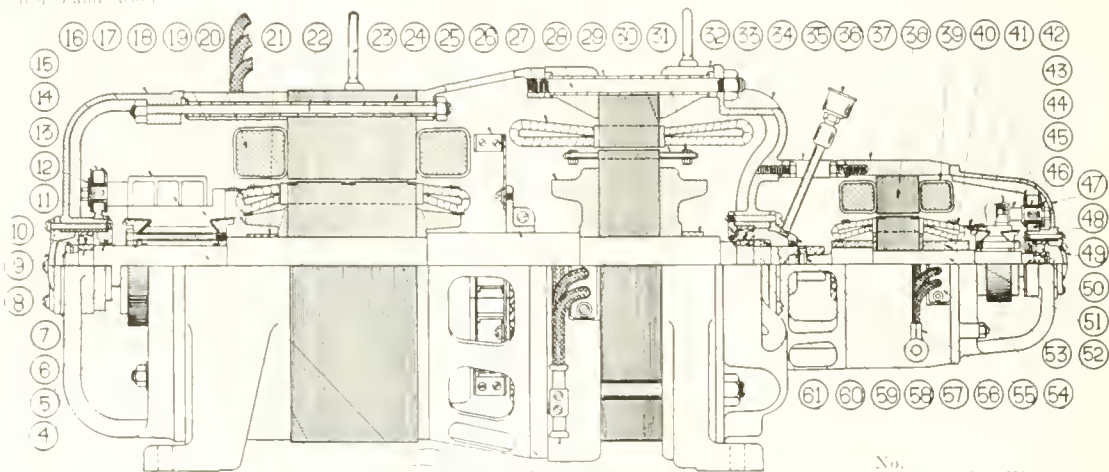

FIG. 123. DIRECT CURRENT SUPPLY



- No. 1 Brush
- 2 Finger
- 3 Shaft
- 4 Commutator Cap
- 5 Mica Ring
- 6 Felt
- 7 S.K.F. Bearing
- 8 Lock Nut
- 9 Dust Cap, Outer
- 10 Lock Nut Spring
- 11 Dust Cap, Inner
- 12 Clamping Washer
- 13 Insulating Washer
- 14 Rocker
- 15 Brush Holder
- 16 Commutator
- 17 Bracket, Welder End
- 18 End Plate, Welder End
- 19 Armature Coils
- 20 Field Coils
- 21 Shrink Collar
- 22 Frame Bolt, Welder End

- No. 23 Eye Bolt
- 24 Frame Rivet Tube, Welder End
- 25 Blower
- 26 End Plate, Motor End
- 27 Stator Coils
- 28 Frame Bolt, Motor End
- 29 Frame Rivet Tube, Motor End
- 30 Rotor Rods
- 31 Rotor End Rings
- 32 Frame Rings
- 33 Shrink Collar, Motor End

- No. 34 Bracket, Motor End
- 35 Connecting Ring, Exciter
- 36 Grease Cup
- 37 Exciter Frame
- 38 Poles
- 39 Field Coils
- 40 Armature Coils, Exciter
- 41 Mica Ring, Exciter
- 42 Commutator, Exciter
- 43 Brush Holder, Exciter
- 44 Insulating Washers, Exciter
- 45 Tube, Brush Holder

- No. 46 Clamping Washer
- 47 Bracket, Exciter End
- 48 Rocker, Exciter End
- 49 Dust Cap
- 50 S.K.F. Bearing, Exciter End
- 51 Dust Cap, Exciter End
- 52 Insulation
- 53 Exciter Shaft
- 54 Terminal Block, Exciter End
- 55 Pig Tail Clip
- 56 Dust Cap, Motor End
- 57 Connecting Pin
- 58 Lock Washer, Motor End
- 59 S.K.F. Bearing
- 60 Dust Cap, Inner, Motor End
- 61 Felt
- 62 Spring, Brush Holder
- 63 Connectors
- 64 Stud, Finger
- 65 Connecting Ring
- 66 Blower Support



FIG. 124. ALTERNATING CURRENT SUPPLY

TEN LESSONS IN ARC WELDING

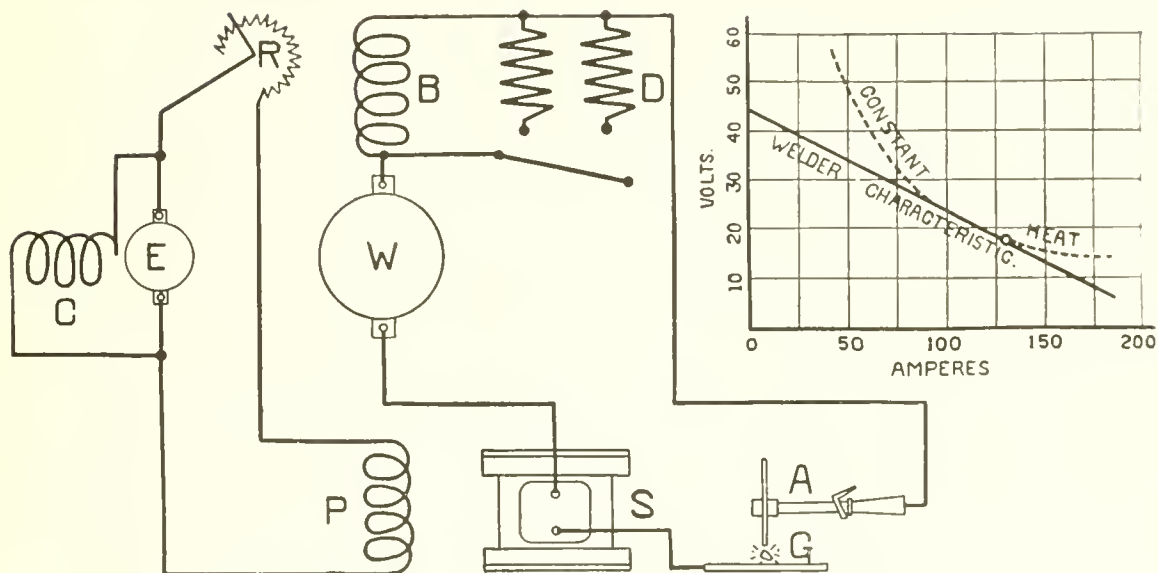

Fig. 1. Diagram of Electrical Connections of D.C. A.C. Welder, and Volt-Ampere Characteristic

- | | | | |
|--|-------------------------|------------------------------|-----------------------|
| (A) Electrode Holder | (C) Exciter Shunt Field | (G) Ground Plate | (S) Stabilizer |
| (B) Series Field (Differential connection) | (D) Diverter Resistance | (P) Separately Excited Field | (W) Welding Generator |
| (E) Exciter | | (R) Rheostat | |

LESSON I

The Arc Welding Machine

It is important that the operator become familiar with the welding machine before attempting to use the arc for welding operations. Two drawings are reproduced showing the names of parts of the welder set. It is not necessary for the operator to memorize the names of the detail parts except that he should understand the location and purpose of the essential parts as follows: Brush, Brushholder, Commutator, Exciter Commutator, Field Coils, Motor, Exciter, Grease Cup, Ball Bearings, Shaft, Bracket, Frame, Poles. (See page 58.) Any electrician can point out these parts on the welder set if the operator is unable to do so.

The arc welding generator is electrically separate from the motor which drives it. A welding generator may be driven by either a direct current motor or an alternating current motor or by a steam or gasoline engine. The source of power to drive the welding generator has nothing whatever to do with the behavior of the welding generator provided, of course, it is furnished in sufficient quantity and turns the welding generator at the proper speed. The motor end of the welding machine is like any other motor of the same rating.

The principle of operation of the welding generator is very simple to the man who has had some experi-

ence with direct current generators but is difficult for any one else to understand. For the benefit of the man who has had electrical experience, it is sufficient to state that the welding generator is merely a specially designed, separately excited generator with a differential compound winding and that an inductive ballast is used in the arc circuit. It is desirable for the operator to understand the principle of operation of the welding set as well as the electrician understands it but it is not absolutely necessary. The accompanying cut shows the volt-ampere characteristic and the wiring diagram of the welding generator.

The welding outfit should always be installed by an electrician. All cables are labeled and the direction of rotation is marked so that no difficulty will be experienced in installing the outfit without the use of a wiring diagram.

The Stabilizer is made up of coils of wire around a laminated steel core and its purpose is to make the arc steady and easy to operate.

An electrician should explain to the operator the proper method of starting the outfit.

The control panel contains the apparatus with which the operator controls the behavior of the welding generator, adjusting it to give the proper amount of heat for welding. Two cuts are shown showing two types

TEN LESSONS IN ARC WELDING

of control panel used. The portable type accomplishes the same thing as the stationary type.

Fig. 128 shows the ordinary equipment used by the operator, and welding table. Referring to Fig. 140, the proper clothing for an operator is shown,—it consists of black cap, unionalls, cotton gauntlet gloves, split leather apron.

Adjustment of Machine

1. Open main switch and control switch on panel.
2. Start welding set.
3. Turn rheostat as far as it will go to the left.
4. Close control switch into position marked 100.

(In this position the current in the arc will be approximately 100 amperes.)

5. Put a piece of $\frac{1}{2}$ " welding wire in the metal electrode holder.

6. Place a piece of boiler plate scrap on welding table to practice on.

7. Close main switch on panel.

8. Sit down on stool in front of welding table. Take hand shield in left hand, metal electrode holder in right hand. With shield held in front of face touch boiler plate with end of welding wire. The result will be a spark and the welding wire will stick to the boiler plate. Let go of electrode holder and open main switch on panel.

9. With a new piece of welding wire, and face shield in front of face, scratch welding wire sidewise on boiler plate to get sprak, then draw welding wire about an eighth of an inch away from the plate. Hold welding wire vertical to boiler plate, otherwise arc will be difficult to start.

Repeat the above operation until an arc can be maintained as long as desirable. The beginner should burn from 75 to 100 pieces of welding wire at this practice, observing through the shield what happens in the arc. As the operator becomes more skillful he should try to hold a shorter arc. The proper length is about an eighth of an inch. The operator should spend about 15 hours on this kind of practice. The amount of current or amperes required for welding depends principally upon the size welding wire used. Three-sixteenths inch welding wire requires about 150 amperes. (Turn rheostat as far to left as it will go and close control switch into 150 ampere position.) For points in between 100 and 150 amperes turn rheostat to right with control switch in 150 ampere position.

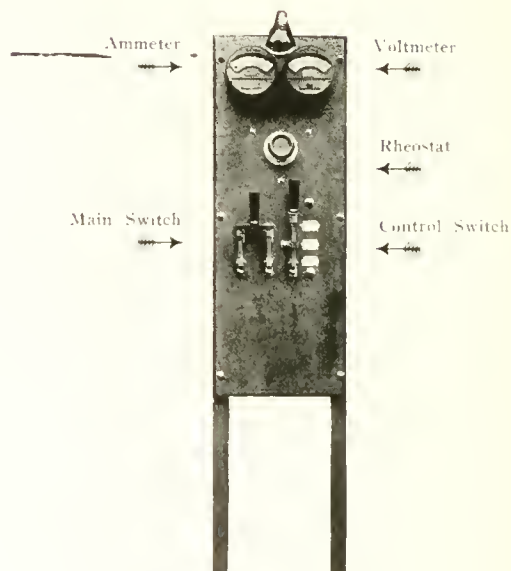

Fig. 126. Stationary Panel

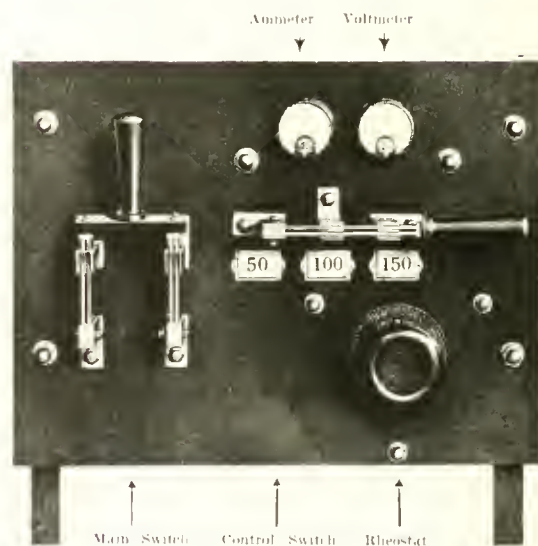

Fig. 127. Portable Panel

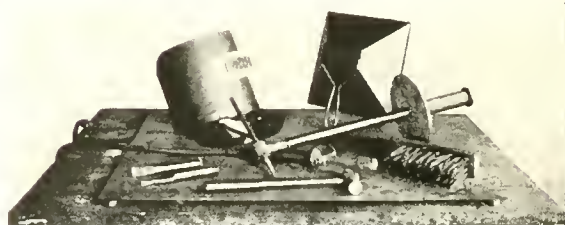

Fig. 128. Operator's Tools

TEN LESSONS IN ARC WELDING

LESSON II

Starting the Arc

This exercise deals with the proper method of starting and stopping an electric arc. The beginner usually draws an arc and starts to weld at whatever point the arc happens to start operating properly. In other words, the beginner usually welds where it is possible for him to weld rather than welding in a predetermined place. The purpose of this exercise is to give the operator sufficient control of the arc to enable him to weld at any place he may decide upon.

1. Place a piece of scrap boiler plate on the welding table. With a piece of soap stone mark a line across the plate. Now weld a bead as nearly as possible $\frac{1}{2}$ " to the right of this line. Make the bead as straight as possible. Repeat this operation until a perfectly straight bead $\frac{1}{2}$ " from the predetermined line can be laid down.

2. In this exercise the operator should print his initials on a piece of scrap boiler plate and weld a bead over the lines. Having produced a perfect set of initials in this manner take another piece of scrap boiler plate and make the initials the same size without previously printing them with soap stone. This operation should be repeated until the operator can reproduce his initials without following the lines. The purpose of this exercise is to train the operator to control an arc and lead it in a predetermined direction. It also involves the training of the operator's eyes to see where he is leading the arc. This will be difficult at first owing to the fact that the operator can see nothing but the arc itself through the protective glass.

3. The operator should now take hammer and chisel and examine the beginning of several beads which he has made. It will be found that the beginning of the bead is usually not securely welded to the plate. This is due to the fact that the arc was held too long at the instant the bead was started. The operation of starting the arc at the predetermined point should be repeated with this fact in view until a satisfactory weld is made at the beginning of the bead.

4. The end of the bead is quite as important as its beginning. In referring to beads which the beginner has previously made it will be found that a considerable crater has been left at the point at which the arc was broken. The objection to this crater is that it is difficult to start welding at this point when it is desirable to continue the bead. The crater may be filled before the arc is fully broken by merely crowding down the arc until the desired amount of metal is

added, and breaking the arc suddenly by pulling the wire sharply to one side. The operator should practice this operation until he is able to finish a bead leaving a crater of not to exceed $\frac{3}{8}$ of an inch in diameter.

5. The exercises outlined in the preceding four paragraphs should occupy at least ten hours of the operator's time. The following sample is to be made as to the record of the operator's ability to start and stop an arc properly:

Material required: One 12"x12"x $\frac{1}{2}$ " piece of boiler plate; three sizes of electrode are required— $\frac{3}{8}$ ", $\frac{3}{16}$ ", $\frac{1}{8}$ ".

No marking with soap stone is to be done on the plate. Referring to the photograph reproduced herewith, the first three rows of beads are to be made with $\frac{3}{8}$ " wire using approximately 150 amperes. Each bead should be one inch long. The beads should be three-quarters of an inch apart. They should be straight and parallel. Each bead should have a perfect weld at its start and a very small crater at the finish. The next five beads are to be made using $\frac{3}{16}$ " electrode and the next two, using $\frac{1}{8}$ " electrode with about 140 and 100 amperes respectively. One side of the plate should be completely welded in accordance with the above instructions. The plate should then be turned over and the operation repeated and perfected on the other side of the plate.



Fig. 29

TEN LESSONS IN ARC WELDING

LESSON III

Building Up Operation

The purpose of this exercise is to show the operator the proper method of building up several layers of welded material. It is assumed that in Lesson II the operator has learned to deposit metal from the welding wire on a piece of boiler plate and have it entirely welded along the line of fusion. Until the operations outlined in Lesson II are completely mastered, it is useless to proceed with the exercise of building-up operations.

Material required: One 10" x 12" x $\frac{1}{2}$ " piece of boiler plate. One size of electrode, $\frac{1}{8}$ of an inch, is recommended. The current should be about 140 amperes.

Referring to the photograph reproduced herewith, three pads are to be built up on the face of the plate. These pads are to be 6" long, 2" wide, 1" high. The first pad starting from the left hand side of the plate is to be built up without any particular design or pattern, and without brushing or cleaning of the oxide-covered surfaces.

The next pad is to be built up following the definite pattern. First, brush the spot on which the second pad is to be built very thoroughly with a wire brush. Second, build up a single layer of metal the width of the pad using a series of beads laid along the 6" dimension, always starting at one end and finishing at the other end. Having deposited the first layer, the oxide-covered surfaces must be brushed thoroughly with a wire brush. Each layer should be brushed at least three minutes. The second layer of the pad should be built up so that the beads run at right angles to the beads of the first layer, *i. e.*, the beads are parallel to the 2" dimension of the pad. This practice is commonly called "lacing." The second layer to be as thoroughly brushed as is required upon finishing the first layer. Each succeeding layer should be thoroughly brushed.

The third pad is to be built up in exactly the same manner as the second pad with the exception that in place of brushing the work with the wire brush only between each layer, the oxide must be entirely cleaned off by the use of the hammer and chisel. It will be noted that the oxide may be removed by comparatively light blows on the chisel. It is not necessary to cut

away any metal to knock the oxide from the top of the layer with a chisel. The wire brush may be used to brush the oxide off the metal after it has been cut away with a chisel.

The operator has now completed three pads. The first pad illustrates how welding should *not* be done. The second pad illustrates a fairly satisfactory practice. The third pad illustrates the best practice. If possible the operator should have this sample sawed diagonally through the three pads. It should then be set up on a grinding machine and a fine surface ground on the cut section of the pads. This can be done in a tool room. The ground surface should then be painted with diluted sulphuric acid or tincture of iodine. It will then be easy to compare the quality of the metal in the three pads. The operator should also observe carefully the line of fusion between the pads and the original plate. This fusion must be perfect if the weld is of any value. The photograph reproduced herewith illustrates the appearance of a good line of fusion.

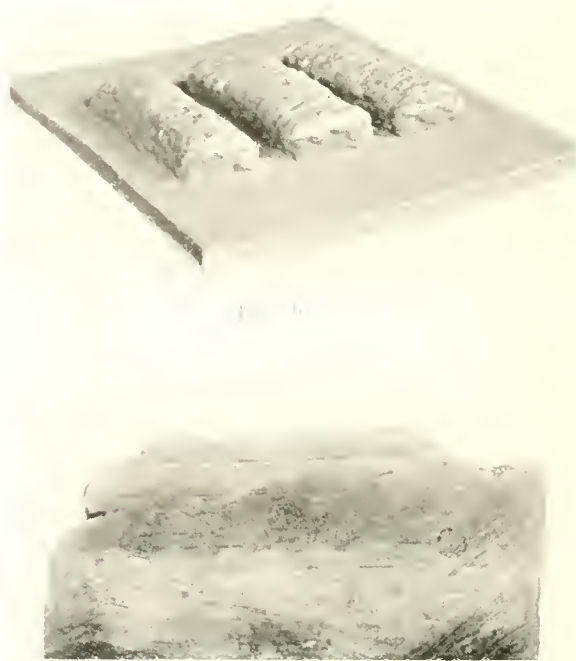

Fig. 131

TEN LESSONS IN ARC WELDING

LESSON IV Plate Welding

This exercise is one of the most important of the series because the welding of plate is the most frequent application of the electric arc welding process. The welds which must be made in structures made of plate, such as tanks, are not always horizontal, so that the operator must learn to weld not only in the horizontal position but also in the vertical and overhead positions. Three samples are to be made as the record of the operator's ability to weld in the horizontal position and the vertical and straight overhead positions.

Material required: Six 10"x12"x $\frac{1}{2}$ " pieces of boiler plate beveled 45 degrees on one 12" edge, $\frac{3}{8}$ " electrode with 140 to 150 amperes.

1. The operator should spend approximately ten hours in preliminary practice. Several pieces of scrap boiler plate should be beveled and tacked together as shown in the accompanying photograph. These plates should then be set up vertically and welded, starting at the bottom and welding up. The operator should use his own resourcefulness in arriving at the best way to make a weld in this position, trying several different methods and observing the following points: Does the weld extend completely from the inner to the outer edge of the plate? Does the heating of the plate cause sufficient expansion and contraction to affect the character of the weld? Does the expansion and contraction caused by the heating of the plate produce warping or buckling? After the operator has satisfied himself on these points two pieces of scrap boiler plate should be beveled and placed in position ready to weld straight overhead, and the operator should try to weld them together in this position, welding from the underside only. The operator should put the pieces approximately one-sixteenth of an inch apart for this exercise. This kind of welding is very difficult and requires a considerable amount of practice to master. It will be found that the operation will be somewhat easier if 150 amperes is used on $\frac{3}{8}$ " electrode at first. In welding beveled plates the operator should remember that the welding wire or electrode should be held as nearly perpendicular to the surface being welded as possible, and *that good welding can only be accomplished when a short arc is maintained.* The operator should pay particular attention to the difference in sound between a long and a short one. A long arc sputters and has a distinct hissing sound. It is impossible to weld with such an arc. A short arc has a rapid fire metallic click which may be readily distinguished. The operator should maintain a short arc on all classes of welding. Where possible an electrician should be asked to connect a low reading volt meter across the arc so that the voltage may be read while the operator is welding. The volt meter should read from 15 to 18 volts while the arc is in operation. The greatest amount of heat is obtained on the work when the electrode holder is negative. This is the proper connection for both metal and carbon electrode work.

While the arc is in operation there will be a circular spot of molten metal upon the work. The operator should concentrate his attention upon the side of this molten spot of metal which is in the direction of motion of the electrode. This may also be described as the forward edge of the circular spot. The arc should be directed on this point, since it is at this point that the greatest amount of heat is desirable. *It is possible to make an electric weld only when the globule of molten metal from the welding wire is thrown into molten metal on the piece being welded.*

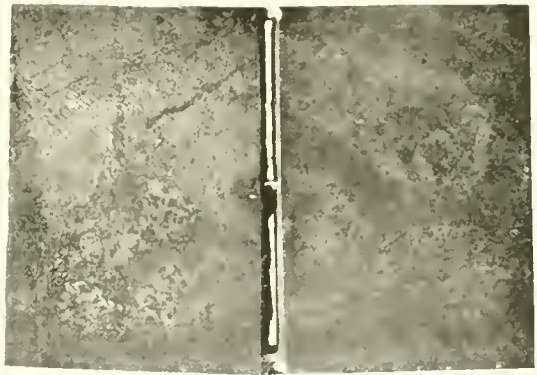

Fig. 132. Tacked Plates



Fig. 133. Horizontal, Vertical and Overhead Samples

TEN LESSONS IN ARC WELDING

If the globule of metal drops on metal which is not molten it may stick but it will not be welded. The operator should study the action of the metal in the heat of the arc very carefully. The operator should begin to realize at this point that merely holding an arc is not necessarily welding but that the art of welding is ninety per cent brain work and ten per cent manual labor.

2. Place the horizontal sample of welding in position on the welding table. Put a $\frac{3}{8}$ " electrode under each plate in a position parallel to the beveled edges and about $\frac{1}{2}$ " from the lower edge of the bevel. This will raise the beveled edges higher than the square edges and give the sample a ridge through the center. The object of this practice is to allow for the warping of the plates by the heating of the arc. After the sample is welded it should be straight with the two plates squarely in line. Place the edges $\frac{1}{8}$ of an inch apart all the way across. Tack the pieces together as shown in Fig. 132. Now with 140 amperes and a $\frac{5}{16}$ " electrode, weld one layer in the bottom of the bevel in about 3" sections. By this is meant that the operator should weld three inches, skip three inches, weld three inches, skip, etc., until he has gone all of the way across the plate, then go across the plate again, filling the three inch gaps. This is to minimize the effect of the heating. The plate will then be welded with one layer all the way across. The operator must manipulate the arc in such a manner as to weld the lower edges of the plate completely together, *i. e.*, the metal from the electrode must run clear through the plates and be firmly welded on the edges. The operator should then take hammer and chisel and clean the oxide from the surface of the welded metal very thoroughly. The second layer may now be welded into the bevel starting at one end and finishing at the other end. This layer should be thin and should not extend higher than the upper surface of the plates. Chip oxide from surface of welded material and put the third and finishing layer on the weld. The third layer should extend about $\frac{1}{4}$ of an inch beyond the edge of the bevel on each plate, and $\frac{1}{8}$ " above the upper plate surfaces. The plate should now be turned over and a re-enforcement of equal width and thickness put on the other side. The purpose of this practice is to make the section of the weld equal on both sides of a center line through the metal of the plate. If the weld were re-enforced on one side and not on the other the stress would be concentrated on the side which was not re-enforced when the weld is put in tension.

3. The two plates should be tacked together as in first exercise but in this case the beveled edges are to be set vertical, as shown in Fig. 134. The weld is to be made according to a definite pattern starting at the bottom and finishing at the top. This pattern is triangular. The operator should start on the right hand plate at a point about $\frac{5}{16}$ of an inch to the right of the beveled edge, holding the welding wire as nearly perpendicular as possible to the surface being welded. The movement should be along the beveled edge of the right hand plate toward the farther edge, then along the beveled edge of the left hand plate toward the nearer edge, extending to a point $\frac{1}{16}$ of an inch to the left of the bevel on the left hand plate, then across to the starting point. Five-thirty-second electrode with about 125 amperes is to be used. The operator must pay particular attention to see that the farther edges of the plates are securely welded together. A consid-

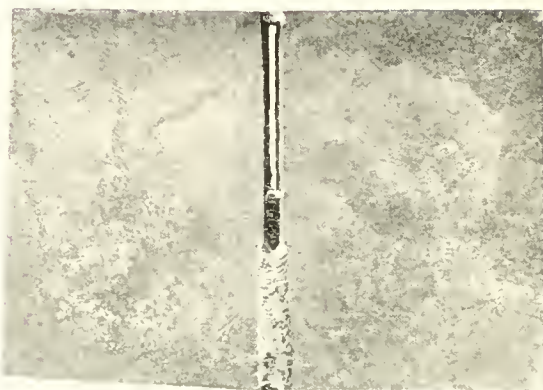

Fig. 134

erable amount of metal should be run through the edges to make this certain.

4. For the sample of overhead welding, the plates may be tacked together as shown previously except that the opening should be approximately $\frac{1}{4}$ of an inch. The two plates are to be welded in the overhead position after they have been tacked. Several pieces of plate $\frac{1}{8}$ of an inch thick, $1\frac{1}{4}$ " wide and 6" long are to be cut, and a $\frac{5}{16}$ " electrode should be stuck on extreme edge of one of the corners so that the electrode stands out perpendicular to the piece. The purpose of the electrode is to serve as a handle. This $\frac{1}{8}$ " piece is to be pushed through quarter inch opening between the plates from the under side and to be brought into position so that it will form a backing for the weld. Fig. 133 shows the position of this plate. After the plate has been placed in position it may be tacked. The use of this plate makes the overhead welding somewhat easier than welding without its use. Start the overhead weld at the center of the job and weld toward one end. A definite pattern should be followed. Start at the lower edge of the right hand plate at a point $\frac{1}{16}$ of an inch to the right of the bevel. Continue along the beveled edge of the right hand plate up to the backing plate, across the backing plate and down the beveled edge of the left hand plate to a point $\frac{1}{16}$ of an inch to the left of the bevel. This will form the first bead. Now start the second bead at the beveled edge of the right hand plate and on top of the first bead, and fill in, as far as possible, the opening formed by the beveled edges of the plates. A third bead will be required to complete this operation. The operator now has two surfaces to weld on, the surface formed by the welding material, which should be approximately vertical, and the surfaces of the plates to be welded. The pattern of the first bead should be followed out from this point on welding at the junction of the previously welded material, and the surfaces of the plates being welded together so far as this is possible. This makes the weld more a vertical weld than an overhead weld and considerably simplifies the operation. The operator should use about 150 amperes to start with, cutting it down to 125 or less as the plate warms up. Having completed one end of the weld in this manner the other end may be welded in exactly the same way. It will be found that the backing plate will warp and tend to get out of contact with the beveled plates. This will not interfere with the welding and will enable the operator to re-enforce the weld on the top side, which is very desirable.

TEN LESSONS IN ARC WELDING

LESSON V *Thin Plate Welding*

This exercise is to give the operator some experience on thin plate welding. The difficulties encountered in thin plate welding are comparatively simple of solution, and the operator is left to use his own resources to a considerable extent in making the sample. The great difficulty in welding thin plate arises from the tendency of the arc to burn through the thin plate owing to the great intensity of heat. Practically all thin plate is covered with a heavy scale of blue oxide, and it is necessary to get this oxide cleaned off in order to make a good weld. This may be done with hammer and chisel or a sand blast. The operator has already found that it is necessary to have clean metal in order to make a good weld. The quickest and best way of getting clean metal is to sandblast the surfaces to be welded. This applies to metal of all thicknesses. The reason blue oxide gives the operator trouble is that it is a very poor conductor of electricity, and it is hard to get the arc started on an oxide-covered surface and also that the oxide gets into the metal of the weld.

Material required: One piece of 24"x30" sheet steel approximately $\frac{1}{8}$ " of an inch in thickness; $\frac{1}{8}$ " electrode with 60 to 90 amperes.

1. The operator should study the drawing reproduced on page 66 (Fig. 137) and lay out the pieces to be

cut in order to make the sand blast pot shown. This will leave some scrap material around the edges which should be cut with a hack saw into pieces approximately 2"x4". The operator should practice welding these scrap pieces by laying them down on the welding table and welding a straight seam. One sample should also be welded with the two pieces perpendicular to each other as shown in accompanying cut. (Fig. 135.) Approximately two hours should be spent on this practice.

2. The operator should now cut the plates necessary to form the sand blast pot and weld them together. It is suggested that the heads be made smaller than the shell so that they fit on the inside. They should set back from the edge of the shell about $\frac{1}{4}$ ". One small hole should be burned through at the location of one of the fittings in order to allow the heated air to escape while the welding is being done. The fitting can be put on the sand blast pot at some later time by the operator.

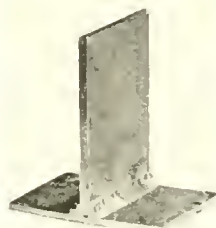

Fig. 137

LESSON VI *Pressure Welding*

This exercise is in the nature of a test of the ability of the operator to make a solid homogeneous weld which is properly and thoroughly done. A great many electric welds are subjected to steam or water pressure and unless they are properly made they will show leaks, and will fail at a point below the pressure for which they were designed. It is very important that the operator should know when he is making a good weld. If he does not know this his work is entirely worthless. He is as poor a workman as the jeweler who must smash an expensive watch in order to find out how it was made. A skillful operator, who has a reasonable degree of judgment and intelligence, knows when he is making a good weld. If he has made a section of a weld which is not good, he should either cut that section out and reweld it or inform the man responsible for the job of the fact that a particular section is faulty. A man who will lie to himself in regard to the quality of his work, will lie to the man who is responsible for its quality, and is worse than worthless as a skilled operator.

Material required: One 18" section of 8" wrought iron pipe or seamless steel tubing, two 5/8" thick boiler plate heads to fit on the inside of the pipe or tube. These heads should be beveled 45 degrees on the circumference, 6 pieces of 1" black wrought iron pipe 6" long, one piece of 3/4" or 1" pipe according to the size water pipe used in the shop where the welding is done. This pipe is to be connected to the water system so that the completed sample may be tested under pressure. Six holes are to be drilled at intervals of 2" into the 8" pipe to take the six 1" pipe. One hole is to be cut to take the 3/4" or 1" pipe.

1. The heads are to be welded into the pipe as shown in the accompanying cut. (Fig. 136.) The operator must be careful to hold a short arc and so far as possible keep the electrode perpendicular to the surface being welded. The surfaces which are to be welded

must be clean and the oxide must be removed from each layer of metal before the next layer is welded, by the use of sand blast or hammer and chisel. The 1" pipes are spaced close enough together so that some difficulty will be experienced in making a good weld between pipes. This is done purposely because it is a difficulty frequently encountered in practice. The operator should mark with chalk the spots where he believes, owing to the manner in which he welded the sample, that the leaks will occur. Weld the ends of the six 1" pipes shut.

2. The operator should connect the sample to the water system of the shop and test it for leakage. (It is advisable to pour the sample full of water before the connection is made so that it will be entirely filled with water when under pressure.) If leaks are found the operator should cut out that part of the weld, examine the weld and find if possible the cause of the leak. The defective spots should be rewelded and the test repeated.

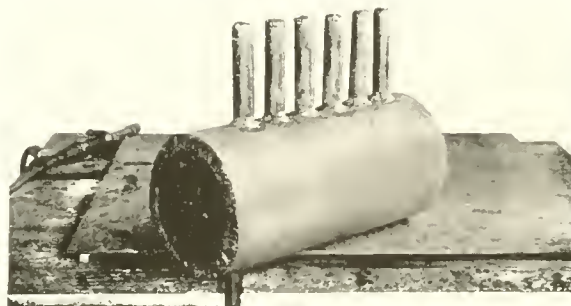

Fig. 136

TEN LESSONS IN ARC WELDING

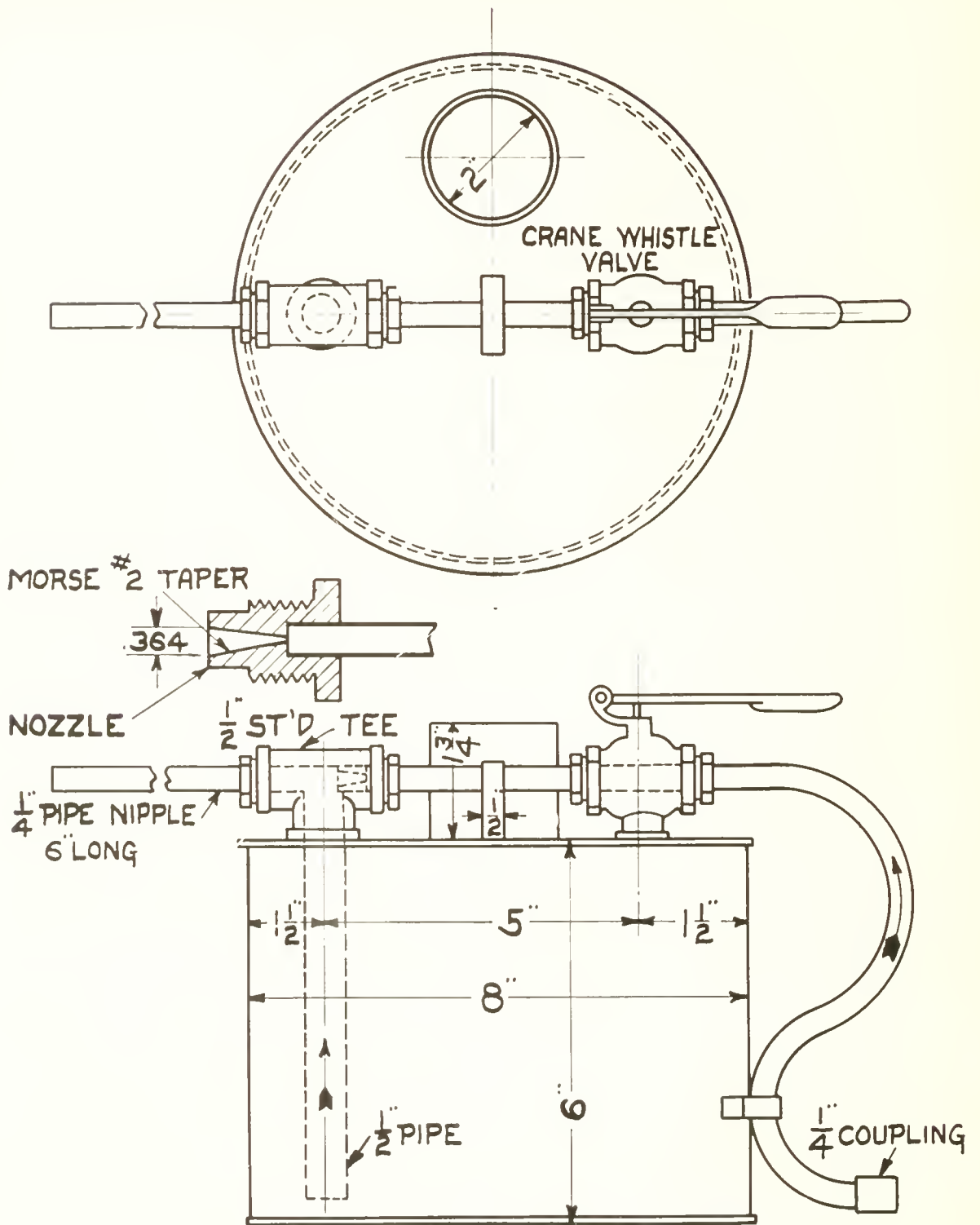

Fig. 137. Sand Blast Pot Made by Arc Welding.

TEN LESSONS IN ARC WELDING

LESSON VII *Miscellaneous Jobs*

The object of this exercise is to give the operator an idea of a few of the many different kinds of applications of the process. A great deal depends upon the operator's natural resourcefulness in planning a job. One of the difficulties is in knowing how to go about a job so that it may be done with the least possible exertion. The more highly skilled the operator is, the easier will be the way which he chooses to perform the operation. This involves careful planning of the operation before it is started. The operator who cannot plan in advance exactly how he is going to do the job will have little success in doing it. As has been stated before, success in welding depends more upon the use of the brain than upon the use of the hands. The operator should be able to tell exactly how he proposes to do a certain job and explain the reasons why he intends to do the job in that particular way.

Material required: One riveted section as shown in Fig. 138, one angle iron section as shown in Fig. 139. These two samples need not conform to any specified dimensions.

1. For preliminary practice the operator should take two pieces of $\frac{1}{4}$ " scrap boiler plate, and tack them together in the form of a lap joint. This sample should then be set up in the vertical position and a fillet welded on the underside of the lap, similar to Fig. 138. This operation should be repeated until the operator is able to get a good weld and the fillet has a uniform appearance. The operator should calculate the number of feet per hour of this work he can do. This work is similar to the operation encountered in the welding of a caulking edge on the riveted seam of a steam boiler. It is necessary to weld only one bead to form the fillet; 140 to 150 amperes should be used. The operator should cut across the seam and examine the fillet to determine whether or not he has made a good weld.

2. With a piece of scrap boiler plate set in the vertical position the operator should weld a number of circular beads approximately $1\frac{1}{2}$ " in diameter. After 8 or 10 of these circular beads have been welded the operator should clean the oxide from the surfaces and weld a second bead around the first bead. This is an operation similar to that of welding around the head of a rivet. One of these circles should be cut and the weld examined to see that it has been properly done and that the second bead is fused thoroughly to the plate and to the first bead. This is an operation which must be thoroughly mastered before proceeding further.

3. This exercise consists of welding two pieces of heavy plate together without beveling. If possible two

pieces of $\frac{5}{8}$ " thickness boiler plate should be obtained for the exercise. Each edge which is to be welded should be set in a horizontal position and a bead welded along the center of the plate. The second bead should then be welded in top of the first, removing the oxide from the first before the second is applied. When both edges are thus prepared and put together the operator will have what amounts to beveled edges to weld together, but it will be necessary to weld from both sides in order to complete the job. One weld of this nature should be made and cut so that the operator may examine it to see that fusion has taken place throughout the entire weld.

4. This exercise is the one shown in the cut (Fig. 138) and consists of welding the caulking edge of a riveted joint and welding around the rivet head. The method of welding the caulking edge has been previously explained. In welding around the rivet head it is advisable to heat the rivet before welding around the head. With the plate in a vertical position (rivets above the caulking edge), draw an arc on the head of the first rivet, allowing the metal from the electrode to fall clear of the rivet head. This should be continued for about two minutes or until the rivet is

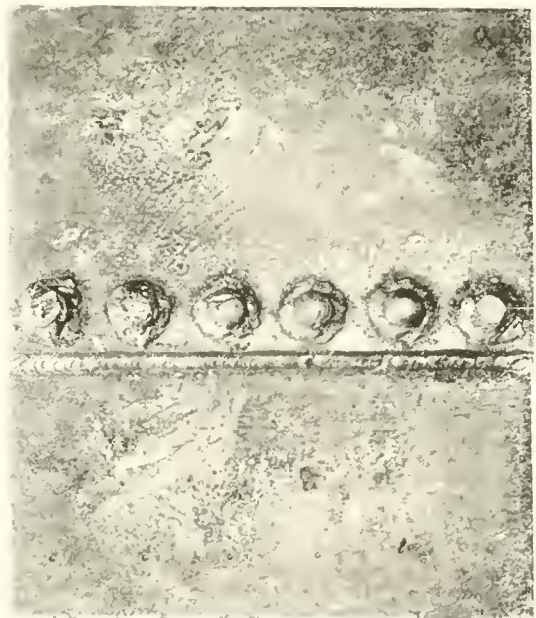

Fig. 138

TEN LESSONS IN ARC WELDING

thoroughly heated, then the fillet should be welded around the rivet. The operator should then skip two rivets and repeat the operation on the fourth rivet. The idea of skipping is to keep the heat distributed

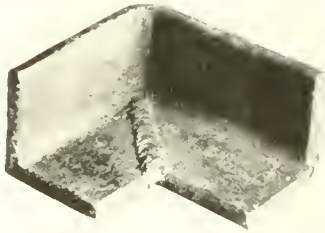

Fig. 139

so that contraction in the metal will not set up shearing stresses in the rivets. By following the above practice a very tight joint will result when the metal

of the rivets and plates cools. The result is similar to the result obtained by putting in a hot rivet and peening it over. When such a rivet cools it contracts and pulls the plates tightly together. The operator may turn the sample over and repeat the operation on the other side, perfecting it if possible.

5. The exercise of welding an angle iron section is one which illustrates a type of job which is quite common. The angle may be cut from a straight angle section and the triangular shape cut out with a hack saw. The triangle is cut out so that the angle may be bent at right angles. The tip of the triangular, however, must be cut square off in order to allow a right angle to be bent without the edges coming entirely together. The distance between the edges after the angle has been bent through 90 degrees should be equal to the thickness of the angle. The operator may then bridge across the two edges from one side allowing as little metal to drop down between the edges as possible. Then the angle should be turned over and the space between the edges completely filled by welding in one or more layers.

LESSON VIII *Flue Welding*

This exercise deals with the welding of flues into the flue sheet of a boiler. This work is encountered in fire tube boilers of all kinds. The operation requires a considerable amount of skill in handling the arc. A preparation of the flue sheet for welding in actual practice is usually what makes the job a success or failure. In practice the proper way of preparing a flue sheet for welding is to put the flues in exactly as if they were not to be welded. The boiler should then be fired at least once to allow the tubes to take

their permanent set. The flue sheet should then be sand blasted to clean the surfaces to be welded. If no sand blast is available the pneumatic tool should be used to knock the oxide off the surfaces, after which the surfaces should be thoroughly brushed with a wire brush, then the welding may be done. If the work is prepared in this manner and properly welded the results will be uniformly successful.

Material required: Section of $\frac{1}{2}$ " boiler plate with four 2" flues rolled in as shown in cut; $\frac{1}{8}$ " electrode with 90 to 115 amperes should be used.

1. Set the sample as shown in the photograph. Use head shield and hold the electrode holder in both hands as shown in the cut. The first flue at the top should be welded starting at the point shown in the cut and welding one-half way around, moving from right to left. Then the other one-half welded starting at the original point and moving downward to the left. The second flue should then be welded starting at the bottom and welding in two halves so that they meet at the top. The operator may then weld the other two flues by either of the two methods illustrated, depending upon which the operator likes the better. One of the flues should then be sawed in half to show the quality of the workmanship.

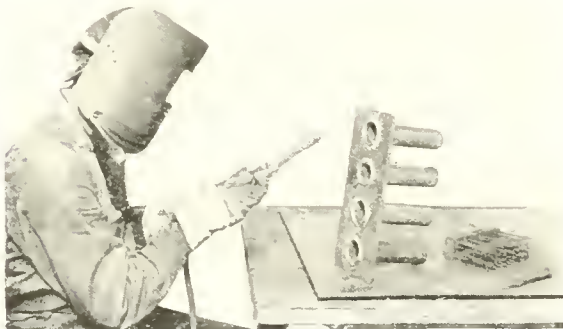

Fig. 140

TEN LESSONS IN ARC WELDING

LESSON IX

Welding Steel Castings with Carbon Arc

This exercise illustrates the kind of work done in a steel foundry and in certain railway shops. The carbon arc is used in the same manner as the flame of an oxy-acetylene torch. From 300 to 600 amperes are required for carbon electrode work of this nature. The operator must use both hands and therefore the head shield is required. The carbon electrode holder is held in the right hand and the welding rod is held in the left hand. Carbon electrode welding is usually considered easier than metal electrode welding but there is considerable skill required to handle a carbon arc successfully.

Material required: One small steel casting (Fig. 141) carbon electrode holder, carbon electrode $\frac{1}{8}$ " in diameter sharpened to a point at one end, 300 amperes welding capacity (if 300-ampere unit is not available, two 150-ampere units may be connected in parallel), $\frac{3}{16}$ " welding rod.

1. For preliminary practice the operator should use the 300-ampere carbon arc and cut into small pieces several pieces of boiler plate scrap. For this work the arc should be held approximately a quarter of an inch long. After the operator has practiced sufficiently at this work to be able to make a clean cut along a predetermined line, he should try welding together two pieces of boiler plate scrap using the carbon arc and the $\frac{3}{16}$ " welding rod to fill in with. It will be rather difficult to control the arc and lead it in any desired direction.

2. If $\frac{3}{16}$ " carbon electrodes are available one should be sharpened and placed in the metal electrode holder

and some cutting of $\frac{1}{4}$ " plate done using 150 ampere. The operator should be able to cut a straight, clean cut upon completing this exercise.

3. Using the riveted sample which was used in Lesson VII the operator should use the 300 amperes carbon arc to cut out a section of the upper plate between two rivets. To perform this operation the plate should be set up in the same position in which it was welded so that when the metal is melted by the carbon arc it can run down out of the cut. The sample should then later be welded flush, using the metal electrode process. After working with the carbon arc and before working with the metallic arc on this job it will be necessary to chip the oxide off the surface to be welded, since the carbon arc forms a very thick coating of oxide.

4. This exercise deals with the correction of a flaw in the steel casting due to a sand spot. This defect in the steel casting is caused by the crumbling of the mold. It is necessary to burn the sand spot out with the carbon arc and fill in new material from the welding rod. If there is no sand spot on the casting available it will be sufficient for the operator to heat a spot approximately $1\frac{1}{2}$ " in diameter to the molten state then quickly break the arc and strike the molten metal a sharp blow with a ball-pein hammer. If the operator had performed this operation on a sand spot he would have floated out most of the sand by the heat of the arc. The sharp blow with the hammer throws the molten sand and slag out of the weld. The next operation is to fill in the defect with new material from the welding rod. The operation must be performed as rapidly as possible, otherwise the metal added as well as the metal of the casting in the vicinity of the weld will be ruined by the extreme heat. The arc should be used to cut off short pieces of the welding rod and then these pieces should be melted and puddled in the proper place. In case the arc breaks during the operation it should be started again on solid metal that is not molten and the arc brought over into the welding area quickly. If the arc is started by touching the molten metal with the carbon electrode it is very likely that the weld will be hard owing to the fact that carbon from the electrode has gotten into the weld. As soon as the added material has been fused into the weld the arc must be broken. There is always a tendency on the part of a beginner to play the arc too long on the completed weld in an attempt to give the weld a smooth finished appearance; this results in burning of the metal. In steel casting work to avoid hard spots two points must be observed: (1) Some pre-heating must be done around the point at which the weld is to be made with the arc so that it will not be cooled too suddenly. (2) The carbon electrode must not be brought in contact with the molten metal as explained before.

This operation should be performed several times by the operator until he can produce a weld which is satisfactory to him.

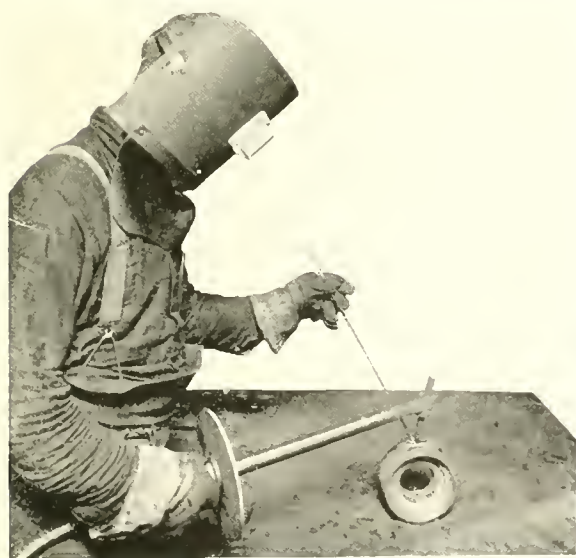

Fig. 141

TEN LESSONS IN ARC WELDING

LESSON X

Cast Iron Welding

The purpose of this exercise is to give the operator an idea of what can be accomplished with the electric arc on cast iron. The difficulty in welding cast iron with the electric arc is not due to the fact that the metal cannot be properly fused, but is due to the fact that the sudden intense heat of the arc over a local area results in the production of a hard weld and the introduction of contraction stresses which often result in cracking. Using the carbon welding process, cast iron welding rods may be fused into a cast iron piece. Using the metal electrode process and a soft iron or steel electrode, it is impossible to make a reliable weld between the added material and the cast iron. Using the metal electrode process certain work can be done by the introduction of steel studs in the cast iron pieces to be welded together so that a certain amount of strength is obtained by the bond formed between the steel studs by the welded material.

Material required—300 amperes welding capacity, 1/8" cast iron welding rod. One small gray iron casting (Fig. 142).

A small gray iron casting should be broken and the edges beveled, using the carbon arc for cutting. The pieces should then be placed in a carbon mold so that the molten iron when it is added will not run away from the joint. This is illustrated in Fig. 142. The carbon arc should be used to preheat the casting. It is not necessary to heat the piece to a red heat. The carbon arc and cast iron welding rod should then be used to fuse the added material to the piece. As in Lesson IX, care should be exercised not to play the arc upon the weld any longer than is necessary to give complete fusion. In case the metal gets too hot and runs badly the arc must be broken and an interval of time allowed for it to cool slightly to eliminate the trouble. After the weld is completed the piece should be wrapped up securely in asbestos paper and allowed

to cool slowly for 6 or 8 hours (larger pieces require from 18 to 24 hours to cool.) As an alternative to wrapping in asbestos paper, the piece may be covered in previously heated slacked lime. The idea of the lime is the same as the asbestos, to cool the casting slowly. If the work is properly pre-heated and welded rapidly and very slowly cooled the material in the weld will be as readily machineable as the balance of the piece. No flux of any kind is required, although borax may be used.



Fig. 142

Supplies for Electric Arc Welding

THE Lincoln Electric Company, while engaged primarily in the manufacture of electrical machinery, handles a complete line of supplies for electric arc welding equipment. The Company's responsibility does not end with the sale of electric arc welding apparatus, but covers the successful application of the process by the purchaser. An extensive organization is maintained to give the purchaser of Lincoln equipment engineering service in connection with the application of the process. It has been found, after considerable experience in the field, that considerably better service can be rendered to the customer if the Company furnishes the supplies for the equipment, and thereby takes the responsibility for the supplies being suitable for the purchaser's use. While there is no obligation whatever for the purchaser of Lincoln equipment to use supplies purchased from The Lincoln Electric Company, it has been found by experience that when the purchaser places the entire responsibility for equipment and supplies with the Company, better results are obtained.

The matter of welding wire is one of considerable importance since the quality of the work and the cost of producing it depends very greatly upon the kind of welding wire used. Owing to the wide experience of the Service Organization and the fact that the Company is only interested in the successful and satisfactory operation of the equipment, the Company offers the best welding wire which can be obtained at the lowest cost to the user. The welding wire which gets the results and costs the least money is naturally the welding wire the Company offers the users of Lincoln equipment.

What is true of welding wire is also true of electrode holders, shields, protective glass and other incidental supplies.

LINCOLN ARC WELDER

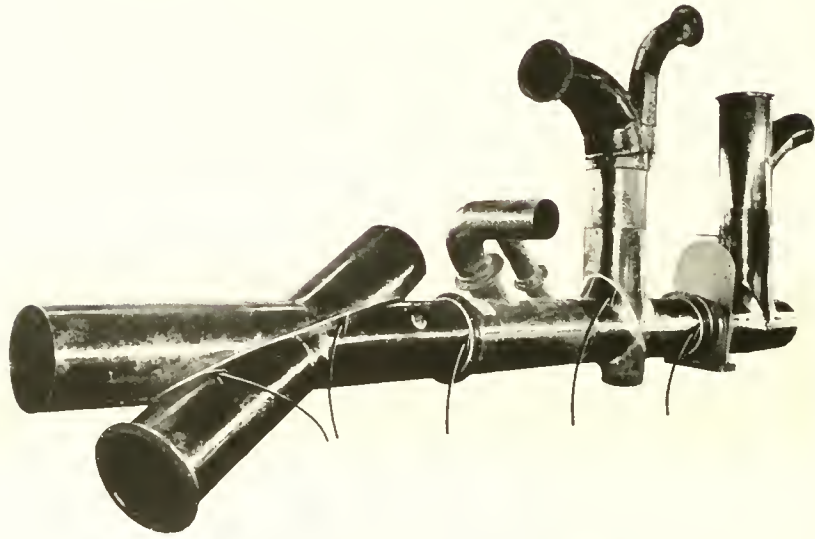

Pipes for gas apparatus made by the Connerly Co., Philadelphia, Pa.,
with Lincoln Arc Welder.

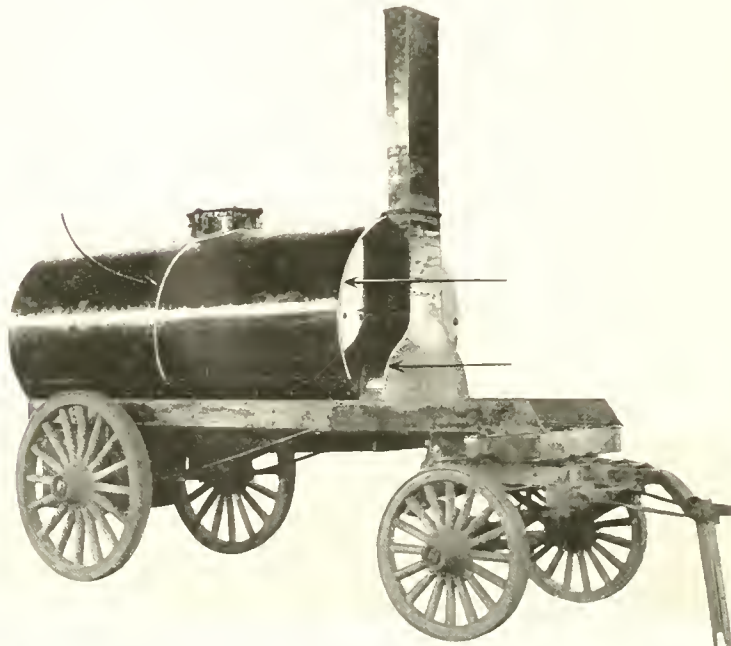

Tank for heating asphalt for street repairs made by the Lincoln Arc Welder.

LINCOLN ARC WELDER



12 Gauge Metal 2" wide
9230 lbs. Pull
46,150 lbs. per sq. inch



16 Gauge Metal 2" wide
7060 lbs. Pull
34,500 lbs. per sq. inch

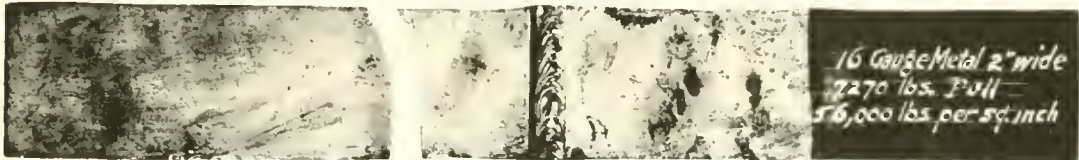

16 Gauge Metal 2" wide
7270 lbs. Pull
36,000 lbs. per sq. inch



14 Gauge Metal 2" wide
7310 lbs. Pull
48,752 lbs. per sq. inch



14 Gauge Metal 2" wide
7150 lbs. Pull
47,741 lbs. per sq. inch

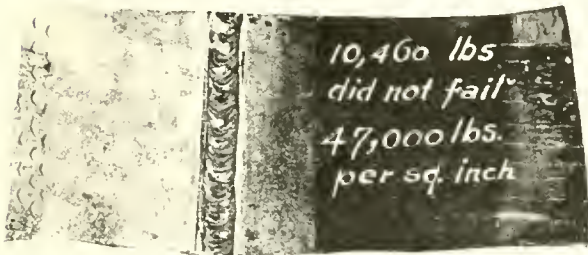

10,460 lbs.
did not fail
47,000 lbs.
per sq. inch

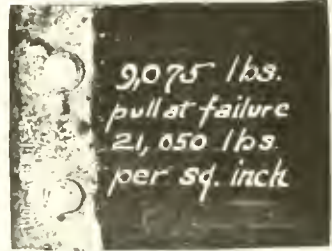

9,075 lbs.
pull at failure
21,050 lbs.
per sq. inch

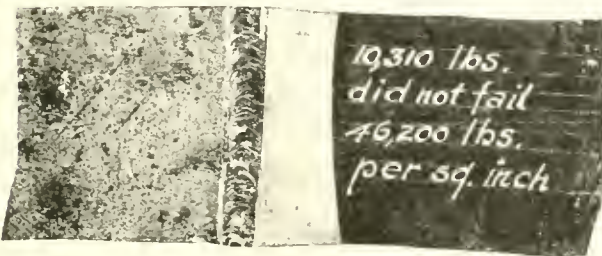

10,310 lbs.
did not fail
46,200 lbs.
per sq. inch

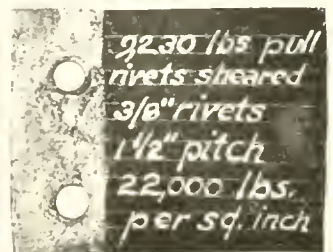
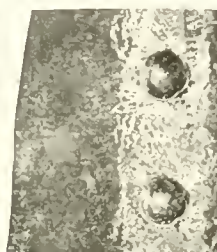

9230 lbs pull
rivets sheared
3/8" rivets
1 1/2" pitch
22,000 lbs.
per sq. inch

LINCOLN MOTORS

These motors are noted for the extreme ruggedness and simplicity of their construction.

They are insulated with a special compound which resists the destructive action of dust, dirt, chemical fumes, water, heat and cold.

On account of these features they are particularly suitable for operating in foundries, steel mills, chemical plants, cotton mills, brick and tile plants, ship-yards and other places where the working conditions are exceptionally severe.

Specifications

Voltage—Standard voltages 110 to 2300 volts. Higher voltages can be obtained on special order.

Phases—Two and three phase alternating current only.

Cycles or Frequency—25, 30, 40, 50 and 60 cycles per second. Other frequencies on special order.

Sizes— $\frac{1}{2}$ to 500 H. P.

Temperature Ratings—Lincoln Motors are guaranteed to operate at a temperature rise of not over 40 degrees C. on continuous full load and 55 degrees C. on 25% overload for two hours.

Guarantee—Lincoln Motors are guaranteed for a period of six months against all defects of material or workmanship and we agree to replace free of charge f. o. b. Cleveland, parts which prove defective within that time, providing the defective part is returned to us in Cleveland, charges prepaid, and that inspection proves the claim.

Prices and illustrated bulletin on application.

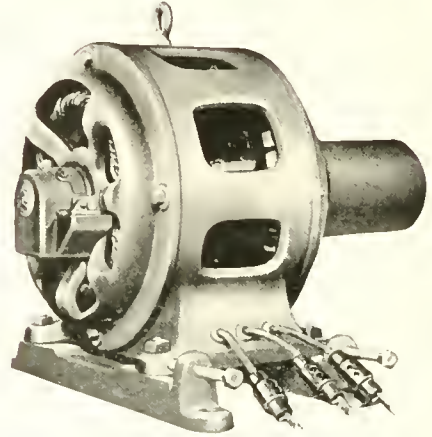

Standard Lincoln Motor

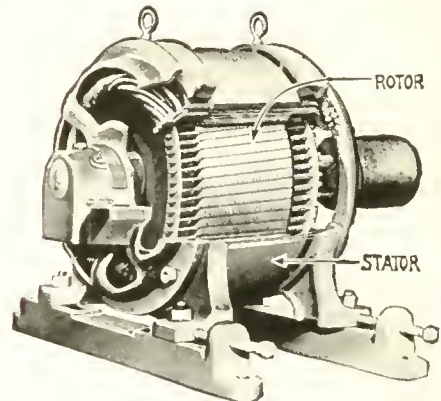

The Lincoln Motor has only two essential parts—the stator in which are mounted the wires carrying the electric supply current, and the rotor or revolving part, rugged as an engine fly-wheel and without any brushes, slip rings or other complicated parts.

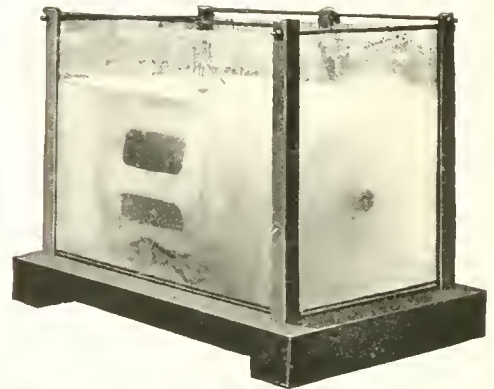

This Standard Lincoln Motor has operated under water for over 3 years without damage to the windings—a convincing proof of the ruggedness and reliability of Lincoln construction.

LIBRARY OF CONGRESS



0 016 091 959 0

