

STP 21-24-SMCT

HEADQUARTERS
DEPARTMENT OF THE ARMY

Soldier's Manual of Common Tasks
Warrior Leader Skills
Level 2, 3, and 4

OCTOBER 2006

DISTRIBUTION RESTRICTION:

Approved for public release; distribution is unlimited.

WARRIOR CREED

I am an American Soldier.

I am a Warrior and a member of a team.

**I serve the people of the United States and live the Army
Values.**

I will always place the mission first.

I will never accept defeat.

I will never quit.

I will never leave a fallen comrade.

**I am disciplined, physically and mentally tough, trained,
and proficient in my warrior tasks and drills.**

I always maintain my arms, my equipment, and myself.

I am an expert and I am a professional.

**I stand ready to deploy, engage, and destroy
the enemies of the United States of America
in close combat.**

**I am a guardian of freedom and
the American way of life.**

I am an American Soldier.

This publication is available at
Army Knowledge Online (www.us.army.mil) and
General Dennis J. Reimer Training and Doctrine
Digital Library at (www.train.army.mil).

**SOLDIER'S MANUAL OF
COMMON TASKS
WARRIOR LEADER SKILLS
LEVEL 2, 3, and 4
TABLE OF CONTENTS**

	Page
Preface	vi
Chapter 1 Introduction	1-1
Chapter 2 Training Guide	2-1
Chapter 3 Warrior Leader Skills Level 2, 3, and 4 Tasks	3-1
Skill Level 2	
Subject Area 1: Individual Conduct and Laws of War	3-1
181-101-2023 Enforce the Uniform Code of Military Justice (UCMJ).....	3-1
181-105-2001 Enforce the Law of War and the Geneva and Hague Conventions	3-6
181-105-2002 Conduct Combat Operations According to the Law of War	3-10
224-176-2426 Enforce Compliance with Media Ground Rules	3-13
805C-PAD-2503 Enforce Compliance with the Army's Equal Opportunity and Sexual Harassment Policies	3-14
Subject Area 2: First Aid	3-17
081-831-0101 Request Medical Evacuation.....	3-17
081-831-1056 Coordinate Medical Activity Support	3-22
081-831-1057 Supervise Compliance with Preventive Medicine Measures.....	3-24
Subject Area 3: Chemical, Biological, Radiological, and Nuclear	3-28
031-503-1001 Identify Chemical Agents Using an M256A1 Chemical-Agent Detector Kit	3-28

Distribution Restriction: Approved for public release; distribution is unlimited.

*This manual supersedes STP 21-24-SMCT, August 2003.

031-503-1005	Submit Nuclear, Biological, and Chemical (NBC) 1 Reports	3-32
031-503-1010	Supervise the Employment of Chemical, Biological, Radiological, and Nuclear (CBRN) Markers.....	3-34
031-503-1022	Operate the AN/VDR-2 Radiac Set	3-36
031-503-1023	Protect Yourself from Chemical, Biological, Radiological, and Nuclear (CBRN) Injury/Contamination when Changing Mission-Oriented Protective Posture (MOPP) Gear	3-39
031-503-1027	Operate the AN/UDR-13 Radiac Set	3-44
031-503-1053	Report Chemical, Biological, Radiological, and Nuclear (CBRN) Information Using NBC 4 Reports	3-47
031-504-1061	Conduct a Mask Fit Test Using the M41 Protection Assessment Test System (PATS)	3-50
Subject Area 4: Survive (Combat Techniques).....		3-53
061-283-6003	Adjust Indirect Fire.....	3-53
071-326-5705	Establish an Observation Post	3-60
071-410-0019	Control Organic Fires	3-63
Subject Area 5: Navigate.....		3-67
071-326-0515	Select a Movement Route Using a Map	3-67
071-329-1019	Use a Map Overlay	3-69
Subject Area 22: Unit Operations.....		3-75
071-326-5502	Issue a Fragmentary Order	3-75
071-326-5503	Issue a Warning Order.....	3-77
551-88N-3043	Prepare for Unit Move.....	3-78
Subject Area 23: Security and Control		3-83
301-371-1052	Protect Classified Information and Material.....	3-83
301-371-1200	Process Captured Materiel.....	3-91
Subject Area 25: Equipment Checks.....		3-95
091-CTT-2001	Supervise Preventive Maintenance Checks and Services (PMCS).....	3-95

Subject Area 27: Risk Management.....	3-97
850-001-2000	Employ the CRM Process and Principles and Show How They Apply to Performance of My Job/Assigned Duties..... 3-97
Subject Area 28: Administration/Management	3-98
805C-PAD-2060	Report Casualties
Skill Level 3	
Subject Area 2: First Aid	3-101
081-831-1058	Supervise Casualty Treatment and Evacuation..... 3-101
081-831-1059	Implement Measures to Reduce Combat Stress..... 3-104
Subject Area 3: Chemical, Biological, Radiological, and Nuclear	3-108
031-503-1002	Conduct Unmasking Procedures..... 3-108
031-503-1016	Implement Mission-Oriented Protective Posture (MOPP)..... 3-110
031-503-3004	Supervise the Crossing of a Contaminated Area..... 3-111
Subject Area 4: Survive (Combat Techniques).....	3-114
052-195-3066	Direct Construction of Nonexplosive Obstacles
071-410-0012	Conduct Occupation of an Assembly Area..... 3-123
071-420-0021	Conduct a Movement to Contact by a Platoon..... 3-126
071-430-0028	Consolidate a Unit
071-430-0029	Reorganize a Unit
Subject Area 5: Navigate	3-131
071-331-0820	Analyze Terrain
071-332-5000	Prepare an Operation Overlay..... 3-133
071-332-5021	Prepare a Situation Map..... 3-147
Subject Area 19: Crowd Control.....	3-148
191-378-4303	Supervise a Riot/Crowd Control Operation with a Squad-Sized Element..... 3-148
Subject Area 21: Defense Measures.....	3-154
071-430-0002	Conduct a Defense by a Squad
Subject Area 22: Unit Operations	3-158
071-326-3013	Conduct a Tactical Road March..... 3-158

071-720-0015	Conduct an Area Reconnaissance by a Platoon	3-161
551-721-3348	Perform Duties as Serial/March Unit Commander	3-167
551-88N-3042	Plan Unit Move	3-170
Subject Area 23: Security and Control		3-173
191-377-4203	Supervise the Establishment and Operation of a Roadblock/Checkpoint	3-173
191-378-5315	Supervise an Installation Access Control Point	3-176
191-379-4407	Plan Convoy Security Operations.....	3-179
805C-PAD-3594	Store Classified Information and Materials	3-183
Subject Area 24: Enemy Personnel.....		3-186
191-377-4250	Supervise the Processing of Detainees at the Point of Capture	3-186
191-377-4252	Supervise the Escort of Detainees	3-190
Subject Area 27: Risk Management		3-196
850-001-3001	Employ the CRM Process and Principles and Apply Them to Operations	3-196
Skill Level 4		
Subject Area 2: First Aid.....		3-199
081-831-1060	Establish Organizational Field Sanitation.....	3-199
Subject Area 3: Chemical, Biological, Radiological, and Nuclear.....		3-202
031-503-4002	Prepare a Unit for a Chemical, Biological, Radiological, and Nuclear (CBRN) Attack	3-202
Subject Area 4: Survive (Combat Techniques).....		3-205
071-326-5775	Coordinate with an Adjacent Platoon	3-205
Subject Area 19: Crowd Control		3-207
191-379-5403	Supervise a Riot/Crowd Control Operation with a Platoon-Sized Element	3-207
191-410-0078	Supervise a Riot/Crowd Control Operation with a Company-Sized Element	3-221
Subject Area 21: Defense Measures.....		3-236
071-326-5805	Conduct a Route Reconnaissance Mission	3-236
071-430-0006	Conduct a Defense by a Platoon.....	3-238

Subject Area 22: Unit Operations	3-242
091-CTT-4001 Supervise Maintenance Operations.....	3-242
159-200-2020 Integrate Threat Capabilities into Mission Planning	3-244
181-101-4001 Conduct a Search/Seizure	3-245
551-721-4326 Perform Duties as Convoy Commander	3-251
Subject Area 23: Security and Control	3-260
191-379-4408 Plan Security for a Command Post (CP).....	3-260
191-379-4440 Supervise the Evacuation of Dislocated Civilians	3-263
Subject Area 27: Risk Management	3-266
850-001-4001 Integrate Composite Risk Management into Mission Plans	3-266
Subject Area 28: Administration/Management	3-267
191-410-0077 Develop a Company Physical Security Plan	3-267
191-415-0001 Implement Brigade or Above Physical Security Program (PSP)	3-273
805C-PAD-4359 Manage Soldier's Deployment Requirements	3-276
805C-PAD-4550 Prepare a Standing Operating Procedure (SOP).....	3-277
805C-PAD-4597 Integrate Newly Assigned Soldiers.....	3-279
Appendix A Proponent School or Agency Codes	A-1
Appendix B Guide to Forms	B-1
Glossary	Glossary-1
References	References-1

PREFACE

This manual is one of a series of Soldier training publications that support individual training. Commanders, trainers, and Soldiers will use this manual and STP 21-1-SMCT, *Soldier's Manual of Common Tasks, Warrior Skills Level 1*, to plan, conduct, sustain, and evaluate individual training of warrior tasks and battle drills in units.

This manual contains an Army Warrior Training plan for warrior leader skills level (SL) 2 through SL 4 and task summaries for SL 2 critical common tasks that support unit wartime missions. This manual is the only authorized source for these common tasks. Task summaries in this manual supersede any common tasks appearing in MOS-specific Soldier manuals.

Training support information such as reference materials, websites, ammunition requirements, and reproducible evaluation forms are also included. Trainers and first-line supervisors will ensure that SL 2 through SL 4 Soldiers have access to this publication in their work areas, unit learning centers, and unit libraries.

This manual applies to the Active Army, the Army National Guard (ARNG)/Army National Guard of the United States (ARNGUS), and the U.S. Army Reserve (USAR).

The proponent of this publication is the Commander, United States Army Training and Doctrine Command (TRADOC), with the Commander, United States Army Training Support Center (ATSC) designated as the principle publishing, printing, and distribution agency. Proponents for the specific tasks are the Army schools and agencies as identified by the school code, listed in appendix A. This code consists of the first three digits of the task identification number.

Record any comments or questions regarding the task summaries contained in this manual on a DA Form 2028 (*Recommended Changes to Publications and Blank Forms*) and send it to the respective task proponent with information copies forwarded to—

- Commander, U.S. Army Training and Doctrine Command, ATTN: ATTG-I, Fort Monroe, VA 23651-5000.
- Commander, U.S. Army Training Support Center, ATTN: ATIC-ITSC-CM, Fort Eustis, VA 23604-5166.

Introduction to the SMCT System

1-1. GENERAL

This manual contains the critical common tasks for warrior skills levels 2, 3, and 4. Mastering the performance of these tasks will help the individual Soldier and the Soldiers that he or she supervises fight better and survive on the battlefield, and perform across the full spectrum of operations. Each Soldier must be able to perform all common critical tasks for that skill level and below. The individual Soldier shares responsibility with the trainer to sustain the skills and knowledge required to perform all warrior skills and warrior leader skills.

a. *Individual Soldiers.* To ensure that you can perform each task, have another Soldier or your supervisor periodically evaluate your performance using the task summaries. If you have questions about how to perform a task or which task to perform, ask your first-line supervisor. The first-line supervisor knows how to perform each task and can direct you to the appropriate training materials. You should also check the Reimer Digital Library for new training materials. It is your responsibility to use these materials to maintain your proficiency.

b. *Trainers.* If you are a supervisor and trainer and have Soldiers working for you, you must train them to do the tasks for their skill level and below. Commanders and trainers should use the Soldier's Manual of Common Tasks (SMCT), military occupational specialty (MOS) specific soldier's training publications (STPs), and mission training plans (MTPs) to establish effective training plans and programs which integrate individual and collective tasks.

1-2. SMCT AND SUPPORT OF BATTLE-FOCUSED TRAINING

a. *Overview.* The SMCTs document the common tasks by skill level on which all Soldiers must be trained and evaluated. These documents assist leaders in identifying the strengths and weaknesses of the Soldiers in their unit and provide a means for evaluating the effectiveness of the unit's individual training program. Evaluation results identify Soldiers who need training on specific tasks. Evaluation results also tell leaders where to concentrate training to improve unit readiness and help Soldiers develop professionally.

b. *Leader's Assessment.* The leader's assessment focuses on specific unit mission requirements. It gives commanders a way to evaluate Soldier performance on individual tasks that directly support their unit mission. These tasks may be common tasks as well as MOS-specific tasks. Leader's assessments should be conducted year round. Unit commanders should make leader's comments an integral part of their unit training so that hands-on evaluation is systematically performed at the unit level.

(1) Tasks selected for leader's assessments include, but are not limited to, individual tasks that—

- (a) Support the units mission essential task list (METL).
- (b) Support other non-METL unit tasks as shown in the MTP.
- (c) Are identified by higher headquarters for inclusion in planned individual training.
- (d) Were rated as substandard on previous training feedback, such as the Army warrior training (AWT) or annual general inspections.

(e) Are relevant to the Soldier's MOS but not required in his or her current duty assignment.

(2) Leaders may conduct their assessment—

- (a) Before, during, or after individual skills training.
- (b) As part of MTP training.
- (c) On the job.
- (d) At specially prepared test sites or in a battlefield scenario.
- (e) During training or job breaks.
- (f) After hours in the barracks.
- (g) During special squad or individual competitive events.
- (h) Battle assembly.

(3) The leader's assessment evaluates the combat effectiveness of Soldiers and the unit. Commanders can use this evaluation to correct training deficiencies and plan unit training. Commanders can also use the results for personnel actions (such as preparing enlisted evaluation reports, making recommendations for promotions, and other personnel management decisions).

c. **Army Warrior Training (AWT):** AWT is hands-on training focused on the warrior tasks and battle drills learned in initial entry training (IET). AWT is based on individual and leader tasks described in STP 21-1-SMCT and STP 21-24-SMCT. Units may conduct AWT *any time* during the collective training period and should be integrated with training exercises to conserve resources and to improve realism. For example, units could test Soldiers during—

- (1) MTP evaluations and other collective training activities.
- (2) Weapons qualification.
- (3) Gas chamber training.
- (4) Mission rehearsal exercises at Combat Training Centers (CTCs).
- (5) Reception, staging, onward movement, and integration (RSOI) training in theater.
- (6) Annual training.

Note: AWT results are objective measures for the commander to use to evaluate unit readiness and the effectiveness of the training program. Leaders also consider AWT results when preparing NCOER and recommending Soldiers for promotion.

1-3. SMCT FEATURES

a. **AWT Training.** The Army warrior training (chapter 2) lists, by skill level, the critical common tasks for which all Soldiers are responsible. It indicates where each task is first taught to standard and how often training on the task is required to sustain proficiency. Leaders should use this information to develop a comprehensive unit training plan.

b. **Task Summary.** Each task summary documents the performance requirements of a warrior task. The summaries provide the Soldier and the trainer with the information necessary to evaluate the critical tasks. The task summaries use the following format:

- (1) **Task Title.** The task title identifies the action to be performed.

(2) **Task Number.** A 10-digit number identifies each task. The first three digits of the number represent the proponent code for that task. (A list of the proponent codes is given in appendix A.) Include the entire 10-digit task number, along with the task title, in any correspondence relating to the task.

(3) **Conditions.** The task conditions identify all the equipment, tools, materials, references, job aids, and supporting personnel that the Soldier needs to perform the task. This section identifies environmental conditions that can alter task performance (such as visibility, temperature, or wind). This section also identifies specific cues or events (such as a chemical attack or identification of an unexploded ordnance hazard) that trigger task performance.

(4) **Standards.** A task standard specifies the requirements for task performance by indicating how well, completely, or accurately a product must be produced, a process must be performed, or both. Standards are described in terms of accuracy, tolerances, completeness, format, clarity, number of errors, quantity, sequence, or speed of performance.

(5) **Training and Evaluation Guide.** This section has two parts. The first part, Performance Steps, lists the individual steps that the Soldier must complete to perform the task. The second part is the Performance Evaluation Guide. This provides guidance on how to evaluate a Soldier's performance of the task. It is composed of three subsections. The Evaluation Preparation subsection identifies special setup procedures and, if required, instructions for evaluating the task performance. Sometimes the conditions and standard must be modified so that the task can be evaluated in a situation that does not exactly duplicate actual field performance. This subsection may also include instructions that the evaluator should give to the Soldier before the performance test. The Performance Measures subsection identifies the criteria for acceptable task performance. The Soldier is rated (GO/NO GO) on each specific action or specific product produced. The Soldier must score a GO on all (or each specified) performance measure to receive a GO on the task.

(6) **References.** This section identifies references that provide more detailed and thorough explanations of task performance requirements than that given in the task summary description. This section identifies resources that the Soldier can use to improve or maintain performance.

Additionally, task summaries can include safety statements, environmental considerations, and notes. Safety statements (danger, warning, caution) alert users to the possibility of immediate death, personal injury, or damage to equipment. Notes provide additional information to support task performance.

c. **Training Support.** This manual includes the following that provide additional training support information.

(1) Appendix A (Proponent School and Agency Codes) lists the task proponents and agency codes (first three digits of the task number) with addresses for submitting comments concerning specific tasks in this manual.

(2) Appendix B (Guide to Forms) explains the use of various SMCT training and evaluation forms and, in the online version, provides links to the forms.

(3) Glossary lists abbreviations and acronyms and their definitions.

(4) References lists all reference materials cited in the task summaries by type, identification number, title, and date.

1-4.CONDUCTING ARMY WARRIOR TRAINING AND EVALUATION

a. *Role of the Commander.* As a commander, you must ensure that your training plan prepares the unit for the full spectrum of operations. The plan should enable your Soldiers to develop and sustain proficiency on the MOS-specific and warrior tasks for their skill level. Use critical common task summaries to evaluate your Soldiers' proficiency on those tasks critical to your unit mission. An effective training program converts unproductive time into effective training time. This will upgrade the skills of individual Soldiers and promote the development of junior leaders. To develop an effective unit training program we reiterate, from the STP 21-1-SMCT, the following seven-step approach—

Step 1. Set the objectives for training.

Step 2. Plan the resources (personnel, time, funds, facilities, devices, training aids).

Step 3. Train the trainers.

Step 4. Provide the resources.

Step 5. Manage risks, environmental and safety considerations.

Step 6. Conduct the training.

Step 7. Evaluate the results.

b. *Role of the Trainer.* Although training is everyone's business, NCOs are the key to training the individual Soldiers assigned to the unit. NCOs should be the first to recognize which tasks each Soldier can or cannot perform. NCOs must ensure that each Soldier takes steps to master these tasks. This manual will assist the NCO (the trainer) in doing what trainers do best—train. To train effectively, NCOs must perform the following functions.

(1) Plan the training. You can usually integrate or conduct training for specific common tasks concurrently with other training or during slack periods. Use the Army Warrior Training Plan in chapter 2 to identify the critical warrior tasks for which each Soldier is responsible.

(2) Prepare yourself. Get training guidance from your chain of command on when to train, what to train, and what resources are available. Know the training objectives for each task and ensure that you can perform the task. Gather the necessary training references for each task as listed in the task summary.

(3) Obtain the resources. Gather the required resources and prepare the training site according to the conditions statement and the evaluation preparation section of the task summary. Ensure that equipment needed to complete the task is operational. Coordinate the use of training aids and devices.

(4) Train the Soldiers. Show the Soldiers how to do the task to standard and explain each step. Give each Soldier at least one chance to perform the task.

(5) Evaluate the Soldiers. Evaluate how well the Soldiers perform. You may conduct the evaluation during individual training or while evaluating individual performance while conducting unit collective tasks. Use the Army Warrior Training to determine how often to check Soldiers to ensure they maintain proficiency.

(6) Record the results.

(a) Score the Soldier GO if all performance measures are passed. Score the Soldier NO GO if any step is failed. If the Soldier fails any step, show or tell him or her what was done wrong and how to do it correctly.

(b) Record the GO/NO GO results in the leader book. You may use DA Form 5165-R; see the Guide to Forms (appendix B) at the end of this publication. Do not make written entries directly on the evaluation guides in the SMCT.

(c) When applicable, conduct an after-action review exercise to allow training participants to discover for themselves what happened, why it happened, and how it can be done better. Once all key points have been discussed and linked to future training, the evaluator will make the appropriate notes for inclusion into the score.

(7) **Retrain and reevaluate.** Work with Soldiers until they can perform the task to specific Soldier's manual standard.

Good training increases the professionalism of each Soldier and helps to develop an efficient unit. You are a vital link in the conduct of good training.

This page intentionally left blank.

Chapter 2
Training Guide

2-1. ARMY WARRIOR TRAINING

This chapter provides information to help the trainer plan, prepare, train, evaluate, and monitor individual training in units. It lists by general subject area, skill level and warrior tasks or battle drill that the critical common task Soldiers must perform, the initial training location, and a suggested frequency of training. The training location column uses brevity codes to indicate where the task is first taught to standards. If the task is taught in the unit the word, "UNIT" appears in this column. "SD" indicates tasks trained via self-development media. If it is taught in the training base, the brevity code (WLC, BNCOC, and ANCOC) of the resident course appears. Brevity codes and resident courses are listed below.

Brevity Codes	
ANCOC	Advanced NCO Course
BNCOC	Basic NCO Course
WLC	Warrior Leaders Course
BCT	Basic Combat Training
OSUT	One Station Unit Training
AIT	Advanced Individual Training
UNIT	Trained in / by the Unit

The sustainment training column lists how often (frequency) Soldiers should train on the task to ensure they maintain their proficiency. This information is a guide for commanders to develop a comprehensive unit-training plan. The commander, in conjunction with the unit trainers, is in the best position to determine on which tasks and how often Soldiers need training to maintain unit readiness.

Frequency Codes	
AN	Annually
SA	Semiannually
QT	Quarterly

Army Warrior Training Plan			
<i>Task Number</i>	<i>Title</i>	<i>Training Location</i>	<i>Sustainment Training Frequency</i>
Warrior Skill Level 2			
Subject Area 1. Individual Conduct and Laws of War			
181-101-2023	Enforce the Uniform Code of Military Justice (UCMJ)	Unit	AN
181-105-2001	Enforce the Law of War and the Geneva and Hague Conventions	Unit	AN
181-105-2002	Conduct Combat Operations According to the Law of War	Unit	AN
224-176-2426	Enforce Compliance with Media Ground Rules	Unit	AN
805C-PAD-2503	Enforce Compliance with the Army's Equal Opportunity and Sexual Harassment Policies	WLC	SA
Subject Area 2. First Aid			
081-831-0101	Request Medical Evacuation	WLC	QT
081-831-1056	Coordinate Medical Activity Support	Unit	SA
081-831-1057	Supervise Compliance with Preventive Medicine Measures	Unit	AN
Subject Area 3. Chemical, Biological, Radiological, and Nuclear (CBRN)			
031-503-1001	Identify Chemical Agents Using an M256A1 Chemical-Agent Detector Kit	Unit	AN
031-503-1002	Conduct Unmasking Procedures	Unit	AN
031-503-1005	Submit Nuclear, Biological, and Chemical (NBC) 1 Reports	WLC	AN

Army Warrior Training Plan			
<i>Task Number</i>	<i>Title</i>	<i>Training Location</i>	<i>Sustainment Training Frequency</i>
031-503-1010	Supervise the Employment of Chemical Biological, Radiological, and Nuclear (CBRN) Markers	Unit	AN
031-503-1016	Implement Mission-Oriented Protective Posture (MOPP)	Unit	AN
031-503-1022	Operate the AN/VDR-2 Radiac Set	Unit	AN
031-503-1023	Protect Yourself from Nuclear, Biological, and Chemical Injury/ Contamination When Changing Mission-Oriented Protective Posture Gear	Unit	SA
031-503-1027	Operate the AN/UDR-13 Radiac Set	Unit	AN
031-503-1053	Report Chemical, Biological, Radiological, and Nuclear (CBRN) Information Using NBC 4 Report	WLC	AN
031-503-3004	Supervise the Crossing of a Contaminated Area	Unit	AN
031-503-4002	Supervise Unit Preparation for a Nuclear, Biological, and Chemical Attack	Unit	AN
031-504-1061	Conduct a Mask Fit Test Using the M41 Protection Assessment Test System (PATS)	Unit	AN
Subject Area 4. Survive (Combat Techniques)			
061-283-6003	Adjust Indirect Fire	WLC	AN
071-326-5705	Establish an Observation Post	WLC	AN
071-410-0019	Control Organic Fires	Unit	AN
Subject Area 5. Navigate			
071-326-0515	Select a Movement Route Using a Map	WLC	SA
071-329-1019	Use a Map Overlay	Unit	AN

Army Warrior Training Plan			
<i>Task Number</i>	<i>Title</i>	<i>Training Location</i>	<i>Sustainment Training Frequency</i>
Subject Area 22. Unit Operations			
071-326-5502	Issue a Fragmentary Order	WLC	QT
071-326-5503	Issue a Warning Order	WLC	QT
551-88N-3043	Prepare for Unit Move	Unit	QT
Subject Area 23. Security and Control			
301-371-1052	Protect Classified Information and Material	WLC	AN
301-371-1200	Process Captured Materiel	WLC	AN
Subject Area 25. Equipment Checks			
091-CTT-2001	Supervise Preventive Maintenance Checks and Services (PMCS)	Unit	AN
Subject Area 27. Risk Management			
850-001-2000	Employ the CRM Process and Principles and Show How They Apply to Performance of My Job/Assigned Duties	Unit	AN
Subject Area 28. Administration/Management			
805C-PAD-2060	Report Casualties	WLC	AN
Warrior Skill Level 3			
Subject Area 2. First Aid			
081-831-1058	Supervise Casualty Treatment and Evacuation	Unit	AN
081-831-1059	Implement Measures to Reduce Combat Stress	Unit	AN
Subject Area 4. Survive (Combat Techniques)			
052-192-3262	Prepare for an IED Threat Prior to Movement	Unit	AN
052-192-4053	Supervise Minefield Breaching Operations	Unit	SA

Army Warrior Training Plan			
<i>Task Number</i>	<i>Title</i>	<i>Training Location</i>	<i>Sustainment Training Frequency</i>
052-195-3066	Direct Construction of Nonexplosive Obstacles	Unit	AN
052-703-9107	Plan for a Improvised EID Threat	Unit	AN
071-410-0012	Conduct Occupation of an Assembly Area	BNCOC	AN
071-420-0021	Conduct a Movement to Contact by a Platoon	BNCOC	AN
071-430-0028	Consolidate a Unit	BNCOC	AN
071-430-0029	Reorganize a Unit	BNCOC	AN
Subject Area 5. Navigate			
071-331-0820	Analyze Terrain	BNCOC	AN
071-332-5000	Prepare an Operational Overlay	BNCOC	AN
071-332-5021	Prepare a Situation Map	BNCOC	QT
Subject Area 19. Crowd Control			
191-378-4303	Supervise a Riot/Crowd Control Operation with a Squad-Sized Element	Unit	AN
Subject Area 22. Unit Operation			
071-326-3013	Conduct a Tactical Road March	Unit	AN
071-720-0015	Conduct an Area Reconnaissance by a Platoon	Unit	QT
551-721-3348	Perform Duties as Serial-March Unit Commander	Unit	AN
551-88N-3042	Plan Unit Move	Unit	SA
Subject Area 23. Security and Control			
191-377-4203	Supervise the Establishment and Operation of a Roadblock/Checkpoint	BNCOC	AN
191-378-5315	Supervise an Installation Access Control Point	Unit	AN
191-379-4407	Plan Convoy Security Operations	Unit	AN
805C-PAD-3594	Store Classified Information and Materials	Unit	AN

Army Warrior Training Plan			
<i>Task Number</i>	<i>Title</i>	<i>Training Location</i>	<i>Sustainment Training Frequency</i>
Subject Area 24. Enemy Personnel			
191-377-4250	Supervise the Processing of Detainees at the Point of Capture	BNCOC	AN
191-377-4252	Supervise the Escort of Detainees	BNCOC	AN
Subject Area 27. Risk Management			
850-001-3001	Control Mission Safety Hazard	Unit	QT
Warrior Leader Skills Level 4			
Subject Area 2. First Aid			
081-831-1060	Establish Organizational Field Sanitation	Unit	AN
Subject Area 4. Survive (Combat Techniques)			
071-326-5775	Coordinate with an Adjacent Platoon	Unit	QT
Subject Area 19. Crowd Control			
191-379-5403	Supervise a Riot/Crowd Control Operation with a Platoon-Sized Element	Unit	SA
191-410-0078	Lead a Company Size Crowd/Riot Control Formation	Unit	AN
Subject Area 21. Defense Measures			
071-326-5805	Conduct a Route Reconnaissance	ANCOC	AN
071-430-0006	Conduct a Defense by a Platoon	ANCOC	QT
Subject Area 22. Unit Operations			
091-CTT-4001	Supervise Maintenance Operations	Unit	AN
151-357-0001	Supervise CSS Functions During Platoon Operations	Unit	AN
151-357-0002	Coordinate Combat Service Support (CSS)	Unit	AN

Army Warrior Training Plan			
<i>Task Number</i>	<i>Title</i>	<i>Training Location</i>	<i>Sustainment Training Frequency</i>
159-200-2020	Integrate Threat Capabilities into Mission Planning	ANCOC	QT
551-721-4326	Perform Duties as Convoy Commander	ANCOC	SA
Subject Area 23. Security and Control			
191-379-4408	Plan Security for a Command Post	Unit	SA
191-379-4440	Supervise the Evacuation on Noncombatives	Unit	SA
Subject Area 27. Risk Management			
181-101-4001	Conduct a Search/Seizure	Unit	SA
850-001-4001	Integrate Risk Management into Mission Plans	Unit	AN
Subject Area 25. Administration/Management			
191-410-0077	Develop a Company Physical Security Plan	Unit	AN
191-415-0001	Implement Brigade or Above Physical Security Program	Unit	AN
805C-PAD-4359	Manage Soldier's Deployment Requirements	Unit	SA
805C-PAD-4550	Prepare a Standing Operating Procedure (SOP)	Unit	SA
805C-PAD-4597	Integrate Newly Assigned Soldiers	Unit	QT

2-2.SUBJECT AREA CODES

Below is a list of subject areas contained in this STP.

Warrior Leader Skills Level 2, 3, and 4

- 1 Individual Conduct and Laws of War
- 2 First Aid
- 3 Chemical, Biological, Radiological, and Nuclear (CBRN)
- 4 Survive (Combat Techniques)
- 5 Navigate
- 19 Crowd Control

- 20 Casualty Reporting and Handling
- 21 Defense Measures
- 22 Unit Operations
- 23 Security and Control
- 24 Enemy Personnel
- 25 Equipment Checks
- 26 Crime Prevention
- 27 Risk Management
- 28 Administration/Management

Chapter 3
Warrior Leader Skills Level 2, 3, and 4 Tasks

Skill Level 2

SUBJECT AREA 1: INDIVIDUAL CONDUCT AND LAWS OF WAR

181-101-2023

Enforce the Uniform Code of Military Justice (UCMJ)

Conditions: You are a noncommissioned officer (NCO) in a leadership position in the U.S. Army. You are responsible for understanding that disciplinary action against a Soldier for misconduct is a command responsibility. You are responsible for understanding the military justice system, including the Uniform Code of Military Justice (UCMJ) and disciplinary options available to a commander. You are responsible for identifying potential violations of the UCMJ and expeditiously reporting them to the appropriate authorities for investigation and processing.

Standards: Understand that disciplinary action against a Soldier for misconduct is a command responsibility. Understand the military justice system, including the UCMJ and the disciplinary options available to a commander. Identify potential violations of the UCMJ and expeditiously report them to the appropriate authorities for investigation and processing.

Performance Steps

1. Describe how disciplinary action against a Soldier is a command responsibility.
 2. Identify who has authority to take disciplinary action against a Soldier for misconduct.
 3. Describe a Soldier's responsibility to identify potential or actual violations of the UCMJ and expeditiously report these violations to the appropriate authorities for investigation and processing.
 4. Describe a commander's responsibility to conduct a preliminary investigation into misconduct allegedly committed by a Soldier under his/her command.
 - a. Describe the basis and procedures of a commander's Inquiry.
 - b. Describe the basis and procedures of an AR 15-6 investigation.
 - c. Describe the requirement for the military police or Criminal Investigation Command (CID) to conduct a criminal investigation.
 5. List the disciplinary options available to the commander.
 - a. Describe how a commander can take no action at all or close a case.
-

Performance Steps

b. Describe how a commander can use administrative or nonpunitive measures.

(1) List administrative or nonpunitive disciplinary measures available to a commander.

(2) Describe why a commander would use nonpunitive or administrative disciplinary measures rather than impose nonjudicial punishment or proceed to court-martial.

(3) Describe how a NCO leader may be involved in imposing nonpunitive or administrative disciplinary measures, such as counseling or corrective training, to a subordinate Soldier.

c. Describe how a commander can use nonjudicial punishment.

(1) Define nonjudicial punishment.

(2) List the different types of nonjudicial punishment.

(3) Describe nonjudicial punishment procedures.

(4) Describe a Soldier's legal rights during nonjudicial punishment procedures.

(5) List the maximum punishment available under nonjudicial punishment.

(6) Describe a Soldier's appellate rights under nonjudicial punishment.

d. Describe how a commander can use judicial punishment.

(1) Define judicial punishment.

(2) List the different types of court-martial in the military justice system.

(3) Describe judicial or court-martial procedures.

(4) Describe a Soldier's legal rights during judicial or court-martial punishment.

(5) List the maximum punishment available under judicial or court-martial punishment.

(6) Describe a Soldier's appellate rights under judicial or court-martial punishment.

6. List factors a commander should consider when determining what disciplinary option to pursue.

a. Describe whether a commander should consider the character and military service of the accused.

b. Describe whether a commander should consider the nature and circumstances of the offense and the extent of the harm caused.

c. Describe whether a commander should consider the needs of the Service and the probable effect of his/her decision on the command and the military community.

Performance Steps

- d. Describe whether a commander should consider the disposition of similar offenses in the past and the general disciplinary trends within the command.
 - e. Describe whether a commander should consider the appropriateness of the authorized punishment to the particular accused and offense.
 - f. Describe whether a commander should determine whether he/she has jurisdiction over the accused and the offense.
 - g. Describe whether a commander should consider the availability and admissibility of evidence against the accused.
 - h. Describe whether a commander should consider the cooperation of the accused in the apprehension or conviction of others.
 - i. Describe whether a commander should consider the possible improper motives of the accuser.
 - j. Describe whether a commander should consider that the victim or others are reluctant to testify.
7. Describe the permissibility of a commander discussing and gaining input from an NCO leader regarding which disciplinary option to pursue against a subordinate Soldier within the unit.
8. Describe the authority of an NCO to issue a lawful order to a subordinate Soldier.
- a. Describe the duty of a subordinate Soldier to follow this order.
 - b. Describe the potential adverse ramifications for a Soldier violating this order.
 - c. Describe the elements and maximum punishment available under Article 91, UCMJ.

Evaluation Preparation: *Setup:* Evaluate this task at the end of military justice training.

Brief Soldier: Tell the Soldier that he/she will be evaluated on his/her ability to understand that disciplinary action against a Soldier for misconduct is a command responsibility. Tell the SOLDIER that he/she will also be evaluated on his/her ability to understand the military justice system, including the UCMJ; the disciplinary options available to a commander; and the ability to identify potential violations of the UCMJ and expeditiously report them to the appropriate authorities for investigation and processing.

Performance Measures	GO	NO GO
1. Described how disciplinary action against a Soldier is a command responsibility.	_____	_____
2. Identified who had authority to take disciplinary action against a Soldier for misconduct.	_____	_____
3. Described a Soldier's responsibility to identify potential or actual violations of the UCMJ and expeditiously reported these violations to the appropriate authorities for investigation and processing.	_____	_____
4. Described a commander's responsibility to conduct a preliminary investigation into misconduct allegedly committed by a Soldier under his/her command.	_____	_____
a. Described the basis and procedures of a commander's inquiry.		
b. Described the basis and procedures of an AR 15-6 investigation.		
c. Described the requirement for the military police or CID to conduct a criminal investigation.		
5. Listed disciplinary options available to the commander.		
a. Described how a commander could take no action at all or close a case.		
b. Described how a commander could use administrative or nonpunitive measures.		
(1) Listed administrative or nonpunitive disciplinary measures available to a commander.		
(2) Described why a commander would use nonpunitive or administrative disciplinary measures rather than impose nonjudicial punishment or proceed to court-martial.		
(3) Described how a NCO leader may be involved in imposing nonpunitive or administrative disciplinary measures, such as counseling or corrective training, to a subordinate Soldier.		
c. Described how a commander could use nonjudicial punishment.		
(1) Defined nonjudicial punishment.		
(2) Listed the different types of nonjudicial punishment.		

Performance Measures	GO	NO GO
<p>(3) Described nonjudicial punishment procedures.</p>		
<p>(4) Described a Soldier's legal rights during nonjudicial punishment procedures.</p>		
<p>(5) Listed the maximum punishment available under nonjudicial punishment.</p>		
<p>(6) Described a Soldier's appellate rights under nonjudicial punishment.</p>		
<p>d. Described how a commander could use judicial punishment.</p>		
<p>(1) Defined judicial punishment.</p>		
<p>(2) Listed the different types of court-martial in the military justice system.</p>		
<p>(3) Described judicial or court-martial procedures.</p>		
<p>(4) Described a Soldier's legal rights during judicial or court-martial punishment.</p>		
<p>(5) Listed the maximum punishment available under judicial or court-martial punishment.</p>		
<p>(6) Described a Soldier's appellate rights under judicial or court-martial punishment.</p>		
<p>6. Listed factors a commander should consider when determining what disciplinary option to pursue.</p>		
<p>a. Described whether a commander should consider the character and military service of the accused.</p>		
<p>b. Described whether a commander should consider the nature and circumstances of the offense and the extent of the harm caused.</p>		
<p>c. Described whether a commander should consider the needs of the Service and the probable effect of his/her decision on the command and the military community.</p>		
<p>d. Described whether a commander should consider the disposition of similar offenses in the past and the general disciplinary trends within the command.</p>		
<p>e. Described whether a commander should consider the appropriateness of the authorized punishment to the particular accused and offense.</p>		
<p>f. Described whether a commander should determine whether he/she has jurisdiction over the accused and the offense.</p>		

Performance Measures	GO	NO GO
<p>g. Described whether a commander should consider the availability and admissibility of evidence against the accused.</p>		
<p>h. Described whether a commander should consider the cooperation of the accused in the apprehension or conviction of others.</p>		
<p>i. Described whether a commander should consider the possible improper motives of the accuser.</p>		
<p>j. Described whether a commander should consider that the victim or others are reluctant to testify.</p>		
<p>7. Described the permissibility of a commander discussing and gaining input from an NCO leader regarding which disciplinary option to pursue against a subordinate Soldier within the unit.</p>		
<p>8. Described the authority of an NCO to issue a lawful order to a subordinate Soldier.</p>		
<p>a. Described the duty of a subordinate Soldier to follow this order.</p>		
<p>b. Described the potential adverse ramifications for a Soldier violating this order.</p>		
<p>c. Described the elements and maximum punishments available under Article 91, UCMJ.</p>		

Evaluation Guidance: Refer to chapter 1, paragraph 1-4 b (6).

References

Required: AR 27-10 and AR 600-20

Related:

181-105-2001

Enforce the Law of War and the Geneva and Hague Conventions

Conditions: You are a Soldier in the U.S. Army. As a Soldier, you are responsible for identifying, understanding, and complying with the provisions of the Law of War, including the Geneva and Hague Conventions. You are also responsible for identifying and notifying the appropriate authorities of any suspected or known violations of the Law of War. The appropriate authorities, including your chain of command, must enforce the provisions of the Law of War, including the Geneva and Hague Conventions.

Standards: Identify, understand, and comply with the Law of War. Identify problems or situations that violate the policies and take appropriate action, including

notifying appropriate authorities, so that expedient action may be taken to correct the problem or situation.

Performance Steps

1. Identify the key violations of the Law of War.
 - a. Define a Law of War violation.
 - b. Identify the two general types of war crimes.
 - c. Define what constitutes a grave breach and give examples.
 - d. Describe what obligations exist if there is a grave breach.
 - e. Define what constitutes an other than grave breach or a simple breach and give examples.
 - f. Describe what obligations exist if there is a simple breach.
2. Describe the responsibilities of U.S. Soldiers to obey the Law of War.
 - a. Describe how U.S. Soldiers are bound to obey all the rules of the Customary Law of War and the Hague and Geneva Conventions.
 - b. Describe how U.S. Soldiers may be court-martialed for violating these rules.
 - c. Describe how U.S. Soldiers may also be prosecuted for committing a war crime.
3. Describe the responsibilities of the commander in regards to violations of the Law of War.
 - a. Describe how the legal responsibility for the commission of a war crime can be placed on the commander as well as the subordinate who actually commits the war crime.
 - b. Describe the circumstances under which a commander may be prosecuted for the commission of a war crime.
4. Describe a criminal order and a Soldier's responsibility toward a criminal order.
 - a. Describe the applicability of a Soldier asserting the defense of "obeying a superior order" for the commission of a war crime.
 - b. Describe whether a subordinate Soldier, who actually commits a war crime, is excused from prosecution if the commander is charged with the commission of the war crime.
 - c. Describe the responsibility of a Soldier to disobey any order which requires the Soldier to commit criminal acts in violation of the Law of War.
 - d. Describe the responsibility of a Soldier to obey the rules of engagement (ROE) and the potential consequences for violating the ROE.

Performance Steps

- e. Describe the responsibility of the Soldier to ask a superior for clarification of an order presumed to be criminal or illegal.
5. Identify the key requirements in processing violations of the Law of War.
- a. Describe the actions required when a Law of War violation is suspected.
 - b. Describe your combatant commander-in-chief's (CINC) guidance.
 - c. Describe the requirement to report suspected violations of the Law of War.
 - d. Describe the obligations of the investigative team.
 - (1) Describe who appoints the investigating officer(s).
 - (2) Describe the qualifications of the investigating officer(s).
 - (3) Describe the importance of timely collection of information/evidence.
 - (4) Describe the initial report format.

Evaluation Preparation: *Setup:* Evaluate this task at the end of Law of War training.

Brief Soldier: Tell the Soldier that he/she will be evaluated on his/her ability to identify, understand, and comply with the Law of War, including the Geneva and Hague Conventions. Tell the Soldier that he/she will also be evaluated on his/her ability to identify problems or situations that violate the Law of War and take appropriate action, including notifying appropriate authorities of actual or suspected violations, so that expedient action may be taken to correct the problem or situation.

Performance Measures	GO	NO GO
1. Identified the key violations of the Law of War. <ol style="list-style-type: none">a. Defined a Law of War violation.b. Identified the two general types of war crimes.c. Defined what constituted a grave breach and gave examples.d. Described what obligations existed if there was a grave breach.e. Defined what constituted an other than grave breach or a simple breach and gave examples.f. Described what obligations existed if there was a simple breach.	—	—
2. Described the responsibilities of U.S. Soldiers to obey the Law of War.		

Performance Measures	GO	NO GO
<p>a. Described how U.S. Soldiers were bound to obey all the rules of the Customary Law of War and the Hague and Geneva Conventions.</p>		
<p>b. Described how U.S. Soldiers may be court-martialed for violating these rules.</p>		
<p>c. Described how U.S. Soldiers may also be prosecuted for committing a war crime.</p>		
<p>3. Described the responsibilities of the commander in regards to violations of the Law of War.</p>	_____	_____
<p>a. Described how the legal responsibility for the commission of a war crime could be placed on the commander as well as the subordinate who actually committed the war crime.</p>		
<p>b. Described the circumstances under which a commander may be prosecuted for the commission of a war crime.</p>		
<p>4. Described a criminal order and a Soldier's responsibility toward a criminal order.</p>		_____
<p>a. Described the applicability of a Soldier asserting the defense of "obeying a superior order" for the commission of a war crime.</p>		
<p>b. Described whether a subordinate Soldier, who actually committed a war crime, was excused from prosecution if the commander was charged with the commission of the war crime.</p>		
<p>c. Described the responsibility of a Soldier to disobey any order which required the Soldier to commit criminal acts in violation of the Law of War.</p>		
<p>d. Described the responsibility of a Soldier to obey the ROE and the potential consequences for violating the ROE.</p>		
<p>e. Described the responsibility of the Soldier to ask a superior for clarification of an order presumed to be criminal or illegal.</p>		
<p>5. Identified the key requirements in processing violations of the Law of War.</p>		_____

Performance Measures	GO	NO GO
<p>a. Described what actions were required when a Law of War violation was suspected.</p>		
<p>b. Described your combatant CINC's guidance.</p>		
<p>c. Described the requirement to report suspected violations of the Law of War.</p>		
<p>d. Described the obligations of the investigative team.</p>		
<p>(1) Described who appointed the investigating officer(s).</p>		
<p>(2) Described the qualifications for the investigating officer(s).</p>		
<p>(3) Described the importance of timely collection of information/evidence.</p>		
<p>(4) Described the initial report format.</p>		

Evaluation Guidance: Refer to chapter 1, paragraph 1-4 b (6).

References

Required: AR 27-1, FM 27-10, FM 27-2, and TC 27-10-1

Related:

181-105-2002

Conduct Combat Operations According to the Law of War

Conditions: You are a Soldier in a deployed unit which has a mission that requires you and your subordinates to be actively involved in operations that are governed by the Law of War.

Standards: Conduct your operations according to the Law of War and employ actions to prevent violations of the Law of War.

Performance Steps

1. Identify the key elements of the Hague and Geneva Conventions that pertain to combat operations.
 - a. Unlawful and lawful targets.
 - b. Noncombatants.
 - c. Lawful use of force.
 - d. Protected property—property dedicated to the humanities, structures, and items of cultural or historical significance, and schools, orphanages and other places dedicated to the use and benefit of children.
 - e. Protected medical transports and facilities.

Performance Steps

- f. Proper use of medical service symbols, a flag of truce, national emblems, and/or insignia or uniforms of an opposing force.
 - g. Define perfidy and treachery.
 - h. Proportionate use of force.
 - i. List weapons and action that causes unnecessary suffering and harm.
 - j. List duties of the captor to prisoners of war (POWs), retained persons, and detainees.
 - k. List duties of combatants toward civilians and civilian property.
 - l. List rights, responsibilities, and discipline of POWs.
 - m. List war crimes constituting grave breaches.
 - n. List State obligations when evidence of a war crime exists.
 - o. List requirements to report Law of War violations.
2. Employ actions to prevent violations of the Law of War.
- a. Protect the following:
 - (1) Noncombatants/civilians.
 - (2) Property.
 - (3) POWs, retained persons, and detainees.
 - (4) Medical transports and facilities.
 - b. Prevent engagement of unlawful targets.
 - (1) Protective emblems.
 - (2) Noncombatants and protected property.
- Note:* Do not fire indiscriminately.
- (3) Rules of engagement (ROE).
 - c. List actions to prevent excessive use of force.
 - d. List actions to prevent unauthorized use of medical service symbols, flags of truce, national emblems, and enemy uniform/insignia.
 - e. List actions to prevent unnecessary destruction or seizure of property.
 - f. List actions to prevent unnecessary suffering and harm.
 - g. List actions to enforce the rights and responsibilities of POWs.
 - h. Describe the obligations of a military commander with respect to prevention, suppression, and prosecution of war crimes.
 - i. Describe the concept of command responsibility in relation to war crimes.
 - j. List methods for reporting violations of the Law of War.

Evaluation Preparation: *Setup:* Evaluate this task at the end of Law of War training.

Brief Soldier: Tell the Soldier that he/she will be evaluated on his/her ability to conduct combat operations according to the Law of War and to employ actions to prevent violations of the Law of War.

Performance Measures	GO	NO GO
1. Employed actions that prevented Law of War violations and war crimes to protect—	_____	_____
a. Noncombatants and civilians.		
b. Property.		
c. POWs and detainees.		
d. Medical transports and facilities.		
2. Employed actions that prevented Law of War violations and war crimes:	_____	_____
a. Engagement of lawful targets.		
b. Excessive use of force.		
c. Unauthorized use of medical services symbol, flag of truce, national emblems, and enemy insignias and uniforms.		
d. Unnecessary suffering and harm.		
3. Employed actions that enforce the rights and responsibilities of POWs.		
4. Listed the duties of the captor to POWs, retained persons, and detainees.		
5. Listed the duties of combatants toward civilians and civilian property.		
6. Listed the rights and responsibilities of POWs.		
7. Listed war crimes that constitute grave breaches.		
8. Listed the State obligations that occurred when evidence of a war crime existed.		
9. Listed the requirement to report Law of War violations.		
10. Listed the specific ROE.		
11. Listed the commander's primary responsibilities.		

Evaluation Guidance:

References

Required: AR 27-1, FM 27-10, FM 27-2, and TC 27-10-1

Related:

224-176-2426

Enforce Compliance with Media Ground Rules

Conditions: Given a copy of your command/installation's media ground rules in a field, military operations in urban terrain (MOUT) or garrison environment, enforce compliance with the rules.

Standards: Identify the steps for enforcing media ground rules.

CAUTION
Media ground rules may change between various command levels within garrison, field and deployment environments.

Performance Steps

Note: Ground rules recognize the importance of media coverage of military operations and are not intended to prevent release of derogatory, embarrassing, or negative information. However, during operations, specific information on friendly troop movements, tactical deployments, and dispositions could jeopardize operational security and endanger lives.

Note: Commanders and public affairs practitioners will establish basic ground rules ensuring the free flow of information while safeguarding classified materials or operational plans.

1. Obtain area-specific ground rules from the local public affairs office or representative.
2. Define media ground rules. Media representatives are required to contact public affairs prior to conducting any media-related activities.
3. Determine if the media representative is aware of the area ground rules; if not, explain the violations.
4. Be professional.
5. Inform the chain of command and public affairs representative if ground rules are violated.

Evaluation Preparation: *Setup:* Provide Soldier with a copy of the media ground rules. Obtain ground

rules from the local public affairs office (PAO), chain of command or refer to FM 46-1. Have one Soldier play the part of a media representative.

Brief Soldier: Tell the Soldier media representatives are in the area and want to interview Soldiers for a print or broadcast story. Evaluate the Soldier on his/her ability to enforce media ground rules.

Performance Measures	GO	NO GO
1. Ensured that the Soldier knew where to obtain a copy of the media ground rules.	___	___
2. Ensured that the Soldier could define media ground rules.	___	___

Performance Measures	GO	NO GO
3. Briefed media representative of violations to the established ground rules.	_____	_____
4. Reported ground rule violations to chain of command or public affairs representative.	_____	_____

Evaluation Guidance: Refer to chapter 1, paragraph 1-4 b (6).

References

Required: AR 360-1

Related: FM 46-1

805C-PAD-2503

Equal Opportunity Enforce Compliance with the Army's and Sexual Harassment Policies

Conditions: You are a small unit/section leader responsible for supervising personnel. Personnel include both male and female, and represent different races, colors, religions, and national origins. You have access to AR 600-20, FM 22-100, the Unit's and Army Equal Opportunity and Sexual Harassment Policies.

Standards: Demonstrate personal behavior and leadership consistent with the Army's equal opportunity (EO) and prevention of sexual harassment (POSH) policies. Enforce compliance with the Army's EO, POSH, and the Army's extremist activities policies.

Performance Steps

1. Act according to the Army's EO and prevention of sexual harassment policies.
 - a. Demonstrate Army values associated with EO.
 - (1) Display unquestionable loyalty.
 - (2) Follow your higher duty to the Army and the nation.
 - (3) Treat people as they should be treated.
 - (4) Live up to all the Army values.
 - b. Conform to the Army's EO and POSH policies. Do not—
 - (1) Make racial or sexual comments and/or gestures.
 - (2) Make national origin or religious comments/jokes/slurs.
 - (3) Display racist or sexually offensive visual materials.
 - (4) Make unsolicited and unwelcomed sexual contact with fellow Soldiers.
 - (5) Stereotype fellow Soldiers or make assumptions about their cultural background, race, religion, or beliefs.
 - (6) Use profanity or sexually oriented language.
 - (7) Discount the religious beliefs of fellow Soldiers.
 - (8) Belong to extremist organizations or participate in extremist activities.

Performance Steps

- c. Demonstrate leadership consistent with EO and POSH policies.
 - (1) Treat subordinates with dignity and respect.
 - (2) Treat subordinates fairly and equally.
 - (3) Recognize and respect subordinates' individual needs, aspirations, and capabilities.
 - (4) Do not discriminate against subordinates based on race, color, national origin, gender or religion.
 - (5) Do not use language that demeans, excludes, or offends subordinates.
2. Keep your unit free from unlawful discrimination and sexual harassment.
 - a. Ensure that subordinates understand Army and unit EO and POSH policies and procedures.
 - (1) Ensure that subordinates understand the required standards of behavior.
 - (2) Counsel subordinates on the legal and administrative repercussions of EO/sexual harassment violations.
 - (3) Ensure that subordinates understand recommended techniques for dealing with sexual harassment.
 - (4) Ensure that subordinates understand the EO and sexual harassment complaint process.
 - (5) Ensure that subordinates understand the Army policy on extremist activities and organizations.
 - b. Make on-the-spot corrections of subordinates whose behaviors are contrary to Army EO and sexual harassment policies.
 - (1) Correct Soldiers using racial or sexually harassing nonverbal gestures.
 - (2) Correct Soldiers using racial or sexually harassing verbal comments.
 - (3) Correct Soldiers displaying racial or sexually harassing visual materials.
 - (4) Do not allow intimidation, harassment, or reprisal against Soldiers for making complaints.

Evaluation Preparation: *Setup:* This task can be tested in an administrative or field environment. Give the Soldier a scenario that provides sufficient information to evaluate his/her knowledge of the Army's EO and POSH policies, prohibited acts, and actions that should be taken if a violation occurs.

Brief Soldier: Inform Soldier that they will be tested on his/her knowledge of the Army's EO and POSH policies, prohibited acts, and actions that should be taken if a violation occurs.

Performance Measures	GO	NO GO
1. Acted according to the Army's EO and POSH policies.	___	___
a. Demonstrated Army values associated with EO.		
(1) Displayed unquestionable loyalty.		

Performance Measures	GO	NO GO
(2) Followed your higher duty to the Army and the nation.		
(3) Treated people as they should be treated.		
(4) Lived up to all the Army values.		
b. Conformed to the Army's EO and POSH policies.		
(1) Did not make racial or sexual comments and/or gestures.		
(2) Did not make national origin or religious comments/jokes/slurs.		
(3) Did not display racist or sexually offensive visual materials.		
(4) Did not make unsolicited or unwelcomed sexual contact with fellow Soldiers.		
(5) Did not stereotype fellow Soldiers or make assumptions about their cultural background, race, religion, or beliefs.		
(6) Did not use profanity or sexually oriented language.		
(7) Did not discount the religious beliefs of fellow Soldiers.		
(8) Did not belong to extremist organizations or participate in extremist activities.		
c. Demonstrated leadership consistent with EO and POSH policies.		
(1) Treated subordinates with dignity and respect.		
(2) Treated subordinates fairly and equally.		
(3) Recognized and respected subordinates' individual needs, aspirations, and capabilities.		
(4) Did not discriminate against subordinates based on race, color, national origin, gender or religion.		
(5) Did not use language that demeaned, excluded, or offended subordinates.		
2. Kept your unit free from unlawful discrimination and sexual harassment.		
a. Ensured that subordinates understood Army and unit EO/POSH policies and procedures.		
(1) Ensured that subordinates understood the required standards of behavior.		
(2) Counseled subordinates on the legal and administrative repercussions of EO/sexual harassment violations.		
(3) Ensured that subordinates understood recommended techniques for dealing with sexual harassment.		

Performance Measures	GO	NO GO
(4) Ensured that subordinates understood the EO and sexual harassment complaint process.		
(5) Ensured that subordinates understood the Army policy on extremist activities and organizations.		
b. Made on-the-spot corrections of subordinates whose behaviors were contrary to Army EO and POSH policies.		
(1) Corrected Soldiers that used racial or sexually harassing nonverbal gestures.		
(2) Corrected Soldiers that used racial or sexually harassing verbal comments.		
(3) Corrected Soldiers that displayed racial or sexually harassing visual materials.		
(4) Did not allow intimidation, harassment, or reprisal against Soldiers that made complaints.		

Evaluation Guidance: Refer to chapter 1, paragraph 1-4 b (6).

References

Required:

Related: AR 600-13, AR 600-20, DA Pam 350-20, DODDIR 7050.6, FM 22-100 and Manual-MCM

SUBJECT AREA 2: FIRST AID

081-831-0101

Request Medical Evacuation

Conditions: You have a casualty requiring medical evacuation (MEDEVAC) and you will need a patient pickup site. You will need operational communications equipment, MEDEVAC request format, a standard scale military map, a grid coordinate scale, and unit signal operation instructions (SOI).

Standards: Transmit a MEDEVAC request, providing all necessary information within 25 seconds. Transmit, as a minimum, line numbers 1 through 5 during the initial contact with the evacuation unit. Transmit lines 6 through 9 while the aircraft or vehicle is en route, if not included during the initial contact.

Performance Steps

1. Collect all applicable information needed for the MEDEVAC request.
 - a. Determine the grid coordinates for the pickup site. (See STP 21-1-SMCT, task 071-329-1002.)
 - b. Obtain radio frequency, call sign, and suffix.
 - c. Obtain the number of patients and precedence.
 - d. Determine the type of special equipment required.

Performance Steps

- e. Determine the number and type (litter or ambulatory) of patients.
- f. Determine the security of the pickup site.
- g. Determine how the pickup site will be marked.
- h. Determine patient nationality and status.
- i. Obtain pickup site nuclear, biological, and chemical (NBC)

contamination information, normally obtained from the senior person or medic.

Note: NBC line 9 information is only included when contamination exists.

2. Record the gathered MEDEVAC information using the authorized brevity codes. (See table 081-831-0101-1.)

Note: Unless the MEDEVAC information is transmitted over secure communication systems, it must be encrypted, except as noted in step 3b(1).

- a. Location of the pickup site (line 1).
- b. Radio frequency, call sign, and suffix (line 2).
- c. Numbers of patients by precedence (line 3).
- d. Special equipment required (line 4).
- e. Number of patients by type (line 5).
- f. Security of the pickup site (line 6).
- g. Method of marking the pickup site (line 7).
- h. Patient nationality and status (line 8).
- i. NBC contamination (line 9).

3. Transmit the MEDEVAC request. (See STP 21-1-SMCT, task 113-571-1022.)

- a. Contact the unit that controls the evacuation assets.
 - (1) Make proper contact with the intended receiver.
 - (2) Use effective call sign and frequency assignments from the SOI.
 - (3) Give the following in the clear "I HAVE A MEDEVAC

REQUEST;" wait one to three seconds for a response. If no response, repeat the statement.

- b. Transmit the MEDEVAC information in the proper sequence.

(1) State all line item numbers in clear text. The call sign and suffix (if needed) in line 2 may be transmitted in the clear.

Note: Line numbers 1 through 5 must always be transmitted during the initial contact with the evacuation unit. Lines 6 through 9 may be transmitted while the aircraft or vehicle is en route.

Performance Steps

- (2) Follow the procedure provided in the explanation column of the MEDEVAC request format to transmit other required information.
 - (3) Pronounce letters and numbers according to appropriate radio/telephone procedures.
 - (4) Take no longer than 25 seconds to transmit.
 - (5) End the transmission by stating "Over."
 - (6) Keep the radio on and listen for additional instructions or contact from the evacuation unit.
-

Performance Steps

Table 081-831-0101-1. MEDEVAC request format

LINE	ITEM	EXPLANATION	WHERE/HOW OBTAINED	WHO NORMALLY PROVIDES	REASON
1	Location of Pickup Site.	Encrypt the grid coordinates of the pickup site. When using the DRYAD Numeral Cipher, the same "SET" line will be used to encrypt the grid zone letters and the coordinates. To preclude misunderstanding, a statement is made that grid zone letters are included in the message (unless unit SOP specifies its use at all times).	From Map	Unit Leader(s)	Required so evacuation vehicle knows where to pick up patient. Also, so that the unit coordinating the evacuation mission can plan the route for the evacuation vehicle (if the evacuation vehicle must pick up from more than one location).
2	Radio Frequency, Call Sign, and Suffix	Encrypt the frequency of the radio at the pickup site, not a relay frequency. The call sign (and suffix if used) of the person to be contacted at the pickup site may be transmitted in the clear.	From SOI	RTO	Required so that the evacuation vehicle can contact the requesting unit while enroute (obtain additional information or change in situation or directions).
3	Number of Patients by Precedence	Report only applicable information and encrypt the brevity codes. A - URGENT. B - URGENT-SURG. C - PRIORITY. D - ROUTINE. E - CONVENIENCE. If two or more categories must be reported in the same request, insert the word "BREAK" between each category.	From Evaluation of Patient(s)	Medic or Senior Person Present	Required by the unit controlling the evacuation vehicles to assist in prioritizing missions.
4	Special Equipment Required	Encrypt the applicable brevity codes. A - None. B - Hoist. C - Extraction equipment. D - Ventilator.	From Evaluation of the Patient/ Situation	Medic or Senior Person Present	Required so that the equipment can be placed on board the evacuation vehicle prior to the start of the mission.
5	Number of Patients by Type	Report only applicable information and encrypt the brevity code. If requesting MEDEVAC for both types, insert the word "BREAK" between the litter entry and ambulatory entry. L + # of Pnt - Litter A + # of Pnt - Ambulatory (sitting)	From Evaluation of Patient(s)	Medic or Senior Person Present	Required so that the appropriate number of evacuation vehicles may be dispatched to the pickup site. They should be configured to carry the patients requiring evacuation.
6	Security of the Pickup Site (Wartime)	N - No enemy troops in the area. P - Possibly enemy troops in the area (approach with caution). E - Enemy troops in the area (approach with caution). X - Enemy troops in the area (armed escort required).	From Evaluation of the Situation	Unit Leader	Required to assist the evacuation crew in assessing the situation and determining if assistance is required. More definitive guidance can be furnished to the evacuation vehicle while it is en route (specific location of the enemy to assist an aircraft in planning its approach).

Performance Steps

Table 081-831-0101-1. MEDEVAC request format (continued)

LINE	ITEM	EXPLANATION	WHERE/HOW OBTAINED	WHO NORMALLY PROVIDES	REASON
6	Number and Type of Wound, Injury, or Illness (Peacetime)	Specific information regarding patient wounds by type (gunshot or shrapnel). Report serious bleeding, along with patient blood type, if known.	From Evaluation of Patient	Medic or Senior Person Present	Required to assist evacuation personnel in determining treatment and special equipment needed.
7	Method of Marking Pickup Site	Encrypt the brevity codes. A - Panels. B - Pyrotechnic signal. C - Smoke signal. D - None. E - Other.	Based on the Situation and Availability of Materials	Medic or Senior Person Present	Required to assist the evacuation crew in identifying the specific location of the pickup. Note that the color of the panels or smoke should not be transmitted until the evacuation vehicle contacts the unit (just prior to its arrival). For security, the crew should identify the color and the unit verify it.
8	Patient Nationality and Status	The number of patients in each category need not be transmitted. Encrypt only the applicable brevity codes. A - US military. B - US civilian. C - Non-US military. D - Non-US civilian. E - EPW	From Evaluation of Patient	Medic or Senior Person Present	Required to assist in planning for destination facilities and need for guards. Unit requesting support should ensure that there is an English-speaking representative at the pickup site.
9	NBC Contamination (Wartime)	Include this line only when applicable. Encrypt the applicable brevity codes. N - Nuclear. B - Biological. C - Chemical.	From the Situation	Medic or Senior Person Present	Required to assist in planning for the mission. (Determine which evacuation vehicle will accomplish the mission and when it will be accomplished.)
9	Terrain Description (Peacetime)	Include details of terrain features in and around the proposed landing site. If possible, describe relationship of the site to prominent terrain feature (lake, mountain, tower).	From an Area Survey	Personnel at Site	Required to allow evacuation personnel to assess route/avenue of approach into the area. Of particular importance if hoist operation is required.

Evaluation Preparation: *Setup:* Evaluate this task during a training exercise involving a MEDEVAC aircraft or vehicle, or simulate it by creating a scenario and providing the information as the Soldier requests it. You or an assistant will act as the radio contact at the evacuation unit during "transmission" of the request. Give a copy of the MEDEVAC request format to the Soldier.

Brief Soldier: Tell the Soldier to prepare and transmit a MEDEVAC request. State that the communication net is secure.

Performance Measures	GO	NO GO
1. Collected all information needed for the MEDEVAC request line items 1 through 9.	_____	_____
2. Recorded the information using the authorized brevity codes.	_____	_____
3. Transmitted the MEDEVAC request within 25 seconds.	_____	_____

Evaluation Guidance: Refer to chapter 1, paragraph 1-4 b (6).

References

Required:

Related: FM 8-10-6

081-831-1056

Coordinate Medical Activity Support

Conditions: You are a noncommissioned officer (NCO) deployed in a forward unit. You are directed to coordinate support from available health care services.

Standards: Integrate combat health support functional areas into the military decisionmaking process (MDMP). Coordinate the force health protection plan with the battalion medical platoon. Ensure that a field sanitation team program is established. Coordinate the preventive medicine (PVTMED) program through the medical platoon to reduce incidents of disease and nonbattle injury (DNBI). Verify that all mental health/combat stress control matters are addressed. Validate that there is a combat lifesaver program. Check the availability of emergency dental and eye services.

Performance Steps

1. Integrate combat health support functional areas into the MDMP.
 - a. Confirm patient evacuation (ground and air) routes from companies/troops to the aid station.
 - b. Confirm aid station locations.
 - c. Identify possible casualty lines of drift.
 - d. Verify casualty collection point locations.
 - e. Integrate the medical platoon into the battle plan, if applicable.
 - f. Plan for medical support to civilians, when possible.

Note: Coordinate with the forward support medical company (FSMC) for this support. In the contemporary operational environment (COE), providing medical attention to a child may encourage the family members to provide valuable information on insurgent operations.

2. Coordinate the force health protection plan with the battalion medical platoon (MEDPLT).
 - a. Medical treatment at Level II.
 - b. Evacuation procedures.
3. Coordinate preventive medicine program through the MEDPLT to include the following:

Note: Medical personnel oversee all PVTMED activities in the unit. The PVTMED personnel will assist in training company/troop field sanitation teams in aspects of environmental sanitation, limited control of animal reservoirs, and disease vectors.

Performance Steps

- a. Food, water, and arthropod-borne diseases.
- b. Environmental injuries, such as heat and cold injuries.
- c. Consultation on the following areas:
 - (1) Environmental sanitation.
 - (2) Epidemiology.
 - (3) Sanitation engineering.
 - (4) Pest management.
4. Verify that commanders support field preventive medicine measures.
 - a. Establish field sanitation teams to preserve the unit's health and reduce incidents of DNBI.
 - b. Enforce food and water safety standards.
 - c. Plan and enforce personnel hygiene measures.
 - d. Develop and enforce a unit sleep plan to provide Soldiers with a minimum of 4 hours of uninterrupted sleep in a 24-hour period.
5. Ensure that all mental health/combat stress control matters are addressed.
6. Validate the combat lifesaver program.
 - a. Each company/troop must have a combat lifesaver program.
 - b. Each squad will have a qualified combat lifesaver.
 - c. Ask the FSMC for training assistance, if needed.
7. Coordinate emergency dental service.
8. Coordinate emergency eye wear/care with optometry section at the MEDPLT.

Evaluation Preparation: *Setup:* Prepare a scenario that requires the Soldier to respond to questions about the performance measures. This may be presented orally or in writing.

Brief Soldier: Tell the Soldier that he/she will be required to correctly respond to questions and that there is not a sequence for the performance measures.

Performance Measures	GO	NO GO
1. Integrated combat health support functional areas into the MDMP process.	_____	_____
2. Coordinated force health protection plan with the battalion MEDPLT.	_____	_____
3. Coordinated preventive medicine program through the MEDPLT.	_____	_____

Performance Measures	GO	NO GO
4. Verified that commanders support field preventive medicine measures.	_____	_____
5. Ensured that all mental health/combat stress control matters were addressed.	_____	_____
6. Validated the combat lifesaver program.	_____	_____
7. Coordinated emergency dental service.	_____	_____
8. Coordinated emergency eye wear with optometry section at MEDPLT.	_____	_____

Evaluation Guidance: Refer to chapter 1, paragraph 1-4 b (6).

References

Required:

Related: FM 21-10, FM 4-02.4, FM 8-55

081-831-1057

Supervise Compliance with Preventive Medicine Measures

Conditions: You are a unit leader. Your unit is deployed to the field. You have the equipment authorized by your table of organization and equipment (TOE), field sanitation equipment and supplies, and a trained field sanitation team (FST).

Note: Health Care Specialists (68W), organic or attached to deployed units, normally fulfill the requirement as the FST with additional training.

Standards: Ensure company-sized units establish and employ manned, trained, and equipped unit FSTs. Ensure that all individual preventive medicine measures (PMMs) are implemented to reduce the threat of disease and nonbattle injuries (DNBIs) which will assist in mission accomplishment. Ensure that personnel are aware of the major components of the medical threat to field forces and are following the individual PMMs necessary to prevent DNBI. Ensure that selected unit personnel receive FST training on the team's major areas of responsibility.

Performance Steps

1. Ensure that personnel are aware of the major components of the medical threat to field forces.
 - a. Heat. Types of heat injuries.
 - (1) Heat cramps.
 - (2) Heat exhaustion.
 - (3) Heatstroke (medical emergency).
 - b. Cold. Types of cold injuries.
 - (1) Chilblain.
 - (2) Immersion foot.
 - (3) Trench foot.

Performance Steps

- (4) Frostbite.
 - (5) General hypothermia (medical emergency).
 - c. Arthropods (insects).
 - (1) Common diseases transmitted directly by arthropods.
 - (a) Mosquitoes—malaria, yellow fever, dengue fever, and encephalitis.
 - (b) Some ticks, as well as mosquitoes—encephalitis.
 - (c) Sand flies—sand fly fever and leishmaniasis.
 - (d) Body lice—epidemic typhus.
 - (e) Hard ticks—Lyme disease.
 - (2) Common diseases transmitted by insects associated with rodents.
 - (a) Fleas—plague and endemic typhus.
 - (b) Mites—scrub typhus.
 - d. Foodborne and waterborne diseases.
 - (1) Common waterborne diseases.
 - (a) Typhoid fever.
 - (b) Cholera.
 - (c) Traveler's diarrhea.
 - (d) Hepatitis A.
 - (2) Common foodborne diseases.
 - (a) Traveler's diarrhea.
 - (b) Cholera.
 - (c) Salmonellosis.
 - (d) Hepatitis.
 - e. Toxic industrial materials (TIMs).
 - (1) Examples of TIMs.
 - (a) Carbon monoxide.
 - (b) Hydrogen chloride.
 - (c) Bore/gun gases.
 - (d) Solvents, greases, insecticides, and oils.
 - (2) Harmful effects of TIMs.
 - (a) Skin irritation.
 - (b) Asphyxiation (choking, suffocation).
-

Performance Steps

- (c) Central nervous system depression.
 - (d) Death.
 - f. Noise hazards.
 - (1) Examples of noise hazards.
 - (a) Weapons.
 - (b) Aircraft.
 - (c) Most military vehicles and generators.
 - (2) Harmful effects of exposure to noise hazards.
 - (a) Temporary loss of hearing—lasts minutes to hours.
 - (b) Permanent loss of hearing.
 - g. Other medical threats to field forces.
 - (1) Skin disease—common in extremely dry or humid climates.
 - (2) Altitude sickness—locations above 8,000 feet.
 - (3) Poisonous plants and animals.
 - (4) Tobacco use.
 - (5) Poor medical threat intelligence.
 - 2. Ensure that personnel are following the individual PMMs necessary to prevent DNBI. (See STP 21-1-SMCT, task 081-831-1053.)
 - a. Protect against cold injuries.
 - b. Protect against heat injuries.
 - c. Protect against arthropods and arthropod-borne diseases.
 - d. Protect against poisonous plants and animals.
 - e. Protect against diseases from contaminated food and water.
 - f. Protect against diseases from human waste.
 - g. Protect against diseases from exposure to soil and common objects.
 - h. Maintain personal hygiene.
 - i. Maintain the proper level of nutrition.
 - j. Take measures to resist stress.
 - k. Protect against sexually transmitted diseases.
 - l. Protect against acquired immune deficiency syndrome (AIDS).
 - m. Avoid adverse effects of tobacco products.
-

Performance Steps

3. Ensure that FST personnel assist the commander in reducing DNBI during all deployment phases.

Note: Training of FST members enables unit commanders to provide limited control of insects, proper disinfection of water, and safe food supplies. Training of personnel as FST members will be provided by supporting preventive medicine resources.

a. Requirements for FST members, when no organic medical personnel are available.

- (1) Two Soldiers are selected to receive FST training.
- (2) One Soldier must be a noncommissioned officer (NCO).
- (3) Selected team members should have at least six months service remaining with their unit.
- (4) These Soldiers should receive training from preventive medicine (PM) personnel according to AR 40-5.

b. FST tasks and/or responsibilities. The unit FST performs the following tasks in the unit area:

- (1) Inspect water containers and trailers.
- (2) Disinfect and monitor unit water supplies for chlorine residual.
- (3) Monitor unit field food service operations.
- (4) Monitor unit waste disposal operations.
- (5) Control arthropods, rodents, and other animals in the unit area.
- (6) Train unit personnel in using individual PMM.
- (7) Monitor the status of PMM in the unit.
- (8) Assist in selecting the unit bivouac site.
- (9) Supervise the construction of field sanitation devices.
- (10) Monitor unit personnel when applying individual PPM.

Evaluation Preparation: *Setup:* Evaluate each Soldier individually during a field training exercise (FTX) or normal training session. Use the location, weather conditions, and duration of the FTX as the scenario to base your evaluation questions around. If the evaluation is conducted during normal training sessions, create a scenario as the basis for your evaluation questions.

Brief Soldier: Tell the Soldier that he/she will be evaluated on his/her ability to answer preventive medicine measure questions pertaining to the training scenario provided.

Performance Measures	GO	NO GO
1. Ensured that personnel were aware of the major components of the medical threat to field forces.	_____	_____
2. Ensured that personnel were following individual PMMs to prevent DNBI.	_____	_____
3. Ensured that FST personnel assisted the commander in reducing DNBI during all deployment phases.	_____	_____

Evaluation Guidance: Refer to chapter 1, paragraph 1-4 b (6).

References

Required:

Related: AR 40-5, CHPPM Tobacco, FM 21-10, FM 4-02.17, FM 4-25.12, and Hooah4Health

SUBJECT AREA 3: CHEMICAL, BIOLOGICAL, RADIOLOGICAL, AND NUCLEAR

031-503-1001

Chemical-Agent Identify Chemical Agents Using an M256A1 Detector Kit

Conditions: You are in a chemically contaminated environment. You are given an M256A1 chemical-agent detector kit, your assigned protective mask, mission-oriented protective posture (MOPP) gear, a watch, TM 3-6665-307-10, TM 43-0003-30, and FM 3-5. This task will be performed in MOPP4.

Standards: Identify chemical agents using an M256A1 chemical-agent detector kit by performing operator checks on the kit, putting the kit into operation, using the correct sequence, and identifying the agent(s) within the limitations of the kit without becoming a casualty.

Performance Steps

1. Perform before-operation, preventive maintenance checks and services (PMCS) on the M256A1 chemical-agent detector kit.
 - a. Ensure that the expiration date on the kit has not passed.
 - b. Ensure that M8 detector paper is present.
 - c. Ensure that there are at least four sampler-detectors in the kit.
2. Prepare the kit for use.
 - a. Read all instruction cards in the kit.
 - b. Remove one sampler-detector from the kit, and read the instructions printed on the bag.

Note: Open the sampler-detector bag, and conduct tests while facing into the wind to keep the vapors from your equipment and clothing from contaminating the test results.

Note: Do not expose the sampler-detector to heavy rain or other forms of water because the test results could be tainted.

Note: Do not touch the sampler-detector test spots because dirt or oil from your gloves could cause the test results to be tainted.

- c. Remove the sampler-detector from the bag (save the bag, so you can use the instructions printed on the outside). Dispose of the sampler-detector if there are broken or missing ampoules, missing spots, or crushed reagent channels, or if the blood-agent test spot is pink.

Performance Steps

3. Test for toxic-agent vapors.

a. Swing out the heater, and remove and save the two heater pads (used for breaking the glass ampoules and holding the heater assembly down). Swing the heater back in. Keep the protective strips over the spots.

b. Remove the pull tab marked "1" to expose the lewisite-detecting tablet. Bend the tab marked "2" over the lewisite-detecting tablet, and rub the upper half of the tab until a mark is visible.

WARNING

Before breaking the glass ampoules (except the heater ampoules), place one heater pad on each side of the sampler-detector covering the ampoule to be broken. These pads will prevent pieces of glass from cutting your gloves and hands.

c. Hold the sampler-detector with the test spots and the arrow pointing up, and crush the four center ampoules marked "3."

Note: Nerve-agent test spots may be difficult to wet with the solution as the kit gets older. Work solutions into the spot carefully while pressing the protective strip over the nerve-agent test spot.

d. Turn the sampler-detector so that the arrow points down. Using the heater pads, squeeze the ampoules to force the liquid through the formed channels onto the test spots.

e. Hold the sampler-detector with the arrow pointing down, and hold your thumb on the protective strip over the middle test spot.

f. Swing the heater away from the blister test spot.

WARNING

Avoid hot vapors that may burn you when crushing the heater ampoules. Hold the sampler-detector to one side while venting it to avoid hot vapors. Do not use the heater pads to crush the green heater ampoules marked "4."

g. Activate the first heater ampoule marked "4" by crushing one green ampoule.

CAUTION

Apply only a slight amount of pressure to hold down the heater assembly to avoid damaging the blister spot.

WARNING

Do not touch any of the sampling spots with your glove while holding the heater assembly.

Note: Place one of the heater assembly pads on top of the heater assembly while holding it down on the test spot in order to provide an added level of protection.

Performance Steps

h. Swing the heater immediately back over the test spot, and place a heater assembly pad on top of the heater. Apply gentle pressure to the top of the heater with your thumb while using your index and middle fingers to support the back of the heater assembly.

i. Wait 2 minutes, and then swing the heater and protective strip away from the test spots.

WARNING

Do not hold the sampler-detector in direct sunlight while exposing the test spots because the test results could be tainted.

j. Expose the test spots to air for 10 minutes, but shield them from direct sunlight. (The sampler-detector can be laid down or held by the hinged protective strip.)

k. Wait 10 minutes, and then crush the second green ampoule marked "4." Immediately swing the heater back over the blister test spot. Place the heater assembly pad on top of the heater, and apply gentle pressure to the top of the heater with your thumb while using your index and middle fingers to support the back of the heater assembly.

l. Wait 1 minute, and then swing the heater away from the test spot.

m. Hold the sampler-detector with the arrow pointing down and the test spots exposed. Use the heater pads to crush the remaining ampoules marked "5." Wet the test spots by squeezing the ampoules and forcing the liquid onto the test spots.

n. Bend the tab marked "2" over the lewisite-detecting tablet, and rub the bottom half of the tab until a mark is visible.

o. Compare the sampler-detector test colors to determine hazard conditions. Turn the sampler-detector upside down, and compare the colors of the test spots (including the lewisite tab) with those shown on the sampler-detector.

Note: Blister-agent test spots (H and CX) develop color immediately after the ampoules are broken.

Note: Blood-agent and lewisite tests may be compared after 10 minutes of exposure time. A nerve-agent test requires a waiting period of 3 minutes after the ampoules have been broken.

(1) Compare the nerve-agent test after a 3-minute wait. If no color develops, a positive nerve test is indicated. Disregard any small, blue or bluish green areas under the plastic rim of the nerve agent spot.

(2) Compare the lewisite test after about 10 minutes of exposure time. Look for a change in the color of the rub marks on the lewisite-detecting tab marked "2." Look very closely. At low concentrations, the color change may be very slight.

Performance Steps

(3) Compare the blood-agent (round spot) test after about 10 minutes of exposure time.

(a) Yellow or orange colors sometimes occur when no agent is present.

(b) Pink or blue colors must be present to indicate blood agents. Any combination of colors, including a rainbow effect that includes pink or blue, should be considered a positive blood-agent test.

Note: If a blood agent is indicated, repeat the testing for toxic-agent vapors with a fresh sampler-detector for blood agents only. If a blood agent is not indicated the second time, then a blood agent is not present. If a blood agent is indicated the second time, then a blood agent is present.

4. Report the results to your supervisor.
5. Dispose of the expended or unserviceable materials.

WARNING

Each sampler-detector contains 2.6 milligrams (mg) of mercuric cyanide and should be considered hazardous waste (HW). Used or expired kits must be demilitarized and turned in to the Defense Reutilization And Marketing Office (DRMO) according to TM 43-0003-30.

a. Dispose of the expended or unserviceable materials according to federal, state, and local laws; military regulations and publications; host-nation laws (if more restrictive than United States [U.S.] laws); and local standing operating procedures (SOPs). At a minimum, place the used decontaminating materials in a sealed plastic bag (such as a zipper-type bag) and label the bag with its contents.

b. Dispose of contaminated HW materials according to FM 3-5.

6. Perform after-operation PMCS on the M256A1 chemical-agent detector kit.

a. Ensure that the expiration date on the kit has not passed.

b. Ensure that the M8 detector paper is present.

c. Ensure that there are at least four sampler-detectors remaining in the kit.

Evaluation Preparation: *Setup:* Provide the Soldier with the items listed in the task conditions statement. Evaluate this task during a field exercise or a tactical training session. Use M256A1 training aid kits for training and evaluation purposes.

Brief Soldier: Tell the Soldier to perform operator checks of the chemical-agent detector kit, put the kit into operation using the correct sequence while in MOPP4, and identify the agent(s) within the limitations of the kit.

Performance Measures	GO	NO GO
1. Performed before-operation PMCS on the M256A1 chemical-agent detector kit.	_____	_____

Performance Measures	GO	NO GO
2. Prepared the kit for use.	_____	_____
3. Tested for toxic-agent vapors.	_____	_____
4. Reported the results to your supervisor.	_____	_____
5. Disposed of expended or unserviceable materials.	_____	_____
6. Performed after-operation PMCS on the M256A1 chemical-agent detector kit.	_____	_____

Evaluation Guidance: Refer to chapter 1, paragraph 1-4 b (6).

References

Required: FM 3-5, TM 3-6665-307-10, and TM 43-0003-30

Related:

031-503-1005

Submit Nuclear, Biological, and Chemical (NBC) 1 Reports

Conditions: You are in an area where a chemical, biological, radiological, and nuclear (CBRN) attack has just occurred. You are given a watch, map, compass, protractor, pencil, paper, FM 3-3, FM 3-3-1, FM 3-11.4, GTA 03-06-008, DA Form 1971-7-R (*NBC 1 Observer's Initial /Follow Up Report*), and NBC report format guide. You have reacted to the CBRN attack and submitted an initial spot report (SPOTREP). You are required to submit the NBC 1 report to higher headquarters. This task may be performed in mission-oriented protective posture (MOPP) 4.

Note: The NBC report format guide can take many forms (such as the unit tactical standing operating procedure (TSOP) with an NBC 1 report format, GTA 03-06-008, or DA Form 1971-7-R).

Standards: Submit the NBC 1 report with the required line information for a nuclear or chemical-biological (CB) attack, and send the report to higher headquarters. Standards are not degraded due to performance in MOPPA.

Performance Steps

1. Gather available data to submit the NBC 1 report.
2. Fill out the required information as outlined in GTA 03-06-008 or FM 3-3 (chemical-biological [CB]) or FM 3-3-1 (nuclear).
 - a. Line B: Location of observer (use grid coordinates or place name).
 - b. Line D: Date-time group (DTG) of the attack (specify local or Zulu time).
 - c. Line H: Type and height of burst (if nuclear) or type of agent and persistency (if CB).
 - d. Line C (direction of attack in miles or degrees from the observer), or Line F (location of attack with grid coordinates or place name).

Performance Steps

3. Select the proper communication precedence.

Note: Flash reports should not be delayed because of the lack of information.

- a. Use flash precedence if this is the first attack of its type (such as the first nuclear, first biological, or first chemical).

Note: A flash precedence is used to report the first use of CBRN weapons against United States (U.S.) troops.

- b. Use immediate precedence for all other attacks.

Note: Line L (nuclear) is measured 5 minutes after the attack, and Line M (nuclear) is measured 10 minutes after the attack. Submit the NBC 1 report after information for Line L or M has been gathered. The M256-series chemical-agent detector kit takes 16 minutes to produce reliable results. Submit the NBC 1 chemical report after this test has been done.

4. Submit the NBC 1 report.

- a. All units submit the NBC 1 report to their higher headquarters.

- b. Units selected by the division level CBRN center as designated observers for nuclear bursts will also submit the NBC 1 report directly to the division level CBRN center.

Evaluation Preparation: *Setup:* Provide the Soldier with the items listed in the task conditions statement. Develop a situation containing observer data (this information may be written). A different situation should be developed for each type of report (nuclear or CB).

Brief Soldier: Tell the Soldier that the test will consist of preparing and submitting NBC 1 reports.

Performance Measures	GO	NO GO
1. Gathered available data to submit the NBC 1 report.	___	___
2. Filled out the required information.	___	___
3. Selected the proper communication precedence.	___	___
4. Submitted the NBC 1 report to higher headquarters.	___	___

Evaluation Guidance: Refer to chapter 1, paragraph 1-4 b (6).

031-503-1010

Supervise the Employment of Chemical, Biological, Radiological, and Nuclear (CBRN) Markers

Conditions: You are in a tactical environment where CBRN weapons have been used. The contamination has been located and identified. You and your unit are at the appropriate mission-oriented protective posture (MOPP) level. You have CBRN markers, a grease pencil or an CBRN contamination marking set, FM 3-3, TM 3-9905-001-10, and the requirement to supervise employing CBRN markers.

Standards: Supervise employing CBRN markers. Ensure that the appropriate marker is selected, the required information is recorded on the marker, and the marker is properly emplaced. There is no change in standards if this task is performed in MOPP4.

Performance Steps

1. Supervise the employment of CBRN markers for nuclear contamination.
 - a. Ensure that all exposed skin is covered (shirt sleeves down, shirt buttoned up, and nose and mouth covered with a rag or t-shirt) prior to actually marking the contaminated area.
 - b. Ensure that markers are placed at the location where a dose rate of 1 centigray per hour (cGyph) or more was measured.
 - c. Ensure that all information is printed on the front side of the marker so that the word "atom" is facing toward you in an upright position. Information should include—
 - (1) The dose rate in cGyph.
 - (2) The date-time group (DTG) (specify local or Zulu) of the detonation. If the DTG is not known, print "unknown."
 - (3) The DTG (specify local or Zulu) of the reading.
 - d. Ensure that markers are positioned so that they can be easily seen and that the recorded information faces away from the area of contamination.
 - (1) Ensure that markers are attached to objects (such as trees or poles) that will be visible from all probable routes through the contaminated area.
 - (2) Ensure that each marker is placed so that the next one can be seen from the last one emplaced.
 2. Supervise employing CBRN markers for biological contamination.
 - a. Ensure that individuals are at MOPP4 prior to actually marking the contaminated area.
 - b. Ensure that all information is printed on the front side of the marker so that the word "bio" is facing toward you in an upright position. Information should include—
 - (1) The type of agent detected. If unknown, print "unknown."
 - (2) The DTG (specify local or Zulu) of detection.
 - (3) The DTG (specify local or Zulu) of the detonation (place beneath the DTG of detection).
 - c. Ensure that markers are positioned so that they can be easily seen and that the recorded information faces away from the area of contamination.
 - (1) Ensure that markers are attached to objects (such as trees or poles) that will be visible from all probable routes through the contaminated area.
 - (2) Ensure that each marker is placed so that the next one can be seen from the last one emplaced.
-

Performance Steps

3. Supervise employing CBRN markers for chemical contamination.
 - a. Ensure that individuals are at MOPP4 prior to actually marking the contaminated area.
 - b. Ensure that all information is printed on the front side of the marker so that the word "gas" is facing toward you in an upright position. Information should include—
 - (1) The type of agent detected. If unknown, print "unknown."
 - (2) The DTG (specify local or Zulu) of detection.
 - (3) The DTG (specify local or Zulu) of the detonation (place beneath the DTG of detection).
 - c. Ensure that markers are positioned so that they can be easily seen and that the recorded information faces away from the area of contamination.
 - (1) Ensure that markers are attached to objects (such as trees or poles) that will be visible from all probable routes through the contaminated area.
 - (2) Ensure that each marker is placed so that the next one can be seen from the last one emplaced.

Evaluation Preparation: *Setup:* Use simulated agents to produce a contaminated environment for chemical and biological (CB) agents. When requiring a marker for nuclear contamination, tell the Soldier the amount of radiation present.

Brief Soldier: Tell the Soldier that the test will consist of ensuring that CBRN markers are properly emplaced and all information is printed on the markers.

Performance Measures	GO	NO GO
1. Supervised employing CBRN markers for nuclear contamination.	___	___
2. Supervised employing CBRN markers for biological contamination.	___	___
3. Supervised employing CBRN markers for chemical contamination.	___	___

Evaluation Guidance: Refer to chapter 1, paragraph 1-4 b (6).

References

Required: FM 3-3 and TM 3-9905-001-10

Related:

031-503-1022

Operate the AN/VDR-2 Radiac Set

Conditions: You are given an AN/VDR-2 radiac set, three BA-3090 batteries, a flat-tip screwdriver, TM 11-6665-251-10, and a requirement to monitor equipment or personnel for radiological contamination.

Standards: Prepare the AN/VDR-2 radiac set for operation, perform an area survey, monitor personnel and equipment, and determine if any beta/gamma radiation is present.

Performance Steps

1. Prepare the AN/VDR-2 radiac set for operation.
 - a. Install the batteries.
 - (1) Ensure that the power (PWR) switch is OFF.
 - (2) Use a flat-tip screwdriver to loosen—but do not remove—the captive screws.

CAUTION

When the batteries are removed from the radiac set, memory is retained for only 5 minutes.

- (3) Remove the battery well cover and the batteries.
 - (4) Insert the new batteries.
 - (5) Replace the well cover, and tighten the captive screws.
 - b. Perform preoperational test procedures.
 - (1) Set the PWR switch to ON.
 - (2) Set the alarm (ALM) switch to audio (AUD).
 - (3) Press and hold the clear/TEST (CLR/TEST) button until the alarm sounds for 2 seconds, and then release the button.
 - (4) Ensure that the display is exactly as shown in TM 11-6665-251-10.
 - (5) Check the following settings:

Note: Check each display in sequence for the correctness of all characters, including decimals. At the end of the 10-second segment test, the digit/unit test begins with three zeros (same as the sequence shown in TM 11-6665-251-10).

- (a) Set the ALM switch to OFF (the alarm sound stops).
 - (b) Set the ALM switch to visual (VIS) (the RATE and DOSE lights come on).
 - (c) Set the ALM switch back to AUD (the lights go out, and the alarm sounds).
 - (6) Set the ALM switch to OFF.
 - (7) Go to step 9 when you see a flashing 9.

Note: If there is a fault discovered during this test, a flashing 0 appears and the alarm pulsates.

Note: During the electrical tests that start immediately after the 999 Gy display, you may see one-digit codes on the display. Ignore these codes.

Note: If all the tests are OK, a flashing 9 appears with a pulsating alarm after 10 to 60 seconds.

- (8) Turn the unit OFF if you see a flashing 0.
 - (9) Press and release the CLR/TEST button. The radiac set is ready for operation.

Performance Steps

Note: The preoperational tests are complete. The display again shows the three zeros and indicates the dose rate, which is variable. The radiac set is ready for normal operation.

Note: Turn the radiac set off and send it to organization maintenance for repair if any of the events required during the preoperational test do not occur.

2. Operate the AN/VDR-2 radiac set.

a. Survey an area for radiation contamination.

- (1) Stand in the open.
- (2) Hold the radiac set waist high. (The probe can be carried either in the pouch or held in your hand, as desired.)
- (3) Turn 360 degrees slowly.
- (4) Record the highest reading.

b. Monitor the equipment or supplies for radiation contamination.

- (1) Open the shield of the probe.
- (2) Face away from the suspected contamination.
- (3) Take a background reading.
- (4) Record the highest reading.
- (5) Leave the shield open, and hold the probe about 1 inch from the item being monitored.
- (6) Hold the probe perpendicular to the surface, and move it along the surface with a slow, steady motion.
- (7) Record the reading using the correct unit of measurement.

Note: If the reading is twice the background or higher, contamination is present.

c. Monitor personnel for radiation contamination.

- (1) Take a background reading, and record the reading.
- (2) Have the person to be monitored stand straight with his/her feet apart, arms extended sideward, palms facing up, and fingers straight.
- (3) Hold the probe about one inch away from the person, and pass the probe over both his/her hands (with his/her palms up) and his/her arms, and then repeat the pass with his/her palms turned down.
- (4) Pass the probe over the entire front of his/her body, starting at the top of his/her head. Check his/her hair, forehead, nose, lips, neckline, torso, knees, and ankles.
- (5) Repeat the process from head to ankles over the back of the individual, and include the soles of his/her feet.
- (6) Record the reading using the correct unit or measurement, and record the portion of his/her body that is contaminated.

Note: If a reading on any portion of the individual's body is twice the background recording or higher, contamination is present.

- (7) Have the individual await further instructions.
- (8) Inform your supervisor of the contamination.

Performance Steps

d. Determine if the contamination is beta only or beta and gamma radiation.

(1) Take a reading with the beta shield open (beta and gamma radiation combined).

(2) Take a reading with the beta shield closed (gamma only).

(3) Subtract the two readings to obtain the beta-only reading.

3. Turn the unit off.

4. Set the PWR switch to OFF.

Note: The power to the set is turned off, but the stored information is retained.

Evaluation Preparation: *Setup:* Ensure that all items listed in the task conditions statement are available to the Soldier. Create a scenario in which radiation monitoring will be required.

Brief Soldier: Direct the Soldier to operate the AN/VDR-2 radiac set.

Performance Measures	GO	NO GO
1. Prepared the AN/VDR-2 radiac set for operation.	___	___
2. Operated the AN/VDR-2 radiac set.	___	___
3. Turned the unit off.	___	___
4. Set the PWR switch to OFF.	___	___

Evaluation Guidance: Refer to chapter 1, paragraph 1-4 b (6).

References

Required: TM 11-6665-251-10

Related: STP 21-24-SMCT

031-503-1023

Protect Yourself from Chemical, Biological, Radiological, and Nuclear (CBRN) Injury/Contamination when Changing Mission-Oriented Protective Posture (MOPP) Gear

Conditions: You are in MOPP4 with load-bearing equipment (LBE). Your MOPP gear is contaminated. Your buddy is in MOPP4 with LBE, and he/she is available to assist you with MOPP gear exchange. You are given FM 3-5, an uncontaminated set of chemical MOPP gear for yourself and your buddy, and an individual decontaminating kit. For chemical and biological (CB) decontamination, you have one personal decontamination kit per person; one 50-pound drum of super tropical bleach (STB) dry mix; and a piece of plastic, a poncho, or similar material. For radiological decontamination, you have 5 gallons of water (if water is not available for radiological decontamination, brush, wipe, or shake off contamination), three 3-gallon pails, one can of government issue (GI) soap or liquid detergent, two sponges, and paper towels.

WARNING

The Joint-service, lightweight, integrated suit technology (jylist) is designed to protect Soldiers from traditional CBRN threats—not the full spectrum of industrial chemical hazards.

Standards: Protect yourself from CBRN injury/contamination while changing MOPP gear, ensuring that you decontaminate your individual gear and equipment without spreading contamination onto your skin or undergarments. Set your uncontaminated gear aside on an uncontaminated surface; and change your overgarments, overboots, and gloves without spreading contamination to the uncontaminated set of MOPP gear. Change MOPP gear without becoming a casualty.

Performance Steps

Note: Both Soldiers perform steps 1 and 2 at the same time.

Note: If the environment is CB contaminated, omit steps 2 and 4. If the environment is radiologically contaminated, omit steps 1 and 3. If the environment is radiologically and CB contaminated, perform all steps.

1. Decontaminate your individual gear for CB contamination without assistance.

Note: If at any time during the technique you suspect you have spread contamination onto your skin or undergarments, decontaminate immediately with the individual decontaminating kit available and then proceed with the MOPP gear exchange.

- a. Remove and discard your chemical protective helmet cover.
- b. Cover the gear with STB dry mix.
- c. Brush or rub STB dry mix into the material, and shake off any excess STB.
- d. Set your gear aside on an uncontaminated surface (plastic, poncho, or similar material).

2. Decontaminate your individual gear for radiological contamination without assistance.

- a. Brush, wipe, or shake off dust or radiological contamination from your individual gear.
- b. Wash the equipment with warm, soapy water.
- c. Set the gear aside to dry on an uncontaminated surface (plastic, poncho, or similar material).

3. Decontaminate the hood and mask for CB contamination.

- a. Buddy 1—
 - (1) Loosens Buddy 2's draw cord.
 - (2) Removes Buddy 2's underarm straps from under his/her arms.
 - (3) Moves Buddy 2's straps over his/her shoulders.

Performance Steps

(4) Reattaches Buddy 2's straps to the hook-and-pile patches on the bottom of his/her hood.

b. Buddy 1 decontaminates Buddy 2's hood and exposed parts of his/her mask using the M291 decontamination kit.

(1) Buddy 1 wipes Buddy 2's mask eye lens outserts first.

(2) Buddy 1 wipes Buddy 2's entire mask, from the top of the hood down.

c. Buddy 1 repeats steps 3b (1) and (2) on his/her own hood and mask using the M291 decontamination kit.

d. Buddy 1 decontaminates his/her own gloves with the personal decontaminating kit after Buddy 2's mask is decontaminated.

4. Decontaminate the hood and mask for radiological contamination.

a. Buddy 1 dips a sponge in hot, soapy water and wipes Buddy 2's mask and hood (and the canister and hose of the M42-, M43-, or M40-series protective masks).

b. Buddy 1 rinses Buddy 2's hood and mask with a sponge dipped in clean water.

c. Buddy 1 dries Buddy 2's hood and mask with paper towels or a rag.

d. Buddy 1 wipes down his/her own gloves.

Note: Cool, soapy water is not as effective for removing contamination, but it can be used if you scrub longer. If no water is available, the personal decontaminating kit may be used for CB decontamination.

5. Roll your hood.

Note: Leave the zipper closed.

a. Buddy 1 grasps the straps and lifts Buddy 2's hood straight up off his/her shoulders.

b. Buddy 1 pulls Buddy 2's hood over his/her head until most of the back of his/her head is exposed, but the hood should not be completely over Buddy 2's face.

c. Buddy 2 places his/her hand over the voice transmitter, if necessary, to prevent the mask seal from being broken.

d. Buddy 1 rolls Buddy 2's hood tightly, starting at the chin and working around the mask, without pulling it completely off the back of his/her head.

6. Remove the jacket.

a. Buddy 1—

(1) Unties Buddy 2's cord.

Performance Steps

- (2) Unfastens Buddy 2's snaps on the front of his/her jacket.
- (3) Unzips Buddy 2's jacket.
- (4) Unsnaps Buddy 2's snaps in the back of his/her jacket from his/her overgarment trousers.

b. Buddy 2 makes a fist as each sleeve is pulled off to prevent his/her gloves from coming off.

c. Buddy 1 pulls Buddy 2's jacket off, one arm at a time, turning the jacket inside out.

d. Buddy 1 places Buddy 2's jacket on the ground nearby, with the black side up.

Note: Buddy 2 will use the jacket later as an uncontaminated surface to stand on while redressing.

7. Remove the trousers.

a. Buddy 1 opens Buddy 2's trouser cuffs, waist snap, zipper, and, if necessary, waist tabs.

b. Buddy 1 grasps Buddy 2's trouser leg by the cuff.

c. Buddy 2 pulls his/her legs from the trousers, one leg at a time.

8. Remove the overboots.

a. Buddy 2 stands next to his/her jacket.

b. Buddy 1 unties or cuts Buddy 2's overboot strings.

c. Buddy 1 pulls Buddy 2's overboots off, one at a time.

d. Buddy 2 steps onto his/her jacket as his/her overboots are removed.

9. Remove the rubber gloves. Buddy 1 helps Buddy 2 remove his/her rubber gloves so that he/she does not touch the outside of the rubber gloves with his/her bare hands.

10. Put on an uncontaminated overgarment.

a. Buddy 1 opens the package containing a new overgarment without touching it.

b. Buddy 2 removes the overgarment, one piece at a time, without touching the outside of the package.

(1) Buddy 2 puts on the new trousers, leaving the cuffs open.

(2) Buddy 2 puts on the jacket.

11. Put on the overboots.

a. Buddy 1 opens the package containing the new overboots without touching them.

Performance Steps

- b. Buddy 2 removes the overboots without touching the outside of the package.
 - c. Buddy 2 puts on the overboots.
12. Put on the gloves.
- a. Buddy 1 opens the package containing the new chemical protective gloves without touching them.
 - b. Buddy 2 removes the chemical protective gloves without touching the outside of the package.
 - c. Buddy 2 puts on the gloves.
13. Secure the hood.
- a. Buddy 1 decontaminates his/her chemical protective gloves with the personal decontaminating kit.
 - b. Buddy 1 repositions Buddy 2's hood as follows:
 - (1) Buddy 1 unrolls Buddy 2's hood.
 - (2) Buddy 1 reattaches Buddy 2's hood straps.
 - c. Buddy 2 checks all the zippers and ties on his/her hood and overgarment to ensure that they are closed.
14. Reverse Buddy 1 and Buddy 2 roles and repeat steps 3 through 13.
15. Secure the gear.
- a. Buddy 1 and Buddy 2 place the new chemical protective cover on their helmets.
 - b. Buddy 1 and Buddy 2 put their individual gear back on.
 - c. Buddy 1 checks the fit of Buddy 2's gear.
 - d. Buddy 2 checks the fit of Buddy 1's gear.
16. Move to the assembly area.

Evaluation Preparation: *Setup:* Provide the items listed in the task conditions statement. Evaluate this task during a field exercise or a normal training session. Soldiers must be in MOPP4. Use the M291 decontamination kit.

Brief Soldier: Identify pairs, designating Buddy 1 and Buddy 2. Provide each Soldier with one of the following three scenarios: the Soldier has been exposed to CB contamination (the Soldier can omit steps 2 and 4); the Soldier has been exposed to radiological contamination (the Soldier can omit steps 1 and 3); or the Soldier has been exposed to radiological and CB contamination (the Soldier must perform all steps).

Performance Measures	GO	NO GO
1. Decontaminated your individual gear for CB contamination without assistance.	___	___
2. Decontaminated your individual gear for radiological contamination without assistance.	___	___
<i>Note:</i> Buddy 1 performs steps 3 through 9.		
3. Decontaminated Buddy 2's hood and mask for CB contamination.	___	___
4. Decontaminated Buddy 2's hood and mask for radiological contamination.	___	___
5. Rolled Buddy 2's hood.	___	___
6. Removed Buddy 2's jacket.		
7. Removed Buddy 2's trousers.		
8. Removed Buddy 2's overboots.		
9. Removed Buddy 2's rubber gloves.		
<i>NOTE:</i> Buddy 2 performs steps 10 through 13.		
10. Put on an uncontaminated overgarment.		
11. Put on the overboots.		
12. Put on the gloves.		
13. Secured the hood.		
14. Repeated steps 3 through 13. Buddy 1 and Buddy 2 reversed roles.		
15. Secured the gear.		
16. Moved to the assembly area.		

Evaluation Guidance: Refer to chapter 1, paragraph 1-4 b (6).

References

Required: FM 3-5

Related:

031-503-1027

Operate the AN/UDR-13 Radiac Set

Conditions: You are given an AN/UDR-13 radiac set, four AAA batteries, TM 11-6665-364-12, STP 21-24-SMCT, and the requirement to operate the AN/UDR-13 radiac set.

Standards: Operate the AN/UDR-13 radiac set. Accurately read the rate and total accumulated dose, view and set the rate and dose alarms, and enter and leave the sleep mode.

Performance Steps

1. Conduct rate and dose accumulation readings.

a. Turn the radiac meter on, and read the rate.

(1) Depress and hold the ON/OFF button for 1 to 2 seconds.

Note: The RATE, ALARM, audio (AUD), and visual (VIS) segments on the display may all be lit or just one segment may be lit, depending on the previous use.

(2) Read the rate, ensuring that the screen displays .000 first.

b. Read the total accumulated dose.

(1) Ensure that the radiac set is in the rate mode.

(2) Depress the DOSE button until the display shows the blinking segment.

(3) Read the total DOSE accumulation.

(4) Ensure that the DOSE segment on the display is lit.

Note: The unit will automatically return to the rate mode if the dose button is not depressed within 10 seconds of any dose-reading operation.

2. Set the rate alarm.

a. Display the set point for the rate alarm.

(1) Depress and hold the ALARM button, and then press the RATE button.

(2) Release both buttons simultaneously. The display will flash the set point value for the RATE ALARM.

Note: The unit will display the rate in about 10 seconds.

b. Change the set point for the rate alarm.

(1) Depress and hold the ALARM button, and then depress the RATE button.

(2) Release both buttons simultaneously and the display will flash the set point value for the RATE ALARM.

(3) Depress and release the CLR/TEST button within 10 seconds.

(4) Depress and release the RATE button until the desired units and the decimal point location are displayed.

(5) Depress and release the CLR/TEST button. This action will lock-in the units and the decimal point selected and will cause the leftmost digit to flash.

(6) Depress and release the RATE button until the desired leftmost digit is displayed.

(7) Depress and release the CLR/TEST button to lock-in this digit.

(8) Repeat the above process to select and lock in the remaining digits.

Performance Steps

Note: The unit will display the rate alarm setting for approximately 10 seconds, and then the unit will return to RATE MODE.

- c. Select the rate alarm visual or audio indicators.

- (1) Depress and hold the ALARM button, and then depress the RATE button.

- (2) Release both buttons. The display will flash the set point value for the rate alarm.

- (3) Select the AUD or the VIS setting by repeatedly depressing and releasing the ALARM button.

Note: Do not change the alarm set points. After approximately 10 seconds, the unit will return to the rate mode and the ALM will display the selected options.

3. Set the dose alarm.

- a. Display the set point for the dose alarm.

- (1) Depress and hold the ALARM button, and then depress the DOSE button.

- (2) Release both buttons. The display will flash the set point value for the dose.

Note: The unit will display the dose in about 10 seconds.

- (3) Press the RATE button to return to the rate mode.

- b. Change the set points for the dose alarm.

- (1) Ensure that the radiac set is in the rate mode.

- (2) Depress and hold the ALARM button, and then depress the DOSE button.

- (3) Release both buttons. The display will flash the set point value for the dose alarm.

- (4) Depress and release the CLR/TEST button within 10 seconds.

- (5) Depress and release the DOSE button until the desired units and the decimal point locations are displayed.

- (6) Depress and release the CLR/TEST button. This action will lock in the units and the decimal point selected and will cause the leftmost digit to flash.

- (7) Depress and release the DOSE button until the desired leftmost digit is displayed.

- (8) Depress and release the CLR/TEST button to lock in the digits.

- (9) Repeat the above process to select and lock in the remaining digits.

- (10) Return to the rate by pressing RATE.

Note: To reset the dose indications to 000, depress the DOSE and CLR/TEST buttons and hold them for approximately 5 seconds.

- c. Select the dose alarm visual and/or audio indicators.

- (1) Depress and hold the ALARM button, and then press the DOSE button.

Performance Steps

(2) Release both buttons. The display will flash the set point value for the dose setting.

(3) Select AUD or VIS by repeatedly depressing and releasing the ALARM button.

Note: Do not change the alarm set points. After approximately 10 seconds, the unit will return to the dose mode and the ALM will display the selected options.

(4) Press RATE to return to the rate mode. (If the RATE button is not pressed, the unit will return to the rate mode within 5 minutes.)

4. Enter the SLEEP mode.

Note: The unit must be in the rate mode in order to enter the SLEEP mode.

a. Depress and hold the RATE button, and then depress the ON/OFF button for approximately 2 seconds or until the display becomes blank except for the SLEEP indicator. Continue to hold the ON/OFF and RATE buttons and - - - will appear, followed by Sleep 5.

b. Release both buttons. The SLEEP indicator will indicate that the unit is now in the SLEEP mode. In this mode, the rate will be in 5-minute intervals.

Note: After each 5-minute interval, the rate will be displayed for approximately 1 second. The unit will again go blank for the next 5-minute interval unless the rate or dose alarm set points are exceeded. In that case, the unit will revert to the normal monitoring mode and will constantly display the rate. If the dose level is above the preset alarm points (if set), the dose alarm will be activated.

c. Return to a continuous rate display. Depress and release the ON/OFF button for a minimum of 2 seconds. This will cause the SLEEP mode to be discontinued. To return to the SLEEP mode, go to step 4a.

5. Turn the display light on by pressing the light button. The light will stay on for approximately 6 seconds.

6. Turn the unit off by depressing and holding the ON/OFF button for approximately 2 seconds.

Evaluation Preparation: *Setup:* Provide all items listed in the task conditions statement. Evaluate this task in conjunction with an exercise. Ensure that the AN/UDR-13 and the radiation test set are available. Create a scenario in which radiation monitoring is required.

Brief Soldier: Tell the Soldier that he/she is to operate the AN/UDR-13 radiac set. Explain how performance measures will be tested in the scenario.

Performance Measures	GO	NO GO
1. Conducted rate and dose accumulation readings.	___	___
2. Set the rate alarm.	___	___
3. Set the dose alarm.	___	___
4. Entered the SLEEP mode.	___	___

Performance Measures	GO	NO GO
5. Turned the display light on.	_____	_____
6. Turned the unit off.	_____	_____

Evaluation Guidance: Refer to chapter 1, paragraph 1-4 b (6).

References

Required: STP 21-24-SMCT and TM 11-6665-364-12

Related:

031-503-1053

Report Chemical, Biological, Radiological, and Nuclear (CBRN) Information Using NBC 4 Reports

Conditions: You are in a CBRN-contaminated tactical environment. You are given a watch, a map, a compass, a protractor, a pencil, paper, and the nuclear, biological, and chemical (NBC) report format guide (such as the example in GTA 03-06-008 or DA Form 1971-10-R [*NBC-4 Radiation Dose Rate Measurements/Chemical/Biological Areas of Contamination*]).

Standards: Report CBRN information using NBC 4 reports. Complete the NBC 4 reports with all heading information and mandatory line items (Q, R, and S for nuclear or H, Q, and S for chemical and biological [CB]). Ensure that each report is in the correct format, and disseminate the completed NBC 4 reports to the proper authority.

Performance Steps

1. Determine whether to report nuclear or CB information based on the type of incident.
 - a. Go to step 2 if preparing a nuclear report.
 - b. Go to step 3 if preparing a CB report.

Note: Depleted uranium low-level radiation materials (DULLRAM) will be treated the same as a radioactive hazard; proceed to step 2.

2. Prepare an NBC 4 nuclear report if you are reporting a nuclear incident.

Note: The mandatory information in an NBC 4 nuclear report is the location of the reading (line Q), the dose rate (line R), and the date-time group (DTG) of the reading (line S).

- a. Complete the heading information for the NBC 4 nuclear report.
 - (1) From: Enter your unit identification.
 - (2) To: Enter the unit identification you are calling.
 - (3) Precedence: Use Immediate.
 - (4) Classification: Usually send Unclassified.
 - (5) DTG: Use six digits (DDHHHH—two digits for the day, four digits to represent military time), plus ZULU or local.
 - (6) Type of Report: Enter Nuclear.

Performance Steps

(7) Category of Report: Enter Initial if this is the first report on this attack you will submit; otherwise, enter Follow-up.

b. Turn the DA Form 1971-10-R to the reverse side.

(1) Line A: Enter the strike serial number.

(2) Line Q: Enter the location of the reading (grid coordinates or place name; specify actual or estimated).

(3) Line R: Enter the dose rate in centigrays per hour (cGyph).

(4) Line S: Enter the DTG of the reading.

Note: The NBC 4 report can contain more than one reading. If it does, repeat lines Q, R, and S.

c. Go to step 4.

3. Prepare an NBC 4 CB report if you are reporting a CB incident.

Note: The mandatory information in an NBC 4 CB report is the type of agent (line H), the location of the reading (line Q), and the DTG of the reading (line S).

a. Report the heading information for the NBC 4 CB report.

(1) From: Enter your unit identification.

(2) To: Enter the unit identification you are calling.

(3) Precedence: Use Immediate.

(4) Classification: Usually send Unclassified.

(5) DTG: Use six digits (DDHHHH—two digits for the day, four digits to represent military time), plus ZULU or local.

(6) Type of report: Enter Chemical or Biological.

(7) Category of Report: Enter Initial if this is the first report on this attack you will submit; otherwise, enter Follow-up.

b. Prepare Section I of the DA Form 1971-10-R.

(1) Line A: Enter the strike serial number.

(2) Line H: Enter the type of agent.

(3) Line Q: Enter the location of the reading (grid coordinates or place name; specify actual or estimated).

(4) Line S: Enter the DTG of the reading.

Note: The NBC 4 report can contain more than one reading. If it does, repeat lines Q, H, and S.

c. Go to step 4.

4. Submit the NBC 4 report to the units of concern.

Evaluation Preparation: *Setup:* Provide the Soldier with the items listed in the task conditions statement. Develop a situation containing observer data. The information may be written and given to the Soldier. Develop a different situation for each type of report.

Brief Soldier: Tell the Soldier that the test will consist of preparing and submitting NBC 4 reports. Give him/her the necessary items, including the data that you developed. Tell the Soldier to prepare and submit NBC 4 reports.

Performance Measures	GO	NO GO
1. Determined whether to report nuclear or CB information based on the type of incident.	___	___
<i>Note:</i> Evaluate the Soldier on steps 2 and 4 if preparing a nuclear report. Evaluate the Soldier on steps 3 and 4 if preparing a CB report.		
2. Prepared an NBC 4 nuclear report if a nuclear incident was reported.	___	___
3. Prepared an NBC 4 CB report if a CB incident was reported.	___	___
4. Submitted the NBC 4 report to the units of concern.	___	___

Evaluation Guidance: Refer to chapter 1, paragraph 1-4 b (6).

References

Required: DA Form 1971-10-R and GTA 03-06-008

Related: FM 3-3 and FM 3-3-1

031-504-1061

Conduct a Mask Fit Test Using the M41 Protection Assessment Test System (PATS)

Conditions: You are given an M41 PATS; M17-, M40-, M42- or M45-series protective masks; PATS operator's manual; TC 3-41; DA Form 2404 (*Equipment Inspection and Maintenance Work Sheet*), and any of the following situations:

1. You are directed by the commander to conduct a mask fit test.
2. You have a Soldier(s) who requires an initial issue, an annual verification, or a replacement mask issue.

Note: This task will not be performed in mission-oriented protective posture (MOPP) 4.

Standards: Conduct a mask fit test. Perform all the steps in sequence to verify the fit of a protective mask to an individual's face.

Performance Steps

1. Prepare the M41 PATS for operation.
 - a. Unpack all equipment without causing damage.
 - b. Inventory the equipment using the operator's manual, and note any missing equipment on DA Form 2404.
 - c. Perform setup procedures.
 - (1) Attach the tube marked A to the ambient port and the tube marked S to the sample port.
 - (2) Connect the alternating current (AC) power supply, or install the battery.
 - (3) Install the alcohol cartridge.

Performance Steps

- (4) Add alcohol.
 - d. Perform a systems check.
 - (1) Prepare the protection assessment test instrument (PATI).
 - (2) Conduct troubleshooting on the PATS.
 2. Prepare the mask for the fit test (M40, M42, or M45 series).
 - a. Attach the drink tube sampling adapter to the drink tube quick-disconnect coupling.
 - b. Have the Soldier sit down for the fit test.
 - c. Have the Soldier don the mask.
 - d. Instruct the Soldier to blow as hard as possible several times into the internal drink tube mouthpiece to remove any trapped fluids or foreign matter. Ensure that the drink tube is clear so that foreign matter will not be drawn into the PATI. Ensure that the PATI will be able to draw air from inside the mask. This is a critical step.
 - e. Have the Soldier adjust the face piece and tighten the head harness. Ensure that the face piece is properly fitted.
 3. Prepare the mask for the fit test (M17 series).
 - a. Attach the drink tube sampling adapter to the drink tube quick-disconnect coupling.
 - b. Attach the drink valve retaining lever to hold the drink valve open.
 - c. Have the Soldier sit down for the fit test.
 - d. Have the Soldier don the mask.
 - e. Instruct the Soldier to blow as hard as possible several times into the internal drink tube mouthpiece to remove any trapped fluids or foreign matter. Ensure that the drink tube is clear so that foreign matter will not be drawn into the PATI. Ensure that the PATI will be able to draw air from inside the mask. This is a critical step.
 - f. Have the Soldier remove the mask. Insert the sample tube extension into the internal drinking tube mouthpiece.
 - g. Remove the drink valve retaining lever from the drink valve lever.

WARNING

Have the Soldier close his/her eyes while putting on the mask to prevent the sample extension tube from injuring his/her eyes.

Performance Steps

- h. Instruct the Soldier to don the mask. Ensure that the sample extension tube is properly positioned.
 - i. Adjust the face piece, and tighten the head harness. Ensure that the face piece is properly fitted.
 - j. Attach the drink valve retaining lever so that the drink valve is held in the OPEN position for the duration of the fit test.
4. Conduct a mask fit test. (See the PATS operator's manual.)

Note: Smoking is NOT permitted in the immediate area where the fit test is being conducted and the Soldier should not smoke for at least 30 minutes before the test. To achieve proper results, the Soldier should not talk during the test.

- a. Remove the high-efficiency particulate air (HEPA) filter from the twin tube assembly.
- b. Attach the twin sample tube (marked SAMPLE) to the sample port on the end of the drink tube sampling adapter.
- c. Monitor the reading on the display with the PATI in the count mode and the Soldier remaining still until an acceptable reading of 3.0 particles/cubic centimeters (cm) or lower is obtained.
- d. Press the FIT TEST key on the keypad after obtaining an acceptable seal to bring the instrument into the standby fit test mode.

Note: Before continuing to the next step, brief the Soldier on how to perform the exercises outlined in the operator's manual. Instruct the Soldier to breathe normally during all exercises except the deep breathing exercise.

- e. Verify that the number of exercises is set to S by pressing the NUMBER OF EXERCISES key.
- f. Press the START/STOP TEST key to begin the fit test. Instruct the Soldier to perform the first exercise.
- g. Have the Soldier remove his/her mask after the test is complete and PASS is indicated.
- h. Remove all testing attachments from the Soldier's mask.
- i. Repeat the test if FAIL is indicated. (Repeat steps 3f and 3g and 4a through 4i.)

Evaluation Preparation: *Setup:* Provide the Soldier with the items listed in the task conditions statement.

Brief Soldier: Tell the Soldier to conduct the mask fit test based on the type of protective mask issued.

Note: Performance measures will vary depending on the type of mask being fitted (M17, M40, M42, or M45 series).

Performance Measures	GO	NO GO
1. Prepared the M41 PATS for operation.	_____	_____
2. Prepared the mask for the fit test (M40, M42, or M45 series).	_____	_____
3. Prepared the mask for the fit test (M17 series).	_____	_____
4. Conducted a mask fit test.	_____	_____

Evaluation Guidance: Refer to chapter 1, paragraph 1-4 b (6).

References

Required: TC 3-41

Related: DA Form 2401, TM 3-4240-279-10, and TM 3-4240-279-20&P

SUBJECT AREA 4: SURVIVE (COMBAT TECHNIQUES)

061-283-6003

Adjust Indirect Fire

Conditions: Given a pair of binoculars, a radio, a compass, pencils, a coordinate scale, a map of the target area, a target to engage within the area, and grid location of friendly troops.

Standards: Determine the target location to within 250 meters of its actual location. Transmit the initial call for fire within 3 minutes after identifying the target. Send adjustments within 45 seconds after each round impacts. Enter the fire-for-effect phase using no more than six rounds (initial round plus five for adjustment). Fire for effect within 50 meters of the target using successive bracketing procedures (or creeping fire if danger close).

Performance Steps

1. Locate the target within 250 meters of the actual target location.
 - a. Locate the target by grid coordinates.
 - b. Determine the direction from your position to the target.
 - c. Formulate a call for fire. Include the elements of the call for fire in sequence.
 - (1) Observer identification (your call sign).
 - (2) Warning order (Adjust fire).
 - (3) Location of target (Grid data).
 - (4) Description of the target (for example "Infantry platoon in the open.>").
 - (5) Method of engagement (may be omitted if area fire is desired).
 - (a) If the target is within 600 meters of friendly troops, announce "Danger close" to the fire direction center (FDC) in the initial call for fire in the method of engagement phase.

Performance Steps

(b) Use creeping procedures to adjust danger close fire. Range corrections should not exceed 100 meters.

(c) Report the initial target location on the enemy side of the target.

(6) Method of fire control. The request for a fire mission would be similar to figure 061-283-6003-1.

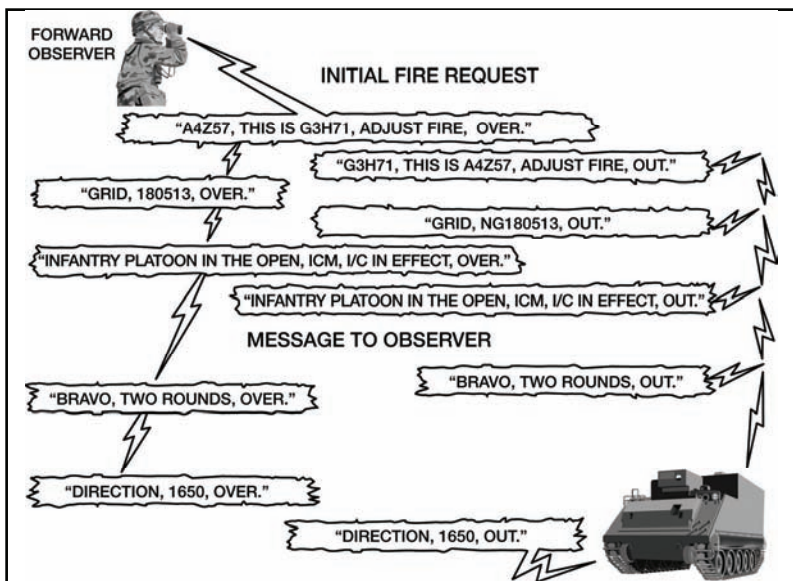

Figure 061-283-6003-1. Initial fire request

2. Transmit the call for fire to the FDC within 3 minutes of target identification.

a. Conduct three transmissions.

(1) Send observer identification and warning order. Example: "A4Z57, This is G3H71, Adjust fire, Over"

(2) Send target location. Example: "Grid 180513, Over". (Give the six-digit grid of the target, with the grid zone identifier, to within 250 meters of the actual target location.)

(3) Send target description, method of engagement, and method of fire and control. Example: "Infantry platoon in the open, ICM in effect, Over."

b. Give the direction to the target within 100 mils (M2 compass), or five degrees (lensatic compass), or give an accurate cardinal direction (no compass available) of the target's actual location. This should be sent before the first correction, or with the first correction.

3. Adjust rounds to within 50 meters of the target, within 45 seconds of the impact of each adjusting round.

Performance Steps

- a. Spot each round when it impacts as right or left, over or short of your target.
- b. Determine corrections for deviation left or right of the target.

Note: Measure deviation. Measure the horizontal angle in mils, using the reticle pattern in the binoculars or hand measurement of angular deviation. Estimate the range to the target and divide by 1,000. This is the observer-target (OT) factor. If the OT distance is 1,000 meters or greater, the OT factor is expressed to the nearest whole number. If the OT distance is less than 1,000 meters, the OT factor is expressed to the nearest 1/10th. For example, $800 = 0.8$. Multiplying the OT factor by the deviation measured in mils produces deviation corrections in meters.

- c. When the first range spotting is observed, make a range correction that would result in a range spotting in the opposite direction. For example, if the first round is short, add enough to get an over on the next round. This is called successive bracketing (figure 061-283-6003-2). Figure 061-283-6003-3 shows the impact of your initial round. The target is 2,100 meters away. Since the round is beyond the target, you must drop. You estimate that the round is 250 meters beyond the target. Therefore, you must drop 400 meters to start successive bracketing procedures. The round impacted 50 mils left of the target. With an OT factor of 2, the round impacted 100 meters left. Your correction to the FDC is "Right 100, Drop 400, Over."

WARNING

DO NOT BRACKET when DANGER CLOSE—it could result in friendly casualties; use the creeping fire procedure (all corrections are 100 meters or less).

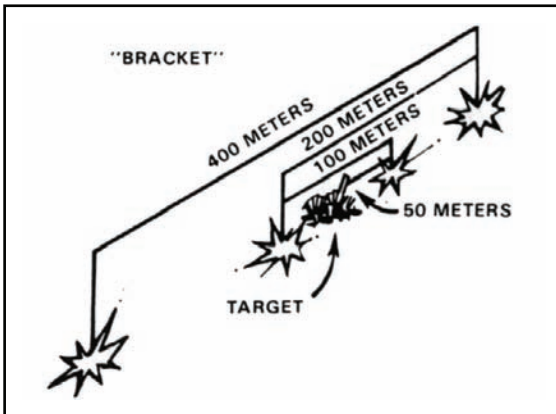

Figure 061-283-6003-2. Successive bracketing

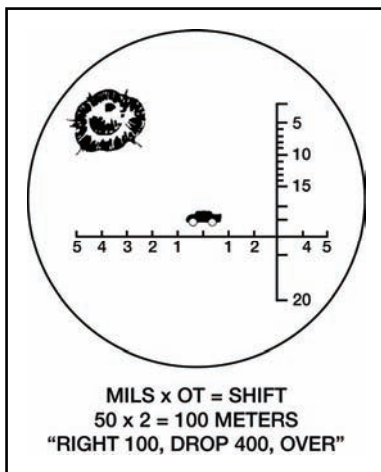

Figure 061-283-6003-3. Reticle pattern

- d. Continue splitting the range bracket until a 100-meter bracket is split or range correct spotting is observed, maintaining deviation on line. (Figure 061-283-6003-4 and figure 061-283-6003-5 show the next adjustments.)

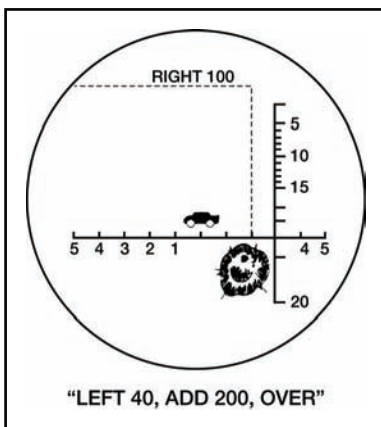

Figure 061-283-6003-4. Second round

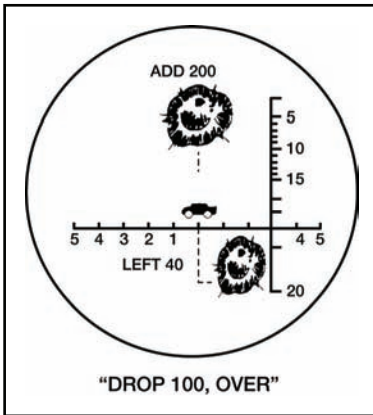

Figure 061-283-6003-5. Third round

e. Transmit corrections to the FDC in meters. The initial correction should bracket the target in range. The adjustment phase of a fire mission would resemble the example shown in figure 061-283-6003-6. Deviation correction should be made to keep the rounds on the observer target line.

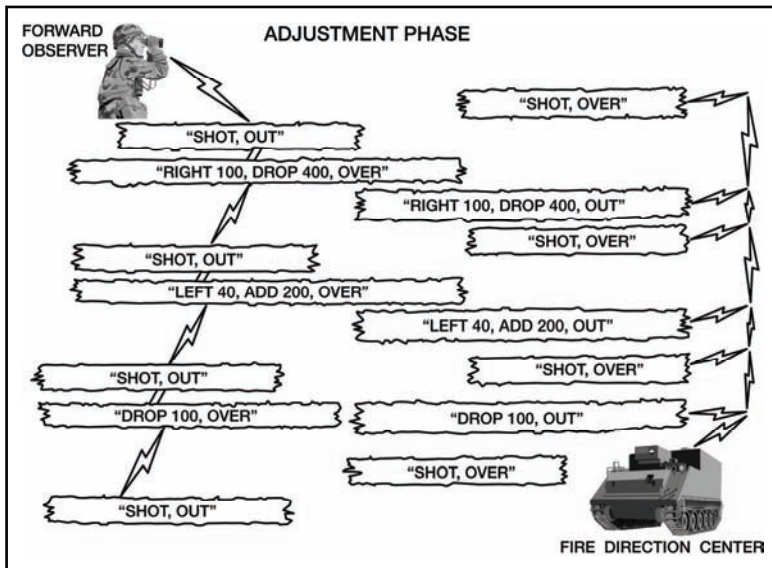

Figure 061-283-6003-6. Adjustment phase

f. Use the following guide to establish a bracket. When the estimated round impact distance to the target is—

- (1) More than 400 meters, add or drop 800 meters.
- (2) More than 200 but less than 400 meters, add or drop 400 meters.

Performance Steps

- (3) More than 100 but less than 200 meters, add or drop 200 meters.
 - (4) Less than 100 meters, add or drop 100 meters.
 - (5) Add or drop 50 meters and announce “Fire for effect.”
4. Initiate fire for effect. When a 100-meter bracket is split or a range correct spotting is made, the fire-for-effect phase is entered (figure 061-283-6003-7). Figure 061-283-6003-8 shows a simulated pattern that might be observed in the fire-for-effect phase and the observed results of fire for effect are reported.

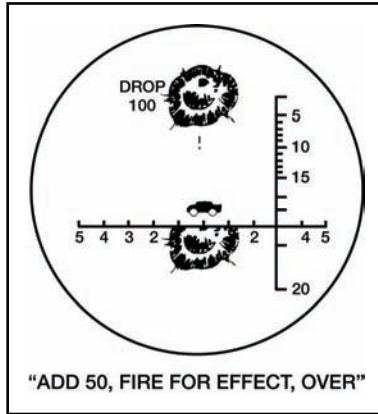

Figure 061-283-6003-7. Fourth round

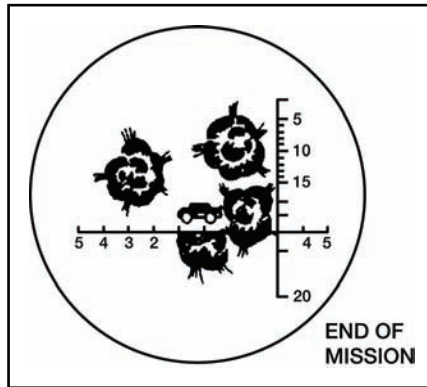

Figure 061-283-6003-8. Fire-for-effect pattern

5. Observe the results of fire for effect, transmit refinements (if necessary), and provide end of mission and surveillance (figure 061-283-6003-9).

Performance Steps

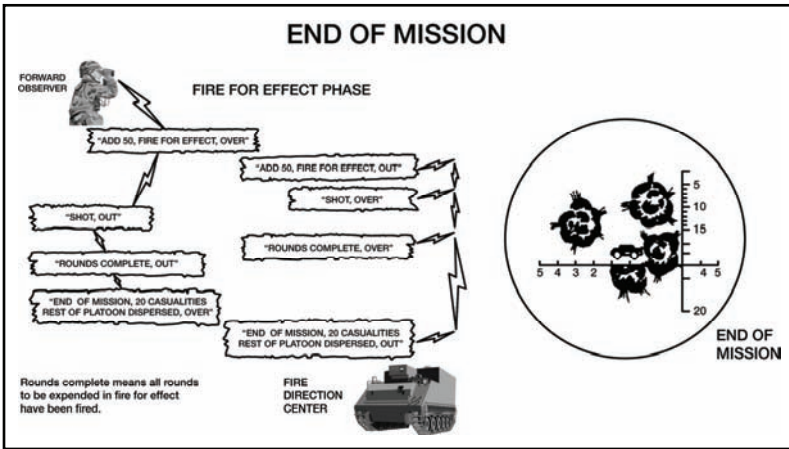

Figure 061-283-6003-9. End of mission

- a. Determine the effects on the target.
- b. Give a brief description of what happened to the target. Example: "EOM, target destroyed, Estimate two casualties, Over."

Evaluation Preparation: *Setup:* Ensure that a target is readily identifiable to the Soldier and the required equipment is present and operational. The evaluator must know the grid location, direction, and distance to the target that will be used.

Brief Soldier: Identify the target to the Soldier. Tell the Soldier that he/she must enter the fire-for-effect phase using no more than six rounds (initial round plus five for adjustment). Fire for effect must be within 50 meters of the target, using successive bracketing procedures. The initial call for fire must be made within 3 minutes after the target has been identified. Adjustments must be sent within 45 seconds after each round impacts.

Note: Ensure that the Soldier understands exactly what is expected of him/her, but do not help him/her in any way.

Performance Measures	GO	NO GO
1. Located the target to within 250 meters of the actual target location.	___	___
2. Transmitted the call for fire to the FDC within 3 minutes of target identification.	___	___
3. Adjusted rounds to within 50 meters of the target, within 45 seconds of the impact of each adjusting round.	___	___
4. Entered the fire for effect phase when a 100 meter bracket was split, or when a range correct spotting was obtained.	___	___

Performance Measures	GO	NO GO
5. Observed the results of fire for effect, transmitted refinements (if necessary), and provided end of mission and surveillance.	—	—

Evaluation Guidance: Refer to chapter 1, paragraph 1-4 b (6).

References

Required:

Related: FM 3-25.26 and FM 6-30

071-326-5705

Establish an Observation Post

Conditions: Given a squad- or platoon-sized element in a defensive position, a TA-312/PT field telephone and communication wire or a radio, and a probable enemy avenue of approach.

Standards: Select a location for an observation post (OP) that provides observation of the avenues of approach, is within small arms range of the element, and offers adequate cover and concealment. Establish communications between the OP and the platoon leader or squad leader.

Performance Steps

Note: The OPs are generally established along probable avenues of approach to listen and observe, and to provide early warning of enemy approach.

1. Select an OP.
 - a. Ensure that the site selected for an OP provides—
 - (1) Maximum observation of the desired area (specified by the platoon leader).
 - (2) Cover and concealment for the occupants of the OP.
 - (3) Concealed routes to and from the OP.

Note: Observation is the best way to determine whether the above conditions exist at a site.

- b. Locate the OP on or near the military crest of a hill, if possible. Avoid topographical crests because of the chance of being skylined. When observation is restricted by the terrain, establishing the OP well down the forward slope might be appropriate (figure 071-326-5705-1).

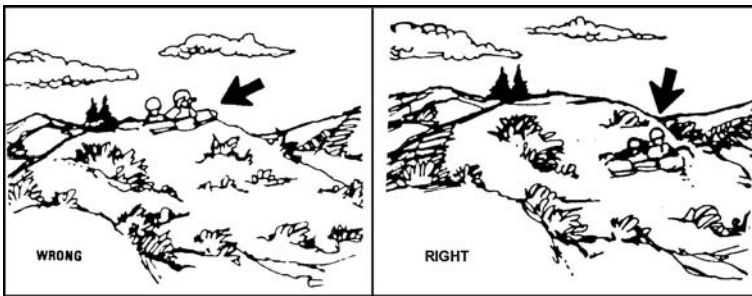

Figure 071-326-5705-1. OP position

c. Establish the OPs within effective small arms range of the unit establishing the OP. Ensure the OPs are supported by other supporting fire when possible.

2. Establish and operate an OP.

a. Wire is the primary means of communication with an OP. You can supplement it with radio. Carefully position and camouflage wire and radio antennas to avoid detection by the enemy (figure 071-326-5705-2).



Figure 071-326-5705-2. Camouflage of communication lines

b. Personnel going to and from the OP must move carefully to avoid revealing their location to the enemy. Establish separate routes to and from the OP. As camouflage is important, camouflage the OP even when natural concealment is adequate.

c. The OPs are operated in reliefs. A minimum of two Soldiers is necessary for each relief. One observes, while the other records and reports observed information. The observer and recorder should switch duties every 20 to 30 minutes because the visual efficiency of an observer decreases rapidly after that length of time.

Performance Steps

3. Establish and operate an OP during limited visibility.

a. The enemy may use a different, more open avenue of approach during limited visibility conditions; therefore, you might have to move the OP to another position at night.

b. Limited visibility OPs are usually closer to defensive positions. You can use night vision devices on the OP. The enemy deploys infiltrators against the defense at night. Setting up a series of OPs, backed up by alert troops equipped with night vision devices and snipers, can counter this infiltration.

c. Operate the OPs in relief, except when movement to and from positions would reveal their locations or endanger personnel.

Evaluation Preparation: *Setup:* In a field environment, with terrain where an OP can be established, provide the element leader with a TA-312/PT field telephone and communication wire or a radio, and two personnel to act as the observer and the recorder.

Brief Soldier: Tell the Soldier to establish an OP to observe an area (designated by the tester) forward or to the flanks of his/her element.

Performance Measures	GO	NO GO
1. Selected an area within small arms range of the squad- or platoon-sized element.	_____	_____
2. Selected a site that provided maximum observation of the desired area.	_____	_____
3. Established and operated an OP in area that offered cover and concealment.	_____	
4. Ensured that wire or radio communication was established.		
5. Ensured that radio antenna, if used, was camouflaged.		
6. Established several concealed routes to and from the OP.		
7. Ensured that the OP was camouflaged.		
8. Placed a minimum of two personnel on the OP.		
9. Instructed the observer and recorder to switch duties every 20 to 30 minutes.		

Evaluation Guidance: Refer to chapter 1, paragraph 1-4 b (6).

References

Required: FM 21-75 and FM 7-8

Related:

071-410-0019

Control Organic Fires

Conditions: Given a unit equipped with TOE weapons, attached fire support elements (machine gun teams; antitank teams; tube launched, optically tracked, wire guided [TOW] squad; Bradley fighting vehicle [BFV]), an area of responsibility, and the requirement to regulate the first of all weapon systems assigned or attached to your unit.

Standards: Assign sectors of fire for each individual and crew-served weapon; issue a priority of target engagement appropriate for each weapon system; inform all personnel of current rules of engagement (ROE); and implement procedures to engage threat targets in your area of responsibility in a timely manner, with the appropriate weapon system, and without causing injury or death to friendly personnel.

Performance Steps

WARNING

Soldiers may be killed or injured when firing weapons. Minimum firing distances, backblast areas, and weapon-specific regulations must be strictly followed.

1. Implement procedures to apply the following principles of fire control:
 - a. Avoid target overkill; conserve ammunition.
 - b. Use each weapon in its intended role.
 - c. Engage targets that offer a high probability of a kill.
 - d. Engage long-range targets first.
 - e. Destroy targets that pose the greatest threat first.
 2. Use fire control methods to—
 - a. Maximize the effects of the weapons on the target.
 - b. Achieve mutual support.
 - c. Cover assigned area of responsibility.
 - d. Ensure Soldiers' safety from friendly fire.
 3. Use the following methods to coordinate and regulate fire:
 - a. Assign sectors of fire. Assign an area for each crew-served weapon, team, or unit to cover by fire. Targets in each assigned sector are the responsibility of the individual(s) assigned to cover the area with fire.
-

Performance Steps

b. Assign priority of fires. Tell each Soldier, according to weapon assignment, what to fire at, when, and why. This ensures that each weapon is used in the role it is best suited for. (For example, Dragon gunners engage light armored vehicles; BFV gunners engage tanks with the TOW and BMPs with the 25 mm; riflemen engage dismounted personnel out to 400 meters.)

c. Use target reference points (TRPs). Designate recognizable points on the ground (natural or manmade) to use as reference points when identifying sectors of fire or targets, or to control supporting fires.

d. Assign final protective fire areas. Assign final protective lines (FPL) or principal directions of fire (PDF) for machine guns and other automatic crew-served weapons, or ground- or carrier-mounted (MK19, BFV coaxial, 25 mm, and so on).

4. Use any of the following techniques to communicate when to start, shift, or cease fire:

a. Prearranged signals. Use visual or sound signals (pyrotechnics, whistles, horns, detonation of a device, firing of a weapon) or set a specific time.

b. Arm-and-hand signals. Use standard signals when feasible. Remember, personnel must see arm-and-hand signals to respond.

c. Fire by example. Initiate firing at or in the direction of the intended target. Have the unit or specific weapon system follow your example.

d. Fire commands. Some elements of fire commands may be omitted. If any element is omitted, ensure that the unit or crew thoroughly understands the command. Every fire command should contain the target description and execution element as a minimum. (See table 071-410-0019-1 and table 071-410-0019-2 for examples of fire command elements.)

Performance Steps

Table 071-410-0019-1. Examples of fire command elements

ELEMENTS	TOW SQUAD	ANTITANK TEAM	CREW-SERVED WEAPON	UNITS
1. ALERT	FIRE MISSION or SQUAD	FIRE MISSION GUN #1	FIRE MISSION GUN #3	FIRE MISSION, A TEAM, 1ST SQUAD, ETC.
2. DESCRIPTION (Direction optional)	TANK	PC	TRUCK WITH TROOPS	TROOPS
2A. DIRECTION (if used)	FRONT, 11 O'CLOCK (Clock method)	RIGHT FRONT, 2 O'CLOCK (Clock method)	LEFT OF LONE PINE TREE (TRP method)	CENTER OF SECTOR
3. RANGE (in meters)	1,000	600	400	200
4. METHOD OF FIRE	FRONTAL, DEPTH, OR CROSSFIRE (SITUATION DEPENDENT)	SINGLE, PAIR, VOLLEY, OR SEQUENCE (SITUATION DEPENDENT)	SUSTAINED, SEARCH, OR TRAVERSE, OR COMBINATION (SITUATION DEPENDENT)	SUSTAINED, OR UNTIL TARGET IS DEFEATED
4A. TYPE MISSILE	TOW 2 TOW 2A	DRAGON, AT-4		
5. EXECUTION	FIRE, OR AT MY COMMAND	FIRE, OR AT MY COMMAND	FIRE, OR AT MY COMMAND	FIRE, OR AT MY COMMAND
6. CLOSING	CEASE TRACKING or CEASE TRACKING, OUT OF ACTION	CEASE TRACKING or CEASE TRACKING, OUT OF ACTION	CEASE FIRE	CEASE FIRE

Table 071-410-0019-2. Examples of fire command elements for a BFV

ELEMENTS	GUNNERY TECHNIQUES	
	BATTLESIGHT	PRECISION
1. ALERT	GUNNER	GUNNER
2. WEAPON/ AMMUNITION	BATTLESIGHT	SABOT HE COAX MISSILE
3. DESCRIPTION	TANK, CHOPPER, TRUCK, TROOPS, PC	PC, TRUCK, TROOPS, TANK
4. DIRECTION (Optional)	SHIFT RIGHT (LEFT), TRP-1 (TRP method) or 2 O'CLOCK (clock method)	SHIFT RIGHT (LEFT), TRP-1 (TRP method) or 2 O'CLOCK (clock method)
5. RANGE (in meters)		600
GUNNER ID*	IDENTIFIED	IDENTIFIED
6. EXECUTION GUNNER'S RESPONSE*	FIRE, OR AT MY COMMAND ON THE WAY	FIRE, OR AT MY COMMAND ON THE WAY
7. CLOSING	CEASE FIRE	CEASE FIRE
*If the BFV gunner cannot identify the target, the Bradley commander (BC) engages the target from his position. The BC announces "From my position, on the way." "Fire" is not announced.		

(1) Use fire commands to direct the fires of units or key weapons and to place a specific type of fire on certain targets. Fire commands for some weapon systems may vary in form because of weapon characteristics. They should identify who is to fire the direction of fire, type of ammunition, type of target, range, and when to fire.

(2) Correct errors in fire commands by stating CORRECTION, correcting the element in error, and then repeating all elements following the corrected element.

(3) Use subsequent fire commands to adjust for range or new targets. For example, shift left (or right) up (or down) and designate new target. For subsequent fire commands for a Bradley, use shift left (or right) PC and up (or down) half or full target frame.

(4) Develop standing operating procedures (SOPs) and drills for certain actions and commands to make fire control more effective.

Performance Steps

CAUTION

Dispose of all belt links and spent brass according to the unit SOP.

Evaluation Preparation: *Setup:* This task should be evaluated during a field training exercise on a live-fire range. Otherwise, assign a defensive position to a fire team and designate team individual sectors of fire. Provide appropriate ammunition for the weapons assigned. Target areas should represent various types of targets, such as an enemy column formation, a line formation, or a linear target with depth.

Brief Soldier: Tell the Soldier to have his/her team engage the various targets and to use the appropriate weapons on the targets.

Performance Measures	GO	NO GO
1. Assigned individual sectors of fire.	—	—
2. Issued a fire command to engage a target.	—	—
3. Issued subsequent fire commands as necessary.	—	—
4. Gave arm-and-hand signals to control fires.	—	—
5. Engaged a target according to the unit SOP. (Graded only if the unit has an SOP for team/squad fire.)	—	—
6. Used appropriate weapon(s) on target.	—	—

Evaluation Guidance: Refer to chapter 1, paragraph 1-4 b (6).

References

Required:

Related: AR 385-63, FM 21-75, FM 3-22., and FM 3-22.68

SUBJECT AREA 5: NAVIGATE

071-326-0515

Select a Movement Route Using a Map

Conditions: Given an operation or fragmentary order, a 1:50, 000 scale military map, and a compass.

Standards: Select a route with the following characteristics:

1. Take advantage of maximum cover and concealment.
2. Ensure observation and fields of fire for overwatch or fire support elements.
3. Allow positive control of all elements.
4. Accomplish the mission quickly, without unnecessary or prolonged exposure to enemy fire.

Performance Steps

- 1.** Select the route that makes the best use of terrain. Use terrain to your best advantage. Take advantage of the terrain to—
 - a.** Cover and conceal the unit during movement.
 - b.** Provide maximum effectiveness of the platoon's weapons.
- 2.** Use the military aspects of terrain and apply them to any given situation, whether it is a defense, a delay, or a road march behind the forward edge of the battle area (FEBA). Consider the following essential elements:
 - a.** Use cover and concealment for any type of movement on the battlefield.
 - (1)** Use cover to shield the unit from the effects of weapon fire, especially direct fire. Take advantage of every ravine or depression in the ground to protect and cover the force, especially if forward of the FEBA. Evaluate the terrain, the capabilities of the enemy's weapons systems, and the position of known or suspected enemy emplacements. Visualize a cross section of the terrain and determine where the enemy cannot place effective direct fire on your proposed route.
 - (2)** Conceal or disguise the unit. Consider concealment from both air and ground observation. Consider that exhaust smoke or dust can reveal your unit to the enemy.
 - b.** Ensure that your proposed route can be covered by fire from overwatch or fire support positions when moving in an area where contact with the enemy is expected.
 - (1)** Consider that direct fire weapons must have good observation to fire at known or suspected enemy positions along the movement route. Control the maneuver of your elements, if they make contact. Consider the effects of smoke and dust from friendly and enemy fire.
 - (2)** Select a route that gives your unit the best field of fire. They must be in a position to provide suppressive fires immediately. Use crew-served weapons to overwatch the movement. Ensure the overwatch element is able to observe the moving element and provide fire support all the way to the objective. Select overwatch positions that have unobstructed fields of fire to the next overwatch position.
 - 3.** Ensure that the route can be covered by fire from overwatch or fire support positions. Select the route that provides the most favorable tactical advantage and meets the mission requirements. If enemy air is active or enemy ground forces are in the area of the route, take maximum advantage of cover and concealment. If speed of movement is critical, select the route with the most easily negotiable terrain, avoiding difficult obstacles. Choose the route that provides movement from one easily distinguishable terrain feature to another. Check the terrain based on the above considerations, and then select the quickest and safest route.

Performance Steps

4. Use special purpose maps and aerial photographs when a planning a route. If those aids are available, they provide the most current information.
5. Reconnoiter the route if time is available and the tactical situation permits it.

Evaluation Preparation: *Setup:* In a field environment, provide the Soldier with a 1:50,000-scale military map of the area and a compass, and issue him/her an oral or written operation order.

Brief Soldier: Tell the Soldier to select a route of movement between two given points (marked on the map) where the likelihood of enemy contact is unknown. The Soldier must select a route that offers the best cover and concealment, ensure the best observation and fields of fire for support elements, allow positive control of elements, and accomplish the mission without unnecessary or prolonged exposure to enemy fire.

Performance Measures	GO	NO GO
1. Conducted a map reconnaissance of the area that you had to move over.	_____	_____
2. Selected a route with the appropriate characteristics.	_____	_____

Evaluation Guidance: Refer to chapter 1, paragraph 1-4 b (6).

References

Required: FM 7-7 and FM 7-8

Related:

071-329-1019

Use a Map Overlay

Conditions: Given a military map and a company level map overlay.

Standards: Position overlay correctly on the map. Identify all graphic symbols and information shown on the map overlay.

Performance Steps

1. Obtain the map sheet(s) listed in the margin.
2. Locate the grid intersections on the map that correspond to the grid register marks in the opposite corners of the overlay.
3. Place the overlay on the map so that the grid register marks fall exactly on top of the grid intersections (figure 071-329-1019-1).

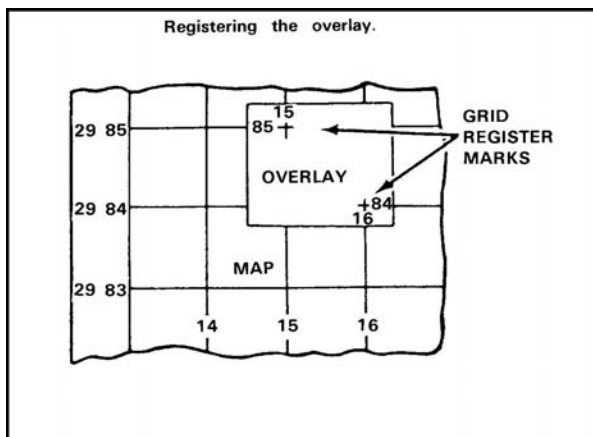

Figure 071-329-1019-1. Registering the overlay

4. Locate the following points and areas identified on the overlay:
 - a. Basic symbols (figure 071-329-1019-2).

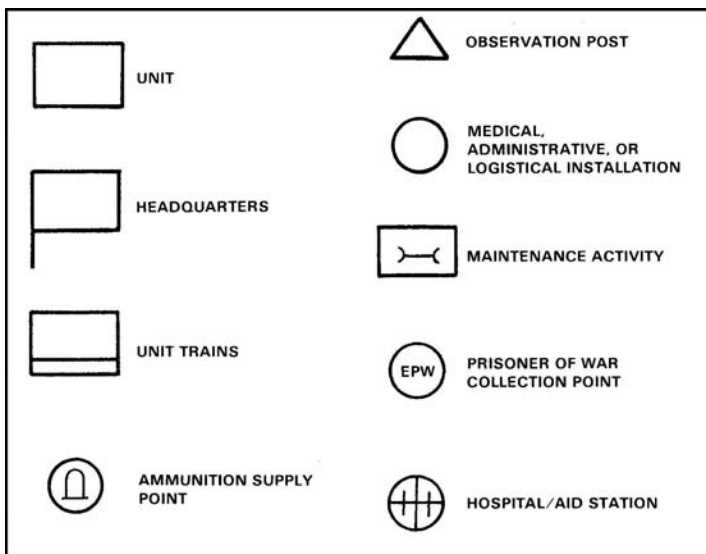

Figure 071-329-1019-2. Basic symbols

- b. Unit symbol (figure 071-329-1019-3).

Performance Steps

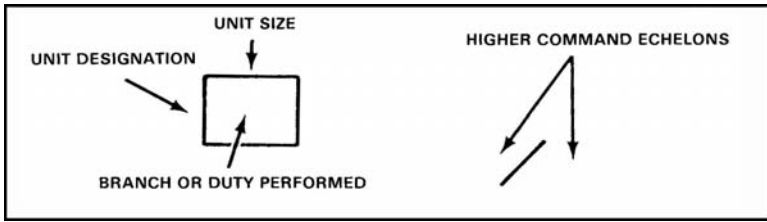

Figure 071-329-1019-3. Development of unit symbol

c. Unit-size symbols (figure 071-329-1019-4).

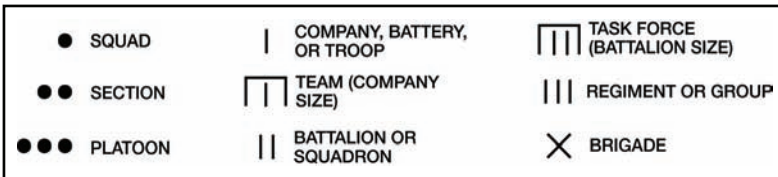

Figure 071-329-1019-4. Unit-size symbols

d. Branch symbols (figure 071-329-1019-5).

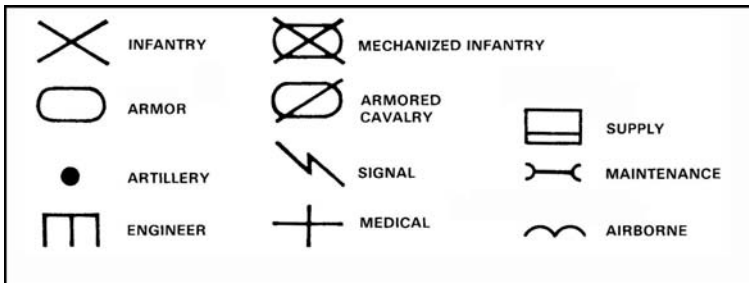

Figure 071-329-1019-5. Branch symbols

e. Enemy unit (red or double lines; figure 071-329-1019-6).



Figure 071-329-1019-6. Enemy unit

Performance Steps

- f. Proposed or future unit position (broken lines; figure 071-329-1019-7).



Figure 071-329-1019-7. Proposed unit position

- g. Tactical control symbols (figure 071-329-1019-8).

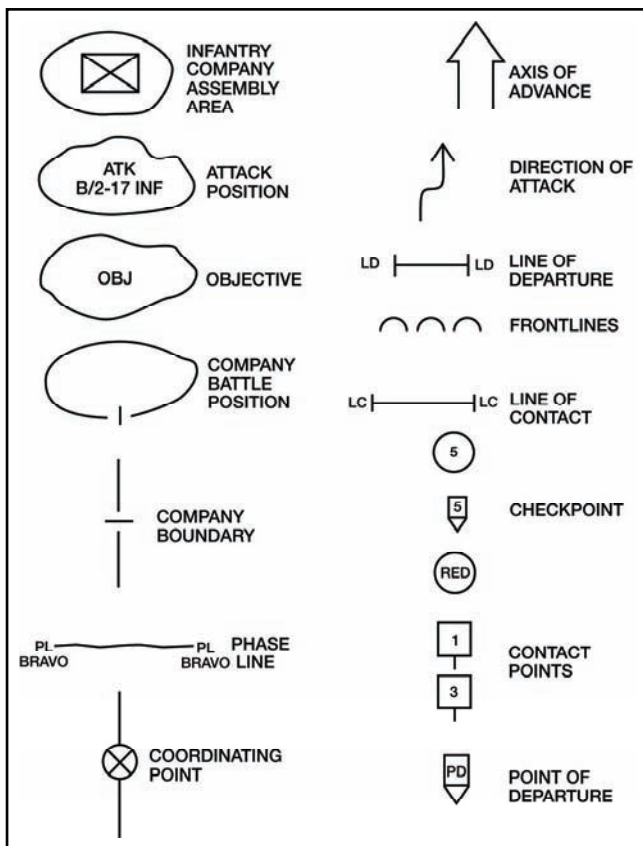

Figure 071-329-1019-8. Tactical control symbols

- h. Weapons symbols (figure 071-329-1019-9).

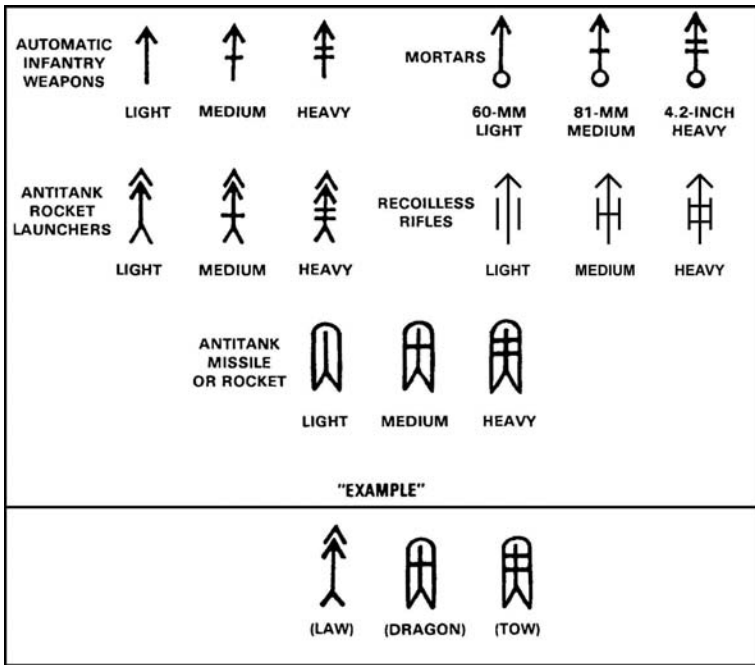

Figure 071-329-1019-9. Weapon symbols

- i. Armored vehicle symbols (figure 071-329-1019-10).

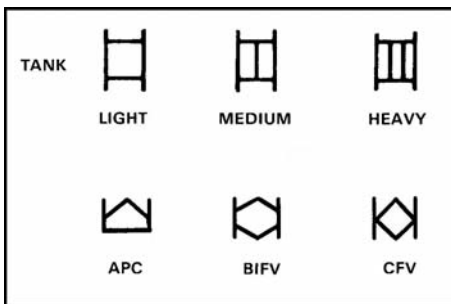

Figure 071-329-1019-10. Armored vehicle symbols

- j. Fortification and obstacle symbols (figure 071-329-1019-11).

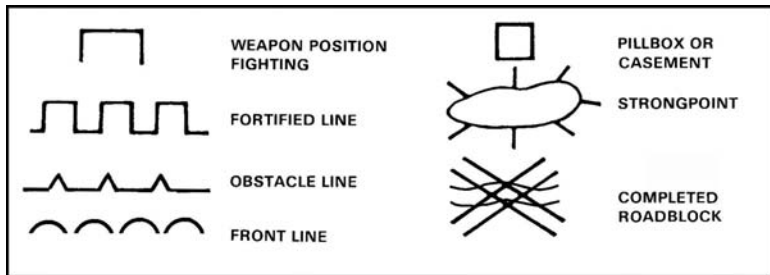

Figure 071-329-1019-11. Fortification and obstacle symbols

k. Tactical wire symbols (figure 071-329-1019-12).

Wire Obstacles	
Unspecified	X X X X X X X X
Single Fence	X — X — X
Double Fence	X X — X X — X X
Double Apron Fence	X X X X X X X X
Low Wire Fence	X X X X X X X X
High Wire Fence	X X X X X X X X
Single Strand Concertina	o o o o o o o o
Double Strand Concertina	o o o o o o o o
Triple Strand Concertina	o o o o o o o o
Trip Wire	†

Figure 071-329-1019-12. Tactical wire symbols

l. Mine symbols (figure 071-329-1019-13).

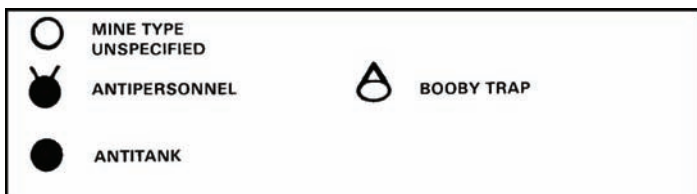

Figure 071-329-1019-13. Mine symbols

m. Indirect fire symbols (figure 071-329-1019-14).

Performance Steps

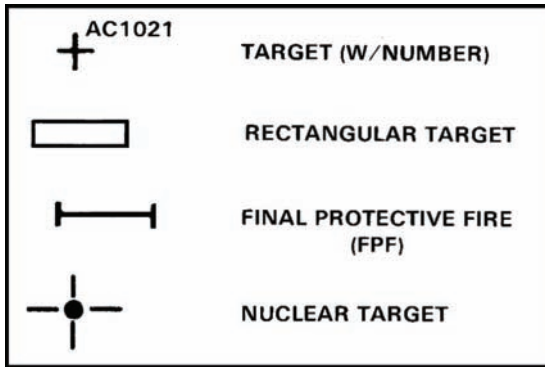

Figure 071-329-1019-14. Indirect fire symbols

Evaluation Preparation: *Setup:* Provide a military map and a company level map overlay. Ask the Soldier to identify information on the overlay from the performance measures.

Brief Soldier: Tell the Soldier to correctly place the overlay on the map and identify any graphic symbols or information on the overlay as requested, without the aid of any references.

Performance Measures	GO	NO GO
1. Placed overlay grid register marks over grid intersections.	___	___
2. Identified marginal information.	___	___
3. Identified security classification.	___	___
4. Identified graphic symbols.	___	___

Evaluation Guidance: Refer to chapter 1, paragraph 1-4 b (6).

References

Required: FM 1-02 and FM 3-25.26

Related:

SUBJECT AREA 22: UNIT OPERATIONS

071-326-5502

Issue a Fragmentary Order

Conditions: Given changes to original operation order, and a requirement to develop and issue a fragmentary order (FRAGO).

Standards: Develop and issue a clear and brief FRAGO based on changes in the mission or additional information and issued the FRAGO in the standard operation order (OPORD) format.

Performance Steps

Note: The FRAGO provides timely changes of existing orders. A FRAGO is either oral or written and addresses only those parts of the original OPORD that have changed.

1. Use standard military terminology.
2. Issue the FRAGO in the same sequence as the OPORD. Use all five paragraph headings (figure 071-326-5502-1).

FRAGMENTARY ORDER _____
References: (Mandatory) Reference the order being modified.
Time Zone Used Throughout the Order: (Optional)
1. SITUATION. (Mandatory) Include any changes to the existing order.
2. MISSION. (Mandatory) List the new mission.
3. EXECUTION.
Intent: (Optional)
a. Concept of operations. (Mandatory)
b. Tasks to subordinate units. (Mandatory)
c. Coordinating instructions. (Mandatory) Include the statement, "Current overlay remains in effect" or "See change 1 to Annex C, Operations Overlay." Mark changes to control measures on overlay or issue a new overlay.
4. SERVICE SUPPORT. Include any changes to existing order or the statement, "No changes to OPORD ____."
5. COMMAND AND SIGNAL. Include any changes to existing order or the statement, "No changes to OPORD ____."
ACKNOWLEDGE: (Mandatory)
NAME (Commander's last name)
RANK (Commander's rank)

Figure 071-326-5502-1. FRAGO example

Evaluation Preparation: *Setup:* At the test site, provide equipment as stated in the conditions statement.

Brief Soldier: Tell the Soldier to develop and issue a FRAGO that includes all changes to the original OPORD.

Performance Measures	GO	NO GO
1. Issued a FRAGO.	_____	_____
2. Used standard military terminology.	_____	_____
3. Included all changes to the original OPORD.	_____	_____

Evaluation Guidance: Refer to chapter 1, paragraph 1-4 b (6).

References

Required:

Related: FM 5-0

071-326-5503

Issue a Warning Order

Conditions: Given preliminary notice of an order or action that is to follow and a requirement to develop and issue a warning order (WARNORD) to subordinates.

Standards: Within time allotted, develop a warning order and issue it to subordinate leaders. Issue order so that all subordinate leaders understand their missions and any coordinated instructions. Issue it in the standard operation order (OPORD) format.

Performance Steps

1. Say "Warning order" before issuing the order.
2. Use standard terminology.
3. Issue the WARNORD in the five-paragraph OPORD format.
 - a. SITUATION paragraph.
 - (1) Enemy forces: Provide available information on disposition, composition, strength, capabilities, and most probable course of action.
 - (2) Friendly forces: Give available information about the missions of next higher and adjacent units.
 - (3) Attachments and detachments: Give information about any units that have been attached or detached.
 - b. MISSION paragraph. Clearly and concisely state the mission as a task to be accomplished and state the purpose for doing it.
 - c. EXECUTION paragraph. Provide information about the operation, if available.
 - d. SERVICE SUPPORT paragraph. Provide all known instructions and arrangements supporting the operation.
 - e. COMMAND AND SIGNAL paragraph. Designate the succession of command if it differs from the unit standing operating procedure (SOP).

Note: Warning orders involving movement should state the time of movement.

Evaluation Preparation: *Setup:* At the test site, provide a platoon-level warning order. The warning order will be given orally to the Soldier. The Soldier will then be given 10 minutes to prepare his/her squad warning order.

Brief Soldier: Tell the Soldier to extract from the platoon warning order all information that pertains to his/her squad. Tell the Soldier that he/she will have 10 minutes to prepare the squad warning order. Tell the Soldier that he/she will present an oral squad warning order.

Performance Measures	GO	NO GO
1. Said "Warning order."	___	___
2. Used standard military terminology.	___	___
3. Issued the warning order in the five-paragraph OPORD format.	___	___
4. Gave all available information.	___	___

Evaluation Guidance: Refer to chapter 1, paragraph 1-4 b (6).

References

Required:

Related: FM 5-0

551-88N-3043

Prepare for Unit Move

Conditions: You have received a movement order directing your unit to conduct a move to the port of embarkation and deploy in support of an Army or Joint mission. You have access to the unit SOP and all unit movement directives.

Standards: Prepare the unit for movement using the necessary references (vehicle - 10s) and equipment to deliver vehicles and equipment to arrive at the port of debarkation with no loss of vehicles or equipment (operational and ready for combat).

Performance Steps

1. Prepare vehicles for shipment.
2. Prepare equipment and supplies for shipment.
3. Prepare hazardous materials for shipment.
4. Load vehicles with unit equipment.
5. Prepare vehicle load cards.
6. Load equipment and supplies into containers.
7. Load vehicles into containers (when applicable).
8. Build 463L pallets.
9. Update the unit deployment list (UDL)

Evaluation Preparation: *Setup:* Evaluate this task during a field training exercise or a unit training exercise.

Brief Soldier: Inform the Soldier that the evaluation is measured on the ability to perform all the functions listed.

Performance Measures	GO	NO GO
1. Prepared vehicles for shipment.	_____	_____
a. Cleaned equipment thoroughly, removing all dirt and oil.		
b. Inspected the vehicle to ensure that it was mechanically sound, free of leaks, drips and other operational defects.		
c. Stenciled the unit identification code (UIC) and shipment unit number (SUN) to the front and rear of vehicles.		
d. Checked fuel levels.		
e. Inspected fuel cans for faulty lid gaskets, leaks, and other defects.		
f. Removed and secured sensitive and classified material.		
g. Removed and consolidated hazardous materials when necessary.		
h. Reduced vehicle length, height, and width.		
i. Secured ignition keys to steering wheel with wire.		
j. Secured rotating parts.		
k. Ensured that all vehicles and trailers were equipped with serviceable tiedown devices or shackles.		
l. Protected radios and other electronic components on the vehicles.		
m. Checked fire extinguishers to ensure that they were approved and were properly secured in their restraining bracket.		
n. Secured basic initial issue (BII) and components of end item (COEI).		
o. Lowered cab assembly (if required).		

Performance Measures	GO	NO GO
<p>p. Applied destination placard (unit, UIC, unit line number [ULN], destination) to the front of the vehicle/container.</p>		
<p>q. Attached the military shipping label (bar code label) to the left front bumper (driver's side) and left side door (driver's door).</p>		
<p>r. Attached the radio frequency (RF) tag to the top of the grill with nylon strips (if applicable).</p>		
<p>s. Verified the RF tag battery life.</p>		
<p>2. Prepared equipment and supplies for shipment.</p>	<p>___</p>	<p>___</p>
<p>3. Prepared hazardous materials for shipment.</p>	<p>___</p>	<p>___</p>
<p>a. Packed for shipment with equipment only those hazardous materials identified by the unit movement officer (UMO).</p>		
<p>b. Applied the required markings, proper shipping name, identification number, and UIC/SUN provided by the UMO.</p>		
<p>c. Marked all oxygen and acetylene containers with the UIC/SUN.</p>		
<p>d. Drained and cleaned all five-gallon fuel cans, field cans, water heaters, gasoline lanterns, portable generators, blow torches, and similar equipment in which combustibles or fuel, other than diesel, was used or stored.</p>		
<p>e. Disconnected the batteries of non-self-propelled equipment, such as generators, and protected the terminal ends from arcing and from corrosion.</p>		
<p>f. Drained and placarded bulk fuel carriers.</p>		
<p>g. Removed all loose ammunition and explosives from all containers and vehicles.</p>		
<p>4. Loaded vehicles with unit equipment.</p>	<p>___</p>	<p>___</p>
<p>a. Maximized use of all cargo space.</p>		
<p>b. Did not exceed vehicle payload capacity.</p>		
<p>c. Protected against metal-to-metal contact.</p>		
<p>d. Protected load from weather damage.</p>		
<p>e. Securely restrained all loaded equipment.</p>		

Performance Measures	GO	NO GO
<p>f. Weighed and documented the load on the load card.</p>		
<p>5. Prepared vehicle load cards.</p>	_____	_____
<p>a. Completed, in duplicate, FORSCOM Form 285-R / DA Form 5748-R (<i>Shipment Unit Packing List and Load Diagram</i>).</p>		
<p>b. Placed one copy of the vehicle load card in the driver's side door pocket (or taped to the inside of the door) and provided one copy to the platoon sergeant or platoon leader.</p>		
<p>6. Loaded equipment and supplies into containers.</p>	_____	_____
<p>a. Inspected containers for defects. Rejected containers with holes, severe dents, faulty doors, damaged lifting points, or structural defects.</p>		
<p>b. Equalized weight distribution throughout the container.</p>		
<p>c. Placed heavy and wet material on the bottom and light and dry material on the top.</p>		
<p>d. Kept the center of balance (CB) of the load, as near as possible, at the center of the container for air shipments. If this was not possible, marked the CB on the outside of the container.</p>		
<p>e. Stored items that could be damaged by water on dunnage off the floor.</p>		
<p>f. Placed packages containing liquid, or that posed a leak hazard, on a double layer of dunnage to reduce leakage damage.</p>		
<p>g. Stowed hazardous material by the doors of the containers.</p>		
<p>h. Blocked and braced spaces between the contents of the load and the container walls and container ceiling to prevent the load from shifting when moved or tilted.</p>		
<p>i. Blocked and braced doors at least six inches back to prevent the load from falling out when the doors were opened.</p>		

Performance Measures	GO	NO GO
<p>j. Placed one copy of the packing list inside the container on the door and one copy on the outside of the container door. Three additional copies of the packing list were provided to the UMO.</p>		
<p>k. Applied destination placard (unit, UIC, ULN, destination) to the front of the container.</p>		
<p>l. Attached RF tag to the front door of the container.</p>		
<p>m. Verified the RF tag battery life.</p>		
<p>7. Loaded vehicles into containers (when applicable).</p>	_____	_____
<p>a. Inspected containers for defects. Rejected containers with holes, severe dents, faulty doors, damaged lifting points, or structural defects.</p>		
<p>b. Prepared vehicles as described in step 1.</p>		
<p>c. Reduced vehicle fuel levels to ¼ tank.</p>		
<p>d. Placed vehicles in gear with the hand brake set.</p>		
<p>e. Disconnected batteries and secured terminal cables to prevent arcing.</p>		
<p>f. Chocked or cradled vehicle wheels on all four sides to prevent lateral and lengthwise movement.</p>		
<p>g. Placarded container appropriately when enclosing vehicle with fuel in the tank.</p>		
<p>h. Documented container load and seal number (if applicable) on the packing list.</p>		
<p>i. Applied destination placard (unit, UIC, ULN, destination) to the front of the container.</p>		
<p>j. Attached RF tag to the front door of the container.</p>		
<p>k. Verified RF tag battery life.</p>		
<p>8. Built 463L pallets.</p>	_____	_____
<p>a. Distributed large, heavy objects from the center of the pallet outwards to maintain CB.</p>		
<p>b. Placed lighter and/or smaller items on top or beside the heavier objects.</p>		
<p>c. Placed containers right-side up with "special handling" labels facing out.</p>		

Performance Measures	GO	NO GO
<p>d. Constructed load in a square or pyramid shape whenever possible to make load stable, easy to handle, and easier to secure on the pallet.</p>		
<p>e. Placed hazardous materials, approved for palletizing by the UMO, on the pallet with the label clearly visible and never buried or hidden.</p>		
<p>f. Placed plastic covers over the load.</p>		
<p>g. Placed nets over the plastic covers and adjusted it to fit snugly to load.</p>		
<p>h. Placed military shipping labels on one end and on the adjacent side at the same end of a pallet.</p>		
<p>i. Attached R) tag to front (near the labels).</p>		
<p>j. Verified RF tag battery life.</p>		
<p>9. Updated the UDL and provided a copy to the UMO or the commander.</p>		

Evaluation Guidance: Refer to chapter 1, paragraph 1-4 b (6).

References

Required:

Related: DA Form 5748-R, FM 3-35.4, FM 4-01.011, FORSCOM Form 285-R, FORSCOM Reg 55-1, and TM 38-250

SUBJECT AREA 23: SECURITY AND CONTROL

301-371-1052

Protect Classified Information and Material

Conditions: This task can be performed in field and garrison locations under all conditions. Given classified documents and/or material, AR 380-5, local standing operating procedures (SOPs), SF 700 (*Security Container Information*), SF 702 (*Security Container Check Sheet*), SF 703 (*Top Secret Cover Sheet*), SF 704 (*Secret Cover Sheet*), and SF 705 (*Confidential Cover Sheet*), DA Form 3964 (*Classified Documents Accountability Record*), office equipment and supplies.

Standards: Safeguard classified information/material—prevent unauthorized disclosure; maintain and store according to operation order (OPORD), AR 380-5, and the local unit standard operating procedures (SOPs).

Performance Steps

1. Identify classified material.

Note: Information is any knowledge that can be communicated or any documentary material (regardless of its physical form or characteristics) that is owned by, produced by or for, or is under the control of the United States Government. Unauthorized disclosure is a communication or physical transfer of classified information to an unauthorized recipient.

a. List the security classification levels.

(1) Confidential. Information, if disclosed to unauthorized persons, could reasonably be expected to cause damage to the national security.

(2) Secret. Information, if disclosed to unauthorized persons, could reasonably be expected to cause serious damage to the national security.

(3) Top Secret. Information, if disclosed to unauthorized persons, could reasonably be expected to cause exceptionally grave damage to the national security.

b. Define original and derivative classifications.

(1) Original classification—an initial determination that information requires, in the interest of national security, protection against unauthorized disclosure.

(2) Derivative classification—the incorporating, paraphrasing, restating, or generating in new form information that is already classified, and marking the newly developed material consistent with the classification markings that apply to the source information.

2. Locate and read the declassification and downgrading instructions, which appear on a classified document. Define declassification and downgrading.

a. Declassification—the authorized change in the status of information from classified information to unclassified information.

Note: Information that already has been declassified and released to the public cannot be reclassified.

(1) At the time of original classification, the original classification authority shall attempt to establish a specific date or event for declassification.

(2) If a specific date or event for declassification cannot be determined, then information shall be marked for declassification 10 years from date of the original decision.

(3) The original classification authority may extend the duration of classification for a successive period, not to exceed 10 years at a time.

(4) At the time of original classification, the original classification authority may exempt for declassification within 10 years specific information that the unauthorized disclosure could reasonably be expected to cause damage to the national security.

(5) Information shall be declassified as soon as it no longer meets the standards for classification.

b. Downgrading—a determination by a declassification authority that information classified and safeguarded at a specific level shall be classified and safeguarded at a lower level.

Performance Steps

3. Review information for required identification and markings.

Note: Classification markings will be in letters larger than those used in the rest of the text.

a. Check the document for required markings:

(1) Ensure that the overall classification of the document is marked, stamped, or affixed permanently—

(a) On the top and bottom of the outside front cover.

(b) On the title page.

(c) On the first page.

(d) On the outside of the back cover.

(2) Each interior page, except those left blank, will be marked on the top and bottom according to content, to include unclassified.

(3) Each section, part, paragraph, or similar portion of a classified document will be marked to show the level of classification of the information contained by showing the appropriate classification symbol.

(4) Charts, maps, and drawings will bear the appropriate classification marking for the legend, title, or scale block. The higher of these markings shall be inscribed at the top and bottom of each such document.

(5) Photographs, films (including negatives), recordings, and their containers will be marked with the specific level of the information contained within.

(6) Information used to simulate classified or unclassified material or documents will be marked clearly to indicate the actual unclassified status of the information (for example, SECRET for Training Purposes Only).

b. Examine all classified documents for completeness; ensure that no parts or pages are missing.

c. Ensure that the following appears on the face of all classified information:

(1) The overall classification of the document should be stamped on the top and bottom.

(2) The identity, by name or personal identifier, and position of the original classification authority.

(3) The agency and office of origin.

(4) Declassification instructions.

(5) Reason for classification.

4. Protect classified information through restricted access.

Performance Steps

a. Define access—the ability or opportunity to gain knowledge of classified information. Access is based on—

(1) Security clearance. Ensure that personal security clearance is equal to or exceeds the classification level of the material required to perform official duties.

(2) Need-to-know. Ensure that a determination has been made by an authorized holder of classified information that a prospective recipient requires access to specific information in order to perform or assist in a lawful and authorized government function.

Note: No one has a right to have access to classified information solely by virtue of rank or position.

b. Prevent unauthorized persons from gaining access to classified material.

(1) Keep all classified documents under constant observation when removed from storage.

(2) Keep all documents face down or covered when not in use.

(3) Place one of the following cover sheets on all classified material:

(a) SF 705 for confidential information.

(b) SF 704 for secret information.

(c) SF 703 for top secret information.

c. Define Special Access Program. This is a program for a specific class of classified information that imposes safeguarding and access requirements that exceed those normally required for information at the same classification level.

5. Safeguard classified Information and material.

a. Use proper precautions to protect classified information and material:

(1) Safeguard classified information when temporarily departing the work area.

(2) Prevent display of classified information in public places.

(3) Use the following procedures when working papers containing classified information are created:

(a) Date the document.

(b) Mark the document with the words "Working papers."

(c) Mark each page, top and bottom, according to the content classification.

Performance Steps

- (d) Bring working papers under control as a finished document when—
- Retained more than 90 days from the date of origin.
 - Released outside the originator's agency.
 - Transmitted electrically or electronically.
 - Filed permanently.
 - Papers contain top secret information.
6. Comply with security regulations when discussing classified information.
- a. Do not discuss classified and/or sensitive information on an unsecured telephone.
 - b. Use the following procedures when presenting a classified briefing:
 - (1) Ensure that the briefing area has been cleared to the highest level of material to be discussed.
 - (2) Check the attendance roster to ensure all personnel are cleared and have a need-to-know.
 - (3) Establish a sign-in roster at the main entrance to the briefing area and control access at all other entrances.
 - (4) Ensure that all training aids are marked with security classification according to their content.
 - (5) Inform the audience of the security classification of the briefing and the policy concerning note taking at the beginning of the briefing.
 - (6) Repeat the security classification at the end of the briefing.
 - c. Ensure that automated information systems (including networks and telecommunications systems) that collect, create, communicate, compute, disseminate, process, or store classified information have controls that—
 - (1) Prevent access by unauthorized persons.
 - (2) Ensure the integrity of the information.
7. Protect classified information during transport.
- a. Do not remove classified information from official premises without proper authorizations.
 - b. Protect classified information when transporting outside of a secured area.
 - (1) Address classified information to an official government activity or Department of Defense (DOD) contractor with a facility clearance and not an individual.
 - (2) Pack classified information in such a manner that the text will not be in contact with the inner envelope or container.
 - (3) Attach or enclose a receipt, DA Form 3964, in the inner envelope or container for all SECRET and TOP SECRET information. CONFIDENTIAL information requires a receipt only if the originator deems it necessary.

Performance Steps

(4) Double wrap classified information in opaque envelopes or similar wrappings.

(a) Mark the inner envelope with the overall classification of the contents and any special instructions.

(b) Mark the inner and outer envelope with the complete sender's and receiver's address.

(c) Do not mark the outer envelope with any indications of the contents or the classification.

(d) Do not display classified material in public places while transporting.

(e) Do not store classified material in any detachable storage compartment (such as automobile trailers or luggage racks) while transporting.

8. Protect classified information during transmission.

a. Transmit classified information and material according to the security classification level, as specified in AR 380-5.

(1) Transmit classified material by—

(a) Approved courier services.

(b) U.S. military personnel.

(c) Government employees.

(d) DOD contractors.

(e) U.S. Postal Service.

(f) Electronic transmission over secure lines using encryption.

b. Ensure transmission has been authorized in writing by the appropriate contracting officer.

c. Ensure that TOP SECRET and SECRET classified information remain in constant custody and protection of the courier at all times.

9. Safeguard classified material when in storage.

a. Store classified information under conditions adequate to prevent unauthorized access.

b. Store typewriter ribbons, computer disks, notes, and similar materials which are classified or used to process classified information, in a locked General Services Administration (GSA) approved security container, when not under the personal control and observation of an authorized person.

c. Follow correct procedures when locking material in a GSA approved security container:

(1) Complete correctly SF 702 with the proper date, time, and initials.

Performance Steps

(2) Turn the "OPEN/CLOSED" sign on the front of the security container to the "CLOSED" position.

(3) Ensure that another person checks the container to make sure that it is locked and initials the SF 702.

10. Use the following procedures when discovering an open or unattended security container.

a. Keep the container or area under guard or surveillance.

b. Notify one of the persons listed on Part 1 of SF 700 attached to the inside of the security container drawer. If one of these individuals cannot be contacted, notify the duty officer, security manager, or other appropriate official.

11. Report possible compromise of classified information.

a. List individual responsibilities in cases of suspected compromise:

(1) Any person having knowledge of the loss or possible compromise of classified information will immediately report it to the security manager, S2, or commanding officer.

(2) Any person who discovers classified information out of proper control will take custody of the information, safeguard it, and immediately report to the security manager, S2, or commanding officer.

(3) The security manager, S2, or commanding officer will initiate a preliminary inquiry to determine the circumstances surrounding the loss or possible compromise of classified information and establish one of the following:

(a) The loss or compromise of classified information did not occur.

(b) The loss or compromise did occur but the compromise reasonably could not be expected to cause damage to the national security.

(c) The loss or compromise of classified information did occur and that the compromise reasonably could be expected to cause damage to the national security.

(4) The security manager or S2 will report the circumstances of the compromise to—

(a) HQDA (DAMI-CIS) when dealing with SECRET and TOP SECRET information.

(b) The commander when dealing with CONFIDENTIAL information.

(5) A further investigation may be initiated if warranted.

12. Use proper procedures when destroying classified information.

a. Destroy classified information to preclude recognition or reconstruction. Destroy classified information by burning, melting, chemical decomposition, pulping, pulverizing, crosscut shredding, or mutilation.

Note: Burning is the preferred method of destroying classified information.

Performance Steps

b. Complete DA Form 3964 for TOP SECRET information. Records shall be dated and signed at the time of destruction.

Evaluation Preparation: *Setup:* Provide the Soldier with the materials listed in the conditions statement. Tell the Soldier to protect the classified material.

Note to the Trainer: If this task is to be evaluated during training, prepare and provide the Soldier with material which is classified "FOR TRAINING PURPOSES ONLY." Ensure that the material is marked to this effect. The Soldier must get a GO on all items to receive a GO on this task.

Performance Measures	GO	NO GO
1. Identified classification of classified material.	___	___
2. Located and read the declassification and downgrading instructions.	___	___
3. Marked documents with all required identification and markings, or corrected incorrect markings.	___	___
4. Restricted access to classified information:	___	___
a. Determined the requirement for access before releasing classified material to other persons:		
(1) Determined the need-to-know.		
(2) Determined security clearance.		
b. Prevented unauthorized persons from gaining access to classified material.		
(1) Kept all classified documents under constant observation when removed from storage.		
(2) Kept documents face down or covered when not in use.		
(3) Took appropriate measures when uncleared personnel entered the work area.		
(4) Placed appropriate cover sheets on classified material.		
5. Safeguarded classified information and material.		
a. Safeguarded classified information when temporarily departing the work area.		
b. Prevented display of classified information in public places.		
c. Used correct procedures when creating classified working papers.		
6. Complied with security regulations when discussing classified information.		

Performance Measures	GO	NO GO
a. Refrained from discussing classified and/or sensitive information on an unsecured telephone.		
b. Used correct security procedures when presenting a classified briefing.		
c. Used proper controls when using automated information systems.		
7. Protected classified information during transport.	_____	_____
8. Identified reference delineating correct transmission procedures.	_____	_____
9. Locked classified material in an appropriate security container (when not in use).		
a. Locked and/or checked the security container.		
b. Initialed and dated the SF 702.		
c. Turned the sign to the "CLOSED" position.		
10. Took appropriate action upon discovery of possible compromise of classified information.		
11. Completed DA Form 3964, and determined the best destruction method for documents of various classifications.		
a. Listed three methods of destruction.		
b. Identified the two standards of destruction.		

Evaluation Guidance: Refer to chapter 1, paragraph 1-4 b (6).

References

Required: AR 380-5, DA Form 3964, SF 702, and USOP

Related:

301-371-1200

Process Captured Materiel

Conditions: This task can be performed in field and garrison locations under all conditions. Given captured enemy materiel consisting of a map, signal operation instructions, unidentified equipment, complete with reference manuals, captured enemy equipment tags, captured document tags, a sheet marked technical documentation (TECHDOC), blank spot reports, detainee's personal effects, and the unit standing operating procedure (SOP) describing how to process and evacuate captured enemy materiel (CEM).

Standards: Secure captured enemy materiel. Prepare a spot report on captured enemy materiel known or believed to be of intelligence value. Fill out and attach the

tag to the item of captured enemy materiel. Receipt detainee's personal effects. Select correct disposition procedure for each item of captured enemy materiel.

Performance Steps

1. Safeguard the captured enemy materiel (CEM).

a. Categorize the CEM into—

(1) Captured enemy documents (CEDs). This includes any piece of recorded information, regardless of form, obtained from the enemy, which subsequently comes into the hands of a friendly force. CEDs can be U.S. or allied documents that were once in the hands of the enemy.

(2) Captured enemy equipment (CEE). This includes all types of foreign materiel found on an enemy prisoner of war (EPW) or on the battlefield that may have military application.

b. Protect CEM.

(1) Protect CEM from looting, loss, misuse, recapture, or destruction by placing under guard at all stages during the intelligence exploitation process. Use the best method available to preserve the item in its original condition.

(2) Personal effects, to include money, will be receipted and a copy will be given to the detainee. Use DA Form 1132-R (*Prisoner's Personal Property List - Personal Deposit Fund*).

Note: To ensure exploitation of the captured enemy materiel, all documenting paperwork and materiel must accompany the detainee to each holding facility. Follow EPW guidelines and the unit SOP.

Note: Correctly identify documents to be impounded. Impound personal documents containing information of intelligence value that outweighs personal or sentimental value. Personal documents are those of a private or commercial origin, such as letters, diaries, newspapers, or books. Impounding means that the documents are taken with the intention of returning them to the EPW/detainee at a later time. Identification documents may be taken and briefly examined and then returned to the EPW/detainee. The Geneva Conventions (FM 27-10) state that identification documents may not be permanently removed from an EPW/detainee.

2. Prepare a spot report on all time-sensitive information.

a. Identify time sensitive information. The technical intelligence (TECHINT) appendix to an intelligence annex will delineate time-sensitive technical items and reporting channels.

Note: Time-sensitive information includes any significant intelligence information with either military or technical application, to include enemy order of battle, enemy maps, overlays, operation orders, signals, codes, cryptographic materiel, new weapons or equipment on the battlefield, information critical to successfully accomplishing friendly courses of action, or information that indicates a significant change in the enemy's capabilities or intentions.

b. Submit a spot report to notify higher commands of the capture or identification of enemy materiel believed to answer intelligence requirements.

Performance Steps

- (1) Use S-A-L-U-T-E format to identify the following:
 - (a) S–Size
 - (b) A–Activity
 - (c) L–Location
 - (d) U–Unit
 - (e) T–Time
 - (f) E–Equipment
 - (2) Report time-sensitive items by the least IMMEDIATE precedence.
3. Tag each CEM item.
- a. Tag all CEM found on the battlefield with no known association to an EPW.
 - (1) Use CEE tag on each piece of equipment.
 - (2) Use a captured document tag for each document.
 - b. Attach a sheet marked TECHDOC to flag the CED, if the CED is associated with a particular piece of CEM.
 - (1) List the precise location, time, circumstances of capture, and a detailed description of the materiel on the sheet marked TECHDOC.
 - (2) Treat all documents marked TECHDOC with the highest priority and forward them through the intelligence officer to the higher command until their value is determined.
 - c. Use special procedures for handling captured communications-electronics (C-E) equipment and documents marked TECHDOC.
 - (1) Handle in close coordination with the communications staff.
 - (2) Treat CEDs containing communications or cryptographic information as secret material.
 - (3) Tag and evacuate through secure channels without delay.
 - d. Use the field expedient method when no preprinted tags are available. Include, as a minimum, the following information:
 - (1) Date and time of capture.
 - (2) Capturing unit and its designation.
 - (3) Circumstances of capture.
 - (4) Identity of the CED or CEE captured.
 - (5) Location where the document was captured, including the six- or eight-digit grid coordinate.
 - e. Tag without defacing the item.
 - (1) Ensure that all markings which appear on the materiel at the time of capture are preserved.
 - (2) Ensure that items are tagged so as not to damage or destroy the documents or equipment.

Performance Steps

- (3) Never write on the document itself.
 - (4) Put the tag, without damaging the CED, in a waterproof bag.
 - (5) Attach the tag to the CEM so that it will not come off.
4. Select the correct disposition procedure for each CEM item.
- a. Identify all time-sensitive captured enemy materiel to be evacuated to the S2. The S2 will screen for intelligence or technical value and then evacuate to the rear for examination and exploitation. All enemy documents captured on the battlefield are sent immediately to the first intelligence staff officer in the chain. The S2/G-2 routes all enemy documents to the nearest interrogation element for tactical exploitation. Interrogators screen the documents for immediate information and forward them to higher command, as required.
 - (1) Evacuate CEM with any technical documents found that relate to its design or operation. When the materiel cannot be evacuated, the documents should be identified with the materiel by attaching a sheet marked TECHDOC and providing the following information:
 - (a) The precise location, time, circumstance of capture.
 - (b) A detailed description of the materiel.
 - (c) Photographs of the equipment (evacuate with the document).
 - (d) Photographs of the materiel, placing an object of known size such as a ruler near the materiel to provide a size reference.

Note: Protect equipment that is too large to evacuate. Detail guards to safeguard the item until you receive further instructions.

 - (g) Keep photos with TECHDOC and evacuate.
 - (2) Evacuate CEM through your chain of command to the S2. The S2 will screen for intelligence or technical value and then evacuate to the rear for examination and exploitation.
 - b. Evacuate other CEM through similar logistic assets (such as route captured petroleum, oil, and lubricants (POL) through your POL points).
 - c. Protect the CEM, which cannot be evacuated, until disposition instructions are received.

Evaluation Preparation: *Setup:* Prepare samples of captured enemy documents. Prepare captured document tags for CEDs. Prepare captured enemy equipment tags for all unidentified equipment, complete with reference manuals. Provide a sheet marked TECHDOC, blank spot reports, and the unit SOP.

Brief Soldier: Instruct the Soldier to process and evacuate all CEDs and CEE using captured document tags, captured enemy equipment tags, and a sheet marked TECHDOC when necessary.

Performance Measures	GO	NO GO
1. Safeguarded each item.	_____	_____
a. Used the best method available to preserve the item in its original condition.		
b. Protected the item from looting, loss, misuse, recapture, or destruction by placing it under guard at all stages during the intelligence exploitation process.		
c. Received detainee's personal effects on DA Form 1132-R.		
2. Submitted a written or verbal spot report on time-sensitive information that included six of six S-A-L-U-T-E items identified correctly.		
3. Completed the appropriate tag for each item.		
a. Used the captured enemy equipment or captured document tag for CEM found on the battlefield.		
b. Attached a sheet marked TECHDOC to any CED associated with a particular piece of CEM. The cover sheet listed the precise location, time, circumstances of capture, and a detailed description of the materiel. Took photos of the CEM with a size reference, if possible, and kept the photo with the TECHDOC.		
c. Use the field expedient method when no preprinted tags were available.		
d. Tagged the item without defacing it.		
4. Select the correct disposition procedure for each item.		

Evaluation Guidance: Refer to chapter 1, paragraph 1-4 b (6).

References

Required:

Related: FM 19-40, FM 34-52, and FM 34-54

SUBJECT AREA 25: EQUIPMENT CHECKS

091-CTT-2001

Supervise Preventive Maintenance Checks and Services (PMCS)

Conditions: In a contemporary operational environment, given equipment, appropriate technical manuals, supporting forms and documentation, tools, petroleum, oils, and lubricants (POL) (if applicable), and personnel.

Standards: Ensure that the maintenance status of assigned equipment is reported and personnel are trained in the proper procedures for conducting preventive maintenance checks and services (PMCS) according to the applicable references.

Performance Steps

1. Direct PMCS.
 - a. Verify that all current and updated technical manuals and references are available or requisitioned for section's assigned equipment.
 - b. Verify that all tools, POL, personnel and other resources are available for PMCS.
 - c. Observe operators performing PMCS at prescribed intervals according to the technical manual.
 - d. Review maintenance forms and reporting procedures for accuracy and completeness.
 - e. Reduce training distractions.
2. Train personnel in the proper procedures for conducting PMCS.
 - a. Enforce the commander's training program for operators of assigned equipment.
 - b. Verify that all operators are licensed for their equipment.
 - c. Verify that all operators are properly trained with PMCS procedures.
3. Report the maintenance status of assigned equipment.
 - a. Verify that the operator has correctly identified and corrected or recorded faults on DA Form 5988-E (*Equipment Inspection Maintenance Worksheet*) or DA Form 2404 (*Equipment Inspection and Maintenance Work Sheet*).
 - b. Confirm that not mission capable (NMC) faults are corrected before dispatch (If applicable).

Performance Measures	GO	NO GO
1. Verified that current and updated technical manuals and references were available.	_____	_____
2. Verified correctly that all tools, POL, personnel and other resources were available for PMCS.	_____	_____
3. Checked operator's DA Form 5988-E to confirm that operators were licensed.	_____	_____
4. Identified correct PMCS intervals according to the technical manual.	_____	_____

Performance Measures	GO	NO GO
5. Verified that the operator had correctly identified and corrected or recorded faults on DA Form 5988-E or DA Form 2404.	_____	_____
6. Reviewed maintenance forms and reporting procedures for accuracy and completeness.	_____	_____

Evaluation Guidance: Refer to chapter 1, paragraph 1-4 b (6).

References

Required: AR 750-1, DA Pam 750-1, DA Pam 750-8, DA Pamphlet 750-35, and TM 9-243

Related:

SUBJECT AREA 27: RISK MANAGEMENT

850-001-2000

Employ the CRM Process and Principles and Show How They Apply to Performance of My Job/Assigned Duties

Conditions: As a small unit leader, given a mission, activity, or task, in a garrison or tactical environment, access to FM 5-19 and a DA Form 7566 (*Composite Risk Management Worksheet*).

Standards: Make an oral or written report that identifies the five steps of the composite risk management (CRM) process, and apply the CRM process to a given mission, activity, or task.

Performance Steps

1. Identify the five steps of the CRM process.
2. Identify and list hazards associated with the mission or task using mission, enemy, terrain and weather, troops and support available, time available, civil considerations (METT-TC) factors.
3. Assess the hazards to determine the level of risk (E,H,M,L) for each hazard and its impact on the mission or task
4. Select appropriate controls and reassess risk (E,H,M,L) for each identified hazard.
5. Identify appropriate methods for implementing the identified controls.
6. Identify appropriate personnel to supervise and evaluate the controls.
7. Determine the overall level of risk (E,H,M,L) for the mission, activity, or task.

Evaluation Preparation: *Setup:* To evaluate this task, you need an assigned mission, task, or activity, on or off duty, which may be in the form of an operations order (OPORD), fragmentary order (FRAGO), warning order, patrol order, training task, and so forth

Brief Soldier: Tell the Soldier to identify the five steps of the CRM process and complete the CRM process for the assigned mission, task, or activity.

Performance Measures	GO	NO GO
1. Identified all five steps of the CRM process.		
2. Identified all hazards associated with the mission or task using METT-TC factors (a minimum of one, depending on the mission or task).		
3. Determined the level of risk (E,H,M,L) for each hazard.		
4. Selected appropriate controls for each hazard and reassessed the risk levels (E,H,M,L) for all identified hazards.		
5. Identified appropriate methods for implementing controls.		
6. Identified the appropriate personnel to supervise and evaluate control implementation.		
7. Determined the overall level of risk (E,H,M,L) for the mission, activity, or task.		

Evaluation Guidance: Refer to chapter 1, paragraph 1-4 b (6).

References

Required: FM 5-19, FM 5-0, and DA Form 7566

Related:

SUBJECT AREA 28: ADMINISTRATION/MANAGEMENT

805C-PAD-2060

Report Casualties

Conditions: You are a Soldier deployed in a field environment. Events are occurring that result in Soldier and Department of Defense (DOD) civilian casualties within U.S. and coalition forces. Given a casualty, DA Form 1156 (*Casualty Feeder Card*), a map, and a pen or pencil.

Standards: Legibly and accurately record all known data elements on the DA Form 1156. Submit the completed DA Form 1156 to your chain of command as soon as the tactical situation permits.

Performance Steps

1. Prepare DA Form 1156. Data items with asterisk, addressed below, indicate minimum information required to submit a casualty report. Complete as much of the DA Form 1156 as you can to preserve background information for the unit and family. (Data fields are numbered to align with the DCIPS-FWD.)

(1) Complete item 2 with the casualty type (such as hostile, nonhostile).

(2) Complete item 3 with the casualty's status (such as NSI, KIA, DUSTWUN).

Note: DUSTWUN/missing/captured will include date, time, and place last seen, age, height, weight, eyes, and identifying marks.

(3) Complete item 7 with the personnel type of casualty (such as military, civilian).

(4) Complete item 8 with the casualty's social security number (SSN) (9 digit number).

(5) Complete item 9 with the casualty's name (last, first, middle initial.).

(6) Complete item 13 with the service branch of the casualty.

(7) Complete item 14(a) with the name of the unit that the casualty is assigned to.

(8) Complete item 36 with the incident date/time.

(9) Complete item 37 with the place of the incident.

(10) Complete item 39 with the circumstances (detailed, factual account).

(11) Complete item 40 with the inflicting force and weapons.

(12) Enter other helpful information.

(a) Body armor and physical features.

(b) Identification of remains will include the means of identification: ID tags, name tag, personal recognition, other.

2. Have DA Form 1156 authenticated. Field grade commander (CDR) will authenticate the completed card for accuracy and thoroughness of items 2, 39, and 40 before dispatching the report. An authorized field grade officer may be designated to authenticate for the CDR.

Evaluation Preparation: *Setup:* Provide the Soldier with DA Form 1156, a map, pencil and paper. Give the Soldier a scenario that provides all the information needed to accomplish the measures.

Brief Soldier: Tell the Soldier that he/she will be evaluated on his/her ability to report casualties by preparing DA Form 1156.

Performance Measures	GO	NO GO
1. Prepared DA Form 1156.	—	—
a. Completed item 2 with the casualty type.		
b. Completed item 3 with the casualty's status.		
c. Completed item 7 with the personnel type of casualty.		
d. Completed item 8 with the casualty's SSN.		
e. Completed item 9 with the casualty's name.		
f. Completed item 13 with the service branch of the casualty.		
g. Completed item 14(a) with the name of the unit that the casualty is assigned to.		
h. Completed item 36 with the incident date/time.		
i. Completed item 37 with the place of the incident.		
j. Completed item 39 with the circumstances.		
k. Completed item 40 with the inflicting force and weapons.		
l. Entered other helpful information.		
2. Had a field grade CDR authenticate the completed card for accuracy and thoroughness of items 2, 39, and 40 prior to dispatch of report.		

Evaluation Guidance: Refer to chapter 1, paragraph 1-4 b (6).

References

Required: DA Form 1156 and FM 3-34.112

Related: AR 600-8-1

This page intentionally left blank.

SUBJECT AREA 2: FIRST AID

081-831-1058**Supervise Casualty Treatment and Evacuation**

Conditions: You are a Soldier deployed to a unit in a forward area. There are casualties that must be treated and evacuated to receive medical aid. A military vehicle (ground vehicle or rotary-wing aircraft) may be available. You may have a litter and straps (or materials to improvise them) to secure the casualty and other Soldiers available to assist in treatment and evacuation.

Standards: Ensure that self-aid/buddy aid is provided to the casualties, as appropriate. Ensure that the casualties are transported to medical aid or to a pickup site using an appropriate carry or, if other Soldiers are available, by litter. Ensure that the litters are properly loaded onto a military vehicle (ground vehicle or rotary-wing aircraft) without dropping or causing further injury to the casualties.

Performance Steps

Note: Perform these procedures when medical and combat lifesaver personnel are not available. As soon as medical personnel are available, assist them, as necessary, in treating and evacuating the casualties.

1. Evaluate the casualties according to the tactical situation. (See STP 21-1-SMCT, task 081-831-1001.)

Note: Tactical combat casualty care (TCCC) can be divided into three phases.

- Care under fire—you are under hostile fire and are very limited as to the care you can provide.
 - Tactical field care—you and the casualty are relatively safe and no longer under effective hostile fire, and you are free to provide casualty care to the best of your ability.
 - Combat casualty evacuation care—care is rendered during casualty evacuation (CASEVAC).
2. Coordinate treatment (self-aid/buddy aid) of the casualties according to the tactical situation and available resources.
 3. Request medical evacuation (MEDEVAC). (See task 081-831-0101.)
 - a. Make contact.
 - b. Determine whether casualties must be moved or will be picked up at the current location. If they must be moved, continue with step 4. If they will not be moved, continue to monitor communications and go to step 6.
 4. Move a casualty, if necessary, using a four-man litter squad.

Note: If military vehicles and litter materials are not available, continue with step 5.

Note: Four-man litter squad bearers should be designated with a number from 1 to 4. The litter bearer designated as #1 is the leader of the squad.

Performance Steps

- a. Prepare the litter.
 - (1) Open a standard litter.
 - (2) Lock the spreader bars at each end of the litter with your foot.
- b. Prepare the casualty.
 - (1) Place the casualty onto the litter.
 - (2) Secure the casualty to the litter with litter straps.
- c. Lift the litter.
 - (1) Position one squad member at each litter handle with the litter squad leader at the casualty's right shoulder.

Note: The leader should be at the right shoulder to monitor the casualty's condition.

- (2) On the preparatory command, "Prepare to lift," the four bearers kneel beside the litter and grasp the handles.

- (3) On the command, "Lift," all bearers rise together.

- (4) On the command, "Four man carry, move," all bearers walk forward in unison.

- (a) If the casualty does not have a fractured leg, carry the casualty—

- Feet first on level ground.
- Head first when going up hill.

- (b) If the casualty has a fractured leg, carry the casualty—

- Head first on level ground.
- Feet first when going up hill.

- (5) To change direction of movement, such as from feet first to head first, begin in a litter post carry position. The front and back bearers release the litter and the middle bearers rotate the litter and themselves.

5. Coordinate transportation of casualties using appropriate carries, if necessary. (See STP 21-1-SMCT, task 081-831-1046.)

6. Coordinate loading of casualties onto a military vehicle.

- a. Ground ambulance.

Note: Ground ambulances have medical personnel to take care of the casualties during evacuation. Follow any special instructions for loading, securing, or unloading casualties.

- (1) Secure each litter casualty to his/her litter.
 - (2) Load the most serious casualty last.
 - (3) Load the casualty head first (head in the direction of travel) rather than feet first.
 - (4) Secure each litter to the vehicle.

- b. Air ambulance.

Performance Steps

Note: Air ambulances have medical personnel to take care of the casualties during evacuation. Follow any special instructions for loading, securing, or unloading casualties.

- (1) Remain 50 yards from the helicopter until the litter squad is signaled to approach the aircraft.
- (2) Approach the aircraft in full view of the aircraft crew, maintaining visual confirmation that the crew is aware of the approach of the litter party. Ensure that the aircrew can continue to visually distinguish friendly from enemy personnel at all times. Maintain a low silhouette when approaching the aircraft.
- (3) Approach UH-60/UH-1 aircraft from the sides. Do not approach from the front or rear. If you must move to the opposite side of the aircraft, approach from the side to the skin of the aircraft. Then, hug the skin of the aircraft, and move around the front of the aircraft to the other side.
- (4) Load the most seriously injured casualty last.
- (5) Load the casualty who will occupy the upper berth first, then load the next litter casualty immediately under the first casualty.

Note: This is done to keep the casualty from accidentally falling on another casualty if his/her litter is dropped before it is secured.

- (6) When casualties are placed lengthwise, position them with their heads toward the direction of travel.
- (7) Secure each litter casualty to his/her litter.
- (8) Secure each litter to the aircraft.

c. Ground military vehicles.

Note: Nonmedical military vehicles may be used to evacuate casualties when no medical evacuation vehicles are available. If medical personnel are present, follow their instructions for loading, securing, or unloading casualties.

Note: FM 8-10-6 contains suggested loading plans for many common nonmedical vehicles. You should become familiar with the plans for vehicles assigned to your unit.

- (1) When loading casualties into the vehicle, load the most seriously injured casualty last.
- (2) When a casualty is placed lengthwise, load the casualty with his/her head pointing forward, toward the direction of travel.
- (3) Secure each litter casualty to his/her litter.
- (4) Secure each litter to the vehicle as it is loaded into place.
- (5) Watch the casualties closely for life-threatening conditions and provide first aid, as necessary, during CASEVAC.

Note: CASEVAC refers to the movement of casualties aboard nonmedical vehicles or aircraft. Care is rendered while the casualty is awaiting pickup or is being transported. A Soldier accompanying an unconscious casualty should monitor the casualty's airway, breathing, and bleeding.

Evaluation Preparation: *Setup:* Evaluate this task during a training exercise involving a MEDEVAC aircraft or vehicle, or simulate it by creating a scenario, and provide the equipment needed for the evaluation.

Brief Soldiers: Tell the Soldiers the scenario to include the end result desired.

Performance Measures	GO	NO GO
1. Evaluated the casualties according to the tactical situation.	_____	_____
2. Coordinated treatment (self-aid/buddy aid) of the casualties according to the tactical situation and available resources.	_____	_____
3. Requested medical evacuation.	_____	_____
4. Moved a casualty using a four-man litter squad, if necessary.		
a. Prepared the litter.		
b. Prepared the casualty.		
c. Lifted the litter.		
5. Coordinated transportation of casualties using appropriate carries, if necessary.		
6. Coordinated loading of casualties onto a military vehicle.		

Evaluation Guidance: Refer to chapter 1, paragraph 1-4 b (6).

References

Required:

Related: FM 4-25.11, FM 8-10-6, and STP 21-1-SMCT

081-831-1059

Implement Measures to Reduce Combat Stress

Conditions: You are a leader of a group of Soldiers who are preparing to enter or are in a combat situation.

Standards: Recognize stress-related behaviors and implement appropriate leader actions that offset and control combat operational stress reaction risk factors.

Performance Steps

1. Recognize stress-related behaviors. (See figure 081-831-1059-1.)
 - a. Positive combat stress behaviors. Positive combat stress behaviors include the heightened alertness, strength, endurance, and tolerance to discomfort which the fight or flight stress response and the stage of resistance can produce when properly in tune.
 - b. Misconduct stress behaviors. These range from minor breaches of unit orders or regulations to serious violations of the Uniform Code of Military Justice (UCMJ) and perhaps the Law of Land Warfare.

Performance Steps

c. Combat operational stress reaction (COSR) (previously called battle fatigue). Some COSR behaviors may accompany excellent combat performance and are often found in heroes. More serious behaviors are warning signs and deserve immediate attention by the leader, medic, or buddy to prevent potential harm to the Soldier, others, or the mission.

d. Post-traumatic stress disorder (PTSD). PTSD is a psychiatric disorder that can occur following the experience or witnessing of life-threatening events such as military combat, natural disasters, and terrorist incidents. Some people have stress reactions that do not go away on their own, or may even get worse over time. People who suffer from PTSD often relive the experience through nightmares and flashbacks, have difficulty sleeping, and feel detached or estranged, and these symptoms can be severe enough and last long enough to significantly impair the person's daily life.

2. Identify COSR risk factors.

a. Domestic worries.

b. Newly assigned to unit.

c. First time in combat, horrors.

d. Casualties.

e. Lack of mobility.

f. Surprise attacks.

g. Inability to strike back—indirect fire, improvised explosive devices (IEDs).

h. Information vacuum.

i. Chemical, biological, radiological, and nuclear (CBRN) weapons threat.

j. Sleep loss.

k. Physical exhaustion.

l. Dehydration, hunger.

3. Take leader actions to control COSR.

a. Build unit cohesion and pride.

b. Help Soldiers stabilize the home front.

c. Keep Soldiers physically fit.

d. Conduct tough, realistic training.

e. Cross train in key areas.

Performance Steps

- f. Enforce sleep discipline.
- g. Plan for personal hygiene.
- h. Preserve Soldiers' welfare, safety, and health.
- i. Reduce uncertainty.
- j. Enforce individual health protection measures.

Positive Combat Stress Behaviors	Misconduct Stress Behaviors and Criminal Acts	Combat Operational Stress Reaction
Unit Cohesion Loyalty to Buddies Loyalty to Leaders Identification with Unit Tradition Sense of Eliteness Sense of Mission Alertness, Vigilance Exceptional Strength and Endurance Increased Tolerance to Hardship, Discomfort, Pain, and Injury Sense of Purpose Increased Faith Heroic Acts Courage Self-sacrifice	Mutilating Enemy Dead Not Taking Prisoners Killing Enemy Prisoners Killing Noncombatants Torture, Brutality Killing Animals Fighting with Allies Alcohol and Drug Abuse Recklessness, Indiscipline Looting, Pillage, Rape Fraternalization Excessively on Sick Call Negligent Disease, Injury Shirking, Malingering Combat Refusal Self-inflicted Wounds Threatening/killing Own Leaders ("Fragging") Going Absent without Leave, Desertion	Hyperalertness Fear, Anxiety Irritability, Anger, Rage Grief, Self-doubt, Guilt Physical Stress Complaints Inattention, Carelessness Loss of Confidence Loss of Hope and Faith Depression, Insomnia Impaired Duty Performance Erratic Actions, Outbursts Freezing, Immobility Terror, Panic Running Total Exhaustion, Apathy Loss of Skills and Memories Impaired Speech or Muteness Impaired Vision, Touch, and Hearing Weakness and Paralysis Hallucinations, Delusions
	Post-Traumatic Stress Disorder	
	Intrusive Painful Memories, "Flashbacks" Trouble Sleeping, Bad Dreams Guilt about Things Done or not Done Social Isolation, Withdrawal, Alienation Jumpiness, Startle Responses, Anxiety Alcohol or Drug Misuse, Misconduct	

Figure 081-831-1059-1. Combat stress behaviors

4. Take leader actions to manage COSR.
 - a. Duty COSR (keep with buddies).
 - (1) Symptoms: Any amount or kind of COSR symptoms that do not endanger the Soldier or others or interfere with the unit's current mission.
 - (2) Actions: Reassure of being normal, rest, clean up, feed, sleep, and keep on duty.
 - b. Rest COSR (rest in parent or support unit).

Performance Steps

- (1) Symptoms: Warning signs that indicate the Soldier is too much of a risk or burden to stay with his/her own buddies.
 - (a) Section cannot provide safe, stable environment for recovery.
 - (b) Soldier is not disruptive or dangerous.
 - (c) No urgent medical evaluation is needed.
- c. Heavy COSR (take to aid station or medical company).
 - (1) Symptoms.
 - (a) Soldier is disruptive or potentially dangerous to self, others, or the mission.
 - (b) Soldier could need urgent medical treatment for illness or injury.
 - (c) Warning signs do not improve.
 - (2) Actions.
 - (a) Take to aid station or medical treatment facility.
 - (b) Maintain contact or visit the Soldier if not returned in hours.
 - (c) Welcome the Soldier back into the unit upon return.

Evaluation Preparation: *Setup:* Prepare a scenario that requires the Soldier to respond to questions about the performance measures. This may be presented orally or in writing.

Brief Soldier: Tell the Soldier that he/she will be required to correctly respond to questions about combat stress behaviors.

Performance Measures	GO	NO GO
1. Recognized stress-related behaviors.	___	___
a. Positive combat stress behaviors.		
b. Misconduct stress behaviors.		
c. COSR.		
d. Post-traumatic stress disorder.		
2. Accurately identified COSR risk factors.	___	___
3. Took appropriate leader actions to control COSR.	___	___
4. Took appropriate leader actions to manage COSR.	___	___

Evaluation Guidance: Refer to chapter 1, paragraph 1-4 b (6).

References

Required:

Related: FM 22-51, TG 240, TG 241, and TG 242

**SUBJECT AREA 3: CHEMICAL, BIOLOGICAL, RADIOLOGICAL,
AND NUCLEAR**

031-503-1002

Conduct Unmasking Procedures

Conditions: You are given a tactical situation, a group of Soldiers in mission-oriented protective posture (MOPP) 4, an M256-series chemical-agent detector kit, a chemical-agent monitor (CAM), M8 and M9 detector paper, a watch, TM 3-6665-307-10, FM 3-11.4, an area where chemical agents have been used, and one of the following situations:

1. An M256A1 chemical-agent detector kit is available.
2. An M256A1 chemical-agent detector kit is not available.

Standards: Conduct unmasking procedures in sequence with or without using the M256-series detector kit and without incurring casualties.

Performance Steps

Note: Before conducting unmasking procedures, make every effort to confirm the absence of chemical contamination. A CAM, an M256-series chemical-agent detector kit, and M8 and M9 detector paper should be used along with a visual check of the area.

Note: The senior person present selects one or two Soldiers to unmask after permission is received from higher headquarters.

1. Conduct unmasking procedures in the following sequence using an M256-series detector kit.
 - a. Conduct unmasking procedures in the shade when possible.
 - b. Use an M256-series detector kit to test for chemical agents. Use M8 detector paper to check for possible liquid contamination. Continue unmasking procedures only if both tests are negative.
 - c. Direct selected Soldiers to unmask for 5 minutes and then don, seal, and clear their masks. If symptoms appear, tell Soldiers to mask immediately, and then treat them for exposure.
 - d. Observe Soldiers for 10 minutes for chemical-agent symptoms.
 - e. Direct all Soldiers to unmask if no symptoms appear.
 - f. Check Soldiers for delayed symptoms. Have first aid treatment available.
2. Conduct unmasking procedures in the following sequence without using an M256-series detector kit.
 - a. Conduct unmasking procedures in the shade when possible.

Performance Steps

- b. Use M8 detector paper and/or a CAM to check for possible liquid contamination. Continue unmasking procedures only if the test is negative.
 - c. Direct selected Soldiers to take a deep breath, break the seals of their masks for 15 seconds (keeping their eyes open), and then seal and clear their masks.
 - d. Observe Soldiers for 10 minutes for chemical-agent symptoms.
 - e. Direct selected Soldiers to break the seals of their masks. If no symptoms appear, direct Soldiers to take two or three breaths, and then seal and clear their masks.
 - f. Observe Soldiers for 10 minutes for chemical-agent symptoms.
 - g. Direct selected Soldiers to unmask for 5 minutes. If no symptoms appear, direct Soldiers to don, seal, and clear their masks.
 - h. Observe Soldiers for 10 minutes for chemical-agent symptoms.
 - (1) If symptoms appear, mask Soldiers immediately and treat for exposure.
 - (2) If no symptoms appear, direct all Soldiers to unmask.
 - i. Check Soldiers for delayed symptoms. Have first aid treatment available.
3. Report the absence of contamination in the area and the successful completion of unmasking procedures to higher headquarters.

Evaluation Preparation: *Setup:* Evaluate this task during a field exercise or a tactical training session. The M256A1 trainer kit will be used for training and evaluation purposes.

Brief Soldier: Tell the Soldier that he/she will be evaluated on his/her ability to conduct unmasking procedures (with or without using a chemical-agent detector kit). The Soldiers participating in the task will act only as directed by the Soldier conducting the unmasking exercise and will not be evaluated on their performance.

Performance Measures	GO	NO GO
1. Conducted unmasking procedures in the sequence given using an M256A-series detector kit.	_____	_____
2. Conducted unmasking procedures in the sequence given without using an M256A1-series detector kit.	_____	_____
3. Reported the absence of contamination in the area and the successful completion of unmasking procedures to higher headquarters.	_____	_____

Evaluation Guidance: Refer to chapter 1, paragraph 1-4 b (6).

References

Required: FM 3-11.4 and TM 3-6665-307-10

Related:

031-503-1016

Implement Mission-Oriented Protective Posture (MOPP)

Conditions: You are in a chemical, biological, radiological, and nuclear (CBRN) environment, or you are warned of a threat of an CBRN hazard. You are given two or more Soldiers with MOPP gear, M8 and M9 detector paper, an M291 or M295 decontaminating kit, three nerve-agent antidote autoinjectors, FM 3-11.4, and requirements to assume the appropriate MOPP level and check Soldiers sleeping in MOPP4.

Standards: Implement and direct Soldiers to assume the appropriate MOPP level, and identify and rectify all deficiencies for Soldiers sleeping in MOPP4.

Performance Steps

1. Direct Soldiers to put on gear and equipment for MOPP0 through MOPP4.
 - a. Ensure that Soldiers assume MOPP0.
 - b. Ensure that Soldiers assume MOPP1.
 - c. Ensure that Soldiers assume MOPP2.
 - d. Ensure that Soldiers assume MOPP3.
 - e. Ensure that Soldiers assume MOPP4.
2. Ensure that Soldiers are wearing the appropriate clothing and equipment properly for the directed MOPP level and that Soldiers don and seal protective masks at MOPP3 and MOPP4.
3. Check Soldiers sleeping in MOPP4.
 - a. Observe the Soldiers to ensure that they are breathing.
 - b. Try to wake the Soldiers if they do not appear to be breathing.
 - c. Perform the task Evaluate a Casualty (task 081-831-1000).
4. Check the Soldiers' mask for indications of a broken seal.
 - a. Wake the Soldiers and have them reseal their masks if the seal appears to be broken.
 - b. Direct a Soldier to observe another Soldier for symptoms of nerve-agent poisoning.
 - c. Perform first aid for nerve-agent injuries if symptoms are observed.
5. Check the Soldiers' protective clothing for problems.

Performance Steps

- a. Fasten or adjust the protective clothing, if the Soldiers' skin is not exposed and no symptoms are observed.
- b. Wake the Soldiers and have them decontaminate using the M291 if their skin is exposed or they appear to be contaminated with liquid. Have the Soldiers adjust their protective clothing or conduct a MOPP gear exchange, as appropriate.
- c. Perform first aid for nerve-agent injuries if skin is exposed or nerve-agent symptoms are observed.

Evaluation Preparation: *Setup:* Evaluate this task during a normal training session. Gather all necessary MOPP gear, and ensure that it is in good condition. Be prepared to direct a series of specific MOPP levels for the evaluated Soldier to implement with the troops provided (such as MOPP0 through MOPP4, sequentially). Have the Soldier explain the deficiencies that he/she should look for and the corrective actions he/she should take for a Soldier sleeping in MOPP4.

Brief Soldier: Tell the Soldier that the test will consist of directing Soldiers to assume the appropriate MOPP level and identifying all deficiencies and taking the appropriate corrective actions for a Soldier sleeping in MOPP4.

Performance Measures	GO	NO GO
1. Directed Soldiers to put on gear and equipment for MOPP0 through MOPP4.	___	___
2. Ensured that Soldiers were wearing the appropriate clothing and equipment properly for the directed MOPP level and that Soldiers donned and sealed protective masks at MOPP3 and MOPP4.	___	___
3. Checked Soldiers sleeping in MOPP4.	___	___
4. Checked the Soldiers' masks for indicators of a broken seal.	___	___
5. Checked the Soldiers' protective clothing for problems.	___	___

Evaluation Guidance: Refer to chapter 1, paragraph 1-4 b (6).

References

Required: FM 3-11.4

Related: FM 4-25.11, TM 10-8415-209-10, and TM 3-4240-279-10

031-503-3004

Supervise the Crossing of a Contaminated Area

Conditions: You receive orders to cross a chemical, biological, radiological, or nuclear (CBRN) contaminated area. You are given a unit with mission-oriented protective posture (MOPP) gear; organic decontamination equipment; individual decontaminating kits; an M256A1 chemical-agent detector kit; M8 chemical-agent detector paper; M9 chemical-detector tape; AN/VDR-2 and AN/UDR-13 radiac sets;

detection and/or warning devices; shielding material (such as sandbags); FM 3-11.4; FM 3-11.3; FM 3-5; and a defined CBRN contaminated area.

Standards: Supervise a unit crossing or passing through a CBRN contaminated area without producing additional casualties or spreading contamination.

Performance Steps

1. Supervise a unit crossing a nuclear contaminated area.
 - a. Before crossing—
 - (1) Provide shielding for personnel. Use vehicles if possible. Place sandbags on the floor and sides of all vehicles (within reason for nonarmored vehicles).
 - (2) Tell vehicle operators to close all doors, windows, hatches, and vents on vehicles.
 - (3) Have Soldiers cover all exposed skin by rolling down their sleeves and buttoning their collars. Ensure that they wear handkerchiefs or similar cloths over their noses and mouths to keep from breathing radioactive dirt or dust.
 - (4) Select the shortest possible route that would cause the least contamination and permit the fastest travel based on mission, enemy, terrain and weather, troops and support available, time available, civil considerations (METT-TC).
 - (5) Ensure that AN/UDR-13 and AN/VDR-2 radiac sets are available and operational.
 - (6) Delay entry into the area as long as possible, within the limits of the mission.
 - b. During crossing—
 - (1) Perform continuous monitoring.
 - (2) Have the monitors watch the dose rate on the AN/UDR-13 or AN/VDR-2 radiac set. Instruct them to keep you informed. Ensure that the commander's turn-back dose rate is not exceeded without approval.
 - (3) Have all personnel with dosimeters check them often to ensure that the commander's turn-back dose is not exceeded without approval.
 - (4) Move through the area as quickly as possible. Do NOT forget safety or security.
 - (5) Ensure that vehicles are far enough apart during movement to minimize dust. Consider the tactical situation, command, and control when spacing the vehicles.
 - c. After crossing—
 - (1) Have personnel check themselves and their equipment for contamination. Have everyone brush the dust from his/her clothing.
 - (2) Determine if decontamination is required.
2. Supervise a unit crossing a chemical contaminated area.
 - a. Before crossing—
 - (1) Select the shortest possible route that would cause the least contamination and allow the fastest travel based on METT-TC.

Performance Steps

- (2) Tell vehicle operators to close all doors, windows, hatches, and vents on vehicles.
 - (3) Assume MOPP4.
 - (4) Have Soldiers attach M9 detector paper to their clothing and equipment.
 - b.** During crossing—
 - (1) Ensure that vehicles are far enough apart during movement to minimize dust. Consider the tactical situation, command, and control when spacing vehicles.
 - (2) Move through the area as quickly as possible. Do NOT forget safety or security. Continuously monitor personnel for chemical-agent symptoms, and give first aid as required.
 - (3) Ensure that Soldiers avoid touching anything in the area if possible.
 - (4) Monitor personnel closely for symptoms of heat stress, and minimize excessive heat buildup.
 - c.** After crossing—
 - (1) Continue to monitor Soldiers for chemical-agent symptoms, and give first aid as required.
 - (2) Have Soldiers use detector paper to check themselves and their equipment for contamination.
 - (3) Have Soldiers use their decontaminating kits to decontaminate any contaminated skin or personal equipment. Seek medical aid as required.
 - (4) Have vehicle operators use available decontaminating equipment to decontaminate their vehicles if required.
- 3.** Supervise a unit crossing a biological contaminated area.
- a.** Before crossing—
 - (1) Select the shortest possible route that would cause the least contamination and allow the fastest travel based on METT-TC.
 - (2) Tell vehicle operators to close all doors, windows, hatches, and vents on vehicles.
 - (3) Assume the appropriate MOPP level as required.
 - b.** During crossing—
 - (1) Move through the area as quickly as possible. Do NOT forget safety or security.
 - (2) Ensure that personnel do not touch anything in the area that can be avoided.
 - (3) Ensure that vehicles are far enough apart during movement to minimize dust. Consider the tactical situation, command, and control when spacing vehicles.
 - c.** After crossing—
 - (1) Decontaminate personnel and equipment by washing them thoroughly with hot, soapy water if time and mission permit.

Performance Steps

- (2) Do as many of the steps as possible for the types of contamination present in the area.
- (3) Seek medical aid if required.

Evaluation Preparation: *Setup:* Evaluate this task during a field exercise or a normal training session. The contaminated area may have been marked with the appropriate markers; or a diagram may have been prepared showing the boundary of the contaminated area, the Soldier's present location, and the desired direction of travel. Gather the necessary equipment and personnel to conduct the movement. Obtain, for training purposes, a fictitious commander's operational exposure guidance (OEG) on the turn-back dose and the turn-back dose rate.

Note: Before conducting this task, ensure that Soldiers have been trained on the following tasks: 031-503-1001, 031-503-1037, 031-503-1013, and 031-503-1009.

Brief Soldier: Tell the Soldier to supervise the movement of a unit through a CBRN contaminated area by performing the appropriate measures before, during, and after the movement through the area. Give the Soldier an illustration, showing the boundary of the contaminated area, the Soldier's present location, and desired direction of travel through the contaminated area.

Performance Measures	GO	NO GO
1. Supervised a unit crossing a nuclear contaminated area.	___	___
2. Supervised a unit crossing a chemical contaminated area.	___	___
3. Supervised a unit crossing a biological contaminated area.	___	___

Evaluation Guidance: Refer to chapter 1, paragraph 1-4 b (6).

References

Required: FM 3-11.3, FM 3-11.4, and FM 3-11.5

Related:

SUBJECT AREA 4: SURVIVE (COMBAT TECHNIQUES)

052-195-3066

Direct Construction of Nonexplosive Obstacles

Conditions: You are given a mission directive, logistical support for the type of nonexplosive obstacles, squad personnel, organic equipment, and a FM 5-34.

Standards: Direct the construction of nonexplosive obstacles that are tied to existing or reinforced obstacles to block, channelize, or delay an enemy according to the mission brief or intent.

Performance Steps

1. Analyze mission requirements using the mission, enemy, terrain and weather, troops and support available, time available, civil considerations (METT-TC) factors. Consider the following:

- a. Manpower available.
- b. Barrier materials available.
- c. Time available.
- d. Type of transportation.
- e. Site selection (take advantage of existing obstacles).
- f. Type of obstacle to be constructed.
- g. Equipment available.

2. Direct the construction of wire obstacles.

Note: When using U-shaped pickets to construct obstacles, ensure that the open end of the U faces the enemy.

- a. Direct the construction of a triple-standard concertina fence.

(1) Ensure that work is done from the enemy side to the friendly side.

(2) Direct the installation of an anchor picket (short picket) at each end of the front row (located on the enemy side) and back row (located on the friendly side) with the first long picket being spaced 1.5 meters (2 paces) from the anchor picket.

(3) Ensure that long pickets are spaced at 3.8-meter (5-pace) intervals, staggering the pickets on the back row between the pickets on the front row (figure 052-195-3066-1).

Performance Steps

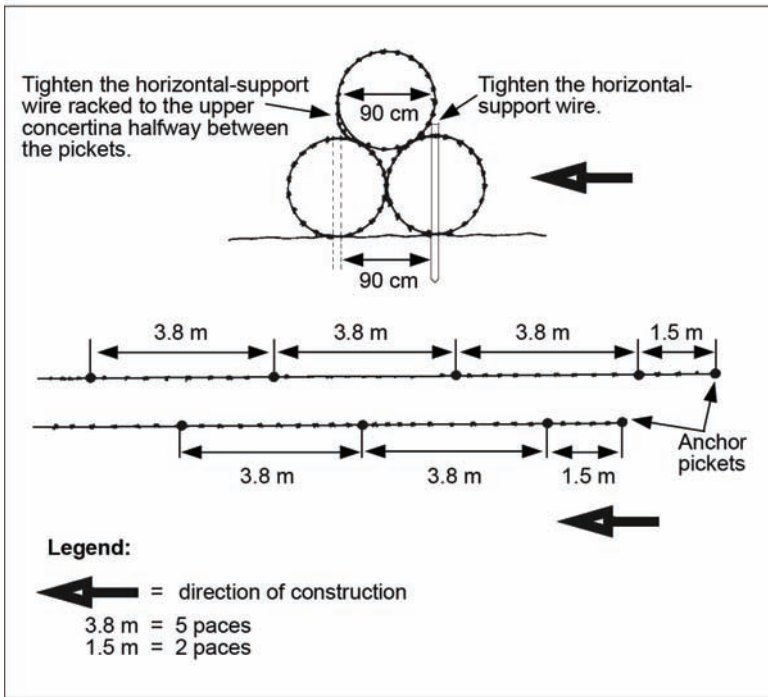

Figure 052-195-3066-1. Triple-standard concertina fence

Note: Install the pickets in such a manner that the lower notch of the long picket is 10 centimeters (4 inches) above ground.

(4) Direct the installation of the concertina wire. Ensure that—

(a) A roll of concertina wire is placed at the third picket in the front row and at every fourth picket thereafter (figure 052-195-3066-2).

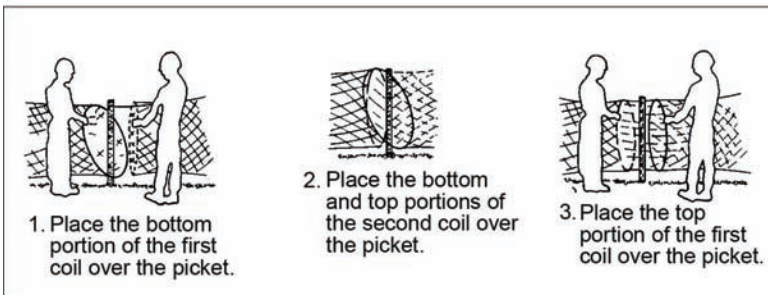

Figure 052-195-3066-2. Joining the concertina wire

Performance Steps

(b) The bottom rows of concertina wire are secured with a horizontal wire (barbed wire) on each row (figure 052-195-3066-3).

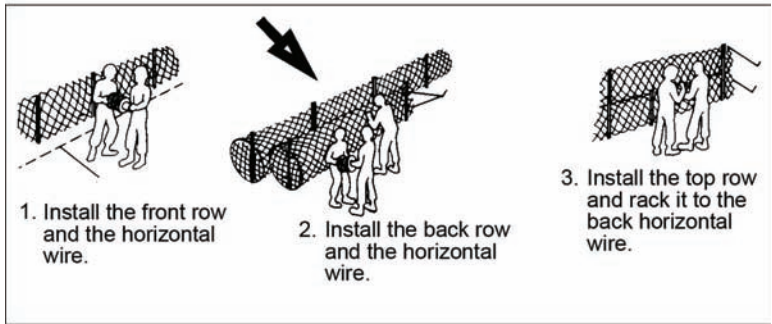

Figure 052-195-3066-3. Installing the concertina and horizontal wires

(c) The back row is begun once the first team has cleared the head of the first row of the fence.

(5) Direct the installation of the remaining row of concertina wire on top of the first two rows, and fasten it securely to the back horizontal wire.

(6) Ensure that the concertina wire is properly tied and that all horizontal wires are properly installed.

b. Direct the construction of a knife rest.

(1) Ensure that work is done from the enemy side to the friendly side and from the bottom up.

(2) Ensure that the knife rest is 3 to 5 meters (10 to 16 feet) long (figure 052-195-3066-4). Ensure that—

(a) The end poles (1.2 meters [4 feet] in height and width) are lashed to form two Xs.

(b) The center pole (3 to 5 meters [10 to 16 feet] in length) is laid across the top intersection of the Xs with each end of the pole lashed to the X.

(c) Barbed wire is used to complete the knife rest.

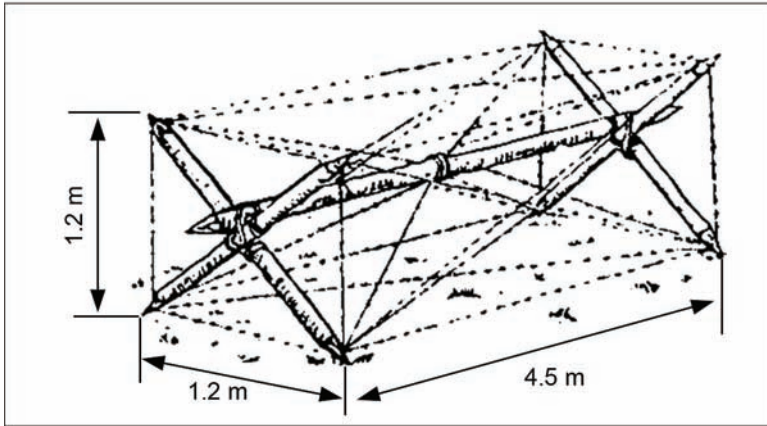

Figure 052-195-3066-4. Knife rest

c. Direct the construction of an 11-row obstacle out of concertina wire.

(1) Ensure that long pickets are installed at 3.8-meter (5-pace) intervals for 11 rows (figure 052-195-3066-5).

NOTE: Place three long pickets 3.8 meters (5 paces) apart per coil, and place the horizontal wire on top of the coil.

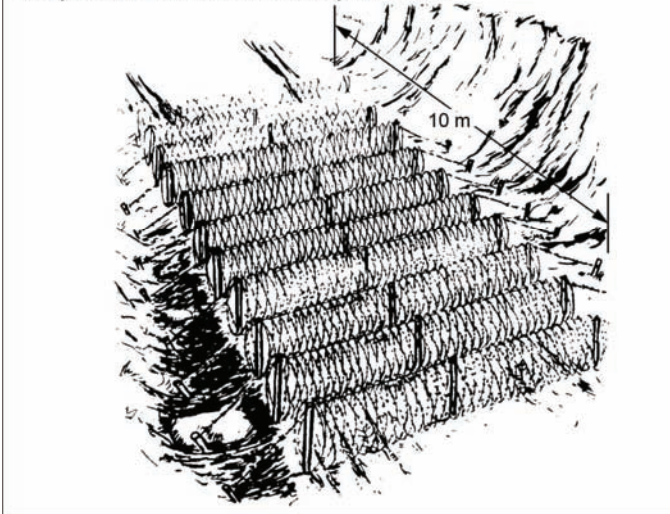

Figure 052-195-3066-5. An 11-row obstacle

(2) Direct the placement of the concertina wire over the long pickets.

Performance Steps

- (3) Ensure that the horizontal wire (barbed wire) is anchored to the anchor pickets, which is 1.5 meters (2 paces) from each end of the concertina rows.
 - (4) Ensure that the horizontal wire is secured over the row of concertina wire.
 - (5) Ensure that a log (20 centimeters [8 inches] in diameter) is placed between the fifth and sixth rows.
 - (6) Ensure that the obstacle is no less than 10 meters (33 feet) deep.
3. Direct the construction of antitank (AT) ditch obstacles (figure 052-195-3066-6).

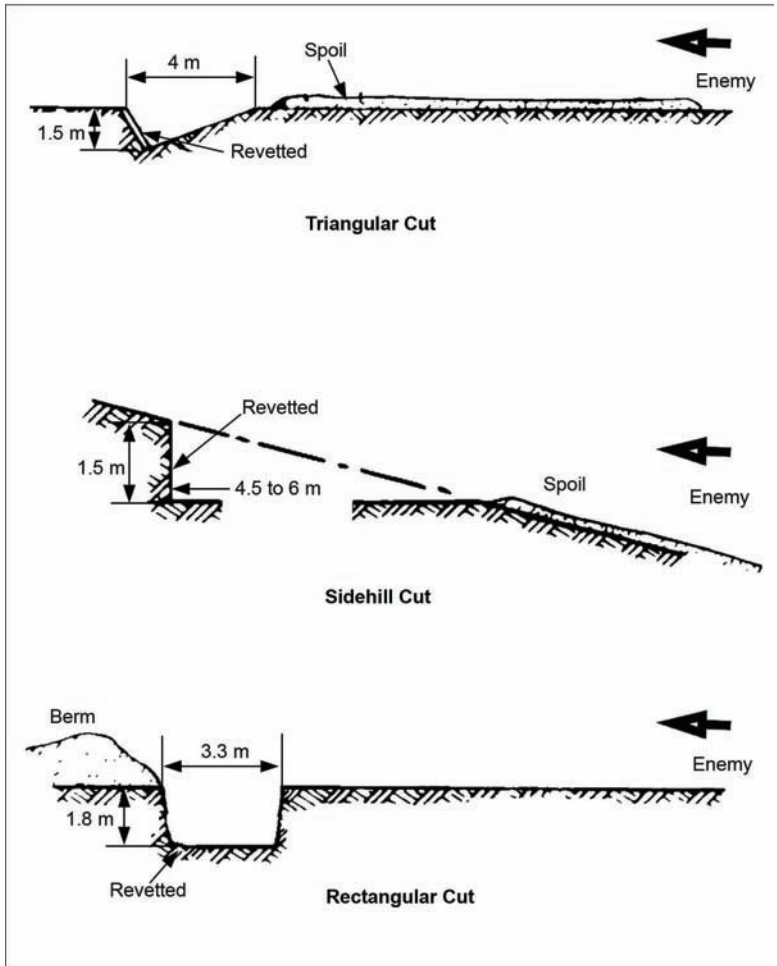

Figure 052-195-3066-6. AT ditch obstacles

Performance Steps

- a. Direct the construction a triangular AT ditch obstacle. Ensure that—
 - (1) The T-push method is used with a dozer/dozer, dozer/loader, dozer/armored combat earthmover (ACE), ACE/ACE, or ACE/loader team configuration.
 - (2) The ditch is dug to a minimum of 1.5 meters (5 feet) deep and 4 meters (13 feet) wide.
 - (3) The spoil is spread on the enemy side of the ditch.
 - b. Direct the construction of a sidehill-cut AT ditch obstacle. Ensure that—
 - (1) The T-push method is used with a dozer/dozer, dozer/loader, dozer/ACE, ACE/ACE, or ACE/loader team configuration.
 - (2) The tank ditch is cut to a minimum of 1.5 meters (5 feet) deep and 4.5 to 6 meters (15 to 20 feet) wide.
 - (3) The spoil is spread on the enemy side of the ditch.
 - c. Direct the construction of a rectangular AT ditch obstacle. Ensure that—
 - (1) The T-push method is used with a dozer/dozer, dozer/loader, dozer/ACE, ACE/ACE, or ACE/loader team configuration.
 - (2) The tandem method is used with a scraper/scrapper, scraper/ACE, or a scraper/dozer team configuration.
 - (3) The ditch is dug to a minimum of 1.8 meters (6 feet) deep and 3.3 meters (11 feet) wide.
 - (4) A berm is placed on the friendly side of the ditch.
4. Direct the construction of barrier obstacles.
- a. Ensure that barrier materials are obtained. Barrier materials include—
 - (1) Steel hedgehogs and tetrahedrons (figure 052-195-3066-7).

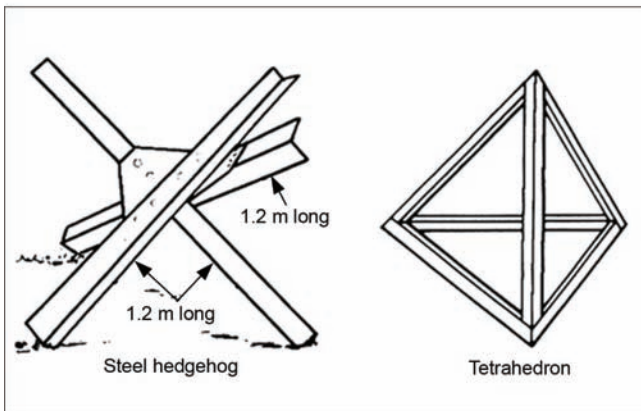

Figure 052-195-3066-7. Steel hedgehog and tetrahedron

Performance Steps

- (2) Concrete tetrahedrons and cubes (figure 052-195-3066-8).

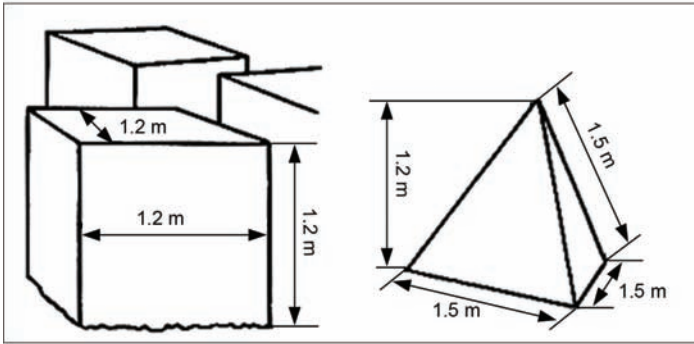

Figure 052-195-3066-8. Concrete Cubes and tetrahedron

- (3) Jersey barriers (figure 052-195-3066-9).

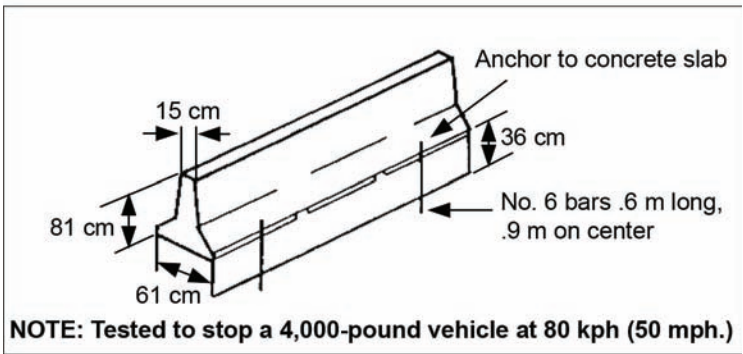

Figure 052-195-3066-9. Jersey barrier

- (4) HESCO Bastion Concertainer® (figure 052-195-3066-10).



Figure 052-195-3066-10. HESCO Bastion Concertainer®

- b. Ensure that barrier materials (figure 052-195-3066-11) are employed.

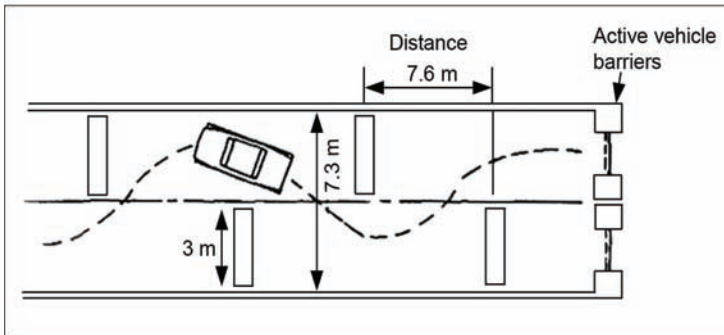

Figure 052-195-3066-11. Concrete obstacle placement

Note: The distance between barriers will vary depending on the type of traffic expected (cars, trucks, or semitrailers).

Evaluation Preparation: *Setup:* Provide the Soldier with the items listed in the conditions and a mission brief describing the type of obstacle to be replaced.

Brief Soldier: Tell the Soldier to direct the construction of the obstacle according to the mission brief.

Performance Measures	GO	NO GO
1. Analyzed mission requirements using the METT-TC factors.	_____	_____

Performance Measures	GO	NO GO
2. Directed the construction of wire obstacles.	___	___
3. Directed the construction of AT ditch obstacles.	___	___
4. Directed the construction of barrier obstacles.	___	___

Evaluation Guidance: Refer to chapter 1, paragraph 1-4 b (6).

References

Required: FM 5-34

Related: FM 5-102

071-410-0012

Conduct Occupation of an Assembly Area

Conditions: As a platoon-sized unit leader, given a company commander's order to occupy a specific sector of a company assembly area and a map of the operational area.

Standards: Move the unit to the location specified in the company order; ensure preparation of the assigned sector is completed in the time specified in the order; and position elements, weapons, and observation posts (OPs) in a manner that support the company plan for occupying the assembly area (AA).

Performance Steps

1. Prepare to occupy the AA.

a. Perform the required troop-leading procedures (TLPs). TLPs are a series of eight interrelated, overlapping processes that are often accomplished concurrently and do not follow a rigid sequence. Use the procedures as outlined below, if only in abbreviated form, to ensure that nothing is left out of planning and preparation and that Soldiers understand the mission and prepare adequately.

(1) Receive the mission in the company operation order (OPORD).

(2) Issue the warning order to subordinate leaders. Include location, special equipment required, and the earliest time for movement.

(3) Make a tentative plan for moving to and preparing the position based on the estimate of the situation and an analysis of mission, enemy, terrain and weather, troops and support available, time available, civil considerations (METT-TC). Your plan must support the company plan for occupying the AA.

(4) Start necessary movement. Movement might need to start while you are still planning. Movement can occur anytime during the TLP.

(5) Reconnoiter the position and the route(s) to it. The situation might prohibit this. At least conduct a map reconnaissance to confirm or deny assumptions made during the estimate of the situation.

(6) Complete the plan.

(7) Issue the order to subordinate leaders. Use the standard OPORD format. At a minimum, include—

(a) Situation.

(b) Mission and purpose for occupying the AA.

Performance Steps

- (c) Each squad's position (left, right, center) in the platoon sector.
 - (d) Security plan (passwords, OPs, percent of personnel on alert).
 - (e) Times for movement or occupation of the AA.
 - (f) Other pertinent information such as location of the command post, methods of waste disposal, and plan for dealing with environmental hazards.
 - (8) Supervise continuously.
- b. As needed, coordinate with elements that will be attached to or adjacent to your position in the AA.
 - c. Provide platoon representatives for the company quartering party. Tell them to perform the following tasks or other tasks as required:
 - (1) Reconnoiter the AA to ensure that it is clear of the enemy.
 - (2) Establish initial security.
 - (3) Select initial positions for all platoon elements.
 - (4) Identify, clear, or mark obstacles in the platoon sector of the AA.
2. Direct platoon movement to the designated platoon release point. Use appropriate movement techniques based on the terrain and the situation.
3. Prepare your sector of the AA according to the company plan.
- a. Link up with guides and move the platoon to its initial position.
 - b. Establish and maintain local security.
 - c. Assign squad sectors. Ensure that sectors are mutually supporting and that all gaps are covered by fire and observation.
 - d. Designate OP(s) locations and the elements responsible for establishing and maintaining them.
 - e. Ensure that communications are established within the platoon and company.
 - f. Submit timely progress reports to company headquarters.
 - g. Establish and enforce priority of work. The following is an example of work priority and may vary based on the unit standing operating procedure (SOP), mission, or METT-TC:
 - (1) Position vehicles, crew-served weapons, and chemical-agent alarms, and designate principal direction of fire (PDF), final protective line (FPL), and final protective fire (FPF).
 - (2) Construct fighting position.
 - (3) Set up wire communications.
 - (4) Prepare range cards.

Performance Steps

- (5) Distribute ammunition, rations, water, supplies, and special equipment.
 - (6) Conduct preventive maintenance checks and services (PMCS) on equipment.
 - (7) Inspect personnel and equipment.
 - (8) Rehearse critical aspects of the upcoming mission.
 - (9) Test small arms (if situation permits).
 - (10) Conduct personal hygiene and field sanitation.
 - (11) Institute a rest plan.
- h.** Coordinate with adjacent units and others as required.
- (1) Coordinate for security patrols (if applicable).
 - (2) Establish responsibility for overlapping enemy avenues of approach between adjacent units.
 - (3) Ensure that there are no gaps between elements.
 - (4) Exchange information on OP locations and unit signals.
 - (5) Coordinate for local counterattacks.
 - (6) Complete and forward a copy of the platoon sector sketch to company headquarters.

Evaluation Preparation: *Setup:* This task should be evaluated during a field training exercise. Otherwise, assign an assembly area to be occupied and a quartering party that has accomplished its tasks according to the company and platoon SOP.

Brief Soldier: Issue an OPORD for an operation requiring the occupation of an assembly area.

Performance Measures	GO	NO GO
1. Conducted preparations for occupying the AA.	___	___
2. Directed platoon movement to the designated release point. Used the appropriate movement technique based on the terrain and situation.	___	___
3. Prepared assigned sector of AA according to the company plan.	___	___

Evaluation Guidance: Refer to chapter 1, paragraph 1-4 b (6).

References

Required:

Related: FM 3-21.71, FM 7-7, and FM 7-8

071-420-0021

Conduct a Movement to Contact by a Platoon

Conditions: In a combat environment, given a platoon and a mission requiring movement to contact.

Standards:

1. Develop a plan that includes objectives, routes, key terrain, fire support, formations, and other required control measures.
2. Include in the preparations the cleaning and test firing of weapons, maintenance of vehicles and equipment, and the resupply of ammunition or needed equipment.
3. Make contact with the threat with the smallest possible element. Develop the situation by controlling movement and fires. Submit situation reports as required.

Performance Steps

1. Receive and analyze the mission.

Note: A warning order should be issued to provide subordinates with as much preparation time as possible.

2. Make a tentative plan.
3. Start preparations.
4. Conduct reconnaissance.
5. Finalize the plan.

Note: Preparation continues as the plan develops. New information is incorporated into preparations. The operation order is issued at the time and place specified in the warning order.

6. Continue preparations.
7. Request supplies.
8. Receive supplies.
9. Conduct rehearsals.
10. Conduct final inspection.
11. Control movement.
12. Control fires.
13. Report contact to the company.

Evaluation Preparation: *Setup:* At the test site, provide an area in which a movement to contact can be conducted. Test this task during a platoon or larger tactical exercise.

Brief Soldier: Tell the Soldier, as the leader of a platoon, to conduct a movement to contact and then must react properly to enemy fire.

Performance Measures	GO	NO GO
1. Received and analyzed the mission.	___	___
2. Made a tentative plan.	___	___
3. Started the preparations.	___	___

Performance Measures	GO	NO GO
4. Conducted the reconnaissance.	___	___
5. Finalized the plan.	___	___
6. Continued preparations.	___	___
7. Requested supplies.	___	___
8. Received supplies.	___	___
9. Conducted rehearsals.	___	___
10. Conducted the final inspection.	___	___
11. Controlled movement.	___	___
12. Controlled fires.	___	___
13. Reported contact to the company.	___	___

Evaluation Guidance: Refer to chapter 1, paragraph 1-4 b (6).

References

Required:

Related: FM 3-21.71, FM 7-7, and FM 7-8

071-430-0028

Consolidate a Unit

Conditions: Given a squad leader with squad or platoon sergeant with platoon or acting platoon leader defending as part of a larger unit. Your element has just repelled an enemy assault.

Standards: Consolidate the unit (squad or platoon) in the defense following enemy contact.

Performance Steps

Once enemy resistance on the objective has ceased, the squad or platoon must quickly take the following steps to consolidate and prepare to defend against a counterattack:

1. Reestablish security if the observation post (OP) withdrew back to the defensive position, and then send OP personnel back out. If OP personnel do not return, they must be accounted for and returned.
2. Use snipers (if available) for targets of opportunity. They may be employed with the OP or at a vantage point on or behind the defensive positions.
3. Restore camouflage and improve fighting positions. Do not over-camouflage positions. If it was not found during the first assault, chances are it will not be found during the next counterattack.

Performance Steps

4. Reestablish communications to higher headquarters and throughout the platoon and squad. Check wires to ensure that it does not break during the attack. Change pyrotechnic signals because the enemy may have learned what they represent.
5. Replace obstacles, mines, and early warning devices (conduct only if the enemy withdraws far enough and time permits). This is a risky action, especially if the enemy has snipers. Soldiers must use caution when moving about. Request smoke to conceal movement or have them wait until limited visibility.
6. Reposition fighting and weapons positions. If the squad or platoon has just repelled an attack, the enemy may have found some of the positions. Reposition those that have been compromised.
7. Reassign sectors of fire to ensure that all gaps caused by the evacuation of casualties are covered and that the firing positions remain mutually supporting.
8. Implement alert and sleep plans once all of the above have been accomplished, and it is feasible to the situation.

Evaluation Preparation: *Setup*: Provide a squad or platoon in an established defensive position, simulated casualties, simulated enemy prisoners of war (EPWs), simulated destroyed crew-served weapons, blank ammunition, and a communication network.

Brief Soldier: Tell the Soldier that his/her unit has just repelled an enemy attack. He/she must now consolidate the unit to prepare for a counterattack.

Performance Measures	GO	NO GO
1. Reestablished security throughout the squad and platoon's sector.	_____	_____
2. Used snipers (if available).	_____	_____
3. Restored camouflage and improved positions.	_____	_____
4. Reestablished communications.	_____	_____
5. Replaced obstacles, mines, and early warning devices.	_____	_____
6. Repositioned fighting and weapon positions.	_____	_____
7. Reassigned sectors of fire for the squad and platoon.	_____	_____
8. Implemented sleep and alert plans (if feasible).	_____	_____

Evaluation Guidance: Refer to chapter 1, paragraph 1-4 b (6).

References

Required: FM 7-8

Related: FM 3-21.71, FM 3-22.90, FM 7-10, and FM 7-7

071-430-0029

Reorganize a Unit

Conditions: Given a squad leader with squad, or platoon sergeant with platoon, or mortar section sergeant, or acting platoon leader defending as part of a larger unit. Your element has just repelled an enemy assault.

Standards: Reorganize the unit (squad, platoon, or mortar section) in the defense following enemy contact.

Performance Steps

1. The platoon leader must plan the required reorganization of the platoon while defending (either deliberate or hasty). He/she must include his/her plan in the order to the squad leaders. The plan must be tentative and flexible and may be changed as the situation evolves. The leader's plan must be as complete and detailed as possible.
 2. Reorganize a unit:
 - a. Reestablish the chain of command; fill all key positions from the remaining element members and ensure that the new chain of command is disseminated down to the last member of your element.
 - b. Evacuate the dead and seriously wounded according to your casualty evacuation plan; ensure that all positions and sectors remain mutually supporting; check all sectors of fire after all casualties are evacuated to ensure that all sectors are covered; If necessary, shift positions or reassign sectors to cover any gaps in your sector.
 - c. Redistribute or resupply ammunition, weapons, and fuel; ensure that the squad leaders pass out additional ammunition (if available), or divide the remainder equally throughout the squad or platoon; conduct a quick inventory and submit a supply request to higher headquarters if necessary.
 - d. Ensure that all enemy prisoners of war (EPWs) are evacuated and that enemy material and enemy information are collected and reported (if possible).
 - e. Ensure that all crew-served weapons are manned and positioned on likely avenues of approach.
 - f. Issue to higher headquarters a liquid, ammunition, casualties, equipment (LACE) report to include—
 - (1) L—Liquid, how much water each Soldier has left (canteens per).
 - (2) A—Ammunition, how much ammunition does the squad or platoon have per Soldier (after redistribution).
 - (3) C—Casualties, how many casualties the squad or platoon encounters.
 - (4) E—Equipment, how much special equipment the squad and platoon have remaining.
-

Performance Steps

3. For the mortar section—
 - a. Reestablish section communications.
 - b. Reestablish the fire direction center (FDC).

Evaluation Preparation: *Setup:* Provide a squad or platoon in an established defensive position, simulated casualties, simulated EPWs, simulated destroyed crew-served weapons, blank ammunition, and a communication network.

Brief Soldier: Tell the Soldier that he/she must reorganize the unit following enemy contact.

Performance Measures	GO	NO GO
1. Reestablished and disseminated the chain of command.	_____	_____
2. Evacuated the dead and seriously wounded.	_____	_____
3. Ensured all positions remained mutually supporting.	_____	_____
4. Checked sectors of fire.	_____	_____
5. Redistributed or resupplied ammunition, weapons, and fuel if needed.		
6. Ensured that squad leaders and platoon sergeants handed out additional ammunition if available.		
7. Ensured that all EPWs were reported and evacuated as soon as possible (ASAP).		
8. Ensured that all crew-served weapons were manned.		
9. Issued a LACE report to higher headquarters.		
10. Reestablished section communications (mortar section).		
11. Reestablished the FDC (mortar section).		

Evaluation Guidance: Refer to chapter 1, paragraph 1-4 b (6).

References

Required: FM 7-8

Related: FM 3-21.71, FM 3-22.90, FM 7-10, and FM 7-7

071-331-0820**Analyze Terrain**

Conditions: Given any tactical mission that involves a specified route or location on the ground or a map, and a standard 1:50,000 scale military map.

Standards: Analyze the route or location in terms of the five military aspects of terrain and determine how each aspect affects the mission.

Performance Steps

Note: To help in analyzing terrain, use the key word OAKOC (observation and fields of fire, avenues of approach, key terrain, obstacles, and cover and concealment).

1. Observation and fields of fire.

a. Observation requires terrain that permits a force to locate the enemy, either visually or through surveillance devices. The best observation generally is obtained from the highest terrain features in an area. Analyze the effects of visibility on observation with weather rather than terrain, because visibility varies with weather, whereas observation varies with terrain.

b. Fire encompasses the influence of the terrain on the effectiveness of direct and indirect fire weapons. Indirect fire is mainly affected by terrain conditions within the target area. Fields of fire for direct fire weapons are mainly affected by terrain conditions between the weapon and target.

c. Identify the terrain features in and by the area of operations (AO) that gives the friendly or enemy force favorable observation and fire. Consider these terrain features in your subsequent analysis of key terrain, enemy forces, and cover and concealment.

2. Avenues of approach.

a. An avenue of approach is a route for a force of a particular size to reach an objective or key terrain. To be an avenue of approach, a route must be wide enough to deploy the size force that will be using it.

b. Analyze an avenue of approach solely on the following terrain considerations:

(1) Observation and fire. Determine if the avenue of approach provides favorable observation and fire for the force moving on it.

(2) Concealment and cover. Determine if the avenue of approach provides cover and concealment. Both can conflict with observation and fire.

(3) Obstacles. Determine if the avenue of approach avoids obstacles that are perpendicular to the direction of advance and, when practical, that takes advantage of those that are parallel to the direction of advance.

(4) Use of key terrain.

(5) Adequate maneuver space.

Performance Steps

(6) Ease of movement.

3. Key terrain. A key terrain feature is any point or area that seizure or control affords a marked advantage to either force. "Seizure" means physical occupation of the terrain by a force, whereas "control" might or might not include physical occupation. The selection of key terrain varies with the level of command, the type of unit, and the unit's mission.

4. Obstacles.

a. An obstacle is any natural or artificial terrain feature that stops or impedes military movement.

b. The mission influences consideration of obstacles.

c. An obstacle might be an advantage or disadvantage. Consider each on its own merits, and for each specific mission. For example, obstacles perpendicular to a direction of attack favor the defender because they slow or channelize the attacker. Obstacles parallel to the direction of attack can help protect the flank of the attacking force.

5. Cover and concealment. Cover is protection from the effects of fire. Concealment is protection from observation. You must determine the cover and concealment available to both friendly and enemy forces.

a. Cover might be provided by terrain features or manmade features. Areas that provide cover from direct fire might or might not protect against the effects of indirect fire. Most terrain features that offer cover also offer concealment.

b. Concealment might be provided by terrain features, vegetation (such as wood, underbrush, or cultivated vegetation), or any other feature that denies observation. Concealment does not necessarily provide cover.

Evaluation Preparation: *Setup:* Give the Soldier a tactical mission that involves a specified route or location on the ground or a map. If only a map is used, issue a standard 1:50,000 scale military map to the Soldier.

Brief Soldier: Tell the Soldier to analyze the route or location in terms of the five military aspects of terrain and determine how each aspect affects the mission.

Performance Measures	GO	NO GO
1. Identified effects of terrain on observation and fire.	—	—
2. Identified concealment and cover along the route or at the position.	—	—
3. Identified obstacles that would be an advantage and a disadvantage along the route or at the position.	—	—

Performance Measures	GO	NO GO
4. Identified key terrain along the route or at the position.	_____	_____
5. Identified the best avenue of approach.	_____	_____

Evaluation Guidance: Refer to chapter 1, paragraph 1-4 b (6).

071-332-5000

Prepare an Operation Overlay

Conditions: Given a complete copy of the operation order (OPORD) that your unit is to execute, a commander's or a battalion operations officer's (S3) guidance (to include time available for preparation), overlay paper, tape, a map of the operational area, colored pencils (red, black, blue, green, and yellow), a No. 2 pencil, a coordinate scale, and FM 101-5-1.

Standards: Within the time specified, ensure that the overlay—

1. Is identified by map reference data, effective date, and purpose.
2. Contains classification markings and downgrading instructions, if applicable.
3. Contains distribution instructions and authentication, if distributed separately.
4. Is prepared according to overlay techniques outlined in FM 101-5-1.
5. Is prepared with boundaries and unit locations plotted to within 50 meters and tactics and fire support measures to within 25 meters.

Performance Steps

Note: Overlay techniques involve the use of military symbols to portray, in a condensed form, the plans, orders, and information concerning a military operation.

1. Register the overlay.
 - a. Orient the overlay material over the map area to the annotated portion and temporarily attach edit to the map with the tape.
 - b. Trace the grid intersections nearest the opposite corners of the overlay and label each with the proper grid coordinates.
2. Plot detail. Use colored pencils or markers in standard colors, when available, to plot any detail (FM 1-02); otherwise, plot the activity to be shown with a pen or pencil that makes a lasting mark, but without cutting the overlay. Use standard military symbols where possible. When nonstandard symbols are used, identify them on the edge of the overlay. Show only the detail with which the document is directly concerned. Use the following standard colors:
 - a. Blue or black: Friendly units, installations, equipment, and activities.
 - b. Red: Enemy installations, equipment, and activities.

Performance Steps

c. Yellow: Any areas of chemical, biological or radiological contamination.

d. Green: Any manmade obstacle.

Note. If only one color is available, show enemy symbols with double lines.

3. Mark the overlay's classification. The classification depends on the classification of the information used to prepare the overlay. Mark the classification on the top and bottom of the overlay.

4. Use the following overlay techniques:

a. Solid and broken lines.

(1) Use solid lines to represent the location of a unit or installation or coordinating detail (such as a line of departure or boundary) that is in effect and will continue; or a location that the operation order will affect.

(2) Use broken lines to represent any proposed or future location, or any coordinating detail to become effective later:

b. Indicated boundaries.

(1) Boundaries show the areas of tactical responsibility. In the offense, these are called zones of action. In the defense and retrograde, they are called sectors of responsibility. When you describe them verbally, describe their lateral boundaries from rear to front in the offense, and from front to rear in the defense and retrograde.

(2) Use rear boundaries when you must precisely define the area of responsibility for forward units. When no rear boundary is delineated, determine the rear limit of a unit's area of responsibility by visualizing a rear boundary, drawn generally parallel to the front, along a natural terrain feature, and connecting at the rearward limit of the unit's lateral boundaries.

(3) Mark the rear boundary as shown. Ensure that the size shown along the boundary corresponds to the low unit. Show the arm or branch as needed to prevent confusion (figure 071-332-5000-1).

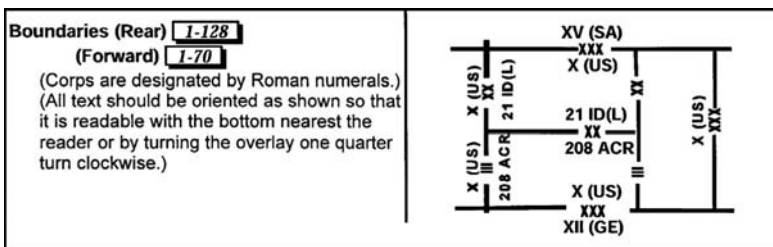

Figure 071-332-5000-1. Rear boundary

Performance Steps

(4) Draw boundaries along terrain features that are easily recognizable on the ground, and where situated, if possible, so that the key terrain features, avenues of approach, and river can completely include the one unit. Show them with a solid line if they are currently in effect or if the OPORD will affect them. Using them is based on the techniques and tactics peculiar to the type of tactical operation.

(5) Use a broken line to represent future or proposed boundaries, and label them to indicate their effective time, if appropriate (figure 071-332-5000-2).

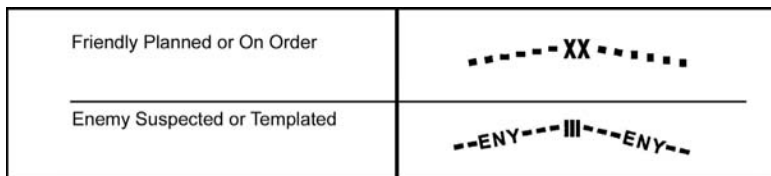

Figure 071-332-5000-2. Proposed boundary

(6) Mark boundaries as follows: Place a symbol on the boundary to show size and designation of the highest units that shared the boundary.

(7) Show units of unequal size. Completely show the symbols of the higher unit and the designation of the lower unit to show its size. The boundary between the 52ID (M) and the 312 SIB (M) is shown in figure 071-332-5000-3.

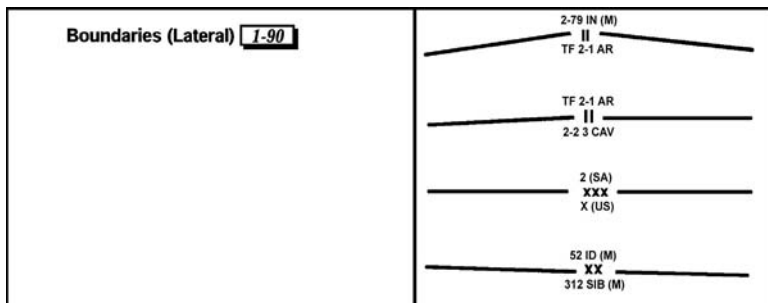

Figure 071-332-5000-3. Lateral boundary

(8) Identify overlays or sketches accompanying written or oral orders that specify task organization. Indicate numerical unit designation on battalion boundaries. When the battalion is organized into a task force, precede the numerical designation with the letters "TF." Identify a unit symbol as task force by placing the TF symbol over the unit size designation (||). Label company boundaries with the appropriate letter, unless the company is organized into a team. In the latter case, label the boundary with the abbreviation TM plus the letter designation or a code name. On other boundaries, only the unit designation needed for clarity is required. Add branch designations only when necessary for clarity. When unequal-sized units share a boundary, spell out the designation of the smaller unit.

Performance Steps

c. Marked axis of advance.

(1) Extend an axis of advance arrow only as far as this form of control is essential to the overall plan. Normally, it is shown from the line of departure (LD) to the objective following an avenue of approach. It shows that the commander may maneuver his/her forces and place them freely to either side of the axis. The purpose is to avoid obstacles, engage the enemy, or bypass enemy forces that cannot threaten his/her security or jeopardize accomplishing the mission. The commander ensures that such deviation does not interfere with adjacent units, that his/her unit remains oriented on the objective, and that the location and size of the bypassed enemy forces is reported to higher headquarters. When the situation dictates, the commander assigns boundaries as an additional control measure when using the axis of advance.

(2) Show an axis of advance as shown below, identified by a code. You could identify it with a unit designation (figure 071-332-5000-4).



Friendly Ground Axis of Supporting Attack I-147	
Friendly Ground Axis of Main Attack I-94	
Friendly Ground Axis On Order with Date and Time (if known) Effective	
Enemy Confirmed	
Enemy Templated	

Figure 071-332-5000-4. Axis of advance

(3) Differentiate between a ground axis of advance and an air assault of advance. To do so, use a twist in the shaft of the open arrow, like a propeller (figure 071-332-5000-5).

Performance Steps

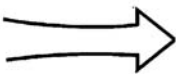

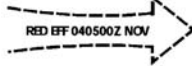
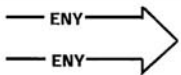
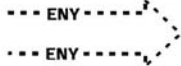
<p>Axis of Advance 1-14 (The tip of the arrow should touch the objective or limit of the movement.)</p>	
<p>Friendly Aviation</p>	
<p>Friendly Attack Helicopter</p>	

Figure 071-332-5000-5. Air assault axis of advance

d. Show direction of attack arrows. Use this control measure when the commander wants to say where the center of mass of a subordinate unit must move in an attack to ensure the accomplishment of a closely coordinated plan of maneuver. One example would be a night attack or counterattack. Extend a direction of attack arrow from the LD to the objective. Do not label it (figure 071-332-5000-6).



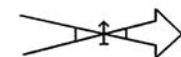

<p>Direction of Attack 1-53 (The tip of the arrow should touch the objective or limit of the movement.)</p>	
<p>Friendly Aviation Planned or On Order</p>	
<p>Enemy Known/Confirmed Aviation</p>	
<p>Templated Enemy Aviation</p>	
<p>Enemy Confirmed/Known Ground</p>	
<p>Templated Enemy Ground</p>	
<p>Friendly Direction of Supporting Attack 1-147</p>	
<p>Friendly Planned or On Order</p>	

Figure 071-332-5000-6. Direction of attack arrow

Performance Steps

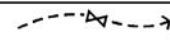
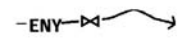
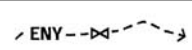
- (1) Use the arrow only where necessary because it restricts the maneuver of the subordinate unit.
- (2) When the unit is directed to seize successive objectives with its main attack along a certain line, use either one arrow extending through the objectives to the final objective or a series of arrows connecting the objectives.
- (3) Use the double arrowhead to distinguish the main attack for the command as a whole (figure 071-332-5000-7).

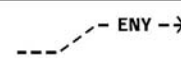

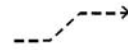
Figure 071-332-5000-7. Arrowhead indicating the main attack

- e. Graphically portray units assigned with a security mission.

(1) Show the general location of a unit with a security mission; arrows generally indicate the terrain where the unit operates and the farthest extension of its mission (figure 071-332-5000-8).

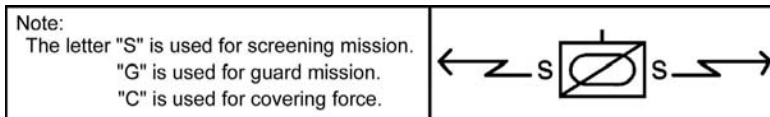

Figure 071-332-5000-8. Unit with security mission

- (2) Show the primary security mission.

- f. Graphically portray supply routes.

(1) The main supply route (MSR) is the route(s) designated within an area of operations where most of the traffic flows in support of the operation. Label the route MSR and assign it a code name.

Note: Do not use the term MSR below division level.

(a) In the defense, the division extends the MSR forward to the brigade trains. The brigade's supply route (SR) extends from the battalion trains to a point at the rear of the forward company defense sectors.

(b) In the offense, the proposed SR is shown forward to the objective or as far as the battalion supply officer (S4) can visualize sustainment for the operation. Forward of the LD, show it as a broken line.

(2) Show the symbols to show the division (offensive action) as shown in figure 071-332-5000-9.

Performance Steps





Supply Routes I-95 Main Supply Route	MSR NAME 
Alternate Supply Route I-8	ASR NAME 
One-way Traffic	MSR NAME 
Alternating Traffic	MSR NAME 
Two-way Traffic	MSR NAME 

Figure 071-332-5000-9. Divisions MSR

(3) Show sustainment facilities on the operation overlay, or the S4 disseminates their location, as appropriate.

g. Portray unit locations.

(1) To show the location of a unit on an overlay, draw the symbol so that its center corresponds with the coordinates where the unit is located (figure 071-332-5000-10).

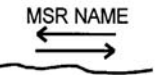

A solid line symbol represents a present or actual location.	
A broken line symbol indicates a future or projected location.	

Figure 071-332-5000-10. Location of a unit

(2) Show the location of a trains area, observation posts, or logistical activity. Ensure that the center of the symbol corresponds with the element's coordinates. Figure 071-332-5000-11 shows the location of an observation post.

Observation Post/Outpost I-112	
---------------------------------------	---

Figure 071-332-5000-11. Location of an observation post

Performance Steps

(3) Use the offset technique for clarity when space precludes normal placement of symbols. "Bend" offset staffs as required. Dash the offset staff for future or proposed locations. Extend offset staffs vertically from the bottom center of the symbol (except for command posts [CPs]). The end of the offset staff shows the exact locations of CPs and aid stations, as well as the center of mass for other units or installations. Ensure that the staff for a CP symbol is always on the left edge (figure 071-332-5000-12).

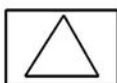

Basic symbols other than the headquarters symbol (for example, points) may be placed on a staff which is extended or bent. The end of the staff indicates the precise location.	
Since the headquarters symbol already includes a staff, this staff may be extended or bent. The end of the staff, or extension (if used), indicates the exact location of the headquarters.	

Figure 071-332-5000-12. Offset technique

(4) Locate units.

(a) Show the locations of attacking units with boundaries (and CP symbols, when the locations of the CPs are known) or with unit symbols.

(b) Show the location of the reserve with an assembly area symbol and with a CP or unit symbol.

(c) Normally show the reserve units of a force assigned to a defense position or battle position with a line enclosing the area occupied or to be occupied—in other words, a "goose egg." Number or letter these positions for convenience. Figure 071-332-5000-13 shows an occupied and unoccupied company assembly area (reserve location). Figure 071-332-5000-14 shows an occupied and unoccupied reserve company battle position.

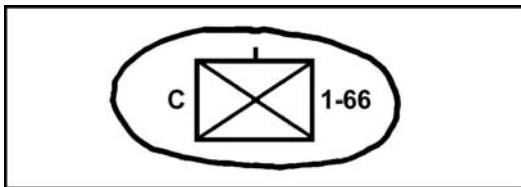

Figure 071-332-5000-13. Occupied and unoccupied company assembly area (reserve location)

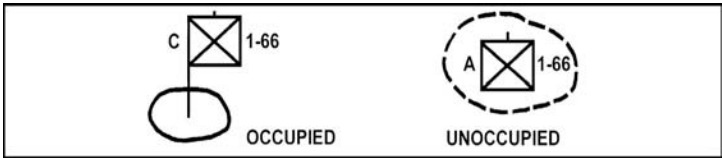

Figure 071-332-5000-14. Occupied and unoccupied reserve company battle position

h. Identify objective(s). Identify each objective by the abbreviation "OBJ" and a number, letter, or name designation (figure 071-332-5000-15).



Figure 071-332-5000-15. Objective

Note: An objective assigned by higher headquarters may be given entirely to one subordinate unit or may be divided. If divided, the objective may be shown graphically as separate objectives and numbered accordingly, or they may be divided into two objectives by a boundary line.

i. Pinch out a unit.

(1) Show this type of operation by drawing the boundary across the front of the unit, usually along a well-defined terrain feature such as a stream, ridge, or highway.

(2) The following example shows that Company A will be pinched out after seizing OBJ 1; then, Company B will seize OBJ 2 and continue the attack to seize OBJ 3 (figure 071-332-5000-16).

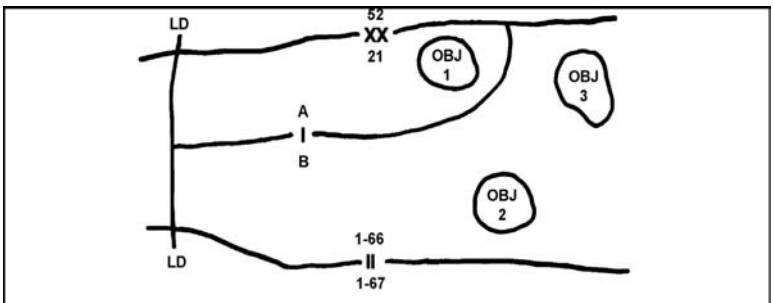

Figure 071-332-5000-16. Pinching out a unit

j. Show the defensive battlefield. The defensive battlefield is organized into the covering force area and the main battle area (MBA) (figure 071-332-5000-17).

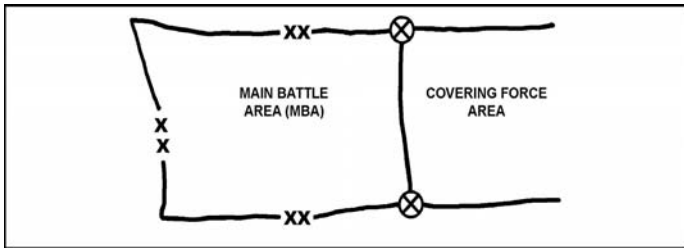

Figure 071-332-5000-17. Organizing the defensive battlefield

k. Show the defended areas. If an area is occupied and the defense of the area is prepared, enclose the area with a line (including the size symbol of the defending unit), and orient the closed side of the symbol toward the most likely enemy threat. If desired, enter the military symbols of the unit in the center of the enclosed area. Figure 071-332-5000-18 shows a defensive area for 2d Plt, C Co, 1st Bn, 6th Inf, and a proposed defensive area for B Co, 3d Bn, 52d Inf.

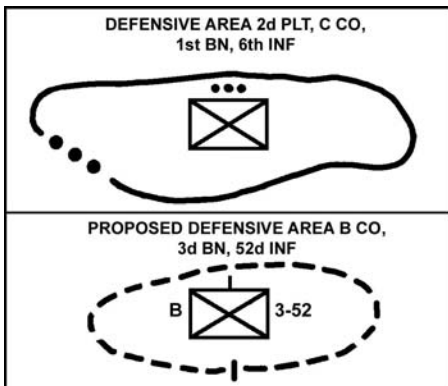

Figure 071-332-5000-18. Defensive area

l. Show control measures as required.

(1) Line of departure (LD). The LD is a control measure to coordinate the advance of an attacking unit (figure 071-332-5000-19). The LD should be—

- (a) Clearly defined on the ground and on the map.
- (b) Roughly perpendicular to the direction of the attack.
- (c) Under control of friendly units.
- (d) Marked on both ends.

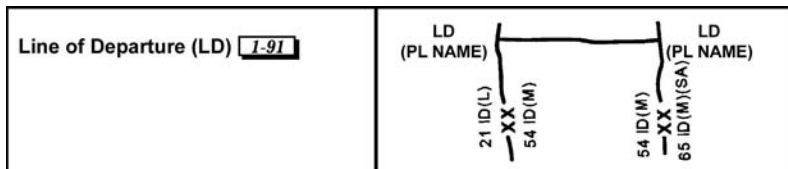

Figure 071-332-5000-19. Line of departure

(2) Line of contact (LC) (figure 071-332-5000-20).

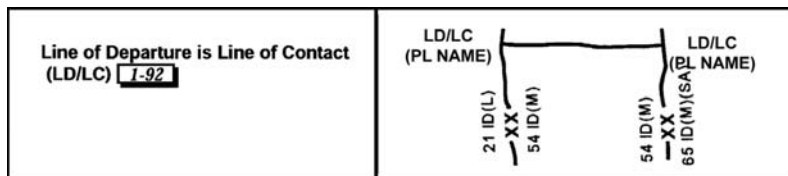

Figure 071-332-5000-20. Line of contact

(a) When units are in contact with the enemy, show the frontline as a series of arcs, and label the ends of the arc "LC."

(b) If the LC is used as an LD, mark it "LD/LC."

(c) If the LC is not used, show the LD with a solid line marked "LD."

(3) Phase line (PLs). Use PLs to control the progress of units for reference in issuing orders or receiving reports. They should be easily recognized terrain features, normally perpendicular to the direction of advance. Also use a PL to control fires and unit movement, and even to limit the advance of attacking elements. Units report their arrival at or clearance of a phase line, but they halt only if ordered to do so. Draw a PL as a solid line with the letters "PL" at each end of the line, or where appropriate to allow easy identification. Identify a PL further by a number, a letter, or code name (using phonetic letters, colors, flowers, cars, or any other code system) under or beside the PL abbreviation (figure 071-332-5000-21).

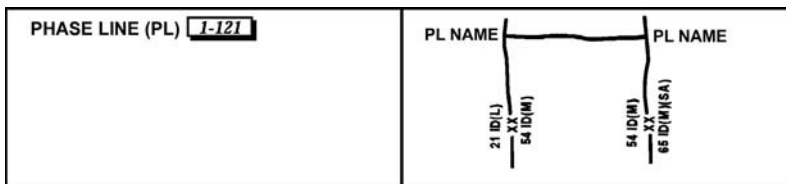

Figure 071-332-5000-21. Phase line

Performance Steps

(4) Initial delay position (IDP). An IDP is where a delaying action begins, trading space for time. The delay sector is defined by boundaries. The initial and all subsequent delay positions can be related to a time-phased forward edge of the battle area (FEBA). The initial and subsequent delay positions are specified, and PLs may be used to report the progress of the battle. The enemy is held forward of delay lines until the specified time or until permission is granted to withdraw. The initial and successive delay positions are shown on boundaries by coordination points with a solid line between them. Although most IDPs are given a code name, they may have a number, letter, or a variety of code names. The letter abbreviation (IDP) can be to the flank of the coordination symbol (when at the flank, it is in parentheses) or on the line itself. Its time phase is indicated as a date-time group having a two-digit day and a four-digit hour, both connected. The month indicator can be a three-letter type or spelled out, depending upon the desires of the commander. Place the letters "IDP" in parentheses between the line code name, letter, or number and the date-time group (figure 071-332-5000-22).

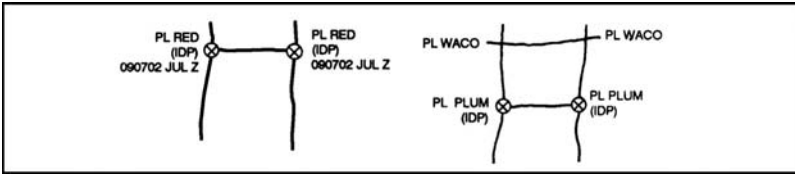

Figure 071-332-5000-22. Initial delay position

(5) Delay lines (DLs). These show the location of a succeeding delay position. Draw delay positions (other than initial) the same, but place the letter abbreviation along the line, and none are placed to the flanks at the coordinating points.

(6) Coordinating points.

(a) Coordinating points are designated on boundaries as specific points for coordination of fires and maneuver between adjacent units. They are indicated whenever a boundary crosses the FEBA and should be indicated whenever the boundary crosses the covering force. Coordinating points are also used where DLs and internal boundaries intersect.

(b) Coordinating points should be located at some terrain feature easily recognizable both on the ground and on a map. Their location on a boundary indicates the general trace of the FEBA, covering force, or DL as visualized by the commander who designates them.

(c) Show the symbol for a coordinating point by a circle with an "X" centered in it (figure 071-332-5000-23). Label the symbol as appropriate.

Performance Steps

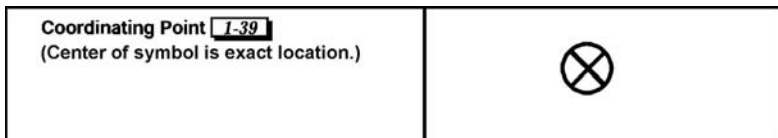

Figure 071-332-5000-23. Coordinating point

(7) Checkpoints. Checkpoints, figure 071-332-5000-24, are shown graphically by a number, letter, or code word inside an upright rectangle with a pointed bottom. They are easily recognizable terrain features or objects, such as crossroads, churches, lone buildings, stream junctions, hills, bridges, and railroad crossings. They may be selected throughout the area of operation. By referring to these points, the subordinate commander can quickly and accurately report his/her location. Higher headquarters can use it to designate objectives, boundaries, assembly areas, phase lines, and so forth.

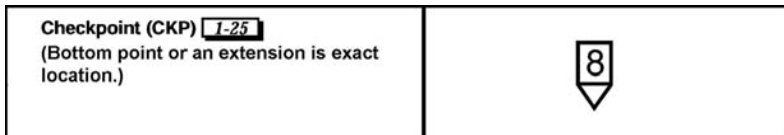

Figure 071-332-5000-24. Checkpoint

(8) Contact points. Contact points, shown graphically by squares with a staff extending from the bottom center, are designated at the units to make physical contact. Contact points may also be used to delineate areas of responsibility in specific localities when boundaries are obviously unsuitable such as between elements of a flank guard (figure 071-332-5000-25).



Figure 071-332-5000-25. Contact point

(9) Passage points (PPs). Show a passage point much like a checkpoint, with the letters "PP" with the number or letter of the passage point within the symbol. Place them along the LD or FEBA of the unit being passed through. The PPs will show where the commander wants the subordinate units to pass.

Performance Steps

(10) Linkup points. A linkup point should be an easily identifiable point on the ground and map. It is used to facilitate the joining, connecting, or reconnecting of elements of a unit or units. They are used when two or more Army elements are to join each other, when Army and sister service elements are to join each other, and when Army or sister service and allied elements are to join each other. The linkup is an operation in itself and is conducted as part of an airborne or airmobile operation, an attack to assist in the breakout of an airborne or airmobile operation, an attack to assist in the breakout of an encircled force, or an attack to join an infiltrating force. The battalion may participate in a linkup as part of a larger force, or it may, itself, conduct a linkup. The symbol for a linkup point is similar to the one for a checkpoint, but with a dot in the center. Place a number, name, or code name near the symbol to ensure that it is clear and that it refers to that symbol (figure 071-332-5000-26).



Figure 071-332-5000-26. Linkup point

(11) Points of departure (PDs). These normally are shown along the LD for night attacks. They look like a checkpoint but contain the letters "PD" and a letter or number. The point of the arrow is at the bottom of its location.

Evaluation Preparation: *Setup:* Provide the Soldier with all the material and equipment listed in the condition statement.

Brief Soldier: Tell the Soldier to prepare an overlay for the operation indicated in the OPORD.

Performance Measures	GO	NO GO
1. Placed registering marks in opposite corners of the overlay.	_____	_____
2. Marked information using standard military symbols.	_____	_____
3. Indicated enemy installations, equipment, or activities with either the color RED or with double-lined symbols.		
4. Indicated future locations or coordinating detail with broken-line symbols.		
5. Placed symbols indicating size on a boundary to indicate the highest unit sharing the boundary.		
6. Extended the axis-of-advance arrow from the LD to the objective.		
7. Labeled the route-of-march arrows with a code name or unit designation.		
8. Labeled the MSR and assigned a code name.		

Performance Measures	GO	NO GO
9. Ensured that the center of a unit's symbol corresponded to the coordinates of the unit.	_____	_____

Evaluation Guidance: Refer to chapter 1, paragraph 1-4 b (6).

References

Required: FM 1-02 and FM 3-90.2 (FM 71-2)

Related:

071-332-5021

Prepare a Situation Map

Conditions: In a combat environment, given the tactical situation.

Standards: Include the following elements on the situation map:

1. All military symbols according to the current FM.
2. The enemy situation depicted in red or with double lines.
3. Control measures.
4. Location of the command post and/or command group.
5. Location of all maneuver elements.
6. Location of reserves.

Performance Steps

1. Depict the control measures.
2. Depict the command post and/or the command group location.
3. Depict the location of the maneuver elements.
4. Depict the location of the reserve.
5. Determine the classification.

Evaluation Preparation: *Setup:* At the test site, provide a copy of the operation order, map board, map, marking pens, overlay paper, coordinate scale, unit standing operating procedure (SOP), and FM 101-5-1.

Brief Soldier: Tell the Soldier to prepare a situation map. The situation map must be prepared according to FM 101-5-1 and the unit SOP.

Performance Measures	GO	NO GO
1. Depicted the control measures.	_____	_____
2. Depicted command post and/or command group location.	_____	_____
3. Depicted the location of the maneuver elements.	_____	_____
4. Depicted the location of the reserve.	_____	_____
5. Determined classification.	_____	_____

Evaluation Guidance: Refer to chapter 1, paragraph 1-4 b (6).

References

Required:

Related: FM 1-02 and FM 5-0

SUBJECT AREA 19: CROWD CONTROL

191-378-4303

Supervise a Riot/Crowd Control Operation with a Squad- Sized Element

Conditions: You are given a riot or crowd control situation and a squad of Soldiers fully equipped with riot control gear, FM 3-19.15, and STP 19-31B1-SM.

Standards: Based on the situation, select the best formation to control or disperse the crowd. Correctly form the squad into the formation selected. Move the squad to disperse or move the crowd and reassemble the squad after the crowd has been controlled or dispersed.

Performance Steps

1. Analyze the mission requirements.

Note: Squad-sized formations are limited based on the number of squad members. A leader should employ a unit-sized formation to fit the circumstances. Squad formations are the smallest formations used and are usually employed to cover a main formation's flanks, such as side streets.

- a. Determine the size of the area to maneuver the unit through.
- b. Determine the approximate number of people in the crowd.
- c. Determine if the mission goal is to—
 - (1) Move the crowd.
 - (2) Make apprehensions.
 - (3) Perform an extraction.
- d. Determine the type of formation to be used, based on the mission.
 - (1) Direct the squad in forming as a line, if required (figure 191-378-

4303-1).

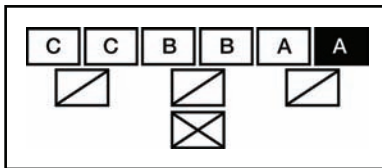

Figure 191-378-4303-1. Squad line formation

Note: This formation is used to push a crowd in a straight line backwards.

- (2) Direct the squad in forming a squad echelon, right or left, if required (figure 191-378-4303-2).

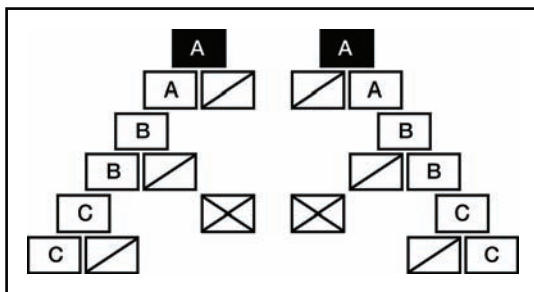

Figure 191-378-4303-2. Squad echelon formations

Note: This formation is used offensively to turn crowds in either open or built-up areas and to move them away from buildings, fences, or walls.

(3) Direct the squad in forming a squad wedge, if required (figure 191-378-4303-3).

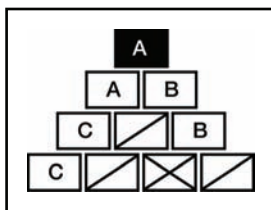

Figure 191-378-4303-3. Squad wedge formation

Note: This formation is used as an offensive formation to penetrate or split crowds.

(4) Direct the squad in forming a diamond or circle, if required (figure 191-378-4303-4).

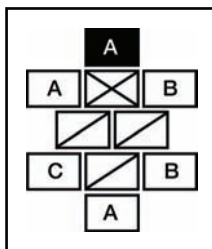

Figure 191-378-4303-4. Squad diamond or circle formation

Note: This formation is used during extraction or recovery operations to penetrate crowds and extract someone or something from that crowd. The decision to use this formation is based on mission, enemy, terrain and weather, troops and support available, time available, civil considerations (METT-TC) and the ability of the squad to perform.

- e. Identify any mission support requirements, to include—
 - (1) A back-up support squad.
 - (2) Vehicle support.

Performance Steps

- (3) Video photographer support.
 - (4) Communications support.
 - (5) Medical support.
 - f. Complete a risk assessment.
 - g. Identify potential threats to the rear of the formation once crowd control movements have been completed.
 - h. Identify the team or operation exit strategy.
2. Identify any nonlethal weapons (NLWs) requirements, to include—
- a. A NLWs Capability SE Kit.
 - b. A 12-gauge shotgun.
 - c. An M203 grenade launcher.

3. Identify any lethal overwatch team requirements.

Note: Lethal overwatch teams are assigned based on the METT-TC, mission risk factors, availability, and the environment in which the mission is to be performed. For example, a hostile fire zone would require the most support from lethal overwatch teams. Examples of when lethal overwatch teams are authorized to employ lethal force are situations involving—

- Self-defense and the defense of others based on imminent danger of death.
 - Assets of national security that are in danger.
 - Assets inherently dangerous, such as explosives or chemical or nuclear materials.
- a. Lethal overwatch teams must be briefed on their ROE and must have communication with the movement leader.
 - b. Sniper cover support to the formation movement, as appropriate.
 - c. Vehicle crew serve support to the formation movement, as appropriate.
 - d. Countersniper support to the formation movement, as appropriate.
4. Organize the squad and support for formation.
- a. Brief the squad and all support teams on—
 - (1) The mission goals.
 - (2) Intelligence relevant to the mission.
 - (3) Contingencies.
 - (4) The NLWs to be used and their location in the formation.
 - (5) The NLWs assignments of squad members.
-

Performance Steps

- b. Form the squad in a single column behind you with the base member directly behind you and the assistant squad leader at the end.
- c. Direct squad members to count off from the front to the rear, with you as number 1 and the base member as number 2.
- d. Tell the squad members which weapon positions to use.

Note: Each position has a specific use.

- (1) Use the safe-port position when making a show of force.
- (2) Use the safe-guard position for semireadiness.
- (3) Use the on-guard position for complete readiness and when troops are in contact with a group showing any kind of resistance or hesitation to withdraw.

- 5. Move the formation from the staging area to the mission area.
 - a. Face the squad and give the command, "Squad line formation."
 - b. Give hand-and-arm signals (simultaneously with the command) by raising the arms straight out, horizontal to the shoulders, hands extended, and palms down.
 - c. Point to where you want the squad to assemble and complete the command, "Move," and ensure that the base member moves where indicated and that the other squad members form according to their number.
 - d. Take your position behind the formation.

Note: The squad leader may use one or all of steps 6, 7, and 8 based on the situation and the formation selected and/or required.

- 6. Direct the squad in forming a squad echelon right (or left), if required.
 - a. Face the squad and give the command, "Squad echelon right (or left)," while simultaneously giving the hand-and-arm signals by extending one arm 45 degrees above the horizon and the other arm 45 degrees below the horizon with arms and hands extended.

Note: When facing the squad, the upper arm shows the direction of the echelon.

- b. Ensure that the base member moves where indicated and that the rest of the squad aligns themselves with the base member (one pace behind the member in front and one pace to the right or left, depending on the echelon).
- c. Point to where the squad should assemble and complete the command, "Move."
- d. Assume the position behind the formation.

- 7. Direct the squad in forming a squad wedge, if required.

Performance Steps

a. Face the squad and give the command, "Squad wedge," while simultaneously giving the hand-and-arm signals by extending both arms down and to the sides at an angle of 45 degrees below the horizon with arms and hands extended and palms down.

b. Ensure that the base member moves where indicated and that the odd-numbered members align themselves behind the base member (one pace to the left and one pace to the rear of the preceding member) and that the even-numbered members align themselves behind the base member (one pace to the right and one pace to the rear of the preceding member).

c. Point to where the squad will assemble and complete the command, "Move."

8. Direct the squad in forming a diamond (or circle), if required.

a. Face the squad and give the command, "Squad diamond (or circle), move," while simultaneously giving hand-and-arm signals by extending the right arm above the head and rotating it in a circle with the left arm at a 45 degree angle, pointing at the circling hand.

b. Ensure that the following are completed on the command of execution:

(1) The A team leader moves the baseman to the location indicated by the squad leader.

(2) The A team lines up to the left of the baseman, covering the 8 to 12 o'clock positions.

(3) The B team lines up to the right of the baseman, covering the 12 to 4 o'clock positions.

(4) The C team lines up covering the 4 to 8 o'clock positions.

9. Move the formation using the command, "Forward, march."

Note: This will begin the forward movement of the formation. Left and right formation movement adjustments will be made by using the command, "Echelon left" or "Echelon right." All other movement commands, such as "Mark time" or "Halt," can be used as appropriate.

a. Identify the flow of the crowd as the team advances and make commands to the team for formation movements to compensate for the crowd's movement and ensure that the squad achieves the goals assigned.

Note: The squad leader and squad members should be mindful of safety factors in formation movement—such as airborne projectiles, antagonistic individuals in the crowd who may need removal, possible incoming direct fire, and the need for peripheral view checks of squad members to the left and right.

b. Give the command, "Halt," once the movement of the crowd is complete according to the goals of the mission.

Performance Steps

c. Review the crowd dispersal and reevaluate the situation to ensure that the mission is complete.

d. Check peripherals, side, and rear to ensure that the squad is safe and secure.

e. Communicate intentions to remove the squad with any support teams before reassembling.

10. Reassemble the squad.

a. Ensure that the squad members hear the command and come to the safe-port position and that the base member faces the squad leader and the other squad members face toward the base member.

b. Take a position a sufficient distance to the rear of the squad and command, "Squad, assemble," while simultaneously raising the right hand in the air and making a circular motion.

c. Point to where the squad should assemble and give the command of execution "Move."

d. Ensure that the base member double-times to the designated spot, the other members of the squad follow the base member and that the squad forms in a column behind the base member and waits for further instruction.

e. Perform an after-action review with the squad and all mission support participants.

(1) Account for and check all participants to see if anyone requires medical attention.

(2) Perform weapons clearing functions, if not in a hostile theater of operations.

(3) Perform ammunition accountability procedures, if not in a hostile theater of operations.

(4) Review what went right.

(5) Review what could be improved from the completed operation.

(6) Release or move Soldiers according to the mission requirements.

Evaluation Preparation: *Setup:* Provide the Soldier with the materials and equipment listed in the conditions statement.

Brief Soldier: Tell the Soldier that he/she will be evaluated based on the performance measures.

Performance Measures	GO	NO GO
1. Analyzed mission requirements.	___	___
2. Identified the NLWs requirements.	___	___
3. Identified the lethal overwatch team requirements.	___	___
4. Organized the squad and support for formation.	___	___

Performance Measures	GO	NO GO
5. Moved the formation from the staging area to the mission area.	_____	_____
6. Directed the squad in forming a squad echelon right (or left) formation, if required.	_____	_____
7. Directed the squad in forming a squad wedge formation, if required.	_____	_____
8. Directed the squad in forming a diamond (or circle) formation, if required.	_____	_____
9. Moved the formation using the command, "Forward, march."	_____	_____
10. Reassembled the squad.	_____	_____

Evaluation Guidance: Refer to chapter 1, paragraph 1-4 b (6).

References

Required: FM 3-19.15 and STP 19-31B24-SM-TG

Related:

SUBJECT AREA 21: DEFENSE MEASURES

071-430-0002

Conduct a Defense by a Squad

Conditions: Given a squad, a priority of work, and locations for crew-served weapons designated by the platoon leader.

Standards: Accomplish preparation of a defensive position within the time specified in the platoon leader's order while maintaining security, camouflage, and concealment.

1. Designate fighting positions for squad members.
2. Designate alternate and supplementary positions for squad members.
3. Ensure assigned priority of work is followed by all squad members.
4. Maintain security.
5. Continue work as rapidly as possible.
6. Maintain camouflage and concealment (to include noise, light, and litter discipline).
7. Construct positions properly.

Performance Steps

1. Designate primary positions.

a. Ensure that each position has cover, concealment, and good fields of fire. Position weapons so fires overlap, mutually support one another, and can be integrated to place heavy surprise fire on the enemy. Watch closely any routes that could provide the attacker cover and positions from where the attacker can mass fire on your position. Be sure your entire squad sector is covered so you can repel any assault.

b. Consider the number of Soldiers available, and then position them so that each Soldier supports the Soldier to their right and left. When the platoon's key weapons have been positioned, the Soldiers in the squad are positioned to protect those weapons from a dismounted assault. Each sector of fire must cross in front of another position at a point beyond hand grenade range. Site each fighting position using natural cover and concealment; then—

(1) Clear fields of fire to allow each Soldier to do the job for which they are positioned. **DO NOT OVER CLEAR.**

(2) Build artificial cover such as a parapet, if required.

(3) Hide everything.

c. Ensure that all enemy approaches into your squad sector are adequately covered by automatic weapons fire.

d. Before digging in, move to the front of the position to ensure that each fighting position has frontal cover from enemy fire and that all positions are mutually supporting.

Note: A good fighting position should allow you to see and fire to the front when not receiving effective direct fire. However, if effective direct fire is received, the Soldier can move behind frontal cover and fire to the oblique.

e. To position each weapon of a rifle squad, follow the procedures below.

(1) Automatic riflemen. Identify dismounted avenues of approach such as ravines, draws, and heavily wooded or brushy areas that are not covered with the machine gun. If possible, find out what dead space the machine gun has and cover it with automatic rifle fire. If there is no dead space, assign a sector that will interlock with and overlap the machine gun's sector and final protective fire.

(2) Grenadiers. Position grenade launchers to cover the dead space of the automatic weapon's final protective fire. They must also be positioned to cover the entire squad sector.

(3) Riflemen. Position riflemen between the remaining positions to give continuous observation and fire throughout the squad sector. They provide mutual support between positions and identify targets for the squad and platoon's key weapons (grenade launcher, squad automatic weapons, machine gun, and Dragons).

(4) Claymore mines. Use these to cover any dead space that cannot be covered with 40-mm grenade launchers and to supplement the fire of your riflemen.

Performance Steps

f. Select a position where you can control the fire of your squad. Use your weapon only when necessary for protection, to direct fire, or to influence the action at a critical point. Position yourself slightly behind the squad so you can observe and contact your squad, or at least your team leaders. If your squad's strength is reduced, or the terrain does not permit you to establish a position to the rear, you must man a forward position. In this case, you may have to construct a single position to be able to observe your squad sector. You must be able to maintain contact with your platoon and fire team leaders from whatever position you select. Look for covered routes that you can use to move to the positions of your team leaders and platoon leader.

2. Designate alternate positions.

a. Prepare alternate positions so they are ready for occupation by the squad when the primary positions are no longer defensible. The locations of alternate positions highly depend on the terrain, cover and concealment, and the existing enemy situation. They must be near enough to the primary positions so the squad can cover the same sectors of fire as from the primary positions without sustaining excessive casualties. A Soldier's alternate position may be to the flank or slightly to the rear of their primary position.

b. When selecting alternate positions, consider the following points:

(1) Do they allow the weapon(s) or element(s) to accomplish the same mission as from the primary positions?

(2) Do they provide—

(a) Observation of the primary sector of fire?

(b) Cover and concealment?

(c) Maximum use of natural and artificial obstacles?

(d) Control of the key terrain in the squad sector?

(e) Coverage of the avenues of approach into the sector?

(f) Cover and concealment of withdrawal?

c. Designate squad alternate positions based on the alternate positions of key weapons (M60 machine gun, M249 machine gun, and Javelin).

d. Depending on their priority, prepare alternate positions immediately after completing the primary positions. Communication trenches should be constructed between primary and alternate positions as time and terrain permit. When supervising the preparation of alternate positions, ensure that they are sited and constructed to take maximum advantage of the natural defensive characteristics of the terrain and the capabilities of organic weapons.

3. Designate supplementary positions.

Performance Steps

- a. Orient supplementary positions (unlike alternate positions) in a different direction than the primary position. Supplementary positions will normally be within 200 meters of primary positions. As time and terrain permit, prepare communication trenches to provide covered routes between primary and supplementary positions.
- b. When selecting supplementary positions, consider the following:
 - (1) Do they allow the squad to defend as part of the platoon against enemy attack from the flank(s) and rear?
 - (2) Do they cover the most dangerous avenues of approach, other than those into the primary positions?
 - (3) Do they meet the same guidelines that apply to placement and construction of primary and alternate positions?

Evaluation Preparation: *Setup:* Select an area in the field with varying terrain, cover and concealment. Show the squad leader the squad's area of responsibility.

Brief Soldier: Tell the Soldier to select primary, alternate, and supplementary positions, in an area specified by the platoon leader, ensuring that the supplementary position is oriented in a different direction than the primary position.

Performance Measures	GO	NO GO
1. Ensured that the primary position met the following requirements:	_____	_____
a. Used natural cover and concealment.		
b. Ensured that all fighting positions and weapons emplacements were mutually supporting.		
c. Marked and informed squad members where fighting positions were constructed.		
d. Supervised construction of the fighting positions.		
2. Ensured that the alternate position met the following requirements:		
a. Provided observation of the primary sector of fire.		
b. Provided cover and concealment.		
c. Provided use of natural and artificial obstacles.		
d. Provided coverage of avenues of approach into the sector.		
e. Provided covered and concealed routes of withdrawal.		
3. Ensured that the supplementary position provided for and met the following requirements:		

Performance Measures	GO	NO GO
a. Allowed the squad to defend as part of the platoon against enemy attack from the flank(s) and rear.		
b. Provided observation of the primary sector of fire.		
c. Provided cover and concealment.		
d. Provided natural and artificial obstacles.		
e. Provided coverage of avenues of approach into the sector.		
f. Provided covered and concealed routes for withdrawal.		
g. Covered dangerous avenues of approach other than those into the primary position.		
h. Provided the same guidelines in construction and placement of the supplementary position as in the alternate position.		

Evaluation Guidance: Refer to chapter 1, paragraph 1-4 b (6).

References

Required: FM 7-7 and FM 7-8

Related:

SUBJECT AREA 22: UNIT OPERATIONS

071-326-3013

Conduct a Tactical Road March

Conditions: As an acting platoon sergeant/platoon leader, given a platoon with table of organization and equipment (TOE) weapons, personnel, equipment, operational vehicles with basic item issue (BII), a 1:50,000 military map of the road march area, a warning order, and an overlay of your route; a requirement to maintain radio listening silence until detected or engaged or until a spot report/status report (SPOTREP/STATREP) must be sent.

Standards: Within the time allowed in the warning order, conduct a tactical road march from one point to an assembly area; plan, organize, and control the road march and secure the assembly area.

Performance Steps

1. Control actions in the assembly area.
 - a. Ensure that the quartering party noncommissioned officer (NCO) guides the section/platoon into the area.

Performance Steps

- b.** Clear the section/platoon release point quickly.
 - c.** Ensure that one man for each vehicle mans the crew-served weapon, monitors the radio, and observes the vehicle sector.
 - d.** Set up the observation posts (OPs).
 - e.** Check primary positions and sectors; adjust if necessary.
 - f.** Camouflage positions.
 - g.** Start the rest plan.
 - h.** Ensure that the range cards are prepared.
 - i.** Locate the troop command post.
 - j.** Coordinate with flank elements.
 - k.** Select and prepare alternate positions.
 - l.** Prepare the platoon fire plan, brief the vehicle commanders, and send a copy of the fire plan to the troop commander.
 - m.** Ensure that maintenance is performed.
 - n.** Check personnel and equipment status; report to the team/troop commander.
 - o.** Resupply.
 - p.** Check security.
- 2.** Plan the sequence for a tactical road march.
 - a.** Prepare and issued the warning order.
 - b.** Prepare an estimate of the situation.
 - c.** Organize and dispatch reconnaissance and quartering parties according to the unit standing operating procedure (SOP).
 - d.** Prepare detailed movement plans.
 - (1)** Organize the march.
 - (2)** Review reconnaissance information.
 - e.** Prepare and issue the complete march order.
- 3.** Issue the march order. The order includes the following:
 - a.** Destination (map).
 - b.** Route of march (map).
 - c.** Location of start point (SP), critical points, and release point (map).

Performance Steps

- d. Start point time.
 - e. March interval (in meters).
 - f. March speed.
 - g. Catch-up speed.
 - h. Time to leave present position.
 - i. Order of march.
4. Organize the march as provided in the following paragraphs.
 - a. March columns contain three elements: head, main body, and trail.
 - (1) The head is the first vehicle of the column and normally sets the pace.
 - (2) The main body is made up of the major elements of column serials and march units.
 - (3) The trail party follows the march column and includes personnel and equipment needed for emergency vehicle repair and recovery, medical aid and evaluation, and unscheduled refueling.
 - b. Ensure that the vehicle commanders assign sectors of observation so that there is 360-degree observation around their vehicles. Ensure that each vehicle commander designates an air guard to provide air security.
5. Control the march as provided below.
 - a. Follow the route specified in the warning order.
 - b. Enter the route of march at the SP.
 - c. Adjust the march at critical points if movement is slow or difficult or when vehicles lose their way.
 - d. Release sections to their mission responsibilities.
 - e. Ensure that the march and catch-up speeds are as specified in the warning order.
 - f. Maintain the order of march. This includes the order of squads in the column and the vehicles in each section.
 - g. Maintain the march interval.
 - h. Close the column intervals during periods of limited visibility.
 - i. Open the column during periods of good visibility.
6. Control actions at halts.
 - a. Establish security off road (when possible).

Performance Steps

- b. Man weapons and radio on each vehicle; ensure that each vehicle sector is observed.
- c. Maintain air guard.
- d. Dismount OP if visibility is poor.
- e. Post guides to help other traffic pass.
- f. Determine the cause of unscheduled halts.
- g. Eliminate the cause of the halt.
- h. Report the status to the platoon leader/troop commander.
- i. Ensure that maintenance is performed at scheduled halts.

Evaluation Preparation: *Setup:* At the test site, provide all equipment and materials given in the task conditions statement and the opportunity to issue a warning order. The task is performed along the specified route within the time allowed in the warning order. This task is performed as part of field training exercises.

Brief Soldier: Tell the Soldier to conduct a tactical road march using the equipment stated in the task conditions statement and the route specified in your warning order.

Performance Measures	GO	NO GO
1. Conducted each step in the planning sequence for a tactical road march.	___	___
2. Ensured that all required actions in the assembly area were performed.	___	___
3. Issued the march order in its entirety.	___	___
4. Identified two of the three elements of the march columns.	___	___
5. Organized the march.	___	___
6. Ensured that all actions at halts were performed.	___	___

Evaluation Guidance: Refer to chapter 1, paragraph 1-4 b (6).

References

Required: FM 17-95, FM 3-21.71, FM 7-7, and FM 7-8

Related:

071-720-0015

Conduct an Area Reconnaissance by a Platoon

Conditions: Given a 1:50,000 map, a lensatic compass, and a mission to conduct an area reconnaissance within a specified time.

Standards: Satisfactorily perform the following within the time specified by the commander:

1. Organize the platoon into the command, reconnaissance, and security elements needed to accomplish the mission.
2. Conduct a reconnaissance using the surveillance or vantage-point method.
3. Obtain and report information about the terrain and enemy within the specified area.
4. Enter and leave the target area without being detected by the enemy.

Performance Steps

1. Estimate the situation. After receiving the reconnaissance mission, develop an estimate of the situation. Base the estimate on current intelligence about the enemy in the vicinity of the target area and on the capabilities of the unit. While planning for the mission, have the unit prepare for the mission also. Tailor the organization to best support the mission. The reconnaissance element of a platoon will normally be no larger than a squad.
 2. Plan details. Develop the overall plan with a consideration of the following factors:
 - a. Use Intelligence. All reconnaissance operations must be based on the best information available as to actual conditions in the objective area.
 - b. Use deceptive measures. The success of reconnaissance operations is determined, to a large extent, on deception measures and on undetected infiltration and exfiltration.
 - c. Use the smallest unit possible to accomplish the mission. This decreases the possibility of enemy detection. Though only a small element reconnoiters, the parent unit must be large enough to provide security or support if the reconnaissance is detected or the element is engaged by an enemy force.
 - d. Remain undetected. The unit uses stealth, camouflage, concealment, and sound and light discipline. These techniques allow the unit to take advantage of periods of limited visibility to avoid contact and to get near, or on, the objective.
 - e. Use surveillance, target acquisition, and night observation (STANO) devices. The unit uses STANO devices to help it move and gain information about the enemy. Based on intelligence reports, consider the enemy's detection devices. When the enemy may have detection devices, use passive devices to decrease the probability of enemy detection.
-

Performance Steps

f. Rehearse. After intelligence has been analyzed, the plan developed, special items of equipment procured and issued, and the troops briefed, the unit rehearses the plan. This rehearsal is a key factor that enhances the probability of the success of the operation. Rehearsals are as detailed as time will allow and include dry runs and briefings with repetition and questioning as needed to ensure understanding of the plan. Contingency plans are also rehearsed; these plans must be repeated by the reconnaissance members to ensure that they are understood.

g. Minimize audio and electronic communications. Constraints on communication depend on enemy detection abilities and on how time sensitive the information obtained from the enemy is. There may be instances where the importance of the information may require an immediate report. The unit's existence could be threatened. Often, a one-time radio contact during the mission is necessary.

h. Inspect. The planning phase of the operation will include at least one inspection of all members of the reconnaissance force, to include their equipment. Only essential equipment, identified by the platoon leader as equipment required for mission accomplishment, will be carried. Special equipment must be closely inspected and safeguarded to ensure that it is functioning during the mission. Extra personnel and equipment assigned to the unit must also be carefully inspected and monitored prior to and during the operation. Any shortcomings found in personnel or equipment are corrected before the operation begins. Thorough inspections and supervision of personnel and equipment before the operation reduce the probabilities of compromise or failure.

3. Assign subordinate missions. Regardless of the types of reconnaissance, units are normally assigned one of three subordinate missions: Command and control, reconnaissance of the objective, or security of the force.

a. Command and control. The commander of the unit conducting a reconnaissance normally requires a small command group to assist in communicating with higher headquarters, subordinate elements, and supporting forces and to coordinate and control supporting elements, fire support, and air or water transport for the operation. For small operations, this group may consist of only the commander and a radio operator. For larger operations, the commander may require intelligence, logistics, and fire support elements, with adequate communication personnel for sustained 24-hour operations. The command group is always kept as small as possible.

b. Reconnaissance of the objective. The element with the reconnaissance mission approaches the target using stealth and concealment. All plans and applicable contingencies are conducted with the major effort made toward obtaining the information required while remaining undetected. The reconnaissance element must skillfully avoid all known and discovered enemy sensing devices; therefore, patience is important. Passive STANO devices will be

Performance Steps

used to observe activities at the objective. Information received about the target may be transmitted back to the appropriate headquarters by electronic means as it is observed. Or, the reconnaissance personnel may withdraw from the target and disseminate information by other means. The reconnaissance site should be sterilized before withdrawal. Withdrawal from the area must be as skillful, patient, and precise as the movement into it.

c. Security of the force. The reconnaissance element(s) with this mission must provide the commander with sufficient warning of the location and movement of enemy forces to permit the parent force to take evasive action or, when this is not possible, to provide covering fires that permit withdrawal of the reconnaissance element. Only if warnings are timely and information is accurate does the commander have the time and space to react. It is also the only way that, if the reconnaissance element is detected, the commander can arrange to give it sufficient overwatching suppressive fires or time to evade and withdraw safely.

4. Conduct an area reconnaissance and obtain information about a specific location and the area immediately around it (for example, road junctions, hills, bridges, enemy positions). Designate the location of the objective by either grid coordinates or a map overlay with a boundary line drawn around the area.

a. Once given an area reconnaissance mission, move the platoon to the appointed area in the shortest amount of time. This normally involves traveling along existing roads using the appropriate movement techniques. During this movement to an area, the platoon reports and bypasses enemy opposition unless ordered to do otherwise.

b. When the platoon reaches its area, it halts and sets up an objective rallying point (ORP). Once the ORP has been set up, the objective can be reconnoitered in one of two ways.

(1) When the terrain permits the security element to move to a position to overwatch the reconnaissance element, the leader may decide to have small reconnaissance teams move to each surveillance point or vantage point around the objective instead of having the entire element move as a unit from point to point. After the objective has been reconnoitered, the elements return to the ORP and information is issued. The patrol then returns to friendly lines.

(2) When the terrain does not allow the platoon to secure the objective area, the platoon leaves a security element at the ORP and uses reconnaissance and security (R&S) teams to reconnoiter the objective. These teams move to different surveillance points or vantage points, from which they reconnoiter the objective. Once the objective has been reconnoitered, the R&S team returns to the ORP, shares the information, and returns to friendly lines.

Evaluation Preparation: *Setup:* At the test site, provide all equipment and material given in the task conditions statement.

Brief Soldier: Tell the Soldier to organize and conduct an area reconnaissance using the surveillance or vantage-point method. Obtain and report any information about

the terrain and enemy within the specified area. Tell the Soldier to complete the mission within the time specified by the commander. You will act as the battalion intelligence officer (S2) to provide answers to any questions the Soldier may ask.

Performance Measures	GO	NO GO
1. Established a plan of action based on the mission and the enemy situation.	_____	_____
2. Conducted a reconnaissance.	_____	_____
3. Conducted deceptive measures during infiltration and exfiltration.	_____	_____
4. Used the smallest unit required to conduct the reconnaissance.	_____	_____
5. Applied stealth, camouflage, and concealment techniques along with noise and light discipline to avoid detection.	_____	_____
6. Conducted pre-mission inspection and rehearsal.	_____	_____
7. Used the correct size command and control group for the mission.	_____	_____
8. Used the correct movement techniques during the mission.	_____	_____
9. Used the correct security techniques during the mission.	_____	_____

Evaluation Guidance: Refer to chapter 1, paragraph 1-4 b (6).

References

Required: FM 3-21.71, FM 7-7, and FM 7-8

Related:

551-721-3348

Perform Duties as Serial/March Unit Commander

Conditions: Given the responsibility as serial/march unit commander, a briefing by the convoy commander, enough vehicles to warrant a serial/march unit, maps, material to be transported, and personnel as vehicle drivers.

Standards: Ensure that all predeparture checks are successfully completed for your vehicles, enforce all safe-driving measures during movement, ensure that your vehicle operators conduct all at-halt checks/duties, and that all drivers complete the required checks/duties at the convoy destination prior to release. Perform all procedures without injury to personnel or damage to vehicles or equipment.

Performance Steps

1. Perform predeparture checks/duties.
 - a. Ensure that before-operations checks have been performed. Check the following:
 - (1) Air hose couplings for proper connection and leakage.
 - (2) Oil and lubrication levels.
 - (3) Cooling systems for proper coolant level and leakage.
 - (4) Brakes.
 - (5) Tires for cuts and general condition.
 - (6) Batteries for obvious defect (such as cracked case; burnt, broken, or loose battery terminals).
 - b. Check the lineup of vehicles to ensure that march column, regardless of size, has three parts.
 - (1) The head is the first task vehicle of the column in the order of march and is the pacesetter.
 - (2) The main body of the column follows immediately after the first task vehicle.
 - (3) The trail is the last element of the march column.
 - c. Check to see that vehicles are properly marked as follows:-
 - (1) A blue flag is on the front of the first task vehicle.
 - (2) A green flag is on the rear vehicle.
 - (3) A black and white flag is on the convoy commander or serial commander vehicle.
 - (4) A "convoy follows" sign is on the front of the first task vehicle.
 - (5) A "convoy ahead" sign is on the rear of the last vehicle.
 - (6) A "convoy commander" sign is on the front and rear of the convoy commander's vehicle.
 - d. Select the pacesetter.
 - (1) This is normally an officer or senior noncommissioned officer (SNCO) at the head to ensure that the column is following the proper route.
 - (2) The pacesetter rides in the first vehicle and sets the pace necessary to meet the travel schedule.
 - (3) This officer or SNCO also checks at scheduled points and receives orders or changes in orders.
 - e. Check weapons on the vehicles to make sure they are operational.
 - (1) Correct existing minor deficiencies on the spot.
 - (2) If major deficiencies exist, have the weapon and vehicle returned to the parent unit and request an operational replacement.
 - f. Check to ensure that the sandbags are installed correctly on the floor of the troop-carrying vehicles and on the cab floors of all vehicles.
 - (1) Cover the floors of troop-carrying vehicles with at least a double interlocking layer of sandbags.

Performance Steps

- (2) Cover the cab floors of all vehicles with a double layer of sandbags under the driver's seat.
 - g. Check the cargo to ensure that it is secured and covered correctly.
 - (1) Cover the cargo to protect it from being damaged by prevailing weather conditions.
 - (2) Cover the cargo, if necessary, to deny intelligence information while providing protection from the elements.
 - h. Brief the drivers on the rules of the road, traffic laws and regulations, speed limits, time and distance gaps, routing plans, review schedules, and march discipline.
 - i. Give the signal/order to the start engine.
 - j. Give the signal/order to move out.
 2. Enforce the correct driving procedures while the convoy is underway.
 3. Instruct drivers at halt checks/duties.
 - a. Inform drivers of the details at halts. Review the following:
 - (1) Time, duration, and purpose of convoy operations.
 - (2) The location of the convoy.
 - (3) The duties of personnel during the convoy.
 - b. Control activities of the drivers. Tell the drivers—
 - (1) To inspect their vehicles and loads.
 - (2) To perform at-halt maintenance.
 - c. Check to see that the drivers are performing during-operation checks. Tell the drivers—
 - (1) To perform necessary during-operation checks using the appropriate -10 series technical manual (TM).
 - (2) To check for and have items repaired, fill fluid levels, or adjust drive belts or other items.
 - d. Check the security of the loads.
 - e. Check to see that the area is policed before moving out.
 - f. Give the signal/order to re-form and start engines.
 - g. Give the signal/order to move out.
 4. Perform all required checks/duties at the release point.
 - a. Update the drivers on additional orders/instructions from the convoy commander.
 - (1) Instruct the drivers to comply with the standing operating procedure (SOP) in dispersing their vehicles.
 - (2) Inform the drivers of the time and place to assemble for the return trip.

Performance Steps

b. Check to see that after-operation checks are performed. Tell the drivers—

(1) To perform necessary after-operation checks using the appropriate -10 series TM.

(2) To check for and have repaired all discrepancies found, fill fluid levels, or adjust drive belts or other items.

c. Recommend disciplinary action for those drivers who violate driving rules during the convoy operation.

d. Dismiss drivers.

Evaluation Preparation: *Setup:* Evaluate this task during a field training exercise or normal training session.

Brief Soldiers: Tell the Soldier he/she will be evaluated on his/her ability to properly perform duties as a serial/march unit commander.

Performance Measures	GO	NO GO
1. Performed predeparture checks/duties.	___	___
2. Enforced the correct driving procedures while the convoy was underway.	___	___
3. Instructed drivers at halt checks/duties.	___	___
4. Performed all required checks/duties at the release point.	___	___

Evaluation Guidance: Refer to chapter 1, paragraph 1-4 b (6).

References

Required:

Related: FM 21-10, FM 21-60, FM 4-01.30, FM 55-30, TM 9-2320-260-10, TM 9-2320-272-10, TM 9-2320-279-10-1, TM 9-2320-279-10-2, TM 9-2320-280-10, TM 9-2320-360-10, TM 9-2320-364-10, TM 9-2320-365-10, TM 9-2320-366-10-1, and TM 9-2320-366-10-2

551-88N-3042

Plan Unit Move

Conditions: You are given a command directive to plan for your unit to conduct a move to port of embarkation to deploy in support of an Army or Joint operations plan (OPLAN). You have access to the unit standing operating procedure (SOP), and all unit movement directives.

Standards: Plan a unit movement using the necessary references (vehicle -10s) and equipment to deliver vehicles and equipment at the port of debarkation (POD) with no loss of vehicles, equipment, or personnel.

Performance Steps

1. Identify what needs to be moved.
2. Identify the equipment to be moved.
3. Identify what needs to be moved by air.
4. Identify hazardous, sensitive, and classified equipment/material.
5. Identify bulk cargo.
6. Develop vehicle load plans.
7. Translate what needs to be moved into transportation terms using Transportation Coordinators' Automated Command and Control Information System/ Transportation Coordinators' Automated Information for Movements System (TC ACCIS / TC-AIMS II).
8. Determine how the personnel and equipment will move to the aerial/seaport of debarkation (APOD/SPOD).
9. Prepare the unit movement plan.
10. Maintain the movement plan.

Evaluation Preparation: *Setup:* Evaluate this task during a field training exercises or a unit training exercise.

Brief Soldier: Inform the Soldier that the evaluation is measured on the ability to perform all the functions listed.

Performance Measures	GO	NO GO
1. Identified what needed to be moved.	___	___
a. Personnel.		
b. Equipment.		
c. Supplies.		
2. Identified the equipment to be moved:	___	___
a. What needs to accompany troops—Yellow (to accompany troops) TAT.		
b. What is needed immediately upon arrival—Red TAT.		
c. What does not have to accompany troops—NTAT.		
<i>Note:</i> NTAT consists of all other equipment that is required for the unit to perform its mission.		
3. Identified what needed to be moved by air.	___	___
a. Advance party personnel.		

Performance Measures	GO	NO GO
<ul style="list-style-type: none"> b. Main body personnel. 		
<ul style="list-style-type: none"> c. Baggage TAT. 		
<ul style="list-style-type: none"> d. Equipment. 		
<p>4. Identified hazardous, sensitive, and classified equipment and material.</p>	_____	_____
<ul style="list-style-type: none"> a. Determined appropriate packaging, labeling, segregating, and placarding for movement. 		
<ul style="list-style-type: none"> b. Identified TAT ammunition quantities. 		
<ul style="list-style-type: none"> c. Identified vehicles (3/4 tank full sea/air). 		
<ul style="list-style-type: none"> d. Identified individual weapons (remain with the Soldier; bolt may be removed) 		
<ul style="list-style-type: none"> e. Identified crew-served weapons (palletized or carried in the baggage compartment). 		
<p><i>Note:</i> Movement personnel must refer to applicable regulations to obtain the detailed information for planning and execution.</p>		
<p>5. Identified bulk cargo.</p>		_____
<ul style="list-style-type: none"> a. Developed a packing list for all consolidated cargo loaded in vehicles, containers, and 463L pallets. 		
<ul style="list-style-type: none"> b. Determined packing list distribution. 		
<ul style="list-style-type: none"> c. Determined blocking, bracing, packing, crating and tiedown (BBPCT) requirements. 		
<p>6. Developed vehicle load plans.</p>		_____
<ul style="list-style-type: none"> a. Planned for cross-country payload capacity. 		
<ul style="list-style-type: none"> b. Reduced vehicles according to the mode of transportation and type of movement. 		
<ul style="list-style-type: none"> c. Tested planned loads. 		
<ul style="list-style-type: none"> d. Weighed and recorded planned loads. 		
<ul style="list-style-type: none"> e. Identified transportation requirements exceeding the unit's organic lift capability. 		
<p>7. Translated what needed to be moved into transportation terms using TC ACCIS/ TC AIMS II:</p>		_____

Performance Measures	GO	NO GO
<p>a. Used the TC ACCIS to translate the automated unit equipment list/deployment equipment list (AUDEL/DEL).</p> <p>b. Used the TC AIMS II to translate the organization equipment list (OEL) /unit deployment list (UDL).</p>		
<p>8. Determined how the personnel and equipment will move to the APOD/SPOD).</p> <p>a. Roadable vehicles.</p> <p>b. Tracked vehicles.</p> <p>c. Rotary wing aircraft.</p>	_____	_____
<p>9. Prepared the unit movement plan. Determined administrative, logistical and coordinating requirements for the plan such as transportation for drivers from the APOD/SPOE and back to the unit and for petroleum, oil and lubricants (POL).</p>		
<p>10. Maintained the movement plan. Kept the AUDEL/OEL current with changes in unit equipment, personnel, and supplies.</p>		

Evaluation Guidance: Refer to chapter 1, paragraph 1-4 b (6).

References

Required: FM 100-17, FM 4-01.011, FM 5-0, FM 55-1, FORSCOM Reg 55-2, and TB 55-46-1

Related: FORSCOM Reg 55-1

SUBJECT AREA 23: SECURITY AND CONTROL

191-377-4203

Supervise the Establishment and Operation of a Roadblock/Checkpoint

Conditions: You are given an operation order (OPORD), required personnel, a combat load, the unit standing operating procedure (SOP), maps and overlays, signal operating instructions (SOI), communications equipment, and materials to use as obstacles and guide signs.

Standards: Establish the roadblock, checkpoint, and holding areas according to the mission requirements. Establish and maintain communications according to the unit SOP. Ensure that the team or squad members correctly perform their assigned duties.

Performance Steps

1. Select a location for the roadblock within the assigned area.
 - a. Ensure that the location provides good cover and concealment for the team.
 - b. Position the roadblock so that unauthorized vehicles or enemy personnel cannot bypass it.
 - c. Place the roadblock at an intersection so that drivers can change to another route with little delay if the roadblock is used to close off a road.
 - d. Select a location where there is room for drivers to turn the vehicles around easily if there is no intersection.
 - e. Select a location for the roadblock where it cannot be seen until the drivers have passed all possible turnoffs if the roadblock is to be used with a checkpoint.

Note: Notify higher headquarters of your arrival time and your exact location.

2. Establish defensive positions.
 - a. Select fighting positions for the automatic weapons.
 - b. Ensure that the emplacement of the weapons provides security and overwatch for the roadblock and the holding area.
 - c. Ensure that the team's vehicle is placed in a covered and concealed location near the team's or squad leader's position.
 - d. Direct the team or squad to camouflage the weapon and vehicle if natural cover and concealment are not available in step 2b and step 2c.
3. Establish communications according to the unit SOP.
4. Supervise the establishment of the roadblock.
 - a. Direct the barricading of the road, road shoulders, and ditches to channel the passing traffic.
 - b. Direct the placement of signs to warn drivers that a roadblock is ahead.
 - c. Ensure that there is adequate lighting for drivers to see the roadblock if the roadblock is set up during limited visibility.
5. Select an appropriate checkpoint and holding area within the assigned area based on the purpose of the checkpoint.
 - a. Place the checkpoint at the entrance of the controlled route if the purpose is to check convoys for authorization to use the route.
 - b. Place the checkpoint just over a hill or around a curve if the purpose is to check the cargo or to spot check vehicle traffic.

Performance Steps

(2) Oversee the operation of the checkpoint.

(a) Ensure that the convoys are checked for movement credits according to the highway traffic division (HTD) and that drivers who are lost are directed to their destinations if the checkpoint is at the entrance to a controlled route.

(b) Ensure that vehicles are checked for movement credits according to the HTD. Check the manifest papers against the actual load when checking cargo vehicles if the checkpoint is on a main supply route.

(c) Remind the team or squad members to be suspicious of military equipment, supplies, or weapons transported in civilian vehicles.

Evaluation Preparation: *Setup:* Schedule a field training exercise with vehicle traffic so that the Soldier can establish and supervise a roadblock, checkpoint, and holding area. Identify a general location. Evaluate the Soldier's ability to select a specific location that offers cover and concealment.

Brief Soldier: Tell the Soldier that he/she will be evaluated as a team or squad leader. Tell the Soldier that contact with the enemy is to be expected and that all vehicles must be stopped and checked.

Performance Measures	GO	NO GO
1. Selected the location for the roadblock within the assigned area.	___	___
2. Established defensive positions.	___	___
3. Established communications according to the unit SOP.	___	___
4. Supervised the establishment of the roadblock.	___	___
5. Selected an appropriate checkpoint and holding area within the assigned area based on the purpose of the checkpoint.	___	___
6. Supervised the establishment of a checkpoint.	___	___
7. Supervised the establishment of the holding area.	___	___
8. Supervised the operation of a roadblock and a checkpoint.	___	___

Evaluation Guidance: Refer to chapter 1, paragraph 1-4 b (6).

References

Required: FM 3-19.4

Related:

191-378-5315

Supervise an Installation Access Control Point

Conditions: As a noncommissioned officer in charge (NCOIC), you are given an installation access control point, personnel, appropriate equipment, the current force protection condition (FPCON) threat level, the local standing operating procedure (SOP), AR 190-13, and AR 525-13.

Standards: Supervise an installation access control point according to the local SOP, AR 190-13, and AR 525-13.

Performance Steps

1. Ensure that the special guard orders include instructions for the following:
 - a. Performing sign-in procedures.
 - b. Maintaining access rosters (if applicable).
 - c. Contacting off-site emergency vehicles.
 - d. Maintaining on-site emergency vehicles.
 - e. Processing of authorized identification card holders.
 - f. Using the contact roster for key personnel.
 - g. Using the map of the installation.
 - h. Maintaining phone numbers for the key organizations of the installation.
 - i. Implementing random antiterrorism measures for FPCONs.
 - j. Using the proper levels of force.
 - k. Maintaining the list of personnel barred from the installation.
 2. Conduct guard mount.
 3. Ensure that initial communication checks, both telephonic (Class C line and direct line) and radio, are made with the military police desk.
 4. Ensure that an equipment inventory is conducted and that discrepancies are reported before taking responsibility for the inventory.
 5. Ensure that traffic control devices are employed according to each gate's special orders. Check the following devices:
 - a. Operational gate (electronic).
 - b. Barriers.
 - c. Directional signs.
 - d. Regulatory signs.
 - e. Warning signs.
-

Performance Steps

- f. Portable lighting.
- g. Traffic cones.

Note: Equipment knocked over or damaged needs to be set up or replaced as soon as possible. These items are part of the working structure and help ensure that the mission operates smoothly and that officer safety and public safety are maintained.

6. Inspect the condition of the facilities (gate house and visitor's center) and surrounding areas.
 - a. Ensure that the facilities are functioning properly (doors, lighting, and rest rooms).
 - b. Ensure that the surrounding areas are properly maintained and free of debris and public hazards.
 - c. Ensure that the visitor's center and other public-access facilities present a neat and organized appearance.
7. Ensure that all gate discrepancies and facility deficiencies are reported or annotated for the record.
 - a. Annotate communication failures.
 - b. Annotate all work orders.
 - c. Report immediately all deficiencies that affect access control operations.
8. Review preliminary investigation reports generated on violations identified by access control personnel.
9. Ensure appropriate interaction by personnel with the public.
 - a. Prevent idle conversation impeding the flow of vehicle or foot traffic.
 - b. Ensure that personnel maintain military bearing (polite and courteous).
10. Ensure that immediate gate closure procedures are performed, according to the appropriate FPCON level (Normal, Alpha, Bravo, Charlie, Delta) and the local SOP.
11. Ensure that a gate equipment inventory is conducted and that the facility is inspected before the end of the shift.

Evaluation Preparation: *Setup:* Provide the Soldier with copies of all references listed in the conditions statement.

Brief Soldier: Tell the Soldier to analyze the situation and correctly perform the necessary steps to supervise an access control point.

Performance Measures	GO	NO GO
1. Ensured that the special guard orders included all required instructions.	___	___
2. Conducted the guard mount.	___	___
3. Ensured that initial communication checks, both telephonic and radio, were made with the military police desk.	___	___
4. Ensured that an equipment inventory was conducted and that discrepancies were reported before taking responsibility for the inventory.	___	___
5. Ensured that traffic control devices were employed according to each gate's special orders.		
6. Inspected the condition of the facilities and surrounding areas.		
7. Ensured that all gate discrepancies and facility deficiencies were reported or annotated for the record.		
8. Reviewed the preliminary investigation reports generated on violations identified by access control personnel.		
9. Ensured appropriate interaction by personnel with the public.		
10. Ensured that immediate gate closure procedures were performed according to the appropriate FPCON level and the local SOP.		
11. Ensured that a gate equipment inventory was conducted and that the facility was inspected before the end of the shift.		

Evaluation Guidance: Refer to chapter 1, paragraph 1-4 b (6).

References

Required: AR 190-13 and AR 525-13

Related: AR 190-14, AR 190-45, DA Form 2823, DA Form 3881, DA Form 3946, DA Form 3975, DA Form 4002, DA Form 4137, DD Form 1408, DD Form 1805, DD Form 1920, FM 19-25, FM 3-19.13, and STP 19-95B1-SM

191-379-4407

Plan Convoy Security Operations

Conditions: You are given an operation order (OPORD), a combat load, a map of the area, a lensatic compass, a protractor, communications equipment, signal operating instructions (SOI), security personnel, and special orders, if required.

Standards: Develop a plan that includes all required considerations for the specific mission, coordinate with appropriate units for required support, ensure that necessary equipment and supplies are available and operational, and prepare briefings for the security personnel on the mission and assign specific duties. Ensure that 360-degree security is maintained from the point of origin to the destination when escorting special weapons.

Performance Steps

1. Receive the OPORD.

Note: Follow all steps in the troop-leading procedures. When carrying special weapons or ammunition, ensure that you obtain the special orders concerning this cargo, that you understand them, and that they cover any situation not covered in the OPORD.

2. Coordinate with host nation (HN) security personnel.
3. Consult with all sources of information, especially the engineers and the highway traffic division (HTD), to obtain as much information as possible.
4. Reconnoiter the convoy route.
 - a. Identify likely trouble spots and ambush sites.
 - b. Determine possible locations for traffic control posts (TCPs) and/or checkpoints.
 - c. Identify route conditions.
 - d. Determine the location of friendly units in the area.
5. Coordinate with the convoy commander.
 - a. Determine the actions to take if—
 - (1) Attacked by a sniper.
 - (2) Ambushed with the road blocked.
 - (3) Ambushed with the road not blocked.
 - (4) Attacked from the air.
 - (5) Attacked with artillery.

Note: Based on the mission and/or the type of cargo, the reaction to an enemy attack may vary. When carrying special weapons or ammunition, ensure that procedures are covered in the special orders on exactly how to react to enemy contact.

- b. Determine the protective measures to take for mines and booby traps.
- c. Determine convoy organizations, to include the location of—
 - (1) Critical cargo vehicles.
 - (2) Control vehicles.
 - (3) Armored vehicles and automatic weapons.

Note: Armored vehicles and automatic weapons are positioned within the convoy so that they are mutually supporting.

- (4) Maintenance and recovery vehicles.

Performance Steps

Note: The convoy commander and/or unit maintenance officer or noncommissioned officer will decide whether to repair, recover, or destroy damaged vehicles.

- d. Determine the primary and backup frequencies.
- e. Determine emergency communications procedures.
- f. Determine the timetable for movements, especially for serials and march units.
- g. Identify the coordination points (assembly area for everyone).
- h. Determine the start and release points.
- i. Determine the security measures to be used at halts and rest stops. The location of the halts should be—
 - (1) In a relatively secure area.
 - (2) Off the roadway where there is some natural cover and concealment.
 - (3) Under the surveillance of a security force.
 - (4) In an area where there is a view for 200 meters at each end of the convoy with no obstructions, such as curves and hills.
 - (5) In an area that is large enough to maintain the proper convoy interval.
 - (6) In an area where local civilians can be kept away from the convoy.
 - (7) In an area that is not heavily populated.
 - (8) In an area where HN police are present, if applicable.

Note: Additional procedures for establishing an exclusion area and enforcing the "two-man rule" must be covered and written in the special orders to ensure that 360-degree security is maintained when carrying special weapons or ammunition. If security cannot be maintained, instructions on how and when to disable the weapons must be included.

- j. Determine the time and place that military police support begins and ends.
- k. Determine any expected changes in the routes.
- l. Determine road conditions.
- m. Determine supporting fires, to include artillery support, engineer support for minesweeping of the route, gunship support, and HN police support, if applicable.
- n. Identify the primary and alternate routes.
- o. Determine the location where military police vehicles and personnel will be positioned in the convoy.

Performance Steps

- p. Determine the method of escort for the convoy. Escort methods are as follows:
- (1) Scout, lead, and trail (leading/following).
 - (2) Empty truck (or modified).
 - (3) Leap frog.
 - (4) Perimeter.
6. Brief the personnel on the mission, enemy situation, and specific individual duties to be performed. Also brief personnel on—
- a. Procedures to be followed in the case of mechanical breakdown.
 - b. Defensive measures to be used against mines and booby traps.
 - c. Actions to be taken when there is contact with the enemy.
 - d. The method of escort.
 - e. Communications.
 - f. Special orders, if applicable.
7. Coordinate with friendly units in the area where the convoy will pass.
- a. Identify the support that friendly units can provide.
 - b. Identify the restrictions that apply to using indirect fire.
8. Coordinate with artillery units.
- a. Identify predetermined targets found during route reconnaissance or through coordination with the convoy commander.
 - b. Identify the locations for rest stops, halts, and possible enemy ambush sites.
9. Coordinate with helicopter and/or Air Force units for gunship support.
10. Inspect the following:
- a. Vehicles.
 - b. Radios.
 - c. Ammunition.
 - d. Weapons.
 - e. Chemical, biological, radiological, and nuclear (CBRN) equipment.
 - f. Combat load.

Evaluation Preparation: *Setup:* Schedule a field training exercise that will require the squad leader to plan convoy security operations.

Brief Soldier: Tell the squad leader being evaluated that he/she must develop an accurate and concise plan for convoy security operations.

Performance Measures	GO	NO GO
1. Received the OPORD.	—	—
<i>Note:</i> Followed all the steps in troop-leading procedures.		
2. Coordinated with HN security personnel.	—	—
3. Consulted with all sources of information, especially the engineers and the HTD, to obtain as much information as possible.	—	—
4. Reconnoitered the convoy route.		
5. Coordinated with the convoy commander.		
<i>Note:</i> Ensured that 360-degree security was maintained from the point of origin to the destination when escorting special weapons.		
6. Briefed personnel on the mission, enemy situation, and specific individual duties to be performed.		
7. Coordinated with friendly units in the area where the convoy would pass.		
8. Coordinated with artillery units.		
9. Coordinated with helicopter and/or Air Force units for gunship support.		
10. Inspected equipment.		

Evaluation Guidance: Refer to chapter 1, paragraph 1-4 b (6).

References

Required:

Related: FM 19-25, FM 3-19.1, FM 3-19.30, FM 3-19.4, and FM 7-10

805C-PAD-3594

Store Classified Information and Materials

Conditions: You are a squad/section leader. Given classified material, simulated storage containers, and AR 380-5.

Standards: Secure classified information and materials in appropriate storage containers.

Performance Steps
1. Determine classification levels of information and materials to be stored.
2. Determine the amounts of classified information and materials to be stored.
3. Determine the method of storage/safeguarding to be used.

Performance Steps

4. Determine the type of facility or storage containers required.
5. Determine the appropriate lock(s) for storage facility or containers.
6. Determine initial or additional facility/equipment requirements.
7. Submit a request for needed facility/equipment through the appropriate channel.
 - a. Determine routing.
 - b. Prepare the request in the proper format.
 - c. Submit the request in distribution or as required by local SOP.
8. Restrict access to facility/materials.
 - a. Determine personnel authorized access to storage facility/containers.
 - b. Verify the level of classified information and/or materials personnel are authorized access.
9. Maintain physical security.
 - a. Secure all classified material when not in use.
 - b. Indicate when containers are locked or open.
 - c. Designate personnel responsible for securing and controlling classified facility/containers.
10. Maintain records of security checks of classified facility/containers.
 - a. Place the security check form on the facility and containers as required.
 - b. Designate personnel to conduct daily/weekly checks.
 - c. Verify that security checks are made.
11. Train section personnel on security requirements for classified materials.
 - a. Provide requirements/authorization for access to facility/materials.
 - b. Provide instructions on conducting security checks.

Evaluation Preparation: *Setup:* To evaluate this task give a scenario that would require the Soldier to perform the performance measures. This will require simulated containers, locks, DA Form 702 (*Security Container Check Sheet*), a list of section personnel with varying security clearances, documents marked with various levels of security classification (marked "classified for training purposes only"), format for security check assignment, and classified document covers.

Brief Soldier: Tell the Soldiers that he/she will be evaluated on his/her ability to select the appropriate container for each document concerned and indicate who would have access to which container.

Performance Measures	GO	NO GO
1. Determined classification levels of information and materials to be stored	___	___
2. Determined the amounts of classified information and materials to be stored.	___	___
3. Determined the method of storage/safeguarding to be used.	___	___
4. Determined the type of facility or storage containers required.	___	___
5. Determined appropriate lock(s) for storage facility or containers.	___	___
6. Determined initial or additional facility/equipment requirements.	___	___
7. Submitted a request for needed facility/equipment through the appropriate channel.	___	___
a. Determined routing.		
b. Prepared the request in the proper format.		
c. Submitted the request in distribution or as required by the local SOP.		
8. Restricted access to facility/materials.		
a. Determined personnel authorized access to storage facility/containers.		
b. Verified the level of classified information and/or materials personnel are authorized access.		
9. Maintained physical security.		
a. Secured all classified material when not in use.		
b. Indicated when containers were locked or open.		
c. Designated personnel responsible for securing and controlling classified facility/containers.		
10. Maintained records of security checks of classified facility/containers.		
a. Placed the security check form on the facility and containers as required.		
b. Designated personnel to conduct daily/weekly checks.		

Performance Measures	GO	NO GO
c. Verified that security checks were made.		
11. Trained section personnel on security requirements for classified materials.	_____	_____
a. Provided requirements/authorization for access to facility/materials.		
b. Provided instructions on conducting security checks.		

Evaluation Guidance: Refer to chapter 1, paragraph 1-4 b (6).

References

Required: AR 380-5

Related:

SUBJECT AREA 24: ENEMY PERSONNEL

191-377-4250

Supervise the Processing of Detainees at the Point of Capture

Conditions: You are given Soldiers with individual equipment, assigned weapons, disposable restraints (wrist and ankle), soft cloth, permanent markers, an interpreter (when available), the rules of engagement (ROE)/rules for the use of force (RUF), AR 190-8, DD Form 2745s (*Enemy Prisoner of War [EPW] Capture Tag*), DA Form 4137s (*Evidence/ Property Custody Document*), STP 19-31B24-SM-TG and STP 19-31B1-SM, first aid supplies, and communications equipment.

Standards: Ensure that Soldiers search detainees according to task 191-377-4254. Ensure that Soldiers tag detainees using a DD Form 2745, document the search using a DA Form 4137, and link both by the DD Form 2745 number. Ensure that Soldiers keep detainees silent and segregated. Safeguard detainees according to U.S. policy and Army values. Enforce ROE/RUF during escape attempts. Correct and report inappropriate treatment and detainee noncompliance.

Performance Steps

Note: The best way to ensure that you are ready for detainee operations is proper planning. Prior to executing missions, gather the latest intelligence capture estimates, if possible. Brief your Soldiers, review the ROE/RUF, conduct rehearsals, and ensure that you have all the required equipment and forms for detainee processing before executing the mission.

1. Disarm and secure the detainees.

Note: Depending on the circumstances of capture (such as the battle outcome, surrender, and refugees), tempers may be high and communications may be difficult. Verbal commands or hand signals may have to be reinforced and given several times, especially when detainees do not understand English.

Performance Steps

a. Upon capture or surrender of combatant forces, direct detainees to—

- (1) Place their weapons on the ground, raise their hands above their heads, and step back 5 paces.

- (2) Raise their shirts, shake clothing loose, and turn 180 degrees in place to allow a visual check for other weapons or explosives.

Note: In the instance of a suicide bomber, the first responsibility is the safety of fellow Soldiers and bystanders. Attempt to remove all bystanders, detainees, and Soldiers from the possible blast zone of a suicide bomber. If that is not feasible, refer to local ROE for direction.

b. Position guards to ensure that they have an unobstructed line of fire.

c. Direct the designated team to move forward to check wounded or dead detainees.

- (1) Ensure that the team members disarm, restrain, and remove wounded detainees to a separate location and position them under guard.

- (2) Ensure that the team members search wounded detainees. Approach wounded detainees with caution, with your weapon drawn on the individual, until the detainee's weapon is out of his/her reach.

- (3) Direct aid and/or a combat lifesaver to provide medical assistance for wounded detainees under supervision of guards.

- (4) Segregate wounded detainees from the nonwounded detainees.

d. Secure weapons and remove weapons on the ground to a safe location in view of the guards. Document the owner of each weapon. Soldiers should not cross between a detainee and the armed guard in case the detainee tries to attack the Soldier.

Note: Detainee weapon documentation should be done when the situation allows. Under stressful situations, the DD Form 2745 number can be annotated on the stock of the weapon with a permanent marker and the DA Form 4137 completed later when you are in a safe area.

2. Organize the Soldiers and prepare for field processing of detainees.

a. Establish an outer perimeter to provide force protection for Soldiers and detainees.

b. Notify higher headquarters of the capture.

c. Establish a search team, which will consist of a Soldier to conduct the search, a Soldier to provide security for the Soldier conducting the search, and an interpreter, if available. Each search team should only process one detainee at a time.

d. Establish two internal guard teams to secure the detainees that have not been searched and the detainees that have been searched. They will escort detainees to and from the search team and segregation areas.

Performance Steps

e. Ensure that all search teams have detainee field processing equipment (for example, disposable restraints, cloth, permanent markers, DD Form 2745s, and DA Form 4137s).

f. Position yourself to maintain situational understanding of the entire operation. Your attention cannot be focused only on the actions of one searcher because you are also responsible for the safety, security, and actions of Soldiers providing force protection security, guarding detainees awaiting search, and guarding detainees that are through the search process.

3. Direct search teams to process detainees.

a. Position members of each search team.

(1) Position the guard to ensure that the guard has a clear line of sight to the detainee.

(2) Position the interpreter to best support the searcher (normally to the guard's rear flank).

(3) Position the searcher to provide lead during the search and instruct the guard and interpreter as necessary.

b. Ensure that Soldiers search detainees according to task 191-377-4254.

c. Ensure that Soldiers tag detainees according to task 191-377-4254.

(1) Ensure that Soldiers initially confiscate all items from detainees (some items will be returned immediately following the search).

Note: Currency will only be confiscated on the express order of a commissioned officer (for example, through an operation order, fragmentary order, or verbal order) per AR 190-8. Soldiers must notify a commissioned officer when currency is found. If a decision is made to confiscate it, it must be accounted for on a DA Form 4137.

(2) Have the Soldiers that completed the search fill out a DD Form 2745 when the search has been completed.

(3) Instruct Soldiers to tag the detainee and the confiscated bundle; use all three copies.

(a) Attach part A to the detainee.

(b) Retain part B for official records.

(c) Attach part C to confiscated items.

Note: The best time to complete the DD Form 2745 is immediately following the search. However, if speed is required, you may complete it at a later time. If you have enough Soldiers, you may want to establish another team to tag the detainees.

(4) Direct Soldiers to complete a DA Form 4137 according to task 191-377-4254 and secure and document confiscated items if the situation permits.

Performance Steps

Note: Ensure that Soldiers mark confiscated items that will be retained or destroyed (such as weapons, personal items, and investigatory/evidentiary items) for identification if time permits. Use a plastic bag or similar container to identify, collect, and temporarily store items that cannot be individually marked because of insufficient time due to imminent attack or any other emergency. Mark property according to task 191-377-4254.

4. Segregate detainees at the point of capture based on mission necessity.
 - a. Base initial segregation on information surrounding the capture events.
 - b. Segregate detainees to the greatest extent possible as more detailed information is known and resources and conditions allow.
5. Ensure that Soldiers maintain silence among detainees.
 - a. Ensure that Soldiers who are guarding the detainees maintain detainee silence. All guards should be alert for detainee leaders trying to give orders and for any attempts to plan an escape.
 - b. Segregate uncooperative detainees to minimize their effect on others if they remain uncooperative.
6. Ensure that Soldiers safeguard detainees from the moment of capture until they are released or repatriated.
 - a. Correct and report any inappropriate treatment immediately.
 - b. Ensure that Soldiers respond to escape attempts according to ROE and RUF.
7. Update higher headquarters on the situation after all the detainees have been processed. Include the following information:
 - a. Date, time, and location of capture.
 - b. Total number of detainees, their categories (if known), and all DD Form 2745 numbers.
 - c. Any confiscated items of intelligence value.
 - d. Any acts or allegations of inhumane treatment or abuse.
 - e. Any detainees requiring medical assistance.
8. Coordinate evacuation of detainees with higher headquarters.

Note: Supervisors must ensure that detainees are transported quickly to the detainee collection point or detainee holding area based on security, operational conditions, and available transportation.

- a. Obtain the location of the designated collection point and execute the mission according to task 191-377-4252.

Performance Steps

- b. Coordinate the date, time, and location of custody transfer if another unit will transport the detainees.
- c. Request additional resources to include food, water, and support along the escort route if they are not already factored by higher headquarters.

Evaluation Preparation: *Setup:* Provide the Soldier with four or more personnel to act as detainees and guards, materials to be used as detainee props, and the materials and references listed in the conditions statement.

Brief Soldier: Tell the Soldier that he/she will be evaluated on his/her ability to supervise the processing of detainees and equipment.

Performance Measures	GO	NO GO
1. Disarmed and secured the detainees.	_____	_____
2. Organized the Soldiers and prepared for field processing of detainees.	_____	_____
3. Directed search teams to process detainees.	_____	
4. Segregated detainees at the point of capture based on mission necessity.		
5. Ensured that Soldiers maintained silence among detainees.		
6. Ensured that Soldiers safeguarded detainees from the moment of capture until they were released or repatriated.		
7. Updated higher headquarters on the situation after all the detainees were processed.		
8. Coordinated for the evacuation of detainees with higher headquarters.		

Evaluation Guidance: Refer to chapter 1, paragraph 1-4 b (6).

References

Required: AR 190-8, DA Form 4137, DD Form 2745, Geneva Conventions, Hague Conventions, STP 19-31B1-SM, and STP 19-31B24-SM-TG

Related: FM 3-19.40

191-377-4252

Supervise the Escort of Detainees

Conditions: In a field environment, you are given a mission to escort detainees from one location to another, fully equipped Soldiers, completed DD Forms 2745 (*Enemy Prisoner of War [EPW] Capture Tags*), DA Form 4137s (*Evidence/Property Custody Document*), blank DD Form 2708s (*Receipt for Inmate or Detained Person*), the rules of engagement (ROE)/rules for the use of force (RUF), first aid

supplies, communications equipment, an interpreter (if available), confiscated property, and a known mode of transportation.

Standards: Brief the Soldiers on the mission. Supervise the safe escort of all assigned detainees from one location to another. Maintain accountability for the detainees and confiscated property.

Performance Steps

1. Plan the detainee escort mission.
 - a. Confirm the mission route, the date, the time, the number of detainees to be transferred, the number of guards, and the mode of transportation.
 - b. Plan the convoy escort based on a risk assessment of detainee status, security, force protection, and resource requirements.
 - c. Task organize your personnel to complete the mission. Supervisors must—
 - (1) Consider the guard-to-detainee ratio based on the threat, the nature of the detainees, the route, the timing, and the external risks.
 - (2) Identify Soldiers for the guard force, train and/or brief them, and rehearse roles and responsibilities.
 - (3) Identify Soldiers for the security force and train and/or brief them on their duties and the ROE/RUF.
 - d. Conduct a route and/or map reconnaissance.
 - (1) Consider the likelihood of the presence of sympathizers, hostile local nationals, or terrorists and their use of improvised explosive devices (IEDs).
 - (2) Determine the location of military police units or other security units along the route.
 - (3) Determine the rest stops.
 - (4) Determine any additional resources required for the convoy, including food, water, and sustainment items.
 2. Brief Soldiers and rehearse the mission when possible.
 - a. Ensure that movement procedures are briefed to all escort Soldiers with an interpreter (if available), including any support personnel (such as drivers and medics) to ensure that they understand what to do during—
 - (1) A convoy.
 - (2) Planned stops.
 - (3) Unexpected stops.
 - (4) An IED incident.
 - (5) An ambush by an aircraft and/or a sniper (task 551-721-2408).
 - (6) Detainee-initiated disturbances.
 - (7) Detainee and/or local population interaction.
 - b. Rehearse the mission when appropriate.
 3. Prepare detainees for transport.
-

Performance Steps

a. Direct the Soldiers to search the detainees for any weapons or contraband that may have been missed by the initial search.

b. Prepare a manifest or roster listing all of the detainees that will be escorted. Account for detainees using a locally produced manifest. Use any appropriate method available, such as a computer program or a pencil and paper, to create a manifest that includes the following minimum required information:

- (1) Name (if known).
- (2) DD Form 2745 number.

Note: The DD Form 2745 number is the only number used to account for a detainee until an internment serial number (ISN) is assigned at a theater internment facility (TIF).

- (3) The capturing unit.
- (4) The vehicle in which the detainees will be transported.
- (5) The destination.

c. Inventory detainees by using the DD Form 2745 numbers. Ensure that each detainee has been tagged using a DD Form 2745 and that Part A is hanging visibly from the detainee. If this is not complete, ensure that the releasing unit prepares the DD Form 2745 before accepting custody of the detainees. If your unit was the capturing unit, you or your Soldiers must prepare the DD Forms 2745.

- (1) Inventory confiscated item bundles using DA Form 4137s.

(a) Ensure that all confiscated equipment and material is accounted for, linked to the DD Form 2745 number, and tagged with DD Form 2745, Part C.

(b) Ensure that the releasing unit prepares the proper documentation before accepting the property if the confiscated equipment and material is not tagged.

(2) Prepare the proper accountability documents, or have your Soldiers prepare it if your unit was the capturing unit.

d. Brief detainees on the planned movement. Use an interpreter (when available) to give clear, brief instructions in their own language, if possible. Give no more information than is necessary to the detainees. As a minimum, brief them on the following:

- (1) The actions to take upon hearing the command "Halt."
- (2) The requirement to remain silent at all times.

Note: It may become necessary to muffle and/or blindfold unruly detainees. If required and authorized, silence uncooperative detainees by muffling them using a soft, clean cloth tied around their mouth and fastened at the back of the head. Do not harm the detainees or affect the detainees' ability to breathe. Do not use duct tape or other adhesives, place cloth or objects inside the mouth, or use physical force to silence detainees. Instruct guards to periodically check detainees to ensure that they are not harmed. Muffle detainees only for as long as needed.

Performance Steps

(3) The actions they are to take during an emergency, such as a delay or a crash.

(4) The hand-and-arm signals used to direct detainee movement.

(5) The implications of, and the guard force response to, escape attempts.

e. Ensure that detainees are properly restrained during transport.

(1) Do not daisy chain detainees together or fasten them to a fixed object during movement unless it is a military necessity or commanded by a higher authority. Vehicle collisions could severely injure restrained limbs.

(2) Ensure that detainees are always wearing a seat belt while on board an aircraft.

(3) Use blindfolds as appropriate to provide operations security.

f. Maintain segregation to the maximum extent possible.

4. Ready the detainees for movement or transport.

a. Ready the detainees for movement by foot.

(1) Put the detainees in close-column formation.

Note: Disposable restraints can remain fastened behind the detainees' backs, but the supervisor has discretion to place disposable restraints to the front when escorting detainees by foot. Factors to consider for this decision should include type of terrain, distance, and length of travel.

Note: Do not blindfold detainees for movement by foot.

(2) Place escort vehicles at the front and rear of the columns.

(3) Transport supplies in vehicles.

(4) Designate a vehicle in the rear of the formation for chase and/or straggler control.

(5) Designate a separate vehicle in the rear for medical support.

(6) Designate walking guards on the flanks.

Note: The number of guards required will be based on mission, enemy, terrain and weather, troops and support available, time available, civil considerations (METT-TC) and the supervisor's discretion.

Note: Ensure that Soldiers search transport vehicles for contraband before and after each escort.

b. Load the detainees for transport by wheeled vehicle.

(1) Search each vehicle to ensure that no contraband or weapons are present.

(2) Position guards at the front and rear of each vehicle.

(3) Place the escort security vehicles at the front and rear of the columns.

(4) Designate the vehicles in the rear to provide flank security and chase.

(5) Ensure that Soldiers assist restrained detainees on and off vehicles.

c. Load the detainees for transport by rail.

Performance Steps

(1) Search each car to ensure that no weapons or contraband are present.

Note: Blindfolds may not be necessary, based on the mode of transportation.

Note: Position the guards according to the METT-TC, the number of available guards, and the type of railcar used. Passenger cars are preferred over freight cars.

(2) Assist restrained detainees on and off cars.

d. Load the detainees for transport by air.

(1) Search the aircraft before and after the mission to ensure that no contraband or weapons are present.

Note: There may be a need to place disposable restraints on detainees' ankles. This is based on guidance from the aircraft commander and/or crew chief.

(2) Ensure that Soldiers assist restrained detainees on and off the aircraft.

(3) Ensure that Soldiers follow the instructions of the aircraft commander and/or crew chief for flight operations rules (such as requirements for seat belts, hearing protection, or special restraints).

5. Supervise and monitor the execution of the mission.

a. Ensure that the guards remain vigilant at all times. Monitor guards to ensure that they—

(1) Maintain weapon control and muzzle awareness.

(2) Maintain detainee silence and segregation.

(3) Restrain the detainees appropriately and check restraints periodically.

(4) Use a guard overwatch when in contact with detainees.

(5) Eliminate and/or reduce any contact between the detainees and the local population.

Note: Detainees will identify and exploit signs of guard boredom, complacency, and fatigue.

b. Prepare for actions at the planned stops and anticipate actions at unexpected stops.

c. Maintain continuous contact with higher headquarters and execute the mission according to the local standing operating procedure (SOP).

d. Direct response actions during emergencies.

e. Correct, report, and document any allegations of detainee abuse.

6. Coordinate with the gaining unit assuming custody of the detainees upon arrival at the designated location (detainee collection point (DCP), detainee holding area (DHA), or TIF).

a. Continue to provide security until properly relieved of custody.

Performance Steps

- b. Review the detainee escort manifest with assigned facility personnel.
 - c. Conduct a joint inventory of all detainees, pertinent documents, and confiscated items using the escort manifest, to include—
 - (1) DD Form 2745 (Parts A, B, and C).
 - (2) DA Form 4137.
 - (3) Medical files or information if available.
 - d. Provide any additional information regarding the circumstances of capture.
 - e. Provide a unit point of contact for any necessary follow-up.
 - f. Have the escort supervisor sign the release of confiscated items on the DA Form 4137 when the joint inventory is completed. The gaining authority signs the receipt of confiscated items on the DA Form 4137, prepares and signs the DD Form 2708, and returns the completed receipt to the escort supervisor.
 - g. Transfer custody of the detainee, respective documents, and confiscated items.
 - h. Brief facility personnel on all issues or information pertaining to the detainees or their conduct during the escort.
7. Notify higher headquarters of the total number of detainees transferred using DD Form 2745 numbers.

Evaluation Preparation: *Setup:* Provide the Soldier with four or more personnel to act as detainees, materials to be used as detainee props, Soldiers as guards, required documentation, and a known mode of transportation.

Brief Soldier: Tell the Soldier that he/she will be evaluated on his/her ability to supervise the escort of detainees.

Performance Measures	GO	NO GO
1. Planned the detainee escort mission.	___	___
2. Briefed the Soldiers and rehearsed the mission.	___	___
3. Prepared the detainees for transport.	___	___
4. Readied the detainees for movement or transport.	___	___
5. Supervised and monitored the execution of the mission.	___	___
6. Coordinated with the gaining unit assuming custody of the detainees upon arrival at the designated location (DCP, DHA, or TIF).	___	___
7. Notified higher headquarters of the total number of detainees transferred using DD Form 2745 numbers.	___	___

Evaluation Guidance: Refer to chapter 1, paragraph 1-4 b (6).

References

Required: DA Form 4137, DD Form 2708, and DD Form 2745

Related: AR 190-8, FM 3-19.40, Geneva Conventions, and Hague Conventions

SUBJECT AREA 27: RISK MANAGEMENT

850-001-3001

Employ the CRM Process and Principles and Apply Them to Operations

Conditions: As a small unit leader, in a garrison or tactical environment, given a subordinate who has completed the composite risk management (CRM) process for a mission, activity, or task, access to FM 5-19 and a completed DA Form 7566 (*Composite Risk Management Worksheet*).

Standards: Verify that the CRM process has been conducted for a given mission, task, or activity by a subordinate leader.

Performance Steps

1. Verify that a risk assessment has been conducted.
 - a. Ensure that mission, enemy, terrain and weather, troops and support available, time available, civil considerations (METT-TC) factors have been considered and hazards associated with the mission or task have been identified.
 - b. Ensure that the level of risk for each hazard was correctly estimated.
2. Verify that controls have been developed and properly implemented.
 - a. Ensure appropriate controls have been developed.
 - b. Ensure that the residual risk for each hazard has been reassessed.
 - c. Ensure that controls have been properly implemented. (How can we ensure controls are implemented?)
3. Verify how the controls will be supervised and evaluated.
 - a. Verify the technique for monitoring the controls.
 - b. Verify how well the controls and the risk management process worked. (How can we verify that the process worked?)
4. Verify that the overall residual risk for the mission or task is correct.
5. Verify that the overall risk for the mission has been accepted by the proper level of the chain of command.

Evaluation Preparation: *Setup:* To evaluate this task, you will require a subordinate who has received a mission or task which may be in the form of an operations order (OPORD), fragmentary order (FRAGO), warning order, patrol order, training task, and so forth.

Brief Soldier: Tell the Soldier that you are going to evaluate him/her on his/her ability to supervise the implementation of the CRM process.

Performance Measures	GO	NO GO
1. Verified that all of the hazards associated with the mission or task (a minimum of one, depending on the mission or task) had been identified.	_____	_____
2. Verified that the level of risk for each hazard had been correctly estimated.	_____	_____
3. Verified that the controls for each hazard were appropriate.		
4. Verified the residual risk for each hazard.		
5. Verified methods for implementing the controls.		
6. Verified how controls would be supervised and evaluated.		
7. Verified the overall residual risk for the mission, task, or activity.		
8. Verified that the overall level of risk had been approved at the proper level of command.		

Evaluation Guidance: Refer to chapter 1, paragraph 1-4 b (6).

References

Required: FM 5-19, FM 5-0, and DA Form 7566

Related:

This page intentionally left blank.

SUBJECT AREA 2: FIRST AID**081-831-1060****Establish Organizational Field Sanitation**

Conditions: You are a leader in a unit performing a mission in a field environment. You are responsible for establishing organizational field sanitation and ensuring personnel employ preventive medicine measures (PMMs) to protect themselves from disease and nonbattle injury (DNBI).

Standards: Ensure that Soldiers are aware of the major components of the medical threat to field forces. Ensure that personnel are trained on (and follow) the individual PMMs necessary to prevent DNBI. Monitor training and performance of field sanitation teams (FST). Enforce Army tobacco use policies. Coordinate, as necessary, with division-level and corps-level preventive medicine units.

Performance Steps

1. Ensure that Soldiers are aware of the major components of the medical threat to field forces. (See task 081-831-1057.)
 - a. Heat.
 - b. Cold.
 - c. Arthropods (insects).
 - d. Foodborne and waterborne diseases.
 - e. Toxic industrial materials (TIM).
 - f. Noise hazards.
 - g. Other medical threats to field forces.
 - (1) Skin disease—common in extremely dry or humid climates.
 - (2) Altitude sickness—locations above 8,000 feet.
 - (3) Poisonous plants and animals.
 - (4) Tobacco use.
 - (5) Poor medical threat intelligence.
2. Ensure that personnel are trained on (and follow) the individual PMMs necessary to prevent DNBI. (See STP 21-1-SMCT, task 081-831-1053.)
 - a. Protect against cold injuries.
 - b. Protect against heat injuries.
 - c. Protect against arthropods and arthropod-borne diseases.
 - d. Protect against poisonous plants and animals.
 - e. Protect against diseases from contaminated food and water.

Performance Steps

- f. Protect against diseases from human waste.
 - g. Protect against diseases from exposure to soil and common objects.
 - h. Maintain personal hygiene.
 - i. Maintain proper level of nutrition.
 - j. Take measures to resist stress.
 - k. Protect against sexually transmitted diseases.
 - l. Protect against acquired immune deficiency syndrome (AIDS).
 - m. Avoid adverse effects of tobacco products.
3. Enforce Army tobacco use policies.
- a. Enforce policies in AR 600-63.
 - b. Ensure that Soldiers are aware of sources to help them become tobacco free.
 - (1) Medical professionals.
 - (2) Local preventive medicine service.
 - (3) American Cancer Society.
 - (4) Nicotine gum and nicotine patches.
 - (5) Family and unit support.
4. Ensure that FST training is provided and that FSTs accomplish their tasks and responsibilities.
5. Coordinate, as necessary, with division-level preventive medicine (PM) sections on their missions to support field forces.
- a. Identify breakdowns in PMMs (individual and leader/unit).
 - b. Inform commanders on specific measures to repair the breakdowns.
 - c. Provide technical assistance for training the unit FSTs.
 - d. Monitor training of individual and unit PMMs.
 - e. Perform limited sanitation and vector control work.
6. Coordinate, as necessary, with corps-level PM units on their missions to support field forces.
- a. Corps PM detachments.
 - (1) Provide PM support to deployed forces in the corps/COMMZ in a direct support role or a general support role.
 - (2) Transport organic personnel and equipment with logistical support from a unit in the geographic area.

Performance Steps

(3) Perform area and aerial spraying missions, PM detachment (entomology) only.

b. Armored cavalry regiment (ACR). Provide the same type of support to the regiment as the division PM section provides to the division.

c. Separate brigades (separate infantry brigade [SIB] and heavy separate brigade [HSB]). Provide the same type of support to the SIB/HSB that the division PM section provides to the division.

d. Civil affairs (CA) units. Provide support for displaced persons, refugees, and evacuees. Reestablish essential public health services.

Evaluation Preparation: *Setup:* Evaluate this task during a field training exercise (FTX) or during a normal training session. If the evaluation is conducted during an FTX, the environmental and physical conditions at the FTX will be used as the scenario to implement PMM policies. If the evaluation is done during a normal training session, create the scenario to include environmental and physical conditions.

Brief Soldier: Tell the Soldier that he/she will be evaluated on his/her ability to supervise or ensure that appropriate preventive medicine policies are followed. The Soldier will respond to appropriate performance measures.

Performance Measures	GO	NO GO
1. Ensured that Soldiers were aware of the major components of the medical threat to field forces.	___	___
2. Ensured that personnel were trained on (and followed) the individual PMMs necessary to prevent DNBI.	___	___
3. Enforced Army tobacco use policies.	___	___
4. Ensured that FST training was provided and that FSTs accomplished their tasks and responsibilities.	___	___
5. Coordinated, as necessary, with division-level PM sections.	___	___
6. Coordinated, as necessary, with corps-level PM units.	___	___

Evaluation Guidance: Refer to chapter 1, paragraph 1-4 b (6).

References

Required:

Related: AR 40-5, AR 600-63, DA PAM 40-11, FM 21-10, and FM 4-25.12

**SUBJECT AREA 3: CHEMICAL, BIOLOGICAL, RADIOLOGICAL,
AND NUCLEAR**

031-503-4002

Radiological, Prepare a Unit for a Chemical, Biological, and Nuclear (CBRN) Attack

Conditions: You are given the commander's guidance, a radio, pioneer tools (ax, shovel, mattock), chemical alarms, chemical-agent detector kits, covering materials (plastic sheets, ponchos, tarpaulins), FM 3-11.4, and Soldiers who have their mission-oriented protective posture (MOPP) gear.

Standards: Prepare a unit for a CBRN attack by supervising unit preparation; preparing and protecting materiel from becoming damaged, contaminated, or inoperable, and preventing unit personnel from becoming casualties. The standard is not degraded if performed in MOPP4.

Performance Steps

1. Supervise unit preparation for a nuclear attack.

a. Individual protection.

(1) Ensure that personnel are sheltered in well-constructed fighting positions with overhead cover, bunkers, and/or armored vehicles.

(2) Ensure that personnel cover all exposed skin (roll sleeves down, button collars).

Note: A handkerchief or similar cloth may be worn over the nose and mouth to prevent inhaling contaminated dust.

b. Position.

(1) Ensure that the terrain is used effectively to minimize the effects of an attack.

(2) Ensure that the type of available shelter selected (covered foxholes, field-expedient overhead cover, buildings, tents, and armored vehicles) provides the best protection from weapon effects.

c. Materiel.

(1) Ensure that supplies, equipment, and vehicles are dispersed and/or dug in as much as possible. Ensure that explosives, ammunition, and flammables (fuel and oil) have been dispersed and/or dug in. Cover them if possible.

(2) Ensure that existing cover provides protection and natural shielding for vehicles, supplies, and equipment in the event of a nuclear explosion. Ensure that vans are parked so that their air conditioner intakes are opposite the prevailing wind direction. Ensure that air conditioners are turned off and intakes are covered with nonporous materials (plastic sheets or ponchos).

(3) Ensure that flammable debris is kept to a minimum. Ensure that small objects are secured to minimize the danger of casualties and damage from flying debris.

(4) Ensure that all food and water are tightly sealed in containers and secured under available cover.

Performance Steps

(5) Ensure that all electronic equipment and radios are turned off if not required for use.

(6) Ensure that power cables, antennas, and unused electronic equipment are disconnected and removed from power mounts.

(7) Ensure that communications and electronics equipment are placed inside bunkers or armored vehicles to enhance protection against an electromagnetic pulse (EMP).

d. Unit. Ensure that CBRN equipment operators prepare the equipment for use.

2. Supervise unit preparation for a biological attack.

a. Individual protection.

(1) Coordinate with medical personnel for needed immunizations.

(2) Ensure that Soldiers practice good hygiene and field sanitation procedures.

(3) Ensure that Soldiers are in good physical condition (well rested, well fed, and healthy).

(4) Ensure that Soldiers button clothing and cover exposed skin or wear the appropriate MOPP level.

(5) Ensure that Soldiers check protective masks and individual equipment for serviceability.

(6) Coordinate with supply personnel for needed parts and equipment.

b. Position.

(1) Ensure that the terrain is used effectively to minimize the effects of an attack.

(2) Ensure that the type of available shelter selected (covered foxholes, field-expedient overhead cover, buildings, tents, and armored vehicles) provides the best protection from weapon effects.

c. Materiel.

(1) Ensure that all food and water are tightly sealed in containers and secured under available cover.

(2) Ensure that unused supplies and equipment are covered to avoid surface contamination from an aerial spray attack.

(3) Ensure that vans are parked so that their air conditioner intakes are opposite the prevailing wind direction. Ensure that air conditioners are turned off and intakes are covered with nonporous materials (plastic sheets or ponchos).

3. Supervise unit preparation for a chemical attack.

a. Individual protection.

(1) Ensure that Soldiers are in good physical condition (well rested, well fed, and healthy).

(2) Ensure that Soldiers check protective equipment for serviceability and that they coordinate with supply personnel for replacement parts and equipment.

Performance Steps

- (3) Ensure that the appropriate MOPP level is assumed.
 - (4) Ensure that individuals seek available overhead cover or use ponchos, plastic sheets, tarpaulins, and so on to cover their positions.
 - (5) Ensure that antidotes and decontaminating kits are serviceable and readily available.
- b. Position.**
- (1) Ensure that the terrain is used effectively to minimize the effects of an attack.
 - (2) Ensure that the type of available shelter selected (covered foxholes, field-expedient overhead cover, buildings, tents, and armored vehicles) provides the best protection from weapon effects.
- c. Materiel.**
- (1) Ensure that all equipment, supplies, and vehicles are dispersed as much as possible. Ensure that these items are covered with nonporous materials (plastic sheets or ponchos). As a last resort, use dense foliage.
 - (2) Ensure that vans are parked so that their air conditioner intakes are opposite the prevailing wind direction. Ensure that air conditioners are turned off and intakes are covered with nonporous materials (plastic sheets or ponchos).
 - (3) Ensure that unpackaged food is in sealed containers. Ensure that Soldiers open food only when they are ready to eat it, keep water in sealed containers, and cover items if possible.
- d. Unit.** Ensure that operators of CBRN equipment prepare the equipment for use.

Evaluation Preparation: *Setup:* To evaluate this task, choose a site that allows the dispersing and/or digging in of vehicles, supplies, and equipment. You may decide to quiz the Soldier on performance measures that are difficult to evaluate otherwise, such as individual preparation for a biological attack.

Brief Soldier: Tell the Soldier that he/she will be evaluated on his/her ability to supervise unit preparations for a CBRN attack.

Performance Measures	GO	NO GO
1. Supervised unit preparation for a nuclear attack.	—	—
2. Supervised unit preparation for a biological attack.	—	—
3. Supervised unit preparation for a chemical attack.	—	—

Evaluation Guidance: Refer to chapter 1, paragraph 1-4 b (6).

References

Required: FM 3-11.4

Related:

071-326-5775**Coordinate with an Adjacent Platoon**

Conditions: Given a platoon-sized element with two adjacent platoon-sized elements.

Standards: Coordinated with the adjacent platoon-sized elements for offensive and defensive operations; ensured mutually supporting positions, fires, and signals.

Performance Steps

1. Coordinate with adjacent elements. After receiving an order for an offensive or defensive operation and during your planning phase, you must consider coordination with adjacent elements. If you receive the order while all other platoon-sized element leaders are present, take that opportunity to coordinate as much as possible to avoid delays later in the operation. While many of the details that must be coordinated will vary with the situation, essential items must always be coordinated.
2. Coordinate in the offense. In the offense, you must coordinate—
 - a. Lateral distance between all attacking elements.
 - b. Movement routes, to ensure that mutual support by fire or maneuver can be maintained between the lead elements.
 - c. Visual signals such as arm-and-hand signals and pyrotechnics.
 - d. Radio call signs.
3. Coordinate in the defense. In the defense, you must coordinate to ensure that there are no gaps and that fires interlock and are mutually supporting. Information coordinated includes—
 - a. Location of positions (primary, alternate, and supplementary).
 - b. Dead space between units.
 - c. Locations of observation posts (OPs).
 - d. Signals.
 - e. Patrols and ambushes (size, type, time of departure and return, and routes).
 - f. Locations and types of obstacles.
 - g. Boundaries.
 - h. Control measures.

Performance Steps

4. Allocate final protective fire. If a mortar or artillery final protective fire is allocated to the platoon-sized elements, it must be coordinated with the fire support team (FIST) forward observer (FO) and integrate it into the fire plan for the element.

Evaluation Preparation: *Setup:* In the defense, provide a field location with varying terrain, two adjacent element leaders, and the last fighting position for each of the flanking elements. In the offensive, provide a field location with varying terrain and two element leaders from adjacent platoons.

Brief Soldier: As the center platoon leader, the Soldier must coordinate with both adjacent element leaders.

Performance Measures	GO	NO GO
1. Coordinated with adjacent element leaders for offensive operations.	_____	_____
a. Lateral distance between attaching elements.	_____	_____
b. Movement routes.	_____	_____
c. Visual signals.	_____	_____
d. Radio call signs.	_____	_____
e. Boundaries.	_____	_____
f. Control measures.	_____	_____
2. Coordinated with adjacent leaders for defensive operations.	_____	_____
a. Location of primary position.	_____	_____
b. Location of alternate position.	_____	_____
c. Location of supplementary position.	_____	_____
d. Dead space between units.	_____	_____
e. Locations of OPs.	_____	_____
f. Signals.	_____	_____
g. Patrols and ambushes.	_____	_____
h. Locations and types of constructed obstacles.	_____	_____
i. Boundaries.	_____	_____
j. Control measures.	_____	_____

Evaluation Guidance: Refer to chapter 1, paragraph 1-4 b (6).

References

Required: FM 3-21.71, FM 3-90.1, FM 7-7, and FM 7-8

Related:

SUBJECT AREA 19: CROWD CONTROL

191-379-5403

Supervise a Riot/Crowd Control Operation with a Platoon-Sized Element

Conditions: You are given a riot or crowd control situation and a platoon of Soldiers fully equipped with riot control gear, FM 3-19.15, and STP 19-31B1-SM.

Standards: Based on the situation, select the best formations to control or disperse the crowd. Correctly form the platoon into the formations. Move the platoon through the formations to disperse or move the crowd, and reassemble the platoon from the formations after the crowd has been controlled or dispersed.

Performance Steps

1. Analyze mission requirements.
 - a. Determine the size of the area the platoon is to maneuver through.
 - b. Determine the approximate number of people in the crowd.
 - c. Determine the goals of the mission as follows:
 - (1) Move the crowd.
 - (2) Apprehend individuals, as appropriate.
 - (3) Extract individuals, as appropriate.
 - d. Complete a risk assessment.
 - e. Determine the necessary mission support requirements (if any).

Determine if there is a need for—

 - (1) Backup support.
 - (2) Vehicle support.
 - (3) Photographer support (video preferred).
 - (4) Communications support.
 - (5) Medical support.
 - f. Identify any potential threats to the rear of the formation once any crowd control movements have been completed.
 - g. Determine the platoon or operation exit strategy.
2. Determine the type of formations to be used based on the mission.

Note: The platoon leader determines into which formation to assemble the platoon. The formation to be used depends on the structure and temperament of the crowd. A squad, platoon, or larger unit may be employed and crowd control formations can be adapted to fit the unit's organization. For more information on formations, see FM 3-19.15.

Performance Steps

a. Form the platoon into a platoon line formation with one squad in direct (figure 191-379-5403-1).

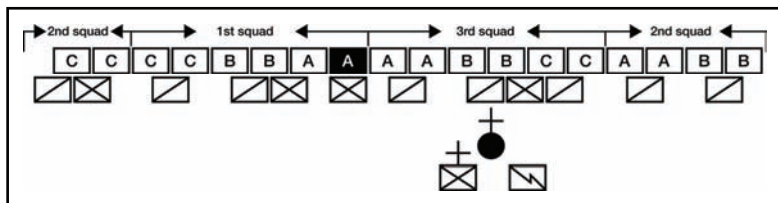

Figure 191-379-5403-1. Platoon line formation

Note: This formation is used to push a crowd in a straight line backwards.

b. Form the platoon into a platoon echelon left (or right) formation (figure 191-379-5403-2).

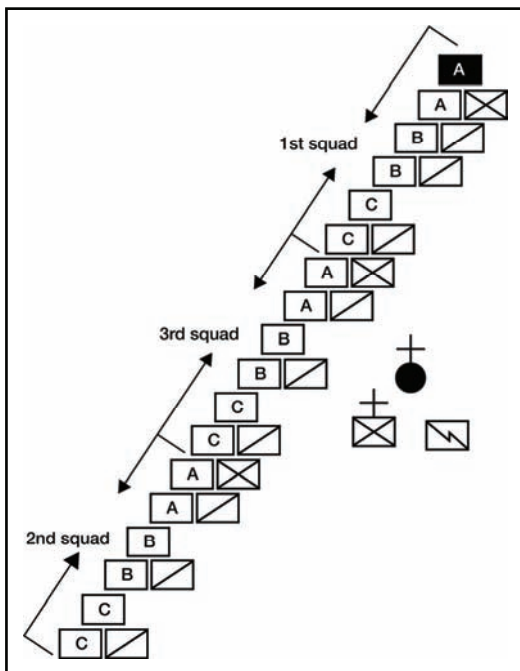

Figure 191-379-5403-2. Platoon echelon left formation

Note: This formation is used offensively to turn groups in either open or built-up areas and to move crowds away from buildings, fences, or walls.

c. Form the platoon into a platoon echelon left (or right) formation with one support squad in general support, the same as with the platoon line formation (figure 191-379-5403-3).

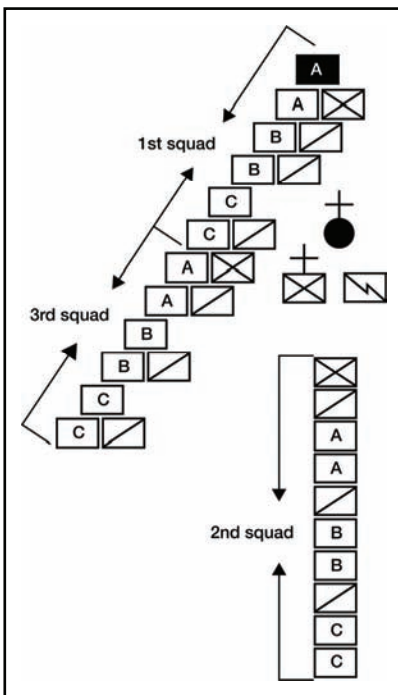

Figure 191-379-5403-3. Platoon echelon left with one support squad in general support

Note: This formation is used offensively to turn groups in either open or built-up areas and to move crowds away from buildings, fences, or walls.

d. Form the platoon into a platoon echelon left (or right) formation with one support squad in lateral support, the same as with the platoon line formation (figure 191-379-5403-4).

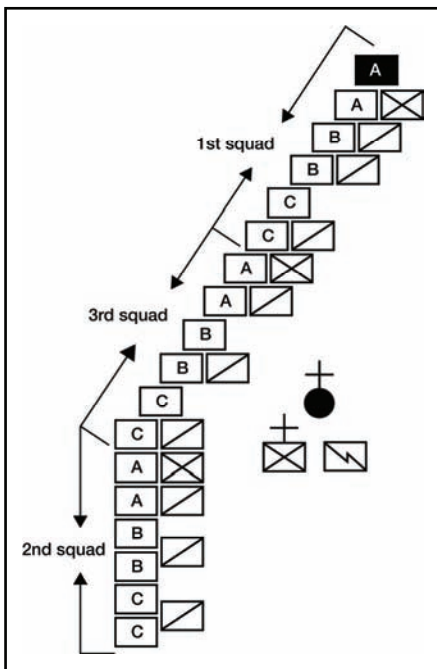

Figure 191-379-5403-4. Platoon echelon formation left with one squad in lateral support

Note: This formation is used offensively to turn groups in either open or built-up areas and to move crowds away from buildings, fences, or walls.

- e. Form the platoon into a platoon echelon left (or right) formation with one support squad in direct support, the same as with the platoon line formation (figure 191-379-5403-5).

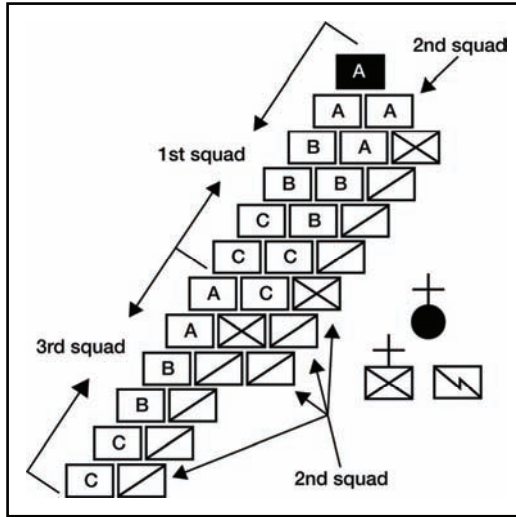

Figure 191-379-5403-5. Platoon echelon formation left with one squad in direct support

Note: This formation is used offensively to turn groups in either open or built-up areas and to move crowds away from buildings, fences, or walls.

- f. Form the platoon into a platoon wedge formation (figure 191-379-5403-6).

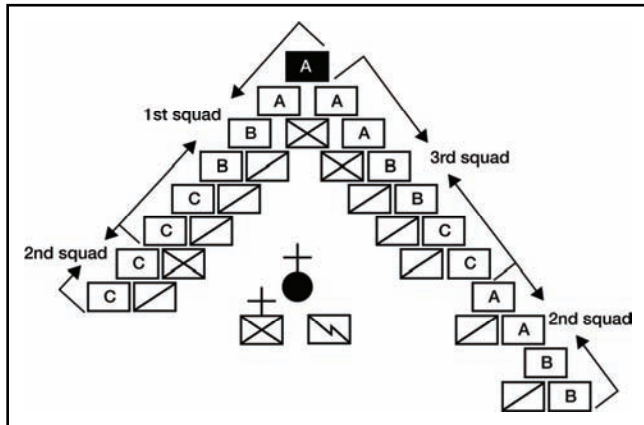

Figure 191-379-5403-6. Platoon wedge formation

Note: This formation is used offensively to penetrate or split crowds.

- g. Form the platoon into a platoon wedge formation with one squad in general support (figure 191-379-5403-7).

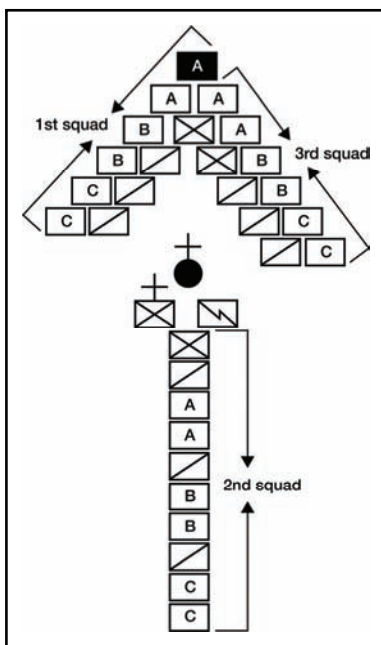

Figure 191-379-5403-7. Platoon wedge formation with one squad in general support

Note: This formation is used offensively to penetrate or split crowds.

- h. Form the platoon into a platoon wedge formation with one squad in lateral support (figure 191-379-5403-8).

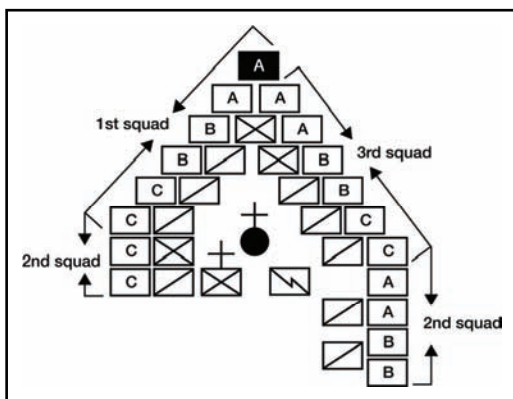

Figure 191-379-5403-8. Platoon wedge formation with one squad in lateral support

Note: This formation is used offensively to penetrate or split crowds.

- i. Form the platoon into a platoon wedge formation with one squad in direct support (figure 191-379-5403-9).

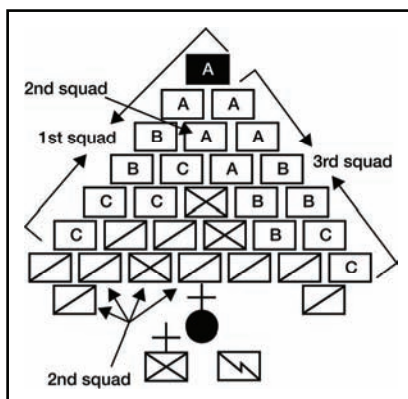

Figure 191-379-5403-9. Platoon wedge formation with one squad in direct support

3. Identify any nonlethal weapons (NLWs) requirement and assign platoon members to NLW positions, as appropriate:

- a. NLW capability SE Kit.
- b. 12-gauge shotguns.
- c. M203 grenade launcher.

Note: If nonlethal munitions are to be used, they should be addressed within the rules of engagement (ROE) and disseminated to the lowest level. This requires that all personnel have a clear understanding of the ROE and the leader's intent.

4. Identify any lethal overwatch team requirements.

Note: Lethal overwatch teams are assigned based on the mission, enemy, terrain and weather, troops and support available, time available, civil considerations (METT-TC); mission risk factors; availability; and the environment in which the mission is to be performed. For example, a hostile fire zone would require the most support from lethal overwatch teams. Examples of when lethal overwatch teams are authorized to employ lethal force are situations involving—

- Self-defense and the defense of others based on imminent danger of death.
 - Assets of national security that are in danger.
 - Assets inherently dangerous, such as explosives or chemical or nuclear materials.
- a. Brief lethal overwatch teams on the ROE, and ensure that they maintain communication with the movement leader.
 - b. Ensure that sniper cover support is available to the formation movement, where appropriate.

Performance Steps

- c. Ensure that vehicle crew support is available to the formation movement, where appropriate.
 - d. Ensure that countersniper support is available to the formation movement, where appropriate.
 - 5. Organize the platoon and support teams for formation and action.
 - a. Brief the platoon and all support teams:
 - (1) Discuss mission goals.
 - (2) Discuss any known intelligence relevant to the mission.
 - (3) Discuss emergency action contingencies.
 - (4) Discuss placement of NLW members in the platoon formation.
 - (5) Discuss rules of force/ROE.
 - b. Direct all support teams to take their positions.
 - 6. Move the platoon from the staging area to the mission area.
 - 7. Form the platoon into a platoon line formation.
 - a. Give the preparatory command, "Platoon on line," while simultaneously using hand-and-arm signals. (Raise both arms straight out to the side, arms and hands extended and palms down.)
 - b. Give the execution command, "Move," and point to the place where you want the formation.
 - c. Ensure that the squad leaders of the 1st and 2d squads give the command, "Follow me," while the leader of the 3d squad gives the command, "Stand fast." The rest of the 2d squad forms a line to the right of the baseman. The 1st squad forms a line to the left.
 - d. Ensure that the squad leader of the 3d squad gives the command, "Follow me," after the 1st and 2d squads have assumed their positions.
 - e. Ensure that the 3d squad forms a line to the right of the 2d squad.
- Note:* All squads dress on the 2d squad.
8. Form the platoon into a platoon line formation with one squad in general support.
 - a. Form the platoon line with one squad in general support in a column of twos.
 - (1) Give the command, "Platoon line, 2d squad in support in a column of twos."
 - (2) Ensure that the leaders of the 1st and 3d squads command, "Follow me," and the leader of the 2d squad commands, "Stand fast."

Performance Steps

(3) Give the command, "Move," and point to the place where you want the formation. The 1st and 3d squads move forward to their appointed places. The 2d squad, at the command of its squad leader, executes a column of twos to the right.

b. Form the platoon into a platoon line with one squad in support in a single column. The support squad, usually the 2d squad, may also be formed into a single column. The command is, "Platoon line, 2d squad in support, move." The 1st and 3d squads execute the formation, while the 2d squad remains in a column formation.

9. Form the platoon into a platoon line formation with one squad in lateral support.

a. Give the command, "Platoon line, 2d squad in lateral support."

b. Give the command, "Move," and point to the place where you want the formation.

c. Ensure that after the 1st squad forms a line to the left of the baseman, the 3d squad forms a line to the right of the baseman. After the line has been formed, the squad leader for the 2d squad commands, "Odd-numbered Soldiers, follow me," and the assistant squad leader commands, "Even-numbered Soldiers, follow me." The odd-numbered Soldiers move out to the left and form a column behind the last Soldier in the 3d squad. The even-numbered Soldiers move out to the right and form a column behind the last Soldier in the 1st squad.

10. Form the platoon into a platoon line formation with one squad in direct support.

a. Give the command, "Platoon line, 2d squad in direct support." The 1st and 3d squads will execute a line.

b. Ensure that the leaders of the 2d squad command, "Stand fast."

c. Ensure that after the 1st and 3d squads move to the appointed place and execute the line, the 2d squad executes a similar line to the rear of the leading line. The 2d squad forms to the right of its baseman. The 2d squad can be shifted to the right or left to support any segment of the formation.

Note: Ensure that the 2d squad closes and covers the intervals between the elements in the leading line.

11. Form the platoon into a platoon echelon left (or right) formation.

a. Give the command, "Platoon echelon, left (or right)."

b. Give the command, "Move," and point to where you want the formation.

Performance Steps

c. Give hand-and-arm signals with voice commands. Extend one arm 45 degrees above and the other 45 degrees below the horizon, arms and hands extended. (When facing the platoon, the upper arm indicates the direction of the echelon.)

d. Ensure that the 1st squad leader commands, "Follow me," and the squad executes an echelon left.

e. Ensure that the 2d and 3d squad leaders command, "Stand fast."

f. Ensure that as each squad clears the column, the next squad moves to extend the echelon formed by the preceding squad.

Note: For an echelon right, the 3d squad executes an echelon right with the rest of the squads following.

12. Form the platoon into a platoon echelon left (or right) with one support squad in general support, the same as with the platoon line formation.

a. Give the command, "Platoon echelon, left (or right), 2d squad in general support."

b. Give the command, "Move," and point to the place where you want the formation.

c. Give hand-and-arm signals with voice commands. Extend one arm 45 degrees above and the other 45 degrees below the horizon, arms and hands extended. (When facing the platoon, the upper arm indicates the direction of the echelon.)

d. Ensure that the 1st squad leader commands, "Follow me," and the squad executes an echelon left (or right).

e. Ensure that the 2d and 3d squad leaders command, "Stand fast."

f. Ensure that as the 1st squad clears the column, the 3d squad moves to extend the echelon formed by the 1st squad. The 2d squad, at the command of its squad leader, executes a column of twos to the left (or right).

13. Form the platoon into a platoon echelon left (or right) with one support squad in lateral support, the same as with the platoon line formation.

a. Give the command, "Platoon echelon, left (or right), 2d squad in lateral support."

b. Give the command, "Move," and point to the place where you want the formation.

Performance Steps

c. Give hand-and-arm signals with voice commands. Extend one arm 45 degrees above and the other 45 degrees below the horizon, arms and hands extended. (When facing the platoon, the upper arm indicates the direction of the echelon.)

d. Ensure that the 1st squad leader commands, "Follow me," and the squad executes an echelon left (or right).

e. Ensure that the 2d and 3d squad leaders command, "Stand fast."

f. Ensure that as the 1st squad clears the column, the 3d squad moves to extend the echelon formed by the 1st squad. After the echelon has formed, the squad leader for the 2d squad commands, "Odd-numbered Soldiers, follow me," and the assistant squad leader commands, "Even-numbered Soldiers, follow me." The odd-numbered Soldiers move out to the left (or right) and form a column behind the last Soldier in the 3d squad. The even-numbered Soldiers move out to the left (or right) and form a column behind the first Soldier in the 1st squad.

14. Form the platoon into a platoon echelon left (or right) formation with one support squad in direct support, the same as with the platoon line formation.

a. Give the command, "Platoon echelon, left (or right), 2d squad in direct support."

b. Give the command, "Move," and point to the place where you want the formation.

c. Give hand-and-arm signals with voice commands. Extend one arm 45 degrees above and the other 45 degrees below the horizon, arms and hands extended. (When facing the platoon, the upper arm indicates the direction of the echelon.)

d. Ensure that the 1st squad leader commands, "Follow me," and the squad executes an echelon left (or right).

e. Ensure that the 2d and 3d squad leaders command, "Stand fast."

f. Ensure that as the 1st squad clears the column, the 3d squad moves to extend the echelon formed by the 1st squad. After the echelon has formed, the 2d squad executes a similar echelon to the rear of the leading echelon. The 2d squad will form to the left (or right) of its baseman. The 2d squad can be shifted to the left or right to support any segment of the formation.

15. Form the platoon in a platoon wedge formation.

a. Give the command, "Platoon wedge," followed by the command, "Move." Give hand-and-arm signals with voice commands. Extend both arms down to the sides at 45 degrees below the horizon, palms down and toward the body. Then point to where you want the formation.

Performance Steps

b. Ensure that the 1st and 3d squad leaders command, "Follow me," while the 2d squad leader commands, "Stand fast."

c. Ensure that the 1st and 3d squads move to the front and, when the last element of the squads have cleared the front of the 2d squad, the 2d squad leader commands, "Follow me." The squad moves to the left and right respectively.

d. Ensure that the 3d squad executes an echelon right off the baseman and the 1st squad executes an echelon left.

e. Ensure that the odd-numbered Soldiers of the 2d squad form an echelon left on the rear element of the 1st squad and the even-numbered Soldiers form an echelon right on the rear element of the 3d squad.

16. Form the platoon in a platoon wedge formation with one squad in general support in a column of twos.

a. Give the command, "Platoon wedge, 2d squad in support in a column of twos, move."

b. Ensure that the 1st and 3d squads execute the wedge and that the 2d squad, at the command of its squad leader, executes a column of twos to the right.

Note: The support squad, usually the 2d squad, may also be formed into a single column. The command for this would be, "Platoon wedge, 2d squad in support, move." The 1st and 3d squads execute the formation, while the 2d squad remains in a column formation.

17. Form the platoon into a platoon wedge formation with one squad in lateral support.

a. Give the command, "Platoon wedge, 2d squad in lateral support, move." The 1st and 3d squads execute the wedge, while the 2d squad stands fast.

b. Ensure that after the wedge has been formed, the squad leader for the 2d squad commands, "Odd-numbered Soldiers, follow me," and the assistant squad leader commands, "Even-numbered Soldiers, follow me." The odd-numbered Soldiers move out to the left and form a column behind the last Soldier in the 3d squad. The even-numbered Soldiers move out to the right and form a column behind the last Soldier in the 1st squad.

c. Give the command, "2d squad, lateral support, move," to move the 2d squad from general support to lateral support.

d. Give the command, "2d squad, extend the wedge, move," to have the 2d squad join the wedge from either general support or lateral support. The 2d squad leader and the assistant squad leader command, "Follow me," and move out to the left and right, respectively, to extend the wedge on the 1st and 3d squads.

Performance Steps

18. Form the platoon into a platoon wedge formation with one squad in direct support.

- a.** Give the command, "Platoon wedge, 2d squad in direct support, move."
- b.** Ensure that the 1st and 3d squads execute a wedge. The 2d squad executes a squad wedge behind, and centered on, the leading wedge.
- c.** Ensure that the Soldiers in the supporting wedge cover the intervals between the Soldiers in the leading wedge.

19. Move the formation using the command, "Forward, march."

Note: This will begin the forward movement of the formation. Left and right formation movement adjustments will be made by using "Echelon left or echelon right." Use other movement commands, such as mark time or halt, as appropriate.

a. Determine the flow of the crowd as your team advances, and make commands to the team for formation movements to compensate for the crowds movement. Ensure that the squad achieves the goals assigned.

Note: Squad leaders and squad members should be mindful of safety factors in formation movements, such as airborne projectiles, active antagonistic members in the crowd that may need removal, possible incoming direct fire, and peripheral view checks of left and right squad members.

- b.** Give the command, "Halt," once movement of the crowd is complete according to mission goals.
- c.** Review the crowd dispersal and reevaluate it to ensure that the mission is complete.
- d.** Check peripherals (side and rear) to ensure security and safety of the squad.
- e.** Communicate your intentions with any support teams to remove your squad before reassemble.

20. Reassemble the platoon from a formation.

- a.** Move to the rear of the platoon where you want the platoon members to assemble and give the command, "Platoon assemble, move," while making a circular motion above your head with your right hand.
- b.** Ensure that the baseman of each squad does an about face and that all other squad members do a facing movement toward their baseman
- c.** Ensure that the platoon comes to port arms upon hearing the command, "Platoon assemble."
- d.** Ensure that upon the command, "Move," the 2d squad leader commands, "Follow me." The 1st and 3d squad leaders command, "Stand fast."

Performance Steps

e. Ensure that as the 2d squad clears the formation, the 1st and 3d squad leaders command, "Follow me." The 1st and 3d squads follow, moving at double time, and dress to the right of the 3d squad until the platoon is fully formed.

Evaluation Preparation: *Setup:* Provide the Soldier with the materials and equipment listed in the conditions statement.

Brief Soldier: Tell the Soldier that this task may be performed to standard without regards to sequence of formations and that all formations in the task must be performed.

Performance Measures	GO	NO GO
1. Analyzed mission requirements.	_____	_____
2. Determined the type of formations to be used based on the mission.	_____	_____
3. Identified any NLWs requirements.	_____	_____
4. Identified any lethal overwatch team requirements.	_____	_____
5. Organized the platoon and support teams for formation and action.	_____	_____
6. Moved the platoon from the staging area to the mission area.	_____	
7. Formed the platoon into a platoon line formation.		
8. Formed the platoon into a platoon line formation with one squad in general support.		
9. Formed the platoon into a platoon line formation with one squad in lateral support.		
10. Formed the platoon into a platoon line formation with one squad in direct support.		
11. Formed the platoon into a platoon echelon left (or right) formation.		
12. Formed the platoon into a platoon echelon left (or right) formation with one support squad in general support.		
13. Formed the platoon into a platoon echelon left (or right) formation with one support squad in lateral support.		
14. Formed the platoon into a platoon echelon left (or right) formation with one support squad in direct support.		
15. Formed the platoon into a platoon wedge formation.		

Performance Measures	GO	NO GO
16. Formed the platoon into a platoon wedge formation with one squad in general support in a column of twos.	___	___
17. Formed the platoon into a platoon wedge formation with one squad in lateral support.	___	___
18. Formed the platoon into a platoon wedge formation with one squad in direct support.	___	___
19. Moved the formation using the command, "Forward, march".	___	___
20. Reassembled the platoon from a formation.	___	___

Evaluation Guidance: Refer to chapter 1, paragraph 1-4 b (6).

References

Required: STP 19-31B1-SM

Related:

191-410-0078

Supervise a Riot/Crowd Control Operation with a Company-Sized Element

Conditions: You are given a riot or crowd control situation, a company of Soldiers fully-equipped with riot control gear, nonlethal weapons, lethal weapons, the rules of engagement (ROE), rules for the use of force (RUF), FM 3-19.15, and STP 19-31B1-SM.

Standards: Based on the situation, select the best formation(s) to control or disperse the crowd. Correctly form the company into the formation(s). Move the company through the formation(s) to disperse or move the crowd and reassemble the company from the formation(s) after the crowd has been controlled or dispersed.

Performance Steps

1. Analyze the mission requirements.

Note: The company commander determines which formation to assemble the company. The formation used depends on the structure and temperament of the crowd.

- a. Determine the size of the area the company is to maneuver through.
- b. Determine the approximate number of people in the crowd.
- c. Review the assigned goals of the mission, to determine—
 - (1) Where to move the crowd.
 - (2) Who to apprehend, if required.
 - (3) Who to extract, if required.

Note: Apprehension and extraction operations may not be required in every mission.

Performance Steps

- d. Complete a risk assessment.
- e. Determine the necessary mission support requirements (if any).

Consider the following:

- (1) Backup support.
- (2) Vehicle support.
- (3) Photographer support (video preferred).
- (4) Communications support.
- (5) Medical support.

f. Identify any potential threat(s) to the rear and flanks of the formation during crowd control operations and at completion.

- g. Determine the operation exit strategy.

2. Determine the type of formation(s) to be used depending on the mission.

Note: Not all of the following formations will be used.

a. Form the company in a company line in depth formation (figure 191-410-0078-1).

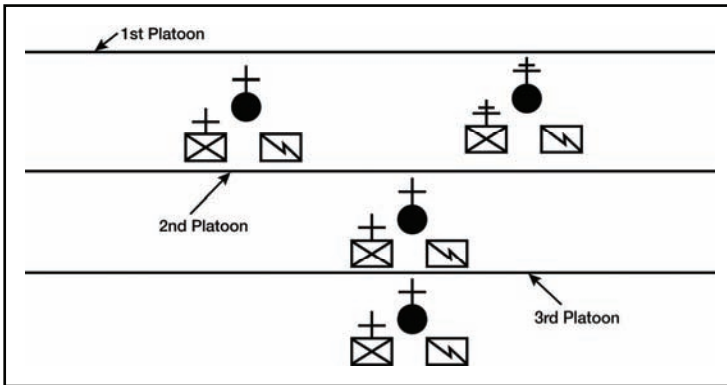

Figure 191-410-0078-1. Company line in depth formation

Note: Formations 2a through 2e have offensive and defensive applications and may be used to push a crowd straight backwards, to hold a crowd, or deny them access to an area.

Note: If the commander wants a more formidable formation, he/she moves the 2d platoon into direct support.

Note: Platoon leaders and platoon sergeants (PSG) assist each other in controlling the company.

b. Form the company into a company line in mass formation (figure 191-410-0078-2).

Performance Steps

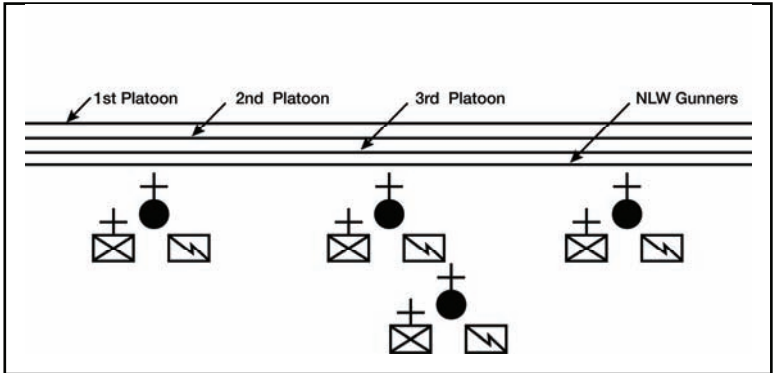

Figure 191-410-0078-2. Company line in mass formation

c. Form the company into a company line formation with support platoon (figure 191-410-0078-3).

Note: Support platoons function in the same manner as a squads in support.

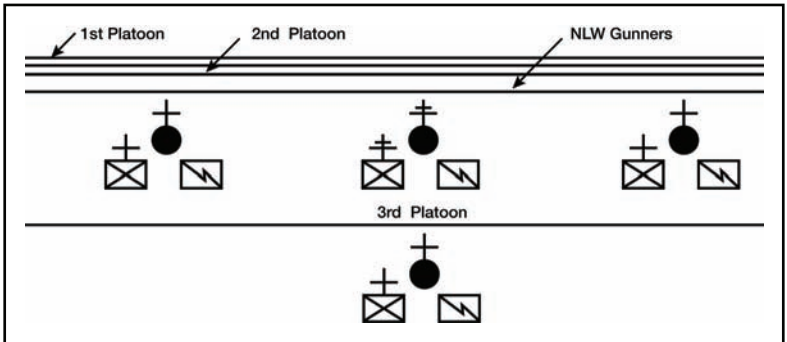

Figure 191-410-0078-3. Company line formation with support platoon

d. Form a company line in mass formation with one platoon in lateral support (figure 191-410-0078-4).

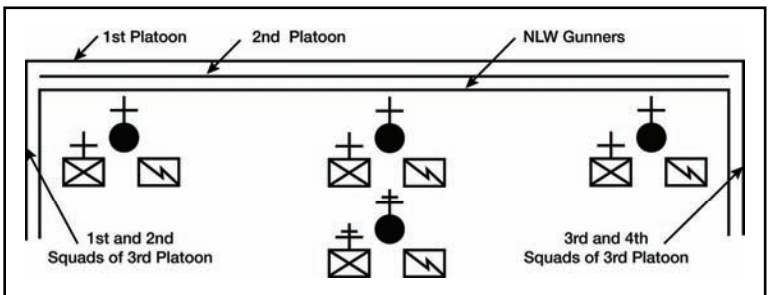

Figure 191-410-0078-4. Company line in mass formation with one platoon in lateral support

Performance Steps

e. Form the company into a company line, one platoon in lateral support, and one platoon in general support (figure 191-410-0078-5).

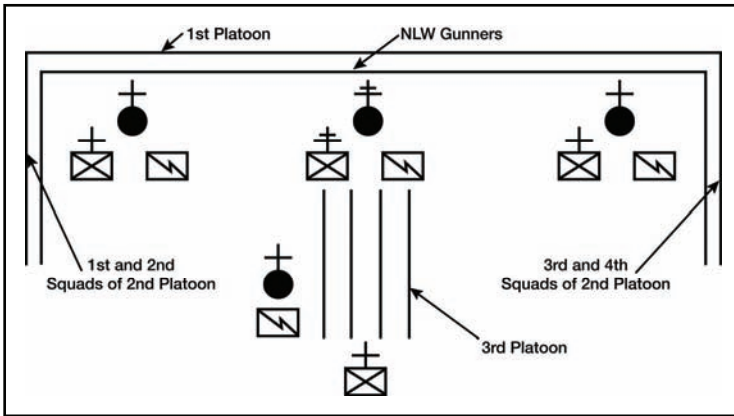

Figure 191-410-0078-5. Company line, one platoon in lateral support, and one platoon in general support

f. Form the company into a company echelon right (or left) formation with one platoon in lateral support and one platoon in general support (figure 191-410-0078-6).

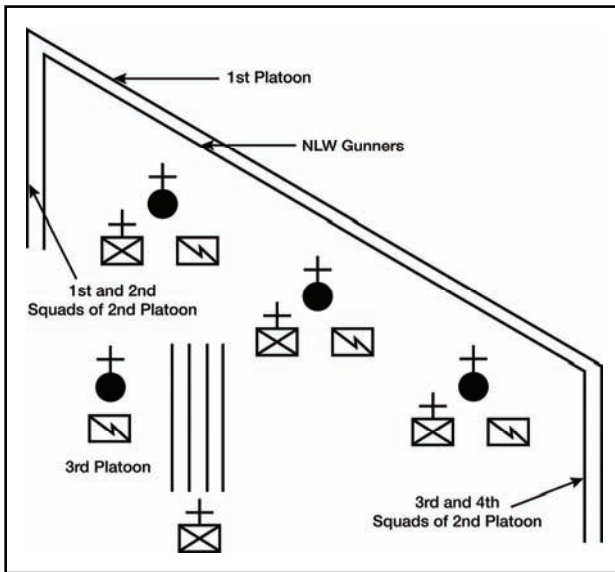

Figure 191-410-0078-6. Company echelon right (or left) formation with one platoon in lateral support and one platoon in general support

Performance Steps

Note: Formations 2f through 2i are used offensively to turn crowds in either open or built-up areas and to move crowds away from buildings, fences, or walls.

g. Form the company into a company echelon right (or left) in mass formation with one platoon in lateral support and one platoon in general support (figure 191-410-0078-7).

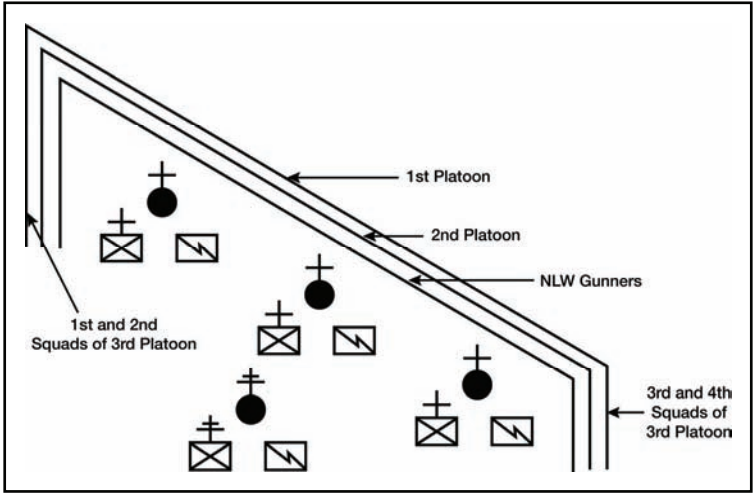

Figure 191-410-0078-7. Company echelon right (or left) in mass formation with one platoon in lateral support and one platoon in general support

h. Form the company into a company echelon right (or left) in mass formation with one platoon in lateral support (figure 191-410-0078-8).

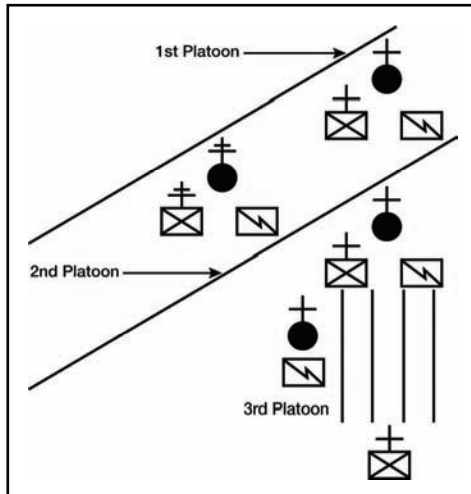

Figure 191-410-0078-8. Company echelon right (or left) in mass formation with one platoon in lateral support

Performance Steps

i. Form the company into a company echelon right (or left) in mass formation with one platoon in general support (figure 191-410-0078-9).

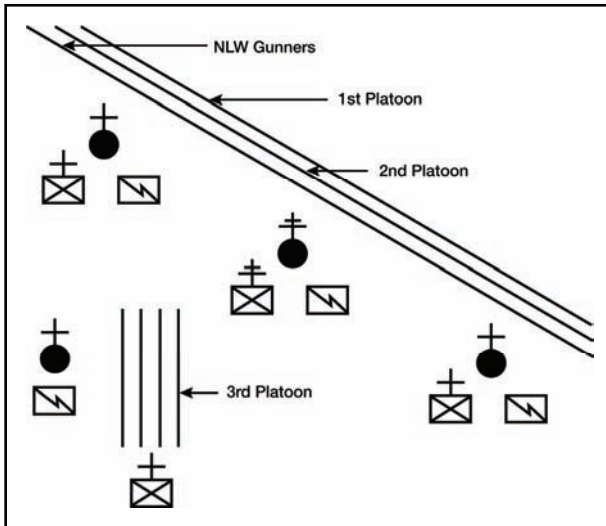

Figure 191-410-0078-9. Company echelon right (or left) in mass formation with one platoon in general support

j. Form the company into a company wedge formation with two platoons in general support (figure 191-410-0078-10).

Note: Formations 2j through 2m are used offensively to penetrate or split crowds.

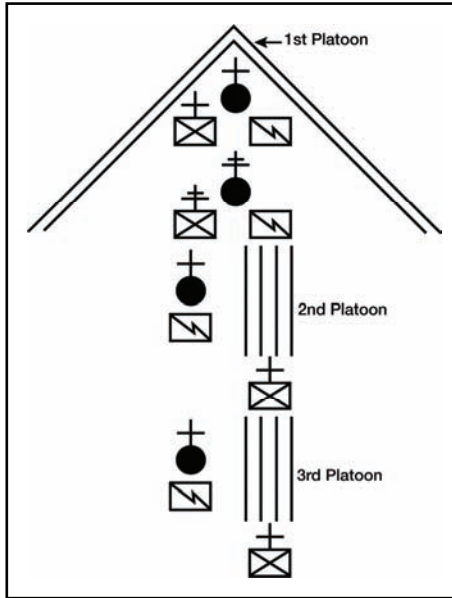

Figure 191-410-0078-10. Company wedge formation with two platoons in general support

k. Form a company into a company wedge formation with one platoon in lateral support (figure 191-410-0078-11).

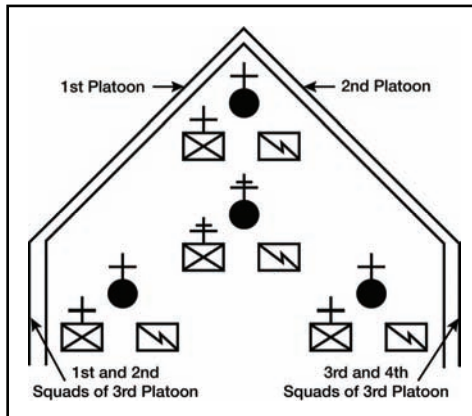

Figure 191-410-0078-11. Company wedge formation with one platoon in lateral support

l. Form a company into a company wedge formation with one platoon in lateral support and one platoon in general support (figure 191-410-0078-12).

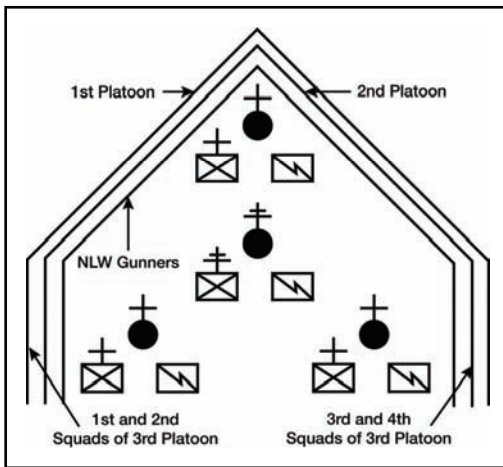

Figure 191-410-0078-12. Company wedge formation with one platoon in lateral support and one platoon in general support

- m. Form a company into company wedge formation with one platoon in lateral support and one platoon in general support (figure 191-410-0078-13).

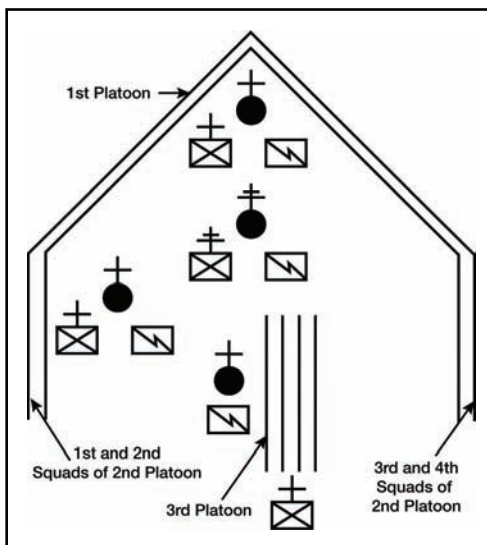

Figure 191-410-0078-13. Company wedge formation with one platoon in lateral support and one platoon in general support

3. Identify any nonlethal weapons (NLWs) requirements such as—
 - a. NLW Capability SE Kit.

Performance Steps

- b. 12 gauge shotguns.
 - c. M203 grenade launcher.
 4. Make NLW assignments to company members (as appropriate).

Note: If nonlethal munitions are to be used, they should be addressed within the ROE and disseminated to the lowest level. This requires that all personnel have a clear understanding of the ROE and the leader's intent.

5. Identify lethal overwatch team (LOT) requirements such as—
 - a. Brief the LOT on their ROE.
 - b. Establish communication with the LOT and movement leader.
 - c. Establish sniper cover support to the formation movement (where appropriate).
 - d. Establish vehicle crew-served support to the formation movement (where appropriate).
 - e. Establish countersniper support to formation movement (where appropriate).

Note: LOTs are assigned based on mission, enemy, terrain and weather, troops and support available, time available, civil considerations (METT-TC), mission risk factors, availability, and the environment that the mission is to be performed in (for example, hostile fire zone should require the most LOT support).

6. Organize the company and support teams for formation and action.
 - a. Brief the company and all support teams on the following:
 - (1) Mission goal(s).
 - (2) Any known intelligence relevant to the mission.
 - (3) Emergency action contingencies.
 - (4) Placement of NLW members in company formation.
 - (5) RUF/ROE.
 - b. Direct all support teams to take their positions.
7. Move the company from the staging area to the mission area.
8. Form the company into a company line in depth formation.

Note: Steps 8 through 20 are only used if the specified formation is required.

Note: In company formations, the 1st platoon usually forms the lead element and the 2d and 3d platoons provide support.

Note: The support platoons can be employed in the same manner as the support squads in platoon formations. One platoon can be relieved from the lead element by another platoon while in formation by having a support platoon pass through the lead platoon.

Performance Steps

a. Give the preparatory command, "Company line in depth," while simultaneously using hand-and-arm signals. Raise both arms straight out to the side, arms and hands extended, palms down.

Note: Each platoon leader gives the command "Platoon line," and each squad leader follows with their commands to their squads to form the platoon line.

b. Give the execution command, "Move," and at the same time point to the place where you want the formation.

Note: Platoon leaders and PSGs assist each other in controlling the company.

c. Establish a more formidable formation, by commanding, "Second platoon, direct support, move." Ensure that the following occurs:

(1) The squad and team leaders from the 1st platoon take two steps backward.

(2) The 2d platoon moves forward and covers the intervals between the members of the lead platoon.

(3) The 3d platoon leader then moves his/her platoon forward to occupy the position formerly held by 2d platoon.

Note: If the 3d platoon is called on to support the company line, it moves forward and takes up a position directly behind the 2d platoon.

9. Form the company into a company line in mass with both platoons in direct support.

a. Give the command, "Company line in mass."

b. Give the command, "Move," and point to where you want the formation.

c. Give hand-and-arm signals with the voice commands. Raise both arms straight out to the side, arms and hands extended, palms down.

Note: Instead of forming it in stages, the company commander indicates his/her desire for this formation in his/her initial command. The each platoon forms a line, and the 2d and 3d platoons close on the 1st platoon without further command.

10. If required, form the company into a company line in mass formation with one platoon in depth.

a. Give the command, "Company line in mass formation, second platoon in depth."

b. Give the command, "Move," and point to where you want the formation.

c. Give hand-and-arm signals with the voice commands. Raise both arms straight out to the side, arms and hands extended, palms down.

Performance Steps

d. Ensure that the 3d platoon forms a line behind the platoon leader of the 2d platoon leader and NLW leader.

11. Form the company into a company line in mass formation with one platoon in lateral support.

a. Give the command, "Company line in mass formation with third platoon in lateral support."

b. Give the command, "Move," and point to where you want the formation.

c. Give hand-and-arm signals with the voice commands. Raise both arms straight out to the side, arms and hands extended, palms down.

d. Ensure that, after the first and second squads of 3d platoon move to the appointed place and execute the line, the 3d and 4th squad of 3d platoon move to their appointed place and execute the line.

12. Form the company into a company line, one platoon in lateral support, and one platoon in general support.

a. Give the command, "Company line, second platoon in lateral support, third platoon in general support."

b. Give the command, "Move," and point to where you want the formation.

c. Give hand-and-arm signals with the voice commands. Raise both arms straight out to the side, arms and hands extended, palms down.

13. Form the company into a company echelon, right (or left) with 2d platoon in lateral support, and 3d platoon in general support, the same as with the line.

a. Give the command, "Company echelon, right (or left), second platoon in lateral support, and third platoon in general support."

b. Give the command, "Move," and point to the place where you want the formation.

c. Give hand-and-arm signals with the voice commands. Extend one arm 45 degrees above and the other 45 degrees below the horizon, arms and hands extended.

Note: When facing the company, the upper arm indicates the direction of the echelon.

14. Form the company into a company echelon, right (or left) in mass formation with one platoon in lateral support and one platoon in general support.

a. Give the command, "Company echelon, right (or left), in mass formation, third platoon in lateral support and second platoon in general support."

Performance Steps

b. Give the command, "Move," and point to the place where you want the formation.

c. Give hand-and-arm signals with the voice commands. Extend one arm 45 degrees above and the other 45 degrees below the horizon, arms and hands extended.

Note: When facing the company, the upper arm indicates the direction of the echelon.

15. Form the company into a company wedge.

a. Give the command, "Company wedge," followed by the command, "Move." Give hand-and-arm signals with the commands. Extend both arms down to the sides at an angle of 45 degrees below the horizon, palms down and toward the body. Then point to where you want the formation as you give the command of execution.

b. Ensure that the 1st and 3d platoon leaders command, "Follow me," while the 2d platoon leader commands, "Stand fast."

c. Ensure that the 1st and 3d platoons move to the front and, when the last element of the platoons have cleared the front of the 2d platoon, the 2d platoon leader commands, "Follow me." The squad moves to the left and right respectively.

d. Ensure that the 3d platoon executes an echelon right off the number 2 member (the base member) and the 1st platoon executes an echelon left.

e. Ensure that the odd-numbered Soldiers of the 2d platoon form an echelon left on the rear element of the 1st platoon and the even-numbered Soldiers form an echelon right on the rear element of the 3d platoon.

16. Form the company into a company wedge with one platoon in general support in a column of twos.

a. Give the command, "Company wedge, second platoon in support in a column of twos, move."

b. Ensure that the 1st and 3d platoons execute the wedge and that the 2d platoon, at the command of its platoon leader, executes a column of twos to the right.

Note: The support platoon, usually the 2d platoon, may also be formed into a single column. The command for this would be, "Company wedge, second in support, move." The 1st and 3d platoons execute the formation, while the 2d platoon remains in column formation.

17. Form the company into a company wedge with one platoon in lateral support.

Performance Steps

a. Give the command, "Company wedge, second platoon in lateral support, move." The 1st and 3d platoons execute the wedge, while the 2d platoon stands fast.

b. Ensure that, after the wedge has been formed, the platoon leader for the 2d platoon commands, "Odd-numbered Soldiers, follow me," and the assistant platoon leader commands, "Even-numbered Soldiers, follow me." The odd-numbered Soldiers move out to the left and form a column behind the last Soldier in the 3d platoon. The even-numbered Soldiers move out to the right and form a column behind the last Soldier in the 1st platoon.

c. Give the command, "Second platoon, lateral support, move," to move the 2d platoon from general support to lateral support.

d. Give the command, "Second platoon, extend the wedge, move," to have the 2d platoon join the wedge from either general support or lateral support. The 2d platoon leader and the assistant platoon leader command, "Follow me," and move out to the left and right, respectively, to extend the wedge on the first and third platoons.

18. Form the company into a company wedge with one platoon in close support.

a. Give the command, "Company wedge, second platoon in close support, move."

b. Ensure that the 1st and 3d platoons execute a wedge. The 2d platoon executes a platoon wedge behind, and centered on, the leading wedge.

c. Ensure that the members in the supporting wedge cover the intervals between members in the leading wedge.

19. Move the formation using the command, "Forward, march."

Note: This will begin the forward movement of the formation. Left and right formation movement adjustments will be made by using "echelon left or echelon right." All other movement commands (such as "Mark time, halt") can be used as appropriate.

a. Identify the flow of the crowd as your team advances and make commands to the team for formation movement(s) to compensate for the crowds movement and ensure that the platoon achieves the goal(s) assigned.

Note: Platoon leader and platoon members should be mindful of the following safety factors in formation movement: airborne projectiles, active antagonistic members in the crowd who may need removal, possible incoming direct fire, and peripheral view checks of left and right platoon members.

b. Once the movement of the crowd has been completed according to the goals of the mission, give the command, "Halt."

c. Review the crowd dispersal and re-evaluate the situation to ensure that the mission is complete.

Performance Steps

- d. Check peripherals, side, and rear to ensure the security and safety of the platoon.
 - e. Communicate your intentions to remove the company with any support teams prior to reassembling the company.
- 20.** Reassemble the company from a formation.
- a. Move to the rear of the company where you want the company members to assemble and give the command, "Company assemble, move," while making a circular motion above your head with your right hand.
 - b. Ensure that the number 2 member (base member) of each platoon does an about face and all other platoon members do a facing movement toward their number 2 member.
 - c. Ensure that the company comes to port arms upon hearing the command, "Company assemble."
 - d. Ensure that, upon the command, "Move," the 2d platoon leader commands, "Follow me." The 1st and 3d platoon leaders command, "Stand fast."
 - e. Ensure that, as the 2d platoon clears the formation, the 1st and 3d platoon leaders command, "Follow me." The 1st and 3d platoons follow, moving at double time, and dress to the right of the 3d platoon until the company is fully formed.

Evaluation Preparation: *Setup:* Provide the Soldier with the materials and equipment listed in the conditions statement.

Brief Soldier: Tell the Soldier to complete the task based on the performance measures.

Performance Measures	GO	NO GO
1. Analyzed the mission requirements.	___	___
2. Identified any NLW requirements.	___	___
3. Identified any LOT requirements.	___	___
4. Organized the company and support teams for formation and action.	___	___
5. Moved the company from the staging area to the mission area.	___	___
6. Formed the company into a company line in depth formation.	___	___
7. Formed the company into a company line in mass with two platoons in direct support.	___	___

Performance Measures	GO	NO GO
8. Formed the company into a company line in mass with one platoon depth.	_____	_____
9. Formed the company into a company line in mass with one platoon lateral support.	_____	_____
10. Formed the company into a company line, one platoon in lateral support, and one platoon in general support.	_____	_____
11. Formed the company into a company echelon right (or left) with 2d platoon in lateral support and 3d platoon in general support.	_____	_____
12. Formed the company into a company echelon, right (or left) in mass with one platoon in lateral support and one platoon in general support.	_____	_____
13. Formed the company into a company wedge.	_____	_____
14. Formed the company into a company wedge with one platoon in general support in a column of twos.	_____	_____
15. Formed the company into a company wedge with one platoon in lateral support.	_____	_____
16. Formed the company into a company wedge with one platoon in close support.	_____	_____
17. Moved the formation using the command, "Forward, march."	_____	_____
18. Reassembled the company from a formation.	_____	_____

Evaluation Guidance: Refer to chapter 1, paragraph 1-4 b (6).

References

Required:

Related: FM 3-19.15

SUBJECT AREA 21: DEFENSE MEASURES

071-326-5805

Conduct a Route Reconnaissance Mission

Conditions: Given a platoon, a 1:50,000 map of the area of operation, and a mission to conduct a route reconnaissance.

Standards: Plan and conduct a route reconnaissance well enough to—

1. Organize the platoon to conduct the reconnaissance mission.
2. Use movement techniques appropriate for the likelihood of enemy contact.
3. Obtain necessary information concerning the conditions, obstacles, critical terrain features, and enemy along the assigned route.

Performance Steps

1. Plan the reconnaissance. Receive the order.
 - a. Issue a warning order
 - b. Gather information and prepare an operation order based on the factors of mission, enemy, terrain and weather, troops and support available, time available, civil considerations (METT-TC).
 - c. Ensure that the plan is as detailed as possible and includes the exact information to obtain, the time to report the information, where to report the information, where to seek the information action to take on enemy contact, and when to execute the mission. Essential details include—
 - (1) Pertinent information on the enemy, friendly troops, and the area of operations.
 - (2) Proposed plans of higher commands, to include anticipated traffic flow along the route and types of vehicles to be employed.
 - (3) When, where, and how to report information.
 - (4) Time of departure.
 - (5) Appropriate control measures.
 - (6) Action to take after completing the mission.
 - (7) Special equipment requirements.
 - (8) Terrain considerations of existing routes and their physical characteristics:
 - (a) Gradients of slope and the radius of curvature.
 - (b) Bridges.
 - (c) Vehicular fording, ferrying, and swimming sites.
 - (d) Tunnels, under passes, and similar obstructions to traffic flow.

Performance Steps

(e) Artificial obstacles (such as areas of chemical, biological, and radiological contamination, roadblocks, craters, and minefields).

(f) Rock falls and slide areas.

(g) Drainage.

(h) Other natural or manmade features (such as wooded and built-up areas) that may affect movement.

2. Supervise the preparation of the route reconnaissance. Ensure that Soldiers—

a. Maintain weapons and equipment on vehicles.

b. Conduct inspections.

c. Conduct rehearsals.

d. Issue the order.

e. Ensure that the rest plan is followed.

3. Control the route reconnaissance.

a. Ensure that—

(1) Reconnaissance commences from the flanks or rear when reconnoitering areas along the route are not likely to be defended by enemy detachments (such as bridge approaches, defiles, or built-up areas).

(2) Detailed observation precedes actual reconnaissance.

(3) Approach routes are checked for mines, booby traps, and signs of ambush.

b. Ensure that when time is available, dismounted personnel are sent forward first, covered by the remaining elements of the unit. The number of dismounted personnel sent forward depends on the size of the objective and on the available approaches, cover, and concealment. If the dismounted patrols find that the near edge of the area is clear, the remainder of the unit moves quickly forward. The dismounted patrols then continue the reconnaissance and overwatch. The remainder of the unit closely follows the dismounted patrols.

c. When conducting a mounted reconnaissance, part of the unit remains mounted and moves forward cautiously but rapidly, overwatched by the remaining mounted elements. If the near edge of the area is clear, the overwatching elements moved forward quickly and the advance continues.

4. When conducting reconnaissance by fire, follow these procedures:

a. Reconnaissance by fire is accomplished by firing on likely or suspected enemy positions in an attempt to remove camouflage and to cause the enemy to disclose his/her presence by movement or return fire. During reconnaissance by fire, positions being reconnoitered are observed continuously so that enemy activity can be quickly and definitely located.

Performance Steps

b. Reconnaissance by fire is employed by route reconnaissance teams as a security measure when time is critical and the loss of surprise is not essential.

c. If the enemy returns fire, the situation is further developed. If the fire is not returned, reconnaissance continues. Caution is exercised to ensure that the presence of a well-disciplined enemy is not overlooked.

Evaluation Preparation: *Setup:* At the test site, provide all personnel, equipment, and material given in the task condition statement.

Brief Soldier: Tell the Soldier to plan and conduct a route reconnaissance using proper movement techniques for the likelihood of enemy contact and to gather information about enemy forces along the assigned route and critical terrain features.

Performance Measures	GO	NO GO
1. Planned reconnaissance based on the intelligence requirement.	_____	_____
2. Issued the plan for the mission.	_____	_____
3. Conducted hasty or deliberate reconnaissance based on time available and detail requirements.	_____	_____
4. Used reconnaissance by fire when permitted by the tactical situation.	_____	_____
5. Avoided decisive engagement with enemy forces.	_____	_____
6. Used proper movement techniques during the route reconnaissance.	_____	_____
7. Reported all items of military significance.	_____	_____

Evaluation Guidance: Refer to chapter 1, paragraph 1-4 b (6).

References

Required: FM 17-95, FM 3-21.71, FM 3-90.1, FM 5-170, FM 7-20, FM 7-7, and FM 7-8

Related:

071-430-0006

Conduct a Defense by a Platoon

Conditions: Given a specified area, a platoon with table of organization and equipment (TOE) equipment, and a requirement to defend that area.

Standards: Engage the threat according to the defensive plan, control fires, retain terrain, and destroy or repel the threat.

Performance Steps

1. Analyze the mission.
 - a. You are given a mission to defend by the company commander in an operation order (OPORD) or a warning order.
 - b. Identify both specified tasks and implied tasks.
 - c. Make an estimate of the situation using the factors of mission, enemy, terrain and weather, troops and support available, time available, civil considerations (METT-TC).
2. Issue a warning order to the squad leaders. The warning order should include the mission, time, place for issuing the OPOrd, and any special instructions needed to start preparing for the mission.
3. Make a tentative plan.
4. Conduct a reconnaissance.
 - a. As a minimum, make a map reconnaissance.
 - b. If at all possible, conduct a ground reconnaissance.
 - c. Evaluate the terrain based on how the available observation, fields of fire, cover and concealment, obstacles, key terrain, and avenues of approach best support your mission and the commander's intent.
 - d. Request that the squad leaders, radio/telephone operator, and forward observers accompany you on the reconnaissance. You may need to take along some additional security depending on the tactical situation.
5. Start necessary movement or preparations. The platoon sergeant should—
 - a. Initiate orders to prepare for any necessary movement and prepare for the defense as soon as the warning order has been issued.
 - b. Request and draw ammunition, rations, water, and any special equipment required.
 - c. Accomplish any needed maintenance.
 - d. Perform any movement required.
 - e. Accomplish this during the time you and your reconnaissance party are conducting the reconnaissance.
6. Complete the plan.
 - a. Complete the initial plan or revise it based on the continuing analysis and completion of the reconnaissance.
 - b. As a minimum, include the following in the plan:
 - (1) The deployment of squads.

Performance Steps

- (2) The deployment of key weapons.
 - (3) The use of indirect fire.
 - (4) The use of mines and obstacles.
 - (5) The establishment of security measures.
 - (6) The selection and operation of a command and observation posts.
7. Occupy the position.
- a. Establish local security. Locate observation posts to make maximum use of long-range observations.
 - b. Position key weapons. Ensure that machine guns cover infantry avenues of approach, have primary and secondary sectors of fire and provide as much grazing fire as possible, and are assigned either a final protective line (FPL) or a principal direction of fire. Ensure that Javelins or Dragons cover armor avenues of approach, have primary and secondary sectors of fire, are positioned to engage targets from the flank, and are mutually supporting.
 - c. Clear fields of fire. Ensure that each fighting position clears its field of fire to engage the advancing enemy without exposing friendly positions. Range cards are prepared for each machine gun and Dragon.
 - d. Ensure that fighting positions have overlapping sectors of fire
 - e. Improve fighting positions as time becomes available. Improving overhead cover, aiming and limiting stakes, and camouflage are an ongoing activities.
 - f. Select and improve alternate and supplementary positions. Improve them as time becomes available.
8. Emplace early warning devices. Use the platoon early warning system, if available. Set out trip flares. Use improvised early warning devices—such as noise makers, trip wire grenades, or other explosives.
9. Emplace hasty minefields and other obstacles. These should be covered by observation and fire.
10. Establish communication systems. Depend on radio as little as possible. Establish wire networks down to each squad and up to the company command post (CP).
11. Stockpile ammunition, water, food, and other supplies. Protect any materiel from direct fire and provide overhead protection.
12. Engage the enemy at maximum range. When the enemy appears in the platoon sector, engage the enemy with supporting direct and indirect fires. As the enemy comes within the range of your organic weapons, direct your gunners to start engaging the enemy.

Performance Steps

- a. When the enemy encounters your minefields and obstacles, use all friendly fires to breakup the enemy formations.
- b. If the enemy is able to start an assault, repel or destroy the enemy by calling for final protective fires (FPF) of small arms, machine guns, mortars, and artillery.

Evaluation Preparation: *Setup:* Select an area in the field large enough for a platoon defensive position, including primary, alternate, and supplementary positions.

Brief Soldier: Tell the Soldier the platoon's sector of responsibility and that the Soldier is the acting platoon leader. Issue an OPORD (from the company commander) for a defense of the position.

Performance Measures	GO	NO GO
1. Analyzed the mission.	___	___
2. Issued a warning order.	___	___
3. Made a tentative plan.	___	___
4. Conducted a reconnaissance.	___	___
5. Initiated necessary movement and preparation.	___	___
6. Completed the plan and issued the order.	___	___
7. Occupied the position.	___	___
a. Established local security.		
b. Positioned key weapons.		
c. Ensured that fields of fire were cleared.		
d. Ensured that sectors of fire overlapped.		
e. Selected alternate and supplementary positions.		
8. Ensured that early warning devices were installed.		
9. Ensured that hasty protective minefields and other obstacles were constructed.		
10. Established communication systems, wire, and radio.		
11. Requested ammunition, food, water, and other supplies for stockpiling.		
12. Engaged the enemy at maximum ranges.		
a. Covered obstacles with fire.		
b. Called for FPL and FPF.		

Evaluation Guidance: Refer to chapter 1, paragraph 1-4 b (6).

References

Required: FM 3-21.71, FM 3-90.1, FM 7-7, and FM 7-8

Related:

SUBJECT AREA 22: UNIT OPERATIONS

091-CTT-4001

Supervise Maintenance Operations

Conditions: In a contemporary operational environment, given a platoon, equipment, maintenance facility/site, standing operating procedures (SOPs), and applicable references.

Standards: Establish and maintain an effective platoon maintenance program according to SOPs and applicable references.

Performance Steps

1. Ensure that platoon maintenance procedures are according to the unit's SOP which is derived from AR 750-1, DA Pam 750-35, and local command policies.
 - a. Review the unit SOP for maintenance.
 - b. Inform unit personnel of changes in policy and new policy that impacts the unit SOP.
2. Provide maintenance guidance and assistance to a platoon.
 - a. Inspect platoon maintenance operations regularly.
 - b. Identify shortcomings.
 - c. Make recommendations for corrective actions.
 - d. Provide training in maintenance procedures.
3. Provide maintenance management to a platoon.
 - a. Review the Non-Mission Capable Report.
 - b. Coordinate with field level maintenance for assistance and repairs above operator level.
 - c. Prioritize maintenance efforts of the platoon.
 - d. Direct cross-leveling of personnel, basic issue items (BII), and workload within a platoon.

Performance Measures	GO	NO GO
1. Demonstrated knowledge of platoon maintenance procedures according to Army regulations and the unit SOP.	—	—

Performance Measures	GO	NO GO
2. Stated correctly the correct period in which an inspection of unit operations should be conducted.	—	—
3. Identified correctly shortcomings in the platoon's maintenance program.	—	—
4. Chose the proper corrective action for deficiencies in the platoon maintenance program.	—	—
5. Determined correctly where to find resources for training a platoon on maintenance tasks.		
6. Identified correctly the data fields on the Non-Mission Capable Report.		
7. Identified inaccuracies of the Non-Mission Capable Report.		
8. Identified the correct level of repair of an identified fault.		
9. Identified correctly which piece of equipment in a platoon had maintenance priority.		
10. Identified correctly workload issues in a platoon which could be solved by moving personnel or BII.		

Evaluation Guidance: Refer to chapter 1, paragraph 1-4 b (6).

References

Required: AR 385-10, AR 385-40, AR 385-55, AR 600-55, AR 700-138, AR 700-4, AR 710-2, AR 725-50, AR 735-5, AR 750-1, AR 750-43, DA Pam 25-30, DA Pam 710-2-1, DA Pam 710-2-2, DA Pam 750-1, DA Pam 750-35, DA Pam 750-8, and FM 4-30.3

Related:

159-200-2020

Integrate Threat Capabilities into Mission Planning

Conditions: You are assigned to a battalion staff in the operations (S3) or intelligence (S2) section. Your battalion is tasked to plan and conduct a field operation based on a brigade operations order. You have access to the brigade operations order, the brigade intelligence estimate, and the battalion commander's initial guidance. You have access to tactical command, control, communications, computers, and intelligence (C4I) systems.

Standards: Correctly identify global threats to the United States and its forces. Correctly identify threat capabilities for the specific tactical and operational situation. Integrate threat capabilities into all courses of action (COAs) analysis and mission planning.

Performance Steps

1. Identify global threats.
 - a. Identify global trends.
 - b. Characterize the global threat environment.
 - c. Recognize competitors to U.S. interests.
 - d. Recognize asymmetrical treat methods and actions.
2. Determine threat capabilities.
 - a. Evaluate intelligence estimate from higher headquarters.
 - b. Recognize available database sources of threat information.
 - c. Access Intelink or Intelink-S sources of regional information.
 - d. Access modernized intelligence database (MIDB).
 - e. Access unclassified internet (worldwide web [www]) sources of regional information.
3. Apply threat capabilities to COA analysis and mission planning.
 - a. Wargame most likely threat COA against friendly plans and incorporate into mission plans.
 - b. Wargame most dangerous treat COA against friendly plans and incorporate into mission plans.
 - c. Identify potential vulnerabilities to friendly plans and incorporate into mission plans.

Evaluation Preparation: *Setup:* Provide the Soldier with the materials listed in the conditions statement and a copy of the performance measures. The performance of this task could be evaluated during a training exercise.

Brief Soldier: Tell the Soldier that he/she will be evaluated on correctly passing all the performance measures.

Performance Measures	GO	NO GO
1. Identified four major global trends and their effect on the operational environment.	_____	_____
2. Described the global threat environment. Described how it was different from that of the Cold War era.	_____	_____
3. Described asymmetrical methods. Explained the difference between asymmetrical and conventional military methods.	_____	_____
4. Located the intelligence estimate within an operations order.	_____	_____

Performance Measures	GO	NO GO
5. Derived applicable information from higher headquarters intelligence estimate.	___	___
6. Identified four available databases containing threat information.	___	___
7. Retrieved regional and threat specific information from Intelink or Intelink-S.		
8. Retrieved regional and threat specific information from unclassified internet sources.		
9. Identified the most likely threat COA and the most dangerous threat COA.		
10. Identified at least one potential vulnerability in the friendly plan.		
11. Incorporated threat findings into all mission planning.		

Evaluation Guidance: Refer to chapter 1, paragraph 1-4 b (6).

References

Required:

Related: FM 34-130

181-101-4001

Conduct a Search/Seizure

Conditions: You are responsible for identifying and understanding the U.S. Constitution’s 4th Amendment protections against unreasonable searches and seizures and its application in the U.S. Army. You must also identify and understand who is permitted to authorize a search; the search's legal basis, purpose, and scope; and permissible exceptions to the 4th Amendment. Additionally, you must identify and understand the differences between an inspection and a search.

Standards: Identify and understand the U.S. Constitution’s 4th Amendment protections against unreasonable searches and seizures and its application in the U.S. Army. Identify and understand who is permitted to authorize a search; the search's legal basis, purpose, and scope; and permissible exceptions to the 4th Amendment. Identify and understand the differences between an inspection and a search.

Performance Steps

1. List the authority for search and seizure.
 - a. Describe the U.S. Constitution's 4th Amendment protections against unreasonable searches and seizures.
 - b. Describe the U.S. Constitution's 4th Amendment as it applies to U.S. Army Soldiers.

Performance Steps

- c. Describe the necessity for the U.S. Constitution's 4th Amendment to apply differently to Soldiers and civilians.
 - d. Describe the U.S. Constitution's 4th Amendment requirement that a search or seizure be based on probable cause and a "warrant" or "authorization" in the Armed Forces.
2. Identify the requirements for conducting a search or seizure.
 - a. Describe the requirement for the commander to first determine whether probable cause exists.
 - (1) Define what constitutes probable cause to search.
 - (2) Describe the totality of the circumstances test used to evaluate whether probable cause exists.
3. Describe which person(s) has the authority to authorize a search.
 - a. Describe where this authority is derived.
 - b. Describe whether this authority can be further delegated.
 - c. Describe why it might be preferable to have a military magistrate or military judge authorize a search instead of the commander.
 - d. Describe the requirement for a commander to have authority over the place to be searched in order to authorize a search of that place.
 - e. Describe whether a commander has authority to authorize a search of a Soldier's off-post quarters or personal property in the continental United States (CONUS).
4. Describe the procedures required to obtain an authorization to search.
5. Describe the scope of an authorized search.
6. Describe the requirement for the commander to be neutral and detached.
7. Describe exceptions to the 4th Amendment.
 - a. Describe various types of searches that are exceptions to the 4th Amendment.
 - (1) Describe the necessity for the suspect to have a reasonable expectation of privacy in the area searched.
 - (2) Describe the 4th Amendment's application to the search of government property.
 - (3) Describe the 4th Amendment's application to items in "open view."
 - b. Describe a consent search.
 - (1) Describe whether command authorization is required with a consent search.

Performance Steps

- (2) Describe whether probable cause is required with a consent search.
 - (3) Describe the requirement for the consent to be voluntary or freely given.
 - (4) Describe the applicability of the totality of the circumstances test to a consent search.
 - (5) Describe how the consent may be partial or limited and the restrictions this places on the search.
 - (6) Describe withdrawal of consent and its effect on continuation of the search.
 - c. Describe a search incident to apprehension.
 - (1) Describe the legitimate reasons for such a search.
 - (2) Describe the scope or parameters of such a search.
 - d. Describe a search Under exigent circumstances.
 - (1) Define what constitutes exigent circumstances.
 - (2) Describe the legitimate reasons for conducting a search under exigent circumstances.
 - (3) Describe whether a search authorization is required for a search under exigent circumstances.
 - e. Describe the requirement and importance of maintaining a proper chain of custody.
8. Describe inspection procedures.
- a. Define an inspection.
 - b. Describe the primary purpose test of an inspection.
 - c. Describe the scope of an inspection.
 - d. Describe whether the 4th Amendment restricts a commander's authority to order an administrative inspection.
 - e. Describe the relationship between a "search" and an "inspection."
 - f. Describe the subterfuge rule regarding an inspection.
 - g. Describe a health and welfare inspection.
 - (1) Describe the primary purpose and scope of a health and welfare inspection.
 - (2) Describe whether the use of drug detection dogs during a health and welfare inspection is permissible.
 - h. Describe the permissibility of a commander conducting an inspection or "lock-down" for lost weapons or ammunition.
 - i. Describe the permissibility of a gate inspection.
-

Performance Steps

j. Describe the admissibility of evidence at trial obtained through an illegal search or inspection.

k. Describe the authority of a commander to conduct an inventory of a Soldier's property.

(1) List the circumstances under which an inventory is required.

(2) Describe whether contraband discovered during an inventory may be seized and used as evidence in a criminal prosecution.

Evaluation Preparation: *Setup:* Evaluate this task at the end of military justice training on conducting searches and seizures.

Brief Soldier: Tell the Soldier that he/she will be evaluated on his/her ability to identify and understand the U.S. Constitution's 4th Amendment protections against unreasonable searches and seizures and its application in the U.S. Army. Tell the Soldier that he/she will also be evaluated on his/her ability to identify and understand who is permitted to authorize a search; the search's legal basis, purpose, and scope; and permissible exceptions to the 4th Amendment. Tell the Soldier that he/she will also be evaluated on his/her ability to identify and understand the differences between an inspection and a search.

Performance Measures	GO	NO GO
1. Listed the authority for search and seizure.	_____	_____
a. Described the 4th Amendment's protection against unreasonable searches and seizures.	_____	_____
b. Described the 4th Amendment's applicability to U.S. Army Soldiers.	_____	_____
c. Described the necessity for the 4th Amendment to apply differently to Soldiers and civilians.	_____	_____
d. Described the 4th Amendment's requirement that a search or seizure be based on probable cause and a "warrant" or "authorization" in the Armed Forces.	_____	_____
2. Identified the requirements for conducting a search or seizure.	_____	_____
a. Described the requirement for the commander to first determine whether probable cause exists.	_____	_____
b. Defined what constitutes probable cause to search.	_____	_____
c. Described the totality of the circumstances test used to evaluate whether probable cause exists.	_____	_____
3. Described which person(s) has the authority to authorize a search.	_____	_____

Performance Measures	GO	NO GO
<p>a. Described where this authority was derived.</p>		
<p>b. Described whether this authority could be further delegated.</p>		
<p>c. Described why it might be preferable to have a military magistrate or military judge authorize a search instead of the commander.</p>		
<p>d. Described the requirement for a commander to have authority over the place to be searched in order to authorize a search of that place.</p>		
<p>e. Described whether a commander had authority to authorize a search of a Soldier's off-post quarters or personal property in the CONUS.</p>		
<p>4. Described the procedures required to obtain an authorization to search.</p>	_____	_____
<p>5. Described the scope of an authorized search.</p>	_____	_____
<p>6. Described the requirement for the commander to be neutral and detached.</p>	_____	
<p>7. Described exceptions to the 4th Amendment.</p>		
<p>a. Described various types of searches that are exceptions to the 4th Amendment.</p>		
<p>(1) Described the necessity for the suspect to have a reasonable expectation of privacy in the area searched.</p>		
<p>(2) Described the 4th Amendment's application to the search of government property.</p>		
<p>(3) Described the 4th Amendment's application to items in "open view."</p>		
<p>b. Described a consent search.</p>		
<p>(1) Described whether command authorization is required with a consent search.</p>		
<p>(2) Described whether probable cause is required with a consent search.</p>		
<p>(3) Described the requirement for the consent to be voluntary or freely given.</p>		
<p>(4) Described the applicability of the totality of the circumstances test to a consent search.</p>		
<p>(5) Described how the consent may be partial or limited and the restrictions this places on the search.</p>		
<p>(6) Described withdrawal of consent and its effect on continuation of the search.</p>		

Performance Measures	GO	NO GO
<p>j. Described the admissibility of evidence at trial obtained through an illegal search or inspection.</p>		
<p>k. Described the authority of a commander to conduct an inventory of a Soldier's property.</p> <p style="padding-left: 40px;">(1) Listed the circumstances under which an inventory was required.</p> <p style="padding-left: 40px;">(2) Described whether contraband discovered during an inventory could be seized and used as evidence in a criminal prosecution.</p>		

Evaluation Guidance: Refer to chapter 1, paragraph 1-4 b (6).

References

Required: AR 27-10 and AR 600-20

Related:

551-721-4326

Perform Duties as Convoy Commander

Conditions: In a contemporary operating environment (COE), given a mission by the company commander to serve as a convoy commander; vehicles and operators; subordinate noncommissioned officers (NCOs) to serve as serial/march unit commanders; information from the commander's operation order (OPORD); map overlays; cargo to transport; and a timeline to follow.

Standards: Plan, prepare, and execute the mission of commanding a convoy in a COE. Notify all supporting elements and brief all receiving units on the mission. Allocate the correct number of vehicles to support movement of all designated cargo, conduct a route reconnaissance, brief all personnel on performing their duties, and complete all actions while adhering to the timeline without injury to personnel or damage to vehicles or cargo.

Performance Steps

1. Plan the convoy movement.
 - a. Consider the following as key factors in the planning process of a convoy.
 - (1) Mission, enemy, terrain and weather, troops and support available, time available, civil considerations (METT-TC).
 - (2) The status of training drivers.
 - (3) Types of loads.
 - (4) Number of vehicles involved.
 - (5) Traffic conditions.
 - (6) Quality of road networks.
 - b. Besides convoy control and organization, consider the following elements during the planning process.
 - (1) Advanced/quartering party.

Performance Steps

- (2) Convoy control personnel.
- (3) Start and release points.
- (4) Halts.
- (5) Gaps and march rate.
- (6) Submission of movement bid (if applicable).
- (7) Communications.
- (8) Route reconnaissance.
- (9) Escort and security elements.
- (10) Convoy support.

Note: The convoy commander should always refer to the unit standing operating procedure (SOP) for standardized information concerning convoy guidelines. Whenever the SOP fails to provide the needed information, the convoy commander should solicit information from the unit chain of command and applicable regulations.

c. Review the OPORD.

- (1) Determine the number of vehicles needed.
- (2) Determine the number of personnel required.
- (3) Determine if a special hauling permit is required.
- (4) Determine the necessity of available supporting elements (fire support, close air support, engineer, chemical, or refueling support).
- (5) Determine if a movement bid or convoy clearance is necessary. If so, submit request (DD Form 1265 [*Request for Convoy Clearance*]). This requirement is based on local guidelines (SOP) and the selected route for the convoy. In North Atlantic Treaty Organization (NATO) controlled areas, standardization agreement (STANAG) 2154 and STANAG 2155 are applicable. Submit at least 10 days prior to a planned move.
- (6) Determine if a request for oversized vehicles/loads is required. If so, submit DD Form 1266 (*Request for Special Hauling Permit*). The request must reach the approving authority 15 days before the planned move.
- (7) Determine the convoy route.

d. Conduct a map and route reconnaissance of the convoy route. Use engineer reconnaissance report information (DA Form 1711-R [*Engineer Reconnaissance Report*]), if available, to determine route characteristics that may play a key part in your convoy mission.

- (1) Select an alternate route, if possible.
- (2) Determine all critical points/checkpoints.
- (3) Determine situational requirements.
- (4) Determine choke points along the route that may endanger the mission.
- (5) Plot all necessary items on a map.
- (6) Plot scheduled halts.

e. Perform a risk management according to FM 5-19.

Performance Steps

- f.** Determine the size of serial/march units.
 - g.** Determine march rate (if not covered by the SOP).
 - h.** Determine the vehicle march order, interval, and location of key vehicles within the convoy.
 - i.** Determine the predeparture assembly area. Seek command guidance if information is not provided in the OPORD.
 - j.** Determine security requirements. Consider the following:
 - (1)** Noise and light discipline.
 - (2)** Front, flank, and rear security.
 - (3)** Security during halts.
 - (4)** Air cover.
 - (5)** Fire support.
 - (6)** Communications security.
 - (7)** Deception.
 - k.** Determine necessity and availability of spare vehicle (bobtails) for recovery.
 - l.** Determine maintenance support.
 - m.** Determine medical support.
 - (1)** Assistant convoy commander.
 - (2)** Serial/march unit commanders.
 - (3)** Pacesetter.
 - (4)** Trail officer.
 - (5)** Trail maintenance officer.
 - n.** Delegate responsibility to construct strip maps for all drivers.
 - o.** Determine if and how many route guides are necessary.
 - p.** Determine time/distance factors. Consider driver limitations, maximum driving time per shift, and co-drivers.
 - q.** Coordinate with squad leaders and maintenance sergeant and other platoon sergeants on the availability of vehicles to support the movement.
 - r.** Determine the preparation time line for the following:
 - (1)** Loading of vehicles.
 - (2)** Marshaling vehicles.
 - s.** Determine the makeup and duties of the advance/quartering party to be performed at the destination (as applicable). Consider the following:
 - (1)** NCOIC.
 - (2)** Other key personnel.
-

Performance Steps

- (3) Ensuring that the convoy is able to move quickly off the route and into the marshaling area.
 - (4) Positioning of vehicles within the marshaling area.
2. Prepare for convoy movement.

Note: The convoy commander must perform specific actions to prepare the convoy. A limited amount of time is available to accomplish the following: select and reconnoiter the route, submit a movement bid if required (DD Form 1265), effect coordination for en route security, give instructions to subordinate element commanders and other supervisory personnel, inspect personnel and vehicles, and brief convoy personnel.

- a. Submit a request for convoy clearance and oversized vehicle/load permits (if applicable).
- b. Assign key convoy duty positions within the convoy to include the following:
 - (1) Assistant convoy commander.
 - (2) Serial/march unit commanders.
 - (3) Pacesetter.
 - (4) Trail officer.
 - (5) Trail maintenance officer.
 - (6) Route guides (if necessary).
 - (7) Security NCOIC and force.
- c. Brief and dispatch the advance/quartering party to destination (as applicable).
- d. Ensure that the following predeparture actions are done prior to movement.
 - (1) Instruct the serial/march unit commander(s) to do the following:
 - (a) Supervise and spot check all preventive maintenance of convoy vehicles.
 - (b) Ensure that all vehicles are dispatched according to the unit SOP.
 - (c) Ensure that all personnel involved in the convoy are prepared and have in their possession all items identified by the unit SOP for the convoy mission.
 - (d) Ensure that all vehicles, to include trailers and support vehicles, are loaded and prepared for movement as directed.
 - (e) Ensure that all personnel have in their possession all applicable accident and load forms required by the unit SOP and regulation (DD Form 518 [*Accident-Identification Card*] and SF 91 [*Motor Vehicle Accident Report*] and DD Form 626 [*Motor Vehicle Inspection*] and DD Form 836 [*Dangerous Goods Shipping Paper/Declaration and Emergency Response*] [if transporting HAZMAT] prior to movement).

Performance Steps

(f) Ensure that all vehicles are marked with convoy clearance numbers (if movement is over a controlled route).

(g) Ensure that convoy control vehicles are marked with the appropriate flags, signs, or lights (as applicable).

(h) Relay all necessary communications information.

(i) Hand out all strip maps to vehicle crews.

(j) Perform sensitive items check (to be verified during convoy briefing).

(2) Once all vehicles, loads, and personnel have been checked, supervise the staging of vehicles in the designated assembly area by order of march and serial/march unit.

(3) Coordinate to obtain artillery support (if available).

e. Ensure that all of the following questions are answered (Convoy Commander's Checklist) prior to movement.

(1) Where is the start point (SP)? The release point (RP)?

(2) What route is to be used?

(3) Has reconnaissance been made? Condition of route determined?

(4) Can bridges, tunnels, underpasses, and defiles safely accommodate all loaded and tracked (if applicable) vehicles?

(5) Are critical points known and listed on the map?

(6) What is the size of serials?

(7) What is the size of march units?

(8) What is the rate of march?

(9) What is the vehicle interval on an open road? Built-up road?

(10) What type of column will be used?

(11) What provision has been made for refueling (if applicable)?

(12) Has a suitable operations area been selected?

(13) Have suitable rest and mess-halt area been selected?

(14) Have convoy clearances been obtained? What date?

(15) Is an escort required? Has it been requested?

(16) Are spare trucks available for emergencies?

(17) Are vehicles fully serviced and ready for loading?

(18) Are loads properly blocked and braced, neat, and balanced?

(19) Are drivers properly briefed? By whom? When? Strip maps furnished?

(20) Is the convoy marked front and rear of each march unit? With convoy number when required? Is each vehicle marked? Are convoy flags on the vehicles?

(21) Are guides in place? Have arrangements been made to post and recover them?

(22) Are blackout lights functioning?

(23) Have maintenance services been alerted?

(24) Is the maintenance truck in the rear? Are medics in the rear?

Performance Steps

- (25) Are all interested parties advised of the estimated time of arrival (ETA)?
- (26) Is the officer at the rear of the convoy ready to take necessary corrective action (such as investigating accidents and unusual incidents and changing loads)?
- (27) Who is the trail officer?
- (28) Is there a truck unloading plan? Who is responsible? Do they have the necessary equipment?
- (29) Is there a plan for feeding personnel?
- (30) Have times been established for loading trucks?
- (31) Has time been established for formation of convoy?
- (32) Have times been established for unloading trucks?
- (33) Has time been established for releasing trucks? Who is responsible?
- (34) Is there a carefully conceived plan known to all convoy personnel that can be used in case of an attack?
- (35) Is a written OPORD, if required, on hand?
- (36) Will a log of road movement be required at the end of the trip? Are necessary forms on hand?
- (37) Has a weather forecast been obtained?
- (38) Do all personnel have proper clothing and equipment?
- (39) Is there a communications plan? Where will communications equipment be located? Has all communications equipment been serviced?
- (40) If transporting hazardous materials, have all involved vehicles been appropriately placarded? Are load manifests in the driver's door pocket or otherwise readily available and known by convoy personnel?
- (41) Have vehicles containing HAZMAT been placed at appropriate locations within the convoy to reduce residual damage in case of enemy attack?
- (42) Has every effort been made to camouflage vehicles to the extent possible during movement? At halts?

f. Conduct convoy briefing.

Note: The convoy commander's briefing is given after all other movement preparations have been completed and verified by all responsible parties and the convoy is prepared to move.

Note: Gather applicable information from the commander's OPORD and local SOP to complete your convoy briefing. Provide as much applicable information as possible that may affect the convoy movement. Apply the information in the following format.

- (1) Situation.
 - (a) Enemy forces.
 - (b) Friendly forces.
 - (c) Support units.
- (2) Mission.

Performance Steps

- (a) Type of cargo (to include hazardous materials precautions and guidelines).
- (b) Origin.
- (c) Destination.
- (3) Execution.
 - (a) General organization.
 - (b) Time schedule.
 - (c) Convoy speed.
 - (d) Catch-up speed.
 - (e) Vehicle distance.
 - (f) Emergency measures (for accidents, breakdowns, and separation from the convoy).
 - (g) Actions of convoy and security personnel if attacked.
 - (h) Medical support.
- (4) Administration and logistics.
 - (a) Personnel control.
 - (b) Billeting.
 - (c) Messing.
 - (d) Refueling and servicing of vehicles, complying with spill prevention guidelines.
- (5) Command and signal.
 - (a) Convoy commander's location.
 - (b) Assistant convoy commander's designation (succession of command).
 - (c) Actions of security force commander.
 - (d) Serial commander's responsibilities.
 - (e) Arm and hand signals.
 - (f) Other prearranged signals.
 - (g) Radio frequencies and call signs (for control personnel, security force commanders, fire support elements, reserve security elements, and medical evacuation).
- (6) Safety.
 - (a) Hazards of the route.
 - (b) Weather conditions.
 - (c) Defensive driving.
- (7) Environmental protection.

Performance Steps

- (a) Spill prevention.
- (b) Transporting HAZMAT.

3. Conduct the convoy movement.

Note: Convoy commander should maintain a log of events during the convoy that may be required in the convoy commander's report upon completing the convoy movement.

Note: The convoy commander must be able to monitor and control all aspects of vehicle operations within the convoy. The convoy commander is ultimately responsible for ensuring that all assets arrive safely at the destination with a minimal amount of losses. The convoy commander's ability to delegate authority and enforce march discipline are key factors in mission accomplishment.

- a. Conduct a communications check of all systems in the convoy radio net. Correct all communications deficiencies on the spot.
 - b. Signal all drivers to start engines.
 - c. Give the signal to begin movement and depart the assembly area (at the time designated in the movement order). Use the closed column formation until entry onto the main convoy route. If expressways are used, instruct drivers to close to approximately 20 meter vehicle interval when entering the acceleration ramp.
 - d. Ensure that the convoy reaches the SP according to the established time line.
 - e. Monitor radio traffic.
 - f. Ensure that the trail officer relays passing the SP on the established time line.
 - g. Ensure that the pacesetter maintains the established speed.
 - h. Signal drivers to adjust speed and interval accordingly.
 - i. Notify higher headquarters upon passing each checkpoint/critical point on the route (as directed by the SOP or commander).
 - j. During halts, ensure that serial/march unit commanders (if entire convoy is at halt) complete halt checks on personnel, vehicles, and loads.
 - (1) Ensure that vehicles are staged so as to facilitate rapid movement. Vehicles should remain in the same order of march as during movement.
 - (2) Ensure that security is posted to prevent pilferage or compromise by enemy forces.
 - (3) Exchange drivers if operating limits have been reached. Do not exceed authorized driving times as listed in AR 385-55, paragraph 2-6.
-

Performance Steps

k. As terrain dictates, direct the column into open or closed formations. Movement through urban areas will facilitate closing the formation to established vehicle intervals.

l. Enforce passive and active defense measures within the convoy.

m. Enforce operations security (OPSEC) and communications security (COMSEC).

n. Report any enemy contact made during movement to higher headquarters. Include attack location, size of the enemy force if known, types and number of weapons used, damage inflicted on convoy assets, reactive measures taken, casualties incurred, and any information covered in the unit SOP.

o. As the convoy passes the RP, ensure that vehicle accountability is conducted and that control is relinquished (as applicable) for those elements [supply convoy] in which custody and control will change and elements may continue to other destinations.

p. Contact trail/trail maintenance officer for updates on any/all vehicle breakdowns, actions taken, and status of effected equipment/loads/personnel.

4. Conduct convoy closure operations.

a. For those convoy assets that are relinquished upon crossing the RP, ensure that the chain of custody is not broken and that all command and control of released assets is delegated to authorized personnel.

b. For those convoy assets that remain under current convoy control upon crossing the RP, the following steps apply.

(1) Ensure that persons designated as ground guides (either assistant drivers or advanced party personnel) escort vehicles off the convoy route and into the assembly area in a timely manner to minimize congestion.

(2) Enforce security measures in the assembly area.

(3) Ensure that all vehicles are positioned in the assembly area as to facilitate security and for off-loading operations as necessary.

(4) Instruct serial/march unit commanders/squad leaders to conduct sensitive items checks and supervise after-operations maintenance on vehicles.

(5) Ensure that vehicles with hazardous cargo are positioned away from facilities according to regulations (AR 385-55, paragraph 2-13).

(6) Maintain contact with trail/trail maintenance officer for closure through RP.

(7) Facilitate the recovery of damaged or other nonoperational vehicles upon arrival at the assembly area.

(8) Coordinate with trail/trail maintenance officer for information regarding any vehicle accident reports that may be necessary (DA Form 285 [*U.S. Army Accident Report*]).

(9) Report closure and convoy status to higher headquarters according to the unit SOP.

Performance Steps

(10) If required, submit convoy commander's report to higher headquarters according to FM 55-15, chapter 3 and FM 55-30, appendix R.

Evaluation Preparation: *Setup:* Evaluate this task during a field training exercise or normal training session. Provide the Soldier with the items listed in the conditions statement.

Brief Soldier: Tell the Soldier that he/she will be evaluated on his/her ability to properly perform duties as a convoy commander.

Performance Measures	GO	NO GO
1. Planned the convoy movement.	_____	_____
2. Prepared for convoy movement.	_____	_____
3. Conducted the convoy movement.	_____	_____
4. Conducted convoy closure operations.	_____	_____

Evaluation Guidance: Refer to chapter 1, paragraph 1-4 b (6).

References

Required: AR 385-55, AR 55-162, DA Form 1711-R, DA Form 285, DD Form 1265, DD Form 1266, DD Form 518, DD Form 626, DD Form 836, FM 21-305, FM 21-60, FM 3-100.12, FM 4-01.30, FM 5-0, FM 5-170, FM 5-19, FM 55-15, FM 55-30, SF 91, STANAG 2154, and STANAG 2155

Related:

SUBJECT AREA 23: SECURITY AND CONTROL

191-379-4408

Plan Security for a Command Post

Conditions: You are a military police platoon sergeant and your platoon has been given a mission to provide security for a command post (CP). You will have orders; information on the size and layout of the CP (massed or dispersed); information on mission, enemy, terrain and weather, troops and support available, time available, civil considerations (METT-TC); and access to the provost marshal and headquarters personnel.

Standards: Develop a security plan that includes all the required elements to detect the enemy and to defend the CP before the enemy can move within direct-fire range.

Performance Steps

1. Determine the number of personnel available to conduct CP security, to include augmented personnel, such as corps assets and the division band. Consider METT-TC and the CP size and layout.

Performance Steps

Note: For dispersed CPs, military police security is concentrated toward providing early warning through screening operations. For massed CPs, the type of military police security provided depends on the presence or absence of augmentation. Only when a CP is massed can the military police provide close-in security through augmentation from corps assets.

2. Identify the personnel to secure critical facilities within the CP.

Note: Critical facilities within the CP requiring security and controlled access include the tactical operations center, the war room, the communications center, the facilities for special intelligence, and the commander's quarters.

3. Conduct a reconnaissance of the routes to the CP and areas around it.
4. Plan the best method and/or mix of forces for security, varying between massed and dispersed CPs, to include static posts, traffic control posts (TCPs), listening posts (LPs), observation posts (OPs), access control, mobile patrols, and quick-response forces, both organic and augmenting.
5. Determine the number of personnel required to provide close-in security for the commander within the area of operations (AO).
6. Determine the amount of Class IX barrier materials needed.
7. Request the barrier materials through the appropriate channels.
8. Obtain an access list of personnel authorized in the CP from the provost marshal or headquarters personnel.
9. Prepare plans for the internal security of the CP. Coordinate directly with the existing security forces, access control personnel, headquarters personnel, and the provost marshal, as appropriate.
10. Plan for the security of tactical CPs when established and when in transit.
11. Prepare a standing operating procedure (SOP) and/or special orders detailing duties, responsibilities, and procedures to be used to provide security to the CP.
12. Brief all Soldiers included in the CP security on the tactical situation and the defensive plans.

Evaluation Preparation: *Setup:* This task may be evaluated in the field or in a classroom environment. Provide the Soldier with information on the size and layout of the CP (massed or dispersed), a map of the area, and METT-TC. The evaluator will act as provost marshal and headquarters personnel and answer any questions the Soldier may have for which information has not been provided.

Performance Measures	GO	NO GO
1. Determined the number of personnel available to conduct CP security, to include augmented personnel.	_____	_____
2. Identified personnel to secure critical facilities within the CP.	_____	_____

Performance Measures	GO	NO GO
3. Conducted reconnaissance of the routes to the CP and the areas around it.	_____	_____
4. Planned the best method and/or mix of forces for security, varying between massed and dispersed CPs, to include static posts, TCPs, LPs, OPs, access control, mobile patrols, and quick-response forces, both organic and augmenting.	_____	_____
5. Determined the number of personnel required to provide close-in security for the commander within the AO.	_____	_____
6. Determined the amount of Class IX barrier materials needed.	_____	_____
7. Requested the barrier materials through the appropriate channels.		_____
8. Obtained an access list of personnel authorized in the CP from the provost marshal or headquarters personnel.		_____
9. Prepared plans for the internal security of the CP. Coordinated directly with the existing security forces, access control personnel, headquarters personnel, and the provost marshal, as appropriate.		_____
10. Planned for the security of tactical CPs when established and when in transit.		_____
11. Prepared an SOP and/or special orders detailing duties, responsibilities, and procedures to be used to provide security to the CP.		_____
12. Briefed all Soldiers included in the CP security on the tactical situation and the defensive plans.		_____

Evaluation Guidance: Refer to chapter 1, paragraph 1-4 b (6).

References

Required: FM 3-19.4

Related:

191-379-4440

Supervise the Evacuation of Dislocated Civilians 191-379-4440

Conditions: You are given a situation with dislocated civilians (DCs), a platoon of fully equipped Soldiers, and vehicles for movement (as appropriate).

Standards: Plan and supervise the evacuation of, accountability for, and welfare and safety of DCs.

Performance Steps

1. Analyze the DC evacuation movement order/situation.
 - a. Provide a warning order to the platoon.
 - b. Determine the number of DCs to be moved.
 - c. Determine the time available and the time necessary for the mission.
 - d. Identify the location for DCs to be evacuated to.
 - (1) Identify safety factors.
 - (2) Identify logistical support, if possible.
 - e. Determine the required resources to complete the evacuation of DCs.
 - (1) Personnel.
 - (2) Movement type.
 - (a) Wheeled vehicles.
 - (b) Transports.
 - (c) Aircraft.
 - (d) Foot.
 - (3) Fuel.
 - (4) Water.
 - (5) Food.
 - (6) Medical.
 - f. Perform a route reconnaissance.
 - (1) Map reconnaissance.
 - (2) Actual reconnaissance (mission/time dependent).
2. Coordinate and prepare necessary resources to evacuate DCs.
 - a. Determine the number of Soldiers required for the mission.
 - b. Determine the number and type of vehicles required for the mission, if appropriate.
 - c. Locate necessary logistics from platoon or company resources.
 - (1) Water.
 - (2) Food.
 - (3) Emergency medical.
 - d. Coordinate the movement of DCs through higher headquarters.
 - (1) Determine the movement location assignment.
 - (2) Coordinate with the movement control center.
 - e. Process DCs.
 - (1) Prepare a log of DCs for movement.
 - (a) Identify DCs.

Performance Steps

- (b) Record DCs' passport number, identification card number, and so forth).
 - (c) Document DCs' location of origin.
 - (d) Document DCs' anticipated direction of movement.
- (2) Screen DCs to determine their grouping.
 - (a) Group I.
 - (b) Group II.
 - (c) Group III.
- 3. Brief Soldiers on the DC evacuation mission.
 - a. Identify mission requirements.
 - b. Identify convoy methods.
 - c. Identify routes.
 - d. Identify emergency response tactics for—
 - (1) Direct fire.
 - (2) Indirect fire.
 - (3) Air attack.
 - (4) Riot.
 - e. Identify secondary marshaling areas following attacks along established route.
 - f. Identify any known friendly fire support along identified routes.
 - g. Identify alternative routes in case of an emergency.
 - h. Identify communications.
 - i. Identify weapons.
- 4. Prepare DCs for movement.
 - a. Brief DCs (in their language when possible) on actions to be taken.
 - b. Address immediate human needs (water consumption, latrine use, and so forth) before movement.
 - c. Load vehicles, if appropriate.

Note: This movement is regarded as a low intensity/no evacuee threat type mission. No physical restraints should be used. Normal precautions (based on the threat; the local standing operating procedure; and the mission, enemy, terrain and weather, troops and support available, time available, civil considerations [METT-TC]) should be considered in this movement. Crew-served weapons should be manned and gunners should be seated where appropriate within the vehicles for convoy security.

Performance Steps

5. Evacuate DCs along an approved main supply route (MSR) or an approved movement route (assigned by the movement control center).
6. Secure the DC evacuation location/site.
7. Move DCs to the evacuation location/site.
8. Notify higher headquarters of mission completion.
 - a. Report the number of DCs moved.
 - b. Report the location of DCs.
 - c. Report issues important to the movement.
 - (1) Mishaps.
 - (2) Injuries.
 - (3) Deaths.
 - (4) Platoon status.

Evaluation Preparation: *Setup*: Provide the Soldier with the materials and equipment listed in the conditions statement.

Brief Soldier: Tell the Soldier to perform the necessary requirements to successfully evacuate DCs to an evacuation location/site.

Performance Measures	GO	NO GO
1. Analyzed the DC evacuation movement order/situation.	—	—
2. Coordinated and prepared necessary resources to evacuate DCs.	—	—
3. Briefed Soldiers on the DC evacuation mission.	—	—
4. Prepared DCs for movement.	—	—
5. Evacuated DCs along an approved MSR or an approved movement route.	—	—
6. Secured the DC evacuation location/site.	—	—
7. Moved DCs to the evacuation location/site.	—	—
8. Notified higher headquarters of mission completion.	—	—

Evaluation Guidance: Refer to chapter 1, paragraph 1-4 b (6).

References

Required:

Related: FM 3-19.4

SUBJECT AREA 27: RISK MANAGEMENT

850-001-4001

Integrate Composite Risk Management into Mission Plans

Conditions: As a company level senior leader, given a mission or task, in a garrison or tactical environment, access to FM 5-19, and a DA Form 7566 (*Composite Risk Management Worksheet*).

Standards: Demonstrate how the five steps of composite risk management (CRM) apply to the eight steps of the troop-leading procedures (TLPs).

Performance Steps

1. Describe the relationship between the five steps of CRM and the eight steps of TLP. See figure 850-001-4001-1.

TROOP LEADING PROCEDURES	RISK MANAGEMENT STEPS				
	STEP 1 Identify Hazard	STEP 2 Assess Hazard	STEP 3 Develop Controls (+) Risk Decision	STEP 4 Implement Controls	STEP 5 Supervise (+) Evaluate
Receive Mission	X	X			
Issue Warning Order	X	X	X		
Make a Tentative Plan	X	X	X		
Initiate Movement	X	X	X	X	
Conduct Recon	X	X	X	X	
Complete Plan	X	X	X	X	
Issue Order			X	X	X
Supervise & Refine				X	X

Figure 850-001-4001-1. TLP and CRM relationship

2. Identify risk guidance received as part of the assigned mission order.

Evaluation Preparation: *Setup:* To evaluate this task, you need an assigned mission or task which may be in the form of an operations order (OPORD), fragmentary order (FRAGO), warning order, patrol order, training task, and so forth. The Soldier will apply the CRM process to the assigned mission or task as an integrated part of TLPs.

Brief Soldier: Tell the Soldier that you are going to evaluate him/her on his/her ability to apply the CRM process to TLPs.

Performance Measures	GO	NO GO
1. Described the relationship between the five steps of CRM and the eight steps of TLP.	___	___
2. Identified the risk guidance contained in the mission order.	___	___

Evaluation Guidance: Refer to chapter 1, paragraph 1-4 b (6).

References

Required: FM 5-0, FM 5-19, and DA Form 7566

Related:

SUBJECT AREA 28: ADMINISTRATION/MANAGEMENT

191-410-0077

Develop a Company Physical Security Plan

Conditions: As a company commander, given a tactical or garrison situation and a need to establish a company physical security plan. You have an outdated physical security plan and have not yet appointed your company physical security officer.

Standards: Develop a comprehensive physical security plan that provides in-depth security of your unit mission essential and vulnerable areas, safeguards company personnel, and prevents unauthorized access to equipment and critical company areas.

Performance Steps

1. Identify company security responsibilities.
 - a. Coordinate with higher headquarters to determine limits of responsibility.
 - b. Receive commander's intent, if available. The following list of commanders is not inclusive, but provides a sample of the senior commands that may generate applicable physical security guidance.
 - (1) Tactical combat force (TCF) commander.
 - (2) Major command (MACOM) commander.
 - (3) Installation commander.
 - (4) Battalion commander.
 - c. Review security regulations and directives.
 - d. Review previous inspections results and command responses to these inspections.
 - e. Review any company waivers and exceptions to the security regulations. Based on these waivers and exceptions, identify the required compensatory measures, and ensure they are maintained in the security plan.

Performance Steps

2. Determine the format of the physical security plan as directed by reference material. Apply the appropriate security classification.
3. Designate a subordinate as the company physical security officer.
4. Identify the areas requiring special security. These areas include, but are not limited to, the following:
 - a. Mission-essential and vulnerable area facilities, such as—
 - (1) Vehicle and carriage-mounted or -towed weapons systems and components at motor pools.
 - (2) Petroleum, oil, and lubricants (POL).
 - (3) Communication and electronics equipment; test, measurement, and diagnostic equipment (TMDE); night-vision devices (NVDs); and other high-value precision equipment and tool kits.
 - (4) Controlled cryptographic items.
 - (5) Sensitive information (included in TM 5-853-1, but not included in DA Pam 190-51).
 - (6) Arms, ammunition, and explosives (AA&E).
 - (7) Sensitive items.
 - b. Restricted areas, such as—
 - (1) Areas devoted to the storage or use of classified documents, equipment, or materials.
 - (2) Other areas designated by the commander.
5. Ensure that security control measures have been identified for the following:
 - a. Personnel access criteria pertinent to each area or structure.
 - (1) Determine who has the authority for access.
 - (2) Identify the specific criteria for access for the following:
 - (a) Unit personnel.
 - (b) Visitors.
 - (c) Maintenance personnel.
 - (d) Contractor personnel.
 - (e) National Guard personnel.
 - (f) Emergency response teams (police, fire, ambulance, and so forth).
 - b. Identification and control.
 - (1) Describe the system to be used in each area. If a badge system is used, a complete description covering all aspects should be used in disseminating requirements for identification and control of personnel conducting business on the installation.

Performance Steps

(2) Determine the specific measures needed to apply the system to the following categories:

- (a) Unit personnel.
- (b) Visitors to restricted areas.
- (c) Visitors to administrative areas.
- (d) Vendors, tradesmen, and so forth.
- (e) Contractor personnel.
- (f) Maintenance or support personnel.
- (g) Fail-safe procedures during power outages.
- (h) Monthly or quarterly inspection.

c. Material control measures.

- (1) Determine procedures for incoming material.
 - (a) Requirements for the admission of material and supplies.
 - (b) Search and inspection of material for possible sabotage

hazards.

(c) Special controls on delivery of supplies or personal shipments in restricted areas.

- (2) Determine procedures for outgoing material.
 - (a) Documentation required.
 - (b) Controls.
 - (c) Classified shipments not involving nuclear/chemical material.

d. Vehicle control measures for the following:

- (1) Military vehicles.
- (2) Privately owned vehicles (POVs).
- (3) Emergency vehicles.
- (4) Vehicle registration.

6. Ensure that a physical security inspection is conducted to determine the need for additional aids to

security to include—

a. Perimeter barrier(s).

- (1) Definition to include type and requirements.
- (2) Clear zones requirements including—
 - (a) Criteria.
 - (b) Maintenance.

b. Perimeter lights consider the following:

- (1) Protective lighting system requirements.

Performance Steps

- (a) Describe how it will be used and who will control the system.
 - (b) Identify inspection responsibilities.
 - (c) Action taken in case of commercial power failure.
 - (d) Action taken in case of failure of alternate power source.
 - (2) Determine emergency lighting system requirements. Consider the following:
 - (a) Stationary.
 - (b) Portable.
 - c. Communications.
 - (1) Locations.
 - (2) Use.
 - (3) Tests.
 - (4) Authentication.
 - d. Warning signs.
 - (1) Types.
 - (2) Posting.
 - e. Intrusion detection systems.
 - (1) Security classification.
 - (2) Inspections.
 - (3) Use and monitoring.
 - (4) Alarm responses.
 - (5) Maintenance.
 - (6) Alarm logs or registers.
 - (7) Tamper-proof provisions.
 - (8) Monitor-panel locations.
7. Ensure that the physical security plan addresses guard force manpower requirements and use.
8. Ensure that contingency plans and standing operating procedures (SOPs) regarding the responsibilities and actions of personnel, including the guard force and alert force, are developed. Detailed instructions such as special orders and SOP information should be attached as annexes. The contingency plans should include, but are not limited to, specific requirements in the following areas:
- a. Composition and organization.
 - b. Tour of duty.
 - c. Essential posts and routes.
 - d. Weapons and equipment.

Performance Steps

- e. Training.
 - f. Standby of military working dog teams.
 - g. Method of challenging with signs and countersigns.
 - h. Alert forces.
 - (1) Composition.
 - (2) Mission.
 - (3) Weapons and equipment.
 - (4) Location.
 - (5) Deployment concept.
 - (6) Availability.
9. Ensure that key and lock control requirements have been determined and specifically identify facilities requiring control. Areas of interest include the following:
- a. Key depositories.
 - b. The key marking method.
 - c. Required actions for lost keys and locks.
 - d. Lock rotation.
 - e. Key control methods.
 - f. Access sign-in rosters.

Evaluation Preparation: *Setup:* Provide a directive from higher headquarters outlining the commander's responsibilities, a threat assessment, unit mission essential task list (METL), a list of critical and high value areas that need prioritized security, a list of available resources, and a copy of FM 3-19.30.

Brief Soldier: Outline the commander's intent based on higher headquarters requirements, create a mission essential vulnerable area (MEVA) list, and develop the company security plan based on the threat.

Performance Measures	GO	NO GO
1. Identified company security responsibilities. <ul style="list-style-type: none"> a. Coordinated with higher headquarters to determine limits of responsibility. b. Received commander's intent if available. c. Reviewed security regulations and directives. d. Reviewed previous inspection results. e. Reviewed company waivers and exceptions. 	—	—

Performance Measures	GO	NO GO
2. Determined the format of the physical security plan as directed by reference material. The plan included the appropriate security classifications.	_____	_____
3. Designated a subordinate as the company physical security officer.	_____	_____
a. Mission.		
b. Vulnerability.		
c. Impact on operations.		
d. Budget limitations.		
e. Personnel resources.		
f. Equipment limitations.		
4. Identified areas requiring special security.	_____	
5. Ensured that security control measures were identified for the following:		
a. Personnel access criteria pertinent to each area or structure.		
b. Identification and control.		
c. Material control measures.		
d. Vehicle control measures.		
6. Ensured that a physical security inspection was conducted to determine the need for additional aids to security to include—		
a. Perimeter barriers.		
b. Perimeter lights.		
c. Communications.		
d. Warning signs.		
e. Intrusion detection systems.		
7. Ensured that the physical security plan addressed guard force manpower requirements and use.		

Performance Measures	GO	NO GO
<p>8. Ensured that the development of contingency plans and SOPs regarding the responsibilities and actions of personnel included the guard force and alert force. Attached detailed instructions such as special orders and SOP information as annexes.</p> <ul style="list-style-type: none"> a. Composition and organization. b. Tour of duty. c. Essential posts and routes. d. Weapons and equipment. e. Training. f. Standby of military working dog teams. g. Method of challenging with signs and countersigns. h. Alert forces. 	<p>_____</p> <p>_____</p> <p>_____</p> <p>_____</p> <p>_____</p> <p>_____</p> <p>_____</p> <p>_____</p>	<p>_____</p> <p>_____</p> <p>_____</p> <p>_____</p> <p>_____</p> <p>_____</p> <p>_____</p> <p>_____</p>
<p>9. Ensured that key and lock control requirements were determined and specifically identified facilities that required control. Areas of interest included—</p> <ul style="list-style-type: none"> a. Key depositories. b. Key marking method. c. Required actions for lost keys and locks. d. Lock rotation. e. Key control methods. f. Access sign-in rosters. 	<p>_____</p> <p>_____</p> <p>_____</p> <p>_____</p> <p>_____</p> <p>_____</p>	<p>_____</p> <p>_____</p> <p>_____</p> <p>_____</p> <p>_____</p> <p>_____</p>

Evaluation Guidance: Refer to chapter 1, paragraph 1-4 b (6).

References

Required: FM 3-19.30

Related: AR 190-13, AR 190-51, DA Pam 190-51, and TM 5-853-1

191-415-0001

Implement Brigade or Above Physical Security Program (PSP)

Conditions: As a brigade commander, given tactical or garrison situation, and a need to establish security priorities, procedures, and requirements to subordinate units. You have an outdated physical security program and have not yet appointed your physical security officer.

Standards: Implement a brigade or above physical security program that prevents or minimizes loss or damage from theft, espionage, sabotage, and other criminal or disruptive activities, and identify adequate resources to support the program.

Performance Steps

1. Identify organization security responsibilities.
 - a. Coordinate with higher headquarters to determine limits of responsibility.
 - b. Receive commander's intent if available.
 - (1) Tactical combat force (TCF) commander.
 - (2) Major command (MACOM) commander.
 - (3) Installation commander.
 - (4) Other higher headquarters commanders.
 - c. Review security regulations and directives.
2. Determine the current security situation.
 - a. Review subordinate organizations physical security plans and mission essential task list (METL) tasks.
 - b. Review the local threat analysis, if none are available, conduct a threat analysis.
 - c. Direct a criminal analysis.
 - d. Participate in the higher headquarters threat working group (TWG).
 - e. Distribute the commander's critical information requirements (CCIR) to subordinate organizations.
3. Determine organization prevention and response procedures.
 - a. Appoint a subordinate as the organization physical security officer.
 - b. Create a list of the areas, buildings, and other structures considered critical and establish priorities for their protection. This consolidated list is the mission essential vulnerability (MEVA) list.
 - c. Direct the development of the organization PSP using FM 3-19.30, appendix F, as a guide. Ensure that the plan reflects the commander's guidance for providing proper and economic use of personnel and equipment to prevent or minimize loss or damage from theft, espionage, sabotage, and other criminal or disruptive activities.

Note: All physical security plans have the potential of being classified documents and must be treated accordingly.

- d. Distribute the PSP to subordinate organizations to use as the basis for their organization PSP and to identify any additional METL tasks.

Note: PSPs are reviewed and updated annually.

Performance Steps

4. Identify resources necessary to establish and maintain the PSP.

Note: Resource management must be conducted in close coordination with the organization resource manager. The commander must identify those resources available that are mission essential and those areas that are vulnerable.

a. Identify resource requirements for physical security as a result of the planning process.

b. Identify requirement changes based on mission, enemy, terrain and weather, troops and support available, time available, civil considerations (METT-TC).

c. Allocate resources consistent with the threat.

d. Budget for the funds necessary to provide and maintain the security program according to the time lines set forth in the Planning, Programming, Budgeting, and Execution System (PPBES).

5. Request physical security funding.

a. Request physical security requirements or enhancements beyond your budgetary means from the host commander or higher headquarters.

b. Include physical security programs and improvements as a part of all annual budgets.

c. Determine which of the following three basic funding programs (subject to change) to use for the type of requirement and if sufficient funds are available.

(1) The RJC6, which resources physical-security equipment purchase and maintenance.

(2) The QLPR, which resources law-enforcement operations (to include security guards and special-reaction teams).

(3) The VTER, which provides resources for projects and temporary programs that enhance any type of security due to an increase in terrorist threat.

Evaluation Preparation: *Setup:* Provide a directive from higher headquarters outlining the command responsibilities, a threat assessment, subordinate unit's METL, a list of critical and high value areas that need prioritized security, the current budget, and a copy of FM 3-19.30.

Brief Soldier: Outline the commander's intent based on higher headquarters requirements, the threat, and the installation security requirements; create a MEVA list; identify necessary security resources and which type of funding would generate these resources.

Performance Measures	GO	NO GO
1. Identified organization security responsibilities.	_____	_____
2. Determined the current security situation.	_____	_____
a. Directed a criminal analysis.	_____	_____
b. Distributed CCIR to subordinate organizations.	_____	_____
3. Determined organization prevention and response procedures.	_____	_____
a. Appointed a subordinate as the organization physical security officer.	_____	_____
b. Created a MEVA list.	_____	_____
c. Directed the development of the organization PSP.	_____	_____
4. Identified resources necessary to establish and maintain the PSP.	_____	_____
a. Allocated resources consistent with the threat.	_____	_____
b. Budgeted for the funds necessary to provide and maintain the security program.	_____	_____
5. Requested physical security funding.	_____	_____
a. Requested physical security requirements or enhancements beyond his/her means from the host commander or higher headquarters.	_____	_____
b. Included physical security programs and improvements as a part of all annual budgets.	_____	_____

Evaluation Guidance: Refer to chapter 1, paragraph 1-4 b (6).

References

Required: AR 190-13, DOD 7000.14-R, FM 14-100, and FM 3-19.30

Related: FM 3-19.4

805C-PAD-4359

Manage Soldier's Deployment Requirements

Conditions: Given a requirement to prepare a section for deployment, access to AR 600-8-101, local standing operating procedures (SOPs), standard office supplies, equipment, and assigned personnel.

Standards: Perform initial deployment activities to include verification of section roster, recall/alert roster, individual Soldier Readiness Processing (SRP) packets.

Performance Steps

1. Review SRP packets to identify deployable and nondeployable Soldiers.
2. Review the section's recall procedures.
3. Identify all equipment the section needs, based on the mission, climate, location, and local SOP.
4. Identify all supplies the section needs, based on the mission, climate, location, and local SOP.
5. Identify any special items of clothing the section needs, based on the mission, climate, location, or local SOP.

Evaluation Preparation: *Setup:* This task can be performed in an administrative environment. Soldiers should be informed to bring the section personnel roster, recall roster, and SRP packets. At the test site, verify that these files and documents have been properly prepared and are accurate and current.

Soldier Brief: Inform the Soldier that he/she is being evaluated on his/her ability to manage Soldier deployment requirements.

Performance Measures	GO	NO GO
1. Reviewed SRP packets to identify deployable and nondeployable Soldiers.	_____	_____
2. Reviewed the section's recall procedures.	_____	_____
3. Identified all equipment the section needs, based on the mission, climate, location, and local SOP.	_____	_____
4. Identified all supplies the section needs, based on the mission, climate, location, and local SOP.	_____	_____
5. Identify any special items of clothing the section needs, based on the mission, climate, location, or local SOP.	_____	_____

Evaluation Guidance: Refer to chapter 1, paragraph 1-4 b (6).

References

Required: AR 600-8-1 and SOP

Related:

805C-PAD-4550

Prepare a Standing Operating Procedure (SOP)

Conditions: Given a requirement to prepare an SOP to standardize routine or recurring actions or functions, appropriate operational references or local policy guidance, and access to AR 25-50 and AR 380-5, computer with authorized software, and office supplies.

Standards: Prepare an SOP in the proper format and identify the purpose, distribution, and references. Apply the proper security classification marks (if applicable) and properly authenticate.

Performance Steps

1. Determine purpose.
 - a. Determine requirement for action/function.
 - b. Analyze intended outcome
2. Determine audience/distribution.
 - a. Identify level of application.
 - b. Identify units, section, and personnel involved.
3. Determine references for content.
4. Select content for the SOP.
5. Prepare the SOP in the format prescribed by local procedures.
6. Determine security classification requirements.
7. Apply the proper security classification marking.
8. Determine coordination requirement for approval.
9. Distribute the SOP for coordination.
10. Review coordination comments.
11. Prepare the final SOP.
 - a. Incorporate appropriate comments.
 - b. Coordinate final review.
12. Obtain the authentication.
13. Determine reproduction requirements.
14. Distribute the SOP as required by local procedures.

Evaluation Preparation: *Setup:* To evaluate this task, gather the items listed in the conditions statement. Have computer and printer or pencil and paper for Soldiers to prepare the SOP.

Brief Soldier: Give the Soldier a scenario that would provide all information necessary to perform the measures to include topic references.

Performance Measures	GO	NO GO
1. Determined purpose. <ol style="list-style-type: none">a. Determined requirement for action/function.b. Analyzed intended outcome.	_____	_____
2. Determined the audience/distribution. <ol style="list-style-type: none">a. Identified the level of application.	_____	_____

Performance Measures	GO	NO GO
b. Identified units, section, and personnel involved.		
3. Determined references for content.	___	___
4. Selected content for the SOP.	___	___
5. Prepared the SOP in the format prescribed by local procedures.	___	___
6. Determined the security classification marking.	___	___
7. Applied the proper security classification marking.	___	
8. Determined coordination requirement for approval.		
9. Distributed the SOP for coordination.		
10. Reviewed coordination comments.		
11. Prepared the final SOP.		
a. Incorporated appropriate comments.		
b. Coordinated the final review.		
12. Obtained the authentication.		
13. Determined reproduction requirement.		
14. Distributed the SOP as required by local procedures.		

Evaluation Guidance: Refer to chapter 1, paragraph 1-4 b (6).

References

Required: AR 25-50, AR 380-5, FM 101-5, and Software-Office

Related:

805C-PAD-4597

Integrate Newly Assigned Soldiers

Conditions: Given a section/platoon, newly assigned Soldiers, and local policy.

Standards: Establish personnel accountability. Provide Soldiers with health and welfare items, initial area orientations, and special orders (if required). Verify Soldiers' qualifications, assign Soldiers to duty positions, inform the commander, and conduct initial counseling.

Performance Steps

1. Receive new Soldiers.
 - a. Provide health and welfare items.
 - b. Provide initial required area orientations and special orders.
2. Verify Soldiers' qualifications and equipment.

Performance Steps

3. Determine duty assignments.
 - a. Notify the commander.
 - b. Notify the Soldiers.
4. Provide initial counseling.
5. Update personnel accountability.

Evaluation Preparation: *Setup:* Provide the Soldier with a scenario and sufficient information to accomplish the performance steps. Provide the Soldier with a section/platoon roster which indicates military occupational specialty (MOS), grades and filled/vacant positions, paper and pencils. Scenario should provide local requirements for personnel accountability, health and welfare items, and area orientations. Have the Soldier list the actions/items he/she would take or provide to integrate newly assigned Soldiers.

Brief Soldier: Inform the Soldier that he/she will be tested on his/her ability to receive and integrate new Soldiers into the section/platoon. Tell the Soldier he/she will list the actions/items necessary to properly integrate newly assigned Soldiers.

Performance Measures	GO	NO GO
1. Received new Soldiers. <ol style="list-style-type: none">a. Provided health and welfare items.b. Provided initial area orientations and special orders.	_____	_____
2. Verified the Soldiers' qualifications and equipment.		
3. Determined duty assignments. <ol style="list-style-type: none">a. Notified the commander.b. Notified the Soldiers.		
4. Provided initial counseling.		
5. Updated personnel accountability.		

Evaluation Guidance: Refer to chapter 1, paragraph 1-4 b (6).

Appendix A

Proponent School or Agency Codes

The first three digits of the task number identify the proponent school or agency responsible for the task. Record any comments or questions regarding the task summaries contained in this manual on a DA Form 2028 (*Recommended Changes to Publications and Blank Forms*) and send it to the proponent school with an information copy to—

Commander, U.S. Army Training Support Center
ATTN: ATIC-ITSC-CM
Fort Eustis, VA 23604-5166.

Table A-1. Proponent School or Agency Codes	
<i>School Code</i>	<i>Command</i>
MANSCEN CM 031	Commandant, US Army Chemical School ATTN: ATSN-TI 464 MANSCEN Loop, Suite 2617 Fort Leonard Wood, MO 65473-8929
MANSCEN EN 052	Commandant, U.S. Army Engineer School ATTN: ATSE-DT (Individual Training Division) 320 MANSCEN Loop, Suite 370 Fort Leonard Wood, MO 65473
MANSCEN MP 191	Commandant, United States Army Military Police School ATTN: ATSJ-TD 401 MANSCEN Loop, Suite 2617 Fort Leonard Wood, MO 65473-8926
FA 061	Directorate of Training and Doctrine U.S. Army Field Artillery School ATTN: ATSF-D Fort Sill, OK 73503-5000
IN 071	Commandant, U.S. Army Infantry School ATTN: ATSH-OTSS Fort Benning, GA 31905-5593
AHS 081	Department of Training Support ATTN: MCCS-HTI 1750 Greeley Rd, Ste 135 Fort Sam Houston, TX 78234-5078
CASCOM 091	U.S. Army Combined Arms Support Command (CASCOM) Training Directorate USACASCOM, ATTN: ATCL-A 401 First St., Suite 227 Fort Lee, VA 23801-1511

Table A-1. Proponent School or Agency Codes

<i>School Code</i>	<i>Command</i>
TRADOC DCSINT 159	Commander, HQ TRADOC ATTN: ATIN-ZA 33 Ingalls Rd. Fort Monroe, VA 23651-1067
JAG 181	Commandant, Judge Advocate General Legal Center and School ATTN: JAGS-TDD 600 Massie Road Charlottesville, VA 22903-1781
APAC 224	Director, Army Public Affairs Center 6 ACR Road, Bldg 8607 ATTN: SAPA-PA Fort Meade, MD 20755-5650
MI 301	Commander, USA Intelligence Center & Fort Huachuca 550 Cibeque Street, Suite 168 ATTN: ATZS-TDS-I Fort Huachuca, AZ 85613-7002
CASCOM 551	U.S. Army Combined Arms Support Command (CASCOM) Training Directorate USACASCOM, ATTN: ATCL-TDM 401 First St., Rm 101A Fort Lee, VA 23801-1511
SSI 805C	Commander, USA Soldier Support Institute ATTN: ATSG-TD-HRD Fort Jackson, SC 29207-7065
TRADOC Safety Office 850	TRADOC Command Safety Office 1 Bernard Road, Bldg 84 ATTN: ATCS-S Fort Monroe, VA 23651-1048

Appendix B

GUIDE TO FORMS

This appendix contains a list of forms pertinent to SMCT and AWT evaluations and administration. In the electronic, online version of this manual, hot links will, where indicated, provide downloadable and reproducible copies of the forms. The user can also visit the PDM site in the Reimer Digital Library where access to the *WTBD List* and *AWT* (Bulletin) provide additional helpful information and links. Some of these forms may be available in your unit.

DA Form 5164-R (*Hands On Evaluation*), used by AWT evaluators to record GO/NO GO for each performance measure in a given task. Refer to the *WTBD List* for the current FY (in the Reimer Digital Library) for links to DA Forms 5164-R that are overprinted with the performance measures for each task.

DA Form 5165-R (*Field Expedient Squad Book*), used to record task proficiency for groups of Soldiers in a squad. This squad book should be especially beneficial for recording training results gathered during MTP, field exercises, or individual training sessions. Once training is completed, trainers may transfer information from DA Form 5165-R to the leader book (FM 7-10).

DA Form 2028 (*Recommended Changes to Publications and Blank Forms*), used by Soldiers and trainers to record any comments or questions regarding the task summaries contained in this manual. Use the task proponent address for the appropriate proponent code given in appendix A (first three digits of the task number).

This page intentionally left blank.

Glossary

5-Cs	confirm, clear, call, cordon, and control
AA	assembly area
AA&E	arms, ammunition, and explosives
AAR	after-action review
AC	alternating current
ACR	armored cavalry regiment
AIT	advanced individual training
ANCOC	advanced noncommissioned officer course
AO	area of operations
AOI	area of interest
AR	Army regulation
ARNG	Army National Guard
ASAP	as soon as possible
ASR	alternate supply route
AT	annual training
AUD	audio (panel nomenclature)
AUEL	automated unit equipment list
AWT	Army Warrior Training
BBPCT	blocking, bracing, packing, crating and tiedown
BC	Bradley commander
BFV	Bradley fighting vehicle
BII	basic item issue
BN	battalion
BNCOC	basic noncommissioned officer course
C4I	command, control, communications, computers, and intelligence
CA	civil affairs
CAM	chemical-agent monitor
CAS	close air support
CASEVAC	casualty evacuation
CB	chemical-biological / center of balance
CBRN	chemical, biological, radiological, or nuclear
CCIR	commander's critical information requirements
C-E	communications-electronics
CED	captured enemy document
CEE	captured enemy equipment
CEM	captured enemy materiel
cGyph	centigray per hour
CID	Criminal Investigation Command
CINC	commander in chief

clr	clear (panel nomenclature)
cm	centimeters
CMO	civil-military operations
co	company
COA	course of action
COE	common operating environment
COEI	components of end item
COMSEC	communications security
CONUS	continental United States
COP	common operational picture
COSR	combat operational stress reaction
CP	command post
CREW	counter, radio-controlled IED electronic warfare
CRM	composite risk management
CSDP	Command Supply Discipline Program
CSS	combat service support
CTA	common tables of allowance
CTC	Combat Training Centers
DA	Department of the Army
DCP	detainee collection point
DEL	deployment equipment list
DHA	detainee holding area
DNBI	disease and nonbattle injury
DOD	Department of Defense
DRMO	Defense Reutilization and Marketing Office
DTG	date-time group
DTSS	Digital Topographic Support System
DULLRAM	depleted uranium low-level radiation materials
DZ	drop zone
ECP	entry control point
EHCC	Explosive Hazard Coordination Center
EHDB	explosive hazard database
EMP	electromagnetic pulse
EO	Equal Opportunity
EOD	emergency ordnance detachment, explosive ordnance disposal
EPW	enemy prisoner of war
ETA	estimated time of arrival
FDC	fire direction center
FEBA	forward edge of the battle area
FO	forward observer

FOB	forward operating base
FORSCOM	United States Army Forces Command
FPCON	force protection condition
FPF	final protective fire
FPL	final protective line
FRAGORD	fragmentary order
FSMC	forward support medical company
FST	field sanitation team
FTX	field training exercise
G-2	Assistant Chief of Staff (Intelligence)
G-3	Assistant Chief of Staff (Operations and Plans)
GI	government issue
GPS	Global Positioning System
GSA	General Services Administration
GTA	graphic training aid
HAZMAT	hazardous material
HEPA	high-efficiency particulate air
HN	host nation
HSB	heavy separate brigade
HTD	highway traffic division
HUMINT	human intelligence
HW	hazardous waste
ICP	incident control point
ID	identification
IDP	initial delay position
IED	improvised explosive device
INF	infantry
ISN	internment serial number
ISR	intelligence, surveillance, and reconnaissance
IVMMD	interim vehicle-mounted mine detector
JSLIST	joint-Service, lightweight integrated suit technology
LACE	liquid, ammunition, casualties, equipment
LBE	load-bearing equipment
LCE	load-carrying equipment
LD	line of departure
LOGPAC	logistics package
LOT	lethal overwatch team
LP	listening post
LZ	landing zone
MACOM	major command
MBA	main battle area

MCM	maintenance control manual
MCS-ENG	Maneuver Control Systems-Engineer
MDMP	military decision making process
MEDEVAC	medical evacuation
MEDPLT	medical platoon
METL	mission essential task list
METT-TC	mission, enemy, terrain and weather, troops and support available, time available, civil considerations
MEVA	mission essential vulnerable area
MG	milligrams
MIDB	modernized intelligence database
MOGAS	mobile gasoline
MOPP	mission-oriented protective posture
MOS	military occupational specialty
MOUT	military operations in urban terrain
MPCV	mine-protected clearance vehicle
MSR	main supply route
MTP	mission training plan
MUTA	multiple unit training assembly
NAI	named areas of interest
NATO	North Atlantic Treaty Organization
NBC	nuclear, biological, and chemical
NCO	noncommissioned officer
NCOER	noncommissioned officers evaluation report
NCOIC	noncommissioned officer in charge
NLW	nonlethal weapon
NMC	not mission capable
NTAT	not to accompany troops
NVD	night-vision devices
OAKOC	observation and fields of fire, avenues of approach, key terrain, obstacles, and cover and concealment
OCIE	organizational clothing and individual equipment
OEG	operational exposure guidance
OEL	organization equipment list
OIP	organizational inspection program
OIP	organizational inspection program
OP	observation posts
OPLAN	operations plan
OPORD	operation order
OPSEC	operations security
ORP	objective rallying point

OSUT	one-station unit training
OT	observer-target
PAO	public affairs office
PATI	protection assessment test instrument
PATS	Protection Assessment Test System
PBIED	person-borne improvised explosive devices
PCC	precombat check
PCI	precombat inspection
PDF	principal direction of fire
PIR	priority intelligence requirements
PL	phase line
PLGR	precision lightweight Global Positioning System receiver
plt	platoon
PM	preventive medicine
PMCS	preventive maintenance checks and services
PMM	preventive medicine measure
POL	petroleum, oils, and lubricants
POSH	prevention of sexual harassment
POV	privately owned vehicles
POW	prisoner of war
PP	passage points
PPBES	Planning, Programming, Budgeting, and Execution System
PPE	personal protective equipment
PSG	platoon sergeants
PSP	Physical Security Program
PSS	personnel services support
PTSD	post-traumatic stress disorder
PVTMED	preventive medicine
pwr	power (panel nomenclature)
QRF	quick-reaction force
qt	quart/quarterly
R&S	reconnaissance and security
RF	radio frequency
ROE	rules of engagement
ROI	rules of interaction
RP	release point
RSR	required supply rate
RUF	rules for the use of force
S1	personnel staff officer
S2	brigade intelligence staff officer
SA	semiannually

SALUTE	size, activity, location, unit, time, and equipment
SIB	separate infantry brigade
SITREP	situation report
SL	skill level
SM	Soldier's manual
SMCT	Soldier's Manual of Common Tasks
SNCO	senior noncommissioned officer
SOI	signal operating instructions
SOP	standing operating procedure
SP	start point
SPOTREP	spot report
SR	supply route
SSN	social security number
STANAG	standardization agreement
STANO	surveillance, target acquisition, and night observation
STATREP	status report
STB	super tropical bleach
STP	Soldier's training publication
SUN	shipment unit number
TACSOP	tactical standing operating procedure
TAI	targeted area of interest
TC	training circular
TC ACCIS	Transportation Coordinators' Automated Command and Control Information System
TC-AIMS II	Transportation Coordinators' Automated Information for Movements System
TCCC	tactical combat casualty care
TCF	tactical combat force
TCP	traffic control post, tactical control point
TECHDOC	technical documentation
TECHINT	technical intelligence
TIF	theater internment facility
TIM	toxic industrial material
TLP	troop-leading procedures
TM	technical manual
TMDE	test, measurement, and diagnostic equipment
TMFDB	Tactical Minefield Database
TOE	table of organization and equipment
TOW	tube launched, optically tracked, wire guided
TRP	target reference point
TSOP	tactical standing operating procedure

TTP	tactics, techniques, and procedures
TWG	threat working group
TWS	thermal weapon sight
U.S.	United States
UAV	unmanned aerial vehicle
UCMJ	Uniform Code of Military Justice
UDL	unit deployment list
UIC	unit identification code
ULN	unit line number
UMO	unit movement officer
UN	United Nations
UND	urgency of need designator
USAR	United States Army Reserve
UTA	unit training assembly
VBIED	vehicle-borne improvised explosive device
WARNORD	warning order
WESS	weapons systems status
WLC	Warrior Leaders Course
WTBD	warrior tasks and battle drills
www	worldwide web

This page intentionally left blank.

References

REQUIRED PUBLICATIONS

Required publications are sources that users must read to understand or comply with this publication.

ARMY REGULATIONS

- AR 25-50, *Preparing and Managing Correspondence*, 3 June 2002.
- AR 27-1, *Legal Services, Judge Advocate Legal Services (Reprinted w/Basic Incl C1)*, 30 September 1996.
- AR 27-10, *Military Justice*, 16 November 2005.
- AR 190-13, *The Army Physical Security Program*, 30 September 1993.
- AR 360-1, *The Army Public Affairs Program*, 15 September 2000.
- AR 380-5, *Department of the Army Information Security Program*, 29 September 2000.
- AR 385-10, *The Army Safety Program*, 29 February 2000.
- AR 385-40, *Accident Reporting and Records*, 1 November 1994.
- AR 385-55, *Prevention of Motor Vehicle Accidents*, 12 March 1987.
- AR 525-13, *Antiterrorism*, 4 January 2002.
- AR 55-162, *Permits for Oversize, Overweight, or Other Special Military Movements on Public Highways in the United States {OPNAVINST 4600.11D; AFR 75-24; MCO 4643.5C; DLAR 4540.8}*, 1 January 1979
- AR 600-8-1, *Army Casualty Program*, 7 April 2006
- AR 600-20, *Army Command Policy*, 7 June 2006.
- AR 600-55, *The Army Driver and Operator Standardization Program (Selection, Training, Testing, and Licensing)*, 31 December 1993.
- AR 700-138, *Army Logistics Readiness and Sustainability*, 26 February 2004.
- AR 700-4, *Logistics Assistance*, 17 March 2006.
- AR 710-2, *Supply Policy Below the National Level*, 8 July 2005.
- AR 725-50, *Requisition, Receipt, and Issue System*, 15 November 1995.
- AR 735-5, *Policies and Procedures for Property Accountability*, 28 February 2005.
- AR 750-1, *Army Materiel Maintenance Policy*, 5 September 2006.
- AR 750-43, *Army Test, Measurement and Diagnostic Equipment Program*, 14 December 2004.

COMMON TABLES OF ALLOWANCE

- CTA 50-900, *Clothing and Individual Equipment*.
- CTA 50-909, *Field and Garrison Furnishings and Equipment*.
- CTA 50-970, *Expendable/Durable Items (Except Medical, Class V, Repair Parts, and Heraldic Items)*.

FORMS

- DA Form 285, *U.S. Army Accident Report*.
- DA Form 1132-R, *Prisoner's Personal Property List - Personal Deposit Fund (LRA)*.
- DA Form 1156, *Casualty Feeder Card*.

DA Form 1711-R. *Engineer Reconnaissance Report (LRA)*.
DA Form 3964. *Classified Document Accountability Record*.
DA Form 4137. *Evidence/ Property Custody Document*.
DA Form 5748-R. *Shipment Unit Packing List and Load Diagram (LRA)*.
DA Form 7566. *Composite Risk Management Worksheet*.
DD Form 518. *Accident-Identification Card*.
DD Form 626. *Motor Vehicle Inspection (Transporting Hazardous Materials)*.
DD Form 836. *Dangerous Goods Shipping Paper/Declaration and Emergency Response Information for Hazardous Materials Transported by Government Vehicles*.
DD Form 1265. *Request for Convoy Clearance*.
DD Form 1266. *Request for Special Hauling Permit*.
DD Form 2708. *Receipt for Inmate or Detained Person*.
DD Form 2745. *Enemy Prisoner of War [EPW] Capture Tag*.
FORSCOM Form 285-R. *Vehicle Load Card*.
Note. FORSCOM forms are at <http://www.forscom.army.mil/forms/default.htm>
SF 91. *Motor Vehicle Accident Report*.
SF 700. *Security Container Information*.
SF 702. *Security Container Check Sheet*.
SF 703. *Top Secret Cover Sheet*.
SF 704. *Secret Cover Sheet*.
SF 705. *Confidential Cover Sheet*.

DEPARTMENT OF THE ARMY PAMPHLETS

DA Pam 25-30, *Consolidated Index of Army Publications and Blank Forms*, 1 October 2006.
DA Pam 710-2-1, *Using Unit Supply System (Manual Procedures) (Standalone Pub)*, 31 December 1997.
DA Pam 710-2-2, *Supply Support Activity Supply System: Manual Procedures*, 30 September 1998.
DA Pam 750-1, *Leader's Unit Level Maintenance Handbook*, 3 October 2003.
DA Pam 750-8. *The Army Maintenance Management System (TAMMS) Users Manual*. 22 August 2005.
DA Pam 750-35, *Guide for Motor Pool Operations*, 1 August 1994.

FIELD MANUALS

FM 1-02. *Operational Terms and Graphics {MCRP 5-12a}* (This Item Is Included on EM 0205), 21 September 2004.
FM 3-11.3 (FM 3-3, FM 3-3-1). *Multiservice Tactics, Techniques, and Procedures for Chemical, Biological, Radiological, and Nuclear Contamination Avoidance {MCWP 3-37.2A, NTTP 3-11.25, AFTP(I) 3-2.56}*. 2 February 2006.
FM 3-11.4. *Multiservice Tactics, Techniques, and Procedures for Nuclear, Biological, and Chemical (NBC) Protection*. {MCWP 3-372, NTTP 3-11.27, AFTTP(I) 3-2.46} 2 June 2003.

FM 3-11.5 (FM 3-5). *Multiservice Tactics, Techniques, and Procedures for Chemical, Biological, Radiological, and Nuclear Decontamination*. {MCWP 3-37.3, NTTP 3-11.26, AFTP(I) 3-2.60,} 4 April 2006.

FM 3-19.4 (FM 19-4), *Military Police Leaders' Handbook*, 4 March 2002.

FM 3-19.30 (FM 19-30), *Physical Security*, 8 January 2001.

FM 3-21.71 (FM 7-7J), *Mechanized Infantry Platoon and Squad (Bradley)*, 20 August 2002.

FM 3-25.26 (FM 21-26), *Map Reading and Land Navigation*, 18 January 2005.

FM 3-90.1 (FM 71-1), *Tank and Mechanized Infantry Company Team*, 9 December 2002.

FM 3-90.2 (FM 71-2), *The Tank and Mechanized Infantry Battalion Task Force*, 11 June 2003.

FM 3-100.12. *Risk Management for Multiservices Tactics, Techniques, and Procedures* {MCRP 5-12.1C; NTTP 5-03.5; AFTTP(I) 3-2.34}, 15 February 2001.

FM 4-01.30. *Movement Control*, 1 September 2003.

FM 4-01.011 (FM 55-65 and FM 55-9), *Unit Movement Operations*, 31 October 2002.

FM 4-25.11 (FM 21-11), *First Aid* {NTRP 4-02.1.1; AFMAN 44-163(I); MCRP 3-02G}, 23 December 2002.

FM 4-30.3 (FM 9-43-1), *Maintenance Operations and Procedures*, 28 July 2004..

FM 5-0 (FM 101-5). *Army Planning and Orders Production*. 20 January 2005.

FM 5-19. *Composite Risk Management*, 21 August 2006.

FM 5-103. *Survivability*. 10 June 1985 (will be revised as FM 3-34.112).

FM 5-170 (FM 5-36), *Engineer Reconnaissance*, 5 May 1998. (Will be revised as FM 3-34.170).

FM 7-7, *The Mechanized Infantry Platoon and Squad (APC)*, 15 March 1985. (Will be revised as FM 3-21.7).

FM 7-8, *Infantry Rifle Platoon and Squad*, 22 April 1992. (Will be revised as FM 3-21.8).

FM 7-20, *The Infantry Battalion*, 6 April 1992. (Will be revised as FM 3-21.20).

FM 1-06 (FM 14-100). *Financial Management Operations*, 21 September 2006.

FM 17-95, *Cavalry Operations*, 24 December 1996. (Will be revised as FM 3-20.95).

FM 21-10, *Field Hygiene and Sanitation*, 21 June 2000. (Will be revised as FM 4-25.10).

FM 21-60, *Visual Signals*, 30 September 1987. (Will be revised as FM 3-12.60).

FM 21-75, *Combat Skills of the Soldier*, 3 August 1984. (Will be revised as FM 3-21.75).

FM 21-305. *Manual for the Wheeled Vehicle Driver*. {AFMAN 24-306} (This Item is Included on EM 0205) 27 August 1993.

FM 27-2. *Your Conduct in Combat Under the Law of War*, 23 November 1984. (Will be revised as FM 1-04.2).

FM 27-10. *The Law of Land Warfare*, 18 July 1956 (This Item is Included on EM 0205). (Will be revised as FM 1-04.10).

FM 46-1. *Public Affairs Operations*, 30 May 1997 (This Item is Included on EM 0205). (Will be revised as FM 3-61).

- FM 55-1, *Transportation Operations*, 3 October 1995 (This Item is Included on EM 0205). (Will be revised as FM 4-01).
- FM 55-15, *Transportation Reference Data*, 27 October 1997 (This Item is Included on EM 0205). (Will be revised as FM 4-01.15).
- FM 55-30, *Army Motor Transport Units and Operations (This Item is Included on EM 0205)*, 27 June 1997. (Will be revised as FM 4-01.40).
- FM 100-17, *Mobilization, Deployment, Redeployment, Demobilization*, 28 October 1992 (This Item is Included on EM 0205). (Will be revised as FM 3-35).

SOLDIER TRAINING PUBLICATIONS

- STP 21-1-SMCT. *Soldier's Manual of Common Tasks Warrior Skill Level 1*, 2 October 2006.
- STP-24-SMCT. *Soldier's Manual of Common Tasks Warrior Leader Skills Level 2, 3, and 4*, October 2006.

TECHNICAL MANUAL

- TM 3-4240-279-10. *Operator's Manual for Mask, Chemical-Biological: Field, ABC-M17 (NSN 4240-00-542-4450) Small; (4240-00-542-4451) Medium; (4240-00-542-4452) Large; M17A1 (4240-00-926-4199) Small; (4240-00-926-4201) Medium; (4240-00-926-4200) Large; M17A2 (4240-01-143-2017); X-Small (4240-01-143-2018); Small (4240-01-143-2019); Medium (4240-01-143-2020); Large*. 5 October 1987.
- TM 3-6665-307-10. *Operator's Manual for Chemical Agent Detector Kit, M256 (NSN 6665-01-016-8399) and M256A1 (6665-01-133-4964)*. (This Item is Included on EM 0045). 1 September 1985.
- TM 3-9905-001-10. *Operator's Manual for Sign Kit, Contamination (NSN 9905-01-346-4716) {TO 11D1-3-10-1}*. (This Item is Included on EM 0045) 23 August 1982.
- TM 9-2320-260-10. *Operator's Manual for Truck, 5-Ton, 6X6, M809 SERIES (Diesel): Truck, Cargo: M813, M813A1 and M814; Truck, Bolster, Logging: M815; Truck, Wrecker, Medium: M816; Truck, Dump: M817; Truck, Tractor: M818; Truck, Tractor, Wrecker: M819; Truck, Van, Expansibile: M820, M820A1 and M820A2 and Truck, Stake, Bridge Transporting: M821 {TO 36A12-1C-481}*, (This Item is Included on EM 0039) 14 June 1985.
- TM 9-2320-272-10. *Operator's Manual for Truck, 5-Ton, 6X6, M939, M939A1, and M939A2 Series Trucks (Diesel), Truck, Cargo: 5-Ton, 6X6 Dropside, M923 (2320-01-050-2084) (EIC: BRY); M923A1 (2320-01-206-4087) (EIC: BSS); M923A2 (2320-01-230-0307) (EIC: BS7); M925 (2320-01-047-8769) (EIC: BRT) M925A1 (2320-01-206-4088) (EIC: BST); M925A2 (2320-01-230-0308) (EIC: BS8); Truck, Cargo: 5-Ton, 6X6 XLWB, M927 (2320-01-047-8771) (EIC: BRV); M927A1 (2320-01-206-4089) (EIC: BSW); M927A2 (2320-01-230-0309) (EIC: BS9); M928 (2320-01-047-8770) (EIC: BRU); M928A1 (2320-01-206-4090) (EIC: BSX); M928A2 (2320-01-230-0310) (EIC: BTM); TRUCK, DUMP: 5-TON, 6X6, M929 (2320-01-047-8756) (EIC: BTH); M929A1 (2320-01-206-4079) (EIC: BSY); M929A2 (2320-01-230-0305) (EIC: BTN); M930 (2320-01-047-8755) (EIC: BTG); M930A1 (2320-01-206-4080) (EIC: BSZ); M930A2 (2320-01-230-0306) (EIC: BTO); Truck, Tractor: 5-Ton, 6X6, Truck, Van, Expansibile: 5-Ton, 6X6, M934 (2320-01-047-8750), M934A1 M931 (2320-01-047-8753) (EIC: BTE); M931A1 (2320-01-206-4077) (EIC: BS2); M931A2 (2320-01-230-0302) (EIC: BTP); M932 (2320-01-047-8752) (EIC: BTD); M923A1; (2320-01-205-2684) (EIC: BS5); M932A2(2320-01- 230-0303)*

(EIC: BTQ); Truck, Van, Expansible: 5-Ton, 6X6, M934 (2320-01-047-8750) (EIC: BTB); M934A1 (2320-01-205-2682) (BIC: BS4); M934A2 (2320-01-230-0300) (EIC: BTR); Truck, Medium Wrecker: 5-Ton, 6X6, M936 (2320-01-047-8754) (EIC: BTF); M936A1 (2320-01-206-4078) (EIC: BS6); M936A2 (2320-01-230-0304) (EIC: BTT) {TO 36A12-1C-441} (Reprinted w/Basic Incl C1) (This Item Is Included on EM 0039), 15 August 1996.

- TM 9-2320-279-10-1. *Operators Manual for M977 Series 8X8 Heavy Expanded Mobility Tactical Trucks (HEMTT), Truck, Cargo, with Winch, M977 (NSN 2320-01-097-0260) Truck, Cargo, with Winch, M977A2 (2320-01-493-3774) Truck, Cargo, with Winch, M977A2R1 (2320-01-493-3782) Truck, Cargo, Without Winch, M977 (2320-01-099-6426) Truck, Cargo, Without Winch, M977A2 (2320-01-493-3779) Truck, Cargo, Without Winch, M977A2R1 (2320-01-493-3785) Truck, Tank, Fuel, with Winch, M978 (2320-01-097-0249) Truck, Tank, Fuel, with Winch, M978A2 (2320-01-492-8216) Truck, Tank, Fuel, with Winch, M978A2R1 (2320-01-492-8226) Truck, Tank, Fuel, Without Winch, M978 (2320-01-100-7672) Truck, Tank, Fuel, Without Winch, M978A2 (2320-01-492-8215) Truck, Tank, Fuel, Without Winch, M978A2R1 (2320-01-492-8225) Truck, Tractor, with Winch, Without Crane, M983 (2320-01-097-0247) Truck, Tractor, with Winch, Without Crane, M983A2 (2320-01-492-8223) Truck, Tractor, with Winch, Without Crane, M983A2R1 (2320-01-492-8231) Truck, Tractor, with Winch, with Crane, M983 (2320-01-099-6421) Truck, Wrecker-Recovery, M984 (2320-01-097-0248) Truck, Wrecker-Recovery, M984A1 (2320-01-195-7641) Truck, Wrecker-Recovery, M984A2 (2320-01-492-8224) Truck, Wrecker-Recovery, M984A2R1 (2320-01-492-8233) Truck, Cargo, with Winch, M985 (2320-01-097-0261) Truck, Cargo, with Winch, M985A2 (2320-01-492-8214) Truck, Cargo, with Winch, M985A2R1 (2320-01-493-3787) Truck, Cargo, Without Winch, M985 (2320-01-100-7673) Truck, Cargo, Without Winch, M985A2 (2320-01-492-8201) Truck, Cargo, Without Winch, M985A2R1 (2320-01-493-3789) Truck, Cargo, with Winch, M985E1 (2320-01-194-7032) Truck, Cargo, with Winch, M985E1A2 (2320-01-493-3790) Truck, Cargo, with Winch, M985E1A2R1 (2320-01-493-3792), (Reprinted w/Basic Incl C1-4) (This Item is Included on EM 0038) 21 November 1986.*
- TM 9-2320-279-10-2. *Operator's Manual for M977 Series, 8X8 Heavy Expanded Mobility Tactical Trucks (HEMTT) Truck, Cargo, with Winch M977 (2320-01-097-0260) Truck, Cargo, with Winch, M977A2 (2320-01-493-3774) Truck, Cargo, with Winch, M977A2R1 (2320-01-493-3782) Truck, Cargo, Without Winch, M977 (2320-01-099-6426) Truck, Cargo, Without Winch, M977A2 (2320-01-493-3779) Truck, Cargo, Without Winch, M977A2R1 (2320-01-493-3785) Truck, Tank, Fuel, with Winch, M978 (2320-01-097-0249) Truck, Tank, Fuel, with Winch, M978A2 (2320-01-492-8216) Truck, Tank, Fuel, with Winch, M978A2R1 (2320-01-492-8226) Truck, Tank, Fuel, Without Winch, M978 (2320-01-100-7672) Truck, Tank, Fuel, Without Winch, M978A2 (2320-01-492-8215) Truck, Tank, Fuel, Without Winch, M978A2R1 (2320-01-492-8225) Truck, Tractor, with Winch, Without Crane, M983 (2320-01-097-0247) Truck, Tractor, with Winch, Without Crane, M983A2 (2320-01-492-8223) Truck, Tractor, with Winch, Without Crane, M983A2R1 (2320-01-492-8231) Truck, Tractor, with Winch, With Crane, M983 (2320-01-099-6421) Truck, Wrecker-Recovery, M984 (2320-01-097-0248) Truck, Wrecker-Recovery, M984A1 (2320-01-195-7641) Truck, Wrecker-Recovery, M984A2 (2320-01-492-8224) Truck, Wrecker-Recovery, M984A2R1 (2320-01-492-8233) Truck, Cargo, with Winch, M985 (2320-01-097-0261) Truck, Cargo, with Winch, M985A2 (2320-01-492-8214) Truck, Cargo, with Winch, M985A2R1 (2320-01-493-3787) Truck, Cargo, Without Winch, M985 (2320-01-100-7673) Truck, Cargo, Without Winch,*

M985A2 (2320-01-492-8201) Truck, Cargo, Without Winch, M985A2R1 (2320-01-493-3789) Truck, Cargo, with Winch, M985E1 (2320-01-194-7032) Truck, Cargo, with Winch, M985E1A2 (2320-01-493-3790) Truck, Cargo, with Winch, M985E1A2R1 (2320-01-493-3792), (Reprinted w/Basic Incl C1-4) (This Item is Included on EM 0038) 15 June 1987.

TM 9-2320-280-10. Operator's Manual for Truck, Utility: Cargo/Troop Carrier, 1-1/4 Ton, 4X4, M998 (NSN 2320-01-107-7155) (EIC: BBD); M998A1 (2320-01-371-9577) (EIC: BBN); Truck, Utility: Cargo/Troop Carrier, 1-1/4 Ton, 4X4, w/Winch, M1038 (2320-01-107-7156) (EIC: BBE); M1038A1 (2320-01-371-9578) (EIC: BBP); Truck, Utility: Heavy Variant, 4X4, M1097 (2320-01-346-9317) (EIC: BBM); M1097A1 (2320-01-371-9583) (EIC: BBU); M1097A2 (2320-01-380-8604) (EIC: BB6); Truck, Utility: Tow Carrier, Armored, 1-1/4 Ton, 4X4, M966 (2320-01-107-7153) (EIC: BBC); M966A1 (2320-01-372-3932) (EIC: BBX); Truck, Utility: Tow Carrier, Armored, 1-1/4 Ton, 4X4, w/Winch, M1036 (2320-01-107-7154) (EIC: BBH); Truck, Utility: Tow Carrier, w/Supplemental Armor, 1-1/4 Ton, 4X4, M1045 (2320-01-146-7191); M1045A1 (2320-01-371-9580) (EIC: BBR); M1045A2 (2320-01-380-8229) (EIC: BB5); Truck, Utility: Tow Carrier, w/Supplemental Armor, 1-1/4 Ton, 4X4, w/Winch, M1046 (2320-01-146-7188); M1046A1 (2320-01-371-9582) (EIC: BBT); Truck, Utility: Armament Carrier, Armored, 1-1/4 Ton, 4X4, M1025 (2320-01-128-9551) (EIC: BBF); M1025A1 (2320-01-371-9584) (EIC: BBV); M1025A2 (2320-01-380-8233) (EIC: BB3); Truck, Utility: Armament Carrier, Armored, 1-1/4 Ton, 4X4, w/Winch, M1026 (2320-01-128-9552) (EIC: BBG); M1026A1 (2320-01-371-9579) (EIC: BBQ); Truck, Utility: Armament Carrier, w/Supplemental Armor, 1-1/4 Ton, 4X4, M1043 (2320-01-146-7190); M1043A1 (2320-01-372-3933); M1043A2 (2320-01-380-8213) (EIC: BB4); Truck, Utility: Armament Carrier, w/Supplemental Armor, 1-1/4 Ton, 4X4, w/Winch, M1044 (2320-01-146-7189); M1044A1 (2320-01-371-9581); Truck, Utility: S250 Shelter Carrier, 4X4, M1037 (2320-01-146-7193) (EIC: BBK); Truck, Utility: S250 Shelter Carrier, 4X4, w/Winch, M1042 (2320-01-146-7187); Truck, Ambulance, 2-Litter, Armored, 4X4, M996 (2310-01-111-2275) (EIC: BBB); M996A1 (2310-01-372-3935) (EIC: BB2); Truck, Ambulance, 4-Litter, Armored, 4X4, M997 (2310-01-111-2274) (EIC: BBA); M997A1 (2310-01-372-3934) (EIC: BBZ); M997A2 (2310-01-380-8225) (EIC: BB8); Truck, Ambulance, 2-Litter, Soft Top, 4X4, M1035 (2310-01-146-7194); M1035A1 (2310-01-371-9585) (EIC: BBW); M1035A2 (2310-01-380-8290) (EIC: BB9), (Reprinted w/Basic Incl C1 (This Item is Included on EM 0030, EM 0034 and EM 0254), 31 January 1996.

TM 9-2320-360-10. Operator's Manual for Truck, Tractor, M1070, 8X8, Heavy Equipment Transporter (HET) (NSN 2320-01-318-9902) (EIC: B5C) (Reprinted w/Basic Incl C1-3), (This Item is Included on EM 0042), 31 March 1994.

TM 9-2320-364-10. Operator's Manual for Truck, Tractor, M1074 AND M1075 Palletized Load System (PLS) (NSN 2320-01-304-2277) (2320-01-304-2278), (This Item is Included on EM 0052 and EM 0206), 30 November 2005.

- TM 9-2320-365-10. *Operator's Instructions Manual for M1078 Series, 2-1/2 Ton, 4X4 Light Medium Tactical Vehicles (LMTV) Trk, Car., LMTV, M1078 w/WN (NSN 2320-01-360-1898) (EIC: BHH) w/o WN (2320-01-354-3385) (EIC: BHD) Trk, Van, LMTV, M1078 w/WN (2320-01-360-1891) (EIC: BHG) w/o WN (2320-01-354-3384) (EIC: BHE) Trk, Chas, LMTV, M1080 (2320-01-353-9098) (EIC: BHC) Trk, Car., LMTV, LVAD, M1081 W/WN (2320-01-360-1899) (EIC: BHJ) w/o WN (2320-01-355-3063) (EIC: BHF), {TO 36A12-1B-1095-1}* (This Item is Included on EM 0122), (This Item is Included on EM 0122), 17 June 1998.
- TM 9-2320-366-10-1. *Operator's Instructions Manual for M1083 Series, 5-Ton, 6X6, Medium Tactical Vehicles (MTV) Volume No. 1 of 2 Trk, Car., MTV, M1083 w/WN (NSN 2320-01-360-1895) (EIC: BT3) w/o WN (2320-01-354-3386) (EIC: BR2) Trk, Car., MTV, w/Matl Hdlg Eqpt (MHE) M1084 (2320-01-354-3387) (EIC: BR3) Trk, Car., MTV, LWB, M1085 w/WN (2320-01-360-1897) (EIC: BT5) w/o WN (2320-01-354-4530) (EIC: BR7) Trk, Car., MTV, LWB, w/Matl Hdlg Eqpt (MHE) M1086 (2320-01-354-4531) (EIC: BR8) Trk, Tractor, MTV, M1088 w/WN (2320-01-360-1892) (EIC: BTY) w/o WN (2320-01-355-4332) (EIC: BTJ) Trk, WKR, MTV, M1089 (2320-01-354-4528) (EIC: BR4) Trk, Dump, MTV, M1090 w/WN (2320-01-360-1893) (EIC: BTZ) w/o WN (2320-01-354-4529) (EIC: BR5) Trk, Chas, MTV, M1092 (2320-01-354-3382) (EIC: BRZ) Trk, Car., MTV, Air Drop, M1093 w/WN (2320-01-360-1896) (EIC: BT4) w/o WN (2320-01-355-3063) (EIC: BR9) Trk, Dump, MTV, Air Drop, M1094 w/WN (2320-01-360-1894) (EIC: BT2) w/o WN (2320-01-355-3062) (EIC: BTK) Trk, Chas, MTV, LWB, M1096 (2320-01-354-4527) (EIC: BR6) {TO 36A12-1C-1091-1}*, (This Item is Included on EM 0122), 15 September 1998.
- TM 9-2320-366-10-2. *Operator's Instructions Manual for M1083 Series, 5-Ton, 6X6, Medium Tactical Vehicles (MTV) Volume No. 2 of 2 Trk, Car., MTV, M1083 w/WN (2320-01-360-1895) (EIC: BT3) w/o WN (2320-01-354-3386) (EIC: BR2) Trk, Car., MTV, w/Matl Hdlg Eqpt (MHE) M1084 (2320-01-354-3387) (EIC: BR3) Trk, Car., MTV, LWB, M1085 w/WN (2320-01-360-1897) (EIC: BT5) w/o WN (2320-01-354-4530) (EIC: BR7) Trk, Car., MTV, LWB, w/Matl Hdlg Eqpt (MHE) M1086 (2320-01-354-4531) (EIC: BR8) Trk, Tractor, MTV, M1088 w/WN (2320-01-360-1892) (EIC: BTY) w/o WN (2320-01-355-4332) (EIC: BTJ) Trk, WKR, MTV, M1089 (2320-01-354-4528) (EIC: BR4) Trk, Dump, MTV, M1090 w/WN (2320-01-360-1893) (EIC: BTZ) w/o WN (2320-01-354-4529) (EIC: BR5) Trk, Chas, MTV, M1092 (2320-01-354-3382) (EIC: BRZ) Trk, Car., MTV, Air Drop, M1093 w/WN (2320-01-360-1898) (EIC: BT4) w/o WN (2320-01-355-3063) (EIC: BR9) Trk, Dump, MTV, Air Drop, M1094 w/WN (2320-01-360-1894) (EIC: BT2) w/o WN (2320-01-355-3062) (EIC: BTK) Trk, Chas, MTV, LWB, M1096 (2320-01-354-4527) (EIC: BR6) {TO 31A12-1C-1091-2}*, (Reprinted w/Basic Incl C1) (This Item is Included on EM 0122), 15 September 1998.
- TM 9-243. *Use and Care of Hand Tools and Measuring Tools {TO 32-1-101; M6290-AJ-MAN-10; TM-10209-10/1}*, (Reprinted w/Basic Incl C1-3) (This Item is Included on EM 0178), 12 December 1983.
- TM 10-8415-209-10. *Operator's Manual for Individual Chemical Protective Clothing. {TM 8415-10/2}*, (This Item is Included on EM 0131), 31 March 1993.
- TM 11-6665-251-10. *Operator's Manual for Radiac Set AN/VDR-2 (NSN 6665-01-222-1425)*, (This Item is Included on EM 0045). 1 March 1988.

- TM 11-6665-365-12&P, *Operator's and Unit Maintenance Manual (Including Repair Parts and Special Tools List) for RADIAC Set AN/PDR-77, (NSN 6665-01-347-6100) (EIC: N/A) (This Item is Included on EM 0045)* 28 February 1995.
- TM 43-0003-30, *Demilitarization Procedures for FSC 5180 Crimping Outfit and Maintenance Kit, FSC 6665 Hazard Detecting Instruments and Apparatus and FSC 6910 - Training Sets, (This Item is Included on EM 0178),* 30 November 1992.

TRAINING CIRCULARS

- TC 3-41, *Protection Assessment Test System (PATS)*, 14 January 1995.
- TC 20-32-5, *Commander's Reference Guide for Land Mine and Explosive Hazards (IRAQ)*, 13 February 2003.
- TC 27-10-1, *Selected Problems in the Law of War*, 26 June 1979.

OTHER PUBLICATIONS

- FORSCOM Reg 55-2, *Unit Movement Data Reporting and System Administration*, 31 October 1997.
- GTA 03-06-008, *NBC Warning and Reporting System*, 1 August 1996.
- STANAG 2154, *Regulations for Military Motor Vehicle Movement by Road*, 19 June 1992.
- STANAG 2155, *Road Movement Bid and Credit*, 26 August 1994.
- TB 55-46-1, *Standard Characteristics (Dimensions, Weight, and Cube) for Transportability of Military Vehicles and Other Outsize/Overweight Equipment (In Toe Line Item Number Sequence), {NAVFAC P-1055}*, 1 January 2002.

RELATED PUBLICATIONS

Related publications are sources of additional information. They are not required to understand this publication.

ARMY REGULATIONS

- AR 40-5, *Preventive Medicine*, 22 July 2005.
- AR 190-8, *Enemy Prisoners of War, Retained Personnel, Civilian Internees and Other Detainees* {OPNAVINST 3461.6; AFJI 31-304; MCO 3461.1}, 1 October 1997.
- AR 385-63, *Range Safety {MCO 3570.1B}*, 19 May 2003.
- AR 190-13, *The Army Physical Security Program*, 30 September 1993.
- AR 190-14, *Carrying of Firearms and Use of Force for Law Enforcement and Security Duties*, 12 March 1993.
- AR 190-45, *Law Enforcement Reporting*, 23 February 2006.
- AR 190-51, *Security of Unclassified Army Property (Sensitive and Nonsensitive)*, 30 September 1993.
- AR 600-8-1, *Army Casualty Program*, 7 April 2006.
- AR 600-13, *Army Policy for the Assignment of Female Soldiers*, 27 March 1992.
- AR 600-20, *Army Command Policy*, 7 June 2006.
- AR 600-63, *Army Health Promotion*, 28 April 1996.
- AR 710-2, *Supply Policy Below the National Level*, 8 July 2005.

DEPARTMENT OF THE ARMY PAMPHLETS

- DA Pam 40-11, *Preventive Medicine*, 22 July 2005.

DA Pam 190-51. *Risk Analysis for Army Property*. 30 September 1993.
DA Pam 350-20. *Unit Equal Opportunity Training Guide*. 1 June 1994.
DA Pam 710-2-1. *Using Unit Supply System (Manual Procedures)*. 31 December 1997.

FIELD MANUALS

FM 2-22.3 (FM 34-52). *Human Intelligence Collector Operations*, 6 September 2006.

FM 3-0. *Operations*. 14 June 2001.

FM 3-19.1. *Military Police Operations (Reprinted w/Basic Incl C1)*, (This Item is Included on EM 0205), 22 March 2001.

FM 3-19.13. *Law Enforcement Investigations*, 10 January 2005.

FM 3-19.15. *Civil Disturbance Operations*, 18 April 2005.

FM 3-19.40. *Military Policy Internment/Resettlement Operations (Formerly FM 19-40)*, (This Item is Included on EM 0205), 1 August 2001.

FM 3-21.10 (FM 7-10). *The Infantry Rifle Company*. 27 July 2006.

FM 3-22.1. *Bradley Gunnery*, (This Item is Included on EM 0205), 28 November 2003.

FM 3-22.68 (FM 23-14). *Crew-Served Machine Guns, 5.56-MM and 7.62-MM (This Item is Included on EM 0205)*, 31 January 2003.

FM 3-22.90. *(O) Mortars*, 31 December 2004.

FM 3-34. *Engineer Operations (This Item is Included on EM 0205)*, 2 January 2004.

FM 3-34-2. *Combined-Arms Breaching Operations (This Item Is Included on EM 0205)*, 31 August 2000. (Will be revised as FM 3-90.11).

FM 4-0. *Combat Service Support*, 29 August 2003.

FM 4-02.17. *Preventive Medicine Services (This Item Is Included on EM 0205)*, 28 August 2000.

FM 4-25.11. *First Aid {NTRP 4-02.1.1; AFMAN 44-163(I); MCRP 3-02G}*, 23 December 2002.

FM 4-25.12. *Unit Field Sanitation Team (FM 21-10-1)*, 25 January 2002.

FM 4-30.51 (FM 21-16). *Unexploded Ordnance (UXO) Procedures {MCRP 3-17.2A}*, 13 July 2006.

FM 6-30. *Tactics, Techniques, and Procedures for Observed Fire (This Item Is Included on EM 0205)*, 16 July 1991. (Will be revised as FM 3-09.30).

FM 8-10-6. *Medical Evacuation in a Theater of Operations Tactics, Techniques, and Procedures (This Item Is Included on EM 0205)*, 14 April 2000. (Will be revised as FM 4-02.2).

FM 8-55. *Planning for Health Service Support (This Item Is Included on EM 0205)*, 9 September 1994.

FM 19-25. *Military Police Traffic Operations*, 30 September 1977. (Will be revised as FM 3-19.25.)

FM 20-32. *Mine/Countermine Operations*, 29 May 1998. (Will be revised as FM 3-34.210.)

FM 22-51. *Leaders' Manual for Combat Stress Control (This Item Is Included on EM 0205)*, 29 September 1994. (Will be revised as FM 6-22.5).

FM 22-100. *Army Leadership (This Item Is Included on EM 0205)*, 31 August 1999 (Will be revised as FM 6-22).

- FM 34-54. *Technical Intelligence*, 30 January 1998. (Will be revised as FM 2-22.4.)
- FM 34-130. *Intelligence Preparation of the Battlefield*, 8 July 1994. (Will be revised as FM 2-01.3/MRCP 2-3A.)
- FM 4-02.4. *Medical Platoon Leaders' Handbook Tactics, Techniques, and Procedures (Formerly FM 8-10-4, 16 Nov 90)*, 24 August 2001.
- FM 100-8. *The Army in Multinational Operations*, 24 November 1997. (Will be revised as FM 3-16.)
- FM 10-27-4. *Organizational Supply and Services for Unit Leaders (This Item Is Included on EM 0205)*, 14 April 2000. (Will be revised as FM 4-20.05.)

FORMS

- DA Form 2401, *Organization Control Record for Equipment*.
- DA Form 2823, *Sworn Statement*.
- DA Form 3881. *Rights Warning Procedure/Waiver Certificate*.
- DA Form 3946. *Military Police Traffic Accident Report*.
- DA Form 3975. *Military Police Report*.
- DA Form 4002. *Evidence/Property Tag*.
- DD Form 1408. *Armed Forces Traffic Ticket (Book, Consisting of 25 Three-Part Sets)*.
- DD Form 1805. *United States District Court Violation Notice*.
- DD Form 1920. *Alcohol Incident Report*.

SOLDIER TRAINING PUBLICATIONS

- STP 19-95B1-SM. *Soldier's Manual for MOS 95B, Military Police Skill Level 1*, 14 January 2003.

TRAINING CIRCULAR

- TC 26-6. *Commander's Equal Opportunity Handbook*. 14 October 1994.

TECHNICAL MANUAL

- TM 3-4240-279-20&P. *Unit Maintenance Manual (Including Repair Parts and Special Tools List) for Mask, Chemical-Biological; Field, ABC-M17 (NSN 4240-00-542-4450), (Small), (4240-00-542-4451), (Medium) and (4240-00-542-4452), (Large); M17A1 (4240-00-926-4199), (Small), (4240-00-926-4201), (Medium) and (4240-00-926-4200) (Large) and M17A2 (4240-01-143-2017), (X-Small), (4240-01-143-2018), (SMALL), (4240-01-143-2019), (Medium) and (4240-01-143-2020), (Large) (Reprinted w/Basic Incl C1-3) (This Item is Included on EM 0045)*. 5 October 1987.
- TM 5-853-1. (O) *Security Engineering Project Development {AFMAN 32-1071, VOL 1}*, 12 May 1994.

OTHER PUBLICATIONS

Center for Health Promotion & Preventive Medicine (CHPPM) Tobacco

Note: CHPPM publications are at

<http://www.hooah4health.com/4you/stoptobaccoshop/default.htm?f=targeting.htm>

DODD 7050.6. *Military Whistleblower Protection*. 23 June 2000.

FMI 3-34.119. *Improvised Explosive Device Defeat (Expires 21 September 2007)* {MCIP 3-17.01}. 21 September 2005.

FORSCOM Reg 55-1. *Unit Movement Planning*. 1 June 2006.

Note. FORSCOM publications are at <http://www.forscom.army.mil/pubs/>

GTA 09-12-001. *Unexploded Ordnance (UXO) Procedures*. 3 January 1992.

IMAS 08.20. *Technical Survey*, 1 January 2003.

IMAS 08.30. *Post-Clearance Documentation*, 1 January 2003.

IMAS 09.10. *Clearance Requirements*, 1 January 2003

IMAS 09.20. *The Inspection of Cleared Land Guidelines for the Use of Sampling Procedures*, 1 January 2003.

IMAS 09.30. *Explosive Ordnance Disposal*, 1 January 2003.

IMAS 09.40. *Guide for the Use of Mine Detection Dogs*, 1 August 2005.

MCM. *Manual for Courts-Martial*. 1 July 2005

Note: This publication can be found at https://akocomm.us.army.mil/usapa/epubs/27_Series_Collection_1.html

USACHPPM Technical Guide (TG) 240, *Combat Stress Behaviors*.

USACHPPM TG 241, *Combat & Operational Stress Reactions*.

USACHPPM TG 242. *Battle Fatigue/Combat Stress Reaction Prevention: Leader Actions*.

Note: TGs may be found at <http://chppm-ww.apgea.army.mil/dhpw/>

This page intentionally left blank.

Order of the Secretary of the Army:

**PETER J. SCHOOMAKER
General, United States Army
Chief of Staff**

Official:

A handwritten signature in black ink that reads "Joyce E. Morrow". The signature is written in a cursive style with a large initial 'J' and 'M'.

**JOYCE E. MORROW
Administrative Assistant to the
Secretary of the Army
0627603**

DISTRIBUTION:

Active Army, Army National Guard, and U.S. Army Reserve: Distribute in accordance with the initial distribution number IDN 114379, requirements for STP 21-24-SMCT.

This page intentionally left blank.

WARRIOR ETHOS

The Warrior Ethos forms the foundation for the American Soldier's spirit and total commitment to victory, in peace and war, always exemplifying the ethical behavior and Army Values. Soldiers put the mission first, refuse to accept defeat, never quit, and never leave behind a fellow American. Their absolute faith in themselves and their comrades makes the United States Army invariably persuasive in peace and invincible in war.

PIN: 065276-000