

Library  
OF

• • • Harry T. Cory • • •

No. 235

UNIVERSITY OF CALIFORNIA  
AT LOS ANGELES

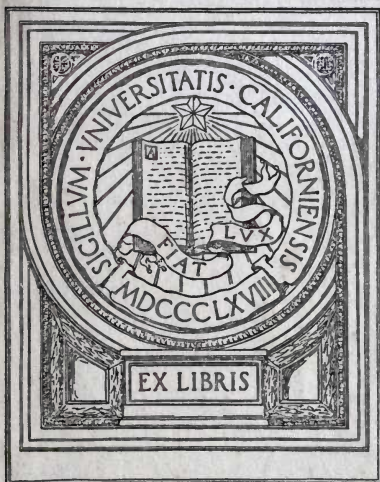

EX LIBRIS







THE  
Steam Engine and the Indicator:

THEIR ORIGIN AND PROGRESSIVE DEVELOPMENT;

INCLUDING THE

MOST RECENT EXAMPLES OF STEAM AND GAS MOTORS,

TOGETHER WITH

THE INDICATOR, ITS PRINCIPLES, ITS UTILITY,  
AND ITS APPLICATION.

BY

WILLIAM BARNET LE VAN,

MEMBER OF THE FRANKLIN INSTITUTE AND OF THE AMERICAN SOCIETY OF  
MECHANICAL ENGINEERS.

Illustrated by 205 Engravings chiefly of Indicator-Cards.

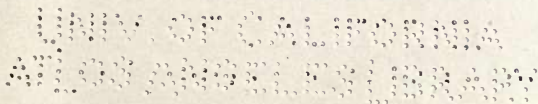

PHILADELPHIA:

HENRY CAREY BAIRD & CO.,

INDUSTRIAL PUBLISHERS, BOOKSELLERS, AND IMPORTERS,  
810 WALNUT STREET.

LONDON:

E. & F. N. SPON, 125 STRAND.

1892.

---

Copyright by  
WILLIAM BARNET LE VAN,  
1889.

---

WILLIAM BARNET LE VAN  
1889

PRINTED AT  
COLLINS PRINTING HOUSE,  
PHILADELPHIA, U. S. A.



TJ  
465  
L57a

## PREFACE.

---

15 12-15-80  
THE author has endeavored, in the following pages, to explain how, economically, to make use of steam in an engine, and has also discussed the most important principles regarding the *theory and action* of the steam engine, with a fair degree of technicality; and yet so as to be intelligible to the ordinary student. He has made an attempt to state the principles laid down by theoretical writers:—Clausius, Tyndall, Rankine, Clark, Maxwell, Colburn, Northcott, Graham, Nystrom, and others, in such a form as to be useful to practical engineers, and to test, by these principles, the modes of working which have been found, in practice, most advantageous.

The early chapters refer especially to the history of the steam engine, and to the theory of the action of steam in the cylinder of a steam engine, and the succeeding ones to the application of the theory in practice.

Copy Lib  
Having felt personally the want of more practical information on the subject than is contained in existing works, it has been the aim of the writer to supply such want, and to enable those who have not the opportunity of making experiments to gain a more intimate knowledge of THE INDICATOR. And it is hoped that the directions here given for the practical application of this instrument will at the same time give the volume a considerable degree of interest to those engineers who are conversant with its ordinary working, but lack a knowledge of the principles involved.

He gladly acknowledges the assistance afforded by the practical treatises of Main and Brown, Stillman, Porter, Salter, Graham, and others, the Engineering periodicals, and above all, by the late John W. Nystrom, who kindly furnished him with a copy of his new tables on the properties of Water and Steam, and also with considerable matter bearing on the Indicator.

He is also under obligations to Messrs. Egbert P. Watson &

(iii)

210961

Son, publishers of *The Engineer*, New York, for the use of indicator cuts.

He has had an experience of over thirty years with the Indicator, and the majority of the diagrams here given were taken by himself.

The tables given in the volume, will be found very useful. By their means almost all calculations connected with the use of *steam* may be solved by any one who is acquainted with the first four rules of arithmetic.

WILLIAM BARNET LEVAN.

*Philadelphia, July 25, 1889.*

*3607 Baring Street.*

# CONTENTS.

## CHAPTER I.

### INTRODUCTION.

|  | PAGE |
|--|------|
| What the steam engine is; Work done by the steam; Physical constitution of heat; What heat is the product of . . . . .         | 17   |
| Dynamics; Definition of dynamics; Principles of the dynamical branch of mechanics; Various uses of the term "energy" . . . . . | 18   |
| Energy, proper definition of . . . . .   | 19   |

## CHAPTER II.

### WHO INVENTED THE STEAM ENGINE?

|  |    |
|--|----|
| Translation of Hero's book by Bennet Woodcroft; Hero not an inventor, but the power of steam was understood in his time; First steps in the invention; Hero's fountain and other ingenious machines . . . . .  | 20 |
| Ignorance of the inventors in ancient times of the principles governing the action of such machines, and of the true nature of steam; Loss of knowledge and progress by reason of the false methods and philosophy of the ancients; The aeolipile described by Vitruvius . . . . .   | 21 |
| The aeolipile, illustrated and described; Illustration of a similar apparatus described by Hero . . . . .  | 22 |
| Use of the pressure of vapors by the Egyptian priests in their mysteries; Giovanni Batista Porta's translation of Hero's "Spiritalia," with additional description of apparatus; Magic lantern and camera obscura said to be inventions of Porta . . . . .   | 23 |
| Porta's machine for raising water by steam pressure illustrated and described; Porta's description of the action of condensation in producing a vacuum . . . . .   | 24 |
| The first recorded notice of the power of steam as shown by an apparatus used by Athemius A. D. 540; Exhibition of a boat propelled by steam at Barcelona, June 17, 1543, by Glasco de Garoy; Description of a machine for raising water by the expanding power of steam by Salomon de Caus, 1615; General knowledge of the expansive properties of steam before the 17th century; The actual steam engine an invention of the 17th century; First application of steam power on a large scale by the Marquis of Worcester about A. D. 1650, and description of his apparatus. | 25 |
| Apparatus invented, in 1697, by Savery, used for raising water at Vauxhall, London, and at Raglan Castle; No real progress in the knowledge or apprehension of the fundamental principles of steam from Archimedes   |    |

|   |    |
|---|----|
| to De Caus; Commencement of real progress with the appearance of men like Descartes, Kepler and Galileo; Weight and pressure of the atmosphere proved, in 1643, by Torricelli . . . . .   | 26 |
| Otto von Guericke's air-pump and hemispheres; Comparison of progress before and after the 17th century; Pascal's rejection and final acceptance of Torricelli's position; His experiment, September 20, 1646, on the summit of the Puy de Dome, at Clermont . . . . .   | 27 |
| Torricelli's experiments and Guericke's invention of the air-pump the true germ of the steam engine; Difference in the significance between Torricelli's tube and the aeolipile and other previous ingenious devices; First suggestion, in 1690, by Papin, of the condensation of steam for the production of a vacuum; Extent of contraction of steam under ordinary pressure . . . . .  | 28 |
| Recognition of the advantages of the use of steam by Papin; The "atmospheric engine" the first engine the principles of whose action are comprehended; Papin's manner of condensing steam and forming a vacuum applied, in 1698, by Savery; Defects of Savery's engine; Application of the cylinder and piston to the purposes of steam power, in 1705, by Newcomen and Cawley, of Dartmouth, England; Description of their engine . . . . .                              | 29 |
| Savery's engine an "atmospheric engine;" Accidental discovery of jet condensation; Origin of the "plug frame" and valve gear of to-day due to a device of the boy Humphrey Potter . . . . .   | 30 |
| First attempts in America to propel boats by steam made by John Fitch of Windsor, Conn., and James Rumsey of Maryland; Successful invention and construction of a steamboat, in 1789, by Nathan Read of Western (now Warren), Mass. . . . .   | 31 |
| Invention and construction by Mr. Read of a portable furnace tubular boiler, and application by him, Feb. 8, 1790, for a patent on a locomotive steam carriage; Mr. Read's various discoveries as set forth by a recommendation from a select committee of the American Academy of Arts and Sciences; Mr. Read's just claims to being the original inventor of the successful application of steam power for locomotion compared with those of his predecessors . . . . . | 32 |
| Historical data in reference to the application of steam power for pumping engines; Catalogue of Watt's discoveries; "Jet condenser" and "surface condenser" . . . . .  | 33 |
| The "real steam engine" as distinguished from the "ideal engine;" "Cylinder condensation;" "Indicator;" "Fly-ball governors;" "Copying press" . . . . .   | 34 |
| The laws which are the key to the whole problem of converting the work of combustion into dynamic power, discovered by Watt; Cornish pumping engines and explanation of a "hundred millions of duty" . . . . .  | 35 |
| Further historical data in reference to the application of steam power for locomotion prior to Mr. Read; The successful use of steam as a propelling power in navigation rendered possible by the invention of the rotary steam engine by Watt, and of the tubular boiler by Read . . . . .   | 36 |
| General Stevens's experiments in steam navigation; the invention of the   |    |

|   | PAGE |
|---|------|
| tubular boiler erroneously attributed to him; Chancellor Livingston's projects with steam on the Hudson; Fulton's first attempt at steam navigation; Launch and first successful trip of the "Clermont;" First steamship to cross the ocean . . . . . | 37   |
| The "Savannah" the first steamship ever built to cross the ocean; Announcement of the intended attempt in the London <i>Times</i> , May 11, 1819; Ludicrous declaration of a distinguished scientist . . . . .  | 38   |
| The American steamer regarded with suspicion by the English authorities.  | 39   |
| The Savannah at Copenhagen, Stockholm and St. Petersburg; Loss of the Savannah . . . . .  | 40   |
| Lesson taught by the steam engine; Tribute to Watt . . . . .  | 41   |

## CHAPTER III.

## HEAT AND WORK.

|   |    |
|---|----|
| Materiality of heat discredited by the earliest philosophers; Rumford's, Mayer's and Joule's experiments; Dynamical value or mechanical equivalent of heat; Science of thermodynamics; Consumption of coal per hour per horse power, of a condensing engine . . . . . | 42 |
| Units of heat generated by a pound of carbon; What an indicated horsepower means; Water; Investigations of water by Priestley, Cavendish and Lavoisier . . . . .  | 43 |
| Specific gravity of ice; Latent heat of liquefaction; Maximum density of water; Vaporization of water; Dalton's experimental results on evaporation below the boiling temperature . . . . .   | 44 |
| Boiling point of water; Vaporous condition of water; Temperature of the gaseous state of water; Specific heat of water; Boiling . . . . .   | 45 |
| Philosophy of boiling and generation of steam; Saturated and superheated steam . . . . .  | 46 |
| Steam; Definition of steam; Quantity of heat required to convert a given quantity of water at 212° F. into steam . . . . .  | 47 |
| Various conditions of water; Density of steam; Specific gravity of steam; Weight of air, steam and water . . . . .  | 48 |
| Atmospheric pressure; Measurement of pressure; Vapors; Definition of vapor; Liquefaction of solids; Formation of vapors . . . . .   | 49 |
| Saturated and unsaturated vapors; Coefficient of expansion of superheated steam; Steam or aqueous vapor; Evaporation of water; Circumstances on which the weight of water evaporated depends . . . . .  | 50 |
| Temperature of the boiling point, on what it depends; Ideal zero of aqueous vapor; Latent heat of steam; Explanation of latent heat . . . . .   | 51 |
| Work accomplished by latent units of heat; Volume of water; Latent and total heat in water from 32 degrees . . . . .  | 52 |
| Temperature of boiling liquid; Condensation of steam; Wet and dry steam; Throttling of steam . . . . .  | 53 |
| Low and high pressure steam; Proper terms for engines; Absolute pressure; Ways of expressing the elastic force of steam; Effect due to vacuum . . . . .   | 54 |
| Measurement of absolute pressure of steam; Steam gages and vacuum   |    |

|  | PAGE |
|--|------|
| gages; Difference between a non-condensing and condensing engine; Explanation of absolute or total pressure . . . . .  | 55   |
| Latent heat and the heat of chemical combination; Explanation of latent heat of water and of steam; Units; Difficulty of the exact determination of the equivalent values of units . . . . . | 56   |
| Unit of work or power; Unit of elasticity; Unit of temperature; Unit of heat . . . . .   | 57   |
| Specific heat of a body; Unit of specific gravity; Expansion; Rate of expansion . . . . .  | 58   |

## CHAPTER IV.

### EXPANSION.

|  |    |
|--|----|
| Increase in efficacy by cutting off the steam; Expansion of steam; Law of expansion . . . . .  | 59 |
| "Full stroke;" Gain and losses from expansion; The action of expanding steam exemplified; Pushing or lifting power of one cubic inch of water wholly evaporated to steam . . . . .   | 60 |
| Utmost power to be got out of a steam engine without a cut-off; The law of expansion, discovered by James Watt, exemplified . . . . .  | 61 |
| The most economical point of cut-off; Considerations which modify the result of expansion; Determination of the lowest final pressure in non-condensing engines; Lowest advantageous final pressure; Highest advantageous rates of expansion . . . . .                           | 62 |
| Percentage of the heat used which is converted into work by steam engines; Cause of loss of heat; Action and work of expanding steam; Exemplification of no cut-off, cut-off at half stroke, and cut-off one-fourth of the stroke, with theoretical indicator diagrams . . . . . | 63 |
| Mean pressure, how calculated; Ratio, or grade of expansion, how calculated . . . . .  | 67 |
| Hyperbolic logarithms; Table for hyperbolic logarithms for numbers up to 39 . . . . .  | 68 |
| Table of hyperbolic logarithms running from 1.11 up to $\frac{1}{10}$ ; Expansion of steam and its effects with equal volumes of steam . . . . .   | 69 |
| Mode of calculating the expansion; Most convenient way of calculating the horse power of an engine . . . . .   | 70 |
| Gain by using steam expanding three-fourths of the stroke . . . . .  | 71 |
| "Indicator coefficient" of the engine; Other valuable effects of expansion; Action of steam when expanded; Action of saturated steam in the cylinder; Nature of the curve described by the pencil of an indicator . . . . .  | 72 |
| Table of initial and mean effective pressure in the cylinder; Expansion diagram of steam in a cylinder, illustrated . . . . .  | 73 |
| Manner of finding the mean pressure for any intermediate point of the stroke . . . . .   | 74 |
| The theoretical gain by the expansion of steam; Rule for finding the increase of efficiency from using steam expansively . . . . .   | 75 |
| Rule for finding the terminal pressure; Saving in fuel by expansion . . . . .  | 76 |
| Rule for computing the gain in fuel . . . . .  | 77 |

|  | PAGE |
|--|------|
| Terminal pressure; Rule for finding the pressure at the end of the stroke; Losses of steam by "wire-drawing," condensation, friction, etc.; Increase in knowledge by the improvement in the power of measurement; The indicator, and reading of an indicator diagram . . . . . | 78   |
| Expansion curves of indicator diagrams; What the actual card from an engine indicates; Variations in the form of diagrams; Indication of leakage by the expansion curve; Precautions necessary in indicating an engine .   | 79   |

## CHAPTER V.

## THE INDICATOR.

|   |    |
|---|----|
| Use and value of the indicator; Ignorance of many manufacturers of what power is yielded by their engine; Consumption of coal per hour per horse power by a good engine . . . . .                                     | 80 |
| Large engines more economical than small engines; Evaporative efficiency of the boiler; Defects in the machinery which can be discovered by means of the indicator; Comparison of the indicator with the stethoscope. | 81 |
| Principle of, and construction of the indicator . . . . .   | 82 |
| The best forms of indicator; The use which can be made of a card or diagram taken from a steam engine; The simplest example of an expenditure of power . . . . .  | 83 |
| Attraction of gravity as a general standard of resistance . . . . .   | 84 |

## CHAPTER VI.

## THE ACTION OF STEAM IN THE CYLINDER OF AN ENGINE.

|   |    |
|---|----|
| Operation of the steam in the cylinder; Nature of the process . . . . .   | 85 |
| Falling pressure the result of "wire-drawing" of the steam; Discharge of the steam from the cylinder; Interpretation of the term "vacuum"; Pressures to be considered in regard to the quantity of work of steam and its efficiency in the steam engine . . . . . | 86 |
| Events which take place in supplying an engine with steam . . . . .   | 87 |
| "Distribution" and "periods of distribution"; The action of steam in the cylinder as shown by the indicator diagrams; Function and utility of the indicator, with diagram illustrating the same . . . . .   | 88 |
| Engine power; Manner of ascertaining what power an engine is exerting, exemplified and illustrated by indicator diagram . . . . .   | 90 |
| Rule for finding the foot pounds raised per minute . . . . .  | 92 |

## CHAPTER VII.

## HORSE-POWER.

|   |    |
|---|----|
| Definition of the real horse-power; Means of raising ore in use by the early English miners; Use of horses for pumping by London brewers; Horse-power of a steam engine; Origin of the term "horse-power;" The real horse-power according to the experiments of Smeaton . . . . . | 94 |
| Watt's experiments to determine a horse-power; The unit of power expressing a horse-power . . . . .   | 95 |

Watt's method of calculating the power of his engine; What the term "horse-power" meant when first used, and what it now means . . . . . 96

"Nominal horse-power;" Distinction between nominal and actual horse-power; Confusion between the terms nominal and commercial as applied to the horse-power of engines . . . . . 97

Definition of work; Definition of power; Measurement of the work done by a force; Man-power; Equivalence of man-power as established by Morin . . . . . 98

Foreign terms and units for horse-power; Rule for finding the absolute horse-power of a steam engine . . . . . 99

Definition of "duty"; Common practice of estimating the performance of an engine; Duty of an engine in foot pounds which produces a horse-power by the consumption of one pound of coal per hour per horse-power. 100

Successive improvements in the steam-engine traced by the progress made in the economy of fuel; Units of heat developed in the combustion of one pound of ordinary coal . . . . . 101

Horse-power by the indicator; Manner of obtaining the indicated horse-power of an engine; Definition of *horse-power constant*, and how found; Example of computing the horse-power exerted in a diagram from the cylinder of a Corliss engine, with illustration . . . . . 102

Manner of calculating the indicated horse-power; "Piston displacement," what it is . . . . . 103

Measurement of the power required by a single machine among many running in a factory . . . . . 104

Manner of ascertaining the mean pressure of the indicator card; How to divide a line into a number of equal spaces, with illustrations . . . . . 105

The planimeter, with illustration . . . . . 107

Directions for using the planimeter, with illustration . . . . . 108

Economical and wasteful engine diagrams (See Figs. 14 and 15) . . . . . 110

How to calculate the diagram of a condensing engine . . . . . 113

Indicated horse-power; Effective horse-power; Engine friction; Percentage of friction . . . . . 114

Reduction of gross power to effective motive power; Variations in the effective motive power; Back-pressure in engines, with illustration . . . 115

Diagram showing excessive back-pressure . . . . . 116

Impossibility of obtaining a perfect vacuum in practice; Ways in which an approximation to a vacuum is effected; Power expended in removing air from the water used for steam engine purposes . . . . . 117

Pressure of the atmosphere; Table of mercury in pounds and vacuum in inches; Object of knowing the exact pressure of the atmosphere; Difference in the vacuum shown by the indicator and the vacuum gage . . . . 118

Vacuum gage; Construction of vacuum gages; Manner of drawing the line of perfect vacuum and that of the boiler pressure on diagrams representing condensing engines; Variation of the line of perfect vacuum in its distance from the atmospheric line . . . . . 119

How to find the mean pressure above the atmosphere during the stroke, the mean average pressure per square inch, and the gross indicated horse-power exerted; The strictly accurate mode of measurement . . . . . 120



|  | PAGE |
|--|------|
| Manner of drawing the line of boiler pressure on diagrams for non-condensing engines; Manner of ascertaining the mean pressure in non-condensing engines; Mode of calculating, on stationary engines, the power shown by the frictional diagrams . . . . . | 121  |
| Manner of ascertaining the power required in non-condensing engines to overcome the resistance of the atmosphere . . . . .   | 122  |
| Necessity of obtaining the average diagram . . . . .   | 123  |

## CHAPTER VIII.

### DIAGRAMS SHOWING THE ACTION OF STEAM IN A STEAM-ENGINE CYLINDER.

|  |     |
|--|-----|
| The best test of the efficiency of the engine; The action of steam in the cylinder; An ideal diagram and manner of obtaining it, with illustration.  | 124 |
| The atmospheric line; The line of perfect vacuum, illustrated by a diagram.  | 125 |
| The line of boiler pressure; The clearance line . . . . .  | 126 |
| The best method of calculating the clearance; Division of the outline drawn by the instrument during a revolution of the engine . . . . .  | 127 |
| Admission line; The steam line; On what the maintenance of a proper steam pressure in the cylinder depends . . . . .   | 128 |
| Importance of the steam line traced by the indicator running in a horizontal direction; Good results obtained with the Corliss and Buckeye valves; The point of cut-off; The expansion curve; Definition of an equilateral hyperbola; Difference between the true ratio of expansion and the corresponding pressures . . . . . | 129 |
| The effect of leakage in altering the actual expansion curve; Influences affecting the mean temperature of the cylinder . . . . .  | 130 |
| Relative effect of the various degrees of expansion and of speed; The point of release or opening of the exhaust-port; A loss of work involved in the non-release of the steam before the end of the stroke . . .  | 131 |
| The exhaust line; Means of getting rid of the pressure of steam before the piston commences its return stroke; Insurance of the greatest amount of work . . . . .  | 132 |
| Back-pressure, or line of counter-pressure; Pressure of condensation; Cause of the pressure in the condenser . . . . .   | 133 |
| The principal cause of increased back pressure; Variation in the excess of the back pressure over the atmospheric pressure in non-condensing engines . . . . .   | 134 |
| The back-pressure line; Back pressure in diagrams from non-condensing and from condensing engines; Size of the passages and pipes communicating with the atmosphere . . . . .  | 135 |
| The point of exhaust closure; The line of compression or cushioning; The most advantageous adjustment of compression; Indication of an excess of compression . . . . .   | 136 |
| Beneficial effects of the proper regulation of compression . . . . .   | 137 |
| No loss of efficiency by compression . . . . .   | 138 |
| Lead, what it means; Definition of the <i>lead of a valve</i> ; Outside and inside lead . . . . .  | 139 |

|   |     |
|---|-----|
| Lead allowed by the Baldwin Locomotive Works; Regulation of the steam admission by lead and compression . . . . .   | 140 |
| The mean effective pressure; The terminal pressure; The initial pressure . . . . .  | 141 |
| Initial expansion; Wire-drawing and throttling . . . . .  | 142 |
| Loss due to wire-drawing; Cause of wire-drawing or lamination of steam; The ordinary throttling governor not economical in fuel; Wire-drawing less in locomotive engines than in throttling engines . . . . . | 143 |
| Improvement in the economy in performance of the locomotive; Avoidance of wire-drawing by modern automatic cut-off valve arrangements; Wire-drawing and throttling accompanied by direct loss . . . . .       | 144 |
| Undulations, or waviness of the expansion line, with illustrations . . . . .  | 145 |
| Great value of the wavy lines; Means of diminishing the extent of the undulations; Manner of determining the area; Effect of friction in indicators . . . . .   | 146 |
| The expansion curve of indicator diagrams; Causes of variations in diagrams; Precautions required in indicating an engine . . . . .   | 147 |

## CHAPTER IX.

### CORRECT INDICATOR DIAGRAMS.

|   |     |
|---|-----|
| Essentials for the correctness of indicator diagrams; Method to obtain the reducing motion of the piston . . . . .  | 148 |
| The proper place to attach the indicator; Advantage of employing two indicators . . . . .   | 149 |
| Precautions in applying the cylinder; Advisability of the repeated retracing of diagrams; Difficulty in taking indicator diagrams from engines running at over 300 revolutions per minute . . . . . | 150 |
| Facts in regard to which the diagrams will testify; Length of indicator diagrams . . . . .  | 151 |
| The correctness affected by long cards; The record obtained by the indicator; Indicator diagrams and manner of taking them from one end of the cylinder, with illustrations . . . . .               | 152 |
| Gross indicated horse power, how obtained . . . . .   | 154 |
| Diagram from a Corliss engine, 8 inches diameter, 24 inches stroke, and 90 revolutions . . . . .  | 155 |
| Manner of taking a diagram from the other or both ends of the cylinder; Use of the indicator for showing the condition of the engine, with illustration . . . . .                                   | 156 |
| Determination between nominal, indicated and effective horse power, by the use of the indicator . . . . .   | 158 |
| Data for ascertaining the power exerted by the steam engine furnished by the indicator; The geometry of the indicator diagram . . . . .   | 159 |
| Back-pressure; Cause of the mean back-pressure exceeding the pressure of condensation . . . . .   | 160 |
| Gain of mean effective pressure with a condensing engine over that of a non-condensing engine . . . . .   | 161 |

## CHAPTER X.

## STEAM EXPANSION CURVES OR PRESSURE OF STEAM IN CYLINDER.

|   |     |
|---|-----|
| Discrepancy between the theoretical curves of expansion and the actual expansion line drawn by the indicator explained . . . . .  | 162 |
| Difference between gases and vapors; Relationship between the pressure and the volume of a gas as established by Boyle and Mariotte, explained and illustrated . . . . .  | 163 |
| Conditions under which Boyle's and Mariotte's law holds good with all gases . . . . .   | 164 |
| Causes of the fall and rise of the expansion curve drawn by the indicator, below and above the theoretical expansion curve, with illustration . . .   | 165 |
| The true cause of a higher terminal pressure in cylinders using steam more expansively than the law of the expansion of gases can account for . .   | 166 |
| Effect due to a leaky piston and exhaust valve, with illustration; <i>Isothermic</i> or <i>hyperbolic</i> and <i>adiabatic</i> curves . . . . .   | 167 |
| The greatest quantity of work obtained in practice from a given quantity of heat; The theoretical diagram with expansion curves produced under the different conditions . . . . .   | 169 |
| The theoretical diagram representing the theoretical curve of expansion; How the total amount of work done during one stroke is represented in every diagram . . . . .  | 170 |
| Representation of the value of the work wasted, with illustrations . . . .  | 171 |
| Confused notions resulting from the inexact use of language as regards the upper and lower lines of the diagram; What the real lower line of the diagram is; How a correct and complete diagram of the pressure on that side of the piston upon which the steam is admitted is obtained, with illustrations . . . . . | 172 |
| Diagram representing the pressure exerted by the exhaust steam and atmosphere to oppose the return of the piston . . . . .  | 173 |
| Diagram showing the total opposing forces . . . . .   | 174 |
| Method of drawing the diagram showing the total opposing forces; The relation between the pressure and volume of saturated steam, as shown by the indicator diagram . . . . .   | 175 |
| Nature of saturated steam; Great value of a curve expressing the relation between the pressure and volume in interpreting the diagrams given by an indicator; Definition of "specific volume" or "relative volume" . .  | 176 |
| Table of temperature and corresponding pressure of saturated steam; Deviation in the form of the curve expressing the relation between the pressure and the volume from Boyle's and Mariotte's law . . . . .  | 177 |
| C. Cowper's diagram of the expansion of saturated steam, with illustration.   | 178 |
| Diagrams presenting a summary of successive improvements in the steam engine . . . . .  | 179 |
| Clearance; What is meant by clearance; The effect of clearance . . . .  | 181 |
| Reason why the terminal pressure as shown by an indicator diagram is usually very much higher than it would be found according to rule . . . .  | 182 |

|  | PAGE |
|--|------|
| Modification of the diagram required for its completion, with illustration . . . . .                                     | 183  |
| Reduction of loss from clearance . . . . .   | 184  |
| Principles which always hold good; Effect of too much clearance on the diagram, with illustration . . . . .              | 185  |
| The expansion curve; Application of the Mariotte, or Boyle, curve to the expansion of steam, with illustration . . . . . | 187  |
| Application of a hyperbola to a diagram . . . . .  | 188  |

## CHAPTER XI.

### COMPARATIVE INDICATOR DIAGRAMS.

|  |     |
|--|-----|
| Standard for comparing engines; Total clearance in the ordinary commercial steam-engine; Manner of calculating the clearance . . . . .   | 189 |
| Mode of constructing a theoretical diagram, with illustration . . . . .  | 191 |
| The advantage of variable automatic expansion; Means of ascertaining the increase of economy which can be gained in an automatic cut-off engine. . . . .   | 194 |
| Ideal expansion diagram; The further advantage of variable expansion and condensing; Secret of economy in using steam expansively . . . . .  | 195 |
| Minimum saving by automatic cut-off condensing engines . . . . .   | 196 |
| Explanation of the diminished efficiency of the throttling-engine; The theoretical diagram: how to construct it geometrically, with illustration . . . . .   | 197 |
| How to lay out the hyperbolic curve from the point of cut-off, with illustration . . . . .   | 199 |
| How to fix the clearance line when not known; The disadvantage of too large an engine . . . . .  | 200 |
| How a direct loss occurs in the non-condensing engine, with illustration . . . . .   | 201 |
| What the work of an engine for its economical use should be; Diagram from an automatic cut-off engine . . . . .  | 203 |
| Condensation in steam-engine cylinders; Heating power of one pound of carbon, and units of heat it is capable of imparting; Difference in the amount of heat taken up by different substances; Definition of "specific heat" . . . . . | 204 |
| Explanation of the unsatisfactory results of high expansive working . . . . .  | 205 |
| Varying temperature of the cylinder . . . . .  | 206 |
| The value of short strokes and high rotative speeds . . . . .  | 207 |

## CHAPTER XII.

### STEAM-JACKETS.

|  |     |
|--|-----|
| The steam-jacket first used by Watt; Principle of the steam-jacket; Conditions of the steam-cylinder in practice . . . . . | 208 |
| The use of an entirely unprotected cylinder wrong and wasteful, with illustration . . . . .                                | 209 |
| Causes of loss in a steam-engine unprotected by a steam-jacket, with illustrations . . . . .                               | 210 |
| The expansion curve of steam in an imperfectly protected cylinder, with illustration . . . . .                             | 212 |
| Condition of the steam in cylinders covered with non-conducting material. . . . .  | 213 |

|   | PAGE |
|---|------|
| Alternate heating and cooling of a cylinder covered with non-conducting material, and Watt's endeavor to eliminate it; The action of the cylinder on the steam . . . . .  | 214  |
| Erroneous opinion of many engineers regarding the steam-jacket; Especial use of the steam-jacket in the expansive engine . . . . .  | 215  |
| Indicator diagram from an expansive engine with a non-jacketed cylinder.  | 216  |
| Indicator diagram from an expansive engine with a jacketed cylinder . . .   | 217  |
| Facts upon which the utility of steam-jacketed cylinders is based . . . . .   | 218  |
| Extension of the use of the steam-jacket; Disadvantages of jacketing with exhaust steam; Supply of steam to the jacket; How the walls of the cylinder may be kept nearly as hot as the entering steam . . . . .                                 | 220  |
| Diagram from an engine with a steam-jacket over the ends and sides; Loss from condensation prevented by the use of a steam-jacket . . . . .   | 221  |
| Work performed by the steam in the jacket; Saving in the efficiency of steam with jacketed cylinders; Actual loss from expanding steam in an unjacketed cylinder; Advisability of the use of a jacket in the absence of super-heating . . . . . | 222  |
| Necessity of the jacket being distinct from the cylinder; Reason why the utility of the steam-jacket is often called in question . . . . .  | 223  |

## CHAPTER XIII.

### VARIETIES OF STEAM-ENGINES.

|   |     |
|---|-----|
| Various modes of classing engines . . . . .   | 224 |
| Condensing engines; Condenser; Function of the condenser; Necessity of condensation for very early engines . . . . .  | 225 |
| The exact relation of the condenser; Jet condenser; Extent of the vacuum created in the condenser; Capacity and temperature of the condenser . . . . .  | 226 |
| Surface condensation; Results of experiments on marine engines using surface condensation; Removal of water from the condensers . . . . .   | 227 |
| Increase in the economical power of an engine by a good condenser; Cause of the efficiency of condensers . . . . .  | 228 |
| Advantages of employing an independent condensing apparatus; Amount of injection water required and loss resulting therefrom; The reason why only a small percentage of the power contained in each pound of coal is realized . . . . . | 229 |
| Importance of utilizing standing water in ponds or wells; Lifting condensing water; No loss of power involved in the lifting of injection water to a condenser by the action of the vacuum in the latter . . . . .                      | 230 |
| Air-pump; Capacity of the air-pump . . . . .  | 231 |
| Work of the air-pump; High pressure steam; Hornblower the inventor of the double or compound cylinder engine; The first practically useful high-pressure engine built and put in operation by Oliver Evans . . . . .                    | 232 |
| Specification of Arthur Woolf's patent for certain improvements in the construction of steam engines; Peculiar theories held by Woolf; Advocacy of the economy of high pressure steam with expansion by Trevethick and Woolf . . . . .  | 233 |

|  | PAGE |
|--|------|
| Increase in the duty of an engine by high pressure of steam and expanding; Comparative efficiency of different engines; The "atmospheric engine" . . . . .   | 234  |
| Function of the steam in the atmospheric engine; Indicator diagram from an atmospheric engine . . . . .  | 235  |
| Single acting engines; Best type of a single acting engine . . . . .   | 236  |
| The principle of single acting engines; Remarkable examples of the application of single acting steam engines to pumping . . . . .   | 237  |
| Indicator diagrams from a single acting engine and their interpretation . . . . .  | 238  |
| Calculation of the horse power of a single acting pumping engine; Double acting engines; Diagram from a double acting engine . . . . .   | 240  |
| Diagram from a condensing engine . . . . .   | 241  |
| Automatic steam engines; The most prominent in general use in the United States; The object of using steam expansively; How the greatest difference between the mean pressure in the cylinder through the stroke and that at the end of the stroke is obtained . . . . . | 242  |
| Superiority of steam engines with a variable cut-off as compared with the throttling engines . . . . .   | 243  |
| Economy in using steam expansively; Requirements for economically running a steam engine at a high grade of expansion; Present imperfect condition of the steam engine; Class of non-condensing engine most in use . . . . .   | 244  |
| Diagram from a non-condensing throttling engine showing excessive back pressure . . . . .  | 245  |
| Diagram exhibiting the improvement in modern throttling engines in the valve motion . . . . .  | 246  |
| Non-condensing automatic cut-off engines; Automatic expansion engines; The fundamental idea of automatic expansion engines . . . . .   | 247  |
| The liberating valve-gear devised by Frederick E. Sickles; Reasonings of the advocates of this system; The distribution of steam required by the theory of working by variable expansion . . . . .   | 248  |
| Automatic cut-off engines; The modern cut-off engine brought out, in 1849, by George H. Corliss . . . . .  | 249  |
| Difficulties of Mr. Corliss in introducing his engine; Indicator diagram from a non-condensing Corliss engine, showing the distribution of steam in the cylinder . . . . .   | 250  |
| Recognition of the value of high pressure, and considerable expansion, in the early part of the present century; The Greene and other automatic engines; Probable substitution of the "positive motion cut-off" for the "drop cut-off" liberating valve gear . . . . .   | 251  |
| The fundamental principle of high rotative speeds . . . . .  | 252  |
| Positive motion cut-off engines; Perfection of the Porter Allen engine, by Mr. Charles T. Porter; Diagram from a Porter Allen engine; The Buckeye engine . . . . .   | 253  |
| Indicator diagrams from a Buckeye automatic engine . . . . .   | 254  |
| The "straight line engine" invented by John E. Sweet; Objection to a single-valve cut-off engine; Diagram from a single-valve straight line engine . . . . .   | 255  |

|   | PAGE |
|---|------|
| New engine designed by Mr. Sweet . . . . .  | 256  |
| Wherein Mr. Sweet's new engine differs from all others . . . . .  | 257  |
| The Westinghouse single-valve engine; The most serious results from high speed in the horizontal engine eliminated by it; The merit of the single acting and self-lubricating principles established by the Westinghouse engine; Improvement in the Westinghouse engine . . . . . | 258  |
| Locomotive engines; Diagram from a Baldwin four-driver locomotive; Diagrams from Baldwin locomotive engine No. 81 . . . . .   | 259  |
| Indicator diagrams showing the tractive power exerted under different rates of speed; Load; Composition of the train . . . . .  | 260  |
| Diagrams from an English locomotive; Engines of the London and North Western Railway; Diagrams showing the tractive power of the "Precursor" . . . . .  | 262  |
| Average weight of trains hauled by the "Precursor" . . . . .  | 266  |
| Compound steam engines; What compounding is . . . . .   | 267  |
| Jonathan Hornblower's patent for using two cylinders . . . . .  | 268  |
| First public announcement of the benefit to be derived from the expansion of the steam; Application of the principle of the double cylinder by Arthur Woolf . . . . .   | 269  |
| Preference of the compound engine for marine purposes; Difference between the simple and compound systems . . . . .   | 270  |
| Loss of pressure with a compound engine . . . . .   | 271  |
| The action and arrangement of the principal varieties of compound engines, with illustrations . . . . .   | 272  |
| Curious form of continuous expansion compound engine . . . . .  | 274  |
| Compound engines with intermediate reservoir, or receiver; Diagram from a compound vertical engine with intermediate receiver . . . . .   | 277  |
| "Continuous expansion engine," with illustration . . . . .  | 278  |
| Advantages claimed for engines built upon the continuous expansion system . . . . .   | 279  |
| Disadvantage of the system . . . . .  | 280  |
| Diagrams from continuous expansion engines; Compound versus simple engines; Points of superiority in the compound engine . . . . .  | 281  |
| Liquefaction more injurious in simple than in compound engines; Diagram from a compound engine . . . . .  | 282  |
| Theoretical diagram; Values of the low pressure diagram . . . . .   | 283  |
| Amount of loss due to back pressure, illustrated . . . . .  | 284  |
| To avoid intermediate expansion; Arrangements for the avoidance or reduction of intermediate drop, with illustration . . . . .  | 285  |
| The theoretical diagram expanding twelve times in a simple engine . . . . .   | 286  |
| Theoretical diagram of a compound condensing engine . . . . .   | 287  |
| Diagram from a simple compound Westinghouse engine; Compound condensing engines; Diagrams from a Westinghouse compound condensing engine; Table of actual steam consumed per indicated horse-power Westinghouse compound engine . . . . .   | 288  |
| Diagrams from a compound condensing engine . . . . .  | 289  |
| Early compound engines; An old French work giving particulars of the steamers plying, in 1842, upon the Gironde and the Garonne . . . . .   | 290  |

|   | PAGE |
|---|------|
| Advantages of the compound steam engine . . . . .   | 29J  |
| Impossibility of explaining by any of the laws heretofore laid down that it is more economical to use steam expansively in the compound engine than in any form of the ordinary engine; Erroneous reasons of many engineers for condemning the compound engine; The offices the steam has to perform upon entering the cylinder . . . . . | 292  |
| Tyndall's researches on aqueous vapors; Experiments made by Mr. C. E. Emery; The transfer of heat from the metal walls of the cylinder to the exhausting steam; Variation in the quantity of heat transferred from a radiating to an absorbing body . . . . .   | 293  |
| Triple expansion engines; The arguments for and against this new class of engine . . . . .  | 294  |
| Advantages of the triple expansion engine; Causes of its superior economy . . . . .   | 295  |
| Diagrams from a compound condensing triple expansion engine . . . . .   | 297  |
| Diagrams from a horizontal compound condensing triple expansion engine. . . . .   | 298  |
| Chart of relative economy, under varying loads; Diagram of the performance of a single cylinder non-condensing engine, as contrasted with the compound engine, non-condensing and condensing . . . . .  | 299  |
| Compound locomotives; Their introduction, in 1850, by John Nicholson . . . . .  | 300  |
| M. Jules Morandiere's attempt at compounding locomotives . . . . .  | 301  |
| M. Anatole Mallet's system of compound locomotives; Chief features of this system . . . . .   | 302  |
| Diagrams from M. Mallet's locomotive; Economy of fuel with compound locomotives; Improved compound locomotive designed and patented by Mr. Francis W. Webb . . . . .  | 303  |
| Success of the Webb compound locomotives; Importation of one of these locomotives by the Pennsylvania Railroad, for trial; Indicator diagrams from a compound locomotive . . . . .  | 304  |
| The assertions of economy made for the Webb locomotives not borne out by the diagrams; Objection to and drawbacks of the Webb locomotive; Compound locomotive patented by T. W. Worsdell . . . . .  | 305  |
| The "intercepting valve" and the starting valve one of the chief features of Mr. Worsdell's locomotive; The action of this arrangement . . . . .  | 306  |
| Indicator diagrams from the Worsdell locomotive . . . . .   | 308  |
| Failure in this country of the compound locomotives as economizers of fuel; Opinion of Mr. A. B. Underhill . . . . .  | 309  |

## CHAPTER XIV.

### GAS-ENGINES.

|   |     |
|---|-----|
| History of gas-engines; Principal features of Dr. Alfred Drake's engine exhibited at the New York Crystal Palace, in 1855 . . . . .   | 310 |
| Lenoir and Hugon gas-engines; Otto and Langen's gas-engine; Otto's improvements in gas-engines; Otto's "silent" gas-engine . . . . .  | 311 |
| Advantages of gas-engines; Their extensive use a benefit to gas manufacturers and gas consumers; Probability of air being the chief motive power of the future; Gas-engines; M. Dugald Clerk's theory of the gas-engine . . . . . | 312 |



|  | PAGE |
|--|------|
| The distinct types of gas-engines at the present time . . . . .  | 312  |
| Calculation of the amounts of gas required by the various types . . . . .  | 314  |
| Error of previous observers in calculating the efficiency of the gas-engine<br>from its diagram . . . . .  | 315  |
| Early gas-engines; Classification of this kind of early motors . . . . .   | 316  |
| Johnson's patent for a gas-engine; Early recognition of the value of gas-<br>engines; Unscrupulous claims made for the Lenoir gas motor . . . . .                          | 317  |
| Lenoir's priority of invention contested by Hugon and Keithmann; Diffi-<br>culty in constructing a satisfactory gas-engine; Diagrams from a Lenoir<br>gas-engine . . . . . | 318  |
| The Otto and Langen atmospheric gas-engine; Its drawbacks and advan-<br>tages . . . . .  | 319  |
| Otto's silent gas-engine; External appearance of these gas-engines and<br>their method of working . . . . .  | 320  |
| Diagrams from the Otto and Langen and Otto's gas-engines . . . . .   | 321  |
| Points in which the new Otto motor differs from its predecessors; The cost<br>of working the Otto engine . . . . .   | 323  |
| The Clerk gas-engine; Its distinctive features . . . . .   | 324  |
| Diagrams from the Clerk gas-engine . . . . .   | 326  |
| The "Stockport" gas-engine . . . . .   | 327  |
| Difference between the Stockport and Otto engines . . . . .  | 328  |
| Gas consumption of the Stockport engine; The Atkinson gas-engine; Dia-<br>gram from an Atkinson "cycle" gas-engine . . . . .   | 331  |
| Arrangement of the Atkinson gas-engine . . . . .   | 332  |
| Causes of the great economy of the Atkinson gas-engine . . . . .   | 333  |
| Trial of an Atkinson patent "cycle" gas-engine, with diagrams of engine<br>and pump . . . . .  | 334  |
| Result of the trial . . . . .  | 336  |
| Brake trial of the Atkinson gas-engine . . . . .   | 337  |
| Table of real percentages of heat actually turned into work, etc. . . . .  | 338  |
| The "Forward" gas-engine; Distinguishing feature of the Forward . . . . .  | 339  |
| Trial of the Forward; Self-acting gas-engine; Clerk's arrangement for<br>starting the engine . . . . .   | 340  |
| Otto's twin-cylinder gas-engine; The self-starting arrangement of this en-<br>gine . . . . .   | 341  |
| Spiel's petroleum engine . . . . .   | 342  |
| Dowson's water-gas; Apparatus for manufacturing the gas . . . . .  | 344  |
| Manner of using the gas . . . . .  | 345  |
| Trials of the Dowson gas by Messrs. Crossly of Manchester; Cost of the<br>Dowson gas . . . . .   | 346  |
| The future of the gas-engine . . . . .   | 347  |
| Gas and steam-engine heat efficiency . . . . .   | 348  |

## CHAPTER XV.

## AUTOMATIC CUT-OFF VS. POSITIVE CUT-OFF.

|   |     |
|---|-----|
| Importance of the question, What will be the cost of fuel to do a given<br>amount of work with either type of engine? Utility of the indicator in<br>solving the question illustrated by a case from practice . . . . . | 349 |
|---|-----|

|  | PAGE |
|--|------|
| Indicator diagrams from a condensing engine . . . . .  | 353  |
| Relative economy of different engines; Diagrams illustrating the relative engine economy . . . . .   | 354  |
| How the relative economy of different engines may be illustrated . . . . .   | 355  |
| Comparison of cost per horse power with a throttling engine and automatic non-condensing engine . . . . .                                      | 356  |
| Diagrams from an automatic non-condensing and an automatic condensing engine . . . . .   | 357  |
| Diagrams from a pair of automatic condensing engines, from a condensing automatic cut-off engine, and from a non-condensing engine . . . . .   | 359  |
| Diagram from a pumping engine . . . . .  | 360  |
| Diagrams from a passenger locomotive . . . . .   | 361  |
| Diagrams from a freight locomotive . . . . .   | 362  |
| Light on some questions about which engineers now differ in opinion to be expected from a careful study of diagrams from locomotives . . . . . | 363  |
| Diagrams from a locomotive of the Southern Pacific Railroad . . . . .  | 365  |
| Diagrams taken in testing the Worthington pumping engine at Belmont, Philadelphia, May, 1872 . . . . .   | 367  |

## CHAPTER XVI.

### MISCELLANEOUS.

|  |     |
|--|-----|
| Leakage of steam-engines as shown by the diagram; Diagram from an automatic cut-off engine . . . . .   | 372 |
| Mode of finding the percentage of leakage . . . . .  | 373 |
| Distorted indicator diagrams; Diagram from a modern built automatic cut-off engine . . . . .   | 374 |
| Diagrams from an upright automatic cut-off engine, see Figs. 178, 179, 180 and 181 . . . . .   | 375 |
| The economy of a steam-engine; How to calculate the amount of steam (water) consumed from an indicator diagram . . . . .   | 376 |
| Reasons why the total amount of water cannot be estimated, except by measuring the feed water . . . . .  | 377 |
| Manner of ascertaining the weight of the steam, of which the indicator shows the pressure . . . . .  | 378 |
| To compute the economy of water consumption; Method for finding the rate of water consumption for the engine alone . . . . .   | 379 |
| To make allowance for compression and clearance, with illustrations . . . . .  | 380 |
| Computation Table No. 8 . . . . .  | 383 |
| Explanation of Table No. 8; Example for use of Table No. 8 . . . . .   | 384 |
| Illustration of Table No. 8 by comparison of different types of engines; Explanation of the comparative steam economy between "throttling" and automatic cut-off regulation, with illustration . . . . . | 385 |
| Evil of light loads; An over-large engine destructive to good economy . . . . .  | 386 |
| Efficiency or duty of pumping engines; Definition and expression of duty; Methods generally employed in estimating the duty . . . . .  | 387 |
| Simple way of measuring the water delivered into a reservoir, suggested by Mr. Nystrom . . . . .   | 388 |

|  | PAGE |
|--|------|
| Trial of Mr. Nystrom's instrument at Fairmount and other steam pumping works of Philadelphia . . . . .   | 389  |
| Reducing motion; Essentials for the correctness of the diagram . . . . .   | 390  |
| Simple plans for reducing the motion, with illustrations . . . . .   | 391  |
| Methods of attaching the various devices to the crosshead; Precautions in the use of these devices . . . . .   | 393  |
| Engine tests at electrical exhibition, Philadelphia, 1884; Test of Porter-Allen engine . . . . .   | 394  |
| Diagram showing the mean of all the indicator cards during the test; Diagram of the card representing most nearly the mean horse power developed. . . . .  | 395  |
| Table giving the pressures corresponding to the different parts of the stroke on the mean indicator card; Test of the Buckeye engine . . . . .   | 397  |
| Mean card (Buckeye engine) . . . . .   | 399  |
| Trial of the Southwark engine . . . . .  | 401  |
| Diagrams showing the mean of all the indicator cards taken during the test, and of the card coming most nearly to the mean horse power . . . . .   | 403  |
| Table giving the pressures corresponding to the different parts of the stroke, which would give the mean indicator card . . . . .  | 404  |
| Horse power; Manner of obtaining the total indicated horse power of the engine . . . . .   | 405  |
| Mean indicator card; Water accounted for by the indicator cards . . . . .  | 406  |
| An approximation to the effective mean pressure; Process of making a close approximation of the mean pressure of a diagram, with illustration; Frequent mistake in measuring on the ordinate lines . . . . . | 407  |
| Conclusion; Causes which influence the form of the indicator diagram . . . . .   | 408  |

## APPENDIX.

|   |     |
|---|-----|
| The indicator; Service of the indicator in developing the steam-engine; Office of the indicator; Conclusions from the indicator are the results of a process of reasoning . . . . . | 411 |
| Instruction to be derived from a careful and comprehensive study of the diagrams from different engines . . . . .   | 412 |
| Indicators in general use; The Thompson indicator, with illustrations . . . . .   | 413 |
| Tabor indicator, with illustrations . . . . .   | 414 |
| The Crosby steam-engine indicator, with illustration . . . . .  | 415 |
| Boilers; The best results obtained with the "flue" boiler . . . . .   | 416 |
| High pressure steam; Steel <i>vs.</i> iron . . . . .  | 417 |
| The reason why <i>mild steel</i> plates are preferred to the best iron plates; Super-heated steam . . . . .   | 418 |
| Priming or boiler disturbance; Horizontal flue boiler; Incrustation of boilers . . . . .  | 419 |
| Drawbacks arising from the incrustation of boilers . . . . .  | 420 |
| George W. Lord's boiler compound . . . . .  | 421 |
| Power of a boiler; Fahrenheit and Centigrade thermometers; Falling bodies. . . . .  | 422 |

|  |     |
|--|-----|
| Bodies falling in a vacuum ; Reason why heavy bodies fall faster than light<br>bodies in air . . . . .   | 423 |
| Table of horse-power constants for single cylinder engines . . . . .   | 425 |
| Horse power constants . . . . .  | 426 |
| Method of computing power . . . . .  | 427 |
| Table of areas and circumferences of circles from $\frac{1}{8}$ to 4 inches in diameter,<br>varying by sixteenths ; and from 4 inches to 100 inches in diameter,<br>varying by one-eighth inch . . . . . | 428 |
| Rule for finding the areas of larger circles ; Properties of water and steam ;<br>In relation to heat ; Volume of water . . . . .  | 433 |
| Properties of water . . . . .  | 434 |
| Latent and total heat in water from 32 degrees . . . . .   | 435 |
| Tables of the properties of water . . . . .  | 436 |
| Steam or aqueous vapor ; The ideal zero of aqueous vapor . . . . .   | 443 |
| Properties of steam . . . . .  | 444 |
| Latent heat of steam . . . . .   | 445 |
| Tables of the properties of steam . . . . .  | 446 |
| Index . . . . .  | 453 |

## STANDARD NOTATIONS OF LETTERS.

---

I have throughout this work attempted to adopt a standard notation of letters, for which some new characters have been added to distinguish different quantities which have heretofore been denoted by identical letters, thereby causing confusion as well as errors.

I have hoped that by so doing that a mere glance at the formulas will denote this meaning, without special reference to the characters.

### INDICATOR DIAGRAMS NOTATIONS.

- A D denotes atmospheric line.
- V V denotes line of perfect vacuum.
- B C denotes line of boiler pressure in pounds.
- k* denotes the initial steam pressure of diagram.
- e* denotes the point of cut-off.
- f* denotes the expansion curve.
- l* denotes the point of release.
- g* denotes the termination of the expansion line.
- d* denotes the termination of the fall of exhaust line.
- h* denotes the commencement of the compression line.
- m* denotes the termination of the exhaust line.
- i* denotes the commencement of the steam lead.

### STEAM NOTATIONS.

- P* = absolute or total steam-pressure, in pounds per square inch.
- p* = steam-pressure above that of atmosphere, as is shown on the steam gage.
- V* = steam volume compared with that of its water.
- H* = units of heat per pound in steam.
- H'* = units of heat per cubic foot in steam.
- L* = latent heat per pound in steam.
- L'* = latent heat per cubic foot in steam.

- $\wp$  = pounds of steam per cubic foot.  
 $\mathcal{C}$  = pounds of steam per pound.  
 $T^{\circ}$  = temperature of steam Fahrenheit.  
 $t^{\circ}$  = temperature of steam Centigrade.  
 $J$  = thermodynamic equivalent.  
 $g$  = grade or ratio of expansion—that is, when the steam is expanded to double its volume, then  $g = 2$ ; when three times the volume,  $g = 3$  and so on.

## WATER NOTATIONS.

- $\mathcal{V}$  = volume of water that at 39 or 40 degrees = 1.  
 $t^{\circ}$  = temperature of water Centigrade.  
 $T^{\circ}$  = temperature of water Fahrenheit.  
 $l$  = latent heat per pound in water from 32 degrees.  
 $l'$  = latent heat per cubic foot in water.  
 $\wp$  = weight in pounds per cubic foot of water.  
 $\mathcal{C}$  = fraction of a cubic foot per pound of water.  
 $W$  = cubic feet of water.  
 $w$  = cubic inches of water.  
 $lbs$  = pounds of water.

## MISCELLANEOUS NOTATIONS.

The letters  $T$  and  $t$  denote time,  $T^{\circ}$  and  $t^{\circ}$  temperature,  $V$  and  $v$  denote velocity,  $HP$  denotes horse-power, and  $\alpha$  equals infinite, or denotes that one quantity varies as another; as  $P$  varies as  $\frac{1}{P}$ .

- $=$  denotes equality.  
 $+$  denotes plus or addition.  
 $-$  denotes minus or subtraction.  
 $\times$  denotes multiplication.  
 $\div$  denotes division.  
 $\sqrt{\quad}$  denotes square root.  
 $\sqrt[3]{\quad}$  denotes cube root.  
 $3^2$  denotes 3 is to be squared.  
 $4^3$  denotes 4 is to be cubed.  
 $d$  denotes diameter.  
 $\pi$  denotes 3.1416, or periphery or a circle when  $d = 1$ .  
 $\frac{3}{4}$  denotes fraction, or broken number.

## CHAPTER I.

### INTRODUCTION.

#### What The Steam Engine Is.

A STEAM-ENGINE is popularly understood to be a machine by which the power generated in a steam boiler is transmitted to where the work is to be executed. From well-known experimental data, the volume of steam generated by the evaporation of a given volume of water being known, this steam volume multiplied by the steam pressure gives the work done by the steam. This work divided by the time in which it is executed, gives the natural effect, or power of the evaporation, independent of the power transmitted by the steam-engine; supposing that the steam is fully admitted throughout the stroke of the piston.

When the steam is expanded in the steam-engine cylinder, the above defined power multiplied by 1, *plus* the hyperbolic logarithm for the expansion, gives the natural effect of the steam, as will be shown further on.

Physically the steam-engine is an apparatus whereby the work latent in the coal is caused to manifest itself as molecular motion, or *heat*, and is eventually transformed into work and motive power.

The physical constitution of heat is not yet well understood, for which reason we cannot give an intelligent explanation of the dynamic elements of combustion and evaporation; but one thing appears to be certain—namely, that the temperature of the heat represents *force*, which is the origin of all power and work. It is also known and demonstrated that heat is convertible into *work*; and consequently, *heat* must be the product of the three simple physical elements *force*, *velocity* and *time*.

If the *temperature* of the heat represents *force*, then the space occupied by the heat must evidently represent the product of *velocity* and *time*.

## Dynamics.

Dynamics is the science of forces in motion, producing power and work.

The dynamical branch of mechanics consists of the following simple principles:

| <i>Elements.</i>             | <i>Functions.</i>         |
|------------------------------|---------------------------|
| Force,<br>Velocity,<br>Time. | Power,<br>Space,<br>Work. |

*Force* is any action that can be expressed simply by weight.

*Velocity* is rate of motion in regard to assumed fixed objects.

*Time* is duration, or that measured by a clock.

*Power* is the product of the first and second elements, *force* and *velocity*.

*Space* is the product of the second and third elements, *velocity* and *time*.

*Work* is the product of the three elements, *force*, *velocity* and *time*.

All dynamical problems, without exception, can be solved with the above six principles.

The term most used in a majority of engineering works is "*energy*" with various adjectives, as follows:—

| <i>Energies.</i>  | <i>Translation.</i>  |
|---|--|
| Plain energy,<br>Potential energy,<br>Intrinsic energy,<br>Kinetic energy,<br>Internal energy,<br>External energy,<br>Equality of energy,<br>Factor of energy,<br>Energy excited,<br>Actual energy,<br>Mechanical energy, | Power,<br>Powerful power,<br>Genuine or true power,<br>Motive power,<br>Inside power,<br>Outside power,<br>Alike power,<br>Terms of power,<br>Power that pushes,<br>Real power,<br>Power in mechanics. |



All the terms employed, as above, whereby to define energy, simply mean *power*, but they are used loosely to denote *work*, with but little regard, frequently, to accuracy of definition.

Within the last few years there have been published in this country a number of works on mechanics, written by professors of institutions of learning in which the foregoing terms are employed; terms that are not understood by the majority of practical mechanics, and hence the value of such works is to a large extent lost.

Energy may be properly defined, so as to be understood by all, as being the power or capacity to do work.

## CHAPTER II.

### WHO INVENTED THE STEAM-ENGINE?

IF, like Topsy, any invention "wasn't born," but "grewed," it is that of the steam engine. Go, reader, to the Franklin Institute of Philadelphia, and ask for Mr. Bennet Woodcroft's translated edition, now out of print, of Hero's book of A. M., 3804, or, say, the year 200 B. C. Hero was not an inventor at all, so far as we know—at any rate his book asserts no personal claims; yet, in his time, the power of steam, and a great deal of what goes to make up the steam-engine—including the slide valve, the spindle valve, and the metallic piston in a metallic cylinder—were understood.

*here* No doubt one of the first steps in the invention was the discovery of combustion or fire, the expansion of water into steam under the influence of *heat*, and the availability of this expansive force for the performance of useful *work*. As to who first observed this cardinal fact we have no historical record, but Hero of Alexandria (in *Spiritualia seu Pneumatica*), describes several ingenious machines, of which perhaps the best known is that which still bears the name of "Hero's Fountain." Among other devices, he describes a ball suspended in mid-air by means of a steam-jet, an apparatus which was revived as an air-jet and exhibited as something quite new (?) at the Centennial Exhibition at Philadelphia, and which created considerable interest and discussion as to the principles involved. Hero also describes an apparatus which we of to-day might call a steam turbine. Another apparatus of Hero represents a priest standing before an altar. When fire is kindled upon the altar, water which it contains is heated, and the steam thus generated forces out by its pressure the water remaining. This water passes through a concealed tube, so that the priest appears to pour water from his flask into an urn upon the altar.

All of these devices are only ingenious, and at that time were merely marvelous toys. They involve, it is true, facts and

principles which, rightly apprehended, might have led to the greatest results. But it is quite clear that they were not thus apprehended, and that the inventors of such toys were themselves ignorant of the principles which governed their actions. A philosophy which arbitrarily assumed that all nature was composed of four elements—earth, air, fire and water—and that steam was a kind of air, generated by the two elements fire and water, which accordingly strove to rise to the place of the next highest element—and such a philosophy prevailed—blinded the eyes of mankind, and prevented a proper interpretation of those very facts of nature of which they even made daily use. The ancients knew nothing of the true nature of steam—could know nothing as long as they were blinded by their arbitrary ideas of what it ought to be. Nature was continually pointing them to roads fruitful on every side with discoveries, but they could not recognize her indications. What of knowledge and progress have been lost to the world by reason of the false methods and philosophy of the ancients, can never be estimated. That it is much is evidenced by the astonishing results of but a few years of modern progress. It is even more strikingly shown by the very discoveries which, in spite of all obstacles, those keen and highly-trained minds achieved, and by the wonderful sagacity they displayed—a sagacity which, in view of their limitations, would seem almost to resemble inspiration.

Thus, the principles involved in Hero's machines remained unrecognized and without result, and we find, accordingly, Vitruvius, a Roman architect at the beginning of the Christian era, describing, without the least reference to previous inventions, and apparently without the least perception of its relations to them, an apparatus called the *æolipile*. This famous apparatus consisted simply of a hollow metallic ball with a small hole in it. That is all! The ball being heated and the inclosed air rarefied, it was then immersed in water. A quantity of water having thus been sucked in as the heated air in the ball cooled and contracted, the ball was taken out of the water, and again heated. Of course, steam was formed, which would for some time issue from the hole with considerable force.

The *Æolipile*.

This machine with some modifications is susceptible of a very fair degree of efficiency, and no doubt it is quite within the bounds of possibility that this instrument may yet displace the cylinder and piston now so universally employed.

Its principle and mode of action will be understood from Figure 1, where *C* represents a globe moving freely on its axis in such a manner as to permit the constant introduction of steam from the boiler *A* through the tube *B*.

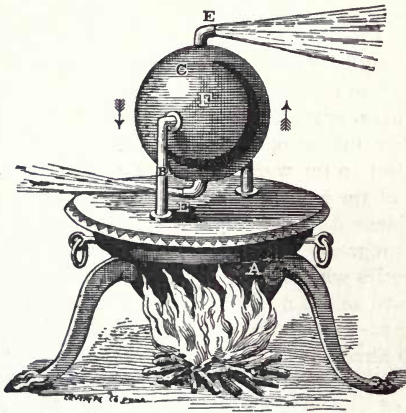

FIG. 1.

The steam escapes through the bent tubes *EE*, and gives, by its reaction, a rotary motion in the direction of the arrows. From the collar *F* on the centre of the globe, motion could be given to machinery.

This, no doubt, is the original rotary steam-engine. Hero also describes another apparatus, in which *A* is a globe, see Figure 2, partially filled with water, which is converted into vapor by the application of heat. A pressure is produced on the surface of the water, which is consequently driven up through the syphon *B*, into the vessel *E*, from which it descends by the pipe *D*, into the close vessel *C*, also partially filled with

water. When the globe *A* cools, the water it contains is relieved from the greater part of its pressure by condensation of the steam, and the water rises from the vessel *C* through the pipe *F*, to supply what had been driven over by the elasticity of the vapor.

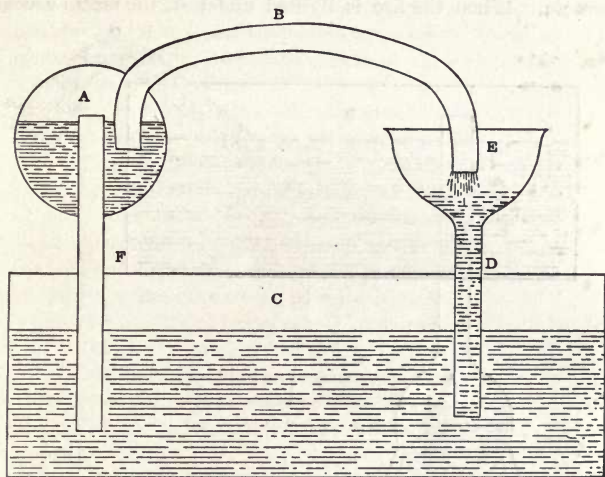

FIG. 2.

There is no doubt that the Egyptian priests used the pressure of vapors in performing their mysteries in and about their temples.

Giovanni Batista Porta, in 1606, published a translation of Hero's "Spiritalia" and added a description of an apparatus by which the pressure of steam might be made to raise a column of water.

Porta was known as an educated gentleman, a mathematician, chemist, and physicist, and was a man of large means. The invention of the magic lantern and the camera obscura are attributed to him; these inventions are described in his commentary on the "Pneumatica."

Porta's machine for raising water by steam pressure is shown in Figure 3.

The retort or boiler, *A*, has a long neck, which passes through the bottom of the air-tight cistern *B*. A bent pipe or syphon *C*, is fitted into the top of the cistern, and descends nearly to the bottom. When the fire is lighted under *A*, the steam ascends

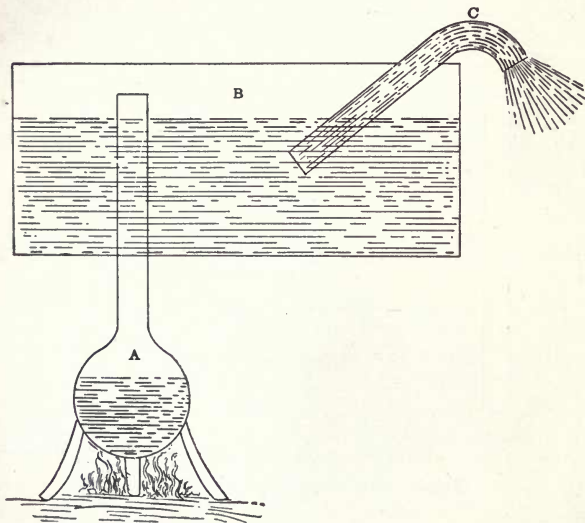

FIG. 3.

in the cistern, and presses upon the water, and forces it up the syphon *C*, into the atmosphere, or it may be led to any desired height. This was called by Porta an improved "steam fountain."

He also described with accuracy the action of condensation in producing a vacuum, and sketched an apparatus in which the vacuum thus secured was filled by water forced in by the pressure upon it of the external atmosphere.

Here, then, are some of the essential principles of the steam-engine of to-day.

Porta's contrivance is the first in which the boiler is separate from the "forcing vessel"—which later inventors claim as ori-

ginal with them, and claim special distinction on account thereof.

Anno Domini 540, Athemius, an architect, arranged several cauldrons of water, each covered with the wide bottom of a leathern tube, which rose to a narrow top, with pipes, extended to the rafters of the adjoining building. A fire was kindled beneath the cauldrons, and the house was shaken by the effect of the steam ascending the tubes. This is the first notice of the power of steam recorded.

In 1543, June 17th, Glasco de Garoy exhibited a boat of 209 tons, propelled by steam with tolerable success, at Barcelona, Spain. The apparatus consisted of a cauldron of boiling water to generate steam, a crude engine, and a movable wheel on each side of the boat. It was laid aside as impracticable.

Salomon de Caus, in 1615, an engineer of mark, published a work at Frankfort in which he describes a machine designed to raise water by the expanding power of steam.

This machine, like that of Porta, consisted of a metal vessel partly filled with water, in which a pipe was fitted, leading nearly to the bottom, and open at the top. Fire being applied, the steam formed by its elastic force drove the water out through a vertical pipe, raising it to a height limited by the strength of the vessel.

Very little improvement upon the contrivances described by Hero was made for many centuries. The expansive properties of steam must have been tolerably widely known, but apparently no serious attempt was made to utilize them. So marked is this circumstance that the actual steam-engine may be truly considered an invention of the 17th century.

The first useful application of steam power on a large scale appears to have been by Edward Somerset, second Marquis of Worcester, about A D, 1650. The apparatus employed consisted of an independent steam generator, and two separate strong vessels. One of these vessels being filled with cold water, steam was admitted into it from the generator, and, pressing directly upon the surface of the water, the latter was forced upwards through an ascending pipe, to a height of about forty feet. Vessel No. 1 being emptied of water in this way, the steam was turned off from it, and on to vessel No. 2, No. 1 being then refilled by man-

ual labor. Obviously a great deal of the steam must have condensed without doing any work; and considerable inconvenience must have arisen from the necessity of refilling the vessels by hand. Thomas Savery removed the latter inconvenience about the year 1697. Savery's apparatus was somewhat similar to the last, but when the vessels became emptied of water and filled with steam, he cut off communication, both with the ascending water pipe and the steam generator, and, opening communication between the vessel and the water supply, condensed the steam in the forcing vessels by the external application of cold water. A vacuum being thereby formed in the forcing vessel, a fresh supply of water was caused to flow into it by the pressure of the atmosphere. This machine was one of the first to do useful work. This apparatus was used for raising water at Vauxhall, London, and at Raglan Castle, his home.

With the Marquis, therefore, we reach the first practical application of the power of steam. But, looking back now over the ground from Archimedes to De Caus, we fail still to find the least real progress in the knowledge or apprehension of fundamental principles. Thus far only known facts have been variously combined. Twenty centuries have passed with scarcely a practical result, and without any clearer insight into the laws and principles involved than in the beginning. The ball of Hero and the æolipile disappear, only to reappear again in some slightly changed form, and constitute eventually all that is known. Progress in natural laws implies investigation of nature, and the time when this truth begins to be recognized we have now but just reached. All has been accomplished that could have been expected from a method which ignored nature and philosophy—which dogmatized about that which it could not comprehend. But with the seventeenth century comes a change and a great awakening from the slumber of ages. Men like Descartes, Kepler and Galileo appear, and real progress begins. Compare now this progress of only two centuries in every department and in all directions with the preceding twenty, and what we owe to science to-day becomes apparent. Torricelli, in 1643, following in the footsteps and working in the spirit of his illustrious master, Galileo, was the first to prove experimentally the weight and pressure of the atmosphere.



Otto von Guericke followed, with his air pump and hemispheres, and forces the unwilling and tardy conviction of a skeptical world. Unwilling conviction! for the old beliefs died hard, as the life and sufferings of Galileo sufficiently attest. Torricelli's demonstration of the pressure of the atmosphere produced at first only opposition. Old dogmas and long-established beliefs proved very tenacious of life. They still live, and die hard.

It is not surprising, then, that Torricelli's discovery remained for a long time unheeded. The progress of these two centuries is well illustrated by the fact that such a discovery made to-day would be known, repeated by thousands of independent observers, and accepted by the scientific world within 48 hours. In that day, however, it was not until 1646, three years later, that Pascal first heard of Torricelli's discovery and repeated it. He rejected at first, however, Torricelli's interpretation, and concluded that "nature's abhorrence of a vacuum was limited." As Galileo sarcastically expressed it, "Nature only abhorred a vacuum as high as 30 inches." The sarcasm of Galileo expressed the serious belief of Pascal. One would naturally suppose that the ecclesiastics would have welcomed a conclusion from such an authoritative source, so entirely in sympathy with their methods of thinking; but, on the contrary—so inconsistent is dogmatism—the scholars attacked Pascal with virulence, for "daring to limit the powers of nature," until, excited by their ignorant opposition, and enraged by their savage attacks, he returned to the investigation anew, and brilliantly demonstrated, beyond cavil, the truth of Torricelli's position.

He reasoned that if Torricelli were right, and if the mercury column in the barometer tube were really sustained by the pressure of the atmosphere, its height must be less when taken to the top of a high mountain, where there is less air above it, than in the plain below, where there is more. On the 20th of September, 1646, just at the close of the Thirty Years' War, he tried the experiment on the summit of the Puy de Dome, at Clermont. It was completely successful and conclusive, and the joyful peals of Münster and Osnabruck, which still lingered in the air, as they rang out the long and dreary war, fitly rang in the triumph of science, and a more glorious victory than they

knew. Otto von Guericke followed up the proof by his invention of the air pump, by which he pumped air out of vessels like so much water, and so multiplied proofs of the most striking character that no room for doubt remained, even to the most intolerant dogmatizer of them all. Here we have reached, in my opinion, the true germ of the steam engine. It begins right here, and it could not possibly begin before. All attempts hitherto made have been merely gropings in the dark.

From the moment when the action of the atmosphere was rightly apprehended, and thus the true significance of a vacuum understood, the steam engine became an inevitable consequence. Torricelli, with his barometer tube, sowed the seed of which we reap the fruits to-day. Was not Torricelli's tube a mere marvelous toy also? like the æolipile, the fountain, the priest and the altar? No! for these were only detached facts, divorced from their true significance, while that illustrated and made clear a principle. Principles are fruitful, and lead to innumerable results; facts alone are barren when they do not lead to principles. Torricelli planted better than he knew, and the results of that simple experiment, just because it was an experiment, a questioning of nature, will reach through all the future ages of man's life upon this earth, just as it now clothes and feeds a world. That simple experiment marks an epoch, and a most memorable epoch. We can scarcely conceive at this day the momentous importance of this simple, and to us most evident, fact of atmospheric pressure.

We have been born and brought up in the knowledge of it, and accept it as the air we breathe. The significance of a vacuum, as a space devoid of air upon which the outside air pressure was unbalanced, began now to be appreciated. Attempts are at once made to utilize this astonishing air-power by producing a vacuum, and a new era begins. Many devices were suggested and tried for this purpose, but remained without result, until Papin in 1690 first suggested the condensation of steam for the production of a vacuum. Many other substances expand when heated and contract when cooled, but when it is stated that *one cubic foot* of steam under ordinary pressure contracts to about *one cubic inch* of water when cooled, its peculiar fitness for the purpose suggested, namely, the production of a

vacuum, becomes at once apparent. The fact of the condensation of steam was by no means unknown before, but only now has the time arrived when that fact stands out in its true significance as a means of producing a vacuum, and thus making the air do work. Papin recognized the advantages which the use of steam presented, and endeavored to utilize it. Here, then, we have a steam engine, or rather, an "atmospheric engine," as it may be called, because it is really the pressure of the atmosphere which furnishes the power, and steam is only used to produce a vacuum. Thus we have for the first time an engine the principles of whose action are comprehended. To Papin, then, as much as to any one man, is due the honor of the conception of a steam engine in the light of a proper comprehension of the principles involved and the end to be attained. It is, of course, but a beginning. It simply points out the way, and in itself, in its present shape, is of no practical utility whatever. Indeed, so evident were its defects that Papin himself abandoned it as impracticable. Improvement, however, is but a matter of detail when once principles are clearly recognized. Here is the central idea clearly apprehended and illustrated. The way is at last opened, Savery in 1698 having learned from Papin the manner of condensing steam and forming a vacuum, by making use of the direct pressure of expanding steam as well as the pressure of the atmosphere obtained by condensing the steam.

This being one step in advance and nearer to the steam engine of to-day, was the first practical machine, and was to some extent actually used for raising water. This engine was no doubt suggested by Papin's engine. But the defects of Savery's engine were many; the most serious was the enormous consumption of fuel for the work done.

Newcomen and Cawley, mechanics of Dartmouth, England, appear to have been the first to apply the cylinder and piston to the purposes of steam power. In their engine, constructed about the year 1705, steam of low pressure was used to raise a piston against the pressure of the atmosphere. The steam under the piston being then condensed by the application of cold water to the outside of the cylinder, and a vacuum thereby formed, the piston was forced down by atmospheric pressure.

The actual work, which consisted in this case also of raising water, was performed during the downward stroke only.

Savery's engine was an "atmospheric engine," the piston being forced down by the weight of the atmosphere. In the engine originally patented the steam was condensed by the application of cold water to the outside of the cylinder, or by surface condensation.

These inventors also accidentally discovered that steam could be condensed much faster by admitting a jet of cold water into the cylinder itself than by water applied externally to the cylinder. And with them originated the principle of jet injection.

The number of great discoveries made by pure accident is very few. Nature discloses her secrets only to patient and persistent inquiry. But just here we meet with an apparent exception—a genuine and important discovery made by chance.

The piston of one of these engines was covered on top with a layer of water to make it air-tight. One day the engine was observed to work with great and unusual rapidity, the steam seeming to be condensed more quickly than usual. Examination showed that the wearing away of the piston had allowed water to enter the cylinder and come into direct contact with the steam. Thus was discovered the fact of condensation by means of water injected into the cylinder, or, as we may call it, jet condensation, and Savery's share in the patent of Watt became necessary.

And now a little boy takes a part in the work of development, and does good service too. The cocks for the admission of steam and water to the cylinder had to be turned by hand just at the right moment. Evidently if the steam-cock is open too long, there is danger of blowing the piston out of the cylinder. The wearisome and monotonous task of watching the stroke and opening and closing the cocks at the proper moment was intrusted to a little boy by the name of Humphrey Potter. He doubtless soon found the work rather unsatisfactory, and his bright wits suggested a remedy. He attached strings to the walking-beam and to the cock-handles in such a manner that the machine was made to watch itself and turn the cocks itself. Simple as it is, this contrivance, suggested by the desire of a boy to join the sports of his playfellows, constituted one of the

most important improvements in detail ever made to the steam engine. It was at once adopted by Newcomen, and was the origin of the so-called "plug frame" and valve gear of to-day.

John Fitch, a native of Windsor, Conn., and James Rumsey, a native of Maryland, were the first in America who made the attempt to propel boats by steam.

Fitch was the first to commence building his boat in 1783, but did not complete it so as to try his experiment until 1787. His attempt was to apply steam power to oars. He launched the boat and made the trial on the Delaware; but his machinery proved insufficient and ill-adapted to the purpose of navigation. This was his first and last experiment, although he retained full faith in the ultimate success of steam for propelling boats.

Rumsey commenced building his boat later in the year 1783 than Fitch, in Shepherdstown, near his residence on the southern bank of the Potomac, and launched it in 1786. His first effort was the application of steam power to a pump, by which he sought to propel the boat by drawing in water at the bow and pouring it out at the stern. This proved inadequate for loaded boats or river navigation against the current. He then attempted to apply his steam power to setting-poles, but without success, and abandoned his project with no further trial.

Nathan Read,\* a native of Western (now Warren), Mass., an apothecary in Salem, Mass., and afterward a member of Congress from Danvers, Mass., noticed the failures of Fitch and Rumsey, and believed they were occasioned by their ill-constructed machinery; that their long awkward oars, and still more awkward pumps and setting-poles, condemned themselves as unsuited to the purpose for which they were designed. Accordingly, in 1789, eighteen years before Fulton appeared with his experiments upon the Hudson, Mr. Read successfully invented and constructed a steamboat of sufficient size to carry a man, and safely propelled himself across an arm of the sea which separates Danvers from Beverly. His boat was constructed with two paddle-wheels, fixed to an axis which extended across the gunwale of the boat, precisely on the same principle as applied at the present day to all steamboats propelled by paddle-wheels.

\*Nathan Read: A contribution to the early History of the Steamboat and Locomotive Engine, by his friend and nephew David Read, New York, 1870.

Undoubtedly this was the first steamboat ever built, and the first voyage ever taken in a steamer constructed upon the same plans and principles as our present boats. The Rev. Dr. Prince, of Salem, and several other gentlemen, were present on this occasion and witnessed this successful experiment of Mr. Read.

At this time he invented and constructed a portable furnace tubular boiler, with the suitable machinery attached to give it locomotion, and made a model of a locomotive steam carriage, and applied for a patent February 8, 1790. This was before any patent laws or regulations had ever been established by the government. At this time Congress was in session in New York, and Mr. Read spent the most of the winter of 1790 in the latter city. He had letters of introduction from Gen. Benjamin Lincoln to President Washington, and members of Congress and other gentlemen of New York City. He was finally rewarded by having his application granted him. The application and petition to Congress were accompanied by a recommendation from a select committee of the American Academy of Arts and Sciences, setting forth his various discoveries as follows :

“An improvement in distillation by a new still and refrigerator.

“Obtaining a perpetual tide fountain for water works, keeping pumps, mills, carding machines, etc., constantly at work from the accumulated forces of the wind.

“An economical portable steam engine.

“Application of steam to purposes of navigation and land carriages.

“A method of constructing perpetual chronometers and self-moving planetaries.”

That Mr. Read has not been accorded justice, as being the original inventor of the successful application of steam power for locomotion, is apparent from a glance at the statements of the experiments made previous to this date. Want of space here will only permit of a brief mention of them.

The Marquis of Worcester made the first experiments in this direction as early as 1655, and expressed his belief that steam power might be used for propelling vessels, but he never tried the experiment.

In 1680 Prince Rupert made an unsuccessful attempt to

propel a boat on the Thames by steam, but it was an utter failure.

Savery, an Englishman, about 1698, is supposed to have been the first to apply steam power to any practical purpose. He used it for pumping water from the mines in Cornwall, and expressed the idea that he could turn paddle-wheels on the outside of a vessel if connected with his pumping engine; but there is no record of his ever having tried the experiment.

In 1707 Denys Papin introduced his steam machine for raising water in one instant to an elevation of 70 feet. In 1710, Newcomen made the first steam-engine in England. In 1718 patents were granted to Savery for the first application of the steam-engine.

The high-pressure engine with two cylinders was proposed by Leupold about A. D., 1725. The compound system of working steam in two cylinders originated with Hornblower, and was improved upon by Woolf.

In 1736, Jonathan Hulls set forth in a publication the idea of steam navigation.

James Watt in 1759 had his attention directed by Dr. Robison to the subject of the steam-engine, and for a few years afterwards made various experiments on the properties of steam.

The progress which he made was marvelous. He discovered all the laws which we now know with almost perfect precision, and he showed us how to apply them to produce results in almost perfect accordance with those laws under which steam must act.

Let us catalogue what this great genius did. He discovered the essential truth that steam must be condensed in a vessel other than the cylinder in which it is used to produce power: and he invented the application of the air-pump to the condenser in order to make a true steam-engine—that is, an engine from which air is excluded, and in which the piston works between two vessels, the boiler and condenser, each of which contains steam, but of different pressures, the power resulting from that difference.

He invented two forms of condensers—the “jet condenser,” in which the steam is cooled by a spray of cold water injected into it, to be used when fresh water is available, and the “sur-

face condenser," in which the steam is separated from the cold water by a thin partition of metal, and is condensed by contact with the cold surfaces. Without this last invention our modern steamships could not carry high-pressure steam in their boilers, and could not attain their wonderful speed.

He discovered the law under which steam used expansively increases its power in a certain ratio; and he invented the best form of cut-off for utilizing this discovery known to man, until it was improved, upon the same principles, by Sickles, Corliss, Thompson, and others.

Watt, by his investigation of the action of steam in the cylinder of the Newcomen engine, revealed the fact and importance of that waste by cylinder condensation, which is only to-day becoming recognized as an essential element in the theory of the "real" steam engine of the engineer, as distinguished from the "ideal" engine of the authors of the theory of thermodynamics, and which is recognized as imperatively demanding consideration, if that theory is to be made of practical use in engineering.

Watt's discovery of this "cylinder condensation" led him to the invention of his separate condenser, and of the long neglected but now familiar steam jacket, an attachment which was, for many years, only seen upon the Watt's Cornish engine, and was almost never used elsewhere. It has now come in with the compound engine, and is familiar to every engineer.

He invented the "Indicator," an instrument which gives us a graphic representation of the force exerted by the steam, and proves the truth of the laws he discovered.

He invented the "fly-ball governor" for maintaining uniform speed of the engine under varying conditions of load and pressure.

He also invented a great number of subordinate details too numerous to mention here; and, as if to admonish the world not to depart from these principles, he invented the "copying press" now in common use everywhere.

When he died he seems to have left no successor capable of appreciating the discoveries he made, and for a generation after his death the art of producing power from fuel by the interven-



tion of a steam engine retrograded, so that less power was obtained from a pound of coal consumed than could be obtained by the use of methods invented and fully explained by James Watt.

The problem is to convert the work of combustion into dynamic power, and that steam engine is the best which can obtain the most power from the least coal.

These three laws are the key to the whole problem, and they were all discovered by James Watt:

First—A cubic inch of water converted into steam, will lift a ton a foot high.

Second—It costs no more fuel to evaporate a cubic inch of water at the pressure of 200 pounds to the square inch than it does to evaporate it in an open vessel; and

Third—The gain of power depends upon the number of times the compressed steam is permitted to expand after it has done the work of lifting a ton a foot high.

Founded upon these principles, the steam engines which were made by Watt and his associates and pupils, before 1830, produced a horse-power with less than two pounds of coal an hour. These engines are known as the Cornish pumping engines; and if we look into the history of these machines, we will find them reported as doing a "hundred millions of duty," which is a technical phrase intended to express the fact that a hundred million pounds of water were lifted a foot high for a hundred weight of coal consumed. Turning that into horse-power, it means about two pounds of coal per hour per horse-power. This result was produced by cutting off steam in the cylinders at one-eighth or one-tenth of the stroke, and allowing it to expand eight or ten times. The engines of that day, of course, were very imperfectly constructed, and great losses occurred from leaking pistons and from imperfectly constructed boilers; but notwithstanding that loss, the result was equal to two pounds of coal per hour per horse-power.

Reconstruct these engines with the tools and machinery of to-day, and the result would be appreciably higher. Or, in other words, an engine expanding steam ten times, and evaporating eight pounds of water to a pound of coal in the boiler, and without any losses from leakage, ought to make a horse-

power with a pound and a half of coal an hour. These results were obtained by obeying Watt's laws, already stated, as nearly as it was possible then to do.

The work of Watt in the systematic experimental study of the steam engine was not taken up by his successors in the profession until about 1850, when it was done by G. A. Hirn, and others.

Watt made the first perfect steam engine in 1764.

Thomas Paine first proposed the application of steam navigation in America in 1778.

In 1785 two Americans published a work on the steam engine.

Oliver Evans, a native of Philadelphia, constructed a locomotive or steam carriage to travel on turnpike roads in 1793.

The French Academy of Sciences having offered a prize for the successful application of steam power for the propelling of vessels, one Bonouville wrote an essay in 1753, in which he demonstrated the principle that it could be accomplished by the rotary motion only, and he won the prize as having offered the most feasible plan.

Genevois, a Frenchman, tried the experiment of operating a paddle in the form of a duck's foot, with an opening and closing motion, but it proved a failure.

Another Frenchman, the Marquis de Jouffroy, was also an unsuccessful experimenter.

It is also said that a Scotchman of the name of Miller moved a boat along the Firth of Clyde canal by steam power, at the rate of seven miles an hour; but Miller himself pronounced his trial a failure and his machinery unfitted for the purpose.

It was not until after Watt, in 1784, produced his rotary steam-engine, that it was made possible to successfully use steam as a propelling power in navigation; but he never made the attempt of so applying it. In fact, it was not until the invention of the tubular boiler by Mr. Read, and his application of Watt's rotary engine, that the thing was made possible in 1789.

At the time Mr. Read was in New York prosecuting his application for a patent, in 1790, he met and explained to General Stevens his drawings and models of a tubular boiler and paddle-

wheels, in combination with Watt's double-acting rotary engine. In the very next year General Stevens, who was a man of great wealth, began his experiments in steam navigation, and is erroneously recorded by Renwick, in his "History of the Steam-Engine," as being the inventor of the tubular boiler; but it is plain that Stevens had formed no idea of a tubular boiler himself, or any ideas whatever of steam navigation, except as derived from Read.

It was eight years afterwards, in 1797, that Chancellor Livingston commenced his projects with steam on the Hudson, and in 1801 he went as Minister to France, and there met Robert Fulton, who had been for five years experimenting unsuccessfully under the patronage of the French government.

In 1803, Livingston employed Fulton, and under his patronage made his first attempt to propel a boat by steam and paddle-wheels, using Read's invention of a tubular boiler and Watt's rotary engine, and in a trial on the Seine that same year, succeeded in attaining a rate of speed of four miles an hour. Livingston then arranged with Fulton to construct a boat of large size for use on the Hudson. In this arrangement General Stevens became a partner of Livingston. In the new boat they substantially adopted the same ideas and methods of Read; the very same style of tubular boiler and paddle-wheels that he invented, together with one of Watt & Boulton's double-action rotary engines made in England, which was delivered in New York, in 1806, and in 1807 the famous "Clermont" was launched on the Hudson, and made her notable and very successful trip to Albany, eighteen years after Mr. Read's successful steaming across the bay between Danvers and Beverly.

#### The First Steamship to Cross the Ocean.

One of the most curious things in the history of Transatlantic steam navigation is the claim that has been set up on the other side of the water to the construction and fitting out of the first pioneer Transatlantic steamers, or, more strictly speaking, to the proprietorship of the first vessels which crossed the ocean propelled exclusively by steam-power. These pioneers, it is claimed, were the *Sirius* and the *Great Western*, the former built for another class of voyages, and afterward lost on the sta-

tion between Cork and London, the latter built expressly for Atlantic navigation. They made the voyage in 1838, which, as will be seen, was *twenty years* too late for pioneers. If "exclusively propelled by steam-power," as is urged for them, means that no sails were set during the passage, the claim may be founded on fact, but that it is deceptive and misleading, there is surely no doubt. The Savannah, an American steamship, was the first ever built to cross the ocean, and, if she carried auxiliary sails and set them when the wind was fair, she did no more than every steamer has done from that time up to the present, and could by no means be forced on that account to forego her claim to being the first steamship that crossed the seas. She was built in 1818, by Col. John Stevens, of New York, and the news of her master's intention to tempt the seas soon reached the English world, being heralded by the *London Times* in its issue of May 11, 1819, in the following paragraph:

"Great experiment.—A new steam vessel of 300 tons has been built at New York for the express purpose of carrying passengers across the Atlantic. She is to come to Liverpool direct." This was the Savannah, which, in May, 1819, left the port of New York for Savannah, from which port she sailed, under the command of Capt. Moses Rogers, bound for St. Petersburg via Liverpool. She reached the latter port on June 20, having used steam 18 days out of the 26, and thus proved the feasibility of Transatlantic steam navigation.

The Savannah, when first descried on the southern coast of Ireland, was reported as a ship on fire at the mast, and moving without sail. The admiral, who lay in the cove of Cork, dispatched one of the King's cutters to her relief. But great was their wonder at their inability, with all sail, in a fast vessel, to come up with a ship under bare poles. After several shots were fired from the cutter the engine was stopped, and the surprise of her crew at the mistake they had made, as well as their curiosity to see the singular Yankee craft, can be easily imagined. They asked permission to go on board, and were much gratified by the inspection of this novelty.

A distinguished scientist had declared long before that it was not possible to cross the ocean by steam. Indeed, so sure was he that it could not be done that, when he heard that Captain

Rogers proposed to make the attempt, he declared that he would swallow the first vessel that should safely reach the British Isles from this country. It would not, therefore, have seemed immodest had Captain Rogers, upon the arrival of the Savannah, have called upon the *savant* to fulfill his promise and swallow the ship.

“On approaching Liverpool, hundreds of people came off in boats to see the steamship. She was compelled to lie outside the bar until the tide should serve for her to go in. During this time she had her colors all flying, when a boat from a British sloop of war came alongside and hailed. The sailing master was on the deck at the time, and answered. The officer of the boat asked him, “Where is your master?” to which he gave the laconic reply, “I have no master, sir.” “Where’s your captain, then?” “He’s below. Do you wish to see him?” “I do, sir.” The captain, who was then below, on being called, asked what he wanted, to which the officer answered, “Why do you wear that pennant, sir?” “Because my country allows me to, sir.” “My commander thinks it was done to insult him, and if you don’t take it down he will send a force that will do it.” Captain Rogers then exclaimed to the engineer, “Get the hot water engine ready.” Although there was no such machine on board the vessel, the order had the desired effect, and John Bull was glad to paddle off as fast as possible.

Several naval officers, noblemen and merchants from London came down to visit her, and were very curious to ascertain her speed, destination, and other particulars.

It is curious in looking over the English newspapers of that date to see how suspiciously the English authorities regarded the American steamer. America was looked upon as very ambitious, and an enterprise like this on the seas, filled the British breast with great alarm. It seems that Napoleon being now in captivity at St. Helena, his brother had offered a large reward to whoever should rescue him, or rather there was, it would appear, a rumor to that effect, and the British press was sure that this Yankee steamer was in European waters for no other purpose.

The Savannah remained nearly a month in British waters.

On the 23d of July, the Savannah set out for St. Petersburg, under steam. She stopped at Copenhagen and also at Stockholm, where, as in England, she was the object of general attention, being visited by all the members of the royal family and the nobles. Captain Rogers' diary says: "Mr. Huse (Christopher Hughes, the American Minister) and lady, and all the Furran ministers and their Laydes, of Stockholm, came on board." In her passage up the Baltic, and while lying in the port of Cronstadt, she was saved from wreck during a terrible storm, in which many vessels were lost, only by the assistance rendered by her paddles. While at Stockholm, Captain Rogers took aboard, as an invited guest, Lord Lynedock, a distinguished English general, who made the journey to St. Petersburg aboard the steamer. When he left the ship, he presented Captain Rogers with a massive gold-lined tea-kettle. This tea-kettle is yet preserved by the descendants of Captain Rogers. It bears the following inscription:

"Presented to Captain Moses Rogers, of the steamship Savannah (being the first steam vessel that had crossed the Atlantic), by Sir Thomas Graham, Lord Lynedock, a passenger from Stockholm to St. Petersburg, September 15th, 1819."

During her stay at St. Petersburg, Alexander, Emperor of the Iron North, pleased with the novel idea of a steamship, presented Captain Rogers with two iron chairs, one of which (one of the only relics left of the adventurous bark) was up to a late period in the possession of Mr. Dunning, of Savannah.

The Savannah sailed for America on October 10th, 1819, and reached Savannah, Ga., November 30th.

Thus it will be seen that the Savannah, which, by the way, was lost off the south side of Long Island, anticipated the alleged steam pioneers Sirius and Great Western by nearly *twenty years*.

And to-day, viewing one of those gigantic engines to be seen in some of our large steamboats, who will deny that there is something awfully grand in the contemplation of it? Stand amidst its ponderous beams and bars, its wheels and cylinders, and watch their increasing play, how regular, yet how wonderful! A lady's Waltham watch is not more nicely adjusted—the rush of the waterfall is not more awful in its strength. Old

Gothic cathedrals and ruined abbeys are solemn places, teaching solemn lessons touching solemn things; but to the contemplative mind, a steam engine can teach a solemn lesson too: it can tell him of mind wielding matter at its will; it can tell him of intellect battling with the elements; it can tell him of genius to invent, skill to fashion, and perseverance to finish.

Many men of genius fill obscure graves in whose souls the living fire of poetry, or the bright sparks of genius, lay hidden and lost, merely wanting opportunity or fortuitous circumstances to have enabled them to shed a lustre over their race. And in some retired spot, may remain the mortal tenement from which the soul of an Arkwright, a Davy, a Watt, an Evans, or a Webster may have fled, which merely wanted education and opportunities for this development. The fact should be a lesson to those who laugh at novelties and put no faith in further invention, that the mighty steam engine, the triumph of art and skill, was once the laughing stock of jeering thousands, and once the waking dream of a boy's mind, as he sat, and in seeming idleness, mused upon a small column of steam spouting from a tea-kettle.

To Watt, however, must always be awarded the first place amongst the inventors and improvers of the steam-engine. For, although the scope of its application and usefulness has since been much extended, and numberless improvements in detail have been effected, the principles and action of the steam-engine remain much as Watt left them, nor has the economy of its running been greatly increased.

## CHAPTER III.

### HEAT AND WORK.

THE materiality of *heat* was discredited even by the earliest of philosophers, whose writings are preserved to us, and speculations were originated which indicate great philosophic intuition, and at some points approach very closely to the theories now almost universally accepted.

These, however, were hypotheses merely until Rumford proved experimentally that *heat* could not be a material substance, but was probably a manifestation of *work*. Mayer suggested the identity of *heat* with *work*, and the interchangeability of *heat* and motive *force*. Joule proved by a long series of experiments that the production of *heat* was attended by the disappearance of a definite amount of mechanical *work*.

The labors of Mayer and Joule resulted in the important discovery of the dynamical value of *heat*, or as it is usually termed, the mechanical equivalent of *heat*. This was found to be equal to 772 foot pounds for a degree Fahrenheit, communicated to one pound of water at its greatest density.

On the basis of this important discovery, and mainly by the labors of Rankine and Thomson, the experimental and other investigations of Black, Carnot, Rudberg, Regnault, and others have been elaborated into the science of thermodynamics.

The knowledge which the above law gives us is exceedingly valuable. From it we learn that in the very best engines that can be made, we are getting only about ten per cent. of the actual power of the coal employed.

If we take a condensing engine averaging 350 horse-power, with a consumption per hour of 630 pounds of coal on the fire-grate, the consumption per hour per horse-power will be:

$$\frac{630}{350} = 1.8 \text{ pounds of coal.}$$

The average anthracite coal contains about eighty-five per



cent. of carbon. Throwing away the other constituents, we are burning eighty-five per cent. of 1.8 pounds of pure carbon; or

$$\text{Carbon} = 1.8 \times 0.85 = 1.53 \text{ pounds.}$$

Experiments show that a pound of carbon generates, while burning to carbonic acid, 14,500 units of heat, that is, it gives off as much heat as will raise 14,500 pounds of water one degree Fahrenheit; and therefore 1.53 pounds will generate

$$14,500 \times 1.53 = 22,185 \text{ units of heat.}$$

We are, therefore, generating in round numbers 22,000 units of heat, and getting in exchange one indicated horse-power.

Above we have seen that one unit of heat is equivalent to 772 pounds raised one foot high; and therefore 22,000 units of heat are equivalent to

$$22,000 \times 772 = 16,984,000 \text{ foot pounds.}$$

But an indicated horse-power means 33,000 pounds raised one foot high per minute, which is equivalent to 33,000 multiplied by 60 minutes:

$$33,000 \times 60 = 1,980,000 \text{ foot pounds per hour.}$$

From this we see that we are burning coal sufficient to raise 16,984,000 foot pounds.

$$\frac{16,984,000}{1,980,000} = 8.58.$$

Therefore we are, in fact, out of one of the very best steam engines, getting but *one-ninth*, or about ten per cent., of the power we should do:

$$100 - 8.58 = 91.42 \text{ or ten per cent.}$$

#### Water.

Water was supposed to be an element until the latter part of the eighteenth century, when Priestley discovered that when hydrogen was burned in a glass tube water was deposited on the sides.

It is due to Cavendish and Lavoisier, who investigated water, that its chemical composition was determined.

The several conditions of water are usually stated as the solid, the liquid and the gaseous. Two conditions are covered

by the last term, and water should be understood as capable of existing in four different conditions—the solid, the liquid, the vaporous and the gaseous. At and below  $32^{\circ}$  Fahr. water exists in the solid state, and is known as ice. According to Rankine, ice at  $32^{\circ}$  has a specific gravity of 0.92. Thus a cubic foot of ice weighs 57.45 pounds.

When water passes from the solid to the liquid state, heat is required for liquefaction sufficient to elevate the temperature of one pound of water  $143^{\circ}$  Fahr. This is termed the latent heat of liquefaction. According to M. Person, the specific heat of ice is 0.504, and the latent heat of liquefaction 142.65.

From  $32^{\circ}$  to  $39^{\circ}$  the density of water increases; above the latter temperature the density diminishes.

Water is said to be at its maximum density at  $39^{\circ}$  Fahr, and under pressure of one atmosphere weighs, according to Berzelius, 62.382 pounds per cubic foot.

Water is said to vaporize at  $212^{\circ}$  Fahr, and at a pressure of 14.7 pounds (one atmosphere), but Faraday has shown that vaporization occurs at all temperatures from absolute zero, and that the limit to vaporization is the disappearance of heat. Dalton obtained the following experimental results on evaporation below the boiling temperature:

| <i>Temp.</i>  | <i>Rate of Evaporation.</i> | <i>Barometer.</i> |
|---------------|-----------------------------|-------------------|
| 212 . . . . . | 1.00 . . . . .              | 29.92             |
| 180 . . . . . | 0.50 . . . . .              | 15.27             |
| 164 . . . . . | 0.33 . . . . .              | 10.59             |
| 152 . . . . . | 0.25 . . . . .              | 7.93              |
| 144 . . . . . | 0.20 . . . . .              | 6.49              |
| 138 . . . . . | 0.17 . . . . .              | 5.57              |

From this, the general law is deduced that the rate of surface evaporation is proportional to the elastic force of the vapor.

Thus, suppose two tanks of similar surface dimensions and open to the atmosphere, one containing water maintained constantly at  $212^{\circ}$  Fahr., and the other containing water at  $152^{\circ}$  Fahr.

Then for each pound of water evaporated in the last tank, four pounds will be evaporated in the first tank.

It should be understood that the law of Dalton holds good only for dry air, and when the air contains vapor having an

elastic force equal to that of the vapor of the water, the evaporation ceases.

The boiling point of water depends upon the pressure. Thus at 14.7 pounds (barometer 29.22") the temperature of ebullition is 212°. With a partial vacuum, or absolute pressure of one pound (2.037 inches of mercury) the boiling point is 101.36° Fahr.

Upon the other hand, if the pressure be 89.7 pounds absolute (75 pounds by the gage), the temperature of evaporation becomes 320.10° Fahr.

The vaporous condition of water is limited to saturation. That is to say, when water has been converted by heat into steam (vapor), and when this steam has been furnished with latent heat sufficient to render it anhydrous, the vaporous condition ends and the gaseous state begins. Superheated steam is water in the gaseous state. Steam exists only as saturated and as superheated steam.

The temperature of the gaseous state of water, like that of the vaporous, depends upon the imposed pressure. Under pressure of 14.7 pounds, water exists in the solid state at and below 32° Fahr., from 32° to 212° it exists in the liquid state, at and above 212° in the vaporous state, and above saturation in the gaseous state.

It has been stated that water boils at 212°, but MM. Magnus and Donney have shown that when water is freed of air and is elevated in temperature to 170°, it will boil.

The specific heat of water under the several conditions is as follows:

|                         |                           |
|-------------------------|---------------------------|
| Solid, 0.504 . . . . .  | Vaporous, 0.475 to 1.000. |
| Liquid, 1.000 . . . . . | Gaseous, 0.475.           |

#### Boiling.

The temperature at which the formation of vapor takes place internally as well as on the surface of a liquid, is called the boiling point, and depends on the essential nature of the liquid and the superincumbent pressure. Water boils at 212° Fahr. under the normal atmospheric pressure of 29.92 inches of mercury, equal to a pressure on the square inch of 14.696 pounds, very nearly. It is common to say that an atmosphere

is 15 pounds on the square inch, or 30 inches of mercury. When evaporation occurs in a closed boiler, the space unoccupied by water is speedily filled with steam mixed with the air already present. To the pressure of the air the tension of the steam is now added, and consequently the water cannot boil at  $212^{\circ}$  Fahr. If the mixed air and steam are allowed to escape until the former has been entirely expelled, and the outlet valve is then closed and the temperature kept constant, in a short time as much steam will be formed as is possible at that temperature, and no further evaporation can take place. The steam has reached its maximum density and tension, and is termed saturated. Steam of higher pressure cannot exist at that temperature. A rise of temperature causes fresh evaporation, but this only continues until the steam attains the maximum pressure corresponding to the new temperature, hence the unit of volume of saturated steam weighs more than at a lower temperature, and therefore its density must be greater. Density and pressure of saturation (tension) stand in a fixed and invariable relation to each other, dependent upon temperature, and this forms the principal difference between steam and the so-called permanent gases. The latter follow Mariotte's law, and independently of temperature may be reduced to all degrees of density and pressure which are attainable by ordinary means. So long as water is present, steam in an inclosed vessel will remain saturated at all temperatures, but if heated when inclosed in a vessel by itself, the tension will rise in the same way as with gas; at the same time, however, the steam ceases to be saturated, and assumes the condition known as superheated. In this condition, of course, neither volume nor density can be changed. If saturated steam be allowed to expand at constant temperature, it ceases to be saturated, and decreases in tension and density, and behaves like superheated steam.

All steam may be considered as superheated which possesses a higher temperature at an equal density, or a lower density at an equal temperature, than saturated steam.

Steam which is greatly superheated approaches in its behavior a perfect gas, but if only slightly superheated, it is subject to special laws which lie between the two extremes of saturated steam and perfect gas.

Slight superheating frequently occurs without additional extraneous heat, for instance by throttling it in its passage. Should the steam in a pipe suddenly encounter an obstacle in the form of a reduction of section, an increase of speed at once takes place in the flow of steam; but, as this increase necessarily involves a lessening of the pressure, the steam behind the contraction is superheated, that is to say, its temperature is higher than the existing pressure warrants.

#### Steam.

Steam, like air, is an elastic, invisible fluid, into which water is converted by heat. It is a great mistake to imagine that the cloudy vapor that is seen issuing like white smoke from steamboats or locomotives is steam: the moment it becomes thus white and cloudy it ceases to be steam.

These misty particles are particles of water, and not steam. If a glass vessel is filled with pure steam, the steam will be as invisible as is the atmosphere. Steam is a gas made from water by the application of heat.

Steam may exist in different states of density; the pressure or elasticity is in proportion to the density.

It is well known that about 5.55 times the quantity of heat is necessary to convert a given quantity of water, at a temperature of 212 degrees, into steam, as is required to raise the same quantity of water from 32 to 212 degrees (Fahrenheit), and it further has been ascertained that steam, when produced under the pressure of the atmosphere (or 15 pounds per square inch), expands to nearly 1700 times the volume of the water which was evaporated, and that, during the process of evaporation, the *temperatures* of both water and steam continue at the same point as that of the water when ebullition commenced, which, under the pressure of 15 pounds per square inch, was 212 degrees Fahr.

The same law obtains at every degree of pressure under which steam might be formed, that is, until the whole of the water subjected to the experiment is evaporated; and however ardent the heat applied may be, the water and steam maintain the same temperature at which ebullition commenced.

This temperature varies with the pressure; and the volume is in the inverse ratio of the pressure—nearly.

The quantities of heat required to convert equal quantities of water into steam are theoretically the same under every pressure; but it must be observed that low pressure steam, when passing off rapidly from the vessel in which it is formed, contains many particles of water in mechanical combination with it. On the other hand, under high pressure, the water is thoroughly evaporated; hence the ratio of volume to pressure, and to the consumption of fuel, is augmented. The volume is also further increased under these circumstances, in consequence of the higher temperature. Water is familiar to us in three conditions, namely,

|                  |              |
|------------------|--------------|
| First . . . . .  | As a Solid.  |
| Second . . . . . | As a Liquid. |
| Third . . . . .  | As a Gas.    |

1st. It requires 140 degrees of heat to convert a pound of ice at 32 degrees into a pound of water at 32 degrees, with a decrease of volume of about one-ninth ( $\frac{1}{9}$ ).

2d. It requires 180 degrees of heat to raise water at 32 degrees to the boiling point (212 degrees under a pressure of 15 pounds per square inch), with an expansion of 0.0433.

3d. It requires about 1000 degrees of heat to convert a given quantity of water into steam at 212 degrees, with an increase of volume of 1700 under a pressure of 15 pounds per square inch.

The temperatures at which fluids boil depend on the pressure.

The volume of steam produced depends on the pressure and temperature.

The elasticity varies with the temperature. An increase of pressure augments the temperature, and *vice versa*. The *density* of steam, considered as a gas, varies inversely with the temperature under *like pressures*; and is directly as the pressure under *like conditions of temperature*.

It is inversely as the volume.

The specific gravity of steam under the pressure of the atmosphere is equal to 625, that of air being equal to 1000.

The weight of a cubic foot of air at 60 degrees is 535.68 grains. The weight of a cubic foot of steam at 212 degrees is 254.3 grains. The weight of a cubic foot of water at 60 degrees is 62.5 pounds.

## Atmospheric Pressure.

The pressure of the atmosphere varies a little at different times in the same localities, and the variation is not the same in one locality as compared with another, but the pressure is generally taken at  $14\frac{7}{16}$  pounds per square inch, as the average pressure at the sea level; and is most commonly reckoned at 15 pounds in mechanical calculations, in order to avoid the fraction  $\frac{1}{16}$ .

At  $14\frac{7}{16}$  pounds per square inch the atmosphere will balance a column of mercury (quicksilver) of about 30 inches in height. If a *vacuum* gage (either a spring gage or a column of mercury like a barometer), attached to the condenser of a steam-engine should indicate  $14\frac{7}{16}$  pounds, the condenser would be void or empty, that is, no steam or air would be in it. But should there be air or vapor in the condenser, the gage will show the pressure of the same by a fall in the mercury's height, or a falling back of the index of the gage. Thus, should the mercury stand at 29, 28, or 27 inches, or at  $13\frac{7}{16}$ ,  $12\frac{7}{16}$  or  $11\frac{7}{16}$  pounds by the spring gage, then there would be a back pressure of 1, 2, or 3 pounds per square inch in the condenser.

All pressures are measured from zero, or nothing, or from a *vacuum*, which word signifies *void*, or containing *nothing*.

## Vapors.

A vapor is a gas at a temperature near to that at which condensation occurs. All bodies assume the gaseous condition at suitable temperatures. In an intensely heated furnace even carbon has been made to appear as a gas, although only in a small quantity. Most solids liquefy before becoming gaseous; but some appear to become gases at once when subjected to intense heat.

According to Professor James Thomson, this always occurs when the boiling point of the substance at the given pressure is lower than the freezing point for the same pressure.

Vapors are formed more readily *in vacuo* than in the air; but, for any given temperature, the quantity of vapor which will form in a space from an exposed liquid is the same, whether air or other gases be present or not, the vapor being formed almost instantaneously in the second case, and requiring more or less time for formation in the first.

The pressure which this vapor eventually adds to the pressure of gases already existing in the space, depends on the temperature only, and is the same, no matter what may have been the previously existing pressure. When no more liquid will change into vapor, we may say that the space is *saturated*.

Unsaturated vapors follow approximately the laws of gases in expanding with heat. Steam, when passing along hot pipes to the engine, may be *superheated*; and its co-efficient of expansion will be found to differ very little from that of common air. By superheating steam we increase its volume, whilst its pressure, within certain limits, is unchanged. We also render it less liable to condense in the cylinder; and we convert into steam many particles of water which are often carried over from the foam in the boiler when the steam is not superheated.

#### Steam or Aqueous Vapor.

Water evaporates at all temperatures, and even ice, when exposed to the air, loses weight on this account. The evaporation of water takes place only on the surface in contact with air.

When the temperature of the water is elevated to or above that of the boiling point, then evaporation takes place in any part of the water where the temperature is elevated.

The weight of water evaporated in a given time is dependent on the following circumstances :

*First.* The area of the surface of exposed water.

*Second.* The temperature to which it is subjected.

*Third.* The movement of the atmosphere. When in a state of tranquillity, the air immediately above the water which is evaporating becomes saturated, and evaporation can then only continue as vapor, already set free, escapes by diffusion. When, on the contrary, the air is agitated, the damp strata are continually borne away and replaced by drier ones, and thus the process of evaporation is facilitated.

*Fourth.* The relative humidity of the atmosphere. The further the air is from its point of saturation, the more rapidly does evaporation take place.

*Fifth.* The pressure of the atmosphere. The less the pressure, the swifter the evaporation.

*Sixth.* By reason of adhesion to any moist body with which the water may be in contact.



The temperature of the boiling point depends upon the pressure on the surface of the water.

$P$  = pressure in pounds per square inch above vacuum on the surface of the water.

$T^\circ$  = temperature Fahrenheit of the boiling point.

$$T^\circ = 200 \sqrt[6]{P - 101} \dots \dots \dots 1$$

$$P = \left[ \frac{T^\circ - 101}{200} \right]^6 \dots \dots \dots 2$$

*Example 1.* At what temperature will water boil under a pressure of  $P=8$  pounds to the square inch?

This is under a vacuum of  $14.7-8=6.7$  pounds to the square inch.

$$\text{Temperature, } T^\circ = 200 \sqrt[6]{8-101} = 181.8^\circ$$

*Example 2.* What pressure is required to elevate the temperature of the boiling point of water to  $T^\circ = 330^\circ$ ?

$$\text{Pressure } P = \left[ \frac{330 + 101}{200} \right]^6 = 100 \text{ pounds.}$$

The temperature of the boiling point is the same as that of the steam evaporated under the same pressure.

Supposing the above formulas to be correct, the ideal zero of aqueous vapor should be at  $-101$  degrees Fahr., or at the temperature  $101$  degrees below Fahr. zero, there is no pressure of the vapor; that is, the force of attraction between the atoms is equal to the force of expansion by heat.

#### Latent Heat of Steam.

One pound of water heated, under atmospheric pressure, from  $32^\circ$  to  $212^\circ$ , requires  $180.9$  units of heat. If more heat is supplied, steam will be generated without elevating the temperature until all the water is evaporated, which requires  $1146.6$  units of heat, and the steam volume will be  $1740$  times that occupied by the water at  $32^\circ$ .

Then,  $1146.6-180.9=965.7$  units of heat will be absorbed in the steam, the temperature of the latter not being raised. This is what is called *latent heat*, because it does not show as temperature, but is the heat consumed in performing the work of converting the water into steam.

One cubic foot of water at  $32^{\circ}$  weighs 62.387 pounds; if heated to the boiling point,  $212^{\circ}$ , there will be required:

$$62.387 \times 180.9 = 11285.8 \text{ units of heat,}$$

and if evaporated to steam under atmospheric pressure, there will be required:

$$62.387 \times 1146.6 = 71532.9 \text{ units of heat,}$$

of which

$$71532.9 - 11285.8 = 60247.1 \text{ will be latent,}$$

It is this latent heat which generated 1740 cubic feet of steam from the cubic foot of water.

The work accomplished by these latent units of heat against the atmospheric pressure will be:

$$K = 144 \times 14.7 \times (1740 + 1) = 3681115 \text{ foot pounds.}$$

$$\text{Foot pounds per unit of heat, Joule} = \frac{3681115}{60247.1} = 61.1.$$

The heat expended in elevating the temperature of the water from  $32^{\circ}$  to  $212^{\circ}$  is not realized as work.

#### Volume of Water.

Water, like other liquids, expands in heating and contracts in cooling, with the exception that in heating it from  $32^{\circ}$  to  $40^{\circ}$  it contracts, and expands in heating from  $40^{\circ}$  upwards. The greatest density or smallest volume of water is therefore at  $40^{\circ}$  Fahr.

#### Latent and Total Heat in Water from $32$ Degrees.

When water expands it absorbs heat, which is not indicated as temperature, but remains latent.

The latent heat in water heated from  $32^{\circ}$  to  $40^{\circ}$  is negative, that is, the water indicates more temperature than units of heat imparted to it. The volume at  $32^{\circ}$  is 1.000156, and the heat units required to raise the temperature of one pound of water from  $32^{\circ}$  to  $40^{\circ}$  or  $8^{\circ}$  are:

$$0.999844 \times 8 = 7.99875 \text{ units.}$$

The heat units required to raise the temperature of one pound of water from  $32^{\circ}$  to  $212^{\circ}$  or  $180^{\circ}$  are 181 units. The heat units required to raise water from  $32^{\circ}$  to  $350^{\circ}$  or  $318^{\circ}$  are 322 units, or 4 units more than the increase of temperature.

### Temperature of Boiling Liquid.

While the temperature of saturated steam always corresponds, when protected against cooling, to the pressure, that of the liquid from which the steam is formed may vary within a few degrees; for, when the latter begins to boil, the lower layers which lie immediately above the heated bottom are hotter than the upper. The steam bubbles which form at the bottom of the vessel condense as they rise with noise (illustrated by the so-called singing of the water that takes place in the common tea-kettle), and only reach the surface when the temperature throughout becomes more uniform.

For the formation of such bubbles in a liquid, it is necessary that the cohesion of the particles among themselves, and their adhesion to the sides of the vessel, be overcome.

### Condensation of Steam.

Steam is condensed either by cooling or compression, passing during the process of condensation from the unsaturated to the saturated, and finally into the liquid state. As a very large amount of heat is set free by condensation, steam is, for many purposes, a very convenient vehicle for the conveyance of heat.

### Wet and Dry Steam.

Steam which is formed rapidly carries with it from the boiler fine drops of water, and is called "wet steam;" to distinguish it from "dry steam," which is unmixed with liquid. The employment of wet steam causes a great loss, as the heat contained in the water is not available in either the steam-engine or the heating apparatus, while the water itself collected in the steam pipe is apt to give trouble in the cylinder. Therefore, the best steam boilers are those provided with a steam dryer. Steam is especially moist when the evaporation follows decrease of pressure.

### Throttling of Steam.

When steam is reduced in pressure by passing it through a contracted passage, as in a stop-valve partly closed, the speed of the steam in passing through will increase correspondingly. As soon as the narrow part is passed, however, the normal speed is resumed, and the force acquired by the steam escapes as heat.

Any water it may have originally conveyed is, by the increase of heat, converted into steam, and thus the steam is drier than before the throttling.

#### Low and High Pressure Steam.

Steam, or the vapor of water, when produced at the usual pressure of the atmosphere and 15 pounds above, is commonly called *low pressure*; and that which exceeds 15 pounds per square inch is termed *high pressure*.

The early steam engines used steam at the atmospheric pressure, or a few pounds per square inch above the atmosphere, and were fitted with a condenser, and by condensing the exhaust steam gained the additional pressure due to the atmosphere; and were usually called *low pressure engines*, instead of condensing engines, their proper name.

In the present advanced state of the art, high pressure steam is now most generally used for supplying condensing engines.

The proper terms for engines at the present time are *condensing*, *compound condensing*, *non-condensing* and *non-condensing compound engines*, respectively.

#### Absolute Pressure.

It is customary to express the elastic force of steam in three ways:

*First.* In pounds of pressure that it exerts on the square inch.

*Second.* The height of the column of mercury which it sustains.

*Third.* In atmospheres. As the actual pressure of the atmosphere is continually varying, engineers have decided to employ 29.922 inches of mercury, which is equal to a pressure on a square inch of 14.696 pounds, nearly, but in practice 14.7 pounds is used.

Water evaporated in the open air is said, according to this notation, to be transformed into steam of zero pressure, instead of steam of 14.7 pounds pressure per square inch, which pressure counter-balances that of the atmosphere. If such steam is used in a condensing engine, the effect is said to be due to *vacuum*, which is still regarded by some people as a separate force unconnected with steam, and in fact operating on the

opposite side of the piston. When steam of higher pressure is used, it is customary, in finding the horse-power, to add the *vacuum* to the *steam pressure*, thus carrying out the same idea.

The absolute pressure of steam is measured from zero or perfect vacuum, and consists of the pressure as shown by the steam-gage (which only shows the pressure above atmospheric pressure), and as before stated, the pressure of the atmosphere is indicated by the barometer. The latter may, for all practical purposes, be taken at 15 pounds, corresponding to 30.6 inches of mercury. The vacuum gages in general use are usually graduated to agree with the scale of the barometer, and the vacuum is usually stated in inches of mercury. To the steam pressure shown by gage, add 15 pounds for total pressure. Thus, if the pressure gage indicates 75 pounds, the total or *absolute* pressure is 90 pounds per square inch. When the piston moves forward in an engine, the total pressure on steam side at any point in the stroke of piston is, the pressure above the atmosphere plus 15 pounds, and the total pressure for whole stroke is the mean pressure above the atmosphere plus 15 pounds. Thus, if the mean pressure for the whole stroke is 25 pounds as per gage, the total mean pressure is  $15 + 25 = 40$  pounds; and this 40 pounds, whether the engine is operated as a condensing or non-condensing engine, is the variable factor in estimating the load on the engine.

Now if the engine be operated as a non-condensing one, the 15 pounds (pressure of atmosphere) on steam side is balanced by a like pressure of atmosphere on exhaust side of piston, and its effect is annihilated or reduced to nothing. But, if the engine be operated as a condensing one, a large proportion of the pressure of atmosphere on the steam side of the piston is made to do useful work. With well-proportioned condensing apparatus, the pressure of the atmosphere on the exhaust side of the piston can be reduced nearly *ninety per cent.*—in other words, a vacuum in the exhaust end of the cylinder of 26.5 inches (13 pounds) may be maintained, and this 26.5 inches or 13 pounds per square inch of area of the piston is an absolute gain, and should in all cases be utilized.

Absolute or total pressure means the steam pressure in pounds per square inch, including the pressure of the atmosphere, and

is generally denoted by  $P$ ; and  $p$  is used to denote the steam pressure above atmosphere, as is shown on the ordinary steam gage. If a mercury column is used, it is shown in inches and fractions of an inch. The specific gravity of mercury at  $32^{\circ}$  Fahr. is 13.5959, compared with water of maximum density at  $39^{\circ}$ . One cubic inch of mercury weighs 0.491 of a pound; and a column of 29.922 inches is equivalent in weight to that of the atmosphere or 14.7 pounds per square inch, very nearly.

#### Latent Heat and the Heat of Chemical Combination.

If we warm a pound of ice, having a temperature of 32 degrees Fahr., we find that when all the ice is melted the water exhibits no augmentation of temperature, the thermometer still standing at 32 degrees, although heat enough has been added to have heated *one* pound of water, at 32 degrees, to 143 degrees Fahrenheit. If, again, we continue to heat the resulting water, the temperature rises until the thermometer stands at 212 degrees, when the water begins to boil. The thermometer now remains stationary, and the water gives off steam, at the same temperature, until it is all boiled away; and to convert the pound of water, at 212 degrees, into a pound of steam at the same temperature, 966.6 times as much heat is required as is needed to raise one pound of water one degree of Fahrenheit. Hence the latent heat of water is said to be 143 degrees; that of steam 966.6 degrees Fahrenheit; so designated by those who first observed the phenomenon, because the heat thus employed to melt the ice, or evaporate the water, was hidden and not sensible to the thermometer. The mechanical theory of heat, however, explains what has become of this hidden heat. It declares that the heat thus expended is consumed in doing internal work. It separates the particles of the ice to form water, or of the water to form steam, and it is given off whenever the water is frozen or the steam condensed. The quantity of heat which is evolved in these changes of state is but very small compared to that set free when the constituent elements of the water undergo combination.

#### Units.

The *exact* determination of the equivalent values of the units is very difficult, and has been the subject of much scientific in-

vestigation. When a quantity can be measured directly, the *unit* is generally of the same quality as the thing to be measured; thus, the *unit* of *time* is *time*, as a day or second; the *unit* of *length* is *length*, as one inch, foot; the *unit* of *volume* is volume, as one cubic foot; the *unit* of *money* is money; of *weight* is weight; of *momentum* is momentum. The *unit* of *work* or *power* is one pound raised one foot high, or one pound of force acting through one foot of distance, and is called the foot-pound, and is taken as our standard *unit* of work done.

33,000 foot-pounds, or units of work, performed in one minute, or 550 pounds in one second, represent one horse-power.

The *unit* of *elasticity*, by which the expansive force exerted by elastic fluids is measured, is, for popular use, one pound on one square inch.

The scientific unit of elasticity is one atmosphere.

One atmosphere is equal to 29.9218004 inches of mercury.

One atmosphere is equal to 406.814704 inches of water.

One atmosphere is equal to 14.696303 pounds on the square inch.

One pound on the square inch is equal to 27.68143 inches of water.

One pound on the square inch is equal to 2.03601 inches of mercury.

The *unit* of *temperature* is the degree Fahrenheit, or  $\frac{1}{180}$  part of the distance on the thermometric scale between the freezing and the boiling points of water, under the pressure of one atmosphere.

The *unit* of *heat* is the quantity of heat necessary to be added to one pound of water, at or near to its freezing point, to raise its temperature one degree Fahrenheit. Water at 32° Fahrenheit is the unit, or standard, of comparison employed for all measurement of the capacities for heat of all substances whatever. If the specific heat of water were constant, then the unit of heat would be merely the quantity of heat required to raise the temperature of one pound of water one degree, which would be the same throughout the entire thermometric scale; but since the specific heat of water is not constant, the unit must be the quantity so required at the temperature at which the specific heat of water is one, and that is 32°. It is immaterial

what the volume of a pound of water may be, as the density of water has no relevancy to this branch of the subject.

One unit of heat is equivalent to 772 units of work. This is known as the mechanical equivalent of heat, or in honor of the physicist by whose investigations this relation has been established, is known as "Joule's equivalent."

The *specific heat* of a body is the quantity of heat necessary to be imparted to it in order to raise its temperature one degree, as compared to the quantity that is required to raise by one degree the temperature of an equal weight of water at or about the temperature of 32 degrees. The specific heat of water is greater than that of any other substance, so that this being taken as one, that of any other substance is expressed in decimals.

The specific heat of superheated steam was investigated by M. Reynault, who ascertained it to be 0.48051.

The *unit of specific gravity* is the weight of water. The specific gravity of a body is its weight at the temperature of 32 degrees Fahrenheit, compared with that of an equal volume of water.

The volume of water being 1—

That of the same weight of air at 32° is 773.283.

And that of the same weight of mercury at 32°, 0.0735514.

The volume of one pound of water is 27.68143 cubic inches, or 0.01602 of a cubic foot.

The weight of a cubic foot of water is 62.4245 pounds.

The weight of a cubic foot of air is 0.080727 of a pound.

The weight of a cubic inch of water is 0.036126 of a pound.

The weight of a cubic inch of mercury is 0.49116 of a pound.

#### Expansion.

The rate of expansion of water by heat varies more than that of any other substance. Between 39.1° and 212° its volume increases from 1 to 1.04332, and its expansion for each one degree added to its temperature, increases from 0 at 40° to 0.00044 at 212°. Above the latter point nothing is known about it.



## CHAPTER IV.

### EXPANSION.

WHEN a volume of air is compressed into a smaller volume, a certain amount of power is expended in compressing it, which power, as in the case of a bent spring, is given back when the pressure is withdrawn. If, however, compressed air is suddenly released into the atmosphere, the power expended in compressing it is lost. But the work existing in such compressed air can be readily utilized in propelling a piston by its expansion. Now, the steam used to propel engines is in the condition of air already compressed, and to save the power which would be lost if the steam were suddenly released into the atmosphere, it must be used expansively, and to use it expansively with regard to economy, it must be cut off, that is, the steam-port must be closed before the piston has completed its stroke. If the flow of steam to an engine be cut off when the piston has performed one-half stroke, leaving the stroke to be completed by the expanding steam, it has been found by experiment that the efficacy of a given quantity of steam will be increased 1.7 times beyond what it would have been if the steam at half-stroke had been released into the atmosphere, instead of allowing it to expand in the cylinder. If cut off at one-third of the stroke, the efficiency will be increased 2.1 times; at one-fourth stroke, 2.4 times; at one-fifth, 2.6 times; at one-sixth, 2.8 times; at one-seventh, 3 times; and at one-eighth, 3.2 times.

### Expansion of Steam.

The law of the expansion of steam is established with hardly less certainty than that the attractive force of gravity is inversely as the square of the distance. Whatever pressure may be exerted upon the piston of a steam engine, while the communication between the boiler and the cylinder is open, it is absolutely certain that unless the steam be immediately condensed or discharged into the air, pressure will be exerted after

the communication with the boiler has been closed. If the piston be free to move along the cylinder, a gradually diminishing pressure, corresponding to the increased volume to which the steam is thus expanded, will be exerted. All the force thus obtained while the piston is in motion, and after the closing of the valve, is so much gain over and above the effect due to the same amount of steam when employed in the manner known as "full stroke," inasmuch as none of this additional pressure would have been exerted had the stroke of the piston terminated at the point at which the steam was cut off. From this gain, however, whatever it may be, is to be deducted the friction of the engine while running with expanded steam, and as the steam loses a considerable part of its temperature during expansion, there is a further loss also from the fact that the cylinder is cooled, and it thus condenses a certain amount of steam on the next stroke, before its temperature is restored. These losses may be measured, however, and they should never, as they seldom do, exceed the gain realized from expansion. To secure the highest gain from expansion, the engine must be fitted with a condenser.

To simplify the action of expanding steam let us take an upright cylinder one inch in diameter and at least 1,700 inches in height, pour into it one cubic inch of water, fit into it a steam tight piston, resting on the water, so counterbalanced as to be weightless, and so arranged as to work without friction, and then place a lamp under the cylinder; we then notice that so soon as the water reaches the temperature of 212 degrees, it will begin to boil and produce steam, and the steam will begin to push up the piston. So long as the lamp continues to burn and the water continues to boil, so long will the steam continue to push up the piston, until all of the water has been evaporated into steam. When all of the water has so evaporated, it will be found that from one cubic inch of water there has been produced 1,700 cubic inches of steam, and as this would fill 1,700 cubic inches of the cylinder, and as the pressure of the atmosphere—the only resistance in this case to be overcome—is 15 pounds (14.7 exact) to the square inch, this experiment would show that one cubic inch of water wholly evaporated into steam, will push or lift, say 15 pounds 1,700 inches, or 142 feet.

If, now, the experiment be carried a little further with a similar cylinder and piston, and 15 pounds be loaded on the piston, making with atmospheric pressure 30 pounds, we shall find that under this additional pressure the temperature of the water must be raised to 252 degrees, instead of 212 degrees, before it begins to boil, and before the steam begins to push up the piston, and that when the whole of the water is evaporated, there will be only 850 instead of 1,700 cubic inches of steam, and the piston will be pushed or lifted up only 850 instead of 1,700 inches, or in round numbers, 71 feet. If, then, one cubic inch of water wholly evaporated, will produce steam enough to push or lift 15 pounds 142 feet, and 30 pounds 71 feet, it would produce steam enough to push or lift 142 times 15 pounds, or—

$$142 \times 15 = 2,130 \text{ pounds—}$$

say one ton one foot. When, then, the steam from one cubic inch of water has pushed or lifted one ton one foot, it has done all it can do, and, if the experiment is to be repeated, this spent steam must be released by means of a valve, called the exhaust valve, and more steam admitted or generated to push or lift up the piston. The machinery used in this experiment represents simply a full-stroke or non-expansion engine, making one stroke, and for each stroke made by such an engine, the utmost possible power to be obtained is equivalent to one ton lifted one foot for every cubic inch of water evaporated, no more, no less. This is all the power we can get out of a steam engine without a cut-off.

But let us experiment a little further. Suppose we load the piston with one ton of bricks, and suppose, instead of opening the exhaust valve, we remove one of the bricks, the load being thus to this extent diminished, the steam, no longer compressed by the whole ton, will expand a little and push or lift up the rest of the bricks a little further, and as brick after brick is removed, the steam will push or lift up the rest of the bricks further and further, until the last brick having been removed, it will be found that the steam has pushed or lifted up the piston to the full height of 1,700 inches, or 142 feet. Now, it will be seen from this experiment, that all the power which was exerted by the steam, as the bricks were successively removed, was a

clear gain, as it cost no fuel or steam other than that which had already pushed or lifted the one ton one foot, and it could do no more, unless and until the steam was relieved of a part or the whole of the resisting weight or pressure. This principle, the law of expanding steam, was discovered by James Watt.

#### The Most Economical Point of Cut-off.

The higher the grade or ratio of expansion the greater is the economy; but the result is somewhat modified by other considerations.

*First.* The higher the rate of expansion the lower is the mean or average pressure throughout the stroke, and a low mean pressure involves the use of a large engine for a given power.

*Second.* With a high rate of expansion the mean pressure is much lower than the initial pressure, and although the power of the engine is only due to the mean pressure, the strength of the engine must be sufficient to withstand the initial pressure.

*Third.* A very high rate of expansion also leads to a very low final pressure, and as to drive the engine itself against its own friction only, and to expel the steam from the cylinder, seldom requires less than three pounds above the external pressure, it follows that if the steam is so far expanded that the terminal pressure falls below this, the expansion is excessive, and the reverse of advantageous.

In non-condensing engines the lowest final pressure is determined by the pressure of the atmosphere, say 15 pounds per square inch, and 18 pounds may be taken as the lowest pressure to which steam can be expanded with advantage. If the exhaust passages are small or the exhaust steam damp, a higher final pressure will be more economical. In condensing engines the temperature of the condenser is generally about 100 degrees Fahr., and the pressure corresponding to this is about one pound per square inch, but the presence of air in the condenser generally prevents the pressure there falling below two pounds per square inch. From four to five pounds may be taken as the lowest advantageous final pressure.

*Fourth.* The highest advantageous rates of expansion, even with jacketed cylinders, appear in practice to be between *twelve*

and *sixteen times*. Higher rates are and should be aimed at, but with our present arrangement of engine, it is doubtful whether the increased economy of very high ratio or grades, pays for the increased complications and the extra cost of the apparatus required to attain it. In unjacketed cylinders the limit of advantageous expansion is much under the lowest of the grades named.

In practice the best result of steam engines does not convert more than *ten per cent.* of the heat used by it into work, and this too in engines of considerable size, and with boilers and furnaces fairly efficient. In small engines it is much less; indeed, it is certain that few among the thousands of steam engines in daily use below five horse-power, give an efficiency greater than *five per cent.* The great cause of loss is the amount of heat necessary to change the water from the liquid to the gaseous state, most of this being expelled with the exhaust either into the condenser or the atmosphere. Many attempts have been made to use liquids of lower specific heat than water, and requiring less heat for evaporation, the principal being alcohol, ether and carbon bisulphide; but for obvious reasons no success has been attained.

#### Action and Work of Expanding Steam.

When steam is supplied to move a piston alternately in a cylinder, and the valve for admission of steam is open during the full stroke of the piston, the cylinder is filled with steam at every stroke, of a pressure nearly equal to that of the boiler, and is exhausted at nearly the same density. The following diagram, Fig. 4, was taken under such circumstances.

In order to save steam, or more correctly to employ its effects to a higher degree, the admittance of steam to the cylinder is cut off when the piston has moved a portion of its stroke. From the cut-off the steam acts expansively with a decreased pressure on the piston, as shown in the following diagram, Fig. 5.

If we admit steam of 85 pounds boiler pressure, to which we add 15 pounds, the atmospheric pressure, the total pressure per square inch in the cylinder will be as follows:

$$85 + 15 = 100 \text{ pounds per square inch.}$$

Now if we cut off the steam when the piston has traveled half the length of the stroke, from *k* to *e*, the steam remaining in the cylinder will expand to double its volume in forcing the

FIG. 4.

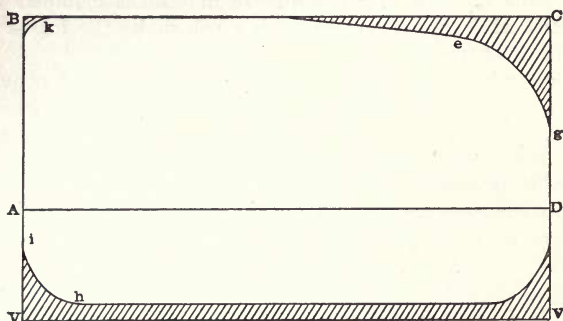

piston to the end of the cylinder, and a certain amount of *work* has been done with half the quantity of steam, as illustrated in the shaded diagram Fig. 5. The steam in expanding after the

FIG. 5.

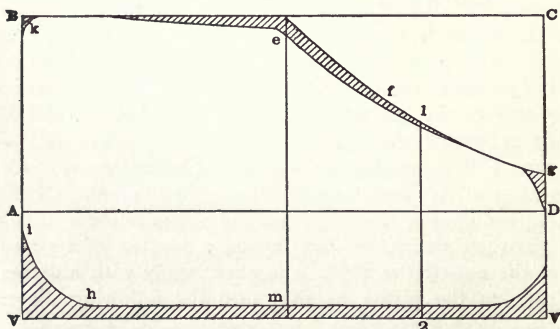

port is closed, during the rest of the stroke continues to do work, as the pressure of the expanding steam is greater in the cylinder than that in the condenser. Now this work performed after the steam was cut off, is greatly in excess of that performed in

Fig. 4, as compared to the respective volumes, as 5 is to 10, and has been obtained by the use of expansion. In this latter case the steam expanded twice its volume, and its pressure was exactly half what it was before; namely, 50 pounds per square inch.

In making this calculation for pressure of steam after it has expanded, the *total pressure P*, must be used, which is reckoned from perfect vacuum.

In Fig. 4, *VB* is the diameter, and *AD* the length of the stroke; the pressure during the stroke, when there is no expansion, is assumed at 85 pounds, as per steam gage, *plus* 15 pounds for perfect vacuum.

$$85 + 15 = 100 \text{ pounds total pressure per square inch.}$$

Now, if the steam is cut off when the piston has moved one-half the length of the cylinder, see diagram Fig. 5, from *k* to *e*, the steam, the volume of which is *V, B, e* and *m*, must expand and fill the whole cylinder, its pressure getting less and less, so that such lines as *e, m, 1, 2*, and *g, V*, in Fig. 5 and *e, m, 1, 2, 3, 4* and *g, V* in Fig. 6, represent pressure at different parts of the stroke, and the curve *e, f, 1, 3*, and *g*, is the expansion curve.

FIG. 6.

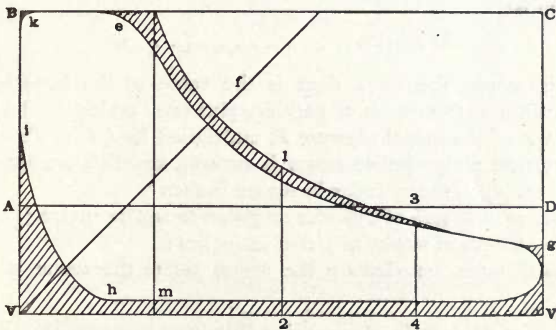

The above diagram, Fig. 6, represents the same engine cutting off at one-quarter the stroke, the average pressure being 59.65 pounds mean pressure.

In fact, Figs. 4, 5 and 6 (heavy shading) are theoretical indi-

cator diagrams, supposed to be taken from a condensing engine. The diagram on the face is the ideal one. The average pressure from a non-condensing engine would be arrived at in the same way, but 15 pounds would be deducted after the calculations were made to allow for pressure of the atmosphere, and hence their areas indicate the relative amounts of work performed in a single stroke of the engine, when there is:

*First.* No cut-off.

*Second.* Cut-off at half stroke.

*Third.* Cut-off at one-fourth of the stroke.

Now the area of Fig. 5 is nearly equal to that of Fig. 4, so that when expansion is allowed, a cylinder *half full of steam* will perform more than *three-fourths* as much work as the cylinder *full of steam* at the *same* initial pressure, can perform *without expansion*.

As a further illustration, Fig. 6 is the diagram that would be made if the steam were cut off after the piston had traveled one-fourth of the stroke. In this case only one-fourth the steam would be required, as was for Fig. 4, performing more than one-half as much as the latter with one-fourth of the steam.

Assuming that in the cylinder the volume of *steam varies inversely as the pressure*, the work done in one stroke of the piston is:

$$A l P (1 + x) \dots \dots \dots 1.$$

Or, in words, the work done is the value of the hyperbolic logarithm  $x$ , from table 2, page 69, plus one, multiplied by the product of the initial pressure  $P$ , multiplied by  $l$ , (the distance the piston moves before steam is cut off), and this product by the area  $A$ , of the cylinder in square inches.

Where  $A$  = area of cylinder or piston in square inches ;

$L$  = length of stroke of piston in inches ;

$l$  = distance traveled by the piston before the steam is cut off ;

$g$  = grade or ratio of expansion  $\frac{L}{l}$

$x$  = hyperbolic logarithm of  $g$  (see table 2) ;

$P$  = initial pressure of steam in pounds per square inch, measuring from perfect vacuum in cylinder before cut-off takes place ;—



Then  $mp$  = mean average pressure after cut-off takes place and during full stroke, in pounds per square inch, and is found by the following formula:

$$mp = \frac{P}{g} (1 + x) \dots \dots \dots 2.$$

Mean Pressure.

When the steam is expanded in the cylinder, the mean pressure ( $mp$ ) throughout the stroke of the piston, will be less than the initial pressure  $P$ . The mean pressure  $mp$  during expansion, will be according to formula 2; or in words:

*Rule.*—Divide the initial pressure  $P$  by the proportion or grade  $g$  of the stroke, during which the steam is admitted, and multiply the quotient by the hyperbolic logarithm  $x$ , plus one (take the value  $x$  from table 2).

Ratio, or Grade of Expansion.

The proportion or grade  $g$  of the stroke during which the steam is admitted, is found by dividing the length  $L$  in inches of the cylinder swept through by the piston by the length  $l$  in inches of the space into which the steam is admitted.

*Example.*—Suppose the length of the stroke of the piston is  $L = 80$  inches, the initial pressure  $P = 90$  pounds per square inch, and the steam to be cut off at  $l = 20$  inches of the stroke, what will be the mean pressure?

Formula 2:

$$mp = \frac{P}{l} (1 + x).$$

$$\text{Grade or ratio } g = \frac{80}{20} = 4 \text{ grade.}$$

Hyperbolic logarithm of 4 = 1.386 (see  $x$  in table No. 2).

Then we have

$$mp = \frac{90}{4} \times (1 + 1.386) = 53.68 \text{ pounds per square inch,}$$

the mean pressure required.

The initial pressure  $P$  given above is the total pressure, measured from perfect vacuum. To find the initial pressure  $P$ , add the atmospheric pressure 15 pounds to the pressure  $p$ , as shown by the steam gage, and from the mean pressure ( $mp$ ) found as

above, subtract the counter or back pressure from effective mean pressure exerted. Thus, in the above case the steam gage is supposed to show a pressure  $p$  of 75 pounds, to which is added 15 pounds for the atmosphere, making

$$75 + 15 = 90 \text{ pounds total pressure.}$$

Assuming the engine to be condensing, in practice we must deduct for loss from imperfect vacuum not less than *four* pounds, and for a non-condensing engine the pressure of the atmosphere. Any estimated counter or back pressure above that must be subtracted from the mean pressure obtained by the calculation.

TABLE NO. 1.  
HYPERBOLIC LOGARITHMS.

|     |         |     |         |     |         |     |         |
|-----|---------|-----|---------|-----|---------|-----|---------|
| 1.  | 0.00000 | 2.6 | 0.95548 | 4.2 | 1.43505 | 5.8 | 1.75785 |
| 1.1 | 0.09530 | 2.7 | 0.99323 | 4.3 | 1.45859 | 5.9 | 1.77495 |
| 1.2 | 0.18213 | 2.8 | 1.02962 | 4.4 | 1.48161 | 6.  | 1.79175 |
| 1.3 | 0.26234 | 2.9 | 1.06473 | 4.5 | 1.50408 | 6.1 | 1.80827 |
| 1.4 | 0.33646 | 3.  | 1.09861 | 4.6 | 1.52603 | 6.2 | 1.82545 |
| 1.5 | 0.40505 | 3.1 | 1.13140 | 4.7 | 1.54753 | 6.3 | 1.84055 |
| 1.6 | 0.46998 | 3.2 | 1.16314 | 4.8 | 1.56859 | 6.4 | 1.85629 |
| 1.7 | 0.53063 | 3.3 | 1.19594 | 4.9 | 1.58922 | 6.5 | 1.87180 |
| 1.8 | 0.58776 | 3.4 | 1.22373 | 5.  | 1.60944 | 6.6 | 1.88658 |
| 1.9 | 0.64181 | 3.5 | 1.25276 | 5.1 | 1.62922 | 6.7 | 1.90218 |
| 2.  | 0.69315 | 3.6 | 1.28090 | 5.2 | 1.64865 | 6.8 | 1.91689 |
| 2.1 | 0.74190 | 3.7 | 1.30834 | 5.3 | 1.66770 | 6.9 | 1.93149 |
| 2.2 | 0.78843 | 3.8 | 1.33046 | 5.4 | 1.68633 | 7.  | 1.94591 |
| 2.3 | 0.83287 | 3.9 | 1.36099 | 5.5 | 1.70475 | 7.1 | 1.96006 |
| 2.4 | 0.87544 | 4.  | 1.38629 | 5.6 | 1.72276 | 7.2 | 1.97406 |
| 2.5 | 0.91629 | 4.1 | 1.41096 | 5.7 | 1.74046 | 7.3 | 1.98787 |
| 7.4 | 2.00149 | 8.8 | 2.17482 | 12  | 2.48491 | 26  | 3.25810 |
| 7.5 | 2.01490 | 8.9 | 2.18615 | 13  | 2.56494 | 27  | 3.29584 |
| 7.6 | 2.02816 | 9.  | 2.19722 | 14  | 2.63906 | 28  | 3.33220 |
| 7.7 | 2.04115 | 9.1 | 2.20837 | 15  | 2.70805 | 29  | 3.36730 |
| 7.8 | 2.05415 | 9.2 | 2.21932 | 16  | 2.77259 | 30  | 3.40120 |
| 7.9 | 2.06690 | 9.3 | 2.23014 | 17  | 2.83321 | 31  | 3.43399 |
| 8.  | 2.07944 | 9.4 | 2.24085 | 18  | 2.89037 | 32  | 3.46574 |
| 8.1 | 2.09190 | 9.5 | 2.25129 | 19  | 2.94444 | 33  | 3.49651 |
| 8.2 | 2.10418 | 9.6 | 2.26191 | 20  | 2.99573 | 34  | 3.52636 |
| 8.3 | 2.11632 | 9.7 | 2.27228 | 21  | 3.04452 | 35  | 3.55535 |
| 8.4 | 2.12830 | 9.8 | 2.28255 | 22  | 3.09104 | 36  | 3.58352 |
| 8.5 | 2.14007 | 9.9 | 2.29171 | 23  | 3.13549 | 37  | 3.61092 |
| 8.6 | 2.15082 | 10  | 2.30258 | 24  | 3.17805 | 38  | 3.63759 |
| 8.7 | 2.16338 | 11  | 2.39589 | 25  | 3.21888 | 39  | 3.66356 |

### Hyperbolic Logarithms.

In estimating the power which an engine will exert with a given pressure of steam, to be cut off at any given point of the

stroke, we ascertain the mean pressure on the square inch which will be exerted during the stroke by means of the table of hyperbolic logarithms, which latter are calculated for expansion according to the law of Boyle and Mariotte.

The common logarithm multiplied by 2.30258509 gives the hyperbolic logarithm, and the hyperbolic logarithm multiplied by 0.43429448 gives the common logarithm.

The above table contains hyperbolic logarithms for numbers up to 39, which is considered sufficient for application to expansion of steam.

TABLE NO. 2.

| Portion of Stroke at which Steam is Cut-off. | Grade or Ratio of Expansion. | Hyperbolic Logarithm. | Mean Pressure of Steam during the Whole Stroke. | Percentage of Gain in Fuel or Power. |
|--|------------------------------|-----------------------|---|--------------------------------------|
| <i>l</i>                                     | <i>g</i>                     | <i>x</i>              | <i>m p</i>                                      | %                                    |
| $\frac{1}{10}$ or 0.1                        | 10.0                         | 2.302                 | 3.302   | 230.0                                |
| $\frac{1}{10}$ or 0.125                      | 8.0                          | 2.179                 | 3.079   | 208.0                                |
| $\frac{1}{10}$ or 0.166                      | 6.0                          | 1.791                 | 2.791   | 179.0                                |
| $\frac{1}{10}$ or 0.2                        | 5.0                          | 1.609                 | 2.609   | 161.0                                |
| $\frac{1}{10}$ or 0.25                       | 4.0                          | 1.386                 | 2.386   | 130.0                                |
| $\frac{1}{10}$ or 0.3                        | 3.33                         | 1.203                 | 2.203   | 120.0                                |
| $\frac{1}{10}$ or 0.333                      | 3.0                          | 1.099                 | 2.099   | 110.0                                |
| $\frac{1}{10}$ or 0.375                      | 2.66                         | 0.978                 | 1.978   | 97.8                                 |
| $\frac{1}{10}$ or 0.4                        | 2.5                          | 0.916                 | 1.916   | 91.6                                 |
| $\frac{1}{10}$ or 0.5                        | 2.0                          | 0.693                 | 1.693   | 69.3                                 |
| $\frac{1}{10}$ or 0.6                        | 1.666                        | 0.507                 | 1.507   | 50.7                                 |
| $\frac{1}{10}$ or 0.625                      | 1.6                          | 0.470                 | 1.470   | 47.1                                 |
| $\frac{1}{10}$ or 0.666                      | 1.5                          | 0.405                 | 1.405   | 40.5                                 |
| $\frac{1}{10}$ or 0.7                        | 1.42                         | 0.351                 | 1.351   | 35.1                                 |
| $\frac{1}{10}$ or 0.75                       | 1.33                         | 0.285                 | 1.285   | 22.3                                 |
| $\frac{1}{10}$ or 0.8                        | 1.25                         | 0.223                 | 1.223   | 20.5                                 |
| $\frac{1}{10}$ or 0.875                      | 1.143                        | 0.131                 | 1.131   | 13.1                                 |
| $\frac{1}{10}$ or 0.9                        | 1.11                         | 0.104                 | 1.104   | 10.4                                 |

The above, Table 2, contains the hyperbolic logarithms for numbers running from 1.11, the grade, or ratio, of  $\frac{1}{10}$ , or 0.9 cut-off, up to  $\frac{1}{10}$ , or 0.1, representing  $\frac{1}{10}$  cut-off, which is considered sufficient for application to expansion of steam for all practical purposes.

#### Expansion of Steam and Its Effects with Equal Volumes of Steam.

The theoretical economy of using steam expansively is shown by the foregoing table, the same volume of steam being expended in each case, and expanded to fill the increased spaces.

In Table No. 2, no deductions are made for a reduction of the temperature of the steam while expanding or for loss by back pressure.

The same relative advantages follow in expansion, as given in the above table, whatever may be the initial pressure of the steam.

The pressure of the atmosphere is to be included in calculating the expansion. It must, therefore, be deducted from the results in non-condensing engines. In condensing engines a deduction must be made for perfect vacuum. This will amount to about ( $2\frac{1}{2}$  pounds per square inch) five inches in well proportioned engines.

Where there is no cut-off, as in diagram Fig. 4, the work done equals  $A P L$ , or the area,  $A$  of the cylinder, multiplied by the absolute pressure  $P$ , and this product by the length of stroke  $L$  of the piston in feet.

When the cut-off takes place at one-fourth of the stroke  $L$ , at the point  $e$ , diagram Fig. 6, there is only one-fourth as much steam admitted as in case of diagram Fig. 4, but the work, instead of being

$$\frac{A P L}{4} \text{ or } \frac{1 \times 100 \times 1}{4} = 25,$$

will be as before stated

$$A e P (1 + x), \text{ or } 1 \times 0.25 \times 1 (1 + 1.386) = 59.65 \text{ pounds.}$$

To make this more clear to the general reader, we will assume an engine doing actual work. It is well known that the most convenient way of calculating the horse-power of an engine, is to multiply the area of the piston in square inches by the speed of the piston in feet per minute, and divide this product by 33,000. The result so obtained will be the horse-power of *one pound mean effective pressure*, and is called the horse-power constant, which, if multiplied by the whole mean effective pressure on the piston during the stroke, will give the indicated horse-power of the engine.

For example, suppose that the engine that would produce indicator diagrams as represented by Figs. 4, 5 and 6, had a stroke  $L = 3$  feet, making  $r = 100$  revolutions per minute, and a diameter of piston  $A = 110$  square inches, and a piston speed of

$$100 \times 3 \times 2 = 600 \text{ feet per minute.}$$

Then the horse-power value of one pound mean effective pressure will be as follows:

$$\text{Horse-power constant} = \frac{110 \times 600}{33,000} = 2 \text{ horse-power.}$$

Now diagram Fig. 4 averaged initial pressure  $P = 100$  pounds, or a mean effective pressure throughout the stroke. The horse-power, therefore, will be as follows:

$$\text{Horse-power} = 100 \times 2 = 200 \text{ horse-power.}$$

In diagram Fig. 6, the steam was cut-off after the piston had moved from  $B$  to  $e$ , or one-fourth of its stroke, the grade or ratio of expansion being  $\frac{3}{4} = 4$ . Therefore, the mean effective pressure  $mp$ , will be, according to formula (2):

$$mp = \frac{P}{g} (1 + x);$$

or substituting values,

$$mp = \frac{100}{4} (1 + 1.386) = 59.65 \text{ pounds per square inch;}$$

or to simplify it still further, it will be as follows:

$$\frac{36}{9} = 4 \text{ hyp. log. of } 4 = 1.386 + 1 = 2.386;$$

then

$$\frac{100}{4} = 25 \times 2.386 = 59.65 \text{ pounds per square inch.}$$

Now diagram, Fig. 6, shows a mean effective pressure  $mp = 59.65$  pounds per square inch, which multiplied by the horse-power constant will be:

$$P = 59.65 \times 2 = 119.30 \text{ horse-power.}$$

Therefore, we see that one-fourth of the steam expanded performs *three-fifths*, or nearly *sixty per cent.* of the whole work, so that by using expansion the work obtained from one pound of steam is 2.386 times what was obtained when permitting full stroke without expansion, as shown by diagram, Fig. 4, or a gain of *forty per cent.* by using steam expanding *three-fourths* of the stroke.

$$\% = \frac{200 - 119.30}{200} = 40.5 \text{ per cent. of gain.}$$

The number 2.386 has lately been called the "indicator coefficient" of the engine. By cutting off at *one-tenth* of the stroke, the efficiency of the steam is increased 3.3 times, that is, the "indicator co-efficient" is 3.3.

Expansion is valuable in another way. At the end of every stroke the piston stops momentarily, returning on its old path, and it is advisable to prepare for the sudden reversal of motion of the piston, by diminishing the steam pressure. Now, when expansion is used, the greatest pressure is exerted at the beginning of the stroke, when the piston moves slowly, and when it is most advisable to get up a great velocity. The pressure after cut-off diminishes gradually until it is very little greater than that of the atmosphere, so that the steam experiences little difficulty in escaping by the exhaust passages on the return stroke. In fast-running engines the exhaust ports are opened before the end of the stroke, and the exhaust port on the other side of the piston is closed, that there may be a cushion of the steam to prevent "shocks" or "jars."

#### Action of Steam when Expanded.

Steam in its ordinary condition as saturated steam, though it does not rank as a perfect gas, nevertheless acts in the cylinder of a steam engine so much to the same effect as a perfect gas could do, that its performance may be treated in the same way as if it were perfect as a gas. The quality in consideration of which a gas is said to be perfect is, as has already been stated, its property of expanding into a larger volume in the same proportion inversely as the pressure falls, the temperature being supposed to remain the same. Now, though saturated steam does not and can not exactly follow this ratio, seeing that the pressure falls more rapidly than the volume increases, yet it is found that the work performed by steam by expansion in the cylinder of an engine is practically the same as if it acted on the principle of a perfect gas.

Therefore, it will be seen that the curve described by the pencil of an indicator indicating the falling pressure of dry saturated steam expanding behind an advancing piston is, if not exactly, nearly hyperbolic in its nature, or such that the products of the pressure at all points of the stroke multiplied by the respective volumes of steam, are equal to each other.

TABLE NO. 3.

## INITIAL AND MEAN EFFECTIVE PRESSURE IN THE CYLINDER.

Assuming that the pressures are inversely as the volume.

| Portion of Stroke at which Steam is Cut-off. | Grade or Ratio of Expansion. | Hyperbolic Logarithm. | Mean Pressure during the Stroke, the Initial Pressure being taken as 1. | Initial Pressure in Cylinder, the Mean Pressure being taken as 1. |
|--|------------------------------|-----------------------|---|---|
| <i>l</i>                                     | <i>g</i>                     | <i>x</i>              | <i>m p</i>  | <i>P</i>  |
| $\frac{2}{7}$ or 0.75                        | 1.333                        | 0.2876                | 0.965   | 1.036   |
| $\frac{3}{7}$ or 0.7                         | 1.428                        | 0.3506                | 0.949   | 1.054   |
| $\frac{4}{7}$ or 0.666                       | 1.5                          | 0.4055                | 0.937   | 1.067   |
| $\frac{5}{7}$ or 0.6                         | 1.666                        | 0.5108                | 0.904   | 1.106   |
| $\frac{6}{7}$ or 0.5                         | 2.0                          | 0.6931                | 0.846   | 1.182   |
| $\frac{3}{4}$ or 0.4                         | 2.5                          | 0.9163                | 0.766   | 1.305   |
| $\frac{2}{3}$ or 0.333                       | 3.0                          | 0.0986                | 0.669   | 1.495   |
| $\frac{1}{2}$ or 0.3                         | 3.333                        | 1.2040                | 0.661   | 1.513   |
| $\frac{1}{3}$ or 0.25                        | 4.0                          | 1.3863                | 0.596   | 1.678   |
| $\frac{1}{4}$ or 0.2                         | 5.0                          | 1.6094                | 0.522   | 1.916   |
| $\frac{1}{6}$ or 0.166                       | 6.0                          | 1.7918                | 0.465   | 2.150   |
| $\frac{1}{8}$ or 0.142                       | 7.0                          | 1.9459                | 0.421   | 2.375   |
| $\frac{1}{10}$ or 0.125                      | 8.0                          | 2.0795                | 0.385   | 2.598   |
| $\frac{1}{12}$ or 0.111                      | 9.0                          | 2.1972                | 0.355   | 2.817   |
| $\frac{1}{15}$ or 0.1                        | 10.0                         | 2.3025                | 0.330   | 3.030   |
| $\frac{1}{18}$ or 0.09                       | 11.0                         | 2.3979                | 0.309   | 3.236   |
| $\frac{1}{21}$ or 0.083                      | 12.0                         | 2.4849                | 0.293   | 3.448   |
| $\frac{1}{24}$ or 0.076                      | 13.0                         | 2.5649                | 0.274   | 3.649   |
| $\frac{1}{28}$ or 0.071                      | 14.0                         | 2.6391                | 0.260   | 3.846   |
| $\frac{1}{35}$ or 0.066                      | 15.0                         | 2.7081                | 0.247   | 4.048   |
| $\frac{1}{42}$ or 0.062                      | 16.0                         | 2.7726                | 0.236   | 4.237   |
| $\frac{1}{50}$ or 0.058                      | 17.0                         | 2.8332                | 0.226   | 4.425   |
| $\frac{1}{56}$ or 0.055                      | 18.0                         | 2.8904                | 0.216   | 4.629   |
| $\frac{1}{63}$ or 0.052                      | 19.0                         | 2.9444                | 0.208   | 4.807   |
| $\frac{1}{70}$ or 0.05                       | 20.0                         | 2.9967                | 0.200   | 5.00  |
| $\frac{1}{84}$ or 0.047                      | 21.0                         | 3.0445                | 0.192   | 5.208   |
| $\frac{1}{105}$ or 0.045                     | 22.0                         | 3.0910                | 0.186   | 5.376   |
| $\frac{1}{126}$ or 0.043                     | 23.0                         | 3.1355                | 0.180   | 5.555   |
| $\frac{1}{154}$ or 0.041                     | 24.0                         | 3.1781                | 0.174   | 5.747   |
| $\frac{1}{175}$ or 0.04                      | 25.0                         | 3.2189                | 0.169   | 5.917   |

## Expansion Diagram of Steam in a Cylinder.

The hyperbolic curve of expansion, expressive of the falling pressure, relative to the increasing volume, is represented by *Cg* on diagram, Fig. 7.

The rectangle *VB CV* is supposed to be the section of a cylinder having a stroke of 24 inches. The diagram is divided into 24 parts, or inches of stroke. During five of these, that is six inches of the stroke, or one-fourth *Be*, the steam is ad-

mitted, and it is expanded during the remaining three-fourths  $m D$ . Assuming that there is no clearance, the terminal pressure  $g D$  would be one-fourth of the initial pressure  $P$ , during admission, that is, it would be equal to the initial pressure  $P$ , taken in this case at 100 pounds total pressure per square inch, multiplied by the period of admission, and divided by the length  $l = 6$  inches of the stroke ; or

$$100 \times \frac{6}{24} = 25 \text{ pounds per square inch,}$$

the terminal pressure.

FIG. 7.

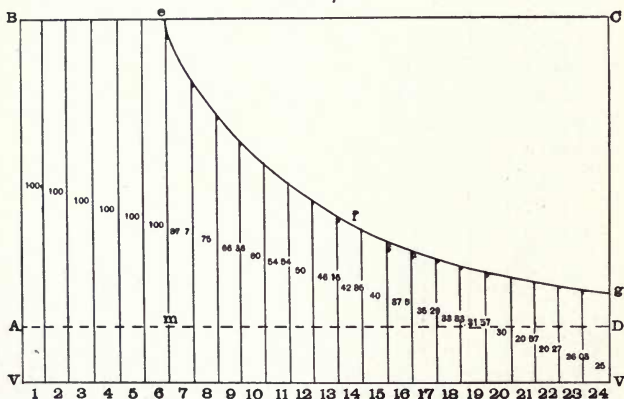

The pressure for any intermediate point of the stroke may be found similarly, by taking the portion of the stroke described from the commencement to the given point, as the divisor. Thus at the end of 12 inches of the stroke, the total pressure is:

$$100 \times \frac{6}{12} = 50 \text{ pounds per square inch.}$$

Finding the pressure similarly for each intermediate inch of the stroke, and drawing ordinates for each inch of stroke, the curve may be formed by tracing it through the extremities of the ordinates, as shown in Fig. 6, shown in shaded lines. The one in outline is the best that can be produced in practice. See page 65.



From the above it will be seen that the work done by expansion may be calculated from the particulars without the aid of hyperbolic logarithms.

#### The Theoretical Gain by the Expansion of Steam.

To find the increase of efficiency arising from using steam expansively:

*Rule.*—Divide the total length of the stroke by the distance (which call one) through which the piston moves before the steam is cut-off. The Napierian logarithm of the part of the stroke performed with the full pressure of steam before cut-off represents the increase of efficiency due to expansion.

*Example.*—Suppose that the steam be cut-off at ( $\frac{2}{10}$ ) two-tenths, or 0.2 of the stroke, what is the increase of efficiency due to expansion?

Now, 0.2 of the whole stroke is the same ( $\frac{1}{5}$ ) one-fifth of the whole stroke; and the ratio, or grade, of the expansion equals 5. The hyperbolic logarithm of 5 is 1.609, which, increased by 1, the value of the portion performed with full initial pressure, gives:

$$1.609 + 1 = 2.609$$

as the relative efficiency of the steam when expanded to this extent (eight-tenths), instead of 1, which would have been the efficiency if there had been no expansion.

If the steam be cut off at the following points of the stroke, the respective ratios, or grades of expansion, will be as follows:

Cut off at  $\frac{1}{10}$ ,  $\frac{2}{10}$ ,  $\frac{3}{10}$ ,  $\frac{4}{10}$ ,  $\frac{5}{10}$ ,  $\frac{6}{10}$ ,  $\frac{7}{10}$ ,  $\frac{8}{10}$  or  $\frac{9}{10}$ th.

Grade of expansion 10, 5, 3.33, 2.5, 2.00, 1.66, 1.42, 1.25, 1.11.

Hyperbolic logarithm 2.303, 1.609, 1.203, 0.916, 0.693, 0.47, 0.351, 0.223, 0.104.

Cut off at  $\frac{1}{8}$ ,  $\frac{2}{8}$ ,  $\frac{3}{8}$ ,  $\frac{4}{8}$ ,  $\frac{5}{8}$  or  $\frac{7}{8}$ .

Grade of expansion 8, 4, 2.66, 2, 1.6, 1.33, 1.143.

Hyperbolic logarithm 2.079, 1.386, 0.978, 0.693, 0.47, 0.285, 0.131.

With the above data, it will be easy to compute the mean pressure of steam of any given initial pressure when cut off at any eighth or any tenth part of the stroke; as we have only to divide the initial pressure of the steam in pounds per square inch by the ratio of expansion, and to multiply the quotient by the hyperbolic logarithm, increased by one, of the number representing the ratio or grade, which gives the mean pressure

throughout the stroke in pounds per square inch. Thus, if steam of  $65+15=80$  pounds absolute, be cut off at half stroke, the ratio or grade of expansion is 2; and 80 divided by  $2=40$ , which multiplied by  $1+0.693=67.72$  mean pressure in pounds per square inch throughout the stroke.

The terminal pressure is found by dividing the initial pressure by the ratio or grade of expansion; thus, the terminal pressure of steam of 80 pounds cut off at half stroke will be:

$$\frac{80}{2} = 40 \text{ pounds per square inch.}$$

*Example.*—What will be the mean pressure, throughout the stroke, of steam of 160 pounds per square inch cut off at one-eighth of the stroke?

First we divide 160 by  $8=20$ , which, multiplied by the hyperbolic logarithm of 8, which is  $2.079+1=3.079$ .  $3.079 \times 20 = 61.580$  pounds per square inch, which is the mean pressure exerted on the piston throughout the stroke. If the steam were cut off at  $\frac{1}{10}$  of the stroke instead of  $\frac{1}{8}$  then we should divide

$$\frac{160}{10} = 16.$$

This, multiplied by  $2.303+1=3.303$  gives:

$$3.303 \times 16 = 52.85 \text{ pounds per square inch,}$$

which would be the mean pressure on the piston throughout the stroke in such a case.

If the initial pressure of the steam were 10 pounds per square inch, and the expansion took place throughout  $\frac{1}{5}$  of the stroke, or the steam were cut off at  $\frac{1}{5}$ th, then 10 divided by  $5 = 2$ , which multiplied by  $1.609 + 1 = 2.609$ ; then

$$2.609 \times 2 = 52.18 \text{ pounds per square inch,}$$

the mean pressure.

#### Saving in Fuel by Expansion.

When steam is cut off before the end of the stroke in a cylinder, the pressure effected by it for the portion at which it flowed for full stroke is represented by 1, and the pressure exerted afterwards by the result due to the relative expansion.

The total pressure or work is represented by the sum of these units. If the steam had flowed for the full stroke of the piston, the pressure would have been 1 added to the proportionate distance during which the steam was admitted had it been used expansively.

The gain of expanding steam by cutting off the supply after the piston has traveled a portion of the stroke:

| Cutting off at $\frac{1}{10}$ the stroke, | efficiency is increased | 3.3 | times. |
|---|-------------------------|-----|--------|
| " $\frac{1}{8}$                           | "                       | "   | 3.1    |
| " $\frac{2}{10}$                          | "                       | "   | 2.61   |
| " $\frac{1}{4}$                           | "                       | "   | 2.386  |
| " $\frac{3}{10}$                          | "                       | "   | 2.203  |
| " $\frac{3}{8}$                           | "                       | "   | 1.98   |
| " $\frac{4}{10}$                          | "                       | "   | 1.92   |
| " $\frac{1}{2}$                           | "                       | "   | 1.69   |
| " $\frac{6}{10}$                          | "                       | "   | 1.51   |
| " $\frac{5}{8}$                           | "                       | "   | 1.47   |
| " $\frac{7}{10}$                          | "                       | "   | 1.35   |
| " $\frac{3}{4}$                           | "                       | "   | 1.285  |
| " $\frac{8}{10}$                          | "                       | "   | 1.22   |
| " $\frac{7}{8}$                           | "                       | "   | 1.13   |
| " $\frac{9}{10}$                          | "                       | "   | 1.10   |

From the above we can compute the gain in fuel as follows:

*Rule.*—Divide the relative effect, or in other words, the number of times the efficiency is increased by the grade of expansion  $g$  (see table of hyperbolic logarithms), and divide 1 by the quotient. The result is the initial pressure of steam required to be expanded to produce a like effect of steam at full stroke. Divide this pressure by the number of times the steam is expanded, and subtract the quotient from 1. The remainder will give the percentage of gain of fuel.

*Example.*—Suppose the steam in an engine cylinder to be cut off after the piston has moved one-fourth the length of the stroke, what is the gain in fuel?

The relative effect (see efficiency due to expansion above) equals 2.386, and the number of times of expansion equals 4.

Then

$$2.386 \text{ divided by } 4 = 0.5965,$$

and

$$1 \text{ divided by } 0.5965 = 1.69 \text{ initial pressure,}$$

and

$$1.69 \text{ divided by } 4 = 0.41,$$

and

$$1 - 0.41 = 0.59 \text{ per cent.}$$

## Terminal Pressure.

Rule for finding the pressure at the end of the stroke, or at any point during expansion:

$P$  = initial pressure of steam in pounds per square inch, including the pressure of the atmosphere.

$L$  = distance travelled by the piston when the pressure of steam equals  $x$ .

$l$  = distance travelled by the piston before the steam is cut off.

$x$  = pressure of steam in the cylinder, including the pressure of the atmosphere, when the piston has travelled a distance  $L$ .

$$x = \frac{Pl}{L}$$

or, in words, the terminal pressure for any cut-off is the absolute pressure  $P$ , multiplied by the distance  $l$ , the piston has moved when steam is cut off, and this product divided by stroke  $L$ .

The steam pressure on the boiler is readily known; but the steam in its passage to the cylinder is subject to various losses, as "wire-drawing," condensation, friction, etc., so that frequently the pressure on the piston does not exceed two-thirds of that on the boiler.

Therefore, recourse must be had to the indicator for furnishing the exact data for ascertaining the precise pressure in the cylinder, so as to ascertain the power exerted by the engine, namely, the *mean* or *average* pressure of steam; or, more accurately, the excess of pressure on the acting side of the piston to produce motive force. And from no other source can it be accurately learned.

In every branch of science our knowledge increases as the power of measurement becomes improved; and we have now to discuss the measuring instrument peculiarly appropriated to the steam-engine, namely, *The Indicator* invented by Watt. The student must thoroughly understand the reading of an indicator diagram before he can appreciate the reason for the various methods of construction adopted with reference to some of the working parts of an engine.

### Expansion Curves of Indicator Diagrams.

A correct curve does not *necessarily* show an economical engine, since the leakage out *may* balance the leakage in, in rare cases, and not affect the diagram. But the opposite is indisputable, that an incorrect curve necessarily and infallibly shows a wasteful engine, to at least the amount calculated upon the diagram.

As indicator diagrams represent the measure of force or pressure of the steam in the cylinder at every point of the stroke, the actual card from an engine, as compared with the theoretic diagram (other things being equal), indicates the working value and economy of the engine.

Therefore they should truthfully represent the real performance of the engine. Diagrams vary in form from various causes; namely, quality or condition of the steam, leakage, condensation, adjustment, and construction; their influence being most noticeable in the expansion curve. This curve will not, in practice, conform exactly to the true theoretical curve. The terminal pressure will always, under the most favorable conditions, be found relatively too high, the amount being greater as the ratio or grade of expansion increases. Where this is not the case and the expansion curve of the diagram coincides exactly with the theoretic curve, the conclusion cannot be otherwise than that the leakage is greater than the re-evaporation; but in the present state of the arts there are no practical means of working steam expansively and preserving the exact temperature due to the pressure while expanding.

When the expansion curve falls throughout its entire length below the hyperbolic or theoretic curve, it is evidently due to leakage. The expansion curve of the indicator diagram, in all ordinary cases, terminates above that of the theoretic curve, in fact, sometimes far above it, due to the re-evaporation of the moisture in the cylinder. An engineer when indicating an engine should see to it that the piston and valves are tight. Unless they are so, the diagram will not indicate what the engine is really doing, and the engineer cannot ascertain the causes of any peculiarities in the form of the diagram.

## CHAPTER V.

### THE INDICATOR.

THE use of the indicator is now very general, and its value is becoming more and more appreciated as an instrument which gives, in skilled hands, exact and valuable information upon various matters connected with the working of the steam engine which formerly were enveloped in mystery. Few high grade engines are now set up without having their valves adjusted for greatest efficiency, as shown by diagrams taken with the indicator, nor are these engines accepted by the purchasers without having diagrams taken to show whether the steam is acting properly or not, and to ascertain the horse-power which is developed by the engine, when running at its intended speed and under its proper load. When a man buys an engine, he generally wants to know what it will cost to run it. There is a certain standard to which any engine may be referred in order to judge of its economy, and this is the amount of coal consumed per hour for each horse-power developed. Many manufacturers, while aware of what amount of coal is consumed, are totally ignorant of what power is being yielded by their engines, and hence do not know whether they are working economically or not. They may be losing annually a large amount of money in consequence of having an engine which is wasteful of fuel, and it therefore becomes important to know just what a horse-power is costing, and whether an engine of certain size is really developing that power which calculation shows it ought to be giving. Engines, designed with a special view to great economy, have been run with an expenditure of *two pounds* of coal per hour per horse-power, and even less than two pounds; but in general an engine may be considered as very good, if it yields a horse-power for every three pounds of good coal consumed per hour. Fuel of poorer quality will require perhaps three and one-half to four pounds, which, bearing in mind the quality of coal, may still be considered a good performance.

Engines in general will consume various amounts of coal, other than these figures, sometimes running as high as nine to twelve pounds per hour per horse power, which is extremely wasteful.

An indicator diagram enables us to calculate the exact horse-power developed, and, knowing what coal is consumed, we can easily find how much is required per hour per horse-power, and compare the figure found with figures which are considered to represent good economy. Large engines will, in general, be found much more economical than small engines, because, although the sources of loss are the same, the proportion which they bear to the total power is very much less. But it must be remembered that the standard for efficiency referred to, includes the working of both engine and boiler, and that, to produce the best results, each must be designed to secure the highest possible economy. Sometimes a good economical engine is supplied with steam from boilers whose evaporative efficiency is very low, and in such a case, it is not fair to charge the engine with a defect which properly belongs to the boiler. In such instance there can be made a separate test of the boiler. Starting with the known fact that an economical boiler should evaporate say nine pounds of water per pound of coal, and ascertaining next the evaporative capacity of the boiler under test with the coal it is consuming to evaporate a given quantity of water, we will at once arrive at a knowledge of how much below the standard is the boiler under test.

The indicator enables us also to discover whether there are any defects in those parts of the machinery by which the steam is admitted to the piston, as follows:

*First.*—It indicates whether the valves are properly set.

*Second.*—It indicates whether the steam ports are large enough.

*Third.*—It indicates whether the steam valves are leaky.

*Fourth.*—Whether a different arrangement of the working parts of the machinery would be advisable.

*Fifth.*—It will at any time of application, and under any given circumstances, when it may be desirable to apply it, indicate what is the actual power developed by the engine.

In fact, in the hands of a skillful engineer, the indicator is as the stethoscope of the physician, revealing the secret workings

of the inner system, and detecting minute derangements in parts obscurely situated, and it also registers the power of the engine.

In principle the indicator is nothing more than an instrument for registering the varying steam pressures in the cylinder during a complete revolution of the engine shaft, or if there is no shaft, during a complete reciprocation of the piston.

#### Construction of the Indicator.

The indicator considered in its simplest form consists merely of a small piston working in a cylinder with considerable clearance, carrying a pencil at the end of its piston rod. One end of this small cylinder is placed, at pleasure, in connection with either end of the steam-engine that is to be indicated, by means of a cock and pipes, and the other end of the indicator cylinder is in free communication with the air, by means of holes drilled in the upper portion of the indicator cylinder or cover, so that if steam goes into the steam-engine cylinder, the pressure is admitted directly to the bottom side of the indicator piston, while upon the other side the air presses continually with whatever the barometric pressure may be at the time.

A spiral spring is attached to the cover of the indicator cylinder at one end, and to the indicator piston itself at the other end. This spring regulates the movements of the piston, and as the steam is at a greater or less pressure, so the spring is more or less compressed.

Assuming that the piston of the steam-engine is at one end of the stroke, and just commencing to move, the indicator spring will be compressed by the steam pressure under it, and the amount to which the indicator piston rises is a measure of the steam pressure. For example, supposing that the spring is compressed one-eighth ( $\frac{1}{8}$ ) inch for every pound, then, if the steam pressure is ten pounds, the piston will rise one and one-quarter ( $1\frac{1}{4}$ ) inches. As the piston of the engine travels forward on its stroke, the steam pressure begins to diminish, and becomes less and less able to compress the indicator spring, and consequently the indicator piston continually falls. In order to register these continually varying pressures, a piece of paper is held on a small cylinder or barrel, in front of the pencil on the



indicator piston, and as the engine piston moves backward and forward, the barrel of the indicator partially rotates backward and forward; and the curved line traced by the pencil moving vertically up and down on the paper, moving at right angles to the up and down movement of the pencil, is called an indicator card or diagram. The diagram is nothing more than a register of the varying pressures in the cylinder as the piston moves to and fro.

The best forms of indicator as made and sold are commercially known as the "Thompson," "Crosby" and "Tabor," and are so well known and described in the circulars of their respective manufacturers that I will not repeat them here.

After a card or diagram is taken from a steam-engine, we must see what use can be made of this register of pressures. The connection between a curved figure and the power developed by the engine is not at first sight apparent; and before showing what it is, it is necessary for me to endeavor to clear away all misunderstanding as to what is a true measure of power exerted. Without a most clear and definite conception of what constitutes a mechanical expenditure of work done, it is impossible to form any notion either of what is meant by economical use of steam, or of the connection between the indicator diagram and the indicated horse-power.

The simplest example of an expenditure of power, and also the commonest, is that of a weight raised from the ground. If one pound has been raised one foot high, just half the work has been required which would be required to raise two pounds one foot high. This is so simple a conception as not to require further explanation. A little consideration will show that, generally speaking, the work required to lift any weight to any height may be said to be equal to a certain number of pounds raised one foot high; or what is just the same thing, one pound raised a certain number of feet high, is equal to a certain number of foot-pounds.

It is a general law in mechanics that when work or power is expended, some resistance has been overcome through some distance, and what is really done in raising a weight is to overcome the attraction of the earth, or gravity, through a certain distance. If we had overcome any other resistance than the

attraction of gravity, as, for instance, compressing a spring, we might, in just the same way, say the expenditure of work was equal to that required to lift a certain number of pounds through a certain height.

We may take the attraction of gravity as a general standard of resistance, and whenever any resistance is overcome, we may refer it to this standard.

A steam-engine at work overcomes some resistance, either propelling a vessel, or pulling a train, or driving machinery; and the amount of force or work expended by the engine in overcoming this resistance through a certain distance is equivalent to a certain number of pounds raised through a certain number of feet.

## CHAPTER VI.

### THE ACTION OF STEAM IN THE CYLINDER OF AN ENGINE.

THE force of steam in a cylinder is exerted for the performance of work. Steam is introduced into the cylinder at nearly the pressure and temperature at which it is generated. Steam operates in the cylinder in a two-fold manner. First, it is admitted, with a greater or less degree of freedom, from the boiler into the cylinder, during a portion of the stroke, following the piston at or near the boiler pressure. When the communication from the boiler to the cylinder is cut off, and the flow stopped, the quantity of steam enclosed within the cylinder continues, though isolated, to force the piston to the end of the stroke by expansion.

A two-fold action takes place as follows:

*First.* The steam flows into the cylinder and forces the piston to the point of cut-off.

*Second.* After cut-off it is "worked expansively" upon the piston to the point of exhaust.

In fact, the whole process is essentially one of expansive action, as the steam admitted direct from the boiler flows into the cylinder by virtue of the expansive force of the steam already generated and being generated, the boiler constitutes the fulcrum or basis. The process is continued on a more limited scale within the cylinder after the steam is cut off, the steam continuing, in virtue of its own elastic force, its expansive action against the piston, when the end of the cylinder constitutes the fulcrum.

The difference of the steam pressure during the two periods, that of admission and that of expansion, is found by the application of the indicator. But in certain conditions and adjustments of the valves the difference disappears. The uniform pressure of the steam on entering the cylinder is not in all cases maintained, and it will be found that the steam line falls, as-

suming the characteristic of expanding steam. This falling pressure, which takes place while the communication between the boiler and the cylinder is open, is the result of what is expressively called a "wire-drawing" of the steam, the flow of steam into the cylinder being partially arrested at the "steam port" or inlet, by the slide-valve when nearly closed, and the volume being thus reduced or "wire-drawn" to a lower pressure.

After the steam has passed into the cylinder, and done its appointed work, it is to be expelled, and its discharge should be effected by the time the piston has completed the stroke. It is discharged either into the atmosphere, if a non-condensing engine is employed, opposed by a pressure of 14.7 pounds per square inch, or in round numbers, 15 pounds, or into the condenser, if a condensing engine is employed, opposed by a resistance of about one pound per square inch more or less, according to the excellence of the means of condensation. The piston of an engine, in fact, works between two pressures, and continues in motion or has a tendency to do so as long as the pressure in the boiler is greater than that of the atmosphere or that in the condenser, or more exactly, in the exhaust passage, and when steam is very greatly expanded in a condensing engine, a low pressure in the condenser is no less necessary than a high pressure in the boiler. If all losses and difficulties incidental to and perhaps in some degree inseparable from the use of steam of very high pressure be neglected, then it must be maintained that the highest pressure in the boiler, coupled with the lowest pressure in the condenser, would give the highest duty for a given quantity of heat, provided the steam is expanded in the cylinder from the greater pressure down to, or nearly down to, the lower pressure.

It may here be remarked, that the term "vacuum" is liable to a double interpretation, signifying either the absolute pressure in the condenser, or the difference between this and the atmospheric pressure. Now, in regard to the question affecting the quantity of work of steam and its efficiency in the steam-engine, there are the total pressures respectively in the two separate vessels which require to be considered; that is to say, the initial pressure in the cylinder, and the total pressure in the

condenser, into which the exhausted steam is propelled by the boiler pressure on the piston. If the pressure of the atmosphere were 10 or 30 pounds, in place of (14.7) 15 pounds per square inch, as it is, it would not at all affect the action of a condensing engine further than slightly diminishing or increasing the force required to work the air pump, and causing a greater or less weight to be placed upon the safety-valve, in order to obtain the same total pressure in the boiler. When the mercury in an ordinary barometer is observed to stand at a height of 30 inches, and the mercury in another tube communicating with the condenser of a steam-engine at a height of 5 inches, instead of describing the conditions of the case as representing a vacuum of 25 inches of mercury, it would afford a clearer conception of the matter to consider that the total pressure in the condenser is equal to 5 inches of mercury, while the total pressure in the boiler is equal to 30 inches of mercury plus the load on the safety-valve. In short, the operations of a condensing engine are practically independent of the incidental variations of atmospheric pressure.

But, the operations of a non-condensing engine, exhausting into the atmosphere, are referable to the atmospheric pressure, as it affords the datum or base line to which the expansive and exhaust pressure should be approximated, and below which the former should not, and the latter cannot, be extended. It is usual, therefore, in dealing with non-condensing engines, to designate the pressure of steam by the difference or excess of its pressure above that of the atmosphere—namely (14.71) 15 pounds absolute pressure per square inch; this absolute pressure being adopted for the zero of the non-condensing scale.

In supplying an engine with steam, four distinct events take place in consecutive order with respect to each end of the cylinder, as follows:

*First*—The admission of the steam at, or just before, the beginning of the stroke.

*Second*—The suppression, or cut-off, of the steam.

*Third*—The release, or exhaust, of the steam.

*Fourth*—The closing of the exhaust valve, causing "compression," or "cushioning," of the exhaust steam, prior to the opening of the steam port.

These four events, together, constitute the "distribution" for the cylinder; and their duration, measured in parts of the stroke, are the "periods of the distribution."

By the aid of the indicator, which, as its name implies, is a sort of stethoscope for the observation of what transpires within the cylinder—a simple instrument for receiving and registering the pressure of the steam—a minute and accurate picture of the operation within is transferred by pencil to paper, affording valuable and, indeed, indispensable data for the measurement of the power and efficiency of the steam in the cylinder.

#### The Action of Steam in the Cylinder as Shown by the Indicator Diagrams.

The action of steam is illustrated in its most simple form in the non-condensing or "high-pressure" engine, in which the question of the vacuum does not enter.

FIG. 8.

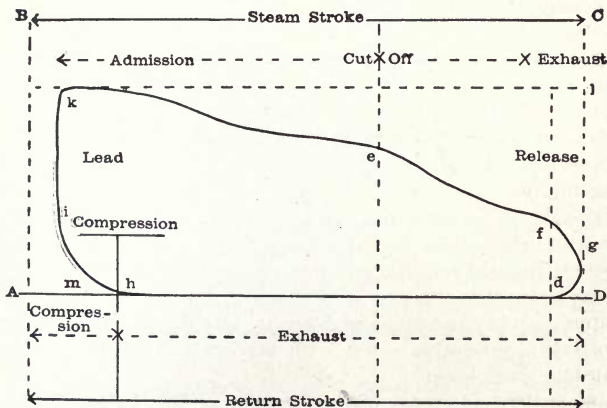

The function and utility of the indicator, as a means by which the action of the steam in the cylinder is portrayed, will appear by an examination of the diagram Figure 8.

The base line  $AD$  is the line of atmospheric pressure,  $mD$  represents the stroke of the piston, and the irregular space

*m*, *k*, *e* and *D*, may be supposed to be the interior of the cylinder. The heavily lined figure *k*, *e*, *f*, *g*, *h*, and *i*, is a diagram of the indicated action of the steam, when the piston moves in the cylinder at an average speed of 100 feet per minute; and shows by its angularity how the steam is controlled by the valve, and the precise points of the stroke at which the changes of the distribution take place. The piston is represented as having started from the left-hand end of the cylinder, under an initial steam pressure of 45 pounds per square inch above the atmosphere, the line of pressure being traced from the upper left-hand corner *k*, until it reaches the point *e* of cut-off. The admission being terminated, the period of expansion is commenced, the pressure falls as the piston advances before the expanding steam, and continues to do so until the piston reaches the point of release *f*. At this point the piston enters on its third and last stage of progress toward the end of the stroke; the steam primarily admitted at 45 pounds above the atmosphere, and reduced to 15 pounds pressure previously to being released, quickly discharges itself into the atmosphere, by its elasticity, and is entirely discharged before the end of the stroke, as indicated by the rapid fall of the steam line during the period of exhaust towards the point *g*. The exhaust is, however, only relative, not absolute, as steam of atmospheric pressure remains in the cylinder, though not obviously sensible in the indicator diagram, during the return stroke; therefore, the valve ought to maintain the exhaust end of the cylinder continuously open, to allow the steam of one atmosphere of pressure to escape from before the returning piston. The benefit of this provision is proved by the diagram, in which it appears that during the continuation of the exhaust the steam of latent pressure remains at the zero point of the scale; at the instant the exhaust valve closes at the point of compression *h*, and there is no longer an exit for the latent steam before the piston, the exhaust line commences to rise upwardly towards the left-hand side, and the steam is compressed against the end of the cylinder. While the volume of the compressed steam is being thus forcibly reduced, the pressure is increased; the pressure is raised until the accumulation of back pressure so induced is merged at *i*, with the boiler pressure of the steam admitted at

this point by *lead* during the remainder of the return stroke for the supply of the next stroke.

The action of the steam in the cylinder may thus, with the aid of the indicator-diagram, the different sections of which are distinctly marked, be clearly traced through the revolution of the engine.

The period of admission, in the example just described, is about two-thirds of the whole stroke; that of expansion about three-tenths; and a simple inspection of the diagram shows that, in this case, nearly one-third of the work of the steam is performed by simple expansion while shut up in the cylinder. Even the period of exhaust supplies its quota of effect, inasmuch as the exhaust is a work of time; and the extra positive pressure so yielded is represented by the small triangular space  $fg$  and  $d$ , between the point of release and the end of the stroke at  $D$ . The force developed by the compression space  $hm$  and  $i$  is properly designated resistance, as it is opposed to the motion of the piston, and must be classed with the slight opposition also made by the *lead* or entering steam at  $i$  for the next stroke.

#### Engine Power.

To ascertain what power an engine is exerting, the simplest way is to find out how many pounds weight it raises in a minute, and through how many feet it raises such weight; the term minute is used as a convenient unit of time, and it is the unit generally adopted.

Now, let us take as an example the following indicator diagram Fig. 9, and divide it into ten equal spaces. The distance from  $A$  to  $B$  is one-tenth of the whole length of the indicator card, and during the time the card traveled horizontally from  $A$  to  $B$ , the piston of the engine traveled one-tenth of its stroke; while the card traveled from  $B$  to  $C$ , the piston of the engine traveled another one-tenth of its stroke, and when the piston had traveled its whole stroke, the card would have traveled from  $A$  to  $K$ , and so backwards on the return stroke. It is not a matter of any importance what the length  $AK$  is when compared with the stroke of the piston, and for convenience  $AK$  is usually made about four inches, excepting in high speed engines. All that we care about is, that when the piston



has moved through one-tenth of its stroke, the card shall have done so also, and that the motions go on corresponding in this way throughout the stroke. Then we have only to look at the indicator card to see what pressure of steam there was in the

FIG. 9.

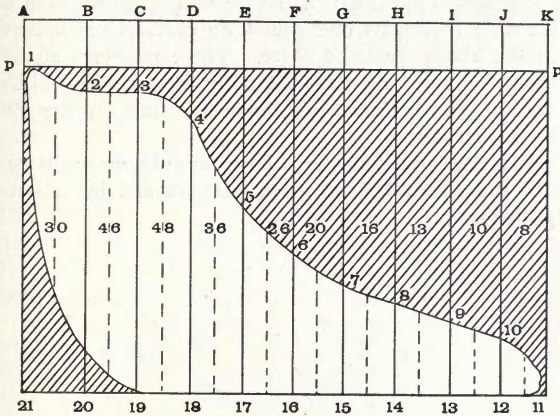

cylinder at any part of the stroke. In this particular case a  $\frac{1}{4}$  spring was attached to the piston of the indicator, which means that for every one pound pressure on the square inch of the piston, the pencil of the indicator will rise  $\frac{1}{4}$  of an inch. If we have 48 pounds boiler pressure, the pencil will rise two (2) inches as soon as the steam is admitted up to the point 1; then, as the piston and card move, the pencil, still held up by the steam, moves to 2, then to 3. Somewhere about this point the steam is cut off, then the steam pressure falls as the piston moves on, and the pressure can no longer compress the spring so much, and the pencil falls gradually to 4, then to 5, and so on to 10, where the steam is exhausted into the air, and the spring being no longer compressed, the pencil falls to the line called atmospheric line.

At 11 the engine begins the return stroke, and up to 19 the steam continues to exhaust into the air; at this point the valve

closes, and what is left in the cylinder is compressed until the point 21 is reached, when steam is admitted again and the spring compressed up to 1.

From this curved figure we must now find what power the engine was exerting. We measure the distance in the center of each of the spaces  $AB$ ,  $BC$ ,  $CD$ , up to and including  $JK$ , by a scale which has the inch divided into 24 spaces, each space on the scale represents one pound, on dotted lines drawn between the above spaces  $AB$  etc. These pressures added together and divided by ten—the number of spaces—will give the *mean effective indicated pressure* acting on the piston during one stroke.

To find the foot pounds raised per minute, we multiply the area of the piston by the mean pressure and by the stroke multiplied by two.

FIG. 10.

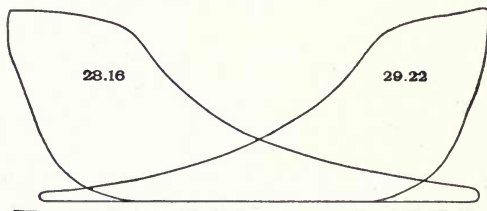

If the engine is a double-acting one, the diagrams for each end of the cylinder are usually taken on the same card, giving a double figure, as in fig. 10. Each of these diagrams has its own mean pressure, and they are rarely the same. In practice they are nearly always treated as above; the horse-power for each end of the cylinder being rarely calculated separately. In the present instance the mean pressure of the left-hand diagram is 28.16 pounds, and that of the right-hand one 29.22 pounds; the mean of both is 28.69 pounds. To find the foot-pounds raised per minute we multiply the mean pressure, 28.69, by twice the stroke in feet, by the number of revolutions per minute, and by the area of the piston in square inches.

*Example.*—Assuming the diameter of the cylinder to be 12

inches and the stroke 24 inches, making 200 revolutions per minute, what number of foot-pounds will be exerted?

$$28.69 \times 200 \times 2 \times 113 = 1,296,788 \text{ foot-pounds per minute.}$$

Having now shown what power an engine is exerting in the simplest way, that is to say, how many pounds weight it raises in a minute, we will now explain how Watt arrived at this method.

## CHAPTER VII.

### HORSE-POWER.

THE power of a horse, or that part of his muscular force which in traveling he is capable of applying upon the load, has been variously stated by different authors. It is not the force exerted by a dead pull, or for a short period, by which we are to estimate a horse's strength, but what he can exert daily, for a long period, without injury to his powers. That is the standard for practice.

The real horse-power, that which a good horse can lift, according to experiments made by Smeaton, is twenty-two thousand (22,000) pounds *one foot* high per minute. This power was derived from the average force exerted by the ordinary draft-horses working at mines. Early English miners had no other means of raising ore. Their apparatus consisted of a fixed pulley at the surface, over which a rope passed. To one end of this rope a horse was hitched, and to the other end a bucket, which latter, on being lowered in the mine and loaded, was raised to the surface by the horse walking horizontally from the pit. London brewers also used horses for pumping by gins and winches.

#### Horse-power of a Steam-engine.

When James Watt began to replace the old-fashioned horse-gins and winches for pumping water with his steam-engine, he soon found that some standard of power should be adopted, to enable his customers to obtain an engine suited to the purpose. It was natural that the horses superseded by the steam-engine should be used as the standard of comparison, and thus the term "horse-power" was introduced. About the year 1784, James Watt was making engines for the London brewers, who were using horses for pumping purposes. When they wished to know what power one of Watt's engines would exert, they asked him how many horses it would be equivalent to.

Watt set to work to determine by a series of practical experiments what a horse-power was. It meant nothing to tell them that the engine had such a sized cylinder, made so many revolutions per minute, with steam of so many pounds pressure per square inch. They knew nothing of cylinders and steam pressures, but as long as the term "horse-power" was one of definite meaning, they could understand that. Watt ascertained, therefore, that a good London horse could go on lifting one hundred and fifty (150) pounds over a pulley at the rate of two and one-half ( $2\frac{1}{2}$ ) miles an hour, or two hundred and twenty (220) feet per minute, and continue the work for eight (8) hours a day. Now the mechanical work done in this case is the same as lifting 220 times the weight through the  $\frac{1}{220}$  part of the distance in the same time, thus:

$$5280 \times 2.5 = 13,200 \text{ feet traveled per hour,}$$

$$\frac{13,200}{60} = 220 \text{ feet traveled per minute,}$$

$$220 \times 150 = 33,000 \text{ pounds lifted one foot high per minute, or}$$

$$\frac{33,000}{60} = 350 \text{ pounds lifted one foot per second.}$$

This experiment resulted in his taking as a unit of power 33,000 pounds lifted one foot high in a minute, which is the same as a force of 550 pounds acting with a velocity of one foot per second. He called this manifestation *one horse-power*.

This power he guaranteed to all his early engines, so that the purchaser, having one and a half times the power of a good horse, should not be in a position to complain of the engine as being inadequate.

This standard, or unit of power, has been retained to the present day to express a horse power. In his own practice he obtained an effective steam-pressure, including the vacuum, of course, (for he used steam but little above the atmospheric pressure,) of seven (7) pounds per square inch; and he found that his piston speed was about one hundred and twenty-eight (128) times the cube root of the stroke of the cylinder in feet per minute, being one hundred and twenty-eight (128) feet for a one foot stroke, and two hundred and fifty-six (256) feet for an eight (8) foot stroke. It became his habit, therefore, to estimate the power of his engines, and as he took good care to conform to

his actual practice, his estimates were always very near the mark.

At the time Watt introduced this measurement, steam was used only at the atmospheric pressure, or (14.7) 15 pounds on the square inch, of which 4.7 pounds was considered to be lost by imperfect condensation, and three pounds by the friction of the engine, leaving, as before stated, seven (7) pounds for effective steam-pressure upon the piston. The speed of piston employed averaged two hundred and twenty (220) feet per minute.

Watt then calculated the power of his engine by multiplying the square of the diameter of the piston in inches by the cube root of the stroke in feet, and dividing the product by sixty (60). This rule would give a horse power for about seven (7) pounds per square inch of piston, supposing it to move at one hundred and twenty feet per minute.

When Watt first used the term horse power for raising coal and pumping water, it meant work actually done in the pumps, etc., not the work done by the steam.

To determine the horse-power of an engine, Watt, and those who immediately followed him, supposed every square inch on the piston to be able to lift a weight of seven pounds; and when doing this work, it was found that the piston would move through two hundred to two hundred and fifty-six feet a minute in a double-acting engine. The area of the piston in square inches multiplied by seven pounds, multiplied by the number of feet traveled through per minute, divided by thirty-three thousand (33,000), was called a horse-power. It is curious to observe that the seven pounds mentioned here were not supposed to be seven pounds of mean steam pressure on the piston, but seven pounds of pressure actually transmitted through the pump-rods, and was equivalent to considerably more than seven pounds of steam-pressure, for all the friction of the machine had to be added, as well as the power required for the air pumps, etc.

Smeaton considered that in his improved engines of Newcomen's type, which preceded Watt's, while his mean steam-pressure was 10.5 pounds, 1.74 pounds or  $16\frac{1}{2}$  per cent. of this was exerted in overcoming friction. Now it means the work done by the steam; from this the friction of the moving parts

must be deducted before we get at the power transmitted through the shaft.

All of Watt's calculations were made accordingly, and thus at its first introduction the term "*nominal horse-power*" really meant something which bore a fixed relation to a real horse-power, and at the time, the use of the term was found not only convenient but almost indispensable.

At the present day, pressures are employed as high as five hundred pounds per square inch, and instead of piston-speeds of one hundred and twenty-eight times the cube root of the stroke, the length of stroke is now known to have but little influence on the speed, and we have many engines running at six hundred times the cube root of the length of their stroke, in feet per minute.

Originally, the number of horse-power defined at once the size and the power of an engine; but when a variety of steam-pressures and speeds came to be employed, the same expression could no longer answer both purposes, and a distinction was introduced, which still prevails, between the *nominal* and the *actual* horse-power; the former being applied to the size of engine, irrespective of the pressure or speed employed, and the latter to the *power* which they exert.

The term *nominal horse-power* has, moreover, acquired a variety of significations in different localities, and it has become difficult to tell, in any case, precisely what is meant by it. In fact, it is merely an expression for the diameter of cylinder and length of stroke, or a measure of the dimensions of an engine, without any reference to the amount of power actually exerted by it.

The term *nominal* is now commonly confounded with the term *commercial* as applied to the horse-power of engines, and the name theoretical horse-power is substituted to represent the received scientific horse-power of 33,000 foot pounds lifted one foot high in one minute.

In the present advanced state of engineering the term *nominal horse-power* is seldom used; engineers, although employing the term, do so with mental reservation, or at least mentally define it in consideration of pressure per square inch, area of piston in square inches, and velocity of piston in feet per minute.

Work is done when a force overcomes resistance through any space. For instance, the force of gravity acting on a mass of one pound of anything is commonly called a force of one pound; and if the weight be allowed to move downwards any distance, whether we still hold it in our hand, or allow it to fall freely vertically, or down a curve or an inclined plane, so that there is always a distance traversed by it in a vertical direction, the *force of gravity* is said to do work. Again, in lifting a weight, *we* do work, for we overcome the force of gravity through a distance. Pressure in a boiler does no work on the shell, but the steam, if properly directed, will do work. Pressure on a piston does work when the piston yields to it. This work, divided by the time in which it is executed, gives the power.

*Work* is, therefore, the product of three simple elements, *force*, *velocity* and *time*, as has been already stated.

*Power* is the product of force and velocity; that is to say, a force multiplied by the velocity with which it is acting is the power in operation.

The work done by a force is measured by the product of the force into the distance through which it acts. The unit of work commonly employed is the work done by gravity on the mass of one pound in falling through one foot, and is commonly called a *foot-pound*. A force of fifty pounds acting through a distance of four feet is said to do:

$$50 \times 4 = 200 \text{ foot pounds of work.}$$

The number of units of work performed in a given time, say one minute, is a measure of the efficiency of the agent employed.

#### Man-power.

Man-power is a unit of power established by Morin, to be equivalent to fifty foot-pounds of power, or fifty effects; that is to say, a man turning a crank with a force of fifty pounds and with a velocity of one foot per second is a standard man-power. An ordinary workman can exert this power eight hours per day, without overstraining himself.

Horse-power is a unit, as before stated, of power established by Watt, to be equivalent to a force of five hundred and fifty



pounds acting with a velocity of one foot per second, which is the same as a force of thirty-three thousand pounds acting with a velocity of one foot per minute. That is to say, one horse-power is five hundred and fifty foot-pounds of power or effects, or eleven man-power of fifty effects each. The product of any force in pounds, and its velocity in feet per second, divided by 550, gives the horse-power in operation.

In Watt's rule for horse-power is given a velocity of only one foot per minute, which is equal to two-tenths (0.2) or  $\frac{1}{5}$  of an inch per second—about the velocity of a snail. The force corresponding to this velocity is 33,000 pounds, or about 15 tons, which is too large for a clear conception of its magnitude, and a horse can never pull with such a force. A horse can pull 550 pounds with a velocity of one foot per second, which is the most natural expression for horse-power. This expression is used on the continent of Europe.

## FOREIGN TERMS AND UNITS FOR HORSE-POWER.

| Countries.      | Terms.           | English Translation. | Unit.              | English Equivalent. |
|-----------------|------------------|----------------------|--------------------|---------------------|
| English . . . . | Horse-power.     | Horse-power.         | 550 foot-pounds.   | 550 foot-pounds.    |
| French . . . .  | Force de cheval. | Force-horse.         | 75 kilogr.-metres. | 542.47 foot-pounds. |
| German . . . .  | Pferde-kraft.    | Horse-force.         | 513 Fuss-pfunde.   | 582.25 foot-pounds. |
| Swedish . . . . | Hist-kraft.      | Horse-force.         | 600 skal-pund-fot. | 542.06 foot-pounds. |
| Russian . . . . | Sul-lochad.      | Force-horse.         | 550 Fyt-funt.      | 550 foot-pounds.    |

An engine which raises 550 pounds through one foot in one second is said to accomplish one horse-power.

When absolute horse-power of a steam engine is required, the "*Indicator*" is attached to the engine cylinder so as to be in communication with each side of the piston, and the action of the steam in the cylinder is registered on a piece of paper called a card or diagram, from which the average steam-pressure on the piston can be calculated.

*Example.*—A steam-engine the area of whose piston is  $A = 110$  square inches, the mean pressure on the piston by the indicator diagram is  $p = 50$  pounds per square inch. Now the product,  $A p = 110 \times 50 = 5500$  pounds, expresses the whole pressure on the piston; this multiplied by the length of the stroke,  $L = 2$  feet, will give  $5500 \times 2 = 11,000$  foot-pounds, the amount of work done in one stroke of the piston; and this

product multiplied by the number of strokes,  $s = 10$  in one second, gives:

$A p L s = 110 \times 50 \times 2 \times 10 = 110,000$  foot-pounds done by the steam in one second of time; this divided by 550 gives the horse-power; hence the expression:

$$\frac{A p L s}{550} = \frac{110 \times 50 \times 2 \times 10}{550} = 200 \text{ horse-power.}$$

#### Duty.

In large engines, especially pumping engines, the term "*duty*" is a measure of their efficiency, and is applied to indicate the number of *millions* of pounds raised through a height of one foot by the burning of one hundred pounds of coal—in England one hundred and twelve (112) pounds is used. But this measure, though suitable for estimating the work done by pumping engines, is not convenient for other purposes, and it has become the more common practice to estimate the performance of an engine by ascertaining the number of pounds of coal burnt per hour for each horse-power at which the engine is working. This gives a useful measure in small numbers, easily remembered.

It was formerly a common performance with steam-engines to consume from four to ten pounds of coal per hour per horse-power. In the present state of the arts a first-class automatic cut-off engine very seldom exceeds the former, and in order to form an idea of the number of pounds that should be consumed per hour per horse-power, we deduce the duty of a modern engine as follows:

*Example.*—Let the duty be estimated by the burning of one hundred pounds of coal. Then *four pounds* do the work represented by  $550 \times 60 \times 60 = 1,980,000$  foot-pounds per hour. Therefore one hundred pounds do the work represented by:

$$\frac{1,980,000 \times 100}{4} = 49,500,000 \text{ foot-pounds, the duty of the engine.}$$

This being so, it follows that the duty of an engine which would produce a horse-power by the consumption of *one pound of coal per hour per horse-power* would be four times as great, or would be represented by 198,000,000 foot-pounds.

The progress made in the economy of fuel by successive improvements in the steam engine may be readily traced by comparison of the number of pounds of coal burnt per hour per horse-power.

Thus, in Smeaton's early engines, on Newcomen's principle in 1775, the consumption was thirty pounds of coal per hour per horse-power. In his later engines it was improved to eighteen pounds per hour.

In Cornish pumping engines originally the consumption was eleven pounds, in the year 1811; in 1842, one and three-quarter pounds; and in 1872, it had increased to three pounds. It is said that Watt began with eight pounds and reduced the consumption to three pounds.

Mr. George H. Corliss, in 1878, reduced the consumption of coal per hour, per indicated horse-power, to *one and seven-tenths* pounds; coal per effective horse-power per hour was *one and eight-tenths* pounds; duty 109,979,487 foot-pounds for each *one hundred pounds of coal*.

Mr. E. D. Leavitt, Jr., about the same time, consumed *one and sixty-three hundredths* pounds of coal per indicated horse-power per hour, and the duty was 111,548,925 foot-pounds for each *one hundred pounds* of coal consumed.

Prior to 1860, the average consumption of coal for driving the best marine and stationary engines was about *four pounds* per hour per horse-power, as per indicator diagrams. In 1872 it appeared, from a comparison of nineteen ocean steamers, that the consumption had been reduced to an average of two and one-tenths pounds, being a saving of about fifty per cent., and in stationary engines the average was three pounds, a saving of about thirty-three per cent.

One pound of ordinary coal develops in its combustion about *ten thousand units of heat*, which, in their turn, represent:

$$10,000 \times 772 = 7,720,000 \text{ foot-pounds of work.}$$

This number of foot-pounds represents a consumption of about *one-quarter* of a pound of coal per hour per indicated horse-power; whereas few engines of the present day produce an indicated horse-power with less than *ten* times that consumption, or say *two and one-half* pounds of coal.

## Horse-Power by the Indicator.

From the experiments of Watt the standard *unit of work or power*, as before stated, is one pound lifted twelve inches, or one pound of force acting through one foot of space, and is called the foot-pound; and 33,000 foot-pounds, or units of work, performed in one minute, or 550 foot-pounds in one second, make a horse-power.

We have also shown how to calculate the number of foot-pounds raised by the engine per minute, and if we divide that number by 33,000 we get the indicated horse-power of the engine.

If the engine is a single-cylinder one, the indicated horse-power is:

$$\frac{\text{Area of Cylinder} \times \text{Mean-pressure} \times \text{Revolutions} \times 2 \times \text{Stroke}}{33,000.}$$

If the engine were a double-cylinder one, the power of both cylinders would have to be added together to get the power of the engine.

Where there are a number of cards all taken from the same engine to be calculated out, a further simplification is made. Instead of multiplying the area of the piston by 2, and by the stroke, and dividing by 33,000 each time for each card, we may find what this sum, which is invariable for each particular engine, is, and multiply it by the mean pressure and the revolutions. This quantity is called the *horse-power constant* for the engine, and is the number of horse-powers which would be exerted by *one pound* of mean pressure. It is found by multiplying together the area of the piston in square inches and the feet traveled by it per minute, and dividing the product by 33,000.

In illustration of the above rules, we will compute the horse-power exerted in the following diagram, taken from the cylinder of a Corliss engine. The diameter of piston was six inches, the length of stroke sixteen inches, and the revolutions per minute 108; diameter of piston rod one and one-half inches. What is the horse-power of this engine by the indicator?

Cylinder, 6 inches diameter; stroke, 16 inches; revolutions, 108; boiler pressure, 70 pounds. To find the mean effective pressure on the piston, proceed as follows:

Divide the card into ten equal spaces and measure the length of each dotted line or ordinate by the scale corresponding to the spring of the indicator (which in this case is 30 pounds equal to one inch in height). The sum of the lengths of the ten ordinates amounts to 344 pounds, which divided by ten, the number of ordinates, gives an average mean effective pressure of 34.4 pounds per square inch.

FIG. 11.

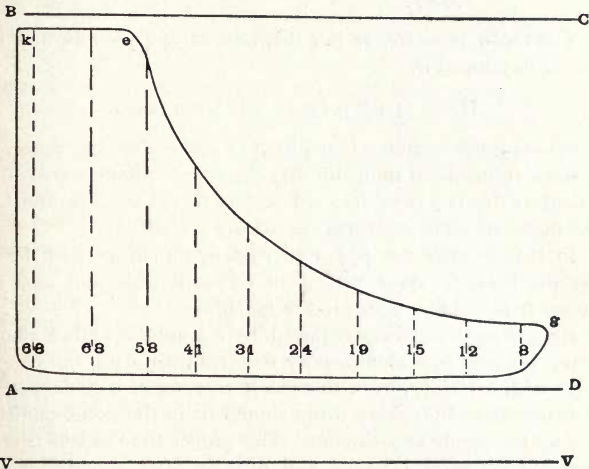

To calculate the indicated horse-power, multiply the area of the piston in square inches by twice the length of the stroke in feet, and the product by the number of revolutions per minute. (This product is known as the "*piston displacement*.") Divide this product by 33,000 and the result is the "*horse-power constant*," or the power developed for every pound of mean effective pressure. Multiply the quotient by the mean effective pressure, (ascertained from the diagram) and the result will be the indicated horse-power.

$$\text{The area of the piston} = 6 \times 6 \times 0.7854 = 28.274."$$

$$\text{The area of the piston rod} = \frac{1.5 \times 1.5 \times 0.7854}{2} = 0.883.$$

Average area of piston, less one-half area of rod, = 27.391.  
(28.274 — 0.883 = 27.391.)

The speed of piston in feet per minute =  $\frac{16 \times 2 \times 108}{12} = 288$  feet.

The constant for this engine is, therefore,

$$\text{HP} = \frac{27.391 \times 288}{33,000} = 0.239, \text{ the horse-power constant.}$$

The mean pressure, as per diagram, is 34.4 pounds, and the power developed is,

$$\text{HP} = 34.4 \times 0.239 = 8.22 \text{ horse-power.}$$

Where great accuracy is required in estimating the power of steam-engines from indicator diagrams, care should be taken to calculate the power of forward and back strokes separately, as the mean effective pressures are not always alike.

In this manner the power exerted by an engine may be ascertained under every variety of circumstances, and also the power required for every kind of machine.

Measuring the power required by a single machine among many running in a manufactory requires great care, but can be done with certainty, even to a small fraction of a horse-power. It is necessary that every thing should be in the same condition during the whole experiment. The proper time to test is after running for several hours, and directly after stopping, when everything is in the best working condition; say, at noon-time. First indicate for the shafting alone, afterwards put on the machine to be tested, the power required for which is to be ascertained; after it has been running for a few minutes, and, finally, after the belt has been thrown off, indicate for the shafting again.

In case the pencil should run over the paper several times, it should be ascertained if it follows the diagram exactly when removed a little from the paper. The first and third diagrams (that is the friction diagram of the shafting) should be identical, and the excess of the second diagram is the power required by the machinery tested. Care should be observed that all the diagrams are taken at the same speed of the engine.

In all cases the greatest pains should be taken to determine if the diagrams are a true representation of the power exerted. See if the pencil will repeat the diagram both when in contact, and when not in contact with the paper. Often the diagram will not repeat exactly. Whenever this is the case, the pencil must be allowed to run over the paper a sufficient number of times, and the average of all the figures must be taken as the true one.

As before stated, the indicator-card is usually run out, or in other words, the mean pressure of the card is usually ascertained by reading off with the aid of the scale the different mean pressures on each of the ten spaces; then adding them together and dividing them by ten, or whatever number of spaces there are. This is correct, provided each reading is an accurate one. The following is a far better and easier method: Take a long strip of paper, say one-half an inch wide, and from 10 to 20 inches long, according to the nature of the card. Mark a starting point on the edge near one end. Then lay the strip of paper along the first dotted line and mark off the length of second dotted line, then lay it on the second space and add the length to second dotted line, and so on to the tenth dotted line. By this means the lengths of each of the ten lines are laid end to end. If we now take a rule and read off how many inches there are in the whole length, and divide them by ten, we get the number of inches in the mean pressure of the whole card.

Generally expressed, we multiply the total number of inches read off the strip by the scale, and divide by ten.

This is one of the best and safest, if not the very best, way of finding the mean pressure of a card or diagram; it is certainly greatly superior to the method of reading off ten different pressures, and adding them together and dividing by ten as heretofore described.

#### How to Divide a Line Into a Number of Equal Spaces.

A foot-rule or scale is usually divided into inches, halves, quarters, eights and tenths of an inch; and, when the line to be divided into a required number of equal spaces is a multiple of those spaces, it is, of course, easy to divide it. Thus it is easy, by applying the rule, to divide a line four

inches long into four inch spaces, or eight half-inch spaces or sixteen quarter-inch spaces, or thirty-two eighth-of-an-inch spaces. But, when the line is not such a multiple of the space, it cannot be divided by applying the rule to it; and the following method may be used: For instance, a line  $4\frac{3}{8}$  inches long is to be divided into *ten* equal spaces. First draw a line at right angles to the given line, at one end of it; then take a strip of paper, and, applying the rule to the strip, mark off on it *ten* equal spaces, which together will exceed the length of the given line; then place one end of the strip at the open end of the given line, and carry the other end of the strip up

FIG. 12.

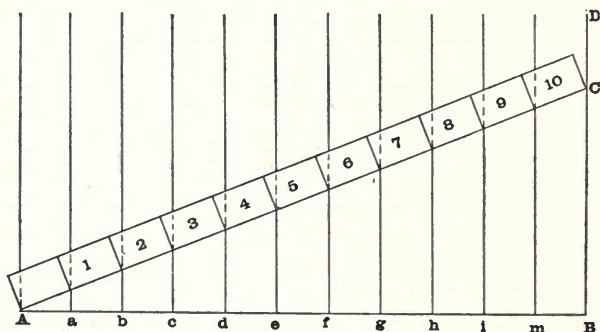

until the last point marked off on it touches the right-angled line, and through the points on the strip draw lines parallel with the right-angled line to the given line; and the given line will be divided as required.

Thus let  $AB$ , Fig 12, be the given line; draw  $BD$  at right angles to it; the first 10 equal spaces on the rule, which will exceed the length of  $AB$  ( $2\frac{3}{8}$  or  $2.062$ ) will be ten one-quarter inches; mark this ten one-quarter inches off on a strip  $A$  to  $C$ ; place the end  $A$  of the strip to the end  $A$  of the line, and move up the strip until the point  $C$  touches  $BD$ ; and, through points 1, 2, 3, 4, 5, 6, 7, 8, 9, and 10 on the strip, draw lines  $a, b, c, d, e, f, g, h, i,$  and  $m$ , parallel with  $BD$ ; and the line  $AB$  will be divided into ten equal spaces.



To those who are frequently in the habit of computing the horse-power of engines from diagrams, this method will be found very advantageous.

#### The Planimeter.

In the present state of the arts there is a most ingenious instrument called a planimeter, which is now in general use for finding the mean pressure. This instrument not only enables one to measure the areas of indicator diagrams correctly, but the

FIG. 13.

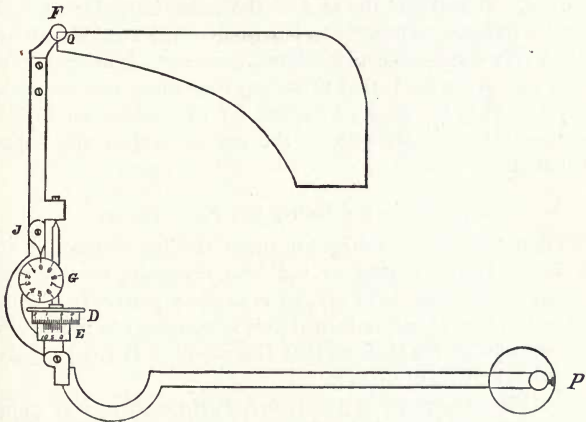

mean pressures may at once be read off, without the aid of intricate mathematical calculations. The action of the planimeter is quite simple, as will be readily understood by Fig. 13.

It consists only of two arms, hinged together, and a wheel. At the end of each arm there is a sharp point. In using the instrument one of these points is stuck lightly through the paper, and the other is moved along the line drawn by the indicator pencil, until it has passed entirely around and returned to the point it started from. Meanwhile the wheel rolls about on the paper. On the edge of the wheel there are numbers, and opposite the upper part of it there is a pointer or zero mark. When the instrument is in position and the engineer is ready to

move the point along the line, as already described, he reads the number opposite the pointer. He reads it again when the pointer comes back to the starting place, and the difference between the two readings is the area of the card in inches. He next measures the length of the card by means of a machinist's scale, graduated say to hundredths, and he divides the area, as found by the planimeter, by the length, as found by the scale. The result is the average height of the card. Multiplying by the scale of the card gives the average effective pressure.

The planimeter is one of the most wonderful instruments yet invented. It will find the area of the most irregular card just as easily and just as exactly as it will find the area of a square. It is so very simple in construction that it was announced, when it was first introduced, that there was something mysterious behind it. This is not so, however, for its action can be fully explained, though not without the use of algebra and higher mathematics.

#### Directions for Using the Planimeter.

To find the area of a diagram, place the instrument on the drawing (whether a plan or indicator diagram), in about the position shown, that is to say, so as to allow perfect freedom of motion in every direction in which it is necessary to move; sink the needle-point  $P$  a little so that the needle will remain fixed, and place the weight upon it.

Then place the point of the tracer,  $F$ , upon any given point, say  $Q$ , of the outline of the figure to be measured, and either adjust the wheels to their respective zeros or take a first reading where they happen to stand; follow the outline of the figure carefully with the tracer-point, moving in the direction taken by the hands of a watch, returning to the starting point,  $Q$ ; then the index must be read.

Having started from zero, suppose we find that the highest figure on the roller wheel,  $D$ , that has passed by zero on the vernier is 2, which in this style of planimeter represents units, and we find the number of intermediate graduations that have also passed zero on the vernier to be 4, then we find the number of the graduation on the vernier,  $E$ , which exactly coincides with a graduation on the wheel, to be 8; then we have 2.48

square inches as the area of drawing. If we start with an old reading, instead of from zero, the first reading should be deducted from the second reading, then the *difference* represents the area of the drawing. If the amount of the first reading should exceed that of the second, 10 should be added to the second reading before subtracting. If the figure is drawn to a scale, multiply the result by the square of the scale for the actual contents of the surface which the drawing represents. If it is an indicator diagram, and we have found the areas, as per above directions, to be 2.48, divide this by the length of the diagram, which we will assume to be 4 inches, and we have 0.62 inch as the average height; multiply this by the scale or number of the spring, which in this instance we will call 40, and we have 24.8 pounds as the average pressure per square inch on the piston.

FIG. 14.

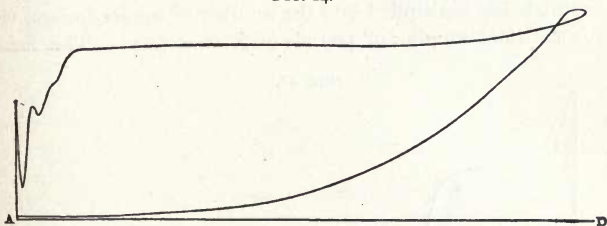

When a set of diagrams are taken, which are of the same length, it is only necessary to multiply the area in square inches with a co-efficient obtained by dividing the "scale" with the length in inches.

For instance:

Area = 3.80 square inches

Length of diagram = 4. inches

Scale = 30. pounds per square inch

$\frac{30}{4} = 7.5$  co-efficient

$3.80 \times 7.5 = 28.5$  pounds per square inch.

In calculating the power from diagrams of condensing engines, it is usual to measure the area above and below the atmospheric lines separately. This method gives the value of the average vacuum obtained, and thus indicates the extent to which the back pressure is reduced below atmospheric pressure.

In measuring the indicator diagram it is of no consequence what the character of it may be, whether most wasteful, like the Figs. 14 and 15, or most economical, like Fig. 16.

FIG. 15.

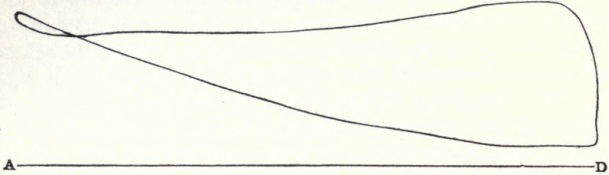

For, ascertaining the power exerted, we have merely to measure its included area, and so get the mean-pressure on one square inch during the stroke, which this area represents. This pressure being multiplied into the number of square inches, we have the total number of pounds of force exerted. This force

FIG. 16.

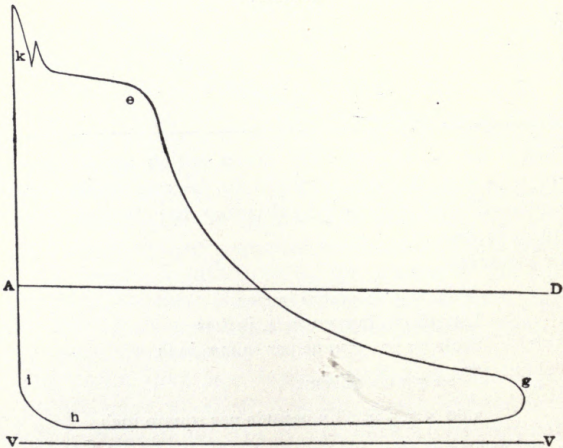

is acting through the distance traveled by the piston. We multiply it by the distance in feet through which the piston travels in one minute, and the product is the number of foot-

pounds of force exerted in one minute. This divided by 33,000, gives the number of horse-power. It is to be observed, that in this calculation force and distance are treated as convertible. However extremely unequal, as in Fig. 17, the pressures may be at different points of the stroke, these are all reduced to an average pressure, which is conceived to be uniformly exerted throughout the stroke. Then, finally, all the power exerted in a minute is conceived as a certain number of pounds of force exerted through one foot.

The above calculation gives what is called "the indicated

FIG. 17.

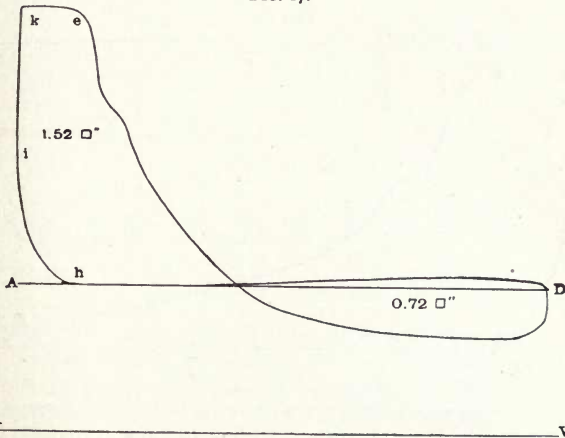

power" of the engine—not the gross power exerted by the engine. The included area of the diagram represents only the difference between the opposing forces which act to produce and to resist the motion of the piston. The force of the steam must in all cases be first applied to overcome what is called the back pressure. In a non-condensing engine this must be at least the pressure of the atmosphere. It is always, in fact, more than this, by the amount of force that is required to expel the exhaust steam through the port, passages, and pipe, against the resistance of the atmosphere. Sometimes the excess of back pressure above that of the atmosphere is scarcely perceptible, as

in diagram Fig. 18. In badly constructed engines, on the other hand, the force required for this purpose may be very great, as in diagram Figures 14 and 15, which are almost too bad in this respect to be credited, but the writer has the originals in his possession. The usefulness of the indicator in revealing defects of this nature can hardly be estimated. Locomotives were running before the introduction of indicators, for high speeds some twenty years ago, with a back pressure of *ten to twenty pounds* above that of the atmosphere. The office of the condenser and air-pump is to remove the back pressure, or resistance of the atmosphere, from the piston of the engine to the piston or

FIG, 18.

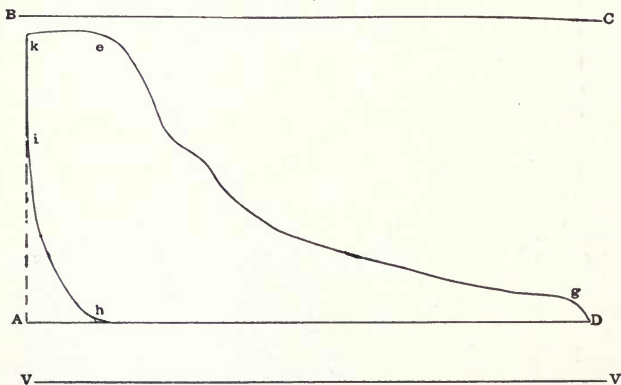

plunger of the air-pump; by which means indeed, it is, to the extent of the vacuum obtained, got rid of altogether, since the atmosphere exerts there the same force to produce motion in one direction that it does to oppose it in the contrary one. But in all cases it is only the net power exerted, after deducting that which is necessary to overcome the back pressure, as represented in the included area of the diagram.

A diagram from a condensing or "low pressure" engine differs from one produced by a non-condensing or "high-pressure" engine, from the fact that in the former the line of back pressure, instead of being a little above atmospheric pressure, approaches more or less to that of perfect vacuum.

In calculating the power from diagrams of condensing or "low-pressure" engines, it is usual to measure the area above and below the atmospheric line separately. This method gives the value of the average vacuum obtained, and thus indicates the extent to which the back pressure is reduced below atmospheric pressure; see diagram, Figure 19.

FIG. 19.

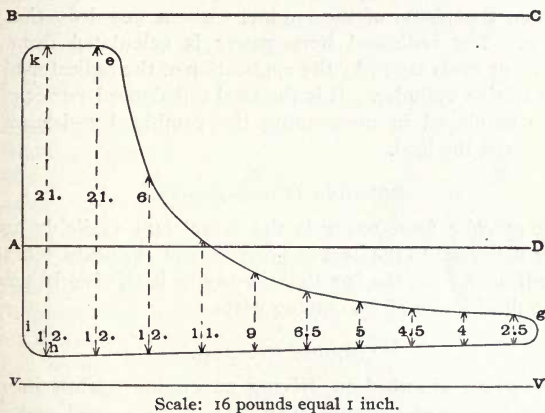

In this the average mean pressure due to the steam was  $21 + 21 + 6 = 48$  pounds, which divided by 10 (the number of divisions on the card) equals 4.8 pounds; and the average vacuum realized was  $12 + 12 + 12 + 11 + 9 + 6.5 + 5 + 4.5 + 4 + 2.5 = 78.5$  pounds, which divided by 10 equals 7.85 pounds; showing that the power realized in this case by removing the resistance of the atmosphere was about *sixty per cent.* of that shown by the indicator, thus:

$$\% = \frac{7.85 - 4.8}{4.8} = 60 \text{ per cent.}$$

In well constructed engines with an early cut-off, the expansion curve, *e g*, (diagram 19,) will often cross the atmospheric line, *A D*, before the piston has moved half the length of the cylinder. In such cases as this the mean pressure represented

by the area above the atmospheric line,  $A D$ , will be less than below it, which difference is due to the reduced back pressure by reason of the comparative vacuum in the condenser. The above diagram, Figure 19, indicates a large amount of expansion.

#### Indicated Horse-power.

The *indicated horse-power* is the power developed by the steam on the piston of the engine, without any deduction for friction. The indicated horse-power is calculated from the diagram or cards taken by the application of the indicator to the steam engine cylinder. It is the total unbalanced power of an engine employed in overcoming the combined resistance of friction and the load.

#### Effective Horse-power.

The *effective horse-power* is the actual and available horse-power delivered to the belt or gearing, and is always less than the indicated, from the fact that the engine itself absorbs power, due to the friction of its moving parts.

#### Engine Friction.

The power absorbed in driving an engine against its own friction is a most variable quantity. With a good and well constructed engine having ample bearing surfaces, efficient means of lubricating them, and valves nearly balanced without over-complication, the friction may not exceed *ten per cent.* of the indicated power. But in badly constructed engines the friction may be nearer fifty per cent. In the case of an engine having ordinary unbalanced slide valves, it is probable that quite one-third of the whole frictional resistance is due to the valve cut-off. The heat due to the internal engine friction—that is to say, the friction of the valves and piston—is imparted to the steam, and either the whole or greater part of it is carried to the condenser or atmosphere with the exhaust steam.

The power absorbed in overcoming friction is not only wasted, but it is wasted in wearing out the engine.

In the diagram, Figure 11, the calculation gave what is called the indicated power, that is, the effective available power of the



engine. It does not show the gross or whole power of the engine. This gross power is reduced to effective motive power in three ways, namely:

*First.* In expelling the steam left in the cylinder at the end of the stroke, the expelled steam carrying its *heat* with it to the atmosphere in a non-condensing or "high-pressure" engine, and to the condenser in a condensing or "low pressure" engine.

*Second.* In compressing the steam in the cylinder after the exhaust-port is closed, but as this steam is again used after compression, the power used in compressing it is not necessarily wholly wasted.

*Third.* In overcoming the friction of the moving parts of the machinery, including, in locomotives, the friction on rails, and, in stationary engines, the friction of the belt or gearing.

The effective, available motive power will therefore vary in proportion to the power lost through these reducing causes. The less power required to expel and compress the steam left in the cylinder and to overcome the friction, the greater will be the effective motive power, and *vice versa*.

In calculating this power, however, from a diagram, only the first and second of these causes are, or can be, considered.

The piston of an engine is always acted upon by two opposing forces, one propelling and the other repelling, and the difference between them is what in practice is called the effective motive force or power.

The propelling force must, of course, in all cases be sufficient at least to overcome the repelling force or back-pressure. This back-pressure, as will presently be seen, is always greater in non-condensing or "high-pressure" engines, than in condensing or "low-pressure" engines. In the former the propelling steam left in the cylinder at the end of the stroke (that is, the exhaust steam) escapes, or is expelled into the air; in the latter, into the condenser. In the former the back-pressure must necessarily be at least the pressure of the atmosphere, which averages about fourteen pounds to the square inch (see Fig. 11), but it is always greater than this, because of the friction of the exhaust steam in the ports and pipe connections, and in badly constructed engines it is much greater. In condensing, or "low-pressure" engines, the back-pressure should

always be less than the pressure of the atmosphere, depending upon the approximation to vacuum obtained in the condenser.

In the diagram, Fig. 20, taken from a non-condensing engine, it will be seen that the back-pressure line,  $g d h$ , is considerably above the atmospheric line,  $A D$ , indicating excessive back-pressure.

Excessive back-pressure in a non-condensing engine is caused by, or results from, too great impediment to the escape of the exhaust steam, and in condensing engines to imperfect vacuum in the condenser. The value of the indicator in revealing defects of this kind cannot be overestimated.

FIG. 20.

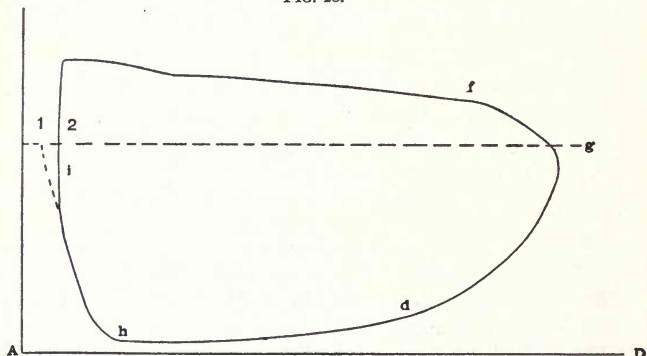

The difference between a non-condensing and a condensing engine is, as has been seen, that in the former the exhaust steam escapes or is expelled more or less directly according to the construction of the port-passages and pipe connections into the air, and in the latter into the condenser.

In the former the back-pressure is the pressure of the atmosphere increased more or less as the escape of the exhaust steam is more or less impeded. In the latter the back-pressure depends chiefly upon the pressure of the exhaust steam, or, in other words, the degree of vacuum, in the condenser.

A perfect vacuum cannot in practice be had—but an average of about 26 inches or 13 pounds is usually obtained by the gage; diagrams generally show from 3 to 4 pounds less. The approximation to a vacuum, and corresponding diminution of back-pressure, are effected in three ways, namely:

*First.* The temperature of the condensing water.

*Second.* The pressure of the atmosphere.

*Third.* The friction of the exhaust-pipes and ports.

*First.* If the temperature should be 32 degrees Fahrenheit, the pressure would be only 0.085 pounds to the square inch, and the vacuum as nearly perfect as is obtainable. The condensing water is, however, usually taken at 40 to 80 degrees, and leaves the condenser at from 90 to 120 degrees, making the temperature in the condenser generally about 100 degrees, which would give a back-pressure from this cause alone of about one pound to the square inch.

*Second.* If the barometer stands at only 28 inches, 13.7 pounds would be a perfect vacuum; 30 inches of mercury being equivalent to 14.7 pounds; and if the water in the condenser be at a temperature of 130 degrees, its vapor will form a resistance of 2.21 pounds; therefore the lowest attainable vacuum would be but  $13.7 - 2.21 = 11.49$  pounds. Whereas, if the barometer stood at 31 inches, a perfect vacuum would be 15.2; and if the water was but 100 degrees its vapor would give a resistance of only 0.9 pound, and consequently the highest attainable vacuum would be  $15.2 - 0.9 = 14.3$  pounds, making a difference of 2.81, or a gain of *twenty per cent.*

*Third.* The friction of the exhaust-pipe and ports will be excessive, if they are too small, to the same extent as in the case of non-condensing engines.

The water used for steam engine purposes invariably contains more or less air, which if allowed to accumulate would gradually destroy the required vacuum. It is necessary, therefore, to draw off this air as well as the water, and this is done by means of an "air pump" worked by the engine; and, of course, the power required to do this, although needfully expended, is so much power to be deducted from the given power, reducing the efficient motive power of the engine. The power thus expended is usually equivalent to from one-half to one pound

pressure. But it is frequently necessary to raise the condensing water from a lower level to the line of the condenser, and in that case the power required to do this work is also power to be deducted from the gross power, also reducing the efficient motive power of the engine. In all cases it is only the net motive power, after deducting the power needed to overcome the back-pressure, that is represented in the area of the diagram.

The pressure of the atmosphere is usually taken as 15 pounds, which is too high, being correct only when the barometer stands at 30.54 inches—a most unusual occurrence; but the error is unimportant, and it is very convenient to avoid the use of a fraction, and to say that 30 pounds, 45 pounds, 60 pounds, and so on, represent 2, 3, 4, 5, 6 atmospheres of pressure.

Mercury in Pounds, and Vacuum in Inches.

TABLE NO. 4.

| Inches of Mercury. | Pounds. | Inches of Mercury. | Pounds. |
|--------------------|---------|--------------------|---------|
| 2.037              | 1       | 16.300             | 8       |
| 4.074              | 2       | 18.337             | 9       |
| 6.111              | 3       | 20.374             | 10      |
| 8.148              | 4       | 22.411             | 11      |
| 10.189             | 5       | 24.448             | 12      |
| 12.226             | 6       | 26.485             | 13      |
| 14.263             | 7       | 28.522             | 14      |

The principal object of knowing the exact pressure of the atmosphere is to ascertain the duty performed by the condenser and the air pump. The temperature of discharge being known, the pressure of vapor inseparable from that temperature is also known (see Nystrom's Pocket Book, page 400), and this being deducted from the actual pressure of the atmosphere, the remainder is the vacuum in which the water would boil. The power of the air-pump is shown in the closeness with which the vacuum approaches this point.

The vacuum shown by the indicator will generally vary from that shown by the vacuum gage, when it is constructed with a glass tube, hermetically sealed at the top; for such gages are designed to show the variation from a perfect vacuum without reference to the weight of the atmosphere; but the vacuum shown by an indicator is affected by all its variations.

## Vacuum Gage.

The common gage for indicating the vacuum of a condenser, consists of an inverted syphon, or **U** shaped tube, the lower part of which contains mercury, and whose legs have a scale attached to them, divided into divisions 1.018 inches apart, and indicate pounds pressure, for the reason that the descent of 1.018 inch in one leg, causes a rise of 1.018 inch in the other, making a difference in the level of the mercury of 2.036 inches, which corresponds to one pound. One leg, by means of a connection, communicates with the condenser; the other is open to the air. The mercury stands lowest in that leg in which the pressure on its upper surface is most intense; and the difference of level of the mercury in the two legs indicates the difference between the pressure in the condenser, and the atmospheric pressure. Mercurial vacuum gages are made, which indicate *directly* the absolute pressure within the condenser, by being constructed like a barometer, having the leg containing the mercurial column that balances the pressure to be measured hermetically closed at the top, with vacuum above the mercury, produced in the usual way, by inverting the tube and boiling the mercury in it. It is necessary to lay out the scale accurately and have it exactly vertical.

On diagrams representing condensing engines, the line of perfect vacuum should be drawn at the bottom, and the line of the boiler pressure, as shown by the steam gage, at the top. The line of perfect vacuum varies in its distance from the atmospheric line, or, more correctly, the latter varies in its distance from the former, according to the pressure of the atmosphere, as shown by the barometer, from 13.72 pounds on the square inch when the mercury stands at 28 inches, to 15 pounds when it stands at 30.6 inches, and it should be drawn according to the fact, if this can be ascertained. The engineer should always have a good aneroid at command.

The principal object of knowing the exact pressure of the atmosphere is to ascertain the duty performed by the condenser and air-pump. The temperature of the discharge being known, the pressure of vapor inseparable from the temperature is also known, and this being deducted from the actual pressure of the atmosphere, the remainder is the total attainable vacuum *at that temperature*.

As before stated, the areas of the diagram above and below the atmospheric line, are usually calculated separately, to ascertain how effectually the resistance of the atmosphere is removed from the non-acting side of the piston, by those parts of the engine whose function this is. In case of engines working very expansively, however, the expansion curve crosses the atmospheric line, and sometimes at an early point of the stroke, as in diagram, Fig. 19. In such cases, the whole space between the atmospheric line and the line of counter-pressure should be credited to the condenser and air-pump; not, of course, to be considered in estimating the power exerted, but for ascertaining the degree of economy in the consumption of steam, which depends greatly on the amount of vacuum maintained.

The lines having been accurately drawn, as above directed, ascertain, by careful measurement with the scale or planimeter, the mean pressure in each division, between the atmospheric line and the upper outline of the diagram, until this crosses the former, if it does so. Add these together, and point off one place of decimals, or divide their sum by the number of divisions, if there are more than ten, and the quotient will be the mean pressure above the atmosphere during the stroke. Then repeat the process for the area between the atmospheric line, or the expansion curve, after it has crossed this line, and the lower outline of the diagram. Add the two mean pressures to ascertain together which will give the mean average pressure per square inch. Then find the number of square inches contained on the surface of the piston; this latter multiplied by the average pressure as found above, this product by the mean velocity of the piston in feet per minute, and divided by 33,000, and the quotient will be the gross indicated horse-power exerted; or the power represented by the two areas of the diagram, above and below the atmospheric line, may be calculated separately.

The strictly accurate mode of measurement is, to measure the pressure of steam from the line of perfect vacuum, when the line of 15 pounds pressure will come a little above the atmospheric line, but it is more convenient, and answers all the purposes of the diagram better, to measure each way from the latter.

The space above the steam line and between this and the line

of boiler pressure, shows how much the pressure is reduced in the cylinder by throttling, or by the insufficient area of the ports, proper allowance being made for the difference of pressure necessary to give the required motion to the steam in the pipe; whilst the space between the line of counter-pressure and the line of perfect vacuum shows the amount of resistance to the motion of the piston.

On diagrams for non-condensing engines, the line of boiler pressure should also be drawn at the top, and it is well to draw the line of perfect vacuum also, that the engineer may be able to see at a glance the quantity of steam consumed, and to compare with it the amount of work done. It is not possible that

FIG. 21.

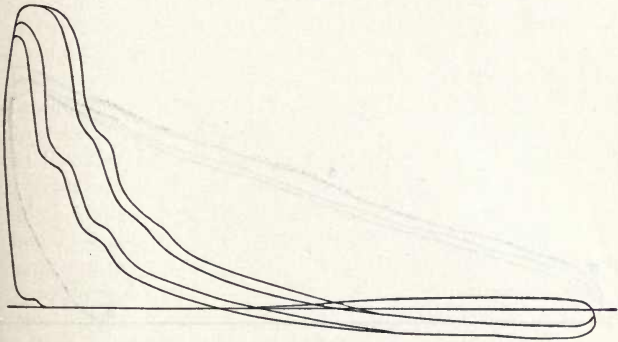

the back pressure resisting the motion of the piston shall be less than the pressure of the atmosphere, but it may be a great deal more; and very frequently in non-condensing engines, the line of resistance is as much as 2 or 3 pounds above the atmospheric line, though it is quite possible to avoid this excess altogether, as is shown in diagram, Fig. 18, page 112.

The mean pressure is ascertained in the manner already directed for obtaining the pressure above the atmospheric line in condensing engines, and the power is calculated in the same way.

In the same manner, on stationary engines, the power shown by the frictional diagrams can be calculated, and also the *va-*

*rious powers* shown by diagrams, Figs. 17 and 21, taken when the shafting only was being driven, and when greater or less proportions of the whole resistance are being overcome; whilst on vessels, the effects of different depths of immersion can be determined.

So also the power required in non-condensing engines, to overcome the resistance of the atmosphere, is readily ascertained.

It often happens, in non-condensing engines working expansively, that the expansion curve falls below the atmospheric

FIG. 22.

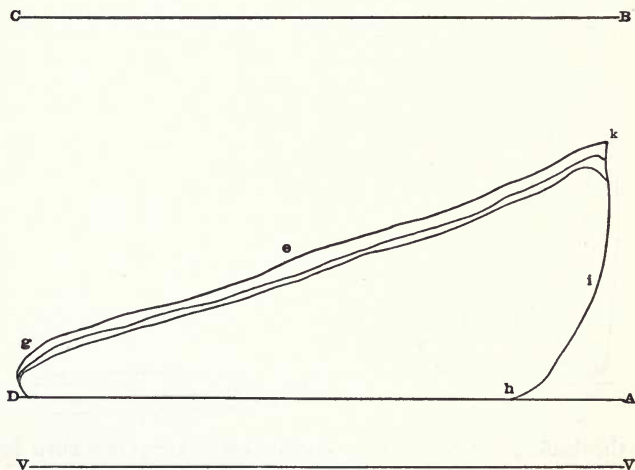

line, as illustrated in Fig. 17, and the following Fig. 21. In such cases the enclosed area below the atmospheric line must be deducted from that above this line, to give the power really exerted; for it is obvious that during the latter portion of the stroke, while the expansion curve ran below the atmospheric line, the pressure of steam was insufficient to overcome the resistance of the atmosphere, which was then exerted, in that degree, to retard the motion, and this deficiency must be made good during the earlier portion of the stroke.

Generally, engines will give the same figure at each revolu-



tion, the pencil retracing the same line so long as the resistance continues the same; but sometimes this is not the case, as in the engine from which the diagram Fig. 22 was taken, where are shown three distinct expansion curves. In such cases, care must be taken to obtain the average diagram. Also, in comparing the pressures required to overcome different resistances, it is essential that the speed of the engine in each case be the same—a requirement often disregarded.

## CHAPTER VIII.

### DIAGRAMS SHOWING THE ACTION OF STEAM IN A STEAM-ENGINE CYLINDER.

SOME of the disturbing causes on diagrams of a steam-engine which make the real differ from the ideal form of the diagram, have already been considered incidentally. At present the more important and usual of these deviations, are to be classed and considered in detail.

These causes affect the power of the engine, as well as the character and shape of the diagram.

The indicator diagram is, of course, the key to the action of the steam in the cylinder. A part of the work performed by the steam is spent in overcoming the friction of the engine itself, and consequently, the efficiency of the *engine* is most fairly tested by the amount of external work absolutely performed against a brake or otherwise.

Where the efficiency of the *steam* alone is concerned, however, the diagram is the only true criterion; and it will be necessary to deal with its theory carefully to prevent misunderstandings, which are frequent in practice.

#### The Action of Steam in the Cylinder.

The action of steam in any steam-engine cylinder is best understood from a diagram representing the varying pressures and volumes through the stroke.

#### An Ideal Diagram.

Such a diagram is usually obtained by an indicator applied to the cylinder, and in such case the pressures shown are actually those of the steam in use. For purposes of comparison and calculation, however, it is more convenient to construct an ideal diagram, as nearly as possible, such as would be given by an indicator applied to an engine as nearly perfect as practicable, working under the same conditions. Such a diagram is shown

in Fig. 23, where horizontal distances represent volume and vertical distances pressure.

The several lines on the ideal diagram will be designated here, reference being had to this diagram.

The base lines of the theoretical diagrams are as follows:

#### The Atmospheric Line.

When the atmosphere has free access to both sides of the piston of the indicator before steam is admitted, a straight line, *A D*, will be drawn by applying the pencil to the moving paper; this line is called the line of atmospheric pressure, or zero, on the steam gage. From this line we measure pressure for non-condensing engines.

FIG. 23.

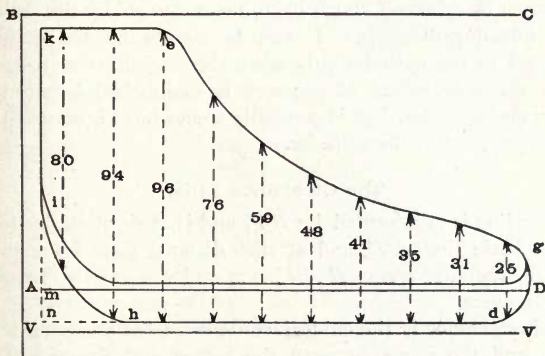

The atmospheric line should not be taken until after the rest of the diagram has been completed; because as the parts become warm by the steam, slight variations occur in its position, depending principally on the alteration in the force of the spring; and since this line serves as the origin from which the pressures are dated, it is necessary to have it laid down as correctly as possible.

#### The Line of Perfect Vacuum.

The line *V V* represents it. This line cannot be drawn by the indicator, but must be drawn by hand, parallel with the

atmospheric line, and at the proper distance below it to represent the pressure of the atmosphere, as shown by the barometer, according to the scale of the indicator diagram. When the actual pressure is not known, it is to be assumed at 15 (14.7 pounds exact) on the square inch, corresponding almost exactly with 30 inches of mercury, which is about the average pressure at the level of the sea. The barometric column falls one one-hundredth of its height for every two hundred and sixty-two feet of elevation above the sea level.

#### The Line of Boiler Pressure.

This line is represented by the letters  $B C$ , and is also drawn by hand, parallel with the atmospheric line, and at the proper distance above it to indicate the steam pressure per square inch, as shown by a correct steam gage, measured off by the scale of the indicator diagram. It can be drawn by the indicator attached to the cylinder only when the engine is at rest, and while an equilibrium of pressure is established between the boiler and cylinder. It is generally somewhat higher than the initial pressure in the cylinder.

#### The Clearance Line.

This line is represented by  $B V$ , and is at right angles to the atmospheric line  $A D$ , and at such distance from  $k i m$  and  $n$ , that the included space,  $B A V$ ,  $n m$  and  $k$ , correctly represents the clearance.

This clearance is the cubical contents of the steam-port passages and the space between the piston and the end of the cylinder, or head, to which it is nearest at the end or beginning of a stroke, supposing them, when added together, to be at each end one-twelfth of the whole cubical contents of the cylinder for one stroke of the piston, then the distance  $A m$ , would be made one-twelfth ( $\frac{1}{12}$ ) of  $m D$ . In the diagram, Figure 23, one-twentieth ( $\frac{1}{20}$ ) has been taken, so that the line  $A m$ , is one-twentieth ( $\frac{1}{20}$ ) of the length of  $m D$ . It is necessary to take these cubical contents into account, for the passages and clearance must always be filled with steam at each stroke, which is compressed and expands just precisely the same as the rest of the steam in the cylinder does after the steam has been cut off.

It is necessary to draw this line and to add this space to the indicator diagram, whenever the theoretical curve is constructed to compare with the actual curve traced by the indicator, and must be reckoned as part of the diagram in calculating the average pressure, and in producing the theoretic curve, or line of perfect expansion. The clearance is, however, rarely given, and it varies in different engines from one to twenty per cent. of the space swept through by the piston in one stroke. If we have the drawings of the engine we can calculate it; if we know the style of engine we can approximate it.

The best method, providing the piston is tight, is as follows:

Put the engine on the center, remove the valve chest cover, uncover the steam-port on the end where the piston is, fill the steam passage and piston clearance full with water up level with the valve seat; allow it to remain a few minutes, and if it maintains its level it is evident the piston is tight; then draw off the water, measure or weigh it, reduce it to cubic inches, and we have it exactly. The number of cubic inches of clearance divided by the cubic inches of space swept through by the piston in one stroke gives the ratio of cylinder capacity to clearance. This matter will be more fully illustrated hereafter.

#### Division of the Outline Drawn by the Instrument During a Revolution of the Engine.

The diagram, Fig. 23, shows all the lines that would be traced by the pencil of the indicator during one revolution of the engine, assuming the action of the steam to be nearly theoretically correct. In order that the student may better understand the subject matter, the following names have been given to the lines represented as follows:

The line from *i* to *k*, the admission line.

The line from *k* to *e*, the steam line.

The line from *e* to *g*, the expansion line.

The line from *g* to *d*, the exhaust line.

The line from *d* to *h*, the back pressure, or line of counter pressure.

The line from *h* to *i*, the compression line.

Of these divisions, the first four are drawn during the forward stroke of the piston and until it is at, or very close to, the termination of its stroke, and the last two are drawn during the return stroke.

## Admission Line.

The admission line,  $i k$ , shows the rise of pressure due to the admission of steam to the cylinder. This line is generally very nearly vertical, and when this is the case, it shows that steam of nearly boiler pressure is had at the commencement of the stroke while the piston is nearly stationary. Should this line incline forward, as shown in Figure 15, or at  $k$  in Figs. 17 and 29, curve with the steam line the reverse as indicated; or should this line continue vertically beyond, and then suddenly drop to the level of the steam line, Fig. 16, it signifies that the steam is wire-drawn, and cannot keep up the full pressure as the piston starts forward; but should this line, after projecting above, be suddenly depressed below the level of the steam line, vibrating back and forth one or more times on the latter line with acute angles of return, it may be attributed to the momentum of the reciprocating parts of the indicator while running at very high speeds: this will be hereafter more fully explained.

## The Steam Line.

The steam line,  $k e$ , is traced while the steam is being admitted to the cylinder, and should be nearly parallel to  $BC$ , and is invariably several pounds pressure below it; this loss in pressure occurs from radiation and friction in the pipes from the boiler to the cylinder. This line also represents the initial pressure acting on the piston up to the point of cut-off, and should be of unvarying height to show that full boiler pressure is maintained. It also shows at its termination the point at which the valve closes, or steam is cut off.

To maintain a proper steam pressure in the cylinder depends of course, in the first place, upon the amount of steam-port area. It will be noticed in diagram, Fig. 11, taken from a Corliss engine, that the piston obtained nearly the full boiler pressure at the very commencement of the stroke—the initial cylinder pressure was 97 per cent. of the pressure in the boiler; while in the diagram, Fig. 22 (fitted with the ordinary slide-valve and the steam controlled or regulated by a valve in the steam pipe), the maximum cylinder pressure reached but 66 per cent. of the boiler pressure, notwithstanding the slower speed of the engine, the former making ninety, and the latter but forty revolutions per minute.

An important consideration in connection with the admission of steam is that the maximum cylinder pressure be fully maintained until the closing of the valve; in other words, that the steam line traced by the indicator should, as much as possible, run in a horizontal direction. (See Figs. 9, 10, 11, 18, and 23.) To effect this, it is necessary to have the steam-port fully uncovered early in the stroke, so that the steam can be rapidly introduced into the cylinder. Referring to the above mentioned diagrams, we find that the steam-line is kept well up to the boiler pressure, and this pressure is nearly fully maintained until the point of cut-off is reached. If we take into consideration the small amount of lead obtained in these cases, we must attribute the comparative good results solely to the employment of Corliss and Buckeye valves, which permit—with a smaller amount of angular advance of the eccentric—a very rapid and good introduction of steam. In locomotive engines the diagrams taken with a high rate of expansion, more particularly at high speeds, the steam line generally falls more or less during the period of admission, indicating that the steam-port opening is too small.

#### The Point of Cut-off.

This takes place at  $e$ . In the theoretical diagram the corner is abrupt, but in practice it is more or less rounded. The diagram does not always show clearly the exact point where the convex curve of the rounded corner changes to the concave curve of the expansion line, but the point of cut-off is properly located at the point where the direction of curvature changes from convex to concave.

#### The Expansion Curve.

This is represented by the line  $e g$ , and results from a fall of pressure due to the expansion of the steam remaining in the cylinder after cut-off takes place. The actual curve, as drawn by the indicator, will be above the theoretical curve laid down by the law of Boyle and Mariotte hereafter explained. That is to say, the pressure is inversely as the volume, and the curve which expresses the pressure for every point of the stroke is an equilateral hyperbola. In all indicator diagrams, a material difference will be noticed between the true ratio of expan-

sion and the corresponding pressures; the amount of departure of the actual pressures from the theoretical curve bearing, however, a certain relation to the degree of expansion, as will be seen hereafter.

There are various causes which produce this action during the period of expansion, but their precise influence is more or less difficult to ascertain. In the first place, leakage at the valves or past the piston is, of course, calculated to alter the actual expansion curve.

The effect of leakage, if such occurs, is generally easily detected by the irregular form of the indicator curves. The main cause of the peculiar action of the expanding steam is, according to a large number of experiments made, the heat given off by the cylinder to the contained steam after its communication with the boiler has been cut off. This condition is facilitated by the presence of a certain quantity of water, which at the commencement of the expansion has the temperature of the live steam; but as the pressure is reduced in the cylinder this water will be instantaneously evaporated, and thus abstract from the cylinder a certain amount of heat. The heat absorbed with such rapidity is sufficient to raise the pressure considerably above that which would have existed had no condensation and re-evaporation taken place. The amount of heat which can be absorbed depends, of course, upon the difference of temperatures between the steam and the metal.

On the other hand, the mean temperature of the cylinder is influenced by the amount of protection against radiation and conduction of heat from the cylinder, by the amount of "throttling" from the boiler to the cylinder, by the extent to which expansion has been carried, and by the speed in revolutions per minute.

When the communication between the boiler and the piston is open, the cylinder will acquire a temperature practically the same as that of the boiler pressure, and if the cylinder contained nothing but dry, or superheated steam, this temperature would probably be maintained for the greater part of the stroke; but owing to a certain amount of water which has been deposited in the cylinder, and which is re-evaporated at the expense of heat imparted to the cylinder, this latter will become materially cooled by the time the piston has reached the end of the stroke.



For these considerations the relative effect of the various degrees of expansion and of speed will readily be appreciated. As the degree of expansion is increased the quantity of water converted into steam becomes also greater, necessitating, however, a larger condensation of high pressure steam during admission; and the longer the duration of the stroke—in other words, the slower the engine is running—the more heat will be absorbed from the cylinder by the conversion of this water into steam.

#### The Point of Release or Opening of the Exhaust-port.

This is at *g*, Fig. 23. To provide a rapid egress for the exhaust steam, and in order that its pressure may be as nearly as possible at a minimum, after the work in the cylinder has been performed, it is necessary that the exhaust-port should be opened before the piston reaches the end of its stroke. The proper amount of this pre-release depends, of course, upon the velocity of the piston and the quantity of steam to be discharged, or the grade of expansion. If, on the contrary, the steam be confined until the last instant, the back pressure at the commencement of the return stroke will be considerably increased, or in proportion to the period of admission. The deficiency of early release produces in the indicator-curves a sharp corner at *g*, at the end of the stroke, as shown in diagrams 11 and 20. It will be noticed, also, that a considerable loss of effective pressure is caused, for the same reason, as clearly shown by the reduction of the area of the indicator diagrams. The amount of back pressure against the piston during the remainder of the exhaust, also depends directly upon the amount of release, and, indirectly, upon the speed of the engine. If the exhaust-port is not well open at the end of the stroke, it is evident that the greater volume of the steam must be discharged during the return stroke of the piston until the closing of the exhaust-port; but as the piston attains its maximum velocity at half-stroke, the minimum back pressure above the atmospheric line must then be greater than it would be under the more favorable condition of premature escape of the steam. Therefore, the non-release of the steam before the end of the stroke involves not only a direct loss of the work done by the steam, as shown by the corner cut off from the indicator diagrams 11 and 20, but

its injurious effect is also manifest during the greater part of the return stroke. The loss of work done through an early release of the exhaust is more than regained during the return stroke, the back pressure against the piston becoming reduced to that of the atmosphere in non-condensing engines. See Figs. 9 and 18.

#### The Exhaust-line.

It is, of course, desirable that the pressure of the steam be got rid of as completely as possible before the piston commences its return stroke. This is accomplished by having the exhaust-port and passages sufficiently large, and opening the port a sufficient time before the termination of the stroke, according to the density of the steam to be released and the velocity of the piston.

The exhaust line commences at the point of release  $g$ , Figs. 18 and 23, where the expansion-curve changes to convex as the pencil travels to the line of counter pressure, and shows the fall of pressure caused by the release or opening of the exhaust-port for the escape of the steam before the forward stroke is finished, in order to diminish the back pressure. In an engine in which there is no pre-release (the exhaust port opening exactly at the end of the forward stroke), the diagram during the return stroke is usually a curve more or less similar to the line  $g d$ , see Fig. 20.

The lower side of the theoretical diagram, Fig. 23, used in calculations, being the line  $V V$ , representing the pressure in the condenser, or in non-condensing or "high pressure" engines the atmospheric pressure line,  $A D$ .

By making the release occur early enough, for example, at the point corresponding to  $g$ , in Fig. 23, the entire fall of pressure may be made to take place towards the end of the forward stroke, so as to make the back-pressure coincide sensibly with that corresponding to the line  $V V$ ; then the end of the diagram will assume a figure represented by the line  $g D d$ , in Fig. 23, which is usually more or less concave. The greatest amount of work is insured by making the release take place at point  $g$ , so that about one-half of the fall of pressure shall take place at the end of the forward stroke, from  $g$  to  $D$ , and the

other half at the commencement of the return stroke, as indicated by the curve,  $D d$ . The line  $g D d$  is traced while the excess of pressure remaining at the point of exhaust is being released.

#### Back-pressure, or Line of Counter-pressure.

If the steam used in working engines were unmixed with air, and if it could escape without resistance, and in an inappreciably short time from the cylinder after having completed the stroke, the back-pressure would be simply, in non-condensing engines (called "*high pressure engines*"), the *atmospheric pressure* for the time; and in condensing engines, the pressure corresponding to the temperature in the condenser, which may be called

FIG. 24.

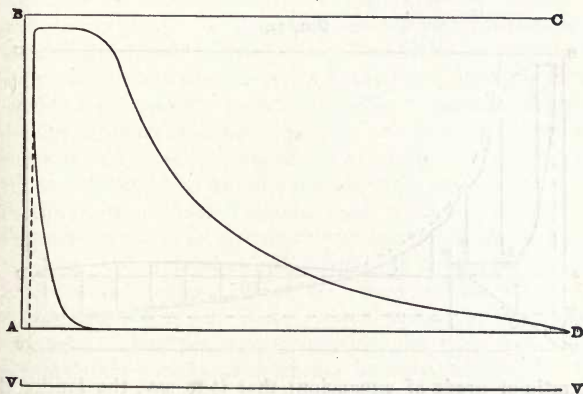

Scale: 40 equal 1 inch.

the *pressure of condensation*. The mean back-pressure, however, always exceeds the pressure of condensation, and sometimes in a considerable proportion. One reason for this, which operates in condensing engines only, is the presence of air mixed with the steam, which causes the *pressure in the condenser*, and consequently the back-pressure also, to be greater than the pressure of condensation of the steam. For example, an ordinary temperature in a condenser when working properly,

is about 100 degrees Fahrenheit, to which the corresponding pressure (absolute) of steam is about one pound on the square inch. But the absolute pressure in the best condensers is scarcely ever less than two pounds on the square inch, or nearly *double* the pressure of condensation.

The principal cause, however, of increased back pressure, is resistance to the escape of the steam from the cylinder, by which in condensing engines, the mean back pressure is caused to be from one to three pounds on the square inch, greater than the pressure in the condenser.

In non-condensing engines, experiments show that the *excess* of the back pressure above the atmospheric pressure varies nearly as the square of the speed; this excess of back pressure is less, the shorter the cut-off is, in other words the greater

FIG. 25.

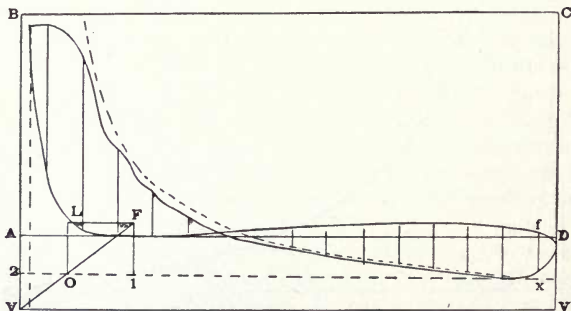

the ratio or grade of expansion; that is to say, the longer the *time* during which the expansion of the steam lasts. In cylinders with a mean of 16 per cent. of release, that is, with the exhaust port opened when the piston had performed 0.84 of its stroke—with steam cut off at one-half the length of stroke—that is, with a ratio or grade of expansion of 2 nearly, and with a piston speed of 600 feet per minute, being the maximum of speed in a good engine, the excess of the back-pressure above atmospheric pressure was about 0.163 of the excess of the pressure of the steam at the instant of release above the atmospheric pressure. When the pressure falls during expansion, as in Fig.

24, as low as the return or back-pressure, this exhaust line does not exist.

When the steam is exhausted below the return pressure, as in Figs. 17, 21 and 25, and the exhaust line is forced up from  $x$  to  $f$ , it indicates a rush of steam from the exhaust chamber back into the cylinder. This shows that the engine is too large for the work, and is working at a loss.

When the steam is exhausted at a high pressure, and through cramped passages, the exhaust line extends over most of the return stroke, as shown in Fig. 20.

#### The Back-pressure Line.

This is represented by the line  $d h$ , Fig. 23, and is the pressure behind the piston during the return stroke, and is called back-pressure because it acts in opposition to the return movement of the piston. In diagrams from non-condensing engines, (commonly called "high-pressure" engines) it is coincident with one or more pounds pressure above the atmospheric line, (see diagrams, Figs. 11 and 26) while in diagrams from condensing engines (commonly called "low-pressure" engines) it is 22 or 24 inches of vacuum below, or such a distance below the atmospheric line as will coincide with the vacuum attained in the condenser (see diagrams, Figs. 16 and 19). The resistance offered to the escape of the released steam has the effect of reducing, by a corresponding extent, the effective or indicated power of the engine. When the steam escapes from a non-condensing engine, the back-pressure cannot be less than the atmospheric pressure (14.7 pounds) at the time; and when it escapes from a condensing engine into a condenser, the back-pressure upon the piston cannot be less than the pressure of vapor existing in the condenser. The excess of resistance over these limits depends chiefly upon the state of the steam, the size and direction of the exhaust passages, and the speed of the engine.

Therefore, the passages and pipes communicating with the atmosphere should be at least *fifty per cent.* larger than the ports, and as free from angles as possible.

These requirements apply to condensing engines even more strongly, and in addition the condenser and air-pump must be able to maintain a proper vacuum.

## The Point of Exhaust Closure.

This is shown at *h* in diagram, Fig. 23, and is where the exhaust port is closed against the escaping steam. It cannot be located in all cases very exactly by inspection, for while, like the point of cut-off and exhaust, it is anticipated by a change of pressure due to a more or less gradual closing of the valve, it is not marked by a change in curvature of the line.

## The Line of Compression or Cushioning.

This line, when it exists, is formed by closing the exhaust before the end of the return stroke—for example: at the point

FIG. 26.

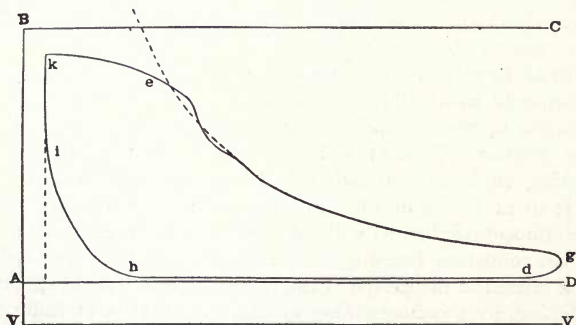

corresponding to *h*, on Figs. 18, 23, 26 and 27. A certain quantity of steam in the cylinder is then compressed by the piston during the remainder of the return stroke, and the rise of its pressure is represented by the curve *h i*. In the diagrams, Figs. 17, 18, taken from one of the most advanced types of engines, this curve terminates at *i*, and represents the *most advantageous adjustment* of compression, which takes place when the quantity of confined or cushioned steam, is just *sufficient to fill the clearance at the initial pressure*.

If this line should be projected above the initial pressure, and then suddenly drop nearly perpendicular to the level of the steam line, thus forming a loop, see Fig. 27, it would indicate an excess of compression, due to closing the exhaust too soon.

It is evident that this would be very objectionable, involving a loss of efficiency. In computing such a diagram, the area contained in the loop *x*, at the commencement of the stroke, denoting negative work as it were, should be subtracted from the total area included in the indicator diagram.

Compression, also, has a useful effect in the working of an engine, by providing an elastic cushion, whereby the momentum of the piston and its connections is gradually absorbed, and the direction of motion reversed without "thump" or "shock," so there is no "jar" from the entering steam when a new stroke begins. The proper regulation of compression serves to make an engine work easily and smoothly, and con-

FIG. 27.

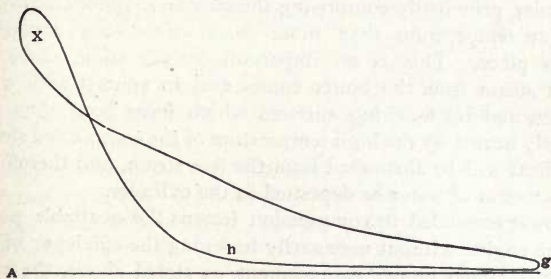

sequently reduces the wear and tear of the working parts. The pressure due to the momentum of these parts will, of course, depend upon their weight and velocity, increasing directly as the square of the speed. These data being given, the amount of cushion or pressure required to counterbalance work stored up in the reciprocating parts, can easily be ascertained. It follows that the compression should decrease rapidly as the speed diminishes, and *vice versa*.

In fast running engines, especially locomotives, compression also serves to prevent waste from clearance. The capacities of the clearance spaces and the steam-ports are relatively larger than in most other steam engines, on account of the higher speed of the former. These spaces must be filled at the commencement of the stroke with high-pressure steam, which is

obtained either by taking a supply of live steam from the boiler, or by compressing into the clearance spaces the low pressure steam that remains in the cylinder at the closing of the exhaust port. But in the latter process a certain quantity of steam is saved at the expense of increased back-pressure. It should be borne in mind, also, that the total heat of the compressed steam increases with its pressure, and as this latter approaches the boiler pressure, the temperature of the steam in compression is also raised, from that of about atmospheric pressure to nearly the temperature of the boiler pressure. These changes of temperature, which the steam undergoes, will affect the surface of the metal with which the steam is in contact during the period of compression. It follows, of course, that the ends of the cylinder principally comprising the clearance spaces, acquire a higher temperature than those parts where only expansion takes place. This is an important consideration, since the fresh steam from the boiler comes first in contact with these spaces, and by touching surfaces which have been thus previously heated by the high temperature of the compressed steam, less heat will be abstracted from the live steam, and therefore a less amount of water be deposited in the cylinder.

Power expended in compression lessens the available power of the engine without necessarily lessening the efficiency of the steam. Under proper management, as stated above, the compressed steam gives out during its re-expansion the power directly expended in compressing it. There is, no doubt, a somewhat great proportional loss by friction, but to counter-balance this, the wasteful back pressure is reduced by the earlier closing of the exhaust.

The termination of the compression curve should coincide with the beginning of the admission line, *ik*, see Fig. 23, page 125.

As in expansion so in compression—the actual curve as shown by the indicator diagrams generally, and more especially those taken from locomotives, do not coincide with the theoretical curve. Here again the application of the law of Boyle and Mariotte, namely, the volume of the retained steam being inversely as the pressure, comes nearest to practical results. It will not be difficult to account for the fact that the indicated



compression curve should be below the theoretical curve. During the period of exhaust the surface of the cylinder cover, piston, and cylinder have become materially cooled. When the exhaust port closes, the pressure and temperature of the retained steam rapidly rise, the temperature of the metal in contact with it rising simultaneously, but owing to the surfaces being large in proportion to the quantity of steam, a portion of the steam will be condensed. This loss of compression pressure is attended by a corresponding gain of total useful pressure; thus the departure of this curve, as well as that of the actual expansion line, below and above the theoretical curves, respectively, shows a proportional increase of the power exerted by the engine, which is clearly demonstrated by the increase of area included in the indicator diagrams.

#### Lead.

Lead means the amount of opening given to the steam port, so as to admit fresh steam into the space where the cushioning is going on, just before the piston comes to the end of the cylinder. In such a case the valve is said to anticipate or *lead* the motion of the piston, and the *lead of a valve* may be defined as the width of opening of the steam port when the piston is at the end of its stroke.

By giving lead to a valve the boiler pressure is brought against the piston just as it is reaching the end of its motion in one direction, and the strain upon the crank-pin is correspondingly relieved. The more rapid the motion of the piston, the greater the necessity for giving lead, and accordingly we find that in locomotive engines and the fast running automatic engines, such as the Porter-Allen, Westinghouse, and others, the lead is very considerable.

The lead, of which mention has been made, is *outside* lead, that is, it relates to the admission of steam, but of course lead can be given on the exhaust side of the valve, and in that case it would be called *inside* lead.

The lead and the period of admission should be the same for each end of the cylinder, for each point of cut-off, and, if possible, in locomotive engines in the back as well as the forward gear.

It is found necessary, especially with high speeds of piston, in order to insure good action of the steam, that the maximum cylinder pressure should be attained at the very commencement of the stroke. If the steam-port is not opened until after the piston has commenced its stroke, especially where there is but little compression, some appreciable time would be consumed in filling the clearance space and the steam passages with steam. In locomotives where the slide valve is worked by the ordinary link-motion, the steam-port will not open rapidly enough to enable steam of the maximum boiler pressure to fill the space after the receding piston, unless the valve begins to open the steam-port *before* the piston begins its stroke; that is, before the end of its preceding stroke. The Baldwin Locomotive Works allow from  $\frac{1}{8}$  (0.0625) to  $\frac{3}{8}$  (0.1875) inch lead according to the class of locomotives, but in ordinary cases from  $\frac{1}{4}$  or 0.03125 to  $\frac{1}{8}$  or 0.0625 of an inch will be sufficient.

When the maximum cylinder pressure is attained at the commencement of the stroke, the admission line of the indicator diagram—the piston being at the end of the stroke—will rise in a vertical line (see Figs. 11, 16, 19 and 23), but if the maximum pressure is not so attained the admission line will deviate slightly from the vertical (see Figs. 14, 15, and 20).

Lead and compression both regulate the steam admission. If the clearance space at the beginning of the admission is already filled with compressed steam, a less amount of lead is necessary, and *vice versa*.

In locomotive engines with the shifting link motion, however, not only the lead but also the compression increases rapidly as the link approaches mid-gear or half stroke; this is not a drawback, as the increased compression is calculated to facilitate greatly the attainment of the full pressure of steam in the cylinder at the commencement of the stroke.

Furthermore, it should be remembered that a good admission of the steam depends, not only on the amount of lead, but also on the commencement of it, or, in other words, on the period at which the valve opens the connection with the steam chest preparatory to the next stroke of the piston.

### The Mean Effective Pressure.

The mean effective pressure is the difference between the mean or average propelling pressure, and the mean or average back pressure. This pressure is best obtained from indicator diagrams. To arrive at it correctly we divide the length of the card into ten or more equal spaces so arranged that there is a half space at each end (see dotted lines, Figs. 9 and 11). Ten is a convenient number, but this is immaterial; any other number may be used; the more numerous the spaces, of course, the greater the accuracy.

### The Terminal Pressure.

This term is sometimes applied to the pressure at the exhaust point when the steam is released, but as it is an indispensable factor in the calculations, it is properly defined as the pressure that would exist at the end of the stroke if the steam had not been released at that earlier point. A continuation of the expansion curve, as at *g*, in Fig. 29, page 145, see dotted line, will explain the method of finding it; Figs. 9, 10, 11 and 19 show that the exhaust has taken place at the end of the stroke; hence in those diagrams terminal and exhaust pressure are the same. This pressure is measured from the extremity of the curve to the vacuum line, *VV*, hence it is the *absolute terminal pressure*.

### The Initial Pressure.

The initial pressure is that pressure which acts upon the piston at the beginning of its stroke up to the point of cut-off, and is always less than that of the boiler, because as soon as the steam leaves the boiler it begins to condense and decrease in pressure. It can receive no more heat from any source, but it must impart heat to everything, and supply all loss resulting from radiation. A portion of the steam is always condensed as it enters the cylinder, from coming in contact with the surfaces which have just been cooled down by being exposed to the colder vapor of the exhaust steam; more especially is this so in slow-running engines where little or no compression takes place.

## Initial Expansion.

Initial expansion is the expansion that takes place during the admission of steam before the steam is cut off. The steam line,  $k e$ , in diagram Figs. 22 and 28 shows considerable initial expansion, which is desirable in a "throttling" engine; from the fact that *saturated* steam becomes *superheated* during the process of "throttling;" but is not desirable in cut-off engines.

## Wire-drawing and Throttling.

When steam is reduced in pressure by passing through a contracted passage, as in a stop-valve partly closed, or in the common "throttle-valve," it is said to be "throttled," and is shown

FIG. 28.

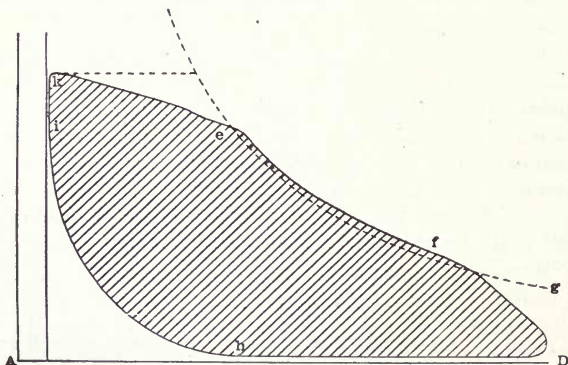

by the fall of the steam line,  $k$  to  $e$ , as exhibited in Figs. 22, 28, and 60.

The term "*wire drawing*" is almost identical in meaning with throttling, but refers especially to the slow cutting off of steam by an ordinary slide valve, the result in the diagram being a gradual slanting downwards of the steam line until it passes imperceptibly into the expansion line. Diagram Fig. 28 is an example of this, and the dotted lines show what the effect of a quick cut-off would accomplish by means of an expansion valve.

With the ordinary valve-gearing, especially the shifting link

in common use in locomotive engines, or when a single eccentric connected directly to the valve-rod is used, it is impossible to obtain an early cut-off without a certain amount of wire-drawing. If, under these circumstances, an earlier cut-off than half stroke is attempted, wire-drawing becomes excessive.

The above diagram, Fig. 28, taken from one of the most advanced types of locomotives, exhibits considerable wire-drawing. The dotted line shows the pressure that might have been obtained with the same amount of steam more rapidly introduced into the cylinder, indicating a loss from this cause alone of about *ten per cent.* of the whole power of the engines.

In fact, wire-drawing is due to the area of the port getting less and less in area, the steam undergoing a reduction of pressure owing to frictional resistance it has to overcome. This phenomenon is called wire-drawing, or more properly by the French, *lamination of steam.*

Diagram, Figure 28, is worthy of study and emulation by builders of fixed cut-off engines, for the locomotive has simply a fixed cut-off engine, variable by hand. But so long as fixed cut-off engines are controlled in speed by the present system of governor, which, as it were, throttles the steam supply to the engine in the act of respiration, but little improvement can be expected in the realized effect of valve motion.

The ordinary throttling governor is a nuisance that should not be tolerated by intelligent steam-engine builders, for in the best form it robs the steam of *twenty per cent. of its work* in effecting regulation, and the high relative economy of the standard automatic cut-off engine is entirely due to admitting steam at or near the boiler pressure, and cutting off the quantity required to overcome the resistance, instead of wire-drawing the steam until the mean pressure is equivalent to the resistance per square inch on piston.

In the locomotive engine, whilst the communication between the steam-dome and cylinder is not as free with early points of cut-off as in the automatic engine, the wire-drawing is very much less than in throttling engines; and if a valve gear be devised for locomotives which will produce a maximum opening of steam port for all points of cut-off, then for equal initial pressures and grades of expansion the economy of the loco-

tive and automatic engines (size of cylinder and speed of piston considered) would approximate.

For a given speed, given load, and given condition of track, the resistance is represented by a certain mean pressure per square inch of piston for a single stroke or for any number of strokes, with the elements affecting the resistance unchanged; and a nearer approximation of the initial pressure in the cylinder to that of the boiler, reduced friction in the port opening as the steam flows in, steam line declining less to the point of cut-off, earlier cut-off and higher grade of expansion, would improve

FIG. 29.

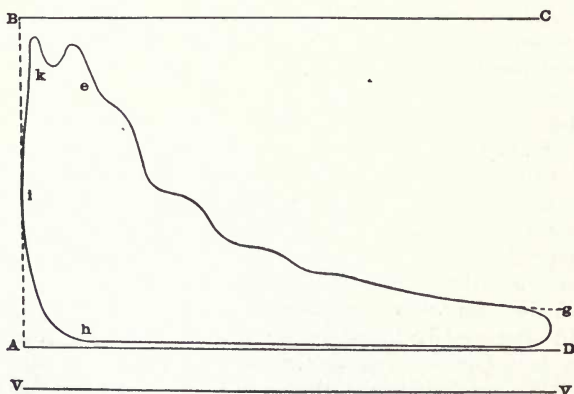

the economy in performance of the locomotive without impairing its efficiency otherwise. It is possible to do all this without materially altering the existing valve gear.

Modern automatic cut-off valve arrangements are so designed as to avoid wire-drawing with high rates of expansion; the commonest and simplest being by means of double eccentrics, one of which is operated by the governor so as to give a sufficiently rapid and early cut-off; see diagrams Figs. 8, 9, 11 and 18, which show a perfectly steady steam line up to point of cut-off, with expansion through the rest of the stroke.

It is an established fact that "wire-drawing" and "throt-

ting" are accompanied by direct loss due to the reduction in pressure which takes place during the process, and by indirect waste owing to the increased proportion of work expended in overcoming the back-pressure.

Aside from the economic loss, there is the no less serious objection to contracted passages, that, as the cylinder pressure is reduced, (and, therefore, the power of the engine in the same proportion), a large sized engine becomes only equal to one of less size, weight and cost, with more liberal steam passages.

#### Undulations, or Waviness of the Expansion Line.

The waviness sometimes seen in expansion lines is caused by the inertia of the indicator piston, and in some cases by the use

FIG. 30.

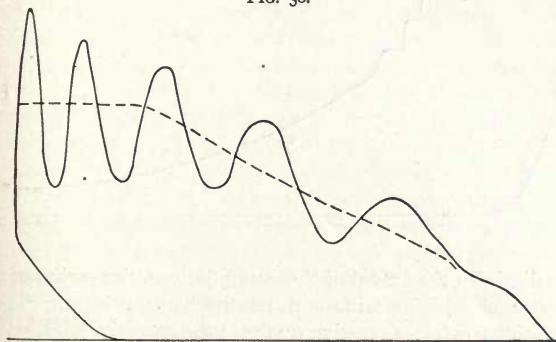

of a weak indicator-spring on high speed engines; see diagram Figs. 29 and 30. The weaker the spring the more rapidly the steam will compress it, and consequently the greater will be the velocity of the indicator-piston in rising; but the momentum (which is proportional to the square of the velocity) carries the piston above the point to which the steam pressure alone would have compressed the spring. When the momentum has been destroyed by the spring, the spring then forces the indicator piston below the point where it and the steam would be in equilibrium, and it is again forced too high. These alternate up and down movements produced by the momentum, combined

with the lateral movement of the card, give the wavy line, as shown in Fig. 30.

These lines are of great value, as they show precisely the degree of suddenness or violence of the action of the indicator. They may occur at the point of admission, of cut-off, and of exhaust.

Diagram, Fig. 29, taken from a high speed engine running at the Brush Electric Light Station, Philadelphia, Pa., in 1882, at 292 revolutions per minute, affords a beautiful illustration of this action.

FIG. 31.

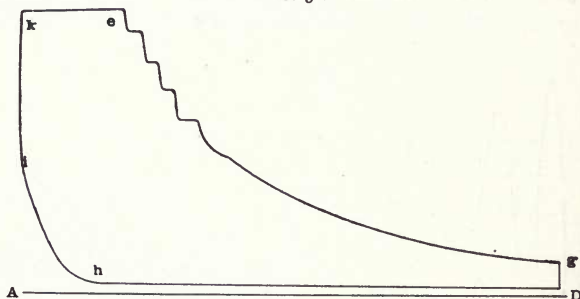

To diminish the extent of these undulations, the spring of the indicator should be stiff, and its mechanism light. These undulations when excessive make it extremely difficult to determine the mean effective pressure from the diagrams when measured by ordinates. To determine the area it is customary, and more accurate, to sketch a diagram freed from these undulations, over the actual diagram taken (as represented by dotted lines in Fig. 30), *midway between the crests and hollows* of the waves. This is better than drawing a line inclosing the same area with the wavy line.

Where the fall of the expansion line is a succession of steps (see diagram, Fig. 31), it shows slight friction in the instrument and that there is no rise of the pencil; no reaction.



### The Expansion Curve of Indicator Diagrams.

A correct curve does not *necessarily* show an economical engine, since the leakage out *may* balance the leakage in, in rare cases, and not affect the diagram. But the opposite is indisputable—that an incorrect curve necessarily, and infallibly, shows a wasteful engine, to at least the amount calculated upon the diagram.

As indicator diagrams represent the measure of force or pressure of the steam in the cylinder at every point of the stroke, the actual card from an engine as compared with the theoretic diagram (other things being equal) indicates the working value and economy of the engine.

Therefore, they should truthfully represent the real performance of the engine. Diagrams vary in form, from various causes; namely, quality or condition of the steam, leakage, condensation, adjustment and construction; their influence being most noticeable in the expansion curve. This curve will not in practice conform exactly to the true theoretical curve. The terminal pressure will always, under the most favorable conditions, be found relatively too high, the amount being greater as the ratio or grade of expansion increases. Where this is not the case, and the expansion curve of the diagram taken coincides exactly with the theoretic curve, the conclusion cannot be otherwise than that the leakage is greater than the re-evaporation; but in the present state of the arts, there are no practical means of working steam expansively, and preserving the exact temperature due to the pressure while expanding.

When the expansion curve falls, throughout its entire length, below the hyperbolic or theoretic curve, it is evidently due to leakage. The expansion curve of the indicator diagram in all ordinary cases terminates above that of the theoretic curve; in fact sometimes far above it, due to the re-evaporation of the moisture in the cylinder. An engineer when indicating an engine should see to it that the piston and valves are tight. Unless they are so, the diagram will not indicate what the engine is really doing, and the engineer cannot ascertain the causes of any peculiarities in the form of the diagram.

## CHAPTER IX.

### CORRECT INDICATOR DIAGRAMS.

IN order that the indicator diagrams shall be correct, it is essential, first, that the motion of the paper drum shall coincide exactly with that of the engine piston; and second, that the position of the pencil shall precisely indicate the pressure of steam in the cylinder.

The first condition is frequently somewhat difficult to bring about, because it is not only necessary that the beginning and end of the motions shall be coincident, but that these and all intermediate points shall be so. Owing to the irregular motion of the engine-piston, consequent upon the varying angularity of the connecting-rod, it is generally advisable to connect the cord in some way to the piston-rod cross-head. If any other point be chosen, it must be carefully seen that the motion given does not vitiate the diagram.

As the motion of the parts mentioned exceeds in length the motion of the indicator, it must be reduced in length by levers of such proportions as may be required for that purpose. For example: If the stroke of the engine is thirty-six inches, and the length of the diagram is to be four inches, then the lengths of levers are as *one* is to *nine*, or if only one lever is used, then the indicator motion must be taken from a point on the lever sufficiently far from its fixed end to obtain the reduced travel required.

A convenient method to obtain the reducing motion of the piston for the paper drum of the instrument is by a lever swinging on a fixed centre, and connected at its free end to the cross-head of the engine, either by a connecting rod, or a pin on the free end, working in a slot of an arm secured to the cross-head; and on this lever a stud is fixed at the proper distance from the fixed centre (as above shown by calculation), to give the required motion by transmitting it by a cord to the indicator.

Either of these arrangements is easily made, and they are

very convenient, since the motion of the pin to which the cord is attached is simply a vibrating one, and it can generally be so placed as to enable the cord to lead directly to the indicator, in a direction, of course, at right angles to the mean position of the lever. The cord used should be of braided linen, about one-twelfth of an inch in diameter. It should be well stretched before being used, then gone over with a piece of bees-wax, and afterward with a piece of soft pine wood, with a notch in it, keeping it well stretched all the time. If the above directions are not carried out, much inconvenience may be the result. (A fine piece of piano wire is often used, and is a good substitute.) Convenient means should be provided for attaching it to, and detaching it from, the short length of cord on the indicator paper drum.

In case of a beam-engine, a point on the beam, or beam-centre, or on the parallel-motion rods, where these are employed, will give the proper motion; but care must be taken that the cord be so led off, that when the engine is on half stroke, it will be at right angles to whatever gives it motion, a requirement too often omitted. Afterwards its direction of motion may be changed as required, care always being taken, however, to use as few carrying pulleys as possible, and the shortest practicable length of cord.

It is perhaps needless to say that the reason why the use of a short direct cord is to be preferred, is that the shorter the cord the less it will stretch, and guide-pulleys may cause slight irregularities, beside stretching the cord more because of increased friction and inertia.

#### The Proper Place to Attach the Indicator.

For great accuracy in fast running engines, the common practice of connecting the two ends of the cylinder together by pipes leading to the indicator is incorrect, as the steam pressure will be seriously diminished by passing through long pipes of small diameter. Two indicators should always be employed.

In most cases only one is used, but it is always desirable to indicate both ends of the cylinder as nearly simultaneously as possible, so as to avoid unknown changes of load while shifting from one end to the other. As before stated, it is best to run

half-inch pipe from each end of the cylinder to a three-way cock at the middle, where the indicator is to be attached. There should also be angle stop-valves in the pipe close to the cylinder ends, the angle stop-valves being merely used to shut off the additional clearance due to the volume of the pipe. If the three-way cock is dispensed with and a tee (**T**) fitting put in its place, the steam when admitted will rush by the tee (**T**) outlet to the other valve before it reacts up the outlet of the tee (**T**) to the indicator. If a three-way cock is not used, put two straight-way cocks as close as possible to the tee (**T**).

In applying the indicator, especially in high-speeded engines, the connection should be made at some part of the cylinder where the steam is as quiet as possible, so that the pressure in the instrument may be the same as in the cylinder, since, from the well-known laws of fluids, if the connection be made at a point where there is a strong current of steam, the pressure in the indicator will be materially affected. The cylinder heads, therefore, will be the best place to make the connection, the hole being drilled for the connection on the opposite side of the steam-port, and not so low down as to be liable to receive the water of condensation, as the latter makes the action of the indicator very irregular. The connecting pipes should be as short as possible, and no more bends or turns should be used than are absolutely necessary, so that the pressure may not be reduced by the friction that these give rise to, and with the same object the pipe should be of large diameter, say not less than one-half inch internally.

When taking diagrams they should be repeated several times in order to obtain a good mean value. It is important to know the effect of changes which take place in the cylinder during the motion; the indicator diagrams are best taken on the same paper, in order to make a comparison.

Those who have never taken indicator diagrams from engines running at over 300 revolutions per minute, must not think it is unattended with difficulties. Although these difficulties exist, they are far from being insuperable. To insure success under such conditions, the indicator drum must be fitted with stiff springs, the length of the diagrams must be made very short, and stiff springs must be used in the indicator cylinder.

In addition to these precautions, care must be taken that the passage between the cylinders and the indicator are short and as straight as possible, and the indicator must be driven in the most direct manner that can be arranged, and with the least possible length of cord, as at high speeds the elasticity of the cord is a source of trouble.

The circumstances under which the diagram was taken should be marked upon the card at once, when it is removed from the drum of the instrument.

Among the facts in regard to which these diagrams will testify are:

*First*—All the functions of the valve motion.

*Second*—Accidental circumstances, such as leaks, contracted steam passages, defective packing, &c.

*Third*—The quantity of *steam* contained in the cylinder at any moment or point of stroke, throwing light on the amount of condensation that takes place.

*Fourth*—The horse-power that the engine is developing.

*Fifth*—The efficiency of the steam ports and passages for the admission or discharge of the steam, including the effect of the condenser.

*Sixth*—From the air-pump the nature of the performance of the pump, and the power required to operate it.

*Seventh*—It will show the line of pressure in the condenser, and that of the back pressure in the cylinder, which will always be less than that shown by the vacuum gage.

*Eighth*—On the steam chest the loss of pressure due to an insufficiency of area in the steam pipe.

*Ninth*—On the exhaust pipe to show the cause of excessive back pressure, whether due to too small an exhaust pipe or port opening.

*Tenth*—On the boiler to register the pulsations caused by the sudden closing of the cut-off valve.

#### Length of Indicator Diagrams.

In slow running engines, the diagram should be at least four inches in length, as a long card is better than a short one, when taken for adjusting valves, because slight variations are represented at correspondingly greater magnitude. On the other

hand, and particularly at high speed, long cords will sometimes introduce errors that should be avoided.

Cards from high speeded engines should not exceed three inches in length, according to speed and other conditions. It must be borne in mind that at high speed the inertia of the paper-drum becomes an important factor, and in long cards this will affect its correctness.

As I have before stated, the indicator is an instrument by means of which a steam engine is caused to write on a piece of paper an accurate record of the performance of the steam that takes place within the cylinder. It gives a record which to the uninstructed eye is unintelligible, but by engineers it is looked

FIG. 32.

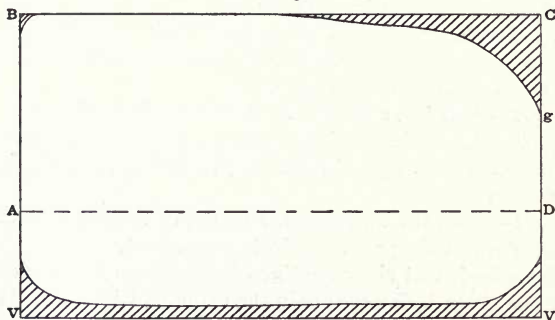

upon as the most reliable statement they can have of the work done by an engine, inasmuch as it tells at each and every part of the stroke of the piston what are the effective pressures tending to produce motion, and what are the back pressures tending to detract from the effective pressures.

#### Indicator Diagrams.

Assuming that we have an indicator attached to a steam engine cylinder, and so connected that the drum containing the paper is moving to and fro, coincident with the piston of the engine, if before letting in steam to the indicator or cylinder, we apply the pencil to the surface of the paper, it will draw upon the paper a horizontal line, *A* to *D*, in length proportionate to the stroke of the engine. See Fig. 32.

Now, if we open the cock attached to the indicator cylinder, and assume that the engine piston has just commenced to move from  $A$  to  $D$ , the indicator piston will also move vertically, and the pencil will trace the line,  $AB$ , representing the pressure per square inch of the steam in the engine cylinder.

Assuming that the indicator spring is one which would compress one inch for every forty pounds pressure per square inch acting on the piston, then if there were 100 pounds pressure per square inch on the engine piston, the pencil would rise two and a half inches from  $A$  to  $B$ . Now, suppose the engine piston to have completed its stroke: the pencil having traced the line  $BC$ , and the slide valve to have opened the exhaust port so as to allow the steam to escape, then the indicator piston will fall, and the line  $CD$  will be traced. On the return stroke, the

FIG. 33.

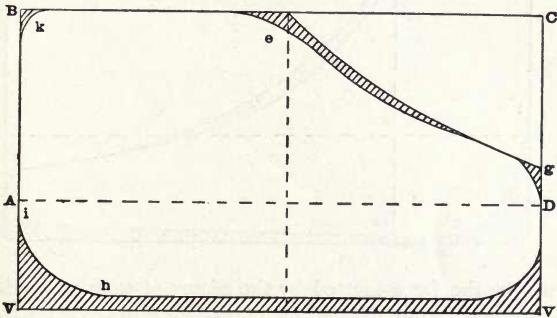

pencil would follow the line  $DA$ , with the exception of any diversion caused by steam that might remain in the cylinder in consequence of the steam not having been perfectly exhausted. Leaving this out of the question, it would have returned to the point  $D$ , and thence to  $A$  thus describing a parallelogram, of which the horizontal line  $AD$  would represent the stroke of the piston, and the vertical line  $VB$  would represent the steam pressure upon the piston. The area of this parallelogram would, therefore, represent pounds pressure into feet moved through by the piston in its stroke, or revolution of the engine.

Now, for simplicity, suppose that the line  $AD$ , Fig. 32, represents a foot stroke of the piston of one foot; that the piston has an area of 99 square inches, and that the line,  $VB$ , represents 100 pounds pressure to the square inch, then we shall have 100 pounds multiplied by one foot, and this equals 100 foot pounds, which multiplied by 99 square inches (area), will equal 9,900 pounds as the work performed by the piston in one stroke, or half revolution. For both strokes, we have 9,900 multiplied by two, equaling 19,800 pounds as the force exerted by the engine through one revolution. If the engine makes 100 revolutions per minute, then  $19,800 \times 100 = 1,980,000$  pounds,

FIG. 34.

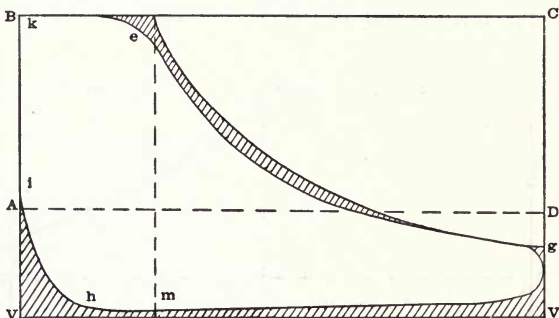

would be the force exerted by the piston of such an engine in one minute. This, divided by 33,000, gives sixty-horse power, which is called the gross indicated horse-power.

Diagram, Fig. 32, is one that seldom if ever occurs in practice. When such are produced, they are only justified by the desire to obtain the greatest possible power from a given size of engine without regard to the highest economy. It will be seen that steam was supposed to have been admitted during the whole length of the stroke, and that no advantage whatever has been taken of the expansive property of the steam.

Diagram, Fig. 33, shows steam used expansively.

Assume the same data as in former case, the 100 pounds pressure above the atmosphere has raised the pencil from  $A$  to  $B$ ;



also assuming that the steam has been admitted to the engine cylinder up to the point *e*, (half the length of the stroke,) and then cut off by the valve; the steam now in the cylinder begins to expand, and as it expands it loses pressure. By the time, therefore, that the piston has arrived at *g*, from *e*, the steam will have lost pressure, and the pencil will gradually fall and trace the curved line *eg*. By the time the piston has reached the end of the stroke, the pressure will further have diminished, say to *g*, and when the exhaust opens it falls down to *D*.

It will be seen by this diagram that, although only half as much steam was admitted into the cylinder, as in the case of diagram, Fig. 32, the area of the diagram is very much more than half of that of Fig. 32; as a matter of fact, it is about 0.83 of that area, and thus a power 0.83 has been obtained by using

FIG. 35.

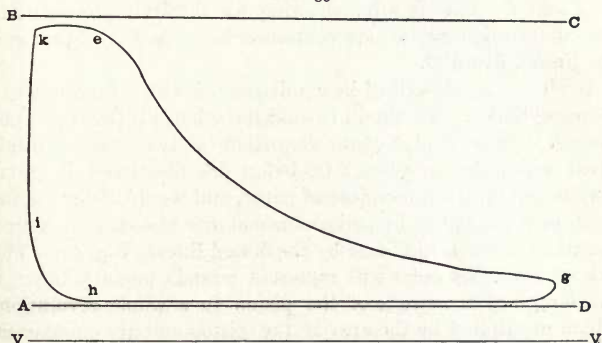

expansively half the steam that was required in the case of Fig. 32.

As a further illustration, Fig. 34 is a diagram that would be produced if the steam were cut off when the piston had moved one-fourth of the stroke. In this instance only one-fourth the steam required, as for Fig. 32, would be needed; but the total area of the diagram is about 0.54 of that of Fig. 32, so that 0.54, or more than one-half as much work, is obtained for one-fourth the steam.

Figure 35 is a diagram taken from a Corliss engine 8 inches diameter and 24 inches stroke; 90 revolutions per minute.

Starting from the top corner  $B$ , the steam pressure remains uniform to about point  $e$ ; here the cut-off valve being closed, the pressure commenced to fall, as represented by the curved line  $eg$ , until it reached the point  $g$ , when the exhaust-valve being opened (allowing the steam to pass into the atmosphere), it quite suddenly drops from  $g$  to  $D$ ; when the piston begins to return. There remains a slight pressure in the cylinder, until the time the piston gets to  $h$ , that is the back-pressure throughout the stroke, so that it keeps the line of the pencil about 0.6 of a pound above the atmospheric line  $AD$ , until the closing of the exhaust-valve, which occurs at the point  $h$ , after which time the steam remaining in the cylinder is compressed, raising the indicator-pencil and forming the curved line  $hi$ .

In this case, the effective work done by the engine is represented by the area contained within the irregular figure  $k, e, g, h$  and  $i$ . This is after allowing for the back-pressure and the compression, which are contained between that figure and the lines  $i, h$  and  $D$ .

We have now described how a diagram is taken from one end of the cylinder. To obtain it from the other, all that has to be done is to make a pipe connection from the two cylinder heads fitted with a three-way cock (as before described) and diagrams may be got on the same piece of paper, and would, if the engine were perfectly equal in performance at the two ends, be represented as it was in this case by the dotted line on Fig. 26. The sum of these two areas will represent pounds pressure through the length of the stroke of the piston in a whole revolution, which multiplied by the area of the piston and the number of revolutions per minute, will give the foot-pounds. This divided by 33,000, will give the gross indicated horse-power of the engine.

#### Use of the Indicator for Showing the Condition of the Engine.

The indicator tells us not merely the power exerted by the engine, but the nature of the faults by which the power is impaired. Thus, the shape of the indicator diagram may show that the steam or exhaust-ports are too small, or that the valve has not sufficient lead or is improperly set. Let us take, for example, the following diagram, Fig. 36.

When the indicator pencil is at the point  $k$ , the engine piston is at the commencement of its stroke, the paper-drum in motion. The line is traced from  $k$  to  $e$ , and thence to  $g$ , at which point the stroke is finished in this direction. At the point  $e$ , the valve closed the steam port, or, in other words, the steam was cut off, and while the line from  $e$  to  $g$  was being traced, the steam pressure in the engine cylinder was expanding, and its pressure consequently decreasing, as shown by the falling of the line  $e g$ . The line from  $e$  to  $g$  being convex, in-

FIG. 36.

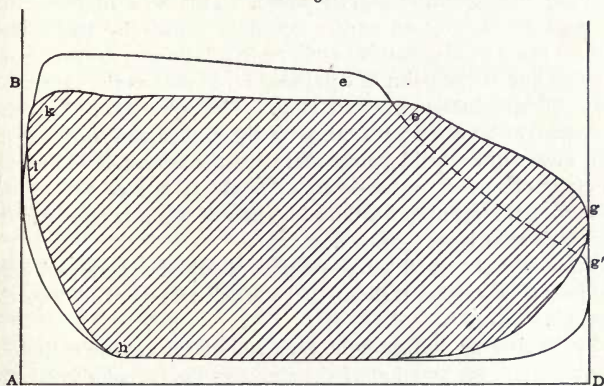

stead of concave in shaded diagram, shows that either the slide valve or the piston, probably both, were not in good order, and admitted steam during expansion. The fall of the steam line from  $k$  to  $e$  also shows that the steam ports are too small. At the point  $g$ , the exhaust valve is open to the atmosphere, the steam escapes, the pressure in the engine cylinder falls, and the pencil descends towards  $D$ . The diagram, as here given, shows that the exhaust port is opened too late, for this corner of the diagram should be very nearly square (see diagram outside of shaded one). The engine piston now commences its return stroke, and the line  $g h$  is traced, representing the exhaust line, and before reaching the end of its stroke, it commences to rise again at  $h$ , thus indicating that there is some pressure arising

from the compression of the steam and vapor remaining in the cylinder. This is due to the closing of the exhaust port  $h$ , before the end of the stroke, causing the curved line  $h z$ . The rounded corner at  $k$  shows that the valve is wanting in "lead," or in other words the steam port was opened too late, as is also the case at  $g$  the exhaust end; in the latter case showing that the release of the exhaust steam is not early enough, and that in consequence of this the back pressure at the commencement of the return-stroke is much too high. This shows that the slide-valve was improperly set, a defect which can be remedied by shifting the eccentric slightly ahead. This will improve the exhaust by causing an earlier opening, shown by the dotted curved line  $e g'$ , also causing earlier compression, as shown by the outside line at the point of compression, as well as the increased lead and initial steam pressure at  $B$ . The power exerted is thus increased at least ten per cent. with the same amount of steam. The steam-line should be parallel with the atmospheric line up to point of cut-off, or nearly so. Should it fall, as the piston advances, the opening for the admission of steam is insufficient, and the steam is *wire-drawn*.

The point of cut-off on all engines should be sharp and well defined: if otherwise, it shows that the valve does not close quick enough.

By having an indicator at each end of the engine cylinder, the back and forth action of the steam in the cylinder is simultaneously recorded in the form of a diagram, as before stated, by horizontal and vertical lines and curves. This diagram comprises time of admission, steam-line, point of cut-off, expansion curve, terminal pressure, point of exhaust (or relief exhaust) line, back-pressure line, compression curve, initial pressure and initial expansion. From these records the total work done by the steam can be accurately ascertained. Very accurate mensurations have been made by the indicator, but the average area of indicator cylinders is only about one-half of a square inch, while that of cylinders indicated may vary from ten square inches to as many square feet. By the use of the indicator, the determination between *nominal* (calculated), *indicated* (real) and *effective* horse-power is found; the variations between which are very marked.

The indicator also furnishes one of the data for ascertaining the power exerted by the steam engine; namely, the *mean or average* pressure of the steam during the stroke, on each square inch of the piston; stated more accurately, it shows the excess of pressure on the steam side of the piston to produce motion over that on the exhaust side to resist it; and from no other source can it be so accurately ascertained.

The pressure in the boiler is readily known, but the steam in its passage to the cylinder is subject to various losses, such as wire-drawing, condensation, friction, etc., so that, frequently, the pressure on the piston does not exceed two-thirds of that on the boiler.

#### The Geometry of the Indicator Diagram.

It is now generally admitted that the true curve traced by the pencil of the indicator, when the steam is expanding in the cylinder, is hyperbolic; and as the remainder of the penciled figure is a portion of a parallelogram, the curve is the only geometrical question to dissect. When the pencil was stationary, the atmospheric line  $AD$  (in Fig. 34, page 154) was drawn straight, from the fact that there was no steam pressure to move the indicator piston; but when the steam pressure acted on it, the pencil rose vertically to  $B$ . At this point the indicator paper drum commenced to move, and therefore, as the pencil was maintained at this height by the steam pressure acting on the piston during the steam supply, a straight horizontal line was traced from  $B$  to  $e$ ; at  $e$ , the steam was cut off from the cylinder, and the expansion of the steam enclosed in the cylinder commenced, due to the forward motion of the engine piston, and the steam pressure gradually commenced to fall as the paper drum of the indicator moved forward coincident with the engine piston, and the indicator pencil described a curve as it descended, until reaching the point  $g$  below the atmospheric line. At this point the paper drum stopped, from the fact that the engine piston had reached the end of its forward stroke, and the pencil continued to fall at right angles to the steam line  $ke$ , until the vertical line  $DV$  was traced, the point  $V$  indicated the amount of vacuum attained in the cylinder; the pencil then became stationary, from the fact that the atmospheric pressure forced the

indicator piston down and kept it in that position while the vacuum was maintained, as firmly as the steam held it up during the time the steam pressure was acting on the piston. From this it will be seen that the indicator pencil is always motionless when the *full* pressures are acting on either side of the indicator piston. When the pencil stopped at *V*, the paper drum commenced to move in the opposite direction, and thus the line *VV* was traced, at the end of which the paper drum again stopped, and when the steam was admitted again into the cylinder the pencil instantly rose, and completed the line *VB*, thus forming the theoretical diagram, Fig. 34.

The movement of the pencil is therefore instantaneous, vertical from *V* to *B* and *D* to *V*, *e g* is a gradual descent, while *k e* and *VV* have no motion. The line *AB* being the admission, *k e* steam supply, *e g* expansion, *g V* exhaust, *VV* continuous exhaust, and *VA* readmission.

#### Back Pressure.

If the steam used to run steam-engines could escape freely without resistance, the back pressure would be simply the pressure of the atmosphere in non-condensing engines, and in condensing engines it would be the pressure corresponding to the temperature in the condenser, which is called the "pressure of condensation." The mean back pressure, however, always—sometimes considerably—exceeds the pressure of condensation. One cause of this, in condensing engines, is the pressure of air mixed with the steam, which causes the pressure in the condenser, and also the back pressure, to be greater than the pressure of the condensation of the steam. The ordinary temperature in the condenser in proper working order is about 100 degrees Fahrenheit, for which the pressure is about *one pound* per square inch, whilst the actual pressure in the best condenser of ordinary engines may be scarcely less than 1.15 to 2 pounds to the square inch. The principal cause, however, of increased back pressure is resistance to the escape of the exhaust steam from the cylinder, due to the exhaust pipes being too small, amounting to from one to two pounds per square inch, greater than the pressure in the condenser.

There is no doubt that practically in condensing engines, the

back pressure increases with the speed of the engine, and also with the density of the exhaust steam and with a reduced size of the exhaust ports.

But with a well constructed and proportioned condensing engine, a gain of about *ten pounds* or *20.4 inches mean effective pressure* over, that of a non-condensing engine can be effected.

In non-condensation engines, especially in locomotive engines, the excess of back pressure above atmospheric pressure, varies nearly as the square of the speed to the pressure of the exhaust steam at the commencement of the exhaust, and inversely as the square of the area of the orifice of the blast pipe, that it is less the greater the ratio of expansion, that it is less the longer the time during which the exhaustion of the steam lasts, and that it is increased when the steam is wet. Sometimes the excess of back pressure above that of the atmosphere is scarcely perceptible, as in diagrams Figs. 24 and 26. In a badly constructed engine, on the other hand, the force required for this purpose may be very great, as in diagrams Figs. 14 and 84.

## CHAPTER X.

### STEAM EXPANSION CURVES OR PRESSURE OF STEAM IN CYLINDER.

THE action that takes place in the cylinder of a steam-engine during the period of expansion is of special importance, for the purpose of comparing the various theories respecting the action of the steam in an engine. The essential difference of these theories consists solely in the application of several hypotheses relating to the relative pressures and volumes of saturated steam. The results of practice show, however, a marked discrepancy between the theoretical curves of expansion and the actual expansion line drawn by the indicator, and I will now explain how they are produced and the cause of their differences.

There are three curves of the hyperbolic form that it is necessary to consider in comparing the lines of indicator diagrams taken from steam engines.

*First*—The curve formed when the expansion takes place by the law of gases, known as either Boyle's law, or the law of Mariotte, which is stated by Regnault as follows:

“The volume of a given weight of a gas, at a constant temperature is inversely proportional to the pressure which the gas sustains; or, in other terms, the densities of the gas, at the same temperature, are proportional to the pressure.” The theory of the law is, that gas being perfectly elastic, its density must vary directly, and its volume inversely, as the pressure to which it is subjected. “We are accustomed,” says Regnault, “to regard the law of Mariotte as the mechanical expression of the perfectly gaseous state.”

The difference between a gas and a vapor is this: A vapor is a gas near its liquefying point—so that the difference is not one of composition, but of condition.

*Steam* is a *vapor*, and the atmosphere is a mixture of gases. It is supposed to be impossible, by any simple means now



known, either to compress or to cool the gases which form the air until they become liquid; nor can they be liquefied by both pressure and cold combined; but steam would very soon become liquid under either influence.

It is necessary to note this difference between gases and vapors, because they behave differently under similar circumstances.

FIG. 37.

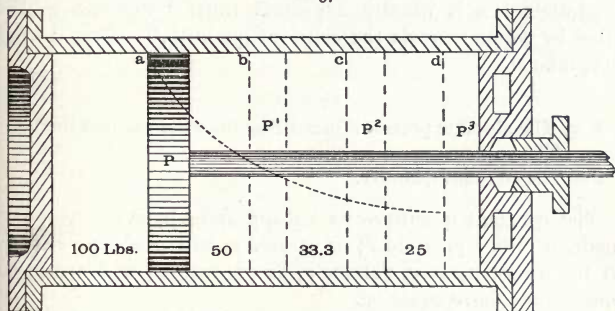

The relationship which exists between the pressure and the volume of a gas as above stated was first announced, independently, in the latter part of the seventeenth century, by the English philosopher Boyle, and by the French Abbe Mariotte, namely: that if a gas (not steam, for reasons I will show presently) inclosed in any vessel like a steam engine cylinder with a piston  $P$  (see Figure 37, where its pressure and volume can be accurately observed), assume the gas against the piston  $P$  in space  $a$ , to be 100 pounds per square inch, after the piston has moved one fourth the length of the cylinder. Now, if the piston move, as represented by  $P^1$ , the space  $a b$  will be filled with gas of a pressure of 50 pounds, or one-half the pressure of  $a$ . Again, if the piston was forced still farther, as shown by piston  $P^2$ , the original pressure of  $a$  will be one-third, and occupy the space indicated by  $a, b$  and  $c$ . And when the piston reaches the end of the cylinder  $P^3$ , the pressure will be one-fourth. In accordance with this law a reverse condition exists when the piston is forced from  $d$  to  $a$ . That is to say when the volume

is made one-half, the pressure is doubled when the piston becomes  $P^1$ , and when it becomes  $P$ , it becomes the original volume of 100 pounds pressure, the temperature of the apparatus and the gas being kept the same throughout.

If the pressure and volume vary inversely (for example, if when you double the one you halve the other), it is clear that the two multiplied together must always be equal to a constant, that is, an unchanging quantity, and accordingly Boyle's and Mariotte's law is usually expressed thus: "Pressure multiplied by volume equals the constant quantity." Thus we say in symbols:

$$P v = c.$$

$P =$  The absolute pressure (measuring from the vacuum line).

$v =$  The volume.

$c =$  The constant quantity.

The constant quantity  $c$  is known, and whatever change is made in either pressure  $P$ , or volume  $v$ , will produce a change in the other; namely, volume  $v$ , or pressure  $P$ , which may be found from above equation.

*Example.*—Suppose the volume  $v$  to be five cubic feet, and pressure  $P$  to be one hundred pounds, then:

$$P v = 100 \times 5 = 500 = c.$$

Now let pressure  $P$  become forty pounds, then:

$$v = 500 \div 40 = 12.5 \text{ cubic feet.}$$

This is a law which holds good with all gases under the following conditions: That they shall be taken at such a temperature and pressure, that either or both together may be varied through wide limits without the gas approaching that point where it begins to condense into a liquid, and that the temperature of the gas shall be kept the same throughout the experiment. When we work with atmospheric pressures and temperatures, we may make wide variations, either way, with both pressure and temperature, and never come near the liquefying point. But when we consider steam, we shall find that although in practice it does so happen that when it expands the pressure follows the above law, we shall also find that the tem-

perature varies much, and consequently, if we were to put steam through the same experiments as if it were a gas, we should find its behavior quite different.

When steam is first admitted into the cylinder at the beginning of the stroke it comes into contact with surfaces having a temperature much below its own, and a certain proportion of the steam is thus condensed in raising the temperature of those surfaces. So long as the inlet port is open, the steam thus condensed is made up by an additional supply from the boiler; but after the cut-off has taken place, the new portions of the cylinder surface exposed by the piston as it advances have to be heated by the condensation of part of the steam shut into the cylinder, and the consequence is that the pressure at first falls in a more

FIG. 38.

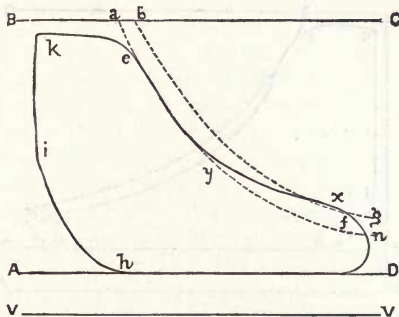

rapid ratio than that due to the expansion alone. As the expansion proceeds, however, and the pressure falls, the temperature of the steam becomes lower than that of the internal surface of the cylinder, and then commences the re-evaporation of the thin film of moisture which has been deposited on the surface during the earlier part of the stroke. The quantity of steam present being thus augmented, the pressure becomes higher than that due to theory by this reboiling. The result of these operations on the expansion curve drawn by the indicator is to cause it at first to fall below, and subsequently to rise above the theoretical expansion curve, as will be seen by the above diagram (Fig. 38).

The theoretic expansion curve  $a, e, y, n$ , being drawn to coincide with the expansion curve of the diagram at its commencement from the point of cut-off  $e$ , the expansion curve of diagram commences at  $y$ , to rise to  $x$ , near the end of the stroke. This is due to the boiling and re-evaporation of the condensed steam as the piston nears the exhausting point  $f$ . If it were not for this re-boiling and re-evaporation the pressure would have terminated at  $n$ .

The hyperbolic curve  $b, x, f, g$ , in dotted line, was drawn to coincide with the terminal prussure  $g, V$ , of the indicator diagram.

The phenomenon of a higher terminal pressure, in cylinders using steam more expansively than the law of the expansion of

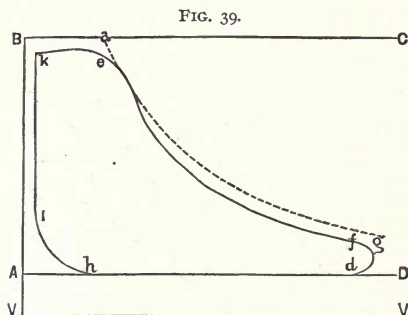

gases could account for, hereafter referred to, was generally explained, until quite recently, by supposing that the valves leaked; but when it was found to be universal, and most noticeable where the steam was most saturated, thoughtful men were not long in detecting the true cause. The temperature of this moisture, as it enters the cylinder, is the same as that of the steam, and being, in great part, relieved from pressure by the expansion will instantly assume the gaseous form; provided the heat (which must be rendered latent on its change of state) is furnished. This heat is abstracted from the surfaces with which the saturated steam comes in contact, and the excess of terminal pressure above that which should exist measures the heat thus lost, and which must be regained at the commencement of the

next stroke from the entering steam as the piston nears the exhausting point  $f$ . If it had not been for this re-boiling and re-evaporation, the pressure would have terminated at  $n$ .

The indicator diagram, Fig. 39, shows the effect due to a leaky piston, and exhaust-valve, the indicator expansion curve falling below the hyperbola, all the way from the point of cut-off  $e$ ; this latter curve being drawn to coincide with the point of actual cut-off.

Steam may, in driving an engine, expand under very different influences according as the heat lost in working is or is not returned to it, and the indicator cards that would be given are known by the names respectively "*Isothermic*" or *Hyperbolic* and "*Adiabatic*."

When steam expands, and its temperature is maintained by re-evaporation nearly the same throughout the experiment, the *curve* formed is termed by engineers an *isothermic* one, signifying equal heat. But when it expands and there is no re-evaporation, the *curve* becomes an *adiabatic* one. In an *adiabatic* curve it is assumed that no heat is lost by the steam while doing *work*, while in an *isothermic curve*, as already shown, the lost heat is returned by the re-boiling and re-evaporation of the water condensed in the cylinder after cut-off takes place.

Therefore, when saturated steam, such as is usually generated in steam boilers, expands while doing work, but meanwhile receiving heat, not only equal to the work performed, but sufficient to convert a portion of the condensed steam into saturated steam by the end of the stroke, the expansion curve is *isothermal* or, approximately, a common *hyperbola*.

This is a very common case, and from the ease with which calculations can be made in accordance with it, the hyperbolic curve is, in practice, generally assumed for all engine diagrams, and when the amount of clearance is known this curve can be very readily laid down (as will be shown hereafter).

*Second.*—The other curve, the *adiabatic*, is produced when dry, saturated steam in a non-conducting or non-radiating cylinder is expanding against pressure, or, in other words, doing work without losing heat, in which case pressure varies (according to Professor Rankine), approximately, as the reciprocal of the tenth power of the ninth root of the volume, or space occupied; that is to say, in symbols:

$$P \propto v - \frac{1}{9} \text{ nearly.}$$

or more intelligibly.

$$P \propto \frac{1}{9} \frac{1}{9}.$$

$P$  = The absolute pressure of the steam.

$v$  = The volume.

$\propto$  = Infinite, or denotes that one quantity varies as another; as  $P$  varies as  $\frac{1}{9}$ .

This formula means that the absolute pressure  $P$ , existing at one point of the stroke during expansion, is equal to the tenth power of the ninth root of the volume  $v$ , of the cylinder, including clearance at the point of cut-off, divided by the tenth power of the ninth root of the corresponding volume at the point of stroke in question, and multiplied by the absolute pressure  $P$ , at the point of cut-off.

The above formula applies when the initial pressure is not less than fifteen pounds, nor more than one hundred and eighty pounds per square inch.

This curve, although useful in certain theoretical investigations, is of little practical use, because non-conducting and non-radiating cylinders do not exist.

*Third*—When dry saturated steam expands, doing work as before, but receiving meanwhile, heat to prevent liquefaction, and the pressure at all points of the stroke is that due to the volume and temperature of saturated steam, the pressure (according to Rankine) varies nearly as the reciprocal of the seventeenth power of the sixteenth root of the space occupied; that is to say, in symbols:

$$P \propto v - \frac{1}{16} \text{ very nearly.}$$

This curve cannot be laid down geometrically, but this equation is very convenient in calculation, because the sixteenth root can be extracted with great rapidity, to a degree of accuracy sufficient for practical purposes, by the aid of a table of squares alone; and by a little additional labor, without any table whatsoever.

“This formula has been tested for initial pressure ranging from thirty to one hundred and twenty pounds to the square

inch, and for grades or ratios of expansion varying from four to sixteen.”

It is found in practice that the greatest quantity of *work* is obtained from a given quantity of *heat*, when sufficient *heat* is imparted during the expansion, as in the case of steam-jacketed cylinders, or superheated steam, which prevents any portion of the steam in the cylinder from falling to water—the fall of pressure being in this case less rapid, owing to a portion of the heat converted into work, being supplied by the condensation of the steam in the jacket.

FIG. 40.

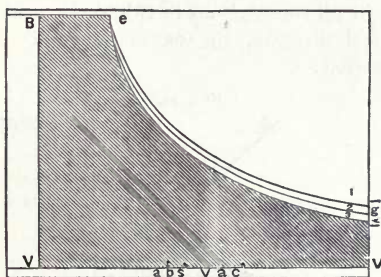

#### The Theoretical Diagram.

The diagram, Figure 40, represents a theoretical diagram with expansion curves produced under the different conditions before explained.

The *adiabatic* curve *e, 1, g*, represents the expansion line for *saturated steam, dry on its admission, in a non-conducting and non-radiating cylinder*; the absolute pressure varying inversely as the tenth power of the ninth root of the volume, or nearly so.

This cannot, as before stated, be perfectly realized in practice; and therefore it only represents the limit which practical results may approach, but cannot attain.

The curve *e, 2, g*, is the expansion line when *saturated steam, dry on its admission and during its expansion*, is prevented from partially liquefying by means of a steam-jacket supplying heat through the cylinder. The absolute pressure varies inversely,

as the seventeenth power of the sixteenth root of the volume, or nearly so.

This is, probably, the best result actually attainable in practice with steam that is not superheated.

The curve *e, 3, g*, represents a common hyperbola, the pressure varying inversely as the volume. To produce such a curve the steam must contain a little absolute water on admission, or immediately afterward, and that water must be evaporated during the expansion by heat drawn from the cylinder. This is the form of diagram, as before stated, on which calculations are most commonly based, and differs but little from the preceding.

Therefore, in all comparisons in this series made by the use of a theoretical diagram, the curve used will be that of a common hyperbola.

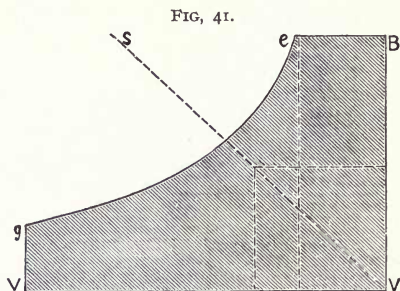

The Theoretical Diagram.

The diagram, Fig. 41, represents the theoretical curve of expansion, supposing the engine to be perfect.

The horizontal line *VV* of exhaust, is supposed to coincide with a perfect *vacuum* (the barometric pressure standing 30.00). The reason for this is that in inquiring into the action of expanding steam, we must deal with the *whole* of the work performed, and not with that part of it only which is utilized through the piston-rod. The back pressure is a force which opposes the advance of the piston. In every diagram the total amount of work done during one stroke is represented by the area, not the figure usually taken by the indicator, but by one



carried right down to the perfect vacuum line; while another diagram, taken simultaneously from the exhausting side of the piston, and bounded above and below by the back pressure and perfect vacuum lines respectively, would represent the value of the work wasted thus:

The area of Fig. 43, subtracted from Fig. 42, will give the amount of work which has been utilized in a perfect non-condensing engine.

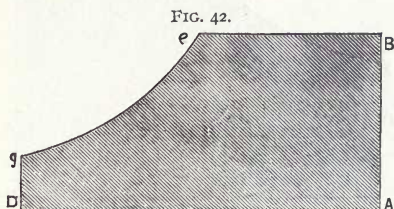

This is best understood by placing the one upon the other, with the vacuum lines in contact, thus: as in Fig. 44.

The diagrams obtained in practice differ from the latter, from

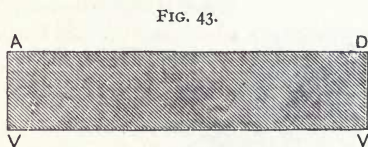

the fact that diagram Fig. 43 deducted on account of back-pressure from that of diagram Fig. 44, representing the total work, is taken from the same side of the piston as the steam line, and at another time; whereas the opposing force must obviously act on the other side of the piston, simultaneously with the back-pressure of the steam which it resists.

The included area of an indicator diagram is commonly supposed to represent the pressure of the piston at each point of the stroke. A moment's reflection will show, however, that it does not. What we, for convenience, call the upper and lower lines of the diagram, have, in fact, no relation to each other. To get a correct idea of the nature of the diagram, we must dis-

abuse our minds of the confused notions which result from this inexact use of language. There is, in reality, no lower line ever drawn by the indicator. The real lower line of the diagram is always the line of perfect vacuum. During one revolution the indicator draws, from opposite sides of the piston, the upper

FIG. 44.

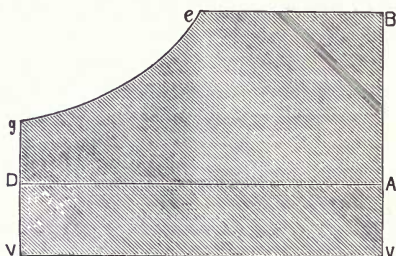

lines of four separate diagrams, and the two which appear together as parts of the same outline are the ones which do not belong together, having no relation to each other whatever.

FIG. 45.

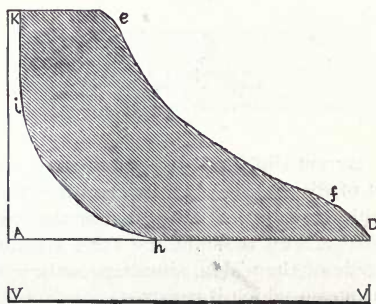

For example: On the forward stroke a line is drawn by the indicator, showing at every point the height at which the pencil is raised by the pressure on that side of the piston upon which the steam is admitted. Beneath this line, at the proper distance, let the line of perfect vacuum be drawn, and the extrem-

ities of the two connected by lines perpendicular to the latter. We have now a correct and complete diagram of the pressure on that side of the piston during that stroke.

To illustrate this, we will take diagram, Fig. 45.

The following diagram, Fig. 46, represents the pressure on the acting side of the piston during the stroke when the upper line of that diagram was drawn.

FIG. 46.

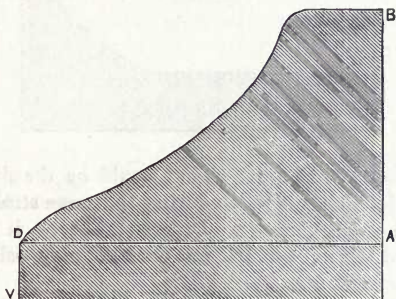

The lower line of diagram, Fig. 46, was commenced after the upper one was finished, and is, in truth, the upper line of another diagram, of which also the line of perfect vacuum is the lower line, and which represents the pressure on the same

FIG. 47.

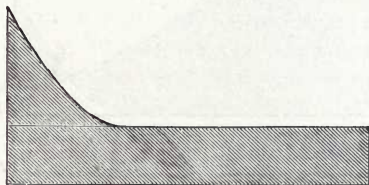

side of piston during the next stroke. Diagram, Fig. 47, drawn in the manner above directed, represents this second diagram.

We say that this last diagram (Fig. 47,) represents the pressure exerted by the exhaust steam and atmosphere to oppose the return of the piston; in fact, the piston is always acted upon by

two opposing forces, of which the difference is the motive force. At every point in the motion of the piston the motive force is the difference between the two opposing forces. To ascertain this, we should, in this case, have the diagram representing the opposing force exerted simultaneously with the force repre-

FIG. 48.

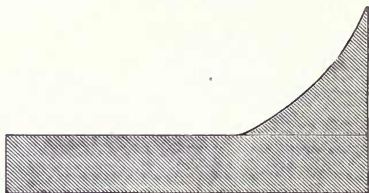

sented by diagram, Fig. 46. That would be the diagram, the upper line of which was taken during the same stroke from the opposite end of the cylinder. Diagram, Fig. 48, it is assumed, will represent the force which was exerted in opposition to that shown in diagram, Fig. 47.

Let us now place one of these over the other, their bases and

FIG. 49.

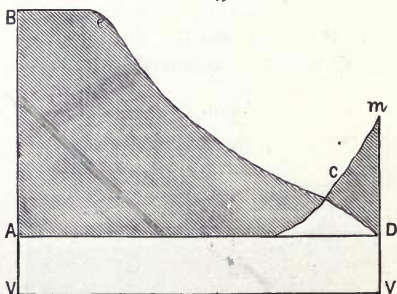

extremities coinciding, and we obtain Figure 49. So far as one covers the other, the two forces neutralized each other, and may be disregarded. The projecting portion *A. B, e, c*, of the first figure, shows the force applied to the piston at each point in its stroke, up to the point *c*, to produce its motion, and that *c m*

$D$ , of the second one, shows the force applied to it at each point beyond  $c$ , and represents effective pressure opposing the advance of the piston. The two forces,  $A, c, D, V, V$ , neutralized each other.

Diagram Fig. 49 is the real one, as it shows the pressure acting on each side of the piston. For computing the power exerted by an engine, it makes no difference from which end of the diagram the compression is deducted, and so, when one does not care to know the effective pressure on the piston to produce or to resist its motion at each point of its stroke, or the distribution of force through the stroke, the diagram as produced by the indicator is sufficient. But in the real diagram, Fig. 49, we see in every case, at a glance, the total opposing forces. We see to what extent they neutralize each other, at what point of the stroke they are in equilibrium, and at every other point in what degree one or the other preponderates. This diagram (Fig. 49) ought, in fact, to be always drawn, for that described by the indicator is liable to convey an erroneous impression respecting the distribution of force through the stroke, and by this means only the truth in this respect can be clearly apprehended.

A simple and ready method of doing this is the following: Lay the diagram from opposite ends on the cylinder one over the other, with the atmospheric lines and extremities of the diagrams coinciding, against a window-pane. Then trace on the upper one with a pencil. Every diagram should be carried down to the line of perfect vacuum; this will represent at a glance the actual steam consumed, the quantity of heat lost by conversion into forces that neutralize each other, and the proportion which the heat so wasted bears to that which is converted into effective work.

#### The Relation Between the Pressure and Volume of Saturated Steam, as Shown by the Indicator Diagram.

Hitherto I have spoken of the expansion of air according to Boyle's or Mariotte's law, as in an adiabatic curve, but in applying the results of experiments on the expansion of steam to a practical use, it becomes important to regard the behavior of that particular substance from another point of view.

It has been shown that the pressure and temperature of saturated steam rise conjointly, though not in the same degree, and tables have been formed expressing the relation between the pressure, volume, and temperature of saturated steam. It will be borne in mind that steam in contact with the water from which it is generated is called saturated steam; and further, that when saturated steam at a high pressure expands while doing work, its temperature falls, and a portion of the steam is re-converted into water. Furthermore, if we operate with saturated steam at a given temperature and endeavor to compress it, we may reduce its volume, but we cannot increase its pressure. Each temperature has its own corresponding pressure (see Nystrom's "Pocket-Book of Mechanics," page 400), which cannot be varied; and, as I have shown, if the volume be diminished while the temperature remains constant, the only result will be that more and more of the steam will be re-converted into water, the pressure remaining unchanged.

If the relation between the pressure and volume be plotted out for any given weight of steam, we have a curve, which is of great value in interpreting the diagrams given by an indicator. It differs from Boyle's and Mariotte's curve of expansion, it differs from the curve of expansion of superheated steam, which would be that of a perfect gas; it is a curve furnished by experimental data, and expresses the conditions which obtain when saturated steam changes its state of pressure, volume, and temperature, without ceasing to be saturated.

The table generally used is as above stated, and has been deduced from Regnault's experiments as regards the temperature, and the volume of steam of the corresponding temperature  $T^{\circ}$ , as compared with that of water of maximum density at  $40^{\circ}$  Fahr., is calculated from the formula of Fairbairn and Tate. The substance being saturated steam, those numbers only are required for the present example:

By "specific volume," or, as it is sometimes termed, "relative volume," is meant the volume of the steam as compared with that of the water from which it is generated; and since the numbers are large, it is common to reduce them by increasing the unit of volume fifty times.

Assuming now that we deal with a given weight of saturated

steam at a steam-pressure of 40 pounds, and a volume 627.91, and allow it to expand three times doing work. Therefore:

$$627.91 \times 3 = 1883.73 \text{ volume.}$$

From the above it is apparent that if the expansion be carried

TABLE NO. 5.

From Nystrom's "Pocket-Book of Mechanics," page 400.

| Pressure in pounds per square inch.<br>P | Temperature Fahrenheit.<br>T° | Specific volume of water equals 1 at 40°.<br>V |
|--|-------------------------------|--|
| 10                                       | 193.20                        | 2373.  |
| 12                                       | 201.90                        | 1994.  |
| 13                                       | 205.77                        | 1845.5   |
| 14.7                                     | 212.00                        | 1641.5   |
| 20                                       | 227.95                        | 1219.7   |
| 25                                       | 240.07                        | 984.23   |
| 30                                       | 250.26                        | 826.32   |
| 35                                       | 259.22                        | 713.8  |
| 40                                       | 267.17                        | 627.91   |

to three times the original volume, the pressure will become about 13 pounds, whereas, according to Boyle's and Mariotte's law, it should be exactly 13.33 pounds  $\left(\frac{40}{3} = 13.33\right)$ . There is, therefore, a small deviation from Boyle's law in the form of the curve.

The point to be noticed is that the curve, when obtained, represents a theoretical indicator diagram. In the present example, setting out a number of intermediate points for pressures at 10, 20, 30 and 40 pounds, and registering the corresponding volumes, also calling 627.91 unity, we have the following diagram, Fig. 50, where all vertical lines represent lines of pressure, and all horizontal lines refer to volumes, and where the steam is maintained in its (hypothetical) conditional state by a supply of heat from without.

Let the horizontal line terminating at  $Vg$  represent the travel of the piston of an engine which is supplied with saturated steam at 25 pounds pressure (steam-gage), and let the pressure be continued constant during one-third the stroke, as indicated by  $Be$ . The steam now expands along the curved line  $efg$ ,

and its pressure falls to  $g y$ , which is a little under 12 pounds. A full opening is then made to the exhaust; and if the condensation of the steam were instantaneous and perfect, the pressure would fall to zero, and would remain so during the return stroke: assuming that the condensation is instantaneous, but that the pressure falls only 12 pounds below the atmosphere, represented by line  $x y$ , and remains constant until the piston reaches the end of its stroke.

FIG. 50.

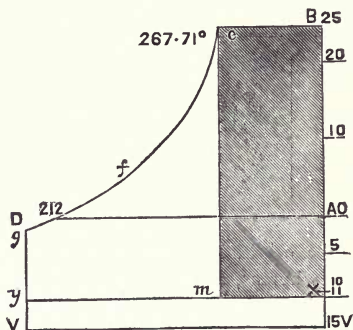

The area  $A B e f g y x$  will represent the whole work done in the double stroke, and is contrasted with the area  $A B e m$  and  $x$ , which represents the work which would have been performed by the same weight of steam if there had been condensation without expansion.

In 1849 Mr. C. Cowper published a complete diagram of the expansion of saturated steam, ranging from a vacuum of 13 pounds per square inch, and up to 120 pounds boiler-pressure. He stated that the diagram was intended to facilitate the calculations of the amount of power obtained by different methods of employing steam. There were two scales—namely:

*First.*—A vertical scale of pressures from zero up to 120 pounds per square inch.

*Second.*—A horizontal scale of volumes, giving the volume of the same weight of steam at each different pressure as compared with the water from which it was generated, one division



on the scale representing 50 units of volume. The general character of the diagram is shown in Fig. 51, each little square being further sub-divided into twenty-five squares in the published card. The dotted line represents the curve of expansion from the top of the figure according to Boyle's law.

FIG. 51.

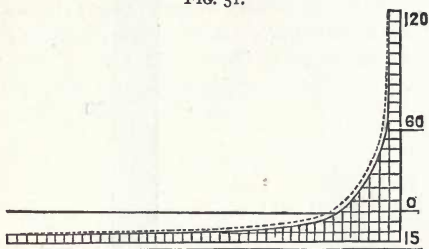

As this curve is generally employed for obtaining the normal or theoretical form of an indicator diagram, the following diagrams, which when rightly understood presents a summary of successive improvements in the steam-engine from the atmospheric engine to the present day.

FIGS. 52 and 53.

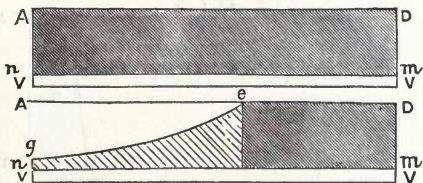

The shaded rectangle  $A D m n$  is the diagram of work done by a given weight of steam when employed in a condensing engine with steam at atmospheric pressure. The rectangular space  $n m V V$ , at the base, represents the loss by imperfect condensation.

The diagram, Fig. 53, represents the work done when steam at the atmospheric pressure is expanded *two and one-half* times with condensation, as in Watt's early engines, before the employment of high pressure steam.

This diagram Fig. 54 represents the work done by an equal weight of steam at a pressure of 60 pounds, without expansion and without condensation.

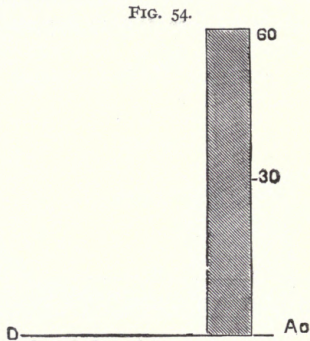

This diagram Fig. 55 shows a moderate expansion of steam at 60 pounds pressure without condensation. The expansion is in this diagram carried to three volumes. The space unshaded in each case represents the loss by back pressure.

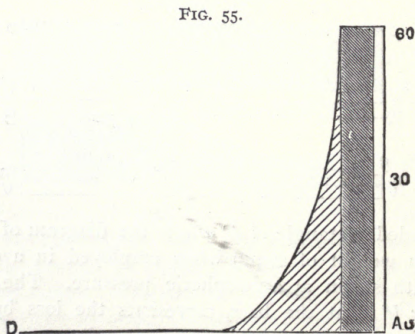

In this diagram Fig. 56 a steam pressure is expanded nine volumes and condensed, which represents an economical engine as in general use at the present time.

## Clearance.

This term includes not merely the clearance proper—the space between the cylinder-head and the piston at end of stroke—but also the space of the steam ports. By clearance is meant the whole space between the piston and the valves, and is a source of loss which cannot in practice be entirely avoided. It is evident that this space must be filled with steam, which expands, and is compressed, precisely as the rest of the steam in the cylinder after the steam is cut off, and it is necessary to take the cubical contents of clearance into account in ascertaining the volume of steam in the cylinder.

FIG. 56.

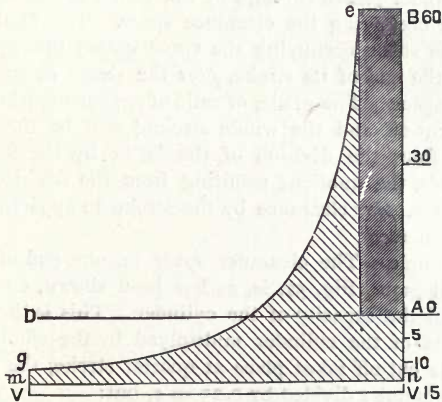

## The Effect of Clearance.

The proportion borne by the capacity of the clearance to the effective cylinder capacity, varies in different engines; it may be as little as one per cent. or as much as twenty per cent. The smaller the engine the greater the loss by clearance, and as it always diminishes the efficiency of the engine, it should be reduced to the utmost extent practicable.

One of the first things that attracts attention in analyzing an indicator diagram is that the terminal pressure is usually very much higher than it would be if found according to rule, by

dividing the initial pressure by the proportion which the stroke before cut-off bears to the whole stroke. The reason is that this proportion does not accurately represent the grade, or ratio of expansion, for the length of the stroke, multiplied by area of the cylinder, does not represent the total space finally occupied by the steam; neither does that portion of the stroke during which steam is admitted before cut-off represent the whole initial volume, as the clearance space is already filled with steam before the stroke commences. This steam in the clearance expands with the admitted steam, and must be taken into consideration, both before and after expansion. The total initial volume will, therefore, be the steam occupying the space in the cylinder passed through by the piston up to cut-off, *plus* the steam occupying the clearance space. The final volume will be the steam occupying the space passed through by the piston to the end of its stroke, *plus* the steam occupying the clearance space. The grade, or ratio of expansion, (the relation between cut-off and the whole stroke,) will be the quotient resulting from the division of the latter by the former; in other words, the quotient resulting from the division of the whole stroke, *plus* clearance by the stroke to apparent cut-off *plus* clearance.

For example.—The clearance space for one end of the cylinder of diagram, Fig. 57, is, as has been shown, 0.05, or five per cent. of the capacity of the cylinder. This is the product of the area of the cylinder multiplied by the whole stroke. Now if the cut-off takes place at quarter stroke, the grade of expansion is not 1 divided by 0.25 = 4, but:

$$\frac{1 + 0.05}{0.25 + 0.05} \text{ or } \frac{1.05}{0.30} = 3.5.$$

It follows that the earlier the cut-off, in such a case, the greater will be the relative proportion of clearance.

Thus, if the cut-off should take place at one-tenth of the stroke, in the given case, the grade of expansion would not be 1 divided by 1.10 = 10, but:

$$\frac{1 + 0.05}{0.25 + 0.05} = \frac{1 + 0.05}{0 + 15} = 7;$$

and the conclusion is that when a high rate of expansion (a very short cut-off) is required, the clearance must be reduced to the minimum.

While, therefore, an indicator diagram accurately represents by its area the work performed, and by its vertical dimensions the pressure of the steam at each point of the stroke, it does not accurately represent by its horizontal dimensions the volume of the steam. To show this, and complete the diagram, a line  $VB$  must be drawn back of the admission end of the diagram, at such a distance from it as will accurately represent the clearance space. Thus, in Fig. 57, the shaded part  $VBko$  shows clearance space.

FIG. 57.

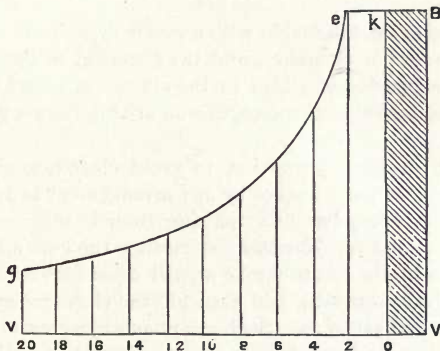

This modification of the diagram corroborates what has already been shown—that the loss by clearance is greater in proportion with an early, than with a late cut-off, because the earlier the cut-off the greater the proportion of clearance to the actual work performed. In this diagram the shaded portion is clearance.

Suppose the stroke to be 20 inches, and the steam cut off when the piston has moved 2 inches, from 0 to 2 (Fig. 57), and the grade should be taken as  $\frac{2}{20} = 10$ . This would be incorrect, for although the steam is cut-off at  $\frac{2}{20}$  of the stroke, the cylinder, at the point of cut-off, contains not only a volume of steam equal to  $\frac{2}{20}$  of the piston's displacement, but an additional

volume from  $V$  to  $o$ , equal to clearance capacity. If then the clearance contains  $\frac{2}{5}$  of the piston displacement, there would be in the cylinder, at cut-off, a volume of steam equal to  $\frac{2}{5} + \frac{2}{5}$  or  $\frac{4}{5}$  from  $B$  to  $e$ , and the actual grade, or ratio of expansion, if continued to  $g$ , the end of the stroke, instead of being 20 divided by 2 = 10, would be 22 divided by 4 =  $5\frac{1}{2}$ .

With even this moderate clearance, the utmost possible practicable grade, or ratio of expansion, in this case, could not exceed 11; that is 20 inches, plus 2 inches clearance, or 22 inches, divided by 2 = 11, which would be attainable if the steam should be cut off immediately after the piston begins its stroke, so that only the clearance space would be filled with full pressure steam, and the entire stroke performed by and during its expansion.

The expansion attainable with a given cylinder is controlled by the amount of clearance, and the character of the steam in it, as the expansion of steam in the clearance, unless of initial pressure, lessens the actual expansion arising from a given cut-off.

It is impossible, in practice, to avoid clearance altogether. The capacity of ports cannot by any arrangement be reduced to absolutely nothing, but loss resulting from it may be reduced, if not almost entirely obviated, by closing the exhaust valve at such point in the return-stroke as will cause sufficient exhaust steam to be compressed, and thus fill the clearance space with steam of initial pressure. Such steam acts as a constant spring, giving out in its expansion the force necessary to compress it again.

The smaller the clearance space the greater will be the pressure from the closing of the exhaust valve at a given point of the stroke, and the less will be the area of the cooling surface, so that the gain from reducing the clearance will be threefold.

In fast running engines the clearance space must be filled with steam at the commencement of the stroke, by steam equal to that of the boiler, which is obtained either from the boiler, or by compressing into the clearance spaces the exhaust still remaining in the cylinder, at the closing of the exhaust-port.

By this latter process, a certain quantity of steam is saved at the expense of increased back-pressure. The total heat of the

compressed steam increases with its pressure, and as this latter approaches the boiler-pressure, the temperature of the steam, in compression, must also have been raised from that of about atmospheric pressure, to nearer the temperature of the boiler steam-pressure. These changes of temperature which the steam undergoes, will affect the surface of the metal with which the steam is in contact during the period of compression. It follows from this, that the ends of the cylinder principally comprising the clearance spaces, must acquire a higher temperature than those parts where expansion only takes place. This is an important consideration, since the fresh steam from the boiler comes first in contact with these spaces, and by touching surfaces which have thus been previously heated, as it were, by the high temperature of the compressed steam, less heat will be abstracted from the entering steam. and therefore a less amount of water will be deposited in the cylinder.

From the above it will be seen that when the clearance is so regulated that the cushion of steam at the end of the stroke would attain the initial pressure of the cylinder, we may entirely dispense with the consideration of clearance in calculating the efficiency of an engine.

Other things being equal, the following principles always hold good, and may be easily remembered:

A large clearance space requires a large ratio of compression.

An early cut-off requires a large ratio of compression.

A small clearance requires a small ratio of compression.

A late cut-off requires a small ratio of compression.

#### Effect of too Much Clearance on the Diagram.

The following diagram, Fig. 58, was taken from an engine having a cylinder 48 inches in diameter, with a stroke of 8 feet, running 15 revolutions per minute. The diagram in dotted line, was taken when there was an excessive amount of clearance, the cut-off valve being placed in the steam-pipe; therefore, the steam contained in the steam-pipe and steam chest expanded after the cut-off valve was closed. The effect of the extra clearance between the slide valve and cut-off valve has raised the expansion curve at the point of exhaust some ten pounds above vacuum line, *V V*. That such is the case will be seen by refer-

ence to the second diagram, in black lines. This diagram was taken when the engine was refitted with a cut-off valve on the back of the main valve, the expansion curve falling within seven pounds of vacuum line by reason of the diminution of clearance.

It will be observed that the pressure of steam is not the same at the beginning of the stroke in the respective diagrams, nor is

FIG. 58.

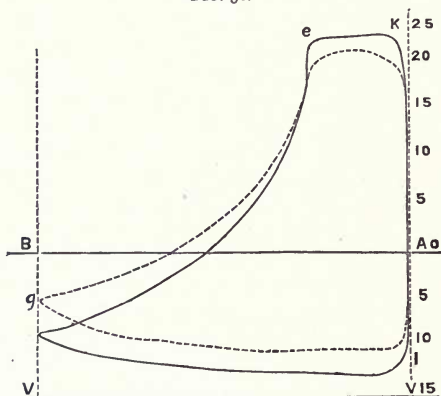

the point of cut-off exactly the same, so that the comparison is not perfect; but, as before shown, clearance must be allowed for in estimating the expansion curve of an indicator diagram; otherwise the information given is deceptive. Another point is, that excessive clearance diminishes the excellence of the vacuum, by reason that the condensation is less perfect when a portion of steam is stored in the passages. This is apparent from the diagrams, the vacuum having improved from eight pounds in the first diagram to ten pounds in the second, solely from the lessening of the amount of clearance. Had there been an earlier release of the steam on the exhaust side, the vacuum would have been further improved, at least five per cent.



## The Expansion Curve.

When steam is used expansively, in either condensing or non-condensing engines, the line produced from the point where the cut-off valve closes, to the end of the stroke, (if the valve is properly constructed and the cylinder sufficiently protected,) should be nearly a hyperbolic curve, and may be thus described.

The Mariotte, or Boyle, curve, as has previously been stated, is the standard by which the character of all expansion curves actually drawn by the indicator is compared, from the fact that it is a determinate mathematical curve, a hyperbola. This can be readily and precisely drawn, and the best curves attainable in practice coincide with it very nearly, if not exactly.

FIG. 59.

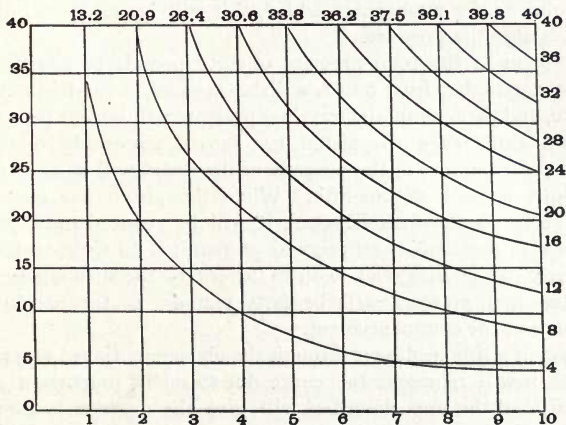

The diagram, Fig. 59, has been drawn to illustrate the application of this curve to the expansion of steam. The pressure is represented by the vertical height, being forty pounds absolute pressure to the square inch. Its length represents the stroke of a piston, including clearance, divided into ten equal parts. The base represents the line of perfect vacuum, assuming the barometer to stand 30.75 inches of mercury, and the left-hand boundary the commencement of the stroke.

The diagonal of a square, drawn from the point of intersection of these lines, from the commencement of the stroke and the vacuum line, is the axis or centre line of every hyperbola that can be described, representing expansion, (according to the law of gases,) from any point of the stroke, and from any pressure whatever.

Curves are described, in diagram Fig. 59, representing this expansion from nine different points of cut-off. The figures at the terminations of the curves give the terminal pressures, and those at the commencement give the mean pressures during the stroke.

Now, we assume that the steam used has an elastic force of twenty-five pounds per square inch above the atmosphere. As shown on a correct steam-gage, and with fifteen pounds pressure due to the atmosphere added, this will be equal to forty pounds absolute pressure.

If steam at the total pressure of forty pounds be admitted into the cylinder, from 0 to 1, a distance equal to one-tenth the stroke, and then cut off, its terminal pressure will be four pounds or one-tenth when the piston has moved two-tenths of the stroke, or from 0 to 2, the pressure of the steam will be reduced to eight pounds, or one-fifth. When the piston has moved five-tenths (to the fifth division), it will be reduced to twenty pounds, or one-half of its original pressure; if to eight-tenths, to thirty-two pounds, and so on to the end of the stroke, where the terminal pressure will be forty pounds, or the absolute pressure at the commencement.

Now, if a line be drawn through the above mentioned several points, it will represent the curve due to such a proportion of cut-off; and the area described will give the average pressure exerted by the steam during the stroke, as above stated. Fig. 59 represents such a curve, and also such other curves as would have been described had the steam been cut off at either of the other points.

Now we will endeavor to show how to apply a hyperbola to a diagram. The hyperbola may be commenced at either end of the expansion curve, but generally it will be found more accurate to commence near the point of release. Both methods will be illustrated and described geometrically.

## CHAPTER XI.

### COMPARATIVE INDICATOR DIAGRAMS.

IN order to compare one engine with another, they should be in precisely similar circumstances. As, however, this rarely occurs, it is necessary to have some standard by which all engines may be compared, and their relative performances determined. The best means of doing this is to compare each engine with a theoretically perfect engine of a similar size under similar circumstances, and the engine which most nearly approaches the theoretical is evidently the best.

The expansion of steam, as before stated, follows a certain law of gases (Boyle and Mariotte) and the quantity of steam being known, as well as the space which it occupies, it is possible to tell the correct pressure for each variation in the space occupied. A curve can thus be calculated which will give a diagram of the theoretical action of a given amount of steam in a given size of cylinder.

A diagram taken from any engine may thus be compared with a theoretical diagram for an equivalent quantity of steam used in the same sized cylinder, and the ratio existing between the actual and the theoretical diagrams will serve as a measure of the perfection of the engine.

In the ordinary commercial steam engine the total clearance averages not less than one-tenth ( $\frac{1}{10}$ ) the piston displacement.

The following dimensions taken from an actual engine will illustrate how to calculate the clearance:

|  |     |
|--|-----|
| <i>Diameter of cylinder in inches,</i> . . . . .                             | 10. |
| <i>Length of stroke in inches,</i> . . . . .                                 | 20. |
| Clearance space between piston and cylinder cover, one-half inch,<br>or 0.5. |     |
| Dimensions of steam port and passage:  |     |
| <i>Steam port length, in inches,</i> . . . . .                               | 10. |
| <i>Width in inches,</i> . . . . .  | 1.  |



reading; this being as before stated 30.75 inches, corresponding to 15 pounds. We then divide the length of the diagram, including clearance, into ten equal spaces, or erect eleven ordinates and number them from 0 to 10. We next measure the pressure at the point of release  $f$ , or exhaust, which is in well constructed engines usually a little—say seven-hundredths (0.07) of the stroke as in Fig. 60—before the end of the stroke. This pressure is found by extending the expansion curve of the actual diagram to the end of the stroke,  $fg$ , Fig. 60, and measuring the height of the extremity of the curve above vacuum line  $VV$ .

Having found the terminal pressure,  $gV$ , to equal 29 pounds, in Fig. 60, the pressure at any other point of the stroke is easily found by the usual formula, or what is known as Boyle's or Mariotte's law, according to which, as before stated, the pressure of gases is inversely as the space occupied, and if, as in practice, assumed applicable without qualification to steam, the expansion curve of a diagram should be of such a shape that the pressure represented by it at different given points would be inversely as the distance of those points from the commencement of the stroke.

Thus, if at one inch from the commencement of the stroke the pressure (above vacuum line) is 100 pounds, it will be 50 pounds at 2 inches; 33.33 at 3 inches; 25 pounds at 4 inches, and so on. Hence, if the distance from any point in the expansion curve to the clearance line  $BV$ , be multiplied by the pressure at such point, the product will be the same wherever the point be located.

This engine was regulated by a throttle valve in the steam pipe, governing the amount of steam required by a Le Van governor.

Diagram Fig. 60, from this engine, will illustrate the simple manner in which a theoretical diagram can be constructed, assuming that the pressure of steam varies inversely as the space occupied; the clearance being taken at *ten per cent.* of the piston displacement. Assuming that the barometer stands at 30.75 inches of mercury, which represents a pressure of about 15 pounds, then measure off 15 pounds with the scale corresponding (in this case 40 pounds equal one inch) to the indicator

spring below the atmospheric line  $A D$ . In considering all questions of expansion and compression of steam, it is the *total pressure*, measuring from the line of no pressure  $V V$ , which we must consider.

The atmospheric line, it must not be forgotten, is merely a line showing what the pressure of the atmosphere happens to be at the time, and the expansion curve has nothing whatever to do with it. This should be well understood.

Where there are ten divisions of the diagram, as in Fig. 60, the several ordinates of the expansion curve may be obtained by multiplying the terminal pressure  $g V$ , by the following series of numbers:

1, 1.11, 1.25, 1.429, 1.667, 2, 2.5, 3.333, 5 and 10. Or more simply still, by dividing the terminal pressure  $g V$ , at the end of the stroke, by the number of the ordinates up to the point of cut-off, as follows:

In the example, diagram Fig. 60, the terminal pressure  $g$ , being fourteen pounds above the atmospheric line  $A D$ , and the distance  $D V$  being fifteen pounds, we have  $14 + 15 = 29$  pounds terminal pressure. Now divide this terminal pressure by the ninth ordinate, thus:  $\frac{29}{9} = 32.2$  pounds as the pressure to lay off on space number nine; and  $\frac{29}{8} = 36.2$  pounds to lay off on space number eight, and so on for number seven, six, five, four, and three. For number three the pressure becomes 96.7 pounds, which exceeds the boiler pressure ( $75 + 15 = 90$  pounds absolute), but we extend the ordinate to this point—namely,  $x$  on the diagram.

Now having found the theoretical pressure at each of the several divisions of the diagram, we then trace a curve  $x f g$  from  $x$  to  $g$ . Through these points (and where the curve thus found intersects the line  $B C$  of boiler pressure) is the point of theoretical cut-off,  $E$ , at which the admission of steam must be suppressed in our theoretical card to give the same terminal pressure as in the actual card where the cut-off is at  $e$  in that diagram.

On the return stroke to form the theoretical diagram complete, the line  $D A$  is traced to clearance line  $A B$ , and up that to boiler pressure line  $B C$ , as this engine was non-condensing. Had it been a condensing engine, the return line would have

followed the line  $VV$ , of no pressure, or absolute vacuum, and up to boiler pressure.

Now we have two diagrams: the theoretical always larger and enclosing the other, the actual diagram. The inner one, or the real diagram, represents the work the steam actually performed in the engine: the outer one in shaded lines is what the same amount of steam should have done in a perfect engine of similar capacity. The proportion which the area of the smaller bears to the larger represents the relative perfection of the mechanism which was used for developing the power of the steam. This may be expressed in percentages of the theoretical, as follows:

Take off the back pressure. In this case, 15 pounds represented by the space marked vacuum, bounded by  $AD$  and  $VV$ . Also, leave out the first space  $ABp$ , and  $m$ , representing clearance. Measure the other nine spaces on dotted lines as marked; add up the pressures thus:

$$26 + 34.5 + 32.5 + 31 + 29 + 26 + 22 + 18 + 13 = 232.$$

This sum divided by nine (the number of spaces) gives  $25.77 = 25.77$  pounds for the mean effective pressure. All that part of the diagram below  $mD$ , marked vacuum, is loss. This will perhaps help to explain why a condensing or "low-pressure" engine is more economical than a non-condensing or "high-pressure" one.

Measuring the different pressures by the scale corresponding to the indicator spring, they were, in the engine under consideration, as follows:

Absolute initial pressure from line  $VV$  to  $S$ , 54 pounds.

Absolute terminal pressure from line  $g$  to  $V$ , 29 pounds.

Absolute back pressure from line  $AD$  to  $VV$ , 15 pounds.

Absolute average pressure from line  $kefg$  to  $VV$ , 38.77 pounds.

And  $38.77 - 15 = 23.77$ , actual mean pressure in pounds.

The real expansion of this card, that is, from cut-off  $e$ , to terminal point  $g$ , is  $\frac{1}{4}$  or 0.44 of total diagram. Including clearance it is  $\frac{1}{4}$ , or 0.4 of the actual working part of cylinder.

Now proceed to measure the theoretical diagram in the same manner; add up the pressures as noted on the spaces marked vacuum (see diagram, Fig. 60), and we have:

$$75 + 75 + 68 + 49 + 37 + 30 + 23.5 + 19 + 15.5 = 392.$$

This total, divided by nine (the number of spaces) gives  $\frac{392}{9} = 43.57$  pounds for the mean effective pressure.

The theoretical available mean effective pressure being greater than the actual mean pressure of the engine diagram by  $43.57 - 25.77 = 17.8$  pounds, the percentage of the actual to that of the theoretical diagram is as follows:

$$\% = \frac{25.77}{43.57} = 59.14 \text{ per cent. of the theoretical diagram.}$$

A good and well made modern automatic expansion engine would realize *ninety per cent.* of the theoretical.

#### The Advantage of Variable Automatic Expansion.

The simplest method of ascertaining the increase of economy which can be gained in an engine, under conditions of variable

FIG. 61.

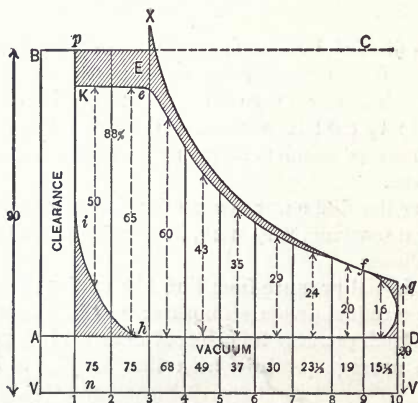

automatic expansion, is to estimate what the maximum work which could have been obtained from an equal amount of steam used at the fullest rates of expansion would be.

This increase we can find by constructing an ideal expansion diagram, which shall represent exactly the same amount of



steam finally exhausted into the atmosphere, as in the case of the actual diagram in Fig. 60, produced by the throttling engine under notice.

Diagram, Fig. 61, is an ideal diagram erected from the volume of steam swept through the cylinder, and calculated from the terminal pressure of diagram, Fig. 60; it illustrates the gain in effect if the engine had been fitted with an *automatic cut-off valve*, in place of a throttling governor valve. The sum of the pressures by the dotted ordinates is as follows:

$$16 + 20 + 24 + 29 + 35 + 43 + 60 + 65 + 50 = 342,$$

which divided by nine gives  $\frac{342}{9} = 38$  pounds, mean pressure in excess of that of the former example, Fig. 60—namely:

$$38 - 25.77 = 12.23 \text{ pounds more, mean effective pressure.}$$

This diagram also shows an effect equal to *eighty-eight and four-tenths per cent.*, nearly, of the theoretical diagram. The average mean pressure of the theoretical diagram being 43 pounds, and the automatic expansion diagram 38 pounds, a gain of:

$$\frac{43 - 38 \times 100}{43} = 11.6 \text{ per cent,}$$

or a gain over the throttling engine, as per diagram, Fig. 60, of:

$$\frac{38 - 25.77 \times 100}{38} = 32 \text{ per cent.}$$

#### The Further Advantage of Variable Expansion and Condensing.

The secret of economy in using steam expansively in engines is in the adaptation of the highest practicable pressure of steam, the earliest cut-off at which the engine will do its work, and as perfect condensation of steam as possible after the steam has done that work.

If the engine that produced diagram, Fig. 61, had been fitted, in addition, with the automatic cut-off, and a condenser, the mean pressure as shown by diagram, Fig. 62, would be 49 pounds, as follows:

$$60 + 78 + 72 + 56 + 47 + 40 + 34 + 29 + 25 = 441.$$

This total, divided by *nine*, gives  $\frac{441}{9} = 49$  pounds mean pressure in place of 38 pounds as per diagram, Fig. 61. This is a gain of *ten* pounds of mean effective pressure, and of 22.4 per cent., as follows:

$$\frac{49 - 38 \times 100}{49} = 22.4 \text{ per cent.}$$

This gain being made by removing the resistance of the atmosphere.

All the above shows that the automatic engine is capable of

FIG. 62.

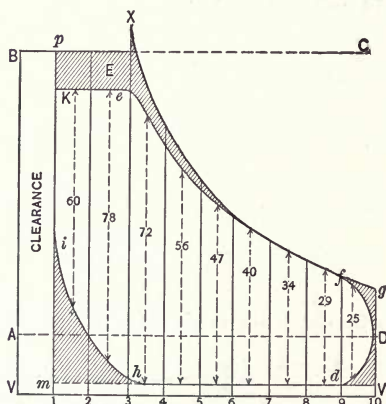

developing a given power at a reduction of 25 to 75 per cent., as compared with the cost of power by the average throttling engine. Under the most favorable conditions, the loss in economy by the slide-valve throttling engine, as compared with the cut-off, is nearly 30 per cent. The performance of throttling and cut-off engines, by actual test, shows that 25 per cent. is the minimum saving by automatic cut-off engines.

To the practical eye of the engineer the gain and advantages are seen at a glance. In such an engine, with steam admitted at nearly the boiler pressure, the duration of admission is proportional to the resistance or load, the full initial pressure being maintained to the point of cut-off.



*First.*—Calculate the clearance space, as before explained; then lay off the distance  $Bp$ , and draw the line  $BV$ ; the area enclosed by  $B$ ,  $p$ ,  $m$  and  $A$  represents the clearance space. Also draw the line  $VV$ , to represent the vacuum line parallel to the atmospheric line  $AD$ , and 14.7 pounds below it. Draw the line of boiler pressure  $BC$  also parallel to the atmospheric line, and as many pounds above as is shown by the steam gage (as before explained).

*Second.*—Select a point  $f$ , which must not be later than the commencement of exhaust opening. From  $f$  draw line  $fF$ , parallel to atmospheric line, and line  $f\delta$ , at right angles to it. From  $\delta$  draw the diagonal line  $\delta V$ , and from its intersection with or crossing the line  $fF$ , and  $E$ , erect the perpendicular line  $EF$ ; the point  $E$ , on line  $BC$ , is the theoretical point of cut-off.

FIG. 64.

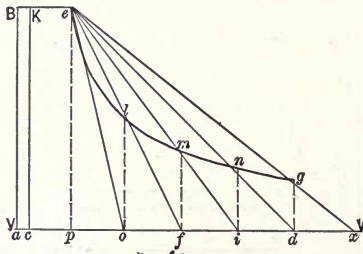

*Third.*—Draw any desired number of vertical lines, as 1, 2, 3, 4 and 5, downwards, from points in line  $BC$ , and from the same points draw diagonal lines to point  $V$ ; from the intersection of each of these diagonal lines,  $FE$ , draw a horizontal line intersecting the vertical lines drawn from  $EC$ . These intersections with the vertical lines locate points  $f$ ,  $x$ ,  $d$ ,  $c$ ,  $b$  and  $a$ , for the desired curve.

The few points being found in this way, the curve can be drawn in by hand, which will be found to be a hyperbola; any one familiar with the properties of conic sections will recognize it as that of a rectangular hyperbola.

This curve is called the *isothermal* curve (signifying equal

heat), because it is constructed on the assumption that the temperature of the steam is the same at all pressures.

**How to Lay Out the Hyperbolic Curve from the Point of Cut-off.**

In the diagram, Fig. 64, let the height  $p e$  represent the total or absolute pressure of the steam at the point of cut-off, or at some point subsequent to the cut-off, if the position of the latter be not accurately known. Also, let  $k e$  represent the length of the cylinder filled with steam of the pressure  $p e$ ; let  $a c$  represent the clearance space. Then the area  $a, B, e, p$ , will represent the quantity of steam to be expanded. Next, on the line of perfect vacuum,  $V V$ , mark off a series of spaces,  $p o, o f, f i, i d$ , and  $d x$ , each equal to  $a p$ , and at the points  $o, f, i$ , and  $d$ , erect perpendiculars, as shown. Then draw diagonal lines

FIG. 65.

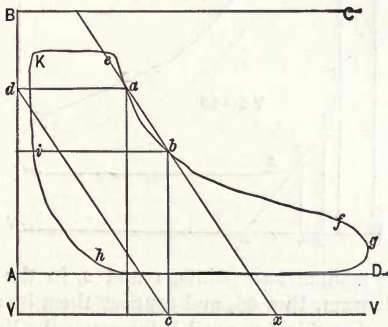

from the point  $e$  to each of the points  $o, f, i, d$ , and  $x$ , and the point at which each of these oblique lines intersects the perpendicular next to that to the vacuum line of which it is drawn, is the point in the desired curve. For instance,  $l, m, n$ , and  $g$ , are such points in diagram.

The curve may, of course, be extended indefinitely towards the right, according to the length of stroke and degree of expansion.

### How to Fix the Clearance Line when not Known.

The clearance space is rarely given, and it varies in different engines from *one to twenty per cent.* of the space swept through by the piston in one stroke, as before stated.

Where the dimensions are not given, it can be computed from the expansion curve as follows:

Take two points,  $a$   $b$ , on the diagram, Fig. 65, assuming the curve to be a common hyperbola. Join the points  $a$ ,  $b$ , by a straight line,  $e$ ,  $a$ ,  $b$ , and  $x$ , and parallel to this line draw another line through the point  $c$ . The intersection of this latter line at  $d$ , with the horizontal line passing through the point  $a$ , will give the distance of clearance line,  $B$   $V$ , from diagram.

FIG. 66.

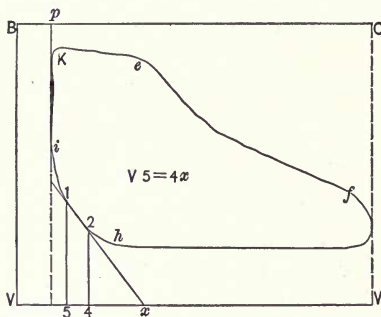

Or we may assume two points, 1 and 2, in the compression curve, see diagram, Fig. 66, and connect them by a line, 1 and 2, and continuing this line until it intersects the line of perfect vacuum,  $V$   $V$ , at  $x$ . Draw the vertical lines, 1, 5, and 2, 4, and make  $V$  5 equal to 4  $x$ . Then erect the vertical line  $V$   $B$ , which will form the end of the theoretical diagram, including clearance, and the distance of  $V$   $B$  from the boundary line  $i$   $k$ , of the indicator diagram, is the clearance in the scale of the length of the diagram which represents the stroke of the piston.

### The Disadvantages of Too Large an Engine.

If an engine is too large, condensation in the cylinder takes place to the fullest extent.

The cut-off takes place early in the stroke, hence the expansion and consequent fall of temperature are excessive. The whole surface of the cylinder must be heated, and the condensed steam be re-evaporated at the expense of the next admission of steam. This being small in quantity, from the light load, will condense very largely. With an engine suitable for the load, the expansion and cooling are much less, and the amount of steam admitted to restore the heat is much larger.

In the non-condensing, or "high-pressure" engine, a direct loss occurs by the steam expanding below the atmospheric line, thus creating a vacuum on the impelling side of the piston

FIG. 67.

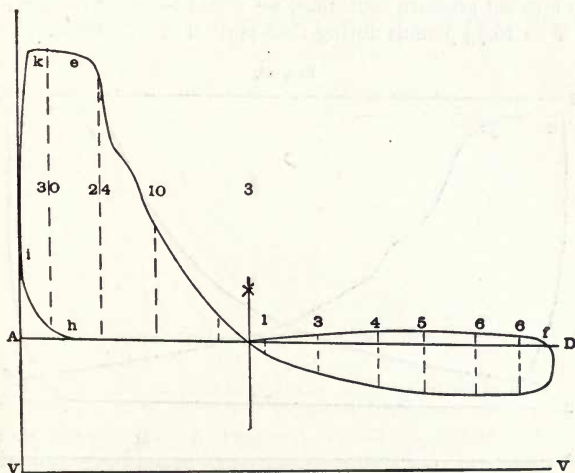

which must be overcome by the momentum of the fly-wheel. Diagram, Fig. 67, shows this plainly.

We have here a diagram from a steam engine for four-tenths of the stroke, while for the remainder of the stroke it becomes an air-pump, whose piston is dragged against 4.2 pounds resistance per square inch (which is the average pressure of area enclosed below atmospheric lines) by the momentum of the fly-wheel.

In a diagram, similar to Fig. 67, from a non-condensing engine expanding below the atmospheric line, then, the pressure for that part of the curve below atmospheric pressure is to be considered negative, as follows:

Above the atmospheric line,  $30 + 24 + 10 + 3 = 67$  pounds.

The first four-tenths of the diagram is, as above, 67 pounds, which, divided by the ten spaces, is  $\frac{67}{10} = 6.7$  pounds. This is all the forward pressure that we have; for, just at the end of the fourth division or space at  $x$ , the expansion curve crosses the line of counter-pressure. If we were to divide the sum of the pressure by four, the number of equal divisions through which the forward pressure continues, we would have a mean pressure of  $\frac{67}{4} = 16.75$  pounds during that portion of the stroke. This,

FIG. 68.

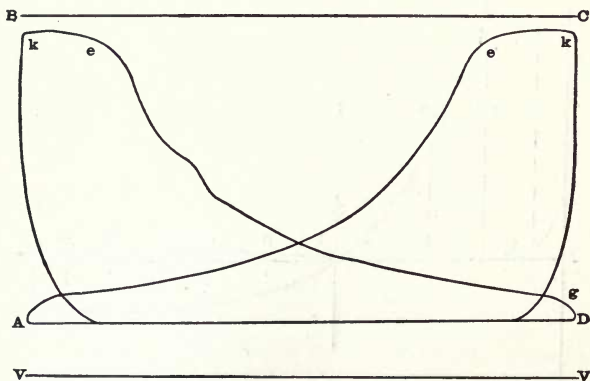

however, would be of no use to us; we want to know what this pressure would average, supposing it to be extended over the entire stroke. We, therefore, get this by dividing the sum of the mean pressure by ten, the whole number of equal divisions, and the result is  $\frac{67}{10} = 6.7$  pounds. The mean pressure to be deducted from this is ascertained in a similar manner, and is as follows:

Below the atmospheric line:  $6 + 6 + 5 + 4 + 3 + 1 = 25$  pounds,  $\frac{25}{10} = 2.5$  pounds mean pressure per square inch.



Then  $6.7 - 2.5 = 4.2$  pounds effective pressure throughout the forward stroke, or in other words the sum of the ordinates below the back pressure line is negative, and the sum of their length (2.5) must be subtracted from the sum of the positive, or the length of the ordinates (6.7) above back pressure.

For the economical use of an engine its work should be such that the indicator diagram would show not less than four pounds terminal pressure above atmosphere. See Diagram, Fig. 68.

When the terminal pressure falls to the atmospheric line, as shown in Diagram, Fig. 69, though the diagram is very correct and fine in its lines, the engine is working at a loss, because

FIG. 69.

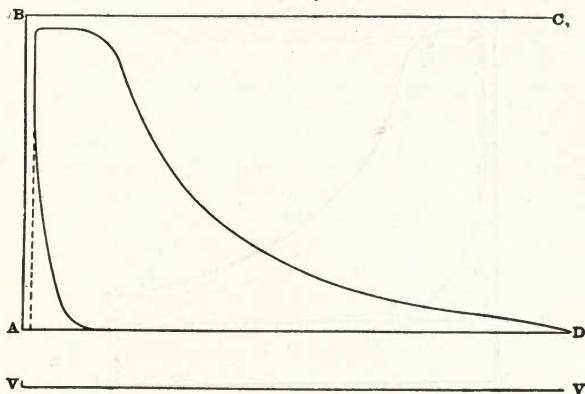

there is not sufficient steam left behind the piston to keep the cylinder heated, and to furnish a cushion on the return stroke.

In fact, the *actual* loss is still greater than that accounted for by the indicator, as the indicator does not show the friction of the engine.

Diagram, Fig. 70, was taken from an automatic cut-off engine; cylinder, 22 inches diameter, stroke, 44 inches; speed, of piston, 520 feet per minute; scale, 40 pounds to the inch; clearance, 1.75 per cent. of the space swept through by the piston; mean effective pressure, 36 pounds per square inch. It shows very perfect performance—its absolute terminal pressure  $g V$ , being 22 pounds.

## Condensation in Steam-Engine Cylinders.

The utmost heating power of one pound of carbon is equal to the evaporation of about 15 pounds of water, from a temperature of 212 degrees. The quantity of heat necessary to raise the temperature of one pound of water through one degree Fahrenheit, is termed a "unit of heat," and as the total temperature of steam is about 1178.6 degrees, or 966 degrees above the boiling point, a pound of carbon is capable of imparting from 14,000 to 15,000 "units of heat." Different substances, however, take up very different amounts of heat, and the quantity of heat which would raise the temperature of one pound of water

Fig. 70.

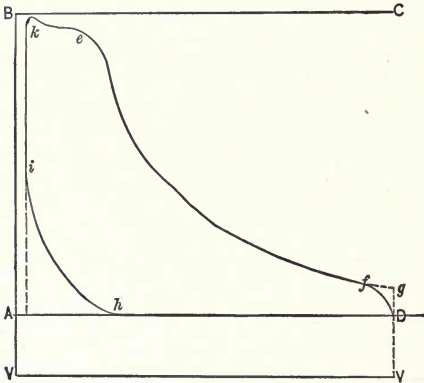

through one degree, would raise that of nine pounds of iron to the same extent. Thus, if all the heat which could be derived from the combustion of one pound of coal, were imparted to 100 pounds of water, the elevation of the temperature of the latter should be about 150 degrees. But the combustion of the same weight of coal in contact with a mass of iron weighing 900 pounds, should raise its temperature 150 degrees, or that of 100 pounds of iron by 1,350 degrees. The term "specific heat" is employed to express the relative capacities of bodies for absorbing different amounts or quantities of heat at the same temperature. Water being taken as unity or the standard of specific

heat, that of iron is 0.14, and it may be easily ascertained by experiment, that one pound of iron heated to 1,200 degrees, or a bright red heat, will raise the temperature of one pound of water (at say 55 degrees) by less than 130 degrees. Half a pound of red-hot iron may be cooled in a pint of water (1.08 pounds) without heating the latter much above blood heat.

In these facts we have the key to one of the most important sources of loss in steam engines, as ordinarily worked, and they enable us to comprehend why high expansive working, as commonly carried out, has given such unsatisfactory results. With all our knowledge of the nature of steam, its expansion in a cylinder, after the communication from the boiler has been shut at one-third stroke, should afford an additional power equal to the whole amount exerted up to the point of cut-off; or in other words, the effect of steam should be doubled by cutting off at one-third stroke. On the first admission of steam to a cold cylinder, a considerable quantity is condensed into water, and this is often produced to such an extent that, but for opening the cylinder cocks, the cylinder head would be knocked off. The cylinder and its attached parts in contact with the steam may weigh 1,000 pounds, and may have to be raised in temperature by 200 degrees on the average of the whole weight of metal. This warming corresponds to heating 112 pounds (one-ninth of 1000 pounds) of water through 200 degrees into steam. This is about the quantity of heat ordinarily obtained from the combustion of three pounds of coal, all of which, therefore, may be considered as expended in warming the cylinder up to a point at which high pressure steam will not condense in it.

If, now, after the cylinder had been once warmed, it would retain its temperature, we might carry expansion to a high pitch by cutting off at an early point of the stroke. The temperature of the cylinder, however, is constantly varying when the engine is running. Steam of 100 pounds pressure, on its admission to the cylinder, should heat it to its own temperature of nearly 340 degrees. When, however, this steam is exhausted into the air, the temperature within the cylinder falls to 212 degrees, and if the steam be discharged into a condenser, the temperature falls to 100 degrees. Nothing is better known than that the expansion and consequent rarification of steam, air and

simple gases, is attended by cooling. Now the cylinder is not heated and cooled at each stroke, *to the same extent* as the interior space to which the steam is admitted. If it were, the steam engine in its present form would be impracticable, for in a fifteen-inch cylinder and thirty-inch stroke (the cylinder weighing about 1,000 pounds) about three pounds of coal would be expended *at every stroke* in warming it up from the temperature to which it was cooled by the exhaust at the preceding stroke. As it is, the inner surface of the cylinder is usually cooler than the steam at the beginning of each stroke, and hotter than the same steam at the end of each stroke. Experiments have been made by placing a glass tube in communication with the cylinder, and at each stroke the interior of this tube was covered with moisture at the beginning of the stroke, while, although the steam was considerably expanded and consequently cooled by cutting off, the tube was always dry at the end of each stroke. A still more striking illustration of the varying temperature of the cylinder is afforded by some of the large Cornish pumping engines, to which high pressure (40 pounds) steam is admitted to only the upper end of a ten-foot stroke. The cylinder is, of course, bored cylindrically from end to end, but the top remains permanently hotter than the bottom, and the difference of temperature and consequent difference of expansion is so great that, while the piston packing is quite tight at the bottom of the stroke, it often blows steam at the top. In this case, the highest temperature of the steam at the top of the stroke is some 289 degrees, but as the steam is expanded eight or ten fold, the bottom of the cylinder can never be heated above 180 degrees, (the steam being finally discharged into a condenser.) If steam were to be admitted also at the bottom, the condensation, therefore, on the first upward stroke, or until the cylinder was warmed, would be enormous. We see, in a surface condenser, how instantaneously steam is condensed when in contact with a cool metallic surface, and a steam cylinder acts, partially, as a surface condenser at every stroke of the piston.

But whatever may be the rapidity with which a cooled cast-iron surface absorbs the heat of steam, by condensing that in front to make room for more behind, the same cast-iron does

not radiate its heat with the same rapidity into steam or air, cooler than itself. Thus while both the steam and the cylinder may be at a temperature of 300 degrees at the beginning of the stroke, the latter does not fall with the former to a temperature of 212 degrees, or less, at the end of the stroke. If indeed the cylinder lost 10 degrees at each stroke, there would be a great expenditure of fuel in keeping it up to the working temperature.

The above shows the value of short strokes and high rotative speeds. It is far better to *use a little steam at a time, to use it very quickly, and to keep it hot.* This is the fundamental principle of high rotative speeds, and there is nothing more practically important in steam-engineering.

I have already above noted the fluctuation of temperature of the interior of cylinder surfaces with each stroke with slow motion. The cooling effect of the expansion penetrates further into the metal of the cylinder, requiring more condensation at each admission to reheat it.

## CHAPTER XII.

### STEAM-JACKETS.

THE actual value of the steam-jacket is frequently called in question, but the best engineers are unanimous in adopting it. The heat abstracted from the steam-jacket transfers the liquefaction from the cylinder to the jacket, and the water so formed in the jacket should invariably be returned to the boiler.

Watt was the first to use the steam-jacket, but for a long time its action was not clearly understood, and many engineers considered it an expensive and useless refinement. Nevertheless, with the increasing application of high pressure and greater rates of expansion, all those designers that aimed at the most perfect and economical performance of the steam engine, found it necessary to apply the steam-jacket.

By enclosing the cylinder in an outside jacket or envelope, and keeping the space between the two filled with steam from the boiler, or better still by steam from a separate boiler carrying a high pressure, the alternate heating and cooling of the cylinder will almost wholly be prevented, and the steam will enter the cylinder without loss. There will then be no initial condensation; and the condensation in the performance of work will also be prevented, as heat will pass from the jacket to the expanding steam, sufficient in many cases to keep the steam in the saturated state throughout the stroke. In engines with long stroke it is generally sufficient to jacket the cylinder only; but in some cases the cylinder-heads are also made hollow to receive steam. In marine engines, where the stroke is necessarily short, the cylinders large, and the rate of expansion high, the piston itself is formed to receive steam, as well as the heads and ordinary jacket.

In practice there are three conditions of the steam cylinder in the usual working of an engine, as follows:

*First.*—The cylinder may be entirely unprotected by any covering whatever.

*Second.*—The cylinder may be coated with felt and wood, or some non-conducting material.

*Third.*—The cylinder may be surrounded by the annular space filled with steam direct from the boiler, or in other words, steam-jacketed; this jacket itself being covered with a non-conducting material.

It is evident, and no doubt clear to any intelligent engineer, that the first mode of using steam is wrong and wasteful. Now in order to impress the student with this view, I will refer him to the following diagram, Fig. 71, which will give a very good idea of the action of steam in an expansive engine.

The upper curve  $ag$  would be obtained by the use of a steam jacket, while the lowest,  $cg$ , shows how the initial pressure is lowered where there is no jacket; the middle curve,  $bg$ , shows the effect of re-evaporation.

Of course, a certain quantity of heat is lost by condensation

FIG. 71.

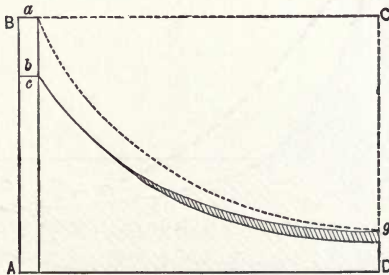

in the jacket, but as the pressure there does not vary, and the condensed water is drained off, *it cannot regenerate into the state of vapor, absorbing a great amount of heat, as it would do in the cylinder.* Thus, the heat lost in the jacket is not so great as it would be if the steam were condensed in the cylinder. But even supposing that the losses were equal, there would still be the advantage that the *power of the engine would be unimpaired.*

It is well known to all engineers that toward the end of the stroke, the pressure and temperature of the expanding steam having fallen considerably, the water in the cylinder, due to the

above, is evaporated again, abstracting the heat from the metal of the cylinder and piston. If there is no steam jacket, these parts have to be heated again by the incoming fresh steam, and a considerable fall of initial pressure is the result—see diagram, Fig. 71, at *b*. This effect can also be seen on any indicator card, by drawing on it a theoretical expansion curve. The actual curve will always be inside the theoretical diagram during the first part of the expansion, while toward the end it will come up to it, and may in some cases even rise above it.

One reason why engines are often not given a steam-jacket, is, that it adds something to the cost of the engine; and the full value of the steam-jacket has not been sufficiently known,

FIG. 72.

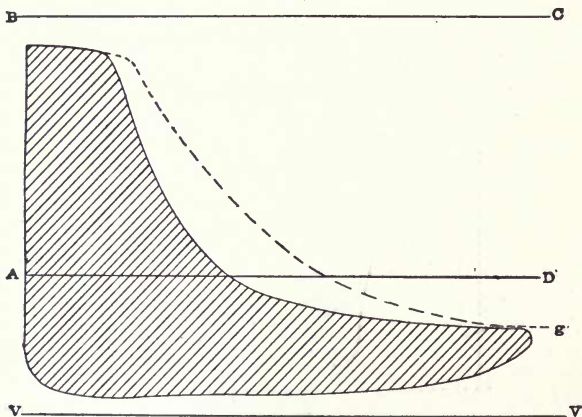

or understood. The whole question has been believed to be one of radiation, whereas the loss is by no means measurable by the loss from radiation, but is a much larger loss, and arises from the fact of the inner surface of the cylinder being cooled and heated by the steam at every stroke of the engine. This action is clearly demonstrated by the diagrams, Figs. 72, 73, 74, and 75. They show the pressure really attained, together with the true expansion curve for the whole quantity of steam that entered the cylinder, dotted in, and which dotted curve



would have been described, if the cylinder had been jacketed. The difference between these curves represents the amount of loss from the want of the steam-jacket, and in Fig. 72 this loss amounts to 11.7 per cent.; in Fig. 73, to 19.66 per cent., there being rather more variation of temperature in this case, owing to there being more expansion.

In Fig. 74 the loss is 27.27 per cent.; whilst in Fig. 75 the loss rises to the formidable proportions of 44.58 per cent. This

FIG. 73.

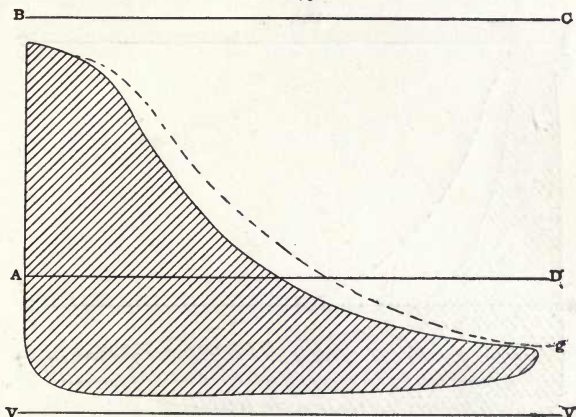

loss is caused by the circumstance that the mass of the cylinder must remain at the average temperature intermediate between the highest and the lowest temperature of the steam, so that when high-pressure steam, which also has a high temperature, enters the cylinder, a considerable quantity of steam is at once condensed, owing to the abstraction of heat by the metal, (see page 209) and also to the transformation of a part of the heat into mechanical power. So soon as the steam is cut off and allowed to expand, it falls much more rapidly in pressure than answers to its augmented volume, owing to still increased condensation, more of it being condensed into water. The action of steam is to heat the inner surface of the cylinder; and towards the end of the stroke, when the steam is much lower in pressure, and

consequently in temperature, than it was at first, the temperature of the cylinder, relatively, is sufficiently high to boil off the water that was condensed from the steam as it entered the cylinder; and such water becoming steam causes the pressure to rise, and thus the curve approaches the true expansion curve at the end of the stroke. The cylinder is cooled by the loss of the heat used in boiling off the water shut within it, and the cooled cylinder condenses the next volume of steam that enters to perform the next stroke. Thus it follows, that without steam-

FIG. 74.

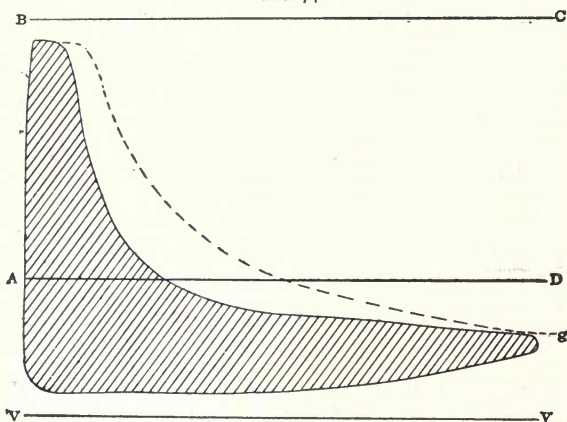

jackets a large quantity of steam passes through the cylinder in the form of water, without doing work; whereas, if the cylinder is steam-jacketed, no condensation takes place, and the whole steam does its full duty according to the degree to which it is expanded. Indeed, without steam-, or hot-air-jackets, or other equivalent means of keeping up the temperature of the cylinder, it will follow that the cylinder will act to some extent as a condenser at the beginning of the stroke, and as a boiler at the end of the stroke.

The diagram, Fig. 76, shows the expansion curve of steam in an imperfectly protected cylinder, as contrasted with the true theoretical curve, which would have corresponded with

the weight of steam found in the cylinder at the end of the stroke.

In this diagram,  $e f g$  represents the actual expansion curve of the steam, and  $a b g$  that which should have been the expansion curve if the walls of the cylinder had detracted nothing from the work done. The steam loses pressure on its entrance by the chilling from the colder metal (see  $a e$ ), and there is an immediate drain upon the molecular motion within the cylinder, on which we rely for the movement of the machinery outside.

FIG. 75.

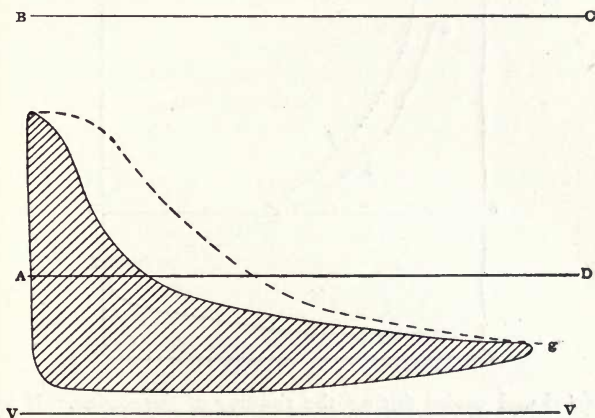

The escape or loss of heat, from whatever cause it may arise, is a direct subtraction from the efficiency of the work to be done, and in the advanced state of the arts it can scarcely be necessary to marshal all the reasons to be urged against such a practice.

In the second case, where the cylinders are clothed with some non-conducting material (and here it is essential to remember that steam cannot expand and do work behind a piston without a fall in temperature), if the steam enters the cylinder direct from the boiler, as is commonly the case, it will be saturated, and reduction of temperature will cause partial condensation. As the expansion goes on, it appears that the temperature of

the steam will fall below that of the surface surrounding it, and toward the end of the stroke the heated metal will boil off the water deposited and send it out as steam into the condenser. By such an action steam will have passed through the cylinder without doing work. A cylinder of metal may be covered with non-conducting covering, but it is still a mass of metal, and it is impossible to reason about it as if it were not alternately

FIG. 76.

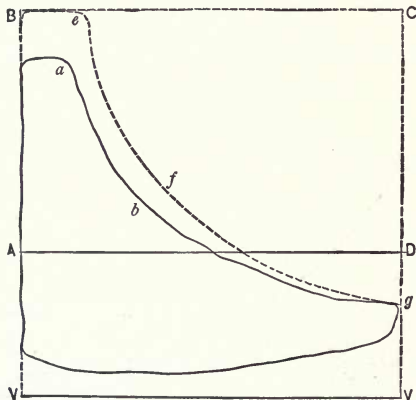

heated and cooled during the running of the engine. It was this alternate heating and cooling which Watt strove to eliminate by a separate condenser and a steam-jacket.

The curve, *a b g*, of expansion, in diagram, Fig. 76, appears to rise more than is usual toward the end of the stroke, and this indicates, as clearly as if the thing were spoken in words, that the steam which had been condensed by chilling is re-evaporated by the walls of the cylinder toward the close of the stroke.

It has been found in practice that with a high grade of expansion, and a marked difference in temperature at the beginning and end of the stroke, the cylinder acts somewhat as a condenser to the entering steam, and as a boiler just before it escapes.

That this is so, has been proved by an experimental trial, where a glass tube, closed at one end, was fitted to the non-

jacketed cylinder of a high-pressure engine working expansively. It was found that the steam condensed in a cloud inside the tube at the beginning of each stroke, and re-evaporated before its conclusion. By holding a shovel of hot coals near the tube, the heat effectually prevented condensation, for it acted as a steam-jacket.

The point I make is, that no covering to the cylinder would raise its temperature permanently to that of the entering steam, for the heat deposited on condensation would not remain, but would be carried away afterward, during the re-evaporation.

*Third.*—The steam-jacket is held by quite a number of engineers as a mere contrivance for keeping the cylinder warm; and that while it might do this, it did it by the waste of more steam than would have been wasted in the unjacketed cylinders; the excess being in Tredgold's judgment, that due to the extra size of the jacket over and above that of the cylinder which it enveloped.

After so great an engineer as Tredgold had fallen into this error, and though clear in almost every point connected with the steam engine, was wrong on the steam-jacket and its office, and led, from that error, to condemn Watt's use of the steam-jacket as a mistake, no engineer need be ashamed to confess that he does not see how a steam-jacket may be an advantage.

The steam-jacket is of especial use in the expansive engine, and the greater the amount of expansion, the greater is the need for and the use of the steam-jacket.

Now, for illustration, I will assume the case of an expansion, non-condensing (high pressure) engine, without a steam-jacket, the piston having made the forward stroke, and the pressure per square inch of the exhaust being 1 or 2 pounds above the atmosphere, and the temperature, therefore, practically that of boiling water.

The metal of the cylinder walls has, so far as the interior skin or surface is concerned, been cooled down to the temperature of the exhaust steam. In this condition of things, steam, say at 100 pounds per square inch above the atmosphere, and at a temperature of 338 degrees, about, is admitted from the boiler into a cylinder, the walls of which are 126 degrees lower than the steam. A quantity of steam sufficient to restore the heat of

the walls of the cylinder must therefore be at once condensed; this is done, and the condensed steam remains in the form of water in the cylinder until the main slide valve has shut off communication with the boiler. The steam in the cylinder then begins to expand and the pressure to be reduced. The water arising from the steam which was first condensed is now in contact with the walls of the cylinder, which are heated to a temperature of 338 degrees, due to 100 pounds pressure, while the pressure in the cylinder has diminished from 100 pounds gradually down to, say 10 pounds, above the atmosphere; the inevitable result of this is, that the water which was first condensed becomes re-evaporated and turned into steam to be used in the cylinder. It may be said that if this is so, its power, which was lost in the act of condensation, will be brought back again by its re-evaporation. But it must be recollected that its power was lost when it was 100 pounds pressure, and that while it is being re-evaporated, it is at all sorts of intermediate pressures between 100 pounds and 10 pounds pressure. The difference in effect will, of course, be very great. This may be made clear to the eye by constructing two diagrams.

FIG. 77.

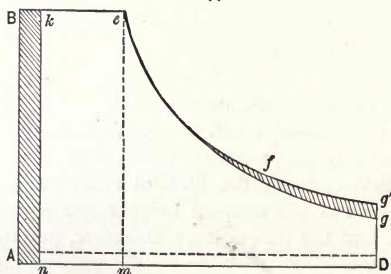

Indicator Diagram from an Expansive Engine with a Non-Jacketed Cylinder.

Diagram, Fig. 77, shows a card from an expansion engine without a jacketed cylinder; the black lines are those made by the indicator, and they would appear to represent that while no greater quantity of steam than was equal to the space con-

tained in the parallelogram,  $k e m n$ , (namely, one-fourth of the stroke of the engine with a steam pressure of 100 pounds), had been consumed, the work performed had been as much as was equal to the area contained by the black lines, less say 2 pounds, average back pressure, as indicated by the space between the atmospheric line,  $A D$ , and the dotted line immediately above. In fact, it would be found, if this diagram were contrasted with one taken from a steam-jacketed cylinder, that the area of the unjacketed diagram, representing the work done, would be greater than that of the jacketed.

FIG. 78.

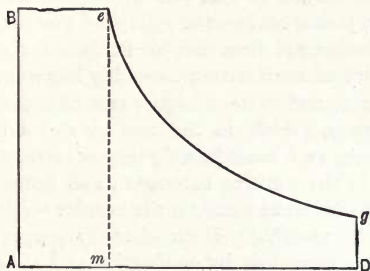

Indicator Diagram from an Expansive Engine with a Jacketed Cylinder.

Diagram, Fig. 78, shows a card taken from a steam jacketed cylinder; and if it be laid over the diagram, Fig. 77, it will be found that the dotted expansion curve,  $e g$ , is lower than the expansion curve,  $e f g$ . That is to say, that the height,  $g D$ , of Fig. 78, is less than the height,  $g' g D$ , of Fig. 77.

Therefore, it may be said that the unjacketed engine of diagram, Fig. 77, made a better use of the amount of steam that came into the cylinder than that of the steam jacketed engine, Fig. 78; but the fact is, that while in diagram, Fig. 78, the parallelogram,  $A B e m$ , truly represents the quantity of 100 pounds steam pressure which is delivered into that cylinder, the parallelogram,  $k e m n$ , of diagram, Fig. 77, does not represent it, because it does not show the actual quantity of 100 pounds steam pressure which came into the cylinder, as a portion was

condensed in heating up the walls of that cylinder. In order to make diagram, Fig. 77, correct, there should be added to it a portion, as  $ABkn$ , to show the steam condensed on its entering the cylinder. If this were done, it would be ascertained that that steam ought to have produced, if utilized, the whole of the area  $ABefg'D$ , instead of the area  $keg'Dn$ . The rise in the diagram of Fig. 77, from  $g$  to  $g'$ , represents of course the re-evaporation of the condensed steam.

Now, it is upon these facts that the utility of steam-jacketed cylinders is based, and it will be seen to consist in the prevention of the condensation of high pressure steam in the cylinder, and its re-evaporation in that cylinder as low pressure steam.

The steam-jacket makes the curve of pressure follow more nearly the isothermal line, and so enables the engine to do a larger quantity of work without sensibly increasing friction and other resistance, and to use a higher rate of expansion to obtain the same power, which in the case of steam implies higher initial pressure, and consequently temperature of a greater fall of the latter in the working substance, and hence economy.

The loss which takes place on the outside of the jacket is one which may be materially diminished by proper cleading (lagging), and is a mere loss by conduction and radiation from the surface; about such as would take place from the surface of the cylinder itself. It must follow, from what has been said here upon steam-jacketing, that to be of use the steam in the jacket should be at all times as high as the very highest steam employed in the cylinder; in fact, it has often been proposed in large engines to jacket the cylinder with steam from a special boiler kept at a higher pressure. If these facts were borne in mind, we should see no more attempts at abortive steam-jacketing, by surrounding the cylinder with steam upon the engine side of the throttle-valve—that is, with steam reduced by wire-drawing below the boiler pressure—or by jacketing with exhaust steam from the engine.

The real advantage of the steam-jacket must be sought for in the fact that the condensation in the cylinder, which it is intended to prevent, is indirectly a great source of loss. A cloud or mist is produced, which is densest at the end of the stroke, and during the exhaust. This removes heat from the cylinder,



partly, perhaps, by direct conduction, but chiefly settling as dew on the surface during the exhaust when the pressure is reduced. The latent heat taken up during this evaporation is borrowed from the metal of the cylinder, and must be repaid by the steam which enters for the next stroke, and which can ill afford to be thus cooled at the outset. A certain amount of alternation of temperature is a necessary consequence of expanding under ordinary circumstances, and any cooling of the metal of the cylinder which takes place during the stroke, adds, by heating the steam, to the small end of the diagram; while the reheating at the commencement of each stroke takes away an equal portion from the other end.

FIG. 79.

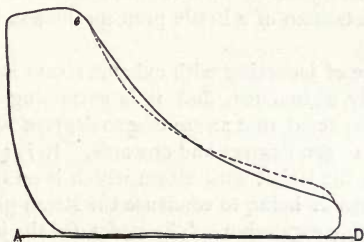

The dotted line in diagram, Fig. 79, represents this action, and it is evident that no great loss results so far. But any cooling of the cylinder, which takes place during the exhaust, requires the subtraction from the beginning of the diagram without any corresponding compensation at the end, as I have before stated, and this cooling is greatly assisted by the presence of moisture. It will vary in extent in different cases, being very slight where the terminal pressure in the cylinder is the same as the back pressure in the condenser, and increasing as the difference between these increases. Where a steam-jacket is used, and condensation during expansion consequently reduced to almost nothing, the only source of loss of heat during the exhaust is by conduction and radiation, and it is no doubt not very great; although reheating of the metal of the cylinder commences probably very soon after the exhaust opens.

The use of the steam-jacket has been somewhat extended of late. It was originally applied to the body of the cylinder only; then to the end and cover; and finally, some engineers have admitted steam to the piston. This is, of course, expensive, and involves extra joints; but it no doubt tends to economy, appreciably, where the surfaces are large. It seems probable, however, that more advantage accrues from the steam-jacketing of one square foot of the working cylinder, than of an equal area of cover or piston; since the former is always kept comparatively clean by the friction of the piston, while the latter surfaces soon become coated with a black carbonaceous deposit, the product of the partial decomposition of the lubricants, which prevents the passage of heat to the steam in the cylinder; just as in a familiar experiment, a similar deposit on the bottom of a kettle protects the hand on which it rests.

The practice of jacketing with exhaust steam is happily now almost entirely abandoned, and it is surprising that any one should have expected that steam of 220 degrees would give up heat to steam of 300 degrees and onwards. It is also objectionable to supply the jacket with steam which is on its way to the cylinder, the result being to condense the steam partially *before* instead of *during* expansion. The steam for the jacket may be taken from the steam-chest, or steam-pipe, but should not be returned; the condensed water should be trapped out.

Where the cylinder is covered both at its ends and sides by a steam-jacket, the external casing being also protected by a covering of non-conducting material, under these circumstances the walls of the cylinder may be kept nearly as hot as the entering steam, and the chilling effect of the metal surface is to a great extent eliminated. Enough has been stated heretofore to demonstrate the serious waste of heat which is inevitable with even the best-constructed engines, and it is a clear advantage to get the greatest possible amount of work out of the steam just at the precise instant when it is in action. There is no known material which is insensible to the action of heat; that is, which cannot be warmed or cooled, and which will not conduct or radiate heat. Of necessity a cylinder is made of metal, a material peculiarly sensitive to changes of temperature,

and possessing every quality, except strength, which we should prefer not to find in it. It would, therefore, appear that the most reasonable course would be to inclose the cylinder in a hot envelope, which may serve to maintain its temperature at a high point, and to supply the heat which is otherwise escaping.

FIG. 80.

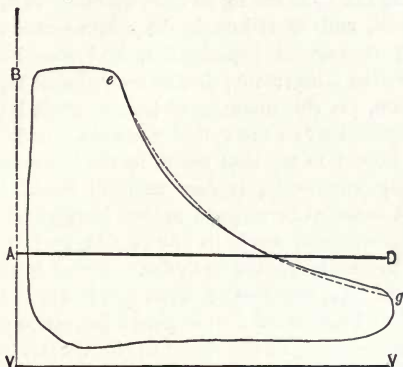

Diagram Fig. 80 was taken from an engine with a steam-jacket over the ends and sides, and the curve of expansion was nearly that given by theory. At the end of the expansion the true curve is represented by the dotted line, and it appears that the actual expansion rises above it, showing that the steam was a little superheated by the hot steam casing.

For the best economical running, then, it is plainly necessary to prevent, as far as possible, any condensation of steam, either at the period of admission or during expansion. High speed, which allows but a very short time for any transfer of heat to take place, is a very excellent way to lessen loss from this cause; but principally may we prevent loss from condensation by using a steam-jacket. When a steam-jacket is employed, the cylinder is kept always at the same temperature, which is at least as high as that due to the initial steam pressure. In this way there is no initial condensation, nor is there any condensation during expansion, since the quantity of heat which disappears by doing work is supplied by the jacket, and the steam

is kept saturated. At the time of exhaust opening, when connection is made with the condenser, the steam expands as before, but it is now dry, saturated steam, which receives and parts with heat slowly, so that it does not abstract as much heat from the cylinder when expanding into the condenser, as did the wet steam in the former case. There is also no water or moisture in the cylinder to be re-evaporated as soon as pressure is relieved, and so although the steam-jacket does supply enough heat to prevent liquefaction, and also heats up the cylinder from the temperature due to the exhaust to that of the entering steam, yet this quantity of heat is much less than that which is extracted when the cylinder is unjacketed.

It is not correct to say that steam in the jacket is condensed without doing any work; it does perform work, because the units of heat supplied correspond to that heat which disappears for the performance of work in the engine, and which causes liquefaction in an unjacketed cylinder. There is also supplied the quantity of heat required to make good that extracted during exhaust, and which otherwise would be just so much taken from the effective work of the steam in the engine.

The relative efficiency of steam, according to recent experiments made with engines both jacketed and unjacketed, have shown a saving of 5 to 15 per cent., according to the grade or ratio of expansion, in favor of jacketed cylinders, or somewhat more if the heat carried away by the liquefied steam be also considered.

The actual loss arising from expanding steam at high grade in an unjacketed cylinder is invariably much more than 15 per cent.

*First.*—Because the expansion curve frequently rises above the common hyperbola.

*Second.*—Because the cooling during exhaust is much greater than the cooling during expansion. In other words, of the total quantity of heat *lent* the cylinder at the beginning of a stroke, only a part is returned during the expansion, and the remainder during the period of exhaust.

With low rates of expansion, say two or three times, it is found that a moderate degree of superheating prevents very appreciable loss, but in the absence of superheating the use of a jacket is advisable.

In all cases the jacket should be distinct from the cylinder, as when the steam is passed through a jacket on its way into the cylinder, the water condensed in the jacket is carried with the steam into the cylinder, and the result is much the same as would be produced without the jacket.

The admission of wet steam into a steam-jacketed cylinder is also productive of great loss, owing to the evaporation of the contained water during the stroke by *heat* abstracted from the jacket. It is not unusual to see engine diagrams in which the expansion curve rises considerably above even the hyperbolic curve. In all such cases the loss must be very considerable.

It is probably chiefly owing to this source of loss that the utility of the steam-jacket is so often called into question. But a steam-jacket may be quite ineffectual, or somewhat worse than ineffectual, if without the means of removing air and water from it.

For ordinary cases we may reckon upon securing an economy of *ten per cent.*, and this with large engines, if of enough importance to warrant the use of a steam-jacket.

## CHAPTER XIII.

### VARIETIES OF STEAM-ENGINES.

THE steam-engine in practice assumes many different forms and arrangements, each of which has a distinguishing name, such as vertical, horizontal, beam, inclined, inverted, rotary, etc. But these arrangements do not in any way affect the action or use of the steam. It is usual, also, to divide engines into two main classes: non-condensing, or "high pressure," and condensing, or "low pressure," the latter being provided with apparatus for condensing the steam.

Non-condensing engines are, on the whole, less economical of fuel than condensing engines; but as they have fewer parts, and occupy less space, they are much used where simplicity and compactness are considered of more importance than economy of fuel. A second mode of classing steam-engines is founded on the manner in which the steam acts upon the piston, and is as follows:

*First.*—Single-acting engines, in which the steam performs its work by its action on one side of the piston only.

*Second.*—Double-acting engines, in which the steam performs its work on either side of the piston alternately.

*Third.*—Rotary engines, in which the steam drives a piston revolving around the shaft.

A third mode of classification distinguishes engines into: First, non-rotative, in which no continuous rotation of a shaft is produced, as in single-acting pumping-engines, steam-hammers, and direct-acting beetling-machines. Second, rotative engines, in which the motion is finally communicated to a continuously revolving shaft. Rotative engines are now the most common. Non-rotative engines are exceptional.

A fourth mode of classing engines is founded on their purposes, as follows: First, stationary engines, such as those used for pumping water, for driving manufacturing machinery, etc. Second, portable engines, which can be removed from place to

place, but are stationary when at work. Third, marine engines, for propelling vessels. Fourth, locomotive engines, for use on railways. Stationary engines exist of all the three modes of classification. Portable engines are usually non-condensing, to save space and to adapt them to situations where condensing water cannot be obtained in sufficient quantity. Most of them are also double-acting and rotative. Marine engines are, in general, condensing, double-acting, and rotative. Locomotive engines are non-condensing, a few compound, and all double-acting and rotative.

#### Condensing Engines.

Steam, the vapor of water, when produced at the usual pressure of the atmosphere, is commonly denominated low-pressure, in opposition to that which is formed at a higher pressure than that of the atmosphere, and accordingly called high-pressure steam. In common language, however, the term, low-pressure steam, is also applied to steam which has a pressure of several pounds to the square inch, and formed at a temperature higher than 212 degrees. Steam-engines supplied with condensers, when first made, used low-pressure steam, and, by condensing the exhaust, gained the additional pressure due to the atmosphere; were usually called low-pressure engines, instead of condensing-engines, as they should have been. In the present advanced state of engineering, high-pressure steam is now generally used in condensing engines, and to distinguish the different classes they are called *condensing* engines, and *non-condensing* engines.

#### Condenser.

The function of the condenser is to cool down the exhaust steam so as to reduce its pressure to a minimum, and in doing so the steam is converted into water. The very early engines could only work by the aid of condensation, as the steam with which they were supplied was generally of a lower pressure than the atmosphere; it is, in fact, owing to this that the steam-engine owes its birth, for steam was preferred by the early mechanics because it was so readily changed from a gas to a liquid, and so produced that vacuum which Nature was supposed to abhor, and to fill which she would do the work of

horses. The exact relation of the condenser is better understood by following the early history of the steam-engine from the day when cooling water was admitted to the cylinder after the steam, and then allowed to run freely away from the bottom on the descent of the piston, to the time when Watt, having perceived the waste of work in always forcing the piston up against the atmospheric pressure, and in admitting the hot steam into the cold cylinder, made the engine double-acting, and effected the condensation in a separate chamber. The jet of water continued long after Watt's time as the means of cooling the steam, and gave in later days the distinguishing name to the condenser, which is now nearly entirely suspended by a more perfect apparatus.

#### Jet Condenser.

In a modern condensing engine, the exhaust steam has communication from both sides of the piston, through the exhaust pipes and valves, into a tight vessel or chamber, termed the condenser, where the exhaust steam is condensed by being intercepted by a spray or jet of cold water, which takes up the sensible and latent heat in the steam, and converts it from an elastic vapor to liquid water, and creates a partial vacuum (a perfect vacuum is never formed in steam engine practice, neither is it desirable, for the extra economy of the perfect vacuum, as compared with the partial vacuum, is neutralized in effect by the extra load on the air pump and diminished temperature of water to the hot well).

The vacuum created in the condenser extends to the exhaust end of the cylinder, and the moving piston, instead of working against an atmospheric resistance of 14.5 pounds, meets a resistance of about 1.5 pounds, the remaining 13 pounds of atmospheric load having been removed by the vacuum thus formed in the condenser.

The capacity of the condenser is from one-fourth to one-half that of the steam cylinder. The area of the injection orifice is about  $\frac{1}{250}$ th of that of the steam piston in ordinary engines, or  $\frac{1}{15}$ th of a square inch per cubic foot of water evaporated by the boiler per hour.

The temperature of the condenser is generally reduced to 100



degrees, consequently the vapor has an elasticity of about *one* pound per square inch. This pressure, measured by the *indicator*, is generally found to run from one to four pounds in the cylinder; the latter pressure proves that the *exhaust* passages are too small.

Sometimes, when pure water is scarce, *surface-condensation* is employed. Here the steam passes into a number of tubes, and is pumped from a vessel connecting their lower extremities by means of a small air-pump. The best effects of surface-condensation were obtained by "Joule," who passed the condensing water through pipes, each of which surrounded a copper steam tube. The water flowed in a direction opposite to that of the steam current. He found it possible to condense 100 pounds of steam per hour per square foot of tube.

In some experiments on marine engines, using surface-condensation, it was found that three to four pounds of steam per hour were condensed per square foot of tube-surface; the pressure of uncondensed steam and air being 1.7 pounds per square inch. Perhaps the best results are obtained when the exhaust steam is first subjected to surface-condensation, the change in state being completed with the help of a small injection-jet.

With surface-condensation there is no great expenditure of water, so this may be very pure when it is first put into the boiler, and may be kept pure by replacing that which leaks away by separate distillation. Sometimes the condensing-water is also dispensed with, the surface condenser being formed of a great number of tubes revolving rapidly in the air.

It has been found in practice that the best result is produced by keeping the condenser at a low temperature. Even when very hot feed-water is required, it is better to heat it during its passage to the boiler, than to have it hot on leaving the condenser.

It has been found, that when the condenser is kept at 100 degrees Fahr., the ratio of the amount of effective condensation to the amount of water lifted by the air-pump is a maximum.

From all condensers the water must be pumped away, and it is necessary for the pump to overcome the pressure of the atmosphere. Now, when the condenser is elevated 33 feet above the ordinary level, and when the water of condensation falls into a

long pipe, the lower opening of which is beneath the surface of water in a cistern, a column will always be maintained in the pipe by atmospheric pressure, and the condensed water will escape at the bottom into the cistern. At first sight it may seem, that with this arrangement there is no loss, as in an air-pump; but a little consideration will show that the engine still does work in removing the condensed water. In fact, the steam and the injection-water have to be raised to a height of 33 feet; and in doing this, whether by creating a vacuum, or otherwise, an amount of work is done which is equivalent to that done by an ordinary air-pump. In the *jet condenser*, also, the air-pump is dispensed with. The velocity with which steam, even when at a low pressure, enters a vacuum, is taken advantage of to convey the water of condensation into the hot-well. The central jet of injection-water is surrounded by a nozzle for exhaust steam; and the receiving-pipe gradually expands towards the hot-well. This condenser is on the principle of the Giffard's injector.

The area of the foot-valves varies from  $\frac{1}{3}$  to  $\frac{7}{8}$ , or in pumps whose buckets move very fast, to the full size of the area of the opening in the bucket.

Condensers are generally provided with *blow-through valves*, communicating with the cylinder, usually shut, but capable of being occasionally opened, and with a *shifting valve* opening outwards to the atmosphere. Through these valves steam can be blown to expel air from the cylinder and condenser before the engine is set to work.

A good condenser will increase the economical power of an engine from 20 to 40 per cent., or for the same power effect a corresponding saving in the amount of steam used and fuel consumed. With an engine of any considerable size, a condenser may always be employed with economical advantage, or we can, when desirable, increase the power of an engine of given size without adding anything to initial steam pressure, or boiler capacity. Condensers owe their efficiency to the fact that they create a partial vacuum on the exhaust side of the piston, and thus reduce back pressure in proportion to the perfection of the vacuum. Atmospheric pressure, such as non-condensing engines work against, amounts to 14.7 pounds per square inch; from 10

to 13 pounds of this may be removed by means of a condenser, and is just so much added to the mean effective pressure, without any additional cost, except for power required to operate the air pump, which gives the injection and removes the condensed steam and injection water, and as elsewhere explained, the steam necessary to develop this power need not be lost when we employ heaters. Since a condenser will thus add so largely to the power and economy of an engine, with but slight additional outlay, a condenser should always be used whenever a sufficient supply of good water can be obtained for rejection.

It has been my practice to employ, whenever the conditions will warrant it, an independent condensing apparatus; because the vacuum is had at starting and may always be maintained, regardless of the speed of the engine or varying temperatures of the injection water; we can use a smaller air pump and do not have to operate at all times a larger pump than necessary in order to provide for emergencies; and the power required to operate the pump does not act in any way to disturb the working of the main engine.

The amount of injection water required is from 20 to 25 times the quantity fed into the boilers. Water discharged from the condenser has a temperature of  $100^{\circ}$  to  $120^{\circ}$  Fahr. A portion of this water may be fed into the boiler, but by far the greater part has to run to waste. We may remark, in passing, that this is a serious and, at present, unavoidable source of loss, which is to a greater or less degree common to all steam engines. In round numbers, if 1100 units of heat are contained in one pound of steam, entering the cylinder, from 900 to 1000 of the units, are carried off by the exhaust steam and imparted to the condensing water. This explains why we can only realize a small percentage of the power contained in each pound of coal; only about 4 per cent. to 16 per cent. can be counted upon, and only about 29 per cent. is possible, supposing steam of 100 pounds to be expanded down to the line of perfect vacuum. The remaining heat is necessarily lost, because there is no means by which any further expansion and resulting work can be secured. But while the percentage of power obtained is low, compared with the power which could be realized with perfect mechanism extracting all the heat, yet, compared with the amount of heat

which is possible to utilize, it may be shown that some of the best types of engines yield about 50 per cent. of the highest efficiency; and future improvements may be expected to increase this figure, which is still so far below what may be considered attainable.

The above shows the importance of utilizing any standing water in ponds or wells, in case no flowing water is obtainable. Whenever the height from the surface of water in the well, pond, or other body of water, from which the injection water is taken, to the centre of injection pipe, does not exceed about 20 feet, there is no separate pump for injection water required; for as a vacuum is created in the condenser, the atmospheric pressure forces the water into the condenser, where it enters in the form of fine spray.

#### Lifting Condensing Water.

It is generally supposed by engineers, that there is a loss of power involved in condensing water being lifted to a condenser by the action of the vacuum in the latter, or to speak more correctly, by the pressure of the atmosphere on the surface of the pond or well, from which the water is drawn. I find that this is a subject on which some misapprehension exists, and will endeavor to make the matter plain to all.

The lifting of injection water to a condenser, in the manner referred to, does not involve a loss of power. All water drawn from a condenser, by an air-pump, requires as much power to extract it as if this water was lifted to a height equal to that of the head of water corresponding to the vacuum in the condenser, and this power is unaffected by the manner in which the water is supplied to the condenser. On the other hand, the resistance to the water entering the condenser, must be such that the work expended in overcoming it, will balance the power exerted by the pump. In the majority of instances, the chief portion of the work done by the entering water, is expended in overcoming the frictional resistances encountered in passing the injection valve or cock, rose, etc., while in cases where the injection water rises to the condenser, the power corresponding to this lifting, forms part of the expenditure of work, balancing the power required to drive the air-pump. For instance, let us suppose the

vacuum in a given condenser to correspond to a 28 feet head of water; and let us further suppose that this condenser can be supplied with injection water from either of two sources, one situated 20 feet above, and the other 20 feet below, the level at which the water enters the condenser. Now, when derived from the upper source, the water would enter the condenser at a rate of flow corresponding to its head, as follows:

$$28 + 20 = 48 \text{ feet,}$$

and the injection cock or valve would have to be set accordingly. On the other hand, if the water was drawn from the lower source, the effective head—vacuum—causing the flow into the condenser, would be as follows:

$$28 - 20 = 8 \text{ feet,}$$

and to obtain the same amount of injection water as before, the injection cock or valve would have to be opened wider. In other words, the frictional resistances offered by the injection cock or valve in the two cases would be adjusted so as to counter-balance the effect due to the different heights from which the injection water was drawn, leaving the work to be done by the air-pump constant. Of course the fall of the water in the one case, and its lifting in the other, would be attended with a rise and fall of temperature, respectively; but inasmuch as the sudden arresting of a particle of water, after falling 772 feet, would only cause its temperature to be raised one degree Fahrenheit, the alteration of temperature, in such cases as we have supposed, would be practically inappreciable.

So far we have only referred to the work done in extracting water from the condenser; of course if the air-pump has to lift the water after its extraction, all such lift represents extra work done, as it adds to the mean effective pressure on the top of the air-pump bucket.

#### Air-Pump.

The air-pump when single acting has a capacity usually from *one-fifth* to *one-sixth* of that of the cylinder. When the air-pump is double acting, it may, of course, be made one-half smaller. The valves through which it draws the water, steam and air

from the condenser, are called *foot valves*, those through which it discharges those fluids into the *hot well*, *delivery valves*. A single acting air-pump has *bucket valves* opening upwards in its piston. Flap valves and other clacks of various forms are used as air-pump valves. The ratio of the area of the valve passages to that of the air-pump piston, ranges in different engines from one-third to equality, being made greater, as the speed of that piston is greater, so that the velocity of fluids pumped may not in any case exceed about ten or twelve feet per second.

The resistance to the motion of the air-pump bucket may be measured by a back pressure in the steam cylinder of from one quarter to one-half pound per square inch.

The air-pump communicates with the *hot well* through the delivery valve, and the hot well, which is a vessel generally placed on the top of the condenser, communicates with the *waste water pipe*.

The air-pump worked by the engine removes the water of condensation, condensing water, air and vapor from the condenser, and delivers into a hot well, from which the water is drawn to supply the boilers.

The expense of engine power in working a well proportioned air-pump is trifling, and should not be considered in the selection of condensing apparatus. In adapting engines for maximum economy, care should be had that the terminal pressure, or pressure at release, should never fall below atmospheric pressure, otherwise the vacuum will be but partially utilized.

#### High-Pressure Steam.

Hornblower invented the double or compound cylinder engine for expansive working, and he intended (as did Watt in his patent of 1782), to employ steam at or near the atmospheric pressure. To Oliver Evans must be awarded the credit of having built and put in operation the first practically useful high-pressure steam-engine, using steam at 100 pounds pressure to the square inch, or more, and dispensing with the complicated condensing apparatus of Watt. The high-pressure engine of Evans had advantages in its great simplicity and cheapness, and ever since his day it has continued the standard steam engine for manufacturing purposes in this country.

The economy resulting from the expansion of steam at a high pressure was, however, first insisted upon by Arthur Woolf, a Cornishman, who converted Hornblower's double cylinder engine into a form suitable for driving machinery, for which he took out a patent in 1804 (No. 2,772) for certain improvements in the construction of steam engines, in which he proposed to employ two steam cylinders of different dimensions, each furnished with a piston, the smaller cylinder having a communication at the top and bottom with the boiler, but communicating also with the two ends of the larger cylinder, in such a way that the steam should cause both pistons to rise and fall together.

The specification describes the admission of steam at a pressure of 40 pounds on the square inch into the smaller cylinder, so as to drive the piston down at the same time that steam from below the same piston is expanding into the larger cylinder, and forcing its piston also in the same direction.

Hence, the two pistons are similarly actuated by the joint pressure of the steam in each cylinder. Woolf was here adopting Hornblower's engine to a new purpose. Woolf erected one of his engines working with high-pressure steam and condensation at Meux's brewery in 1806. Woolf entertained the most fanciful and enormous ideas as to the power of high-pressure steam when expanded, but, although quite wrong in his theory, he persevered in the construction of his engines, and erected several which ran with a steam pressure of from 40 to 60 pounds above the atmospheric pressure.

Although Woolf had peculiar theories, he was a thoroughly practical mechanic, and performed more admirable work in the construction of high-pressure engines, and in advocating tubular boilers for the generation of high-pressure steam.

Down to the year 1814 the pressure of steam in Cornish engines never greatly exceeded that of the atmosphere, and at this low initial pressure there was practically but little economy resulting from expansive working; whereby it appears that after Watt's immediate connection with the mining districts ceased, expansion fell rapidly into neglect. Then it was Evans in America, R. Trevethick and Woolf in England; the latter both advocated in Cornwall the economy of high pressure steam with expansion, a mode of working which was applied by

Hornblower, in Watt's single cylinder engine, and by Woolf in the double cylinder engine.

It was, indeed, proved that by high pressure of steam and expanding by the new method, it was possible to raise the *duty* of an engine from twenty million of foot pounds for one bushel of coal, at which point Watt had left it, to fifty or sixty million, and at the present day as high as one hundred million foot pounds.

Up to 1850 marine engines were run at a pressure on the boiler from 5 to 15 pounds above the atmosphere. Within the last twenty years, however, a great change has occurred in the construction of both marine and stationary engines. The ordinary boiler pressure now runs from 80 to 160 pounds per square inch. It is an everyday occurrence for a stationary engine to develop a horse-power per hour with a consumption of *three pounds of coal*, and compound marine engines with *two pounds*.

#### Comparative Efficiency of Different Engines.

I shall discuss the performance of steam-engines by reference to the indicator diagrams taken from them, and shall commence with the atmospheric engine of Newcomen, as his was the first that was considered a steam-engine. The apparatus of Savery was not what would be called to-day a steam-engine, as it had no moving parts, but consisted of either a single pair of closed vessels or three vessels, one of which was a boiler, and the other or others, metal chambers of spherical, cylindrical or ellipsoidal form, which were at once condensers and pumps. The latter were filled with steam, which being condensed, the water rose into and filled them, and was then forced out by a succeeding charge of steam, of pressure exceeding that of the head against which the lift took place. The usual pressure was about (45) forty-five pounds per square inch, and the consumption of coal amounted to about *thirty pounds of coal* per hour, per horse-power, as a minimum.

The "Atmospheric Steam-Engine" consisted of a steam cylinder, with a piston taking steam at the bottom; the upper end of the cylinder being open to the atmosphere, the piston actuating a "walking-beam," and, through the latter, working



pumps attached to the opposite end. Neither crank, shaft, nor fly-wheel was used, the action of the engine being controlled entirely by the adjustment of its valves. In its operation, steam at a little higher than atmospheric pressure, was admitted below the piston; the weight at the pump end depressed that extremity of the beam, raising the piston. The steam below the piston was then condensed by a jet of water thrown into the cylinder, producing a vacuum, and atmospheric pressure finally forced the piston down, raising the pump-rod and plunger. The weight on the latter was adjusted to the work, so that, when steam was admitted, this weight should force the pumps to discharge the water. The only function of the steam was the displacement of the atmosphere, or counterbalancing it, by entering below the piston, and thus permitting the formation of a vacuum. The coal consumption was, at best, about twenty pounds per hour per horse-power.

FIG. 81.

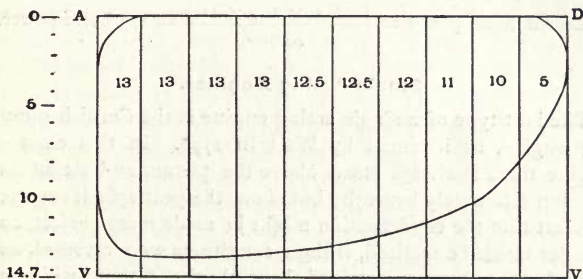

In the diagram, Fig. 81, the steam pressure never rises above the atmospheric line *AD*, the horizontal lines represent volumes occupied by steam in the cylinder, otherwise the amount of travel of the piston, for one stroke is identical with the other. The diagram being intersected by ten vertical lines at equal distances, dividing the length of stroke into ten equal parts, the first thing to be done is to determine the mean pressure of the steam in each of these divisions.

The action of the steam is quite intelligible. The pressure is maintained during the upward stroke, but there is a loss at the

beginning due to the injection water, which remains in the cylinder. On the downward stroke the condensation is imperfect at first, but improves afterwards, and the pressure of vapor in the cylinder falls to two and one-half pounds, or five inches of vacuum.

Now, by adding the number of pounds pressure at each division together, we find that the sum is

$$15 + 13 + 13 + 13 + 12.5 + 12.5 + 12 + 11 + 10 + 5 = 115,$$

which, when divided by *ten*, gives 11.4 as the mean effective pressure on the piston in pounds per square inch during one stroke. The dimensions of the engine and rate at which the piston moves are now to be taken into account. The cylinder of this engine was 80 inches in diameter and ten feet stroke, and the number of strokes ten per minute; hence;

Area of piston =  $80 \times 80 \times 0.7854 = 5026.5$  square inches.

Travel of piston, per minute,  $10 \times 10 = 100$  feet.

Indicated horse-power =  $\frac{5026.5 \times 100 \times 11.5}{33,000} = 175$  horse-power.

#### Single Acting Engines.

The best type of a single acting engine is the Cornish pumping engine, as invented by Watt in 1778. In this class of engine there is always steam above the piston, and steam and vacuum alternately beneath; but about the year 1780 it occurred to Watt that the condensation might be made more perfect, and a better result be realized, if these conditions were reversed, and a perfect vacuum maintained beneath the piston, while an alternate steam pressure and vacuum was used above it. When the engine is applied to work a common pump, the force being needed only when the pump buckets are raised, not in their descent, an arrangement was required in the cylinder by which the piston should be only driven by steam in its descent, the pump buckets being then raised by the other end of the beam; but in its ascent the piston would be lifted by the weight of the descending buckets, without any aid from the steam. Engines adapted to work pumps are therefore so arranged that the valve shall only admit steam above the piston, a vacuum being made

below it in the descent. Engines constructed in this manner are called single acting engines, while those in which the steam acts both above and below the piston are called double acting engines.

The single acting engine in its principle differs in no respect from those I have described. A valve is provided at the top of the cylinder by which steam is admitted above the piston when it begins to descend. Another valve is provided at the bottom, by which the steam under the piston passes to the condenser; and the piston descends exactly in the same manner as in the double acting engine. But when the piston has reached the bottom of the cylinder, a valve is opened which gives a communication between the top and the bottom of the cylinder, so that the steam which has just forced the piston down now passes equally above and below it, the piston being then drawn up by the weight of the descending buckets. The steam which was above it passes below it, through a tube attached in which the valve just mentioned, communicating between the top and bottom of the cylinder, is placed. When the piston has reached the top of the cylinder, the steam which previously filled the cylinder above the piston will now fill it below the piston; and when the piston is about to descend by the pressure of steam admitted above it, the steam below it is discharged to the condenser by another valve already mentioned, and so the operation proceeds.

Single acting engines are only applicable to pumping or to some other operation in which an intermitting force, acting in one direction, is required.

The most remarkable examples of the application of the single acting steam-engines to pumping are presented in the mining districts of Cornwall in England, where engines constructed on an enormous scale are applied to the drainage of mines. The largest steam-engines in the world are used for this purpose. Cylinders eight and nine feet in diameter are not unknown. The expansive principle may here be applied without limit, inasmuch as regularity of motion is not necessary. Steam of fifty pounds per square inch above the atmosphere is admitted to act on the piston, and cut off after performing from  $\frac{1}{4}$  to  $\frac{1}{2}$  of the stroke, the remainder of the stroke being effected by the expansion alone of the steam.

Double acting engines are only applicable in pumping by the use of double-acting pumps.

The following indicator diagram, Fig. 82, was taken from a single acting engine, or Cornish pumping engine, having a

FIG. 82.

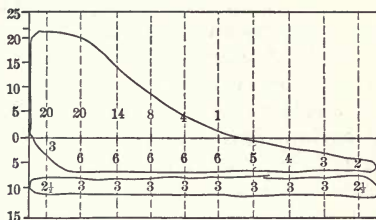

cylinder 70 inches in diameter, making four strokes per minute, under a mean pressure of fourteen and three tenths pounds per square inch.

In the single acting engines two diagrams must be taken, one from the top and the other from the bottom of the cylinder. It will be seen that these diagrams are quite unlike in form, for the action during the down-stroke is not repeated during the up-stroke as in a double acting engine, and our first task will be to comprehend the reasons of the particular conformation observed. Each diagram must be interpreted in its turn.

FIG. 83.

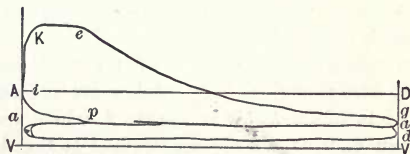

As far as the upper diagram is concerned, that figure indicates the admission and cut-off of steam, together with the opening of the equilibrium valve, which corresponds to an ordinary diagram from a condensing engine. The lower diagram, Fig. 83, has reference to the state of things below the piston, where the equilibrium and exhaust valves are opened consecutively.

Beginning at the point  $i$  with the piston at rest at the top of the cylinder, we note that the pressure rises until the down-stroke commences, when the steam line  $ke$ , and the expansion  $eg$ , is traced out. The portion  $ke$  is horizontal, and cut-off takes place at  $e$ . The line  $ap$  indicates that the equilibrium valve is open, and that the steam pressure has fallen somewhat during the circulation which takes place. At the point  $p$  the equilibrium valve is closed, and compression or cushioning begins, just as in a double acting engine. At the point  $i$  the piston is coming to rest, and there is a drop in the curve which is often much more marked than in the present example, and which indicates loss of pressure before the down-stroke begins. Such loss would be due to leakage of the compressed steam round the circumference of the piston, or perhaps to loss of heat.

As to the lower diagram, the nearly horizontal line,  $ap$ , shows that the equilibrium valve is opened. When compression begins at  $p$ , above the piston, expansion will also begin to a much less extent below it, and there will be a slight drop towards the end of  $ap$ , otherwise the lines  $ap$  and  $a$  nearly coincide, and would absolutely if there were no disturbing causes at work; but the diagram shows some difference of pressure at the two ends of the cylinder, when the equilibrium valve is open.

With regard to the work done, the piston is driven down by the steam from above it, as opposed by the back pressure of the exhaust space underneath, and that part of the action is fully determined by comparison of the lines,  $ke$ ,  $g$  and  $ap$ . But the whole work done by the steam in the double stroke is, according to our principles, obtained by a careful measurement of the areas of the enclosed diagrams.

At first sight the student might imagine that the horse-power may be calculated by simply noting the pressures indicated by the steam and exhaust lines, the cutting away of any part of the intermediate area—as by compression, or by want of coincidence of the lines  $ap$  and  $a$ —affecting only the up-stroke, when the weight of the pump rods is the moving force. But a little consideration will show that this view is erroneous, and that the compression of steam in the up-stroke, and the resistance to the motion of the piston due to inequality of pressure when the equilibrium valve is open, must be deducted from the total

efficiency. The steam opposes the piston in its ascent, to some degree, and this gives rise to negative work, which must be deducted from the positive work accomplished in the down-stroke. In other words, during the down-stroke the steam does the work, and during the up-stroke work is done upon the steam.

It follows, therefore, that the portion of unoccupied space between the two intermediate horizontal lines is a veritable subtraction from the efficiency of the agent.

To calculate the horse-power in the case of a single acting pumping-engine, having a cylinder 100 inches diameter with a stroke of 10 feet, and making eight strokes per minute.

Taking the steam pressures as noted on the diagram Fig. 82 in their order, there is above the atmospheric line a series amounting to—

Above the atmosphere:

$$20 + 20 + 14 + 8 + 4 + 1 = 67$$

Below the atmosphere:

$$3 + 6 + 6 + 6 + 6 + 6 + 5 + 4 + 3 + 2 = 47$$

Lower diagram:

$$2.5 + 3 + 3 + 3 + 3 + 3 + 3 + 3 + 3 + 2.5 = 29$$

$$\text{Total} \dots \dots \dots 143$$

This total divided by the ten ordinates =  $\frac{143}{10} = 14.3$  pounds average pressure.

$$\text{HP.} = \frac{0.7854 \times 100 + 100 + 10 + 2 + 8 + 14.3}{33000} = 574 + \text{HP.}$$

#### Double-Acting Engines.

When steam acts on both sides of the piston alternately, the engine is called double-acting. In fact, it is only in rare cases that a single-acting steam-engine is now used. Gas engines are single-acting.

In the following Fig. 84, diagram *K*, was taken from a double-acting engine, with steam at atmospheric pressure only.

This engine had a cylinder 36 inches diameter, and a stroke of 5 feet.

The vacuum gage attached to the condenser exhibited a constant vacuum of about 28 inches, or 14 pounds, and it was

thought to be doing good duty; but on the application of the indicator, it was found that the average vacuum acting upon the piston was not over  $17\frac{1}{4}$  inches.

By resetting the valves, and giving a little lead to them, also cutting off after the piston had moved  $\frac{7}{10}$ ths of the stroke, and increasing the steam to one pound above the atmosphere, to compensate in part for this loss of power due to cutting off, a much superior vacuum was produced, and the power of the engine increased with a saving in fuel of about a ton of coal per day. See diagram *H* in shaded lines, Fig. 84.

FIG. 84.

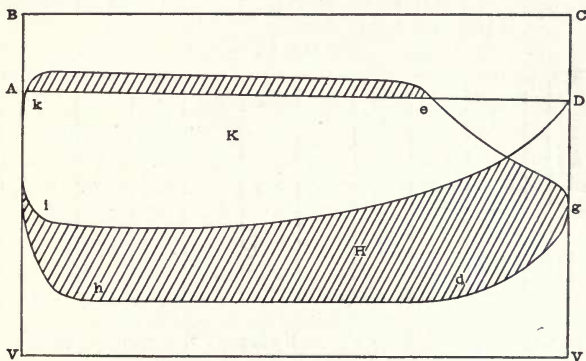

The diagram, Fig. 85, was taken from a condensing-engine, some thirty years ago, and will give an idea of a first-class engine, working under a steam-pressure of from five to seven pounds per square inch above the atmosphere.

The engine had a cylinder 80 inches diameter, with a stroke of 6 feet, making fifteen revolutions per minute.

The steam pressures above the atmospheric line at the different spaces are as follows:

$$5.5 + 5 + 5 + 5 + 4.5 + 4.5 + 3 + 2 + 1 = 35.5.$$

The pressures due to vacuum are as follows:

$$11 + 12 + 12.5 + 12.5 + 12.5 + 12 + 12 + 12 + 12 + 8 = \frac{116.5}{\text{Total} \dots \dots \dots 152.0}$$

Mean pressure,  $152 \div 10 = 15.2$  pounds.

$$\text{HP.} = \frac{80 \times 80 \times .7854 \times 6 \times 2 \times 15 \times 15.2}{33,000} = 416.48 \text{ HP.}$$

#### Automatic Steam-Engines.

Within the last few years variable cut-off engines for stationary uses are the rule and not the exception. The fundamental idea upon which this class of engines are designed is that of variable expansion.

The following are the most prominent in general use in the United States: The Corliss, Greene, Buckeye, Porter-Allen, Straight Line, etc., etc. Engines of this class have no regulating valve, but full boiler pressure is maintained in the valve

FIG. 85.

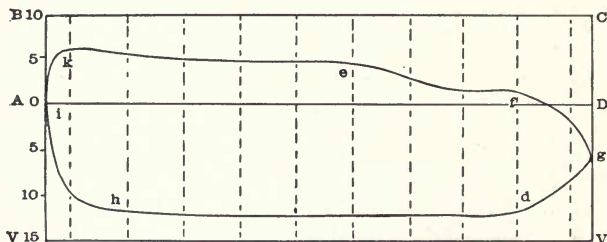

chest, and admitted to the cylinder at the commencement of each stroke, and the governor adjusts the force to the varying resistance, acting directly on the main valves, and changing the point of cut off. The action of the regulating valve raises or lowers the steam line on the diagram, while that of the variable cut-off lengthens or shortens it, as the load on the engine is increased or diminished.

The object of using steam expansively is to obtain a high mean pressure throughout the stroke with a low terminal pressure, on the assumption that while the former represents the work done, the latter represents the quantity of steam expended in doing it.

It is readily demonstrated and abundantly proved in practice, that the greatest difference between the mean pressure in the cylinder through the stroke and that at the the end of the stroke,



or at the point of exhaust, is obtained by admitting the highest attainable pressure at the very commencement of the stroke, maintaining it up to the point of cut-off, cutting off early and sharply, and permitting the enclosed steam to exert its expansive force to the end of the stroke. Theoretically, the earlier the cut-off, and the further expansion is carried, the better; but this is greatly modified by various practical considerations.

It is well known that steam-engines in which uniformity of speed is maintained by variable cut-off, under the direct control of the governor, are, other things being equal, superior in point of economy in the use of steam to similar engines which are regulated by a throttle valve in the steam-pipe throttling engines, so called; and that engines of the first mentioned class also possess much greater efficiency with the same capacity of cylinder, than engines of any other class.

To the practiced eye of the engineer these qualities are revealed by a glance at the indicator diagram.

It is seen that with the variable cut-off, steam is admitted to the cylinder at very nearly the full boiler pressure, and the duration of admission is proportioned to the resistance, or work, and controlled by the governor, and speed.

With the throttle-valve, on the other hand, the pressure is greatly reduced in its passage from the boiler to the cylinder, during regular, ordinary work; admitted at higher than the ordinary pressure, for increase of resistance or work, by the slow-moving governor, and reduced to still more attenuated pressure for any decrease of resistance by the more rapidly revolving governor.

It will readily be seen that we have in this reduced pressure an explanation of diminished power, or efficiency, of the throttled engine with given capacity of cylinder, speed of piston, and steam pressure in the boiler.

Other causes, some of which will be noticed further on, conspire with this to the same result; and all these causes, while they promote efficiency, also promote economy, as will be seen from an analysis of indicator diagrams from each style of engine.

## Economy in Using Steam Expansively.

The secret of economy in using steam expansively in engines is in the adoption of the highest practicable pressure of steam; thorough jacketing about the cylinders, steam-pipes, and valve-chests, the earliest cut-off at which the engine will do its work, and as perfect condensation of steam as possible after the steam has done that work. The steam should have the readiest possible access to the cylinder, and the only principle upon which any valve, however ingenious, can work successfully, is that of providing a large opening immediately at the commencement of the stroke, with prompt cut-off at whatever point may be determined upon, and in early and unobstructed exhaust.

No steam-engine can run economically at a high grade of expansion, except it be fitted with a condenser, for the greatest economy of working expansively is in expanding below the pressure of the atmosphere. The highest attainable economy would be in expanding down to a perfect vacuum, thereby relieving the boiler from overcoming the pressure of the atmosphere at each half revolution of the engine, as is the case with all non-condensing engines. The valve-gear and condenser for attaining these results, may possess different degrees of mechanical merit; but none can be considered as successful which (with an evaporation of from eight to ten pounds of water in the boiler, per pound of coal burned) require more than *two pounds* of coal per hour per horse-power.

The steam-engine is still in an exceedingly imperfect condition, and we do not doubt but that it would be rapidly improved were it not that there is so little room for additional discovery, and that so little is left to be patented. The great principles of steam-engine economy are open to the free application of all, and they are so simple that none should fail to recognize and adopt them.

The action of steam in an engine cylinder is developed in its most simple form in the non-condensing or high pressure engine, in which the vacuum takes no part.

The class most in use is the non-condensing throttling engine, in which the steam follows to the end, or nearly to the end, of the stroke, and in all cases where the pressure is reduced between the boiler and the cylinder by the action of the regulating valve—that is, by throttling.

The diagram given by such engines (see Fig. 86) is as follows:

The steam-line,  $k g$ , rapidly declines, from throttling of the steam; this also occurs when the steam-ports, or steam-pipe, are too small.

When the pressure declines throughout the stroke of the engine, as above, on account of the contraction of the steam-pipe area by the governor-valve, the steam is said to be "wire-drawn." The engine being non-condensing, the atmospheric line is below the whole enclosed area of the diagram. See  $A, D$ , Fig. 86.

FIG. 86.

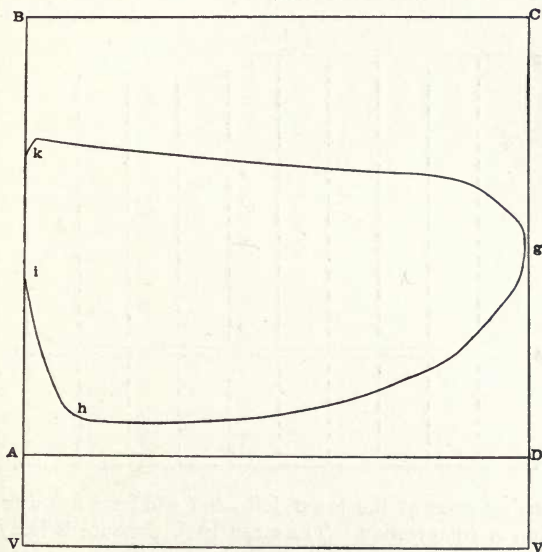

In order to save steam, or more correctly, to employ its effect more economically, we must, of course, admit the steam at a greater pressure than if we are using it full stroke, because we must obtain the same mean pressure. Taking, for example, an engine using a steam pressure of 75 pounds per square inch, and following the piston full stroke, how much must that pressure be increased to run the same engine with steam expanded?

Diagram, Fig. 87, exhibits the improvement made in modern engines in the valve motion. The distance between *k* and *e* shows the travel of the piston during steam admission; at *e* the lap on the valve covers the port, the steam is cut off, and the distance between *e* and *g* represents the travel of piston during the expansion in the cylinder. To avoid excessive back pressure at the commencement of the return stroke as shown in diagram, Fig. 87, the steam is released at *l*, the distance from *l* to *g* being the travel of the piston after the exhaust-port is opened; the space between the atmospheric line *A D*, and bottom or exhaust line of diagram, represents the back pressure.

FIG. 87.

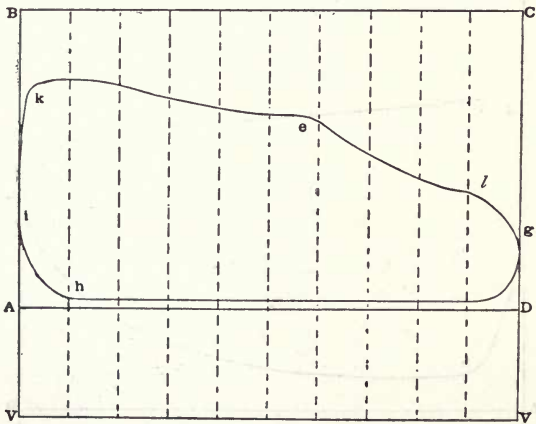

The rising curve at the lower left-hand end from *h* to *i* is the cushion or compression. The mean back pressure is less than five-hundredths (0.05) of the mean direct pressure.

In the above diagram, the piston has moved to about five-eighths (0.63) of the stroke when the cut-off took place. The cut-off is obtained with a single slide-valve and eccentric; at the point *l*, the exhaust-port opens after the steam has expanded from *e* to *l*, or about 93 per cent. of the stroke; the early release at *l*, allows the spent steam to discharge itself so that the pressure falls to a minimum on the return stroke.

Non-condensing, automatic cut-off engines are those in which the movement of the cut-off valve (which is sometimes independent of the main valve) is so controlled by the governor as to cut off the steam earlier or later in the stroke, as may be required to maintain the desired uniformity of speed under variations of load and steam pressure. It is so called in contradistinction to the throttling or "wire-drawing" engine, in which the governor effects the desired regulation by throttling the steam more or less in its passage to its work.

#### Automatic Expansion Engines.

The fundamental idea upon which automatic expansion engines are designed, is that of variable expansion. Engines of this class have no regulating valve in the steam pipe, but full boiler pressure is maintained in the valve chest, and is admitted to the cylinder at the commencement of each stroke, and the governor adjusts the force to the varying resistance by changing the point of cut-off. The action of the governor raises or lowers the steam line on the diagram, while that of the variable cut-off lengthens or shortens it, as the load on the engine is increased or diminished. The object of using steam expansively is to obtain a high mean pressure throughout the stroke with a low terminal pressure, on the assumption that while the former represents the work done, the latter represents the quantity of steam expended in doing it.

It is readily demonstrated, and is abundantly proven in practice, that the greatest difference between the mean pressure in the cylinder through the stroke, and that at the end of the stroke, or at the point of release, is obtained by admitting the highest attainable pressure at the very commencement of the stroke, maintaining it up to the point of cut-off, cutting off early and sharply, and permitting the confined steam to exert its expansive force to the end of the stroke.

Theoretically, the earlier the cut-off and the further expansion is carried the better, but this is greatly modified by various practical considerations.

While engineers are agreed in employing some degree of expansion, perhaps no two would recommend precisely the same. Expansion can certainly be overdone.

To Frederick E. Sickles, of New York, must be given the credit of the liberating valve-gear. The apparatus devised by him for its application to the double-beat-valves employed on steamboat engines on the North River and Long Island Sound, was singularly ingenious and efficient, and has for the last fifty years or more been known as the Sickles cut-off. It combined an opening, at first exceedingly gradual, and then accelerated as the motion of the piston was increased with an almost instantaneous closing of the port.

The reasoning of the advocates of this system was short, and in their own view, conclusive. It ran as follows:

“Steam to be expanded to the best advantage must be cut off sharply. The sucking in of steam into the cylinder through a gradually contracting passage technically termed ‘wire drawing,’ involves a great loss, and is not to be tolerated in any degree. A valve closed by a return of the opening motion cannot effect a sharp cut-off, but if it could have a motion sufficiently rapid for this purpose, then the opening motion would need to be equally so, and this would admit the steam so suddenly and violently on the centres as soon to destroy the engine. The admission must be gradual, the cut-off must be sudden. The liberating gear only can give to the valve a slow opening and a swift closing movement. *Ergo*, all the world must sooner or later come to use the liberating valve gear.”

The theory of working by variable expansion requires the following distribution of the steam:

*First.*—The load on the valve should be constant, or the same for all points of cut-off, admitting the full pressure at the beginning of the stroke.

*Second.*—The opening should be sufficient to enable this pressure to be maintained in the cylinder up to the point of cut-off, and the cut-off should be so rapid that the pressure shall not fall during the operation of closing the port.

*Third.*—The exhaust action should not be affected by changes in the point of cut-off; should permit the confined steam to exert its expansive force, as nearly as possible, to the end of the stroke, and then discharge it without loss of power from back pressure.

Thus every feature of the diagram is invariable, except the

point of cut-off, which is moved by the action of the governor, according to the changes occurring in the load. From the above it will be seen that it is not possible to effect all these objects by means of a single valve.

The exhaust-valves must differ from the admission-valves both in their dimensions and in their movements. Each must be adapted to the performance of its own function, and to this end must be quite independent of the other.

#### Automatic Cut-Off Engines.

The fundamental idea upon which these engines are designed is that of variable expansion. Engines of this class have no regulating valve in the steam-pipe, common to all ordinary throttling slide-valve engines, but the full boiler pressure is maintained in the valve-chest, and admitted to the cylinder at the commencement of each stroke, and the governor adjusts the force to the varying resistance by changing the point of cut-off. The action of the regulating valve raises or lowers the steam-line on the diagram, while that of the variable cut-off lengthens or shortens it, as the load on the engine is increased or diminished. The object of working steam expansively is, to obtain a high mean pressure through the stroke with a low terminal pressure, on the assumption that, while the former represents the work done, the latter represents the quantity of steam expended in doing it. It is readily demonstrated, and is abundantly proven in practice, that the greatest difference between the mean pressure in the cylinder through the stroke and that at the end of the stroke, or at the point of release, is obtained by admitting the highest attainable pressure at the very commencement of the stroke, maintaining it up to the point of cut-off, cutting off early and sharply, and permitting the confined steam to exert its expansive force to the end of the stroke.

Theoretically, the earlier the cut-off, and the further expansion is carried, the better; but this is greatly modified by various practical considerations.

In 1849, George H. Corliss brought out the modern "cut-off engine," and advocated a boiler pressure of seventy pounds per square inch in combination with a piston speed of 450 feet per

minute, by which means he reduced the coal consumption from six to eight pounds of coal per horse-power per hour, in the best engines, to three pounds.

When Corliss first offered to sell his engine to manufacturers, they could not understand it, although he explained to them that the efficiency of it was due to a higher initial steam-pressure in the cylinder; the steam-line maintained without expansion; the rapid closing of the steam-valves, whereby wire-drawing was prevented, and the whole expansive force of the steam secured; a low terminal, and a free exhaust. Under these conditions, the steam was expanded until there was no more work in it. But with all the above advantages, Mr. Corliss could not introduce his engine at the advanced price he asked over that of those then in use, except by agreeing to take the saving in fuel for a stated period for his pay. This state of affairs only lasted a few years, when the reputation of the engine became well-established, and it was copied all over the world on the expiration of the patent.

The following indicator diagram (Fig. 88) from a non-con-

FIG. 88.

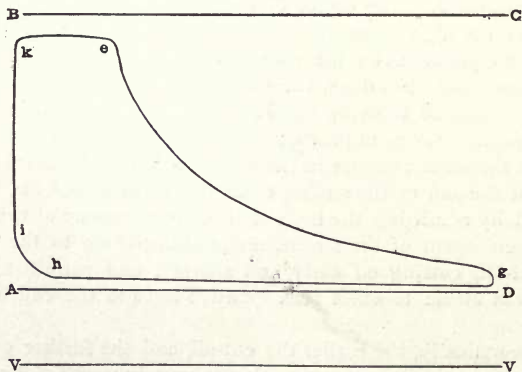

densing Corliss engine, is a fair sample of the distribution of steam in the cylinder.

The knowledge acquired in the time of Watt, of the essential principles of steam-engine construction, has since become



familiar to intelligent engineers. It has led to the selection of simple, strong, and durable forms of engine and boiler, to the introduction of various kinds of valves and valve-gearing, capable of adjustment to any desired range of expansive working, and to the attachment of efficient governors to regulate the speed of the engine, by determining automatically the point of cut-off which will, at any instant, adjust the work exerted by the expanding steam to the load.

The value of high pressure, and considerable expansion, was recognized in the early part of the present century, and Watt gave the steam-engine very nearly the shape it has to-day. The compound engine, in principle at least, was invented by contemporaries of Watt, and the only important modifications since are the introduction of the "drop cut-off," the attachment of the governor to the expansion apparatus in such a manner as to control the degree of expansion, the improvement in proportions, the use of higher steam and greater expansion, and the employment of double-cylinder engines, after the rise in steam pressure, and the discovery of internal condensation and re- evaporation in the cylinder, which were entirely unknown to Watt and his contemporaries.

The Corliss engine was followed by the Greene engine, built by Thurston, Greene & Co., of Providence, R. I., and at the present time by the Providence Steam-Engine Co. This engine was invented by Noble T. Greene, and patented in 1855. It is similar to the Corliss in having four valves—two steam, and two exhaust—so placed as to reduce clearance to a minimum, the only difference being in the type of valve, Corliss using a vibrating valve worked by a "wrist-plate" connected to a single eccentric, and the Greene engine using a plain slide-valve for the steam, and gridiron slides for the exhaust, the latter set at right angles to the steam valves; each are worked by a separate eccentric. Other automatic engines are the Wright, Brown, Fitchburg, etc.

In the present advanced state of the arts, it looks as if the "drop cut-off" will be superseded by the "positive-motion cut-off," especially for direct connection, due to the high rotative speed in demand by the introduction of electric lighting. In this respect, it is but a repetition of the transition in hydraulics,

which dispensed with the ponderous overshot and breastwheels, and substituted in their place the fast-running and close-governing turbines.

One of the greatest losses of the steam-engine is the condensation of steam and loss of heat at entrance into the cylinder, by the action of the metal surfaces to which it is exposed on all sides at the beginning of the stroke, and this is augmented, when at work, by light loads, large cylinders, and low rotative speeds; the remedy is the converse. In non-condensing engines, a direct loss occurs by expansion below the atmosphere, thus creating a vacuum resistance on the impelling side of the piston, at the expense of the fly-wheel, see diagrams, Figures 17, 21 and 67, which show this plainly. High-pressure steam should mean dry steam, and as a consequence there will be less condensation at the commencement of the stroke. High rotative speed, also, to a greater or less extent, diminishes cylinder condensation. It is evident that the longer time steam remains in contact with a cooler surface, the more it will be condensed. To use a little steam at a time, to use it very quickly, and to keep it hot, is the fundamental principle of high rotative speeds, than which there is nothing more practically important in steam-engineering. With a slow motion, the cooling effect of the expansion penetrates further into the metal of the cylinder, requiring more steam and entailing more condensation at each admission to reheat it. High rotative speed reduces the dimension of the engine and the sizes of pulleys, and effects an economy of space which is often very valuable; therefore, in the best practice, engines are now run at very high velocities of piston, with a given maximum speed of rotation, reducing the time for condensation of each charge, and the necessary change of temperature preceding such condensation. The amount of steam condensed is thus made a minimum in a given time, the percentage of loss of the increased quantity of steam consumed by the engine becomes the least possible.

Corliss, Greene, Brown, and others, all have increased the rotative speed of their engines, but have not modified their designs in any degree, and are, in fact, limited in speed, due to their detachable cut-off arrangements.

## Positive-Motion Cut-Off Engines.

The Porter Allen engine was one of the first to show the value of high rotative speed, and is distinguished by a system of valves and valve movements perfectly adapted to the speed it is run at.

The perfection of this engine is due to Mr. Charles T. Porter, who by his courage, persistence, and skill brought the engine into use it spite of every discouragement. Now it belongs to the class of variable expansion engines having an invariable exhaust; the valves receive positive movements and work in equilibrium. It embodies many radical improvements, and is a decided advance in steam-engineering.

FIG. 89.

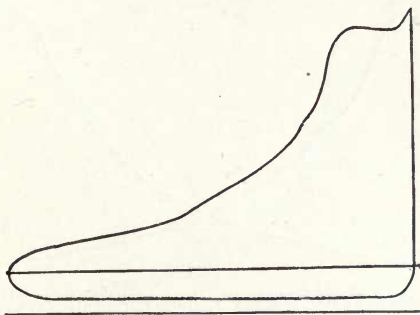

The above diagram, Fig. 89, is from a Porter Allen engine,  $11\frac{1}{2}$ " by 30", at 230 revolutions per minute.

Diagram Fig. 156, is from a condensing engine of the above pattern,  $11\frac{1}{2}$ " by 16", and 350 revolutions per minute.

## The Buckeye Engine.

This engine was designed by Mr. J. W. Thompson and built by the Buckeye Engine Co., at Salem, Ohio. It is fitted with a positive-motion "automatic" valve-gear and a balanced valve, and has a stability and an excellence of workmanship that make it safe at high speeds, while the peculiarities of its construction are such as give it a high place as an economical machine. It is capable of meeting, in competition, the best engines of the day.

This engine has a peculiar balanced valve which can be proportioned to take any desired portion of the steam pressure, leaving, if properly adjusted, just enough on the valve to hold it with certainty to its seat, and to secure proper wear and bearing on the seat. This valve is arranged to take steam through itself and deliver it outside of it; has perfectly flat wearing surfaces, positive movements of invariable extent, preventing the formation of shoulders on seat or valve; while the clearance is so small that it is easily counteracted as regards ill effects ordinarily due to moderate compression. It has only two ports, and possesses such advantages as may be claimed for that arrange-

FIG. 90.

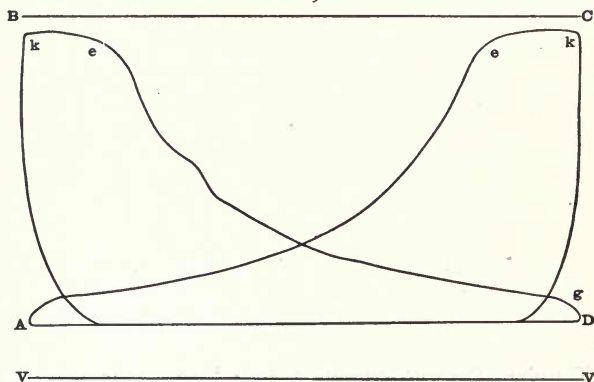

ment. The governor is driven by a positive connection with the shaft on which it is set; and as the cut-off is adjusted by the motion of an eccentric, the ratio of expansion is the same at both ends of the cylinder; it possesses the advantage, common to all engines having a positive-motion valve-gear, of being unrestricted in speed.

Indicator diagrams, Figs. 90 and 91 are from a Buckeye automatic engine. The steam being cut off at *e* is released at *g*.

Diagram Fig. 92 shows the action of the steam in a first-class automatic condensing engine.

The only difference between this engine and the former is the

addition of a condenser. Condensing engines with automatic cut-off produce diagrams as shown in Figs. 89 and 92, which show the highest attainment of valve adjustment and the expansive action of the steam.

The previous three engines described use independent valves to cut off the steam. I now propose to show indicator diagrams from high-speed engines in which a single valve does duty both as a distributing and a cut-off valve. The first engine to which I refer is "The Straight Line Engine." It is the invention of John E. Sweet, of Syracuse, N. Y. The problem proposed was to design an engine which, while consisting of the smallest possible number of parts, should be economical in the use of steam, capable of the most perfect regulation attainable with any known device, strong and stiff in every part when subjected

FIG. 91.

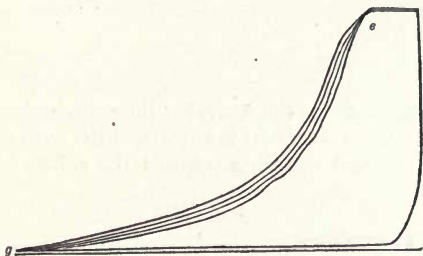

to the working strains of high speeds, inexpensive in first cost, and as durable as a simple engine can be.

The only objection to a single-valve cut-off engine is the fact that the mean pressure of the steam entering the cylinder up to the point of cut-off is necessarily less than with the double-valve gear introduced by Corliss, Porter-Allen, and the Buckeye Engine Company, which have been long standards, and which are admittedly superior in this respect.

The Sweet engine is so proportioned and arranged in the disposition of its details, that with 300 revolutions and upwards there is no excessive jar, serious wear, or heating of journals.

Diagrams Figs. 94 and 95 were taken from a single-valve straight line engine.

Mr. Sweet has also designed an engine which differs from the engine just described. The new engine has an independent exhaust valve similar to the Corliss, Buckeye and others. The

FIG. 92.

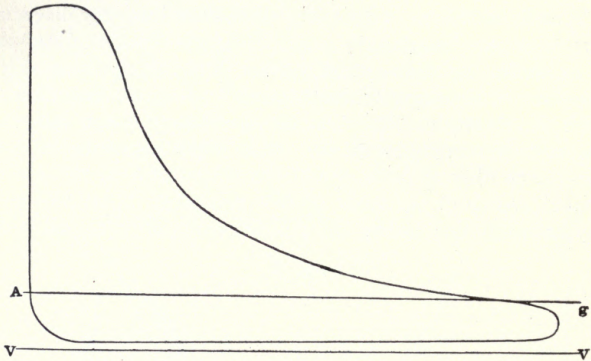

general design remains the same, but the cylinder is square outside. The steam valve is on one side, and the exhaust valve on the other. A fixed eccentric controls the exhaust valve, and

FIG. 93.

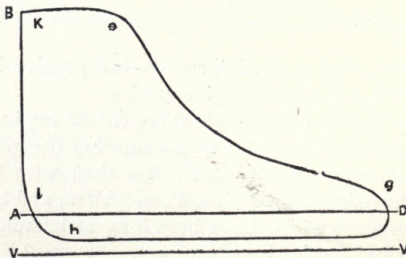

necessarily the exhaust and compression; and a shifting eccentric operated by the governor operates the steam valve, and so controls the admission and cut-off.

A new feature is introduced which makes this engine differ

from all others so far as is known to the writer, namely, while the lead of engines, having one or more valves for the steam inlet, and one or more for exhaust, is made as nearly constant as

FIG. 94.

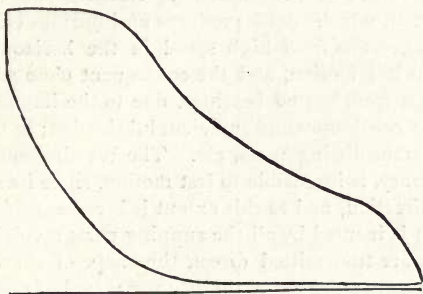

possible, in this engine the lead is variable as well as the cut-off. That is to say, when taking steam at three-quarter stroke, which

FIG. 95.

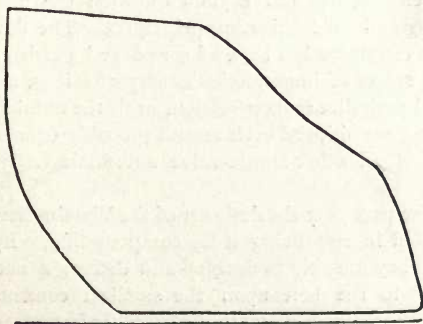

it does while yet under the control of the governor, there is a prominent positive lead, and when cutting off short, either no lead or a negative lead. The object is to vary the lead accord-

ing to the amount of power developed, so as to bring the reciprocating parts to rest without shocks.

#### The Westinghouse Single Valve Engine.

In respect to high speeds the Westinghouse engine marks a distinct period in steam engineering. Its design has eliminated every point in which speed produces an injurious effect. The most serious results from high speed in the horizontal engine are found in lost motion, and the consequent close adjustment; in the danger from heated bearings, due to the impossibility of maintaining continuous and sufficient lubrication; in the springing of the transmitting parts, etc. The Westinghouse engine, on the contrary, is insensible to lost motion, since its strains are all in one direction, and to this extent it becomes self-adjusting. Lubrication is insured by all the running parts revolving in oil. All strains are transmitted direct, the shape of the bed being such as to insure a degree of rigidity per pound of metal not attained in any other design. This fact is most clearly illustrated by the every-day practice, in which the matter of 50 or 100 revolutions more or less is considered of no practical importance.

The practical success attained by the Westinghouse standard automatic engine, has put beyond question the merit of the single-acting and self-lubricating principles. The development of this type of engine has been of sound and persistent growth through all stages of imperfections and perfections, and against unmeasured prejudice and opposition, until the number of Westinghouse engines shipped each month probably equals the combined sales of all other single-valve automatic engines in the market.

Within the past year the designer of the Westinghouse engine has succeeded in improving it by compounding. By this improvement they are able to develop and deliver a net effective horse-power to the belt upon the smallest consumption of measured water (steam) yet attained. This fact is evident by inspection of indicator diagrams, Figs. 123 and 124, pages 288 and 280.



## Locomotive Engines.

In a diagram taken from a locomotive engine when running slow, the periods of steam admission, from *k* to *e* expansion,

FIG. 96.

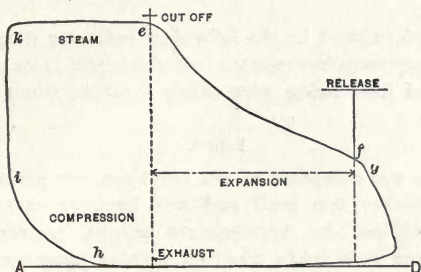

from *e* to *f* release at *f*, exhaust from *f* to *h*, and compression from *h* to *i*, lead from *i* to *k*, are often well marked, as confirmed by the reduced diagram Fig. 96, from a Baldwin four-driver locomotive with 16" by 24" cylinder and 61" drivers, running at the rate of ten miles an hour, hauling 1,565,583.33 pounds or 782,942 tons of 2000 pounds; boiler pressure 120 pounds per square inch above atmosphere. The diagram exhibits successive stages in the modification of the indicator-card.

The following diagrams were taken from Baldwin locomotive engine, No. 81, having two pairs of driving-wheels 68 inches in diameter, on the Cincinnati, New Orleans, and Texas Pacific Railway.

The dimensions of this locomotive are as follows:

Diameter of cylinder, 18"; stroke of piston, 24"; number of drivers, 4; diameter of drivers, 68"; outside lap of valve,  $\frac{7}{8}$ "; lead in full gear,  $\frac{1}{8}$ "; length of steam port, 16"; length of exhaust port, 16"; width of steam port,  $1\frac{1}{4}$ "; width of exhaust port,  $2\frac{1}{2}$ "; diameter of exhaust nozzle,  $3\frac{1}{4}$ "; area of grate, 17 square feet; heating surface in flues, 1324.6 square feet; heating surface in fire-box, 133.2 square feet; total heating surface, 1457.8 square feet; weight in working order, 90,000 pounds; weight on drivers, 60,000 pounds. Type of valve "Allen Richardson."

The tractive power exerted is as follows:

$$\frac{18^2 \times 24}{68} = \frac{324 \times 24}{68} = 114.35 \text{ pounds}$$

for each pound of effective pressure per square inch exerted on the pistons.

The data furnished by the following indicator diagrams will show the tractive power exerted under different rates of speed in practice, the load being very nearly constant when the cards were taken.

#### Load.

The train was composed of one hotel car, one parlor car, two ordinary coaches, one mail and one baggage car; total, six coaches well loaded. Approximate weight, 340,000 pounds. The diagrams were taken when on regular passenger run and under ordinary conditions, throttle opening, light; maximum grade, sixty feet per mile; average grade, forty feet per mile.

These diagrams are a fair average of the performance of American locomotives.

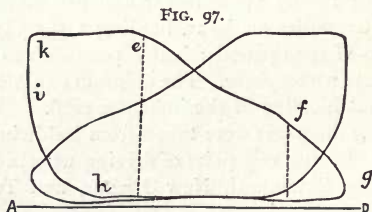

Boiler pressure, 140 pounds per square inch. Cut off at ten inches. Revolutions, 126 per minute. Throttle open one-half. Miles per hour, 25.4. Horse-power, 624.

At this speed the steam line is maintained during the admission for ten inches up to the point of cut-off *e*, then comes expansion from *e* to *f*; at the latter point we have release, or commencement of exhaust, which continues up to *h*, when compression begins and extends to *i*, where lead commences; see diagram Fig. 96.

Diagram Fig. 97 was taken when starting with a boiler pressure of 140 pounds per square inch, and making 126 revolutions

per minute. The scale of indicator was 60 pounds per inch; the average mean pressure at this speed being 80.4 pounds per square inch; the tractive power exerted was as follows:

$$\frac{18^2 \times 24 \times 80.4}{68} = 9193.74 \text{ pounds.}$$

In diagram Fig. 98 the points shown in diagram Fig. 97 are still defined, but the greater speed of the locomotive causes them to lose much of their distinctive character. The boiler pressure is 145 pounds, but the speed is *forty-five* miles per hour, or 222 revolutions per minute, and the piston speed 888 feet per minute

FIG. 98.

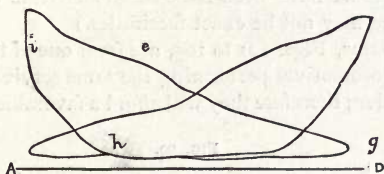

on an up grade. The mean effective pressure on piston being 47.8 pounds, the tractive force is as follows:

Boiler pressure per square inch, 145 pounds. Cut-off at *eight* inches. Revolutions per minute, 222. Throttle open one-third. Miles per hour, 45. Horse-power, 650.

$$\frac{18^2 \times 24 \times 47.8}{68} = 5466 \text{ pounds.}$$

and the horse-power was:

$$\frac{252.5 \times 888 \times 47.8}{33,000} \times 2 = 650 \text{ horse-power.}$$

Diagram Fig. 99 the revolutions being 276 per minute, the speed of the piston being 1104 feet per minute, quite altered the characteristics of the steam line. The train was running on a slight descending grade at 56 miles per hour, and it is apparent that steam line, cut-off, expansion, and release are hopelessly blended together.

The mean effective pressure was 29.2 pounds, which corresponds to a tractive force of

$$\frac{18^2 \times 24 \times 29.2}{68} = 4339 \text{ pounds,}$$

and a development of

$$\frac{252.5 \times 1104 \times 29.2}{33,000} \times 2 = 593 \text{ horse-power.}$$

Boiler pressure, 135 pounds per square inch. Cut-off at *four* inches. Revolutions, 276 per minute. Throttle open one-quarter. Miles per hour, 55.8. Horse-power, 593.

(The diagrams have been reduced in size from the originals, and therefore may not be exact facsimiles.)

The diagrams, Figs. 101 to 105, are from one of the best build of English locomotives performing the same service as the Baldwin locomotive; therefore they will afford a favorable comparison.

FIG. 99.

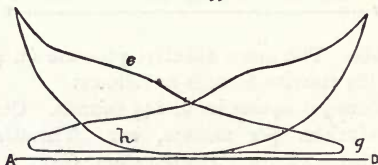

The engines of the London and North-Western Railway for running the Scotch express have two pair of driving-wheels,  $5\frac{1}{2}$  feet in diameter. The cylinders are 17 inches in diameter with 24 inches stroke, and the tractive power exerted is, therefore:

$$\frac{17^2 \times 24}{66} = \frac{289 \times 24}{66} = 105.09 \text{ pounds}$$

for each pound of effective pressure per square inch exerted on the pistons.

The data afforded by the diagrams, Figs. 101 to 105, taken from the "*Precursor*," the first engine built of the above type, will show the tractive power exerted by this locomotive under different conditions in practice.

Diagram Fig. 101 was taken when starting out of Carlisle with a train of fifteen carriages, and a boiler pressure of 128 pounds per square inch. It shows a mean effective pressure on the pistons of 97.6 pounds per square inch, and the tractive power exerted was

$$\frac{17^2 \times 24 \times 97.6}{66} = 10,257 \text{ pounds.}$$

FIG. 100.

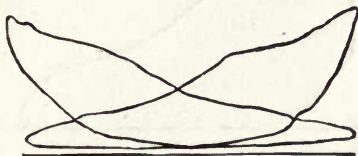

The above calculation is based on the supposition that the diagram fairly represents those which would have been obtained from both ends of both cylinders.

FIG. 101.

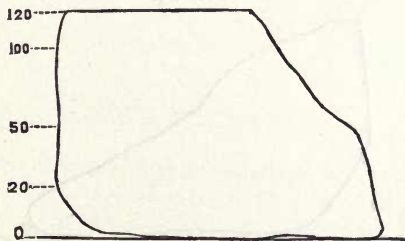

Diagram Fig. 102 was taken while ascending a grade of 1 in 75, with a train of 11 coaches, at a speed of 28 miles per hour, corresponding to 142.6 revolutions per minute, and a piston speed of 570.4 feet per minute. In this case the boiler pressure was also 128 pounds; the mean effective pressure on piston 61.7 pounds; the tractive force

$$\frac{17^2 \times 24 \times 61.7}{66} = 6484 \text{ pounds;}$$

and the power was

$$\frac{226.98 \times 570.4 \times 61.7}{33,000} \times 2 = 484 \text{ horse-power.}$$

FIG. 102.

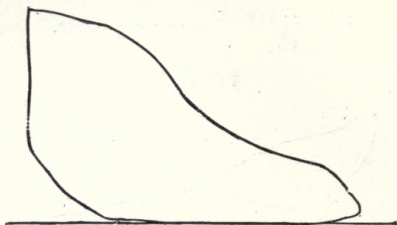
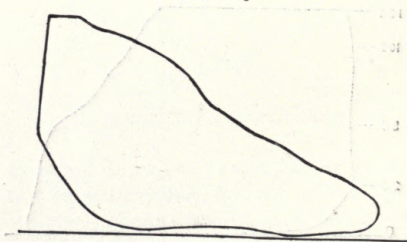

Diagram Fig. 103 was taken ascending a grade of 1 in 125, with a train of 15 carriages, at a speed of 33 miles an hour, or 168 revolutions per minute, giving a piston-speed of 640 feet per minute, with a boiler pressure of 128 pounds, and

FIG. 103.



a mean effective pressure of 64 pounds, corresponding to a tractive force of

$$\frac{17^2 \times 24 \times 64}{66} = 6726 \text{ pounds,}$$

and the development of

$$\frac{226.98 \times 640 \times 64}{33,000} \times 2 = 592 \text{ horse-power.}$$

Diagram Fig. 104 was taken while descending a grade of 1 in 106, the train consisting of 14 vehicles, with a heavy rain and a side wind blowing, amounting to a gale. In this case the boiler pressure was 126 pounds, the speed 49 miles per hour, or 249.6 revolutions per minute, and the mean effective pressure 38.6 pounds; this corresponds to a tractive force of

$$\frac{17^2 \times 24 \times 38.6}{66} = 4047 \text{ pounds,}$$

and the development of

$$\frac{226.98 \times 249.6 \times 38.6}{33,000} \times 2 = 529 \text{ horse-power.}$$

The last diagram, Fig. 105, of the series, was taken with a train of 11 carriages running on a level at a speed of 58 miles

FIG. 104.

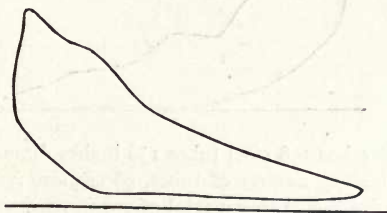

per hour, corresponding to 295.4 revolutions, or a piston speed of 1181.6 feet per minute, and a boiler pressure of 123 pounds per square inch. In this case the mean effective pressure is 32.7 pounds, corresponding to a tractive force of

$$\frac{17^2 \times 24 \times 32.7}{66} = 3436 \text{ pounds,}$$

and the development of

$$\frac{226.98 \times 1181.6 \times 32.7}{33,000} \times 2 = 531.5 \text{ horse-power.}$$

The "Precursor," the locomotive from which the diagrams above referred to were taken, had been running about 11

months, pulling the Scotch express train between Crewe and Carlisle, a distance of about 125 miles. The average weight of the trains hauled was about 140 tons, exclusive of the engine itself (the average gross weight of the train being about 187 tons) and the consumption of fuel but 33.2 pounds per mile. On examination at this time, it was found that the machinery showed no appreciable wear, while the tool-marks were not worn out of the horn-blocks and axle-boxes, and the coupled wheels were found to have worn quite equally, thus showing that a small wheel locomotive can be made, which can be used for running fast trains without incurring excessive wear and tear.

FIG. 105.

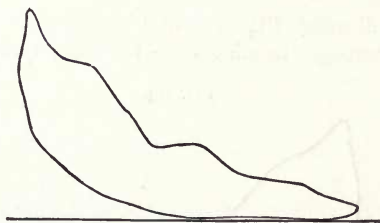

This boiler has 198 steel tubes  $1\frac{7}{8}$  inches diameter, 10 feet 1 inch long; heating surface of tubes, 980 square feet, and 94 feet 6 inches in fire box, being a total of 1074 square feet, and 17.14 square feet of grate. Three English coaches equal one American car.

#### Compound Steam Engines.

Compounding is a method of prolonging the expansion.

Compound engines are those which have two or more cylinders (connected to one shaft) within which the steam acts consecutively, from one cylinder to another. Steam is admitted to the first cylinder, where it may be partially expanded; and when the first piston arrives at or near to the end of the stroke, the steam is exhausted from the first into the second cylinder, within which it expands again behind the second piston during its next stroke. The steam from the second cylinder may be further expanded in a third cylinder, but it is most commonly exhausted from the second cylinder into the condenser.



The steam which is exhausted into the second cylinder reacts upon the first piston, while the exhaust-valve is open, by back pressure during its return stroke. It follows that if the second cylinder had the same diameter and stroke as the first cylinder—the same capacity—there would not be any expansive action of the steam so exhausted, as it would simply pass from one cylinder into the other, and there would be no useful work done; the work done by positive pressure on the second cylinder being equal to the opposing work done on the first piston by back pressure. To effect useful work, therefore, in exhausting steam from the first into the second cylinder, the second cylinder must be of greater capacity than the first, either by having a greater diameter or a longer stroke, or both together, in order that the steam from the first cylinder may *expand* in the second, by virtue of the enlargement of volume and reduction of pressure which follows the transference. Still, there is resistance (by back pressure) on the first piston in the process of expansion; and as this is the same, or nearly the same, pressure per square inch both ways—on the second piston and on the first piston—it follows that the useful work done by expansion from the first into the second cylinder (supposing the strokes to be equal) is that due to the difference in the areas of the pistons.

Generally, looking to the increase of volume by expansion between the first and second cylinders, the work of the steam in this (the second stage of its operation) is simply that due to the number of times the final volume in the first cylinder is contained in the final volume of the second cylinder; in other words, to the ratio of expansion in the second cylinder. If there is no expansive using of steam in the first cylinder, so that the whole of the expansion is done in the second cylinder, then the proportional work or efficiency of the steam is to be calculated on the ratio of the volume of the second to that of the first cylinder. But if the steam is cut off in the first cylinder before the end of the stroke, then the total ratio of expansion will be that of the partial expansion in the first cylinder multiplied by the ratio of the volume of the second to that of the first cylinder. For example: let the areas of the first and second cylinders be in the proportion of 1 to 4, the strokes being equal. Then the

ratio of expansion from the first into the second cylinder is 4. Let the steam be cut off in the first cylinder at half-stroke, or so as to expand it to twice its initial volume when the stroke is completed, then the ratio of expansion in the first cylinder is 2. Thus the total combined expansion of the steam in the two cylinders is  $4 \times 2 = 8$  times the initial volume, and the ratio may be succinctly stated thus:

|  |        |
|--|--------|
| Expansion in first cylinder . . . . .  | 1 to 2 |
| Expansion in second cylinder . . . . . | 1 to 4 |
| Total combined expansion . . . . .     | 8      |

Now, in this instance, by means of two cylinders combined, it appears that a total expansion of eight times is effected, although the greatest in either cylinder individually is only an expansion of four times. In this reduction of the extreme of expansive working in any individual cylinder is to be found the source of the advantages of using steam by compound engines.

In the year 1781, Jonathan Hornblower, who built the Newcomen engines, obtained a patent for using two cylinders, one larger than the other, to get the benefit of the expansion, in which the steam at boiler pressure, after impelling a small piston, was to pass into the large cylinder and act upon the greater number of square inches with a less pressure per square inch, thus rendering the two cylinders approximately equal in power. After getting his patent, however, he could make no use of it, as Watt's claims covered every variety of engine to which such a principle could be applied.

At this time, also, there were probably no engines in use supplied with steam at a much higher pressure than 2 or 3 pounds per square inch above the atmosphere. Viewed by the light of our present knowledge, the employment of the double-cylinder system under such circumstances appears little better than an absurdity, and it is not to be wondered that, after some years of trial, it was found that Hornblower's engines could not compete successfully with the single-cylinder engines of Watt. To this result the fact that the independent condenser invented by Watt in 1769 was found to be a necessary adjunct to Hornblower's engine, no doubt, in some measure contributed.

It is noteworthy that this patent of Hornblower's was the

first public announcement that there was any benefit to be derived from the expansion of the steam, when not flowing freely from the boiler; although Watt had made a practical application of the principle in an engine erected at Soho, near Birmingham, in 1776, five years before, by closing his induction valves before the piston had arrived at the end of the stroke in an ordinary single-cylinder engine. Hornblower's engine met with small success. As it used steam at low pressure, it had but limited expansive power, and the advantages were of no account; rather, they became negative on account of the resistances due to the use of two pistons. At this time the use of two cylinders proved unsuccessful.

But when higher pressure was employed, Arthur Woolf did for the engines of Evans, Trevithick, and others, what Hornblower had done for those of Watt; he applied to them the principle of the double cylinder. As he could use high-pressure steam, there was promise of success for the invention, and it did succeed, and he has given his name to engines having two cylinders.

In 1804, Woolf took out a patent (No. 2772) for "certain improvements on the construction of steam-engines," in which he applied the same principle to high-pressure engines. Woolf employed two steam cylinders of different dimensions, each furnished with a piston, the smaller cylinder having a communication at the top and bottom with the boiler, but communicating also with the two ends of the larger cylinder in such a manner that the steam would cause both pistons to move in the same direction.

That which contributed to the success of Woolf engines was that, although the expansion was not sufficient to yield much advantage over ordinary engines, the division of the work of the steam between the two pistons diminished the differences in pressure and the loss of steam. This was an important matter in the early construction of steam-engines.

Of late years—notwithstanding, on the one hand, the unreasoning advocacy of many practical men, who have claimed for the system unaccountable advantages and impossible savings, and, on the other hand, the adverse opinions of some theoretical writers, who have held it to be useless complication,

possessing no advantage whatever—the compound engine has grown into considerable favor. For marine purposes, indeed, it has almost displaced the simple engine.

It is well known that a given initial pressure, in expanding down to a given final pressure, is capable of exerting a definite quantity of motive-power, and it is certain that whether the steam is expanded in one, two, or ten cylinders, this limit of power cannot be exceeded. In practice, the theoretical limit of power is never attained, either with simple or compound engines, there being apparently sources of loss peculiar to, and not easily separable from, each system.

The main difference between the simple and compound systems arises from the circumstance that, with the former, the entire variation in temperature and pressure of steam due to a high rate of expansion occurs in one cylinder, for the temperature of the steam falls with the pressure, and the cylinder is cooled to a certain extent by the end of the stroke. When the next charge of steam of higher pressure is introduced for the next stroke, a part of it is condensed upon the cooler walls of the cylinder, which are thus heated to nearly the temperature of the entering steam. This is a direct loss, for although the steam so condensed is partially re-evaporated towards the end of the stroke by the heat partially returned from the cylinder to the expanded steam, nevertheless, the absolute loss is so serious as to nullify attempts at usefully expanding steam beyond limits of about four times in one cylinder. Hence the advantage of dividing the expansion of steam between two cylinders (thereby reducing the range of injurious variations of temperature) more or less evenly between two or more cylinders. Wide variation of pressure in a single cylinder leads to objectionable irregularity of rotative effort on the crank-pin. It may also cause strains upon the mechanism somewhat in the nature of blows, and in any case it imposes strains much in excess of the mean strain. But variation of pressure does not affect the indicated power developed. In so far, however, as the compound engine equalizes the strains upon the mechanism, its action is undoubtedly advantageous.

Extreme variation of temperature in an unjacketed, or partially jacketed cylinder, leads to initial condensation, and final

re-evaporation in the cylinder, the effects of which are to very much reduce the economy of the engine... When, therefore, (as is almost invariably, but not necessarily, the case in practice) the steam is expanded under conditions which allow of liquefaction, any arrangement reducing the variation of temperature tends to reduce the amount of alternate condensation and evaporation, and consequently, also, to reduce the loss arising from such action. But if the simple cylinder be wholly jacketed, or nearly jacketed, provided the steam is brought into it sufficiently superheated to raise the temperature of its unjacketed portions up to that of steam of the initial pressure, by parting with its superheat, variations of temperature are productive of no appreciable loss. Further, it is probable that were steam used in a simple engine absolutely without liquefaction, the indicated *work* developed would be quite as great as, if not greater, than that obtained with any kind of compound engine.

There is, with the compound engine, an unavoidable loss of pressure between the two cylinders, arising from the resistance of the passages. This loss need not exceed one pound per square inch of pressure, provided the steam is dry, and the passages properly arranged. A serious fall of pressure frequently arises from the unresisted expansion of the steam into the clearance space between the two cylinders. This loss may be, to a large extent, avoided by low pressure cylinder compression, and by having an expansion valve on the low pressure cylinder. In most cases, the actual fall of pressure from these two causes is very appreciable, and the mean pressure obtained with a given ratio of expansion falls short of that of steam expanded to the same extent in a single cylinder, the *work* developed by a pound of steam being consequently reduced.

The steam when expanded down to its final pressure, occupying the low pressure cylinder only, the size of this cylinder for a given power would—if there were no loss by useless expansion—be the same as that of a simple engine of the same power, working with the same pressure and ratio of expansion. Owing to the loss of pressure arising with the compound engine, the low pressure cylinder has to be made somewhat larger than would suffice for the simple engine. The high pressure cylinder, therefore, adds nothing to the power of the arrangement;

but, on the contrary, if the low pressure cylinder were used alone, as a simple engine, it would, with the same steam pressure and expansion, develop a greater power than the two together working on the compound system.

The following figures, 106, 108 and 109 illustrate, in outline, the action and arrangement of the principal varieties of compound engines; the shaded portion represents steam.

In Fig. 106, the two pistons travel together in the same direction, and work on the same connecting-rod and crank-pin, and it is known in the trade as a "Tandem" engine.

The steam from the boiler enters the high pressure cylinder, and after being partially expanded in that cylinder, it is exhausted directly into the opposite side of the low pressure cylinder, where the expansion is completed. The course taken by the steam is indicated by arrows.

FIG. 106.

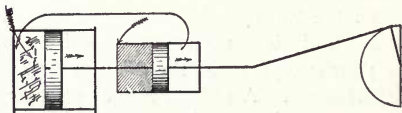

Indicator diagram, Fig. 107, is from a "Tandem" engine; the upper diagram, *H*, is from the high pressure cylinder, and the lower diagram, *L*, from the low pressure cylinder.

It will be seen, from an inspection of Figs. 106 and 108, that *First*.—the maximum steam pressure from the boiler comes upon the high pressure piston at the same time that the maximum exhaust pressure from the high pressure cylinder comes upon the low pressure pistons, the periods of maximum and minimum pressure being coincident.

*Second*.—The pressure on the connecting-rod at any point of the stroke is equal to the combined load upon the two pistons at that point, and the single connecting-rod upon the crank-pin precisely as in the simple engine.

*Third*.—The back pressure against the high pressure piston is—disregarding the friction of the steam passages—always the same as the forward pressure upon the low pressure piston.

*Fourth*.—The temperature in the high pressure cylinder

varies between much the same limits as in the case of the simple engine; but the variation is spread over both strokes, and the high pressure cylinder is at no time in communication with the condenser.

The cylinders in Fig. 108 are placed side by side; the pistons travel in opposite directions, being coupled to two crank-pins placed at opposite centers, or nearly so. An expansion-valve is necessary for the high pressure cylinder only. Instead of locating the crank-pins exactly at opposite centers, it is advisable to place one slightly in advance of the center, as the engine may then be started from any position, and this without any sacrifice of steam efficiency.

FIG. 107.

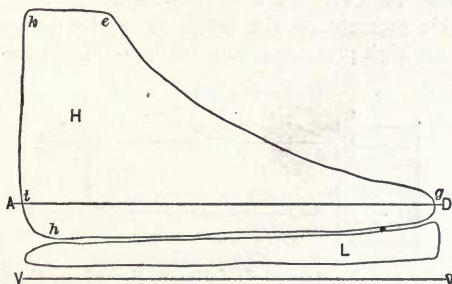

The action of steam in this engine, and consequently its indicator diagram, is precisely the same as in the last. Although the pistons are traveling in contrary directions, the points of maximum and minimum pressure upon the two pistons are coincident, and the rotational effort upon the crank is much the same as in the last arrangement.

One curious form of continuous-expansion compound engine is constructed somewhat on the principle of the bucket and plunger pump (see Fig. 109).

One cylinder only is used, and the efficient area of the piston is reduced on one end to, say, one-half or one-third of its total area by means of a trunk piston-rod, the other side of the piston having its whole surface exposed to pressure. The steam from the boiler is admitted on the reduced or annular side of

the piston, or trunk side, *a*, and it expands here, as in an ordinary high pressure cylinder, to the end of the stroke. It exhausts, however, by an appropriate valve, to the other side, *A*, of the piston, where it acts on a greater area, and produces the return stroke, expanding ultimately to the whole capacity of the cylinder, and then exhausting into the condenser. The same cylinder is thus exposed to the highest and lowest pressure, viz., that of the entering steam and that of the condenser; so that one of the alleged advantages of compound engines is here sacrificed. It is noticeable, too, that the high pressure steam is opposed only by the back pressure in the condenser, while the low pressure steam during the return stroke is opposed by steam of the same pressure, the same steam, in fact, acting, however, on a smaller area. In each case the atmospheric pressure on the trunk is in the same direction, assisting the high pressure steam and opposing the low pressure

FIG. 108.

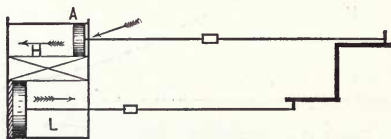

to an exactly equal extent. It follows, therefore, that the pressure during the return stroke must be more than that of the atmosphere, unless the latter is counterbalanced by a weight, or removed by the substitution of the condenser pressure. It is not easy to resort to this last expedient in the engines just described, except in a partial-manner, by using the outer end of the trunk as the ram of the air-pump. It is, however, resorted to in some engines identical in principle with these, though differing a little in form, the arrangement being something of this kind; a high and a low pressure cylinder are placed in one line, say for instance, in a vertical engine, the high above the low, and the pistons secured to a single piston-rod. The ends of the two cylinders which are next to each other—that is, the bottom of the high and the top of the low—are always in free communication with each other, and it is from this space that the atmospheric pressure is removed by connection with the



condenser. Steam from the boiler is admitted above the small piston, and completes a stroke, as before, in the high pressure cylinder. On exhausting, it passes to the under side of the large piston, and produces the up-stroke by pressure on the increased area of the low pressure piston. Here the high pressure steam is opposed by the pressure in the condenser, and the low pressure by steam of equal pressure, as in the case of the trunk compound engine.

In the above engines as the exhaust-port of the high pressure cylinder opens, the low pressure piston is at the end of its stroke, so that no expansion of the exhaust steam from the high pressure cylinder can take place (as in the case of compound engines with a receiver, as will be shown hereafter)

FIG. 109.

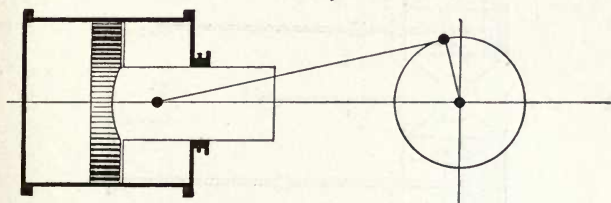

except into the clearance of the low pressure cylinder and the intermediate passages. As the two pistons advance, which they do simultaneously, the steam flows from the smaller to the larger cylinder, expanding meanwhile. The communication between the cylinders is not closed until the end of the stroke, or nearly so, and consequently the lowest pressure of the exhaust in the high pressure cylinder is the same as the terminal pressure in the condensing cylinder. Diagram, Fig. 107, taken from an engine of this class, and the coincidence of the exhaust-line of the high pressure diagram with the steam-line of the low pressure, shows the reduction of pressure of the high pressure exhaust referred to. The consequence of this reduction is, that the high pressure cylinder is subjected to the cooling influence of a pressure very little above that in the condenser; but the loss on this account is very slight indeed, if there is any, because it occurs only at the end of the exhaust stroke,

and also because the second cylinder acts as a trap for any heat which would otherwise escape by this means to the condenser. The real practical objection to this description of engine is one which applies more to marine than to stationary engines; it is that the pistons must begin and end the stroke together, moving therefore always in the same, or always in opposite directions, so that where the cylinders are parallel, and only two are used, the *dead points* coincide.

To get over this difficulty some engineers have made a compromise, keeping the cylinders parallel, but the cranks some twenty degrees or so out of the straight line—that is to say, at an angle of about one hundred and sixty degrees with each

FIG. 110.

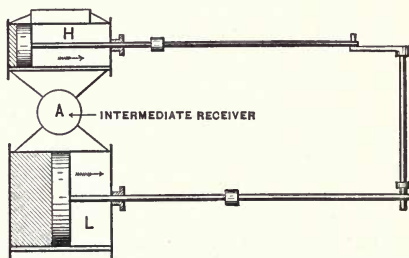

other. By this means the engines go over the dead points without difficulty, and the pistons move very nearly together. The high pressure piston ought to commence its stroke just before the other (and therefore the *low pressure crank* should lead); then the only effect of the alteration is to give a higher back pressure against the small piston at the beginning of each stroke (see diagram, Figs. 111 and 118), by compression of the exhaust steam until the low pressure steam-valve opens. This valve must be arranged to close again by the time that the high pressure piston reaches the end of its stroke—cutting off, that is to say, at about three-quarters of the stroke of its own cylinder.

### Compound Engines with Intermediate Reservoir, or Receiver.

In Figure 110 the two cylinders placed side by side work upon two crank-pins located at right angles to each other. When one piston is at the end of its stroke, the other is in its mid-position. Under this arrangement it is necessary that the steam from the high pressure cylinder, instead of exhausting direct into the low pressure cylinder, shall exhaust into an intermediate vessel, from which the low pressure cylinder in turn draws its steam. If both cylinders have expansion-valves, and the intermediate reservoir is of good capacity, the reservoir

FIG. 111.

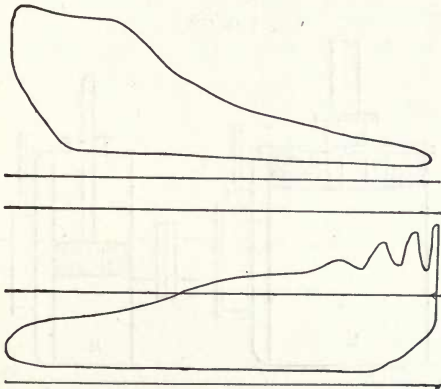

pressure may be kept very nearly constant. The action of the arrangement then becomes almost identical with that of two simple engines—one high pressure non-condensing, the other low pressure condensing—each working with a moderate range of expansion.

Fig. 111 was taken from a compound vertical engine with intermediate receiver, attached to cranks at right angles. The cylinders were steam-jacketed, each 24 and 38 inches diameter and 27 inches stroke, having a surface condenser. One effect of the intermediate receiver arrangement is to maintain a more constant back pressure against the high pressure piston, and to

reduce the variation of temperature in that cylinder. Generally, in practice, the high pressure cylinder only is furnished with an expansion valve, and the intermediate pressure cannot then be so steadily maintained. What the engine gains in simplicity by this, it loses in efficiency. The intermediate receiver compound engine is probably the most efficient yet devised. It is the form most usually adopted for marine purposes, and very good results have been obtained from it, both for economy of steam and regularity of motion.

It has been stated that, in compound engines provided with a receiver, the work of admission to the large cylinder is sometimes due partly to intermediate expansion, but always partly,

FIG. 112.

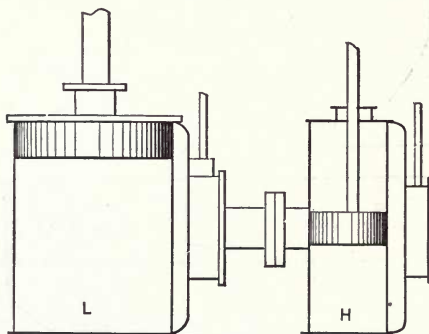

and sometimes entirely, to direct transfer of work from the small piston. In the continuous-expansion compounds without a receiver this work of admission, transferred directly from one piston to the other, occurs throughout the low pressure stroke, simultaneously with the work due to expansion, and consequently it is not distinguishable from the latter in the diagram.

There is another form of compound engine, if such it may be called, to which the term "*continuous-expansion engine*" has been especially applied. It has two cylinders placed side by side (Fig. 112), and the cranks are at right angles with each other. Steam is admitted to the high pressure cylinder *H* during something less than the half-stroke. At this point, or just

before it, the low pressure piston being then at the beginning of its stroke, a communication is opened between the two cylinders through the back of the low pressure cylinder valve, and through ports formed in the side of the small cylinder at about half-stroke. The steam is now free to expand in both cylinders during the remainder of the high pressure stroke; at the end of which time the low pressure piston will have reached its half-stroke. Instead, however, of the high pressure cylinder then opening at once to exhaust, the steam is retained in it for a short time, during which expansion of the steam in both cylinders continues in consequence of the advance of the large piston, which is traveling at this time at its maximum velocity; the small one, on the other hand, being nearly stationary. When, however, the low pressure piston reaches its three-quarter stroke, or thereabouts, the communication between the cylinder is

FIG. 113.

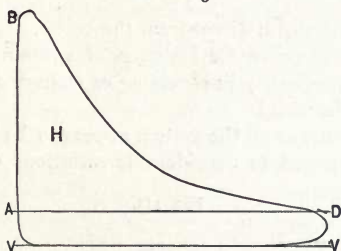

closed by the low pressure valve, and immediately afterwards the high pressure cylinder exhausts into the condenser. Expansion is still continued in the low pressure cylinder until the end of its stroke, at *g*, when it, too, exhausts into the condenser. See diagram Fig. 114.

The advantage claimed for engines built upon this system over non-compounds is that any required rate of expansion may be obtained without the waste of steam which takes place in the passages and clearance of the single cylinder with an early cut-off. Again, the advantage over compounds lies in obtaining continuous expansion to any desired extent with cranks at right angles and without the use of extra valves and eccentrics.

Three valves only are required, namely, a main valve for each cylinder, and a small valve for retarding the high pressure exhaust. An expansion-valve may, however, be beneficial on the small cylinder. Provision is made in these engines for rendering the cylinders independent at a moment's notice, both cylin-

FIG. 114.

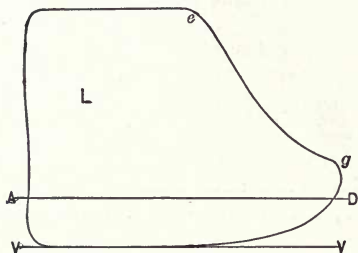

ders then taking steam direct from the boiler. This is a great convenience in the case, for instance, of a steam-vessel coming into port, giving facility in reversing or changing the direction or motion of the vessel.

The disadvantages of the system appear to be that both cylinders are subjected to considerable variations of temperature

FIG. 115.

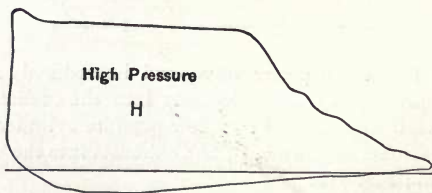

and pressure. Both receive steam of pressure nearly equal to that in the boiler, and both ultimately communicate with the condenser, so that the loss of heat by radiation, etc., during the exhaust, must be appreciable. The strain also at the time of the opening of communication between the cylinders must be very great, as both pistons are under the pressure of unex-

panded steam. It has been found in practice that the horse-power developed from the high pressure cylinder is sometimes decidedly in excess of that from the low pressure, but this would not be a very serious drawback in most cases.

The diagrams taken from the continuous-expansion engines, of which Figs. 115 and 116 are a facsimile, present no peculiarities except the very rapid fall of pressure after the half-stroke

FIG. 116.

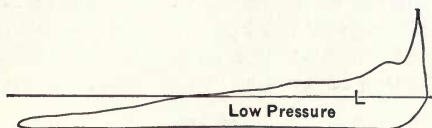

in the high pressure cylinder, and from the beginning of the stroke in the low pressure cylinder. The repression of the exhaust from the high pressure cylinder is also very clearly shown.

#### Compound versus Simple Engines.

In most compound engines, the theoretical action of the steam is not so perfect as in simple engines. This is owing to the resistance of the ports and connections between the cylinders, and, in many cases, to the loss by sudden expansion of the steam on its admission to the receiver. Notwithstanding this, the testimony of steam users—who are best qualified to judge—is in favor of compound engines.

We may now consider other points of superiority in the compound engine. When steam does work by expansion, the quantity of heat derived from it is sufficient, not only to lower the temperature of the steam to that corresponding to its decreased pressure, but also to cause a portion of it to liquefy. When the communication to the condenser is opened and the pressure falls to the condenser pressure, the interior surfaces of the cylinder, cylinder-heads, and piston, which may be supposed to have an intermediate temperature to that of the steam and of the condenser, give out heat to the water condensed on them. This causes the water to re-evaporate, increasing the back pressure and sending a quantity of heat direct to the condenser, without having performed any useful work.

In the same way the action of these surfaces on the entering steam deprives it of some of its heat, and, consequently, lowers its pressure. The great loss from liquefaction is, therefore, due to the fact that it acts as an equalizer of temperature, lowering the initial, and increasing the final temperatures and pressures, and thus decreasing the efficiency of the steam.

There can be little doubt that liquefaction, which is one of the principal causes that make the actual indicated work of steam fall short of its theoretical amount, is much more injurious in simple engines, with higher rates of expansion, than it is in compound engines. The liquefaction due to work done would, of course, be the same in both cases; but the difference

FIG. 117.

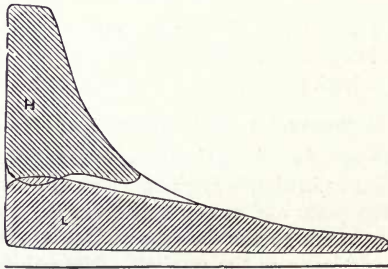

of temperature between the entering steam and the sides of the cylinder (in the case of the simple expansive engine) is much greater than in the compound engine, and consequently, we may infer, from the laws of radiation and conduction, that the reduction of the initial pressure and the increase of the back pressure, in the case of the simple engine, would be greater than in the compound engine.

The above diagram, Fig. 117, is what might be expected from a compound engine; the lengths of the diagram being made proportional to the volume of the cylinders so as to show the efficiency of the expansion. The outline of the combined diagrams may be taken to represent the theoretical diagram from a simple engine, no allowance being made for the lowering of the initial or the increase of the back pressure due to the liquefaction.



Some objection has been urged against compound engines, due to the loss by intermediate expansion.

Diagram, Fig. 118, is a theoretical diagram. In order to avoid any variations of the curve due to the differing conditions of expansion in a compound engine, a steam-jacket may be supposed to be applied throughout. Let the first part of the curve,  $e, f$ , represent expansion in the small or high pressure cylinder;  $f, c$ , the intermediate expansion or "drop" in the receiver; and  $c, g$ , the expansion in the low pressure cylinder. Then  $e, f, p, i, k$ , will be the high pressure diagram;  $i, c, g, n, h$ , the low pressure diagram; and the waste which has resulted from having an intermediate drop, or "gap" is shown by the triangle,  $f, c, p$ .

FIG. 118.

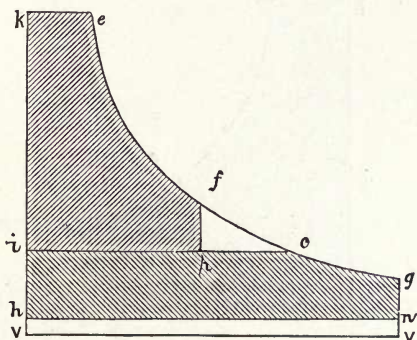

If, therefore, a "drop" can be avoided without altering the total ratio of expansion, a saving to this extent will be effected. When, however, the only convenient mode of avoiding a drop would be to decrease the capacity of the large cylinder, and, therefore, also to diminish the total ratio of expansion, there would be no saving; since more area is cut off from the end of the diagram than is saved in the middle, and the result is seen in Fig. 119.

The values of the low pressure diagram are very nearly the same in each case; in fact, if expansion followed Mariotte's law, they would be exactly the same for the initial, and, therefore, the mean

pressure in the low pressure cylinder would be in inverse proportion to the capacity, and the product of these two would be identical in each case. Here the matter is affected, however, by the fact remarked upon under the head of "*Wire-drawing and Throttling*" (Chapter IX, page 142, *ante*), that the loss due to back pressure in the condenser is in proportion to the capacity of the cylinder which exhausts into it. Thus, if the choice of mean pressure is between 20 pounds on a small piston, or 10 pounds on one double the size, and if the back pressure is 4 pounds, then the former of these gives just one-third more available work than the latter. The area below the line *h n*, in Figs. 118 and 119, shows the amount of loss in each case due to

FIG. 119.

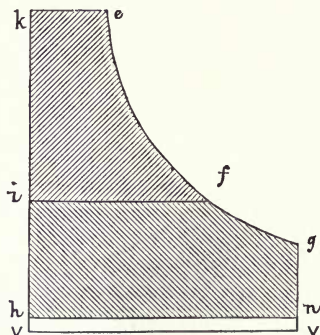

back pressure. While this area increases with any increase of capacity of the low pressure cylinder, the area of the high pressure diagram increases, also, by the lowering of the line *i, p, c*, and the best result will therefore be attained when this line *i, p, c*, is brought down just so far that any further reduction would take more from the low pressure diagram than it would add to the high. Where an expansion valve is used, on the other hand, and intermediate expansion therefore prevented, the low pressure cylinder may be made of such a capacity that the pressure of steam in it at the end of the stroke shall be little, if at all, higher than that in the condenser.

## To Avoid Intermediate Expansion.

There are several arrangements in use by which intermediate *drop* may be avoided altogether, or reduced to any desired extent, without diminishing the amount of expansion which takes place after the steam leaves the small or high-pressure cylinder. The commonest of these is that referred to by providing the large or low-pressure cylinder with an expansion valve, by which means its capacity up to the point of cut-off may be reduced to that of the high-pressure cylinder.

FIG. 120.

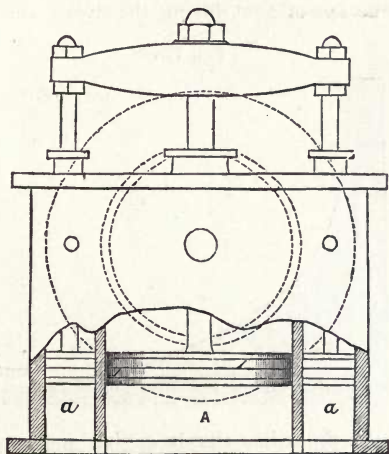

Another way of avoiding a drop of pressure is to make the pistons begin and end the stroke together (see Figs. 106 and 108), and to exhaust directly from the high-pressure cylinder into the low-pressure cylinder. In this class of engines the intermediate receiver is done away with, and the passages by which the steam exhausts from one cylinder to the other are made as small as possible, one cylinder being even placed sometimes *within* the other (see Fig. 120.)

In this class of engines, when the exhaust-port of the high pressure cylinder opens, the low pressure piston is at the end of

its stroke, so that no expansion of the exhaust steam from the high pressure cylinder can take place, except into the clearance of the low pressure cylinder and the intermediate passages. As the two pistons advance, simultaneously, the steam flows from the high pressure cylinder to the larger cylinder, expanding meanwhile. The communication between the cylinder is not closed until the end of the stroke, or nearly so, and, consequently, the lowest pressure of the exhaust in the high is the same as the initial pressure in the low pressure cylinder (see Diagram 107.)

Diagram, Fig. 121, is a theoretical one, on the assumption that there is no loss of heat during the stroke, the steam being

FIG. 121.

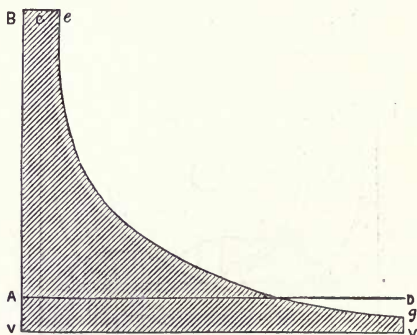

expanded *twelve* times in a simple engine and condensing;  $V, B$ , represents the total initial pressure of sixty pounds absolute;  $B, e$ , the constant supply of steam before cut-off takes place;  $e$  is the point of cut-off, being *one-twelfth* part of the stroke;  $e, g$ , the expansion curve;  $g, V$ , represents the terminal pressure, and  $V, V$ , the line of perfect vacuum.

Fig. 122 represents a theoretical diagram of a compound condensing engine. The line  $V, B$ , represents the initial pressure of sixty pounds above perfect vacuum,  $B, e$ , the steam line before cut-off,  $e, g$ , is the expansion curve from the high pressure cylinder, and  $g, n$ , the expansion curve formed by the condensing low pressure cylinder;  $g, V$ , the terminal pressure

in the high pressure cylinder, and equal to 17.32 pounds above a perfect vacuum, and  $V, n$ , the terminal pressure in low pressure cylinder, and equal to five pounds.

It will be seen from the above that to compound an engine by adding a second cylinder of about three and one-half times the piston area, which is known as the low pressure cylinder, into which the exhaust steam of the first or high pressure cylinder, instead of being thrown away, is utilized, results in a further amount of work being effected. The additional work thus obtained is roughly proportional to the mean effective

FIG. 122.

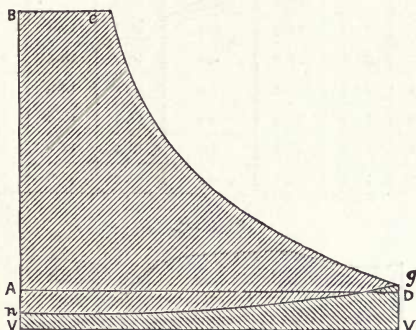

pressure in the low pressure cylinder multiplied by the differences in area of the two pistons. By this means the power of the engine is increased, and the steam, when finally exhausted, is at a pressure so low that little or no unused work remains in it. The maximum possibilities of economy are thus secured.

Diagram Fig. 123 was taken from a simple compound Westinghouse engine developing 160 brake horse-power, actual *water consumption 25.5 pounds per hour.*

#### Compound Condensing Engines.

Diagram, Fig. 124, was taken from a Westinghouse compound condensing engine developing 200 brake horse-power, actual *water consumption of 19.62 pounds per hour.*

TABLE NO. 6.

TABLE OF ACTUAL STEAM CONSUMED PER INDICATED H. P.  
Westinghouse Compound Engine, Cylinders 14'' and 24'' x 14''.

By Test, under Varying Loads and Pressures.

Unjacketed and Uncorrected for Entrained Water.

February, 1888.

| Non-condensing.   |         |          |          | Horse Powers. | Condensing.       |          |         |         |
|-------------------|---------|----------|----------|---------------|-------------------|----------|---------|---------|
| Boiler Pressures. |         |          |          |               | Boiler Pressures. |          |         |         |
| 60 lbs.           | 80 lbs. | 100 lbs. | 120 lbs. |               | 120 lbs.          | 100 lbs. | 80 lbs. | 60 lbs. |
|                   |         |          | 22.6     | 210           | 18.4              |          |         |         |
|                   |         | 23.0     | 21.9     | 170           | 18.1              | 18.8     |         |         |
|                   | 24.9    | 23.6     | 22.2     | 140           | 18.2              | 18.5     | 20.0    |         |
|                   | 25.7    | 23.9     | 22.2     | 115           | 18.2              | 18.6     | 19.6    | 20.5    |
| 26.9              | 25.2    | 24.9     | 22.4     | 100           | 18.3              | 18.6     | 19.7    | 20.3    |
| 27.7              | 25.2    | 25.1     | 24.6     | 80            | 18.3              | 18.6     | 19.9    | 20.1    |
| 30.3              | 28.7    | 29.4     | 28.8     | 50            | 20.4              | 20.8     | 20.7    | 20.4    |

FIG. 123.

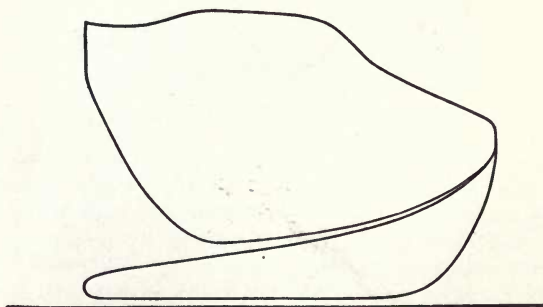

|  |      |
|--|------|
| Diameter of high pressure cylinder in inches . . . . . | 14   |
| Diameter of low pressure cylinder in inches . . . . .  | 24   |
| Length of stroke in inches . . . . .                   | 14   |
| Revolutions per minute . . . . .                       | 250  |
| Boiler pressure per square inch in pounds . . . . .    | 120  |
| Water consumption per hour in pounds . . . . .         | 25.5 |
| Brake Horse-power . . . . .                            | 160  |

Diagrams Figs. 125 and 126 were taken from a compound condensing engine. The mill was originally driven by a pair of horizontal slide valve engines, with cut-off of the following dimensions:

|   |    |
|---|----|
| Diameter of cylinders in inches . . . . . | 24 |
| Length of stroke in feet . . . . .        | 4  |

In order to get good results, it was arranged to erect boilers adapted to carry at least 160 pounds steam per square inch, and to replace one of the twenty-four inch slide-valve cylinders by a Corliss cylinder fourteen inches in diameter and four feet stroke: the new cylinder was steam jacketed, and the cranks being at right angles, a receiver was placed between the engines.

FIG. 124.

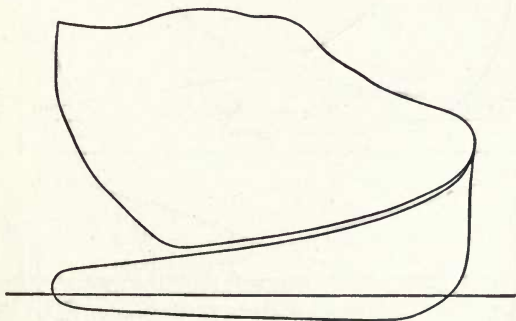

This alteration has been found to be a very great improvement, and the following diagrams taken from the altered engines, speak for themselves.

It will be seen that running sixty revolutions per minute, and with 165 pounds of steam in the boiler, the non-condensing Corliss cylinder indicates 125.2 horse-power, with a mean pressure of fifty-six pounds, and the condensing cylinder 131.1 horse-power, with a mean pressure of 19.75 pounds, or, collectively, 256.3 horse-power. About one pound of difference of pressure is shown between the two cylinders.

This engine has been frequently run up to 350 horse-power, when all the mill machinery has been on at once. The consumption of water so stated has been measured, and found to be about thirteen pounds per hour, per indicated horse-power, equivalent to a consumption of 1.3 pounds of coal per hour per indicated horse-power, with a boiler evaporation of ten pounds of water per pound of coal. The steam was very dry, and the indicator cards account for but 10.33 pounds of water per hour per horse-power developed.

FIG. 125.

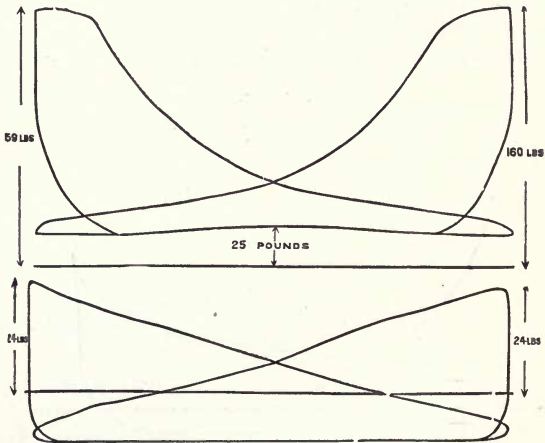

Diagrams 126 were taken from a pair of engines connected at right angles, using 1.7 pounds of coal per hour per horse-power; the boilers evaporating 8.46 pounds of water with one pound of coal.

#### Early Compound Engines.

An old and comparatively little known work entitled "*Recueil de Décrets, Ordonnances, Instructions, Décisions Réglementaires, sur les Machines à Feu et les Bateaux à Vapeur,*" by C. A. Trementsuk, published at Bordeaux in 1842, gives some interesting particulars of the steamers plying at that date upon the Gironde and the Garonne. Amongst these was the *Union*, set



to work in June, 1829, and which was fitted with a compound engine constructed by Hallette, of Arras, this engine having two inclined cylinders.

FIG. 126.

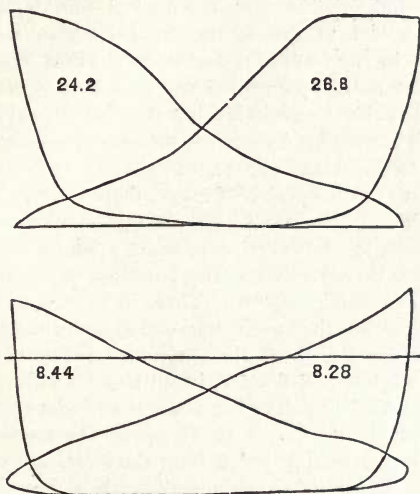

High pressure cylinder, 25 inches diameter.

Low pressure cylinder, 44 inches diameter.

Stroke of piston, 36 inches.

Revolutions per minute, 67.

#### Advantages of the Compound Steam Engine.

*First.*—It furnishes a better working engine mechanically, for utilizing the benefits of the expansion of high pressure steam. This point will be very generally conceded. The expansion of steam is necessary to secure economy; but, if the application of the principle be carried to the extent desired, the great changes of pressure in the cylinder cause severe strains on the main connections, and, although the latter be made unusually strong, it is frequently found expedient to reduce the

pressure, and, necessarily, the measure of expansion, and so increase the consumption of fuel in order to reduce the losses caused by frequent repairs, but more particularly by the delays they occasion. The compound engine, in any form, equalizes the strains, and distributes the load.

*Second.*—Independently of mechanical considerations, it is more economical to use steam expansively in a compound engine than in any form of the ordinary engine.

This point must be accepted as a fact by any one who will examine the evidence available, but the abstract explanation of the result is impossible by any of the laws heretofore laid down in respect to the steam engine. It should be borne in mind that, contrary to the opinion of many, there is no gain in power by the addition of the small high pressure cylinder of the compound engine, for the effective pressure upon its piston is only the difference between that of the entering steam and that admitted to the second cylinder. There is, in fact, a little power *lost* in transferring the steam from one cylinder to the other.

It is not strange, then, that many engineers condemn the compound engine, and declare, in spite of all failures, that the same results can be produced in a single cylinder engine if it be made of sufficient strength to withstand the unequal strains. These engineers simply judge from the information they have had the opportunity of acquiring. They have been taught that the capacity of the cylinder is the measure of the steam used, and reason that, if the compound engine gives no more power with the same steam, it is a useless contrivance. No other conclusion could be reached on such an assumption. The error in the reasoning lies in the fact that the volume of the cylinder is not an accurate measure of the quantity of steam used by the engine. This fact has been proved by experiment both at home and abroad, but, strange to say, has never attracted much attention. People will assume that steam can be measured by the cylinderful as accurately as pease in a bushel; but the fact is, that the metal walls of a steam cylinder are at every stroke so cooled by the performance of work, and by the low temperature during the exhaust, that the steam from the boiler, upon entering, has two offices to perform, namely:—

*First.*—To reheat the surfaces.

*Second.*—To fill the cylinder and maintain the desired pressure.

In many cases it may require as much steam to do the first as the last; and, as the steam for the first purpose is condensed, that for the second will only fill the space, and, in fact, two volumes of steam may enter into a vessel capable of holding but one of a liquid or non-condensable gas.

Tyndall has found that aqueous vapor is one of the most powerful radiators and absorbents of radiant heat known. Steam when slightly chilled by the performance of work, is in respect to heat in the same condition as the aqueous vapor of the atmosphere; therefore, if steam enters a cylinder at a temperature of, say, 280 degrees, and heats the metal surface to that point, when such steam is exhausted and falls in pressure so that the temperature is, say, only 130 degrees, the surfaces rapidly radiate heat, which is absorbed by the steam and carried to waste, and the next steam that enters has to reheat the surface, and an additional quantity is required to fill the cylinder and do the work.

Experiments made show that the cylinder of a perfect engine should be made of glass or other non-conducting material. Experiments made by Mr. C. E. Emery, of New York, proved that very nearly the same results could be obtained by the use of a modification of the compound engine, which involved no difficult mechanical details. The transfer of heat from the metal walls of the cylinder to the exhausting steam takes place in two ways, namely:

*First.*—By direct contact.

*Second.*—By radiation.

The bulk of the steam can only be acted upon by radiation, which, therefore, causes the material part of the loss.

It has been proved by experiment that the quantity of heat transferred from a radiating to an absorbing body varies as the square of the difference in temperature; so, taking the previous case, namely, that the temperature of the metal surfaces of a steam cylinder is 280 degrees, and that of the exhaust steam 130 degrees, the difference in temperature is 150 degrees; and, if we use steam in two cylinders instead of one, we may reduce the temperature in each to, say, one-half that amount, and the condensation will be as  $1^2$  to  $2^2$ , or one-fourth as much in the two

cylinders as in the single one, or not less than one-third as much if an allowance be made for the increased surface in the two. This explanation shows that if the condensation in the single cylinder be one-half the whole amount, two-thirds of this or ( $\frac{2}{3} \times \frac{1}{2} =$ ) *one-third of the whole* may be saved by a compound engine, which calculation agrees with the facts, but varies, of course, with changes in the condition.

Mr. Emery speaks of many compound engines that were so constructed that they gave but little better results than a single cylinder engine. During his experiments several improvements applicable to the compound engine were worked out, which, in connection with that principle, using a steam pressure of only 40 pounds per square inch, reduced the cost of the power in the experimental engine from 39.2 pounds of feed water per hour per horse-power to 23.6 pounds. This proportion of saving would, in a large engine, reduce the cost to as nearly that promised by theory as the most sanguine could expect; for larger engines are positively known to be more economical than small ones, which may be explained by the fact that the ratio of internal surface to capacity decreases with the size of the cylinder. The practical evidences of the advantages of the compound engine are overpowering, as eighty per cent. of all the large ocean steamships recently constructed abroad and at home have such engines, and many of the largest establishments on land also employ them.

#### Triple Expansion Engines.

The success of the triple expansion engine is now so well assured, and all doubts as to its efficiency and good working are so effectually dispelled, that it is without doubt the engine of the day. It does not differ in any essential feature from the ordinary compound engine, and its success is in no small measure due to the fact that most makers of the new type departed as little as possible from their previous practice in its general construction. The arguments for and against this new class of engine bear a striking resemblance to those used in the well-remembered warfare of compound *versus* expansion engines, and the objections most strongly insisted on by the opponents of this new system are just those used against the original compound

engine, and are rather the echo of old battle cries than the sound of new ones. A few years' experience has demonstrated that the triple expansion engine is more economical than the ordinary compound engine; that the wear and tear is no more but rather less, when three cranks are employed than with the two of the ordinary compound, and that boilers of the common marine design can be made to work satisfactorily at a pressure of 150 pounds per square inch, and even higher, while with ordinary care, their durability and good continued working are not likely to be less than those of similar boilers pressed to 60 pounds per square inch under similar circumstances. Speaking generally the consumption of fuel is 25 per cent. less with a triple expansion engine than with an ordinary compound engine working under similar circumstances. That is, a triple expansion engine, supplied with steam at 140 pounds pressure, uses 25 per cent. less weight of water per indicated horse-power than an ordinary compound engine supplied with steam at, say, 90 pounds pressure, both engines being equally well designed, manufactured and attended to. Also that a triple expansion engine is more economical than an ordinary compound engine, when both are supplied with steam at the same pressure, for all pressures of 95 pounds and upwards, and especially so in the case of large engines. Hence it may be taken that the superior economy of the triple expansion engine, as now constructed, is due to two causes, namely:

*First.*—To the higher steam pressure used, and the higher rate of expansion thereby possible.

*Second.*—To the system whereby large initial strains and large variations of temperature in the cylinders and large "drops" in the receivers are avoided.

Increased pressure of steam is obtained by a very slight increase of consumption of fuel, and the efficiency of steam rapidly increases with increased pressure; hence, steam of high pressure is more economical than that at a lower pressure.

For example:

(a) The total heat of evaporation of one pound of water from 100 degrees and at 276.2 degrees Fahrenheit (corresponding to 45 pounds pressure absolute) is 1166.2 units of heat from 32 degrees.

(b) From 100 degrees and at 322.4 (corresponding to 90 pounds absolute) is 1180.3 units of heat.

(c) From 100 degrees and at 346.2 (corresponding to 125 pounds absolute) is 1187.5 units of heat.

(d) From 100 degrees and at 354.8 (corresponding to 140 pounds absolute) is 1190.1 units of heat.

(e) From 100 degrees and at 378.5 (corresponding to 190 pounds absolute) is 1197.4 units of heat.

Suppose in each case the steam to be expanded to a terminal pressure of 10 pounds absolute, the rates of expansion will then be 4.5, 9, 14 and 19, respectively; and the mean pressure corresponding to these initial pressures and rates of expansion will be 25 pounds, 32 pounds, 36 pounds, and 39 pounds respectively. If the volume of a pound of steam varied exactly in the inverse ratio of the pressure, these figures would represent the relative values of the efficiency of the steam at the various pressures. But taken exactly, the relative values are 25, 33.3, 38.5 and 42.6, thus showing as follows:

*First.*—That a pound of steam at 90 pounds pressure is capable of doing 33 *per cent.* more work than a pound at 45 pounds.

*Second.*—A pound of steam at 140 pounds pressure 16 *per cent.* more work than a pound at 90 pounds.

*Third.*—A pound of steam at 190 pounds pressure 10.6 *per cent.*, more work than a pound at 140 pounds pressure.

In other words, an engine using steam at 140 pounds pressure should, apart from any practical considerations, consume sixteen per cent. less fuel than one using steam at 90 pounds; and again, an engine using steam at 190 pounds should consume twenty-eight per cent. less fuel than one using steam at 90 pounds, and ten and six-tenths per cent. less fuel than one using steam at 140 pounds pressure.

Looking to see how far practice agrees with these results and comparing the ordinary compound engine, using steam at 90 pounds, with the triple expansion engine using steam at 140 pounds pressure, it will be found that the latter gives a greater economy than theory shows should be due to the increased pressure. It follows, then, that there is some other cause operating to produce the economic results shown in every

day practice with this new engine, for there is now no question that the saving in fuel effected by a triple expansion engine using steam and expanding 11 or 12 times, is about 25 per cent. compared with that used by an ordinary compound engine of the same power, using steam at 90 pounds, and expanding 8 to 9 times. The other cause, or rather causes, are not remote, for it is to be noticed at once that since by using steam in the two cylinders of a compound engine, the large variation in temperature in the cylinder of the expansive engine was avoided (and this, doubtless, was one of the chief causes of its superior economy over the latter), then, by using three cylinders for the higher pressures, a similar result would be obtained. Further, as the ordinary compound engine is not subject to such severe initial and working strains as prevail in expansive engines of the same power, and using steam of the same pressure, so in the triple expansion engine with three cranks, these strains are still further reduced. In other words, by extending those leading features of the compound engine which conduced to its economy, the engineers of to-day have achieved, with the triple expansion, a victory similar to that obtained about twenty years ago by their predecessors, but with somewhat less brilliant results; and it is not difficult to see that any further advances must meet with still less gain. Until science and skill have discovered new materials or other applications of old ones, there will not be much practical advantage in using steam at higher pressures than now obtained, and 200 pounds absolute pressure seems about the limit at which theoretical economy is swallowed up by practical losses.

It has been shown in practice that the saving in fuel is from 20 to 30 per cent. by the use of triple expansion over that of compound engines, independent of the more even distribution of pressure; also that the resistance of the slide valves is very materially lessened, and the losses due to mechanical causes decreased; also experience has shown that the wear and tear of the triple expansion engine with three cranks is very considerably less than with the ordinary two crank compound engine of the same power and stroke, and no doubt this is due to those causes already shown to exist with this class of engine.

Diagrams Fig. 127 were taken from a compound condensing,

triple-expansion engine, developing 357 horse-power, with a consumption of 1.3 pounds of coal per hour per horse-power. Steam pressure in boiler, 155 pounds above the atmosphere.

FIGS. 127.

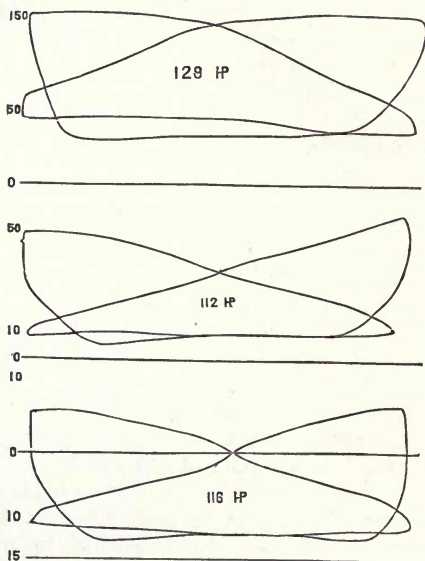

Diagrams Fig. 128 were also taken from a horizontal compound-condensing, triple-expansion engine. The three cylinders are placed one above the other, that is to say, the low pressure cylinder is placed on the bottom next the intermediate, and on top of this the high pressure cylinder: all the piston rods are connected to one and the same crosshead. For boldness of design this engine is unique.

The cylinders are  $8\frac{1}{4}$  inches,  $13\frac{1}{4}$  inches, and 21 inches in diameter respectively, with a common stroke of 48 inches.

The valves of the high cylinder are of the Corliss type; the intermediate cylinder is fitted with two slides and cut-off valves. These valves can be regulated to cut-off earlier or later, to



equalize the amount of work done by the respective cylinders. To facilitate adjustment the cut-off spindle has a screw index wheel.

The low pressure cylinder is fitted with an ordinary slide valve worked by an eccentric.

The diagrams were taken before the cylinders were lagged. The small fall of steam pressure between the steam supply pipe and the high pressure piston is worthy of notice, as well as the

FIG. 128.

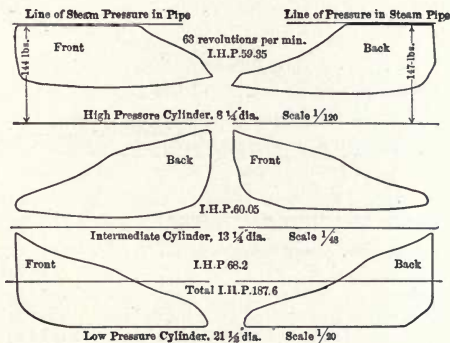

parallel admission steam line into the high pressure Corliss cylinder. The diagrams were taken with the full load of 187 horse-power on the engine at 63 revolutions per minute, but under ordinary circumstances the engine works in conjunction with a turbine, the latter driving from 20 to 70 horse-power according to the height of the water in the supply dam. The average load on the engine will be 150 to 160 horse-power.

There is a blow-through valve from the high pressure to the intermediate cylinder, to get the strain fairly applied to the middle of the cross-head in starting.

#### Chart of Relative Economy, Under Varying Loads.

Diagram, Fig. 129, represents the performance of a single cylinder non-condensing engine, as contrasted with the compound engine, non-condensing and condensing.

To fully realize what this economy means, I append the best recorded duty in pounds of water per horse-power per hour of some of the best types of engines working under the most favorable conditions:

FIG. 129.

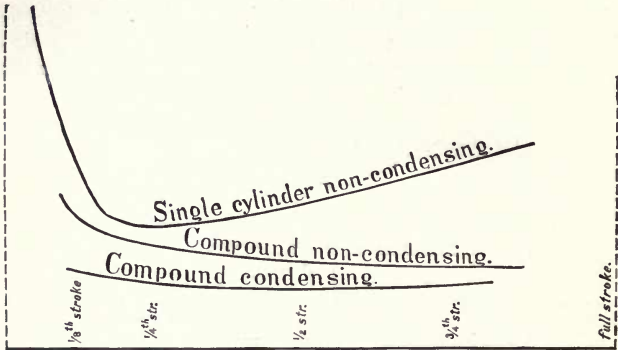

|   |                  |
|---|------------------|
| Pumping engines, compound condensing . . . . .          | 15 to 18 pounds. |
| Westinghouse engines, " " . . . . .                     | 17 to 19 "       |
| Corliss engines, " " . . . . .                          | 18 to 22 "       |
| Westinghouse engines, compound non-condensing . . . . . | 22 to 24 "       |
| Corliss engines, compound and condensing . . . . .      | 17 to 19 "       |
| Corliss engines, condensing . . . . .                   | 22 "             |
| Corliss engines, non-condensing . . . . .               | 28 to 35 "       |
| Buckeye engines, non-condensing . . . . .               | 25 to 30 "       |

It must be borne in mind that the duties above named are measured by water fed to boilers. It is customary with some engine builders to rate their consumption by computing from the indicator diagrams. This is misleading, as an engine showing 22 to 24 pounds by the indicator card will actually consume at least 28 to 32 pounds of *weighed* feed water.

Compound Locomotives.

Compound locomotives were first introduced in 1850 on the Eastern Counties (now the Great Eastern) Railway, England, James Samuel, superintendent, the system being due to John Nicholson, engineer.

Each locomotive was fitted with two cylinders having piston

areas approximately as 1 to 2, the strokes being the same, and the pistons being coupled to cranks at right angles in the ordinary way, see Fig. 110. Steam from the boiler was admitted to the smaller cylinder up to half stroke (or less, according to the power required), while at half stroke a supplementary valve opened up a communication between that end of the small cylinder, which had been receiving steam, and the larger cylinder, the expansion during the greater part of the remainder of the stroke of the small piston going on in both cylinders simultaneously, see Figs. 113 and 114. Near the end of the stroke of the small piston, however, the communication between the two cylinders was closed, and the main valve of the small cylinder opening to the exhaust, such steam as remained in that cylinder passed to the blast nozzle in the ordinary way. By this time the piston of the larger cylinder had reached half stroke, the remainder of the stroke being completed by the expansion of the steam then shut into that cylinder. To facilitate the handling of the engine at starting, provision was made for shutting off the communication between the cylinders, and for admitting steam direct to the valve chest of the low pressure cylinder.

With cylinders of the proportion above named, it will be seen that approximately, and neglecting the effect of clearances and steam passages—with the cut-off at half stroke in the small cylinder, half the steam used was expanded four-fold and half of it eight-fold. One of Mr. Nicholson's objects in designing this particular system of working appears to have been to secure the discharge of a portion of the steam at such a pressure as to maintain an effective blast, the remaining half being expanded down to a very low pressure.

The next attempt at compounding locomotives was made by M. Jules Morandiere of the Northern Railway of France, in November, 1866, on a locomotive having eight drivers, the drivers being formed in two groups—two pairs in each group. The wheels forming the front group were driven by a pair of outside cylinders placed as usual, while the axle of the front pair of wheels of the hind group was furnished with a central crank driven by a single cylinder (same as the present Webb system) placed under the boiler. The steam was first admitted

into the single cylinder, from which it was exhausted into two outside cylinders.

In July, 1876, M. Anatole Mallet, of Paris, France, introduced on the Bayonne and Biarritz Railway, his system of compound locomotives, three being put in service. They proved very successful, and were followed by others the ensuing year. One of the chief features of M. Mallet's system was the provision of a special arrangement of distributing valve, by which the steam from the boiler could be admitted either to the high

FIG. 130.

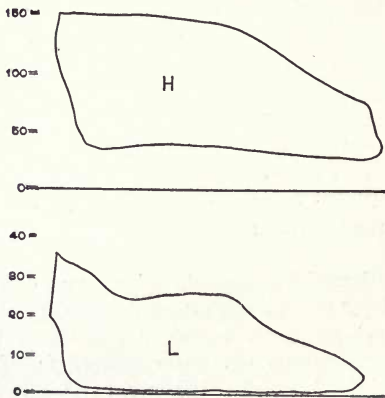

pressure cylinder only, or to both cylinders when required for starting; the distributing valve also effecting the direct discharge into the stack of the exhaust from the small cylinder when the engine was working non-compound. In M. Mallet's earlier engines, when working non-compound, the steam from the boiler passed direct to the large cylinder, but subsequently he fitted his locomotives with a reducing valve, through which the steam on its way from the boiler to the large cylinder had to pass, this valve being set to give in the cylinder a certain fraction of the boiler pressure, thus equalizing the work done in the two cylinders. Another special feature of M. Mallet's locomotive is the reversing gear, which is so arranged that, while

the gear for the two engines of the locomotive can be reversed simultaneously, the cut-offs in the high and low pressure cylinders can be adjusted independently, so as to equalize the work.

Diagrams Fig. 130 were taken with a boiler pressure of 150 pounds per square inch above the atmosphere, the cylinder being placed as in the ordinary locomotives.

In 1878 the Paris and Orleans Railway altered some of their express locomotives, having  $10\frac{1}{2}$  inch cylinders, by replacing the right-hand cylinder with a  $21\frac{3}{4}$  inch cylinder, the stroke being 24 inches; diagram Figure 131 was taken from one of these altered locomotives.

FIG. 131.

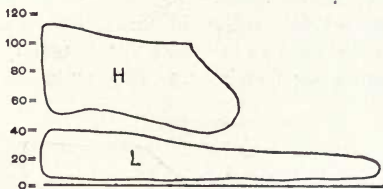

M. Mallet's system also includes an arrangement of a pair of tandem compounds—namely, one high pressure and one low pressure cylinder on each side of the locomotive, the two pistons being on one rod; this arrangement is peculiarly fitted for application to outside cylinder locomotives.

M. Mallet's experiments since 1872 established the fact that compound locomotives under good conditions gave an economy of fuel of *twenty per cent.*; this is based on a pressure not exceeding 120 pounds; a higher boiler pressure might have shown better results.

In 1881-82 Mr. Francis W. Webb, of the London and North-Western Railway, England, after having a compound locomotive on M. Mallet's system running for five years, on the Ashly and Nuneaton branch of the above line, found the results obtained with this locomotive to be so satisfactory, that he designed and patented an improved compound locomotive. This has three cylinders, two high pressure outside cylinders of equal size, arranged to drive the hind driving axle, and one low pressure

cylinder placed inside the frames underneath the smoke-box, acting on a central crank on the front driving axle. The high pressure cylinders are  $11\frac{1}{2}$  inches, and the low pressure cylinder 26 inches in diameter, the stroke in both cases is 24 inches; the driving wheels are 6 feet 6 inches in diameter. By the above arrangement Mr. Webb obtains the advantages of a coupled locomotive without the use of coupling rods; in other words, he has two pairs of single drivers on one locomotive.

These locomotives proved so successful that (to meet heavier loads) the high pressure cylinders have been increased to 14 inches diameter, and the low pressure cylinder to 30 inches; the driving wheels have been reduced to 75 inches, and the leading wheels to 45 inches diameter. The total wheel base is 18' 1".

The heating surface of flues in square feet = 1224.4. The heating surface of fire box in square feet = 159.1. Total heating surface in square feet, 1401.5. Fire grate, in square feet,

FIG. 132.

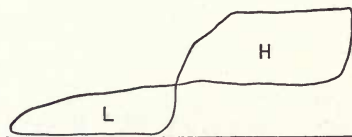

20.5. Ratio of fire grate area to heating surface area 1: 68.36. Pressure per square inch in the boiler, 175 lbs.. Total weight, 42 tons 10 cwt.

The Pennsylvania Railroad imported early in 1889 one of these locomotives for trial on their line. It was built by Beyer, Peacock & Co., England, and is known as the "Dreadnaught" class, and is named "Pennsylvania."

One of the Webb compound locomotives runs the Scotch express from Euston (London) to Carlisle, a continuous trip of  $300\frac{1}{4}$  miles, with an average load (including locomotive and tender) of 207 tons. The consumption of fuel averages 29.2 pounds per mile, and the evaporation of water is 9.49 pounds per pound of coal, the average speed being 44.7 miles per hour.

Indicator diagram Fig. 132 was taken from one of the com-

pound locomotives with 13 inch high pressure, and 26 inch low pressure cylinder.

Speed slow; Full gear; Boiler pressure 150 pounds; Indicator scale 56 pounds = 1 inch.

The following diagram, Figure 133, was taken when the speed was fifty miles per hour, boiler pressure 150 pounds, cutting off at thirty-five per cent. of the stroke.

Speed 50 miles per hour; Boiler pressure 150 pounds per square inch; Cut-off, 35 per cent. of the stroke.

It will be seen that the work performed is nearly all done by the high pressure engines, and of course there is a great drop in the receiver.

FIG. 133.

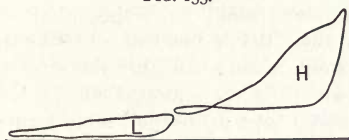

The above diagrams, in view of the great publicity given to these improved locomotives, do not bear out the assertions of economy made for them. The work in the low pressure cylinder, at the above speed, is a mere trifle, scarcely justifying the great additional complication and weight entailed. On this point—multiplication of parts, and crowding necessary to get them in—there is great objection, and it will require a much longer experience and impartial judgment to determine whether this type of locomotive is desirable. There is another serious drawback, as I understand the Webb compound locomotive; there is no arrangement for exhausting direct from the high pressure cylinder into the stack; therefore, in starting, the engine has to back the train first, to get rid of the accumulated exhaust steam in the low pressure cylinder.

T. W. Worsdell, superintendent of the Great Eastern Railway, England, patented a compound locomotive with inside cylinders, similar to the Mallet type, the high pressure cylinder being 18 inches diameter and the low pressure cylinder 26 inches diameter, with a common stroke of 24 inches.

The cylinders have the valve chests on top of the cylinder,

the exhaust steam from the high pressure cylinder traversing an arched pipe in the smoke-box on its way to the low pressure valve chest. In this arched pipe is introduced the "intercepting valve," which, with its adjunct, the starting valve, forms one of the chief features in Mr. Worsdell's system of compound locomotives.

The intercepting valve is a flap valve situated in a chamber on the line of the high pressure cylinder exhaust pipe; the normal position of this valve being open, except when starting. The spindle on which this flap valve is hinged, passes out through the side of the smoke box and carries at its outer end an arm which enters a slot in the rod of a piston, which works in a small cylinder forming part of the starting valve casing. This piston has some small holes through it. The starting valve is a double one, the first movement of the spindle opening the small valve only, while a further movement will open the larger valve, which is then approximately balanced. Both valves are normally kept up to their seats by spring pressure. By means of a branch pipe the starting valve casing is placed in communication with the steam pipe leading from the regulator steam valve to the high pressure cylinder.

The action of the arrangement we have just described, is as follows: If the engine happens to have stopped in such a position that it does not start again when steam is turned on in the ordinary way, the engineer pulls open the starting valve, thus allowing steam from the main steam pipe to act against the small piston which we have already mentioned as working in a prolongation of the starting valve casing. The pressure of steam on the piston uncovers a port on the upper side of the cylinder in which the piston works. This port is covered by a small spring loaded valve, which is raised by the steam, the latter thus getting access through a bye pass to the pipe communicating with the intercepting valve chamber. At the same time the forward motion of the small piston raises the intercepting valve, and closes the communication with the high pressure cylinder exhaust, and thus the steam admitted by the starting valve to the intercepting valve chamber, can only get access to the valve chest of the low pressure cylinder. When the engine has started, the exhaust from the high pressure



cylinder, of course, acts on the upper side of the intercepting valve, re-opening that valve, carrying back the starting valve piston, and restoring the parts generally to the positions they occupied before the starting valve was opened. These various movements are perhaps tedious to describe, but the whole operation is exceedingly simple, and the arrangements act exceedingly well and promptly, enabling these engines to be handled as easily as non-compound engines. The low pressure cylinder

FIG. 134.

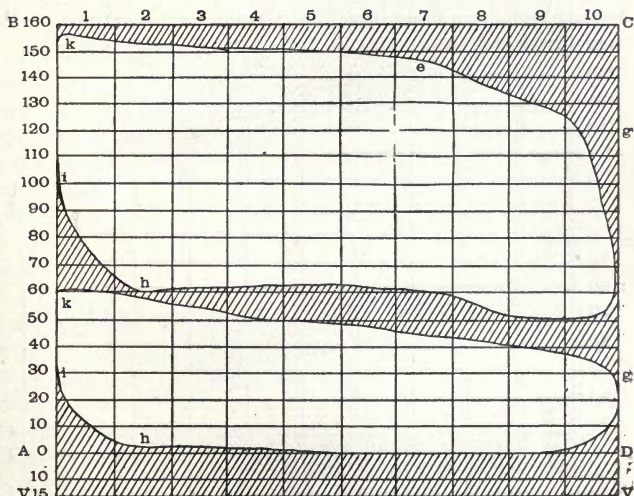

Speed 10 miles per hour. Cut-off 75 per cent. of stroke.  
 Horse-power of high pressure cylinder . . . . . 102.3  
 Horse-power of low pressure cylinder . . . . . 114.8  
 Total indicated horse-power . . . . . 217.1  
 Boiler pressure above atmosphere, 150 pounds.

is fitted with large spring loaded relief valves, so as to prevent excessive steam pressure being exerted on the low pressure piston; but as a matter of fact these valves rarely come into action, the small quantity of steam which it is necessary to

admit by the starting valve, being easily controlled by the engineer.

The engines are fitted with Joy's valve-gear, and a differential adjustment of the quadrants, in which the expansion block-work insures such a control of the point of cut-off in the two cylinders, as to secure a very close approximation to equality of work. This result is well shown by the indicator diagrams: Figs. 134 and 135.

FIG. 135.

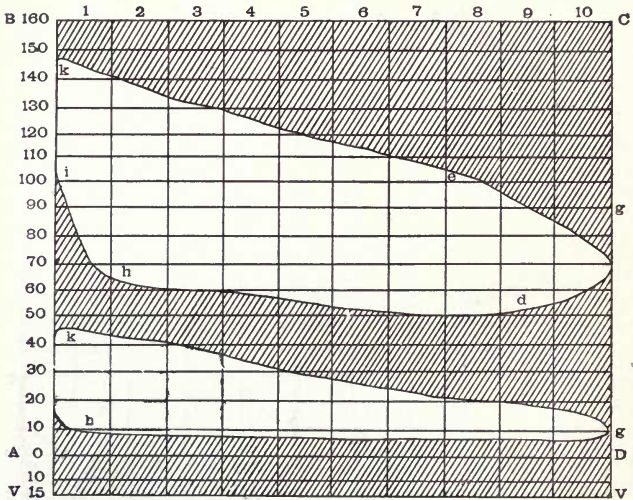

Speed 55 miles per hour. Cut-off 75 per cent. of stroke.

Horse-power of high pressure cylinder . . . . . 395.3

Horse-power of low pressure cylinder . . . . . 368.3

763.6

This high speed diagram shows the work fairly divided between the two cylinders, and it also shows the result of linking up both engines to cut-off at three-quarter stroke, and is instructive as showing what might be expected from bringing up the low pressure gear of a Webb locomotive until the work at speeds was nearly divided.

On an up grade with a heavy train, necessitating a late cut-off in the high pressure cylinder, owing to the valve gear in both engines being connected, the cut-off in the low pressure cylinder is late also, and there is a serious loss from drop in the receiver, but the two cylinders assist one another in their work.

This locomotive runs the newspaper express of twelve coaches, between Newcastle and Edinburgh, and on the round trip, consumes only 22.5 pounds of coal per mile, this coal being carefully weighed; whereas, the average consumption of these trains, with ordinary locomotives, is 30 pounds per mile, showing a saving for the former of twenty-five per cent.

In this county the compound locomotives tried on the Boston and Albany Railroad have proved a failure as economizers of fuel, and have been changed into the ordinary form. They had four cylinders; large cylinders 20 inches by 26, small cylinders 12 inches by 26 inches, placed one in front of the other with the same piston-rod, or "tandem" as it is called. They failed simply for the reason that they were more expensive to maintain than the ordinary locomotives, without showing any corresponding economy.

Mr. A. B. Underhill, superintendent of motive power of the road, says "The locomotive worked well, but we could get no economy. Our road has heavy grades and in working direct steam, in the cylinders, on the grades, we lost more than we gained by compounding on the levels." "I am a good deal skeptical about Compound Engines being economical for rail-way service."

## CHAPTER XIV.

### GAS-ENGINES.

#### History of Gas-Engines.

AT the present time, when gas-engines are coming into general use for many purposes, a brief account of them may prove interesting.

An engine driven by the explosion of a mixture of coal-gas and atmospheric air was exhibited by Dr. Alfred Drake, of Philadelphia, at the New York Crystal Palace, in 1855. The principal feature in Dr. Drake's engine was the means employed to light the mixture of gas and air within the cylinder, which was done in the following manner: At two points, one for each stroke, a hole was formed in the cylinder, the distance of these holes from the ends of the cylinder corresponding with the space into which the mixture was to be admitted before it was exploded. These holes were each furnished with stuffing-boxes, and in each of these stuffing-boxes was placed a cast-iron cup, or thimble, the solid end of which projected into the shell of the cylinder, so as to be just clear of the bore. In each of these thimbles a jet of gas and air was kept constantly burning, and by this means the ends of the thimbles were maintained at a red heat. When, in the course of its stroke, the piston passed over one of these thimbles, the mixture of gas and air which had been admitted behind it came in contact with the red-hot surface and was instantly ignited. The explosive mixture was admitted to and released from the cylinder by ordinary double-beat valves.

The air and gas were slightly compressed during their mixture by an air-pump furnished with suitable stop-cocks, by means of which the proportions of the gas and air could be regulated. The air-pump was worked by hand, in order to obtain a supply of the explosive mixture for starting the engine; afterwards it was run by the engine itself. The explosive mixture used consisted of one-tenth coal-gas, and nine-tenths atmos-

pheric air, and Dr. Drake considered that, when this was ignited, an initial pressure of about 150 pounds per square inch was obtained.

The ignition of the gas in the cylinder caused considerable heat to be evolved. In Dr. Drake's engine and cylinder, the cylinder covers, piston, and piston-rods, were all made hollow, and through them a constant stream of water was forced. By this means they were kept moderately cool. The speed of the engine was controlled by a throttle valve connected with a governor, as in the ordinary steam-engine. This engine did not come into general use at that time, from the excessive price of gas (\$4.00 per 1000 cubic feet) and further from the death of Dr. Drake. It was followed by the Lenoir and Hugon gas-engines of Paris, the latter's engine requiring 74 cubic feet of gas per hour, per horse-power, or about ten pounds of coal per hour, per horse-power.

At the Paris Exhibition Otto and Langen's gas-engine was shown. The consumption of gas was about 30 cubic feet per hour, per horse-power. In this engine gas mixed with atmospheric air is exploded, as in the common forms of gas-engine, but instead of the pressure being imparted to a crank in the usual manner, there is no resistance opposed to the movement of the piston at the moment of explosion, but it is shot up in the cylinder like a shot propelled from a gun, and the vacuum produced by the explosion and also by momentum of the piston is the moving force. The object of this arrangement is to prevent an inconvenient accumulation of heat in the cylinder. The gas used is coal-gas, and is ignited without the aid of electricity.

Prior to 1876 many attempts had been made to produce a satisfactory gas-engine, but all of them, including the previous efforts of Otto himself, fell short of practical success, as they were somewhat noisy. Otto, on May 17th, 1876, invented improvements in gas-engines of a most important character, to wit:

*First.*—The introduction of a body of inert gas between the piston and the combustible mixture by which it is impelled.

*Second.*—The compression of the charge in the cylinder by means of the return stroke.

This engine is known as the Otto "silent" gas-engine, and

in it the violent shocks, so objectionable in former engines, are avoided.

Considering that in the employment of gas-engines fuel is not being consumed when the engine is not in actual operation, it is evident that they form economical motors where small powers are required. Further advantages are that they occupy small space, are ready at a moment's notice, avoid any risk and danger of explosion, reduce cost of insurance, and allow insurance to be effected in places where, with a steam-engine and boiler, companies would not undertake it. They need no special buildings or chimney, and do not make the premises where they are used uncomfortable with heat, dust and cinders.

Gas-engines will, before long, come into extensive use, not only as supplementers to some extent of steam-engines, but also as affording a cheap and efficient motive power in a great number of places where the use of steam is difficult or impossible. It is obviously to the interest of gas companies and gas managers to forward their employment as much as possible, because they not only increase consumption of gas, but by using it chiefly during the hours of daylight, no corresponding increase of capital expenditure is involved; and their extended use would not only benefit gas manufacturers, but also gas consumers in general, by reducing the cost of making the gas by increasing its consumption.

The problem of the conversion of heat into mechanical work has been partially solved by the steam-engine, but its efficiency is so low that it can not be considered as complete. Hot air, in the past, has been looked upon as a possible advance, but owing to many mechanical difficulties it has long been deemed useless to look in that direction for better results. The great progress recently made in gas-engines, from the stage of an interesting but troublesome toy to a practical and powerful rival of the steam-engine, has shown that air might, after all, be the chief motive power of the future.

#### Gas-Engines.

Before proceeding to give an account of the early history of these engines, I will preface it with the theory of the gas-engine by M. Dugald Clerk, an expert in these motors.

There are three distinct types of gas-engines at the present time, as follows:

*First*.—An engine drawing into the cylinder gas and air at atmospheric pressure for a portion of its stroke, cutting off communication with the outer atmosphere, and immediately igniting the mixture, the piston being pushed forward by the pressure of the ignited gases during the remainder of its stroke. The return stroke discharges the products of combustion.

*Second*.—An engine in which a mixture of gas and air is drawn into a pump, and discharged by the return stroke into a reservoir in a state of compression. From the reservoir the mixture enters a cylinder, being ignited as it enters, and without rise in pressure, but simply increased in volume, following the piston as it moves forward. The return stroke discharges the products of combustion.

*Third*.—An engine in which a mixture of gas and air is compressed, or introduced under pressure into a cylinder or space at the end of a cylinder, and then ignited. While the volume remains constant the pressure increases. Under this increased pressure the piston moves forward, and on the return stroke exhausts. Types *one* and *three* are explosion engines, the volume of the mixture remaining constant while the pressure increases. Type number *two* is a gradual combustion engine, in which the pressure remains constant, but the volume increases. Calculating the power to be obtained from each of these methods, supposing no loss of heat to the cylinder, it was found that an engine of the first type using 100 heat-units would convert 21 units into mechanical work, in the second type 36 units, and in the third type 45 units. The great advantage of compression was clearly seen by the simple operation of compression before heating, the last engine giving for the same expenditure of heat 2.1 times as much work as the first. In any gas-engine compression before ignition, (igniting at constant volume and expanding to the volume as before ignition), the possible duty,  $D$ , was determined by the atmospheric absolute temperature after compression,  $T$ ; and hence

$$D = \frac{T-t}{T}$$

whatever might be the maximum temperature after ignition.

In the formula  $D =$  duty,  $T =$  temperature after compression,  $t =$  temperature before compression. Increasing the temperature of ignition increased the power of the engine, but it did not cause the conversion of a greater portion of heat into work. That is to say, the possible duty of the engine was determined solely by the amount of compression before ignition. Compression made it possible to obtain from heated air a great amount of work with but a small movement of piston, the smaller volume giving greater pressures and thus rendering the power developed mechanically available. Seeing the great difference produced between types *one* and *three* by the simple difference in the cycle of operation when there was no loss of heat through the outside of the cylinder, the questions arose: which engine in actual practice, (with the cylinder kept cold by water) would come nearest to this theory? In which of the engines would there be the smallest loss of heat? Comparing the two engines, with equal movements of piston, it was found that the compression engine had the advantage of a lower average temperature, and a greater amount of work done; also of less surface exposed to flame, consequently it lost less heat in the cylinder. Taking all the circumstances into consideration, it was certainly not over-estimating the advantage of the compression engine to say that it would, under practical conditions, give for a certain amount of heat three times the work it was possible to get from an engine not using compression.

It is interesting to calculate the amounts of gas required by the three types under the supposed conditions. Taking the amount of heat evolved by one cubic foot of average coal gas as equivalent to 505,000 foot-pounds, and calculating the gas required if all the heat were converted into work, it was found to be 3.92 cubic feet per hour per horse-power. Therefore, the amounts of gas required by the three types of engines would be:

$$\text{Type one } \frac{3.92}{0.20} = 18.3 \text{ cubic feet per hour per horse-power.}$$

$$\text{Type two } \frac{3.92}{0.36} = 10.9 \text{ cubic feet per hour per horse-power.}$$

$$\text{Type three } \frac{3.92}{0.45} = 8.6 \text{ cubic feet per hour per horse-power.}$$

Comparing these figures with results obtained in practice



from the three types of engine losing heat through the sides of the cylinder, it was ascertained that the amount of gas consumed was as follows: Type one (Lenoir) 95 cubic feet per hour, per indicated horse-power; (Hugon) 85 cubic feet per hour, per indicated horse-power. Type two (Brayton) 50 cubic feet per hour, per indicated horse-power. Type three (Otto) 20 cubic feet per hour, per indicated horse-power.

It will be seen that the order of consumption coincided with the theory. The Otto engine converted about 18 per cent. of the heat used by it into work, while the Hugon engine only converted 3.9 per cent. Taking the loss of heat to the cylinder as given by the comparison of the *adiabatic* line of fall of temperature with the actual line of fall as shown on the indicator diagram, it appeared much less than was really the case, as shown by the gas consumed by the engine. The maximum pressure produced was much less than would be expected from the amount of gas present. This was due to the limiting effect of chemical dissociation. The gas-engine presented a more complicated problem than a hot-air engine using air heated to the same degree. Analyzing the disposal of 100 heat units by Clerk's gas engine, it was found to convert 17.8 into work to discharge 29.3 with the exhaust gases, and to lose through the sides of the cylinder and piston 52.9 units. About one-half of the whole heat used passed through the cylinder, and was expended in heating the water-jacket. St. Claire Deville had shown that water was decomposed into its constituents at a comparatively low temperature, considerable decomposition taking place at 1200 degrees Centigrade (2192 Fahr.). The cause of so near an approach to the line of theoretical fall, as shown by the actual indicator diagram, was simply the continuous combination of the dissociated gases. At a maximum temperature of about 1600 deg. Cent. (2912 Fahr.), complete combination of the gases with oxygen was impossible, and could only take place when the temperature fell low enough.

In calculating the efficiency of the gas-engine from its diagram, all previous observers had fallen into error, through neglecting the effects of dissociation, and, accordingly, their results were much too high. To account for this so-called sustained pressure, Otto advanced the theory that inflammation

was not complete when the maximum pressure was attained at the beginning of the stroke, but that by a peculiar arrangement of strata he had made it gradual, and continued the spread of the flame while the piston moved forward. Otto called this slow combustion. This designation seemed erroneous to Clerk. Such action should rather be called slow inflammation. It existed in the Otto engine, but only when it was working badly, and was attended with great loss of heat and power. This was proved by a diagram, and by certain considerations deduced from Bunsen and Mallard's experiments on the rates of propagation of flame through combustible mixtures. The conclusion arrived at was that slow inflammation was to be avoided in the gas-engine, and that every effort should be made to secure complete inflammation at the beginning of the stroke. Clerk found it possible to ignite a whole mass in any given time, between the limits of one-tenth and one-hundredth part of a second, by arranging the plan of ignition so that some mechanical disturbance by the entering flame was permitted. A diagram taken from the Otto and Langen free-piston engine, as given in a paper by Mr. F. W. Crossley, and an analysis of his reasoning, showed that the results were misinterpreted, and false conclusions arrived at concerning the nature of an explosion. Mr. Crossley considered that an explosion of gas and air, pure and simple, must be accompanied by a rapid rise and an almost instantaneous fall of pressure. This, he thought, was proved by the diagram, but in this statement the author could not concur.

From the considerations advanced in this paper, it would be seen that the cause of the comparative efficiency of the modern gas-engine over the old Lenoir and Hugon type may be summed up in one word—compression. Without compression before ignition an engine could not be produced giving power economically and with small bulk. The mixture used might be diluted, air might be introduced in front of gas and air, or an elaborate system of stratification might be adopted, but without compression no good effect would be produced.

#### Early Gas-Engines.

The early motors, in which work was attempted to be performed by means of heat generated by the combustion of illuminating or similar gases, may be classed as follows:

The first motor, having a cylinder and piston, was introduced in 1685, and was designed by *Huyghens*, in which powder was exploded to generate the gas to drive it. *Papin* in 1688 also invented a similar machine. The labors of these pioneers were not crowned with success, and the gas-engine remained in this embryo condition for more than a hundred years. In 1791, one John Barber took out a patent in England for the production of force through the combustion of hydrocarbons in air.

In 1794 Robert Street also patented a gas-engine, and in 1801 Franzose Lebon, in which the ignition was produced by an electric machine, also patented one. In 1823 Samuel Brown invented one, and also in 1833 a Mr. Wright. This latter machine showed substantial progress, compared with previous efforts. It stood nearly on a level with modern constructions, having a water-jacket, flame ignition, and was provided with a centrifugal regulator, which regulated the air and gas supply in proportion to the requirements of the work, so that the total quantity of gas remained the same, and consequently the condition of the mixture was unchanged.

Up to 1841 quite a number of gas-engine patents were issued which are not worthy of mention, except one, specified by Johnson in the above year. This patent pointed to the explosive working effect of a mixture of oxygen and hydrogen, as well as to utilizing the effect of the vacuum after the combustion.

To show how justly the value of gas-engines was recognized, I quote a letter written in 1826 by Cheverton: "It has been the wish for a long time of the practical mechanic to succeed in the possession of a dynamic engine which is always ready for work without costing too much to drive, and causing no loss of time in preparation. These properties would make it in every case applicable when only a small force is necessary at irregular times; and the avoidance of manual labor is so important that the advantages which society would derive from such a machine would be incalculable, even if the cost should be much greater than with the employment of steam."

In 1855, Dr. Alfred Drake, of Philadelphia, succeeded in constructing a gas-motor as before described, which was followed in 1860 by the Lenoir gas motor, which caused unusual attention, and justly so; for unscrupulous claims were every-

where made for it. It is only just to state, however, that the engines at the beginning worked tolerably well, as they were carefully constructed and finished. Through these good properties many persons were led into giving orders without any proof of the cost of working. These were so numerous that a special company was formed—the Lenoir Company—to undertake the construction. When these engines were put in place, and the gas bills appeared, it was found by the users that instead of a consumption of a half cubic meter (17.6583 cubic feet) of gas per hour per horse-power, the Prony brake exhibited, with unerring certainty, that three cubic meters (105.96 cubic feet) at least were required on an average. *Hugon*, the director of the Parisian gas works, and *Keithmann*, a watchmaker, of Munich, hotly contested Lenoir's priority of invention.

FIG. 136.

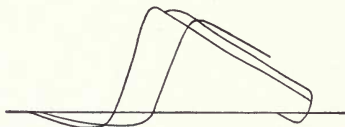

Up to this time, independent of the large consumption of gas, the great difficulty in the way of constructing a satisfactory gas-engine has always arisen from the *suddenness* of the explosion and expansion which has to be utilized, as shown in the accompanying diagrams taken from a Lenoir gas-engine about 1866.

FIG. 137.

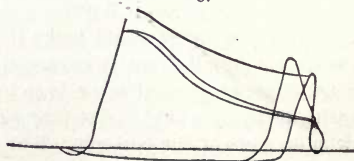

The engine from which these diagrams were taken had a cylinder 8.66-inch diameter, with a stroke of 16.25 inches, and the explosion of the mixed air and gas was arranged to take place at half stroke. Diagrams Figures, 136, 137 and 138 were

taken at a speed of 50 revolutions per minute. The explosion did not take place immediately upon the closing of the valve, and the pressure of the mixed air and gas within the cylinder consequently fell, as the piston advanced, to 11 pounds above a vacuum. When the explosion took place the pressure rose to 48 pounds, the time occupied by the explosion appearing to be about  $\frac{1}{7}$  of a second.

At the Paris International Exhibition of 1867, and at Philadelphia in 1876, Otto and Langen, of Deutz, exhibited their atmospheric gas-engine. As the name implies, the explosive effect of the gas in this engine was by no means employed direct for the performance of work; it only served to throw up

FIG. 138.

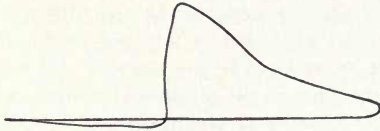

the piston of the simple working cylinder, whilst it was out of connection with the shaft of the engine. In order to procure a place for the combustion products, the tension of the latter was caused to fall very suddenly, in consequence of outside cooling, and the vacuum succeeding allowed the piston to drop by its own weight; and then, in connection with the shaft, the stroke was not so sudden as that of Lenoir's. But it had many drawbacks, which at one time were relatively great. It had many complications in construction, which were calculated to cause doubts as to its durability, and it also made a horrible noise, much more unpleasant by reason of its irregularity. Notwithstanding these drawbacks, the engine had great advantages, which covered its defects. It used very little gas at the beginning, 1.2 cubic meters, or 38.852 cubic feet, finally only 0.8 of a cubic meter (or 28.26 cubic feet per hour per horse-power), a result which hitherto had not been exceeded. It was, therefore, practically useful for small industries. It could not only compete with the steam-engine, but in many cases, beat it out of the field.

As before stated, in the Otto and Langen gas-engine the suddenness of the explosion and expansion which was to be utilized was surmounted very ingeniously by allowing the expansion to take place under a *free* piston, whose velocity was not limited by the motion of a crank, and engaging the piston-rod with the driving shaft only on its downward stroke. In this way the sudden expansion could, of course, be more completely utilized than where the velocity was limited by the motion of a crank, and engaging the piston-rod with the driving shaft only on its downward stroke. Further, the sudden expansion could be more completely utilized than where the velocity of the piston was controlled by the usual connection to a crank-shaft. The whole arrangement had, however, very distinct drawbacks, and was obviously open to improvement.

In "Otto's" silent gas-engine the difficulty arising from the suddenness of the explosion is removed in a totally different way, namely: by making it less sudden. This could not be done previously, because the mixture of air and gas was always drawn into the cylinder at atmospheric pressure, and was already used as dilute as was possible under these conditions. If, however, the mixture could be used *under pressure*, a much larger dilution of air could be employed without destroying its explosiveness, and in consequence, the violence and rapidity of the explosion would be very much reduced. It is upon this principle that the engines of to-day are constructed. The sudden explosion has been reduced to what is really not much more than rapid combustion and expansion, but not too rapid to be used without loss at the beginning of the stroke of an engine arranged in the usual way.

These gas-engines in general external appearance resemble an ordinary horizontal engine, but the resemblance is only superficial. The cylinder is single-acting, open at the front end, and so arranged that it only completes its cycle of operation once in *two* complete double strokes. Its method of working is as follows: The piston in moving forward draws into the cylinder a mixture of air and coal gas, the latter in measured quantity. Returning, it compresses this mixture into little more than one-third of its volume, as drawn in at atmospheric pressure. These two operations require one complete double stroke. As the

piston is ready to commence the next stroke the compressed mixture is ignited, and expanding, drives the piston before it, while in the second return stroke the burnt gases are expelled from the cylinder, and the whole made ready to start afresh. Work is actually being done on the piston, therefore, only during one-quarter of the time it is in motion, the gearing, as well as the work driven, being carried forward by the fly-wheel during the rest of the time.

The cylinder is enclosed in a water-jacket in order to prevent overheating. To insure a circulation of water, it has been

FIG. 139.

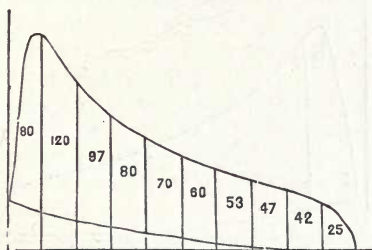

found sufficient to simply connect the top and bottom of the jacket with the top and bottom of a filled reservoir, the difference in the densities of the hot and cold water being enough to set up and maintain the requisite circulation. The cylinder is also cooled sufficiently by contact with the air in the reservoir to be used continuously. To avoid shock at exhaust, the hot gases are discharged through a pipe into a reservoir placed at a little distance, from which they pass into the atmosphere.

Diagram Fig. 139 was taken from what is called a five-horse engine, diameter of cylinder being 6 inches with a stroke of 12 inches, making 160 revolutions per minute; scale of indicator, 112 pounds equal one inch.

From diagram Fig. 140 it appears that the pressure comes on very gradually, and that about one-tenth of a revolution is required for the maximum pressure to be attained. Therefore, there is not an explosion, but a gradual combustion. The indicator diagram (Fig. 140), scale 112 pounds = one inch, is

a fair sample of a card taken from a Otto gas-engine. Beginning at *A*, the gas and air are entering the cylinder up to *D*, at this point the inlet-valve closes, and on the return stroke the gases begin to compress at *h* into the clearance space at the back end of the cylinder. This compression is represented by the line *h i*, and shows a pressure of about 45 pounds at *i*. One revolution of the engine is now complete, and the charge is ignited just as the crank is passing the center. The rapid

FIG. 140.

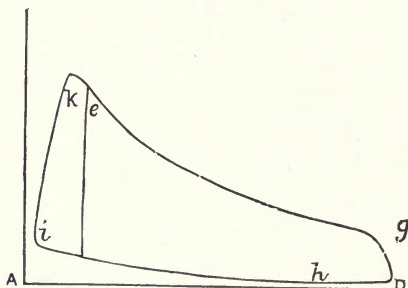

burning of the gas liberates a large amount of heat, increasing the temperature and pressure, which latter reaches about one hundred and fifty pounds per square inch as a maximum. The line *i, k, e*, is called the explosion or rapid combustion line. The gases now expand during the second forward stroke and exert power upon the piston, which, by means of the fly-wheels, carries the engine through the remainder of the revolution. At *g* the exhaust valves open, allowing the burned gases to escape. The line *D to A* shows the pressure, while these gases are being expelled by the second return stroke of the piston.

When the governor prevents the admission of gas to the cylinder, the cycle is somewhat modified. After compression of the air no explosion can take place, since there is no combustible mixture present. The expansion line then follows closely the previous compression line, and the cycle is completed by expulsion of the air. Two revolutions are required to complete the cycle when the engine takes gas at every charge; and four,



six, eight, and sometimes ten revolutions may occur before the engine returns to its original state.

In fact, the new Otto motor is distinct from its predecessors, by its very pleasing appearance, quiet, regular action, and harmonious dimensions, and accordance with recognized principles in three points, namely:

*First*—In the compression of the gas mixture before ignition; and, on account of its compactness.

*Second*—Having a great piston velocity, the change of heat into work is facilitated by prolonging the combustion.

*Third*—By modifying the initial temperature, and by better employment of the heat generated, in consequence of the cooling of the cylinder. In fact, the Otto is one of the most efficient constructions in the line of gas-engines, and is a striking example of skill and of deep thought.

*The cost of working.*—The consumption of gas stands only a little higher than that of the atmospheric-engine; the smaller powers use, on an average, 24 cubic feet per hour per horsepower, while for the larger constructions the consumption of gas is about 22 cubic feet.

Notwithstanding these engines are single-acting, they run very regularly, particularly with a heavy load. Suction takes place with pressure a little under 15 pounds, the compression shows 45 pounds; through the explosion the pressure is sent up to about 165 pounds, and falls gradually again in consequence of the expansion to 45 pounds. Then the outlet valve opens at about 10 per cent. of the piston-stroke before the end of the stroke, when the pressure is about 15 pounds, remaining so to the end. The gases escape at about 400 degrees. From the diagrams it is conclusive that the highest temperature is 900 to 1000 degrees. The indicated work represents about 18 per cent. of the total heat of combustion of the gas. The useful actual work is  $14\frac{1}{2}$  per cent. The best steam-engines utilize only *ten per cent.* of the total heat of combustion of the coal, and small engines scarcely exceed *five per cent.*, so that it will be seen that the gas-engine is by far the more perfect heat-engine.

## The Clerk Gas-Engine.

This engine possesses the distinctive feature of making an explosion at every revolution. The engine comprises two cylinders—the working, and the so-called “displacer” cylinder. The pistons of the former are connected to the crank in the ordinary manner, but the piston of the displacer cylinder, in which the pressure is very slight, never exceeding 5 pounds to the square inch, is driven by a pin in the arm of the fly-wheel. The pin is at right angles to the crank and in advance of it. When the piston in the displacer advances, a combustible mixture of gas and air is drawn in during the first half of the stroke; the admission valve is then closed, and air is admitted during the remainder of the stroke. On the return of the piston a valve is opened, making a communication between the two cylinders. At this time the piston of the driving cylinder is at the outer end of its stroke, and an annular port is opened, communicating with the exhaust pipe. Through this opening the products of combustion from the last explosion pass, the pressure in the cylinder falls, and the cylinder is ready to receive its next charge from the displacer chamber. The first portion that enters the cylinder from the displacer is the pure air that passed in after its piston had reached the half stroke, and the combustible mixture of gas and air had been cut off. This flows through the motor cylinder, washing it out as it were, at each stroke, and escaping through the exhaust until the latter is closed by the piston starting on the return stroke. Meanwhile, the explosive mixture has followed the pure air into the motor cylinder, and remains, as the exhaust opening has now been closed. The returning piston compresses this mixture in a space at the end of the cylinder until it is about 45 pounds pressure, when the charge is exploded. The pressure then rises to, say 250 pounds per square inch, driving the piston forward to the other end of the cylinder, when the exhaust is again opened, and the exploded gases escape, leaving the cylinder free for the next charge from the displacer. This series of operations takes place at every stroke.

It will be noticed that a particular feature of this engine is the passing through the cylinder at each stroke a volume of

pure air, which cools it down and at the same time thoroughly displaces all the residual gases from the previous stroke. To produce this result the capacity of the displacer-chamber is larger than that of the driving cylinder, and the space at the end into which the explosive mixture is compressed; and as half of each charge from the displacer is pure air, the desired object of cleaning and cooling the cylinder at every stroke must be attained. In large engines this device should be of the greatest possible service, as it should effectually prevent premature firing of the explosive charge, which would otherwise sometimes occur through the existence of sparks from the ignition of particles of carbon on the sides of the cylinder. The volume of air which sweeps through the cylinder at each stroke in the Clerk engine cools it down so as to prevent the existence of sparks, or if they should be created, removes them as it passes rapidly to the exhaust. The valve-gear and cut-off arrangement are very simple. The mixed charge of gas and air is admitted into the displacing chamber by an automatic lifting valve, and another similar valve makes a communication between the displacer and the driving cylinder. This is actuated by the pressure of the air and gas in the displacer, but this pressure is very low, all that is required being sufficient to raise the valve and help to displace the residual gases left by the previous explosion in the motor cylinder. The ignition of the mixture at each stroke is effected by a small slide at the back of the engine, worked by an eccentric on the main shaft, and the same slide cuts off the supply of gas to the displacing cylinder at half stroke. The igniting device is very perfect, and as it is required to operate more frequently than in gas-engines, where explosions take place every second revolution, it also forms a novelty in detail. In the ignition slide is a cavity, from each end of which is a small port leading to opposite ends of the slide. At one end of the cavity is a perforated plate, through which the explosive mixture passes from the motor cylinder, communication being made by a small hole in the slide and a groove in the face of the slide, which is always in a passage in the engine face leading to the combustion chamber at the end of the motor cylinder. After passing through this perforated plate, the mixture is lighted by a Bunsen burner, the flame fill-

ing the cavity and discharging at the port in the face of the slide. The movement of this latter opens this port into a port on the side of the combustion chamber, causing ignition at each stroke. So efficient is this arrangement that it will operate successfully at a speed of 300 explosions a minute, a far higher rate than can be obtained, or is indeed required, by the ordinary gas-engines. Before the ignition slide is open to the combustion chamber, it is of course closed to the atmosphere. The ignition port is very small, 0.5 inch by 0.25 inch, so that a very moderate pressure keeps the slide to its face, even against the 250 pounds per square inch caused by the explosion. The slide being so small, there is no necessity for ventilating the port, as the mixture from the cylinder requires no exterior air to support its

FIG. 141.

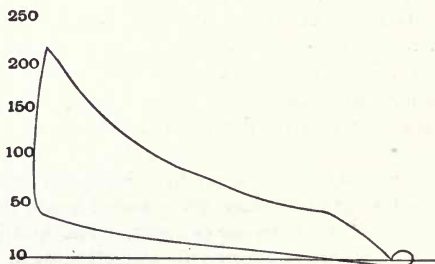

combustion. It may be mentioned that the admission valve to the displacer chamber, and that between this latter and the driving cylinder, are prevented from rattling by a very simple arrangement of air cushion.

It will be seen by the indicator diagram, Fig. 141, that in this engine the expansion is only continued until the volume of the hot gases becomes equal to the volume before compression.

Diagram, Fig. 142 was taken from a 12 horse-power engine running with full load. Diameter of cylinder, 9 inches; length of stroke, 20 inches; revolutions, 132 per minute; mean pressure, 66.1 pounds per square inch; maximum pressure,  $177 + 55 = 232$  pounds; pressure before ignition, 55 pounds; indicated horse-power, 28.01; consumption of gas per indicated horse-

power, 23.21 cubic feet; consumption of gas per brake horse-power, 24.12 cubic feet.

Fig. 143 is from Clerk's gas-engine; diameter of motor-cylinder, 6 inches; stroke, 12 inches; and rated by the makers as 6 horse-power. The indicated horse-power is 9.15, while the effective power given out on the brake was 6.56 horse-power;

FIG. 142.

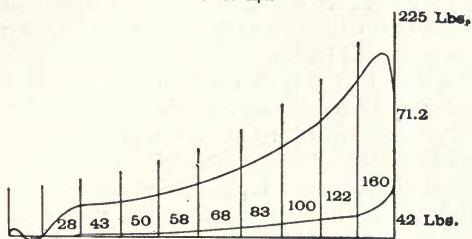

the consumption of gas being at the rate of 21.8 cubic feet per indicated horse-power, or 30.2 cubic feet per hour per brake horse-power. It will be seen from the diagram that a very rapid ignition is obtained, in fact, the inventor endeavors to make this ignition as rapid as possible.

FIG. 143.

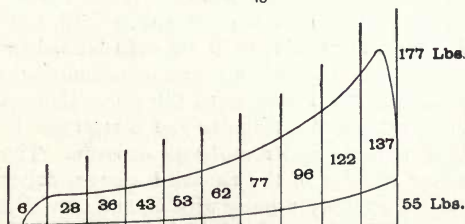

The "Stockport" Gas-Engine.

This gas-engine was exhibited for the first time in this country at the Novelties Exhibition, Philadelphia, and attracted considerable attention. As it possesses very many points of interest, a short description may prove of interest.

The Stockport gas-engine is of the type (3) of those which

compress the charge, and have an explosion at every revolution, whether the engine be lightly or heavily loaded. It consists of two cylinders, arranged on the same axial line; one draws in the combustible mixture of gas and air, the other acts as the working cylinder in which the charge is exploded to produce power. The pistons of these two cylinders are connected by a trunk, so that they are in rigid union, moving simultaneously in the same direction. The central part of this trunk, in the free space between the two cylinders, is partly cut away, so that for a portion of its length it is no longer cylindrical, but rather less than half a cylinder. This is for the purpose of accommodating the connecting rod, which is pivoted at one end in the center of the trunk, and at the other end to the crank-pin, which works in the reduced portion of the trunk. The whole arrangement is similar to some form of steam pumps, with the crank-shaft midway between the steam and water cylinder.

This engine differs from the Otto, from the fact that there is an explosion at every revolution. The operation is simple and is easy to follow. Commencing with the explosion, the working piston is driven forward by the force of the expanding gases, which follow it almost to the termination of its stroke. Just before it reaches the end, however, it passes an open exhaust port, communicating through a pipe with the outer air. At this point the gases have, in the normal conditions of working, a pressure of about 30 pounds per square inch, and they instantly discharge themselves until the cylinder and combustion chamber are filled only with products of combustion at atmospheric pressure. At this moment the slide-valve opens communication between the cylinder and a reservoir filled with combustible mixture under moderate pressure. This sweeps out whatever remains of the exploded charge, driving it before it without sensibly mixing with it, and completely filling the cylinder before the piston (which has now commenced its return stroke) covers the port. All this occupies but a very slight portion of the piston-stroke, but as it travels very slowly for a considerable angle of the crank on each side of the center, there is ample time for the evacuation of the spent charge and the introduction of the new one. The piston now moves inwards, driven by the work stored in the fly-wheel, and com-

presses the mixture in the combustion chamber at the end of the cylinder until the crank again passes the center, when the ignition port is opened, and the revolution is complete.

Commencing now with the supply cylinder, also at the moment when the explosion occurs, we find the cylinder filled with an intimate mixture of gas and air. These two fluids are intentionally blended as completely as possible, stratification, or the introduction of air cushions, being purposely avoided, as the thorough ventilation of the working cylinder at each revolution keeps the temperature of the metal and the residual gases below the point at which they will ignite the incoming charge. As the piston moves backward it forces the mixture into a reservoir in the bedplate of the engine, where it is momentarily retained, and then, on its outward stroke, it draws in a fresh supply. Thus it will be seen that when the working piston is driven by an explosion, the supply piston forces a charge into the reservoir ready to sweep out the products of combustion, and to take its place ready for compression; and when the working piston is compressing this charge, the supply cylinder is being filled afresh.

As there is an explosion at every revolution, it follows that the strength of the charge must be varied to suit the load on the engine. This is done by a governor which controls a small equilibrium valve in the gas passage, raising and lowering it as the speed increases and decreases. There is, however, a limit beyond which this method of regulation cannot be carried, for if the mixture be made too dilute it will not ignite. If an engine were running absolutely empty it might easily happen that the lowest ignitable mixture would provide too much power, and the result would be an excess of speed. To prevent this the governor, besides controlling the throttle valve, determines the position of a stud on a lever connected with a valve on the cylinder. At a given speed the stud is moved into the path of a tappet, and opens the valve when the compression is taking place in the working cylinder. The result of this is that a part of the charge is driven out of the cylinder through a pipe which ends in the air inlet pipe to the supply cylinder, from which the rejected charge is drawn at the next stroke and delivered again to the reservoir.

Besides the above mentioned tappet valve, which is usually out of action, there are only two valves in the engine, both of them slide valves, and both operated from the same eccentric. The working cylinder valve is driven direct, as in a steam-engine. The supply cylinder valve is worked by an arm at the end of a small weighted shaft, the other end of which carries a slotted lever gearing with a pin projecting from the strap of the eccentric. This pin follows a curved path, moving backwards and forwards in the slot, the result being that the angular velocity of the lever, and consequently the speed of travel of the valve, varies very greatly at different parts of the stroke. The valve of the supply cylinder is a flat plate working between the face on the cylinder and a back plate, in which there is a cavity in constant communication with the gas pipe after it has passed the throttle valve. There are three ports in the cylinder face, one opening into the air, one to the cylinder, and one to the reservoir, and there is a cavity in the face of the valve with a number of small passages leading from it to meet the cavity in the back plate. During the indrawing stroke the gas enters the valve in fine streams, and the air sweeps across it at right angles as it is drawn to the inlet port of the cylinder. At the end of the stroke the movement of the valve cuts off the gas and air, and puts the cylinder port in communication with the pipe leading to the reservoir. The whole arrangement is exceedingly simple, and resembles the valve of a single acting steam engine.

The valve of the working cylinder is likewise a flat plate-valve. It slides on the side of the cylinder, not the end, in the same way as the valve of a steam-engine. Its function is to put the cylinder in communication with the reservoir when the piston passes the exhaust-port, and to break the communication when the piston again closes the port. In addition to this very simple operation, it has to effect the ignition of the charge. The master-light burns in a recess or chimney formed in the end of the cylinder, or more correctly, in the combustion chamber. It has an opening through the valve face, and past this opening there travels a cavity in the valve. This is supplied by gas, which becomes ignited, and in this condition is carried to the main port of the cylinder, the whole width of the cavity being



presented to the port at once, insuring the certainty of an explosion. The valve is cored out for the circulation of water, which enters and leaves through flexible connections. By this means its temperature is kept at a point where there is little fear of seizing or cutting. It is held up to its place by a back-plate with springs under the nuts which secure it, and is further retained by clamps on the studs. These give way as the valve expands, and allow it to obtain just the amount of room which it requires.

The gas consumption of these engines is 35 cubic feet per actual horse-power per hour, or 20 cubic feet per indicated horse-power per hour, when running at their full capacity. The average pressure in the cylinder is about 74 pounds per square inch, the initial and terminal pressures being 210 pounds and 30 pounds. The motion is regular, since there is an explosion at each revolution, whether the load be light or heavy, and any sudden increase of work cannot stop the engine.

Its regularity will commend it to those who require steady power, while its general simplicity and its compact design will attract users who do not understand complicated machinery.

#### The Atkinson Gas-Engine.

Diagrams Figs. 144, 145 and 146 were taken from a six horse-power Atkinson "cycle" gas-engine combined with a pump. By means of the link work the piston has imparted to it four strokes for each revolution of the crank shaft. These strokes all vary in length, being as follows:

|                              |                          |
|------------------------------|--------------------------|
| Suction stroke . . . . .     | 6 $\frac{1}{8}$ inches.  |
| Compression stroke . . . . . | 5 inches.                |
| Working stroke . . . . .     | 11 $\frac{1}{8}$ inches. |
| Exhaust stroke . . . . .     | 12 $\frac{1}{2}$ inches. |

The cycle commences, say at the end of the exhaust stroke, the piston at this time being as close to the end of the cylinder as is compatible with safety, thus driving out practically all the residuum, which is still further cleared out by the momentum of the exhaust gases in the exhaust pipe dragging a little air through the passages and small clearance space left. From an economical point of view it is now pretty well understood that the total elimination of the burnt gases is a desirable feature;

in fact, engines have recently been made which sacrifice an entire revolution for the purpose of obtaining this desirable object.

A short suction stroke is now made, followed by a slightly shorter compression stroke, the difference in the lengths of these strokes leaving a chamber into which, together with the clearance spaces, the charge is compressed. At this time ignition takes place and a long working stroke is made, followed by a slightly longer exhausting stroke, when we arrive at the completion of the cycle, the whole being performed during one revolution of the crank shaft.

The arrangement of this engine is very simple of construction and very economical in running. There are only three valves in the engine: the exhaust-valve, which is similar to that commonly used in most gas-engines, the suction valve, which is practically a duplicate of the exhaust valve, and the gas governor valve, which is also similar to those commonly used for the same purpose. The exhaust valve is opened by a cam on the main shaft, the cam rod working a lever which opens the valve. The suction valve is operated in a similar manner. Both these valves open inwards, so that any pressure in the cylinder tends to keep them closed. They are also closed by one spring which is arranged between them operating through a yoke which presses against the ends of bridles on each of them. The gas governor valve is opened by the suction valve cam whenever the governor permits of its being so opened. The ignition is caused by the compression forcing a portion of the charge into a small tube which is closed at the outer end and kept red-hot by means of an external "Bunsen" burner. There is no valve in connection with this ignition arrangement, the timing of the ignition being caused by the chimney being raised or lowered. As the charge is always uniform throughout its volume, this gives a sufficiently regular ignition for practical purposes, and doing without a valve in this position gets rid of what has hitherto been the greatest source of trouble with gas-engines. We are informed that several of these engines have worked for six months ten hours every day without a valve being removed for cleaning, without the piston being taken out, and without a single bearing being adjusted. This seems com-

ing within measurable distance of the simplicity and certainty of a steam-engine.

The great economy of these engines is obtained mainly from two causes. In the first place, it will be seen that unlike any other gas-engine, the expansion of the ignited charge does not end when it has reached the original volume of the charge, but is continued to any desired extent, generally about twice the original volume. This continued expansion adds about a third more work for the same consumption of gas; its value is very much increased from the second main source of economy, which is the rapidity with which the expansion takes place. Other gas-engines expand to original volume during one-half of a revolution, this one expands to original volume during one-eighth of a revolution, so that work is done four times as fast. When it is understood that one of the greatest sources of loss is the passage of heat through the walls of the cylinder to the water jacket, it will be seen how necessary it is to do the work rapidly. From this cause the expansion line of the diagram, when the expansion has taken place as far as original volume, will be found to be from five to ten pounds higher (it is generally about forty-five pounds); this leaves a considerable pressure with which to continue the expansion. The terminal pressure is generally about fourteen pounds, which gives a quiet exhaust and a better opportunity for the gas to be thoroughly consumed during the working stroke.

In all gas-engines there is a heavy initial pressure which in every other instance is transmitted to the crank-pin and main bearing. Here, however, this heavy pressure is transmitted directly to the long bearing of the vibrating link. This bearing is made the whole width of the engine, is lined with white metal, and thus takes this heavy shock without any straining and with very little friction or wear.

Taking an ordinary diagram from one of these engines, the pressure on the crank-pin and main bearings never exceeds about thirty-five per cent. of the maximum pressure on the piston. The work done in the cylinder during the early part of the expansion is also transmitted more gradually to the crank-pin, so there is not the jerkiness in running so commonly associated with gas-engines; combining this with the ignition at

every revolution controlled by a wonderfully sensitive governor, the running of these engines is remarkably steady and regular. The makers assert that when everything is in first-rate order they will not vary more than from one to two per cent. between maximum and minimum loads, and that it is perfectly immaterial how suddenly changes in the working load are made.

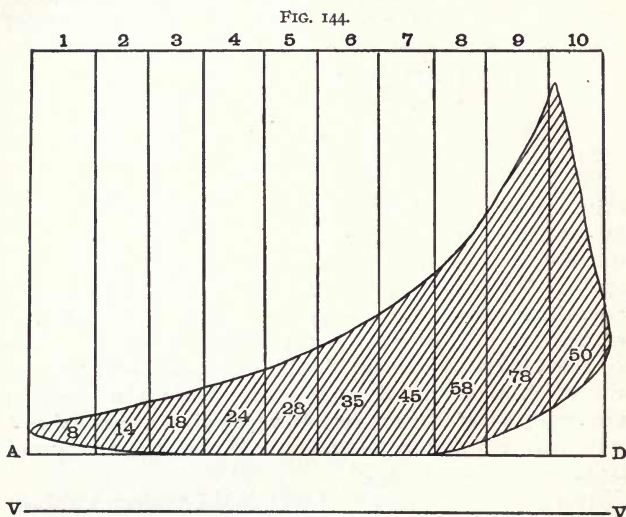

Governor cutting out 20 per cent. of ignitions.

Stroke Suction  $6\frac{1}{8}$  inches.

Stroke Compression 5 inches.

Stroke Working  $11\frac{1}{8}$  inches.

Stroke Exhaust  $12\frac{1}{8}$  inches.

The pressures being as follows:

$$50 + 78 + 58 + 45 + 35 + 28 + 24 + 18 + 14 + 8 = 358.$$

$$\text{Mean average pressure} = \frac{358}{10} = 35.8 \text{ pounds.}$$

A trial was made for five hours of a six horse-power nominal Atkinson patent "Cycle" gas-engine working a double-acting

pump direct, the engine being driven by "Dowson" gas. The pump being four inches in diameter, and the stroke can be adjusted from eight to twelve inches. The water was taken from a reservoir under the engine-room floor, and delivered through a six-inch rising main into a storage reservoir 2043 feet distant, and elevated 171 feet high, revolutions of engine 120 per minute.

FIG. 145.

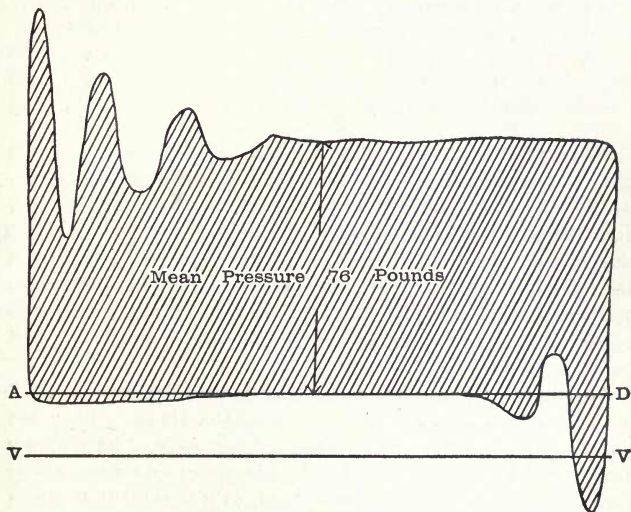

Pump 4 inches diameter.

Stroke adjusted to  $8\frac{1}{8}$  inches.

Revolutions 120 per minute.

Diagram from bottom of pump.

Diagram Fig. 145 was taken from the pump, from which it will be seen that its full capacity was delivered. Diagram Fig. 144 was taken at the same time from the engine, the gas consumption being also taken by observing how long it took for a gas-holder six feet in diameter to fall four feet. The engine diagram is by no means as full as can be taken with "Dowson" gas, but as the engine was only taking ninety-six ignitions per minute the gas was reduced so as to give diagram Fig. 144.

The following is the result of this trial:

|   |       |
|---|-------|
| Indicated horse-power in engine, . . . . .                                    | 6.951 |
| Indicated horse-power in pump, . . . . .                                      | 4.538 |
| Actual horse-power in water lifted, . . . . .                                 | 4.5   |
| Dowson gas per hour in cubic feet, . . . . .                                  | 542.0 |
| Equivalent in coal, coal consumption in pounds, . . . . .                     | 7.74  |
| Dowson gas per indicated horse-power in engine in cubic feet, .               | 78.0  |
| Equivalent coal consumption in pounds, . . . . .                              | 1.11  |
| Dowson gas per actual horse-power in water lifted in cubic<br>feet, . . . . . | 120.0 |
| Equivalent coal consumption in pounds, . . . . .                              | 1.706 |
| Combined efficiency of engine and pump, . . . . .                             | 63.46 |

When it is understood that this plant was only started for a couple of hours the previous day, the above figures are astonishing, and as the makers state that rapid improvements will take place in the working of the engine and pump, they assert that it is the most economical pumping plant ever erected, and though slightly better figures have been obtained from first-class compound condensing engines of large size, we feel inclined to agree with them, as the saving in first cost of machinery and buildings must also be very great.

Although the pump was running at 120 revolutions per minute, the valves closed without the slightest shock. They are very large diameter, are guided top and bottom, and have strong springs fitted to them. The loss by friction in valves and rising main was only 0.038 of a horse-power, so it is evident that the pump must have worked in a very satisfactory manner. We doubt also whether it would be possible to attain such a high efficiency by using any system of geared pumps. It is needless to state that a plant of this description can be erected for very much less outlay than if geared pumps had been used: not only would the engine and pumps have cost more, but also the foundations and buildings; the cost for maintenance would also be very much increased.

To enable the engine to be started without the load of the pump, there is a bye pass from the delivery to the suction: a reflux valve in the delivery valve just beyond keeps the delivery main charged.

There are no doubt numerous instances in which a plant which is so economical in first cost and working, could be adopted with advantage where the cost of enormous engines, geared pumps, and high buildings, have been prohibitory.

FIG. 146.

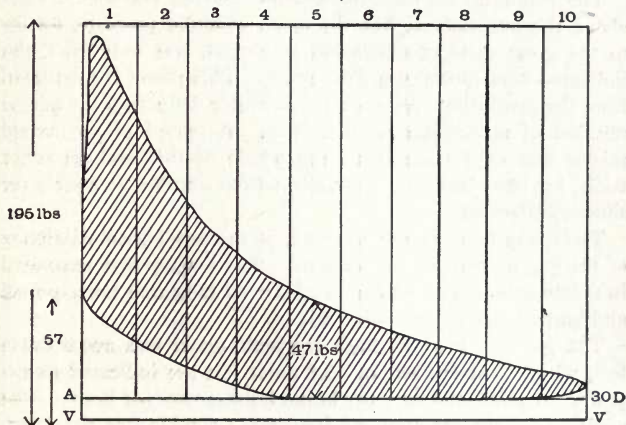

Coal gas. Speed 130 revolutions per minute.

Total pressure  $P = 195$  pounds.

Total compression, 57 pounds.

Total terminal pressure, 30 pounds.

A six hours' continuous brake trial was made of the Atkinson gas-engine, brake loaded for 9.5 horse-power, revolutions 130 per minute. Indicator diagrams were taken every quarter of an hour, and worked out with the number of revolutions made in that interval as read on the counter. The two meters were read every quarter of an hour, and the gas pressure and temperature noted at the same time. The water meter was also read every quarter of an hour. The spring balances on the brakes were read every five minutes. The work taken up by each of the two fly-wheels was kept as nearly equal as possible. The rope brakes were worked perfectly dry, without any lubricant whatever.

The mean speed of the engine was 131.1 revolutions per

minute. The maximum speed for any quarter-hour was 132.7 revolutions per minute, minimum for any similar period 129.2 revolutions per minute. The number of explosions per minute was 121.6, so that 7.2 per cent. of the explosions were cut off by the governor.

The mean initial pressure was 166 pounds per square inch above the atmosphere, but the mean effective pressure, owing to the great ratio of expansion employed, was only 46.1, the indicated horse-power was thus 11.15. This power is calculated from the revolutions per quarter-hour after deducting the actual number of misses during that time. A record of the actual misses was kept throughout the whole of this and all other trials, by two observers, who relieved one another at hourly (or shorter) intervals.

The brake horse-power was 9.48, so the mechanical efficiency of the engine reached 85 per cent. The horse-power expended in driving the engine (difference between indicated horse-power and brake horse-power) was 1.67.

The gas per hour through the main meter was 209.8 cubic feet, which is at the rate of 18.8 cubic feet per indicated horse-power per hour, and 22.1 per brake horse-power per hour. The additions of the gas used for ignition, 4.5 cubic feet per hour, raises these figures to 19.2 and 22.6 cubic feet respectively.

Diagrams were taken with a light indicator spring to enable some estimate to be made of the power expended by the engine in what have been called the "pumping strokes." The work done during the pumping strokes was equivalent to a mean pressure during the working stroke of about one pound per square inch, and this corresponds to an indicated horse-power of 0.26.

The calorific value of gas used per explosion was:

$$0.000896 \times 19200 \times 772 = 13,280 \text{ foot pounds per explosion.}$$

The following Table No. 7 gives the actual percentages of heat actually turned into work, etc., the heat per explosion being taken as above at 13,280 foot-pounds:

The actual expenditure of heat was at the rate of 11.250 units of heat per indicated horse-power per hour, which corresponds to the absolute efficiency of 22.8 per cent. above given.



The efficiency of this engine, as compared with a perfect engine working between the same limits of temperature, and receiving the same amount of heat, is 28.2 per cent.

It has been found, by observation extending over a period of five years, that the average cost of a gas-engine is \$60.00 per annum per horse-power, whilst a steam-engine costs about \$50.00.

TABLE 7.

| Items.  | per cent. |
|---|-----------|
| Heat turned into work as shown by indicator diagrams . . . . .                                  | 22.8      |
| Heat rejected in jacket water . . . . .   | 27.0      |
| Heat rejected in exhaust, lost by imperfect combustion, and otherwise unaccounted for . . . . . | 50.2      |
|   | 100.0     |

#### The "Forward" Gas-Engine.

The latest and one of the best gas-engines in the market is the "Forward;" its mechanical simplicity is a great recommendation.

The distinguishing feature of the Forward is a rotating valve by which the ignition of the combustible charge in the cylinder is effected. In this valve there are eight ignition ports which come into action successively. Each port after having fulfilled its office has to make a revolution through an entire circle before it comes into action again, and in the mean time it is exposed to the air, by which the greater part of the heat which it has absorbed is carried away. It thus follows that the valve always works cool, and runs scarcely any risk of cutting, while the constant motion in one direction affords another element of safety. Every time the cylinder takes in a charge the valve gives a partial revolution, but when the gas is cut off completely the valve ceases to move, and the small firing charge which would otherwise be wasted is saved. The number of missed explosions is not, however, great in this engine, as the strength of the charge is reduced as the work falls off until it approaches the point at which it would cease to explode; the gas is then cut off entirely, and the valve left stationary until the governor arm again falls.

A trial of this engine was had at full working load, at half load, and unloaded, the latter test being divided into three parts, at fast, medium and slow speeds. The full working load trial lasted 85 minutes, the speed being 176.86 revolutions per minute. The indicated horse-power was 5.54, and the brake horse-power 4.807, giving a mechanical efficiency of 0.8677. The gas consumed in driving the engine was 163.2 feet, or 20.79 cubic feet per hour per indicated horse-power, and 23.97 feet per brake horse-power. At half power the brake horse-power was 3.084, equal to a gas consumption of 31.86 feet per hour per horse-power. The lighting jet burned about two feet per hour. When the engine was running empty it burned 53 feet of gas per hour at the high speed, 44 feet at the medium speed, and 34 feet at low speed.

#### Self-starting Gas-Engine.

The usual method of starting a gas-engine—by pulling it around until a charge of gas and air had been compressed and exploded—was quite practical when confined to small sizes; but now that gas-engines are so much larger, it is a matter of considerable difficulty to start them. Mr. Clerk has devised an arrangement whereby his engine may be started like an ordinary steam-engine. By means of a valve in the pipe between the displacer cylinder and the working cylinder, the compressed inflammable mixture, instead of entering the latter cylinder, can be directed into a receiver, where it is stored at a pressure of 70 pounds per square inch, the engine running meanwhile by the stored work in the fly-wheel. As the valve is easily manipulated, the charge is delivered alternately to the engine and the receiver, two or three minutes sufficing to raise the pressure to the required amount. To start the engine the crank is left just over the center, as in a steam-engine, in which position the crank of the displacer cylinder is almost vertical, and then the compressed mixture is admitted from the receiver into the displacer, where, acting upon its piston, it starts the engine. At the same time the valve between the displacer cylinder and the main cylinder is raised, and the pressure acts on the main piston through its outward stroke. On the back stroke the charge is compressed, part of it escaping through a valve opened

for the purpose; at the end of the instroke the inflammable mixture is ignited and the engine is fairly started. The communication with the reservoir is then cut off, and the displacer cylinder resumes its usual functions. An engine may be stopped and started many times in succession by one charging of the receiver, and each time without any difficulty; the operation, when the crank is in the right position, being within the capacity of a boy. It has often been proposed to make a self-starting gas-engine, and there are many patents for the purpose, but this is the first time it has come into practical use.

#### Otto's Twin-Cylinder Gas-Engine.

The new twin-cylinder gas-engines are fitted with their self-starting arrangement. These engines are so arranged that when running full power an impulse is given every revolution, instead of every alternate revolution as in the ordinary Otto engine. The two cylinders are placed side by side, and their pistons are coupled to the same crank, so that they move together, while a single valve passes across their back ends and affects the gas and air distribution of both. The ignition arrangements are both such that when the engine is running at its full power the explosion takes place in the two cylinders alternately, one cylinder taking in a charge while an explosion occurs in the other. As the power required is reduced, the governor first reduces the number of explosions made per minute in one cylinder, eventually shutting off the gas supply from that cylinder altogether, and then reduces the number of explosions in the second cylinder, so that at very low powers the engine is driven by explosions in one cylinder only.

The self-starting arrangement consists of a strong cylindrical chamber, or accumulator, placed by the side of the engine, communicating with the adjacent cylinder by a connecting pipe and loaded valve. The arrangement is such that at each explosion, as soon as a certain pressure is reached, a small quantity of the gaseous products passes over into the accumulator. This goes on until the pressure in the accumulator reaches that attained in the cylinder. When the engine has to be started, the gases under pressure stored in the accumulator are admitted to the cylinders by a hand-moved valve, and act on the pistons

just as steam or compressed air would. It is only necessary to give a single impulse in this way to start the engine. We may mention that the valve through which the gases pass to the accumulator is fitted with an arrangement of oil-trap, which renders it necessary that it should only be oil-tight and not gas-tight. This, of course, greatly facilitates the retention of the pressure in the accumulator for long periods. The accumulator has sufficient storage to enable the engine to be started a dozen times, or even more, with one charge, if care be taken in the manipulation of the admission valve.

#### Spiel's Petroleum-Engine.

This petroleum-engine was invented by Johannes Spiel, of Berlin, Germany. It is a very neat and successful form, and in general appearance very much resembles the well-known Otto motor, the points of difference relating mainly to the devices by which the motive fluid is measured and delivered to the cylinder, in admixture with the proper proportions of air. The operation is as follows:

The piston on its outstroke draws in a charge of air and petroleum; it then returns, compressing this mixture, which is exploded as the crank passes the back center. On the next stroke the combustion and expansion of the charge occurs, while the fourth and last stroke drives out the products of combustion. There is thus one working stroke in every four, the motion being continued through the other three by the work stored in the fly-wheel.

The source of power is petroleum spirit, otherwise known as benzoline, or naphtha. This has a specific gravity of 0.7 or 0.71, and a very low flashing point, so that it will not pass the fire test; consequently it cannot be stored and used without special precautions. If the proper conditions are observed, the use of this spirit does not involve any extraordinary risk, for it is employed in large quantities in the dry cleaning process, and also in the manufacture of india rubber. When used with this engine it is stored in a closed receptacle connected by a pipe to the reservoir attached to the cylinder of the engine. From this reservoir a pipe runs to the pump, by which measured quantities are injected to the cylinder. At the bottom of the pump

there is, in place of a foot-valve, a plug worked by a link from a tappet, as will be presently explained. During the induction stroke of the piston, the cock is turned so as to force the liquid in the pump into the space above the inlet valve, whilst at the same time the admission of liquid through the pipe from the reservoir is cut off. During the remaining strokes the cock cuts off the communication with the valve, whilst the pump is again in communication with the reservoir. The petroleum does not pass through the plug, but along a channel cut round it. The passage of the oil, or spirit, from the pump to the cylinder is past the valve, and through the pipe leading into the cylinder. This enters by a pipe, and in passing the valve it drives forward the spirit, breaking it into spray, and carrying it into the cylinder in admixture with itself. The curved gutter formed round the mouth of the pipe (entering the cylinder) serves to arrest any liquid that may be imperfectly mixed, and as the explosive mixture flows over it, and beneath the valve, the gutter tends to direct the current upwards, so as to break up and still further mix the air with the liquid. The valve, the pump, and plug, are operated by a cam on a shaft running parallel with the cylinder, which is driven by bevel gear, and revolves at half the speed of the crank-shaft. A crosshead is connected to a rocking beam, which at its other extremity carries a rod ending in a roller, which runs in contact with a cam, and is raised at the appropriate times. A spring draws down the roller when the projection on the cam has passed. Another portion of the cam opens the exhaust valve. The firing valve consists of a plate operated by a tappet on the end of the parallel shaft. The valve spindle is prolonged and provided with a spring by which the valve is shot back when the tappet ceases to act on the friction bowl. The force of the recoil is moderated by the spring stops which run between the rollers, and must be compressed as the valve nears the end of its stroke.

The firing light is the flame of a lamp which is kept constantly burning. At a suitable moment it ignites the burner in the valve, and by the quick return movement a flash is transported to the firing apparatus in the cylinder. The combustible mixture finds its way into the burner during the compression stroke. In front and surrounding the burner is a chamber

which serves to convey a flame from the outer jet to the charge in the cylinder. The chamber forms an annular space round the burner, and a passage opens into this space, and maintains a communication for the supply of the combustible gas or vapor during the times when the main passage is closed. The gas passing through flows round the burner, and thus becomes heated and ignites more readily. When the chamber is filled with gas the valve is moved by a ram until the burner is opposite the port in the cover. The gas is then ignited by the outer flame, and continues to burn during the return stroke of the firing valve until the chamber comes opposite the passage, when the charge in the combustion chamber of the cylinder is ignited. The maintenance of the firing flame is effected by the flow of gas through the passage.

Engines of  $3\frac{1}{2}$  brake horse-power will work with a consumption of about one quart of benzoline per hour per horse-power. This motor works satisfactorily, does not clog in the valves or cylinders, and bids fair to find a good field where gas is unattainable, and the local rules concerning the storage for petroleum spirit are not too stringent.

#### Dowson's Water-Gas.

In England it has been found that the use of "Dowson gas," after careful trials, has shown a fuel consumption of only 1.2 pounds per hour per indicated horse-power, this amount being equal to the best steam-engine running with steam of a very high pressure. Thus we see that after twenty-five years of improvement the gas-engine has equaled the best steam-engine in economy.

This gas is made in the following described apparatus: The retort or generator consists of a vertical cylindrical iron casing which encloses a thick lining of ganister to prevent loss of heat and oxidation of the metal. At the bottom of this cylinder is a grate on which a fire is built up. Under the grate is a closed chamber, and a jet of superheated steam plays into this and carries with it (by induction) a continuous current of air. The pressure of the steam forces the mixture of steam and air upwards through the fire, so that the combustion of the fuel is maintained while a continuous current of steam is decomposed.

In this way the working of the generator is constant, and the gas is produced without fluctuation in quality. The well-known re-actions occur; the steam is decomposed, and the oxygen from the steam and air combines with the carbon of the fuel to form carbon dioxide ( $\text{CO}_2$ ), which is reduced to the monoxide ( $\text{CO}$ ) on ascending the fuel column. In this way the resulting gases form a mixture of hydrogen, carbon monoxide, and nitrogen, with a small percentage of carbon dioxide, which usually escapes without reduction. The steam should have a pressure of 24 to 30 pounds per square inch, and is produced and super-heated in a zig-zag coil, fed with water from a neighboring boiler. The quantity of water required is very small, being only about one gallon for each 1,000 cubic feet of gas, and, except on the first occasion when the apparatus is started, the coil is heated by some of the gas drawn from the holder, so that after gas is lighted under the coil the superheater requires no attention.

For boiler and furnace work the gas can be used direct from the generator, but where uniformity of pressure is essential, as for gas-engines, gas-burners, etc., the gas should pass into a holder. The latter somewhat retards the production, but the steam-injector causes gas to be made so rapidly that a holder is easily filled against a back pressure of 1 inch to  $1\frac{1}{2}$  inches of water, and at this pressure the generator can pass gas continuously into the holder, while at the same time it is being drawn off for consumption.

The nature of the fuel required depends on the purpose for which the gas is used. If for heating boilers, furnaces, etc., coke or any kind of coal may be used; but for gas-engines or any application of the gas requiring great cleanliness and freedom from sulphur and ammonia, it is best to use anthracite, as this does not yield condensable vapors, and is very free from impurities. Good qualities of this fuel contain over 90 per cent. of carbon, and so little sulphur, that for some purposes purification is not necessary. For gas-engines, etc., it is, however, better to pass the gas through some hydrated oxide of iron to remove the sulphuretted hydrogen. The oxide can be used over and over again after exposure to the air, and the purifying is thus effected without smell or appreciable expense. Gas made by this process, and with anthracite coal, has no tar and

no ammonia, and the small percentage of carbon dioxide present does not sensibly affect the heating power. A further advantage of this gas is that it cannot burn with a smoky flame, and there is no deposition of soot, even when the object to be heated is placed over or in the flame; this is of importance for the cylinder and valves of a gas-engine.

To produce 1,000 cubic feet, only 12 pounds of anthracite are required, allowing 8 to 10 per cent. for impurities and waste; thus a generator which produces 1000 cubic feet per hour, needs only 12 pounds at that time, and this can be added once in an hour or at longer intervals. No skilled labor is necessary.

The comparative explosive force of coal-gas and the Dowson gas, calculated in the usual way, is as 3.4: 1; that is to say, coal-gas has 3.4 times more work than Dowson gas. Messrs. Crossly, of Manchester, England, have made several careful trials of this gas with some of their  $3\frac{1}{2}$  horse-power (nominal) engines, and in one trial they took diagrams every half hour for nine consecutive days. These practical trials have shown that, without altering the cylinder of the engine, it is possible to admit enough of the Dowson gas to give the same power as with ordinary coal-gas. It has been seen that the comparative explosive force of the two gases is as 3.4: 1, but, as is well known the combustion of carbon monoxide proceeds at a comparatively slow rate; and for this reason and because of the diluents present in the cylinder, which affect the weaker gas more than coal-gas, experience has shown that it is best to allow five volumes of the Dowson for one volume of coal-gas, and then the same uniform power is obtained as with the latter.

This gives very important economical results; for if the cost of the Dowson gas, as per experiment made, be 10 cents per 1,000 cubic feet, is multiplied by five, the cost will be 50 cents per 1,000 cubic feet. Taking the cost of coal-gas to consumers in Philadelphia, which is \$1.50 per 1,000 cubic feet, this will represent an actual saving of *sixty-six per cent.* in running cost. Another practical consideration is that coal-gas requires 224 pounds to 250 pounds of coal per 1,000 cubic feet of gas. Dowson gas requires only twelve pounds per 1,000 cubic feet, and multiplying this by five to give the equivalent of 1,000 cubic feet of coal-gas for engine work, there are 60 pounds instead of



224 to 250 pounds. This is only 24 to 27 per cent. of the weight of coal required for coal-gas; and in many outlying districts this will effect an appreciable saving in the cost of freight.

The modern gas-engine does not use slow inflammation, but, when working as it is intended to do, completely inflames its gaseous mixture under compression at the beginning of the stroke. By complete inflammation is meant complete spread of the flame throughout the mass, not complete burning or combustion. If, by some fault in the engine or igniting arrangement, the inflammation is a gradual one, then the maximum pressure is attained at the wrong end of the cylinder, and great loss of power results.

Compression is the great advance on the old system; the greater the compression, the more rapid will be the transformation of heat into work by a given movement of the piston after ignition, and, consequently, the less will be the proportional loss of heat through the sides of the cylinder. The amount of compression is, of course, limited by the practical consideration of strength of the engine and leakage of piston, but it is certain that compression will be carried advantageously to a much greater extent than at present. The greatest loss in the gas-engine is that of heat through the sides of the cylinder, and this is not astonishing when the high temperature of the flame in the cylinder is considered. In larger engines, using greater compression and greater expansion, it will be much reduced. As an engine increases in size, the volume of gaseous mixture increases as the cube, while the surface exposed only increases as the square, so that the proportion of volume of gaseous mixture used to surface cooling is less the larger the engine becomes. Taking this into consideration, it may be accepted as probable that an engine of about 50 indicated horse-power could be made to work on 12 cubic feet of coal-gas per indicated horse-power per hour, or a duty of about 32 per cent.

The gas-engine is as yet in its infancy, and many long years of work are necessary before it can rank with the steam-engine in capacity for all manner of uses; but it can and will be made as manageable as the steam-engine in by no means a remote future. The time will come when factories, railways, and ships will be driven by gas-engines as efficiently as any steam-engine,

and with much more safety and economy of fuel. Gas generators will replace steam boilers, and power will not be stored up in enormous reservoirs, but generated from coal direct, as required by the engine.

#### Gas and Steam-Engine Heat Efficiency.

The heat efficiency of the steam engine is ten per cent. which is probably very nearly as much as can be ever attained; it may be exceeded by using high steam pressures and great expansion, but it will never be possible to attain anything like twenty per cent. The limits of temperature are such that if the steam cycle were perfect, only thirty per cent. of the whole heat could be converted into work; at the boiler pressures and condenser temperatures used, the theoretical efficiency of the steam engine cycle is within eighty per cent. of the cycle of a perfect engine, that is, the efficiency theoretically possible is:—

$$30 \times 0.8 = 24 \text{ per cent.}$$

From experiments made on compound engines, the best results are as follows:—

|  |                |
|--|----------------|
| Absolute efficiency . . . . .            | 11.1 per cent. |
| Efficiency of a perfect engine . . . . . | 28.4 per cent. |
| Relative efficiency . . . . .            | 39.1 per cent. |

The engines under test received 100 units of heat from the boiler as dry steam, and gave 11.1 unites as indicated work in the cylinder.

With the pressure and temperature given the steam engine cycle, if perfectly carried out, falls short of the cycle of a perfect heat engine between the limits, so that 22.7 per cent. is the maximum efficiency which could be obtained, supposing no other loss than that due to imperfection of the cycle. The cylinder losses, condensation, incomplete expansion and misapplication of heat, make the actual indicated efficiency 11.1 per cent., so that half has gone. The furnace loss diminishes the absolute efficiency to 9.2 per cent., and it is extremely improbable that improvement can ever increase this to twenty per cent., whereas in the best indicated efficiency of the modern gas-engine is as high as twenty-eight per cent.

A possible efficiency of forty per cent. is probable with the gas-engine.

## CHAPTER XV.

### AUTOMATIC CUT-OFF VS. POSITIVE CUT-OFF.

THE writer deems it highly essential, in order that the mechanics who build stationary engines, and the engineers in charge, and the manufacturers who buy engines, should have a complete knowledge of their value.

The superiority of the automatic cut-off engine, over the positive located cut-off engine, is generally conceded by engineers, and engine builders; and it now remains to be shown exactly what that superiority amounts to—that is, with the consumption of a given amount of fuel, what will be the useful effect produced by either type of engine? or in other words, to do a given amount of work, what will be the cost of fuel?

This is a very important matter, not alone to the user of the engine, but to the builder. When a manufacturer or user of an engine is shown that it requires five or six pounds of coal per horse-power per hour, and that substituting an automatic engine, or making a change in his present engine, but three pounds of coal per hour per horse-power will be required, he will not be long in investigating the causes, and making the required change, to accomplish the latter result.

To arrive at the above, we must have recourse to the Indicator; by its application it will register at any instant of time, and under any given circumstances, what is the actual condition and power of the engine, and knowing the coal consumption per hour, the comparison can be readily made.

To illustrate, the writer was called upon to consult in regard to the amount of power developed by two plain slide valve engines, fitted with throttling governor. The engines had just been overhauled, by one of the best engineering firms in Philadelphia.

The owners of the flouring mill, in which these engines were located found that the coal consumption was large for the num-

ber of barrels of flour manufactured, and they wished to know whether it was the engines or boilers that were at fault.

On making a careful survey, I found that the heating and grate surface of each boiler (four in number), was sufficient to generate seventy horse-power each, or a total of 280 horse-power, based on *fifteen square feet* of heating surface, per horse-power, and was, therefore, satisfied that the trouble lay in the form and condition of the engines. On the report of these facts to the owners, they agreed to make a commercial test of the amount of coal consumed, as well as the quantity of flour that could be made in a period of two weeks, the engines to be indicated once a day, and an account of the coal burnt during the test.

FIG. 147.

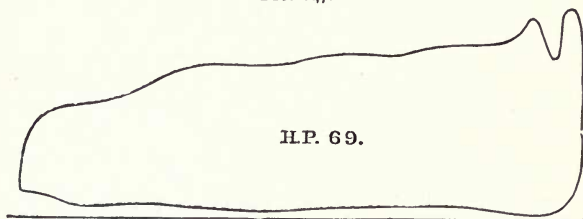

|  |          |
|--|----------|
| Mill run day and night, number of hours. . . . .           | 144.     |
| Pounds of coal consumed . . . . .                          | 100,000. |
| Duty in barrels of flour . . . . .                         | 2250.    |
| Engines. . . . .   | 2.       |
| Boilers . . . . .  | 4.       |
| Horse-power developed by each engine $69 \times 2 =$ . . . | 138.     |
| Revolutions per minute . . . . .                           | 55.      |
| Pressure of steam in pounds per square inch, per gage.     | 100.     |
| Diameter of cylinders, in inches . . . . .                 | 16.      |
| Length of stroke, in inches. . . . .                       | 30.      |
| Coal per hour, per horse-power, in pounds . . . . .        | 5.       |

The engines ran continuously, day and night, commencing Monday morning at 12, and continued until Saturday night, up to 12 o'clock, for two weeks. With hard firing, and a steam pressure of 100 pounds per square inch, it was all the four boilers could do to run the engines at 55 revolutions per minute, the speed required.

Diagram Fig. 147 is a fair average card taken from the engines during the two weeks' run, and represents the horse-power developed by each engine.

The above shows that 2,000 pounds of coal was required to make 45 barrels of flour: or, in other words, to manufacture one barrel of flour, 44.45 pounds of coal were required, with the usual connected arrangements.

FIG. 148.

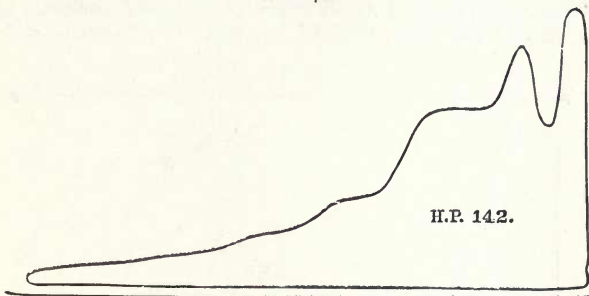

|  |       |
|--|-------|
| Mill runs each day, in hours. . . . .              | 13.   |
| Pounds of coal consumed in 13 hours. . . . .       | 5400. |
| Duty in barrels of flour per day . . . . .         | 216.  |
| Engine, Corliss . . . . .                          | 1.    |
| Boilers (horizontal flue) . . . . .                | 4.    |
| Horse-power as per indicator diagrams. . . . .     | 142.  |
| Revolutions per minute . . . . .                   | 55.   |
| Pressure on boilers per gage in pounds . . . . .   | 88.   |
| Scale of indicator per inch. . . . .               | 40.   |
| Diameter of cylinder, in inches. . . . .           | 23.   |
| Length of stroke, in feet . . . . .                | 4.    |
| Coal per hour, per horse-power, in pounds. . . . . | 2.92. |

About this time there was great competition amongst the flouring mills, and I was instructed to see what, if any, change could be made to produce a barrel of flour with a less amount of coal.

With the data obtained from Fig. 147, I communicated with the builder of an automatic cut-off engine, who finally went over the premises with me, and agreed to put in one of his

improved engines, in the place of the two throttling engines, and guarantee *forty-five per cent.* more work, with the same amount of fuel, for a stated sum, and in case his engine failed to perform as above, he would accept a less price than called for in his agreement—the reduction to be pro rata.

Diagram Fig. 148 was taken from the engine erected under the above stipulation—boilers and machinery the same. Instead of running day and night, the time run was 13 hours; during the remaining 11 hours, the fires were “*banked,*” and engine and machinery allowed to stand. The average result,

FIG. 149.

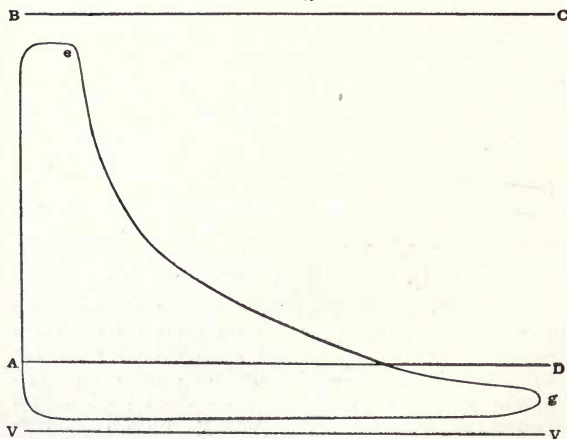

|   |          |
|---|----------|
| Diameter of cylinder, in inches. . . . .  | 32.      |
| Length of stroke, in inches . . . . .     | 84.      |
| Revolutions per minute . . . . .          | 33.      |
| Piston speed in feet per minute . . . . . | 462.     |
| Scale of indicator . . . . .              | 30 = 1". |

under these circumstances, was 80 barrels of flour to the ton of coal (2000 pounds), which is *twenty-five pounds* to the barrel.

The above result shows a saving of *eighty-two per cent.* Had a compound condensing engine been substituted the saving would have been still further increased, as shown in Fig. 125, page 290, where the coal per horse-power was only 1.3 pounds.

Indicator diagram Fig. 149, was taken by the writer from a condensing engine of same make as Fig. 148.

Coal consumption per hour, per horse-power, two and one-half pounds.

Diagram, Fig. 150, was also taken from same make of engine, the boiler pressure being 115 pounds per square inch, the dimensions of engine being as follows:

FIG. 150.

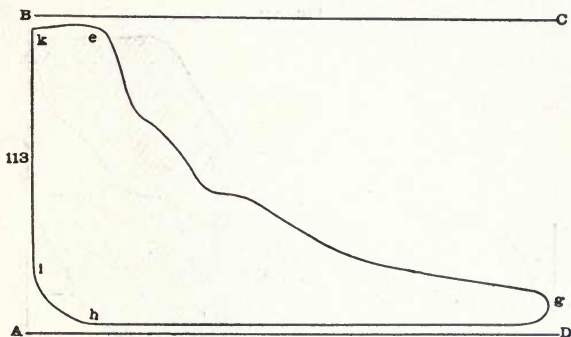

|   |      |
|---|------|
| Diameter of cylinder in inches . . . . .  | 16.  |
| Length of stroke in inches. . . . .       | 36.  |
| Revolutions per minute . . . . .          | 80.  |
| Piston speed in feet per minute . . . . . | 480. |
| Boiler pressure per square inch . . . . . | 115. |

This diagram shows nearly the whole of the boiler pressure in the cylinder, or 114½ pounds is shown upon the piston, up to point of cut-off, or deducting for back pressure, 113 pounds remained effective throughout the whole period of admission, which was for hardly more than *one-ninth*, or *four* inches of the stroke. The terminal pressure is 15 pounds above the atmosphere, of course very much higher than would correspond to the application of Boyle's law. The back pressure, including a slight amount of compression, hardly amounting to *two pounds*. The point of cut-off is very sharply marked, although a slight amount of wire-drawing, not worth considering, is to be seen. The exhaust is perfect, expansion being carried to the very end

of the stroke before exhausting. The waving appearance of the steam line is, as every engineer will be aware, due merely to the vibration of the indicator pencil, aggravated, it is just possible, by a slight amount of water in the steam.

#### Relative Economy of Different Engines.

The following diagrams, Fig. 151 and Fig. 152, will illustrate the relative engine economy.

FIG. 151.

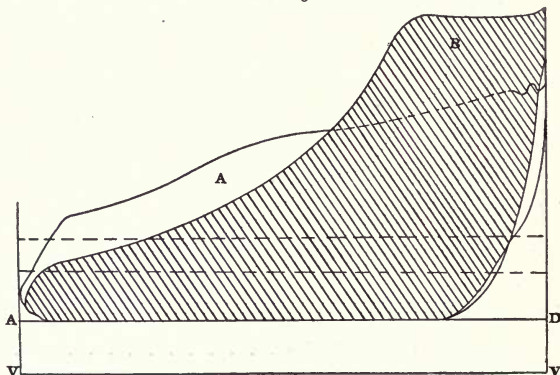

Scale, 40 pounds equal one inch in height.

Diagram 151 is composed of two indicator cards. Card *A* is a superior throttling engine diagram, and card *B* may be regarded as a medium automatic cut-off engine diagram; it shows excellent engine performance, but the load is rather too heavy for the highest economy, for a non-condensing engine.

Diagram, Fig. 152, is also a duplex card; *A* shows a throttling engine card, the average economy of which is better than the general run of this class of engines.

Diagram *B* is from an automatic cut-off condensing engine, showing about the highest attainable economy with any engine.

The mean effective pressure of card *A*, Fig. 151, is 40.23 pounds, and its absolute terminal pressure is 36 pounds.

The mean effective pressure of card *B*, Fig. 151, is 41.94 pounds, and its absolute terminal pressure is 28 pounds.



The mean effective pressure of card *A*, Fig. 152, is 32.34 pounds, and its absolute terminal pressure is 30 pounds.

The mean effective pressure of card *B*, Fig. 152, is 33.14 pounds, and its absolute terminal pressure is 12 pounds.

I have before called special attention to the fact that the *mean effective pressure* of any engine diagram is the exact measure of the power developed, and that the absolute *terminal pressure* is the corresponding measure of the consumption or *cost of fuel*. Hence, the relative economy of different engines may be thus illustrated. Let each pound of mean effective pressure be called one horse-power; and each pound of absolute terminal pressure represent one dollar (\$1.00) paid for fuel.

FIG. 152.

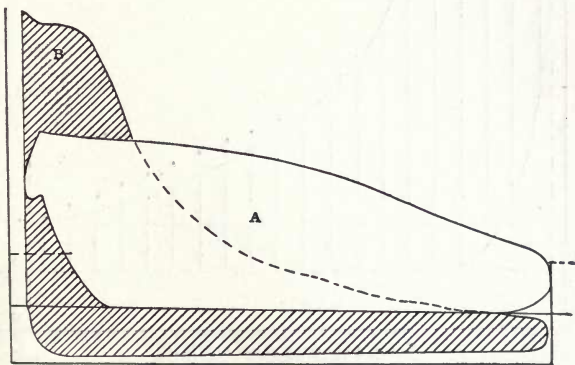

Scale, 40 pounds equal one inch.

Card *A*, Fig. 151, gives us 40.23 horse-power for \$36.00, thus costing \$89.37 per horse-power.

Card *B*, Fig. 151, gives us 41.94 horse-power for \$28.00, thus costing \$65.38 per horse-power.

Card *A*, Fig. 152, gives us 32.34 horse-power for \$30.00, thus costing \$92.76 per horse-power.

Card *B*, Fig. 152, gives us 33.14 horse-power for \$12.00, thus costing \$36.21 per horse-power.

In general, the absolute terminal pressure of throttling engine diagrams will exceed the mean effective pressure, or continuing the cost illustration, the cost will be more than \$1.00 per horse-power, as is the case with diagram, Fig. 184, page 382, which is from a new, carefully made engine. Its mean effective pressure is 38.26 pounds, and its absolute terminal pressure is 52 pounds, giving a comparative cost of over \$1.35 per horse-power. Comparing this with diagram, Fig. 154, which represents 36.73 pounds mean effective pressure, and 22 pounds terminal pressure, a cost of \$0.55 cents per horse-power, it will be seen that by substituting the latter engine for the former, a

FIG. 153.

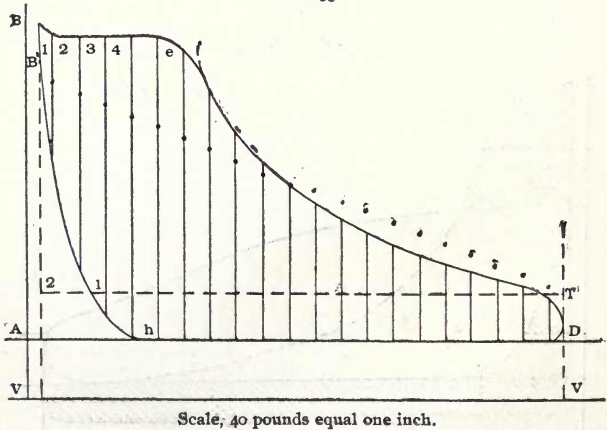

saving of 59 *per cent.* would be effected, and though Fig. 184 represents a trifle worse than the average practice with such engines, it is not an exceptionally extreme case. Thousands of engines, new and old, are in use, which, on an average, give no better results.

Those who use or contemplate using steam-power in locations where sufficient water can be obtained to operate a condenser, will be interested in diagram Fig. 152, card B. It is a case in which a throttling engine was taken out of a flouring mill and a first-class automatic cut-off condensing engine substi-

tuted. *A* is a card from the throttling engine, and *B* was taken from the engine substituted. The saving in fuel is over *sixty per cent.*

The above method of illustration is valuable for *comparison* only. It gives no clue to the actual cost due to a given power (as the preceding article) for the element of *time* is not considered.

Diagram Fig. 154 is from an automatic non-condensing engine.

FIG. 154.

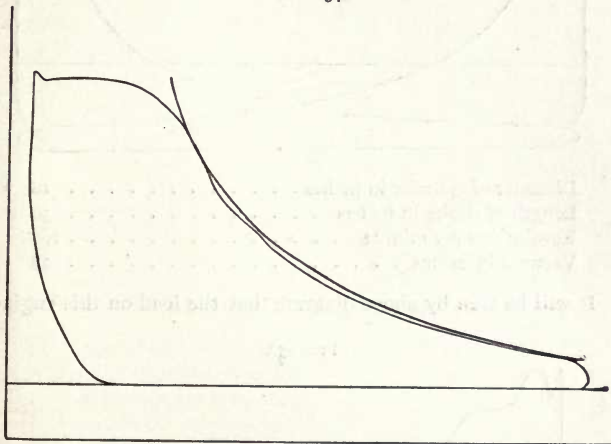

|   |        |
|---|--------|
| Scale of diagram on pounds . . . . .  | 40.    |
| Diameter of cylinder in inches . . . . .                                      | 12.    |
| Stroke of piston in inches . . . . .  | 20.    |
| Revolutions per minute. . . . .   | 150.   |
| Initial pressure in pounds . . . . .  | 80.    |
| Absolute terminal pressure in pounds. . . . .                                 | 22.    |
| Mean effective pressure in pounds . . . . .                                   | 36.73. |
| Mean effective pressure measured to the adiabatic<br>curve in pounds. . . . . | 37.8.  |
| Percentage of the latter realized . . . . .                                   | 97.17. |
| Dry steam per hour per horse-power in pounds . . . . .                        | 19.18. |

Diagram, Fig. 155, was taken from an automatic condens-

ing engine running light at 108 revolutions per minute, and of the following dimensions:

FIG. 155.

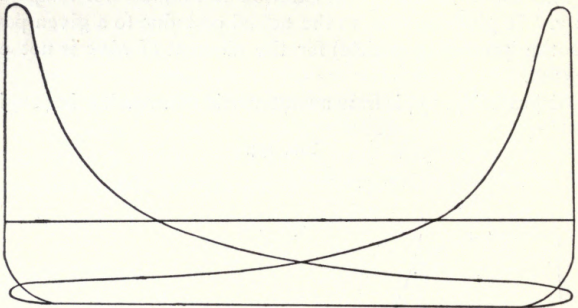

|  |     |
|--|-----|
| Diameter of cylinder in inches . . . . . | 18  |
| Length of stroke in inches . . . . .     | 30  |
| Revolutions per minute . . . . .         | 108 |
| Vacuum in inches . . . . .               | 28  |

It will be seen by above diagram that the load on this engine

FIG. 156.

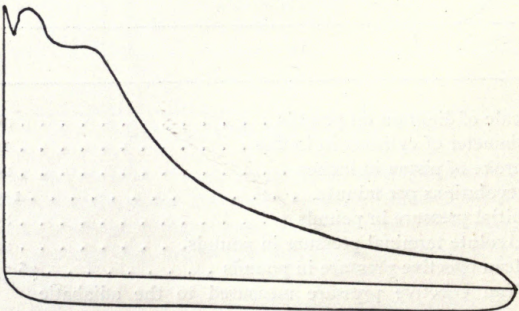

was too light for economy, but the diagram is a good one; the admission line and steam line are good; the expansion line coincides very closely with the theoretical curve, and there is a free

exhaust and excellent line of counter pressure. The compression might begin a little earlier with advantage.

Diagram Fig. 156 was taken from a pair of automatic condensing engines,  $11\frac{1}{4}$  inches diameter by 16 inches stroke, running at 350 revolutions per minute, and developing from 200 to 250 horse-power. The vacuum is maintained by a "siphon" condenser.

The following diagram, Fig. 157, was taken from a condensing automatic cut-off engine, dimensions as follows:

FIG. 157.

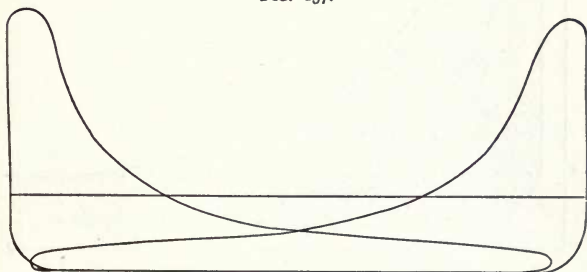

Scale of indicator, 30 pounds equal 1 inch.

|  |    |
|--|----|
| Diameter of cylinder in inches . . . . . | 20 |
| Length of stroke in inches . . . . .     | 46 |
| Revolutions per minute. . . . .          | 73 |
| Boiler steam pressure in pounds. . . . . | 65 |

Diagram, Fig. 158, is from an automatic condensing engine, revolutions 200 per minute. This is also taken with a light load. The point of cut-off is well defined, and expansion and exhaust lines are good. The line of counter pressure runs nearly parallel with atmospheric line.

Diagram, Fig. 159, is from a non-condensing engine, revolutions, 90; steam pressure, 90 pounds per square inch. The load on this engine is such as we consider a good one for ordinary economical running; the point of cut-off is at about one-fourth stroke. The steam line is good and parallel to that of the boiler pressure, and only a few pounds below it. At the point of cut-off the corner is but slightly rounded, and the expansion

curve follows closely the theoretical line. The exhaust is excellent, as is also the line of back pressure, which comes close to the atmospheric line, and there is a good compression line.

FIG. 158.

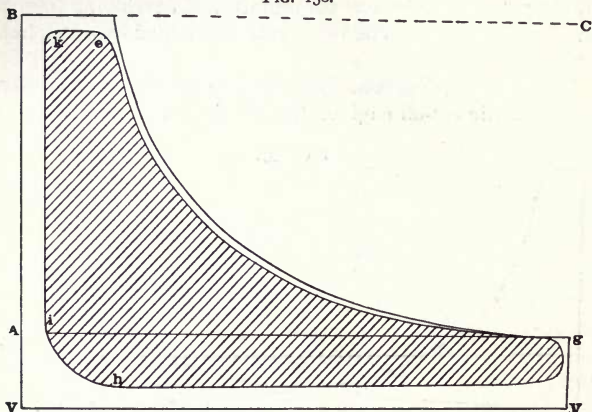

Diagram, Fig. 160, is from a pumping engine. The cylinder 4 feet diameter, with a stroke of 9 feet, the steam and exhaust

FIG. 159.

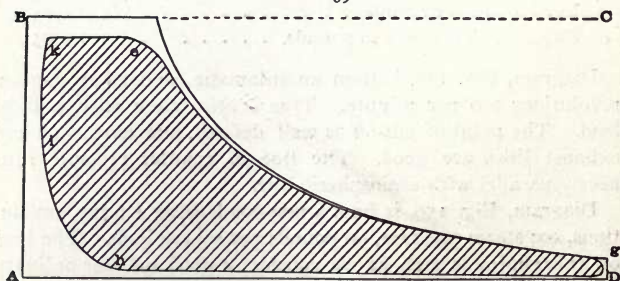

valves are of the double beat class, and making 13 double strokes per minute, the steam being at cut off 13 inches. The maximum steam pressure in the diagram is  $29\frac{1}{2}$  pounds, and

the maximum vacuum is a little over 12 pounds, whilst the average vacuum is 11 pounds, and the average effective pressure on piston throughout the stroke 13.6 pounds, indicating 201 horses, and the duty averages 87,000,000 foot pounds.

FIG. 160.

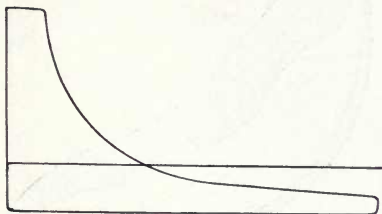

Diagrams, Fig. 161 and 162, were taken from a passenger locomotive, and both at the same point of cut-off. The larger shaded diagram *A*, was taken at 40 revolutions per minute, while the other was taken at 260 revolutions per minute, or about 66 miles an hour. The point of cut-off is one-sixth the stroke, the initial pressure on the piston being 106 pounds, and the slower speed 120 pounds at full speed.

FIG. 161.

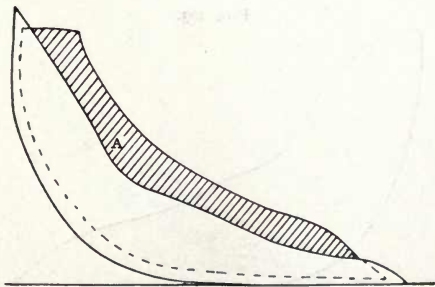

Diagram, Fig. 162, was taken from the same locomotive in a different notch, the larger diagram *B*, at 50 revolutions giving 105 pounds initial pressure, the smaller one at 200 revolutions with 102 pounds initial pressure. Here the point of

cut-off is between one-fifth and one-sixth the stroke, or exactly 22.5 per cent.—the locomotive running for a long distance at the same cut-off.

FIG. 162.

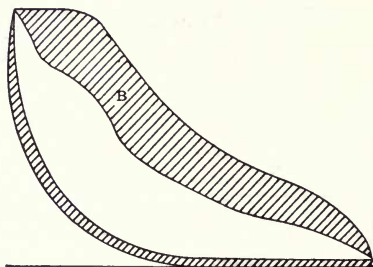

Diagram, Fig. 163, was taken at 180 revolutions, and the steam appears to have been cut off at about  $\frac{1}{3}$ ths of the stroke. The initial cylinder pressure is 120 pounds.

The following pair of diagrams, Fig. 164, are from a freight locomotive. The larger one in shaded lines, card C, was taken with a heavy train on an up grade; the other one was taken in running on a level part of the road.

FIG. 163.

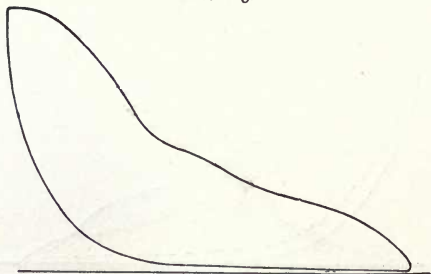

The diagram, C, was taken at nearly full travel, and the piston received the full boiler pressure of 120 pounds. The smaller one shows an initial pressure of 100 pounds, considerably throttled. A remarkable feature of these diagrams is the



trifling back pressure exhibited, which is accounted for by the ample ports, and the size of the blast orifice, five inches diameter.

Diagrams from locomotives, on account of the great variety

FIG. 164.

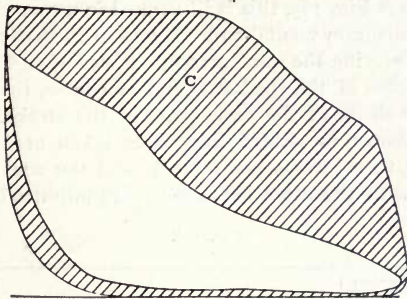

of speeds and point of cut-off at which they are taken, and the variations which they exhibit in the power exerted, are of higher general interest, in some respects, than those obtained

FIG. 165.

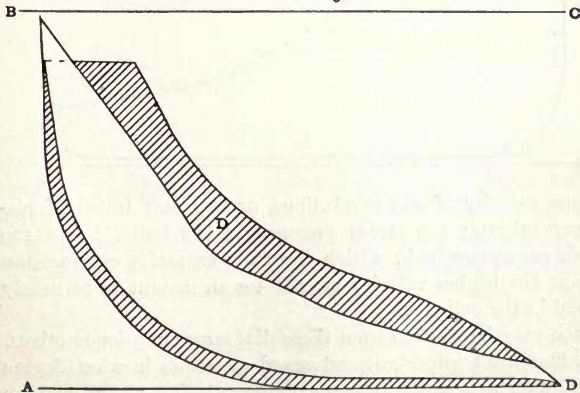

from either stationary or marine engines; and a careful study of them may confidently be expected to throw light on some ques-

tions about which engineers now differ in opinion. They show at once, for example, at what speed of piston a certain area of port ceases to be sufficient for a given diameter of cylinder, and precisely how velocity of piston, in different degrees, affects the pressure obtained.

In diagrams Fig. 165, this is illustrated in a remarkable manner. This diagram was taken by Mr. Charles Porter, when the boiler was carrying the same pressure of steam, and running in the same notch of the quadrant, and of course, therefore, cutting off the steam at the same point of the stroke. The diagram, *D*, shown in shaded lines, was taken at a speed not exceeding 50 revolutions per minute, and the one not shaded was taken with the same instrument five minutes later, at the

FIG. 166.

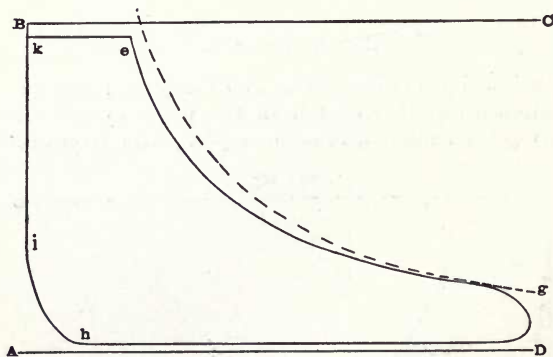

extreme velocity of 260 revolutions, or 1040 feet travel of piston per minute; the steam pressure in the boiler being 120 pounds per square inch, which the more excessive compression made at the higher velocity caused for an instant to be nearly reached in the cylinder.

Much may be learned from these diagrams from locomotives, upon that most important and vexed question, in what degree the cylinder acts as a condenser of the entering steam, and by what means, and in what degree in non-condensing engines, this vicious action may be corrected; and what, on the other hand, tends to aggravate it?

Diagram Fig. 166 was taken from locomotive No. 51, Southern Pacific Railroad, with independent cut-off (variable by lever arm and quadrant in cab, under the control of the engineer), built by the Danforth Locomotive Works, Paterson, New Jersey, from designs of Mr. A. J. Stevens, General Master Mechanic of the Central Pacific Railroad, at Sacramento, Cal., with cylinders 20 inches diameter and 30 inches stroke, when hauling 496.25 tons, on 105 foot grade (inclusive of weight of locomotive and tender of 93 tons), and running 40 revolutions per minute, or at the rate of  $6\frac{1}{2}$  miles an hour, cutting off the steam at about

FIG. 167.

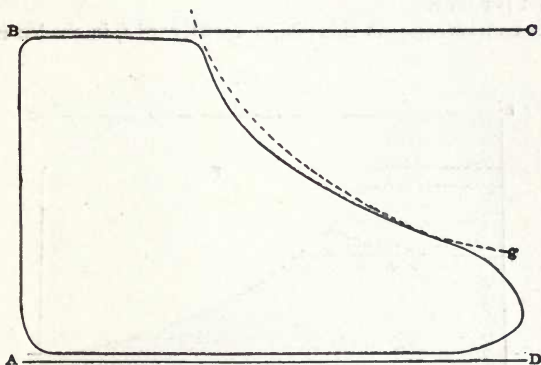

one-sixth of the stroke with a pressure of 135 pounds per square inch, and developing  $(110.92 + 120.32) 229.36$  horse-power, and showing a utilization of *eighty-nine per cent.* of theoretical diagram.

Diagram Fig. 167 was taken when running at about 10 miles an hour (60 revolutions per minute), cutting off at about one-third of the stroke, and developing

$$248.16 + 268.44 = 507.6 \text{ horse-power,}$$

and shows an effect equal to *ninety-seven per cent.* of the theoretical diagram.

These diagrams show a well maintained steam line up to the point of cut-off, and show a marked contrast in the mean effec-

tive cylinder pressure of 59 and 88 pounds per square inch, respectively, as compared with diagram Fig. 168 taken from the Shaw locomotive, cutting off at half stroke under practically similar conditions, and should set at rest any doubts as to the value of an independent variable cut-off valve for locomotives.

Diagram, Fig. 168, card *F*, in outline, was taken at 27 revolutions per minute. It will be seen that at this slow speed the steam attained very nearly the mean effective pressure of that of the boiler, namely 120 pounds per square inch on the piston following very nearly full stroke, and developing 130 horse-power running at the rate of  $5\frac{1}{2}$  miles per hour up a grade of 63 feet per mile.

Let us now compare this diagram with card *f*, in shaded lines,

FIG. 168.

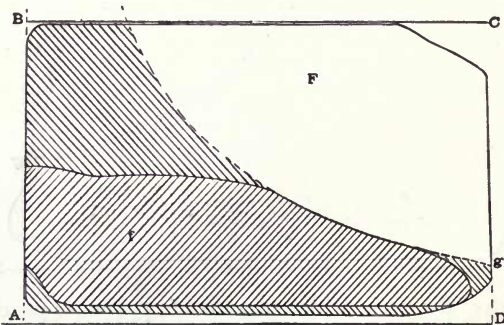

taken on a level at a speed of 24 miles an hour, pulling the same load as indicated in diagram *F*, with a boiler pressure of 130 pounds per square inch, and a mean effective cylinder pressure of 42.6 pounds per square inch, steam being cut off at half stroke; throttle valve partially closed and developing 211.29 horse-power. The low initial steam pressure of 58 pounds per square inch, is due to the partial closure of the throttle valve, but is well maintained without expansion up to point of cut-off.

Diagram, Fig. 169, was also taken from this locomotive when running at the rate of 65 miles an hour, corresponding to 315 revolutions per minute, or a piston speed of 1,260 feet, and a



or jagged lines whatever. This shows conclusively, that the water valves seat themselves perfectly, due to the practical uniformity of motion of the water column, therefore, causing no shock or jar. The mean water pressure was 86.724 pounds per square inch, and the height due to this pressure, the water being

FIG. 170.

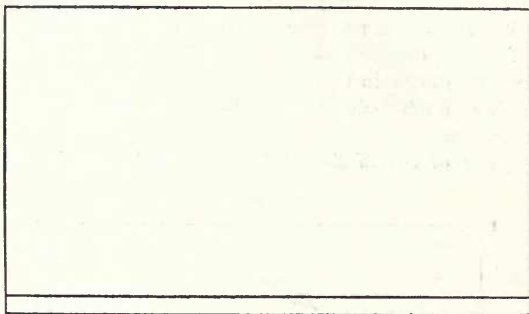

66°, was 200.46 feet, and the lift from center of gage to water in pump well, was 17.28 feet. Total height, including frictional resistance, 217.74 feet.

FIG. 171.

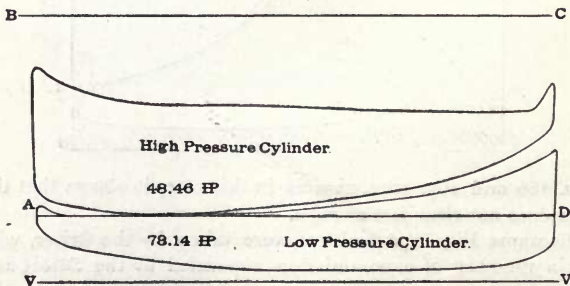

Diagrams, Fig. 171, represents the steam cylinders, there being two non-condensing, and two condensing cylinders. The boilers evaporated about 30 pounds of water per hour, per horse-power, showing a consumption of about four pounds of coal per hour, per horse-power.

The diagram Fig. 172, was taken from a plain slide valve engine, fitted with an independent cut-off valve and governor, similar to a "Tremper."

The boiler pressure was 75 pounds, and the engine was running 58 revolutions per minute.

The valves were fairly set. The cut-off valve closed promptly

FIG. 172.

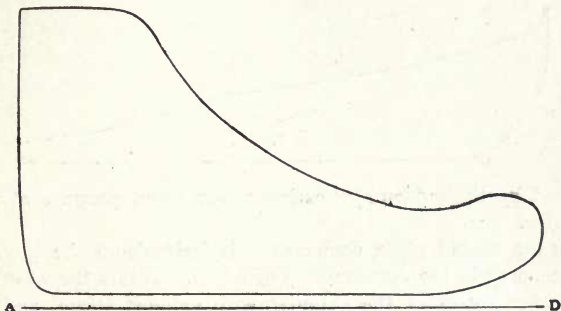

enough, and the steam in the cylinder by expansion fell in pressure to about 23 pounds above the atmosphere, at about  $\frac{1}{4}$  of the stroke, at which point of the stroke more steam through

FIG. 173.

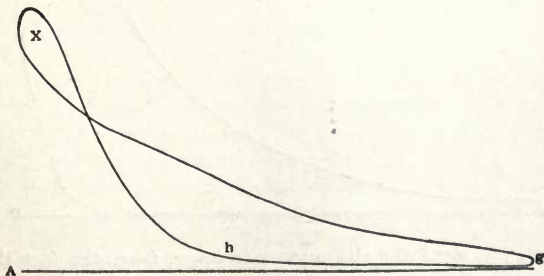

some leak, not at the time discovered, was admitted to the cylinder, the result being that the pressure in the cylinder rose to 26 pounds at one end and to 33 pounds at the other end of

the cylinder, causing the distortion as shown at the terminal end of the diagram.

This engine, as will be seen from the diagram, had no compression whatever.

Compression also serves to overcome the momentum of the reciprocating parts, and to reduce the strain upon the connections,

FIG. 174.

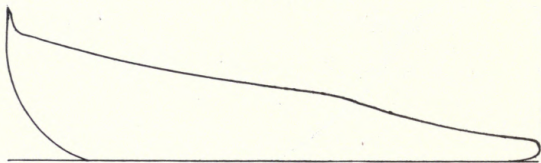

caused by the sudden application of the steam pressure at admission.

In the second place, compression is desirable on the ground of economy in the consumption of steam. It fills the wasteful clearance spaces of the cylinder with exhaust steam, and in

FIG. 175.

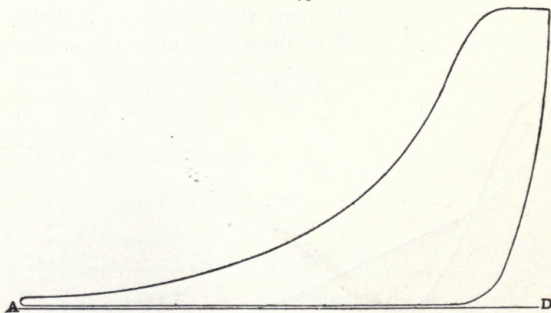

the case last cited the clearance was large, from the fact that the cut-off valve set on top of the steam chest, all of which had to be filled with steam from the boiler. True, compression produces a loss by this increased back pressure which it occasions, but the loss is more than covered by the gain resulting from the reduction of clearance waste.



Theoretically, the greater the amount of exhaust that is utilized by compression, the less the consumption of steam. Practically, it is not advisable to compress above the boiler pressure, as shown in diagram, Fig. 173.

Diagram, Fig. 174, is from the same engine that produced Fig. 173, and was taken after resetting the valves.

In non-condensing, automatic cut-off engines with three per cent. clearance, with a boiler pressure of 80 pounds per square inch, and cutting off at about one-fifth of the stroke, and exhausting under a minimum back pressure, the gain produced by compressing up to boiler pressure over working under the same conditions without compression, as shown by diagram, Fig. 175, will not be less than about six per cent. In a condensing engine, running under similar conditions, the gain should be larger, also with an earlier cut-off.

The steam line in automatic cut-off engines should be parallel with the atmospheric line (see Figs. 88, 153, 159 and 167), and should not be more than three pounds less than the boiler pressure; the *point of cut-off* is where the expansion line commences to fall abruptly and shows during what part of the stroke the steam is admitted; through the remainder of the stroke the steam expands gradually, reducing the pressure as shown by the dotted lines. Just before the end of the stroke the exhaust should commence, open as shown at *g* in Fig. 166 and 167.

The back pressure should not in any engine exceed *one pound* when exhausting into the atmosphere.

The dotted line in Figs. 166 and 167 represents the theoretical power of the amount of steam exhausted from the cylinder of the same size, with no losses from friction in the passages, back pressure or clearances. The proportion of the area of the actual, the one in outline, to the theoretical, the one in dotted line, represents the relative efficiency of the several diagrams as stated on page 365, showing *eighty-nine* and *ninety-seven per cent.* efficiency due to a properly proportioned cut-off engine.

## CHAPTER XVI.

### MISCELLANEOUS.

Leakage of Steam-Engines as shown by the Diagram.

The following diagram, Fig. 176, was taken from an automatic cut-off engine, of the following dimensions:

The clearance, or waste, room between the cut-off valve and piston, when the latter is at the end of its stroke, amounts to *seven per cent.* of the piston displacement.

FIG. 176.

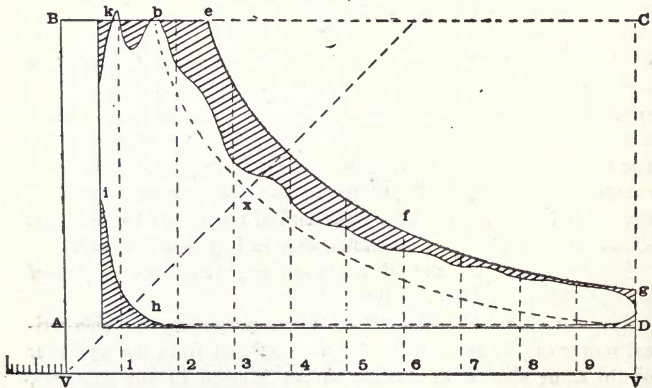

|   |     |
|---|-----|
| Diameter of cylinder in inches . . . . .            | 8   |
| Length of stroke in inches . . . . .                | 16  |
| Revolutions per minute . . . . .                    | 287 |
| Diameter of rod in inches . . . . .                 | 1.5 |
| Boiler pressure in pounds per square inch . . . . . | 103 |

The above diagram, Fig. 176, is from the back, or follower end of cylinder, and shows that the admittance of steam was cut off when the piston moved only about 0.2 of the stroke, whilst the terminal pressure shows the steam to have been cut

off at  $e$ , or 0.275 of the stroke, and the difference is the leakage of steam through the distribution valve after the steam was cut off.

Adiabatic curves of expansion have been constructed on the diagrams, Fig. 176, both for the terminal pressure and for the apparent point of cut-off.

The adiabatic curve  $e, f, g$  is for the terminal pressure, and  $b, x, D$  that for the apparent point of cut-off.

The clearance of the piston, amounting to seven per cent., has been added to the stroke on the card  $BV$ . Then the percentage of leakage is found in the following way:

$$\text{Percentage} = \frac{100 (k, e - k, b)}{a, c} . . . . . 1$$

For the use of this formula the vacuum line  $VV$  is extended one-tenth beyond  $V$  and divided into ten equal parts, which forms a scale for measuring  $k b$  and  $k e$ .

By this scale it is found that  $k b = 12$ , and  $k e = 27$ .

$$\text{Leakage of steam } \% = 100 \frac{(27 - 12)}{27} = 55.5 \text{ per cent.}$$

It is assumed in this formula that the exhaust valves are perfectly tight, which is probably not the case, and the full leakage can therefore not be determined by the indicator cards.

That is to say, that 55.5 per cent. of all the steam in the cylinder, when the piston reaches the end of the stroke, had leaked through the valve face during expansion, or after the valve had cut off the steam. Had all the steam been admitted from the beginning of the stroke and cut off at  $e$ , it would have produced the adiabatic curve  $e, f, g$ , and the useful effect would then have been represented by the area  $C = e, f, g, D, h$  and  $k$ , instead of the area  $D = k, b, x, g, D$  and  $h$ , which was actually produced. The loss of effect is represented by the enclosed area  $E = e, f, g$ , and  $b$ .

$$\text{Loss of effect } \% = \frac{100 E}{C} = \text{per cent.} . . . . . 2$$

By actual measurements of these areas we find  $E = 0.49$  and

$C = 3.17$  square inches. Then the loss of effect by leakage will be:

$$\% = \frac{100 \times 0.49}{3.17} = 15.45 \text{ per cent.}$$

As before stated, the leakages of the exhaust valves are not included in this calculation, which therefore does not represent the full leakage.

The natural effect of the steam is represented by the whole area  $F = V, B, b, e, f, g, V$ , which divided into the realized effect  $D$ , gives the fraction of the natural effect or duty obtained from the steam.

$$\text{Duty \%} = \frac{100 D}{F} = \text{percentage.}$$

#### Distorted Indicator Diagrams.

FIG. 177.

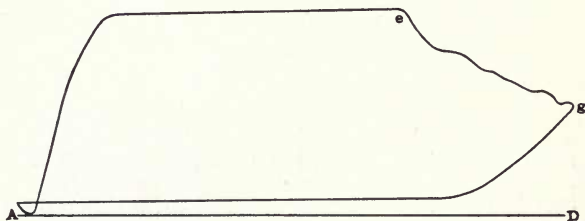

The above rather antique looking diagram, Fig. 177, is from a modern built automatic cut-off engine. The size of this engine is 16 inches diameter, 48 inches stroke, running 40 revolutions per minute, boiler pressure 70 pounds per square inch, scale of indicator 40 pounds per inch.

The steam admission does not commence until the piston has traveled about one-sixth of the stroke. The exhaust valve had no lead, not opening until the piston had reached the end of its stroke; the piston being retarded at the commencement of its return stroke, by about 30 pounds per square inch back pressure, and did not reach the atmospheric line,  $A D$ , at all, until on the next stroke, as shown by the loop which was caused by

the lost motion in the connections of exhaust valve, at the moment of the piston changing its motion.

The maximum pressure, before cut-off, was comparatively low, the average back pressure was high, and there was entire absence of compression.

The valves were re-set, and the result was, the engine consumed one-half the steam, and developed more power than shown above.

The following diagrams, Figs. 178 and 179, were taken from an upright automatic cut-off engine, 42 inches diameter, and 42 inches stroke. The engine was located in a rolling mill making steel rails. At times the engine came very nearly to a stand still with an ignot in the rolls and it was with difficulty that sufficient steam could be generated in the boilers to run the

FIG. 178.

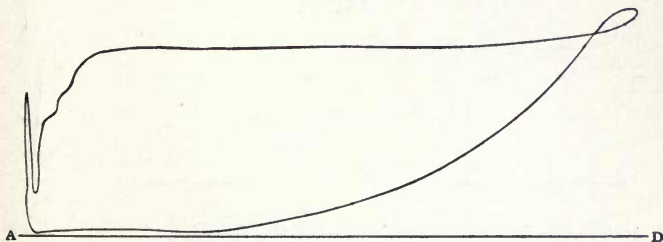

mill at proper speed. The writer was called on to locate the trouble. On applying the indicator, diagrams Figs. 178 and 179, were the result.

The valves were reset and the piston packing also set out, and the result was the diagrams, Figs. 180 and 181.

The engine was running at full speed and steam constantly blowing off at the safety valves on the boilers.

Diagrams, Fig. 180, *A, a*, represent the power when train of rolls was running empty. Diagrams *B C* and *C* when ignot was passing through the rolls. Cards *C*, Fig. 180, and *C*, Fig. 181, show that no cut-off took place, the steam following the piston its full stroke. This engine being a Corliss does not cut off if its full load is maintained beyond half stroke.

### The Economy of a Steam-Engine.

The economy of a steam-engine is expressed in terms of the number of pounds of water consumed per horse-power per hour. The rate of *water* consumption is the only intelligible expression for the engine alone, as the amount of fuel used must depend largely upon the kind of boiler and its conditions, the manner in which it is set and fired, the quality of the fuel, the draft, and numerous other factors, for which the engine is in no way responsible.

#### How to Calculate the Amount of Steam (Water) Consumed from an Indicator Diagram.

It is not claimed that the theoretical rate of water consumption as deduced from the diagrams can ever be realized in practice. A certain amount will always be lost from condensation,

FIG. 179.

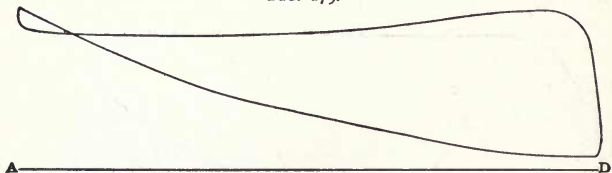

leakage and unevaporated foam in the steam, which no process of calculation makes allowance for. This loss may amount in some cases to nearly one-half, and 25 to 30 per cent. is not above the average under ordinary conditions. But for the purpose of comparing the economy of different engines, or the relative economy of different pressures and loads on the same engine, it possesses great value, as whatever uncertainty may exist as to the *amount* of unindicated loss, it is safe to assume an equal per cent. of loss in each case, and hence the comparison would not be affected.

As the mean pressure during the stroke measures the work done, so the pressure at the end of the stroke measures the steam consumed in doing it.

The useful evaporation of a boiler may through the steam-engine be approximately calculated from the indicator diagrams

by ascertaining the weight of the water existing in the form of steam in the cylinder at every point in the stroke; not absolutely—since we do not know exactly the weight of steam at different temperatures—but without doubt, very nearly. This, when measured just before the opening of the exhaust, is the weight of water accounted for by the indicator.

From a variety of causes, the weight of water so accounted for can never be the full weight required to supply the boiler, as it is not possible to estimate the total amount, except by measuring the feed water, for the following reasons:

FIG. 180.

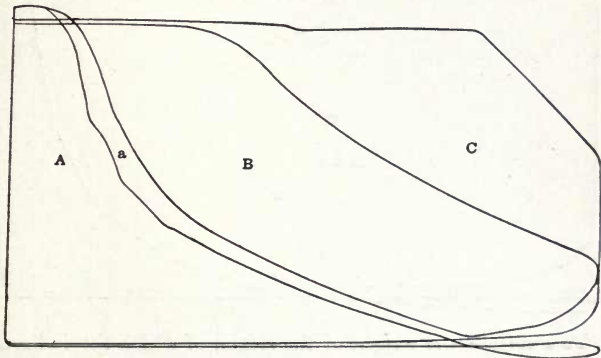

*First.*—A certain amount of water always disappears from a boiler in ways which cannot be accounted for. If a boiler is shut perfectly tight, without visible outlet for any steam whatever, and a steam pressure is maintained in it, the water will gradually subside. When experiments are to be conducted, the rate of this disappearance from the boiler, under the pressure to be employed, ought to be ascertained.

*Second.*—Unless the steam is superheated, more or less water is carried over to the engine mechanically. This is especially the case with boilers which show a *great evaporative capacity*.

*Third.*—As soon as the steam leaves the boiler it begins to be condensed. It can receive no more heat from any source, but it must impart heat to everything and supply all loss from radiation.

*Fourth.*—A certain amount of condensation is produced by the conversion during the expansion of heat into mechanical work.

*Fifth.*—A portion of the steam is always condensed as it enters the cylinder from coming in contact with the surfaces which have just been cooled by being exposed to the colder vapor of the exhaust, and especially by the evaporation, at the same time, of moisture from them, abstracting the heat necessary to supply to such moisture the heat of vaporization.

FIG. 181.

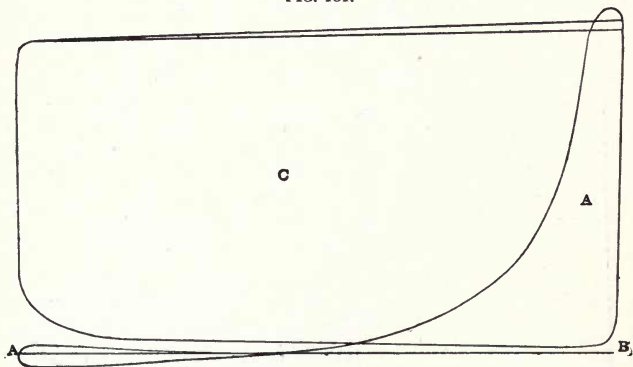

To ascertain the weight of the steam, of which the indicator shows the pressure, we have first to determine the volume of the steam or the capacity of the chamber which it fills.

If a piston one inch square moves twelve inches, it will do work equal to *one* foot pound for every pound per square inch pressure of steam. That is to say, every twelve cubic inches of cylinder area represents one foot pound of mean effective pressure.

Twelve cubic inches equal  $\frac{1}{144}$  of a cubic foot. The piston then must sweep a volume of  $\frac{33,000 \times 60}{144} = 13749.9$ , or say 13,750 cubic feet per hour per horse-power, if mean pressure equals unity.

The volume of steam used per horse-power varies inversely as the effective pressure, and if we call the weight of a cubic foot of steam at the pressure of release  $W$ , and the mean effective pressure ( $m e p$ ), we have the formula  $\frac{13.750}{m e p} \times W =$  pounds of



water evaporated per indicated horse-power, exclusive of waste by condensation and leakage.

This formula is not quite correct, as it does not allow for the effects of clearance and compression.

#### To Compute the Economy of Water Consumption.

The following method is in general use for finding the rate of water consumption for the engine alone:

*Rule.*—Divide the constant number 859,375 by the *volume* of steam at the terminal pressure, and by the mean effective pressure (*m e p*). The quotient will be the desired rate.

FIG. 182.

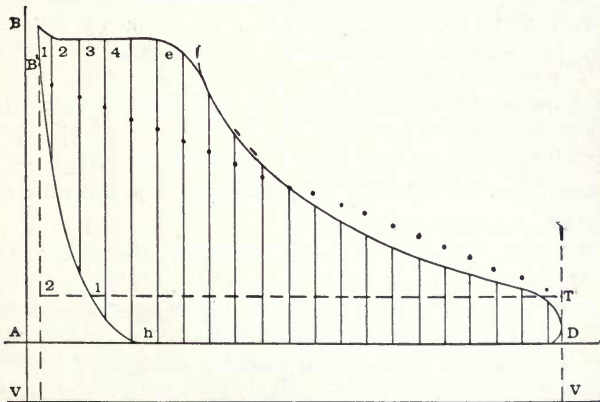

This constant is the number of pounds of water that would be used in one hour by an engine developing one horse-power, if run by water (instead of steam) at one pound pressure per square inch. Then, with pressure of more than one pound the amount required would be as many times less as the pressure was greater than one pound, and when steam is used, the amount would be as much less as the volume of the steam at the pressure at which it is released is greater than an equal weight of water. Hence the above rule. The constant is found as follows: The standard horse-power being 33,000 foot pounds, or 33,000 pounds lifted one foot per minute, would be equivalent to  $33,000 \times 12 =$

396,000 pounds lifted one inch per minute. Hence an engine whose piston displacement was 396,000 cubic inches per minute would develop one horse-power with one pound mean effective pressure on the piston. This for one hour would be  $396,000 \times 60$  minutes = 23,760,000 cubic inches per hour. Then suppose the engine to be run by water at one pound pressure per square inch, instead of steam, and taking the number of cubic inches of water per pound at 27,648, this  $\frac{23,760,000}{27,648} = 859,375$ , which is the desired constant.

Example. Diagram Fig. 182, was taken from an improved automatic cut-off engine.

Applying the rule of analysis, we find first that the combined length of the 20 lines, 1, 2, 3, 4, &c., is  $21\frac{1}{8}$  inches, showing that we have  $42\frac{1}{8}$  pounds mean effective pressure.

The terminal pressure (T. V.) is 27 lbs.; the volume at that pressure is given at 926; that is, one cubic inch of water at a temperature of  $60^\circ$ , makes 926 cubic inches of steam at 27 lbs. pressure per square inch. Hence by the rule the rate of water consumption becomes  $\frac{859375}{926 \times 42.2} = 21.74$  lbs. of water per indicated horse-power per hour.

But early exhaust closure saves some steam, while exhausting from the clearance at a pressure greater than the back pressure wastes some, and the process, so far, makes no allowance for either. When the maximum compression equals the terminal, the loss and gain are equal, but when the *compression* exceeds the *terminal*, there is a balance of gain from compression, equal to the excess of steam compressed into the clearance space over that exhausted from it, and when the terminal exceeds the compression, there is a balance of loss due to exhausting from the clearance space, hence the following rule:

#### To Make Allowance for Compression and Clearance.

1st. Fix the terminal pressure at point *T* (Fig. 182 and other diagrams) where it would have been if the steam had not been released till the end of the stroke was reached.

2d. Draw the line *T 2* parallel with the atmospheric line, which will cut the compression line at *I*, at which point the quantity of steam exhausted from the clearance has been re-

stored, and the consumption will be as much less than the rule shows, as the line  $T I$  is shorter than the line  $T 2$ , or the length of the diagram.

3d. Multiply the result obtained by the rule by the length of the line  $T I$ , and divide the product by the length of the line  $T 2$ . The result will be the rate of consumption corrected for both clearance and compression.

Example. The result obtained from the rule is 21.74 lbs., the length of line  $T I$  is 3.17 inches, and the length of line  $T 2$  is  $3\frac{1}{2}$  inches, hence  $21.74 \times 3.17 \div 3.5 = 19.69$  lbs. per indicated horse-power per hour, the corrected rate. It should be understood that this rate is *theoretical*, and assumes perfect conditions, such as dry steam, entire absence of loss from leakage, condensation, &c.

FIG. 183.

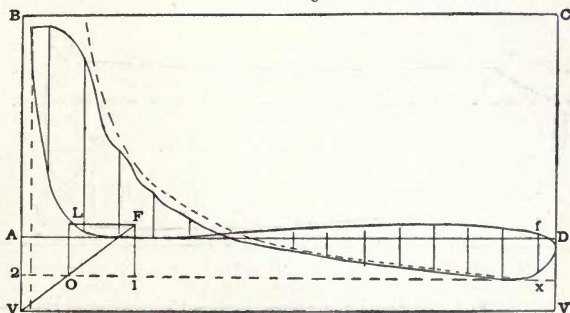

Diagram, Fig. 183, illustrates a method of finding the point  $I$  ( $X I$ ) in the terminal line, when that line is located below the atmospheric line, and consequently below any part of the compression curve defined on the diagram.

Select any point in the actual curve, as at  $L$ . From that point draw a line at right angles to atmospheric line, to terminal line, as at  $O$ . Then from  $V$ , where the clearance line cuts the vacuum line, draw a diagonal line *through point O* to point  $F$ , (same height as point  $L$ ), then a line at right angles to atmospheric line, from  $F$ , will cut the terminal line at the proper place for point  $I$ . The process will be recognized as the same

in principle as that used for finding a point in the isothermal expansion curve.

The consumption for diagram, Fig. 183, is as follows:

The mean effective pressure is 2 lbs., and the terminal pressure  $D. V.$  is  $6\frac{3}{4}$  pounds. The volume for  $6\frac{3}{4}$  pounds is given as 3427 (the mean for  $6\frac{1}{2}$  and 7 lbs.), hence  $\frac{859375}{3427 \times 2} = 125.4$  lbs. Line  $X I$  is  $2\frac{3}{4}$  inches long, and line  $X \mathcal{Q}$  (or whole length of card) is  $3\frac{1}{2}$  inches, hence  $125.4 \times 2.75 \div 3.5 = 98.53$  lbs. per indicated horse-power. per hour, the correct rate. This will serve to show the utter absurdity of very light loads.

FIG. 184.

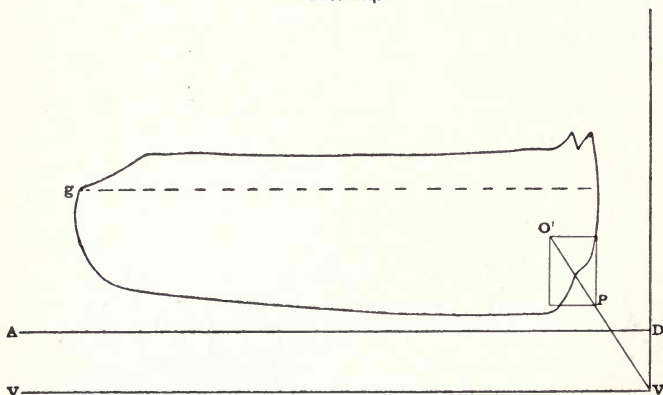

When the compression pressure does not equal the terminal, as in diagram Fig. 20, page 116, the curve may be continued upward and beyond the end of diagram until it reaches the height of terminal line. The extension may be made by the eye with sufficient accuracy. In this case distance  $g I$  becomes the longer one, and the result obtained from the rule is increased, as distance  $g I$  is always the multiplier, and  $g \mathcal{Q}$  the divisor in the corrections.

Diagram, Fig. 184, illustrates a method of locating the clearance line from the conformation of compression curve, as follows: First select two points in the curve and form a paral-

lelogram through said points as illustrated. Then draw a diagonal line through points  $O P$ , till it intersects the vacuum line, the clearance line will be a vertical one drawn from said point of intersection, as  $V. D$ . The degree of accuracy will depend upon the perfection or tightness of piston and valve, leakage generally having the effect of showing too much clearance.

*Computation Table.*—Thus far the constant number 859,375 in connection with the volumes of steam, has been used for computing the rate of water consumption. To make the process available, a table of volumes must always be present, and to render our instructions complete we should publish such a table, but in lieu of that, we submit herewith a Computation Table.

COMPUTATION TABLE NO. 8.

| P  | W     | P  | W     | P  | W     | P  | W     | P  | W     | P   | W     | P   | W     |
|----|-------|----|-------|----|-------|----|-------|----|-------|-----|-------|-----|-------|
| 3  | 39.10 | 20 | 34.99 | 37 | 33.72 | 54 | 32.98 | 71 | 32.46 | 88  | 32.07 | 105 | 31.73 |
| 4  | 38.47 | 21 | 34.89 | 38 | 33.67 | 55 | 32.94 | 72 | 32.43 | 89  | 32.05 | 106 | 31.71 |
| 5  | 37.95 | 22 | 34.79 | 39 | 33.62 | 56 | 32.91 | 73 | 32.40 | 90  | 32.03 | 107 | 31.69 |
| 6  | 37.54 | 23 | 34.70 | 40 | 33.57 | 57 | 32.88 | 74 | 32.38 | 91  | 32.00 | 108 | 31.67 |
| 7  | 37.22 | 24 | 34.61 | 41 | 33.52 | 58 | 32.85 | 75 | 32.36 | 92  | 31.98 | 109 | 31.65 |
| 8  | 36.93 | 25 | 34.53 | 42 | 33.47 | 59 | 32.82 | 76 | 32.34 | 93  | 31.96 | 110 | 31.63 |
| 9  | 36.67 | 26 | 34.45 | 43 | 33.42 | 60 | 32.79 | 77 | 32.32 | 94  | 31.94 | 111 | 31.61 |
| 10 | 36.44 | 27 | 34.37 | 44 | 33.38 | 61 | 32.76 | 78 | 32.30 | 95  | 31.92 | 112 | 31.59 |
| 11 | 36.24 | 28 | 34.29 | 45 | 33.34 | 62 | 32.73 | 79 | 32.27 | 96  | 31.90 | 113 | 31.57 |
| 12 | 36.06 | 29 | 34.22 | 46 | 33.30 | 63 | 32.70 | 80 | 32.25 | 97  | 31.88 | 114 | 31.55 |
| 13 | 35.89 | 30 | 34.15 | 47 | 33.26 | 64 | 32.67 | 81 | 32.23 | 98  | 31.86 | 115 | 31.54 |
| 14 | 35.73 | 31 | 34.08 | 48 | 33.22 | 65 | 32.64 | 82 | 32.20 | 99  | 31.84 | 116 | 31.53 |
| 15 | 35.59 | 32 | 34.01 | 49 | 33.18 | 66 | 32.61 | 83 | 32.18 | 100 | 31.82 | 117 | 31.52 |
| 16 | 35.46 | 33 | 33.95 | 50 | 33.14 | 67 | 32.58 | 84 | 32.16 | 101 | 31.80 | 118 | 31.51 |
| 17 | 35.34 | 34 | 33.89 | 51 | 33.10 | 68 | 32.55 | 85 | 32.14 | 102 | 31.78 | 119 | 31.50 |
| 18 | 35.22 | 35 | 33.83 | 52 | 33.06 | 69 | 32.52 | 86 | 32.12 | 103 | 31.77 | 120 | 31.49 |
| 19 | 35.10 | 36 | 33.77 | 53 | 33.02 | 70 | 32.49 | 87 | 32.09 | 104 | 31.75 | 121 | 31.48 |

It has been stated in our definitions of mean effective and terminal pressures, that the former is the *measure of the power developed*, and the latter the corresponding measure of the consumption or *cost of the power*. Hence we should be enabled to find a number which, if multiplied by the terminal pressure, and divided by the mean effective pressure, would give us the rate of water consumption at once, excepting the required correction for compression and clearance.

## Explanation of Table No. 8.

The numbers in columns  $P$  stand for so many different total terminal pressures, and the numbers in columns  $W$  are the numbers sought, as referred to above. Each of the numbers under  $W$  is found by dividing our constant number 859,375, by the numbers to the left of it under  $P$ , representing terminal pressure, and that quotient by the volume of steam at that pressure. Each number under  $W$  will therefore represent the rate of water consumption, for a diagram having both mean effective and total terminal pressures, the same as the number to the left of it under  $P$ ; and when any given diagram has a mean effective pressure greater than its total terminal pressure, its rate of consumption will be proportionately less than if they were the same, and if the mean effective is less, the rate will be proportionately higher.

Hence the rule: Find in column  $P$  the total terminal pressure of the diagram or the number nearest it. For fractions of a pound in the terminal, an approximate average of or mean of two numbers, should be found, to insure accurate results. Then multiply the number under  $W$  opposite the number so found by the total terminal pressure of the diagram, and divide the product by its mean effective pressure; the quotient will be the rate in pounds of water per I. HP. per hour, subject, however, to the correction for compression and clearance, as previously explained.

## Example for Use of Table No. 8.

Referring to diagram, Fig. 182, we have total terminal pressure  $T V = 27$  pounds, mean effective pressure 42.2 pounds, number in table under  $W$  for 27 pounds: is 34.37. Line  $T 1 = 3.17$  inches and line  $T 2 = 3.5$  inches.

Then

$$\frac{34.37 \times 27}{42.2} = 21.99 \text{ pounds of water,}$$

Correction:

$$\frac{21.99 \times 3.17}{3.5} = 19.91 \text{ pounds of water,}$$

per indicated horse-power per hour, corrected rate.

By reference to Fig. 182 it will be seen that the point  $T$  is

where the terminal pressure would have been if the steam had not been released until the end of the stroke was reached; the dotted line  $T'1$  is parallel with the atmospheric line, and cuts the compression curve at a point where compression has restored the amount of steam exhausted from the clearance.

The above Table No. 8 is best illustrated by the following comparison of different types of engines. We would further explain by the double diagram Figure 185, which graphically illustrates the comparative steam economy between "throttling" and "automatic cut-off" regulation. The diagram is engraved from actual cards. Both represent very favorable loads, and each

FIG. 185.

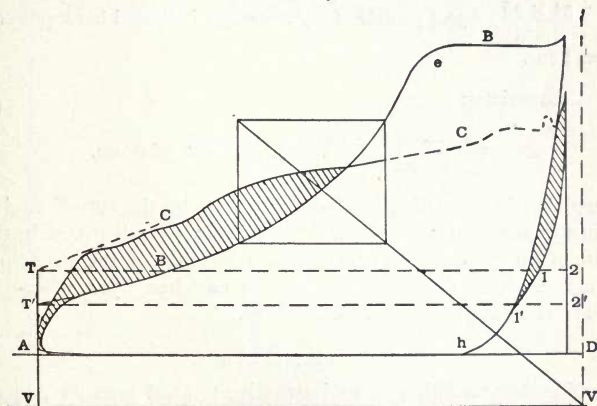

shows excellent results for its type of engine. The "throttling" card  $C C$  develops 40.25 pounds mean effective pressure, with 36 pounds terminal pressure ( $TV$ ), while the cut-off card  $BB$  develops 42 pounds mean effective pressure, with only 28 pounds total terminal pressure ( $T'V$ ). Thus the cut-off engine was developing 42 pounds of work with an expenditure of its cylinder full of steam at 28 pounds pressure, while the "throttling" engine developed but 40.25 pounds of work with its cylinder full of steam at 36 pounds pressure per square inch.

The comparison in percentages is very nearly as follows, bear-

ing in mind that the total pressure (viz: pressure above vacuum line), is the measure of the consumption of steam, and the mean effective pressure is the corresponding measure of the power developed. Assuming the constant number 34 (which, while not precisely correct for either terminal, is the mean between the two, dropping fractions, in favor of the throttling card), then for the cut-off engine the result is as follows:

$\frac{34 \times 28}{42} = 22.7$  pounds of dry steam per indicated horse-power per hour.

For the throttling engine card:

$\frac{34 \times 36}{40.25} = 30.4$  pounds of dry steam per indicated horse-power per hour.

Comparison:

$$\frac{30.4 - 22.7 \times 100}{22.7} = 34 \text{ per cent. of steam,}$$

used by the throttling engine more than by the cut-off engine for the same amount of work. This shows the advantage in the use of an automatic cut-off engine over that of the throttling engine. This difference can always be relied upon whenever the cut-off engine is given a fair load.

#### Evil of Light Loads.

No other condition is so destructive to good economy, as an engine over-large for its work: this fact should be well understood by purchasers of steam-engines.

With a too light load, internal condensation comes in to the fullest extent. The cut-off is early, hence the expansion and consequent fall of temperature are excessive. It admits of no denial that the immediate surfaces, at least of the interior of the cylinder, share in this fall of temperature, which still further continues during the exhaust, and experiment has also shown that a deposit of water like dew takes place on them. All these surfaces have got to be reheated, and all this water re-evaporated, at the expense of the next admission of steam, which being



necessarily small, from the light load, suffers severely from condensation. With a substantial load, the expansion and cooling are much less, and the amount of steam admitted to restore the heat is much larger.

We must not be misunderstood as advocating overloading. We do wish, however, to correct the fatal idea, arising partly from the manufacturer's fear of insufficient power, and partly from the impression that economy increases definitely with increase of expansion, that "it is no mistake to get an engine too large." Moreover, in non-condensing engines, a direct loss occurs by expansion below atmosphere, thus creating a vacuum resistance on the impelling side of the piston, at the expense of the fly-wheel; also see Fig. 25, and Figs. 183 and 186.

FIG. 186.

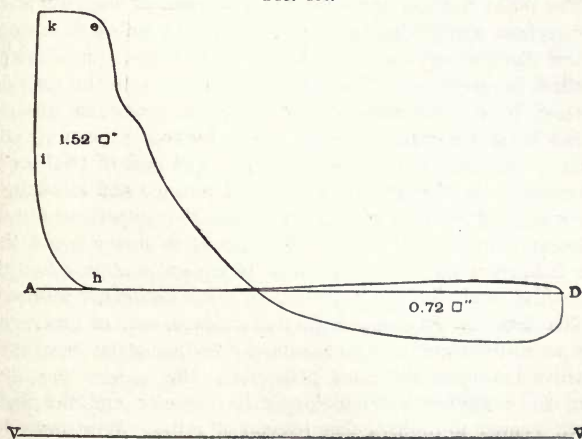

#### Efficiency or Duty of Pumping Engines.

The term "duty" is a measure of the efficiency of a pumping engine, and is based upon the delivery of water into the reservoir (with the friction of the water pipes) per hundred pounds of coal. Duty is usually expressed in foot pounds.

The method usually employed neglects the actual delivery of water and head, against which the pump works, but assumes

that the area of the pump piston multiplying the average pressure or head pumped against measured to level of water in the pumping well (and the pressure due friction), and multiplying the lineal travel of the piston, represents the work done, and this divided by one pound of coal for each hundred burned, represents the duty; or, by formula:

$$\text{Duty} = \frac{A P (S \times 2)}{C} \times 100.$$

Where

A = area of pump piston.

P = load in pounds pressure per square inch.

S = stroke of piston in feet.

C = coal consumed.

The above method is employed in estimating the duty when the engines pump directly into the mains or into a stand-pipe. When the delivery of water is into a reservoir, the following method is employed: The delivery of water into the reservoir is noted by weir measurement, which is the most exact method; if this is not convenient it is done by calculating the cubic contents of reservoir at the commencement and end of trial, or by estimating the theoretical delivery of pumps, and allowing a percentage of leakage, which is determined by experiment in the following manner: The engine is run at so slow a speed that the leakage would be equal to the pumpage, that is, when the ascending main is kept full, but no water enters the reservoir.

The late Mr. Nystrom suggested a simple way of measuring the water delivered into a reservoir by the use of an instrument constructed upon the same principle as the *marine log*, only that the propeller is much larger in diameter, and the clock-work geared to indicate feet instead of miles. Nystrom's log consists principally of a propeller, which is set in rotation by the current of water in which it is immersed. An endless screw, on the end of the propeller shaft, sets the clock-work in motion in the casing, and the number of feet of current passing the propeller represents 10 feet, on the second 100, on the third 1,000 and on the fourth 10,000 feet.

Thus with the four dials, 100,000 feet can be indicated. A sleeve covers the dials when the log is in operation, to prevent

solid matter in the water from interfering with the hands and settling in the instrument.

Two of these instruments were constructed expressly for measuring the water at Fairmount, and other Steam Pumping Works of Philadelphia, by a Commission appointed to measure the duty of the different works, of which Commission the writer had the honor to be a member, and cannot speak too highly of their operation.

The number on the dials, multiplied by 1.14, is the space in feet, which multiplied by the area of cross-section in square feet of the current, gives the cubic feet of water that have passed the log.

When the actual delivery of water is made the basis for estimating the duty, the lift is taken, either by differences of levels of water in pump well and reservoir, or by taking the pressure in the rising main in the pump house, and adding the difference of level between the gage and water in the well; to this is added the allowance for friction, and necessary resistances between gage and well. The delivery is usually reduced to gallons, and the weight of water at mean observed temperature accurately determined.

$$\text{Duty} = \frac{G W H}{C} \times 100.$$

G = gallons delivered into reservoir.

W = weight per gallon.

H = constant head in feet to which the water is delivered.

C = coal consumed during trial.

The following data are from the contract trial of H. R. Worthington, of N. Y., with Belmont Water Works:

|  |            |
|--|------------|
| Discharged by weir measurement . . . . .                 | 11,744,320 |
| Weight per gallon in pounds . . . . .                    | 8.38       |
| Lift, including allowance for friction in feet . . . . . | 217.74     |
| Coal consumed in pounds . . . . .                        | 28,890     |

$$\text{Duty} = \frac{11744.320 \times 8.38 \times 217.74}{38,890} \times 100 = 54,416,694$$

pounds raised one foot high with 100 pounds of coal.

## Reducing Motion.

In order that the diagram shall be correct, it is essential—

*First.*—That the motion of the paper drum shall coincide exactly with that of the engine piston.

*Second.*—That the position of the pencil shall precisely indicate the pressure of steam in the cylinder.

The first condition is frequently somewhat difficult to bring about, because it is not only necessary that the beginning and end of motions shall be coincident, but that these and all intermediate points shall be so. Owing to the irregular motion of

FIG. 187.

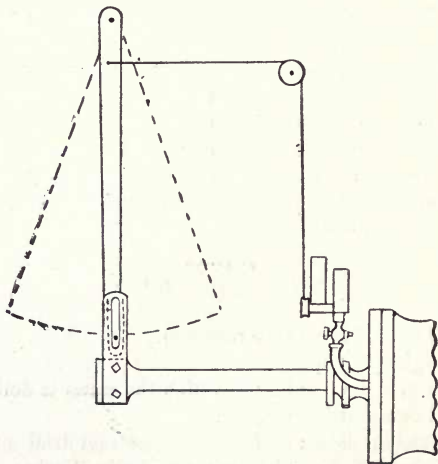

the engine piston, consequent upon the varying angularity of the connecting-rod, it is, therefore, generally advisable to connect the cord in some way to the piston cross-head. If any other point be chosen, it must be carefully seen that the motion given does not vitiate the diagram.

As the motion of the parts mentioned exceeds in length the motion of the indicator paper drum, it must be reduced in length by levers of such proportions as may be required for that purpose. For example, if the stroke of the engine is forty-eight

inches, and the length of the diagram is to be four inches, then the lengths of levers are as *one* is to *twelve*; or, if only one lever is used, then the indicator motion must be taken from a point on the lever sufficiently far from its fixed end to obtain the reduced travel required.

One of the simplest ways of reducing the motion is by a swinging lever, with a pin working in a slot of an arm secured to the cross-head of the engine, and transmitting the motion by a cord to the indicator, as shown in Fig. 187.

FIG. 188.

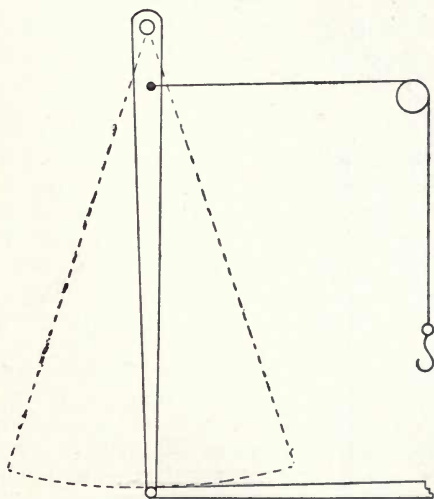

The above Fig. 188, also shows a simple plan which can be made of hard wood, or what is known as the "Brumbo" pulley, as illustrated in Fig. 189.

It is simply a narrow bar of wood, at least one and a half times as long as the stroke of the engine, connected by a link of a convenient length to the cross-head. The cord runs over an arc, the centre of which is the pin on which the bar swings. The radius of the arc necessary to give the desired length of the diagram can be readily found by dividing the length of the bar

by the stroke and multiplying the quotient by the length of the diagram desired. The product will be the required radius. For example, if the bar is 30 inches long and the stroke 20 inches, and we wish to obtain a 3-inch diagram, we have  $30 \text{ inches} \div 20 \text{ inches} = 1\frac{1}{2}$ ;  $1\frac{1}{2} \times 3 \text{ inches} = 4\frac{1}{2} \text{ inches}$ , the radius required to give a diagram 3 inches in length. When the cross-head is in the middle of the stroke, the swinging bar must be in the middle of its path. To prevent errors caused by the angularity of the swinging bar in different positions, the pin

FIG. 189.

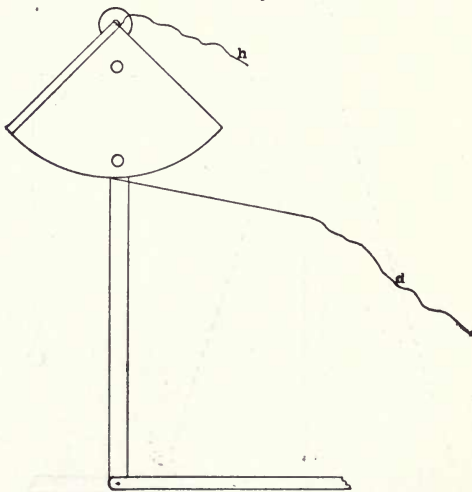

which connects the end of the bar with the link should be the same distance below the line of motion of the bolt connecting the link with the cross-head when the bar is in its middle position, as it is above that line of motion when the bar is in its extreme positions.

The Brumbo pulley can be cheaply and quickly made, has but few joints, and can be used on almost any engine. The bar does not have to swing in a vertical plane, but may swing at any angle by using a little ingenuity in connecting the link

with the cross-head. A link made of a thin strip of steel that will bend and twist a little is very convenient. Care must always be taken that, in whatever position the bar may be, the cord will run straight off the arc. When well put up this device is accurate and reliable. Some engines are furnished with a permanent drum motion of this kind, made of steel with nice joints, which, of course, is more satisfactory than any temporary arrangement.

The methods of attaching the various devices to the cross-head are so numerous that it will be impossible to give any rule for universal application. If there are no projections of the engine frame, the device may be attached direct to the cross-head by a bolt tapped in for the purpose, and which will furnish a pivot upon which the device is to act. For the Brumbo pulley and other levers of that stamp, there must be a connecting rod between the cross-head and the lever. This may usually be quite short, and attached either directly to the cross-head or to a bar or strap bolted to it. Usually there is some projecting part of the engine, like the rocker stands, portions of the frame or rods, that prevent the parallel motion devices from being directly attached to the cross-head. In such cases each engineer must make his own device. However, there is one method that the writer has most frequently used, that may be of service to others. On an ordinary engine the bolts that are used for adjusting the cross-head gibs usually have a jamb-nut to hold them in position, and there is, or should be, at least a quarter of an inch between this nut and the head of the bolt. By loosening this nut there will be room to put a bar of quarter-inch iron underneath, and it will be firmly held in position by screwing the nut down upon it. This bar may be made of suitable shape and length to project beyond the frame of the engine, and the device for reducing the motion may be pivoted near the end of the bar instead of the cross-head.

In making use of any of these contrivances, great care should be taken that there be no lost motion at the joints, and that the parts move easily when connected.

Most indicators are now made so that the cord may lead off in any direction, and it is unnecessary to have the instrument in a direct line with the reducing motion; but it is absolutely essen-

tial to accuracy that the cord should lead from the parallel or other motion device directly in the line of this motion. To accomplish this, an idle pulley as shown in Fig. 188 is so placed that it receives the cord in a direct line from the device and delivers it to the indicator. This cord should be strong, flexible and inelastic. A hook should be provided on the cord from the indicator and an eye at the proper place on the cord from reducing device, so that the connection may be made easily while the engine is in motion, and disconnected after the cord is taken. Fasten the cord securely to the reducing device and adjust the eye to such a length that when holding it in one hand when the engine is in motion, it will not quite catch the hook on the cord from the paper drum when the drum is at rest, with the least tension on the spring, and so that it will pass beyond the hook when the drum cord is pulled out and the greatest tension is on the spring. Then by pulling this drum cord out as far as possible, the eye may be hooked on very easily and quietly, without jerking the instrument in the slightest. The indicator is now in position and the drum ready to oscillate with the corresponding motion of the piston.

Engine Tests at Electrical Exhibition, Philadelphia, 1884.

Test of Porter-Allen engine:

Test began, . . . . . 1.10 p. m., October 23, 1884.

Test ended, . . . . . 11.10 p. m., October 23, 1884.

The engines was stopped 2.9 minutes at 6.15 p. m., to change indicators.

|                                       |                      |
|---------------------------------------|----------------------|
| Diameter cylinder, . . . . .          | 11½ inches.          |
| Stroke, . . . . .                     | 20 inches.           |
| Diameter piston rod, . . . . .        | 1¾ inches.           |
| Diameter steam pipe, . . . . .        | 5 inches.            |
| Diameter exhaust pipe, . . . . .      | 5 inches.            |
| Area steam ports, . . . . .           | 6.75 square inches.  |
| Area exhaust ports, . . . . .         | 10.94 square inches. |
| Diameter fly wheel (belt drum), . . . | 66 inches.           |
| Face of fly wheel, . . . . .          | 15 inches.           |
| Weight of fly wheel, . . . . .        | 1,000 pounds.        |
| Weight of engine complete, . . . . .  | 8,500 pounds.        |

Displacement (measured)—

Crank end of cylinder, . . . . . 2018.3 cubic inches.



|   |                       |
|---|-----------------------|
| Head end of cylinder, . . . . .                               | 2070.14 cubic inches. |
| Clearance (measured)—   |                       |
| Crank end, . . . . .  | 127.87 cubic inches.  |
| Crank end, . . . . .  | 6.33 % displacement.  |
| Head end, . . . . .   | 136.94 cubic inches.  |
| Head end, . . . . .   | 6.61 % displacement.  |
| Water used in engine, . . . . .                               | 27849.07 pounds.      |
| Total time engine in operation, . . .                         | 9 hours 57.1 min.     |
| Mean revolutions per minute, . . . .                          | 227.51                |
| Maximum revolutions per minute, . .                           | 230.2                 |
| Minimum revolutions per minute, . .                           | 221.8                 |
| Variation from mean speed, . . . . .                          | + 1.18 per cent.      |
| Variation from mean speed, . . . . .                          | — 2.51 per cent.      |
| Mean horse-power (indicated) of en-<br>gines, . . . . .       | 69.34                 |
| Maximum horse-power (indicated) of<br>engines, . . . . .      | 76.16                 |
| Minimum horse-power (indicated) of<br>engines, . . . . .      | 63.16                 |
| Mean temperature of steam at engine,                          | 329.33°               |
| Maximum temperature of steam at en-<br>gine, . . . . .        | 338.°                 |
| Minimum temperature of steam at en-<br>gine, . . . . .        | 306.5°                |
| Mean pressure of steam at engine, . .                         | 90.5 pounds.          |
| Maximum pressure of steam at engine,                          | 101.6 pounds.         |
| Minimum pressure of steam at engine,                          | 59.0 pounds.          |
| Mean pressure of steam at boiler, . .                         | 92.8 pounds.          |
| Maximum pressure of steam at boiler,                          | 104.3 pounds.         |
| Minimum pressure of steam at boiler,                          | 61.0 pounds.          |
| Mean barometer, . . . . .                                     | 30.059 inches.        |
| Mean temperature of air, . . . . .                            | 47.4° Fahr.           |
| Mean power required to run engine<br>with load off, . . . . . | 5.16 HP.              |

The diagram, Fig. 190, shows the mean of all the indicator cards taken during the test: the clearance line is drawn at each end of diagram, and the theoretical (hyperbola) expansion and compression lines have been drawn. The scale to which the diagrams are drawn is twenty-five pounds to one inch.

Diagram, Fig. 191, is a reproduction of the card taken at

8.45 p. m., October 23d, showing 69.38 horse-power. This card represents more nearly the mean horse-power developed than any other that was taken.

FIG. 190.

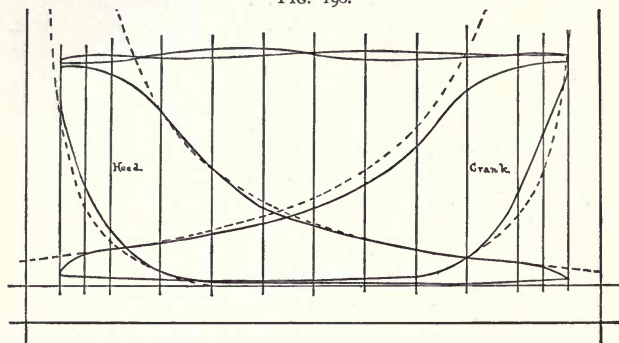

The pressures corresponding to the different parts of the stroke on the mean indicator card, are given in Table 9. The first

FIG. 191.

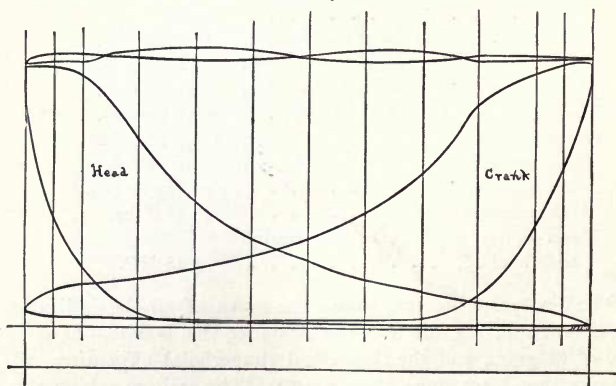

column *A* shows the points of the stroke. The columns headed *B* show the pressure in the end of the cylinder away from the

shaft, while making the stroke towards the shaft and returning; and the column headed *C*, shows the pressures in the opposite end. The column headed *D*, shows the quantity of dry saturated steam used in the cylinder per horse-power per hour from the indicator cards, using the mean number of revolutions and the mean horse-power, and allowing for the amount of steam compressed in the clearance. Re-evaporation after initial condensation is clearly shown by this:

The amount of water used by actual weight is 44.307 pounds per horse-power per hour.

TABLE NO. 9.

| A.<br>Part of<br>Stroke. | B.                 |            | C.                  |            | D.<br>Steam Ac-<br>counted<br>for in both<br>Ends of<br>Cylinder.  |
|--------------------------|--------------------|------------|---------------------|------------|--|
|                          | Head End Cylinder. |            | Crank End Cylinder. |            |  |
|                          | Advancing.         | Returning. | Advancing.          | Returning. |  |
| Beginning.               | 86.28              | 70.00      | 87.82               | 81.63      | Clearance,<br>6.3107 pds.<br><br>19.8733<br>20.0799<br>20.3880<br>20.8786<br>21.5601<br>22.2940<br>23.3827 |
| .05                      | 86.22              | 38.00      | 87.72               | 59.86      |  |
| .1                       | 83.88              | 20.79      | 85.30               | 36.42      |  |
| .2                       | 69.62              | 5.47       | 77.10               | 11.12      |  |
| .3                       | 46.60              | 2.00       | 54.72               | 3.18       |  |
| .4                       | 32.80              | 1.64       | 39.70               | 2.58       |  |
| .5                       | 24.04              | 1.40       | 30.42               | 2.38       |  |
| .6                       | 18.11              | 1.22       | 24.40               | 2.40       |  |
| .7                       | 14.03              | 1.05       | 20.18               | 2.42       |  |
| .8                       | 10.92              | 9.6        | 17.06               | 2.63       |  |
| .9                       | 8.92               | 1.21       | 14.84               | 3.18       |  |
| .95                      | 6.82               | 1.60       | 12.74               | 3.36       |  |
| End.                     | 1.88               | 1.85       | 6.82                | 4.32       |  |

Fig. 192, shows the amount of dry saturated steam which should have been present in the cylinder at the different points of each stroke, together with their sum, the upper line being simply a graphic representation of column *D*, of Table 9.

#### Test of the Buckeye Engine.

Test began, . . . . . 6 p. m., October 31, 1884.  
 Test ended, . . . . . 4 a. m., November 1, 1884.  
 Diameter cylinder, . . . . . 10 inches.  
 Stroke, . . . . . 20 inches.  
 Diameter piston-rod, . . . . . 1½ inches.

|                                      |                       |
|--------------------------------------|-----------------------|
| Diameter steam pipe, . . . . .       | 3½ inches.            |
| Diameter exhaust pipe, . . . . .     | 4 inches.             |
| Area steam ports, . . . . .          | 5/8 x 8¾ inches.      |
| Area exhaust ports, . . . . .        | 7/8 x 8¾ inches.      |
| Diameter fly wheel, . . . . .        | 84 inches.            |
| Face of fly wheel, . . . . .         | 19 inches.            |
| Weight of fly wheel, . . . . .       | 3200 pounds.          |
| Weight of engine complete, . . . . . | 9800 pounds.          |
| Displacement (measured),—            |                       |
| Crank end, . . . . .                 | 1464.48 cubic inches. |
| Head end, . . . . .                  | 1557.36 cubic inches. |

FIG. 192.

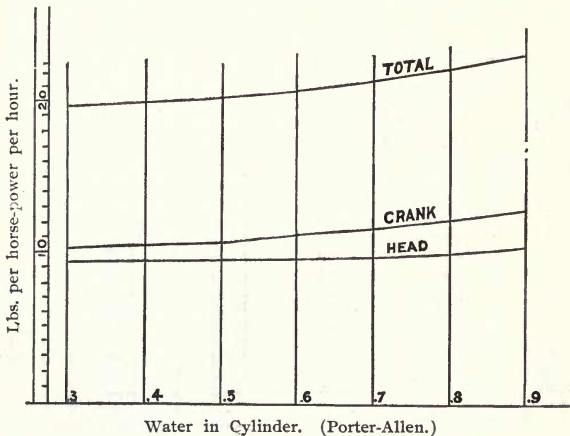

Clearance (measured) to face of cut-off,—

|   |                      |
|---|----------------------|
| Crank end, . . . . .                      | 47.95 cubic inches.  |
| Crank end, . . . . .                      | 3.27 % displacement. |
| Head end, . . . . .                       | 53.57 inches.        |
| Head end, . . . . .                       | 3.44 % displacement. |
| Water used in engine, . . . . .           | 16803.30 pounds.     |
| Total time engine in operation, . . . . . | 10 hours.            |
| Mean revolutions per minute, . . . . .    | 201.11.              |
| Maximum revolutions per minute, . . . . . | 205.6.               |
| Minimum revolutions per minute, . . . . . | 194.4.               |
| Variation from mean speed, . . . . .      | + 2.23 per cent.     |

|   |                  |
|---|------------------|
| Variation from mean speed, . . . . .              | — 3.33 per cent. |
| Mean indicated horse-power, . . . . .             | 54.32            |
| Maximum indicated horse-power, . . . . .          | 56.27.           |
| Minimum indicated horse-power, . . . . .          | 52.35.           |
| Mean temperature of steam at engine, . . . . .    | 332.83°.         |
| Maximum temperature of steam at engine, . . . . . | 390°.            |
| Minimum temperature of steam at engine, . . . . . | 304.5°.          |
| Mean pressure of steam at engine, . . . . .       | 98.04 pounds.    |
| Maximum pressure of steam at engine, . . . . .    | 107.30 pounds.   |
| Minimum pressure of steam at engine, . . . . .    | 89.80 pounds.    |

FIG. 193.

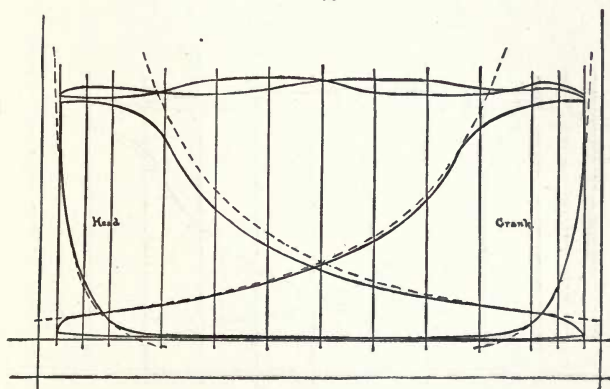

Mean Card Buckeye Engine.

|   |            |
|---|------------|
| Mean barometer, . . . . .   | 30.012.    |
| Mean temperature of air, . . . . .                                    | 46°.       |
| Mean power required to run the engine<br>with the load off, . . . . . | 5.26 H. P. |

## Mean Card (Buckeye Engine.)

Diagram Fig. 193 shows the mean of all the indicator cards taken during the test, the mean being determined as before described.

Diagram, Fig. 194, is a reproduction of the cards taken at

11.20 P. M., October 31, 1884, showing 54.34 horse-power. This card was chosen because it comes more nearly to the mean horse-power than any other that was taken.

The pressures corresponding to the different parts of the stroke, which would give the mean indicator card, are given in Table 10.

The first column *A* shows the point of the stroke, *B* is the pressure in the end of the cylinder away from the shaft, while the piston is making the stroke towards the shaft and returning. *C* is the pressure in the opposite end. *D* is the quantity of dry saturated steam in the cylinder per horse-power per hour from the indicator card, using the mean number of revolutions and

FIG. 194.

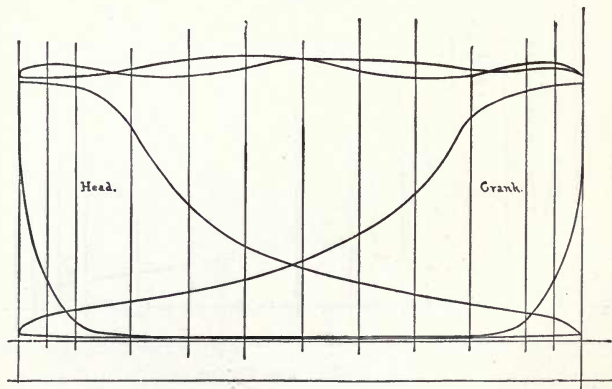

the mean horse-power, and allowing for the amount of steam compressed in the clearance.

Amount of water used by actual weight =  $\frac{16803.3}{10 \times 54.32} = 30.93$  pounds.

Diagram Fig. 195, shows the relative weights of dry saturated steam that should be present (theoretically) in the cylinder at different points of the stroke, together with the amount per horse-power per hour, as shown in Table 10.

Trial of the Southwark Engine.

Test began, . . . . . 1 p. m., November 8, 1884.

Test ended, . . . . . 12:02 a. m., November 9, 1884.

TABLE NO. 10.

| A.<br>Part of<br>Stroke. | B.<br>Head End Cylinder. |            | C.<br>Crank End Cylinder. |            | D.<br>Steam Ac-<br>counted<br>for in Both<br>Ends of<br>Cylinder. |
|--------------------------|--------------------------|------------|---------------------------|------------|---|
|                          | Advancing.               | Returning. | Advancing.                | Returning. |   |
| Beginning.               | 90.58                    | 78.72      | 90.95                     | 76.52      |   |
| .05                      | 90.49                    | 21.82      | 90.95                     | 20.34      |   |
| .1                       | 89.46                    | 6.94       | 89.86                     | 6.40       |   |
| .2                       | 76.76                    | 1.79       | 80.42                     | 1.39       |   |
| .3                       | 49.25                    | 1.62       | 52.94                     | 1.14       | 17.310  |
| .4                       | 35.04                    | 1.50       | 37.40                     | 1.08       | 17.743  |
| .5                       | 26.32                    | 1.38       | 28.18                     | .94        | 18.270  |
| .6                       | 20.40                    | 1.00       | 21.64                     | .90        | 18.713  |
| .7                       | 16.29                    | .56        | 16.98                     | .92        | 19.226  |
| .8                       | 13.12                    | .42        | 13.40                     | 1.04       | 19.689  |
| .9                       | 10.39                    | .52        | 10.65                     | 1.22       | 20.062  |
| .95                      | 8.28                     | .68        | 9.26                      | 1.49       |   |
| End.                     | 1.95                     | 1.95       | 3.76                      | 2.40       |   |

FIG. 195.

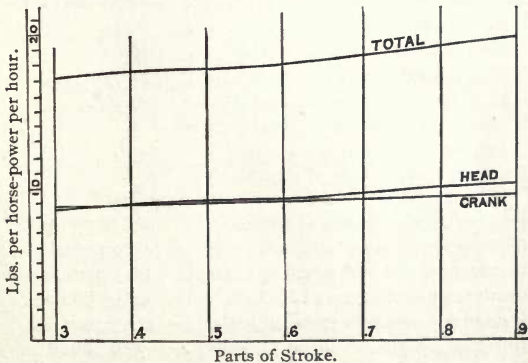

Steam in Cylinder. (Buckeye Engine.)

Diameter cylinder, . . . . . 9 inches.

Stroke, . . . . . 10 inches.

|   |                       |
|---|-----------------------|
| Diameter piston rod, . . . . .  | 1½ inches.            |
| Diameter steam pipe, . . . . .  | 3 inches.             |
| Diameter exhaust, . . . . .   | 3½ inches.            |
| Area steam port, . . . . .  | 5.7 square inches.    |
| Area exhaust port, . . . . .  | 5.7 square inches.    |
| Diameter fly-wheel (belt drum), . . .                                   | 40 inches.            |
| Face of fly-wheel, . . . . .  | 8½ inches.            |
| Weight of fly-wheel, . . . . .  | 400 pounds.           |
| Weight of engine, complete, . . . . .                                   | 2,600 pounds.         |
| Displacement (measured)—  |                       |
| Crank end, . . . . .  | 606.03 cubic inches.  |
| Head end, . . . . .   | 633.31 cubic inches.  |
| Clearance (measured)—   |                       |
| Crank end, . . . . .  | 66.1 cubic inches.    |
| Crank end, . . . . .  | 10.91 % displacement. |
| Head end, . . . . .   | 70.42 cubic inches.   |
| Head end, . . . . .   | 11.12 % displacement. |
| Water used in engine, . . . . .   | 14792.07 pounds.      |
| Total time engine in operation, . . . .                                 | 11 hours, 2 minutes.  |
| Mean revolutions per minute, . . . . .                                  | 305.06                |
| Maximum revolutions per minute, . . .                                   | 309.87                |
| Minimum revolutions per minute, . . .                                   | 301.                  |
| Variation from mean speed, . . . . .                                    | + 1.57 per cent.      |
| Variation from mean speed, . . . . .                                    | —1.33 per cent.       |
| Mean horse-power of engine, . . . . .                                   | 29.11                 |
| Maximum horse-power of engine, . . .                                    | 46.82                 |
| Minimum horse-power of engine, . . .                                    | 14.97                 |
| Mean temperature of steam at engine, .                                  | 329.16°.              |
| Maximum temperature of steam at engine, .                               | 335°.                 |
| Minimum temperature of steam at engine, .                               | 315°.                 |
| Mean pressure of steam at engine, . . .                                 | 87.58 pounds.         |
| Maximum pressure of steam at engine, .                                  | 96.0 pounds.          |
| Minimum pressure of steam at engine, .                                  | 68.5 pounds.          |
| Mean pressure of steam at boiler, . . .                                 | 92.97 pounds.         |
| Maximum pressure of steam at boiler, .                                  | 101.3 pounds.         |
| Minimum pressure of steam at boiler, .                                  | 73.0 pounds.          |
| Mean barometer, . . . . .   | 30.256                |
| Mean horse-power delivered, as shown by Tatham's dynamometer, . . . . . | 23.44                 |
| Maximum horse-power delivered, as shown by Tatham's dynamometer, . .    | 43.15                 |



|  |      |
|--|------|
| Minimum horse-power delivered, as shown by Tatham's dynamometer. . . . . | 9.13 |
| Mean horse-power required to run engine with belt off, . . . . .         | 4.68 |

Diagram, Fig. 196, shows the mean of all the indicator cards taken during the test, the mean being determined as before described.

Diagram, Fig. 197, is a reproduction of the cards taken at 7:15 P. M., November 8, 1884, showing 29.21 horse-power. This card was chosen, because it comes more nearly to the mean horse-power than any other that was taken during the test.

FIG. 196.

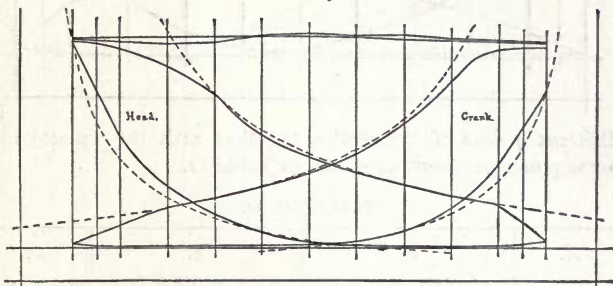

The pressures corresponding to the different parts of the stroke, which would give the mean indicator card, are given in Table II.

The first column *A* shows the points of the stroke. *B* is the pressure in the end of the cylinder away from the shaft, while the piston is making the stroke towards the shaft and returning. *C* is the pressure in the opposite end. *D* is the quantity of dry saturated steam in the cylinder per horse-power per hour from the indicator card, using the mean number of revolutions and the mean horse-power, and allowing for the amount of steam compressed in the clearance.

The amount of water used by actual weight per horse-power per hour =

$$\frac{14792.07}{11\frac{1}{8} \times 29.11} = 46.05 \text{ pounds.}$$

Diagram Fig. 198 shows the relative weights of dry saturated steam that should be present (theoretically) in the cylinder at

FIG. 197.

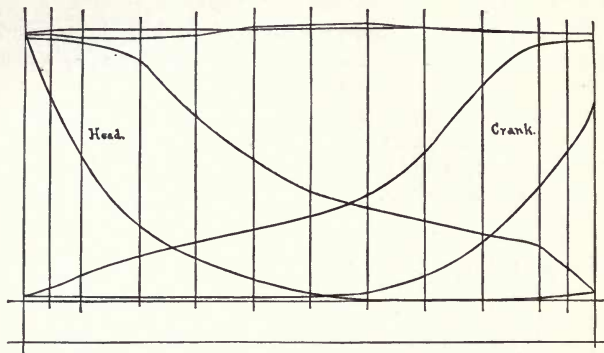

different points of the stroke, together with the amount for horse-power per hour, as shown in Table II.

TABLE NO. II.

| A.<br>Part of<br>Stroke. | B.<br>Head End Cylinder. |            | C.<br>Crank End Cylinder. |            | D.<br>Steam Ac-<br>counted<br>for in both<br>Ends of<br>Cylinder. |
|--------------------------|--------------------------|------------|---------------------------|------------|---|
|                          | Advancing.               | Returning. | Advancing.                | Returning. |   |
| Beginning.               | 86.80                    | 87.56      | 84.99                     | 67.14      |   |
| .05                      | 86.08                    | 66.21      | 84.99                     | 50.55      |   |
| .1                       | 83.90                    | 47.38      | 84.32                     | 35.02      |   |
| .2                       | 76.69                    | 25.56      | 71.05                     | 16.92      |   |
| .3                       | 62.58                    | 14.25      | 52.62                     | 7.00       | 20.781  |
| .4                       | 47.51                    | 6.36       | 39.40                     | 2.44       | 21.201  |
| .5                       | 37.97                    | 2.17       | 31.84                     | 1.36       | 22.155  |
| .6                       | 32.06                    | 0.44       | 25.60                     | 1.08       | 23.107  |
| .7                       | 26.75                    | 0.07       | 20.90                     | .69        | 23.676  |
| .8                       | 22.38                    | 0.11       | 17.08                     | .42        | 24.045  |
| .9                       | 18.24                    | 0.49       | 9.74                      | .58        |   |
| .95                      | 11.20                    | 1.46       | 3.27                      | 1.16       |   |
| End.                     | 3.47                     | 2.77       | 1.98                      | 1.80       |   |

The indicated horse-power of the engines were taken with a "Crosby" and a "Tabor" indicator on each cylinder, and a

Crosby was used on the valve chest. The indicator reducing motions used were practically exact.

On the Porter-Allen engine test, the indicators were changed when the test was half concluded, and as the cards taken by the two indicators from the same end were as nearly identical as possible, the indicators were not changed during the other tests.

The indicator springs were tested against a Crosby steam gauge, and were found to be practically correct both in ascending and descending.

FIG. 198.

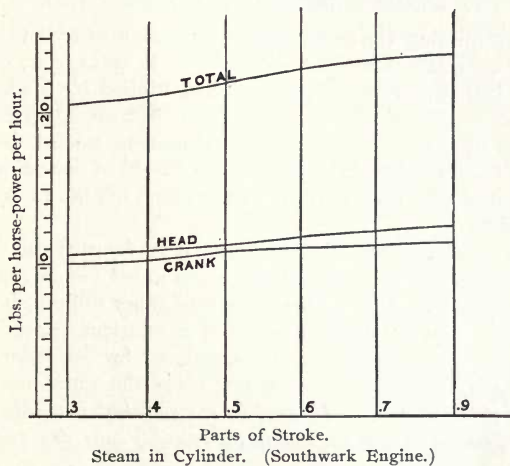

#### Horse-Power.

The areas of the cards were taken by a Crosby planimeter. The length of the cards were measured to  $\frac{1}{100}$  of an inch. The mean effective pressure was determined from this data. The constant for each end of the cylinder was found by dividing the displacement in cubic inches (found by experiment) by twelve times 33,000. This result, multiplied by the mean effective pressure and by the number of revolutions, gives the horse-power developed in one end of the cylinder. The sum of these results is the total indicated horse-power of the engine.

## Mean Indicator Card.

On each indicator card lines were drawn at right angles to the atmospheric line at the ends of the card, and also at .05, .1, .2—8, .9, .95, the length of the card. The distance from the atmospheric line to both the top and bottom of the card was measured in  $\frac{1}{16}$  of an inch and tabulated.

A mean of these tabulated results is taken as the mean indicator card from which the amount of water accounted for by the indicator card is calculated.

## Water Accounted for by Indicator Cards.

In determining the amount of water accounted for on the indicator card, the volume of the cylinder to .3, .4, etc., of the stroke, including clearance, has been multiplied by the weight of one cubic foot of steam at the pressure corresponding to that point of the stroke, and from this has been subtracted the volume of the clearance multiplied by the weight of one cubic foot of steam, at the pressure to which the steam has been raised by compression.

This amount being calculated separately for each end of the cylinder, gives the weight of steam accounted for on the card for each stroke. Adding these results together and multiplying by sixty times the mean number of revolutions per minute, gives the total weight of steam accounted for per hour, and dividing by the mean horse-power, gives the water used per horse-power per hour. *It must be remembered that this is on the supposition that the steam in the cylinder was dry and saturated.*

As none of the exhibitors made application for a competitive test as prescribed under the code, all tests are quantitative. And the fact that the engines were placed at very different distances from the boiler feeding them, caused the Committee to submit their results without an expression of opinion.

W. D. MARKS, *Chairman*,  
CHAS. E. RONALDSON,  
WM. BARNET LE VAN,  
H. W. SPANGLER, *Secretary*.

### An Approximation to the Effective Mean Pressure.

The process of finding the mean effective pressure by ordinates or the planimeter requires generally a little time. A simple and quick way of making a close approximation of the mean pressure of a diagram is as follows:

Draw the line  $ab$ , in Fig. 199, touching at  $a$ , and so that the space  $d$  will equal in area the spaces  $c$  and  $e$  taken together, as nearly as can be estimated by the eye.

Then measure distance  $f$ , taken at the middle of the diagram; this distance, measured by the scale of the indicator, will be the mean effective pressure throughout the stroke.

FIG. 199.

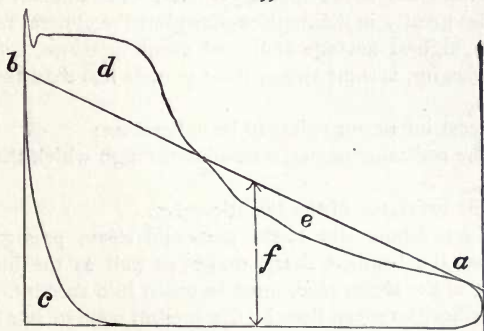

With a little practice, verifying the results in the usual way, the ability can soon be acquired to make estimates in this way with only a fraction of a pound of error, with diagrams representing some degree of load. With very high initial pressure and early cut-off, it is not so available.

Of diagram Fig. 9, I have already made a detailed explanation, but I wish to call the student's attention to a frequent mistake, namely in measuring on the ordinate lines, the measurements should be taken in the centre of the ordinates, or better still erect the ordinates as shown in dotted lines on Fig. 19, on page 113. The end spaces should be half the width of the others, as in this example the ordinates stand for the centres of equal spaces.

Ten is the most convenient and usual number of ordinates, though more would give more accurate results.

#### Conclusion.

It is hoped that enough has been said to present a general view of the application and use of the indicator, and before closing, it may be useful to append a few general remarks.

Rankine, Bourne, Northcott, Graham, Colburn, Salter, Nystrom, and Porter, in their books on the steam-engine and the indicator, discuss a large number of causes which influence the form of the indicator diagram.

*First.*—The steam pressure undergoes some fall during the passage from the boiler to the cylinder. The amount of such fall varies greatly in different engines; but the general result is, that the highest average indicated steam pressure, before expansion begins, is some two or three pounds less than the boiler pressure.

The most important points to be noticed are:

(a) The resistance of the steam-pipe through which the steam passes.

(b) The resistance of the throttle-valve.

(c) The resistance due to the ports and steam passages; and here, also, the bends or sharp angles, as well as the imperfect covering of the steam pipe, must be taken into account.

All authorities agree that in the present state of our knowledge it is impossible to calculate, separately, the losses of pressure due to these causes; and, if it were possible, the resulting formulæ would be too complicated to be of much use. An observation of this kind has a wide application. It may be pointed out, that steam which has been lowered in pressure by the resistance of passages (or has been *wire-drawn*, as we have termed it), is, to some extent, *superheated* by the friction of its molecules, the tendency of all friction being to produce heat.

*Second.*—There is in practice a rounding of the angle at *e*—see diagrams, Figs. 18, 24, 35, 39, 68 and 90, at which the expansion curve begins. This is called *wire drawing cut-off*. It is always to be seen where the steam valve closes gradually, as in diagram Figs. 169 and 174; but is reduced to a minimum in the improved form of cut-off valves, in general use, such as the

Buckeye, Porter-Allen, and other engines. Speaking generally it may be said that the steam begins, as it were, to work expansively a little before the valve is completely closed, or that the power exerted is nearly the same as if the valve had closed instantaneously at a somewhat earlier point of the stroke, which point may be termed the "effective cut-off." Such a point is easily obtained by carrying the expansion curve a little higher, and by prolonging the probable steam line to meet it.

*Third.*—The rounding of the expansion curve commences (see diagrams, Figs. 28, 39, 45, 61 and 62 at  $f$  to  $D$ ), when the exhaust begins, before the end of the stroke, and it is recommended that the point of exhaust release should be so adjusted that one-half of the fall of pressures shall take place at the end of the forward stroke, and the other half at the beginning of the return stroke (see  $Dd$ ). Where the release is small, the expansion curve is continued to the end of the diagram (see Fig. 62).

*Fourth.*—The general effect of water in the cylinder, from whatever cause produced, but which we will suppose to be present in some degree throughout the stroke, is to lower the steam line in the first portion of the stroke, and to raise it in the latter portion.

*Fifth.*—There is also the conduction of heat to or from the walls of the cylinder, the general effect of which is the same as in the last case.

*Sixth.*—Clearance will modify the form of the expansion curve of steam by removing backwards through a small space the zero line of volumes (see diagrams, Figs. 20, 24, 26 and 57,) and as we have seen, if the steam be completely exhausted from the cylinder during the return stroke, the effect of clearance is to waste a quantity of steam during the double stroke (see diagrams, Figs. 17 and 21). But inasmuch as it is possible to compress a portion of the exhaust steam in the cylinder during the return stroke (see diagrams, Figs. 9, 18, 24, 28 and 68, and 90), the loss above referred to may be greatly reduced, or perhaps wholly eliminated. The best authorities on this subject recommend that the point of compression should be adjusted in such a manner that the quantity of steam confined or cushioned should be just sufficient to fill the clearance spaces with steam, at the initial pressure, when the piston comes to rest. In such

a case the work expended in compression is restored again during expansion, and the steam spring is continually reproduced without waste.

*Seventh.*—It will be seen by Diagrams Figs. 28, 162, 163, 165, that *throttling* and *wire-drawing* are accompanied by direct *loss*, due to the reduction of the initial pressure which takes place during the process, and by indirect waste, owing to the increased proportion of work expended in overcoming the *back-pressure*.

*Eighth.*—There is a great necessity for a delicate steam-engine indicator, giving continuous diagrams on a roll of paper, similar to the stock-quotation indicators.



# APPENDIX.

---

## The Indicator.

THE indicator has been of incalculable service in developing the steam-engine up to its present state of perfection, as without it many of the most valuable refinements in engine construction could not have been reached at all. To the erecting mechanic it is now regarded as indispensable in first attaining correct adjustments of valves and regulator, and it is also equally valuable to the engineer in charge in maintaining those adjustments. It is thus valuable because its indications are obtained during the regular working of the engine, and directly from the impelling pressure, a proper admission and release of which is the prime object, and adjustments thus made are not subject to the uncertain allowances for expansion and elasticity of parts, which are necessary with the primitive methods. After a *most careful* adjustment by measurements and allowance for expansion and elasticity of parts, the indicator is sure to detect and locate surprisingly small imperfections.

Every engine should be indicated occasionally, and preferably by the engineer himself, so that he may be well informed as to the condition of its adjustments, which is so liable to be neglected in case of unindicated engines.

The indicator shows only the pressure at each point of the stroke: to represent this faithfully is its sole office. It tells nothing about the causes which have determined the form of the figure which it describes. The engineer concludes what these are, as the result of a process of reasoning, and this is the point where errors are liable to be committed. Conclusions which seem obvious sometimes turn out to have been wrong, and the ability to form an accurate judgment, as to the causes of the peculiarities present in the diagram, is one of the highest attainments of an engineer.

The variety of diagrams as illustrated in this work from different engines and by some of the same engines under different circumstances, is endless, and there is perhaps nothing more instructive to the student of engineering, as there is nothing more interesting to the accomplished engineer, than their careful and comprehensive study, with a knowledge of the modifying circumstances under which each one was taken. Lines which at first appeared meaningless become full of meaning; that, which then, scarcely arrested his attention comes to possess an absorbing interest. He becomes acquainted with the innumerable variety of vicious forms, and learns the points and degrees as well as the causes of their departure from the single perfect

FIG. 200.

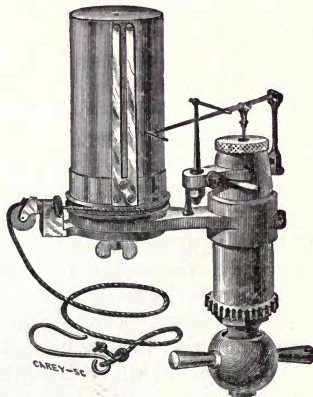

Thompson Indicator, Exterior View.

form; he becomes familiar with the effects produced by different construction and movements of parts, and competent to judge correctly as to the performance of an engine, and to advise concerning changes by which it may be improved. He ceases to be a mere imitator of material shapes, and learns to strive after the highest excellence, and at the same time to comprehend its conditions. No one at the present day can claim to be a mechanical engineer who has not become familiar with the use of the indicator, and skillful in turning to practical advantage the varied information which it furnishes.

## Indicators in General Use.

*The Thompson Indicator.*

The claims for this indicator (Figs. 200 and 201) are that the parallel motion is the most accurate of any in use in such instruments, and that errors, said to exist in drawing correct vertical lines, do not appear in the limited movement of the pencil in taking diagrams from steam engine and other cylinders with this instrument.

FIG. 201.

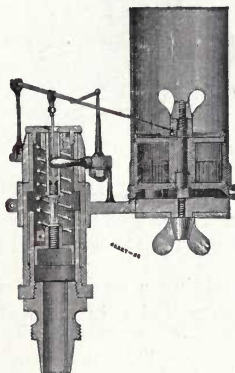

Thompson Indicator, Sectional View.

The paper cylinder movement is so constructed that the tension of the coiled drum spring within the paper cylinder can be increased or decreased for different speeds of engine.

The diameter of the piston is 0.798 inch, equal to one-half inch area. These indicators are fitted with a "detent motion" consisting of a pawl and spring stop, by the use of which the paper drum cylinder can be stopped and a change of cards made, without unhooking or disconnecting the driving cord.

The advantage of this arrangement is that the cord being entirely free, runs loosely with the motion of the engine, and the paper drum being stationary, cards can be changed without the least disturbance of adjustments. Again it obviates the change of adjustments, and is particularly valuable to amateurs and others not familiar with the use of the indicator.

*Tabor Indicator.*

The improvement claimed in this instrument (Figs. 202 and 203) is to produce a straight line movement of the pencil. A

FIG. 202.

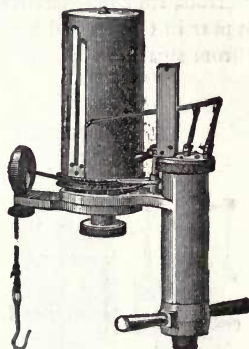

Tabor Indicator, Front View of Pencil Mechanism.

stationary plate containing a curved slot is firmly secured to the cover of the steam cylinder, in an upright position. This

FIG. 203.

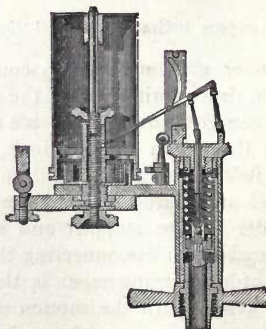

Tabor Indicator, Sectional View.

slot serves as a guide and controls the motion of the pencil bar. The side of the pencil bar carries a roller which turns on a pin,

and this is fitted so as to roll freely from end to end of the slot with little lost motion. The curve of the slot is so adjusted and the pin attached to such a point, that the end of the pencil bar, which carries the pencil, moves up and down in a straight line when the roller is moved from one end of the slot to the other. The curve of the slot just compensates the tendency of the pencil point to move in a circular arc, and a straight line motion results. The outside of the curve is nearly a true circle with a radius of one inch.

The improvements above described are shown in Fig. 203. This instrument is also fitted with a "detent motion" as described in the former indicator.

The springs used are of the duplex type, being made of two spiral coils of wire. The springs are so mounted that the points of connection of the two coils lie on opposite sides of the connections.

The coupling has but one thread, therefore it is operated by simply turning it in the proper direction.

#### *The Crosby Steam-Engine Indicator.*

The improvement in this instrument (Figs. 204 and 205) is a short spiral paper drum spring. This form of spring gives, at the beginning of the stroke in one direction, a comparatively slight resistance, which gradually increases until it reaches the maximum at the end of the stroke. In the other direction the strength of the recoil is greatest at the beginning of the stroke, and gradually decreases until the end of the stroke is reached. The levers for the pencil movement are made as light as possible to avoid all errors from momentum.

Each point is formed by a hardened steel pin running in a hardened steel bearing. The piston is made as light as possible, and is provided with steam chambers in the outer surface, on which the pressure of the steam acts and prevents the piston from touching the sides of the cylinder. The springs are of a unique and ingenious design, which enables the strains to which they are subjected to be transmitted from the centre of the piston. Each spring is made of a single piece of wire wound from the middle into a double coil. This construction gives it all the advantages of a double spring. Every spring is carefully tested

and rated under steam pressure in the indicator, so that it will be accurate when in actual use on the cylinder of the steam-engine.

### Boilers.

Steam boilers being the source of the motive force to run engines, a passing word may not be amiss in regard to their proper form and construction. The steam-engine as we have

FIG. 204.

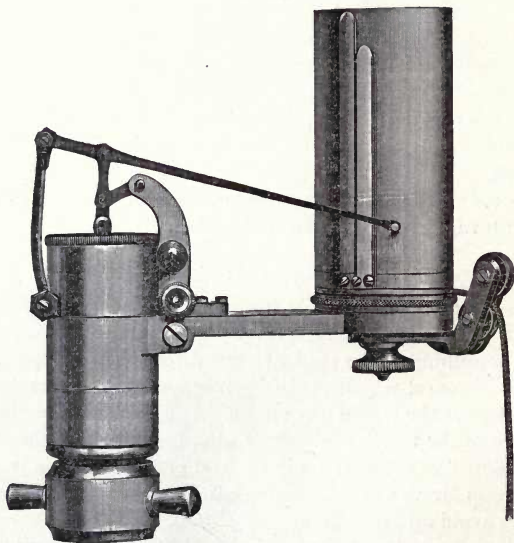

Crosby Indicator, Exterior View.

shown has been the subject of constant and unremitting improvement, ever since its introduction. The "flue" boiler introduced at the beginning of this century, with its internal flues very nearly similar in construction and dimensions to those now in use, has given by far the best results, performing a duty of nearly one hundred million pounds, raised one foot high, with a consumption of less than one hundred pounds of coal, or over one million pounds duty with one pound of coal.

This remarkable result was due as much to the boiler as to the engine itself.

### High Pressure Steam.

The demand of to-day is high pressure steam for the improved form of engines. To economically generate high pressure steam is the great problem of the age.

FIG. 205.

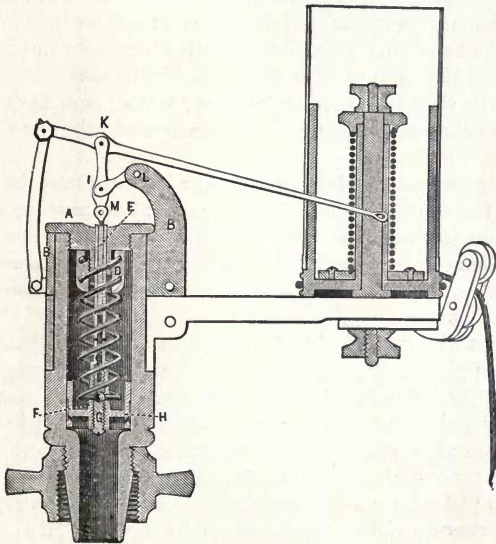

Crosby Indicator, Sectional View.

### Steel vs. Iron.

The superiority of steel as compared with wrought iron for boilers has now been so fully proven, and is so widely admitted, that it cannot be understood why boilers are not made exclusively from steel.

The best boilers of to-day have all the horizontal seams *double well* butt-joints, triple riveted. Thus the shearing of the rivets must occur in three places; and on this account their resistance

is very nearly twice as great as in other joints. This joint is free from the distortion on account of the oblique action of the stress on the rivets, to which the lap-joints and single-welt butt-joints are subjected.

These butt-joints distribute the strain at the joint uniformly over the whole section of the metal; whereas, with an ordinary lap-joint the strain is concentrated at the edges of the overlapping plates.

The rivet-holes are punched less in diameter than the rivet, and when all the plates are brought well together by temporary bolts, the holes are reamed fair to receive the rivets and counter-sunk slightly, so as to form a fillet to rivet heads.

All the shell-plates average about 58,000 pounds per square inch tensile strength, with an elongation of thirty to fifty per cent.

At the present time it is universally admitted that plates made from a metal in a state of fusion, poured into an ingot while fluid, compressed, and then hammered and rolled, are much more likely to be mechanically homogeneous than *iron plates made up of a number of pieces welded together by hammering and rolling.*

This is why *mild steel plates* are preferred in the place of the best iron plates. Steel plates are not only more homogeneous, but are *free from lamination and blister*, and have more equal tenacity and ductility lengthwise and crosswise, will bear cold flanging and bending in all directions, will also stand drawing like copper or lead, and will stand the most severe cold punching.

Steel plates have, from experiments made, yielded very much before rupture if the tensile strain is applied fairly over the whole section.

Punching the holes small in diameter, and reaming them out to rivet size after the boiler is in proper shape, dispenses with the complex strains by the usual mode caused by varying strengths of joints, as well as the improper distribution of the heat.

#### Superheated Steam.

For some time past engineers have abandoned superheating, although its value is well understood, but with the increased steam pressures and greater rates of expansion, all engineers



who are anxious for the economical performance of their steam engines find it desirable to superheat the steam, the results being identical with that of the steam-jacket. See Figs. 71, 72, 73, 74, 75 and 76.

The advantages to be gained in the use of superheated steam cannot be over-estimated. The use of wet steam augments cylinder condensation, whereas by the use of superheated steam cylinder condensation will be reduced to a minimum, from the fact that the latter conducts heat very slowly.

#### Priming or Boiler Disturbance.

The worst defect a boiler can have is a disposition to prime; in other words, to send water as well as steam to the engine. Whether a boiler primes much or little, the defect is serious. Priming is, in conventional terms, nothing more than a boiling-over. The steam as it is generated, instead of escaping freely from the water, is entangled with it, and carries over in its grasp a certain portion of the fluid, therefore producing wet steam.

#### Horizontal Flue Boiler.

The horizontal flue boiler, with a steam drum connected by a single neck, and having the products of combustion passing all around it, is no doubt the best boiler that can be erected, considering all conditions. At the present time, the desire of the principal boiler-makers is to secure accuracy and solidity of workmanship, which will defy for a long period the continual strain due to the high steam pressures now carried to produce economy in fuel.

#### Incrustation of Boilers.

Every engineer and boiler owner doubtless knows what is conveyed in the term "*incrustation*" of boilers—the loss of fuel and damage to the plates, and the risk of explosion and loss consequent therefrom, and they know also of the numerous schemes which have been promulgated for its prevention, and the still more numerous schemes brought forward for its cure. To many the term conveys no other idea but that of inconvenience of a certain character not deemed likely to be serious further than that it may cause an extra expenditure of fuel—no great

matter to many in these days of cheap fuel, who care nothing for speculation as to the time when it will not be cheap—but this restricted view of incrustation is by no means a correct one. I have no hesitation, indeed, in saying that through incrustation many most serious explosions have taken place, and the risk of many more taking place in future is daily incurred.

The scale covers the plates, causes them to be overheated, and from the unequal expansion and contraction to which they are subjected from its presence, the *wear* and *tear* of the boiler is much increased; it prevents proper examination of the plates so as to ascertain their condition, and frequently a corrosive action proceeds to a highly dangerous extent under it; and yet its existence is not known, or, if conjectured, cannot be properly ascertained until all the scale is taken off, a matter which involves more trouble and expense than is sometimes thought of, in some cases the scale being so welded, so to speak, to the surface of the plates, that even with the aid of the hammer and chisel, the greatest difficulty is experienced in getting it off. Further—and for the present finally—water which causes incrustation in the boiler also causes certain *wear* and *tear* to the working parts of the steam-engine which it runs, the earthy matter in it being frequently carried over by the steam, especially where the boiler is “*priming*” or “*foaming*”—that is, carrying over steam saturated or partly so with water—and cutting the valve-faces, piston-rings and the cylinder itself, causing leaks which are plainly shown on steam-engine indicator diagrams. From the above it will be seen that very great drawbacks arise from the *incrustation of boilers* and hence the importance of any mode by which it can be prevented. The most obvious way is, of course, to use good water. It does not imply that the water is good because it may happen to be pure and clean, for what might, compared with pure water, be called almost a dirty one, may, and often does, yield less deposit. The carbonate of lime, if present in water, yields a soft deposit or loose powder, which may be and in practice is got rid of by the process of “*blowing out*,” that is, allowing a certain quantity of the contents of the boiler to be blown out of or through a cock and pipe placed at the lowest part of the boiler for that purpose. If the water contains a sulphate of lime, the deposit

is formed as a hard crust, cake or scale, and if both the carbonate and the sulphate of lime are present in the water used for boiler purposes, then a crust is formed more or less dense or hard in proportion to the percentage of the carbonate or the sulphate present. It is not always, indeed not often, that a choice of waters is presented to the users of steam power; but where it is, it is assuredly the wisest plan to have them analyzed, so that the best amongst them may be taken.

But when one kind of water only is available (such as is the case of towns and cities) and that kind bad, the next plan open to the users of steam-power is to employ a mode of preventing the scale or deposit; and here the difficulty comes in play, how to choose amongst so many plans.

The acids which cause "pitting," "channeling," "furrowing," "grooving," etc., held in solution in the water fed to the boiler and set free by heat, are beyond the reach of any mechanical devices, and can only be neutralized by a chemical combination, which is known to the trade as boiler solvents.

Boiler incrustation remedies are exceedingly numerous; and so few out of the many are thoroughly good, that it is not the embarrassment of riches, as the French say, but that of poverty, which is the puzzle to those who are choosing.

The boiler compound of George W. Lord, of Philadelphia, Pa., has a high reputation as a scale preventor and acid neutralizer, and is recommended by a large number of manufacturers and others using it.

Messrs. Booth & Garrett, chemists, of Philadelphia, who stand at the head of their profession, make the statement over their signature that "it is free from any substance that could prove injurious to the boiler."

The advantage of Lord's compound is that it is in the form of a dry granulated powder. It readily dissolves in water, and can therefore be applied in a dry state through the man-hole, or in a liquid state by the feed-pump.

The quantity introduced will depend upon the nature and amount of water evaporated, as well as the amount of scale attached, also upon the construction of the boilers, etc.

## Power of a Boiler.

The steaming capacity or power of a boiler is usually expressed in horse-power, as with the engine itself, and the horse-power is taken to be equal to the evaporation of thirty (30) pounds of water at and from 212 degrees.

Thirty pounds of water converted into steam, although a convenient unit of measurement so far as the boiler is concerned, does not indicate the power of the engine. The best modern engines exert an indicated horse-power per hour with less than twenty (20) pounds of water, whereas some engines largely sold have been found to use over sixty (60) pounds per hour per horse-power.

Square feet of heating surface is no criterion as between different styles of boilers—a square foot under some circumstances being many times as efficient as in others. In the tests at the Brush Electric Light Company, at Philadelphia, the horizontal-flue boilers developed a horse-power for each 9.4 square feet of heating surface, whereas the water-tube boilers required 14.1 square feet, a difference of 33 per cent.; or, in other words, the water-tube boilers require 33 per cent. more heating surface to develop the same power that the horizontal-flue boilers require.

## Fahrenheit, and Centigrade Thermometers.

The Reaumur thermometer is gradually being abolished, and now used only in Peru.

|  | Fahrenheit in<br>Degrees. | Centigrade in<br>Degrees. |
|--|---------------------------|---------------------------|
| Boiling point of <i>water</i> means atmo-<br>spheric pressure of 14.7 pounds<br>per square inch. } | 212                       | 100                       |
| Melting point of <i>ice</i> under atmo-<br>spheric pressure. }                                     | 32                        | 0                         |

To convert any number of degrees Fahrenheit into degrees Centigrade, or *vice versa*:

Degrees Fahrenheit  $- 32 \times \frac{5}{9} =$  degrees of Centigrade.

Degrees Centigrade  $\times \frac{9}{5} + 32 =$  degrees of Fahrenheit.

## Falling Bodies.

The following formulæ apply to bodies acted upon by gravity in vacuo. Although near enough for almost all practical pur-

poses to be exact, the formula should vary with the latitude and elevation.

In vacuum a heavy body does not fall faster than a light one, because the weight of each body is equal to the force of gravity acting upon it; but when a body falls in air or liquid, its force of gravity is diminished by an amount equal to the weight of the air or liquid displaced by the body, and whilst the mass is constant, a smaller force has a heavier body to move, and the body will fall slower. A pound of lead displaces less weight of air than does a pound of cork, for which reason the lead will fall faster than the cork in air.

The force of gravity must also overcome the resistance of the air to the motion of the falling body, which is independent of the weight of air the body displaces. This resistance increases as the square of the velocity and as the surface exposed to the motion. A pound of cork exposes more surface to the motion than does a pound of lead, for which reason the cork falls more slowly.

$S$  = space in feet.

$V$  = velocity in feet per second.

$T$  = time in seconds of the fall.

$g = 32^2$  a constant representing *gravity*.

*First.*—The *height* or vertical distance through which a body will fall in a given time is:

$$\text{Space } S = \frac{g T^2}{2}$$

*Second.*—The *velocity* acquired at the end of a given time:

$$\text{Velocity } V = g T$$

*Third.*—The *velocity* due to a given space of fall:

$$\text{Velocity } V = 8.025 \sqrt{S}$$

*Fourth.*—The *space* of fall due to a given velocity is:

$$\text{Space } S = \frac{V^2}{2g}$$

*Fifth.*—The *time* of fall from a given space:

$$\text{Time } T = \sqrt{\frac{2S}{g}}$$

Example: A body is dropped from a height of  $S = 100$ ; required the time of fall, and with what velocity it reaches the ground?

Formula 5:

$$T = \sqrt{\frac{2 \times 100}{32.17}} = 7.8 \text{ seconds.}$$

## HORSE-POWER CONSTANTS FOR SINGLE CYLINDER ENGINES.

TABLE NO. 12.

Effective Horse-Power per Indicator exerted for each Pound Average Pressure upon the pistons of engines, varying in diameter from 4 to 60 inches, when moving with a speed in feet corresponding with the figures at the head of the several columns. Calculated as explained on pages 103 and 104.

| DIAMETER OF CYLINDER. | Speed of Piston in Feet per Minute. |        |        |        |        |        |        |        |        |        |
|-----------------------|-------------------------------------|--------|--------|--------|--------|--------|--------|--------|--------|--------|
|                       | 240                                 | 300    | 350    | 400    | 450    | 500    | 550    | 600    | 650    | 750    |
| 4                     | 0.091                               | 0.114  | 0.133  | 0.152  | 0.171  | 0.190  | 0.209  | 0.228  | 0.247  | 0.285  |
| 4½                    | 0.115                               | 0.144  | 0.168  | 0.192  | 0.216  | 0.240  | 0.264  | 0.288  | 0.312  | 0.360  |
| 5                     | 0.144                               | 0.180  | 0.210  | 0.240  | 0.270  | 0.300  | 0.330  | 0.360  | 0.390  | 0.450  |
| 5½                    | 0.173                               | 0.216  | 0.252  | 0.288  | 0.324  | 0.360  | 0.396  | 0.432  | 0.468  | 0.540  |
| 6                     | 0.205                               | 0.256  | 0.299  | 0.342  | 0.385  | 0.428  | 0.471  | 0.513  | 0.555  | 0.641  |
| 6½                    | 0.245                               | 0.307  | 0.391  | 0.409  | 0.461  | 0.512  | 0.563  | 0.614  | 0.698  | 0.800  |
| 7                     | 0.279                               | 0.348  | 0.408  | 0.466  | 0.524  | 0.583  | 0.641  | 0.699  | 0.756  | 0.874  |
| 7½                    | 0.321                               | 0.401  | 0.468  | 0.534  | 0.602  | 0.669  | 0.735  | 0.802  | 0.869  | 1.002  |
| 8                     | 0.365                               | 0.456  | 0.532  | 0.608  | 0.685  | 0.761  | 0.837  | 0.912  | 0.989  | 1.121  |
| 8½                    | 0.413                               | 0.516  | 0.602  | 0.688  | 0.774  | 0.860  | 0.946  | 1.032  | 1.118  | 1.29   |
| 9                     | 0.462                               | 0.577  | 0.674  | 0.770  | 0.866  | 0.963  | 1.059  | 1.154  | 1.251  | 1.444  |
| 9½                    | 0.515                               | 0.644  | 0.751  | 0.859  | 0.966  | 1.074  | 1.181  | 1.288  | 1.395  | 1.610  |
| 10                    | 0.571                               | 0.714  | 0.833  | 0.952  | 1.071  | 1.190  | 1.309  | 1.428  | 1.547  | 1.785  |
| 10½                   | 0.630                               | 0.787  | 0.919  | 1.050  | 1.181  | 1.313  | 1.444  | 1.575  | 1.706  | 1.969  |
| 11                    | 0.691                               | 0.864  | 1.008  | 1.152  | 1.296  | 1.440  | 1.584  | 1.728  | 1.872  | 2.160  |
| 11½                   | 0.754                               | 0.943  | 1.100  | 1.257  | 1.414  | 1.572  | 1.729  | 1.886  | 2.043  | 2.357  |
| 12                    | 0.820                               | 1.025  | 1.195  | 1.366  | 1.540  | 1.708  | 1.880  | 2.050  | 2.222  | 2.564  |
| 13                    | 0.964                               | 1.206  | 1.407  | 1.608  | 1.809  | 2.010  | 2.211  | 2.412  | 2.613  | 3.015  |
| 14                    | 1.119                               | 1.398  | 1.631  | 1.864  | 2.097  | 2.331  | 2.564  | 2.797  | 3.029  | 3.495  |
| 15                    | 1.285                               | 1.606  | 1.873  | 2.131  | 2.404  | 2.677  | 2.945  | 3.112  | 3.479  | 4.004  |
| 16                    | 1.461                               | 1.827  | 2.131  | 2.436  | 2.741  | 3.045  | 3.349  | 3.654  | 3.958  | 4.567  |
| 17                    | 1.643                               | 2.054  | 2.396  | 2.739  | 3.081  | 3.424  | 3.766  | 4.108  | 4.450  | 5.135  |
| 18                    | 1.849                               | 2.312  | 2.697  | 3.083  | 3.468  | 3.854  | 4.239  | 4.624  | 5.009  | 5.780  |
| 19                    | 2.064                               | 2.577  | 3.006  | 3.436  | 3.865  | 4.295  | 4.724  | 5.154  | 5.583  | 6.442  |
| 20                    | 2.292                               | 2.855  | 3.331  | 3.807  | 4.285  | 4.759  | 5.234  | 5.731  | 6.186  | 7.138  |
| 21                    | 2.518                               | 3.148  | 3.672  | 4.197  | 4.722  | 5.247  | 5.771  | 6.296  | 6.820  | 7.869  |
| 22                    | 2.764                               | 3.455  | 4.031  | 4.607  | 5.183  | 5.759  | 6.334  | 6.911  | 7.486  | 8.638  |
| 23                    | 3.021                               | 3.776  | 4.405  | 5.035  | 5.664  | 6.294  | 6.923  | 7.552  | 8.181  | 9.440  |
| 24                    | 3.289                               | 4.111  | 4.797  | 5.482  | 6.167  | 6.853  | 7.538  | 8.223  | 8.908  | 10.279 |
| 25                    | 3.569                               | 4.461  | 5.105  | 5.948  | 6.692  | 7.436  | 8.179  | 8.923  | 9.566  | 11.053 |
| 26                    | 3.861                               | 4.826  | 5.630  | 6.435  | 7.239  | 8.044  | 8.848  | 9.652  | 10.456 | 12.065 |
| 27                    | 4.159                               | 5.199  | 6.066  | 6.932  | 7.799  | 8.666  | 9.532  | 10.399 | 11.265 | 12.998 |
| 28                    | 4.477                               | 5.596  | 6.529  | 7.462  | 8.395  | 9.328  | 10.261 | 11.193 | 12.125 | 13.991 |
| 29                    | 4.805                               | 6.006  | 7.007  | 8.008  | 9.009  | 10.010 | 11.011 | 12.012 | 13.013 | 15.015 |
| 30                    | 5.141                               | 6.426  | 7.497  | 8.568  | 9.639  | 10.710 | 11.781 | 12.852 | 13.923 | 16.065 |
| 31                    | 5.486                               | 6.865  | 8.001  | 9.148  | 10.287 | 11.430 | 12.573 | 13.716 | 14.866 | 17.145 |
| 32                    | 5.846                               | 7.308  | 8.526  | 9.744  | 10.962 | 12.180 | 13.398 | 14.616 | 15.834 | 18.270 |
| 33                    | 6.216                               | 7.770  | 9.065  | 10.360 | 11.655 | 12.959 | 14.245 | 15.540 | 16.835 | 19.425 |
| 34                    | 6.590                               | 8.238  | 9.611  | 10.984 | 12.357 | 13.730 | 15.103 | 16.476 | 17.849 | 20.595 |
| 35                    | 6.993                               | 8.742  | 10.199 | 11.656 | 13.113 | 14.570 | 16.027 | 17.484 | 18.941 | 21.855 |
| 36                    | 7.401                               | 9.252  | 10.794 | 12.336 | 13.878 | 15.420 | 16.962 | 18.504 | 20.046 | 23.130 |
| 37                    | 7.819                               | 9.774  | 11.403 | 13.032 | 14.861 | 16.290 | 17.919 | 19.548 | 21.177 | 24.435 |
| 38                    | 8.246                               | 10.308 | 12.026 | 13.744 | 15.462 | 17.180 | 18.898 | 20.616 | 22.334 | 25.770 |
| 39                    | 8.648                               | 10.86  | 12.670 | 14.480 | 16.290 | 18.100 | 19.910 | 21.620 | 23.530 | 27.150 |

TABLE No. 12—Continued.

| DIAMETER OF CYLINDER. | Speed of Piston in Feet per Minute. |        |        |        |        |        |        |        |        |        |
|-----------------------|-------------------------------------|--------|--------|--------|--------|--------|--------|--------|--------|--------|
|                       | 240                                 | 300    | 350    | 400    | 450    | 500    | 550    | 600    | 650    | 750    |
| Inches.               |                                     |        |        |        |        |        |        |        |        |        |
| 40                    | 9.139                               | 11.424 | 13.328 | 15.232 | 17.136 | 19.040 | 20.944 | 22.848 | 24.752 | 28.560 |
| 41                    | 9.604                               | 12.006 | 14.007 | 16.008 | 18.009 | 20.000 | 22.011 | 24.012 | 26.013 | 30.015 |
| 42                    | 10.065                              | 12.594 | 14.693 | 16.792 | 18.901 | 20.990 | 23.089 | 25.188 | 27.287 | 31.485 |
| 43                    | 10.560                              | 13.200 | 15.400 | 17.600 | 19.800 | 22.000 | 24.200 | 26.400 | 28.600 | 33.000 |
| 44                    | 11.046                              | 13.818 | 16.121 | 18.424 | 20.727 | 23.030 | 25.333 | 27.636 | 29.939 | 34.545 |
| 45                    | 11.563                              | 14.454 | 16.863 | 19.272 | 21.681 | 24.090 | 26.399 | 28.908 | 31.317 | 36.135 |
| 46                    | 12.086                              | 15.128 | 17.626 | 20.144 | 22.662 | 25.180 | 27.698 | 30.216 | 32.754 | 37.770 |
| 47                    | 12.614                              | 15.768 | 18.396 | 21.024 | 23.652 | 26.280 | 28.908 | 31.536 | 34.164 | 39.420 |
| 48                    | 12.846                              | 16.446 | 19.187 | 21.928 | 24.669 | 27.410 | 30.151 | 32.152 | 35.633 | 41.115 |
| 49                    | 12.913                              | 17.142 | 19.999 | 22.856 | 25.713 | 28.570 | 31.427 | 34.284 | 37.141 | 42.855 |
| 50                    | 14.280                              | 17.850 | 20.825 | 23.800 | 26.775 | 29.750 | 32.725 | 35.700 | 38.675 | 44.625 |
| 51                    | 14.832                              | 18.540 | 21.665 | 24.760 | 27.855 | 30.950 | 34.045 | 37.080 | 40.205 | 46.425 |
| 52                    | 15.437                              | 19.296 | 22.512 | 25.728 | 28.944 | 32.160 | 35.376 | 38.592 | 41.808 | 48.240 |
| 53                    | 16.041                              | 20.052 | 23.394 | 26.736 | 30.078 | 33.420 | 36.762 | 40.104 | 43.446 | 50.130 |
| 54                    | 16.656                              | 20.820 | 24.290 | 27.760 | 31.230 | 34.700 | 38.170 | 41.640 | 45.110 | 52.050 |
| 55                    | 17.275                              | 21.594 | 25.193 | 28.792 | 32.391 | 35.990 | 39.589 | 43.188 | 46.787 | 53.985 |
| 56                    | 17.909                              | 22.386 | 26.117 | 29.848 | 33.579 | 37.310 | 41.041 | 44.772 | 48.503 | 55.965 |
| 57                    | 18.557                              | 23.196 | 27.062 | 30.928 | 34.794 | 38.660 | 42.526 | 46.392 | 50.258 | 57.990 |
| 58                    | 19.214                              | 24.018 | 28.021 | 32.024 | 36.027 | 40.030 | 44.033 | 48.036 | 52.039 | 60.045 |
| 59                    | 19.902                              | 24.852 | 28.994 | 33.136 | 37.278 | 41.420 | 45.562 | 49.704 | 53.846 | 62.130 |
| 60                    | 20.558                              | 25.698 | 29.981 | 34.264 | 38.547 | 42.83  | 47.113 | 51.396 | 55.679 | 64.245 |

## Horse-Power Constants.

The above table, No. 12, gives the horse-power constants for engine cylinders from 4 inch to 60 inches, at speeds of 240, 350, 400, 450, 500, 550, 600, 650 and 750 feet of piston travel per minute.

This constant is the number of horse-powers which would be exerted by *one pound* of mean pressure; this being multiplied by the mean pressure as calculated from the indicator diagram will give the number of horse-powers developed.

Table, No. 12, does not take into account the area of the piston rod, as there is no standard for diameter of piston rods accepted by engine builders; but the table is near enough correct where great accuracy is not called for.

In case of great accuracy, knowing the piston's area, we take the area from table 13, page 427; from this is to be deducted one-half the area of the rod, the remainder is the average area of the two faces of the piston. We multiply this by the mean pressure on the square inch, and the product is the total constant force under which the piston is moving, or which is acting



through the distance traveled by the piston. This being multiplied into the distance, in feet, through which the piston travels, or through which the force acts, in one minute, gives the foot-pounds of power developed, or of work done, in that time, and this sum, divided by 33,000, gives the number of horse-powers developed.

It is interesting to consider the variety of the conditions out of which this result is derived. We have, first, every variation of pressure, from the highest to the lowest; and second, in combination with this, every different speed of piston, from infinitely slow up to the velocity of the crank. The latter variation is not regarded. Forces different in amount are separate forces. The diagram tells us what each separate force was, and through what distance it acted; and this is all we require for the computation of power. Each force being multiplied into the distance through which it acted, and the product divided by the length of the cylinder in units of such distance, the sum of all is the pounds of force acting through the length of the stroke. That some forces were exerted for a longer time than others, in acting through an equal distance, is nothing. Static forces, though exerted forever, have no dynamical value. Force acquires this value only as it acts through distance.

Therefore the better method of computing power is, first, to obtain for any engine a constant, which, being multiplied by the mean pressure, will give the horse-power developed. This constant is the number of horse-powers which would be developed by one pound mean pressure.

An illustration of this will be found on pages 103 and 104, Fig. 11. The different velocities of piston given in the foregoing table embrace those most in general use. In case of the power of an engine having a speed not stated, it may be found by adding together the numbers opposite to the diameter of piston, in any two of the columns that will equal the desired speed, or by adding to the one such portion of another as would make it. Thus, if a number is sought for a speed of 200 feet per minute, it is found by dividing the number under 400 by two; or if 1000 feet is wanted, it will be found by multiplying the appropriate number under 500 feet per minute by two.

TABLE NO. 13.

Areas and Circumferences of Circles from  $\frac{1}{8}$  to 4 inches in diameter varying by sixteenths; and from 4 inches to 100 inches diameter varying by one-eighth inch.

| Diam. in Inches. | Area in Square Inches. | Circum. in Inches. | Diam. in Inches. | Area in Square Inches. | Circum. in Inches. | Diam. in Inches. | Area in Square Inches. | Circum. in Inches. |
|------------------|------------------------|--------------------|------------------|------------------------|--------------------|------------------|------------------------|--------------------|
| $\frac{1}{8}$    | 0.00019                | 0.0490             | $3\frac{1}{8}$   | 7.3662                 | 9.6211             | 8.               | 55.088                 | 26.31              |
| $\frac{1}{4}$    | 0.00076                | 0.0951             | $3\frac{1}{4}$   | 7.6699                 | 9.8175             | $8\frac{1}{16}$  | 56.745                 | 26.70              |
| $\frac{3}{8}$    | 0.00306                | 0.1963             | $3\frac{1}{2}$   | 7.9798                 | 10.0138            | $8\frac{1}{8}$   | 58.426                 | 27.10              |
| $\frac{1}{2}$    | 0.0122                 | 0.3927             | $3\frac{3}{4}$   | 8.2957                 | 10.2102            | $8\frac{1}{4}$   | 60.132                 | 27.49              |
| $\frac{5}{8}$    | 0.0276                 | 0.5890             | $4$              | 8.6179                 | 10.4065            | $8\frac{3}{8}$   | 61.862                 | 27.88              |
| $\frac{3}{4}$    | 0.0490                 | 0.7854             | $4\frac{1}{8}$   | 8.9462                 | 10.6029            | $8\frac{1}{2}$   | 63.617                 | 28.27              |
| $\frac{7}{8}$    | 0.0767                 | 0.9817             | $4\frac{1}{4}$   | 9.2806                 | 10.7992            | 9.               | 65.396                 | 28.66              |
| $1$              | 0.1104                 | 1.1781             | $4\frac{1}{2}$   | 9.6211                 | 10.9956            | $9\frac{1}{16}$  | 67.200                 | 29.06              |
| $1\frac{1}{8}$   | 0.1503                 | 1.3744             | $4\frac{3}{4}$   | 9.9678                 | 11.1919            | $9\frac{1}{8}$   | 69.029                 | 29.45              |
| $1\frac{1}{4}$   | 0.1963                 | 1.5708             | $5$              | 10.3210                | 11.3883            | $9\frac{1}{4}$   | 70.882                 | 29.85              |
| $1\frac{3}{8}$   | 0.2485                 | 1.7671             | $5\frac{1}{8}$   | 10.6796                | 11.5846            | $9\frac{3}{8}$   | 72.759                 | 30.24              |
| $1\frac{1}{2}$   | 0.3067                 | 1.9630             | $5\frac{1}{4}$   | 10.9446                | 11.7810            | $9\frac{1}{2}$   | 74.662                 | 30.63              |
| $1\frac{5}{8}$   | 0.3712                 | 2.1590             | $5\frac{3}{4}$   | 11.4159                | 11.9773            | $9\frac{5}{8}$   | 76.588                 | 31.02              |
| $1\frac{3}{4}$   | 0.4417                 | 2.3565             | $6$              | 11.7932                | 12.1737            | 10.              | 78.540                 | 31.42              |
| $1\frac{7}{8}$   | 0.5174                 | 2.5512             | $6\frac{1}{8}$   | 12.1768                | 12.3700            | $10\frac{1}{16}$ | 80.515                 | 31.81              |
| $2$              | 0.6013                 | 2.7490             | $6\frac{1}{4}$   | 12.566                 | 12.57              | $10\frac{1}{8}$  | 82.516                 | 32.20              |
| $2\frac{1}{8}$   | 0.6902                 | 2.9453             | $6\frac{3}{4}$   | 13.364                 | 12.96              | $10\frac{1}{4}$  | 84.540                 | 32.59              |
| $2\frac{1}{4}$   | 0.7854                 | 3.1416             | $7$              | 14.186                 | 13.35              | $10\frac{3}{8}$  | 86.590                 | 32.99              |
| $2\frac{3}{8}$   | 0.8861                 | 3.3379             | $7\frac{1}{8}$   | 15.033                 | 13.74              | $10\frac{1}{2}$  | 88.664                 | 33.38              |
| $2\frac{1}{2}$   | 0.9940                 | 3.5343             | $7\frac{1}{4}$   | 15.904                 | 14.14              | $10\frac{5}{8}$  | 90.762                 | 33.77              |
| $2\frac{5}{8}$   | 1.1075                 | 3.7306             | $7\frac{3}{4}$   | 16.800                 | 14.53              | $10\frac{3}{4}$  | 92.885                 | 34.16              |
| $2\frac{3}{4}$   | 1.2271                 | 3.9270             | $8$              | 17.720                 | 14.92              | 11.              | 95.033                 | 34.56              |
| $2\frac{7}{8}$   | 1.3529                 | 4.1233             | $8\frac{1}{8}$   | 18.665                 | 15.32              | $11\frac{1}{16}$ | 97.205                 | 34.95              |
| $3$              | 1.4848                 | 4.3197             | $8\frac{1}{4}$   | 19.635                 | 15.71              | $11\frac{1}{8}$  | 99.402                 | 35.34              |
| $3\frac{1}{8}$   | 1.6229                 | 4.5160             | $8\frac{3}{4}$   | 20.629                 | 16.10              | $11\frac{1}{4}$  | 101.62                 | 35.74              |
| $3\frac{1}{4}$   | 1.7671                 | 4.7124             | $9$              | 21.648                 | 16.49              | $11\frac{3}{8}$  | 103.87                 | 36.13              |
| $3\frac{3}{8}$   | 1.9175                 | 4.9087             | $9\frac{1}{8}$   | 22.690                 | 16.89              | $11\frac{1}{2}$  | 106.14                 | 36.52              |
| $3\frac{1}{2}$   | 2.0739                 | 5.1051             | $9\frac{1}{4}$   | 23.758                 | 17.28              | $11\frac{5}{8}$  | 108.43                 | 36.91              |
| $3\frac{5}{8}$   | 2.2365                 | 5.3014             | $9\frac{3}{4}$   | 24.850                 | 17.67              | $11\frac{3}{4}$  | 110.75                 | 37.31              |
| $3\frac{3}{4}$   | 2.4052                 | 5.4978             | $10$             | 25.967                 | 18.06              | 12.              | 113.10                 | 37.70              |
| $3\frac{7}{8}$   | 2.5801                 | 5.6941             | $10\frac{1}{8}$  | 27.108                 | 18.46              | $12\frac{1}{16}$ | 115.47                 | 38.09              |
| $4$              | 2.7611                 | 5.8905             | $10\frac{1}{4}$  | 28.274                 | 18.85              | $12\frac{1}{8}$  | 117.86                 | 38.48              |
| $4\frac{1}{8}$   | 2.9483                 | 6.0868             | $10\frac{3}{4}$  | 29.464                 | 19.24              | $12\frac{1}{4}$  | 120.28                 | 38.88              |
| $4\frac{1}{4}$   | 3.1416                 | 6.2832             | $11$             | 30.680                 | 19.64              | $12\frac{3}{8}$  | 122.72                 | 39.27              |
| $4\frac{3}{8}$   | 3.3411                 | 6.4795             | $11\frac{1}{8}$  | 31.919                 | 20.03              | $12\frac{1}{2}$  | 125.18                 | 39.66              |
| $4\frac{1}{2}$   | 3.5468                 | 6.6759             | $11\frac{1}{4}$  | 33.183                 | 20.42              | $12\frac{5}{8}$  | 127.68                 | 40.06              |
| $4\frac{5}{8}$   | 3.7582                 | 6.8722             | $11\frac{3}{4}$  | 34.471                 | 20.81              | $12\frac{3}{4}$  | 130.19                 | 40.45              |
| $4\frac{3}{4}$   | 3.9760                 | 7.0686             | $12$             | 35.785                 | 21.21              | 13.              | 132.73                 | 40.84              |
| $4\frac{7}{8}$   | 4.2001                 | 7.2649             | $12\frac{1}{8}$  | 37.122                 | 21.60              | $13\frac{1}{16}$ | 135.30                 | 41.23              |
| $5$              | 4.4302                 | 7.4618             | $12\frac{1}{4}$  | 38.484                 | 21.99              | $13\frac{1}{8}$  | 137.89                 | 41.63              |
| $5\frac{1}{8}$   | 4.6664                 | 7.6576             | $12\frac{3}{4}$  | 39.871                 | 22.38              | $13\frac{1}{4}$  | 140.50                 | 42.02              |
| $5\frac{1}{4}$   | 4.9087                 | 7.8540             | $13$             | 41.282                 | 22.78              | $13\frac{3}{8}$  | 143.14                 | 42.41              |
| $5\frac{3}{8}$   | 5.1573                 | 8.0503             | $13\frac{1}{8}$  | 42.718                 | 23.17              | $13\frac{1}{2}$  | 145.80                 | 42.80              |
| $5\frac{1}{2}$   | 5.4119                 | 8.2467             | $13\frac{1}{4}$  | 44.179                 | 23.56              | $13\frac{5}{8}$  | 148.49                 | 43.20              |
| $5\frac{5}{8}$   | 5.6727                 | 8.4430             | $13\frac{3}{4}$  | 45.663                 | 23.95              | $13\frac{3}{4}$  | 151.20                 | 43.59              |
| $5\frac{3}{4}$   | 5.9395                 | 8.6394             | $14$             | 47.173                 | 24.35              | 14.              | 153.94                 | 43.98              |
| $5\frac{7}{8}$   | 6.2126                 | 8.8357             | $14\frac{1}{8}$  | 48.707                 | 24.74              | $14\frac{1}{16}$ | 156.70                 | 44.38              |
| $6$              | 6.4918                 | 9.0321             | $14\frac{1}{4}$  | 50.265                 | 25.13              | $14\frac{1}{8}$  | 159.48                 | 44.77              |
| $6\frac{1}{8}$   | 6.7772                 | 9.2284             | $14\frac{3}{4}$  | 51.848                 | 25.52              | $14\frac{1}{4}$  | 162.29                 | 45.16              |
| $6\frac{1}{4}$   | 7.0686                 | 9.4248             | $15$             | 53.456                 | 25.92              | $14\frac{3}{8}$  | 165.13                 | 45.55              |

TABLE NO. 13—Continued.

| Diam. in Inches. | Area in Square Inches. | Circum. in Inches. | Diam. in Inches. | Area in Square Inches. | Circum. in Inches. | Diam. in Inches. | Area in Square Inches. | Circum. in Inches. |
|------------------|------------------------|--------------------|------------------|------------------------|--------------------|------------------|------------------------|--------------------|
| 14.              | 167.99                 | 45.95              | 21.              | 358.84                 | 67.15              | 28.              | 621.26                 | 88.36              |
|                  | 170.87                 | 46.34              |                  | 363.05                 | 67.54              |                  | 626.80                 | 88.75              |
|                  | 173.78                 | 46.73              |                  | 367.28                 | 67.94              |                  | 632.36                 | 89.14              |
| 15.              | 176.71                 | 47.12              |                  | 371.54                 | 68.33              |                  | 637.94                 | 89.54              |
|                  | 179.67                 | 47.52              |                  | 375.83                 | 68.72              |                  | 643.55                 | 89.93              |
|                  | 182.65                 | 47.91              | 22.              | 380.13                 | 69.12              |                  | 649.18                 | 90.32              |
|                  | 185.66                 | 48.30              |                  | 384.46                 | 69.51              |                  | 654.84                 | 90.71              |
|                  | 188.69                 | 48.69              |                  | 388.82                 | 69.90              | 29.              | 660.52                 | 91.11              |
|                  | 191.75                 | 49.09              |                  | 393.20                 | 70.29              |                  | 666.23                 | 91.50              |
|                  | 194.83                 | 49.48              |                  | 397.61                 | 70.69              |                  | 671.96                 | 91.89              |
|                  | 197.93                 | 49.87              |                  | 402.04                 | 71.08              |                  | 677.71                 | 92.28              |
| 16.              | 201.06                 | 50.27              |                  | 406.49                 | 71.47              |                  | 683.49                 | 92.68              |
|                  | 204.22                 | 50.66              |                  | 410.97                 | 71.86              |                  | 689.30                 | 93.07              |
|                  | 207.39                 | 51.05              | 23.              | 415.48                 | 72.26              |                  | 695.13                 | 93.46              |
|                  | 210.60                 | 51.44              |                  | 420.                   | 72.65              |                  | 700.98                 | 93.85              |
|                  | 213.82                 | 51.84              |                  | 424.56                 | 73.04              | 30.              | 706.86                 | 94.25              |
|                  | 217.08                 | 52.23              |                  | 429.13                 | 73.43              |                  | 712.76                 | 94.64              |
|                  | 220.35                 | 52.62              |                  | 433.74                 | 73.83              |                  | 718.69                 | 95.03              |
|                  | 223.65                 | 53.01              |                  | 438.36                 | 74.22              |                  | 724.64                 | 95.43              |
| 17.              | 226.98                 | 53.41              |                  | 443.01                 | 74.61              |                  | 730.62                 | 95.82              |
|                  | 230.33                 | 53.80              |                  | 447.70                 | 75.                |                  | 736.62                 | 96.21              |
|                  | 233.70                 | 54.19              | 24.              | 452.39                 | 75.40              |                  | 742.64                 | 96.60              |
|                  | 237.10                 | 54.59              |                  | 457.11                 | 75.79              |                  | 748.69                 | 97.                |
|                  | 240.53                 | 54.98              |                  | 461.86                 | 76.18              | 31.              | 754.77                 | 97.39              |
|                  | 243.98                 | 55.37              |                  | 466.64                 | 76.58              |                  | 760.87                 | 97.78              |
|                  | 247.45                 | 55.76              |                  | 471.44                 | 76.97              |                  | 766.99                 | 98.17              |
|                  | 250.95                 | 56.16              |                  | 476.26                 | 77.36              |                  | 773.14                 | 98.57              |
| 18.              | 254.47                 | 56.55              |                  | 481.11                 | 77.75              |                  | 779.31                 | 98.97              |
|                  | 258.02                 | 56.94              |                  | 485.98                 | 78.15              |                  | 785.51                 | 99.35              |
|                  | 261.59                 | 57.33              | 25.              | 490.87                 | 78.54              |                  | 791.73                 | 99.75              |
|                  | 265.18                 | 57.73              |                  | 495.80                 | 78.93              |                  | 797.98                 | 100.14             |
|                  | 268.80                 | 58.12              |                  | 500.74                 | 79.33              | 32.              | 804.25                 | 100.53             |
|                  | 272.45                 | 58.51              |                  | 505.71                 | 79.72              |                  | 810.54                 | 100.92             |
|                  | 276.12                 | 58.90              |                  | 510.71                 | 80.11              |                  | 816.86                 | 101.32             |
|                  | 279.81                 | 59.30              |                  | 515.72                 | 80.50              |                  | 823.21                 | 101.71             |
| 19.              | 283.53                 | 59.69              |                  | 520.77                 | 80.90              |                  | 829.58                 | 102.10             |
|                  | 287.27                 | 60.08              |                  | 525.84                 | 81.29              |                  | 835.97                 | 102.49             |
|                  | 291.04                 | 60.48              | 26.              | 530.93                 | 81.68              |                  | 842.39                 | 102.89             |
|                  | 294.83                 | 60.87              |                  | 536.05                 | 82.07              |                  | 848.83                 | 103.28             |
|                  | 298.65                 | 61.26              |                  | 541.19                 | 82.47              | 33.              | 855.30                 | 103.67             |
|                  | 302.49                 | 61.65              |                  | 546.36                 | 82.86              |                  | 861.79                 | 104.06             |
|                  | 306.35                 | 62.05              |                  | 551.55                 | 83.25              |                  | 868.30                 | 104.46             |
|                  | 310.25                 | 62.44              |                  | 556.76                 | 83.64              |                  | 874.84                 | 104.85             |
| 20.              | 314.16                 | 62.83              |                  | 562.                   | 84.04              |                  | 881.41                 | 105.24             |
|                  | 318.10                 | 63.22              |                  | 567.27                 | 84.43              |                  | 888.                   | 105.64             |
|                  | 322.06                 | 63.62              | 27.              | 572.56                 | 84.82              |                  | 894.62                 | 106.03             |
|                  | 326.05                 | 64.01              |                  | 577.87                 | 85.21              |                  | 901.25                 | 106.42             |
|                  | 330.06                 | 64.40              |                  | 583.21                 | 85.61              | 34.              | 907.92                 | 106.81             |
|                  | 334.10                 | 64.79              |                  | 588.57                 | 86.                |                  | 914.61                 | 107.21             |
|                  | 338.16                 | 65.19              |                  | 593.96                 | 86.39              |                  | 921.32                 | 107.60             |
|                  | 342.25                 | 65.58              |                  | 599.37                 | 86.79              |                  | 928.06                 | 107.99             |
| 21.              | 346.36                 | 65.97              |                  | 604.81                 | 87.18              |                  | 934.82                 | 108.39             |
|                  | 350.50                 | 66.37              |                  | 610.27                 | 87.57              |                  | 941.60                 | 108.78             |
|                  | 354.66                 | 66.76              | 28.              | 615.75                 | 87.96              |                  | 948.42                 | 109.17             |

TABLE NO. 13—Continued.

| Diam. in Inches.  | Area in Square Inches. | Circum. in Inches. | Diam. in Inches.  | Area in Square Inches. | Circum. in Inches. | Diam. in Inches.  | Area in Square Inches. | Circum. in Inches. |
|-------------------|------------------------|--------------------|-------------------|------------------------|--------------------|-------------------|------------------------|--------------------|
| 34. $\frac{1}{2}$ | 955.25                 | 109.56             | 41. $\frac{1}{2}$ | 1360.8                 | 130.8              | 48. $\frac{1}{2}$ | 1837.9                 | 152.               |
| 35. $\frac{1}{2}$ | 962.11                 | 109.96             |                   | 1369.                  | 131.2              |                   | 1847.5                 | 152.4              |
|                   | 968.99                 | 110.35             | 42. $\frac{1}{2}$ | 1377.2                 | 131.6              |                   | 1857.                  | 152.8              |
|                   | 975.91                 | 110.74             |                   | 1385.4                 | 131.9              |                   | 1866.5                 | 153.2              |
|                   | 982.84                 | 111.13             |                   | 1393.7                 | 132.3              |                   | 1876.1                 | 153.5              |
|                   | 989.80                 | 111.53             |                   | 1402.                  | 132.7              | 49. $\frac{1}{2}$ | 1885.7                 | 153.9              |
|                   | 996.78                 | 111.92             |                   | 1410.3                 | 133.1              |                   | 1895.4                 | 154.3              |
|                   | 1003.79                | 112.31             |                   | 1418.6                 | 133.5              |                   | 1905.                  | 154.7              |
|                   | 1010.80                | 112.70             |                   | 1427.                  | 133.9              |                   | 1914.7                 | 155.1              |
| 36. $\frac{1}{2}$ | 1017.88                | 113.10             |                   | 1435.4                 | 134.3              |                   | 1924.4                 | 155.5              |
|                   | 1024.95                | 113.49             |                   | 1443.8                 | 134.7              |                   | 1934.1                 | 155.9              |
|                   | 1032.06                | 113.88             | 43. $\frac{1}{2}$ | 1452.2                 | 135.1              |                   | 1943.9                 | 156.3              |
|                   | 1039.19                | 114.28             |                   | 1460.6                 | 135.5              |                   | 1953.7                 | 156.7              |
|                   | 1046.35                | 114.67             |                   | 1469.1                 | 135.9              | 50. $\frac{1}{2}$ | 1963.5                 | 157.1              |
|                   | 1053.52                | 115.06             |                   | 1477.6                 | 136.3              |                   | 1973.3                 | 157.4              |
|                   | 1060.73                | 115.45             |                   | 1486.2                 | 136.7              |                   | 1983.2                 | 157.9              |
|                   | 1067.95                | 115.85             |                   | 1494.7                 | 137.1              |                   | 1993.                  | 158.2              |
| 37. $\frac{1}{2}$ | 1075.2                 | 116.2              |                   | 1503.3                 | 137.4              |                   | 2003.                  | 158.7              |
|                   | 1082.5                 | 116.6              |                   | 1511.9                 | 137.8              |                   | 2012.8                 | 159.               |
|                   | 1089.8                 | 117.               | 44. $\frac{1}{2}$ | 1520.5                 | 138.2              |                   | 2022.8                 | 159.4              |
|                   | 1097.1                 | 117.4              |                   | 1529.2                 | 138.6              |                   | 2032.8                 | 159.8              |
|                   | 1104.5                 | 117.8              |                   | 1537.9                 | 139.               | 51. $\frac{1}{2}$ | 2042.8                 | 160.2              |
|                   | 1111.8                 | 118.2              |                   | 1546.5                 | 139.4              |                   | 2052.8                 | 160.6              |
|                   | 1119.2                 | 118.6              |                   | 1555.3                 | 139.8              |                   | 2062.9                 | 161.               |
|                   | 1126.7                 | 119.               |                   | 1564.                  | 140.2              |                   | 2072.9                 | 161.3              |
| 38. $\frac{1}{2}$ | 1134.1                 | 119.4              |                   | 1572.8                 | 140.6              |                   | 2083.1                 | 161.8              |
|                   | 1141.6                 | 119.8              | 45. $\frac{1}{2}$ | 1581.6                 | 141.               |                   | 2093.2                 | 162.1              |
|                   | 1149.1                 | 120.2              |                   | 1590.4                 | 141.4              |                   | 2103.3                 | 162.6              |
|                   | 1156.6                 | 120.6              |                   | 1599.3                 | 141.8              |                   | 2113.5                 | 162.9              |
|                   | 1164.2                 | 121.               |                   | 1608.2                 | 142.2              | 52. $\frac{1}{2}$ | 2123.7                 | 163.4              |
|                   | 1171.7                 | 121.3              |                   | 1617.                  | 142.6              |                   | 2133.9                 | 163.7              |
|                   | 1179.3                 | 121.7              |                   | 1626.                  | 142.9              |                   | 2144.2                 | 164.1              |
|                   | 1186.9                 | 122.1              |                   | 1634.9                 | 143.3              |                   | 2154.4                 | 164.5              |
| 39. $\frac{1}{2}$ | 1194.6                 | 122.5              |                   | 1643.9                 | 143.7              |                   | 2164.8                 | 164.9              |
|                   | 1202.3                 | 122.9              |                   | 1652.9                 | 144.1              |                   | 2175.                  | 165.3              |
|                   | 1210.                  | 123.3              | 46. $\frac{1}{2}$ | 1661.9                 | 144.5              |                   | 2185.4                 | 165.7              |
|                   | 1217.7                 | 123.7              |                   | 1671.                  | 144.9              |                   | 2195.7                 | 166.1              |
|                   | 1225.4                 | 124.1              |                   | 1680.                  | 145.3              | 53. $\frac{1}{2}$ | 2206.2                 | 166.5              |
|                   | 1233.2                 | 124.5              |                   | 1689.1                 | 145.7              |                   | 2216.6                 | 166.8              |
|                   | 1241.                  | 124.9              |                   | 1698.2                 | 146.1              |                   | 2227.                  | 167.3              |
|                   | 1248.8                 | 125.3              |                   | 1707.4                 | 146.5              |                   | 2237.5                 | 167.6              |
| 40. $\frac{1}{2}$ | 1256.6                 | 125.6              |                   | 1716.5                 | 146.9              |                   | 2248.                  | 168.1              |
|                   | 1264.5                 | 126.               |                   | 1725.7                 | 147.3              |                   | 2258.5                 | 168.4              |
|                   | 1272.4                 | 126.4              | 47. $\frac{1}{2}$ | 1734.9                 | 147.7              |                   | 2269.                  | 168.9              |
|                   | 1280.3                 | 126.8              |                   | 1744.2                 | 148.               |                   | 2279.6                 | 169.2              |
|                   | 1288.2                 | 127.2              |                   | 1753.5                 | 148.4              | 54. $\frac{1}{2}$ | 2290.2                 | 169.6              |
|                   | 1296.2                 | 127.6              |                   | 1762.7                 | 148.8              |                   | 2300.8                 | 170.               |
|                   | 1304.2                 | 128.               |                   | 1772.1                 | 149.2              |                   | 2311.5                 | 170.4              |
|                   | 1312.2                 | 128.4              |                   | 1781.4                 | 149.6              |                   | 2322.1                 | 170.8              |
| 41. $\frac{1}{2}$ | 1320.3                 | 128.8              |                   | 1790.8                 | 150.               |                   | 2332.8                 | 171.2              |
|                   | 1328.3                 | 129.2              |                   | 1800.1                 | 150.4              |                   | 2343.5                 | 171.6              |
|                   | 1336.4                 | 129.6              | 48. $\frac{1}{2}$ | 1809.6                 | 150.8              |                   | 2354.3                 | 172.               |
|                   | 1344.5                 | 130.               |                   | 1819.                  | 151.2              |                   | 2365.                  | 172.3              |
|                   | 1352.7                 | 130.4              |                   | 1828.5                 | 151.6              | 55. $\frac{1}{2}$ | 2375.8                 | 172.8              |

TABLE NO. 13—Continued.

| Diam. in Inches. | Area in Square Inches. | Circum. in Inches. | Diam. in Inches.  | Area in Square Inches. | Circum. in Inches. | Diam. in Inches.  | Area in Square Inches. | Circum. in Inches. |                   |        |
|------------------|------------------------|--------------------|-------------------|------------------------|--------------------|-------------------|------------------------|--------------------|-------------------|--------|
| 55.              | 2386.6                 | 173.1              | 61. $\frac{1}{8}$ | 3006.9                 | 194.3              | 68. $\frac{1}{8}$ | 3698.7                 | 215.5              |                   |        |
|                  | 2397.5                 | 173.6              |                   | 62. $\frac{1}{8}$      | 3019.1             |                   | 194.8                  | 68. $\frac{1}{4}$  | 3712.2            | 215.9  |
|                  | 2408.3                 | 173.9              |                   | 62. $\frac{1}{4}$      | 3031.2             |                   | 195.1                  | 68. $\frac{3}{8}$  | 3725.7            | 216.3  |
|                  | 2419.2                 | 174.4              |                   | 62. $\frac{1}{2}$      | 3043.5             |                   | 195.6                  | 69. $\frac{1}{8}$  | 3739.3            | 216.7  |
|                  | 2430.1                 | 174.7              |                   | 62. $\frac{3}{4}$      | 3055.7             |                   | 195.9                  |                    | 69. $\frac{1}{4}$ | 3752.8 |
| 56.              | 2441.                  | 175.1              | 63. $\frac{1}{8}$ | 3068.                  | 196.3              | 69. $\frac{1}{2}$ | 3766.4                 | 217.5              |                   |        |
|                  | 2452.                  | 175.5              |                   | 63. $\frac{1}{4}$      | 3080.2             | 196.7             | 69. $\frac{3}{8}$      | 3780.              | 217.9             |        |
|                  | 2463.                  | 175.9              |                   | 63. $\frac{1}{2}$      | 3092.6             | 197.1             | 69. $\frac{1}{2}$      | 3793.7             | 218.3             |        |
|                  | 2474.                  | 176.3              |                   | 63. $\frac{3}{4}$      | 3104.8             | 197.5             | 70. $\frac{1}{8}$      | 3807.3             | 218.7             |        |
|                  | 2485.                  | 176.7              |                   | 63. $\frac{1}{2}$      | 3117.2             | 197.9             | 70. $\frac{1}{4}$      | 3821.              | 219.1             |        |
| 57.              | 2496.1                 | 177.1              | 64. $\frac{1}{8}$ | 3129.6                 | 198.3              | 70. $\frac{1}{2}$ | 3834.7                 | 219.5              |                   |        |
|                  | 2507.2                 | 177.5              |                   | 64. $\frac{1}{4}$      | 3142.              |                   | 198.7                  | 70. $\frac{3}{8}$  | 3848.5            | 219.9  |
|                  | 2518.2                 | 177.8              |                   | 64. $\frac{1}{2}$      | 3154.4             |                   | 199.                   | 70. $\frac{1}{2}$  | 3862.2            | 220.3  |
|                  | 2529.4                 | 178.3              |                   | 64. $\frac{3}{4}$      | 3166.9             |                   | 199.5                  | 71. $\frac{1}{8}$  | 3876.             | 220.7  |
|                  | 2540.5                 | 178.6              |                   | 64. $\frac{1}{2}$      | 3179.4             |                   | 199.8                  | 71. $\frac{1}{4}$  | 3889.8            | 221.   |
| 58.              | 2551.8                 | 179.1              | 65. $\frac{1}{8}$ | 3191.9                 | 200.3              | 71. $\frac{1}{2}$ | 3903.6                 | 221.5              |                   |        |
|                  | 2562.9                 | 179.4              |                   | 65. $\frac{1}{4}$      | 3204.4             |                   | 200.6                  | 71. $\frac{3}{8}$  | 3917.4            | 221.8  |
|                  | 2574.2                 | 179.9              |                   | 65. $\frac{1}{2}$      | 3217.              |                   | 201.1                  | 71. $\frac{1}{2}$  | 3931.4            | 222.2  |
|                  | 2585.4                 | 180.2              |                   | 65. $\frac{3}{4}$      | 3229.5             |                   | 201.4                  | 72. $\frac{1}{8}$  | 3945.2            | 222.6  |
|                  | 2596.7                 | 180.6              |                   | 65. $\frac{1}{2}$      | 3242.2             |                   | 201.8                  | 72. $\frac{1}{4}$  | 3959.2            | 223.   |
| 59.              | 2608.                  | 181.               | 66. $\frac{1}{8}$ | 3254.8                 | 202.2              | 72. $\frac{1}{2}$ | 3973.1                 | 223.4              |                   |        |
|                  | 2619.4                 | 181.4              |                   | 66. $\frac{1}{4}$      | 3267.5             |                   | 202.6                  | 72. $\frac{3}{8}$  | 3987.1            | 223.8  |
|                  | 2630.7                 | 181.8              |                   | 66. $\frac{1}{2}$      | 3280.1             |                   | 203.                   | 72. $\frac{1}{2}$  | 4001.1            | 224.2  |
|                  | 2642.1                 | 182.2              |                   | 66. $\frac{3}{4}$      | 3292.8             |                   | 203.4                  | 73. $\frac{1}{8}$  | 4015.2            | 224.6  |
|                  | 2653.4                 | 182.6              |                   | 66. $\frac{1}{2}$      | 3305.5             |                   | 203.8                  | 73. $\frac{1}{4}$  | 4029.2            | 225.   |
| 60.              | 2664.9                 | 183.               | 67. $\frac{1}{8}$ | 3318.3                 | 204.2              | 73. $\frac{1}{2}$ | 4043.3                 | 225.4              |                   |        |
|                  | 2676.3                 | 183.3              |                   | 67. $\frac{1}{4}$      | 3331.              |                   | 204.5                  | 73. $\frac{3}{8}$  | 4057.             | 225.8  |
|                  | 2687.8                 | 183.8              |                   | 67. $\frac{1}{2}$      | 3343.9             |                   | 205.                   | 73. $\frac{1}{2}$  | 4071.5            | 226.2  |
|                  | 2699.3                 | 184.1              |                   | 67. $\frac{3}{4}$      | 3356.7             |                   | 205.3                  | 74. $\frac{1}{8}$  | 4085.6            | 226.5  |
|                  | 2710.9                 | 184.6              |                   | 67. $\frac{1}{2}$      | 3369.6             |                   | 205.8                  | 74. $\frac{1}{4}$  | 4099.8            | 227.   |
| 61.              | 2722.4                 | 184.9              | 68. $\frac{1}{8}$ | 3382.4                 | 206.1              | 74. $\frac{1}{2}$ | 4114.                  | 227.3              |                   |        |
|                  | 2734.                  | 185.4              |                   | 68. $\frac{1}{4}$      | 3395.3             |                   | 206.6                  | 74. $\frac{3}{8}$  | 4128.2            | 227.7  |
|                  | 2745.5                 | 185.7              |                   | 68. $\frac{1}{2}$      | 3408.2             |                   | 206.9                  | 74. $\frac{1}{2}$  | 4142.5            | 228.1  |
|                  | 2757.2                 | 186.1              |                   | 68. $\frac{3}{4}$      | 3421.2             |                   | 207.3                  | 75. $\frac{1}{8}$  | 4156.8            | 228.5  |
|                  | 2768.8                 | 186.5              |                   | 68. $\frac{1}{2}$      | 3434.1             |                   | 207.7                  | 75. $\frac{1}{4}$  | 4171.             | 228.9  |
| 62.              | 2780.5                 | 186.9              | 69. $\frac{1}{8}$ | 3447.2                 | 208.1              | 75. $\frac{1}{2}$ | 4185.4                 | 229.3              |                   |        |
|                  | 2792.2                 | 187.3              |                   | 69. $\frac{1}{4}$      | 3460.1             |                   | 208.5                  | 75. $\frac{3}{8}$  | 4199.7            | 229.7  |
|                  | 2803.9                 | 187.7              |                   | 69. $\frac{1}{2}$      | 3473.2             |                   | 208.9                  | 75. $\frac{1}{2}$  | 4214.1            | 230.1  |
|                  | 2815.6                 | 188.1              |                   | 69. $\frac{3}{4}$      | 3486.3             |                   | 209.3                  | 76. $\frac{1}{8}$  | 4228.5            | 230.5  |
|                  | 2827.4                 | 188.5              |                   | 69. $\frac{1}{2}$      | 3499.4             |                   | 209.7                  | 76. $\frac{1}{4}$  | 4242.9            | 230.9  |
| 63.              | 2839.2                 | 188.8              | 70. $\frac{1}{8}$ | 3512.5                 | 210.               | 76. $\frac{1}{2}$ | 4257.3                 | 231.3              |                   |        |
|                  | 2851.                  | 189.3              |                   | 70. $\frac{1}{4}$      | 3525.6             |                   | 210.5                  | 76. $\frac{3}{8}$  | 4271.8            | 231.7  |
|                  | 2862.8                 | 189.6              |                   | 70. $\frac{1}{2}$      | 3538.8             |                   | 210.8                  | 76. $\frac{1}{2}$  | 4286.3            | 232.   |
|                  | 2874.8                 | 190.1              |                   | 70. $\frac{3}{4}$      | 3552.              |                   | 211.3                  | 77. $\frac{1}{8}$  | 4300.8            | 232.5  |
|                  | 2886.6                 | 190.4              |                   | 70. $\frac{1}{2}$      | 3565.2             |                   | 211.6                  | 77. $\frac{1}{4}$  | 4315.3            | 232.8  |
| 64.              | 2898.5                 | 190.9              | 71. $\frac{1}{8}$ | 3578.5                 | 212.1              | 77. $\frac{1}{2}$ | 4329.9                 | 233.2              |                   |        |
|                  | 2910.6                 | 191.2              |                   | 71. $\frac{1}{4}$      | 3591.7             |                   | 212.4                  | 77. $\frac{3}{8}$  | 4344.5            | 233.6  |
|                  | 2922.5                 | 191.6              |                   | 71. $\frac{1}{2}$      | 3605.              |                   | 212.8                  | 77. $\frac{1}{2}$  | 4359.2            | 234.   |
|                  | 2934.4                 | 192.               |                   | 71. $\frac{3}{4}$      | 3618.3             |                   | 213.2                  | 78. $\frac{1}{8}$  | 4373.8            | 234.4  |
|                  | 2946.5                 | 192.4              |                   | 71. $\frac{1}{2}$      | 3631.7             |                   | 213.6                  | 78. $\frac{1}{4}$  | 4388.5            | 234.8  |
| 65.              | 2958.5                 | 192.8              | 72. $\frac{1}{8}$ | 3645.                  | 214.               | 78. $\frac{1}{2}$ | 4403.1                 | 235.2              |                   |        |
|                  | 2970.6                 | 193.2              |                   | 72. $\frac{1}{4}$      | 3658.4             |                   | 214.4                  | 78. $\frac{3}{8}$  | 4417.9            | 235.6  |
|                  | 2982.6                 | 193.6              |                   | 72. $\frac{1}{2}$      | 3671.8             |                   | 214.8                  | 78. $\frac{1}{2}$  | 4432.6            | 236.   |
|                  | 2994.8                 | 194.               |                   | 72. $\frac{3}{4}$      | 3685.3             |                   | 215.2                  | 78. $\frac{1}{2}$  | 4447.4            | 236.4  |

TABLE NO. 13—Continued.

| Diam. in Inches. | Area in Square Inches. | Circum. in Inches. | Diam. in Inches. | Area in Square Inches. | Circum. in Inches. | Diam. in Inches. | Area in Square Inches. | Circum. in Inches. |
|------------------|------------------------|--------------------|------------------|------------------------|--------------------|------------------|------------------------|--------------------|
| 75.              | 4462.1                 | 236.7              | 82.              | 5297.1                 | 258.               | 88.              | 6203.6                 | 279.2              |
|                  | 4477.                  | 237.2              |                  | 5313.3                 | 258.4              | 89.              | 6221.1                 | 279.6              |
|                  | 4491.8                 | 237.5              |                  | 5329.4                 | 258.8              |                  | 6238.6                 | 280.               |
|                  | 4506.7                 | 238.               |                  | 5345.6                 | 259.2              |                  | 6256.1                 | 280.4              |
|                  | 4521.5                 | 238.3              |                  | 5361.8                 | 259.6              |                  | 6273.6                 | 280.8              |
| 76.              | 4536.5                 | 238.8              |                  | 5378.1                 | 260.               |                  | 6291.2                 | 281.2              |
|                  | 4551.4                 | 239.1              |                  | 5394.3                 | 260.4              |                  | 6308.8                 | 281.6              |
|                  | 4566.4                 | 239.5              | 83.              | 5410.6                 | 260.8              |                  | 6326.4                 | 282.               |
|                  | 4581.3                 | 239.9              |                  | 5426.9                 | 261.1              |                  | 6344.                  | 282.3              |
|                  | 4596.3                 | 240.3              |                  | 5443.3                 | 261.5              | 90.              | 6361.7                 | 282.7              |
|                  | 4611.3                 | 240.7              |                  | 5459.6                 | 261.9              |                  | 6379.4                 | 283.1              |
|                  | 4626.4                 | 241.1              |                  | 5476.                  | 262.3              |                  | 6397.1                 | 283.5              |
|                  | 4641.5                 | 241.5              |                  | 5492.4                 | 262.7              |                  | 6414.8                 | 283.9              |
| 77.              | 4656.6                 | 241.9              |                  | 5508.8                 | 263.1              |                  | 6432.6                 | 284.3              |
|                  | 4671.7                 | 242.2              |                  | 5525.3                 | 263.5              |                  | 6450.4                 | 284.7              |
|                  | 4686.9                 | 242.7              | 84.              | 5541.8                 | 263.9              |                  | 6468.2                 | 285.1              |
|                  | 4702.1                 | 243.               |                  | 5558.3                 | 264.3              |                  | 6486.                  | 285.5              |
|                  | 4717.3                 | 243.5              |                  | 5574.8                 | 264.7              | 91.              | 6503.9                 | 285.9              |
|                  | 4732.5                 | 243.8              |                  | 5591.3                 | 265.               |                  | 6521.7                 | 286.3              |
|                  | 4747.8                 | 244.3              |                  | 5607.9                 | 265.5              |                  | 6539.7                 | 286.7              |
|                  | 4763.                  | 244.6              |                  | 5624.5                 | 265.8              |                  | 6557.6                 | 287.1              |
| 78.              | 4778.4                 | 245.               |                  | 5641.2                 | 266.2              |                  | 6575.5                 | 287.5              |
|                  | 4793.7                 | 245.4              |                  | 5657.8                 | 266.6              |                  | 6593.5                 | 287.8              |
|                  | 4809.                  | 245.8              | 85.              | 5674.5                 | 267.               |                  | 6611.5                 | 288.2              |
|                  | 4824.4                 | 246.2              |                  | 5691.2                 | 267.4              |                  | 6629.5                 | 288.6              |
|                  | 4839.8                 | 246.6              |                  | 5707.9                 | 267.8              | 92.              | 6647.6                 | 289.               |
|                  | 4855.2                 | 247.               |                  | 5724.6                 | 268.2              |                  | 6665.7                 | 289.4              |
|                  | 4870.8                 | 247.4              |                  | 5741.5                 | 268.6              |                  | 6683.8                 | 289.8              |
|                  | 4886.1                 | 247.7              |                  | 5758.2                 | 268.9              |                  | 6701.9                 | 290.2              |
| 79.              | 4901.7                 | 248.2              |                  | 5775.1                 | 269.4              |                  | 6720.1                 | 290.6              |
|                  | 4917.2                 | 248.5              |                  | 5791.9                 | 269.7              |                  | 6738.2                 | 291.               |
|                  | 4932.7                 | 249.               | 86.              | 5808.8                 | 270.2              |                  | 6756.4                 | 291.4              |
|                  | 4948.3                 | 249.3              |                  | 5825.7                 | 270.5              |                  | 6774.7                 | 291.8              |
|                  | 4963.9                 | 249.8              |                  | 5842.6                 | 271.               | 93.              | 6792.9                 | 292.2              |
|                  | 4979.5                 | 250.1              |                  | 5859.5                 | 271.3              |                  | 6811.1                 | 292.6              |
|                  | 4995.2                 | 250.5              |                  | 5876.5                 | 271.7              |                  | 6829.5                 | 293.               |
| 80.              | 5010.8                 | 250.9              |                  | 5893.5                 | 272.1              |                  | 6847.8                 | 293.4              |
|                  | 5026.5                 | 251.3              |                  | 5910.6                 | 272.5              |                  | 6866.1                 | 293.7              |
|                  | 5042.2                 | 251.7              |                  | 5927.6                 | 272.9              |                  | 6884.5                 | 294.1              |
|                  | 5058.                  | 252.1              | 87.              | 5944.7                 | 273.3              |                  | 6902.9                 | 294.5              |
|                  | 5073.7                 | 252.5              |                  | 5961.7                 | 273.7              |                  | 6921.3                 | 294.9              |
|                  | 5089.6                 | 252.9              |                  | 5978.9                 | 274.1              | 94.              | 6939.8                 | 295.3              |
|                  | 5105.4                 | 253.3              |                  | 5996.                  | 274.4              |                  | 6958.2                 | 295.7              |
|                  | 5121.2                 | 253.7              |                  | 6013.2                 | 274.9              |                  | 6976.7                 | 296.1              |
|                  | 5137.1                 | 254.1              |                  | 6030.4                 | 275.2              |                  | 6995.2                 | 296.5              |
| 81.              | 5153.                  | 254.5              |                  | 6047.6                 | 275.7              |                  | 7013.8                 | 296.9              |
|                  | 5168.9                 | 254.9              |                  | 6064.8                 | 276.               |                  | 7032.4                 | 297.3              |
|                  | 5184.9                 | 255.3              | 88.              | 6082.1                 | 276.5              |                  | 7051.                  | 297.7              |
|                  | 5200.8                 | 255.6              |                  | 6099.4                 | 276.8              |                  | 7069.5                 | 298.1              |
|                  | 5216.8                 | 256.               |                  | 6116.7                 | 277.2              | 95.              | 7088.2                 | 298.5              |
|                  | 5232.8                 | 256.4              |                  | 6134.                  | 277.6              |                  | 7106.9                 | 298.8              |
|                  | 5248.9                 | 256.8              |                  | 6151.4                 | 278.               |                  | 7125.6                 | 299.2              |
|                  | 5264.9                 | 257.2              |                  | 6168.8                 | 278.4              |                  | 7144.3                 | 299.6              |
| 82.              | 5281.                  | 257.6              |                  | 6186.2                 | 278.8              |                  | 7163.                  | 300.               |

TABLE NO. 13—Continued.

| Diam. in Inches. | Area in Square Inches. | Circum. in Inches. | Diam. in Inches. | Area in Square Inches. | Circum. in Inches. | Diam. in Inches. | Area in Square Inches. | Circum. in Inches. |
|------------------|------------------------|--------------------|------------------|------------------------|--------------------|------------------|------------------------|--------------------|
| 95.              | 7181.8                 | 300.4              | 97.              | 7408.8                 | 305.1              | 98.              | 7639.4                 | 309.8              |
|                  | 7200.6                 | 300.8              |                  | 7428.                  | 305.5              |                  | 7658.9                 | 310.2              |
|                  | 7219.4                 | 301.2              |                  | 7447.                  | 305.9              |                  | 7678.2                 | 310.6              |
| 96.              | 7238.2                 | 301.6              |                  | 7466.2                 | 306.3              | 99.              | 7697.7                 | 311.               |
|                  | 7257.1                 | 302.               |                  | 7485.3                 | 306.7              |                  | 7717.1                 | 311.4              |
|                  | 7276.                  | 302.4              |                  | 7504.5                 | 307.1              |                  | 7736.6                 | 311.8              |
|                  | 7294.9                 | 302.8              |                  | 7523.7                 | 307.5              |                  | 7756.1                 | 312.2              |
|                  | 7313.8                 | 303.2              | 98.              | 7543.                  | 307.9              |                  | 7775.6                 | 312.6              |
|                  | 7332.8                 | 303.5              |                  | 7562.2                 | 308.3              |                  | 7795.2                 | 313.               |
|                  | 7351.8                 | 303.9              |                  | 7581.5                 | 308.7              |                  | 7814.8                 | 313.4              |
|                  | 7370.7                 | 304.3              |                  | 7600.8                 | 309.               |                  | 7834.3                 | 313.8              |
| 97.              | 7389.8                 | 304.7              |                  | 7620.1                 | 309.4              | 100.             | 7854.                  | 314.2              |

If the areas of larger circles are required, they will be found by the following:

*Rule.*—Multiply the square of the diameter in inches, by the decimal 0.7854, and the product will be the area in square inches; or, multiply half the circumference by half the diameter.

If the circumference of a larger circle is wanted, and having the diameter, the rule is as follows:

*Rule.*—As 7 is to 22, so is the diameter to the circumference, or diameter multiplied by 3.1416 equal circumference.

### Properties of Water and Steam.

#### *In Relation to Heat.*

The following tables for water and steam were calculated by the late John William Nystrom, C. E. M. E., and furnished the writer prior to his publication of them in his new treatise on "Steam Engineering." The relation between temperature and pressure of steam conforms to a uniform curve or law.

#### Volume of Water.

Water, like other liquids, expands in heating and contracts in cooling, with the exception that in heating it from 32 degrees to 40 degrees it contracts, and expands in heating from 40 degrees upwards. The greatest density or smallest volume of water is therefore at 40 degrees Fahrenheit.

The most reliable experiments made on this subject are probably those of Kopp, by which the greatest density of water is indicated to be between 39 and 40 degrees, or nearer 39 degrees; but however accurately these experiments might have been made,

it is impossible without the aid of mathematics to determine correctly the temperature of the greatest density, because the curve tangents the abscissa at that point.

Mr. Nystrom treated Kopp's experiments with very careful mathematical and graphical analysis, resulting in locating the greatest density of water at 40 degrees.

#### Properties of Water.

Column  $t^\circ$  contains the temperature of the steam and water Centigrade scale.

Column  $T^\circ$  contains the temperature of the steam and water, Fahrenheit scale.

Column  $\mathcal{V}$  contains the volume of water of temperature  $T^\circ$ , that at 40 degrees being unit.

This column is calculated from the formula 1, deduced from Kopp's experiments, as follows:

$$\mathcal{V} = 1 + \frac{(t^\circ - 40)^2}{1400 t^\circ + 398500} \dots \dots \dots 1$$

The volume deduced from the same experiment, but with the assertion that the greatest density of water is at 39 degrees, will be:

$$\mathcal{V} = 1 + \frac{(t^\circ - 39)^2}{1400 T^\circ + 405400} \dots \dots \dots 2$$

Formula 1 is the more correct.

Column  $\mathcal{W}$  contains the weight in pounds per cubic foot of water of temperature  $T^\circ$ . Water of the maximum density at 40 degrees weighs 62.383 pounds per cubic foot.

Column  $\mathcal{C}$  contains the fractional cubic feet per pound of water of temperature  $T^\circ$ .

Column  $h$  contains the units of heat required to raise each pound of water from 32 degrees to  $T^\circ$ :

Column  $h'$  contains the units of heat required to raise each cubic foot of distilled water from 32 degrees to temperature  $T^\circ$  under the pressure  $P$ .

Column  $+P$  denotes the absolute pressure of vapor above vacuum.

Column  $-p$  denotes the pressure of vapor under that of the atmosphere, which is the vacuum.



Column *l* contains the units of heat latent in water from 32° to *T*° per pound.

Column *l'* contains the units of heat latent in water from 32° to *T*° per cubic foot.

+ means pressure above the atmosphere.

— means vacuum under the atmosphere.

**Latent and Total Heat in Water from 32 Degrees.**

When water expands it absorbs heat, which is not indicated as temperature, but remains latent.

*l* = latent heat per pound of water heated from 32 degrees.

*V* = volume per formula 1,

*t*° = temperature of the water.

*h* = total units of heat per pound of water heated from 32 degrees.

Latent heat,  $l = 0.1 t^\circ (V - 1) \dots \dots \dots 3$

Total heat,  $h = 0.1 t^\circ (V + 9) - 32 \dots \dots \dots 4$

*Pounds Per Cubic Foot.*

*Cubic Feet Per Pound.*

$$\mathfrak{P} = \frac{62.388}{V} \dots \dots \dots 5$$

$$\mathfrak{C} = \frac{V}{62.388} \dots \dots \dots 7$$

$$\mathfrak{P} = \frac{1}{\mathfrak{C}} \dots \dots \dots 6$$

$$\mathfrak{C} = \frac{1}{\mathfrak{P}} \dots \dots \dots 8$$

The latent heat in water heated from 32 to 40 degrees is negative; that is, the water indicates more temperature than units of heat imparted to it. The volume at 32 degrees is 1.000156, and the heat required to raise the temperature of one pound of water from 32 to 40 degrees or 8 degrees, is as follows:

$$0.999844 \times 8 = 7.99875 \text{ units.}$$

The heat required to raise the temperature of one pound of water from 32 to 212 degrees, or 180 degrees, are 181 units of heat. The heat required to raise water from 32 to 350 degrees, or 318 degrees, are 322 units of heat, or 4 units of heat more than the increase of temperature.

TABLE NO. 14—PROPERTIES OF WATER.

| Temperature. |       | Volume.<br>Wat. = 1<br>at 40°. | Weight<br>per cubic<br>foot. | Bulk.<br>cubic feet<br>per lb. | Units of heat. |            | Pressure of vapor. |           |
|--------------|-------|--------------------------------|------------------------------|--------------------------------|----------------|------------|--------------------|-----------|
| Centig.      | Fahr. |                                |                              |                                | per lb.        | pr. c. ft. | Absol.             | under at. |
| t°           | T°    | V                              | W                            | U                              | h.             | h'.        | +P.                | -p.       |
| 0.           | 32    | 1.000109                       | 62.3871                      | 0.0160304                      | 0.00000        | 0.0000     | 0.0864             | -14.614   |
| 0.55         | 33    | 1.000077                       | 62.3830                      | 0.0160299                      | 1.00000        | 62.383     | 0.0904             | -14.610   |
| 1.11         | 34    | 1.000055                       | 62.3842                      | 0.0160295                      | 2.00000        | 124.77     | 0.0945             | -14.606   |
| 1.66         | 35    | 1.000035                       | 62.3859                      | 0.0160292                      | 3.00001        | 187.16     | 0.0988             | -14.601   |
| 2.22         | 36    | 1.000020                       | 62.3868                      | 0.0160290                      | 4.00003        | 249.55     | 0.1033             | -14.597   |
| 2.77         | 37    | 1.000009                       | 62.3875                      | 0.0160288                      | 5.00006        | 311.99     | 0.1079             | -14.592   |
| 3.33         | 38    | 1.000003                       | 62.3876                      | 0.0160288                      | 6.00010        | 374.33     | 0.1127             | -14.587   |
| 3.88         | 39    | 1.000001                       | 62.3879                      | 0.0160287                      | 7.00015        | 436.72     | 0.1176             | -14.582   |
| 4.44         | 40    | 1.000000                       | 62.3880                      | 0.0160287                      | 8.00022        | 499.12     | 0.1228             | -14.577   |
| 5.00         | 41    | 1.000003                       | 62.3878                      | 0.0160288                      | 9.00030        | 561.51     | 0.1281             | -14.571   |
| 5.55         | 42    | 1.000016                       | 62.3873                      | 0.0160290                      | 10.00040       | 623.89     | 0.1336             | -14.566   |
| 6.11         | 43    | 1.000034                       | 62.3859                      | 0.0160292                      | 11.00051       | 686.28     | 0.1393             | -14.561   |
| 6.66         | 44    | 1.000053                       | 62.3847                      | 0.0160295                      | 12.00065       | 748.66     | 0.1452             | -14.555   |
| 7.22         | 45    | 1.000077                       | 62.3832                      | 0.0160299                      | 13.00081       | 811.03     | 0.1513             | -14.549   |
| 7.77         | 46    | 1.000101                       | 62.3815                      | 0.0160304                      | 14.00098       | 879.40     | 0.1576             | -14.542   |
| 8.33         | 47    | 1.000136                       | 62.3797                      | 0.0160308                      | 15.00132       | 935.70     | 0.1642             | -14.536   |
| 8.88         | 48    | 1.000171                       | 62.3774                      | 0.0160314                      | 16.00140       | 997.77     | 0.1709             | -14.529   |
| 9.44         | 49    | 1.000211                       | 62.3749                      | 0.0160321                      | 17.00165       | 1060.0     | 0.1780             | -14.522   |
| 10.00        | 50    | 1.000254                       | 62.3722                      | 0.0160328                      | 18.00192       | 1122.8     | 0.1852             | -14.515   |
| 10.55        | 51    | 1.000302                       | 62.3692                      | 0.0160335                      | 19.00222       | 1185.1     | 0.1927             | -14.507   |
| 11.11        | 52    | 1.000353                       | 62.3660                      | 0.0160344                      | 20.00255       | 1248.0     | 0.2004             | -14.499   |
| 11.66        | 53    | 1.000408                       | 62.3626                      | 0.0160352                      | 21.00292       | 1310.1     | 0.2084             | -14.491   |
| 12.22        | 54    | 1.000468                       | 62.3589                      | 0.0160362                      | 22.00329       | 1372.3     | 0.2166             | -14.483   |
| 12.77        | 55    | 1.000531                       | 62.3549                      | 0.0160372                      | 23.00370       | 1434.3     | 0.2252             | -14.475   |
| 13.33        | 56    | 1.000597                       | 62.3508                      | 0.0160383                      | 24.00415       | 1496.4     | 0.2339             | -14.466   |
| 13.88        | 57    | 1.000668                       | 62.3464                      | 0.0160394                      | 25.00462       | 1558.6     | 0.2430             | -14.457   |
| 14.44        | 58    | 1.000740                       | 62.3419                      | 0.0160405                      | 26.00513       | 1620.9     | 0.2524             | -14.448   |
| 15.00        | 59    | 1.000819                       | 62.3370                      | 0.0160418                      | 27.00568       | 1683.2     | 0.2621             | -14.438   |
| 15.55        | 60    | 1.000901                       | 62.3319                      | 0.0160431                      | 28.00626       | 1745.5     | 0.2720             | -14.428   |
| 16.11        | 61    | 1.000986                       | 62.3266                      | 0.0160445                      | 29.00687       | 1807.8     | 0.2824             | -14.418   |
| 16.66        | 62    | 1.001075                       | 62.3211                      | 0.0160459                      | 30.00752       | 1870.1     | 0.2930             | -14.407   |
| 17.22        | 63    | 1.001167                       | 62.3153                      | 0.0160474                      | 31.00821       | 1932.4     | 0.3040             | -14.396   |
| 17.77        | 64    | 1.001262                       | 62.3094                      | 0.0160489                      | 32.00894       | 1994.4     | 0.3153             | -14.385   |
| 18.33        | 65    | 1.001362                       | 62.3032                      | 0.0160505                      | 33.00970       | 2056.6     | 0.3269             | -14.373   |
| 18.88        | 66    | 1.001464                       | 62.2968                      | 0.0160522                      | 34.01051       | 2118.7     | 0.3389             | -14.361   |
| 19.44        | 67    | 1.001570                       | 62.2902                      | 0.0160539                      | 35.01136       | 2180.8     | 0.3513             | -14.349   |
| 20.00        | 68    | 1.001680                       | 62.2834                      | 0.0160556                      | 36.01224       | 2242.9     | 0.3640             | -14.336   |
| 20.55        | 69    | 1.001793                       | 62.2763                      | 0.0160575                      | 37.01317       | 2305.0     | 0.3771             | -14.323   |
| 21.11        | 70    | 1.001909                       | 62.2692                      | 0.0160592                      | 38.01415       | 2367.1     | 0.3906             | -14.309   |
| 21.66        | 71    | 1.002028                       | 62.2618                      | 0.0160612                      | 39.01516       | 2429.2     | 0.4045             | -14.296   |
| 22.22        | 72    | 1.002151                       | 62.2541                      | 0.0160632                      | 40.01622       | 2491.2     | 0.4188             | -14.281   |
| 22.77        | 73    | 1.002277                       | 62.2463                      | 0.0160652                      | 41.01733       | 2553.2     | 0.4336             | -14.266   |
| 23.33        | 74    | 1.002406                       | 62.2383                      | 0.0160673                      | 42.01848       | 2615.2     | 0.4487             | -14.251   |
| 23.88        | 75    | 1.002539                       | 62.2300                      | 0.0160694                      | 43.01968       | 2677.1     | 0.4644             | -14.236   |
| 24.44        | 76    | 1.002675                       | 62.2216                      | 0.0160716                      | 44.02092       | 2739.2     | 0.4804             | -14.220   |
| 25.00        | 77    | 1.002814                       | 62.2130                      | 0.0160738                      | 45.02222       | 2801.0     | 0.4970             | -14.203   |
| 25.55        | 78    | 1.002956                       | 62.2042                      | 0.0160761                      | 46.02356       | 2862.8     | 0.5139             | -14.186   |
| 26.11        | 79    | 1.003101                       | 62.1952                      | 0.0160784                      | 47.02495       | 2924.6     | 0.5314             | -14.169   |
| 26.66        | 80    | 1.003249                       | 62.1860                      | 0.0160808                      | 48.02640       | 2985.4     | 0.5493             | -14.151   |
| 27.22        | 81    | 1.003400                       | 62.1766                      | 0.0160832                      | 49.02789       | 3048.2     | 0.5677             | -14.132   |

TABLE NO. 14—PROPERTIES OF WATER—Continued.

| Temperature. |           | Volume.<br>Wat. = 1<br>at 40°. | Weight<br>per cubic<br>foot. | Bulk.<br>cubic feet<br>per lb. | Units of heat. |           | Pressure of vapor. |           |
|--------------|-----------|--------------------------------|------------------------------|--------------------------------|----------------|-----------|--------------------|-----------|
| Centig.      | Fahr.     |                                |                              |                                | per lb.        | pr. c.ft. | Absol.             | under at. |
| <i>t°</i>    | <i>T°</i> | <i>V</i>                       | <i>W</i>                     | <i>C</i>                       | <i>h</i>       | <i>h'</i> | +P.                | -p.       |
| 27.77        | 82        | 1.003554                       | 62.1671                      | 0.0160857                      | 50.02944       | 3111.0    | 0.5868             | -14.113   |
| 28.33        | 83        | 1.003711                       | 62.1574                      | 0.0160882                      | 51.03104       | 3172.8    | 0.6063             | -14.093   |
| 28.88        | 84        | 1.003872                       | 62.1474                      | 0.0160908                      | 52.03269       | 3234.4    | 0.6264             | -14.074   |
| 29.44        | 85        | 1.004035                       | 62.1373                      | 0.0160934                      | 53.03439       | 3296.2    | 0.6470             | -14.053   |
| 30.00        | 86        | 1.004199                       | 62.1272                      | 0.0160960                      | 54.03615       | 3358.2    | 0.6681             | -14.032   |
| 30.55        | 87        | 1.004370                       | 62.1166                      | 0.0160987                      | 55.03797       | 3418.7    | 0.6898             | -14.010   |
| 31.11        | 88        | 1.004542                       | 62.1059                      | 0.0161015                      | 56.03984       | 3480.4    | 0.7121             | -13.988   |
| 31.66        | 89        | 1.004717                       | 62.0951                      | 0.0161043                      | 57.04177       | 3542.1    | 0.7351             | -13.965   |
| 32.22        | 90        | 1.004894                       | 62.0840                      | 0.016107                       | 58.0437        | 3603.8    | 0.7586             | -13.94    |
| 32.77        | 91        | 1.005094                       | 62.0718                      | 0.016110                       | 59.0458        | 3665.0    | 0.7827             | -13.91    |
| 33.33        | 92        | 1.005258                       | 62.0617                      | 0.016113                       | 60.0479        | 3726.6    | 0.8075             | -13.89    |
| 33.88        | 93        | 1.005443                       | 62.0502                      | 0.016116                       | 61.0501        | 3788.2    | 0.8329             | -13.86    |
| 34.44        | 94        | 1.005633                       | 62.0386                      | 0.016119                       | 62.0523        | 3849.8    | 0.8590             | -13.84    |
| 35.00        | 95        | 1.005825                       | 62.0267                      | 0.016122                       | 63.0546        | 3911.2    | 0.8858             | -13.81    |
| 35.55        | 96        | 1.006019                       | 62.0148                      | 0.016125                       | 64.0569        | 3972.6    | 0.9132             | -13.79    |
| 36.11        | 97        | 1.006216                       | 62.0026                      | 0.016128                       | 65.0593        | 4033.9    | 0.9609             | -13.74    |
| 36.66        | 98        | 1.006415                       | 61.9904                      | 0.016131                       | 66.0618        | 4095.2    | 0.9704             | -13.73    |
| 37.22        | 99        | 1.006618                       | 61.9779                      | 0.016135                       | 67.0643        | 4156.5    | 1.000              | -13.70    |
| 37.77        | 100       | 1.006822                       | 61.9653                      | 0.016138                       | 68.0669        | 4217.7    | 1.030              | -13.67    |
| 38.33        | 101       | 1.007030                       | 61.9525                      | 0.016141                       | 69.0696        | 4278.9    | 1.061              | -13.64    |
| 38.88        | 102       | 1.007240                       | 61.9396                      | 0.016145                       | 70.0723        | 4340.1    | 1.093              | -13.61    |
| 39.44        | 103       | 1.007553                       | 61.9204                      | 0.016150                       | 71.0751        | 4401.3    | 1.126              | -13.57    |
| 40.00        | 104       | 1.007668                       | 61.9133                      | 0.016152                       | 72.0779        | 4462.5    | 1.159              | -13.54    |
| 40.55        | 105       | 1.007905                       | 61.8987                      | 0.016155                       | 73.0809        | 4523.0    | 1.194              | -13.50    |
| 41.11        | 106       | 1.008106                       | 61.8864                      | 0.016159                       | 74.0838        | 4585.0    | 1.229              | -13.47    |
| 41.66        | 107       | 1.008328                       | 61.8728                      | 0.016162                       | 75.0869        | 4645.9    | 1.265              | -13.43    |
| 42.22        | 108       | 1.008554                       | 61.8589                      | 0.016166                       | 76.0900        | 4706.8    | 1.302              | -13.40    |
| 42.77        | 109       | 1.008781                       | 61.8450                      | 0.016169                       | 77.0932        | 4767.7    | 1.340              | -13.36    |
| 43.33        | 110       | 1.009032                       | 61.8296                      | 0.016173                       | 78.0965        | 4828.6    | 1.378              | -13.32    |
| 43.88        | 111       | 1.009244                       | 61.8166                      | 0.016177                       | 79.0998        | 4889.5    | 1.418              | -13.28    |
| 44.44        | 112       | 1.009479                       | 61.8022                      | 0.016180                       | 80.1032        | 4950.4    | 1.459              | -13.24    |
| 45.00        | 113       | 1.009718                       | 61.7876                      | 0.016184                       | 81.1067        | 5011.3    | 1.500              | -13.20    |
| 45.55        | 114       | 1.009956                       | 61.7730                      | 0.016188                       | 82.1103        | 5072.2    | 1.543              | -13.16    |
| 46.11        | 115       | 1.010197                       | 61.7583                      | 0.016192                       | 83.1139        | 5133.0    | 1.587              | -13.11    |
| 46.66        | 116       | 1.010442                       | 61.7433                      | 0.016196                       | 84.1176        | 5193.7    | 1.631              | -13.07    |
| 47.22        | 117       | 1.010688                       | 61.7283                      | 0.016200                       | 85.1214        | 5254.3    | 1.677              | -13.02    |
| 47.77        | 118       | 1.010938                       | 61.7130                      | 0.016204                       | 86.1252        | 5314.9    | 1.723              | -12.98    |
| 48.33        | 119       | 1.011189                       | 61.6977                      | 0.016208                       | 87.1292        | 5375.5    | 1.771              | -12.93    |
| 48.88        | 120       | 1.011442                       | 61.6823                      | 0.016212                       | 88.1332        | 5436.1    | 1.820              | -12.88    |
| 49.44        | 121       | 1.011698                       | 61.6666                      | 0.016216                       | 89.1373        | 5496.6    | 1.870              | -12.83    |
| 50.00        | 122       | 1.011956                       | 61.6509                      | 0.016220                       | 90.1414        | 5557.1    | 1.921              | -12.78    |
| 50.55        | 123       | 1.012216                       | 61.6351                      | 0.016224                       | 91.1456        | 5617.6    | 1.974              | -12.73    |
| 51.11        | 124       | 1.012478                       | 61.6192                      | 0.016229                       | 92.1500        | 5678.1    | 2.026              | -12.67    |
| 51.66        | 125       | 1.012743                       | 61.6030                      | 0.016233                       | 93.1543        | 5738.6    | 2.082              | -12.62    |
| 52.22        | 126       | 1.013010                       | 61.5868                      | 0.016237                       | 94.1588        | 5798.9    | 2.137              | -12.56    |
| 52.77        | 127       | 1.013278                       | 61.5805                      | 0.016241                       | 95.1634        | 5859.2    | 2.195              | -12.50    |
| 53.33        | 128       | 1.013550                       | 61.5540                      | 0.016246                       | 96.1680        | 5919.5    | 2.253              | -12.45    |
| 53.88        | 129       | 1.013823                       | 61.5374                      | 0.016250                       | 97.1727        | 5979.7    | 2.312              | -12.39    |
| 54.44        | 130       | 1.014098                       | 61.5207                      | 0.016255                       | 98.1775        | 6040.0    | 2.374              | -12.33    |
| 57.22        | 135       | 1.015505                       | 61.4355                      | 0.016277                       | 103.2027       | 6340.3    | 2.699              | -12.00    |

TABLE NO. 14—PROPERTIES OF WATER—*Continued.*

| Temperature. |          | Volume.<br>Wat. = 1<br>at 40°. | Weight<br>per cubic<br>foot. | Bulk.<br>cubic feet<br>per lb. | Units of heat. |            | Pressure of vapor. |           |
|--------------|----------|--------------------------------|------------------------------|--------------------------------|----------------|------------|--------------------|-----------|
| Centig.      | Fahr.    |                                |                              |                                | per lb.        | pr. c. ft. | Absol.             | under at. |
| <i>t</i>     | <i>T</i> | <i>v</i>                       | <i>w</i>                     | <i>ε</i>                       | <i>h</i>       | <i>h'</i>  | +P.                | -p.       |
| 60.00        | 140      | 1.016962                       | 61.3473                      | 0.016301                       | 108.230        | 6639.6     | 3.058              | -11.64    |
| 62.77        | 145      | 1.018468                       | 61.2567                      | 0.016325                       | 113.260        | 6937.9     | 3.462              | -11.24    |
| 65.55        | 150      | 1.020021                       | 61.1635                      | 0.016350                       | 118.291        | 7215.1     | 3.907              | -10.79    |
| 68.33        | 155      | 1.021619                       | 61.0678                      | 0.016375                       | 123.326        | 7531.2     | 4.397              | -10.30    |
| 71.11        | 160      | 1.023262                       | 60.9697                      | 0.016401                       | 128.362        | 7826.2     | 4.939              | -9.761    |
| 73.88        | 165      | 1.024947                       | 60.8695                      | 0.016429                       | 133.401        | 8098.1     | 5.534              | -9.166    |
| 76.66        | 170      | 1.026672                       | 60.7673                      | 0.016456                       | 138.443        | 8412.8     | 6.188              | -8.512    |
| 79.44        | 175      | 1.028438                       | 60.6620                      | 0.016485                       | 143.487        | 8704.2     | 6.906              | -7.794    |
| 82.22        | 180      | 1.030242                       | 60.5567                      | 0.016513                       | 148.537        | 8994.      | 7.693              | -7.007    |
| 85.00        | 185      | 1.032083                       | 60.4487                      | 0.016543                       | 153.583        | 9281.      | 8.550              | -6.150    |
| 87.77        | 190      | 1.033960                       | 60.3389                      | 0.016573                       | 158.635        | 9571.      | 9.488              | -5.212    |
| 90.55        | 195      | 1.035873                       | 60.2275                      | 0.016604                       | 163.691        | 9858.      | 10.51              | -4.19     |
| 93.33        | 200      | 1.037819                       | 60.1146                      | 0.016635                       | 168.749        | 10318.     | 11.62              | -3.08     |
| 96.11        | 205      | 1.039798                       | 60.0002                      | 0.016667                       | 173.809        | 10428.     | 12.83              | -1.87     |
| 98.88        | 210      | 1.041809                       | 59.8843                      | 0.016799                       | 178.873        | 10712.     | 14.13              | -0.57     |
| 100.00       | 212      | 1.042622                       | 59.8376                      | 0.016811                       | 180.900        | 18824.     | 14.70              | -0.000    |

TABLE NO. 15—WATER.

| Temperature of the water. |       | Volume. water = 1 at 40°. | Weight. lbs. per cubic ft. | Bulk. cubic feet per pound. | Units of heat in water from 32° to T°. |       |            |       |
|---------------------------|-------|---------------------------|----------------------------|-----------------------------|--|-------|------------|-------|
| Cent.                     | Fahr. |                           |                            |                             | Total per                              |       | Latent per |       |
| t°                        | T°    | v                         | w                          | e                           | h.                                     | h'.   | l.         | l'    |
| 100.                      | 212.  | 1.04262                   | 59.838                     | 0.01671                     | 180.90                                 | 10825 | 0.903      | 54.03 |
| 100.5                     | 213.  | 1.04296                   | 59.819                     | 0.01671                     | 181.91                                 | 10882 | 0.915      | 54.73 |
| 102.4                     | 216.4 | 1.04436                   | 59.743                     | 0.01674                     | 185.36                                 | 11063 | 0.957      | 56.73 |
| 104.2                     | 219.6 | 1.04534                   | 59.668                     | 0.01676                     | 188.59                                 | 11241 | 0.994      | 59.31 |
| 106.                      | 222.8 | 1.04638                   | 59.594                     | 0.01678                     | 191.83                                 | 11414 | 1.033      | 61.56 |
| 107.6                     | 225.7 | 1.04785                   | 59.520                     | 0.01680                     | 194.78                                 | 11583 | 1.082      | 64.40 |
| 109.1                     | 228.5 | 1.04946                   | 59.447                     | 0.01682                     | 197.63                                 | 11749 | 1.130      | 67.17 |
| 110.6                     | 231.2 | 1.05062                   | 59.384                     | 0.01684                     | 200.37                                 | 11895 | 1.170      | 69.48 |
| 112.1                     | 233.8 | 1.05175                   | 59.322                     | 0.01685                     | 203.01                                 | 12037 | 1.209      | 71.72 |
| 113.6                     | 236.3 | 1.05284                   | 59.261                     | 0.01687                     | 205.55                                 | 12175 | 1.248      | 73.96 |
| 114.8                     | 238.7 | 1.05389                   | 59.201                     | 0.01689                     | 207.98                                 | 12309 | 1.281      | 75.71 |
| 116.1                     | 241.0 | 1.05490                   | 59.142                     | 0.01690                     | 210.32                                 | 12439 | 1.322      | 78.19 |
| 117.7                     | 243.3 | 1.05588                   | 59.086                     | 0.01692                     | 212.66                                 | 12561 | 1.359      | 80.38 |
| 118.5                     | 245.4 | 1.05683                   | 59.032                     | 0.01694                     | 214.79                                 | 12678 | 1.394      | 82.42 |
| 119.7                     | 247.5 | 1.05776                   | 58.980                     | 0.01695                     | 216.84                                 | 12791 | 1.437      | 84.42 |
| 120.7                     | 249.4 | 1.05867                   | 58.930                     | 0.01697                     | 218.86                                 | 12901 | 1.462      | 86.32 |
| 121.8                     | 251.4 | 1.05955                   | 58.881                     | 0.01698                     | 220.90                                 | 13007 | 1.496      | 88.09 |
| 123.0                     | 253.4 | 1.06042                   | 58.832                     | 0.01700                     | 222.93                                 | 13113 | 1.532      | 90.02 |
| 124.0                     | 255.3 | 1.06128                   | 58.784                     | 0.01701                     | 224.86                                 | 13217 | 1.565      | 91.92 |
| 125.1                     | 257.2 | 1.06213                   | 58.737                     | 0.01702                     | 226.80                                 | 13318 | 1.598      | 93.78 |
| 126.1                     | 259.0 | 1.06297                   | 58.690                     | 0.01704                     | 228.63                                 | 13416 | 1.630      | 95.65 |
| 127.0                     | 260.7 | 1.06380                   | 58.646                     | 0.01705                     | 230.36                                 | 13510 | 1.664      | 97.59 |
| 128.0                     | 262.4 | 1.06460                   | 58.603                     | 0.01706                     | 232.09                                 | 13602 | 1.695      | 99.37 |
| 128.9                     | 264.1 | 1.06538                   | 58.561                     | 0.01707                     | 233.83                                 | 13692 | 1.726      | 101.1 |
| 129.8                     | 265.7 | 1.06614                   | 58.519                     | 0.01709                     | 235.45                                 | 13780 | 1.756      | 102.8 |
| 130.7                     | 267.3 | 1.06689                   | 58.477                     | 0.01710                     | 237.09                                 | 13866 | 1.790      | 104.5 |
| 131.6                     | 268.9 | 1.06761                   | 58.437                     | 0.01711                     | 238.72                                 | 13950 | 1.816      | 106.1 |
| 132.5                     | 270.4 | 1.06832                   | 58.398                     | 0.01712                     | 240.25                                 | 14036 | 1.846      | 107.9 |
| 133.4                     | 271.9 | 1.06902                   | 58.359                     | 0.01713                     | 241.78                                 | 14115 | 1.879      | 109.6 |
| 134.0                     | 273.3 | 1.06971                   | 58.321                     | 0.01714                     | 243.20                                 | 14192 | 1.905      | 111.2 |
| 134.9                     | 274.8 | 1.07039                   | 58.284                     | 0.01716                     | 244.73                                 | 14267 | 1.935      | 112.7 |
| 135.6                     | 276.2 | 1.07105                   | 58.250                     | 0.01717                     | 246.16                                 | 14339 | 1.961      | 114.2 |
| 136.4                     | 277.6 | 1.07170                   | 58.214                     | 0.01718                     | 247.59                                 | 14411 | 1.990      | 115.8 |
| 137.2                     | 279.0 | 1.07234                   | 58.179                     | 0.01719                     | 249.02                                 | 14482 | 2.018      | 117.4 |
| 137.9                     | 280.3 | 1.07297                   | 58.145                     | 0.01720                     | 250.34                                 | 14551 | 2.045      | 118.9 |
| 138.6                     | 281.6 | 1.07359                   | 58.112                     | 0.01721                     | 251.67                                 | 14620 | 2.075      | 120.3 |
| 139.3                     | 282.8 | 1.07421                   | 58.078                     | 0.01722                     | 252.90                                 | 14688 | 2.098      | 121.7 |
| 40.0                      | 284.1 | 1.07483                   | 58.045                     | 0.01723                     | 254.22                                 | 14755 | 2.126      | 123.2 |
| 140.8                     | 285.4 | 1.07534                   | 58.012                     | 0.01724                     | 255.66                                 | 14821 | 2.150      | 124.7 |
| 141.4                     | 286.6 | 1.07594                   | 57.980                     | 0.01725                     | 256.77                                 | 14886 | 2.175      | 126.2 |
| 142.0                     | 287.8 | 1.07653                   | 57.948                     | 0.01726                     | 258.00                                 | 14951 | 2.202      | 127.7 |

TABLE NO. 16—WATER.

| Temperature of the water. |          | Volume of water = 1 at 40°. | Weight, lbs. per cubic ft. | Bulk, cubic feet per pound. | Units of heat in water from 32° to T°. |             |            |           |
|---------------------------|----------|-----------------------------|----------------------------|-----------------------------|--|-------------|------------|-----------|
| Cent.                     | Fahr.    |                             |                            |                             | Total per                              |             | Latent per |           |
| <i>t</i>                  | <i>T</i> | <i>V</i>                    | <i>W</i>                   | <i>C</i>                    | pound.                                 | cubic foot. | pound.     | cubic ft. |
| 142.8                     | 289.0    | 1.07720                     | 57.917                     | 0.01726                     | 259.23                                 | 15014       | 2.230      | 129.2     |
| 143.4                     | 290.2    | 1.07778                     | 57.886                     | 0.01727                     | 260.46                                 | 15075       | 2.260      | 130.8     |
| 144.0                     | 291.3    | 1.07835                     | 57.857                     | 0.01728                     | 261.58                                 | 15135       | 2.286      | 132.2     |
| 144.6                     | 292.4    | 1.07892                     | 57.823                     | 0.01729                     | 262.71                                 | 15195       | 2.310      | 133.5     |
| 145.2                     | 293.6    | 1.07943                     | 57.795                     | 0.01730                     | 263.93                                 | 15254       | 2.335      | 134.7     |
| 145.9                     | 294.7    | 1.07998                     | 57.768                     | 0.01731                     | 265.05                                 | 15312       | 2.354      | 136.0     |
| 146.6                     | 295.8    | 1.08051                     | 57.739                     | 0.01732                     | 266.18                                 | 15368       | 2.382      | 137.4     |
| 147.1                     | 296.9    | 1.08104                     | 57.711                     | 0.01733                     | 267.30                                 | 15424       | 2.406      | 138.8     |
| 147.7                     | 298.0    | 1.08157                     | 57.683                     | 0.01734                     | 268.43                                 | 15480       | 2.430      | 140.2     |
| 148.3                     | 299.0    | 1.08209                     | 57.655                     | 0.01735                     | 269.45                                 | 15535       | 2.454      | 141.6     |
| 148.8                     | 300.0    | 1.08259                     | 57.629                     | 0.01736                     | 270.48                                 | 15588       | 2.480      | 142.9     |
| 149.3                     | 301.0    | 1.08311                     | 57.604                     | 0.01737                     | 271.50                                 | 15641       | 2.503      | 144.2     |
| 150.0                     | 302.0    | 1.08362                     | 57.579                     | 0.01738                     | 272.52                                 | 15693       | 2.525      | 145.5     |
| 150.5                     | 303.0    | 1.08411                     | 57.546                     | 0.01738                     | 273.55                                 | 15746       | 2.548      | 146.7     |
| 151.1                     | 304.0    | 1.08460                     | 57.522                     | 0.01739                     | 274.58                                 | 15797       | 2.572      | 147.8     |
| 151.6                     | 305.0    | 1.08507                     | 57.497                     | 0.01740                     | 275.60                                 | 15846       | 2.595      | 149.2     |
| 152.2                     | 306.0    | 1.08556                     | 57.472                     | 0.01740                     | 276.62                                 | 15896       | 2.618      | 150.4     |
| 152.8                     | 307.0    | 1.08604                     | 57.447                     | 0.01741                     | 277.64                                 | 15945       | 2.640      | 151.6     |
| 153.3                     | 307.9    | 1.08653                     | 57.420                     | 0.01741                     | 278.56                                 | 15995       | 2.658      | 152.8     |
| 153.8                     | 308.9    | 1.08700                     | 57.395                     | 0.01742                     | 279.58                                 | 16044       | 2.686      | 154.1     |
| 154.3                     | 309.8    | 1.08747                     | 57.370                     | 0.01743                     | 280.51                                 | 16093       | 2.707      | 155.3     |
| 154.8                     | 310.7    | 1.08792                     | 57.346                     | 0.01743                     | 281.43                                 | 16140       | 2.728      | 156.6     |
| 155.1                     | 311.6    | 1.08838                     | 57.322                     | 0.01744                     | 282.35                                 | 16187       | 2.755      | 157.9     |
| 155.9                     | 312.5    | 1.08883                     | 57.298                     | 0.01745                     | 283.27                                 | 16233       | 2.776      | 159.2     |
| 156.3                     | 313.4    | 1.08928                     | 57.275                     | 0.01745                     | 284.19                                 | 16278       | 2.795      | 160.4     |
| 156.8                     | 314.3    | 1.08971                     | 57.252                     | 0.01746                     | 285.12                                 | 16324       | 2.822      | 161.6     |
| 157.3                     | 315.1    | 1.09014                     | 57.230                     | 0.01747                     | 285.94                                 | 16368       | 2.840      | 162.7     |
| 157.7                     | 315.9    | 1.09057                     | 57.208                     | 0.01747                     | 286.76                                 | 16411       | 2.860      | 163.8     |
| 158.1                     | 316.7    | 1.09100                     | 57.186                     | 0.01748                     | 287.58                                 | 16453       | 2.881      | 164.8     |
| 158.6                     | 317.5    | 1.09138                     | 57.164                     | 0.01749                     | 288.40                                 | 16493       | 2.900      | 165.9     |
| 159.1                     | 318.4    | 1.09180                     | 57.142                     | 0.01750                     | 289.32                                 | 16533       | 2.920      | 166.9     |
| 159.6                     | 319.2    | 1.09222                     | 57.121                     | 0.01750                     | 290.14                                 | 16574       | 2.940      | 168.0     |
| 160.0                     | 320.0    | 1.09264                     | 57.100                     | 0.01751                     | 290.96                                 | 16614       | 2.960      | 169.1     |
| 160.4                     | 320.8    | 1.09305                     | 57.078                     | 0.01752                     | 291.78                                 | 16654       | 2.980      | 170.2     |
| 160.8                     | 321.6    | 1.09346                     | 57.057                     | 0.01752                     | 292.60                                 | 16695       | 3.000      | 171.3     |
| 161.2                     | 322.4    | 1.09384                     | 57.036                     | 0.01753                     | 293.42                                 | 16735       | 3.022      | 172.4     |
| 161.6                     | 323.2    | 1.09425                     | 57.015                     | 0.01754                     | 294.25                                 | 16774       | 3.047      | 173.5     |
| 162.2                     | 324.0    | 1.09465                     | 56.994                     | 0.01754                     | 295.07                                 | 16813       | 3.068      | 174.6     |
| 162.6                     | 324.7    | 1.09506                     | 56.973                     | 0.01755                     | 295.79                                 | 16852       | 3.089      | 175.7     |
| 163.0                     | 325.4    | 1.09546                     | 56.953                     | 0.01755                     | 296.5                                  | 16890       | 3.100      | 176.7     |

TABLE NO. 17—WATER.

| Temperature of the water. |            | Volume. water = 1 at 40°. | Weight. lbs. per cubic ft. | Bulk. cubic foot per pound. | Units of heat in water from 32° to T°. |           |            |           |
|---------------------------|------------|---------------------------|----------------------------|-----------------------------|--|-----------|------------|-----------|
| Cent.                     | Fahr.      |                           |                            |                             | Total per                              |           | Latent per |           |
| <i>t</i> °                | <i>T</i> ° | <i>V</i>                  | <i>W</i>                   | <i>C</i>                    | pound.                                 | cubic ft. | <i>l</i> . | <i>l'</i> |
| 163.4                     | 326.2      | 1.09578                   | 56.934                     | 0.01756                     | 297.32                                 | 16928     | 3.121      | 177.7     |
| 163.8                     | 327.0      | 1.09617                   | 56.914                     | 0.01756                     | 298.14                                 | 16966     | 3.142      | 178.8     |
| 164.2                     | 327.7      | 1.09655                   | 56.894                     | 0.01757                     | 298.86                                 | 17004     | 3.163      | 179.9     |
| 164.6                     | 328.5      | 1.09692                   | 56.875                     | 0.01758                     | 299.68                                 | 17046     | 3.183      | 181.0     |
| 165.0                     | 329.2      | 1.09730                   | 56.855                     | 0.01758                     | 300.40                                 | 17078     | 3.204      | 182.1     |
| 165.4                     | 329.9      | 1.09768                   | 56.836                     | 0.01759                     | 301.12                                 | 17114     | 3.222      | 183.1     |
| 165.9                     | 330.7      | 1.09804                   | 56.818                     | 0.01759                     | 301.94                                 | 17149     | 3.240      | 184.1     |
| 166.3                     | 331.3      | 1.09840                   | 56.804                     | 0.01760                     | 302.56                                 | 17183     | 3.258      | 185.1     |
| 166.7                     | 331.9      | 1.09876                   | 56.786                     | 0.01760                     | 303.17                                 | 17217     | 3.276      | 186.0     |
| 167.0                     | 332.6      | 1.09911                   | 56.769                     | 0.01761                     | 303.89                                 | 17251     | 3.294      | 186.9     |
| 167.3                     | 333.3      | 1.09949                   | 56.743                     | 0.01761                     | 304.61                                 | 17284     | 3.312      | 187.9     |
| 167.7                     | 334.0      | 1.09984                   | 56.725                     | 0.01762                     | 305.33                                 | 17318     | 3.330      | 189.0     |
| 168.0                     | 334.7      | 1.10019                   | 56.706                     | 0.01763                     | 306.05                                 | 17350     | 3.349      | 190.0     |
| 168.4                     | 335.4      | 1.10055                   | 56.688                     | 0.01763                     | 306.77                                 | 17384     | 3.368      | 191.0     |
| 168.8                     | 336.1      | 1.10091                   | 56.670                     | 0.01764                     | 307.49                                 | 17427     | 3.387      | 192.0     |
| 169.2                     | 336.8      | 1.10125                   | 56.652                     | 0.01764                     | 308.21                                 | 17461     | 3.406      | 193.0     |
| 169.6                     | 337.4      | 1.10159                   | 56.635                     | 0.01765                     | 308.82                                 | 17493     | 3.425      | 194.0     |
| 170.0                     | 338.0      | 1.10193                   | 56.618                     | 0.01766                     | 309.44                                 | 17525     | 3.444      | 195.0     |
| 170.4                     | 338.7      | 1.10226                   | 56.600                     | 0.01766                     | 310.16                                 | 17557     | 3.462      | 196.0     |
| 170.8                     | 339.4      | 1.10260                   | 56.583                     | 0.01767                     | 310.88                                 | 17589     | 3.481      | 197.0     |
| 171.1                     | 340.0      | 1.10292                   | 56.566                     | 0.01768                     | 311.50                                 | 17621     | 3.500      | 198.0     |
| 172.9                     | 343.2      | 1.10459                   | 56.483                     | 0.01770                     | 314.79                                 | 17772     | 3.590      | 202.8     |
| 174.5                     | 346.2      | 1.10627                   | 56.403                     | 0.01773                     | 317.88                                 | 17921     | 3.678      | 207.5     |
| 176.2                     | 349.2      | 1.10787                   | 56.326                     | 0.01775                     | 320.96                                 | 18068     | 3.763      | 212.1     |
| 177.7                     | 352.0      | 1.10940                   | 56.236                     | 0.01778                     | 323.85                                 | 18212     | 3.850      | 216.5     |
| 179.2                     | 354.8      | 1.11070                   | 56.166                     | 0.01780                     | 326.73                                 | 18349     | 3.927      | 220.8     |
| 180.7                     | 357.4      | 1.11208                   | 56.098                     | 0.01782                     | 329.41                                 | 18481     | 4.010      | 225.0     |
| 182.2                     | 360.0      | 1.11344                   | 56.031                     | 0.01784                     | 332.09                                 | 18607     | 4.090      | 229.0     |
| 183.7                     | 362.5      | 1.11478                   | 55.965                     | 0.01787                     | 334.67                                 | 18730     | 4.168      | 233.3     |
| 185.0                     | 365.0      | 1.11613                   | 55.900                     | 0.01789                     | 337.24                                 | 18850     | 4.244      | 237.2     |
| 186.5                     | 367.4      | 1.11742                   | 55.834                     | 0.01791                     | 339.72                                 | 18966     | 4.318      | 241.0     |
| 188.0                     | 369.8      | 1.11869                   | 55.770                     | 0.01793                     | 342.19                                 | 19080     | 4.390      | 244.6     |
| 188.5                     | 372.0      | 1.11993                   | 55.708                     | 0.01795                     | 344.46                                 | 19190     | 4.460      | 248.5     |
| 190.0                     | 374.2      | 1.12109                   | 55.648                     | 0.01797                     | 346.73                                 | 19296     | 4.530      | 252.1     |
| 191.2                     | 376.4      | 1.12227                   | 55.591                     | 0.01799                     | 349.00                                 | 19399     | 4.598      | 255.7     |
| 192.5                     | 378.5      | 1.12343                   | 55.534                     | 0.01800                     | 351.16                                 | 19501     | 4.666      | 259.1     |
| 193.7                     | 380.6      | 1.12456                   | 55.477                     | 0.01802                     | 353.33                                 | 19602     | 4.731      | 262.5     |
| 194.4                     | 382.6      | 1.12561                   | 55.426                     | 0.01804                     | 355.39                                 | 19698     | 4.794      | 265.7     |
| 197.0                     | 386.6      | 1.12783                   | 55.317                     | 0.01807                     | 359.54                                 | 19885     | 4.940      | 272.8     |
| 199.1                     | 390.4      | 1.13000                   | 55.211                     | 0.01811                     | 363.48                                 | 20068     | 5.082      | 279.8     |

TABLE NO. 18—WATER—Continued.

| Temperature of the water. |          | Volume of water = 1 at 40°. | Weight. lbs. per cubic foot. | Bulk. cubic feet per pound. | Units of heat in water from 32° to <i>T</i> |             |            |          |
|---------------------------|----------|-----------------------------|------------------------------|-----------------------------|---|-------------|------------|----------|
| Cent.                     | Fahr.    |                             |                              |                             | Total per                                   |             | Latent per |          |
| <i>t</i>                  | <i>T</i> | <i>V</i>                    | <i>W</i>                     | <i>C</i>                    | pond.                                       | cubic foot. | pond.      | cubic ft |
| 201.1                     | 394.0    | I.13210                     | 55.108                       | 0.01814                     | 367.20                                      | 20236       | 5.200      | 286.6    |
| 203.5                     | 397.6    | I.13301                     | 55.017                       | 0.01817                     | 370.92                                      | 20402       | 5.318      | 292.9    |
| 205.0                     | 401.0    | I.13577                     | 54.926                       | 0.01821                     | 374.44                                      | 20561       | 5.437      | 299.1    |
| 206.8                     | 404.3    | I.13760                     | 54.838                       | 0.01824                     | 357.86                                      | 20720       | 5.558      | 305.2    |
| 208.7                     | 407.5    | I.13944                     | 54.752                       | 0.01826                     | 381.18                                      | 20870       | 5.679      | 311.2    |
| 210.2                     | 410.6    | I.14119                     | 54.670                       | 0.01829                     | 384.40                                      | 21015       | 5.800      | 317.1    |
| 211.9                     | 413.5    | I.14285                     | 54.590                       | 0.01832                     | 387.40                                      | 21147       | 5.903      | 324.6    |
| 213.6                     | 416.5    | I.14441                     | 54.514                       | 0.01834                     | 390.50                                      | 21273       | 6.006      | 332.0    |
| 215.1                     | 419.2    | I.14589                     | 54.440                       | 0.01837                     | 393.31                                      | 21394       | 6.109      | 339.5    |
| 216.7                     | 422.1    | I.14743                     | 54.367                       | 0.01839                     | 396.31                                      | 21510       | 6.212      | 346.7    |
| 218.2                     | 424.8    | I.14897                     | 54.299                       | 0.01841                     | 399.11                                      | 21625       | 6.315      | 353.8    |
| 219.6                     | 427.4    | I.15050                     | 54.230                       | 0.01844                     | 401.82                                      | 21751       | 6.418      | 356.9    |
| 221.1                     | 430.0    | I.15202                     | 54.161                       | 0.01846                     | 404.52                                      | 21876       | 6.521      | 359.9    |
| 222.4                     | 432.4    | I.15339                     | 54.093                       | 0.01849                     | 407.02                                      | 21997       | 6.624      | 362.8    |
| 223.6                     | 434.9    | I.15481                     | 54.024                       | 0.01851                     | 409.63                                      | 22114       | 6.727      | 365.6    |
| 225.1                     | 437.3    | I.15621                     | 53.959                       | 0.01853                     | 412.13                                      | 22238       | 6.830      | 368.5    |
| 226.4                     | 439.6    | I.15764                     | 53.895                       | 0.01856                     | 414.53                                      | 22347       | 6.926      | 373.2    |
| 227.7                     | 441.9    | I.15880                     | 53.834                       | 0.01858                     | 416.92                                      | 22452       | 7.020      | 377.9    |
| 228.9                     | 444.1    | I.16003                     | 53.777                       | 0.01859                     | 419.21                                      | 22553       | 7.111      | 382.5    |
| 230.2                     | 446.4    | I.16127                     | 53.721                       | 0.01861                     | 421.60                                      | 22650       | 7.200      | 386.9    |
| 231.4                     | 448.5    | I.16250                     | 53.667                       | 0.01863                     | 423.79                                      | 22744       | 7.288      | 391.1    |
| 232.5                     | 450.6    | I.16372                     | 53.614                       | 0.01865                     | 425.97                                      | 22843       | 7.374      | 395.3    |
| 233.6                     | 452.6    | I.16494                     | 53.563                       | 0.01867                     | 428.06                                      | 22938       | 7.459      | 399.4    |
| 234.7                     | 454.6    | I.16571                     | 53.513                       | 0.01869                     | 430.14                                      | 23029       | 7.542      | 403.6    |
| 235.9                     | 456.7    | I.16695                     | 53.455                       | 0.01871                     | 432.32                                      | 23116       | 7.623      | 407.3    |
| 237.0                     | 458.7    | I.16818                     | 53.406                       | 0.01872                     | 434.40                                      | 23200       | 7.700      | 411.2    |
| 238.0                     | 460.6    | I.16942                     | 53.352                       | 0.01874                     | 436.38                                      | 23282       | 7.787      | 415.5    |
| 239.0                     | 462.5    | I.17066                     | 53.293                       | 0.01876                     | 438.39                                      | 23363       | 7.893      | 423.3    |
| 241.1                     | 466.1    | I.17274                     | 53.158                       | 0.01881                     | 442.21                                      | 23555       | 8.113      | 433.2    |
| 244.1                     | 471.5    | I.17598                     | 53.027                       | 0.01886                     | 447.83                                      | 23741       | 8.329      | 442.9    |
| 246.5                     | 475.7    | I.17917                     | 52.900                       | 0.01890                     | 452.24                                      | 23923       | 8.541      | 452.4    |
| 248.8                     | 479.8    | I.18231                     | 52.768                       | 0.01895                     | 456.55                                      | 24091       | 8.747      | 461.6    |
| 253.1                     | 487.6    | I.18531                     | 52.588                       | 0.01901                     | 464.66                                      | 24436       | 9.060      | 476.5    |
| 257.2                     | 494.9    | I.18961                     | 52.430                       | 0.01907                     | 472.28                                      | 24762       | 9.381      | 491.8    |
| 261.0                     | 501.8    | I.19343                     | 52.264                       | 0.01913                     | 479.51                                      | 25061       | 9.710      | 507.5    |
| 263.5                     | 508.4    | I.19742                     | 52.102                       | 0.01919                     | 486.40                                      | 25577       | 10.00      | 521.0    |
| 268.1                     | 514.6    | I.20131                     | 51.943                       | 0.01925                     | 492.97                                      | 25606       | 10.37      | 538.7    |
| 271.9                     | 521.4    | I.20562                     | 51.787                       | 0.01931                     | 500.14                                      | 25901       | 10.74      | 556.2    |
| 273.3                     | 526.0    | I.20812                     | 51.642                       | 0.01936                     | 505.00                                      | 26079       | 11.00      | 568.1    |
| 277.5                     | 531.6    | I.21147                     | 51.498                       | 0.01942                     | 510.84                                      | 26307       | 11.242     | 578.8    |



## Steam or Aqueous Vapor.

Water under atmospheric pressure at ordinary temperature under the boiling point; but that evaporation takes place only on the surface in contact with the air.

When the temperature of the water is elevated to or above that of the boiling point, then evaporation takes place in any part of the water where the temperature is so elevated.

The temperature of the boiling point depends upon the pressure on the surface of the water.

$P$  = pressure in pounds per square inch above vacuum on the surface of the water.

$T_0$  = temperature Fahrenheit of the boiling point.

$$T_0 = 200 \sqrt[6]{P} - 101 \dots \dots \dots 1$$

$$P = \left[ \frac{T_0 + 101}{200} \right]^6 \dots \dots \dots 2$$

*Example 1.* At what temperature will water boil under a pressure  $P = 8$  pounds to the square inch?

This is under a vacuum of  $14.7 - 8 = 6.7$  pounds to the square inch.

$$\text{Temperature } T_0 = 200 \sqrt[6]{8} - 101 = 181.8 \text{ degrees.}$$

*Example 2.* What pressure is required to elevate the temperature of the boiling point of water  $T_0 = 330$  degrees?

$$\text{Pressure } P = \left( \frac{330 + 101}{200} \right)^6 = 100 \text{ pounds.}$$

The temperature of the boiling point is the same as that of the steam evaporated under the same pressure.

Supposing the above formulas to be correct, the ideal zero of aqueous vapor should be at  $-101$  degrees Fahrenheit, or at the temperature  $101$  degrees below Fahrenheit zero, there is no pressure of the vapor; that is, the force of attraction between the atoms is equal to the force of expansion by heat.

Steam exists only as saturated and as superheated steam. The number of units of heat contained in the former is given in the following Tables. The additional number contained in the

latter is found by multiplying the degrees of superheat — by which the temperature exceeds that of saturated steam under the same pressure—by the decimal 0.48061. Experiments have proved that all the heat abandoned by steam, when condensed, is thus accounted for.

#### Properties of Steam.

Column *P* contains the total steam pressure in pounds per square inch, including the pressure of the atmosphere.

Column *I* is the same pressure in inches of mercury. The specific gravity of mercury at 32 degrees is 13.5959, compared with water of maximum density at 40 degrees. One cubic inch of mercury weighs 0.49086 pounds, of which a column of 29.9218 inches is a mean balance of the atmosphere, or 14.68757 pounds per square inch.

Column *T* contains the temperature of the steam or Fahrenheit scale, deduced from Regnault's experiments.

Column *V* contains the volume of steam of the corresponding temperature *T*, compared with that of water of maximum density at 40 degrees Fahrenheit.

Column *W* contains the weight per cubic foot in fractions of a pound.

Column *C* contains the cubic feet per pound of saturated steam under the pressure *P* and the temperature *T*.

Column *H* contains the units of heat (calorics) per pound of steam from 32 degrees to temperature *T* and pressure *P*, calculated from the formula :

$$H = 1082.91 + 0.305 T \dots \dots \dots 3$$

Column *H'* contains the units of heat (calorics) per cubic foot of steam from 32 degrees temperature *T*.

The above columns *H* and *H'* give the calorics required to heat the water from 32 degrees to boiling-point, and evaporate the same to steam under the pressure *P* and of temperature *T*.

Column *L* contains the latent units of heat per pound in steam of temperature *T* and pressure *P*. The latent heat expresses the work done in the evaporation, or the difference between the calorics per pound in the steam and in the water of the same temperature.

Column  $L'$  contains the latent heat per cubic foot of steam.

Column  $p$  contains the steam pressure above the atmosphere, as shown on the steam-gage.

#### Latent Heat of Steam.

One pound of water heated under atmospheric pressure, from 32 to 212 degrees, requires 180.9 units of heat. If more heat is supplied, steam will be generated without elevating the temperature until all the water is evaporated, which requires 1146.6 units of heat, and the steam volume will be 1740 times that occupied by the water at 32 degrees. Then,  $1146.6 - 180.9 = 965.7$  units of heat in the steam which have not increased its temperature. This is what is called *latent heat*, because it does not show as temperature, but is the heat consumed in performing the work of steam.

One cubic foot of water at 32 degrees weighs 62.387 pounds; if heated to the boiling point 212 degrees, requires:

$$H = 62.387 \times 180.9 = 11285.8 \text{ units of heat,}$$

and if evaporated to steam under atmospheric pressure, requires:

$$H = 62.387 \times 1146.6 = 71532.9 \text{ units of heat,}$$

of which:

$$71532.9 - 11285.8 = 60247.1, \text{ will be latent.}$$

It is this latent heat which generated 1740 cubic feet of steam from the cubic foot of water.

The work accomplished by the latent units of heat against the atmospheric pressure will be:

$$\text{Work } K = 144 \times 14.7 \times (1740 - 1) = 3681115 \text{ foot pounds.}$$

$$\text{Foot-pounds per unit of heat, } J = \frac{3681115}{60247.1} = 61.1.$$

The heat expended in elevating the temperature of the water from 32 to 212 degrees is not realized as work.

TABLE NO. 19.—STEAM.

| Total pressure.    |                | Temperat' re Fahr. | Volume water = 1 at 40°. | Weight lbs. per cubic ft. | Bulk cubic ft. per lb. | Units of heat from 32° to 7°. |           |            |           | Pressure ab' ve at- mos- ph' re |
|--------------------|----------------|--------------------|--------------------------|---------------------------|------------------------|-------------------------------|-----------|------------|-----------|---------------------------------|
| lbs. per sq. inch. | Inches mercur. |                    |                          |                           |                        | Total per                     |           | Latent per |           |                                 |
| <i>P</i>           | <i>I</i>       | <i>T°</i>          | <i>V</i>                 | <i>ρ</i>                  | <i>ε</i>               | <i>H</i>                      | <i>H'</i> | <i>L</i>   | <i>L'</i> | <i>p</i>                        |
| 14.7               | 29.92          | 212                | 1740                     | 0.0358                    | 27.897                 | 1146.6                        | 41.100    | 965.7      | 34.61     | .00                             |
| 15                 | 30.55          | 213                | 1706                     | 0.0365                    | 27.347                 | 1147.0                        | 41.920    | 965.1      | 35.29     | .3                              |
| 16                 | 32.59          | 216.4              | 1601                     | 0.0389                    | 25.674                 | 1148.0                        | 44.700    | 962.7      | 37.50     | 1                               |
| 17                 | 34.63          | 219.6              | 1509                     | 0.0413                    | 24.186                 | 1149.0                        | 47.478    | 960.4      | 39.68     | 2                               |
| 18                 | 36.67          | 222.8              | 1426                     | 0.0437                    | 22.865                 | 1149.9                        | 50.255    | 958.1      | 41.86     | 3                               |
| 19                 | 38.71          | 225.7              | 1353                     | 0.0461                    | 21.693                 | 1150.8                        | 53.030    | 956.0      | 44.05     | 4                               |
| 20                 | 40.74          | 228.5              | 1288                     | 0.0484                    | 20.690                 | 1151.7                        | 55.802    | 954.1      | 46.23     | 5                               |
| 21                 | 42.78          | 231.2              | 1228                     | 0.0508                    | 19.678                 | 1152.6                        | 58.572    | 952.2      | 48.41     | 6                               |
| 22                 | 44.82          | 233.8              | 1173                     | 0.0532                    | 18.804                 | 1153.4                        | 61.340    | 950.7      | 50.48     | 7                               |
| 23                 | 46.85          | 236.3              | 1123                     | 0.0555                    | 18.005                 | 1154.2                        | 64.106    | 948.7      | 52.65     | 8                               |
| 24                 | 48.89          | 238.7              | 1078                     | 0.0579                    | 17.272                 | 1155.0                        | 66.870    | 946.0      | 54.82     | 9                               |
| 25                 | 50.93          | 241.0              | 1035                     | 0.0602                    | 16.597                 | 1155.7                        | 69.632    | 945.4      | 56.96     | 10                              |
| 26                 | 52.97          | 243.3              | 995.1                    | 0.0625                    | 15.994                 | 1156.4                        | 72.392    | 943.8      | 59.09     | 11                              |
| 27                 | 55.00          | 245.4              | 958.2                    | 0.0648                    | 15.422                 | 1157.1                        | 75.159    | 942.3      | 61.21     | 12                              |
| 28                 | 57.04          | 247.5              | 926.4                    | 0.0672                    | 14.881                 | 1157.7                        | 77.914    | 940.9      | 63.31     | 13                              |
| 29                 | 59.08          | 249.4              | 895.6                    | 0.0696                    | 14.371                 | 1158.2                        | 80.667    | 939.6      | 65.41     | 14                              |
| 30                 | 61.11          | 251.4              | 866.7                    | 0.0720                    | 13.892                 | 1158.7                        | 83.410    | 937.8      | 67.51     | 15                              |
| 31                 | 63.15          | 253.4              | 838.3                    | 0.0743                    | 13.456                 | 1159.3                        | 86.162    | 936.4      | 69.60     | 16                              |
| 32                 | 65.19          | 255.3              | 812.0                    | 0.0766                    | 13.059                 | 1159.9                        | 88.913    | 935.1      | 71.68     | 17                              |
| 33                 | 67.23          | 257.2              | 787.8                    | 0.0789                    | 12.669                 | 1160.5                        | 91.662    | 933.7      | 73.75     | 18                              |
| 34                 | 69.26          | 259.0              | 765.7                    | 0.0812                    | 12.313                 | 1161.0                        | 94.411    | 932.4      | 75.83     | 19                              |
| 35                 | 71.30          | 260.7              | 745.8                    | 0.0834                    | 11.955                 | 1161.5                        | 97.156    | 931.2      | 77.89     | 20                              |
| 36                 | 73.34          | 262.4              | 726.9                    | 0.0860                    | 11.624                 | 1162.0                        | 99.901    | 929.9      | 79.95     | 21                              |
| 37                 | 75.38          | 264.1              | 708.8                    | 0.0884                    | 11.309                 | 1162.5                        | 102.65    | 928.7      | 82.01     | 22                              |
| 38                 | 77.41          | 265.7              | 691.7                    | 0.0908                    | 11.013                 | 1163.0                        | 105.40    | 927.6      | 84.06     | 23                              |
| 39                 | 79.45          | 267.3              | 675.4                    | 0.0930                    | 10.745                 | 1163.5                        | 108.15    | 926.4      | 86.10     | 24                              |
| 40                 | 81.49          | 268.9              | 654.9                    | 0.0952                    | 10.498                 | 1164.0                        | 110.87    | 925.3      | 88.14     | 25                              |
| 41                 | 83.52          | 270.4              | 640.0                    | 0.0974                    | 10.262                 | 1164.5                        | 113.61    | 924.3      | 90.18     | 26                              |
| 42                 | 85.56          | 271.9              | 625.4                    | 0.0997                    | 10.031                 | 1164.9                        | 116.35    | 923.1      | 92.21     | 27                              |
| 43                 | 87.60          | 273.3              | 611.2                    | 0.1020                    | 9.8030                 | 1165.4                        | 119.09    | 922.1      | 94.24     | 28                              |
| 44                 | 89.64          | 274.8              | 597.4                    | 0.1044                    | 9.5801                 | 1165.8                        | 121.83    | 921.1      | 96.26     | 29                              |
| 45                 | 91.67          | 276.2              | 584.1                    | 0.1068                    | 9.3617                 | 1166.2                        | 124.57    | 920.1      | 98.28     | 30                              |
| 46                 | 93.71          | 277.6              | 571.9                    | 0.1093                    | 9.1465                 | 1166.7                        | 127.31    | 919.1      | 100.3     | 31                              |
| 47                 | 95.75          | 279.0              | 560.1                    | 0.1117                    | 8.9486                 | 1167.2                        | 130.05    | 918.0      | 102.3     | 32                              |
| 48                 | 97.78          | 280.3              | 548.8                    | 0.1141                    | 8.7596                 | 1167.6                        | 132.79    | 917.1      | 104.3     | 33                              |
| 49                 | 99.82          | 281.6              | 537.8                    | 0.1166                    | 8.5776                 | 1168.0                        | 135.53    | 916.2      | 106.3     | 34                              |
| 50                 | 101.86         | 282.8              | 527.2                    | 0.1183                    | 8.4504                 | 1168.4                        | 138.27    | 915.4      | 108.3     | 35                              |
| 51                 | 103.90         | 284.1              | 517.5                    | 0.1206                    | 8.2899                 | 1168.8                        | 141.00    | 914.5      | 110.3     | 36                              |
| 52                 | 105.93         | 285.4              | 507.1                    | 0.1230                    | 8.1284                 | 1169.2                        | 143.73    | 913.6      | 112.3     | 37                              |
| 53                 | 107.97         | 286.6              | 498.0                    | 0.1254                    | 7.9724                 | 1169.5                        | 146.46    | 912.7      | 114.3     | 38                              |
| 54                 | 110.01         | 287.8              | 489.2                    | 0.1278                    | 7.8249                 | 1169.8                        | 149.18    | 911.8      | 116.3     | 39                              |

TABLE NO. 20—STEAM.

| Total pressure.          |                   | Temperat're<br>Fahr. | Volume<br>water =<br>1 at 40°. | Weight<br>lbs. per<br>cubic ft. | Bulk.<br>cubic ft.<br>per lb. | Units of heat from 32° to T°. |                        |       |        | Pres-<br>sure<br>ab've<br>at-<br>mos-<br>ph're |
|--------------------------|-------------------|----------------------|--------------------------------|---------------------------------|-------------------------------|-------------------------------|------------------------|-------|--------|--|
| lbs.<br>per sq.<br>inch. | Inches<br>mercur. |                      |                                |                                 |                               | Total per<br>pound.           | Latent per<br>cubic ft | po'nd | cub.ft |  |
| P                        | I                 | T°                   | V                              | W                               | C                             | H                             | H'                     | L     | L'     | p  |
| 55                       | 112.04            | 289.0                | 480.6                          | 0.1298                          | 7.7028                        | 1170.1                        | 151.91                 | 910.9 | 118.3  | 40   |
| 56                       | 114.08            | 290.2                | 472.1                          | 0.1302                          | 7.6774                        | 1170.5                        | 154.64                 | 910.1 | 120.3  | 41   |
| 57                       | 116.12            | 291.3                | 464.0                          | 0.1324                          | 7.5524                        | 1170.9                        | 157.37                 | 909.9 | 122.2  | 42   |
| 58                       | 118.16            | 292.4                | 456.2                          | 0.1346                          | 7.4277                        | 1171.3                        | 160.10                 | 908.6 | 124.2  | 43   |
| 59                       | 120.19            | 293.6                | 448.8                          | 0.1388                          | 7.2034                        | 1171.6                        | 162.83                 | 907.7 | 126.1  | 44   |
| 60                       | 122.23            | 294.7                | 441.6                          | 0.1422                          | 7.0786                        | 1171.9                        | 165.56                 | 906.9 | 128.1  | 45   |
| 61                       | 124.27            | 295.8                | 434.6                          | 0.1434                          | 6.9709                        | 1172.3                        | 168.28                 | 906.1 | 130.0  | 46   |
| 62                       | 126.30            | 296.9                | 427.8                          | 0.1456                          | 6.8643                        | 1172.6                        | 171.00                 | 905.3 | 131.9  | 47   |
| 63                       | 128.34            | 298.0                | 421.2                          | 0.1479                          | 6.7588                        | 1172.9                        | 173.71                 | 904.5 | 133.9  | 48   |
| 64                       | 130.38            | 299.0                | 414.9                          | 0.1502                          | 6.6543                        | 1173.2                        | 176.41                 | 903.8 | 135.8  | 49   |
| 65                       | 132.42            | 300.0                | 408.7                          | 0.1526                          | 6.5510                        | 1173.5                        | 179.13                 | 903.0 | 137.8  | 50   |
| 66                       | 134.45            | 301.0                | 402.6                          | 0.1548                          | 6.4570                        | 1173.8                        | 181.84                 | 902.3 | 139.7  | 51   |
| 67                       | 136.49            | 302.0                | 396.7                          | 0.1571                          | 6.3660                        | 1174.1                        | 184.53                 | 901.6 | 141.7  | 52   |
| 68                       | 138.53            | 303.0                | 391.1                          | 0.1593                          | 6.2750                        | 1174.4                        | 187.24                 | 900.9 | 143.6  | 53   |
| 69                       | 140.36            | 304.0                | 385.6                          | 0.1616                          | 6.1852                        | 1174.7                        | 190.00                 | 900.1 | 145.6  | 54   |
| 70                       | 142.60            | 305.0                | 380.4                          | 0.1640                          | 6.0972                        | 1175.0                        | 192.71                 | 899.4 | 147.5  | 55   |
| 71                       | 144.64            | 306.0                | 374.7                          | 0.1662                          | 6.0162                        | 1175.3                        | 195.42                 | 898.7 | 149.5  | 56   |
| 72                       | 146.68            | 307.0                | 369.5                          | 0.1684                          | 5.9363                        | 1175.6                        | 198.14                 | 898.0 | 151.4  | 57   |
| 73                       | 148.72            | 307.9                | 364.7                          | 0.1707                          | 5.8576                        | 1175.9                        | 200.85                 | 897.4 | 153.3  | 58   |
| 74                       | 150.75            | 308.9                | 360.2                          | 0.1730                          | 5.7799                        | 1176.2                        | 203.58                 | 896.6 | 155.2  | 59   |
| 75                       | 152.79            | 309.8                | 355.8                          | 0.1753                          | 5.7033                        | 1176.5                        | 206.29                 | 896.0 | 157.1  | 60   |
| 76                       | 154.83            | 310.7                | 351.1                          | 0.1775                          | 5.6324                        | 1176.8                        | 209.00                 | 895.4 | 159.0  | 61   |
| 77                       | 156.86            | 311.6                | 346.6                          | 0.1798                          | 5.5624                        | 1177.1                        | 211.71                 | 895.8 | 160.9  | 62   |
| 78                       | 158.90            | 312.5                | 342.3                          | 0.1820                          | 5.4933                        | 1177.4                        | 214.42                 | 894.1 | 162.8  | 63   |
| 79                       | 160.94            | 313.4                | 338.1                          | 0.1843                          | 5.4251                        | 1177.6                        | 217.13                 | 893.4 | 164.7  | 64   |
| 80                       | 162.98            | 314.3                | 334.3                          | 0.1866                          | 5.3576                        | 1177.8                        | 219.84                 | 892.7 | 166.6  | 65   |
| 81                       | 165.01            | 315.1                | 330.3                          | 0.1888                          | 5.2947                        | 1178.1                        | 222.55                 | 892.2 | 168.5  | 66   |
| 82                       | 167.05            | 315.9                | 326.4                          | 0.1911                          | 5.2327                        | 1178.4                        | 225.25                 | 891.7 | 170.4  | 67   |
| 83                       | 169.09            | 316.7                | 322.6                          | 0.1926                          | 5.1916                        | 1178.7                        | 227.96                 | 891.1 | 172.3  | 68   |
| 84                       | 171.12            | 317.5                | 318.8                          | 0.1956                          | 5.1114                        | 1178.9                        | 230.68                 | 890.5 | 174.2  | 69   |
| 85                       | 173.16            | 318.4                | 315.2                          | 0.1979                          | 5.0522                        | 1179.1                        | 233.38                 | 889.8 | 176.1  | 70   |
| 86                       | 175.20            | 319.2                | 311.7                          | 0.2002                          | 4.9955                        | 1179.4                        | 236.09                 | 889.3 | 178.0  | 71   |
| 87                       | 177.24            | 320.0                | 308.2                          | 0.2024                          | 4.9399                        | 1179.7                        | 238.79                 | 888.8 | 179.9  | 72   |
| 88                       | 179.27            | 320.8                | 304.8                          | 0.2047                          | 4.8855                        | 1179.9                        | 241.50                 | 888.1 | 181.8  | 73   |
| 89                       | 181.31            | 321.6                | 301.5                          | 0.2069                          | 4.8322                        | 1180.1                        | 244.21                 | 887.5 | 183.6  | 74   |
| 90                       | 183.35            | 322.4                | 298.2                          | 0.2092                          | 4.7803                        | 1180.3                        | 246.91                 | 886.9 | 185.4  | 75   |
| 91                       | 185.38            | 323.2                | 295.0                          | 0.2114                          | 4.7293                        | 1180.6                        | 249.62                 | 886.4 | 187.3  | 76   |
| 92                       | 187.32            | 324.0                | 291.9                          | 0.2137                          | 4.6794                        | 1180.9                        | 252.33                 | 885.9 | 189.2  | 77   |
| 93                       | 189.46            | 324.7                | 288.9                          | 0.2159                          | 4.6305                        | 1181.1                        | 255.04                 | 885.3 | 191.0  | 78   |
| 94                       | 191.50            | 325.4                | 285.9                          | 0.2182                          | 4.5827                        | 1181.3                        | 257.75                 | 884.8 | 193.2  | 79   |

TABLE NO. 21—STEAM.

| Total pressure.         |                   | Temperat're<br>Fahr. | Volume.<br>water =<br>1 at 40°. | Weight<br>lbs. per<br>cubic ft. | Bulk.<br>cubic ft.<br>per lb. | Units of heat from 32° to T°. |                        |                     |                      | Pressure<br>above at-<br>mosphere. |
|-------------------------|-------------------|----------------------|---------------------------------|---------------------------------|-------------------------------|-------------------------------|------------------------|---------------------|----------------------|------------------------------------|
| lbs.<br>per sq<br>inch. | Inches<br>mercur. |                      |                                 |                                 |                               | Total per<br>pound.           | Total per<br>cubic ft. | Latent per<br>po'nd | Latent per<br>cub.ft |                                    |
| P                       | I                 | T°                   | V                               | W                               | B                             | H                             | H'                     | L                   | L'                   | p                                  |
| 95                      | 193.53            | 326.2                | 283.0                           | 0.2204                          | 4.5361                        | 1181.5                        | 260.46                 | 884.2               | 194.9                | 80                                 |
| 96                      | 195.57            | 327.0                | 280.2                           | 0.2227                          | 4.4902                        | 1181.8                        | 263.16                 | 883.8               | 196.7                | 81                                 |
| 97                      | 197.61            | 327.7                | 277.4                           | 0.2249                          | 4.4454                        | 1182.1                        | 265.86                 | 883.3               | 198.6                | 82                                 |
| 98                      | 199.65            | 328.5                | 274.7                           | 0.2271                          | 4.4017                        | 1182.3                        | 268.55                 | 882.6               | 200.4                | 83                                 |
| 99                      | 201.68            | 329.2                | 272.0                           | 0.2294                          | 4.3591                        | 1182.5                        | 271.23                 | 882.1               | 202.3                | 84                                 |
| 100                     | 203.72            | 329.9                | 269.4                           | 0.2316                          | 4.3176                        | 1182.7                        | 273.93                 | 881.6               | 204.2                | 85                                 |
| 101                     | 205.76            | 330.7                | 266.8                           | 0.2338                          | 4.2769                        | 1182.9                        | 276.63                 | 881.0               | 206.1                | 86                                 |
| 102                     | 207.79            | 331.3                | 264.3                           | 0.2360                          | 4.2367                        | 1183.1                        | 279.32                 | 880.6               | 208.0                | 87                                 |
| 103                     | 209.83            | 331.9                | 261.8                           | 0.2382                          | 4.1970                        | 1183.3                        | 282.62                 | 880.1               | 209.8                | 88                                 |
| 104                     | 211.87            | 332.6                | 259.4                           | 0.2405                          | 4.1577                        | 1183.5                        | 284.70                 | 879.6               | 211.6                | 89                                 |
| 105                     | 213.91            | 333.3                | 257.0                           | 0.2428                          | 4.1187                        | 1183.7                        | 287.40                 | 879.1               | 213.4                | 90                                 |
| 106                     | 215.94            | 334.0                | 254.6                           | 0.2450                          | 4.0813                        | 1183.9                        | 290.09                 | 878.6               | 215.2                | 91                                 |
| 107                     | 217.98            | 334.7                | 252.3                           | 0.2472                          | 4.0444                        | 1184.1                        | 292.78                 | 878.1               | 217.0                | 92                                 |
| 108                     | 220.02            | 335.4                | 250.1                           | 0.2495                          | 4.0081                        | 1184.3                        | 295.48                 | 877.5               | 218.9                | 93                                 |
| 109                     | 222.06            | 336.1                | 247.9                           | 0.2517                          | 3.9723                        | 1184.5                        | 298.18                 | 877.0               | 220.7                | 94                                 |
| 110                     | 224.10            | 336.8                | 245.7                           | 0.2540                          | 3.9376                        | 1184.7                        | 300.87                 | 876.5               | 222.6                | 95                                 |
| 111                     | 226.13            | 337.4                | 243.5                           | 0.2561                          | 3.9036                        | 1184.9                        | 303.56                 | 876.1               | 224.4                | 96                                 |
| 112                     | 228.17            | 338.0                | 241.4                           | 0.2584                          | 3.8701                        | 1185.1                        | 306.26                 | 875.7               | 226.3                | 97                                 |
| 113                     | 230.20            | 338.7                | 239.3                           | 0.2603                          | 3.8411                        | 1185.3                        | 308.94                 | 875.1               | 228.1                | 98                                 |
| 114                     | 232.24            | 339.4                | 237.3                           | 0.2628                          | 3.8047                        | 1185.5                        | 311.65                 | 874.6               | 229.9                | 99                                 |
| 115                     | 234.28            | 340.0                | 235.3                           | 0.2651                          | 3.7722                        | 1185.7                        | 314.33                 | 874.2               | 231.8                | 100                                |
| 120                     | 244.4             | 343.2                | 226.0                           | 0.2759                          | 3.6244                        | 1186.6                        | 327.89                 | 873.8               | 241.0                | 105                                |
| 125                     | 254.6             | 346.2                | 217.2                           | 0.2867                          | 3.4875                        | 1187.5                        | 341.44                 | 869.6               | 250.1                | 110                                |
| 130                     | 264.8             | 349.2                | 209.1                           | 0.2984                          | 3.3516                        | 1188.4                        | 355.00                 | 867.4               | 259.0                | 115                                |
| 135                     | 275.0             | 352.0                | 201.4                           | 0.3098                          | 3.2278                        | 1189.3                        | 368.55                 | 865.5               | 268.1                | 120                                |
| 140                     | 285.2             | 354.8                | 194.3                           | 0.3212                          | 3.1139                        | 1190.1                        | 381.88                 | 863.5               | 277.0                | 125                                |
| 145                     | 295.4             | 357.4                | 187.8                           | 0.3322                          | 3.0105                        | 1190.9                        | 395.16                 | 861.5               | 285.8                | 130                                |
| 150                     | 305.6             | 360.0                | 181.8                           | 0.3432                          | 2.9136                        | 1191.7                        | 408.38                 | 859.6               | 294.5                | 135                                |
| 155                     | 310.8             | 362.5                | 176.5                           | 0.3534                          | 2.8289                        | 1192.5                        | 421.54                 | 857.8               | 303.2                | 140                                |
| 160                     | 325.9             | 365.0                | 171.5                           | 0.3646                          | 2.7432                        | 1193.3                        | 435.08                 | 856.1               | 312.1                | 145                                |
| 165                     | 336.0             | 367.4                | 166.6                           | 0.3756                          | 2.6617                        | 1194.0                        | 448.64                 | 854.3               | 321.0                | 150                                |
| 170                     | 346.3             | 369.8                | 161.1                           | 0.3871                          | 2.5831                        | 1194.7                        | 462.22                 | 852.5               | 329.9                | 155                                |
| 175                     | 356.5             | 372.0                | 157.0                           | 0.3973                          | 2.5171                        | 1195.4                        | 475.80                 | 851.0               | 338.7                | 160                                |
| 180                     | 366.7             | 374.2                | 152.8                           | 0.4075                          | 2.4541                        | 1196.1                        | 488.96                 | 849.4               | 347.1                | 165                                |
| 185                     | 376.9             | 376.4                | 148.8                           | 0.4182                          | 2.3916                        | 1196.8                        | 502.10                 | 847.8               | 355.5                | 170                                |
| 190                     | 378.1             | 378.5                | 145.0                           | 0.4292                          | 2.3299                        | 1197.4                        | 515.20                 | 846.2               | 363.9                | 175                                |
| 195                     | 387.3             | 380.6                | 141.5                           | 0.4409                          | 2.2684                        | 1198.1                        | 528.27                 | 844.8               | 372.4                | 180                                |
| 200                     | 407.4             | 382.6                | 138.1                           | 0.4517                          | 2.2137                        | 1198.7                        | 542.07                 | 843.3               | 381.0                | 185                                |
| 210                     | 427.8             | 386.6                | 132.0                           | 0.4719                          | 2.1192                        | 1199.8                        | 568.40                 | 840.3               | 398.0                | 195                                |
| 220                     | 448.2             | 390.4                | 126.3                           | 0.4935                          | 2.0265                        | 1201.0                        | 574.70                 | 837.5               | 414.8                | 205                                |

TABLE NO. 22.—STEAM.

| Total pressure.          |                   | Temperat're<br>Fahr. | Volume<br>water<br>1 at 40°. | Weight<br>lbs. per<br>cubic ft. | Bulk<br>cubic ft.<br>per lb. | Units of heat from 32° to T°. |           |            |           | Pres-<br>sure<br>ab've<br>at-<br>mos-<br>ph're |
|--------------------------|-------------------|----------------------|------------------------------|---------------------------------|------------------------------|-------------------------------|-----------|------------|-----------|--|
| lbs.<br>per sq.<br>inch. | Inches<br>mercur. |                      |                              |                                 |                              | Total per                     |           | Latent per |           |  |
| <i>P</i>                 | <i>I</i>          | <i>T</i>             | <i>V</i>                     | <i>W</i>                        | <i>E</i>                     | <i>H</i>                      | <i>H'</i> | <i>L</i>   | <i>L'</i> | <i>p</i>                                       |
| 230                      | 468.5             | 394.0                | 120.8                        | 0.5165                          | 1.9360                       | 1202.2                        | 620.96    | 835.0      | 431.3     | 215  |
| 240                      | 488.9             | 397.6                | 116.1                        | 0.5364                          | 1.8646                       | 1203.2                        | 647.41    | 832.3      | 447.9     | 225  |
| 250                      | 509.3             | 401.0                | 111.7                        | 0.5595                          | 1.7874                       | 1204.2                        | 673.85    | 829.8      | 464.4     | 235  |
| 260                      | 529.7             | 404.3                | 107.5                        | 0.5803                          | 1.7230                       | 1205.2                        | 700.28    | 827.4      | 480.8     | 245  |
| 270                      | 550.0             | 407.5                | 103.7                        | 0.6016                          | 1.6621                       | 1206.2                        | 726.66    | 825.0      | 497.1     | 255  |
| 280                      | 570.4             | 410.6                | 100.2                        | 0.6238                          | 1.6031                       | 1207.2                        | 753.04    | 822.8      | 513.3     | 265  |
| 290                      | 590.8             | 413.5                | 97.01                        | 0.6459                          | 1.5481                       | 1208.1                        | 779.40    | 820.7      | 529.4     | 275  |
| 300                      | 611.1             | 416.5                | 94.22                        | 0.6681                          | 1.4967                       | 1209.0                        | 805.74    | 818.6      | 545.4     | 285  |
| 310                      | 631.5             | 419.2                | 91.13                        | 0.6896                          | 1.4499                       | 1209.8                        | 832.96    | 816.5      | 561.4     | 295  |
| 320                      | 651.9             | 422.1                | 88.21                        | 0.7107                          | 1.4071                       | 1210.6                        | 858.36    | 814.4      | 577.3     | 305  |
| 330                      | 672.3             | 424.8                | 85.44                        | 0.7302                          | 1.3695                       | 1211.5                        | 884.63    | 812.4      | 593.2     | 315  |
| 340                      | 692.6             | 427.4                | 83.19                        | 0.7547                          | 1.3250                       | 1212.3                        | 910.89    | 810.5      | 608.9     | 325  |
| 350                      | 713.0             | 430.0                | 80.99                        | 0.7745                          | 1.2915                       | 1213.1                        | 937.13    | 808.6      | 624.5     | 335  |
| 360                      | 733.4             | 432.4                | 78.84                        | 0.7943                          | 1.2590                       | 1213.9                        | 963.34    | 806.9      | 640.2     | 345  |
| 370                      | 753.8             | 434.9                | 76.74                        | 0.8146                          | 1.2275                       | 1214.7                        | 989.51    | 805.1      | 655.8     | 355  |
| 380                      | 774.1             | 437.3                | 74.66                        | 0.8353                          | 1.1968                       | 1215.5                        | 1015.7    | 803.4      | 671.3     | 365  |
| 390                      | 794.5             | 439.6                | 72.90                        | 0.8626                          | 1.1597                       | 1216.2                        | 1041.8    | 801.7      | 686.7     | 375  |
| 400                      | 814.9             | 441.9                | 71.19                        | 0.8745                          | 1.1434                       | 1216.9                        | 1067.9    | 800.0      | 702.0     | 385  |
| 410                      | 835.2             | 444.1                | 69.52                        | 0.8952                          | 1.1170                       | 1217.6                        | 1094.0    | 799.4      | 717.2     | 395  |
| 420                      | 855.6             | 446.4                | 67.90                        | 0.9142                          | 1.0938                       | 1218.3                        | 1120.2    | 797.7      | 732.4     | 405  |
| 430                      | 876.0             | 448.5                | 66.34                        | 0.9400                          | 1.0634                       | 1218.9                        | 1146.3    | 795.0      | 747.6     | 415  |
| 440                      | 896.4             | 450.6                | 64.91                        | 0.9599                          | 1.0417                       | 1219.5                        | 1172.3    | 793.5      | 762.8     | 425  |
| 450                      | 916.7             | 452.6                | 63.55                        | 0.9804                          | 1.0201                       | 1220.1                        | 1198.3    | 792.0      | 777.9     | 435  |
| 460                      | 937.1             | 454.6                | 62.22                        | 1.0007                          | 0.9993                       | 1220.7                        | 1224.3    | 790.5      | 792.9     | 445  |
| 470                      | 957.5             | 456.7                | 60.94                        | 1.0211                          | 0.9793                       | 1221.3                        | 1250.4    | 789.0      | 807.8     | 455  |
| 480                      | 977.8             | 458.7                | 59.72                        | 1.0446                          | 0.9573                       | 1221.9                        | 1276.5    | 787.5      | 822.7     | 465  |
| 490                      | 998.2             | 460.6                | 58.54                        | 1.0652                          | 0.9388                       | 1222.5                        | 1302.3    | 786.1      | 837.4     | 475  |
| 500                      | 1018.6            | 462.5                | 57.45                        | 1.0859                          | 0.9209                       | 1223.0                        | 1328.1    | 784.7      | 852.1     | 485  |
| 525                      | 1069.5            | 466.1                | 54.81                        | 1.1381                          | 0.8786                       | 1224.5                        | 1392.6    | 782.3      | 881.8     | 510  |
| 550                      | 1120.4            | 471.5                | 52.47                        | 1.1890                          | 0.8410                       | 1225.8                        | 1456.9    | 778.0      | 921.3     | 535  |
| 575                      | 1171.4            | 475.7                | 50.32                        | 1.2397                          | 0.8066                       | 1227.2                        | 1521.0    | 775.0      | 960.4     | 560  |
| 600                      | 1222.3            | 479.8                | 48.35                        | 1.2901                          | 0.7751                       | 1228.3                        | 1584.8    | 771.8      | 1000      | 585  |
| 650                      | 1324.2            | 487.6                | 44.75                        | 1.3943                          | 0.7172                       | 1230.6                        | 1709.5    | 766.0      | 1082      | 635  |
| 700                      | 1426.0            | 494.9                | 41.70                        | 1.4964                          | 0.6684                       | 1232.7                        | 1933.8    | 760.4      | 1157      | 685  |
| 750                      | 1527.9            | 501.8                | 39.05                        | 1.5977                          | 0.6259                       | 1234.9                        | 2057.7    | 755.4      | 1234      | 735  |
| 800                      | 1629.8            | 508.4                | 36.73                        | 1.6986                          | 0.5887                       | 1237.0                        | 2101.2    | 750.6      | 1307      | 785  |
| 850                      | 1731.6            | 514.6                | 34.68                        | 1.7989                          | 0.5554                       | 1238.9                        | 2228.3    | 745.9      | 1374      | 835  |
| 900                      | 1833.5            | 521.4                | 32.87                        | 1.8979                          | 0.5269                       | 1241.0                        | 2355.4    | 740.0      | 1435      | 885  |
| 950                      | 1935.5            | 526.0                | 31.21                        | 1.9992                          | 0.5002                       | 1242.4                        | 2482.5    | 737.4      | 1490      | 935  |
| 1000                     | 2037.2            | 531.6                | 29.73                        | 2.0986                          | 0.4765                       | 1243.5                        | 2609.6    | 732.3      | 1538      | 985  |

TABLE NO. 23—MEAN PRESSURE OF EXPANDING STEAM.

| Absolute<br>steam<br>pressure.<br>P | Grade of expansion of steam, denoted by $g$ .    |               |               |               |               |               |               |               |
|-------------------------------------|--|---------------|---------------|---------------|---------------|---------------|---------------|---------------|
|                                     | 1.333  | 1.5           | 1.6           | 2             | 2.666         | 3             | 4             | 8             |
|                                     | Steam cut off at $l$ , from beginning of stroke. |               |               |               |               |               |               |               |
|                                     | $\frac{3}{4}$                                    | $\frac{2}{3}$ | $\frac{5}{8}$ | $\frac{1}{2}$ | $\frac{3}{8}$ | $\frac{1}{3}$ | $\frac{1}{4}$ | $\frac{1}{8}$ |
| 0.5                                 | 0.4826   | 0.4683        | 0.4587        | 0.4232        | 0.3713        | 0.3497        | 0.2982        | 0.1924        |
| 1                                   | 0.9652   | 0.9367        | 0.9175        | 0.8465        | 0.7426        | 0.6995        | 0.5965        | 0.3849        |
| 2                                   | 1.9304   | 1.8734        | 1.8350        | 1.6931        | 1.4482        | 1.3991        | 1.1931        | 0.7698        |
| 3                                   | 2.8956   | 2.8100        | 2.7524        | 2.5396        | 2.2280        | 2.0986        | 1.7897        | 1.1548        |
| 4                                   | 3.8608   | 3.7468        | 3.6700        | 3.3862        | 2.8964        | 2.7982        | 2.3862        | 1.5396        |
| 5                                   | 4.8262   | 4.6835        | 4.5875        | 4.2328        | 3.7133        | 3.4977        | 2.9828        | 1.9246        |
| 6                                   | 5.7914   | 5.6202        | 5.5050        | 5.0794        | 4.4559        | 4.1972        | 3.5794        | 2.3095        |
| 7                                   | 6.7566   | 6.5569        | 6.4225        | 5.9260        | 5.1966        | 4.8967        | 4.1760        | 2.6944        |
| 8                                   | 7.7216   | 7.4936        | 7.3400        | 6.7726        | 5.9413        | 5.5963        | 4.7726        | 3.0794        |
| 9                                   | 8.6866   | 8.5303        | 8.2574        | 7.6192        | 6.6840        | 6.2958        | 5.3692        | 3.4643        |
| 10                                  | 9.6524   | 9.3670        | 9.1750        | 8.4657        | 7.4267        | 6.9954        | 5.9657        | 3.8493        |
| 11                                  | 10.617   | 10.304        | 10.092        | 9.3123        | 8.1694        | 7.6949        | 6.5622        | 4.2342        |
| 12                                  | 11.583   | 11.240        | 11.010        | 10.159        | 8.9121        | 8.3944        | 7.1589        | 4.6191        |
| 13                                  | 12.548   | 12.177        | 11.927        | 11.005        | 9.6548        | 9.0940        | 7.7555        | 5.0041        |
| 14                                  | 13.513   | 13.113        | 12.845        | 11.852        | 10.397        | 9.7935        | 8.3520        | 5.3890        |
| 15                                  | 14.478   | 14.050        | 13.762        | 12.698        | 11.140        | 10.493        | 8.9485        | 5.7739        |
| 16                                  | 15.443   | 14.987        | 14.679        | 13.545        | 11.882        | 11.192        | 9.5451        | 6.1588        |
| 17                                  | 16.408   | 15.923        | 15.597        | 14.392        | 12.625        | 11.892        | 10.141        | 6.5437        |
| 18                                  | 17.373   | 16.860        | 16.514        | 15.238        | 13.368        | 12.591        | 10.738        | 6.9287        |
| 19                                  | 18.339   | 17.797        | 17.432        | 16.085        | 14.110        | 13.291        | 11.335        | 7.3136        |
| 20                                  | 19.304   | 18.734        | 18.350        | 16.931        | 14.853        | 13.991        | 11.931        | 7.6986        |
| 21                                  | 20.269   | 19.671        | 19.268        | 17.778        | 15.596        | 14.690        | 12.527        | 8.0835        |
| 22                                  | 21.234   | 20.508        | 20.185        | 18.625        | 16.339        | 15.390        | 13.124        | 8.4684        |
| 23                                  | 22.199   | 21.545        | 21.103        | 19.471        | 17.082        | 16.089        | 13.720        | 8.8534        |
| 24                                  | 23.165   | 22.481        | 22.020        | 20.318        | 17.823        | 16.789        | 14.317        | 9.2383        |
| 25                                  | 24.130   | 23.481        | 22.938        | 21.164        | 18.567        | 17.488        | 14.913        | 9.6232        |
| 26                                  | 25.096   | 24.355        | 23.855        | 22.011        | 19.318        | 18.188        | 15.511        | 10.008        |
| 27                                  | 26.061   | 25.291        | 24.773        | 22.857        | 20.052        | 18.887        | 16.107        | 10.393        |
| 28                                  | 27.026   | 26.228        | 25.690        | 23.704        | 20.795        | 19.587        | 16.704        | 10.778        |
| 29                                  | 27.991   | 27.165        | 26.607        | 24.551        | 21.538        | 20.287        | 17.300        | 11.162        |
| 30                                  | 28.956   | 28.100        | 27.524        | 25.396        | 22.280        | 20.986        | 17.897        | 11.548        |
| 31                                  | 29.920   | 29.036        | 28.440        | 26.244        | 23.022        | 21.684        | 18.493        | 11.932        |
| 32                                  | 30.886   | 29.974        | 29.358        | 27.090        | 23.764        | 22.384        | 19.090        | 12.317        |
| 33                                  | 31.852   | 30.910        | 30.276        | 27.936        | 24.508        | 23.084        | 19.687        | 12.702        |
| 34                                  | 32.816   | 31.846        | 31.194        | 28.784        | 25.250        | 23.784        | 20.282        | 13.087        |
| 35                                  | 33.782   | 32.784        | 32.110        | 29.630        | 25.992        | 24.484        | 20.880        | 13.472        |
| 36                                  | 34.746   | 33.720        | 33.028        | 30.476        | 26.736        | 25.182        | 21.476        | 13.857        |
| 37                                  | 35.712   | 34.656        | 33.946        | 31.322        | 27.478        | 25.882        | 22.072        | 14.242        |
| 38                                  | 36.678   | 35.594        | 34.864        | 32.170        | 28.220        | 26.582        | 22.670        | 14.627        |
| 39                                  | 37.642   | 36.530        | 35.780        | 33.016        | 28.964        | 27.282        | 23.266        | 15.012        |



TABLE NO. 24—MEAN PRESSURE OF EXPANDING STEAM.

| Absolute steam pressure.<br>P | Grade of expansion of steam, denoted by <i>g</i> .    |               |               |               |               |               |               |               |
|-------------------------------|---|---------------|---------------|---------------|---------------|---------------|---------------|---------------|
|                               | 1.333   | 1.5           | 1.6           | 2             | 2.666         | 3             | 4             | 8             |
|                               | Steam cut off at <i>l</i> , from beginning of stroke. |               |               |               |               |               |               |               |
|                               | $\frac{3}{4}$   | $\frac{2}{3}$ | $\frac{5}{8}$ | $\frac{1}{2}$ | $\frac{3}{8}$ | $\frac{1}{3}$ | $\frac{1}{4}$ | $\frac{1}{8}$ |
| 50                            | 48.262  | 46.835        | 45.875        | 42.328        | 37.133        | 34.977        | 29.828        | 19.246        |
| 55                            | 53.088  | 51.518        | 50.462        | 46.561        | 40.846        | 38.474        | 32.811        | 21.170        |
| 60                            | 57.914  | 56.202        | 55.050        | 50.794        | 44.559        | 41.972        | 35.794        | 23.095        |
| 65                            | 62.740  | 60.885        | 59.637        | 55.027        | 48.273        | 45.470        | 38.777        | 25.020        |
| 70                            | 67.566  | 65.599        | 64.225        | 59.260        | 51.986        | 48.967        | 41.760        | 26.944        |
| 75                            | 72.393  | 70.252        | 68.812        | 63.493        | 55.700        | 52.465        | 44.743        | 28.869        |
| 80                            | 77.216  | 74.936        | 73.400        | 67.726        | 59.413        | 55.963        | 47.726        | 30.794        |
| 85                            | 82.042  | 79.619        | 77.987        | 71.959        | 63.126        | 59.461        | 50.709        | 32.718        |
| 90                            | 86.866  | 85.303        | 82.574        | 76.192        | 66.840        | 62.958        | 53.692        | 34.643        |
| 95                            | 91.699  | 89.986        | 87.163        | 80.425        | 70.553        | 66.456        | 56.675        | 36.568        |
| 100                           | 96.524  | 93.670        | 91.750        | 84.657        | 74.267        | 69.954        | 59.657        | 38.493        |
| 105                           | 101.35  | 98.353        | 96.337        | 88.890        | 77.981        | 73.451        | 62.640        | 40.417        |
| 110                           | 106.17  | 103.04        | 100.92        | 93.123        | 81.694        | 76.949        | 65.622        | 42.342        |
| 115                           | 111.00  | 107.72        | 105.51        | 97.356        | 85.407        | 80.447        | 68.606        | 44.267        |
| 120                           | 115.83  | 112.40        | 110.10        | 101.59        | 89.121        | 83.944        | 71.589        | 46.191        |
| 125                           | 120.65  | 117.08        | 114.68        | 105.82        | 92.834        | 87.442        | 74.572        | 48.116        |
| 130                           | 125.48  | 121.77        | 119.27        | 110.05        | 96.548        | 90.940        | 77.555        | 50.041        |
| 135                           | 130.30  | 126.45        | 123.86        | 114.28        | 100.26        | 94.437        | 80.538        | 51.966        |
| 140                           | 135.13  | 131.13        | 128.45        | 118.52        | 103.97        | 97.935        | 83.520        | 53.890        |
| 145                           | 139.96  | 135.82        | 133.03        | 122.75        | 107.68        | 101.43        | 86.502        | 55.815        |
| 150                           | 144.78  | 140.50        | 137.62        | 126.98        | 111.40        | 104.93        | 89.485        | 57.739        |
| 155                           | 149.60  | 145.18        | 142.20        | 131.22        | 115.11        | 108.42        | 92.468        | 59.663        |
| 160                           | 154.43  | 149.87        | 146.79        | 135.45        | 118.82        | 111.92        | 95.451        | 61.588        |
| 165                           | 159.26  | 154.55        | 151.38        | 139.68        | 122.54        | 115.42        | 98.434        | 63.513        |
| 170                           | 164.08  | 159.23        | 155.97        | 143.92        | 126.25        | 118.92        | 101.41        | 65.437        |
| 175                           | 168.91  | 163.92        | 160.55        | 148.15        | 129.96        | 122.42        | 104.40        | 67.362        |
| 180                           | 173.73  | 168.60        | 165.14        | 152.38        | 133.68        | 125.91        | 107.38        | 69.287        |
| 185                           | 178.56  | 173.28        | 169.73        | 156.61        | 137.39        | 129.41        | 110.36        | 71.212        |
| 190                           | 183.39  | 177.97        | 174.32        | 160.85        | 141.10        | 132.91        | 113.35        | 73.136        |
| 195                           | 188.21  | 182.65        | 178.90        | 165.08        | 144.82        | 136.41        | 116.33        | 75.061        |
| 200                           | 193.04  | 187.34        | 183.50        | 169.31        | 148.53        | 139.91        | 119.31        | 76.986        |
| 210                           | 202.69  | 196.71        | 192.68        | 177.78        | 155.96        | 146.90        | 125.27        | 80.835        |
| 220                           | 212.34  | 205.08        | 201.85        | 186.25        | 163.39        | 153.90        | 131.24        | 84.684        |
| 230                           | 221.99  | 215.45        | 211.03        | 194.71        | 170.82        | 160.89        | 137.20        | 88.534        |
| 240                           | 231.65  | 224.81        | 220.20        | 203.18        | 178.23        | 167.89        | 143.17        | 92.383        |
| 250                           | 241.30  | 234.18        | 229.38        | 211.64        | 185.67        | 174.88        | 149.13        | 96.232        |
| 260                           | 250.96  | 243.55        | 238.55        | 220.11        | 193.18        | 181.88        | 155.11        | 100.08        |
| 270                           | 260.61  | 252.91        | 247.73        | 228.57        | 200.52        | 188.87        | 161.07        | 103.93        |
| 280                           | 270.26  | 262.28        | 256.90        | 237.04        | 207.95        | 195.87        | 167.04        | 107.78        |
| 300                           | 289.56  | 281.00        | 275.24        | 253.96        | 222.80        | 209.86        | 178.97        | 115.48        |

| Year | Month | Day | Time  | Location | Event   | Remarks |
|------|-------|-----|-------|----------|---------|---------|
| 1900 | Jan   | 1   | 10:00 | St. Paul | Service |         |
| 1900 | Jan   | 2   | 10:00 | St. Paul | Service |         |
| 1900 | Jan   | 3   | 10:00 | St. Paul | Service |         |
| 1900 | Jan   | 4   | 10:00 | St. Paul | Service |         |
| 1900 | Jan   | 5   | 10:00 | St. Paul | Service |         |
| 1900 | Jan   | 6   | 10:00 | St. Paul | Service |         |
| 1900 | Jan   | 7   | 10:00 | St. Paul | Service |         |
| 1900 | Jan   | 8   | 10:00 | St. Paul | Service |         |
| 1900 | Jan   | 9   | 10:00 | St. Paul | Service |         |
| 1900 | Jan   | 10  | 10:00 | St. Paul | Service |         |
| 1900 | Jan   | 11  | 10:00 | St. Paul | Service |         |
| 1900 | Jan   | 12  | 10:00 | St. Paul | Service |         |
| 1900 | Jan   | 13  | 10:00 | St. Paul | Service |         |
| 1900 | Jan   | 14  | 10:00 | St. Paul | Service |         |
| 1900 | Jan   | 15  | 10:00 | St. Paul | Service |         |
| 1900 | Jan   | 16  | 10:00 | St. Paul | Service |         |
| 1900 | Jan   | 17  | 10:00 | St. Paul | Service |         |
| 1900 | Jan   | 18  | 10:00 | St. Paul | Service |         |
| 1900 | Jan   | 19  | 10:00 | St. Paul | Service |         |
| 1900 | Jan   | 20  | 10:00 | St. Paul | Service |         |
| 1900 | Jan   | 21  | 10:00 | St. Paul | Service |         |
| 1900 | Jan   | 22  | 10:00 | St. Paul | Service |         |
| 1900 | Jan   | 23  | 10:00 | St. Paul | Service |         |
| 1900 | Jan   | 24  | 10:00 | St. Paul | Service |         |
| 1900 | Jan   | 25  | 10:00 | St. Paul | Service |         |
| 1900 | Jan   | 26  | 10:00 | St. Paul | Service |         |
| 1900 | Jan   | 27  | 10:00 | St. Paul | Service |         |
| 1900 | Jan   | 28  | 10:00 | St. Paul | Service |         |
| 1900 | Jan   | 29  | 10:00 | St. Paul | Service |         |
| 1900 | Jan   | 30  | 10:00 | St. Paul | Service |         |
| 1900 | Jan   | 31  | 10:00 | St. Paul | Service |         |

# INDEX.

- A**BSOLUTE pressure, 54-56  
 definition of, 55, 56  
 of steam, how measured, 55
- Accidental inventions, 30
- Action and work of expanding steam, 63-67  
 of steam in the cylinder, 124  
 in the cylinder as shown by the indicator diagrams, with illustration, 88-90  
 in the cylinder of an engine, 85-93  
 when expanded, 72, 73
- Actual horse-power, definition of, 97
- Adiabatic cards, 167  
 curve, 167, 168
- Admission line, 128
- Advantage of variable automatic expansion, 194, 195
- Advantages of the compound steam engine, 291-294
- Aeolipile, the, described and illustrated, 22
- Air, how removed from water for steam engine purposes, 117  
 the possible chief motive power of the future, 312  
 weight of a cubic foot of, 48
- Air-pump, 231, 232  
 capacity of, 231  
 invention of the, 28
- Alexander, Emperor of Russia, present to Capt. Rogers by, 40
- Allowance for compression and clearance, to make, 379-384
- America, first attempt to propel boats by steam in, 31
- American Academy of Arts and Sciences, recommendation from a select committee of, for granting a patent to Nathan Read, 32
- Locomotives, fair average of the performance of, 260-262
- Ancients, loss of knowledge and progress by reason of the false methods and philosophy of the, 21  
 the true nature of steam not known by the, 21
- Aneroid, necessity for a, 119
- Apparatus for making Dowson's gas, 344, 345  
 used by the early English miners for raising ore, 94
- Approximation, an, to the effective mean pressure, 407, 408
- Aqueous vapor, ideal zero of, 51  
 vapor or steam, 50, 51, 443, 444
- Areas and circumferences of circles, table of, 428-433
- Athemius, experiment by, 25
- Atkinson gas-engine, 331-339  
 "cycle" gas-engine, diagrams from the, 331  
 patent "cycle" gas-engine, trial of, 334-339
- Atmosphere, an, definition of, 45, 46  
 momentous importance of the discovery of the pressure of the, 28  
 object of knowing the exact pressure of the, 118, 119  
 the weight and pressure of the, proved by Torricelli, 26
- "Atmospheric engine," 29  
 engine of Newcomen, with illustration, 234-236  
 gas-engine, Otto and Langen, 319, 320  
 line, 125  
 the, how drawn on diagrams, 119  
 pressure, 49
- Automatic condensing engine, diagram from, 357-359  
 cut-off engine, diagrams from, 203, 372-375  
 superiority of the, exemplified, 349-354  
 engines, 249-252  
 saving by, 196  
*vs.* positive cut-off, 349-371  
 engines, varieties of, 251  
 expansion engines, 247-249  
 non-condensing engine, diagram from, 357  
 steam-engine, 242, 243  
 steam-engines, the most prominent in general use, 242
- Avoidance of intermediate expansion, 285-287

- B**ACK-PRESSURE, 160, 161  
 cause of increased, 134  
 diminution of, how effected, 117  
 in non-condensing and condensing engines, with illustration, 115, 116  
 line, 135  
 or line of counter-pressure, 133-135  
 principal cause of increased, 160, 161  
 variation in the excess of, in non-condensing engines, 134, 135
- Baldwin locomotive, No. 81, diagrams from, 259, 260  
 Works, lead allowed by the, 140
- Barber, John, patent for the production of force taken out by, 317
- Barcelona, Spain, early exhibition of a steamboat in, 25
- Bayonne and Biarritz Railway, introduction of compound locomotives on, 302
- Belmont Water Works, Philadelphia, data from the contract trial of H. R. Worthington, with, 389  
 "Blowing out," 420
- Blow-through valves, 228
- Boiler, calculation of the useful evaporation of a, 376, 377  
 compound of George W. Lord, of Philadelphia, advantage of, 421  
 disturbance, or priming, 419  
 foaming of, 420  
 horizontal flue; 419  
 incrustation remedies, 421  
 portable furnace tubular, invented by Nathan Read, 32  
 power of a, 422  
 pressure, line of, 126  
     how drawn on diagrams for non-condensing engines, 121  
 solvents, 421
- Boilers, 416, 417  
 incrustation of, 419-421  
 joints of, 417, 418  
 rivet holes of, 418  
 strength of shell-plates of, 418  
 superiority of steel for, 417
- Boiling, 45-47  
 liquid, temperature of, 53  
 point, definition of, 45  
     of water, on what it depends, 51  
     temperature of, 443
- Bonouville, essay by, 36
- Booth & Garrett of Philadelphia, endorsement of Lord's boiler compound by, 421
- Boston and Albany Railroad, trial of compound locomotives by, 309
- Boyle's law, 162
- Boyle and Mariotte's law, 129  
 Boyle and Mariotte's law as usually expressed, 164  
 conditions under which it holds good with all gases, 164, 165  
 deviation from, 177
- Brown, Samuel, gas-engine invented by, 317
- "Brumbo" pulley, illustrated, 391-393
- Brush Electric Light Station, Philadelphia, diagram from an engine at the, 146
- Bucket valves, 232
- Buckeye automatic engine, indicator diagrams from a, 254  
 engine, 253-258  
     diagrams from, 399, 400  
     mean card of, 399, 400  
     table of pressures of, 400, 401  
     test of, 397-399
- C**AMERA obscura, invention of, 23  
 Carbon, heating power of one pound of, 204  
 units of heat generated by a pound of, 43
- Card, best way of finding the mean pressure of a, 105
- Cavendish and Lavoisier, investigation of water by, 43
- Cawley and Newcomen's engine, 29, 30
- Centigrade and Fahrenheit thermometers, 422
- Chart of relative economy, under varying loads, 299, 300
- Cheverton, letter on gas-engines by, 317
- Circles, table of circumferences and areas of, 428-433
- Circumferences and areas of circles, table of, 428-433
- Classification of steam-engines, 224, 225
- Clearance, 181  
 and compression, to make allowance for, 379-384  
 effect of, 181-185  
     too much on the diagram, illustrated, 185, 186  
 how to calculate the, 189, 190  
 impossibility of avoiding, 184  
 in the ordinary steam-engine, 189  
 line, 126, 127  
     how to fix when not known, illustrated, 200  
     method of locating the, with diagram, 382, 383  
     principles relating to, 185  
     proportion of loss by, 181-184  
 "Clermont," the launching of, 37
- Clerk gas-engine, 324-327  
 diagrams from, 326, 327

- Clerk, M. Dugald, theory of the gas-engine by, 312-316
- Coal, amount of, required per hour per horse-power, 80, 81  
 anthracite, average content of carbon of, 42, 43  
 gas and Dowson gas, comparative explosive force of, 346  
 progress in the economy of fuel by improvements in the steam engine traced by the number of pounds burnt per hour per horse-power, 101.  
 quantity of heat obtained from the combustion of three pounds of, 205  
 of, required to produce an indicated horse power, 101  
 reason why only a small percentage of the power contained in each pound is realized, 229, 230  
 units of heat developed by one pound of, 101
- Co-efficient of expansion of superheated steam, 50
- Commercial horse-power, 97
- Comparative efficiency of different engines, 234-236  
 indicator diagrams, 189-207
- Compound and simple system, 270, 271  
 condensing engine, diagrams from, 289  
 theoretical diagram of a, 286, 287  
 engines, 287-290  
 engine, condemned by many engineers, 292  
 points of superiority of, 281, 282  
 engines, action and arrangement of the principal varieties of, illustrated, 272-276  
 best results of, 348  
 early, 290, 291  
 objection to, 283  
 with intermediate reservoir or receiver, 277-281
- locomotive, improved by Francis W. Webb, 303, 304  
 patented by T. W. Worsdell, 305-309
- locomotives, 300-309  
 economy of fuel of, 303  
 failure in this country as economizers of fuel, 309
- steam engine, advantages of, 291-294  
 engines, 266-276  
 historical data referring to, 269, 270
- system, advantage claimed for, 279, 280
- Compound system, disadvantages of, 280, 281  
 versus simple engines, 281-284
- Compounding, what it is, 266
- Compression, actual curve of, as shown by the indicator, 138, 139  
 and clearance, to make allowance for, 379-384  
 curve, termination of, 138  
 desirability of, with diagrams, 370, 371  
 indication of an excess of, 136, 137  
 line of, 136-139  
 most advantageous adjustment of, 136  
 useful effect of, 137, 138
- Computation of the economy of water consumption, 379, 380  
 table, 383  
 example for use of the, with illustration, 384-386  
 explanation of, 384
- Conclusion, 408-410
- Condensation in cylinders clothed with non-conducting material, 213  
 in steam engine cylinders, 204-207  
 of steam, 53  
 necessity of preventing the, 221  
 pressure of, 133, 160
- Condenser, 225, 226  
 actual pressure in the best, 160  
 capacity of, 226  
 cause of the pressure in the, 133, 134  
 jet, 226-230  
 saving effected by a good, 228  
 temperature of the, 226, 227  
 vacuum in the, 226
- Condensers, cause of their efficiency, 228  
 "jet," 33  
 removal of water from, 227, 228  
 "surface," 33
- Condensing and non-condensing engine, difference between a, 87  
 and non-condensing engines, difference between, 116  
 variable expansion, further advantage of, 195-197
- automatic cut-off engine, diagram from, 359  
 engine, theoretical indicator diagrams from, 65-67  
 engines, 225  
 back-pressure in, 115, 116  
 water, lifting of, 230, 231
- Construction of the indicator, 82-84
- Continuous expanding compound engine, curious form of, 273-275  
 expansion engine, 278, 279

- Corliss compound engine, diagram illustrated, 290  
 engine, diagram from a, 155, 156  
 horse-power of a, by the indicator, with illustration, 102-104
- Corliss, George H., introduction of the modern cut-off engine by, 249, 250  
 reduction in the consumption of coal, by, 101
- Cornish engines, pressure of steam in, 233  
 pumping engine, as invented by Watt, 236  
 engines, consumption of coal by, 101  
 duty of, 35  
 history of, 35  
 indicator diagram from, 238
- Cornwall, remarkable examples of the application of the single-acting engines to pumping in, 237
- Correct indicator diagrams, 148-161
- Counter pressure, line of, 133-135
- Cowper C., diagram published by, with illustrations, 178, 179
- Crosby, Messrs., trial of Dowson gas, by, 346  
 steam engine indicator, with illustrations, 415, 416
- Curve, adiabatic, 167, 168  
 isothermal, 198  
 isothermic, 167  
 of expansion, 129-131, 187, 188
- Cushioning, 136-139
- Cut-off, automatic *vs.* positive, 349-371  
 most economical point of, 62, 63  
 point of, 129  
 valve arrangements, modern automatic, 144
- Cylinder, action of the, towards the steam, 214  
 action of steam in the, 124  
 action of steam in the, as shown by the indicator diagrams, with illustration, 88-90  
 condensation, 34  
 "distribution" for the, 88  
 higher terminal pressure in, 166  
 how to take a diagram from each end of the, 156  
 maintenance of a proper steam pressure in the, 128, 129  
 mean temperature of, how influenced, 130  
 offices the steam has to perform upon entering the, 292, 293  
 variation in the temperature of, 205, 206
- D**ALTON'S experimental results on evaporation below the boiling temperature, 44  
 law, 44, 45
- De Caus, Salomon, machine for raising water described by, 25
- Descartes, Kepler and Galileo, 26
- Diagram, best way of finding the mean pressure of a, 105  
 essentials for the correctness of the, 390  
 exhibiting improvement in modern engines in the valve motion, 246  
 from a compound engine, 282  
 vertical engine with intermediate receiver, 277  
 condensing automatic cut-off engine, 359  
 Corliss engine, 155, 156  
 double-acting engine, 240-242  
 locomotive engine, when running slow, 259  
 modern built automatic cut-off engine, 374, 375  
 non-condensing engine, 359.  
 Corliss engine, 250  
 throttling engine, 245  
 plain slide valve engine, 369, 370  
 Porter-Allen engine, 253  
 pumping engine, 360  
 simple compound Westinghouse engine, 287  
 Westinghouse compound condensing engine, 287  
 an automatic condensing engine, 357-359  
 cut-off engine, 203, 372-374  
 non-condensing engine, 357  
 engine with a steam jacket over the ends and sides, 221  
 at the Brush electric light station, Philadelphia, Pa., 146  
 how taken from each end of the cylinder, 156  
 ideal, with illustration, 124, 125  
 illustrating a method of locating the clearance line, 382, 383  
 low pressure, values of, 283, 284  
 of the action of the steam in an automatic condensing engine, 254  
 action of steam in an expansive engine, 209  
 expansion curve of steam in an imperfectly protected cylinder, 212, 213  
 real, how drawn, 175  
 showing steam used expansively, 154, 155

- Diagram, the causes of different form of engine, 79  
theoretical, with illustrations, 169-175
- Diagrams, facts to which they will testify, 151  
frictional, power shown by, how calculate on stationary engines, with illustrations, 121, 122  
from a Clerk gas engine, 326, 327  
compound-condensing engine, 289  
triple-expansion engine, 297, 298  
an upright automatic cut-off engine, 375  
Baldwin locomotive, No. 81, 259, 260  
continuous-expansion engines, 281  
five horse Otto engine, 321, 322  
freight locomotive, 362, 363  
horizontal compound-condensing, triple-expansive engine, 298, 299  
Lenoir gas engine, 318, 319  
locomotive No. 51, Southern Pacific Railroad, 365-367  
locomotives, general interest of, 363  
what may be learned from, 364  
M. Mallet's locomotive, 302, 303  
one of the best build of English locomotives, 262-266  
pair of engines connected at right angles, 290  
passenger locomotive, 361, 362  
Porter Allen engine, 395, 396  
single acting engines, interpretation of, 238-240  
single valve straight line engine, 255, 256  
the Atkinson "cycle" gas engine, 331  
the Buckeye engine, 399, 400  
the engines of a flouring mill, 350-354  
the Southwark engine, 403, 404  
the Worthington pumping engine at Belmont, Philadelphia, 367, 368  
illustrating the relative engine economy, 354-357  
instructiveness of, 412  
presenting a summary of successive improvements in the steam engine, 179, 180
- Diagrams, showing a fair average of the performance of American locomotives, 260-262  
the action of steam in a steam engine cylinder, 124-147
- Directions for using the planimeter, with illustrations, 108-114
- Disadvantages of too large an engine, 200-203
- Discovery of jet condensation, 30
- Distorted indicator diagrams, 374, 375  
"Distribution" for the cylinder, 88  
"periods of," 88
- Division of the outline drawn by the instrument during a revolution of the engine, 127
- Double-acting engines, 240-242
- Dowson's water gas, 335, 344-348
- Drake, Alfred, construction of a gas motor by, 317  
gas engines exhibited by, 310, 311  
"Drop," or intermediate expansion, 283  
cut-off," 251
- Dry and wet steam, 53
- Duty, 100, 101  
definition of, 100, 387  
estimation of, 388  
extraordinary, from a gas pumping engine, 336  
of a modern engine, how deduced, 100  
or efficiency of pumping engines, 387-389  
the best recorded, of the best types of engines, 300
- Dynamical branch of mechanics, elements and functions of, 18  
problems, how solved, 18
- Dynamics, 18  
principles of, 18
- E**ARLY gas engines, 316-323  
Economy in using steam expansively, 244-247  
of a steam engine, 376  
relative chart of under, varying loads, 299, 300
- Effect of clearance, 181-185  
too much clearance on the diagram, illustrated, 185, 186
- Effective horse-power, 114  
motive power, reduction of gross power to, 115
- Efficiency or duty of pumping engines, 387-389
- Elasticity, unit of, 57
- Electrical exhibition, Philadelphia, 1884, engine tests at, 394-406
- Elements of the dynamical branch of mechanics, 18

- Emery, C. E., experiments by, 293, 294
- "Energy," use of the term of, in engineering works, 18, 19
- Engine, atmospheric, 29
- compound-condensing, triple-expansion, diagrams from, 297, 298
- condensing, theoretical indicator, diagrams from, 65-67
- constructed by Hallette, of Arras, 291
- continuous-expansion, 278, 279
- expanding compound, curious form of, 273-275
- difference between a condensing and non-condensing, 87
- disadvantages of too large an, 200-203
- division of the outline drawn by the instrument during a revolution of the, 127
- economy, relative, illustrated by diagrams, 354-357
- efficiency of the, how tested, 124
- events taking place in supplying it with steam, 87
- friction of, 114-118
- horizontal, compound-condensing, triple-expansion, diagrams from, 298, 299
- how to deduce the duty of a modern, 100
- manner of ascertaining the absolute horse-power of an, 99, 100
- method for finding the rate of water consumption for the, 379
- of ascertaining the increase of economy which can be gained in an, illustrated, 194, 195
- new, designed by John E. Sweet, 256-258
- Newcomen and Cawley's, 29, 30
- plain slide valve, diagram from, 369, 370
- Porter-Allen, test of, 394-397
- power, 90-93
- rule for finding foot pounds raised per minute by an, 92, 93
- Savery's, defects of, 29
- simple compound Westinghouse, diagram from, 287
- single valve cut-off, objection to, 255
- standard by which to judge its economy, 80
- straight line, 255
- tests at Electrical Exhibition, Philadelphia, 1884, 394-406
- the Buckeye, 253
- test of, 397-399
- the Southwark, trial of, 401-405
- Engine, throttling, explanation of the diminished efficiency of the, 197
- use of the indicator for showing the condition of the, with illustration, 156-159
- useful effect of compression in the working of an, 137, 138
- what its work for economical use should be, 203
- Westinghouse single valve, 258
- Engines, automatic cut-off, 249-252
- saving by, 196
- expansion, 247-249
- best recorded duty of the best types of, 300
- comparative efficiency of different, 234-236
- comparison of, 189
- compound-condensing, 287-290
- versus simple, 281-284
- with intermediate reservoir, or receiver, 277-281
- difference between a non-condensing and a condensing, 116
- double acting, 240-242
- early compound, 290, 291
- high-speeded, application of the indicator in, 150, 151
- length of cards from, 152
- locomotive, 259, 260
- marine and stationary, average consumption of coal by, prior to 1860, and in 1872, 101
- of a flouring mill, diagrams from, 350-354
- performance of, with diagram, 299
- proper terms for, 54
- relative economy of different, 354-371
- single acting, 236-240
- triple-expansion, 294-299
- superior economy of, 265-297
- English locomotives, diagrams from one of the best build, 262-266
- Evans, Oliver, 36
- and the high-pressure steam engine, 232
- Evil of light loads, 386, 387
- Example for use of the computation table, with illustration, 384-386
- Exhaust-closure, point of, 136
- line, 132, 133
- port, opening of, 131, 132
- steam, communication of the, into the condenser, 226
- Expanding steam, exemplification of the action of, 60-62
- loss from, in an unjacketed cylinder, 222



- Expanding steam, work and action of, with illustrations. 63-67
- Expansion, 59-79  
 advantages of, 72  
 curve, 129-131, 187, 188  
 of indicator diagrams, 147  
 the steam in an imperfectly protected cylinder, diagram of, 212, 213  
 curves of indicator diagrams, 79  
 diagram of steam in a cylinder, 73-75  
 initial, 142  
 intermediate, 283  
 avoidance of, 285-287  
 law of, 59  
 line, undulations or waviness of the, with illustrations, 145, 146  
 of steam, 59-62  
 and its effects with equal volumes of steam, 69-72  
 ratio or grade of, 67, 68  
 with the steam cut off at certain points of the stroke, 75  
 saving in fuel by, 76, 77  
 variable, distribution of the steam, in working by, 248  
 and condensing, further advantage of, 195-197
- Expansive engine, especial use of the steam jacket in the, 215, 216  
 non-jacketed cylinder, indicator diagram from, 216, 217  
 with a jacketed cylinder, diagram from, 217-223
- Explanation of the computation table, 384
- F**ACTS to which the diagrams will testify, 151
- Fahrenheit and Centigrade thermometers, 422
- Falling bodies, 422-424
- First steamship to cross the ocean, 37-41
- Fitch, John, attempt to propel boats by steam by, 31
- "Flue" boiler, 416
- Fly-ball governor, 34
- Foot-pound, definition of, 98  
 pounds raised per minute by an engine, rule for finding, 92, 93  
 valves, 232
- Force, elastic, of steam, mode of expressing, 54  
 how expressed, 18  
 what it is, 17
- Foreign terms and units for horsepower, 99
- Formulæ applying to bodies acted upon by gravity in vacuo, 422-424  
 "Forward" gas engine, 339, 340  
 Friction in engines, 114-118  
 percentage of, 114
- Fuel, computation of gain in, 77  
 saving in, by expansion, 76, 77  
 "Full stroke," 60
- Fulton and the "Clermont," 37
- Functions of the dynamical branch of mechanics, 18
- Further advantage of variable expansion and condensing, 195-197
- G**AGE, vacuum, 119-123  
 Gages, vacuum, 55  
 different construction of, 119
- Gain in fuel, computation of, 77  
 of expanding steam by cutting off its supply after the piston has travelled a portion of the stroke, 77
- Galileo, Descartes and Kepler, 26
- Galileo's sarcasm on Toricelli's discovery, 27
- Gas and steam engine efficiency, 348  
 vapor, difference between, 162  
 calculation of amounts of, required by gas engines, 314  
 relationship between the pressure and the volume of a, with illustration, 163, 164
- Gases, conditions under which Boyle's and Mariotte's law holds good with all, 164, 165
- Gas engine, diagrams from a five horse Otto, 321, 322  
 error in calculating the efficiency of the, 315, 316  
 future of the, 347, 348  
 Otto's "silent," 320-323  
 twin-cylinder, 341, 342  
 self-starting, 340, 341  
 the Atkinson, 331-339  
 patent "Cycle," trial of, 334-339  
 "Clerk," 324-327  
 "Forward," 339, 340  
 "Stockport," 327-331  
 theory of the, 312-316
- engines, 310-348  
 advantages of, 312  
 calculation of the amounts of gas required by, 314  
 early, 316-323  
 recognition of the value of, 317  
 history of, 310-312  
 types of, 313  
 motors, early, classification of, 316, 317

- Genevois, experiment by, 36  
 Geometry of the indicator diagram, 159, 160  
 Glasco de Garoy, exhibition of a steam-boat by, 25  
 Grade or ratio of expansion, 67, 68  
 "Great Western" and the "Sirius," 37, 38  
 Greene, Noble T., engine invented by, 251  
 Gross power, reduction of effective motive power to, 115  
 Guericke, Otto von, invention of the air pump by, 28
- H**ALLETTE, of Arras, engine constructed by, 291  
 Heat and work, 42-58  
   equivalency of one unit of, 43  
   latent, definition of, 51  
     of liquefaction, 44  
   materiality of, 42  
   of chemical combination and latent heat, 56  
   percentage of, converted into work, by modern engines, 63  
   quantities of, required to convert equal quantities of water into steam, 48  
   specific, definition of, 58  
   unit of, 57, 58  
   units of, generated by a pound of carbon, 43  
     required for heating one pound of water, 51  
   what is the product of, 17  
     the space occupied by it represents, 17  
 Hero, apparatus described by, 20, 22, 23  
 Hero's book of 200 B. C., translated edition of, 20  
   "Fountain," 20  
   "Spiritualia," translated by Giovanni Batista Porta, 23  
 High and low pressure steam, 54  
   pressure engine, loss occurring in, illustrated, 201  
   steam, 232-234, 417  
 Hirn, G. A., 36  
 Historical data referring to compound steam engines, 269, 270  
   relating to the steam engine, 33-37  
 History and adventures of the S. S. "Savannah," 38-40  
   of gas engines, 310-312  
 Horizontal flue boiler, 419  
 Hornblower, Jonathan, patent obtained by, for using two cylinders, 268, 269  
 Hornblower, the inventor of the double or compound cylinder engine, 232  
 Horse-power, 94-123, 405  
   absolute, of an engine, how ascertained, 99, 100  
   by the indicator, 102-105  
   commercial, 97  
   constant, rule for finding, 70, 71  
   constants, 425-427  
     for single cylinder engines, table of, 425, 426  
   definition of, 94  
   effective, 114  
   foreign terms and units for, 99  
   gross indicated, how found, 120  
   indicated, 114  
     how to calculate the, 103, 104  
   most convenient way of calculating the, 70  
   nominal and actual, definition of, 97  
   of a Corliss engine by the indicator, with illustration, 102-104  
   of a steam engine, 94-98  
   meaning of an indicated, 43  
   real, 94  
   Watt's practical experiments relating to a, 95  
     rule for, 99  
     what it meant in Watt's time, 96, 97  
 Hot well, 232  
   delivery valves, 232  
 How to calculate the amount of steam (water) consumed from an indicator diagram, 376-379  
   to divide a line into a number of equal spaces, with illustration, 105-107  
   to fix the clearance line when not known, illustrated, 200  
   to lay out the hyperbolic curve from the point of cut-off, illustrated, 199  
 Hugon, priority of invention of Lenoir's gas engine claimed by, 318  
 Hulls, Jonathan, idea of steam navigation set forth by, 33  
 Huyghens, motor designed by, 317  
 Hyperbola, application of a, to a diagram, 188  
 Hyperbolic curve, how to lay it out from the point of cut-off, illustrated, 199  
   logarithms, 68, 69  
     table of, 68, 69  
   or isothermic cards, 167

- I**CE, melting point of, 422  
 specific gravity of, 44  
 Ideal diagram, an, with illustration, 124, 125  
 Incrustation of boilers, 419-421  
 Indicated horse-power, 114  
   how to calculate the, 103, 104  
 Indicating an engine, precautions in, 79  
 Indicator, the, 80-84, 411-413  
   best forms of, 83  
   co-efficient, 72  
   construction of the, 82-84  
   diagram, causes which influence the form of, 408-410  
     from a Cornish pumping engine, 238  
     from an expansive engine with a jacketed cylinder, 217-223  
       with a non-jacketed cylinder, 216, 217  
     from a Tandem engine, 272  
     from a unique compound engine, 299  
     the geometry of the, 159, 160  
     uses of the, 81  
   diagrams, comparative, 189-207  
     correct, 148-161  
     distorted, 374, 375  
     essentials for their correctness, 148  
     expansion curve of, 147  
       curves of, 79  
     from a Buckeye automatic engine, 254  
       Webb compound locomotive, 304, 305  
       Worsdell compound locomotive, 308  
     length of, 151, 152  
     theoretical, from a condensing engine, 65-67  
     with illustrations, 152-156  
   functions of the, 78  
   the proper place to attach the, 149-151  
   use of the, for showing the condition of the engine, with illustration, 156-159  
     in discovering defects in the machinery, 81  
 Indicators in general use, 413-416  
 Initial and mean effective pressure in the cylinder, table of, 73  
   expansion, 142  
   pressure, 141  
 Injection orifice, area of, 226  
   water, amount of, required, 229  
 Intermediate expansion, avoidance of, 285-287  
   receiver, effect of, 277, 278  
 Inventions made by accident, 30  
 Isothermal curve, 198  
 Isothermic or hyperbolic cards, 167  
   curve, 167  
**J**ACKETING with exhaust steam, 220  
 Jet condensation, how discovered, 30  
   condenser, 33, 226-230  
 Johnson, gas engine patented by, 317  
 Jouffrey, Marquis de, 36  
 Joule and Mayer, labors of, 42  
   effects of surface condensation obtained by, 227  
**K**EITHMANN, priority of invention of Lenoir's gas engine claimed by, 318  
 Kepler, Galileo and Descartes, 26  
 Kopp's experiments on the density of water, 433, 434  
**L**AMINATION of steam, 143  
 Latent heat and the heat of chemical combination, 56  
   and total heat in water from 32 degrees, 52, 435  
   heat, definition of, 51  
     of liquefaction, 44  
     of steam, 51, 52, 445  
   units of heat, work accomplished by, 52  
 Lavoisier and Cavendish's investigations of water, 43  
 Law of Boyle and Mariotte, 129  
   as usually expressed, 164  
   conditions under which it holds good with all gases, 164, 165  
   of expansion, 59  
 Laws which are the key to the problem of converting the work of combustion, into power, 35  
 Lead, 139, 140  
   inside, 139  
   of a value, definition of, 139  
   outside, 139  
 Leakage, effect of, how detected, 130  
   of steam engines as shown by diagram, 372, 374  
   the change of form of the expansion curve due to, 79  
 Leavitt, E. D. Jr., consumption of coal per indicated horse-power per hour by, 101  
 Lebon, Franzose, gas engine invented by, 317

- Length of indicator diagrams, 151, 152  
unit of, 57
- Lenoir and Hugon gas engines, 311  
gas engine, diagrams from a, 318, 319  
gas-motor, unscrupulous claims  
made for the, 317, 318
- Lenoir's priority of invention con-  
tested, 318
- Leupold, high-pressure engine with two  
cylinders, proposed by, 33
- Lever, swinging, illustrated, 391
- Liberating valve gear, 248  
the reasoning of the ad-  
vocates of, 248
- Lifting condensing water, 230, 231
- Line, atmospheric, 125  
how drawn on diagrams, 119  
clearance, 126, 127  
how to divide a, into a number of  
equal spaces, with illustration,  
105-107  
of admission, 128  
back pressure, 135  
boiler pressure, 126  
how drawn on diagrams for  
non-condensing engines, 121  
compression or cushioning, 136-  
139  
counter pressure, 133-135  
exhaust, 132, 133  
expansion, undulations or wavi-  
ness of, with illustrations, 145,  
146  
perfect vacuum, 125, 126  
how it should be drawn on  
diagrams, 119  
steam, 128, 129
- Liquefaction, 282  
of solids, 49
- Livingston, Chancellor, projects of,  
with steam, 37
- Load, 260-266
- Loads, light, evils of, 386, 387
- Locomotive engine, diagram from a,  
when running slow, 259  
wire drawing in the, 143,  
144  
engines, 259, 260  
lead in, 139  
freight, diagrams from, 362, 363  
M. Mallet's diagrams from, 302, 303  
No. 51, Southern Pacific Railroad,  
diagrams from, 365-367  
passenger, diagrams from, 361, 362  
steam carriage, model of, by  
Nathan Read, 32
- Locomotives, American, fair average  
of the performance of, 260-262  
compound, 300-309  
general interest of diagrams from,  
363
- Locomotives, what may be learned  
from diagrams from, 364
- Logarithms, hyperbolic, 68, 69
- Lord, George W., of Philadelphia, high  
reputation of the boiler compound  
of, 421
- Loss from the want of the steam jacket,  
210-212
- Low and high pressure steam, 54  
pressure diagram, values of, 283,  
284
- Lynedock, Lord, present to Capt. Rog-  
ers by, 40
- M**ACHINE for raising water, de-  
scribed by De Caus, 25  
for raising water invented by Porta,  
described and illustrated, 24  
measurement of power, required  
by a single, among many run-  
ning, 104, 105
- Machinery, use of the indicator in dis-  
covering defects in, 81
- Magic lantern, invention of, 23
- Mallet, M. Anatole, system of com-  
pound locomotives of, 302, 303
- Man-power, 98-100
- Marine engines, average consumption  
of coal by, prior to 1860 and in  
1872, 101  
jacketing of, 208  
pressure on the boiler of, 234
- Mariotte and Boyle curve applied to  
the expansion of  
steam, with illus-  
tration, 187, 188  
Boyle's law, 129, 162  
as usually expressed, 164  
condition under which  
it holds good with all  
gases, 164, 165  
deviation from, 177
- Mayer and Joule, labors of, 42
- Mean card (Buckeye engine), 399, 400
- Mean effective and initial pressure in  
the cylinder, table of, 73  
indicator card, 406  
pressure, 141  
definition of, 383  
what it is, 355  
pressure, 67  
above the atmosphere during  
the stroke, how found, 120  
of expanding steam, table of,  
450
- Mercury in pounds, and vacuum in  
inches, table of, 113
- Meux's brewery, engine erected in,  
in 1806, 233
- Miller, experiments by, 36

- Miscellaneous, 372-410  
 Momentum, unit of, 57  
 Money, unit of, 57  
 Morandiere, M. Jules, attempt at compounding locomotives by, 301, 302  
 Most economical point of cut-off, 62, 63  
 Motion, reduction of, 390-394
- N**EWCOMEN and Cawley's engine, 29, 30  
 the first steam engine in England made by, 33  
 Newcomen's atmospheric engine, with illustration, 234-236  
 Nicholson, John, system of compound locomotives due to, 300, 301  
 Nominal horse-power, definition of, 97  
 Non-condensing and condensing engine, difference between a, 87  
     engines, difference between, 116  
     automatic cut-off engines, 247  
 Corliss engine, diagram from, 250  
 engine, diagram from, 359  
 engines, back-pressure in, 115, 116  
     loss in, 252  
     variation in the excess of the back-pressure in, 134, 135  
 throttling engine, diagram from, 245  
 Nystrom, J. W., analysis of Kopp's experiments, by, 434  
 method of measuring water delivered into a reservoir, suggested by, 388, 389
- O**BJECTIONS to the compound engine by engineers, 292  
 Otto and Langen, atmospheric gas engine, 319, 320  
     gas engine, 311  
 Otto's improvements in gas engines, 311  
     "silent" gas engine, 311, 312, 320-323  
 new, motor, cost of working of, 323  
     distinct features of, 323  
 twin-cylinder gas engine, 341, 342
- P**AINE, Thomas, 36  
 Papin, introduction of steam machine by, 33  
 motor designed by, 317  
 recognition of the advantages of steam by, 29  
 the condensation of steam for the production of a vacuum first suggested by, 28
- Parallel motion devices, how to attach, 393  
 Paris and Orleans Railway, alteration of express locomotives of, 303  
 Pascal, experiment by, 27  
     the truth of Toricelli's position demonstrated by, 27  
 Pennsylvania Railroad, importation of a Webb compound locomotive by the, 304  
     "Periods of distribution," 88  
 Petroleum engine, Spiel's, 342-344  
 "Piston displacement," what it is, 103  
     how to obtain the reducing motion of the, 148, 149  
     mean effective, indicated pressure acting on the, during one stroke, 92  
     the, of an engine, how it works, 86  
 Planimeter, the, with illustration, 107, 108  
     directions for using the, with illustrations, 108-114  
 "Plug frame" and valve gear, origin of, 31  
 Point of cut-off, 129  
     exhaust closure, 136  
     release, or opening of the exhaust port, 131, 132  
 Porta, description of inventions by, 23  
     Giovanni Batista, machine for raising water by, described and illustrated, 24  
     translation of Hero's "Spirit-alia," by, 23  
 Portable furnace, tubular boiler, invented by Nathan Read, 32  
 Porter-Allen engine, diagrams from, 253, 395, 396  
     lead in, 139  
     table of pressures of, 396, 397  
     test of, 394-397  
 Porter, Charles T., diagram taken by, 364  
     tribute to, 253  
 Positive motion cut-off engines, 253  
 Potter, Humphrey, improvement to the steam engine by, 30, 31  
 Power, effective, motive, reduction of gross power to, 115  
     expended in working an air-pump, 232  
     horse-power as a unit of, 98, 99  
     man-power as a unit of, 98  
     method of computing, 427  
     of a boiler, 422  
     an engine, exemplified by an indicator diagram, 91-93  
     engine, way of ascertaining the, 90

- Power or work, unit of, 57  
 required by a single machine  
 among many running in a fac-  
 tory, measurement of, 104, 105  
 simplest example of expenditure  
 of, 83  
 standard of, adopted by James  
 Watt, 94  
 what it is, 18  
     the product of, 98  
 "Precursor" locomotive, diagrams  
 from, 262-266  
 Pressure, absolute, 54-56  
     or total, definition of, 55, 56  
     atmospheric, 49  
     at the end of the stroke, rule for  
     finding the, 78  
     average, per square inch, how  
     found, 120  
     effective, mean, an approximation  
     to, 407, 408  
     initial, 141  
     and mean effective, in the  
     cylinder, table of, 73  
     in the condenser, cause of, 133,  
     134  
     mean, 67  
     above the atmosphere during  
     the stroke, how found, 120  
     computation of, 75, 76  
     effective, 141  
     definition of, 383  
     indicated, acting on the  
     piston during one stroke,  
     92  
     of a card or diagram, best way  
     of finding the, 105  
     of condensation, 133, 160  
     steam in cylinder or steam ex-  
     pansion curves, 162-188  
     terminal, 78, 141  
     definition of, 383  
     rule for finding, 76  
 Priestley's discovery in relation to  
 water, 43  
 Priming or boiler disturbance, 419  
 Principles of the dynamical branch of  
 mechanics, 18  
     relating to clearance, 185  
 Progress, commencement of, with the  
 appearance of Descartes, Kepler and  
 Galileo, 26  
 Proper place to attach the indicator,  
 149-151  
 Properties of steam, 444, 445  
     tables of, 446-449  
     of water, 434, 435  
     tables of, 436-442  
     and steam, 433-450  
 Pulley, the "Brumbo," illustrated,  
 391-393  
 Pumping engine, diagram from, 360  
     engines, duty of Cornish, 35  
     efficiency or duty of, 387-389  
     history of Cornish, 35  
     remarkable examples of the appli-  
     cation of the single-acting en-  
     gines to, 237  
 Puy de Dome, Pascal's experiment on  
 the summit of, 27  
 RATIO or grade of expansion, 67,  
 68  
 Read, Nathan, invention of a portable  
 furnace tubular boiler, and con-  
 struction of a model of a loco-  
 motive steam carriage, by, 32  
     invention of a steamboat by, 31,  
     32  
     patent to, before the establishment  
     of patent laws in the United  
     States, 32  
 Real diagram, how drawn, 176  
 Reaumur thermometer, 422  
 Reducing motion, 390-394  
 Regnault, on the law of Mariotte, 162  
 Relation between the pressure and vol-  
 ume of saturated steam, as shown by  
 the indicator diagram, 175-180  
 Relative economy of different engines,  
 354-371  
     volume, what is meant by, 175  
 Release, point of, 131, 132  
 Resistance, general standard of, 84  
 Rogers, Moses, captain of the "Sa-  
 vannah," 38  
 Rule for finding foot pounds raised per  
 minute by an engine, 92, 93  
     the horse-power constant, 70, 71  
     the increase of efficiency arising  
     from using steam expansively,  
     75  
     the mean pressure, 67  
     the pressure at the end of the  
     stroke, 78  
 Rumford, experiments of, 42  
 Rumsay, James, attempt to propel  
 boats by steam by, 31  
 Rupert, Prince, attempt to propel a boat  
 by steam by, 32, 33  
 S<sup>T.</sup> CLAIR DEVILLE, experiments  
 on the decomposition of water by,  
 315  
 Samuel, J., compound locomotives in-  
 troduced by, 300  
 Saturated space, definition of, 50  
     steam, definition of, 46  
 "Savannah," the, the first steamship  
 to cross the ocean, 38

- "Savannah," history and adventures of the, 38-40  
 Savery's engine, defects of, 29  
 Savery, Thomas, apparatus invented by, 26  
     first practical application of steam power by, 33  
     patents for the first application of the steam engine granted to, 33  
 Saving in fuel by expansion, 76-78  
 Scotch express train, average speed of, 304  
     average weight of, 266  
 Self-starting gas engine, 340, 341  
 Shifting valve, 228  
 Sickles, F. E., and the liberating valve gear, 248  
 Simple and compound system, 270, 271  
 Single-acting engines, 236-240  
     interpretation of diagrams taken from, 238-240  
     cylinder engine, rule for finding the indicated horse-power of a, 102  
     table of horse-power constants for, 425, 426  
     valve cut-off engine, objection to, 255  
     straight line engine, diagrams from, 255, 256  
 "Sirius" and the "Great Western," 37, 38  
 Smeaton's early engines, consumption of coal by, 101  
 Smeaton, the real horse-power by, 94  
 Solids, liquefaction of, 49  
 Southern Pacific Railroad, diagrams from locomotive No. 51, of, 365-367  
 Southwark engine, diagrams from, 403, 404  
     table of pressures of, 403, 404  
     trial of, 401-405  
 Space, what it is the product of, 18  
 Specific gravity, unit of, 58  
     heat, 204  
     definition of, 58  
     volume, what is meant by, 176  
 Speed, high rotative, effect of, 252  
 Speeds, high rotative, fundamental principle of, 207  
 Spiel's petroleum engine, 342-344  
 Stationary engine, development of a horse-power by a, 234  
     engines, average consumption of coal by, prior to 1860, and in 1872, 101  
     power shown by the frictional diagrams, how calculated, with illustrations, 121, 122  
 Steam, 47, 48  
     absolute pressure of, how measured, 55  
     action of the, in an automatic condensing engine, with diagram, 254  
         in the cylinder of a steam engine, 85-93  
         as shown by the indicator diagrams, with illustration, 88-90  
         when expanded, 72, 73  
     admission, regulation of, 140  
     and water, law of temperatures of, 48.  
         properties of, 433-450  
     bubbles, formation of, in a liquid, 53  
     computation of the mean pressure of, 75, 76  
     condensation of, 53  
         for the production of a vacuum, first suggestion of, 28  
     condition of, used to propel engines, 59  
     contraction of, under ordinary pressure, 28  
     criterion of the efficiency of, 124  
     definition of, 47  
     density of, 48  
     diagram of the action of, in an expansive engine, 209  
     diagrams showing the action of, in a steam-engine cylinder, 124-147  
     distribution of, in working by variable expansion, 248  
     dry and wet, 53  
     economy in using expansively, 244-247  
     elasticity of, 48  
     events taking place in supplying an engine with, 87  
     exemplification of the action of expanding, 60-62  
     expanding, work and action of, with illustrations, 63-67  
     expansion of, 59-62  
         and its effects with equal volumes of steam, 69-72  
         curves or pressure of steam in cylinder, 162-188  
     first notice of the power of, on record, 25  
     for the jacket, 220  
     form of, 443  
     high pressure, 417  
     how to ascertain the weight of, 378  
     (water), how to calculate the amount of, consumed, from an indicator diagram, 376-379  
     in a cylinder, expansion diagram of, 73-75

- Steam in the jacket, work done by the, 222  
 lamination of, 143  
 latent heat of, 51, 52, 445  
 low and high-pressure, 54  
 mode of expressing the elastic force of, 54  
 object of the expansive use of, 242  
 of zero pressure, 54  
 offices to be performed by the, upon entering the cylinder, 292, 293  
 or aqueous vapor, 50, 51, 443, 444  
 pressure of, in Cornish engines, 233  
 properties of, 444, 445  
 saturated, definition of, 46  
   relation between the pressure and volume of, as shown by the indicator diagram, 175-180  
 specific gravity of, 48  
 super-heated, definition of, 46  
 table of mean pressure of expanding, 450  
 tables of properties of, 446-449  
 theoretical action of, in compound engines, 281  
   gain by the expansion of, 75, 76  
 throttled, definition of, 142  
 throttling of, 53, 54  
 true nature of, not known by the ancients, 21  
 various losses of, 78  
 volume of, on what it depends, 48  
 weight of a cubic foot of, 48  
 wire drawing of the, 86  
 work done by the, how calculated, 17
- Steamboat, exhibition of a, in 1543, 25  
 the first ever built, 32
- Steamboats, attempt at, by Prince Rupert, 32, 33  
 first attempt at, in America, 31
- Steam-cylinder, conditions of, in practice, 208, 209  
 engine, action of the steam in the cylinder of a, 85-93  
   and gas efficiency, 348  
   automatic, 242, 243  
   commencement of the true germ of the, 28  
   cylinder, diagrams showing the action of steam in a, 124-147  
   condensation in, 204-207  
   diagrams presenting a summary of successive improvements in the, 179, 180
- Steam cylinder, economy of a, 376  
 principles of, 244  
 first perfect, 36  
 historical data relating to the, 33-37  
 horse-power of a, 94-98  
 the, an invention of the 17th century, 25  
 what it is, 17-19  
 who invented the, 20-41
- engines, classification of, 224, 225  
 compound, 266-276  
 key to the sources of loss in, 205  
 leakage of, as shown by the diagram, 372-374  
 varieties of, 224-309
- Steamers, early, plying upon the Gironde and Garonne, 290  
 "Steam-fountain," described and illustrated, 24
- Steam-jacket, diminution of loss on the outside of the, 218  
 economy secured by the use of the, 223  
 especial use of, in the expansive engine, 215, 216  
 extension in the use of the, 220  
 loss from the want of the, 210-212  
 real advantage of, 218, 219  
 value of, 207
- Steam-jackets, 208-223
- Steam-line, 128, 129
- Steam-power, first practical application of, 33  
 first useful application on a large scale of, 25, 26
- Steamship, the first to cross the ocean, 37-41
- Steel vs. iron, 417, 418  
 plates, why preferred for boilers, 418
- Stevens, Col. John, builder of the "Savannah," 38  
 General, experiments by, 36, 37  
 "Stockport" gas engine, 327-331
- Straight line engine, 255
- Street, Robert, gas engine patented by, 317
- Superheated steam, 418, 419  
 co-efficient of expansion of, 50  
 definition of, 46
- Surface condensation, 227  
 condenser, 33
- Sweet, John E., new engine designed by, 256-258  
 the straight line engine designed by, 255
- Swinging lever, illustrated, 391



System, compound, advantage claimed for, 279, 280  
disadvantages of, 280, 281

**T**ABLE of areas and circumferences of circles, 428-433  
of horse-power constants for single cylinder engines, 425, 426  
of hyperbolic logarithms, 68, 69  
of initial and mean effective pressure in the cylinder, 73  
of mean pressure of expanding steam, 450  
of mercury in pounds, and vacuum in inches, 118  
of temperatures with their corresponding pressures, 177

Tables of properties of steam, 446-449  
of the properties of water, 436-442

Tabor indicator, with illustrations, 414, 415

Tandem engine, indicator diagram from, 272

Temperature, mean, of the cylinder, how influenced, 130  
of boiling liquid, 53  
of the boiling point, 443  
of the condenser, 226, 227  
unit of, 57  
variation of, in the cylinder, 205, 206

Temperatures, table of, with their corresponding pressures, 177

Terminal pressure, 78, 141  
definition of, 383  
rule for finding, 76  
what it is, 355

Test of the Buckeye engine, 397-399  
Porter-Allen engine, 394-397

Theoretical diagram, 283, 286  
construction of a, with illustration, 191-193  
how to construct it geometrically, illustrated, 197-199  
of a compound condensing engine, 286, 287  
with illustrations, 169-175  
gain by the expansion of steam, 75, 76

Thermo-dynamics, basis of the science of, 42

Thermometers, conversion of degrees Fahrenheit into degrees Centigrade, or *vice versa*, 422

Thompson indicator, with illustrations, 413  
J. W., the Buckeye engine designed by, 253

Throttled engine, explanation of diminished power of, 243

Throttled steam, definition of, 142

Throttling and wire drawing, 142-145  
engine, explanation of the diminished efficiency of the, 197  
governor, the ordinary, a nuisance, 143  
loss caused by, 144, 145  
of steam, 53, 54

Time, the minute as a unit of, 90  
unit of, 57  
what it is, 18

Toricelli, experiments on the weight and pressure of the atmosphere by, 26  
momentous importance of his discovery, 28  
opposition to his demonstration of the pressure of the atmosphere, 27

Tredgold's error regarding the steam-jacket, 215

Tremtsuk, C. A., work by, 290

Trial of the Southwark engine, 401-405

Triple expansion engines, 294-299  
superior economy of, 295-297

Tyndall, investigations of aqueous vapor by, 293

**U**NDERHILL, A. B., opinion on compound engines by, 309

Undulations or waviness of the expansion line, with illustrations, 145, 146

Unit of heat, equivalency of, 43

Units, 56-58  
of heat generated by a pound of carbon, 43

Upright automatic cut-off engine, diagrams from, 375

Use of the indicator for showing the condition of the engine, with illustration, 156-159

**V**ACUUM, approximation to a, how effected, 117  
first suggestion for its production by the condensation of steam, 28  
gages, 119-123  
different constructions of, 119  
graduation, etc., of, 55  
how regarded by some people, 54  
in inches, and mercury in pounds, table of, 118  
in the condenser, 226  
liability to a double interpretation of the term, 86  
line of perfect, 125, 126  
how it should be drawn on diagrams, 119

Valve, definition of the lead of a, 139  
gear and "plug frame," origin of, 31

- Valve gear, liberating, the reasoning of the advocates of, 248  
 motion, improvement of, in modern engines, with illustration, 246
- Vapor and gas, difference between, 162
- Vapors, 49, 50  
 use of the pressure of, by the Egyptian priests, 23
- Varieties of steam-engines, 224-309
- Velocity, what it is, 18
- Volume of water, 52, 433, 434  
 unit of, 57
- W**ASTEFUL diagrams due to bad valve setting, illustrated, 109, 110
- Waste-water pipe, 232
- Water, 43-45  
 accounted for by indicator cards, 406  
 and steam, law of temperatures of, 48  
 properties of, 433-450  
 boiling point of, 45, 422  
 on what it depends, 51  
 circumstances on which the weight of, evaporated in a given time depends, 50  
 constituents of, which cause boiler incrustation, 420, 421  
 consumption, computation of the economy of, 379, 380  
 Dalton's experimental results on the evaporation of, below the boiling point, 44  
 decomposition of, 315  
 delivered into a reservoir, measurement of, 388, 389  
 density of, 44, 433, 434  
 for steam engine purposes, how freed from air, 117  
 greatest density or smallest volume of, 52  
 latent and total heat in, from 32 degrees, 52, 435  
 loss of, by condensation, 376  
 machine for raising, described and illustrated, 24  
 by De Caus, 25  
 properties of, 434, 435  
 rate of expansion of, 58  
 removal of, from condensers, 227, 228  
 specific heat of, 45  
 standing in ponds or wells, 230  
 tables of properties of, 436-442  
 temperature of the gaseous state of, 45  
 vaporization of, 44  
 various conditions of, 48  
 volume of, 52, 433, 434
- Water, weight of a cubic foot of, 48
- Water-gas, Dowson's, 344-348
- Watt, James, catalogue of inventions and discoveries by, 33-36  
 endeavor to eliminate alternate heating and cooling by, 214  
 mode of calculating the power of his engine, of, 96, 97  
 practical experiments relating to a horse-power, 95  
 rule for horse-power, of, 99  
 standard of power adopted by, 94  
 tribute to, 41  
 and Boulton's double-action rotary engines, 37
- Waviness of the expansion line, with illustrations, 145, 146
- Webb compound locomotive, indicator diagrams from, 304, 305  
 Francis W., improved compound locomotive designed and patented by, 303, 304
- Weight, unit of, 57
- Westinghouse compound condensing engine, diagram from, 287  
 engine, table of actual steam consumed per indicated h. p., 288  
 engine, lead in, 139  
 single valve engine, 258
- Wet and dry steam, 53
- What the steam engine is, 17-19
- Who invented the steam engine? 20-41
- Wire drawing and throttling, 142-145  
 cause of, 143  
 definition of, 142  
 in the locomotive engine, 143, 144  
 loss caused by, 144, 145  
 of the steam, 86
- Woodcroft, Bennet, translated edition of Hero's book by, 20
- Woolf, Arthur, patent for improvements in steam engines taken out by, 233  
 peculiar theories entertained by, 233
- Worcester, Marquis of, application of steam-power by, 25, 26  
 experiments on the application of steam power for propelling vessels, 32
- Work accomplished by latent units of heat, 52  
 and action of expanding steam, 63-67  
 and heat, 42-58  
 done by the steam in the jacket, 222  
 greatest quantity of, obtained in practice, 169

- |  |  |
|--|--|
| <p>Work, measurement of, 98<br/> of the steam, how calculated, 17<br/> or power, unit of, 57<br/> what it is the product of, 18, 98</p> <p>Worsdell compound locomotive, indi-<br/> cator diagrams from, 398</p> <p>T. W., compound locomotive<br/> patented by. 305-309</p> | <p>Worthington, H. R., data of, from con-<br/> tract trial with Belmont Water<br/> Works, 389</p> <p>pumping engine at Belmont, Phil-<br/> adelphia, diagrams from, 367,<br/> 368</p> <p>Wright, Mr., gas engine invented by,<br/> 317</p> |
|--|--|







CATALOGUE  
OF  
Practical and Scientific Books  
PUBLISHED BY  
HENRY CAREY BAIRD & CO.

INDUSTRIAL PUBLISHERS, BOOKSELLERS AND IMPORTERS.

810 Walnut Street, Philadelphia.

- ✦ Any of the Books comprised in this Catalogue will be sent by mail, free of postage, to any address in the world, at the publication prices.
- ✦ A Descriptive Catalogue, 84 pages, 8vo., will be sent free and free of postage, to any one in any part of the world, who will furnish his address.
- ✦ Where not otherwise stated, all of the Books in this Catalogue are bound in muslin.

**AMATEUR MECHANICS' WORKSHOP:**

A treatise containing plain and concise directions for the manipulation of Wood and Metals, including Casting, Forging, Brazing, Soldering and Carpentry. By the author of the "Lathe and Its Uses." Seventh edition. Illustrated. 8vo. . . . \$3.00

**ANDRES.—A Practical Treatise on the Fabrication of Volatile and Fat Varnishes, Lacquers, Siccatives and Sealing Waxes.**

From the German of ERWIN ANDRES, Manufacturer of Varnishes and Lacquers. With additions on the Manufacture and Application of Varnishes, Stains for Wood, Horn, Ivory, Bone and Leather. From the German of DR. EMIL WINCKLER and LOUIS E. ANDES. The whole translated and edited by WILLIAM T. BRANNT. With 11 illustrations. 12mo. . . . \$2.50

**ARLOT.—A Complete Guide for Coach Painters:**

Translated from the French of M. ARLOT, Coach Painter, for eleven years Foreman of Painting to M. Eherler, Coach Maker, Paris. By A. A. FESQUET, Chemist and Engineer. To which is added an Appendix, containing Information respecting the Materials and the Practice of Coach and Car Painting and Varnishing in the United States and Great Britain. 12mo. . . . \$1.25

**ARMENGAUD, AMOROUX, AND JOHNSON.**—The Practical Draughtsman's Book of Industrial Design, and Machinist's and Engineer's Drawing Companion :

Forming a Complete Course of Mechanical Engineering and Architectural Drawing. From the French of M. Armengaud the elder, Prof. of Design in the Conservatoire of Arts and Industry, Paris, and MM. Armengaud the younger, and Amoroux, Civil Engineers. Rewritten and arranged with additional matter and plates, selections from and examples of the most useful and generally employed mechanism of the day. By WILLIAM JOHNSON, Assoc. Inst. C. E. Illustrated by fifty folio steel plates, and fifty wood-cuts. A new edition, 4to, half morocco . . . . . \$10.00

**ARMSTRONG.**—The Construction and Management of Steam Boilers :

By R. ARMSTRONG, C. E. With an Appendix by ROBERT MALLET, C. E., F. R. S. Seventh Edition. Illustrated. 1 vol. 12mo. 75

**ARROWSMITH.**—Paper-Hanger's Companion :

A Treatise in which the Practical Operations of the Trade are Systematically laid down: with Copious Directions Preparatory to Papering; Preventives against the Effect of Damp on Walls; the various Cements and Pastes Adapted to the Several Purposes of the Trade; Observations and Directions for the Panelling and Ornamenting of Rooms, etc. By JAMES ARROWSMITH. 12mo., cloth . . . . . \$1.25

**ASHTON.**—The Theory and Practice of the Art of Designing Fancy Cotton and Woollen Cloths from Sample :

Giving full instructions for reducing drafts, as well as the methods of spooling and making out harness for cross drafts and finding any required reed; with calculations and tables of yarn. By FREDERIC T. ASHTON, Designer, West Pittsfield, Mass. With fifty-two illustrations. One vol. folio . . . . . \$6.00

**ASKINSON.**—Perfumes and their Preparation :

A Comprehensive Treatise on Perfumery, containing Complete Directions for Making Handkerchief Perfumes, Smelling-Salts, Sachets, Fumigating Pastils; Preparations for the Care of the Skin, the Mouth, the Hair; Cosmetics, Hair Dyes, and other Toilet Articles. By G.W. ASKINSON. Translated from the German by ISIDOR FURST. Revised by CHARLES RICE. 32 Illustrations. 8vo. \$3.00

**BAIRD.**—Miscellaneous Papers on Economic Questions. By Henry Carey Baird. (*In preparation.*)

**BAIRD.**—The American Cotton Spinner, and Manager's and Carder's Guide:

A Practical Treatise on Cotton Spinning; giving the Dimensions and Speed of Machinery, Draught and Twist Calculations, etc.; with notices of recent Improvements: together with Rules and Examples for making changes in the sizes and numbers of Roving and Yarn. Compiled from the papers of the late ROBERT H. BAIRD. 12mo. \$1.50



**BAIRD.—Standard Wages Computing Tables :**

An Improvement in all former Methods of Computation, so arranged that wages for days, hours, or fractions of hours, at a specified rate per day or hour, may be ascertained at a glance. By T. SPANGLER BAIRD. Oblong folio . . . . . \$5.00

**BAKER.—Long-Span Railway Bridges :**

Comprising Investigations of the Comparative Theoretical and Practical Advantages of the various Adopted or Proposed Type Systems of Construction; with numerous Formulæ and Tables. By B. BAKER. 12mo. . . . . \$1.50

**BAKER.—The Mathematical Theory of the Steam-Engine :**

With Rules at length, and Examples worked out for the use of Practical Men. By T. BAKER, C. E., with numerous Diagrams. Sixth Edition, Revised by Prof. J. R. YOUNG. 12mo. . . . . 75

**BARLOW.—The History and Principles of Weaving, by Hand and by Power :**

Reprinted, with Considerable Additions, from "Engineering," with a chapter on Lace-making Machinery, reprinted from the Journal of the "Society of Arts." By ALFRED BARLOW. With several hundred illustrations. 8vo., 443 pages . . . . . \$10.00

**BARR.—A Practical Treatise on the Combustion of Coal :**

Including descriptions of various mechanical devices for the Economic Generation of Heat by the Combustion of Fuel, whether solid, liquid or gaseous. 8vo. . . . . \$2.50

**BARR.—A Practical Treatise on High Pressure Steam Boilers :**

Including Results of Recent Experimental Tests of Boiler Materials, together with a Description of Approved Safety Apparatus, Steam Pumps, Injectors and Economizers in actual use. By WM. M. BARR. 204 Illustrations. 8vo. . . . . \$3.00

**BAUERMAN.—A Treatise on the Metallurgy of Iron :**

Containing Outlines of the History of Iron Manufacture, Methods of Assay, and Analysis of Iron Ores, Processes of Manufacture of Iron and Steel, etc., etc. By H. BAUERMAN, F. G. S., Associate of the Royal School of Mines. Fifth Edition, Revised and Enlarged. Illustrated with numerous Wood Engravings from Drawings by J. B. JORDAN. 12mo. . . . . \$2.00

**BAYLES.—House Drainage and Water Service :**

In Cities, Villages and Rural Neighborhoods. With Incidental Consideration of Certain Causes Affecting the Healthfulness of Dwellings. By JAMES C. BAYLES, Editor of "The Iron Age" and "The Metal Worker." With numerous illustrations. 8vo. cloth, \$3.00

**BEANS.—A Treatise on Railway Curves and Location of Railroads :**

By E. W. BEANS, C. E. Illustrated. 12mo. Tucks . . . . . \$1.50

**BECKETT.—A Rudimentary Treatise on Clocks, and Watches and Bells :**

By Sir EDMUND BECKETT, Bart., LL. D., Q. C. F. R. A. S. With numerous illustrations. Seventh Edition, Revised and Enlarged. 12mo. . . . . \$2.25

**BELL.—Carpentry Made Easy:**

Or, The Science and Art of Framing on a New and Improved System. With Specific Instructions for Building Balloon Frames, Barn Frames, Mill Frames, Warehouses, Church Spires, etc. Comprising also a System of Bridge Building, with Bills, Estimates of Cost, and valuable Tables. Illustrated by forty-four plates, comprising nearly 200 figures. By WILLIAM E. BELL, Architect and Practical Builder. 8vo. . . . . \$5.00

**BEMROSE.—Fret-Cutting and Perforated Carving:**

With fifty-three practical illustrations. By W. BEMROSE, JR. 1 vol. quarto . . . . . \$2.50

**BEMROSE.—Manual of Buhl-work and Marquetry:**

With Practical Instructions for Learners, and ninety colored designs. By W. BEMROSE, JR. 1 vol. quarto . . . . . \$3.00

**BEMROSE.—Manual of Wood Carving:**

With Practical Illustrations for Learners of the Art, and Original and Selected Designs. By WILLIAM BEMROSE, JR. With an Introduction by LLEWELLYN JEWITT, F. S. A., etc. With 128 illustrations, 4to. . . . . \$2.50

**BILLINGS.—Tobacco:**

Its History, Variety, Culture, Manufacture, Commerce, and Various Modes of Use. By E. R. BILLINGS. Illustrated by nearly 200 engravings. 8vo. . . . . \$3.00

**BIRD.—The American Practical Dyers' Companion:**

Comprising a Description of the Principal Dye-Substances and Chemicals used in Dyeing, their Natures and Uses; Mordants, and How Made; with the best American, English, French and German processes for Bleaching and Dyeing Silk, Wool, Cotton, Linen, Flannel, Felt, Dress Goods, Mixed and Hosiery Yarns, Feathers, Grass, Felt, Fur, Wool, and Straw Hats, Jute Yarn, Vegetable Ivory, Mats, Skins, Furs, Leather, etc., etc. By Wood, Aniline, and other Processes, together with Remarks on Finishing Agents, and Instructions in the Finishing of Fabrics, Substitutes for Indigo, Water-Proofing of Materials, Tests and Purification of Water, Manufacture of Aniline and other New Dye Wares, Harmonizing Colors, etc., etc.; embracing in all over 800 Receipts for Colors and Shades, accompanied by 170 Dyed Samples of Raw Materials and Fabrics. By F. J. BIRD, Practical Dyer, Author of "The Dyers' Hand-Book." 8vo. \$10.00

**BLINN.—A Practical Workshop Companion for Tin, Sheet-Iron, and Copper-plate Workers:**

Containing Rules for describing various kinds of Patterns used by Tin, Sheet-Iron and Copper-plate Workers; Practical Geometry; Mensuration of Surfaces and Solids; Tables of the Weights of Metals, Lead-pipe, etc.; Tables of Areas and Circumferences of Circles; Japan, Varnishes, Lackers, Cements, Compositions, etc., etc. By LEROY J. BLINN, Master Mechanic. With One Hundred and Seventy Illustrations. 12mo. . . . . \$2.50

**BOOTH.—Marble Worker's Manual :**

Containing Practical Information respecting Marbles in general, their Cutting, Working and Polishing; Veneering of Marble; Mosaics; Composition and Use of Artificial Marble, Stuccos, Cements, Receipts, Secrets, etc., etc. Translated from the French by M. L. BOOTH. With an Appendix concerning American Marbles. 12mo., cloth \$1.50

**BOOTH and MORFIT.—The Encyclopædia of Chemistry, Practical and Theoretical :**

Embracing its application to the Arts, Metallurgy, Mineralogy, Geology, Medicine and Pharmacy. By JAMES C. BOOTH, Melter and Refiner in the United States Mint, Professor of Applied Chemistry in the Franklin Institute, etc., assisted by CAMPBELL MORFIT, author of "Chemical Manipulations," etc. Seventh Edition. Complete in one volume, royal 8vo., 978 pages, with numerous wood-cuts and other illustrations . . . . . \$3.50

**BRAMWELL.—The Wool Carder's Vade-Mecum :**

A Complete Manual of the Art of Carding Textile Fabrics. By W. C. BRAMWELL. Third Edition, revised and enlarged. Illustrated. Pp. 400. 12mo. . . . . \$2.50

**BRANNT.—A Practical Treatise on Animal and Vegetable Fats and Oils :**

Comprising both Fixed and Volatile Oils, their Physical and Chemical Properties and Uses, the Manner of Extracting and Refining them, and Practical Rules for Testing them; as well as the Manufacture of Artificial Butter, Lubricants, including Mineral Lubricating Oils, etc., and on Ozokerite. Edited chiefly from the German of DR. KARL SCHÆDLER, G. W. ASKINSON, and RICHARD BRUNNER, with Additions and Lists of American Patents relating to the Extraction, Rendering, Refining, Decomposing, and Bleaching of Fats and Oils. By WILLIAM T. BRANNT. Illustrated by 244 engravings. 739 pages. 8vo. . . . . \$7.50

**BRANNT.—A Practical Treatise on the Manufacture of Soap and Candles :**

Based upon the most Recent Experiences in the Practice and Science; comprising the Chemistry, Raw Materials, Machinery, and Utensils and Various Processes of Manufacture, including a great variety of formulas. Edited chiefly from the German of Dr. C. Deite, A. Engelhardt, Dr. C. Schædler and others; with additions and lists of American Patents relating to these subjects. By WM. T. BRANNT. Illustrated by 163 engravings. 677 pages. 8vo. . . . . \$7.50

**BRANNT.—A Practical Treatise on the Raw Materials and the Distillation and Rectification of Alcohol, and the Preparation of Alcoholic Liquors, Liqueurs, Cordials, Bitters, etc. :**

Edited chiefly from the German of Dr. K. Stammer, Dr. F. Elsner, and E. Schubert. By WM. T. BRANNT. Illustrated by thirty-one engravings. 12mo. . . . . \$2.50

- BRANNT—WAHL.**—The Techno-Chemical Receipt Book:  
Containing several thousand Receipts covering the latest, most important, and most useful discoveries in Chemical Technology, and their Practical Application in the Arts and the Industries. Edited chiefly from the German of Drs. Winckler, Elsner, Heintze, Mierzinski, Jacobsen, Koller, and Heinzerling, with additions by Wm. J. BRANNT and Wm. H. WAHL, PH. D. Illustrated by 78 engravings. 12mo. 495 pages . . . . . \$2.00
- BROWN.**—Five Hundred and Seven Mechanical Movements:  
Embracing all those which are most important in Dynamics, Hydraulics, Hydrostatics, Pneumatics, Steam-Engines, Mill and other Gearing, Presses, Horology and Miscellaneous Machinery; and including many movements never before published, and several of which have only recently come into use. By HENRY T. BROWN. 12mo. . . . . \$1.00
- BUCKMASTER.**—The Elements of Mechanical Physics:  
By J. C. BUCKMASTER. Illustrated with numerous engravings. 12mo. . . . . \$1.50
- BULLOCK.**—The American Cottage Builder:  
A Series of Designs, Plans and Specifications, from \$200 to \$20,000, for Homes for the People; together with Warming, Ventilation, Drainage, Painting and Landscape Gardening. By JOHN BULLOCK, Architect and Editor of "The Rudiments of Architecture and Building," etc., etc. Illustrated by 75 engravings. 8vo. \$3.50
- BULLOCK.**—The Rudiments of Architecture and Building:  
For the use of Architects, Builders, Draughtsmen, Machinists, Engineers and Mechanics. Edited by JOHN BULLOCK, author of "The American Cottage Builder." Illustrated by 250 Engravings. 8vo. \$3.50
- BURGH.**—Practical Rules for the Proportions of Modern Engines and Boilers for Land and Marine Purposes.  
By N. P. BURGH, Engineer. 12mo. . . . . \$1.50
- BYLES.**—Sophisms of Free Trade and Popular Political Economy Examined.  
By a BARRISTER (SIR JOHN BARNARD BYLES, Judge of Common Pleas). From the Ninth English Edition, as published by the Manchester Reciprocity Association. 12mo. . . . . \$1.25
- BOWMAN.**—The Structure of the Wool Fibre in its Relation to the Use of Wool for Technical Purposes:  
Being the substance, with additions, of Five Lectures, delivered at the request of the Council, to the members of the Bradford Technical College, and the Society of Dyers and Colorists. By F. H. BOWMAN, D. Sc., F. R. S. E., F. L. S. Illustrated by 32 engravings. 8vo. . . . . \$6.50
- BYRNE.**—Hand-Book for the Artisan, Mechanic, and Engineer:  
Comprising the Grinding and Sharpening of Cutting Tools, Abrasive Processes, Lapidary Work, Gem and Glass Engraving, Varnishing and Lackering, Apparatus, Materials and Processes for Grinding and

- Polishing, etc. By OLIVER BYRNE. Illustrated by 185 wood engravings. 8vo. . . . . \$5.00
- BYRNE.—Pocket-Book for Railroad and Civil Engineers:**  
Containing New, Exact and Concise Methods for Laying out Railroad Curves, Switches, Frog Angles and Crossings; the Staking out of work; Levelling; the Calculation of Cuttings; Embankments; Earthwork, etc. By OLIVER BYRNE. 18mo., full bound, pocket-book form . . . . . \$1.75
- BYRNE.—The Practical Metal-Worker's Assistant:**  
Comprising Metallurgic Chemistry; the Arts of Working all Metals and Alloys; Forging of Iron and Steel; Hardening and Tempering; Melting and Mixing; Casting and Founding; Works in Sheet Metal; the Processes Dependent on the Ductility of the Metals; Soldering; and the most Improved Processes and Tools employed by Metal-Workers. With the Application of the Art of Electro-Metallurgy to Manufacturing Processes; collected from Original Sources, and from the works of Holtzapffel, Bergeron, Lenpold, Plumier, Napier, Scoffern, Clay, Fairbairn and others. By OLIVER BYRNE. A new, revised and improved edition, to which is added an Appendix, containing The Manufacture of Russian Sheet-Iron. By JOHN PERCY, M. D., F. R. S. The Manufacture of Malleable Iron Castings, and Improvements in Bessemer Steel. By A. A. FESQUET, Chemist and Engineer. With over Six Hundred Engravings, Illustrating every Branch of the Subject. 8vo. . . . . \$5.00
- BYRNE.—The Practical Model Calculator:**  
For the Engineer, Mechanic, Manufacturer of Engine Work, Naval Architect, Miner and Millwright. By OLIVER BYRNE. 8vo., nearly 600 pages . . . . . \$4.50
- CABINET MAKER'S ALBUM OF FURNITURE:**  
Comprising a Collection of Designs for various Styles of Furniture. Illustrated by Forty-eight Large and Beautifully Engraved Plates. Oblong, 8vo. . . . . \$2.00
- CALLINGHAM.—Sign Writing and Glass Embossing:**  
A Complete Practical Illustrated Manual of the Art. By JAMES CALLINGHAM. 12mo. . . . . \$1.50
- CAMPIN.—A Practical Treatise on Mechanical Engineering:**  
Comprising Metallurgy, Moulding, Casting, Forging, Tools, Workshop Machinery, Mechanical Manipulation, Manufacture of Steam-Engines, etc. With an Appendix on the Analysis of Iron and Iron Ores. By FRANCIS CAMPIN, C. E. To which are added, Observations on the Construction of Steam Boilers, and Remarks upon Furnaces used for Smoke Prevention; with a Chapter on Explosions. By R. ARMSTRONG, C. E., and JOHN BOURNE. Rules for Calculating the Change Wheels for Screws on a Turning Lathe, and for a Wheel-cutting Machine. By J. LA NICCA. Management of Steel, Including Forging, Hardening, Tempering, Annealing, Shrinking and Expansion; and the Case-hardening of Iron. By G. EDE. 8vo. Illustrated with twenty-nine plates and 100 wood engravings . . . \$5.00

- CAREY.—A Memoir of Henry C. Carey.**  
By DR. WM. ELDER. With a portrait. 8vo., cloth . . . 75
- CAREY.—The Works of Henry C. Carey :**  
**Harmony of Interests: Agricultural, Manufacturing and Commercial.** 8vo. . . . . \$1.50  
**Manual of Social Science.** Condensed from Carey's "Principles of Social Science." By KATE MCKEAN. 1 vol. 12mo. . . \$2.25  
**Miscellaneous Works.** With a Portrait. 2 vols. 8vo. . \$10.00  
**Past, Present and Future.** 8vo. . . . . \$2.50  
**Principles of Social Science.** 3 volumes, 8vo. . . . \$7.50  
**The Slave-Trade, Domestic and Foreign; Why it Exists, and How it may be Extinguished (1853).** 8vo. . . . . \$2.00  
**The Unity of Law: As Exhibited in the Relations of Physical, Social, Mental and Moral Science (1872).** 8vo. . . . \$3.50
- CLARK.—Tramways, their Construction and Working :**  
Embracing a Comprehensive History of the System. With an exhaustive analysis of the various modes of traction, including horse-power, steam, heated water and compressed air; a description of the varieties of Rolling stock, and ample details of cost and working expenses. By D. KINNEAR CLARK. Illustrated by over 200 wood engravings, and thirteen folding plates. 2 vols. 8vo. . . \$12.50
- COLBURN.—The Locomotive Engine :**  
Including a Description of its Structure, Rules for Estimating its Capabilities, and Practical Observations on its Construction and Management. By ZERAH COLBURN. Illustrated. 12mo. . . \$1.00
- COLLENS.—The Eden of Labor; or, the Christian Utopia.**  
By T. WHARTON COLLENS, author of "Humanics," "The History of Charity," etc. 12mo. Paper cover, \$1.00; Cloth . . . \$1.25
- COOLEY.—A Complete Practical Treatise on Perfumery :**  
Being a Hand-book of Perfumes, Cosmetics and other Toilet Articles, With a Comprehensive Collection of Formulæ. By ARNOLD J COOLEY. 12mo. . . . . \$1.50
- COOPER.—A Treatise on the use of Belting for the Transmission of Power.**  
With numerous illustrations of approved and actual methods of arranging Main Driving and Quarter Twist Belts, and of Belt Fastenings. Examples and Rules in great number for exhibiting and calculating the size and driving power of Belts. Plain, Particular and Practical Directions for the Treatment, Care and Management of Belts. Descriptions of many varieties of Beltings, together with chapters on the Transmission of Power by Ropes; by Iron and Wood Frictional Gearing; on the Strength of Belting Leather; and on the Experimental Investigations of Morin, Briggs, and others. By JOHN H. COOPER, M. E. 8vo. . . . . \$3.50
- CRAIK.—The Practical American Millwright and Miller.**  
By DAVID CRAIK, Millwright. Illustrated by numerous wood engravings and two folding plates. 8vo. . . . . \$5.00

**CREW.—A Practical Treatise on Petroleum :**

Comprising its Origin, Geology, Geographical Distribution, History, Chemistry, Mining, Technology, Uses and Transportation. Together with a Description of Gas Wells, the Application of Gas as Fuel, etc. By BENJAMIN J. CREW. With an Appendix on the Product and Exhaustion of the Oil Regions, and the Geology of Natural Gas in Pennsylvania and New York. By CHARLES A. ASHBURNER, M. S., Geologist in Charge Pennsylvania Survey, Philadelphia. Illustrated by 70 engravings. 8vo. 508 pages . . . \$5.00

**CROSS.—The Cotton Yarn Spinner:**

Showing how the Preparation should be arranged for Different Counts of Yarns by a System more uniform than has hitherto been practiced; by having a Standard Schedule from which we make all our Changes. By RICHARD CROSS. 122 pp. 12mo. . . 75

**CRISTIANI.—A Technical Treatise on Soap and Candles:**

With a Glance at the Industry of Fats and Oils. By R. S. CRISTIANI, Chemist. Author of "Perfumery and Kindred Arts." Illustrated by 176 engravings. 581 pages, 8vo. . . \$15.00

**CRISTIANI.—Perfumery and Kindred Arts:**

A Comprehensive Treatise on Perfumery, containing a History of Perfumes from the remotest ages to the present time. A complete detailed description of the various Materials and Apparatus used in the Perfumer's Art, with thorough Practical Instruction and careful Formulae, and advice for the fabrication of all known preparations of the day, including Essences, Tinctures, Extracts, Spirits, Waters, Vinegars, Pomades, Powders, Paints, Oils, Emulsions, Cosmetics, Infusions, Pastilles, Tooth Powders and Washes, Cachous, Hair Dyes, Sachets, Essential Oils, Flavoring Extracts, etc.; and full details for making and manipulating Fancy Toilet Soaps, Shaving Creams, etc., by new and improved methods. With an Appendix giving hints and advice for making and fermenting Domestic Wines, Cordials, Liquors, Candies, Jellies, Syrups, Colors, etc., and for Perfuming and Flavoring Segars, Snuff and Tobacco, and Miscellaneous Receipts for various useful Analogous Articles. By R. S. CRISTIANI, Consulting Chemist and Perfumer, Philadelphia. 8vo. . . \$10.00

**DAVIDSON.—A Practical Manual of House Painting, Graining, Marbling, and Sign-Writing:**

Containing full information on the processes of House Painting in Oil and Distemper, the Formation of Letters and Practice of Sign-Writing, the Principles of Decorative Art, a Course of Elementary Drawing for House Painters, Writers, etc., and a Collection of Useful Receipts. With nine colored illustrations of Woods and Marbles, and numerous wood engravings. By ELLIS A. DAVIDSON. 12mo. \$3.00

**DAVIES.—A Treatise on Earthy and Other Minerals and Mining:**

By D. C. DAVIES, F. G. S., Mining Engineer, etc. Illustrated by 76 Engravings. 12mo. . . \$5.00

- DAVIES.—A Treatise on Metalliferous Minerals and Mining:**  
 By D. C. DAVIES, F. G. S., Mining Engineer, Examiner of Mines, Quarries and Collieries. Illustrated by 148 engravings of Geological Formations, Mining Operations and Machinery, drawn from the practice of all parts of the world. 2d Edition, 12mo., 450 pages \$5.00
- DAVIES.—A Treatise on Slate and Slate Quarrying:**  
 Scientific, Practical and Commercial. By D. C. DAVIES, F. G. S., Mining Engineer, etc. With numerous illustrations and folding plates. 12mo. . . . . \$2.00
- DAVIS.—A Treatise on Steam-Boiler Incrustation and Methods for Preventing Corrosion and the Formation of Scale:**  
 By CHARLES T. DAVIS. Illustrated by 65 engravings. 8vo. \$1.50
- DAVIS.—The Manufacture of Paper:**  
 Being a Description of the various Processes for the Fabrication, Coloring and Finishing of every kind of Paper, Including the Different Raw Materials and the Methods for Determining their Values, the Tools, Machines and Practical Details connected with an intelligent and a profitable prosecution of the art, with special reference to the best American Practice. To which are added a History of Paper, complete Lists of Paper-Making Materials, List of American Machines, Tools and Processes used in treating the Raw Materials, and in Making, Coloring and Finishing Paper. By CHARLES T. DAVIS. Illustrated by 156 engravings. 608 pages, 8vo. \$6.00
- DAVIS.—The Manufacture of Leather:**  
 Being a description of all of the Processes for the Tanning, Tawing, Currying, Finishing and Dyeing of every kind of Leather; including the various Raw Materials and the Methods for Determining their Values; the Tools, Machines, and all Details of Importance connected with an Intelligent and Profitable Prosecution of the Art, with Special Reference to the Best American Practice. To which are added Complete Lists of all American Patents for Materials, Processes, Tools, and Machines for Tanning, Currying, etc. By CHARLES THOMAS DAVIS. Illustrated by 302 engravings and 12 Samples of Dyed Leathers. One vol., 8vo., 824 pages . . . \$10.00
- DAWIDOWSKY—BRANNT.—A Practical Treatise on the Raw Materials and Fabrication of Glue, Gelatine, Gelatine Veneers and Foils, Isinglass, Cements, Pastes, Mucilages, etc.:**  
 Based upon Actual Experience. By F. DAWIDOWSKY, Technical Chemist. Translated from the German, with extensive additions, including a description of the most Recent American Processes, by WILLIAM T. BRANNT, Graduate of the Royal Agricultural College of Eldena, Prussia. 35 Engravings. 12mo. . . . \$2.50
- DE GRAFF.—The Geometrical Stair-Builders' Guide:**  
 Being a Plain Practical System of Hand-Railing, embracing all its necessary Details, and Geometrically Illustrated by twenty-two Steel Engravings; together with the use of the most approved principles of Practical Geometry. By SIMON DE GRAFF, Architect. 4to. \$2.50



**DR KONINCK—DIETZ.—A Practical Manual of Chemical Analysis and Assaying :**

As applied to the Manufacture of Iron from its Ores, and to Cast Iron, Wrought Iron, and Steel, as found in Commerce. By L. L. DR KONINCK, Dr. Sc., and E. DIETZ, Engineer. Edited with Notes, by ROBERT MALLET, F. R. S., F. S. G., M. I. C. E., etc. American Edition, Edited with Notes and an Appendix on Iron Ores, by A. A. FESQUET, Chemist and Engineer. 12mo. . . . \$2.50

**DUNCAN.—Practical Surveyor's Guide :**

Containing the necessary information to make any person of common capacity, a finished land surveyor without the aid of a teacher By ANDREW DUNCAN. Illustrated. 12mo. . . . \$1.25

**DUPLAIS.—A Treatise on the Manufacture and Distillation of Alcoholic Liquors :**

Comprising Accurate and Complete Details in Regard to Alcohol from Wine, Molasses, Beets, Grain, Rice, Potatoes, Sorghum, Asphodel, Fruits, etc.; with the Distillation and Rectification of Brandy, Whiskey, Rum, Gin, Swiss Absinthe, etc., the Preparation of Aromatic Waters, Volatile Oils or Essences, Sugars, Syrups, Aromatic Tinctures, Liqueurs, Cordial Wines, Effervescing Wines, etc., the Ageing of Brandy and the improvement of Spirits, with Copious Directions and Tables for Testing and Reducing Spirituous Liquors, etc., etc. Translated and Edited from the French of MM. DUPLAIS, Ainè et Jeune. By M. MCKENNIE, M. D. To which are added the United States Internal Revenue Regulations for the Assessment and Collection of Taxes on Distilled Spirits. Illustrated by fourteen folding plates and several wood engravings. 743 pp. 8vo. \$10 00

**DUSSAUCE.—Practical Treatise on the Fabrication of Matches, Gun Cotton, and Fulminating Powder.**

By Professor H. DUSSAUCE. 12mo. . . . \$3 00

**DYER AND COLOR-MAKER'S COMPANION :**

Containing upwards of two hundred Receipts for making Colors, on the most approved principles, for all the various styles and fabrics now in existence; with the Scouring Process, and plain Directions for Preparing, Washing-off, and Finishing the Goods. 12mo. \$1 25

**EDWARDS.—A Catechism of the Marine Steam-Engine,**

For the use of Engineers, Firemen, and Mechanics. A Practical Work for Practical Men. By EMORY EDWARDS, Mechanical Engineer. Illustrated by sixty-three Engravings, including examples of the most modern Engines. Third edition, thoroughly revised, with much additional matter. 12mo. 414 pages . . . \$2 00

**EDWARDS.—Modern American Locomotive Engines,**

Their Design, Construction and Management. By EMORY EDWARDS. Illustrated 12mo. . . . \$2.00

**EDWARDS.—The American Steam Engineer :**

Theoretical and Practical, with examples of the latest and most approved American practice in the design and construction of Steam Engines and Boilers. For the use of engineers, machinists, boiler-makers, and engineering students. By EMORY EDWARDS. Fully illustrated, 419 pages. 12mo. . . . \$2.50

**EDWARDS.—Modern American Marine Engines, Boilers, and Screw Propellers,**

Their Design and Construction. Showing the Present Practice of the most Eminent Engineers and Marine Engine Builders in the United States. Illustrated by 30 large and elaborate plates. 4to. \$5.00

**EDWARDS.—The Practical Steam Engineer's Guide**

In the Design, Construction, and Management of American Stationary, Portable, and Steam Fire-Engines, Steam Pumps, Boilers, Injectors, Governors, Indicators, Pistons and Rings, Safety Valves and Steam Gauges. For the use of Engineers, Firemen, and Steam Users. By EMORY EDWARDS. Illustrated by 119 engravings. 420 pages. 12mo. . . . . \$2 50

**EISSLER.—The Metallurgy of Gold:**

A Practical Treatise on the Metallurgical Treatment of Gold-Bearing Ores, including the Processes of Concentration and Chlorination, and the Assaying, Melting, and Refining of Gold. By M. EISSLER. With 132 Illustrations. 12mo. . . . . \$3.50

**EISSLER.—The Metallurgy of Silver:**

A Practical Treatise on the Amalgamation, Roasting, and Lixiviation of Silver Ores, including the Assaying, Melting, and Refining of Silver Bullion. By M. EISSLER. 124 Illustrations. 336 pp. 12mo. . . . . \$4.25

**ELDER.—Conversations on the Principal Subjects of Political Economy.**

By DR. WILLIAM ELDER. 8vo. . . . . \$2.50

**ELDER.—Questions of the Day,**

Economic and Social. By DR. WILLIAM ELDER. 8vo. . . . . \$3.00

**ERNI.—Mineralogy Simplified.**

Easy Methods of Determining and Classifying Minerals, including Ores, by means of the Blow-pipe, and by Humid Chemical Analysis, based on Professor von Kobell's Tables for the Determination of Minerals, with an Introduction to Modern Chemistry. By HENRY ERNI, A.M., M.D., Professor of Chemistry. Second Edition, rewritten, enlarged and improved. 12mo. . . . . \$3.00

**FAIRBAIRN.—The Principles of Mechanism and Machinery of Transmission.**

Comprising the Principles of Mechanism, Wheels, and Pulleys, Strength and Proportions of Shafts, Coupling of Shafts, and Engaging and Disengaging Gear. By SIR WILLIAM FAIRBAIRN, Bart. C. E. Beautifully illustrated by over 150 wood-cuts. In one volume, 12mo. . . . . \$2.50

**FLEMING.—Narrow Gauge Railways in America.**

A Sketch of their Rise, Progress, and Success. Valuable Statistics as to Grades, Curves, Weight of Rail, Locomotives, Cars, etc. By HOWARD FLEMING. Illustrated, 8vo. . . . . \$1 00

**FORSYTH.—Book of Designs for Headstones, Mural, and other Monuments:**

Containing 78 Designs. By JAMES FORSYTH. With an Introduction by CHARLES BOUTELL, M. A. 4 to., cloth . . . . . \$5 00

- FRANKEL—HUTTER.—A Practical Treatise on the Manufacture of Starch, Glucose, Starch-Sugar, and Dextrine:**  
Based on the German of LADISLAUS VON WAGNER, Professor in the Royal Technical High School, Buda-Pest, Hungary, and other authorities. By JULIUS FRANKEL, Graduate of the Polytechnic School of Hanover. Edited by ROBERT HUTTER, Chemist, Practical Manufacturer of Starch-Sugar. Illustrated by 58 engravings, covering every branch of the subject, including examples of the most Recent and Best American Machinery. 8vo., 344 pp. . . \$3.50
- GARDNER.—The Painter's Encyclopædia:**  
Containing Definitions of all Important Words in the Art of Plain and Artistic Painting, with Details of Practice in Coach, Carriage, Railway Car, House, Sign, and Ornamental Painting, including Graining, Marbling, Staining, Varnishing, Polishing, Lettering, Stenciling, Gilding, Bronzing, etc. By FRANKLIN B. GARDNER. 158 Illustrations. 12mo. 427 pp. . . \$2.00
- GARDNER.—Everybody's Paint Book:**  
A Complete Guide to the Art of Outdoor and Indoor Painting, Designed for the Special Use of those who wish to do their own work, and consisting of Practical Lessons in Plain Painting, Varnishing, Polishing, Staining, Paper Hanging, Kalsomining, etc., as well as Directions for Renovating Furniture, and Hints on Artistic Work for Home Decoration. 38 Illustrations. 12mo., 183 pp. . . \$1.00
- GEE.—The Goldsmith's Handbook:**  
Containing full instructions for the Alloying and Working of Gold, including the Art of Alloying, Melting, Reducing, Coloring, Collecting, and Refining; the Processes of Manipulation, Recovery of Waste; Chemical and Physical Properties of Gold; with a New System of Mixing its Alloys; Solders, Enamels, and other Useful Rules and Recipes. By GEORGE E. GEE. 12mo. . . \$1.75
- GEE.—The Silversmith's Handbook:**  
Containing full instructions for the Alloying and Working of Silver, including the different modes of Refining and Melting the Metal; its Solders; the Preparation of Imitation Alloys; Methods of Manipulation; Prevention of Waste; Instructions for Improving and Finishing the Surface of the Work; together with other Useful Information and Memoranda. By GEORGE E. GEE. Illustrated. 12mo. \$1.75
- GOTHIC ALBUM FOR CABINET-MAKERS:**  
Designs for Gothic Furniture. Twenty-three plates. Oblong \$2.00
- GRANT.—A Handbook on the Teeth of Gears:**  
Their Curves, Properties, and Practical Construction. By GEORGE B. GRANT. Illustrated. Third Edition, enlarged. 8vo. \$1.50
- GREENWOOD.—Steel and Iron:**  
Comprising the Practice and Theory of the Several Methods Pursued in their Manufacture, and of their Treatment in the Rolling-Mills, the Forge, and the Foundry. By WILLIAM HENRY GREENWOOD, F. C. S. With 97 Diagrams, 536 pages. 12mo. \$2.00

- GREGORY.—Mathematics for Practical Men:**  
 Adapted to the Pursuits of Surveyors, Architects, Mechanics, and Civil Engineers. By OLINTHUS GREGORY. 8vo., plates \$3.00
- GRIMSHAW.—Saws:**  
 The History, Development, Action, Classification, and Comparison of Saws of all kinds. *With Copious Appendices.* Giving the details of Manufacture, Filing, Setting, Gumming, etc. Care and Use of Saws; Tables of Gauges; Capacities of Saw-Mills; List of Saw-Patents, and other valuable information. By ROBERT GRIMSHAW. Second and greatly enlarged edition, *with Supplement*, and 354 Illustrations. Quarto . . . . . \$5.00
- GRISWOLD.—Railroad Engineer's Pocket Companion for the Field:**  
 Comprising Rules for Calculating Deflection Distances and Angles, Tangential Distances and Angles, and all Necessary Tables for Engineers; also the Art of Levelling from Preliminary Survey to the Construction of Railroads, intended Expressly for the Young Engineer, together with Numerous Valuable Rules and Examples. By W. GRISWOLD. 12mo., tucks . . . . . \$1.75
- GRUNER.—Studies of Blast Furnace Phenomena:**  
 By M. L. GRUNER, President of the General Council of Mines of France, and lately Professor of Metallurgy at the Ecole des Mines. Translated, with the author's sanction, with an Appendix, by L. D. B. GORDON, F. R. S. E., F. G. S. 8vo. . . . . \$2.50
- Hand-Book of Useful Tables for the Lumberman, Farmer and Mechanic:**  
 Containing Accurate Tables of Logs Reduced to Inch Board Measure, Plank, Scantling and Timber Measure; Wages and Rent, by Week or Month; Capacity of Granaries, Bins and Cisterns; Land Measure, Interest Tables, with Directions for Finding the Interest on any sum at 4, 5, 6, 7 and 8 per cent., and many other Useful Tables. 32 mo., boards. 186 pages . . . . . .25
- HASERICK.—The Secrets of the Art of Dyeing Wool, Cotton, and Linen,**  
 Including Bleaching and Coloring Wool and Cotton Hosiery and Random Yarns. A Treatise based on Economy and Practice. By E. C. HASERICK. *Illustrated by 323 Dyed Patterns of the Yarns or Fabrics.* 8vo. . . . . \$7.50
- HATS AND FELTING:**  
 A Practical Treatise on their Manufacture. By a Practical Hatter. Illustrated by Drawings of Machinery, etc. 8vo. . . . . \$1.25
- HOFFER.—A Practical Treatise on Caoutchouc and Gutta Percha,**  
 Comprising the Properties of the Raw Materials, and the manner of Mixing and Working them; with the Fabrication of Vulcanized and Hard Rubbers, Caoutchouc and Gutta Percha Compositions, Water-proof Substances, Elastic Tissues, the Utilization of Waste, etc., etc. From the German of RAIMUND HOFFER. By W. T. BRANNT. Illustrated 12mo. . . . . \$2.50

**HAUPT—RHAWN.—A Move for Better Roads:**

Essays on Road-making and Maintenance and Road Laws, for which Prizes or Honorable Mention were Awarded through the University of Pennsylvania by a Committee of Citizens of Philadelphia, with a Synopsis of other Contributions and a Review by the Secretary, LEWIS M. HAUPT, A. M., C. E.; also an Introduction by WILLIAM H. RHAWN, Chairman of the Committee. 319 pages. 8vo. . . . . \$2.00

**HUGHES.—American Miller and Millwright's Assistant:**

By WILLIAM CARTER HUGHES. 12mo. . . . . \$1.50

**HULME.—Worked Examination Questions in Plane Geometrical Drawing:**

For the Use of Candidates for the Royal Military Academy, Woolwich; the Royal Military College, Sandhurst; the Indian Civil Engineering College, Cooper's Hill; Indian Public Works and Telegraph Departments; Royal Marine Light Infantry; the Oxford and Cambridge Local Examinations, etc. By F. EDWARD HULME, F. L. S., F. S. A., Art-Master Marlborough College. Illustrated by 300 examples. Small quarto . . . . . \$2.50

**JERVIS.—Railroad Property:**

A Treatise on the Construction and Management of Railways; designed to afford useful knowledge, in the popular style, to the holders of this class of property; as well as Railway Managers, Officers, and Agents. By JOHN B. JERVIS, late Civil Engineer of the Hudson River Railroad, Croton Aqueduct, etc. 12mo., cloth \$2.00

**KEENE.—A Hand-Book of Practical Gauging:**

For the Use of Beginners, to which is added a Chapter on Distillation, describing the process in operation at the Custom-House for ascertaining the Strength of Wines. By JAMES B. KEENE, of H. M. Customs. 8vo. . . . . \$1.25

**KELLEY.—Speeches, Addresses, and Letters on Industrial and Financial Questions:**

By HON. WILLIAM D. KELLEY, M. C. 544 pages, 8vo. . . . \$3.00

**KELLOGG.—A New Monetary System:**

The only means of Securing the respective Rights of Labor and Property, and of Protecting the Public from Financial Revulsions. By EDWARD KELLOGG. Revised from his work on "Labor and other Capital." With numerous additions from his manuscript. Edited by MARY KELLOGG PUTNAM. Fifth edition. To which is added a Biographical Sketch of the Author. One volume, 12mo. Paper cover . . . . . \$1.00  
Bound in cloth . . . . . 1.50

**KEMLO.—Watch-Repairer's Hand-Book:**

Being a Complete Guide to the Young Beginner, in Taking Apart, Putting Together, and Thoroughly Cleaning the English Lever and other Foreign Watches, and all American Watches. By F. KEMLO, Practical Watchmaker. With Illustrations. 12mo. . . . \$1.25

- KENTISH.—A Treatise on a Box of Instruments,**  
And the Slide Rule; with the Theory of Trigonometry and Logarithms, including Practical Geometry, Surveying, Measuring of Timber, Cask and Malt Gauging, Heights, and Distances. By THOMAS KENTISH. In one volume. 12mo. . . . . \$1.25
- KERL.—The Assayer's Manual:**  
An Abridged Treatise on the Docimastic Examination of Ores, and Furnace and other Artificial Products. By BRUNO KERL, Professor in the Royal School of Mines. Translated from the German by WILLIAM T. BRANNT. Second American edition, edited with Extensive Additions by F. LYNWOOD GARRISON, Member of the American Institute of Mining Engineers, etc. Illustrated by 87 engravings. 8vo. . . . . \$3.00
- KICK.—Flour Manufacture.**  
A Treatise on Milling Science and Practice. By FREDERICK KICK, Imperial Regierungsrath, Professor of Mechanical Technology in the Imperial German Polytechnic Institute, Prague. Translated from the second enlarged and revised edition with supplement by H. H. P. POWLES, Assoc. Memb. Institution of Civil Engineers. Illustrated with 28 Plates, and 167 Wood-cuts. 367 pages. 8vo. . \$10.00
- KINGZETT.—The History, Products, and Processes of the Alkali Trade:**  
Including the most Recent Improvements. By CHARLES THOMAS KINGZETT, Consulting Chemist. With 23 illustrations. 8vo. . \$2.50
- KIRK.—The Founding of Metals:**  
A Practical Treatise on the Melting of Iron, with a Description of the Founding of Alloys; also, of all the Metals and Mineral Substances used in the Art of Founding. Collected from original sources. By EDWARD KIRK, Practical Foundryman and Chemist. Illustrated. Third edition. 8vo. . . . . \$2.50
- LANDRIN.—A Treatise on Steel:**  
Comprising its Theory, Metallurgy, Properties, Practical Working, and Use. By M. H. C. LANDRIN, JR., Civil Engineer. Translated from the French, with Notes, by A. A. FESQUET, Chemist and Engineer. With an Appendix on the Bessemer and the Martin Processes for Manufacturing Steel, from the Report of Abram S. Hewitt, United States Commissioner to the Universal Exposition, Paris, 1867! 12mo. . . . . \$3.00
- LANGBEIN.—A Complete Treatise on the Electro-Deposition of Metals:**  
Translated from the German, with Additions, by WM. T. BRANNT. 125 illustrations. 8vo. . . . . \$4.00
- LARDNER.—The Steam-Engine:**  
For the Use of Beginners. Illustrated. 12mo. . . . . 75
- LEHNER.—The Manufacture of Ink:**  
Comprising the Raw Materials, and the Preparation of Writing, Copying and Hektograph Inks, Safety Inks, Ink Extracts and Powders, etc. Translated from the German of SIGMUND LEHNER, with additions by WILLIAM T. BRANNT. Illustrated. 12mo. . \$2.00

**LARKIN.—The Practical Brass and Iron Founder's Guide:**

A Concise Treatise on Brass Founding, Moulding, the Metals and their Alloys, etc.; to which are added Recent Improvements in the Manufacture of Iron, Steel by the Bessemer Process, etc., etc. By JAMES LARKIN, late Conductor of the Brass Foundry Department in Reany, Neafie & Co.'s Penn Works, Philadelphia. New edition, revised, with extensive additions. 12mo. . . . \$2.50

**LEROUX.—A Practical Treatise on the Manufacture of Worsteds and Carded Yarns:**

Comprising Practical Mechanics, with Rules and Calculations applied to Spinning; Sorting, Cleaning, and Scouring Wools; the English and French Methods of Combing, Drawing, and Spinning Worsteds, and Manufacturing Carded Yarns. Translated from the French of CHARLES LEROUX, Mechanical Engineer and Superintendent of a Spinning-Mill, by HORATIO PAINE, M. D., and A. A. FESQUET, Chemist and Engineer. Illustrated by twelve large Plates. To which is added an Appendix, containing Extracts from the Reports of the International Jury, and of the Artisans selected by the Committee appointed by the Council of the Society of Arts, London, on Woolen and Worsted Machinery and Fabrics, as exhibited in the Paris Universal Exposition, 1867. 8vo. . . . \$5.00

**LEFFEL.—The Construction of Mill-Dams:**

Comprising also the Building of Race and Reservoir Embankments and Head-Gates, the Measurement of Streams, Gauging of Water Supply, etc. By JAMES LEFFEL & CO. Illustrated by 58 engravings. 8vo. . . . \$2.50

**LESLIE.—Complete Cookery:**

Directions for Cookery in its Various Branches. By MISS LESLIE. Sixtieth thousand. Thoroughly revised, with the addition of New Receipts. 12mo. . . . \$1.50

**LE VAN.—The Steam Engine and the Indicator:**

Their Origin and Progressive Development; including the Most Recent Examples of Steam and Gas Motors, together with the Indicator, its Principles, its Utility, and its Application. By WILLIAM BARNET LE VAN. Illustrated by 205 Engravings, chiefly of Indicator-Cards. 469 pp. 8vo. . . . \$4.00

**LIEBER.—Assayer's Guide:**

Or, Practical Directions to Assayers, Miners, and Smelters, for the Tests and Assays, by Heat and by Wet Processes, for the Ores of all the principal Metals, of Gold and Silver Coins and Alloys, and of Coal, etc. By OSCAR M. LIEBER. 12mo. . . . \$1.25

**Lockwood's Dictionary of Terms:**

Used in the Practice of Mechanical Engineering, embracing those Current in the Drawing Office, Pattern Shop, Foundry, Fitting, Turning, Smith's and Boiler Shops, etc., etc., comprising upwards of Six Thousand Definitions. Edited by a Foreman Pattern Maker, author of "Pattern Making." 417 pp. 12mo. . . . \$3.00

**LUKIN.—Amongst Machines:**

Embracing Descriptions of the various Mechanical Appliances used in the Manufacture of Wood, Metal, and other Substances. 12mo.

\$1.75

**LUKIN.—The Boy Engineers:**

What They Did, and How They Did It. With 30 plates. 18mo.

\$1.75

**LUKIN.—The Young Mechanic:**

Practical Carpentry. Containing Directions for the Use of all kinds of Tools, and for Construction of Steam-Engines and Mechanical Models, including the Art of Turning in Wood and Metal. By JOHN LUKIN, Author of "The Lathe and Its Uses," etc. Illustrated. 12mo.

\$1.75

**MAIN and BROWN.—Questions on Subjects Connected with the Marine Steam-Engine:**

And Examination Papers; with Hints for their Solution. By THOMAS J. MAIN, Professor of Mathematics, Royal Naval College, and THOMAS BROWN, Chief Engineer, R. N. 12mo., cloth.

\$1.50

**MAIN and BROWN.—The Indicator and Dynamometer:**

With their Practical Applications to the Steam-Engine. By THOMAS J. MAIN, M. A. F. R., Ass't S. Professor Royal Naval College, Portsmouth, and THOMAS BROWN, Assoc. Inst. C. E., Chief Engineer R. N., attached to the R. N. College. Illustrated. 8vo.

\$1.50

**MAIN and BROWN.—The Marine Steam-Engine.**

By THOMAS J. MAIN, F. R. Ass't S. Mathematical Professor at the Royal Naval College, Portsmouth, and THOMAS BROWN, Assoc. Inst. C. E., Chief Engineer R. N. Attached to the Royal Naval College. With numerous illustrations. 8vo.

\$5.00

**MAKINS.—A Manual of Metallurgy:**

By GEORGE HOGARTH MAKINS. 100 engravings. Second edition rewritten and much enlarged. 12mo., 592 pages.

\$3.00

**MARTIN.—Screw-Cutting Tables, for the Use of Mechanical Engineers:**

Showing the Proper Arrangement of Wheels for Cutting the Threads of Screws of any Required Pitch; with a Table for Making the Universal Gas-Pipe Thread and Taps. By W. A. MARTIN, Engineer. 8vo.

50

**MICHELL.—Mine Drainage:**

Being a Complete and Practical Treatise on Direct-Acting Underground Steam Pumping Machinery. With a Description of a large number of the best known Engines, their General Utility and the Special Sphere of their Action, the Mode of their Application, and their Merits compared with other Pumping Machinery. By STEPHEN MICHELL. Illustrated by 137 engravings. 8vo., 277 pages.

\$6.00

**MOLESWORTH.—Pocket-Book of Useful Formulæ and Memoranda for Civil and Mechanical Engineers.**

By GUILFORD L. MOLESWORTH, Member of the Institution of Civil Engineers, Chief Resident Engineer of the Ceylon Railway. Full-bound in Pocket-book form.

\$1.00



**MOORE.—The Universal Assistant and the Complete Mechanic:**

Containing over one million Industrial Facts, Calculations, Receipts, Processes, Trades Secrets, Rules, Business Forms, Legal Items, Etc., in every occupation, from the Household to the Manufactory. By R. MOORE. Illustrated by 500 Engravings. 12mo. . . . \$2.50

**MORRIS.—Easy Rules for the Measurement of Earthworks:**

By means of the Prismoidal Formula. Illustrated with Numerous Wood-Cuts, Problems, and Examples, and concluded by an Extensive Table for finding the Solidity in cubic yards from Mean Areas. The whole being adapted for convenient use by Engineers, Surveyors, Contractors, and others needing Correct Measurements of Earthwork. By ELWOOD MORRIS, C. E. 8vo. . . . \$1.50

**MORTON.—The System of Calculating Diameter, Circumference, Area, and Squaring the Circle:**

Together with Interest and Miscellaneous Tables, and other information. By JAMES MORTON. Second Edition, enlarged, with the Metric System. 12mo. . . . 50

**NAPIER.—Manual of Electro-Metallurgy:**

Including the Application of the Art to Manufacturing Processes. By JAMES NAPIER. Fourth American, from the Fourth London edition, revised and enlarged. Illustrated by engravings. 8vo.

**NAPIER.—A System of Chemistry Applied to Dyeing.**

By JAMES NAPIER, F. C. S. A New and Thoroughly Revised Edition. Completely brought up to the present state of the Science, including the Chemistry of Coal Tar Colors, by A. A. FESQUET, Chemist and Engineer. With an Appendix on Dyeing and Calico Printing, as shown at the Universal Exposition, Paris, 1867. Illustrated. 8vo. 422 pages . . . . \$3.50

**NEVILLE.—Hydraulic Tables, Coefficients, and Formulæ, for finding the Discharge of Water from Orifices, Notches, Weirs, Pipes, and Rivers:**

Third Edition, with Additions, consisting of New Formulæ for the Discharge from Tidal and Flood Sluices and Siphons; general information on Rainfall, Catchment-Basins, Drainage, Sewerage, Water Supply for Towns and Mill Power. By JOHN NEVILLE, C. E. M. R. I. A.; Fellow of the Royal Geological Society of Ireland. Thick 12mo. . . . \$5.50

**NEWBERY.—Gleanings from Ornamental Art of every style:**

Drawn from Examples in the British, South Kensington, Indian, Crystal Palace, and other Museums, the Exhibitions of 1851 and 1862, and the best English and Foreign works. In a series of 100 exquisitely drawn Plates, containing many hundred examples. By ROBERT NEWBERY. 4to. . . . \$12.50

**NICHOLLS.—The Theoretical and Practical Boiler-Maker and Engineer's Reference Book:**

Containing a variety of Useful Information for Employers of Labor, Foremen and Working Boiler-Makers, Iron, Copper, and Tinsmiths

- Draughtsmen, Engineers, the General Steam-using Public, and for the Use of Science Schools and Classes. By SAMUEL NICHOLLS. Illustrated by sixteen plates, 12mo. \$2.50
- NICHOLSON.—A Manual of the Art of Bookbinding:**  
Containing full instructions in the different Branches of Forwarding, Gilding, and Finishing. Also, the Art of Marbling Book-edges and Paper. By JAMES B. NICHOLSON. Illustrated. 12mo., cloth \$2.25
- NICOLLS.—The Railway Builder:**  
A Hand-Book for Estimating the Probable Cost of American Railway Construction and Equipment. By WILLIAM J. NICOLLS, Civil Engineer. Illustrated, full bound, pocket-book form \$2.00
- NORMANDY.—The Commercial Handbook of Chemical Analysis:**  
Or Practical Instructions for the Determination of the Intrinsic or Commercial Value of Substances used in Manufactures, in Trades, and in the Arts. By A. NORMANDY. New Edition, Enlarged, and to a great extent rewritten. By HENRY M. NOAD, Ph.D., F.R.S., thick 12mo. \$5.00
- NORRIS.—A Handbook for Locomotive Engineers and Machinists:**  
Comprising the Proportions and Calculations for Constructing Locomotives; Manner of Setting Valves; Tables of Squares, Cubes, Areas, etc., etc. By SEPTIMUS NORRIS, M. E. New edition. Illustrated, 12mo. \$1.50
- NYSTROM.—A New Treatise on Elements of Mechanics:**  
Establishing Strict Precision in the Meaning of Dynamical Terms, accompanied with an Appendix on Duodenal Arithmetic and Metrology. By JOHN W. NYSTROM, C. E. Illustrated. 8vo. \$2.00
- NYSTROM.—On Technological Education and the Construction of Ships and Screw Propellers:**  
For Naval and Marine Engineers. By JOHN W. NYSTROM, late Acting Chief Engineer, U. S. N. Second edition, revised, with additional matter. Illustrated by seven engravings. 12mo. \$1.50
- O'NEILL.—A Dictionary of Dyeing and Calico Printing:**  
Containing a brief account of all the Substances and Processes in use in the Art of Dyeing and Printing Textile Fabrics; with Practical Receipts and Scientific Information. By CHARLES O'NEILL, Analytical Chemist. To which is added an Essay on Coal Tar Colors and their application to Dyeing and Calico Printing. By A. A. FESQUET, Chemist and Engineer. With an appendix on Dyeing and Calico Printing, as shown at the Universal Exposition, Paris, 1867. 8vo., 491 pages \$3.50
- ORTON.—Underground Treasures:**  
How and Where to Find Them. A Key for the Ready Determination of all the Useful Minerals within the United States. By JAMES ORTON, A.M., Late Professor of Natural History in Vassar College, N. Y.; Cor. Mem. of the Academy of Natural Sciences, Philadelphia, and of the Lyceum of Natural History, New York; author of the "Andes and the Amazon," etc. A New Edition, with Additions. Illustrated \$1.50

- OSBORN.—The Prospector's Field Book and Guide:**  
In the Search for and the Easy Determination of Ores and Other Useful Minerals. By Prof. H. S. OSBORN, LL. D., Author of "The Metallurgy of Iron and Steel;" "A Practical Manual of Minerals, Mines, and Mining." Illustrated by 44 Engravings. 12mo. . . . . \$1.50
- OSBORN.—A Practical Manual of Minerals, Mines and Mining:**  
Comprising the Physical Properties, Geologic Positions, Local Occurrence and Associations of the Useful Minerals; their Methods of Chemical Analysis and Assay: together with Various Systems of Excavating and Timbering, Brick and Masonry Work, during Driving, Lining, Bracing and other Operations, etc. By Prof. H. S. OSBORN, LL. D., Author of the "Metallurgy of Iron and Steel." Illustrated by 171 engravings from original drawings. 8vo. \$4.50
- OVERMAN.—The Manufacture of Steel:**  
Containing the Practice and Principles of Working and Making Steel. A Handbook for Blacksmiths and Workers in Steel and Iron, Wagon Makers, Die Sinkers, Cutlers, and Manufacturers of Files and Hardware, of Steel and Iron, and for Men of Science and Art. By FREDERICK OVERMAN, Mining Engineer, Author of the "Manufacture of Iron," etc. A new, enlarged, and revised Edition. By A. A. FESQUET, Chemist and Engineer. 12mo. . . . . \$1.50
- OVERMAN.—The Moulder's and Founder's Pocket Guide:**  
A Treatise on Moulding and Founding in Green-sand, Dry-sand, Loam, and Cement; the Moulding of Machine Frames, Mill-gear, Hollow-ware, Ornaments, Trinkets, Bells, and Statues; Description of Moulds for Iron, Bronze, Brass, and other Metals; Plaster of Paris, Sulphur, Wax, etc.; the Construction of Melting Furnaces, the Melting and Founding of Metals; the Composition of Alloys and their Nature, etc., etc. By FREDERICK OVERMAN, M. E. A new Edition, to which is added a Supplement on Statuary and Ornamental Moulding, Ordnance, Malleable Iron Castings, etc. By A. A. FESQUET, Chemist and Engineer. Illustrated by 44 engravings. 12mo. . . . . \$2.00
- PAINTER, GILDER, AND VARNISHER'S COMPANION:**<sup>1</sup>  
Containing Rules and Regulations in everything relating to the Art of Painting, Gilding, Varnishing, Glass-Staining, Graining, Marbling, Sign-Writing, Gilding on Glass, and Coach Painting and Varnishing; Tests for the Detection of Adulterations in Oils, Colors, etc.; and a Statement of the Diseases to which Painters are peculiarly liable, with the Simplest and Best Remedies. Sixteenth Edition. Revised, with an Appendix. Containing Colors and Coloring—Theoretical and Practical. Comprising descriptions of a great variety of Additional Pigments, their Qualities and Uses, to which are added, Dryers, and Modes and Operations of Painting, etc. Together with Chevreul's Principles of Harmony and Contrast of Colors. 12mo. Cloth \$1.50
- PALLETT.—The Miller's, Millwright's, and Engineer's Guide.**  
By HENRY PALLETT. Illustrated. 12mo. . . . . \$2.00

**PERCY.—The Manufacture of Russian Sheet-Iron.**

By JOHN PERCY, M. D., F. R. S., Lecturer on Metallurgy at the Royal School of Mines, and to The Advance Class of Artillery Officers at the Royal Artillery Institution, Woolwich; Author of "Metallurgy." With Illustrations. 8vo., paper . . . 50 cts.

**PERKINS.—Gas and Ventilation :**

Practical Treatise on Gas and Ventilation. With Special Relation to Illuminating, Heating, and Cooking by Gas. Including Scientific Helps to Engineer-students and others. With Illustrated Diagrams. By E. E. PERKINS. 12mo., cloth . . . \$1.25

**PERKINS AND STOWE.—A New Guide to the Sheet-iron and Boiler Plate Roller :**

Containing a Series of Tables showing the Weight of Slabs and Piles to Produce Boiler Plates, and of the Weight of Piles and the Sizes of Bars to produce Sheet-iron; the Thickness of the Bar Gauge in decimals; the Weight per foot, and the Thickness on the Bar or Wire Gauge of the fractional parts of an inch; the Weight per sheet, and the Thickness on the Wire Gauge of Sheet-iron of various dimensions to weigh 112 lbs. per bundle; and the conversion of Short Weight into Long Weight, and Long Weight into Short. Estimated and collected by G. H. PERKINS and J. G. STOWE. \$2.50

**POWELL-CHANCE-HARRIS.—The Principles of Glass Making.**

By HARRY J. POWELL, B. A. Together with Treatises on Crown and Sheet Glass; by HENRY CHANCE, M. A. And Plate Glass, by H. G. HARRIS, Asso. M. Inst. C. E. Illustrated 18mo. . . \$1.50

**PROCTOR.—A Pocket-Book of Useful Tables and Formulæ for Marine Engineers :**

By FRANK PROCTOR. Second Edition, Revised and Enlarged. Full-bound pocket-book form . . . \$1.50

**REGNAULT.—Elements of Chemistry :**

By M. V. REGNAULT. Translated from the French by T. FORREST BETTON, M. D., and edited, with Notes, by JAMES C. BOOTH, Melter and Refiner U. S. Mint, and WILLIAM L. FABER, Metallurgist and Mining Engineer. Illustrated by nearly 700 wood-engravings. Comprising nearly 1,500 pages. In two volumes, 8vo., cloth . . . \$7.50

**RICHARDS.—Aluminium :**

Its History, Occurrence, Properties, Metallurgy and Applications, including its Alloys. By JOSEPH W. RICHARDS, A. C., Chemist and Practical Metallurgist, Member of the Deutsche Chemische Gesellschaft. Illustrated . . . \$5.00

**RIFFAULT, VERGNAUD, and TOUSSAINT.—A Practical Treatise on the Manufacture of Colors for Painting :**

Comprising the Origin, Definition, and Classification of Colors; the Treatment of the Raw Materials; the best Formulæ and the Newest Processes for the Preparation of every description of Pigment, and the Necessary Apparatus and Directions for its Use; Dryers; the Testing, Application, and Qualities of Paints, etc., etc. By MM. RIFFAULT, VERGNAUD, and TOUSSAINT. Revised and Edited by M.

- F. MALÉPEYRE.** Translated from the French, by A. A. FESQUET, Chemist and Engineer. Illustrated by Eighty engravings. In one vol., 8vo., 659 pages . . . . . \$7.50
- ROPER.—A Catechism of High-Pressure, or Non-Condensing Steam-Engines :**  
Including the Modelling, Constructing, and Management of Steam-Engines and Steam Boilers. With valuable illustrations. By STEPHEN ROPER, Engineer. Sixteenth edition, revised and enlarged. 18mo., tucks, gilt edge . . . . . \$2.00
- ROPER.—Engineer's Handy-Book :**  
Containing a full Explanation of the Steam-Engine Indicator, and its Use and Advantages to Engineers and Steam Users. With Formulas for Estimating the Power of all Classes of Steam-Engines; also, Facts, Figures, Questions, and Tables for Engineers who wish to qualify themselves for the United States Navy, the Revenue Service, the Mercantile Marine, or to take charge of the Better Class of Stationary Steam-Engines. Sixth edition. 16mo., 690 pages, tucks, gilt edge . . . . . \$3.50
- ROPER.—Hand-Book of Land and Marine Engines :**  
Including the Modelling, Construction, Running, and Management of Land and Marine Engines and Boilers. With illustrations. By STEPHEN ROPER, Engineer. Sixth edition. 12mo., tucks, gilt edge. \$3.50
- ROPER.—Hand-Book of the Locomotive :**  
Including the Construction of Engines and Boilers, and the Construction, Management, and Running of Locomotives. By STEPHEN ROPER. Eleventh edition. 18mo., tucks, gilt edge . . . . . \$2.50
- ROPER.—Hand-Book of Modern Steam Fire-Engines.**  
With illustrations. By STEPHEN ROPER, Engineer. Fourth edition, 12mo., tucks, gilt edge . . . . . \$3.50
- ROPER.—Questions and Answers for Engineers.**  
This little book contains all the Questions that Engineers will be asked when undergoing an Examination for the purpose of procuring Licenses, and they are so plain that any Engineer or Fireman of ordinary intelligence may commit them to memory in a short time. By STEPHEN ROPER, Engineer. Third edition . . . . . \$3.00
- ROPER.—Use and Abuse of the Steam Boiler.**  
By STEPHEN ROPER, Engineer. Eighth edition, with illustrations. 18mo., tucks, gilt edge . . . . . \$2.00
- ROSE.—The Complete Practical Machinist :**  
Embracing Lathe Work, Vise Work, Drills and Drilling, Taps and Dies, Hardening and Tempering, the Making and Use of Tools, Tool Grinding, Marking out Work, etc. By JOSHUA ROSE. Illustrated by 356 engravings. Thirteenth edition, thoroughly revised and in great part rewritten. In one vol., 12mo., 439 pages \$2.50
- ROSE.—Mechanical Drawing Self-Taught :**  
Comprising Instructions in the Selection and Preparation of Drawing Instruments, Elementary Instruction in Practical Mechanical Draw-

- ing, together with Examples in Simple Geometry and Elementary Mechanism, including Screw Threads, Gear Wheels, Mechanical Motions, Engines and Boilers. By JOSHUA ROSE, M. E. Illustrated by 330 engravings. 8vo., 313 pages . . . \$4.00
- ROSE.—The Slide-Valve Practically Explained:**  
Embracing simple and complete Practical Demonstrations of the operation of each element in a Slide-valve Movement, and illustrating the effects of Variations in their Proportions by examples carefully selected from the most recent and successful practice. By JOSHUA ROSE, M. E. Illustrated by 35 engravings . . . \$1.00
- ROSS.—The Blowpipe in Chemistry, Mineralogy and Geology:**  
Containing all Known Methods of Anhydrous Analysis, many Working Examples, and Instructions for Making Apparatus. By LIEUT.-COLONEL W. A. ROSS, R. A., F. G. S. With 120 Illustrations. 12mo. . . . . \$2.00
- SHAW.—Civil Architecture:**  
Being a Complete Theoretical and Practical System of Building, containing the Fundamental Principles of the Art. By EDWARD SHAW, Architect. To which is added a Treatise on Gothic Architecture, etc. By THOMAS W. SILLOWAY and GEORGE M. HARDING, Architects. The whole illustrated by 102 quarto plates finely engraved on copper. Eleventh edition. 4to. . . . . \$10.00
- SHUNK.—A Practical Treatise on Railway Curves and Location, for Young Engineers.**  
By W. F. SHUNK, C. E. 12mo. Full bound pocket-book form \$2.00
- SLATER.—The Manual of Colors and Dye Wares.**  
By J. W. SLATER. 12mo. . . . . \$3.00
- SLOAN.—American Houses:**  
A variety of Original Designs for Rural Buildings. Illustrated by 26 colored engravings, with descriptive references. By SAMUEL SLOAN, Architect. 8vo. . . . . \$1.50
- SLOAN.—Homestead Architecture:**  
Containing Forty Designs for Villas, Cottages, and Farm-houses, with Essays on Style, Construction, Landscape Gardening, Furniture, etc., etc. Illustrated by upwards of 200 engravings. By SAMUEL SLOAN, Architect. 8vo. . . . . \$3.50
- SLOANE.—Home Experiments in Science.**  
By T. O'CONNOR SLOANE, E. M., A. M., F. R. S. Illustrated by 91 engravings. 12mo. . . . . \$1.50
- SMEATON.—Builder's Pocket-Companion:**  
Containing the Elements of Building, Surveying, and Architecture; with Practical Rules and Instructions connected with the subject. By A. C. SMEATON, Civil Engineer, etc. 12mo. . . . \$1.50
- SMITH.—A Manual of Political Economy.**  
By E. PESHINE SMITH. A New Edition, to which is added a full Index. 12mo. . . . . \$1 25

**SMITH.—Parks and Pleasure-Grounds:**

Or Practical Notes on Country Residences, Villas, Public Parks, and Gardens. By CHARLES H. J. SMITH, Landscape Gardener and Garden Architect, etc., etc. 12mo. . . . . \$2.00

**SMITH.—The Dyer's Instructor:**

Comprising Practical Instructions in the Art of Dyeing Silk, Cotton, Wool, and Worsted, and Woolen Goods; containing nearly 800 Receipts. To which is added a Treatise on the Art of Padding; and the Printing of Silk Warps, Skeins, and Handkerchiefs, and the various Mordants and Colors for the different styles of such work. By DAVID SMITH, Pattern Dyer. 12mo. . . . . \$2.00

**SMYTH.—A Rudimentary Treatise on Coal and Coal-Mining.**

By WARRINGTON W. SMYTH, M. A., F. R. G., President R. G. S. of Cornwall. Fifth edition, revised and corrected. With numerous illustrations. 12mo. . . . . \$1.75

**SNIVELY.—Tables for Systematic Qualitative Chemical Analysis.**

By JOHN H. SNIVELY, Phr. D. 8vo. . . . . \$1.00

**SNIVELY.—The Elements of Systematic Qualitative Chemical Analysis:**

A Hand-book for Beginners. By JOHN H. SNIVELY, Phr. D. 16mo. . . . . \$2.00

**STOKES.—The Cabinet-Maker and Upholsterer's Companion:**

Comprising the Art of Drawing, as applicable to Cabinet Work; Veneering, Inlaying, and Buhl-Work; the Art of Dyeing and Staining Wood, Ivory, Bone, Tortoise-Shell, etc. Directions for Lacking, Japanning, and Varnishing; to make French Polish, Glues, Cements, and Compositions; with numerous Receipts, useful to work men generally. By STOKES. Illustrated. A New Edition, with an Appendix upon French Polishing, Staining, Imitating, Varnishing, etc., etc. 12mo . . . . . \$1.25

**STRENGTH AND OTHER PROPERTIES OF METALS:**

Reports of Experiments on the Strength and other Properties of Metals for Cannon. With a Description of the Machines for Testing Metals, and of the Classification of Cannon in service. By Officers of the Ordnance Department, U. S. Army. By authority of the Secretary of War. Illustrated by 25 large steel plates. Quarto . . . \$10.00

**SULLIVAN.—Protection to Native Industry.**

By Sir EDWARD SULLIVAN, Baronet, author of "Ten Chapters on Social Reforms." 8vo. . . . . \$1.50

**SULZ.—A Treatise on Beverages:**

Or the Complete Practical Bottler. Full instructions for Laboratory Work, with Original Practical Recipes for all kinds of Carbonated Drinks, Mineral Waters, Flavorings, Extracts, Syrups, etc. By CHAS. HERMAN SULZ, Technical Chemist and Practical Bottler. Illustrated by 428 Engravings. 818 pp. 8vo. . . . . \$10.00

- SYME.—Outlines of an Industrial Science.**  
 By DAVID SYME. 12mo. . . . . \$2.00
- TABLES SHOWING THE WEIGHT OF ROUND, SQUARE, AND FLAT BAR IRON, STEEL, ETC.,**  
 By Measurement. Cloth . . . . . 63
- TAYLOR.—Statistics of Coal:**  
 Including Mineral Bituminous Substances employed in Arts and Manufactures; with their Geographical, Geological, and Commercial Distribution and Amount of Production and Consumption on the American Continent. With Incidental Statistics of the Iron Manufacture. By R. C. TAYLOR. Second edition, revised by S. S. HALDEMAN. Illustrated by five Maps and many wood engravings. 8vo., cloth . . . . . \$10.00
- TEMPLETON.—The Practical Examiner on Steam and the Steam-Engine:**  
 With Instructive References relative thereto, arranged for the Use of Engineers, Students, and others. By WILLIAM TEMPLETON, Engineer. 12mo. . . . . \$1.25
- THAUSING.—The Theory and Practice of the Preparation of Malt and the Fabrication of Beer:**  
 With especial reference to the Vienna Process of Brewing. Elaborated from personal experience by JULIUS E. THAUSING, Professor at the School for Brewers, and at the Agricultural Institute, Mödling, near Vienna. Translated from the German by WILLIAM T. BRANNIT, Thoroughly and elaborately edited, with much American matter, and according to the latest and most Scientific Practice, by A. SCHWARZ and DR. A. H. BAUER. Illustrated by 140 Engravings. 8vo., 815 pages . . . . . \$10.00
- THOMAS.—The Modern Practice of Photography:**  
 By R. W. THOMAS, F. C. S. 8vo. . . . . 75
- THOMPSON.—Political Economy. With Especial Reference to the Industrial History of Nations:**  
 By ROBERT E. THOMPSON, M. A., Professor of Social Science in the University of Pennsylvania. 12mo. . . . . \$1.50
- THOMSON.—Freight Charges Calculator:**  
 By ANDREW THOMSON, Freight Agent. 4mo. . . . . \$1.25
- TURNER'S (THE) COMPANION:**  
 Containing Instructions in Concentric, Elliptic, and Eccentric Turning; also various Plates of Chucks, Tools, and Instruments; and Directions for using the Eccentric Cutter, Drill, Vertical Cutter, and Circular Rest; with Patterns and Instructions for working them. 12mo. . . . . \$1.25
- TURNING: Specimens of Fancy Turning Executed on the Hand or Foot-Lathe:**  
 With Geometric, Oval, and Eccentric Chucks, and Elliptical Cutting Frame. By an Amateur. Illustrated by 30 exquisite Photographs. 4to. . . . . \$3.00



- VAILE.—Galvanized-Iron Cornice-Worker's Manual:**  
Containing Instructions in Laying out the Different Mitres, and Making Patterns for all kinds of Plain and Circular Work. Also, Tables of Weights, Areas and Circumferences of Circles, and other Matter calculated to Benefit the Trade. By CHARLES A. VAILE. Illustrated by twenty-one plates. 4to. . . . . \$5.00
- VILLE.—On Artificial Manures:**  
Their Chemical Selection and Scientific Application to Agriculture. A series of Lectures given at the Experimental Farm at Vincennes, during 1867 and 1874-75. By M. GEORGES VILLE. Translated and Edited by WILLIAM CROOKES, F. R. S. Illustrated by thirty-one engravings. 8vo., 450 pages . . . . . \$6.00
- VILLE.—The School of Chemical Manures:**  
Or, Elementary Principles in the Use of Fertilizing Agents. From the French of M. GEO. VILLE, by A. A. FESQUET, Chemist and Engineer. With Illustrations. 12mo. . . . . \$1.25
- VOGDES.—The Architect's and Builder's Pocket-Companion and Price-Book:**  
Consisting of a Short but Comprehensive Epitome of Decimals, Duodecimals, Geometry and Mensuration; with Tables of United States Measures, Sizes, Weights, Strengths, etc., of Iron, Wood, Stone, Brick, Cement and Concretes, Quantities of Materials in given Sizes and Dimensions of Wood, Brick and Stone; and full and complete Bills of Prices for Carpenter's Work and Painting; also, Rules for Computing and Valuing Brick and Brick Work, Stone Work, Painting, Plastering, with a Vocabulary of Technical Terms, etc. By FRANK W. VOGDES, Architect, Indianapolis, Ind. Enlarged, revised, and corrected. In one volume, 368 pages, full-bound, pocket-book form, gilt edges . . . . . \$2.00  
Cloth . . . . . 1.50
- VAN CLEVE.—The English and American Mechanic:**  
Comprising a Collection of Over Three Thousand Receipts, Rules, and Tables, designed for the Use of every Mechanic and Manufacturer. By B. FRANK VAN CLEVE. Illustrated. 500 pp. 12mo. \$2.00
- WAHNSCHAFFE.—A Guide to the Scientific Examination of Soils:**  
Comprising Select Methods of Mechanical and Chemical Analysis and Physical Investigation. Translated from the German of Dr. F. WAHNSCHAFFE. With additions by WILLIAM T. BRANNT. Illustrated by 25 engravings. 12mo. 177 pages . . . . . \$1.50
- WALL.—Practical Graining:**  
With Descriptions of Colors Employed and Tools Used. Illustrated by 47 Colored Plates, Representing the Various Woods Used in Interior Finishing. By WILLIAM E. WALL. 8vo. . . . . \$2.50
- WALTON.—Coal-Mining Described and Illustrated:**  
By THOMAS H. WALTON, Mining Engineer. Illustrated by 24 large and elaborate Plates, after Actual Workings and Apparatus. \$5.00

**WARE.—The Sugar Beet.**

Including a History of the Beet Sugar Industry in Europe, Varieties of the Sugar Beet, Examination, Soils, Tillage, Seeds and Sowing, Yield and Cost of Cultivation, Harvesting, Transportation, Conservation, Feeding Qualities of the Beet and of the Pulp, etc. By LEWIS S. WARE, C. E., M. E. Illustrated by ninety engravings. 8vo.

\$4.00

**WARN.—The Sheet-Metal Worker's Instructor:**

For Zinc, Sheet-Iron, Copper, and Tin-Plate Workers, etc. Containing a selection of Geometrical Problems; also, Practical and Simple Rules for Describing the various Patterns required in the different branches of the above Trades. By REUBEN H. WARN, Practical Tin-Plate Worker. To which is added an Appendix, containing Instructions for Boiler-Making, Mensuration of Surfaces and Solids, Rules for Calculating the Weights of different Figures of Iron and Steel, Tables of the Weights of Iron, Steel, etc. Illustrated by thirty-two Plates and thirty-seven Wood Engravings. 8vo.

\$3.00

**WARNER.—New Theorems, Tables, and Diagrams, for the Computation of Earth-work:**

Designed for the use of Engineers in Preliminary and Final Estimates, of Students in Engineering, and of Contractors and other non-professional Computers. In two parts, with an Appendix. Part I. A Practical Treatise; Part II. A Theoretical Treatise, and the Appendix. Containing Notes to the Rules and Examples of Part I.; Explanations of the Construction of Scales, Tables, and Diagrams, and a Treatise upon Equivalent Square Bases and Equivalent Level Heights. The whole illustrated by numerous original engravings, comprising explanatory cuts for Definitions and Problems, Stereometric Scales and Diagrams, and a series of Lithographic Drawings from Models: Showing all the Combinations of Solid Forms which occur in Railroad Excavations and Embankments. By JOHN WARNER, A. M., Mining and Mechanical Engineer. Illustrated by 14 Plates. A new, revised and improved edition. 8vo.

\$4.00

**WATSON.—A Manual of the Hand-Lathe:**

Comprising Concise Directions for Working Metals of all kinds, Ivory, Bone and Precious Woods; Dyeing, Coloring, and French Polishing; Inlaying by Veneers, and various methods practised to produce Elaborate work with Dispatch, and at Small Expense. By EGBERT P. WATSON, Author of "The Modern Practice of American Machinists and Engineers." Illustrated by 78 engravings.

\$1.50

**WATSON.—The Modern Practice of American Machinists and Engineers:**

Including the Construction, Application, and Use of Drills, Lathe Tools, Cutters for Boring Cylinders, and Hollow-work generally, with the most Economical Speed for the same; the Results verified by Actual Practice at the Lathe, the Vise, and on the Floor. Together

- with Workshop Management, Economy of Manufacture, the Steam-Engine, Boilers, Gears, Belting, etc., etc. By **EGBERT P. WATSON**. Illustrated by eighty-six engravings. 12mo. . . . . \$2.50
- WATSON**.—The Theory and Practice of the Art of Weaving by Hand and Power.  
With Calculations and Tables for the Use of those connected with the Trade. By **JOHN WATSON**, Manufacturer and Practical Machine-Maker. Illustrated by large Drawings of the best Power Looms. 8vo. . . . . \$6.00
- WATT**.—The Art of Soap Making:  
A Practical Hand-book of the Manufacture of Hard and Soft Soaps, Toilet Soaps, etc., including many New Processes, and a Chapter on the Recovery of Glycerine from Waste Leys. By **ALEXANDER WATT**. Ill. 12mo. . . . . \$3.00
- WEATHERLY**.—Treatise on the Art of Boiling Sugar, Crystallizing, Lozenge-making, Comfits, Gum Goods,  
And other processes for Confectionery, etc., in which are explained, in an easy and familiar manner, the various Methods of Manufacturing every Description of Raw and Refined Sugar Goods, as sold by Confectioners and others. 12mo. . . . . \$1.50
- WIGHTWICK**.—Hints to Young Architects:  
Comprising Advice to those who, while yet at school, are destined to the Profession; to such as, having passed their pupilage, are about to travel; and to those who, having completed their education, are about to practise. Together with a Model Specification involving a great variety of instructive and suggestive matter. By **GEORGE WIGHTWICK**, Architect. A new edition, revised and considerably enlarged; comprising Treatises on the Principles of Construction and Design. By **G. HUSKISSON GUILLAUME**, Architect. Numerous illustrations. One vol. 12mo. . . . . \$2.00
- WILL**.—Tables of Qualitative Chemical Analysis.  
With an Introductory Chapter on the Course of Analysis. By Professor **HEINRICH WILL**, of Giessen, Germany. Third American, from the eleventh German edition. Edited by **CHARLES F. HIMES**, Ph. D., Professor of Natural Science, Dickinson College, Carlisle, Pa. 8vo. . . . . \$1.50
- WILLIAMS**.—On Heat and Steam:  
Embracing New Views of Vaporization, Condensation, and Explosion. By **CHARLES WYE WILLIAMS**, A. I. C. E. Illustrated 8vo. . . . . \$3.50
- WILSON**.—A Treatise on Steam Boilers:  
Their Strength, Construction, and Economical Working. By **ROBERT WILSON**. Illustrated 12mo. . . . . \$2.50
- WILSON**.—First Principles of Political Economy:  
With Reference to Statesmanship and the Progress of Civilization. By Professor **W. D. WILSON**, of the Cornell University. A new and revised edition. 12mo. . . . . \$1.50

**WOHLER.—A Hand-Book of Mineral Analysis :**

By F. WÖHLER, Professor of Chemistry in the University of Göttingen. Edited by HENRY B. NASON, Professor of Chemistry in the Rensselaer Polytechnic Institute, Troy, New York. Illustrated. 12mo. . . . . \$3.00

**WORSSAM.—On Mechanical Saws :**

From the Transactions of the Society of Engineers, 1869. By S. W. WORSSAM, JR. Illustrated by eighteen large plates. 8vo. \$2.50

RECENT ADDITIONS.

**ANDERSON.—The Prospector's Hand-Book :**

A Guide for the Prospector and Traveler in Search of Metal Bearing or other Valuable Minerals. By J. W. ANDERSON. 52 Illustrations. 12mo. . . . . \$1.50

**BEAUMONT.—Woollen and Worsted Cloth Manufacture :**

Being a Practical Treatise for the use of all persons employed in the manipulation of Textile Fabrics. By ROBERT BEAUMONT, M. S. A. With over 200 illustrations, including Sketches of Machinery, Designs, Cloths, etc. 391 pp. 12mo. . . . . \$2.00

**BRANNT.—The Metallic Alloys :**

A Practical Guide for the Manufacture of all kinds of Alloys, Amalgams and Solders used by Metal Workers, especially by Bell Founders, Bronze Workers, Tinsmiths, Gold and Silver Workers, Dentists, etc., etc., as well as their Chemical and Physical Properties. Edited chiefly from the German of A. Krupp and Andreas Wildberger, with additions by WM. T. BRANNT. Illustrated. 12mo. \$3.00

**BRANNT.—A Practical Treatise on the Manufacture of Vinegar and Acetates, Cider, and Fruit-Wines :**

Preservation of Fruits and Vegetables by Canning and Evaporation; Preparation of Fruit-Butters, Jellies, Marmalades, Catchups, Pickles, Mustards, etc. Edited from various sources. By WILLIAM T. BRANNT. Illustrated by 79 Engravings. 479 pp. 8vo. \$5.00

**BRANNT.—The Metal Worker's Handy-Book of Receipts and Processes :**

Being a Collection of Chemical Formulas and Practical Manipulations for the working of all Metals; including the Decoration and Beautifying of Articles Manufactured therefrom, as well as their Preservation. Edited from various sources. By WILLIAM T. BRANNT. Illustrated. 12mo. \$2.50

**DEITE.—A Practical Treatise on the Manufacture of Perfumery:**

Comprising directions for making all kinds of Perfumes, Sachet Powders, Fumigating Materials, Dentifrices, Cosmetics, etc., with a full account of the Volatile Oils, Balsams, Resins, and other Natural and Artificial Perfume-substances, including the Manufacture of Fruit Ethers, and tests of their purity. By Dr. C. DEITE, assisted by L. BORCHERT, F. EICHBAUM, E. KUGLER, H. TOEFFNER, and other experts, From the German, by Wm. T. BRANNT. 28 Engravings. 358 pages. 8vo. . . . . \$3.00

**EDWARDS.—American Marine Engineer, Theoretical and Practical:**

With Examples of the latest and most approved American Practice. By EMORY EDWARDS. 85 illustrations. 12mo. . . . . \$2.50

**EDWARDS.—600 Examination Questions and Answers:**

For Engineers and Firemen (Land and Marine) who desire to obtain a United States Government or State License. Pocket-book form, gilt edge . . . . . \$1.50

**POSSELT.—Technology of Textile Design:**

Being a Practical Treatise on the Construction and Application of Weaves for all Textile Fabrics, with minute reference to the latest Inventions for Weaving. Containing also an Appendix, showing the Analysis and giving the Calculations necessary for the Manufacture of the various Textile Fabrics. By E. A. POSSELT, Head Master Textile Department, Pennsylvania Museum and School of Industrial Art, Philadelphia, with over 1000 illustrations. 292 pages. 4to. . . . . \$5.00

**POSSELT.—The Jacquard Machine Analysed and Explained:**

With an Appendix on the Preparation of Jacquard Cards, and Practical Hints to Learners of Jacquard Designing. By E. A. POSSELT. With 230 illustrations and numerous diagrams. 127 pp. 4to. . . . . \$3.00

**POSSELT.—The Structure of Fibres, Yarns and Fabrics:**

Being a Practical Treatise for the Use of all Persons Employed in the Manufacture of Textile Fabrics, containing a Description of the Growth and Manipulation of Cotton, Wool, Worsted, Silk, Flax, Jute, Ramie, China Grass and Hemp, and Dealing with all Manufacturers' Calculations for Every Class of Material, also Giving Minute Details for the Structure of all kinds of Textile Fabrics, and an Appendix of Arithmetic, specially adapted for Textile Purposes. By E. A. POSSELT. Over 400 Illustrations. quarto. . . . . \$10.00

**RICH.—Artistic Horse-Shoeing:**

A Practical and Scientific Treatise, giving Improved Methods of Shoeing, with Special Directions for Shaping Shoes to Cure Different Diseases of the Foot, and for the Correction of Faulty Action in Trotters. By GEORGE E. RICH. 62 Illustrations. 153 pages. 12mo. . . . . \$1.00

**RICHARDSON.—Practical Blacksmithing :**

A Collection of Articles Contributed at Different Times by Skilled Workmen to the columns of "The Blacksmith and Wheelwright," and Covering nearly the Whole Range of Blacksmithing, from the Simplest Job of Work to some of the Most Complex Forgings. Compiled and Edited by M. T. RICHARDSON.

|           |                    |            |       |   |   |        |
|-----------|--------------------|------------|-------|---|---|--------|
| Vol. I.   | 210 Illustrations. | 224 pages. | 12mo. | . | . | \$1.00 |
| Vol. II.  | 230 Illustrations. | 262 pages. | 12mo. | . | . | \$1.00 |
| Vol. III. | 390 Illustrations. | 307 pages. | 12mo. | . | . | \$1.00 |
| Vol. IV.  | 226 Illustrations. | 276 pages. | 12mo. | . | . | \$1.00 |

**RICHARDSON.—The Practical Horseshoer :**

Being a Collection of Articles on Horseshoeing in all its Branches which have appeared from time to time in the columns of "The Blacksmith and Wheelwright," etc. Compiled and edited by M. T. RICHARDSON. 174 illustrations. . . . \$1.00

**ROPER.—Instructions and Suggestions for Engineers and Firemen :**

By STEPHEN ROPER, Engineer. 18mo. Morocco . . . \$2.00

**ROPER.—The Steam Boiler: Its Care and Management :**

By STEPHEN ROPER, Engineer. 12mo., tuck, gilt edges. \$2.00

**ROPER.—The Young Engineer's Own Book :**

Containing an Explanation of the Principle and Theories on which the Steam Engine as a Prime Mover is Based. By STEPHEN ROPER, Engineer. 160 illustrations, 363 pages. 18mo., tuck . . . \$3.00

**ROSE.—Modern Steam-Engines :**

An Elementary Treatise upon the Steam-Engine, written in Plain language; for Use in the Workshop as well as in the Drawing Office. Giving Full Explanations of the Construction of Modern Steam-Engines: Including Diagrams showing their Actual operation. Together with Complete but Simple Explanations of the operations of Various Kinds of Valves, Valve Motions, and Link Motions, etc., thereby Enabling the Ordinary Engineer to clearly Understand the Principles Involved in their Construction and Use, and to Plot out their Movements upon the Drawing Board. By JOSHUA ROSE, M. E. Illustrated by 422 engravings. 4to., 320 pages . . . \$6.00

**ROSE.—Steam Boilers:**

A Practical Treatise on Boiler Construction and Examination, for the Use of Practical Boiler Makers, Boiler Users, and Inspectors; and embracing in plain figures all the calculations necessary in Designing or Classifying Steam Boilers. By JOSHUA ROSE, M. E. Illustrated by 73 engravings. 250 pages. 8vo. . . . \$2.50

**SCHRIBER.—The Complete Carriage and Wagon Painter :**

A Concise Compendium of the Art of Painting Carriages, Wagons, and Sleighs, embracing Full Directions in all the Various Branches, including Lettering, Scrolling, Ornamenting, Striping, Varnishing, and Coloring, with numerous Recipes for Mixing Colors. 73 Illustrations. 177 pp. 12mo. . . . \$1.00









This book is DUE on the last date stamped below

JAN 19 1955

JUN 2 1961

REC'D LD-URL

MAY 27 1974

JUN 3 1974

REC'D LD-URL

LD  
URL

FEB 16 1977

FEB 16 1977



A 001 264 562 8



PLEASE DO NOT REMOVE  
THIS BOOK CARD



University Research Library

TJ 465 L575

CALL NUMBER

ISS

VOL

PT

COP

AUTHOR

1 2 3 4 5 6 7 8 9 10 11 12 13 14 15 16 17 18 19 20 21 22 23 24 25 26 27 28 29 30 31 32 33 34 35 36 37 38 39 40 41 42 43 44 45 46 47 48 49 50 51 52 53 54 55 56 57 58  
JUN 195993

ORNTA

